

ACERBID

2020

INDICE INDEX

P. 4 - 21 **OTTANO**

P. 22 - 61 **HELMETS**

P. 62 - 117 **GEAR**

P. 118 - 131 **GLOVES**

P. 132 - 155 **BOOTS**

P. 156 - 195 **PROTECTIONS**

P. 196 - 217 **BAGS**

P. 218 - 235 **CASUAL**

P. 236 - 269 **HANDGUARDS**

P. 270 - 277 **HEADLIGHTS**

P. 278 - 287 **SEATS**

P. 288 - 303 **FUEL TANKS**

P. 304 - 341 **ACERBIS PLASTICS**

P. 342 - 349 **MERCHANDISING**

P. 350 - 361 **OVERVIEW**



Maximus Vohland
#2
U.S.A.



OFF 'N' ROAD





OTTANO

- P.7** Jet Helmet
- P.8** Jacket Adventuring Ottano 2.0
- P.9** Jacket Ottano 2.0
- P.10** Vest Ottano 2.0
- P.11** Pants Adventuring Ottano 2.0
- P.12** Pants Ottano 2.0
- P.13** Pants Racing Ottano 2.0
- P.14** Gloves Ottano 2.0
- P.15** Sweater Ottano 2.0
- P.15** Waistpack
- P.15** Mechanic Suit Ottano 2.0
- P.16** Matches/Abbinamenti



OTTANO
ACERBIS

OTTANO is a line of clothing created and produced by ACERBIS. It's **Urban Offroad** and **Light Enduro**, in other words it's inspired by the offroad world, where **ACERBIS** comes from, with shapes, fit and characteristics studied for road/urban/outdoor uses

OFF 'N' ROAD

Jet Helmet

Jet Helmet in ABS with a very **compact** shell (in three sizes and six different measurements), weight 1000 gr. ± 50, **homologated** ECE/ONU 2205. Closure with strap and double ring, sun protection visor (available in three colours) included



light blue
code: 0022995.042.



grey
code: 0022995.070.



blue/green
code: 0022995.250.

sizes	code	sizes	code	sizes	code
XS	061	M	064	XL	068
S	062	L	066	XXL	069

Visor Replacements



0022213.030



0022213.040



0022213.090

Jacket Adventuring Ottano 2.0

Waterproof ¾ length jacket (15.000 mm water column, breathability of 15.000g/m2/24h) in stretch Cordura fabric, arm inserts in comfort fabric, **removable protection** (level 2) shoulder, elbow and back, central zip opening and side zips with dual pocket/ ventilation function. Five external pockets, one on the sleeve, one internal, two in the removable padded liner. Side adjustment via laces and rubberised buckles. Back with **“MOLLE”** design as used in the military arena.



blue
code:0022975.040.



blue/green
code: 0022975.255.

code: **0022975.**

sizes	code	sizes	code	sizes	code
S	062	L	066	XXL	069
M	064	XL	068		

Jacket Ottano 2.0

Short **waterproof** jacket (15.000 mm water column, breathability of 15.000g/m²/24h) in stretch Cordura fabric, arm inserts in comfort fabric, **removable protection** (level 2) shoulder, elbow and back, central zip opening and side zips with dual pocket/ventilation function. Four external pockets, one internal, two in the removable padded liner. Side adjustment via laces and rubberised buckles. Back with **"MOLLE"** design as used in the military arena.



blue/green
code:0022970.255.



urban green
code: 0022970.872.



code: **0022970.**

sizes	code	sizes	code	sizes	code
S	062	L	066	XXL	069
M	064	XL	068		

Vest Ottano 2.0

Two-part gilet: outer in mesh with removable nylon pockets, inner in quilted polyester with a thin layer of thermal fleece. The two parts of this gilet can also be worn **separately**. Like the jacket, this gilet has modular nylon straps at the back with the **"MOLLE"** system as used in the military arena



blue
code:0022974.040.

code: **0022974.**

sizes	code	sizes	code	sizes	code
S/M	063	XXL	069		
L/XL	067				

Pants Adventuring Ottano 2.0

New for 2018. Created in **Water-Repellent** Nylon Cordura 500D, with removable knee guards which can be adjusted in height with hook and loop fastener. Inner mesh lining. Inserts in stretch fabric on the back to increase **comfort** and allow fitting over Dualroad boots. Waterproof zip on front for ventilation. **"MOLLE"** design on left leg. Hook and loop fastener waist adjustment. Custom Ottano print on left leg



white
code:0022972.030.



blue
code: 0022972.040.

code: **0022972.**

sizes	code	sizes	code	sizes	code
S	062	L	066	XXL	069
M	064	XL	068		

Pants Ottano 2.0

Technical trousers that are easy to wear and offer a **casual look**. Made of stretch cotton with inserts in technical fabric. The removable **certified** knee guards are new for 2018. **Ventilation** is provided via a zip on the left leg. Lower part has a super-stretch insert to allow fitting over Dualroad boots.



blue
code:0022971.040.



urban green
code: 0022971.872.

code: **0022971.**

size	code	size	code	size	code
S	062	L	066	XXL	069
M	064	XL	068		

Pants Racing Ottano 2.0

Enduro technical trousers in nylon/Cordura with stretch **X-FLEX** inserts and two-way stretch fabric sections on the back of the legs. Kevlar Shoeller fabric reinforcement and vulcanised rubber inside the right knee, Kevlar on left knee.



white
code:0023125.030.

code: **0023125.**

sizes	code	sizes	code	sizes	code
S	062	L	066	XXL	069
M	064	XL	068		

Gloves Ottano 2.0

Summer gloves with mesh fabric construction on the back of the hand and shaped appliqué with good **grip** on the palm. **Perforated** fabric on the sides of the fingers for better ventilation. Cut short at the wrist with neoprene fastening and hook and loop fastener adjuster.



white/brown
code:0022973.236.



green/white
code: 0022973.371.

code: **0022973.**

sizes	code	sizes	code	sizes	code
S	062	L	066	XXL	069
M	064	XL	068		

Sweater Ottano 2.0

code: **0023124.**

sizes	code	sizes	code	sizes	code
S	062	L	066	XXL	069
M	064	XL	068		



blue
code:0023124.040.

Waistpack

code: **0022159.030**



Mechanic suit Ottano 2.0

code: **0023193.**

sizes	code	sizes	code	sizes	code
S	062	L	066	XXL	069
M	064	XL	068	3XL	070



Abbinamenti Matches

Find out the perfect match for your
OTTANO look

Trova l'abbinamento perfetto per il tuo
look **OTTANO**



JET HELMET OTTANO

blue/green
code: 0022995.250.



JACKET OTTANO 2.0

blue/green
code:0022970.255.



WAISTPACK OTTANO

white
code: 0022159.030.



GLOVES OTTANO 2.0

green/white
code: 0022973.371.



PANTS OTTANO RACING

white
code: 0023125.030.

Abbinamenti Matches

Find out the perfect match for your

OTTANO look



JET HELMET OTTANO

grey

code: 0022995.070.



JACKET OTTANO 2.0

urban green

code: 0022970.872.



PANTS OTTANO 2.0

blue

code: 0022971.040



GLOVES OTTANO 2.0

white/brown

code:0022973.236.

Abbinamenti Matches

Find out the perfect match for your
OTTANO look



JET HELMET OTTANO

light blue
code: 0022995.042.



JACKET ADVENTURING OTTANO 2.0

blue
code:0022975.040.



GLOVES OTTANO 2.0

white/brown
code:0022973.236.

PANTS ADVENTURING OTTANO 2.0

white
code:0022972.030.

Abbinamenti Matches

Find out the perfect match for your

OTTANO look



JET HELMET OTTANO

blue/green

code: 0022995.250.



JACKET ADVENTURING OTTANO 2.0

blue/green

code:0022975.255.



GLOVES OTTANO 2.0

green/white

code: 0022973.371.

PANTS ADVENTURING OTTANO 2.0

blue

code:0022972.040.

Abbinamenti Matches

Find out the perfect match for your
OTTANO look



JET HELMET OTTANO
blue/green
code: 0022995.250.



SWEATER OTTANO 2.0
blue
code:0023124.040.



VEST OTTANO 2.0
blue
code:0022974.040.



PANTS OTTANO 2.0
urban green
code: 0022971.872.



GLOVES OTTANO 2.0
white/brown
code:0022973.236.





HELMETS CASCHI

- P. 24** Steel Carbon
- P. 26** X-Racer VTR
- P. 30** X-Track VTR
- P. 32** Profile 4
- P. 36** Steel Junior
- P. 38** Reactive VTR
- P. 42** Flip FS-606
- P. 44** Derwel
- P. 46** Serel
- P. 48** Full Face X-Street
- P. 50** Full Face FS-807
- P. 52** Carlino Kid
- P. 54** Firstway
- P. 56** Jet Aria
- P. 60** Accessories



STEEL CARBON HELMET

MATERIALS:

- **Outer shell:** Carbon fibre.
- **ECE/ONU APPROVAL 22-05**
- Double outer shell, double inner shell
- WEIGHT 940g +- 50g in size "M".

DETAILS:

- A design ensuring great protection and helmet balance on the head as well with outstanding ergonomics
- Chin/nose area which provides complete protection of the nose from branches or debris.
- Adjustable aerodynamic visor
- Double ring strap closure.
- Shell compatible with Neck Brace

FRONT VENTILATION:

- Excellent central chin vent area,
- Air vent on the lower/lateral part of the helmet to facilitate the extraction of hot air / humidity from the helmet

REAR VENTILATION:

- Rear fin for increased air extraction
- Extensive lower and upper ventilation in the nape area

INTERIOR:

- Soft touch interior for effective humidity release
- Removable, hypo-allergenic and washable interior.
- Complete Comfort System cheek pads that cover the fastening strap, ensure optimum helmet fit and stability



0023424.010.

ORANGE



SIZES

XS	53-54 cm	code: .061	L	59-60 cm	code: .066
S	55-56 cm	code: .062	XL	61-62 cm	code: .068
M	57-58 cm	code: .064	XXL	63-64 cm	code: .069



0023424.110.
RED



0023424.040.
BLUE



0023424.030.
WHITE



0023424.020.
BLACK/SILVER



0023424.070.
GREY



X-RACER VTR HELMET

MATERIALS:

- **Outer shell:** fibreglass.
- **ECE/ONU APPROVAL 22-05**
- Double outer shell, double inner shell
- **WEIGHT** 1190g +- 50g in size "M".

DETAILS:

- Chin/nose area which provides complete protection of the nose from branches or debris.
- Adjustable aerodynamic visor
- Visor with removable appendix
- A design ensuring great protection and helmet balance on the head
- Double ring strap closure.
- Shell compatible with Neck Brace

FRONT VENTILATION:

- Excellent central chin vent area,
- Air vent on the lower/lateral part of the helmet to facilitate the extraction of hot air / humidity from the helmet

REAR VENTILATION:

- Rear fin for air extraction
- Extensive ventilation in the nape area

INTERIOR:

- Soft touch interior for effective humidity release
- Removable, hypo-allergenic and washable interior.
- Padding, complete with Comfort System cheek pads that cover the fastening strap, ensures optimum helmet fit and stability and is also easy to remove and wash.



0023444.209.

ORANGE CAMOUFLAGE



SIZES

XS	54 cm	code: .061	L	59-60 cm	code: .066
S	55-56 cm	code: .062	XL	61-62 cm	code: .068
M	57-58 cm	code: .064	XXL	63-64 cm	code: .069



0023444.315.
WHITE/BLACK



0023444.343.
RED/WHITE



0023444.344.
DARK BLUE/WHITE



0023444.743.
CAMOUFLAGE



STEEL CARBON HELMET REPLACEMENT

VISORS



0023432.010
ORANGE



0023432.020
BLACK/GOLD



0023432.030
WHITE



0023432.040
BLUE



0023432.070
GREY



0023432.100
BLACK/GOLD



0023432.110
RED

FRONT AIR VENT



0023433.010
ORANGE



0023433.030
WHITE



0023433.040
BLUE



0023433.070
GREY



0023433.090
BLACK



0023433.110
RED

SCREWS



0023435.090

INNER LINING



0023434.319.
BLACK/GREY

SIZES

XS	code: .061	L	code: .066
S	code: .062	XL	code: .068
M	code: .064	XXL	code: .069

X-RACER VTR REPLACEMENT

VISORS



0023445.209.
ORANGE CAMOUFLAGE



0023445.315.
WHITE/BLACK



0023445.343.
RED/WHITE



0023445.344.
DARK BLUE/WHITE



0023445.743.
CAMOUFLAGE

FRONT AIR VENT



0023446.030.
WHITE



0023446.040.
BLUE



0023446.070.
GREY



0023446.071.
MATT GREY



0023446.110.
RED



0023446.708.
BEIGE

BACK AIR VENT



0023447.030.
WHITE



0023447.070.
GREY



0023447.110.
RED



0023447.708.
BEIGE

INNER LINING



0023448.319.
BLACK/GREY

SIZES

XS	code: .061	L	code: .066
S	code: .062	XL	code: .068
M	code: .064	XXL	code: .069

SCREWS



0023449.120

X-TRACK VTR HELMET

MATERIALS:

- **Outer shell:** fibreglass.
- **ECE/ONU APPROVAL 22-05**
- Double outer shell, double inner shell
- WEIGHT 1050g ± 50g in size "M"

DETAILS:

- A design ensuring great protection and helmet balance on the head as well with outstanding ergonomics
- Chin/nose area which provides complete protection of the nose from branches or debris.
- Adjustable aerodynamic visor
- Double ring strap closure.
- Shell compatible with Neck Brace

FRONT VENTILATION:

- Excellent central chin vent area,
- Air vent on the lower/lateral part of the helmet to facilitate the extraction of hot air / humidity from the helmet

REAR AIRFLOW:

- Rear fin for increased air extraction
- Extensive lower and upper ventilation in the nape area

INTERIOR:

- Soft touch interior for effective humidity release
- Removable, hypo-allergenic and washable interior.
- Complete Comfort System cheek pads that cover the fastening strap, ensure optimum helmet fit and stability



0023901.243.
BLUE/ORANGE



SIZES

XS	53-54 cm	code: .061	L	59-60 cm	code: .066
S	55-56 cm	code: .062	XL	61-62 cm	code: .068
M	57-58 cm	code: .064	XXL	63-64 cm	code: .069



0023901.040.

BLUE



0023901.248.

BLUE/YELLOW



0023901.070.

GREY



PROFILE 4 HELMET

MATERIALS:

- **Shell:** thermoplastic.
- **ECE/ONU APPROVAL 22-05**
- Double outer shell, double inner shell
- WEIGHT 1,290 ± 60 gr. (size M)

DETAILS:

- A design ensuring great protection and helmet balance on the head as well with outstanding ergonomics
- Chin/nose area which provides complete protection of the nose from branches or debris.
- Adjustable aerodynamic visor
- Double ring strap closure.
- Shell compatible with Neck Brace

FRONT VENTILATION:

- Excellent central chin vent area,
- Air vent on the lower/lateral part of the helmet to facilitate the extraction of hot air / humidity from the helmet

REAR AIRFLOW:

- Rear fin for increased air extraction
- Extensive lower and upper ventilation in the nape area.



0022821.313.
BLACK/ORANGE



SIZES

XS	54 cm	code: .061	L	59-60 cm	code: .066
S	55-56 cm	code: .062	XL	61-62 cm	code: .068
M	57-58 cm	code: .064	XXL	63-64 cm	code: .069



0022821.229.
WHITE/ORANGE



0022821.232.
WHITE/BLUE



0022821.031.
SP CLUB WHITE



0022821.092.
SP CLUB BLACK



0022821.091.
MATT BLACK



X-TRACK VTR REPLACEMENT

VISORS



0023900.040
BLUE



0023900.070
GREY



0023900.243
BLUE/ORANGE



0023900.248
BLUE/YELLOW

FRONT AIR INTAKE



0024026.040
BLUE



0024026.070
GREY



0024026.248
YELLOW



0024026.243
DARK BLUE

INNER LINING



0023434.319.
BLACK/GREY

SCREWS



0023435.090

SIZES

XS	code: .061	L	code: .066
S	code: .062	XL	code: .068
M	code: .064	XXL	code: .069

PROFILE 4 REPLACEMENT

VISORS



0022828.232
WHITE/BLUE



0022828.229
WHITE/ORANGE



0022828.313
BLACK/RED



0022828.743
CAMOUFLAGE



0022828.245
BLUE/WHITE



0022828.471
BLUE/ORANGE



0022828.091.
MATT BLACK



0022828.092.
SP CLUB BLACK



0022828.031.
SP CLUB WHITE

FRONT AIR INTAKE



0022829.010
ORANGE



0022829.030
WHITE



0022829.040
BLUE



0022829.090
BLACK

INNER LINING



0022830.070.
GREY

SCREWS



0022835

SIZES

XS	code: .061	L	code: .066
S	code: .062	XL	code: .068
M	code: .064	XXL	code: .069

STEEL JUNIOR HELMET

MATERIALS:

- **Shell:** thermoplastic.
- One outer shell and one inner shell
- **ECE/ONU 22 05 APPROVAL**
- WEIGHT 1050g +- 60g in size "YL".

DETAILS:

- Helmet for children
- A design ensuring great protection and helmet balance on the head as well with outstanding ergonomics
- Chin/nose area which provides complete protection of the nose from branches or debris.
- Adjustable aerodynamic visor
- Double ring strap closure.
- Shell compatible with Neck Brace

FRONT VENTILATION:

- Excellent central chin vent area,
- Air vent on the lower/lateral part of the helmet to facilitate the extraction of hot air / humidity from the helmet

REAR AIRFLOW:

- Rear fin for increased air extraction
- Extensive lower and upper ventilation in the nape area

INTERIOR:

- Soft touch interior for effective humidity release
- Removable, hypo-allergenic and washable interior.
- Complete Comfort System cheek pads that cover the fastening strap, ensure optimum helmet fit and stability



0023425.237.

WHITE/BLACK



SIZES

Y/S	47-48 cm.	code: .050	Y/L	51-52 cm.	code: .054
Y/M	49-50 cm.	code: .052			



0023425.207.
ORANGE/GREY



0023425.347.
RED/GREY



0023425.249.
BLUE/GREY



STEEL/ECLIPSE JUNIOR REPLACEMENT

VISORS



0023308.207
ORANGE/GREY

0023308.347
RED/GREY

0023308.237
WHITE/BLACK

0023308.249
BLUE/GREY

FRONT AIR INTAKE



0023306.040
BLUE

0023306.041
LIGHT BLUE

0023306.070
GREY

0023306.071
MATT GREY

INNER LINING



0023307.070
GREY

SIZES

Y/S	code: .050	Y/L	code: .054
Y/M	code: .052		

SCREWS



0023436.090



REACTIVE VTR HELMET

MATERIALS:

- **Shell:** fibreglass.
- **ECE/ONU APPROVAL 22-05**
- 2 outer shells and 2 inner shells
- WEIGHT 1.350gr ± 50 gr (size M)

DETAILS:

- Max-Enduro helmet specific for ENDURO ROAD, MOTARD and ATV
- Adjustable and removable polycarbonate outer visor
- Aerodynamic visor
- Integrated sun visor operated by a slider
- Micro-adjustable quick release fastener

FRONT VENTILATION:

- Central chin vent area with slider for opening and closing
- Air vents on the shell with a slider for opening and closing

REAR AIRFLOW:

- Rear fin for increased air extraction

INTERIOR:

- Removable and washable hypoallergenic and breathable interior material.
- Removable chincurtain



0023466.708.

BEIGE



SIZES

XS	53-54 cm	code: .061	L	59-60 cm	code: .066
S	55-56 cm	code: .062	XL	61-62 cm	code: .068
M	57-58 cm	code: .064	XXL	63-64 cm	code: .069



0023466.343.
RED/WHITE



0023466.229.
WHITE/ORANGE



0023466.319.
BLACK/GREY



0023466.426.
LIGHT BLUE/BLUE



0022513.091.
BLACK



REACTIVE REPLACEMENT

VISORS



0022700.091.

BLACK



0023467.319.

BLACK/GREY



0023467.343.

RED/WHITE



0023467.426.

LIGHT BLUE/BLUE



0023467.708.

BEIGE



0023467.229.

WHITE/ORANGE

SCREWS

CODE: 0022704.090



SUN VISOR

CODE: 0022703.090



TRASPARENT VISOR

CODE: 0022701



INNER LINING

CODE: 0022702.090.



SIZES

XS	code: .061	L	code: .066
S	code: .062	XL	code: .068
M	code: .064	XXL	code: .069



FLIP FS-606 HELMET

MATERIALS:

- **Shell:** Thermoplastic.
- **ECE/ONU 22 2205 APPROVAL**
- One outer shells and one inner shells
- Weight 1560gr (size M)

DETAILS:

- Specific off-road helmet ENDURO ROAD, MOTARD AND ATV
- Upper visor REMOVABLE AND WITH APPROPRIATE KIT for use as a full face helmet
- Adjustable, scratch-resistant and removable polycarbonate outer visor
- Integrated sun visor operated by a slider
- Micro-adjustable quick release fastener

FRONT VENTILATION:

- Central chin vent area with slider for opening and closing
- Air vents on the shell with a slider for opening and closing

REAR AIRFLOW:

- Rear fin for increased air extraction

INTERIOR:

- Removable and washable hypoallergenic and breathable interior material.
- Removable chincurtain
- Removable breathguard



REMOVABLE
TRANSPARENT VISOR



0022310.014.

FLUO ORANGE



SIZES

XS	53-54 cm	code: .061	L	59-60 cm	code: .066
S	55-56 cm	code: .062	XL	61-62 cm	code: .068
M	57-58 cm	code: .064	XXL	63-64 cm	code: .069



0022310.030.

WHITE



0022310.061.

FLUO YELLOW



0022310.091.

BLACK



FLIP FS-606 REPLACEMENT

KIT COVER

CODE: 0023123.090



SCREWS

CODE: 0022317.020



TRASPARENT VISOR

CODE: 0022322.120



SUN VISOR

CODE: 0022323.090



VISORS



0022315.014.

FLUO ORANGE



0022315.030.

WHITE



0022315.061.

FLUO YELLOW



0022315.091.

BLACK

INNER LINING

CODE: 0022324.090.



SIZES

XS	code: .061	L	code: .066
S	code: .062	XL	code: .068
M	code: .064	XXL	code: .069



DERWEL HELMET

MATERIALS:

- **Shell:** thermoplastic.
- **ECE/ONU 22 -05 APPROVAL**
- 2 outer shells and 2 inner shells
- Weight 1550gr (Size M)

DETAILS:

- Modular helmet
- Central button chin guard opening
- Adjustable and removable polycarbonate outer visor
- Integrated sun visor operated by a slider
- Micro-adjustable quick release fastener

FRONT VENTILATION:

- Central chin vent area with slider for opening and closing
- Air vents on the shell with a slider for opening and closing

REAR AIRFLOW:

- Rear opening for increased air extraction

INTERIOR:

- Removable and washable hypoallergenic and breathable interior material.
- Removable chincurtain
- Removable breathguard



0023640.318.
BLACK/YELLOW



SIZES

XS	53-54 cm	code: .061	L	59-60 cm	code: .066
S	55-56 cm	code: .062	XL	61-62 cm	code: .068
M	57-58 cm	code: .064	XXL	63-64 cm	code: .069



0023640.239.

WHITE/RED



0023640.313.

BLACK/ORANGE



0023640.030.

WHITE



0023640.090.

BLACK



DERWEL REPLACEMENT

SCREWS

CODE: 0023698.090



TRASPARENT VISOR

CODE: 0023697.120



SUN VISOR

CODE: 0023696.090



INNER LINING

CODE: 0023695.090.



SIZES

XS	code: .061	L	code: .066
S	code: .062	XL	code: .068
M	code: .064	XXL	code: .069

SEREL HELMET

MATERIALS:

- **Shell:** thermoplastic.
- **ECE/ONU 22 05 APPROVAL**
- One outer shells and one inner shells
- WEIGHT 1500g ± 50g in size "M"

DETAILS:

- Modular helmet
- Central button chin guard opening
- Adjustable and removable polycarbonate outer visor
- Integrated sun visor operated by a slider
- Micro-adjustable quick release fastener

FRONT VENTILATION:

- Central chin vent area with slider for opening and closing
- Air vents on the shell with a slider for opening and closing

REAR AIRFLOW:

- Rear opening for increased air extraction

INTERIOR:

- Removable and washable hypoallergenic and breathable interior material.
- Removable chincurtain
- Removable breathguard



0023929.091.

BLACK



SIZES

XS	53-54 cm	code: .061	L	59-60 cm	code: .066
S	55-56 cm	code: .062	XL	61-62 cm	code: .068
M	57-58 cm	code: .064	XXL	63-64 cm	code: .069



0023929.061.
FLUO YELLOW



0023929.030.
WHITE



SEREL REPLACEMENT

SUN VISOR

CODE: 0023935.090



TRANSPARENT VISOR

CODE: 0023932.120



VISOR MECHANISM

CODE: 0023933.090



INNER LINING

CODE: 0023934.090.



SIZES

XS	code: .061	L	code: .066
S	code: .062	XL	code: .068
M	code: .064	XXL	code: .069



FULL FACE X-STREET HELMET

MATERIALS:

- **Shell:** thermoplastic.
- **ECE/ONU APPROVAL 22-05**
- One outer shells and one inner shells
- Weight 1450gr+-50 (Size M).

DETAILS:

- Adjustable, scratch-resistant and removable polycarbonate outer visor
- Integrated sun visor operated by a slider
- Micro-adjustable quick release fastener

FRONT VENTILATION:

- Central chin vent area with slider for opening and closing
- Air vents on the shell with a slider for opening and closing

REAR AIRFLOW:

- Rear fin for increased air extraction

INTERIOR:

- Removable and washable hypoallergenic and breathable interior material.
- Removable chincurtain
- Removable breathguard



0023960.203.

ORANGE/WHITE



SIZES

XS	53-54 cm	code: .061	L	59-60 cm	code: .066
S	55-56 cm	code: .062	XL	61-62 cm	code: .068
M	57-58 cm	code: .064	XXL	63-64 cm	code: .069



0023960.251.
BLUE/BLACK



0023960.277.
YELLOW/GREY



0023960.349.
RED/BLACK



FULL FACE X-STREET REPLACEMENT

SCREWS

CODE: 0024017.090



SUN VISOR

CODE: 0024012.090



TRANSPARENT VISOR

CODE: 0024015.120



INNER LINING

CODE: 0024016.090.



SIZES

XS	code: .061	L	code: .066
S	code: .062	XL	code: .068
M	code: .064	XXL	code: .069



FS-807 FULL FACE HELMET

MATERIALS:

- **Shell:** thermoplastic.
- **ECE/ONU APPROVAL 22-05**
- One outer shells and one inner shells
- Weight 1450gr+-50 (Size M).

DETAILS:

- Adjustable, scratch-resistant and removable polycarbonate outer visor
- Integrated sun visor operated by a slider
- Micro-adjustable quick release fastener

FRONT VENTILATION:

- Central chin vent area with slider for opening and closing
- Air vents on the shell with a slider for opening and closing

REAR AIRFLOW:

- Rear fin for increased air extraction

INTERIOR:

- Removable and washable hypoallergenic and breathable interior material.
- Removable chincurtain
- Removable breathguard



0022762.091.

BLACK



SIZES

XS	53-54 cm	code: .061	L	59-60 cm	code: .066
S	55-56 cm	code: .062	XL	61-62 cm	code: .068
M	57-58 cm	code: .064	XXL	63-64 cm	code: .069

FS-807 FULL FACE REPLACEMENT

VISOR SMOKE
CODE: 0022782.090



TRANSPARENT VISOR
CODE: 0022763.120



VISOR SCREWS
CODE: 0023156.



INNER LINING
CODE: 0022764.090.



SIZES

XS	code: .061	L	code: .066
S	code: .062	XL	code: .068
M	code: .064	XXL	code: .069



CARLINO KID HELMET

MATERIALS:

- **Shell:** thermoplastic.
- **ECE/ONU APPROVAL 22-05**
- One outer shell and one inner shell
- WEIGHT 1230+-50g (size M)

DETAILS:

- Children's helmet
- Adjustable, scratch-resistant and removable polycarbonate outer visor
- Micro-adjustable quick release fastener
- Kit of stickers (for children) to personalise the helmet

FRONT VENTILATION:

- Central chin vent area with slider for opening and closing
- Air vents on the shell with a slider for opening and closing

REAR AIRFLOW:

- Rear fin for increased air extraction

INTERIOR:

- Removable and washable hypoallergenic and breathable interior material.
- Removable chincurtain
- Removable breathguard



0023681.030.

WHITE



SIZES

Y/S	47-48 cm.	code: .050	Y/L	51-52 cm.	code: .054
Y/M	49-50 cm.	code: .052			

DECALS INCLUDED ADESIVI INCLUSI

- Stickers kit (for kids) to personalise the helmet.
- Kit Adesivi (per bambini) per la personalizzazione del casco.



CARLINO KID REPLACEMENT

INNER LINING



0023766.090.

BLACK

TRANSPARENT VISOR

CODE: 0023765.120



SIZES

Y/S	47-48 cm.	code: .050	Y/L	51-52 cm.	code: .054
Y/M	49-50 cm.	code: .052			



FIRSTWAY HELMET

MATERIALS:

- **Shell:** thermoplastic.
- **ECE/ONU APPROVAL 22-05**
- One outer shell and one inner shell
- **WEIGHT** 1340g ± 50 g in size "M".

DETAILS:

- Adjustable, scratch-proof and removable polycarbonate outer visor with extended protection up to the chin
- Integrated sun visor operated by a slider
- Micro-adjustable quick release fastener

FRONT VENTILATION:

- Air vents on the shell with a slider for opening and closing

REAR AIRFLOW:

- Rear openings for increased air extraction

INTERIOR:

- Removable and washable hypoallergenic and breathable interior material.



0023758.090.

BLACK



SIZES

XS	53-54 cm	code: .061	L	59-60 cm	code: .066
S	55-56 cm	code: .062	XL	61 cm	code: .068
M	57-58 cm	code: .064			



0023758.031.
WHITE



FIRSTWAY REPLACEMENT

SUN VISOR

CODE: 0023761.090



TRANSPARENT VISOR

CODE: 0023760.120



INNER LINING

CODE: 0023759.090.



SIZES

XS	code: .061	L	code: .066
S	code: .062	XL	code: .068
M	code: .064		



JET ARIA HELMET

MATERIALS:

- **Shell:** thermoplastic.
- **ECE/ONU APPROVAL 222205**
- One outer shell and two inner shells
- Weight 1110 ± 50 gr. (size M)

DETAILS:

- Removable upper visor
- Integrated sun visor operated by a slider
- Micro-adjustable quick release fastener

FRONT VENTILATION:

- Air vents on the shell with a slider for opening and closing

REAR AIRFLOW:

- Rear openings for increased air extraction

INTERIOR:

- Removable and washable hypoallergenic and breathable interior material.



REMOVABLE
SUN VISOR



0022569.293.

GREY/BLACK



SIZES

XS	53-54 cm	code: .061	L	59-60 cm	code: .066
S	55-56 cm	code: .062	XL	61 cm	code: .068
M	57-58 cm	code: .064			



0022569.318.
BLACK/FLUO YELLOW



0022569.287.
GREY/WHITE



0022569.313.
BLACK/ORANGE



0022569.743
CAMOUFLAGE



0022569.070.
GREY



0022569.110.
RED





0022569.030.

WHITE



0022569.061.

FLUO YELLOW



0022569.091.

BLACK



JET ARIA REPLACEMENT

SUN VISOR

CODE: 0022571.090



TRANSPARENT VISOR

CODE: 0022623.120



PLASTIC VISOR



0022570.014
FLUO ORANGE



0022570.030
WHITE



0022570.041
LIGHT BLUE



0022570.061
FLUO YELLOW



0022570.070
GREY



0022570.091
BLACK



0022570.110
RED



0022570.131
GREEN



0022570.141
FUCSIA



0022570.743
CAMOUFLAGE



0022570.287
GREY/WHITE



0022570.293
GREY/BLACK



0022570.313
BLACK/ORANGE



0022570.318
BLACK/FLUO YELLOW

INNER LINING

CODE: 0022572.090.



SIZES

XS	code: .061	L	code: .066
S	code: .062	XL	code: .068
M	code: .064		

VISOR SCREWS

CODE: 0022573.090





BRIDE FACE MASK

0016527.090

COMPONENTS: 50% nylon, 45% neoprene, 5% elasthan
Made of Neoprene and Nylon. Good protection for cold weather. Elastic Neoprene inserts for better comfort. Good for any weather conditions. Protects from wind and keeps you dry. Printed Acerbis logo.

SIZES

S/M	code: .063	L/XL	code: .067
------------	-------------------	-------------	-------------------



GIANSEY FACE MASK

0016531.090

COMPONENTS: 99% polyester, 1% elasthan
Made of Polyester. Inner lining in soft pile for a better comfort. Breathable inserts. Printed logo, very light and perfect fitting.

SIZES

S/M	code: .063	L/XL	code: .067
------------	-------------------	-------------	-------------------



MATRIX FACE MASK

0020110.090.067

components: 60% cotton 40% polyester
material: Coolmax*



SIZES

ONE SIZE



DALBY NECK WARMER

0016529.090

COMPONENTS: 99% polyester, 1% elasthan
Wind breaker collar is produced with a laminated and breathable membrane, offering a good wind protection. Soft inner lining for better comfort, this wind breaker collar gives good service in all weather conditions.

SIZES

S/M	code: .063	L/XL	code: .067
------------	-------------------	-------------	-------------------



KITTERLAND FACE MASK

0016530.090

COMPONENTS: 90% neoprene, 8% nylon, 2% elasthan
Made of Neoprene for a better protection against cold weather. Breathable neoprene inserts good for any weather conditions.

SIZES

S/M	code: .063	L/XL	code: .067
------------	-------------------	-------------	-------------------



REGABY FACE MASK

0016528.090

COMPONENTS: 99% polyester, 1% elasthan
Made of anti-wind laminated and breathable soft fabric. Good for any weather condition. Back hook and loop fastener closure. Printed logo.

SIZES

S/M	code: .063	L/XL	code: .067
------------	-------------------	-------------	-------------------



SWEAT 2 GO

0013748.090

COMPONENTS: 70% cotton, 27% polyester, 3% elasthan

COMPOSIZIONE: 70% cotone, 27% poliestere, 3% elastane

SIZES

S/M	code: .063	L/XL	code: .067
------------	-------------------	-------------	-------------------

QUICK STRAP



0000127.030

WHITE



0000127.090

BLACK

ACCESSORIES

SP CLUB NECK WARMER

COMPONENTS: 100% polyester

SIZES

ONE SIZE



0910281.076

WINGS



0910282.073

ACROBAT



0910283.872

SHIELD



0910284.591

STREET



0910285.090

RUSH

SP CLUB NECK WARMER DISPLAY

COMPONENTS: 100% polyester

- 2 PCS. WINGS
- 2 PCS. ACROBAT
- 2 PCS. SHIELD
- 2 PCS. STREET
- 2 PCS. RUSH



0910286.315

HELMET BAG

DETAILS:

- Designed to easily hold off-road or on-road helmets.
- Fabric exterior and soft internal lining to protect the helmet.
- Equipped with a practical carrying handle.
- Easy opening with a double slide zipper.
- Ventilated for breathability.
- Side pocket for accessories.



0023262.318

BLACK/FLUO YELLOW



GEAR

ABBIGLIAMENTO

- P. 64** X-Flex STARWAY
- P. 68** LTD FIREFLIGHT
- P. 70** LTD START & FINISH
- P. 74** Vented HELIOS
- P. 78** Kid SKYHIGH
- P. 81** Kid DESERT STORM
- P. 82** MTB Gear
- P. 86** Softshell
- P. 87** Mx One 1 Jacket
- P. 88** Enduro One Jacket
- P. 89** Enduro One Baggy
- P. 90** Enduro One Jersey
- P. 92** CE X-Tour Jacket
- P. 93** CE Discovery Safari Jacket
- P. 94** CE Discovery Forest Jacket
- P. 95** CE Discovery Forest Lady Jacket
- P. 96** CE Discovery Ghibly Jacket
- P. 97** CE Discovery Ghibly Lady Jacket
- P. 98** CE Ramsey Vented Jacket
- P. 99** CE Ramsey Vented Lady Jacket
- P. 100** Jacket Accessories
- P. 102** Adventure Pants
- P. 103** Adventure Baggy
- P. 104** Bray Hill Pants
- P. 105** Ramsey My Vented Pants
- P. 106** CE Pack Jeans
- P. 107** CE Pack Lady Jeans
- P. 108** Rain Deck
- P. 109** Rain Pro Transparent 3.0 Jacket
- P. 110** Rain Pro Transparent 3.0 Set
- P. 111** Rain Transparent 3.0 Kid Jacket
- P. 112** Highway Vest
- P. 112** Freeway Vest
- P. 113** Rain Set Mat-X 3.0
- P. 114** Rain Suit Logo
- P. 115** Corporate Raincoat
- P. 115** H2O Rain Gloves Cover
- P. 116** H2O Rain Boot Cover
- P. 116** Light 4.0 Rain Boot Cover



Maximus Vohland
#2
U.S.A.



X-FLEX JERSEY

COMPONENTS:

- 88% polyester, 12% elastane.

MATERIALS:

- High-density polyester.
- Mesh inserts in the chest, armpit and kidney areas.

DETAILS:

- Innovative Acerbis X-Flex technology: lightweight and totally stretch fabrics for revolutionary comfort.
- Mesh inserts for wearing the garment with or without (even the most voluminous) protections.
- Weight 210 g.



SIZES

S	code: .062	XL	code: .068
M	code: .064	XXL	code: .069
L	code: .066	3XL	code: .070

SIZE	S	M	L	XL	2XL	3XL
Chest	90-95 cm.	95-101 cm.	101-108 cm.	108-116 cm.	116-123 cm.	123-129 cm.
Sleeve	60-61 cm.	62-63 cm.	64-65 cm.	66-67 cm.	68-69 cm.	70-72 cm.

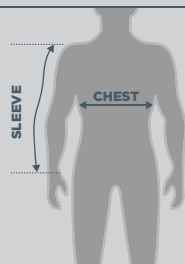

X-FLEX PANTS

COMPONENTS:

- **Shell:** 81.7% Polyester, 6.7% Nylon, 5.2% PU, 3.1% Kevlar, 2.6% Synthetic leather, 0.7% Spandex.
- **Lining:** 100% Polyester.

MATERIALS:

- **Inner:** reinforcement in Stretch Kevlar® Armortex® and innovative AX Suede fabric inside pants.
- **Outer:** high-density 600D Polyester, fully elasticized. 500D Cordura inserts in the area in contact with the seat.

DETAILS:

- Innovative ACERBIS X-Flex technology: fully elasticized material.
- Foam padding in knees area.
- Laser perforation in key areas for perfect ventilation.
- Can take any type of knee guard thanks to stretch mesh in the calf area.
- Double waist adjustments with hook and loop fastener.
- Closure with hook and button.
- Weight 650 g



Kevlar®

CORDURA

ARMORTEX®

SIZES

28	code: .028	34	code: .034
30	code: .030	36	code: .036
32	code: .032	38	code: .038

SIZE	28	30	32	34	36	38
Waist	74-79 cm.	79-84 cm.	84-89 cm.	89-94 cm.	94-99 cm.	99-104 cm.
Hip	89-94 cm.	94-99 cm.	99-104 cm.	104-109 cm.	109-114 cm.	114-119 cm.
Inseam	72-74 cm.	74-76 cm.	76-78 cm.	78-80 cm.	80-82 cm.	82-84 cm.

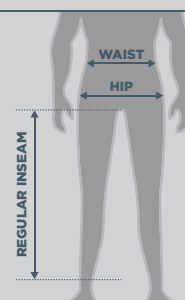

STARWAY

RED/GREY
JERSEY COD. 0023903.347.
GREY/DARK GREY
PANTS COD. 0023904.899.



BACK



STARWAY

BLUE/GREY
JERSEY COD. 0023903.249.
GREY/DARK GREY
PANTS COD. 0023904.899.



BACK



STARWAY

ORANGE/GREY
JERSEY COD. 0023903.207.
GREY/DARK GREY
PANTS COD. 0023904.899.



BACK



STARWAY

GREY/GREY
JERSEY COD. 0023903.291.
GREY/DARK GREY
PANTS COD. 0023904.899.



BACK





LTD JERSEY

COMPONENTS:

- 100% Polyester.

DETAILS:

- Broad mesh area from hip to armpit.
- Mesh area on inner sleeve.
- Lightweight and totally stretch fabrics for good comfort.
- Reviewed slim-fit for wearing the garment with or without (even the most voluminous) protections.
- Weight 180 g



SIZES

S	code: .062	XL	code: .068
M	code: .064	XXL	code: .069
L	code: .066	3XL	code: .070

SIZE	S	M	L	XL	2XL	3XL
Chest	90-95 cm.	95-101 cm.	101-108 cm.	108-116 cm.	116-123 cm.	123-129 cm.
Sleeve	60-61 cm.	62-63 cm.	64-65 cm.	66-67 cm.	68-69 cm.	70-72 cm.

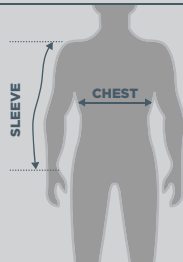

LTD PANTS

COMPONENTS:

- **Shell:** 88% Polyester; 2,8% Nylon; 2,7% Kevlar; 2,7% synthetic leather; 2,3% PU; 1,5% spandex.

- **Lining:** 100% Polyester

MATERIALS:

- **Outer:** High-density 600D Polyester, fully elasticized above the knee; 1200D polyester below the knee.

- **Inner:** Kevlar® Armortex® and AX Suede reinforcement inside pants.

DETAILS:

- Innovative ACERBIS X-Flex technology: fully elasticized material on waist.
- Foam padding in the knee area.
- Can take any type of knee guard thanks to stretch mesh in the calf area.
- Double waist adjustments with hook and loop fastener.
- Closure with hook button and flycammicroadjustmentinplastic.
- Excellent ventilation thanks to mesh in the calf area and above the knee.
- Weight 700 g.



Kevlar®

ARMORTEX®

SIZES

28	code: .028	34	code: .034
30	code: .030	36	code: .036
32	code: .032	38	code: .038

SIZE	28	30	32	34	36	38
Waist	74-79 cm.	79-84 cm.	84-89 cm.	89-94 cm.	94-99 cm.	99-104 cm.
Hip	89-94 cm.	94-99 cm.	99-104 cm.	104-109 cm.	109-114 cm.	114-119 cm.
Inseam	72-74 cm.	74-76 cm.	76-78 cm.	78-80 cm.	80-82 cm.	82-84 cm.

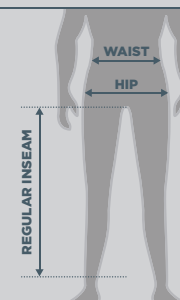

FIREFLIGHT

BLACK/ORANGE
JERSEY COD. 0023717.313.

BLACK/ORANGE
PANTS COD. 0023718.313.



BACK



START & FINISH

BLACK/BLUE
JERSEY COD. 0023891.316.
BLACK/WHITE
PANTS COD. 0023892.315.



BACK

START & FINISH

BLACK/YELLOW
JERSEY COD. 0023891.318.
BLACK/WHITE
PANTS COD. 0023892.315.



BACK



START & FINISH

BLACK/RED
JERSEY COD. 0023891.323.
BLACK/WHITE
PANTS COD. 0023892.315.



BACK



START & FINISH

BLACK/GREEN
JERSEY COD. 0023891.325.
BLACK/WHITE
PANTS COD. 0023892.315.



BACK



START & FINISH

BLACK/WHITE
JERSEY COD. 0023891.315.
BLACK/WHITE
PANTS COD. 0023892.315.



BACK



START & FINISH

BLACK/ORANGE
JERSEY COD. 0023891.313.
BLACK/WHITE
PANTS COD. 0023892.315.



BACK





Maximus Vohland
#2
U.S.A.



VENTED JERSEY

COMPONENTS:

- 100% Polyester.

DETAILS:

- Fully vented jersey.
- Stretch fabric inserts on the cuff and neck.
- Lightweight and totally stretch fabrics for good comfort.
- Reviewed slim-fit for wearing the garment with or without (even the most voluminous) protections.
- Weight 180 g.



SIZES

S	code: .062	XL	code: .068
M	code: .064	XXL	code: .069
L	code: .066	3XL	code: .070

SIZE	S	M	L	XL	2XL	3XL
Chest	90-95 cm.	95-101 cm.	101-108 cm.	108-116 cm.	116-123 cm.	123-129 cm.
Sleeve	60-61 cm.	62-63 cm.	64-65 cm.	66-67 cm.	68-69 cm.	70-72 cm.

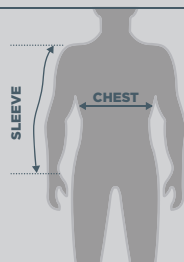

VENTED PANTS

COMPONENTS:

- **Shell:** 88% Polyester; 2.8% Nylon; 2.7% Kevlar; 2.7% synthetic leather; 2.3% PU; 1.5% spandex

- **Lining:** 100% Polyester

MATERIALS:

- **Outer:** High-density 600D Polyester, fully elasticized above the knee; 1200D polyester below the knee for excellent wear resistance.
- **Inner:** Kevlar® Armortex® and AX Suede™ reinforcement inside pants. **DETAILS:**
- Fully ventilated pants.
- Elastic bands on the crotch and back area for maximum mobility.
- Can take any type of knee guard thanks to stretch mesh in the calf area.
- Double waist adjustments with hook and loop fastener.
- Closure with hook button and flycammicroadjustmentinplastic.
- Weight 700 g.



Kevlar® ARMORTEX®

SIZES

28	code: .028	34	code: .034
30	code: .030	36	code: .036
32	code: .032	38	code: .038

SIZE	28	30	32	34	36	38
Waist	74-79 cm.	79-84 cm.	84-89 cm.	89-94 cm.	94-99 cm.	99-104 cm.
Hip	89-94 cm.	94-99 cm.	99-104 cm.	104-109 cm.	109-114 cm.	114-119 cm.
Inseam	72-74 cm.	74-76 cm.	76-78 cm.	78-80 cm.	80-82 cm.	82-84 cm.

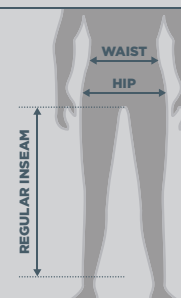

HELIOS

BLUE/WHITE
JERSEY COD. 0023905.245.
GREY/WHITE
PANTS COD. 0023906.287.



BACK



HELIOS

GREY/WHITE
JERSEY COD. 0023905.287.
GREY/WHITE
PANTS COD. 0023906.287.



BACK



HELIOS

ORANGE/WHITE
JERSEY COD. 0023905.203.
GREY/WHITE
PANTS COD. 0023906.287.



BACK



HELIOS

RED/WHITE
JERSEY COD. 0023905.343.
GREY/WHITE
PANTS COD. 0023906.287.



BACK





KID JERSEY

COMPONENTS: 100% polyester

MATERIALS:

- Inner polyester.
- Outer 100% Polyester

DETAILS:

- Pre-curved fitting for better movement when chest protector worn under the jersey.
- Stretch fabric inserts.
- Weight 140 g.



SIZES

XS	code: .061	L	code: .066
S	code: .062	XL	code: .068
M	code: .064	XXL	code: .069

SIZE	XS	S	M	L	XL	2XL
Chest	62-66 cm.	66-70 cm.	70-75 cm.	75-80 cm.	80-85 cm.	85-90 cm.
Sleeve	39-43 cm.	43-47 cm.	47-51 cm.	51-55 cm.	55-58 cm.	58-60 cm.

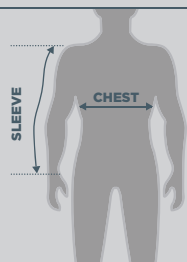

KID PANTS

COMPONENTS:

- Shell 93% polyester; 5,70% nylon; 1,30% spandex
- Lining 100% polyester

MATERIALS:

- Inner Mesh lining to the knee.
- Outer High density polyester 600D.

DETAILS:

- Zip closure, snap and plastic micro adjustments.
- Double waist adjustments with tape and hook and loop fastener.
- Reinforcement with Cordura® for the inside of the knee.
- Foam reinforcements on the knee.
- High-density polyester in the area of contact with the seat to provide greater grip, comfort and durability.
- Elastic bands above the knee, front, lower back and calf area for maximum mobility.
- Innovative digital technology that has the ability to obtain fluorescent colors.
- Double and triple stitching in critical areas.
- Weight 450 g.



CORDURA®

SIZES

18	code: .018	24	code: .024
20	code: .020	26	code: .026
22	code: .022	28	code: .028

SIZE	18	20	22	24	26	28
Waist	53-56 cm.	56-59 cm.	59-63 cm.	63-66 cm.	66-70 cm.	70-74 cm.
Hip	63-68 cm.	68-73 cm.	73-78 cm.	78-83 cm.	83-88 cm.	88-93 cm.
Inseam	38-42 cm.	42-47 cm.	47-53 cm.	53-58 cm.	58-64 cm.	64-70 cm.

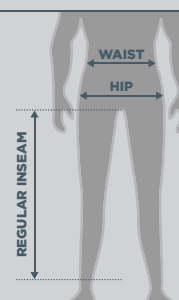

SKYHIGH

GREY/DARK GREY
JERSEY COD. 0023907.899.
GREY/BLACK
PANTS COD. 0023908.293.



BACK



SKYHIGH

BLUE/GREY
JERSEY COD. 0023907.249.
GREY/BLACK
PANTS COD. 0023908.293.



BACK



SKYHIGH

ORANGE/GREY
JERSEY COD. 0023907.207.
GREY/BLACK
PANTS COD. 0023908.293.



BACK



SKYHIGH

RED/GREY
JERSEY COD. 0023907.347.
GREY/BLACK
PANTS COD. 0023908.293.



BACK



SKYHIGH

GREY/BLACK
JERSEY COD. 0023907.293.
GREY/BLACK
PANTS COD. 0023908.293.



BACK



DESERT STORM

CAMOUFLAGE
JERSEY COD. 0023473.743.
CAMOUFLAGE
PANTS COD. 0023474.743.



BACK



SPEEDER MTB JERSEY

COMPONENTS:

Shell 98% Polyester; 2% Elastane

MATERIALS:

Outer

- Microfresh fabric , high-tech breathable, absorb sweat and quick dry
- 100% Vented Jersey

DETAILS:

- Slim-fit for wearing the garment with or without (even the most voluminous) protections.
- Back pocket with zipper
- Weight 200 gr



SIZES

S	code: .062	XL	code: .068
M	code: .064	XXL	code: .069
L	code: .066	3XL	code: .070



0023909.316.
BLACK/BLUE

SIZES	S	M	L	XL	2XL	3XL
Chest	90-95 cm.	95-101 cm.	101-108 cm.	108-116 cm.	116-123 cm.	123-129 cm.
Sleeve	60-61 cm.	62-63 cm.	64-65 cm.	66-67 cm.	68-69 cm.	70-72 cm.

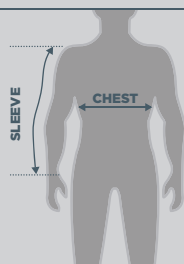

0023909.347.
RED/GREY



0023909.319.
BLACK/GREY

COMBAT MTB JERSEY

COMPONENTS:

Shell 100% Polyester

MATERIALS:

Outer

- Microfresh fabric , high-tech breathable , absorb sweat and quick dry
- 100% Vented Jersey

DETAILS:

- Slim-fit for wearing the garment with or without (even the most voluminous) protections.
- Back pocket with zipper
- Weight 160 gr



SIZES

S	code: .062	XL	code: .068
M	code: .064	XXL	code: .069
L	code: .066	3XL	code: .070



0023911.319.

BLACK/GREY

SIZES	S	M	L	XL	2XL	3XL
Chest	90-95 cm.	95-101 cm.	101-108 cm.	108-116 cm.	116-123 cm.	123-129 cm.
Sleeve	60-61 cm.	62-63 cm.	64-65 cm.	66-67 cm.	68-69 cm.	70-72 cm.

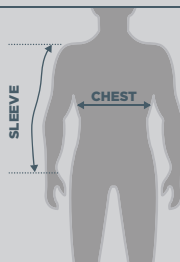

LEGACY MTB PANTS

COMPONENTS:

Outshell 91% polyester, 7% nylon, 2% spandex

Lining 100% polyester

MATERIALS:

Outer

- High-density 600D Polyester , fully elasticized

DETAILS:

- Innovative ACERBIS X-fl ex technology: fully elasticized and water repellent
- Mesh inner lining till knee with stretchable fabric on waist for better comfort
- Can take any type of knee guard thanks to stretch mesh in the calf area
- Double waist adjustment with hook and loop fastener
- Double closure with button and hook button
- Excellent ventilation thanks to laser holes and mesh in the back area
- 2 Pockets with zippers in the thigh area



SIZES

28	code: .028	34	code: .034
30	code: .030	36	code: .036
32	code: .032	38	code: .038

SIZES	28	30	32	34	36	38
Waist	74-79 cm.	79-84 cm.	84-89 cm.	89-94 cm.	94-99 cm.	99-104 cm.
Hip	89-94 cm.	94-99 cm.	99-104 cm.	104-109 cm.	109-114 cm.	114-119 cm.
Inseam	72-74 cm.	74-76 cm.	76-78 cm.	78-80 cm.	80-82 cm.	82-84 cm.

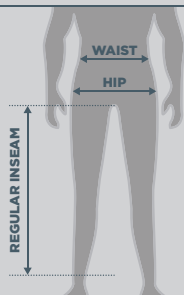

0023910.319.

BLACK/GREY

LEGEND MTB SHORTS

COMPONENTS:

Outshell 83.5% polyester, 11% spandex, 5.5% nylon

MATERIALS:

Outer

- High-density 500D Polyester, fully elasticized

DETAILS:

- Innovative ACERBIS X-flex technology: fully elasticized and water repellent.
- Without inner lining in order to have lighter shorts
- Can take any type of knee guard thanks to stretch mesh in the back area.
- Double waist adjustment with hook and loop fastener.
- Double closure with button and hook button.
- Excellent ventilation thanks to laser holes and mesh in the back area .
- 2 Pockets with zippers in the thigh area.



SIZES

28	code: .028	34	code: .034
30	code: .030	36	code: .036
32	code: .032	38	code: .038

SIZES	28	30	32	34	36	38
Waist	74-79 cm.	79-84 cm.	84-89 cm.	89-94 cm.	94-99 cm.	99-104 cm.
Hip	89-94 cm.	94-99 cm.	99-104 cm.	104-109 cm.	109-114 cm.	114-119 cm.
Inseam	72-74 cm.	74-76 cm.	76-78 cm.	78-80 cm	80-82 cm.	82-84 cm.

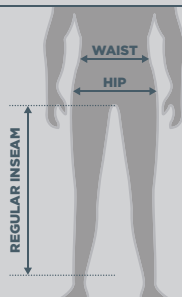

0023912.319.
BLACK/GREY



SOFTSHELL X-WIND VEST

COMPOSITION: Polyester 100%.

MATERIALS:

- **Outer:** Softshell no wind WINDTEX SHIELD VAGOTEX in polyester: breathable, resistant to tearing and abrasion, water repellent, Powerstretch Carvico in polyester for side insert.
- **Inner:** Microfleece.

DETAILS:

- Off-Road fit.
- Vest with digital print.
- 2 front pockets and 1 back pocket with zip.

COMPOSIZIONE: Poliestere 100%

MATERIALI:

- **Esterno:** Softshell antivento WINDTEX SHIELD VAGOTEX in poliestere: traspirante, resistente allo strappo e all'abrasione, idrorepellente, Powerstretch Carvico in poliestere per inserto laterale.
- **Interno:** Micro pile

DETTAGLI:

- Vestibilità Off Road.
- Gilet con stampa in digitale.
- 2 tasche anteriori e 1 tasca posteriore con lampo.



VAGOTEX

Carvico

SIZES

S	code: .062	XL	code: .068
M	code: .064	XXL	code: .069
L	code: .066	3XL	code: .070

SIZES	S	M	L	XL	2XL	3XL
Chest	90-95 cm.	95-101 cm.	101-108 cm.	108-116 cm.	116-123 cm.	123-129 cm.

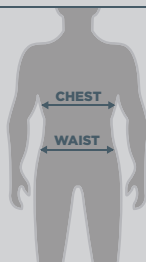

0023441.319.
BLACK/GREY



0023441.246.
BLUE



0023441.799.
GREY/ORANGE

MX ONE 1 JACKET

COMPONENTS:

- 92% Polyester; 8% Elastane

A NEW JACKET MADE OF SOFTSHELL, A NEW TYPE OF MATERIAL that, due to its special structure and use of a wind-blocking elastic membrane provides three key features: Wind protection, water protection (up to 8000 ml.) and breathability. It is extremely soft, very elastic and waisted, following the lines of the body, making it particularly comfortable. Removable sleeves, adjustable wrists with hook and loop fastener closure, front pockets with zipper.



SIZES

M	code: .064	XL	code: .068
L	code: .066	XXL	code: .069

SIZES	M	L	XL	2XL		
Chest	95-99 cm.	99-103 cm.	103-107 cm.	107-111 cm.		
Waist	63-65 cm.	65-67 cm.	67-68 cm.	68-69 cm.		
Sleeve	89-93 cm.	93-97 cm.	97-101 cm.	101-105 cm.		

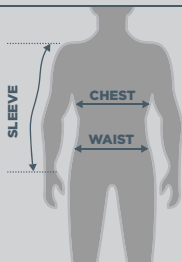

0017030.090.

BLACK

ENDURO ONE JACKET

COMPOSITION:

- 100% Polyester

MATERIALS:

Inner mesh lining

Outer High density Polyester.

DETAILS:

- Enduro technical jacket
- Sport fit
- Designed for the use with protections
- Adjustable waist with drawstring
- Adjustments on the bottom with hook and loop fastener
- Removable sleeves with zip
- 5 pockets - 3 front, 1 wide rear pocket, 1 inside
- Reflective customization



SIZES

S	code: .062	XL	code: .068
M	code: .064	XXL	code: .069
L	code: .066	3XL	code: .070

SIZES	S	M	L	XL	2XL	3XL
Chest	91-95 cm.	95-99 cm.	99-105 cm.	105-111 cm.	111-117 cm.	117-123 cm.
Waist	87-91 cm.	91-95 cm.	95-101 cm.	101-105 cm.	105-111 cm.	111-117 cm.
Sleeve	61-63 cm.	63-65 cm.	65-67 cm.	67-68 cm.	68-69 cm.	69-70 cm.

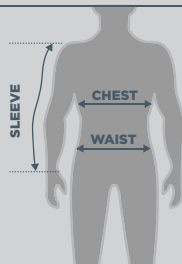

0022169.313.

BLACK/FLUO ORANGE



0022169.318.

BLACK/FLUO YELLOW



0022169.319.

BLACK/GREY

ENDURO ONE BAGGY

COMPOSITION:

Exterior: 85.60% polyester, 6.80% nylon, 6.30% Kevlar, 1.30% Spandex

Interior: 99.80% polyester, 0.20% Spandex

MATERIALS:

Exterior: high density polyester

Interior: net lining

DETAILS:

- Sport wearability
- Dual regulation on waist with band and hook and loop fastener
- Safety closure on waist with hook and button
- Knee volume regulation with tape
- Wide-bottomed adjustable pants
- Inserts in elasticized fabric that envelop the knees front and back
- Inserts in elasticized fabric on rear
- Use of fluorescent and reflecting details
- 3 large front pockets, easy to reach (2 on waist and 1 on thigh)
- Use of Kevlar reinforcement along the entire inner knee area and bottom
- Possible to wear pants both inside and outside boot
- Pockets inside the knee area for inserting protections (sold separately)
- Cordura reinforcement on seat panels area



0022424.318

BLACK/FLUO YELLOW



Kevlar®

CORDURA®

ARMORTEX®

SIZES

30	code: .030	36	code: .036
32	code: .032	38	code: .038
34	code: .034	40	code: .040

SIZES	30	32	34	36	38	40
Waist	79-84 cm.	84-89 cm.	89-94 cm.	94-99 cm.	99-104 cm.	104-109 cm.
Hip	94-98 cm.	98-102 cm.	102-106 cm.	106-114 cm.	114-118 cm.	118-122 cm.
Inseam	77-79 cm.	79-80 cm.	80-81 cm.	81-82 cm.	82-83 cm.	83-84 cm.

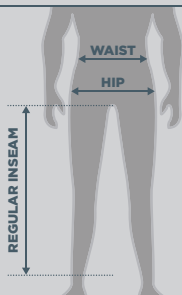

0022424.319.

BLACK GREY



ENDURO ONE JERSEY

COMPONENTS:

- 100% Polyester

MATERIALS:

- High density Polyester

DETAILS:

- Lightweight and stretch fabrics for good comfort
- Reviewed slim-fit to wear the garment with or without (even the most voluminous) protections
- Reflective details for passive safety
- Cuff with high frequency details in fluorescent color



SIZES

S	code: .062	XL	code: .068
M	code: .064	XXL	code: .069
L	code: .066	3XL	code: .070

SIZES	S	M	L	XL	2XL	3XL
Chest	90-95 cm.	95-101 cm.	101-108 cm.	108-116 cm.	116-123 cm.	123-129 cm.
Sleeve	60-61 cm.	62-63 cm.	64-65 cm.	66-67 cm.	68-69 cm.	70-72 cm.

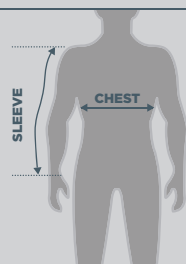

0022581.318.

BLACK/FLUO YELLOW



0022581.319.

BLACK/GREY



CE X-TOUR JACKET

COMPONENTS:

Jacket: Shell: 99% Polyester, 1% Polyamide
Lining: 64% Polyester, 36% Polyamide

Membrane and Padding: 100% Polyester

MATERIALS:

Outer

- Fabric for jacket 600D in polyester resistant to tearing and abrasion, water repellent
- Front, side and sleeve insert 600D RIPSTOP in polyester
- Collar, shoulder, back and elbow insert 1200D in polyester
- Collar insert in nylon stretch

Inner

- Inner collar in fabric
- Detachable inner membrane waterproof and breathable 3L 10K/10K, windproof, seams totally taped
- Detachable inner padding gr.120

DETAILS:

- Touring fit
- CE JACKET **FprEN 17092-3:2018 class AA**
- CE SHOULDER & ELBOW PROTECTORS **EN 1621-1: 2012 Type A Level 2**
- Predisposition for CE BACK PROTECTOR **EN 1621-2: 2014 Type FB Level 2**
- Body and sleeve ventilations in mesh completely openable with zip
- 3 pockets outside and 1 zip pocket inside the jacket waterproof totally taped
- 1 pocket inside detachable membrane and padding
- Cuff, sleeve, waist and bottom regulation
- Zip connection inside for pants
- Reflective Acerbis logo and applications on the front, sleeve and back



0023684.076.

LIGHT GREY



SIZES

S	code: .062	XL	code: .068
M	code: .064	XXL	code: .069
L	code: .066	3XL	code: .070

SIZES	S	M	L	XL	2XL	3XL
Chest	88-94 cm.	94-100 cm.	100-106 cm.	106-112 cm.	112-118 cm.	118-124 cm.
Waist	78-84 cm.	84-90 cm.	90-96 cm.	96-102 cm.	102-108 cm.	108-114 cm.
Sleeve	65-66 cm.	66-67 cm.	67-68 cm.	68-69 cm.	69-70 cm.	70-71 cm.

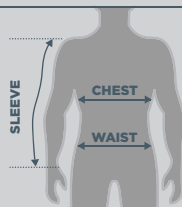

0023684.090.

BLACK



0023684.708.

BEIGE

ACCESSORIES



PROTECTOR CE XY905S FB LEV 2
CODE: 0023994.060
SIZE: S
FOR: MAN JACKET (S,M,L)

PROTECTOR CE XY905M FB LEV 2
CODE: 0023995.060
SIZE: M
FOR: MAN JACKET (XL,2XL,3XL)

CE DISCOVERY SAFARY JACKET

COMPONENTS:

Shell 100% Polyester Lining 90% Polyamide, 10% Polyester

MATERIALS:

Outer

- Fabric for jacket 600D in polyester resistant to tearing and abrasion, water repellent
- Color Fluo Yellow: it respects the norm **HIGH VISIBILITY (BS EN ISO 20471:2013+A1:2016)**
- Fabric for elbow insert 1200D in polyester
- Collar insert in nylon stretch

Inner

- Inner collar in microfleece
- Waterproof and breathable coating applied inside the lining, seams totally taped
- Detachable inner padding gr. 90

DETAILS: Touring fit

- CERTIFIED JACKET **FprEN 17092-3:2018 class AA**
- CERTIFIED SHOULDER & ELBOW PROTECTORS **EN 1621-1: 2012 Type A Lev 2**
- Predisposition for CERTIFIED BACK PROTECTOR **EN 1621-2: 2014 Type FB Level 2** (separately sold)
- Front and back ventilation in mesh with zip
- 5 pockets outside waterproof totally taped, 1 pocket inside the jacket and 1 pocket inside the detachable padding
- Cuff, sleeve, waist and bottom regulation
- Reflective Acerbis logo and applications on the front, sleeve and back



0023739.319.

BLACK/DARK GREY



0023739.090.

BLACK



0023739.318.

BLACK/FLUO YELLOW



SIZES

S	code: .062	XL	code: .068
M	code: .064	XXL	code: .069
L	code: .066	3XL	code: .070

SIZES	S	M	L	XL	2XL	3XL
Chest	88-94 cm.	94-100 cm.	100-106 cm.	106-112 cm.	112-118 cm.	118-124 cm.
Waist	78-84 cm.	84-90 cm.	90-96 cm.	96-102 cm.	102-108 cm.	108-114 cm.
Sleeve	65-66 cm.	66-67 cm.	67-68 cm.	68-69 cm.	69-70 cm.	70-71 cm.

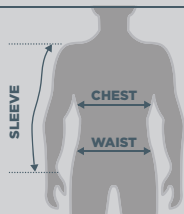

ACCESSORIES



PROTECTOR CE XY905S FB LEV 2
CODE: 0023994.060
SIZE: S
FOR: MAN JACKET (S,M,L)

PROTECTOR CE XY905M FB LEV 2
CODE: 0023995.060
SIZE: M
FOR: MAN JACKET (XL,2XL,3XL)



CE DISCOVERY FOREST JACKET

COMPONENTS:

Shell 100% Polyester Lining 90% Polyamide, 10% Polyester

MATERIALS:

Outer

- Fabric for jacket 600D in polyester resistant to tearing and abrasion, water repellent
- Color Fluo Yellow: it respects the norm **HIGH VISIBILITY (BS EN ISO 20471:2013+A1:2016)**
- Fabric for elbow insert 1200D in polyester
- Collar insert in nylon stretch

Inner

- Inner collar in microfleece
- Waterproof and breathable coating applied inside the lining, seams totally taped
- Detachable inner padding gr. 90

DETAILS:

- Touring fit
- CERTIFIED JACKET **FprEN 17092-3:2018 class AA**
- CERTIFIED SHOULDER & ELBOW PROTECTORS **EN 1621-1: 2012 Type A Level 2**
- Predisposition for CERTIFIED BACK PROTECTOR **EN 1621-2: 2014 Type FB Level 2** (separately sold)
- Shoulder and back ventilation in mesh with zip
- 2 pockets outside waterproof totally taped, 1 pocket inside the jacket and 1 pocket inside the detachable padding
- Cuff, sleeve, waist and bottom regulation
- Reflective Acerbis logo and applications on the front, sleeve and back



0023740.318.
BLACK/FLUO YELLOW



SIZES

S	code: .062	XL	code: .068
M	code: .064	XXL	code: .069
L	code: .066	3XL	code: .070

SIZES	S	M	L	XL	2XL	3XL
Chest	88-94 cm.	94-100 cm.	100-106 cm.	106-112 cm.	112-118 cm.	118-124 cm.
Waist	78-84 cm.	84-90 cm.	90-96 cm.	96-102 cm.	102-108 cm.	108-114 cm.
Sleeve	65-66 cm.	66-67 cm.	67-68 cm.	68-69 cm.	69-70 cm.	70-71 cm.

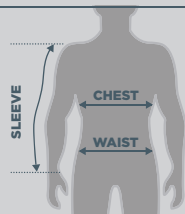

0023740.090.
BLACK



0023740.319.
BLACK/DARK GREY

ACCESSORIES



PROTECTOR CE XY905S FB LEV 2
CODE: 0023994.060
SIZE: S
FOR: MAN JACKET (S,M,L)

PROTECTOR CE XY905M FB LEV 2
CODE: 0023995.060
SIZE: M
FOR: MAN JACKET (XL,2XL,3XL)

CE DISCOVERY FOREST LADY JACKET

COMPONENTS:

Shell 100% Polyester Lining 90% Polyamide, 10% Polyester

MATERIALS:

Outer

- Fabric for jacket 600D in polyester resistant to tearing and abrasion, water repellent
- Color Fluo Yellow: it respects the norm **HIGH VISIBILITY (BS EN ISO 20471:2013+A1:2016)**
- Fabric for elbow insert 1200D in polyester
- Collar insert in nylon stretch

Inner

- Inner collar in microfleece
- Waterproof and breathable coating applied inside the lining, seams totally taped
- Detachable inner padding gr. 90

DETAILS:

- Touring fit
- CERTIFIED JACKET **FprEN 17092-3:2018 class AA**
- CERTIFIED SHOULDER & ELBOW PROTECTORS **EN 1621-1: 2012 Type A Level 2**
- Predisposition for CERTIFIED BACK PROTECTOR **EN 1621-2: 2014 Type FB Level 2** (separately sold)
- Shoulder and back ventilation in mesh with zip
- 2 pockets outside waterproof totally taped, 1 pocket inside the jacket and 1 pocket inside the detachable padding
- Cuff, sleeve, waist and bottom regulation
- Reflective Acerbis logo and applications on the front, sleeve and back



0023741.318.

BLACK/FLUO YELLOW



0023741.090.

BLACK



0023741.319.

BLACK/DARK GREY

SIZES

XS	code: .061	L	code: .066
S	code: .062	XL	code: .068
M	code: .064	XXL	code: .069

SIZES	XS	S	M	L	XL	2XL
Chest	80-84 cm.	84-88 cm.	88-92 cm.	92-96 cm.	96-101 cm.	101-106 cm.
Waist	64-68 cm.	68-72 cm.	72-76 cm.	76-80 cm.	80-85 cm.	85-90 cm.
Sleeve	59-60 cm.	60-61 cm.	61-62 cm.	62-63 cm.	63-64 cm.	64-65 cm.

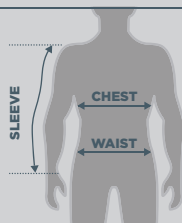

ACCESSORIES



PROTECTOR CE XY905S FB LEV 2
 CODE: 0023994.060
 SIZE: S
 FOR: LADY JACKET (XS,S,M,L,XL,2XL)



CE DISCOVERY GIBLY JACKET

COMPONENTS:

Shell 100% Polyester **Lining** 100% Polyester

MATERIALS:

Outer

- Fabric for jacket 600D in polyester resistant to tearing and abrasion, water repellent
- Color Fluo Yellow: it respects the norm **HIGH VISIBILITY (BS EN ISO 20471:2013+A1:2016)**
- Fabric for shoulder and elbow insert 1200D in polyester
- Collar insert in nylon stretch

Inner

- Inner collar in microfleece
- Lining in mesh
- Detachable inner padding gr. 90
- Predisposition for waterproof and breathable membrane (separately sold)

DETAILS: Sport fit

- **CERTIFIED JACKET FprEN 17092-3:2018 class AA**
- **CERTIFIED SHOULDER & ELBOW PROTECTORS EN 1621-1: 2012 Type A Lev 2**
- Predisposition for **CERTIFIED BACK PROTECTOR EN 1621-2: 2014 Type FB Lev 2** (separately sold)
- Shoulder and back ventilation in mesh with zip
- 2 pockets outside, 1 pocket inside the jacket and 1 pocket inside the detachable padding
- Cuff, sleeve, waist and bottom regulation
- Reflective Acerbis logo and applications on the front, sleeve and back



0023742.090.

BLACK



SIZES

S	code: .062	XL	code: .068
M	code: .064	XXL	code: .069
L	code: .066	3XL	code: .070

SIZES	S	M	L	XL	2XL	3XL
Chest	88-94 cm.	94-100 cm.	100-106 cm.	106-112 cm.	112-118 cm.	118-124 cm.
Waist	78-84 cm.	84-90 cm.	90-96 cm.	96-102 cm.	102-108 cm.	108-114 cm.
Sleeve	65-66 cm.	66-67 cm.	67-68 cm.	68-69 cm.	69-70 cm.	70-71 cm.

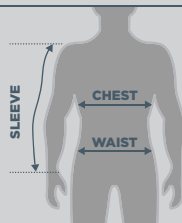

0023742.318.
BLACK/FLUO YELLOW



0023742.319.
BLACK/DARK GREY

ACCESSORIES



PROTECTOR CE XY905S FB LEV 2
CODE: 0023994.060
SIZE: S
FOR: MAN JACKET (S,M,L)

PROTECTOR CE XY905M FB LEV 2
CODE: 0023995.060
SIZE: M
FOR: MAN JACKET (XL,2XL,3XL)



DISCOVERY GIBLY
MEMBRANE
CODE: 0022884.090

CE DISCOVERY GIBLY LADY JACKET

COMPONENTS:

Shell 100% Polyester Lining 100% Polyester

MATERIALS:

Outer

- Fabric for jacket 600D in polyester resistant to tearing and abrasion, water repellent
- Color Fluo Yellow: it respects the norm **HIGH VISIBILITY (BS EN ISO 20471:2013+A1:2016)**
- Fabric for shoulder and elbow insert 1200D in polyester
- Collar insert in nylon stretch

Inner

- Inner collar in microfleece
- Lining in mesh
- Detachable inner padding gr. 90
- Predisposition for waterproof and breathable membrane (separately sold)

DETAILS: Sport fit

- CERTIFIED JACKET **FprEN 17092-3:2018 class AA**

- CERTIFIED SHOULDER & ELBOW PROTECTORS

EN 1621-1: 2012 Type A Level 2

- Predisposition for CERTIFIED BACK PROTECTOR

EN 1621-2: 2014 Type FB Level 2 (separately sold)

- Shoulder and back ventilation in mesh with zip
- 2 pockets outside, 1 pocket inside the jacket and 1 pocket inside the detachable padding
- Cuff, sleeve, waist and bottom regulation
- Reflective Acerbis logo and applications on the front, sleeve and back



0023743.090.

BLACK



0023743.318.

BLACK/FLUO YELLOW



0023743.319.

BLACK/DARK GREY



SIZES

XS	code: .061	L	code: .066
S	code: .062	XL	code: .068
M	code: .064	XXL	code: .069

SIZES	XS	S	M	L	XL	2XL
Chest	80-84 cm.	84-88 cm.	88-92 cm.	92-96 cm.	96-101 cm.	101-106 cm.
Waist	64-68 cm.	68-72 cm.	72-76 cm.	76-80 cm.	80-85 cm.	85-90 cm.
Sleeve	59-60 cm.	60-61 cm.	61-62 cm.	62-63 cm.	63-64 cm.	64-65 cm.

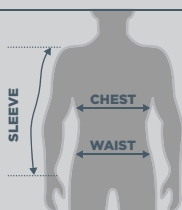

ACCESSORIES



PROTECTOR CE XY905S FB LEV 2
CODE: 0023994.060
SIZE: S
FOR: LADY JACKET (XS,S,M,L,XL,2XL)



DISCOVERY GIBLY LADY
MEMBRANE
CODE: 0022885.090



CE RAMSEY VENTED JACKET

COMPONENTS:

- **Shell:** 100% Polyester
- **Lining:** 100% Polyester

MATERIALS:

- **Outer:**
 - Fabric for jacket and shoulder insert 450D in polyester resistant to tearing and abrasion, water repellent
 - Body, sleeve and cuff inserts in heavy mesh resistant to tearing and abrasion
 - Collar insert in polyester stretch
- **Inner:**
 - Inner collar in microfleece
 - Lining in mesh
 - Predisposition for waterproof and breathable membrane (separately sold)

DETTAGLI:

- Sport fit
- CERTIFIED JACKET **FprEN 17092-3:2018 class AA**
- CERTIFIED SHOULDER & ELBOW PROTECTORS **EN 1621-1: 2012 Type A Level 1**
- Predisposition for CERTIFIED BACK PROTECTOR **EN 1621-2: 2014 Type FB Level 2** (separately sold)
- 2 pockets outside and 1 pocket inside the jacket
- Cuff, sleeve and bottom regulation
- Reflective Acerbis logo and applications on the front, sleeve and back



0023744.290.

GREY/FLUO YELLOW



SIZES

S	code: .062	XL	code: .068
M	code: .064	XXL	code: .069
L	code: .066	3XL	code: .070

SIZES	S	M	L	XL	2XL	3XL
Chest	88-94 cm.	94-100 cm.	100-106 cm.	106-112 cm.	112-118 cm.	118-124 cm.
Waist	78-84 cm.	84-90 cm.	90-96 cm.	96-102 cm.	102-108 cm.	108-114 cm.
Sleeve	65-66 cm.	66-67 cm.	67-68 cm.	68-69 cm.	69-70 cm.	70-71 cm.

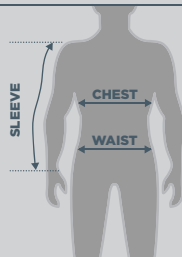

0023744.090.

BLACK



0023744.318.

BLACK/FLUO YELLOW



0023744.323.

BLACK/RED

ACCESSORIES



PROTECTOR CE XY905S FB LEV 2
CODE: 0023994.060
SIZE: S
FOR: MAN JACKET (S,M,L)

PROTECTOR CE XY905M FB LEV 2
CODE: 0023995.060
SIZE: M
FOR: MAN JACKET (XL,2XL,3XL)



RAMSEY VENTED MEMBRANE
CODE: 0022649.090

CE RAMSEY VENTED LADY JACKET

COMPONENTS:

- **Shell:** 100% Polyester
- **Lining:** 100% Polyester

MATERIALS:

- **Outer:**
 - Fabric for jacket and shoulder insert 450D in polyester resistant to tearing and abrasion, water repellent
 - Body, sleeve and cuff inserts in heavy mesh resistant to tearing and abrasion
 - Collar insert in polyester stretch
- **Inner:**
 - Inner collar in microfleece
 - Lining in mesh
 - Predisposition for waterproof and breathable membrane (separately sold)

DETTAGLI:

- Sport fit
- CERTIFIED JACKET **FprEN 17092-3:2018 class AA**
- CERTIFIED SHOULDER & ELBOW PROTECTORS **EN 1621-1: 2012 Type A Level 1**
- Predisposition for CERTIFIED BACK PROTECTOR **EN 1621-2: 2014 Type FB Level 2** (separately sold)
- 2 pockets outside and 1 pocket inside the jacket
- Cuff, sleeve and bottom regulation
- Reflective Acerbis logo and applications on the front, sleeve and back



0023745.723.
BLACK/PINK



0023745.090.
BLACK



0023745.290.
GREY/FLUO YELLOW



SIZES

XS	code: .061	L	code: .066
S	code: .062	XL	code: .068
M	code: .064	XXL	code: .069

SIZES	XS	S	M	L	XL	2XL
Chest	80-84 cm.	84-88 cm.	88-92 cm.	92-96 cm.	96-101 cm.	101-106 cm.
Waist	64-68 cm.	68-72 cm.	72-76 cm.	76-80 cm.	80-85 cm.	85-90 cm.
Sleeve	59-60 cm.	60-61 cm.	61-62 cm.	62-63 cm.	63-64 cm.	64-65 cm.

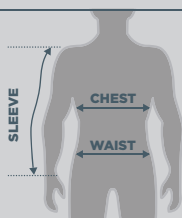

ACCESSORIES



PROTECTOR CE XY905S FB LEV 2
CODE: 0023994.060
SIZE: S
FOR: LADY JACKET (XS,S,M,L,XL,2XL)



RAMSEY VENTED LADY MEMBRANE
CODE: 0023420.090



JACKET ACCESSORIES

DISCOVERY GIBLY MEMBRANE

MAN 0022884.090. / LADY 0022885.090.

COMPONENTS:

Shell 100% Polyamide

MATERIALS:

Outer

Fabric waterproof and breathable, seams totally taped

DETAILS:

Predisposition for the sport jacket (separately sold)

Inner pocket



MAN VERSION 0022884.090.

ONLY FOR: CE DISCOVERY GIBLY JACKET

SIZES

S	code: .062	XL	code: .068
M	code: .064	XXL	code: .069
L	code: .066	3XL	code: .070



LADY VERSION 0022885.090.

ONLY FOR: CE DISCOVERY GIBLY LADY JACKET



SIZES

XS	code: .061	L	code: .066
S	code: .062	XL	code: .068
M	code: .064	XXL	code: .069



RAMSEY VENTED MEMBRANE

MAN 0022649.090. / LADY 0023420.090.

COMPONENTS:

Shell 100% Polyester

MATERIALS:

Outer

Fabric waterproof and breathable, seams totally taped

DETAILS:

Predisposition for the vented jacket (separately sold)

Inner pocket



MAN VERSION 0022649.090.

ONLY FOR: CE RAMSEY VENTED JACKET

SIZES

S	code: .062	XL	code: .068
M	code: .064	XXL	code: .069
L	code: .066	3XL	code: .070



LADY VERSION 0023420.090.

ONLY FOR: CE RAMSEY VENTED LADY JACKET



SIZES

XS	code: .061	L	code: .066
S	code: .062	XL	code: .068
M	code: .064	XXL	code: .069



BACK FOAM REINFORCEMENT

0021845.070

SIZES

S/M	code: .063
------------	-------------------



JACKET ACCESSORIES

OPTIONAL BACK PROTECTOR

COMPONENTS:

Shell: 100% Polyurethane

MATERIALS:
Memory PU

DETAILS:

CERTIFIED BACK PROTECTOR **EN 1621-2: 2014 Type FB Level 2**

Partially perforated

Ergonomic, soft, light and comfort

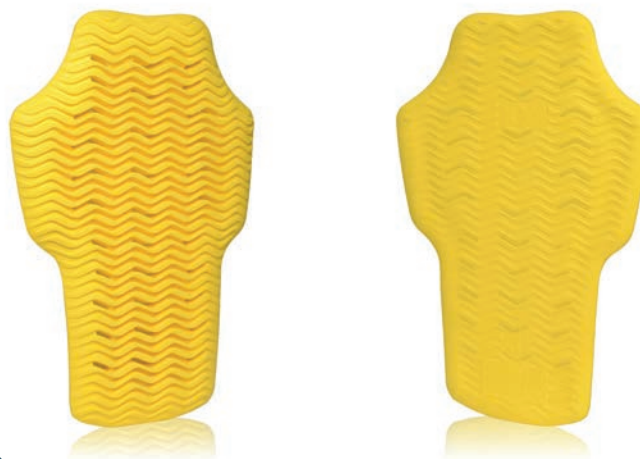

CE XY905S FB LEV 2

CODE 0023994.060

SIZE S

CE XY905M FB LEV 2

CODE 0023995.060

SIZE M

CE XY905L FB LEV 2

CODE 0024248.060

SIZE L

JACKET AND PANTS ACCESSORIES

PROTECTORS

COMPONENTS:

Shell: 100% Polyurethane

CERTIFIED SHOULDER, ELBOW, KNEE AND UPPER TIBIA PROTECTORS EN 1621-1: 2012 Type A Level 1



PROTECTORS CE XY805 TYPE A LEV1
CODE: 0023768.090



PROTECTORS CE XY806 TYPE A LEV1
CODE: 0023769.090

ADVENTURE PANTS

COMPONENTS: 100% polyester

MATERIALS:

Inner Quilted lining and UREAMAX™

5000/5000 ml. removable membrane.

Outer High density Polyester.

DETAILS: Touring fit. Ventilation on the hips.

Adjustable waist with elastic strap; Hook and buttons closure.

Front and rear reflective inserts; 2 pockets.

CE EN 1621-1 CERTIFIED.



UREAMAX™

SIZES

S	code: .062	XL	code: .068
M	code: .064	XXL	code: .069
L	code: .066	3XL	code: .070

SIZES	S	M	L	XL	XXL	3XL
Waist	80-84 cm.	84-88 cm.	88-92 cm.	92-96 cm.	96-100 cm.	100-104 cm.
Hip	97-102 cm.	102-107 cm.	107-112 cm.	112-115 cm.	115-118 cm.	118-121 cm.
Inseam	77-79 cm.	79-81 cm.	81-82 cm.	82-83 cm.	83-85 cm.	85-86 cm.

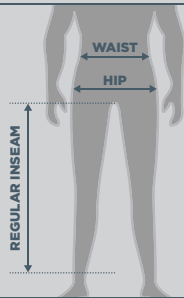

0017807.090.

BLACK

ADVENTURE BAGGY

COMPONENTS: 95,7% Polyester; 4% TPU; 0,3% Elastane

MATERIALS:

Inner Quilted lining and UREAMAX™

5000/5000 ml. removable membrane.

Outer High density Polyester.

DETAILS: Baggy fit. Ventilation on the hips.

Adjustable waist with elastic strap; Hook and buttons closure.

Front and rear reflective inserts; 2 pockets.

CE EN 1621-1 CERTIFIED.



UREAMAX™

SIZES

S	code: .062	XL	code: .068
M	code: .064	XXL	code: .069
L	code: .066	3XL	code: .070

SIZES	S	M	L	XL	XXL	3XL
Waist	80-84 cm.	84-88 cm.	88-92 cm.	92-96 cm.	96-100 cm.	100-104 cm.
Hip	97-102 cm.	102-107 cm.	107-112 cm.	112-115 cm.	115-118 cm.	118-121 cm.
Inseam	77-79 cm.	79-81 cm.	81-82 cm.	82-83 cm.	83-85 cm.	85-86 cm.

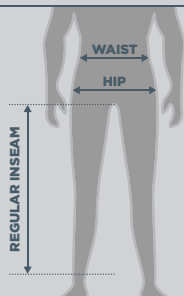

0021702.090.

BLACK



BRAY HILL PANTS

COMPONENTS: 97% polyester, 3% nylon

MATERIALS:

Inner Removable quilted polyester inner lining.

Outer Made of 600D Oxford Polyester with Nylon stretch knees.

DETAILS: Category: Touring.

UREAMAX™ membrane waterproof - water column: 5000 mm.

Adjustable waist;

CERTIFIED PROTECTIONS (CE EN 1621-1)

EVA back protector; Reflective inserts on both front and rear.

Durable stretch fabric inserts on the hips, knees and hollows of the knees for a maximum comfort.



SIZES

S	code: .062	XL	code: .068
M	code: .064	XXL	code: .069
L	code: .066	3XL	code: .070

SIZES	S	M	L	XL	XXL	3XL
Waist	80-84 cm.	84-88 cm.	88-92 cm.	92-96 cm.	96-100 cm.	100-104 cm.
Hip	95-99 cm.	99-103 cm.	103-107 cm.	107-111 cm.	111-115 cm.	115-119 cm.
Inseam	76-77 cm.	77-79 cm.	79-81 cm.	81-82 cm.	82-83 cm.	83-84 cm.

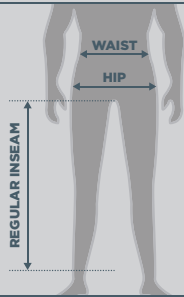

0015972.090.

BLACK

RAMSEY MY VENTED PANTS

COMPOSITION: 100% Polyester

MATERIALS:

Inner: Mesh lining 100% polyester

Outer: polyester with mesh inserts

DETAILS:

Summer pants; Mesh inserts on the front and rear part

Stretch fabric on the rear part and above the knee; Waist adjustable with

hook and loop fastener and straps; Reflective print on left side; Hidden

pockets at the waist; Predisposition for the vented jacket (separately sold)

APPROVED XY CE EN 1621-1 LEVEL 1 PROTECTION KNEE



SIZES

S	code: .062	XL	code: .068
M	code: .064	XXL	code: .069
L	code: .066		

SIZES	S	M	L	XL	XXL
Waist	80-84 cm.	84-88 cm.	88-92 cm.	92-96 cm.	96-100 cm.
Hip	95-99 cm.	99-103 cm.	103-107 cm.	107-111 cm.	111-115 cm.
Inseam	76-77 cm.	77-79 cm.	79-81 cm.	81-82 cm.	82-83 cm.

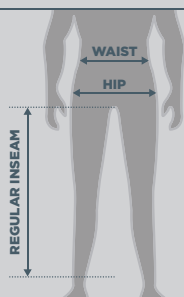

0022112.090.

BLACK



CE PACK JEANS

COMPOSITION:

Shell 98% Cotton 2% Elastane

Lining 65% Polyester 35% Cotton

Insert 72% Polyester, 28% Aramid

MATERIALS:

Outer

- Fabric for pants in denim 11.05 oz stretch

Inner

- Reinforcement in aramid fiber on the knees and back
- Reflective insert on the bottom of the pants to turn up

DETTAGLI:

- Jeans all seasons
- CERTIFIED PANTS **FprEN 17092-3:2018 class A**
- CERTIFIED KNEE PROTECTORS **EN 1621-1: 2012 Type A Level 1**
- 3 front pockets and 2 back pockets



SIZES

28	code: .028	34	code: .034
30	code: .030	36	code: .036
31	code: .031	38	code: .038
32	code: .032	40	code: .040
33	code: .033		

SIZES	28	30	31	32	33	34
Waist	74-79 cm.	79-82 cm.	81-84 cm	84-87 cm	86-89 cm	89-94 cm.
Hip	88-93 cm.	93-96 cm.	95-98 cm	98-101 cm	100-103 cm	103-108 cm.
Inseam	80-85 cm.	80-85 cm.	80-85 cm	80-85 cm	80-85 cm	83-88 cm.

SIZES	36	38	40			
Waist	94-99 cm.	99-104 cm.	104-109 cm.			
Hip	108-113 cm.	113-118 cm.	118-123 cm.			
Inseam	83-88 cm.	83-88 cm.	83-88 cm.			

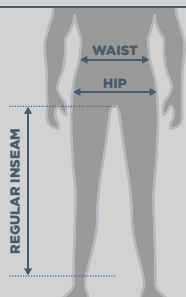

0023746.040.

BLUE

CE PACK LADY JEANS

COMPOSITION:

Shell 98% Cotton 2% Elastane

Lining 65% Polyester 35% Cotton

Insert 72% Polyester, 28% Aramid

MATERIALS:

Outer

- Fabric for pants in denim 11.05 oz stretch

Inner

- Reinforcement in aramid fiber on the knees and back
- Reflective insert on the bottom of the pants to turn up

DETTAGLI:

- Jeans all seasons
- CERTIFIED PANTS **FprEN 17092-3:2018 class A**
- CERTIFIED KNEE PROTECTORS **EN 1621-1: 2012 Type A Level 1**
- 3 front pockets and 2 back pockets



SIZES

25	code: .025	30	code: .030
26	code: .026	31	code: .031
27	code: .027	32	code: .032
28	code: .028	33	code: .033
29	code: .029		

SIZES	25	26	27	28	29	30
Waist	64-67 cm.	67-70 cm.	69-72 cm.	72-75 cm.	74-77 cm.	77-80 cm.
Hip	84-87 cm.	87-90 cm.	89-92 cm.	92-95 cm.	94-97 cm.	97-100 cm.
Inseam	77-83 cm.	77-83 cm.	77-83 cm.	77-83 cm.	77-83 cm.	81-86 cm.

SIZES	31	32	33			
Waist	79-82 cm.	82-85 cm.	84-87 cm.			
Hip	99-102 cm.	102-105 cm.	104-107 cm.			
Inseam	81-86 cm.	81-86 cm.	81-86 cm.			

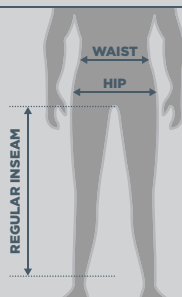

0023747.040.

BLUE

RAIN DEK PACK JACKET

COMPOSITION:

Main Fabric: 100% Polyester

Coating: 100% Thermoplastic Polyurethan (TPU)

MATERIALS:

Outer: Membrane waterproof and breathable 5K/1K, windproof, seams totally taped

DETAILS:

- Sport fit, the garment is is studied to be wear with or without (even the most voluminous) protectors.
- Pocket on chest area to can pack item inside them , with fixing way through strap
- Race numer perfectly visible in all the colorways
- Stretchable neck and cuff with Acerbis silicon logo details
- Refractive Acerbis logo and applications on the front, sleeve and back
- Reccomended offroad use only
- Weight 160 gr



SIZES

S	code: .062	XL	code: .068
M	code: .064	XXL	code: .069
L	code: .066	3XL	code: .070

SIZES	S	M	L	XL	2XL	3XL
Chest	88-94 cm.	94-100 cm.	100-106 cm.	106-112 cm.	112-118 cm.	118-124 cm.
Waist	78-84 cm.	84-90 cm.	90-96 cm.	96-102 cm.	102-108 cm.	108-114 cm.
Sleeve	65-66 cm.	66-67 cm.	67-68 cm.	68-69 cm.	69-70 cm.	70-71 cm.

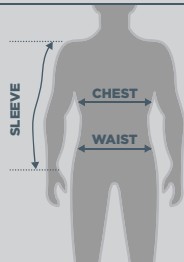

0023691.060.

FLUO YELLOW



0023691.030.

WHITE



0023691.090.

BLACK

RAIN PRO TRANSPARENT 3.0 JACKET

COMPOSITION:

- 100% chlorofibre

DETAILS:

- Transparent rain jacket
- Central zip closure
- Mesh inserts on the sides in contrasting color
- Bottom and cuffs with elastic and contrasting color
- Neoprene collar with contrasting color
- Custom ACERBIS logos



SIZES

S/M	code: .063	XXL	code: .069
L/XL	code: .067	3XL	code: .070

SIZES	S/M	L/XL	XXL	3XL		
Chest	90-101 cm.	101-116 cm.	116-123 cm.	123-129 cm.		
Sleeve	60-63 cm.	64-67 cm.	68-69 cm.	70-72 cm.		

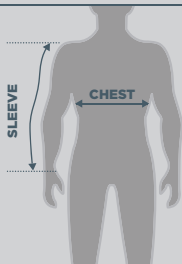

0022174.120.
TRANSPARENT



RAIN TRANSPARENT 3.0 JACKET

COMPOSITION:

- 100% chlorofibre

DETAILS:

- Transparent rain jacket
- Central zip closure
- Ventilation eyelets under the armpit
- Raglan sleeve cut
- Elastic on the bottom with contrast colour
- Custom ACERBIS logos



SIZES

S/M	code: .063	XXL	code: .069
L/XL	code: .067	3XL	code: .070

SIZES	S/M	L/XL	XXL	3XL		
Chest	90-101 cm.	101-116 cm.	116-123 cm.	123-129 cm.		
Sleeve	60-63 cm.	64-67 cm.	68-69 cm.	70-72 cm.		

RAIN TRANSPARENT 3.0 PANTS

COMPOSITION:

100% chlorofibre

DETAILS:

- Transparent rain pant
- Elastic on the waist with contrast colour
- Custom ACERBIS logos



SIZES

S/M	code: .063	XXL	code: .069
L/XL	code: .067	3XL	code: .070

SIZES	S/M	L/XL	XXL	3XL		
Waist	79-89 cm.	89-99 cm.	99-104 cm.	104-107 cm.		
Hip	94-104 cm.	104-114 cm.	114-120 cm.	120-126 cm.		
Inseam	74-78 cm.	78-82 cm.	82-84 cm.	84-85 cm.		

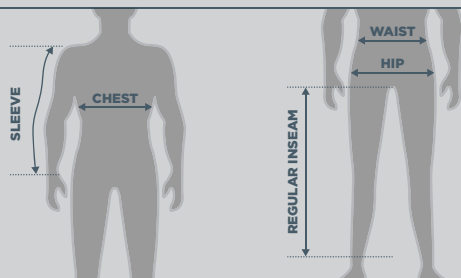

TRANSPARENT
 JACKET COD. 0022172.120.
 PANTS COD. 0022173.120.

RAIN TRANSPARENT 3.0 KID JACKET

COMPOSITION:

- 100% chlorofibre

DETAILS:

- Transparent rain jacket
- Central zip closure
- Ventilation eyelets under the armpit
- Raglan sleeve cut
- Elastic on the bottom with contrast colour
- Custom ACERBIS logos



SIZES

S/M	code: .063	XXL	code: .069
L/XL	code: .067		

SIZES	S/M	L/XL	XXL			
Chest	66-75 cm.	75-85 cm.	85-90 cm.			
Sleeve	43-51 cm.	51-58 cm.	58-60 cm.			

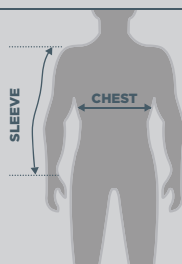

0023191.120.
TRANSPARENT



HIGHWAY VEST

COMPONENTS: 90% Polyester, 7% Nylon, 3% Other fibers

DETAILS:

- Long cut vest with high visibility.
- Reflective inserts on the front, side and rear.
- **BACK PROTECTOR LEVEL 2 PROTECTION STANDARD.**
- Adjustable waist straps.
- Side zippers allowing use over jacket.
- Two front pockets and one rear.
- **EN ISO 20471 APPROVED HIGH VISIBILITY**



SIZES

S/M	code: .063	L/XL	code: .067



0021674.060.
FLUO YELLOW



FREEWAY VEST

COMPONENTS: 100% Polyester

DETAILS:

- Short cut vest with high visibility.
- Reflective inserts on the front, side and rear.
- **BACK PROTECTOR LEVEL 2 PROTECTION STANDARD.**
- Adjustable waist straps.
- Side zippers allowing use over jacket.
- Two front pockets and one rear.
- **EN ISO 20471 APPROVED HIGH VISIBILITY**



SIZES

S/M	code: .063	L/XL	code: .067



0021675.060.
FLUO YELLOW



RAIN SET MAT-X 3.0

COMPOSITION:

- 100% Polyester.

DETAILS:

- Rain suit with jacket and pant
- Central zip closure and hook and loop fastener flap
- Adjustable waist with hook and loop fastener flap
- 2 front pockets
- Internal waistband on the bottom
- Reflective ACERBIS logo on the back
- Pant with elastic waist
- Pocket on right leg
- Bottom leg closure with hook and loop fastener flap
- Adjustable with zip on the bottom
- Reflective custom logos



SIZES

S	code: .062	XL	code: .068
M	code: .064		
L	code: .066		

SIZE	S	M	L	XL
Chest	95-98 cm.	98-105 cm.	105-109 cm.	109-113 cm.
Sleeve	61-63 cm.	63-65 cm.	65-67 cm.	67-68 cm.
SIZE	S	M	L	XL
Waist	80-84 cm.	84-88 cm.	88-92 cm.	92-96 cm.
Hip	95-99 cm.	99-103 cm.	103-107 cm.	107-111 cm.
Inseam	76-77 cm.	77-79 cm.	79-81 cm.	81-82 cm.

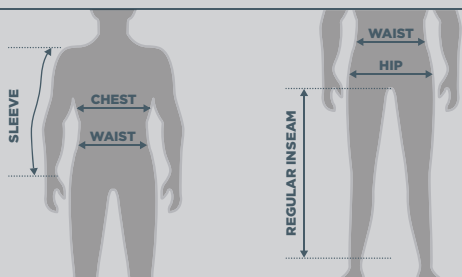

0022167.090.

BLACK



RAIN SUIT LOGO

COMPONENTS: 70% PVC, 30% polyester

MATERIALS:

Inner Polyester.

Outer Polyester and PVC.

DETAILS: Adjustable cuffs with elastic panel and hook and loop fastener. Elastic material on the waist for better comfort. Zip closure at the end of the pants for an easy fit.

REFLECTIVE FABRICS EN ISO 20471 APPROVED.

Waterproof pocket on the front of the jacket. Hooded zipper. Ventilation and reflective details on the back of jacket.



SIZES

XS	code: .061	XL	code: .068
S	code: .062	XXL	code: .069
M	code: .064	3XL	code: .070
L	code: .066		

SIZES	XS	S	M	L	XL
Chest	92-95 cm.	95-98 cm.	98-105 cm.	105-109 cm.	109-113 cm.
Sleeve	60-61 cm.	61-63 cm.	63-65 cm.	65-67 cm.	67-68 cm.

SIZES	XS	S	M	L	XL
Waist	76-80 cm.	80-84 cm.	84-88 cm.	88-92 cm.	92-96 cm.
Hip	93-95 cm.	95-99 cm.	99-103 cm.	103-107 cm.	107-111 cm.
Inseam	75-76 cm.	76-77 cm.	77-79 cm.	79-81 cm.	81-82 cm.

SIZES	2XL	3XL
Chest	113-116 cm.	116-119 cm.
Sleeve	68-69 cm.	69-70 cm.

SIZES	2XL	3XL
Waist	96-100 cm.	100-104 cm.
Hip	111-115 cm.	115-119 cm.
Inseam	82-83 cm.	83-84 cm.

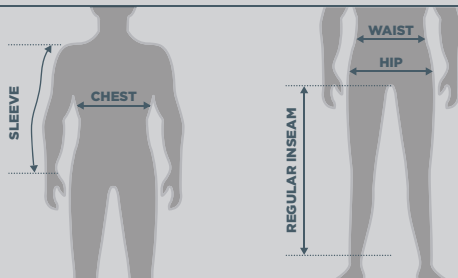

0016428.318.
FLUO YELLOW/BLACK



0016428.090.
BLACK

0016428.209.
FLUO ORANGE/BLACK



0016428.251.
BLUE/BLACK



0016428.349.
RED/BLACK

CORPORATE RAINCOAT

MATERIAL: 100% POLYESTER



SIZES

M	code: .064	XL	code: .068
L	code: .066	XXL	code: .069



0011506.090.

BLACK

H2O RAIN GLOVES COVER

COMPONENTS: 100% Polyester

MATERIALS:

- Fabric in polyester: waterproof

DETAILS:

- Packable glove cover
- With opening and cuff elastic
- Seams totally taped
- Reflective Acerbis logo on the front



SIZES

S/M	code: .063	XXL	code: .069
L/XL	code: .067		



0024256.090.

BLACK



H2O RAIN BOOT COVER

COMPONENTS: 80% Polyester 20% Rubber

MATERIALS:

- Fabric in polyester: waterproof
- Rubber sole: skidproof and fl exible

DETAILS:

- Packable boot cover
- Openable on the side with rubber elastic, zip and hook and loop fastener
- Elastic on the foot
- Seams totally taped
- Reflective Acerbis logo and applications outside and back



SIZES

S (37-38)	code: .062	XL (43-44)	code: .068
M (39-40)	code: .064	2XL (45-46-47)	code: .069
L (41-42)	code: .066		



0024257.090.

BLACK

LIGHT 4.0 RAIN BOOT COVER

COMPONENTS: 100% Polyester

MATERIALS:

- Light fabric in polyester: waterproof
- Reinforcement on the left boot cover for gear changing and for the sole

DETAILS:

- Packable boot cover
- Boot cover opening and foot adjustable
- Seams totally taped
- Reflective Acerbis logo outside



SIZES

S (37-38)	code: .062	XL (43-44)	code: .068
M (39-40)	code: .064	2XL (45-46-47)	code: .069
L (41-42)	code: .066		



0023507.063.

FLUO YELLOW









GLOVES GUANTI

- P. 120** Mx-Wp Homologated
- P. 121** Mx-Wp
- P. 122** Mx X-H
- P. 123** Mx X-P
- P. 124** Mx X-K Kid
- P. 125** Palm Protector
- P. 126** CE Adventure
- P. 127** CE Carbon "G" 3.0
- P. 128** CE G-Road P
- P. 128** CE G-Road
- P. 129** Zero Degree 2.0
- P. 129** Neoprene 2.0
- P. 130** Freeland 2.0
- P. 130** Urban
- P. 131** CE Ramsey My Vented



MX-WP HOMOLOGATED GLOVES

COMPONENTS: 57% Polyester, 40% Polyurethane, 3% Nylon.

MATERIALS:

- **Back of hand** Stretch fabric
- **Palm** Single panel in Nanofront®, Outer reinforcement in Synthetic leather, padding 3MM and inner reinforcement resistant to tearing and abrasion.
- **Lining** Waterproof and breathable HIPORA® membrane, fully taped seams.

DETAILS:

- Enduro fit.
- **CERTIFIED GLOVES EN 13594:2015.**
- Glove with extreme precurved and comfortable fit without stitching on the fingertips.
- Cuff adjustment.
- Rubber reinforcement over the fingers.
- Silicon insert under the fingertips for a better grip.



NANOFRONT® HIPORA®

SIZES

S	code: .062	XL	code: .068
M	code: .064	XXL	code: .069
L	code: .066		



0023419.293.
GREY/BLACK

MX-WP GLOVES

COMPONENTS: 57% Polyester, 37% Polyurethane, 6% Nylon.

MATERIALS:

- **Back of hand** Stretch fabric
- **Palm** Single panel in Nanofront®, Outer reinforcement in tear- and abrasion-resistant synthetic leather.
- **Lining** Waterproof and breathable HIPORA® membrane, fully taped seams.

DETAILS:

- Enduro fit.
- Glove with extreme precurved and comfortable fit without stitching on the fingertips.
- Cuff adjustment.
- Rubber reinforcement over the fingers.
- Silicon insert under the fingertips for a better grip.



NANOFONT®

HIPORA®

SIZES

S	code: .062	XL	code: .068
M	code: .064	XXL	code: .069
L	code: .066		



0023264.207.
ORANGE/GREY



0023264.293.
GREY/BLACK



0023264.426.
LIGHT BLUE/BLUE



0023264.318.
BLACK/FLUO YELLOW



MX X-H GLOVES

COMPONENTS: 70% Polyester, 20% Polyurethane, 10% Nylon.

MATERIALS:

- **Back of hand** Stretch fabric.
- **Palm** Single panel in Nanofront®, outer reinforcement in tear- and abrasion-resistant synthetic leather, 3 mm padding and tear- and abrasion-resistant inner reinforcement.

DETAILS:

- Enduro fit.
- **CERTIFIED GLOVES EN 13594:2015**
- Glove with extreme precurved and comfortable fit without stitching on the fingertips
- Cuff adjustment
- Rubber reinforcement over the fingers
- Touchscreen gloves



NANOFONT®

SIZES

S	code: .062	XL	code: .068
M	code: .064	XXL	code: .069
L	code: .066		



0023409.203.
BLACK/FLUO ORANGE



0023409.287.
GREY/WHITE

MX X-P GLOVES

COMPONENTS: 80% Polyester, 10% Polyurethane, 10% Nylon.

MATERIALS:

- **Back of hand** Stretch fabric.
- **Palm** Single panel in Nanofront®, outer reinforcement in tear- and abrasion-resistant synthetic leather.

DETAILS:

- Enduro fit.
- Glove with extreme precurved and comfortable fit without stitching on the fingertips.
- Cuff adjustment.
- Rubber reinforcement over the fingers.
- Silicon insert under the fingertips for a better grip.



NANOFONT®

SIZES

S	code: .062	XL	code: .068
M	code: .064	XXL	code: .069
L	code: .066		



0023408.315.

BLACK/WHITE



0023408.207.

ORANGE/GREY



0023408.347.

RED/GREY



0023408.249.

BLUE/GREY



0023408.291.

GREY/GREY



0023408.293.

GREY/BLACK



0023408.343.

RED/WHITE



0023408.203.

ORANGE/WHITE



0023408.294.

GREY/GOLD



0023408.273.

YELLOW/WHITE



0023408.371.

GREEN/WHITE



MX X-K KID GLOVES

COMPONENTS: 80% Polyester, 10% Polyurethane, 10% Nylon.

MATERIALS:

- **Back of hand** Stretch fabric.
- **Palm** Single panel in Nanofront®, outer reinforcement in tear-and-abrasion-resistant synthetic leather.

DETAILS:

- Enduro fit.
- Glove with extreme precurved and comfortable fit without stitching on the fingertips.
- Cuff adjustment.
- Rubber reinforcement over the fingers.
- Silicon insert under the fingertips for a better grip.



NANOFRONT®

SIZES

XS	code: .061	L	code: .066
S	code: .062	XL	code: .068
M	code: .064	XXL	code: .069



0023410.207.
ORANGE/GREY



0023410.249.
BLUE/GREY



0023410.899.
GREY/DARK GREY



0023410.343.
RED/WHITE



0023410.293.
GREY/BLACK

PALM PROTECTOR

COMPONENTS:

- 60% Polyester; 40% Neoprene

DETAILS:

- Made using a thin material to offer complete protection of the palm of the hand
- Perfect for protecting against blisters and for absorbing vibrations from the handlebars



SIZES

S/M	code: .063	L/XL	code: .067
------------	-------------------	-------------	-------------------



0022717.010.

ORANGE



0022717.040.

BLUE



0022717.090.

BLACK



0022717.060.

YELLOW



0022717.110.

RED



0022717.130.

GREEN



CE ADVENTURE GLOVES

COMPOSITION:

BLACK 090 43% Nylon, 32% Polyurethane, 23% Polyester, 2% Neoprene
BLACK/GREY 319 50% Polyester, 25% Nylon, 23% Polyurethane, 2% Neoprene

MATERIALS:

Backhand: Highly abrasion-resistant fabric

Palm: Single panel in Nanofront

DETAILS:

• CERTIFIED GLOVES EN 13594:2015 Lev 1 KP

- Touchscreen gloves
- Foam reinforcement on palm and on the back of the thumb
- Reinforcement on fingers
- Protection on knuckles
- Gloves combined to the ADVENTURE suit



NANOFRONT® **Carino™**

SIZES

S	code: .062	XL	code: .068
M	code: .064	XXL	code: .069
L	code: .066		



0023487.319.
BLACK/GREY



0023487.090.
BLACK

CE CARBON "G" 3.0 GLOVES

COMPOSITION:

- 40% Polyester; 30% Nylon; 10% Polyurethane; 10% Neoprene; 10% Goat Leather

MATERIALS:

Backhand: Neoprene panel

Palm: Single panel in vented Nanofront

DETAILS:

- **CERTIFIED GLOVES EN 13594:2015.**
- Silicone inserts on fingertips to get the maximum grip
- No seams on fingertips
- Wrist closure with soft rubber patches
- Carbon effect protection knuckles
- Soft rubber reinforcements on fingers
- Reflective piping
- Use of fluo colours
- Touchscreen gloves.



NANOFONT *Clarino*™

SIZES

S	code: .062	XL	code: .068
M	code: .064	XXL	code: .069
L	code: .066		



0022214.279.

FLUO YELLOW/BLACK



0022214.319.

BLACK/GREY



CE G-ROAD P GLOVES

COMPONENTS: 50% Nylon; 25% Polyester; 20% Polyurethane; 5% PVC.

MATERIALS:

Back of hand: Polyester **Palm:** Synthetic Leather **Inner:** Hypora Membrane

DETAILS:

- **Gloves certified EN 13594:2015**
- Highly resistant fabric back, with reflective details for passive safety
- Synthetic leather palm with abrasion-resistant reinforcements
- Internal area with Hypora Membrane to make the glove impermeable
- Soft ribbing fits wrist snugly
- Wrist closure with strap
- Touchscreen gloves
- Ideal also in harsh weather conditions
- Soft protection on back, **EN 13594: 2015 CERTIFIED**
- Gloves for motorcycle use level 1 with knuckle protectors



HIPORA® VISCO-LAB

SIZES

S	code: .062	XL	code: .068
M	code: .064	XXL	code: .069
L	code: .066	3XL	code: .070

CE G-ROAD GLOVES

COMPONENTS: 60% Nylon; 20% Polyester; 15% Polyurethane; 5% PVC.

MATERIALS: Back of the hand: Polyester; **Palm:** Synthetic Leather.

Inner: Hipora Membrane; **Lining:** Thinsulate.

DETAILS:

- **Gloves certified CE EN 13594:2015**
- Highly resistant fabric back, with reflective details for passive safety
- Synthetic leather palm with abrasion-resistant reinforcements
- Internal area with Hipora Membrane to make the glove impermeable
- Cuff closing with hook and loop fastener flap
- Touchscreen gloves
- Ideal also in harsh weather conditions thanks to Thinsulate lining
- Gloves for motorcycle use level 1



HIPORA®
3M
Thinsulate
INSULATION

SIZES

S	code: .062	XL	code: .068
M	code: .064	XXL	code: .069
L	code: .066	3XL	code: .070



0022667.090.

BLACK



0022666.090.

BLACK

ZERO DEGREE 2.0 GLOVES

COMPONENTS: 50% synthetic leather, 50% neoprene

MATERIALS:

Back of hand Soft fleece.

Palm Clarino™.

DETAILS:

- Soft fleece strap closure.
- Clarino reinforcements in the area of contact with the handlebar.
- Padding on the palm.
- Reflective silicone prints on the back of the hand.
- Foam reinforcements on the palm.
- Silicone printing for enhanced grip.
- Suitable for extreme cold conditions.



SIZES

S	code: .062	XL	code: .068
M	code: .064	XXL	code: .069
L	code: .066		



0017791.090.

BLACK

NEOPRENE 2.0 GLOVES

COMPONENTS: 60% polyester, 40% synthetic leather

MATERIALS:

Back of hand Neoprene.

Palm Clarino™.

DETAILS:

- Neoprene strap closure
- Clarino reinforcements in the areas of contact with the handlebar.
- Reflective silicone prints on the back of hand.
- Silicone printing for enhanced grip



SIZES

S	code: .062	XL	code: .068
M	code: .064	XXL	code: .069
L	code: .066		



0017790.090.

BLACK



FREELAND 2.0 GLOVES

COMPONENTS: 50% fleece; 47% synthetic leather, 3% elastane.

MATERIALS:

- **Back of hand** Highly technical Nylon.
- **Palm** Synthetic leather.

DETAILS:

- Hipora® waterproof membrane.
- Synthetic leather reinforcement on the palm and fingertips.
- Reflective silicone print on the back.
- Silicone printing for enhanced grip



HIPORA®

SIZES

S	code: .062	XL	code: .068
M	code: .064	XXL	code: .069
L	code: .066	3XL	code: .070



0017789.090.

BLACK

X-ROCK

Powered by 





BOOTS STIVALI

- P. 134** X-Rock Boots
- P. 136** X-Move 2.0 Boots
- P. 140** X- Pro V Boots
- P. 144** X-Team Boots
- P. 148** X- Kid Boots
- P. 151** Jurby Boots
- P. 151** Asphalt Boots
- P. 152** Walky Shoes
- P. 152** Step Shoes
- P. 153** Key Sneaker
- P. 153** Mud Shoes
- P. 154** Sp Club Wood Shoes
- P. 154** X-Kal Shoes
- P. 155** 00Set Boots



X-ROCK BOOTS

DETAILS:

- Cut and abrasion-resistant leather and microfibre uppers
- Hinge at the ankle area
- Protection of the shinbone with upper and lower anatomically shaped shin guards
- Shaped heel guard to make changing gears easier when starting
- Protection of the midfoot and toe area in plastic with ribbing for improved impact absorption
- TPU Insert in differentiated density in the gear change area for maximum control
- Burn Guard Grip in heat and wear-resistant vulcanized rubber
- Fastens with 4 buckles with large, new aluminium levers
- Shin gaiters in permeable microfibre
- **Vibram® wear-resistant sole in shock-proof "Double Composite" rubber EN 13634:2010 certified**
- Shock absorbing antibacterial insole with multilayered structure
- Inner made in 3d Mesh for optimum comfort and sweat absorption
- Insole made in composite plastic/steel material to guarantee greater rigidity and absorption on the foot against compression impacts
- Reinforced steel toe
- **EN 13634: 2017 CERTIFIED**



SIZES

39	code: .039	44	code: .044
40	code: .040	45	code: .045
41	code: .041	46	code: .046
42	code: .042	47	code: .047
43	code: .043		

0022441.319.

BLACK/GREY





0022441.245.
BLUE/WHITE



X-MOVE 2.0 BOOTS

DETAILS:

- Hinge in the ankle area.
- Leather upper.
- Rubber inserts on the inside of the calf to increase resistance to abrasion.
- Interior in hypoallergenic fabric.
- Extra padding to protect the ankle.
- TPU soft gaiter at the top with hook and loop fastener closure.
- Double stitching **VIBRAM** sole.
- New aluminum buckles with memory and a quick release/locking system.
- Reinforced steel toe.
- **CERTIFIED EN 13634:2017**



SIZES

39	code: .039	44	code: .044
40	code: .040	45	code: .045
41	code: .041	46	code: .046
42	code: .042	47	code: .047
43	code: .043		



0017719.110.

RED



0017719.010.
ORANGE



0017719.041.
NAVY BLUE



0017719.090.
BLACK



X-ROCK REPLACEMENT

STRAPS SET

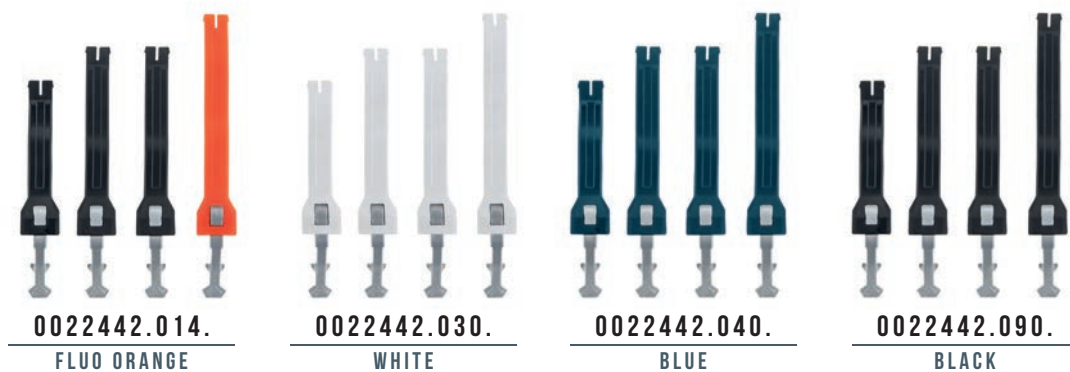

BUCKLE KIT



RECEIVER



TOE PLATE



SOLE

SIZES			
39-41	code: .041	45-47	code: .047
42-44	code: .044		



X-MOVE REPLACEMENT

X-MOVE 2.0 STRAPS SET



0017737.010.
ORANGE



0017737.014.
FLUO ORANGE



0017737.020.
GREY



0017737.030.
WHITE



0017737.041.
NAVY BLUE



0017737.090.
BLACK



0017737.110.
RED

X-MOVE STRAPS SET



0016238.030.
WHITE



0016238.090.
BLACK

X-MOVE 2.0 BUCKLE KIT



0017738.014.
FLUO ORANGE



0017738.040.
BLUE



0017738.060.
YELLOW



0017738.110.
RED

SOLE

SIZES

39-41	code: .041	45-47	code: .047
42-44	code: .044		



0016285.030.
WHITE



TOE PLATE



0013781.



X-PRO V BOOTS

DETAILS:

- Leather boots.
- Extended plastic covers.
- Steel capped toe.
- Vulcanized rubber.
- 4 micrometer adjustment straps on an aluminum base.
- Abrasion resistant suede heat guard.
- **VIBRAM®** outersole.
- **CERTIFIED EN 13634:2017**



SIZES

39	code: .039	44	code: .044
40	code: .040	45	code: .045
41	code: .041	46	code: .046
42	code: .042	47	code: .047
43	code: .043		



0021596.110.

RED



0021596.245.

NAVY BLUE/LIGHT BLUE



0021596.090.

FULL BLACK



0021596.290.

GREY/YELLOW



0021596.346.

RED/YELLOW



0021596.379.

GREEN/RED



X-PRO V. REPLACEMENT

X-PRO V STRAPS SET



0017779.014.
FLUO ORANGE



0017779.030.
WHITE



0017779.040.
BLUE



0017779.061.
YELLOW



0017779.090.
BLACK



0017779.091.
MATT BLACK



0017779.110.
RED



0017779.131.
GREEN 2

SCOTH/GRAFFITI STRAPS SET



0013743.030.
WHITE



0013743.090.
BLACK

TOE PLATE



0013781.

SOLE

SIZES

39-41	code: .041	45-47	code: .047
42-44	code: .044		



0016285.030.
WHITE





Massimo Bianconcini
#929
Italia



X-TEAM BOOTS

DETAILS:

- Protective boots that are extremely lightweight
- Cut and abrasion-resistant uppers
- Heel protection in elastomeric material for improved comfort and shock absorption
- Differentiated structure TPU inserts in the area of the tibia, ankle and gear-change for maximum protection
- 4-clasp fastening with buckles for micrometric adjustment and hook and loop fastener on the gaiter.
- Heat protection in suede
- Gaiter and tibial folds in soft cut and abrasion-proof microfiber
- Highly abrasion-resistant dual-density rubber sole
- Interior made of 3D Mesh for improved comfort and sweat absorption
- **CERTIFICATION EN 13634: 2017**

DETTAGLI:



SIZES

39	code: .039	44	code: .044
40	code: .040	45	code: .045
41	code: .041	46	code: .046
42	code: .042	47	code: .047
43	code: .043		



0022999.243.

BLUE/ORANGE





0022999.245.
BLUE/WHITE



0022999.319.
BLACK/GREY



0022999.743.
CAMOUFLAGE





0022999.203.
ORANGE/WHITE



0022999.315.
BLACK/WHITE



0022999.343.
RED/WHITE



X-TEAM REPLACEMENT

X-TEAM STRAPS SET



0023289.010.
ORANGE



0023289.020.
SILVER



0023289.030.
WHITE



0023289.040.
BLUE



0023289.060.
YELLOW



0023289.061.
FLUO YELLOW



0023289.090.
BLACK



0023289.100.
SAND



0023289.110.
RED



0023289.130.
GREEN



X-KID BOOTS

DETAILS:

- Customized plastic protection;
- Printed Leather;
- Steel-capped toe;
- Customized gaiter in vulcanized rubber;
- 3 aluminum adjustments with micrometric increments;
- Abrasion-resistant suede heat guard.
- Sole resistant to abrasion, oil and gasoline;
- **CERTIFIED EN 13634:2017**



SIZES

32	code: .032	36	code: .036
33	code: .033	37	code: .037
34	code: .034	38	code: .038
35	code: .035		



0023415.426.
LIGHT BLUE/BLUE



0023415.010.

ORANGE



0023415.090.

BLACK



0017934.344.

RED/BLUE

X-KID REPLACEMENT

X-KID STRAPS SET



000000 015VAT

0017779.014.

FLUO ORANGE



000000 015VAT

0017779.030.

WHITE



000000 015VAT

0017779.040.

BLUE



000000 015VAT

0017779.041.

NAVY BLUE



000000 015VAT

0017779.061.

YELLOW



000000 015VAT

0017779.090.

BLACK



000000 015VAT

0017779.091.

MATT BLACK



000000 015VAT

0017779.110.

RED



000000 015VAT

0017779.131.

GREEN 2

TOE PLATE



0013782.





JURBY BOOTS

MATERIALS:

Leather upper. Rubber sole 100% resistant to abrasion, oil and gasoline.

DETAILS: Touring fit; Waterproof membrane; Hypoallergenic fabric inserts. Reinforced protection for shin, Ankle, & heels; TPU inserts. YKK zipper and hook and loop fastener closure.

CERTIFIED EN 13634:2010.



SIZES

37	code: .037	43	code: .043
38	code: .038	44	code: .044
39	code: .039	45	code: .045
40	code: .040	46	code: .046
41	code: .041	47	code: .047
42	code: .042		



0016803.090.

BLACK

ASFALT BOOTS

MATERIALS:

- Synthetic upper
- Rubber sole 100% waterproof

DETAILS:

- Touring fit
- Waterproof membrane
- Hypoallergenic fabric lining
- Reinforced protection for shin, Ankle, & heels
- TPU inserts
- YKK zipper and hook and loop fastener closure

CERTIFIED EN 13634:2010



SIZES

37	code: .037	43	code: .043
38	code: .038	44	code: .044
39	code: .039	45	code: .045
40	code: .040	46	code: .046
41	code: .041	47	code: .047
42	code: .042		



0023927.090.

BLACK



WALKY SHOES

DETAILS: Suede leather 100% waterproof bike shoes.
Ankle and toes reinforcements. Extra resistance tissue at shifter.
Anti slip sole; Soft hypoallergenic inner liner.
Certified EN13634 :2015



SIZES

37	code: .037	43	code: .043
38	code: .038	44	code: .044
39	code: .039	45	code: .045
40	code: .040	46	code: .046
41	code: .041	47	code: .047
42	code: .042		



0017811.090.

BLACK

STEP SHOES

DETAILS:

- Suede synthetic leather bike shoes
- 100% waterproof
- Ankle and toes protection inserts
- Extra resistance tissue at shifter
- Anti slip sole
- Soft hypoallergenic inner liner
- Resistant to oil and petrol abrasion
- **Certified EN13634:2015**



SIZES

40	code: .040	46	code: .046
41	code: .041	47	code: .047
42	code: .042		
43	code: .043		
44	code: .044		
45	code: .045		



0023928.090.

BLACK

KEY SNEAKER

MATERIALS:

50% Nylon; 25% Real leather; 25% Polyurethane

DETAILS:

Ergonomic sneakers technically designed; Suede effect on the toe; Reinforcements for extra support; Iron Texture inserts; Zipper Ventilation inserts



SIZES

41	code: .041	44	code: .044
42	code: .042	45	code: .045
43	code: .043	46	code: .046



0021896.070.

GREY

MUD SHOES

COMPONENTS:

- 50% nylon; 50% PU

DETTAGLI:

- Winter boot, flexible, light and waterproof
- Heel and toe reinforcement
- Hot-welded motif, no stitching, with details in contrasting color
- Internal part in soft mesh and jacquard fabric in contrasting color
- Lace-up with jacquard shoe laces with motif in contrasting color
- Resistant rubber sole in contrasting color
- **Hydroguard 8000 /8000ml**



SIZES

41	code: .041	45	code: .045
42	code: .042	46	code: .046
43	code: .043		
44	code: .044		



0022810.318.

BLACK/YELLOW



SP CLUB WOOD SHOES

COMPONENTS:

- 95% PU; 5% nylon

DETAILS:

- Winter boot in synthetic material with faux leather effect
- Matching velvet in the upper part of the shoe for added comfort
- Matching sole on the base, flexible and resistant
- Matching shoe laces

SIZES

41	code: .041	44	code: .044
42	code: .042	45	code: .045
43	code: .043	46	code: .046



0022771.090.

BLACK

X-KAL SHOES

MATERIALS:

Upper 80% Polyester; 10% Synthetic; 10% TPU

Lining 100% Polyester

Insole 100% Polyester

Outsole 80% Phylon + 20% TPR

DETAILS:

- Jacquard Seamless upper shoes with personalized design
- Thermoformed and Perforated Insole with Breathable Mesh
- Sole with Rubber insert in areas with increased wear



0023613.030.

WHITE



SIZES

41	code: .041	44	code: .044
42	code: .042	45	code: .045
43	code: .043	46	code: .046



0023613.090.

BLACK

OFFSET BOOTS

MATERIALS:

100% Rubber

DETAILS:

- **EN ISO 20345:2011 certified**
- Water, mud, oil and grease protection
- Maximum protection against crushing of the toes thanks to the steel cap and maximum protection against penetration
- Outsole with grip



SIZES

40	code: .040	44	code: .044
41	code: .041	45	code: .045
42	code: .042	46	code: .046
43	code: .043	47	code: .047



0023859.060.

YELLOW



PROTECTIONS

PROTEZIONI

- P. 158** Galaxy Body Armour
- P. 159** Galaxy Jacket
- P. 159** Jump Mx Chest Protector
- P. 160** X-Fit Future Body Armour
- P. 161** Scudo 3.0 Body Armour
- P. 162** Mx Soft Pro Body Armour
- P. 163** Koerta 2.0 Body Armour
- P. 164** X-Air Body Armour
- P. 165** X-Air Vest
- P. 166** Gravity 1621 Body Armour
- P. 167** Gravity Body Armour
- P. 168** Profile Chest Protector
- P. 170** Pulsar Back Protector
- P. 171** Back Comfort 2.0 Back Protector
- P. 172** Gorilla Knee Guards
- P. 173** X- Strong Knee Guards
- P. 174** Impact Evo 3.0 Knee Guards
- P. 175** Soft 3.0 Elbow Guards
- P. 175** Soft 3.0 Knee Guards
- P. 176** X-Fit Elbow Guards
- P. 176** Profile 2.0 Knee Guards
- P. 177** X-Fit Future Kid Body Armour
- P. 178** Scudo Junior 2.0 Body Armour
- P. 179** Gravity Kid Body Armour
- P. 180** Cub 2.0 Chest
- P. 181** Impact Junior Knee Guards
- P. 181** Profile 2.0 Junior Knee Guards
- P. 182** Soft Kid Elbow Guard
- P. 182** Soft Kid Knee Guards
- P. 183** Moto Brand 2.0 Belt
- P. 183** Moto Brand 2.0 Junior Belt
- P. 183** Profile 2.0 Belt
- P. 184** K-Belt Belt
- P. 184** X-Roll
- P. 184** X-Roll Junior
- P. 185** X-Round Collar
- P. 185** X-Round Kid Collar
- P. 186** X-Fit Pants L Riding Pants
- P. 186** X-Fit Pants S Riding Pants
- P. 187** Free Moto 2.0 Riding Shorts
- P. 187** Soft 2.0 Riding Shorts
- P. 188** X-Body Winter Technical Undergear
- P. 189** X-Body Summer Technical Undergear
- P. 190** X-Knee Geco Underwear Reinforcement
- P. 190** Tube Knee Leech Reinforcement
- P. 191** Elastic Socks
- P. 191** X-Leg Pro Socks
- P. 192** Mx Pro Socks
- P. 193** Mx Impact Socks
- P. 194** Mx Impact Junior Socks
- P. 194** Cotton Socks
- P. 195** Sport Socks





PROTECTIONS / PROTEZIONI



GALAXY BODY ARMOUR

MATERIALS:

Polyurethane 45%, Polypropylene 30%, Polyester 11%, Spandex 3%, Steel 3%, Aluminium 2%, Nylon 3%, Rubber 2%, Others 1%

DETAILS:

- Innovative nest-texture for the plastic parts: ventilation and protection guaranteed.
- Solid plates enclosed in a soft memory foam for a better shock-absorbing protection.
- Front/Back protection and lower plate removable, to accommodate the Neck brace.
- Shoulder band closure with hook and loop fastener adjustments
- Coccyx-shield removable cover.
- Waist band closure with hook and loop fastener adjustments
- **CHEST PROTECTION IS 1621/3 2017 CERTIFIED**
- **BACK PROTECTION IS EN 1621-2/2014 LEVEL 2 CERTIFIED**
- Extra insert for hips protection
- Separated elastic body armour for maximum ventilation, with **CERTIFIED (1621/1) REMOVABLE SHOULDER AND ELBOW PADS** made of memory foam
- Side YKK zipper



0023731.293.
GREY/BLACK

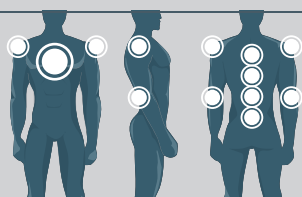

6 PROTECTIVE AREAS

SIZES

S/M	160-175 cm - 65/75 Kg	code: .063
L/XL	175-190 cm - 75/90 Kg	code: .067
XXL	190-200 cm - 90/105 Kg	code: .069



0023731.232.
WHITE/BLUE



0023731.237.
WHITE/BLACK

GALAXY JACKET

MATERIALS:

Polyurethane 42%, Polyester 40%, Spandex 9%, Nylon 7%, Rubber 2%

DETAILS:

- Separated elastic body armour for maximum ventilation, with **CERTIFIED (1621/1) REMOVABLE SHOULDER AND ELBOW PADS** made of memory foam
- Side YKK zipper



SIZES

S/M	160-175 cm - 65/75 Kg	code: .063
L/XL	175-190 cm - 75/90 Kg	code: .067
XXL	190-200 cm - 90/105 Kg	code: .069

JUMP MX CHEST PROTECTOR

MATERIALS:

Polyurethane 41%, Polypropylene 36%, Polyester 5%, Spandex 2%, Steel 6%, Aluminium 4%, Nylon 2%, Rubber 1%, Others 3%

DETAILS:

- Innovative nest-texture for the plastic parts: ventilation and protection guaranteed.
- Solid plates enclosed in a soft memory foam for a better shock-absorbing protection.
- Front/Back protection and lower plate removable, to accommodate the Neck brace.
- Shoulder band closure with hook and loop fastener adjustments
- Coccyx-shield removable cover.
- Waist band closure with hook and loop fastener adjustments
- **CHEST PROTECTION IS 1621/3 2017 CERTIFIED**
- **BACK PROTECTION IS EN 1621-2/2014 LEVEL 2 CERTIFIED**
- Extra insert for hips protection



SIZES

ONE SIZE



0023730.293.

GREY/BLACK



0023730.232.

WHITE/BLUE



0023730.237.

WHITE/BLACK



0023729.293.

GREY/BLACK



0023729.232.

WHITE/BLUE



0023729.237.

WHITE/BLACK



X-FIT FUTURE BODY ARMOUR

DETAILS:

- Protective summer / winter underwear.
- Highly breathable Dryarn fabric technology.
- Side zip fastening.
- Compatible with Neck-Brace.
- Removable protectors, P.O.I. Technology in Visco - Elastic material.
- Chest / back / shoulder / elbow protectors that are more ergonomic, softer and thinner.
- Additional hip protection in Memory Foam material.
- New "cold hand" fabric.
- The key perspiration points (arms / hips / armpits / chest / back) feature a mesh fabric for maximum ventilation.
- **EN1621-2/2014 homologated back protector.**
- **EN1621/3 homologated chest protector 2017.**
- **EN1621/2012 homologated shoulder and elbow guards.**
- Side YKK zipper

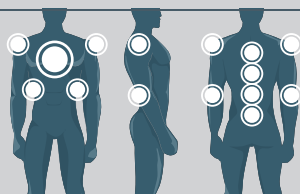

8 PROTECTIVE AREAS

SIZES

S/M	160-175 cm - 65/75 Kg	code: .063
L/XL	175-190 cm - 75/90 Kg	code: .067
XXL	190-200 cm - 90/105 Kg	code: .069



0023406.090.

BLACK

SCUDO 3.0 BODY ARMOUR

COMPONENTS:

Polypropylene 29%; EVA 27%; Polyurethane 25%; Polyester 15%; Other 4%

DETAILS:

- Elastic strap on the waist with hook and loop fastener closure
- 2 shoulder straps with front and back adjustment
- Chest protection made of plastic cover and polyester PE multilayer foam with **CERTIFICATION 1621-3**
- **Side protection** in memory foam for high impact absorption
- Protection of shoulders and elbows in memory foam for high impact absorption, with **CERTIFICATION EN 1621-1/2012**
- Padding on back in multilayer expanded plastic plates with **CERTIFICATION EN 1621-1/2014**
- Sleeves in perforated elastic material with high breathability
- Body armour in elastic mesh to increase comfort and breathability
- Side YKK zipper

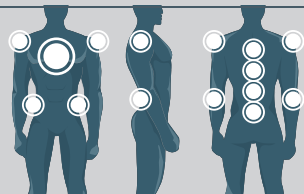

6 PROTECTIVE AREAS

SIZES

S/M	160-175 cm - 65/75 Kg	code: .063
L/XL	175-190 cm - 75/90 Kg	code: .067
XXL	190-200 cm - 90/105 Kg	code: .069



0022777.070.

GREY



MX SOFT PRO BODY ARMOUR

DETAILS:

- Body Armour protection created with ML.SP, an easily removable elastic material.
- Quick release elastic closure with hook and loop fastener adjustment.
- Soft kidneys and collarbone protection.
- Neck brace compatibility.
- **BACK PROTECTOR (3-LAYER) EN 1621-2: 2014 LEVEL 2 CERTIFIED.**
- **FRONT PROTECTOR STONEGUARD (3-LAYER) EN 14021 CERTIFIED.**
- **SHOULDER AND ELBOW PROTECTOR EN 1621-1: 2012 CERTIFIED.**

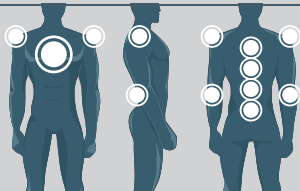

6 PROTECTIVE AREAS

SIZES

S/M	160-175 cm - 65/75 Kg	code: .063
L/XL	175-185 cm - 75/85 Kg	code: .067
XXL	185-195 cm - 85/95 Kg	code: .069



0021673.090.

BLACK

KOERTA 2.0 BODY ARMOUR

DETAILS:

- Ergonomically designed for full protection.
- **BACK PROTECTOR EN 1621-02:2014 CERTIFIED.**
- **ELBOW AND SHOULDER PROTECTIONS EN 1621 - 1/2012 CERTIFIED.**
- **STONE SHIELD HOMOLOGATED EN 14021.**
- Double hook and loop fastener waist adjustment.
- Made of polypropylene, inner lining, stretch mesh for perfect ventilation.
- Double back padding is removable and washable.
- Removable collarbone protection.
- Side YKK zipper

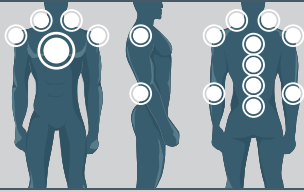

8 PROTECTIVE AREAS

SIZES

S/M	170-180 cm - 65/75 Kg	code: .063
L/XL	180-190 cm - 75/85 Kg	code: .067
XXL	190-200 cm - 85/100 Kg	code: .069



0017756.319.

BLACK/RED



X-AIR BODY ARMOUR

DETAILS:

- Protection with breathable, ventilated elastic mesh fabric.
- Side opening with YKK zip and zipper pull.
- **EN1621-2/2014 homologated back protector.**
- **EN1621/3 homologated chest protector (dated 2017).**
- **EN1621/2012 homologated shoulder and elbow guards.**
- Removable protectors which allow for complete washing of the garment.
- Protections with P.O.I. technology in a visco-elastic material.
- Chest / back / shoulder / elbow protectors that are ergonomic, soft and thin.
- Side YKK zipper

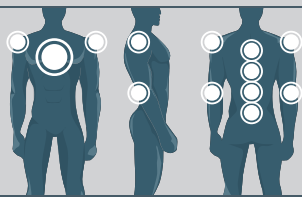

6 PROTECTIVE AREAS

SIZES

S/M	160-175 cm - 65/75 Kg	code: .063
L/XL	175-190 cm - 75/90 Kg	code: .067
XXL	190-200 cm - 90/105 Kg	code: .069



0023292.090.

BLACK

X-AIR VEST

DETAILS:

- Protection with breathable, ventilated elastic mesh fabric.
- Side opening with YKK zip and zipper pull.
- **EN1621-2/2014 homologated back protector.**
- **EN1621/3 homologated chest protector (dated 2017).**
- Removable protectors which allow for complete washing of the garment.
- Protections with P.O.I. technology in a visco-elastic material.
- Chest / back protectors that are ergonomic, soft and thin.

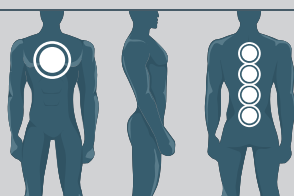

2 PROTECTIVE AREAS

SIZES

S/M	160-175 cm - 65/75 Kg	code: .063
L/XL	175-190 cm - 75/90 Kg	code: .067
XXL	190-200 cm - 90/105 Kg	code: .069



0023293.090.

BLACK

GRAVITY 1621 BODY ARMOUR

DETAILS:

- Molded in an innovative nest-texture construction to increase ventilation and protection while reducing weight
- Plastics plates that adapt to the body, fixed on the soft Bio-foam, to increase shock absorption and to improve the fit
- Back and front protector with removable lower plate to accommodate a neck brace
- Stone shield protections
- Hip protections
- Adjustable sizes thanks to shoulder regulation
- CHEST PROTECTOR **EN 14021:2003 STONE SHIELD CERTIFIED**
- BACK PROTECTOR **EN-1621-2 CE Level 2**
- SHOULDER PROTECTION **EN 14021:2003 STONE SHIELD CERTIFIED**
- HIP PROTECTION **EN 14021:2003 STONE SHIELD CERTIFIED**
- Adjustable and removable shoulders protectors

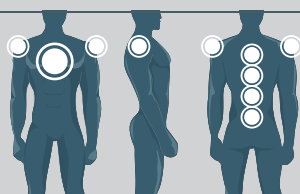

4 PROTECTIVE AREAS

SIZES

S/M	160-175 cm - 65/75 Kg	code: .063
L/XL	175-190 cm - 75/90 Kg	code: .067
XXL	190-200 cm - 90/200 Kg	code: .069



0023991.090.

BLACK



0023991.010.

ORANGE



0023991.030.

WHITE

GRAVITY BODY ARMOUR

DETAILS:

- Molded in an innovative nest-texture construction to increase ventilation and protection while reducing weight
- Plastics plates that adapt to the body, fixed on the soft Bio-foam, to increase shock absorption and to improve the fit
- Back and front protectors with removable lower plate to accommodate a neck brace
- Stone shield protections
- Hip protections
- Adjustable sizes thanks to shoulder regulation
- CHEST PROTECTOR **EN 14021:2003 STONE SHIELD CERTIFIED**
- BACK PROTECTOR **EN 14021:2003 STONE SHIELD CERTIFIED**
- SHOULDER PROTECTION **EN 14021:2003 STONE SHIELD CERTIFIED**
- HIP PROTECTION **EN 14021:2003 STONE SHIELD CERTIFIED**
- Adjustable and removable shoulders protectors



0023898.010.

ORANGE

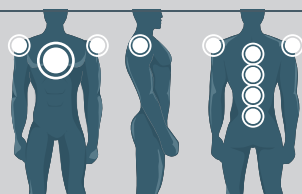

4 PROTECTIVE AREAS

SIZES

S/M	160-175 cm - 65/75 Kg	code: .063
L/XL	175-190 cm - 75/90 Kg	code: .067
XXL	190-200 cm - 90/200 Kg	code: .069



0023898.030.

WHITE



0023898.090.

BLACK



0023898.040.

BLUE



0023898.120.

TRANSPARENT



0023898.110.

RED



PROFILE CHEST PROTECTOR

DETAILS:

- Comfortable and light, designed for riders between 160 cm. to 185 cm.
- Protects the back and chest.
- Good ventilation.
- The shoulders are made of a soft material for more ergonomic fit.
- Adjustable elastic fasteners on the side.
- **EN 14021 STONE SHIELD CERTIFIED.**

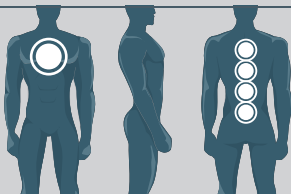

2 PROTECTIVE AREAS

SIZES

ONE SIZE



0016987.061.
FLUO YELLOW





0016987.014.
FLUO ORANGE



0016987.030.
WHITE



0016987.040.
BLUE



0016987.090.
BLACK



0016987.110.
RED



PULSAR BACK PROTECTOR

COMPOSIZIONE:

Shell: 100% Polyester

Lining: 90% Polyamide 10% Polyester

DETTAGLI:

- **Back protector EN 1621-2/2014 livello 2**
- Innovative plastic parts nest-texture: guaranteed ventilation and protection
- Solid plates enclosed in soft memory foam, for a better shock-absorbing protection
- Adjustable and removable hips protections
- Removable cover for Neck-Brace use
- X-shaped adjustment system which does not weigh heavily on the underarm area, with central quick release and 4 hook and loop fastener straps adjustment
- Waist elastic band closure with double hook and loop fastener adjustment.

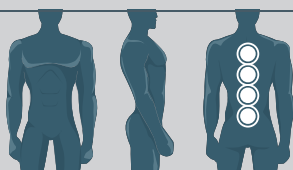

1 PROTECTIVE AREA

SIZES

S/M	160-175 cm	code: .063
L/XL	176-195 cm.	code: .067



0024057.090.

BLACK

BACK COMFORT 2.0 BACK PROTECTOR

DETAILS:

- Ergonomic design.
- Protection created with ML.SP, a honeycomb pattern material that guarantees a perfect fit and protection whilst allowing full freedom of movement.
- Elastic waist belt, adjustable with hook and loop fastener straps.
- Elastically adjustable and removable shoulder.
- **BACK PROTECTOR EN 1621-2 / 14 CERTIFIED.**

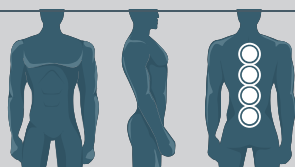

1 PROTECTIVE AREA

SIZES

S/M	160-175 cm	code: .063
L/XL	175-195 cm.	code: .067



0017172.323.

BLACK/RED

GORILLA KNEE GUARDS

COMPOSITION:

- 10% Steel; 35% Epdm; 35% Polypropylene; 15% Neoprene; 5% Other fibers

DETTAGLI:

- High end Knee Guard
- Kneecap, tibia and lower femur guard made of elastomer material in order to adapt to the leg's anatomy and to absorb the shocks
- Extreme freedom of movement and excellent torsional and flexural rigidity of the knee guaranteed by the double articulation system realized by combining technopolymeric materials and steel inserts
- Movable kneecap shell ensures wide range of movement
- Removable and washable padding in soft neoprene
- 3 adjustable straps
- **EN 1621-1/12 HOMOLOGATED**



SIZES

ONE SIZE

Designed for riders who need a knee brace with more flexibility and torsional protection compared to a conventional knee brace. Knee cap, tibia and the lower femur protections consist of an elastomeric material which allows impact to be absorbed and makes the central area of the knee brace flexible, guaranteeing a perfect fit. The double articulation system on the sides is made from a combination of various technopolymers and stainless steel inserts which in turn guarantees maximum freedom of movement and at the same time gives excellent torsional rigidity and high flexibility of the knee. The kneecap shell guarantees freedom of movement and a comfortable fit, it is also adjustable. The interior is made of a soft neoprene material which is removable and washable. A perfect fit is assured by the 3 adjustable straps, numbered in the correct closing order. Protection of the knee, tibia and femur **Homologation EN 1621-1/12**



0022114.323.
BLACK/RED

OPTIONALS



ELASTIC SOCKS
0016947.090



TUBE KNEE LEECH
0022734.090



X-KNEE GECO
0022716.319

X-STRONG KNEE GUARDS

DETAILS:

- The kneecap, tibia, and the low part of the femur are constructed in a sandwich of thermoplastic material and a padding that allows high energy absorption from shock (**P.O.I. TECHNOLOGY**).
- The **system is double articulated** and it is well adaptable to the knee anatomy, ensures maximum movement with a great torsional stiffness, also through the fixing system made of 2 big neoprene bands.
- **TRANSPORT BAG AND ELASTIC SOCKS INCLUDED.**
- **K+L EN 1621-1/2012 CERTIFIED FOR KNEE AND TIBIA.**



SIZES

ONE SIZE



0016810.315.
BLACK/RED

OPTIONALS



ELASTIC SOCKS
0016947.090



TUBE KNEE LEECH
0022734.090



X-KNEE GECO
0022716.319



IMPACT EVO 3.0 KNEE GUARDS

DETAILS:

- Knee, tibia and femur protection in plastic and EVA padding.
- Air vents to increase ventilation of knee and shinbone.
- Pre-shaped, asymmetrical design for comfort and fit.
- **Double pivot system** to facilitate movement of the knee.
- Removable padding, soft and comfortable fabric, hypoallergenic and breathable.
- Adjustable, elastic straps with hook and loop fastener closure.
- **EN 1621-1/2012 CERTIFIED.**



SIZES

ONE SIZE



0021608.315.

WHITE



0021608.323.

BLACK/RED

OPTIONALS



ELASTIC SOCKS
0016947.090



TUBE KNEE LEECH
0022734.090



X-KNEE GECO
0022716.319

SOFT 3.0 ELBOW GUARDS

COMPONENTS:

- 34% Polyurethane; 27% Neoprene; 20% Nylon;
- 8% Polyester; 5% Polyethylene; 5% Rubber; 1% Polypropylene

DETAILS:

- Breathable and perforated technical fabric
- Curved construction to perfectly suit the anatomy of the elbow
- Silicon straps for maximum adherence
- Padded material around the vulnerable elbow areas
- **EN 1621-1: 2012 CERTIFIED**



SIZES

ONE SIZE



0023456.323.

BLACK/RED

SOFT 3.0 KNEE GUARDS

COMPONENTS:

- 34% Nylon; 29% Polyurethane; 20% Neoprene; 6% Polyester;
- 4% Polyethylene; 4% Rubber; 2% EVA; 1% Polypropylene

DETAILS:

- Durable fabric for high breathability and for impact and abrasion protection
- Curved construction to perfectly suit the anatomy of the knee
- Silicon straps for maximum adherence
- Protection on the knee and on the upper side of the shinbone
- Padded material around the vulnerable knee areas
- **EN 1621-1 CERTIFIED**



SIZES

ONE SIZE



0023454.323.

BLACK/RED

X-FIT ELBOW GUARDS

COMPOSITION: 70% Polyurethane; 15% Polyamide; 10% Polypropylene; 5% Other fibres

DETAILS:

- Soft and flexible allowing comfortable safety.
- **Dryam** technology fabric for high breathability.
- Adjustable silicone straps for added comfort.
- Removable **P.O.I. technology** protection (visco elastic material).
- **EN 1621-1 / 2012 CERTIFIED.**



SIZES

ONE SIZE



0021654.090.

BLACK

PROFILE 2.0 KNEE GUARDS

DETAILS:

- Plastic protections extended on the knee and shinbone.
- Soft and comfortable padding made of hypoallergenic and breathable fabric.
- Pre-shaped, asymmetrical design for comfort and fit.
- Air vents to increase ventilation of knee and shinbone.
- Adjustable double straps with hook and loop fastener closure.
- **EN 1621-1/2012 CERTIFIED.**



SIZES

ONE SIZE



0017757.090.

BLACK

X-FIT FUTURE KID BODY ARMOUR

DETAILS:

- Protective summer / winter underwear.
- Highly breathable Dryarn fabric technology.
- Side zip fastening.
- Compatible with Neck-Brace.
- Removable protectors, P.O.I. Technology in Visco - Elastic material.
- Chest / back / shoulder / elbow protectors that are more ergonomic, softer and thinner.
- New "cold hand" fabric.
- The key perspiration points (arms / hips / armpits / chest / back) feature a mesh fabric for maximum ventilation.
- **EN1621-2/2014 homologated back protector.**
- **EN1621/3 homologated chest protector 2017.**
- **EN1621/2012 homologated shoulder and elbow guards.**



Dryarn
THE FEEL GOOD TECHNOLOGY
BY AQUATIC

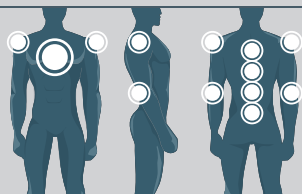

6 PROTECTIVE AREAS

SIZES

S/M	yrs 7/10 125-145 cm.	code: .063
L/XL	yrs 11/13 145-160 cm.	code: .067



0023407.090.

BLACK

SCUDO JUNIOR 2.0 BODY ARMOUR

DETAILS:

- **EN 1621-3/XX CERTIFIED FRONT PROTECTOR** with cover in plastics and expanded PU padding.
- **EN 1621- 2/2014 CERTIFIED BACK PROTECTION** with cover in plastics and expanded PU padding.
- Elbow and shoulder guards.
- Side closure with zip and adjustable and removable elastic waist belt with double hook and loop fastener closure.
- Jacket made of fully vented stretch mesh fabric.
- Elastic cuffs to ensure perfect fit.
- 4 straps to regulate the tension on shoulders and arms.

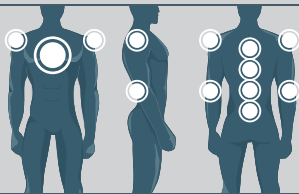

6 PROTECTIVE AREAS

SIZES

S/M	yrs 7/8/9	115-130 cm.	code: .063
L/XL	yrs 10/11/12	130-140 cm.	code: .067
XXL	yrs 13/14	140-160 cm.	code: .069



0017767.319.

BLACK/RED

GRAVITY KID BODY ARMOUR

DETAILS:

- Molded in an innovative nest-texture construction to increase ventilation and protection while reducing weight
- Plastic plates that adapt to the body, fixed on the soft Bio-foam, to increase shock absorption and to improve the fit
- Adjustable and removable shoulder protections
- Hip protections
- Adjustable sizes thanks to shoulder regulation
- CHEST PROTECTOR **EN 14021:2003 STONE SHIELD CERTIFIED**
- BACK PROTECTOR **EN 14021:2003 STONE SHIELD CERTIFIED**
- SHOULDER PROTECTION **EN 14021:2003 STONE SHIELD CERTIFIED**
- HIP PROTECTION **EN 14021:2003 STONE SHIELD CERTIFIED**



0023899.010.

ORANGE



0023899.040.

BLUE



0023899.120.

TRANSPARENT

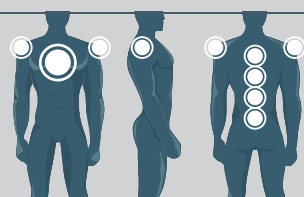

4 PROTECTIVE AREAS

SIZES

ONE SIZE

(da 8 a 13anni altezza da 125 a 160cm)



CUB 2.0 CHEST

DETAILS:

- Fitting designed for younger riders;
- Perforated padding for maximum breathability;
- Practical and easy to wear;
- Waist and shoulder elastic closure;
- Rubber protection on the chest, back and shoulders to increase the level of safety;

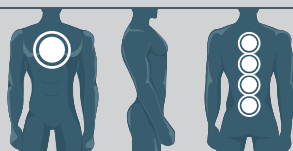

2 PROTECTIVE AREAS

SIZES

S/M	years 4/5	95-110 cm	code: .063
L/XL	years 6/7	110-125 cm.	code: .067



0017946.323.

BLACK/RED

IMPACT JUNIOR KNEE GUARDS

DETAILS:

- Knee, tibia and femur protection in plastic and EVA padding.
- Pre-shaped, asymmetrical design for comfort and fit.
- **Double pivot system** to facilitate movement of the knee.
- Removable padding, comfortable and hypoallergenic fabric.
- Adjustable, elastic straps with hook and loop fastener closure.
- **EN 1621-1/2012 CERTIFIED.**



SIZES

ONE SIZE



0023918.323.

BLACK/RED

PROFILE 2.0 JUNIOR KNEE GUARDS

DETAILS:

- Plastic protections extended on the knee and shinbone.
- Soft and comfortable padding made of hypoallergenic and breathable fabric.
- Flexible knee protection
- Adjustable double elastic straps with hook and loop fastener closure.
- **EN 1621-1/2012 CERTIFIED.**



SIZES

ONE SIZE



0017758.090.

BLACK



SOFT KID ELBOW GUARD

COMPONENTS:

- 34% Polyurethane; 27% Neoprene; 20% Nylon; 8% Polyester; 5% Polyethylene; 5% Rubber; 1% Polypropylene

DETAILS:

- Breathable and perforated technical fabric
- Curved construction to perfectly suit the anatomy of the elbow
- Silicon straps for maximum adherence
- Padded material around the vulnerable elbow areas
- **EN 1621-1: 2012 CERTIFIED**



SIZES

ONE SIZE



0023457.323.

BLACK/RED

SOFT KID KNEE GUARDS

COMPONENTS:

- 34% Nylon; 29% Polyurethane; 20% Neoprene; 6% Polyester; 4% Polyethylene; 4% Rubber; 2% EVA; 1% Polypropylene

DETAILS:

- Durable fabric for high breathability and for impact and abrasion protection
- Curved construction to perfectly suit the anatomy of the knee
- Silicon straps for maximum adherence
- Protection on the knee and on the upper side of the shinbone
- Padded material around the vulnerable knee areas
- **EN 1621-1 CERTIFIED**



SIZES

ONE SIZE



0023455.323.

BLACK/RED

MOTOBRAND 2.0 BELT

DETAILS:

- Hypoallergenic stretch waist band with hook and loop fastener closure.
- Double braided elastic insert to follow and wrap the lumbar area.
- Articulated soft rubber back panels for ergonomic support.



SIZES

S/M	code: .063	L/XL	code: .067
-----	------------	------	------------

MOTOBRAND 2.0 JUNIOR BELT

DETAILS:

- Antiallergic stretch waist band with hook and loop fastener closure.
- Double braided elastic insert to follow and wrap the lumbar area.
- Articulated soft rubber back panels for ergonomic support.



SIZES

ONE SIZE

PROFILE 2.0 BELT

DETAILS:

- Stretch elastic waist band with double hook and loop fastener closure.
- Triple stretch insert to follow and support the lumbar area.
- Several mesh inserts for breathability to facilitate ventilation.
- TPU protection on the lumbar area.



SIZES

S/M	code: .063	L/XL	code: .067
-----	------------	------	------------



0017763.090.

BLACK



0017764.090.

BLACK



0017765.090.

BLACK



K-BELT BELT

COMPONENTS: 95% Neoprene; 5% Others.

DETAILS:

- Hook and loop fastener closure.
- Soft inner lining and washable exterior.
- 6 flexible ribs for added support to the lumbar region.
- Permeability and protection against catching cold thanks to the dual-lined perforated neoprene structure.
- Ideal in preventing slight injury to the lumbar area and lower back and to sooth back pain.



SIZES

S/M	code: .063	L/XL	code: .067
------------	-------------------	-------------	-------------------

X-ROLL

DETAILS:

- The ergonomically shaped stabilization collar is made of hypoallergenic, soft, comfortable and breathable materials.
- The collar is equipped with removable fastening system to ensure a comfortable, but secure fit.
- The collar padding is completely removable and washable.



SIZES

ONE SIZE

X-ROLL JUNIOR



SIZES

ONE SIZE



0022774.319.

BLACK



0017193.323.

BLACK/RED



0017194.323.

BLACK/RED

X-ROUND COLLAR

DETAILS:

- Characterised by an ergonomic design
- Soft padding
- Easily removable and washable lining
- Easy to wear
- Strap fast to close



SIZES

ONE SIZE



0023930.323.

BLACK/RED

X-ROUND KID COLLAR

DETAILS:

- Characterised by an ergonomic design
- Soft padding
- Easily removable and washable lining
- Easy to wear
- Strap fast to close



SIZES

ONE SIZE



0023931.323.

BLACK/RED



X-FIT PANTS L RIDING PANTS

COMPOSITION: 45% Polyurethane; 25% Polyamide; 25% Polypropylene; 5% Other fibres

DETAILS:

- 4 Season protective under garment.
- **Dryarn** technology fabric for high breathability.
- Compatible with any type of knee brace.
- Removable side vented protectors with **P.O.I. technology** (visco elastic material).
- Perfect to be used with knee guards and knee braces



THE FEEL GOOD MICROFIBRE
Dryarn
BY AQUAFIL

SIZES

S/M	28/30	code: .063
L/XL	32/34	code: .067
XXL	36/38	code: .069



0021652.090.

BLACK

X-FIT PANTS S RIDING PANTS

COMPOSITION: 60% Polyurethane; 20% Polyamide; 15% Polypropylene; 5% Other fibres

DETAILS:

- 4 Season protective under garment.
- **Dryarn** technology fabric for high breathability.
- Removable side vented protectors with **P.O.I. technology** (visco elastic material).



THE FEEL GOOD MICROFIBRE
Dryarn
BY AQUAFIL

SIZES

S/M	28/30	code: .063
L/XL	32/34	code: .067
XXL	36/38	code: .069



0021653.090.

BLACK

FREE MOTO 2.0 RIDING SHORTS

DETAILS:

- Stretch mesh construction.
- Comfortable, breathable and anti-allergic fabric.
- Strategically placed plastic panels with anti-shock padding.
- Fabric stretch and silicon inserts on thighs for maximum comfort.



SIZES

S	28/30	code: .062
M	32	code: .064
L	34	code: .066
XL	36	code: .068
XXL	38	code: .069



0017768.319.

BLACK/RED

SOFT 2.0 RIDING SHORTS

DETAILS:

- Protective underwear.
- anti shock insert for hips, coccyx and femur.
- Breathable and anti-allergic fabric.
- Fabric stretch on the waist and silicon inserts help easy moving.



SIZES

S	28/30	code: .062
M	32	code: .064
L	34	code: .066
XL	36	code: .068
XXL	38	code: .069



0017174.319.

BLACK/RED



X-BODY WINTER TECHNICAL UNDERGEAR

COMPOSITION:

- 75% Dryarn Polypropylene; 20% Polyamide; 5% Elastane

DETAILS:

- Polypropylene **DRYARN**® is considered the lightest fabric existent in nature (10 km. of fabric weight 1 gr).
- The word **DRYARN**® derives from the ability of the fabric to not absorb water.
- Long technical undergear
- Use of high breathability Dryarn fabric
- 3D setting allows the sweat out
- Keeps the body temperature and improves the performances consequently
- Provides thermal insulation even during the resting phase

Dryarn
THE FEEL GOOD MICROFIBRE

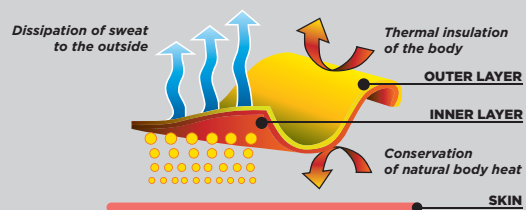

SIZES

S/M	code: .063	XXL	code: .069
L/XL	code: .067		



JERSEY

0021912.323.

BLACK/RED



PANTS

0021913.323.

BLACK/RED

X-BODY SUMMER TECHNICAL UNDERGEAR

COMPOSITION:

- 70% Dryarn Polypropylene; 25% Polyamide; 5% Elastane

DETAILS:

- Polypropylene **DRYARN®** is considered the lightest fabric existent in nature (10 km. of fabric weight 1 gr).
- The word **DRYARN®** derives from the ability of the fabric to not absorb water.
- Light technical undergear
- Use of high breathability Dryarn fabric
- Keeps the body temperature and improves the performances consequently

FEEL GOOD TECHNOLOGY
Dryarn
BY AQUARIL

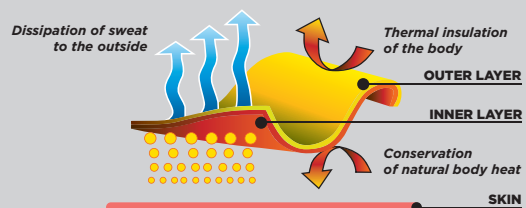

SIZES

S/M	code: .063	XXL	code: .069
L/XL	code: .067		



JERSEY

0021910.323.

BLACK/RED



PANTS

0021911.323.

BLACK/RED

X-KNEE GECO UNDERWEAR REINFORCEMENT

COMPONENTS:

- 60% Polyester; 30% Nylon; 10% PU

DETAILS:

- Stretch fabric to wear protections (even the most voluminous)
- Abrasion resistance AX Suede reinforcement, against the most cumbersome knee guards, including orthopedic guards
- Containing function to allow faster and less bothersome pulling on of any type of pants
- Extremely comfortable and fast drying thanks to technical fabric
- Mesh insert in the calf area



SIZES

S/M	code: .063	XXL	code: .069
L/XL	code: .067		



0022716.319.
BLACK/GREY

TUBE KNEE LEECH REINFORCEMENT

COMPONENTS:

- 85% Nylon, 10% PU, 5% Polyester

DETAILS:

- Stretch fabric to wear protections (even the most voluminous)
- Abrasion resistance AX Suede reinforcement, against the most cumbersome knee guards, including orthopedic guards
- Containing function to allow faster and less bothersome pulling on of any type of pants
- Extremely comfortable and fast drying thanks to technical fabric
- Mesh insert in the calf area
- Tube version adapts perfectly around the knee area



SIZES

S/M	code: .063	L/XL	code: .067
------------	-------------------	-------------	-------------------



0022734.090.
BLACK

ELASTIC SOCKS

COMPOSITION:

- 100% Polyester.

DETAILS:

- Washable knee legging
- To be worn under the knee-guard for better comfort



SIZES

ONE SIZE

X-LEG PRO SOCKS

MATERIALS: 80% Polyamide Meryl® Skinlife; 10% Polypropylene Dryarn; 10% elastane.

DETAILS:

- Long sock designed for use with knee guards and knee braces.
- Silicone edge to maintain the fit of the sock.
- Reinforcements around the shin and ankle.
- Zone compression for better blood circulation.
- Breathable insert on the instep.
- Reinforcements on the toe and heel.
- Flat seam at the toe line.

Dryarn
THE FEEL GOOD MICROFIBER
BY AQUATIC



SIZES

S/M	39-41	code: .063	XXL	45-47	code: .069
L/XL	42-44	code: .067			



0016947.090.

BLACK



0021693.313.

BLACK/FLUO ORANGE



0021693.316.

BLACK/BLUE



0021693.318.

BLACK/FLUO YELLOW



0021693.323.

BLACK/RED



MX PRO SOCKS

COMPOSITION: 60% acrylic; 20% polyamide; 10% polypropylene; 10% elastan.

DETAILS:

- Knee-high sport socks
- Realized with a thicker frame and studied with reinforcements in the most critical areas like toe tips, malleolus and tibia.
- Soft sponge padding
- Use of technical yarns
- Patterns developed with Dryarn fabric to improve breathability
- Flat seam at the toe line

THE FEEL GOOD MICROBIOME
Dryarn
BY THE INNOVATION

meryl
skincare

SIZES

S/M	39-41	code: .063	XXL	45-47	code: .069
L/XL	42-44	code: .067			



0022077.313.

BLUE/RED



0022077.316.

BLACK/BLUE



0022077.318.

BLACK/FLUO YELL.



0022077.323.

BLACK/RED

ACCESSORIES

DISPLAY
CODE: 0021677.366



MX IMPACT SOCKS

MATERIALS: 85% Polyamide Meryl® Skinlife; 10% Polypropylene Dryarn®
5% Elastane

DETAILS:

- Reinforcements around the shin and ankle.
- Fabrics designed to regulate body temperature and dissipate moisture easily.
- Breathable inserts on the instep.
- Reinforcements on the toe and heel.
- Flat seam at the toe line.

THE FEEL GOOD EXPERIENCE
Dryarn
BY POLYPROPYLENE



SIZES

S/M	39-41	code: .063	XXL	45-47	code: .069
L/XL	42-44	code: .067			



0021633.010.

ORANGE



0021633.040.

BLUE



0021633.110.

RED



0021633.204.

FLUO ORAN./BLUE



0021633.323.

BLACK/RED



0021633.243.

BLUE/FLUO ORAN.



ACCESSORIES

DISPLAY
CODE: 0021677.366



MX IMPACT JUNIOR SOCKS

MATERIALS: 85% Polyamide Meryl® Skinlife; 10% Polypropylene Dryarn®
5% Elastane

DETAILS:

- Reinforcements around the shin and ankle.
- Fabrics designed to regulate body temperature and dissipate moisture easily.
- Breathable inserts on the instep.
- Reinforcements on the toe and heel.
- Flat seam at the toe line.



THE FEEL GOOD FIBER
Dryarn
BY POLYMER



SIZES

S/M	32-34	code: .063	L/XL	35-38	code: .067
------------	-------	-------------------	-------------	-------	-------------------

COTTON SOCKS

COMPOSIZIONE: 67% Cotton; 27% Polyamide; 6% Elastane

DETTAGLI:

- Ankle-length sock
- Heel and under foot area in terry toweling to protect and amortize
- Upper part developed in ribbing 2/2
- Part of the instep in ribbing 1/1
- Personalized with jacquard logo in contrasting color from front part

SIZES

S/M	39-41	code: .063	XXL	45-47	code: .069
L/XL	42-44	code: .067			



0021909.204.
FLUO ORAN./BLUE



0021909.206.
FLUO ORAN./FLUO YELL.



0021909.323.
BLACK/RED



0022491.014.
FLUO ORANGE



0022491.030.
WHITE



0022491.063.
FLUO YELLOW



0022491.090.
BLACK



0022491.110.
RED

SPORT SOCKS

COMPOSITION: 80% Poliammide Meryl* Skinlife; 10% Polipropilene Dryarn. 10% Elastan.

DETAILS:

- Short technical socks
- Toe and heel in a contrasting colour
- Developed with Skinlife Polyamide which guarantees the natural balance of the skin at any activity level

THE FEEL GOOD MICROFIBRE
Dryarn
BY POLYMER

THE SKINLIFE
meryl
skinlife

SIZES

ONE SIZE



0022168.010.
FLUO ORANGE



0022168.030.
WHITE



0022168.040.
BLUE



0022168.060.
FLUO YELLOW



0022168.090.
BLACK



0022168.110.
RED





BAGS

BORSE

- P. 198** X-Storm Drink Bag
- P. 199** H2O Drink Backpack
- P. 200** Acqua Drink Bag
- P. 201** Dromy Drink Waistpack
- P. 202** Impact Waistpack
- P. 202** Profile Waistpack
- P. 203** Ram Waistpack
- P. 203** Fanny Waistpack
- P. 204** Tools Bag Rear Fender
- P. 204** Tools Bag Front Fender
- P. 205** Shadow Backpack
- P. 206** Profile Backpack
- P. 207** No Water Backpack
- P. 207** Root Backpack
- P. 208** No Water Horizontal Bag
- P. 208** No Water Vertical Bag
- P. 209** No Water 6 L Waistpack
- P. 209** No Water 4 L Waistpack
- P. 210** No Water 3 L Waistpack
- P. 210** No Water Bag
- P. 211** No Water Trip Bag
- P. 211** X-Side Bag
- P. 212** X- Moto Bag
- P. 213** X-Trip Bag
- P. 214** Go Home Trolley
- P. 215** Cargo Bag
- P. 215** Profile Bag
- P. 216** Boots Bag
- P. 216** Helmet Bag
- P. 217** Office Bag



X-STORM DRINK BAG

COMPONENTS: 95% Polyester; 5% Others

DETTAGLI:

- Back pack capacity: 14.5 liters
- Hydro bag capacity: 2.5 liters
- Easy to clean thanks to the large cap
- Drinking straw with adjustable opening and closing valve
- Ideal for those who need a supply of water and want to replace the carrier with a back pack
- Pocket for tools
- Braces at X with quick release center and adjustments with 4 hook and loop fastener straps
- Breathable fabric in the area in contact with the back
- Water bag exclusion available. The glove boxes turns in two carry flasks
- Waist belt

CAPACITY

BACK PACK CAPACITY	14,5 lt.
HYDRO BAG CAPACITY	2,5 lt.



0022818.318.
BLACK/FLUO YELLOW



REPLACEMENTS



2,5 L HYDRO BAG
CODE: 0022883.
CAPACITY: 2,5 LT.



2,5 L HYDRO BAG VALVE
CODE: 0022891.

H2O DRINK BACKPACK

COMPONENTS: 95% polyester; 5% Others fibres

DETAILS:

- Capacity 10 litres (including hydro bag of 2 litres.)
- Dorsal part, in contact with the back is made of breathable fabric.
- Hydro bag of 2 litres, with adjustable opening and closing valve easy to clean.
- Adjustable waist belt with quick release buckle.
- Adjustable shoulder straps, pre-shaped for spine Outer compartment.
- Numerous pockets: inside pocket and small storage pocket, net outer pocket to hold original motorcycle license plate, a small external pocket with zip closure, internal tool holder.

CAPACITY

BACK PACK CAPACITY	10 lt.
HYDRO BAG CAPACITY	2 lt.



0017046.318.
BLACK/FLUO YELLOW



REPLACEMENTS



HYDRO BAG
CODE: 0016863.
CAPACITY: 2 LT.



2,5 L HYDRO BAG VALVE
CODE: 0022891.



ACQUA DRINK BAG

COMPONENTS: 95% polyester; 5% Others fibres

DETAILS:

- **Back pack capacity: 3 liters.**
- **Hydro bag capacity: 2 liters.**
- Easy to clean thanks to the large cap.
- Drinking straw with adjustable opening and closing valve.
- Ideal for those who need a supply of water and want to replace the carrier with a back pack.
- Removable pocket and trousse for tools bag.
- Braces at X with quick release center and adjustments with 4 hook and loop fastener straps.
- Breathable fabric in the area in contact with the back.

CAPACITY

BACK PACK CAPACITY	3 lt.
HYDRO BAG CAPACITY	2 lt.



0017071.318
BLACK/FLUO YELLOW



REPLACEMENTS



HYDRO BAG
CODE: 0016863.
CAPACITY: 2 LT.



2,5 L HYDRO BAG VALVE
CODE: 0022891.

DROMY DRINK WAISTPACK

COMPONENTS:

Waistpack 95 % Polyester; 5 % Other Materials

Hydro Bag 95 % TPU; 5 % Other Materials

DETAILS:

- **Waistpack capacity: 3 liters.**
- **Hydro bag capacity: 1.5 liters.**
- Quick release buckle and hook and loop fastener closure.
- Drinking straw integrates with helmet.
- Pocket for documents on the belt.
- Side storage compartment with hook and loop fastener/zipper.
- Transparent document holders.
- Identification label on the inside of the belt.
- Contact areas shaped for added breathability.



HYDRO BAG INCLUDED

CAPACITY

WAISTPACK CAPACITY	3 lt.
HYDRO BAG CAPACITY	1,5 lt.



0021643.318

BLACK/FLUO YELLOW



REPLACEMENTS



HYDRO BAG
CODE: 0021649.
CAPACITY: 1.5 LT.



EASY LOCKING SYSTEM



HELMET MOUNTING SYSTEM



IMPACT WAIST PACK

COMPONENTS: 95% polyester; 5% Others fibres

DETAILS:

- **Capacity 5 liters.**
- Double closure through elastic belt with hook and loop fastener and plastic buckle.
- Rubber patch on the lower back to ensure a perfect fit.
- Belt with pocket for driving license or stamp card, with internal rider identifying label.
- Numerous pockets: back pocket for tools and extra pocket including an extra pocket for compass, which is easily accessible from the outside.
- Removable side pocket for water bottle, removable accessories side pocket and transparent pocket for documents.

CAPACITY

WAIST PACK CAPACITY	5 lt.
---------------------	--------------

PROFILE WAIST PACK

COMPONENTS: 95% polyester; 5% Others fibres

DETAILS:

- **Capacity 3 liters.**
- Double closure through elastic belt with hook and loop fastener and plastic buckle.
- Rubber patch on the lower back to ensure a perfect fit.
- Belt with pocket for driving license or stamp card, with internal rider identifying label.
- Numerous pockets: back pocket for tools and extra pocket including an extra pocket for compass, which is easily accessible from the outside.
- Removable side pocket for water bottle, removable accessories side pocket and transparent pocket for documents.

CAPACITY

WAIST PACK CAPACITY	3 lt.
---------------------	--------------



0017032.318
BLACK/FLUO YELLOW



0017033.318
BLACK/FLUO YELLOW



RAM WAIST PACK

COMPONENTS: 95% polyester; 5% Others fibres

DETAILS:

- **Capacity 2 liters.**
- Double closure through elastic belt with hook and loop fastener and plastic buckle.
- Rubber patch on the lower back to ensure a perfect fit.
- Belt with pocket for driving license or stamp card, with internal rider identifying label.
- Numerous pockets: back pocket for tools including an extra compass pocket, two side pockets for other riding essentials.



CAPACITY

WAIST PACK CAPACITY

2 lt.

0017031.318

BLACK/FLUO YELLOW



FANNY WAIST PACK

COMPONENTS: 95% polyester; 5% Others fibres

DETAILS:

- Front zip closure.
- Adjustable waist strap and a handy plastic clip.



0000087.318

BLACK/YELLOW



TOOLS BAG REAR FENDER

COMPONENTS: 95% polyester; 5% Others fibres

CAPACITY: 2 liters Made of polyester. Triple locking system: zip, hook and loop fastener and buckles. Internal tools pocket and small outside pocket, bottom transparent. Printed front logo. To be mounted with 4 screws on rear fender.

CAPACITY

TOOLS BAG CAPACITY	2 lt.
--------------------	--------------

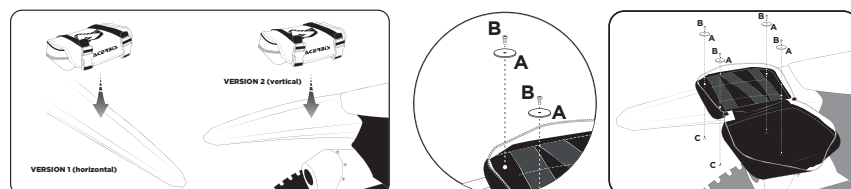

0012972.318

BLACK/FLUO YELLOW



TOOLS BAG FRONT FENDER

COMPONENTS: 95% polyester; 5% Others fibres

DETAILS:

- **Capacity: 2 liters.**
- Compact tool bag
- Fast locking system to the front fender with 4 metallic hooks
- Closure with adjustable straps
- Rubber base for a better grip
- Wide internal tools pocket
- Clear internal pocket for bushings

CAPACITY

TOOLS BAG CAPACITY	2 lt.
--------------------	--------------

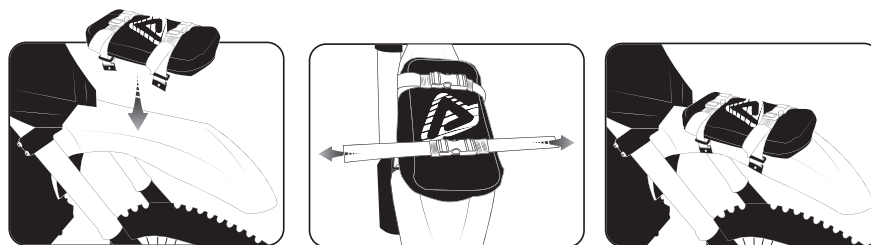

0022013.318
0022013.318

BLACK/FLUO YELLOW



SHADOW BACKPACK

COMPONENTS: 100% polyester

MATERIALS:

- Polyester 600D.

DETAILS:

- **Capacity: 38 liters - Weight: 1.27 kg.**
- Reinforced, breathable mesh inserts in the back.
- Internal bottom and side straps in nylon.
- Waist closure with padded hip strap to secure grip and comfort.
- Adjustable shoulder straps.
- Pre-shaped for spine.
- Removable internal reinforcement.
- Easy opening with zip-cast.
- Numerous pockets: three stretch net outside pockets, double outside pocket with welt closure and top pocket.
- Stretch panels for transportation of mechanic equipment.



CAPACITY

BACKPACK CAPACITY

38 lt.



0017045.318
BLACK/FLUO YELLOW



PROFILE BACKPACK

COMPONENTS: 100% polyester

MATERIALS:

- **Inner** Jacquard lining.
- **Outer** Polyester and reinforced fabric on the base.

DETAILS:

- **Dimensions** 28x61x45 cm.; **Volume** 20 lt.; **Weight** 0.450 kg .
- Lining in contrasting colour.
- High Definiton text logo.
- Two main pockets.
- Mesh side pockets.
- Mesh side pockets.
- Hidden waterproof cover in the bottom pocket.



Hidden waterproof cover

CAPACITY

BACKPACK CAPACITY	20 lt.
-------------------	---------------



Hidden waterproof cover

0021572.090

BLACK/FLUO YELLOW



0021572.251

BLUE/BLACK



0021572.349

RED/BLACK



0021572.204

BLUE/ORANGE

NO WATER BACKPACK

COMPONENTS: 95% PVC; 5% Other fibers

DETAILS:

- 22 litre WATERPROOF Backpack.
- Taped seams and zippers, water-resistant exterior.
- Internal compartment with completely waterproof pockets, useful for storing items such as tablets and/or a laptop with a maximum size of 26x38 cm.
- External bottle pocket.
- Breathable padding on the back area.
- Padded and adjustable backpack straps.



CAPACITY

BACKPACK CAPACITY

22 lt.



0021644.319

BLACK/FLUO YELLOW



ROOT BACKPACK

COMPONENTS: 90% polyester, 10% Pu

DETAILS:

- 8L capacity
- Waterproof
- Easy to transport (packable)
- Roll top closure with hook fastening
- Maximum lightness
- External zip pocket
- Ideal for MTB and Motorcycles usage



CAPACITY

BACKPACK CAPACITY

8 lt.



0024107.090

BLACK



NO WATER HORIZONTAL BAG

COMPOSITION: 15% Polyester; 85% Pvc;

DETAILS:

- Bag ideal for motorcyclists
- 40 Lt. Capacity
- Outer heat-sealed seams
- Useful to store big items (Max 60x33)
- Comfortable and flexible
- +70° - 30° resistant
- Abrasion resistant



CAPACITY

BAG CAPACITY

40 lt.

NO WATER VERTICAL BAG

COMPOSITION: 10% Polyester; 90% Pvc;

DETAILS:

- Duffel bag ideal for motorcyclists
- 40 Lt. Capacity
- Outer heat-sealed seams
- Shoulder strap
- Fixing through rings
- Useful to store big items (max 70x30)
- Comfortable and flexible
- +70° - 30° resistant
- Abrasion resistant



CAPACITY

BAG CAPACITY

40 lt.



0022229.319

BLACK/GREY



ACCESSORIES

TENAY BELT
GREY

Length : 170 cm

0023893.070



TENAY BELT
BLACK

Length : 170 cm

0023893.090



0022230.319

BLACK/GREY



ACCESSORIES

TENAY BELT
GREY

Length : 170 cm

0023893.070



TENAY BELT
BLACK

Length : 170 cm

0023893.090



NO WATER 6L WAIST PACK

COMPONENTS: 95% PVC; 5% Others fibres

DETAILS:

- 6 litre WATERPROOF waistpack.
- Taped seams and zippers, water-resistant exterior.
- Completely waterproof internal pockets, useful for storing items such as tablets and/or a laptop with a maximum size of 21x32 cm.



CAPACITY

WAIST PACK CAPACITY

6 lt.

NO WATER 4L WAIST PACK

COMPONENTS: 95% PVC; 5% Others fibres

DETAILS:

- 4 litre WATERPROOF waistpack.
- Taped seams and zippers, water-resistant exterior.
- Completely waterproof internal pockets, useful for storing items such as tablets and/or a laptop with a maximum size of 21x32 cm.



CAPACITY

WAIST PACK CAPACITY

4 lt.



0021645.319

BLACK/GREY



0022858.319

BLACK/GREY



NO WATER 3L WAIST PACK

COMPONENTS: 95% PVC; 5% Others fibres

DETAILS:

- 3 litre WATERPROOF waistpack.
- Taped seams and zippers, water-resistant exterior.
- Completely waterproof internal pockets, useful for storing items such as tablets and/or a laptop with a maximum size of 21x32 cm.



CAPACITY

WAIST PACK CAPACITY	3 lt.
---------------------	--------------



0023418.319

BLACK/GREY



NO WATER BAG

COMPONENTS: 95% PVC; 5% Others fibres

DETAILS:

- 12 litre WATERPROOF bag.
- Taped seams and zippers, water-resistant exterior.
- Internal compartment with completely waterproof pockets, useful for storing items such as tablets and/or a laptop with a maximum size of 24x35 cm.
- Adjustable waist strap.



CAPACITY

BAG CAPACITY	12 lt.
--------------	---------------



0021646.319

BLACK/GREY



NO WATER TRIP BAG

COMPOSITION: 10% Polyester; 90% Pvc;

DETAILS:

- Legpack
- 2lt. capacity
- External heat-sealed seams
- Fully waterproof inner part
- Fixing with double adjustable strap
- Useful for storing small items like smartphone (max 17x11)
- Practical and flexible
- Especially useful on rainy days



CAPACITY

TRIP BAG CAPACITY

2 lt.

X-SIDE BAG

COMPOSITION: 100% Polyester

DETAILS:

- Right and left legs bag
- Adjustable strap on the waist and on the thigh
- 1L capacity
- Removable waterproof cover
- One size
- Reflective inserts
- Internal compartments for phone / wallet / documents
- Keys hook



CAPACITY

TRIP BAG CAPACITY

1 lt.



0022228.319

BLACK/GREY



0024216.090

BLACK



X-MOTO BAG

COMPONENTS: 100% polyester

MATERIALS:

- Inner Lining and mesh inserts.
- Outer Rip resistant high density polyester.

DETAILS:

- Dimensions 96x46x43 cm. Capacity 190 lt. Weight 7 kg.
- Central zip closure to divide two main areas and straps for volume adjustment.
- Two handles for easy movement.
- Telescopic main handle.
- Reinforced fabric on the bottom and in the back side.
- Pull out mat on side pocket.

CAPACITY

BAG CAPACITY

190 lt.



0017669.110

RED



0017669.010

ORANGE



0017669.040

BLUE



0017669.319

BLACK/GREY

X-TRIP BAG

COMPONENTS: 100% polyester

MATERIALS:

- **Inner** Lining and mesh inserts.
- **Outer** Rip resistant high density polyester.

DETAILS:

- **Dimensions 75x45x35 cm; Capacity 105 lt.; Weight 5,5 kg.**
- Central zip closure to divide two main areas and straps for volume adjustemet.
- Two handles for easy movement.
- Telescopic main handle.
- Reinforced fabric on the bottom and in the back side.

CAPACITY

BAG CAPACITY

105 lt.



0017668.319

BLACK/GREY



0017668.010

ORANGE



0017668.040

BLUE



0017668.110

RED



GO-HOME TROLLEY

COMPONENTS:

Shell: 100% ABS

Lining: 100% Polyester

MATERIALS:

- **Outer** Hard Shell in ABS
- **Inner** Lining in polyester with pockets

DETAILS:

- **Dimensions 55X38X21 cm. Volume 35 Lt. Weight 2,5 Kg**
- Double tube telescopic handle system
- Double handles one on the top and one on the side.
- 4 Multidirectionals wheels
- Lockable Main Zippers
- Top compartment with pocket and bottom compartment with divider pad and ribbons



CAPACITY

BAG CAPACITY

35 lt.



0023702.090

BLACK

CARGO BAG

COMPONENTS: 100% Polyester

DETAILS:

- Dimensions 90x40x50 cm.; Capacity 180 lt.; Weight 1.9 kg.
- Top-loading bag
- Shoulder strap and double handles to make moving easier
- Large side pockets for boots and helmets
- Large central zip
- Check-list as reference to contain all accessories

CAPACITY

BAG CAPACITY	180 lt.
--------------	---------



0022517.318

BLACK/FLUO YELLOW



PROFILE BAG

COMPONENTS: 100% Polyester

DETAILS:

- Dimensions: 30X28X60cm; Volume: 50 lt; Weight: 1.1 kg.
- Central compartment with zipper closure.
- Waterproof side pocket.
- Comfortable padded shoulder strap.
- Identification label.
- Internal plastic base to give the bag a rigid structure.

CAPACITY

BAG CAPACITY	50 lt.
--------------	--------



0021678.090

BLACK



0021678.349

RED/BLACK



0021678.743

CAMOUFLAGE



HELMET BAG

COMPOSITION: 100% Polyester

DETAILS:

- Designed to easily hold off-road or on-road helmets
- Fabric exterior and soft internal lining to protect the helmet
- Equipped with a practical carrying handle
- Easy opening with a double slide zipper
- Ventilated for breathability
- Side pocket for accessories



0023262.318
BLACK/FLUO YELLOW



BOOTS BAG

DETAILS:

- Designed to easily hold off-road and on-road boots, from the smallest size up to size 47
- Washable by hand
- Equipped with a practical carrying handle
- Easy opening with double slider
- Ventilation for breathability



0023865.318
BLACK/FLUO YELLOW



OFFICE BAG

COMPONENTS:

- **Inner** 100% Polyester.
- **Outer** 100% Nylon.

DETAILS:

- **Size 47x27x12cm; Volume 15 lt. ; Weight 1.2 kg.**
- Lining in contrasting color.
- Re flective silver logo.
- Two exterior compartments.
- Internal computer pouch.
- Side drink pocket.
- Adjustable straps.
- Comfortable shoulder straps with central padding.
- Reinforced main handle.
- Compatible with trolley, attachable hook and loop fastener straps.



CAPACITY

BAG CAPACITY

15 lt.

0017940.090

BLACK





UB
TED
ONE

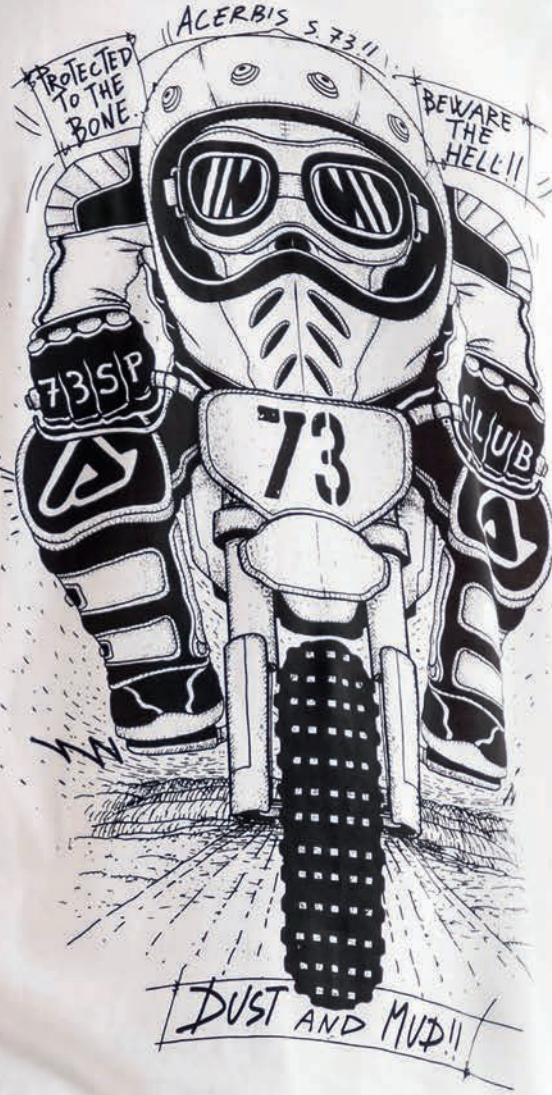

AC
SO



CASUAL SP CLUB

- P. 220** Hill O35 Jacket
- P. 221** Wind Sp Club Jacket
- P. 222** Paint Sp Club Sweatshirt
- P. 222** Round Fun Sp Club Sweatshirt
- P. 222** Heaven Lady Sweatshirt
- P. 223** Great River Shirt
- P. 223** Team Shirt
- P. 223** Team Lady Shirt
- P. 224** Therapist Sp Club Polo
- P. 224** Freedom Sp Club Polo
- P. 224** Sun Sp Club Piquet Polo
- P. 224** Iron Sp Club Piquet Polo
- P. 226** Paint Sp Club T-Shirt
- P. 226** Wings Sp Club T- Shirt
- P. 226** Acrobat Sp Club T- Shirt
- P. 227** Shield Sp Club T-Shirt
- P. 227** Street Sp Club T-Shirt
- P. 227** V Street Sp Club T-Shirt
- P. 228** Graffiti Sp Club T-Shirt
- P. 228** Freedom Sp Club T-Shirt
- P. 228** Club Sp Club T-Shirt
- P. 229** Wings Sp Club Lady T-Shirt
- P. 229** Rush Sp Club Lady T-Shirt
- P. 229** University Sp Club Lady Top
- P. 229** Wings Sp Club Kid T-Shirt
- P. 229** Acrobat Sp Club Kid T-Shirt
- P. 230** Shield Sp Club Kid T-Shirt
- P. 230** Wisdom Sp Club Kid T-Shirt
- P. 230** Hell Sp Club Kid T-Shirt
- P. 230** Cross Sp Club Kid T-Shirt
- P. 232** Corporate Jeans
- P. 232** Corporate Lady Jeans
- P. 232** Pasadena Lady Jeans
- P. 233** Camou Sp Club Bermuda
- P. 233** Cargo Sp Club Bermuda
- P. 234** Podium Cap
- P. 234** Podium Beanie
- P. 234** Float Sam Cap
- P. 234** Jet Sam Cap
- P. 234** Acerbis Wallet



HILL 035 JACKET

COMPONENTS:

Shell 100% Polyamide

Lining 100% Polyamide

Padding 100% Polyester

MATERIALS:

Outer

- Fabric for jacket in polyamide matt and water repellent

Inner

- Lining in polyamide
- Padding in polyester down effect

DETAILS:

- Packable jacket
- With fixed hood
- Front opening and side pockets with zip
- Elastic tape to border hood, cuffs and bottom



SIZES

S	code: .062	XL	code: .068
M	code: .064	XXL	code: .069
L	code: .066		



0023413.318.

BLACK/YELLOW

WIND SP CLUB JACKET

COMPONENTS:

Shell 100% Polyamide

Lining 100% Polyamide

MATERIALS:

Outer

- Fabric for jacket in polyamide water repellent

Inner

- Lining in polyamide

DETAILS:

- Emergency hood in the back collar pocket with coulisse regulation
- Front opening and side pockets with waterproof zip
- Cuffs and bottom in rib



SIZES

S	code: .062	XL	code: .068
M	code: .064	XXL	code: .069
L	code: .066		



0023020.073.

DARK GREY



0023020.793.

GREY WORKS



0023020.872.

URBAN GREEN



PAINT SP CLUB SWEATSHIRT

MATERIAL: 100% COTTON



0910276.899.

GREY/DARK GREY

SIZES

S	code: .062	XL	code: .068
M	code: .064	XXL	code: .069
L	code: .066		

ROUND FUN SP CLUB SWEATSHIRT

MATERIAL: 100% COTTON



0023018.872.

URBAN GREEN

SIZES

S	code: .062	XL	code: .068
M	code: .064	XXL	code: .069
L	code: .066		

HEAVEN SP CLUB LADY SWEATSHIRT

MATERIAL: 100% COTTON



0910278.076.

LIGHT GREY

SIZES

XS	code: .061	L	code: .066
S	code: .062	XL	code: .068
M	code: .064		

GREAT RIVER SHIRT

MATERIAL: 100% COTTON

SIZES

S	code: .062	XL	code: .068
M	code: .064	XXL	code: .069
L	code: .066	3XL	code: .070



0021914.040.

BLUE

TEAM SHIRT

MATERIAL: 100% COTTON

SIZES

S	code: .062	XL	code: .068
M	code: .064	XXL	code: .069
L	code: .066	3XL	code: .070



white/black
code: **0023584.237**



white/blue
code: **0023584.232**



white/red
code: **0023584.239**

TEAM LADY SHIRT

MATERIAL: 100% COTTON

SIZES

XS	code: .061	L	code: .066
S	code: .062	XL	code: .068
M	code: .064	XXL	code: .069



white/black
code: **0023585.237**

THERAPIST SP CLUB POLO

MATERIAL: 100% COTTON

SIZES

S	code: .062	XL	code: .068
M	code: .064	XXL	code: .069
L	code: .066		



0023012.872.

URBAN GREEN

FREEDOM SP CLUB POLO

MATERIAL: 100% COTTON

SIZES

S	code: .062	XL	code: .068
M	code: .064	XXL	code: .069
L	code: .066		



0023015.110.

RED

SUN SP CLUB PIQUET POLO

MATERIAL: 100% COTTON



0022457.132.

GREEN

SIZES

S	code: .062	XL	code: .068
M	code: .064	XXL	code: .069
L	code: .066		

IRON SP CLUB PIQUET POLO

MATERIAL: 100% COTTON



0022458.047.

BLUE

SIZES

S	code: .062	XL	code: .068
M	code: .064	XXL	code: .069
L	code: .066		



CASUAL



PAINT SP CLUB T-SHIRT

MATERIAL: 100% COTTON

SIZES

S	code: .062	XL	code: .068
M	code: .064	XXL	code: .069
L	code: .066		



0910277.899.

GREY/DARK GREY

WINGS SP CLUB T-SHIRT

MATERIAL: 100% COTTON

SIZES

S	code: .062	XL	code: .068
M	code: .064	XXL	code: .069
L	code: .066		



0910262.030.

WHITE



0910262.073.

DARK GREY



0910262.076.

LIGHT GREY

ACROBAT SP CLUB T-SHIRT

MATERIAL: 100% COTTON

SIZES

S	code: .062	XL	code: .068
M	code: .064	XXL	code: .069
L	code: .066		



0910266.030.

WHITE



0910266.073.

DARK GREY



0910266.591.

GRAPHITE

SHIELD SP CLUB T-SHIRT

MATERIAL: 100% COTTON

SIZES

S	code: .062	XL	code: .068
M	code: .064	XXL	code: .069
L	code: .066		



0910267.030.

WHITE



0910267.042.

ROYAL BLUE



0910267.591.

GRAPHITE

STREET SP CLUB T-SHIRT

MATERIAL: 100% COTTON



0910268.591.

GRAPHITE

SIZES

S	code: .062	XL	code: .068
M	code: .064	XXL	code: .069
L	code: .066		

V STREET SP CLUB T-SHIRT

MATERIAL: 100% COTTON



0910269.872.

URBAN GREEN

SIZES

S	code: .062	XL	code: .068
M	code: .064	XXL	code: .069
L	code: .066		



GRAFFITI SP CLUB T-SHIRT

MATERIAL: 100% COTTON

SIZES

S	code: .062	XL	code: .068
M	code: .064	XXL	code: .069
L	code: .066		



0023003.591.

GRAPHITE

FREEDOM SP CLUB T-SHIRT

MATERIAL: 100% COTTON

SIZES

S	code: .062	XL	code: .068
M	code: .064	XXL	code: .069
L	code: .066		



0023004.073.

DARK GREY



0023004.591.

GRAPHITE



0023004.872.

URBAN GREEN

CLUB SP CLUB T-SHIRT

MATERIAL: 100% COTTON

SIZES

S	code: .062	XL	code: .068
M	code: .064	XXL	code: .069
L	code: .066		



0023005.073.

DARK GREY



0023005.110.

RED



0023005.591.

GRAPHITE



0023005.872.

URBAN GREEN

WINGS SP CLUB LADY T-SHIRT

MATERIAL: 95% COTTON, 5% ELASTANE



0910270.030.

WHITE

SIZES

XS	code: .061	L	code: .066
S	code: .062	XL	code: .068
M	code: .064		

RUSH SP CLUB LADY T-SHIRT

MATERIAL: 95% COTTON, 5% ELASTANE



0910271.076.

LIGHT GREY

SIZES

XS	code: .061	L	code: .066
S	code: .062	XL	code: .068
M	code: .064		



0910271.141.

FUCHSIA

UNIVERSITY SP CLUB LADY TOP

MATERIAL: 95% COTTON, 5% ELASTANE



0910272.591.

GRAPHITE

SIZES

XS	code: .061	L	code: .066
S	code: .062	XL	code: .068
M	code: .064		

WINGS SP CLUB KID T-SHIRT

MATERIAL: 100% COTTON



0910273.073.

DARK GREY

SIZES

M	code: .064	XXL	code: .069
L	code: .066		
XL	code: .068		

ACROBAT SP CLUB KID T-SHIRT

MATERIAL: 100% COTTON



0910274.042.

ROYAL BLUE

SIZES

M	code: .064	XXL	code: .069
L	code: .066		
XL	code: .068		



SHIELD SP CLUB KID T-SHIRT
MATERIAL: 100% COTTON



0910275.591.
GRAPHITE

SIZES		
M	code: .064	XXL code: .069
L	code: .066	
XL	code: .068	

WISDOM SP CLUB KID T-SHIRT
MATERIAL: 100% COTTON



0023026.073.
DARK GREY

SIZES		
M	code: .064	XXL code: .069
L	code: .066	
XL	code: .068	

HELL SP CLUB KID T-SHIRT
MATERIAL: 100% COTTON



0023028.110.
RED

SIZES		
M	code: .064	XXL code: .069
L	code: .066	
XL	code: .068	

CROSS SP CLUB KID T-SHIRT
MATERIAL: 100% COTTON



0023029.591.
GRAPHITE

SIZES		
M	code: .064	XXL code: .069
L	code: .066	
XL	code: .068	



CASUAL



CORPORATE JEANS

COMPONENTS:

Shell 98% Cotton, 2% Elastan

Lining 65% Poliestere 35% Cotone

COMPOSIZIONE:

Esterno 98% Cotone, 2% Elastane

Fodera 65% Poliestere 35% Cotone

SIZES

30	code: .030	36	code: .036
32	code: .032	38	code: .038
34	code: .034		



MAN
0023422.040.
BLUE



LADY
0023423.040.
BLUE

CORPORATE LADY JEANS



SIZES

25	code: .025	30	code: .030
26	code: .026	31	code: .031
27	code: .027	32	code: .032
28	code: .028	33	code: .033
29	code: .029		

PASADENA LADY JEANS

MATERIAL: 100% COTTON



SIZES

26	code: .026	31	code: .031
27	code: .027	32	code: .032
28	code: .028		
29	code: .029		
30	code: .030		



0017847.070.
GREY

CAMOU SP CLUB BERMUDA
MATERIAL: 97% COTTON, 3% ELASTANE

SIZES

30	code: .030	34	code: .034
31	code: .031	36	code: .036
32	code: .032	38	code: .038
33	code: .033		



0910279.899.
GREY/DARK GREY

CARGO SP CLUB BERMUDA
MATERIAL: 97% COTTON, 3% ELASTANE

SIZES

30	code: .030	34	code: .034
31	code: .031	36	code: .036
32	code: .032	38	code: .038
33	code: .033		



0910280.073.
DARK GREY



0910280.872.
URBAN GREEN



PODIUM CAP

MATERIAL: 95% POLYESTER; 5% ELASTAN



0017186.090.

BLACK

SIZES

S/M code: .063

L/XL code: .067

PODIUM BEANIE

MATERIAL: 95% POLYESTER; 5% ELASTAN



0021712.090.

BLACK

SIZES

ONE SIZE

FLOATSAM CAP

MATERIAL: 85% POLYESTER; 15% ELASTAN



0022814.090.

BLACK

SIZES

S/M code: .063

L/XL code: .067

JETSAM CAP

MATERIAL: 85% POLYESTER; 15% ELASTAN



0022815.076.

LIGHT GREY

SIZES

S/M code: .063

L/XL code: .067

ACERBIS WALLET



0022372.010

ORANGE



0022372.030

WHITE



0022372.040

BLUE



0022372.090

BLACK



0022372.110

RED



0022372.130

GREEN



CASUAL





HANDGUARDS PARAMANI



X-FACTOR HANDGUARDS

X-Factor is the new ultra-resistant handguard made for people looking for more protection, in extreme enduro, but also for maxi-enduro users. Featured with an ANTICORODAL bar with 35 mm. "C" section **(1)**, that ensures a resistance 5 times higher than a classic aluminum handguard. The bracelet has an increased thickness from 15 mm to 19 mm **(2)**, offering not only increased rigidity, but also increases torsional strength, this is guaranteed by the expander made entirely of steel. The broader bi-injection cover protects **(3)** almost all of the riders hands. Finally the pre-shaped slits allow increased the ventilation **(4)**.

APPLICATION: All off-road aluminum handlebars with an internal diameter of 13.5 mm. to 16 mm. and an outside diameter of 22 mm. Fatbar and Twinwall with an external diameter of 28 mm.

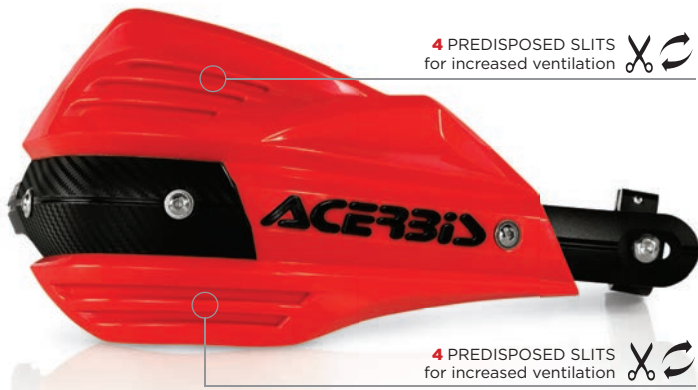

orange
code: **0017557.010**



orange/white
code: **0017557.011**



KTM orange 2016
code: **0017557.011.016**



white
code: **0017557.030**



blue
code: **0017557.040**



yellow
code: **0017557.060**



black
code: **0017557.090**



red
code: **0017557.110**



green
code: **0017557.130**



red/white
code: **0017557.343**

REPLACEMENTS



PLASTICS
model: **X-FACTOR**
code: **0017632.**
colors: ORANGE **010** / ORANGE/WHITE **011** / KTM ORANGE 2016 **011.016**
WHITE **030** / BLUE **040** / YELLOW **060** / BLACK **090** / RED **110** / GREEN **130**
RED/WHITE **343**



BARS
model: **X-FACTOR**
code: **0017633.090**



X-FACTORY HANDGUARDS

- Closed hand guard
- Steel bar printed on its surface in different colours
- Anticorrosion armbands to fasten the hand guard to the handlebar
- Steel expander for tighter fastening and to oppose torsion in case of impact.
- Dual-injection covers
- Application: on handlebars with inner diameter from 13.5 mm. to 16 mm. and outside diameter from 22 mm. to 28 mm.



MOUNTING KIT
code: **0022427.**



orange/white
code: **0022397.203**



orange/black
code: **0022397.209**



white/orange
code: **0022397.229**



white/blue
code: **0022397.232**



white/yellow
code: **0022397.234**



white/black
code: **0022397.237**



white/red
code: **0022397.239**



blue/white
code: **0022397.245**



yellow/black
code: **0022397.279**



black/orange
code: **0022397.313**



black/white
code: **0022397.315**



black/green
code: **0022397.325**



red/white
code: **0022397.343**



red/black
code: **0022397.349**



green/black
code: **0022397.377**



white/fluo yellow
code: **0022397.455**



black/fluo orange
code: **0022397.442**



white/fluo green
code: **0022397.454**



black/fluo green
code: **0022397.719**

REPLACEMENTS COVERS



orange/white
code: **0022399.203**



orange/black
code: **0022399.209**



white/orange
code: **0022399.229**



white/blue
code: **0022399.232**



white/yellow
code: **0022399.234**



white/black
code: **0022399.237**



white/red
code: **0022399.239**



blue/white
code: **0022399.245**



yellow/black
code: **0022399.279**



black/orange
code: **0022399.313**



black/white
code: **0022399.315**



black/green
code: **0022399.325**



red/white
code: **0022399.343**



red/black
code: **0022399.349**



green/black
code: **0022399.377**

REPLACEMENTS BARS



orange
code: **0022394.010**



fluo orange
code: **0022394.014**



white
code: **0022394.030**



blue
code: **0022394.040**



yellow
code: **0022394.060**



fluo yellow
code: **0022394.061**



black
code: **0022394.090**



red
code: **0022394.110**



green
code: **0022394.130**



fluo green
code: **0022394.131**



MULTIPLO "E" HANDGUARDS



KIT X-STRONG
code: **0013060.090**



KTM orange 2016
code: **0013056.011.016**



white
code: **0013056.030**



blue
code: **0013056.040**



black
code: **0013056.090**

ENDURANCE HANDGUARDS



KIT X-STRONG
code: **0013060.090**



orange
code: **0016865.010**



KTM orange 2016
code: **0016865.011.016**



white
code: **0016865.030**



blue
code: **0016865.040**



black
code: **0016865.090**



red
code: **0016865.110**

REPLACEMENTS



PLASTICS "E"

model: **MULTIPLO "E"**
code: **0007982.**
colors: ORANGE **010** / KTM ORANGE2016 **011.016** / WHITE **030**
BLUE **040** / YELLOW **060** / BLACK **090** / RED **110**



PLASTICS "T"

model: **MULTIPLO "E"**
code: **0007981.**
colors: BLACK **090**



PLASTICS

model: **ENDURANCE**
code: **0013013.**
colors: ORANGE **010** / KTM ORANGE2016 **011.016** / WHITE **030**
BLUE **040** / YELLOW **060** / BLACK **090** / RED **110** / GREEN **130**



SUPERMOTO HANDGUARDS



UNIVERSAL MOUNTING KIT
code: **0013060.090**



white
code: **0013063.030**



black
code: **0013063.090**

REPLACEMENTS



PLASTICS "E"
model: **SUPERMOTO / MULTICONCEPT**
code: **0009109.**
colors: **WHITE 030 / BLACK 090**



BARS
model: **SUPERMOTO**
code: **0015642.**



SLIDERS
model: **SUPERMOTO**
code: **0009791.090**



PLASTICS "T"
model: **SUPERMOTO / MULTICONCEPT**
code: **0009112.**
colors: **WHITE 030 / BLACK 090**



BARS
model: **MULTICONCEPT**
code: **0016867.090**



RALLY PRO HANDGUARDS



KIT X-STRONG
code: **0013060.090**



orange
code: **0013054.010.098**



KTM orange 2016
code: **0013054.011.016**



white
code: **0013054.030**



blue
code: **0013054.040.098**



black
code: **0013054.090**



red
code: **0013054.110**



red 00
code: **0013054.110.990**

UNIKO ATV HANDGUARDS



HANDLEBARS Ø BETWEEN
16 mm. AND 19 mm.



white
code: **0009463.030**



black
code: **0009463.090**

REPLACEMENTS

PLASTICS

model: **RALLY PRO**
code: **0003094.**
colors: ORANGE **010.098** / KTM ORANGE 2016 **011.016** / WHITE **030** / BLUE **040.098**
YELLOW **060** / BLACK **090** / RED **110** / RED 00 **110.990** / GREEN **130**



SPOILER

model: **RALLY PRO**
code: **0001501.090**



PLASTICS

model: **UNIKO ATV**
code: **0010884.**
colors: ORANGE **010** / WHITE **030** / BLUE **040** / BLACK **090** / RED **110**



TRI FIT HANDGUARDS

Made of Nylon. This innovative, multi-functional handguard kit allows 4 different configurations: MX open (2), STRONG closed (1), ATV without bracelet (3) and Strong closed without bar and cover (4). It can be fitted on Cross bikes, dirt bikes, motard, and ATV. Great flexibility of use. The mounting kit is included (for aluminum handlebar).

• MIN. \varnothing 13,6 mm. - MAX. \varnothing 14,6 mm.

1 > STRONG CLOSED



2 > MX OPEN



3 > ATV

WITHOUT BRACELET



4 > STRONG CLOSED

WITHOUT COVER



MOUNTING KIT INCLUDED



orange
code: **0016508.010**



KTM orange 2016
code: **0016508.011.016**



white
code: **0016508.030**



blue
code: **0016508.040**



yellow
code: **0016508.060**



black
code: **0016508.090**



red
code: **0016508.110**



green
code: **0016508.130**

REPLACEMENTS

PLASTICS

model: **TRI FIT**
code: **0016633.**
colors: ORANGE **010** / KTM ORANGE 2016 **011.016**
WHITE **030** / BLUE **040** / YELLOW **060**
BLACK **090** / RED **110** / GREEN **130**



BRACELETS

2 bracelets + screws
model: **TRI FIT**
code: **0016632.090**



EXPANDER

for handlebars \varnothing from 15 mm to 16 mm
model: **TRI FIT**
code: **0016943.**



X-OPEN BRE > PAG. 251



X OPEN > PAG. 256

RALLY PROFILE HANDGUARDS

MOUNTING KIT
INCLUDED



X-RALLY
code: **0013437.**



orange
code: **0013057.010**



KTM orange 2016
code: **0013057.011.016**



white
code: **0013057.030**



blue
code: **0013057.040**



yellow
code: **0013057.060**



black
code: **0013057.090**



red
code: **0013057.110**



green
code: **0013057.130**

REPLACEMENTS



EXPANDER

for handlebars \varnothing from 15 mm to 16 mm
model: **RALLY PROFILE**
code: **0016943.**



PLASTICS

model: **RALLY PROFILE**
code: **0010932.**
colors: ORANGE **010** / KTM ORANGE 2016 **011.016** / WHITE **030** / BLUE **040** / YELLOW **060** / BLACK **090** / RED **110** / GREEN **130**



RALLY BRUSH HANDGUARDS

MOUNTING KIT
INCLUDED



X-RALLY
code: **0013437.**



white
code: **0000528.030**



black
code: **0000528.090**



REPLACEMENTS



SPOILER
model: **RALLY BRUSH**
code: **0000607.090**



EXPANDER
for handlebars \varnothing from 15 mm to 16 mm
model: **RALLY BRUSH**
code: **0016943.**

MINICROSS RALLY HANDGUARDS

MOUNTING KIT
INCLUDED



MOUNTING KIT
FOR STANDARD BARS \varnothing 22 mm.
code: **0006972.**



white
code: **0005511.030**



black
code: **0005511.090**



RAM VX HANDGUARDS

COMPONENTS:

- 65% Polyester; 30% Aluminum; 5% Others

DETAILS:

- Open hand guard with high strength aluminum half bar
- Cover with air intake for optimum ventilation
- Cover and aluminum bar guarantee protection, rigidity and opening typical of cross hand guards
- Can be mounted on handlebars with diameter between 22 and 28 mm.
- Fixing bracelets to the handle bars in high strength aluminum
- Mounting kit included in the package

APPLICATION:

- **All off-road aluminum handlebars with outside diameter of 22 mm, fatbar, and twinwall with the external diameter of 28 mm.**



orange
code: **0022809.010**



KTM orange 2016
code: **0022809.011.016**



white
code: **0022809.030**



blue
code: **0022809.040**



black
code: **0022809.090**



red
code: **0022809.0110**



MOUNTING KIT
code: **0022951.090**



X-ULTIMATE HANDGUARDS

- Open hand guard: applicable, while it maintains the original position of the button panel
- Nylon Bracelets
- Upper and lower lids removable for maximum ventilation
- Universal mounting behind the pump
- Horizontally adjustable
- **Application: handlebars external diameter from 22 mm. to 28 mm. and twinwall**



MOUNTING KIT
code: **0022480.**



HORIZONTALLY
ADJUSTABLE



UNIVERSAL
MOUNTING BEHIND
THE PUMP

WITH SPOILER

← REMOVABLE SPOILER

WITHOUT SPOILER



orange/white
code: **0022115.203**



orange/black
code: **0022115.209**



white/orange
code: **0022115.229**



white/blue
code: **0022115.232**



white/yellow
code: **0022115.234**



white/black
code: **0022115.237**



white/red
code: **0022115.239**



blue/white
code: **0022115.245**



yellow/blue
code: **0022115.274**



yellow/black
code: **0022115.279**



black/orange
code: **0022115.313**



black/white
code: **0022115.315**



black/green
code: **0022115.325**



red/white
code: **0022115.343**



red/blue/white
code: **0022115.344**



red/black
code: **0022115.349**



green/black
code: **0022115.377**

REPLACEMENTS COVERS

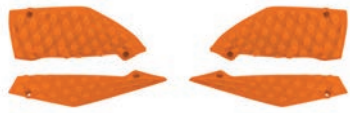

orange
code: **0022479.010**



white
code: **0022479.030**



blue
code: **0022479.040**



dark blue
code: **0022479.041**



yellow
code: **0022479.060**



black
code: **0022479.090**



red
code: **0022479.110**



green
code: **0022479.130**



X-OPEN HANDGUARDS



MOUNTING KIT INCLUDED



orange
code: **0016967.010**



KTM orange 2016
code: **0016967.011.016**



white
code: **0016967.030**



blue
code: **0016967.040**



yellow
code: **0016967.060**



black
code: **0016967.090**



red
code: **0016967.110**



green
code: **0016967.130**

REPLACEMENTS



PLASTICS

model: **X-OPEN BRE / X-OPEN**

code: **0016633.**

colors: ORANGE **010** / KTM ORANGE 2016 **011.016** / WHITE **030** / BLUE **040** / YELLOW **060** / BLACK **090** / RED **110** / GREEN **130**



BRACELETS

2 bracelets + screws

model: **X-OPEN BRE**

code: **0017886.**



BRACELETS

2 bracelets + screws

model: **X-OPEN**

code: **0016632.090**

X-FORCE HANDGUARDS

X-FORCE offroad handguards have been developed and tested in collaboration with the riders of our **KAWASAKI MONSTER ENERGY** team, **YAMAHA MONSTER ENERGY** team and **KTM FARIOLI** team. Made of polypropylene, nylon bracelet with two fixing points in the vertical, extremely light and fully vented. A removable spoiler that provides added protection from stones, shock and weathering. Easy and quick installation. Universal mounting system can be positioned both below and above the lever. Universal mounting kit included.



UNIVERSAL MOUNTING KIT
code: **0013741.**

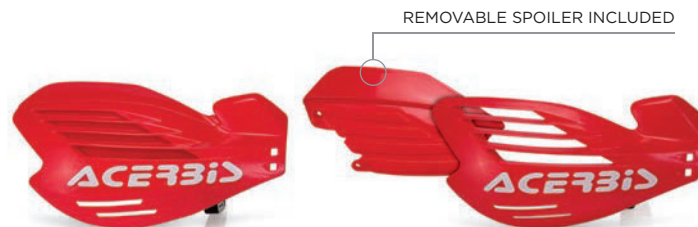

orange
code: **0013709.010**



KTM orange 2016/white
code: **0013709.011.016**



fluo orange /white
code: **0013709.014.016**



white
code: **0013709.030**



blue
code: **0013709.040**



yellow
code: **0013709.060**



fluo yellow
code: **0013709.061**



black
code: **0013709.090**



red
code: **0013709.110**



green
code: **0013709.130**



pink
code: **0013709.140**



black/green
code: **0013709.325**

REPLACEMENTS



SPOILER

model: **X-FORCE**
code: **0013801.**

colors: ORANGE **010** / KTM ORANGE 2016 **011.016** / WHITE **030** / BLUE **040** / YELLOW **060**
BLACK **090** / RED **110** / GREEN **130**



MX UNIKO VENTED HANDGUARDS



UNIVERSAL MOUNTING KIT
code: 0010987.090



orange
code: 0009846.010



KTM orange 2016
code: 0009846.011.016



white/orange
code: 0009846.011



white
code: 0009846.030



white/fluo yellow
code: 0009846.032



blue
code: 0009846.040



white/blue
code: 0009846.041



yellow
code: 0009846.060



black
code: 0009846.090



red
code: 0009846.110



white/red
code: 0009846.111



red/black
code: 0009846.112



green
code: 0009846.130



white/green
code: 0009846.131



orange
code: 0009846.203



black/orange
code: 0009846.313



black/green
code: 0009846.325

MX UNIKO HANDGUARDS



UNIVERSAL MOUNTING KIT
code: 0008158.090



orange
code: 0008159.010



KTM orange 2016
code: 0008159.011.016



white
code: 0008159.030



blue
code: 0008159.040



yellow
code: 0008159.060



black
code: 0008159.090



red
code: 0008159.110



red/black
code: 0008159.112



green
code: 0008159.130



orange/white
code: 0008159.203

X-FACTOR

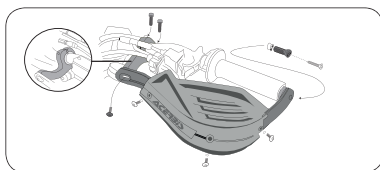

X-FACTOR MOUNTING KIT
for handlebars
internal \varnothing from 13,5 mm to 16 mm
esternal \varnothing from 22 mm to 28 mm
code: **0017631**.



TRI FIT

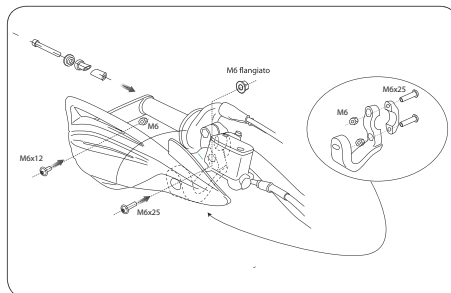

BRACELETS
2 bracelets + screws
code: **0016632.090**



SPACERS KIT
insert for \varnothing 14,5 mm.
handlebar
code: **0013061**.



EXPANDER
for handlebars \varnothing
from 15 mm to 16 mm
code: **0016943**.



X-OPEN



X-OPEN BRE

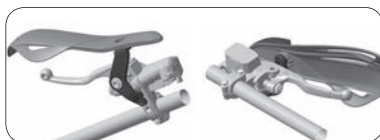

BRACELETS
2 bracelets + screws
code: **0017886**.



RALLY III

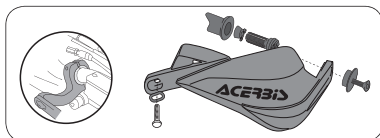

KIT X-STRONG
code: **0013060.090**



MULTIPL0 "E"



MULTIPL0 "R"



ENDURANCE



RALLY PRO



SUPERMOTO



MULTICONCEPT

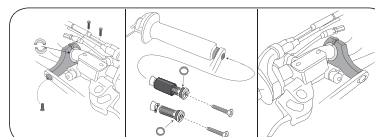

KIT X-STRONG
for handlebars
internal \varnothing from 13,5 mm to 19 mm
esternal \varnothing from 22 mm to 28 mm
code: **0013060.090**



SPACERS
code: **0006832**.



EXPANDER complete
for handlebars internal \varnothing
from 13,5 mm to 17,5 mm
code: **0006773**.



X-FACTORY



KIT X-FACTORY
code: **0022427**.



EXPANDER complete
for handlebars internal \varnothing
from 13,5 mm to 16 mm
code: **0023109**.



X-ULTIMATE



KIT X-ULTIMATE
code: **0022480**.



RALLY PROFILE



RALLY BRUSH

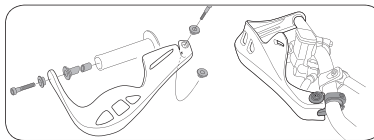

UNIVERSAL MOUNTING KIT X-RALLY

for handlebars
internal \varnothing from 13,5 mm to 14,5 mm
external \varnothing from 22 mm to 28 mm
material: **Aluminium**
code: **0013018.**



UNIVERSAL MOUNTING KIT X-RALLY

for handlebars
internal \varnothing from 13,5 mm to 14,5 mm
external \varnothing from 22 mm to 28 mm
material: **Plastic**
code: **0013437.**



SPACERS KIT

for handlebars
internal \varnothing from 13,5 mm to 14,5 mm
code: **0013061.**



EXPANDER

for handlebars
internal \varnothing from 15 mm to 16 mm
code: **0016943.**



MOUNTING KIT FOR STEEL BARS

for handlebars
internal \varnothing from 17,5 mm to 18,5 mm
external \varnothing from 22 mm to 28 mm
code: **0017819.**



UNIKO ATV

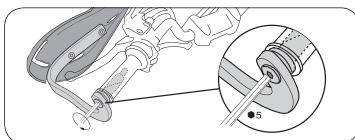

MOUNTING KIT KOREN

for handlebars
internal \varnothing from 13 mm to 14,6 mm
code: **0009790.**



MINICROSS RALLY

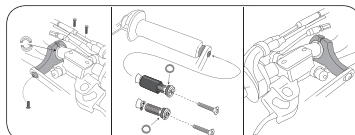

STANDARD HANDLEBAR

for handlebars
internal \varnothing from 13,5 mm to 14,5 mm
external \varnothing 22 mm
code: **0006972.**



X-FORCE

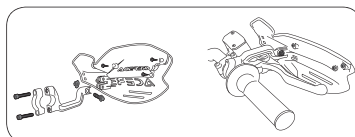

UNIVERSAL MOUNTING KIT

code: **0013741.**



MX UNIKO VENTED

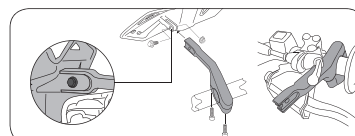

UNIVERSAL MOUNTING KIT
code: **0010987.090**
material: **Plastic**



MX UNIKO

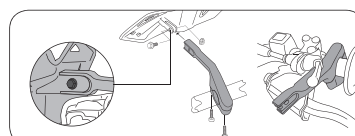

UNIVERSAL MOUNTING KIT
code: **0008158.090**
material: **Plastic**



UNIVERSAL MOUNTING KIT
code: **0008141.**
material: **Aluminium**



AFRICA TWIN MOUNTING KIT

AFRICA TWIN MOUNTING KIT
code: **0023417.**

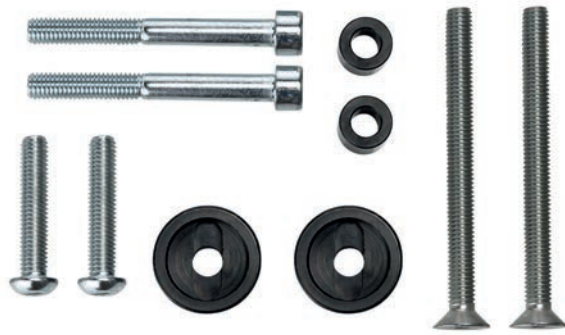

MODEL	YEAR	CODE	OPTIONAL KIT
AFRICA TWIN CRF 1000L	16/18	0023417.	/
AFRICA TWIN ADVENTURE SPORTS	16/18	0023417.	/
AFRICA TWIN TRAVEL EDITION	16/18	0023417.	/

COMPATIBLE FOR:

X-FACTORY



MULTIPL0 "E"



ENDURANCE



SUPERMOTO



RALLY PRO



X-FACTOR



OBLIVION HANDGUARDS

- Aerodynamic design.
- Chrome screen, aluminium effect.
- Anti-vibration nylon arm.
- ACERBIS logo on the screen.
- MOUNTING KIT INCLUDED.
- **CAN BE INSTALLED ON ALL MOTORCYCLE MODELS THAT HAVE A HANDLE WITH AN INNER DIAMETER OF 13.6 mm TO 19 mm.**



code: **0021618.090**

REPLACEMENTS



MOUNTING KIT
code: **0015644.**

APPLICATIONS FOR OBLIVION HANDGUARDS

MODEL	YEAR	CODE	OPTIONAL KIT
BMW NINE T SCRAMBLER	15/17	0021618.090	+ 0021716.*
BMW R NINE T	15/17	0021618.090	+ 0021716.*
BMW F 750 GS	18/19	0021618.090	+ 0017835.*
BMW F 850 GS	18/19	0021618.090	+ 0017835.*
BMW F 800 R	18/19	0021618.090	+ 0021716.*
BMW R 1250 R	18/19	0021618.090	+ 0017835.*
BMW G 310 R	2019	0021618.090	+ 0023386.*
BMW G320 GS	2019	0021618.090	+ 0023386.*
BMW C 650 SPORT	2019	0021618.090	+ 0023386.*
CABALLERO SCRAMBLER 125/250	18/19	0021618.090	/
CABALLERO SCRAMBLER 500	2019	0021618.090	/
DUCATI SCRAMBLER 800	15/17	0021618.090	/
DUCATI MONSTER 797	2019	0021618.090	/
DUCATI MULTISTRADA 950 S	2019	0021618.090	/
DUCATI MULTISTRADA 1260 S	2019	0021618.090	/
DUCATI SCRAMBLER 1100	2019	0021618.090	/
DUCATI SCRAMBLER 803	2019	0021618.090	/
DUCATI DIABEL	2019	0021618.090	/
DUCATI MONSTER 1200 S	2019	0021618.090	/
DUCATI MONSTER 821	2019	0021618.090	/
DUCATI YPERMOTAR 950	2019	0021618.090	/
DUCATI SUPER SPORT	2019	0021618.090	/
DUCATI 959 PANIGALE	2019	0021618.090	/
DUCATI PANIGALE	2019	0021618.090	/
GUZZI AUDACE	16/17	0021618.090	+ 0017572.*
GUZZI CALIFORNIA	16/17	0021618.090	+ 0017572.*
GUZZI ELDORARO 1400	14/17	0021618.090	+ 0017572.*
GUZZI GRISO 1200 8V	11/17	0021618.090	+ 0017572.*
GUZZI NEVADA 1000	08/17	0021618.090	+ 0017572.*
GUZZI V7	11/15	0021618.090	+ 0017572.*
GUZZI V7 II	16/17	0021618.090	+ 0017572.*
GUZZI V7 II SPECIAL	16/17	0021618.090	+ 0017572.*

MODEL	YEAR	CODE	OPTIONAL KIT
GUZZI V7 STORNELLO	16/17	0021618.090	+ 0017572.*
GUZZI V9 BOBBER	16/17	0021618.090	+ 0017572.*
GUZZI V9 ROAMER	16/19	0021618.090	+ 0017572.*
GUZZI V 85 TT	18/19	0021618.090	+ 0017572.*
GUZZI V7 III STONE	18/19	0021618.090	+ 0017572.*
GUZZI CALIFORNIA	18/19	0021618.090	+ 0017572.*
GUZZI V 7 III ROUGH	18/19	0021618.090	+ 0017572.*
GUZZI V 7 III SPECIAL	18/19	0021618.090	+ 0017572.*
HONDA CB 1100/EX	10/17	0021618.090	/
HONDA X-ADV	18/19	0021618.090	/
HONDA MONKEY	18/19	0021618.090	+ 0017572.*
HONDA AFRICA TWIN ADV.	18/19	0021618.090	/
HONDA CBR 500 R	18/19	0021618.090	/
HONDA CBR 650 R	18/19	0021618.090	/
HONDA CB 125 R	18/19	0021618.090	/
HONDA CB 1000 R	18/19	0021618.090	/
HONDA CB 125 F	18/19	0021618.090	/
HONDA INTEGRA-SEXP	18/19	0021618.090	/
HONDA CMX 500 REBEL	18/19	0021618.090	/
HONDA CROSSRUNNER	18/19	0021618.090	/
HONDA CROSSTURER	18/19	0021618.090	/
HONDA SH 300	2019	0021618.090	+ 0017572.*
HONDA VOLTUS	2019	0021618.090	/
HONDA VT 750 S SHADOW	2016	0021618.090	/
HONDA CB 300 R	18/19	0021618.090	/
HONDA CRF 450 XR	2019	0021618.090	/
HONDA CRF 600/650	2019	0021618.090	/
HONDA CB 1100	17/19	0021618.090	/
HONDA CB 500 X	16/19	0021618.090	/

* ADDITIONAL MOUNTING KIT

APPLICATIONS FOR OBLIVION HANDGUARDS

MODEL	YEAR	CODE	OPTIONAL KIT
HUSQVARNA VITPILEN 401/701	18/19	0021618.090	/
HUSQVARNA SVARTPILEN 701	2019	0021618.090	/
KAWASAKI VULCAN	15/17	0021618.090	+ 0017571.*
KAWASAKI W800	10/17	0021618.090	+ 0017571.*
KAWASAKI Z900 R-S	2018	0021618.090	+ 0017571.*
KAWASAKI VERSYS 650	18/19	0021618.090	+ 0017571.*
KAWASAKI VERSYS 300	18/19	0021618.090	/
KAWASAKI VERSYS 1000	18/19	0021618.090	+ 0017571.*
KAWASAKI Z 750	08/14	0021618.090	+ 0017571.*
KAWASAKI VN 1200-900	09/19	0021618.090	/
KAWASAKI VULCAN 650 S	08/19	0021618.090	+ 0017571.*
KAWASAKI Z 800	13/16	0021618.090	+ 0017571.*
KAWASAKI S 300-125	14/19	0021618.090	+ 0017571.*
KAWASAKI Z 900	16/19	0021618.090	+ 0017571.*
KAWASAKI ER-6N	09/16	0021618.090	+ 0017571.*
KAWASAKI Z 1000	08/19	0021618.090	+ 0017571.*
KAWASAKI Z 300	15/19	0021618.090	+ 0017571.*
KAWASAKI Z 400	18/19	0021618.090	+ 0017571.*
KAWASAKI Z 125	2019	0021618.090	+ 0017571.*
KYMCO AK 550	2019	0021618.090	/
KYMCO X CITING 400	2019	0021618.090	/
KTM 790 ADVENTURE	18/19	0021618.090	/
KTM 1200 ADVENTURE	18/19	0021618.090	/
KTM 390 DUKE	2019	0021618.090	/
MV AGUSTA 1090 ESP	2019	0021618.090	/
MV AGUSTA 910 R	2019	0021618.090	/
SUZUKI V-STRONG 1000 XT	18/19	0021618.090	/
SUZUKI V-STRONG 650 STAND-XT	18/19	0021618.090	/
SUZUKI V-STRONG 250	18/19	0021618.090	/
SUZUKI KATANA 1000	2019	0021618.090	/
SUZUKI GSX-S 750	18/19	0021618.090	/
SUZUKI SV 650	18/19	0021618.090	/
SUZUKI SV 650 X	18/19	0021618.090	/
TRIUMPH BONNEVILLE	11/17	0021618.090	+ 0017572.*

MODEL	YEAR	CODE	OPTIONAL KIT
TRIUMPH SCRAMBLER	11/17	0021618.090	+ 0017572.*
TRIUMPH THRUXTON	11/17	0021618.090	+ 0017572.*
TRIUMPH 1200 TIGER	2018/19	0021618.090	+ 0017572.*
TRIUMPH 800 TIGER	2018/19	0021618.090	+ 0017572.*
TRIUMPH 1050 TIGER SPORT	2018/19	0021618.090	+ 0017572.*
TRIUMPH SPEED TRIPLE 1050 RS	2018/19	0021618.090	+ 0017572.*
TRIUMPH SCRAMBLER 1200 XE	2018/19	0021618.090	+ 0017572.*
TRIUMPH SCRAMBLER 1200 XC	2018/19	0021618.090	+ 0017572.*
TRIUMPH STREET SCRAMBLER 900	2018/19	0021618.090	+ 0017572.*
TRIUMPH BONVILLE 120 BLACK	2018/19	0021618.090	+ 0017572.*
TRIUMPH STREET TWIN	2018/19	0021618.090	+ 0017572.*
TRIUMPH THRUXTON 1200	2018/19	0021618.090	+ 0017572.*
TRIUMPH BOBBER 1200	2018/19	0021618.090	+ 0017572.*
TRIUMPH STREET CUP	2018/19	0021618.090	+ 0017572.*
TRIUMPH SPEEDMASTER B. 1200	2019	0021618.090	+ 0017572.*
TRIUMPH BONVILLE T 100	2018/19	0021618.090	+ 0017572.*
VESPA 6 GIORNI	2018/19	0021618.090	+ 0017572.*
YAMAHA XJR 1300	15/17	0021618.090	+ 0017634.*
YAMAHA V MAX ABS	15/17	0021618.090	/
YAMAHA MT 09	2019	0021618.090	+ 0017634.*
YAMAHA MT 07	2019	0021618.090	+ 0017634.*
YAMAHA MT 10	2019	0021618.090	+ 0017634.*
YAMAHA TRACER 900/900GT/700	15/17	0021618.090	/
YAMAHA XSR 900	15/17	0021618.090	+ 0017634.*
YAMAHA MT 125	15/17	0021618.090	+ 0017634.*
YAMAHA NIKEN GT	15/17	0021618.090	+ 0017634.*
YAMAHA MT 03	15/17	0021618.090	+ 0017634.*
YAMAHA XSR 700	15/17	0021618.090	+ 0017634.*
YAMAHA SCR 950	15/17	0021618.090	/
YAMAHA AEROS 50	15/17	0021618.090	/

* ADDITIONAL MOUNTING KIT



X-TARMAC HANDGUARDS

A unique handguard designed for road use. X-TARMAC combines style, safety and convenience. Featuring a futuristic flat light that easy to connect to the lighting system (12v). This hand guard is trimmed with a transparent removable spoiler, designed to increase the deflection of air and rain. **X-TARMAC CAN BE FITTED ON ALL THE BIKES WITH HANDLEBAR THAT HAS AN INTERNAL DIAMETER FROM 13,6 MM TO 19 MM.** The hinged side allows the front cover to be rotated horizontally ensuring an optimal adaptation. The aerodynamic design is co-injected with metal insert to provide a considerable rigidity. There is an optional kit, sold separately, for installation on handlebars with a different diameter type.



code: **0017564.090**

REMOVABLE SPOILER

JOINT FOR HANDGUARDS REGULATION

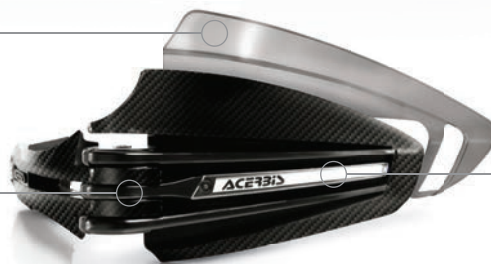

ELECTROLUMINESCENT INSERTS INCLUDED

X-TARMAC WITHOUT ELECTROLUMINESCENT INSERTS

For the applications see cod. 0017564.090 at pag. 261/262/263



code: **0017931.090**

REPLACEMENTS



ELECTROLUMINESCENT INSERTS (2 pcs)
code: **0017575.**



MOUNTING KIT
code: **0015644.**

DUAL ROAD HANDGUARDS

- Antivibration bar inserts
- Aerodynamic design
- Bar made of nylon PA66
- Spoiler made of polycarbonate
- Removable spoiler
- Led (sold separately)
- **CAN BE FITTED ON ALL THE BIKES WITH HANDLEBAR THAT HAS AN INTERNAL DIAMETER FROM 13,6 MM TO 19 MM.**



DUAL ROAD WITHOUT MOUNTING KIT

MOUNTING KIT SOLD SEPARATELY



OPTIONALS

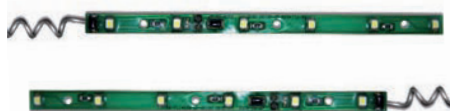

LED (2 pcs)
code: **0013081.**

REPLACEMENTS



MOUNTING KIT
code: **0015644.**



FLASH HANDGUARDS

- Made of Polypropylene with steel antivibration bar inserts
- Equipped with 6 bright led bulbs, powered by two AAA batteries
- battery lifetime is approximately 90 hours with continuous use
- Mounting kit included
- 2 AAA batteries included.



MOUNTING KIT
INCLUDED



APPLICATIONS FOR FLASH

MODEL	YEAR	CODE	OPTIONAL KIT
APRILIA SCARABEO 125	09/12	0013824.090	/
APRILIA SCARABEO 200	09/12	0013824.090	/
APRILIA SCARABEO 50	09/10	0013824.090	/
APRILIA SCARABEO 300s	09/12	0013824.090	/
APRILIA SCARABEO 400s	09/10	0013824.090	/
APRILIA SPORTCITY 50	09/10	0013824.090	/
APRILIA SPORTCITY 125	09/10	0013824.090	/
APRILIA SPORTCITY 200	09/10	0013824.090	/
APRILIA SPORTCITY 250	09/10	0013824.090	/
APRILIA SPORTCITY CUBE	09/12	0013824.090	/
APRILIA SPORTCITY CUBE 200	09/12	0013824.090	/
APRILIA SPORTCITY CUBE 300	09/12	0013824.090	/
APRILIA SR 50 R	09/10	0013824.090	/
DERBY GPI	09/10	0013824.090	/
GARELLI FLEXY	09/12	0013824.090	/
GARELLI TIESSE	09/12	0013824.090	/
GARELLI XO 125	09/10	0013824.090	/
GARELLI XO 150	09/10	0013824.090	/
GILERA RUNNER 50	09/10	0013824.090	/
GILERA RUNNER 125	09/10	0013824.090	/
GILERA RUNNER 200	09/10	0013824.090	/
GILERA FUOCO 500 cupo. basso	08/10	0013824.090	/
HONDA SH 125	09/12	0013824.090	+ 0017572.*
HONDA SH 150	09/12	0013824.090	+ 0017572.*
HONDA SH 300	09/10	0013824.090	+ 0017572.*
HONDA PCX	2010	0013824.090	/
KYMCO DINK 125	08/12	0013824.090	/
KYMCO DINK 200	08/12	0013824.090	/
KYMCO AGILITY 50	09/12	0013824.090	/
KYMCO AGILITY 125	09/12	0013824.090	/
KYMCO AGILITY 150	09/12	0013824.090	/
KYMCO AGILITY R16	09/12	0013824.090	/
KYMCO PEOPLE 125 S	09/12	0013824.090	/
KYMCO PEOPLE 200	09/12	0013824.090	/
KYMCO PEOPLE S 300	09/12	0013824.090	/
KYMCO SUPER8 50	09/12	0013824.090	/
MALAGUTI CENTRO	09/10	0013824.090	/
MALAGUTI CIAK	09/12	0013824.090	/

MODEL	YEAR	CODE	OPTIONAL KIT
MALAGUTI FIO	05/12	0013824.090	/
MALAGUTI MADISON 250	09/12	0013824.090	/
MALAGUTI PASSWORD	09/12	0013824.090	/
MALAGUTI PHANTOM 50	00/12	0013824.090	/
PEUGEOT GEOPOLIS 300	10/12	0013824.090	/
PIAGGIO BEVERLY 125	09/10	0013824.090	/
	12/17	0013824.090	+ 0017572.*
PIAGGIO BEVERLY 150	12/17	0013824.090	+ 0017572.*
PIAGGIO BEVERLY 250	09/10	0013824.090	/
PIAGGIO BEVERLY 300	12/17	0013824.090	+ 0017572.*
PIAGGIO BEVERLY 350	12/17	0013824.090	+ 0017572.*
PIAGGIO BEVERLY 500	09/10	0013824.090	/
PIAGGIO CARNABY 125-250	09/10	0013824.090	/
PIAGGIO LIBERTY 125	09/10	0013824.090	/
PIAGGIO LIBERTY 250	09/10	0013824.090	/
PIAGGIO MADLEY 125/150	2017	0013824.090	+ 0017572.*
PIAGGIO MP3 300 EI	2017	0013824.090	+ 0017572.*
PIAGGIO NRG 50	09/12	0013824.090	/
PIAGGIO VESPA 125 LGT-LXV	09/12	0013824.090	/
PIAGGIO VESPA 125 GTS-GTV	09/12	0013824.090	/
PIAGGIO VESPA GTS TOURING	12/17	0013824.090	+ 0017572.*
PIAGGIO VESPA 300 evo	09/12	0013824.090	/
PIAGGIO VESPA 200 LGT	09/12	0013824.090	/
PIAGGIO VESPA 250 GTS-GTD	09/12	0013824.090	/
PIAGGIO VESPA 3000 GTS SUPER	09/12	0013824.090	/
PIAGGIO X7 125/250	09/10	0013824.090	/
PIAGGIO ZIP 50 SP/4T	07/12	0013824.090	/
SUZUKI BURGMAN 650	08/17	0013824.090	/
SYM CITYCOM 300	10/12	0013824.090	/
SYM HD 125	10/12	0013824.090	/
SYM HD 200	10/12	0013824.090	/
SYM JET 50	10/12	0013824.090	/
SYM VS 125	10/12	0013824.090	/
SYM VS 150	10/12	0013824.090	/
YAMAHA AEROX SCOOTER 50	08/10	0013824.090	/
YAMAHA MAJESTY 400	2009	0013824.090	/
YAMAHA NEOS 50	09/10	0013824.090	/

* ADDITIONAL MOUNTING KIT

APPLICATIONS FOR X-TARMAC / DUAL ROAD HANDGUARDS

MODEL	YEAR	COD. DUAL ROAD	COD. X-TARMAC
APRILIA 1100 FACTORY	2016	0013046.	0017564.090
APRILIA CAPONORD 1200	15/16	0013046. + 0017572.*	0017564.090 + 0017572.*
APRILIA CAPONORD RALLY	2016	0013046.	0017564.090
APRILIA DORSODURO 750	08/18	0013046. + 0017572.*	0017564.090 + 0017572.*
APRILIA DORSODURO 900	17/18	0013046. + 0017568.*	0017564.090 + 0017634.*
APRILIA MANA 850	08/16	0013046. + 0017572.*	0017564.090 + 0017572.*
APRILIA PEGASO 650	07/09	0013046. + 0017572.*	0017564.090 + 0017572.*
APRILIA SCARABEO 300 S	16/18	0013046. + 0017572.*	0017564.090 + 0017572.*
APRILIA SCARABEO 200/500	07/14	0013046. + 0017572.*	0017564.090 + 0017572.*
APRILIA SHIVER 750	08/18	0013046. + 0017572.*	0017564.090 + 0017572.*
APRILIA SHIVER 900	17/18	0013046. + 0017568.*	0017564.090 + 0017634.*
APRILIA SPORTCITY 125/200/250	07/14	0013046.	0017564.090
APRILIA TUONO 125	17/18	0013046. + 0017634.*	0017564.090 + 0017634.*
APRILIA TUONO 1000	08/18	0013046. + 0017572.*	0017564.090 + 0017572.*
APRILIA TUONO 1100	17/18	0013046. /	0017564.090 + 0017634.*
APRILIA SRV 850	12/16	0013046. + 0017572.*	0017564.090 + 0017572.*
APRILIA SRV 900	17/18	0013046. + 0017572.*	0017564.090 + 0017572.*
BENELLI TRK 502	17/18	/	0017564.090
BENELLI GRANPASSO	09/10	0013046.	0017564.090
BENELLI TNT 125 NAKED	17/18	0013046.	0017564.090
BENELLI TNT 899	08/12	0013046.	0017564.090
BENELLI TNT SPORT EVO 1130	09/12	0013046.	0017564.090
BENELLI TORNADO NAKED 1130	08/12	0013046.	0017564.090
BENELLI TRE AMAZONAS 898	08/12	0013046.	0017564.090
BENELLI LEONCINO 500	17/18	0013046.	0017564.090
BENELLI BN 251/302	17/18	0013046.	0017564.090
BIMOTA DB6 DELIRIO	09/10	0013046.	0017564.090
BMW 310 GS	17/18	0013046. + 0023386.*	0017564.090 + 0023386.*
BMW F 650 GS	07/14	0013046. + 0017567.*	0017564.090 + 0017567.*
BMW F 650 GT	2017	0013046. + 0021716.*	0017564.090 + 0017567.*
BMW F 700 GS	12/16	/	0017564.090
		/	+ 0017568.*
	2017	0013046. /	0017564.090 + 0017568.*
BMW F 800 GS	08/12	0013046. + 0017567.*	0017564.090 + 0017567.*
	13/17	0013046. + 0017568.*	0017564.090 + 0017568.*
BMW F 800 ST	09/17	0013046. + 0017568.*	0017564.090 + 0017568.*
BMW F 800 R	09/13	0013046. + 0017567.*	0017564.090 + 0017567.*
	14/19	0013046. + 0021716.*	0017564.090 + 0021716.*
BMW F 750/850 GS	18/19	0013046. + 0017568.*	0017564.090 + 0017568.*
BMW C 650 SPORT	2019	0013046. + 0023386.*	0017564.090 + 0023386.*
BMW C 400 GT-X/C 650 GT	2019	/	0017564.090
		/	+ 0023386.*
BMW G 310 R	2019	0013046. + 0023386.*	0017564.090 + 0023386.*

MODEL	YEAR	COD. DUAL ROAD	COD. X-TARMAC
BMW G 320 GS	2019	0013046. + 0023386.*	0017564.090 + 0023386.*
BMW G 650 GS	14/16	/	0017564.090
		/	+ 0017572.*
	2017	0013046. + 0021716.*	0017564.090 + 0017572.*
BMW K 1200 R	06/16	0013046. + 0017568.*	0017564.090 + 0017568.*
BMW NINE-T	2019	/	0017564.090
		/	+ 0021716.*
BMW K 1300 R / S	09/17	0013046. + 0017568.*	0017564.090 + 0017568.*
BMW K 1300 GT	10/14	0013046. + 0017569.*	0017564.090 + 0017569.*
BMW K 1600 GT	18/19	/	0017564.090
		/	+ 0017571.*
BMW K 1600 B/GT/GT-L	17/18	0013046. /	0017564.090 + 0017571.*
BMW R 1200 GS	07/12	0013046. + 0017570.*	0017564.090 + 0017570.*
	13/18	0013046. + 0017835.*	0017564.090 + 0017835.*
BMW R 1250 GS	18/19	/	0017564.090
		/	+ 0017835.*
BMW R 1200 GS ADVENTURE	07/13	0013046. + 0017570.*	0017564.090 + 0017570.*
	14/18	0013046. + 0017835.*	0017564.090 + 0017835.*
BMW R 1200 R	07/14	0013046. + 0017568.*	0017564.090 + 0017568.*
	15/18	0013046. + 0017835.*	0017564.090 + 0017835.*
BMW R 1250 R	18/19	0013046. + 0017835.*	0017564.090 + 0017835.*
BMW R 1200 RS	15/18	/	0017564.090
		/	+ 0017568.*
BMW R 1200 RT	07/09	0013046. + 0017569.*	0017564.090 + 0017569.*
	10/18	0013046. + 0017568.*	0017564.090 + 0017568.*
BMW R NINE T SCRAMBLER	15/18	/	0017564.090
		/	+ 0021716.*
BMW S 1000 XR	15/18	/	0017564.090
		/	+ 0017835.*
BMW S 1000 R	15/18	0013046. + 0021716.*	0017564.090 + 0021716.*
BUELL 1125 CR	08/11	0013046.	0017564.090
CABALLERO SCRAMBLER 125/250	18/19	0013046.	0017564.090
CABALLERO SCRAMBLER 500	2019	0013046.	0017564.090
DUCATI DIAVEL	12/19	0013046.	0017564.090
DUCATI HYPERMOT. 950	2019	0013046.	0017564.090
DUCATI HYPERMOT. 1100	08/09	0013046.	0017564.090
DUCATI HYPERMOT. 1100 EVO/821	10/17	0013046. + 0017572.*	0017564.090 + 0017572.*
DUCATI HYPERMOTARD 939 SP	16/18	0013046.	0017564.090
DUCATI MONSTER 696/796/797	08/18	0013046.	0017564.090
DUCATI MONSTER 797	2019	0013046.	0017564.090
DUCATI MONSTER 821	14/19	0013046.	0017564.090
DUCATI MONSTER 1200	16/18	0013046.	0017564.090
DUCATI MONSTER 1200 S	2019	0013046.	0017564.090
DUCATI MONSTER S 1100	08/17	0013046.	0017564.090
DUCATI MONSTER S 1100 EVO	08/17	0013046.	0017564.090
DUCATI MULTISTRADA 1100	08/18	0013046.	0017564.090
DUCATI MULTISTRADA 1100 S	08/18	0013046.	0017564.090
DUCATI MULTISTRADA 1200 S	12/18	0013046.	0017564.090
DUCATI MULTISTRADA 950/1260 S	2019	0013046.	0017564.090
DUCATI SCRAMBLER	15/18	0013046.	0017564.090
DUCATI SCRAMBLER 803/1100	2019	0013046.	0017564.090
DUCATI SPORTCLASSIC	10/18	0013046.	0017564.090
DUCATI SUPERSPORT	2018	0013046.	0017564.090

* ADDITIONAL MOUNTING KIT



APPLICATIONS FOR X-TARMAC / DUAL ROAD HANDGUARDS

MODEL	YEAR	COD. DUAL ROAD	COD. X-TARMAC
KAWASAKI Z 300	15/19	0013046. + 0017571. *	0017564.090 + 0017571. *
KAWASAKI Z 400	18/19	0013046. + 0017571. *	0017564.090 + 0017571. *
KAWASAKI Z 750	02/14	0013046. + 0017571. *	0017564.090 + 0017571. *
KAWASAKI Z 800	13/16	0013046. + 0017571. *	0017564.090 + 0017571. *
KAWASAKI Z 900	16/19	0013046. + 0017571. *	0017564.090 + 0017571. *
KAWASAKI 800E/Z300	13/18	0013046. + 0017571. *	0017564.090 + 0017571. *
KAWASAKI Z 900 RS	2018	0013046. + 0017571. *	0017564.090 + 0017571. *
KAWASAKI Z 1000	08/19	0013046. + 0017571. *	0017564.090 + 0017571. *
KYMCO AK 550	2019	0013046.	0017564.090
KYMCO X-CITING 400	2019	0013046.	0017564.090
KYMCO GTI 125/300	2019	/	0017564.090
KYMCO AGILITY 50/125/150	2019	/	0017564.090
KYMCO G DINK 300	2019	/	0017564.090
KTM 990 SUPERMOTO IE	09/14	0013046.	0017564.090
KTM ADVENTURE 790/1200	18/19	0013046.	0017564.090
KTM ADVENTURE 950/990	05/12	0013046.	0017564.090
KTM ADVENT. R 1190/1050/1290	12/18	0013046.	0017564.090
KTM ADVENTURE 1090R	17/18	0013046.	0017564.090
KTM DUKE 125	13/18	0013046. /	0017564.090 + 0017572.*
KTM DUKE 200/390/690	09/18	0013046. + 0017572.*	0017564.090 + 0017572.*
KTM DUKE 390	16/18	0013046. + 0017572.*	0017564.090 + 0017572.*
KTM DUKE 390	2019	0013046.	0017564.090
KTM DUKE 690	2016	0013046.	0017564.090
KTM S.DUKE 790/1290/1290 R/1300	13/18	0013046. + 0017572.*	0017564.090 + 0017572.*
KTM S.DUKE 990	11/14	0013046.	0017564.090
KTM SMC 690	09/15	0013046.	0017564.090
KTM SM 950	06/09	0013046.	0017564.090
KTM SM 990	09/12	0013046.	0017564.090
MALAGUTI PHANTOM 50	08/10	0013046.	0017564.090
MORINI CORSARO 1200	08/15	0013046.	0017564.090
MORINI GRANPASSO	09/15	0013046.	0017564.090
MV AGUSTA DRAGSTER 800 RR	2019	/	0017564.090 + 0017572. *
MV AGUSTA 910 R	2019	0013046.	0017564.090
MV AGUSTA 1090 ESP	2019	0013046.	0017564.090
MV AGUSTA BRUTALE 675	12/14	0013046.	0017564.090
MV AGUSTA BRUTALE 750 S	03/05	0013046.	0017564.090
MV AGUSTA BRUTALE 800	12/15	0013046.	0017564.090
MV AGUSTA BRUTALE RR 800	18/19	/	0017564.090 + 0017634. *
MV AGUSTA BRUTALE RR 675	18/20	/	0017564.090 + 0017634. *
MV AGUSTA BRUTALE 910 S/R	05/11	0013046.	0017564.090
MV AGUSTA BRUTALE 920	12/13	0013046.	0017564.090
MV AGUSTA BRUTALE 989 R	08/13	0013046.	0017564.090
MV AGUSTA BRUTALE 990	09/13	0013046.	0017564.090
MV AGUSTA BRUTALE 1078 RR	08/13	0013046.	0017564.090
MV AGUSTA BRUTALE 1090	09/14	0013046.	0017564.090
PIAGGIO 6 GIORNI 300	2018	/	0017564.090 + 0017572. *
PIAGGIO BEVERLY 125	12/15	0013046. + 0017572. *	0017564.090 + 0017572. *
PIAGGIO BEVERLY 250	08/18	0013046. + 0017572. *	0017564.090 + 0017572. *
PIAGGIO BEVERLY 500	08/18	0013046. + 0017572. *	0017564.090 + 0017572. *
PIAGGIO BEVERLY 350	18/19	/	0017564.090 + 0017572.*
PIAGGIO BEVERLY 350/300 E.I	11/18	0013046. + 0017572.*	0017564.090 + 0017572.*

MODEL	YEAR	COD. DUAL ROAD	COD. X-TARMAC
PIAGGIO BEVERLY 500 E.I	11/16	0013046. + 0017572.*	0017564.090 + 0017572.*
PIAGGIO BEVERLY POLICE	16/17	0013046. + 0017572. *	0017564.090 + 0017572. *
PIAGGIO BEVERLY POLICE	18/19	/	0017564.090 + 0017572. *
PIAGGIO BEVERLY S	16/17	0013046. + 0017572. *	0017564.090 + 0017572. *
PIAGGIO BEVERLY S	18/19	/	0017564.090 + 0017572. *
PIAGGIO CARNABY 300	12/14	0013046. + 0017572.*	0017564.090 + 0017572.*
PIAGGIO FLY 125	08/14	0013046. + 0017572.*	0017564.090 + 0017572.*
PIAGGIO YOURBAN 300	11/18	0013046. + 0017572.*	0017564.090 + 0017572.*
PIAGGIO LIBERTY 125 POSTE	11/18	0013046. + 0017572.*	0017564.090 + 0017572.*
PIAGGIO LIBERTY 125/150	08/17	0013046.	0017564.090
PIAGGIO MEDLEY S	18/19	/	0017564.090 + 0017572. *
PIAGGIO MEDLEY 125/150	16/18	0013046. + 0017572. *	0017564.090 + 0017572. *
PIAGGIO MEDLEY 125/150	2019	/	0017564.090 + 0017572. *
PIAGGIO MP3 300	18/19	/	0017564.090 + 0017572.*
PIAGGIO MP3 300 / 500	11/18	/	0017564.090 + 0017572.*
PIAGGIO SPORT / BUSINESS	11/18	/	0017564.090 + 0017572.*
SUZUKI 1000 R	17/19	/	0017564.090
SUZUKI BANDIT 650/600 (NO S)	14/18	0013046.	0017564.090
SUZUKI BANDIT GSF 1250	09/18	0013046.	0017564.090
SUZUKI B-KING 1300	09/16	0013046.	0017564.090
SUZUKI BURGMAN ESECUTIVE	18/19	/	0017564.090
SUZUKI BURGMAN 125/200/650	08/18	0013046. + 0017571. *	0017564.090 + 0017571. *
SUZUKI BURGMAN 400	2018	/	0017564.090
SUZUKI DRZ 125 SM	08/13	0013046.	0017564.090
SUZUKI GLADIUS 650	09/17	0013046. + 0017572.*	0017564.090 + 0017572.*
SUZUKI GSR 600	08/18	0013046.	0017564.090
SUZUKI GSR 750	08/18	0013046.	0017564.090
SUZUKI GSX S 750	18/19	0013046.	0017564.090
SUZUKI GSX S 750/1000	15/18	0013046.	0017564.090
SUZUKI INAZUMA 250	13/17	0013046.	0017564.090
SUZUKI KATANA 1000	2019	0013046.	0017564.090
SUZUKI SV 650 (NO S)	99/19	0013046.	0017564.090
SUZUKI SV 650 X	18/19	0013046.	0017564.090
SUZUKI SV 1000 (SCARENATA)	03/05	0013046.	0017564.090
SUZUKI VANVAN RV 125	09/17	0013046.	0017564.090
SUZUKI V STROM	04/18	0013046.	0017564.090
SUZUKI V-STRONG 250	18/19	0013046.	0017564.090
SUZUKI V-STRONG 1000 XT	18/19	0013046.	0017564.090
SUZUKI V-STRONG 650 STAND-XT	18/19	0013046.	0017564.090
TRIUMPH BOBBER 1200	18/19	0013046. + 0017572.*	0017564.090 + 0017572.*
TRIUMPH BONNEVILLE 120 BLACK	18/19	0013046. + 0017572.*	0017564.090 + 0017572.*
TRIUMPH BONNEVILLE 1200	11/18	0013046. + 0017572.*	0017564.090 + 0017572.*
TRIUMPH BONNEVILLE SCRAMBLER 900	17/18	0013046. + 0017572.*	0017564.090 + 0017572.*
TRIUMPH BONNEVILLE T100	18/19	0013046. + 0017572.*	0017564.090 + 0017572.*
TRIUMPH BONNEVILLE T1000	17/18	0013046. + 0017572.*	0017564.090 + 0017572.*
TRIUMPH BONNEVILLE T1200	16/18	0013046. + 0017572.*	0017564.090 + 0017572.*

* ADDITIONAL MOUNTING KIT



APPLICATIONS FOR X-TARMAC / DUAL ROAD HANDGUARDS

MODEL	YEAR	COD. DUAL ROAD	COD. X-TARMAC
TRIUMPH THRUXTON	16/18	0013046. + 0017572.*	0017564.090 + 0017572.*
TRIUMPH THRUXTON 1200	18/19	0013046. + 0017572.*	0017564.090 + 0017572.*
TRIUMPH SCRAMBLER 1200 XE/XC	18/19	0013046. + 0017572.*	0017564.090 + 0017572.*
TRIUMPH SPEED TRIPLE 1050	01/16	0013046. + 0017572.*	0017564.090 + 0017572.*
TRIUMPH SPEED TRIPLE 1050 RS	18/19	0013046. + 0017572.*	0017564.090 + 0017572.*
TRIUMPH SPEED MASTER	2018	0013046. + 0017572.*	0017564.090 + 0017572.*
TRIUMPH SPEED MASTER B.	2019	0013046. + 0017572.*	0017564.090 + 0017572.*
TRIUMPH STREET CUP	18/19	0013046. + 0017572.*	0017564.090 + 0017572.*
TRIUMPH STREET CUP 900	16/17	0013046. + 0017572.*	0017564.090 + 0017572.*
TRIUMPH STREET SCRAMBLER 900	18/19	0013046. + 0017572.*	0017564.090 + 0017572.*
TRIUMPH STREET TRIPLE 675	07/18	0013046. + 0017572.*	0017564.090 + 0017572.*
TRIUMPH STREET TRIPLE 765/767/1050	17/18	0013046. + 0017572.*	0017564.090 + 0017572.*
TRIUMPH STREET TWIN 900	16/18	0013046. + 0017572.*	0017564.090 + 0017572.*
TRIUMPH STREET TWIN	18/19	0013046. + 0017572.*	0017564.090 + 0017572.*
TRIUMPH TIGER 800/1200	18/19	0013046. + 0017572.*	0017564.090 + 0017572.*
TRIUMPH TIGER 800 XR/XCX	10/18	0013046. + 0017572.*	0017564.090 + 0017572.*
TRIUMPH TIGER 1050 SPORT	07/19	0013046. + 0017572.*	0017564.090 + 0017572.*
TRIUMPH TIGER EXPLORER	13/18	0013046. + 0017572.*	0017564.090 + 0017572.*
VESPA GTS 300/SUPER	18/19	/	0017564.090 + 0017572.*
VESPA 6 GIORNI	18/19	0013046. + 0017572.*	0017564.090 + 0017572.*
YAMAHA DT 50	03/13	0013046. + 0017634.*	0017564.090 + 0017634.*
YAMAHA FZ1	08/16	0013046.	0017564.090
YAMAHA FZ6/FZ8	06/16	0013046.	0017564.090
YAMAHA J 125	2018	/	0017564.090 + 0017572.*
YAMAHA J 600	08/14	0013046. + 0017634.*	0017564.090 + 0017634.*
YAMAHA MT 03	2019	0013046. + 0017572.*	0017564.090 + 0017572.*
YAMAHA MT 07/09/10	13/19	0013046. + 0017634.*	0017564.090 + 0017634.*
YAMAHA MT 125	18/19	0013046. + 0017534.*	0017564.090 + 0017534.*
YAMAHA TRACER 900	16/18	0013046. + 0017634.*	0017564.090 + 0017634.*
YAMAHA TRACER 700/900/900 GT	2019	0013046.	0017564.090
YAMAHA MT03 660	08/18	0013046. + 0017572.*	0017564.090 + 0017572.*
YAMAHA N-MAX 125/155	2019	/	0017564.090 + 0017572.*
YAMAHA N-MAX	17/18	/	0017564.090 + 0017572.*
YAMAHA NEOS 50	08/10	0013046. + 0017634.*	0017564.090 + 0017634.*
YAMAHA NIKEN GT	2019	0013046. + 0017634.*	0017564.090 + 0017634.*
YAMAHA TENERE	2018	/	0017564.090 + 0017534.*
YAMAHA SUPER TENERE 1200 XT	2019	/	0017564.090 + 0017534.*

MODEL	YEAR	COD. DUAL ROAD	COD. X-TARMAC
YAMAHA SUPER TENERE 1200	10/18	0013046.	0017564.090
YAMAHA SCR 950	2019	0013046.	0017564.090
YAMAHA TDM 900	08/18	0013046. + 0017634.*	0017564.090 + 0017634.*
YAMAHA T-MAX 500/530	01/18	0013046. + 0017634.*	0017564.090 + 0017634.*
	01/19	/	0017564.090 + 0017634.*
YAMAHA X-MAX 300/400	2019	/	0017564.090 + 0017572.*
YAMAHA XJ6	10/14	0013046. + 0017634.*	0017564.090 + 0017634.*
YAMAHA XJR 1300	08/18	0013046. + 0017634.*	0017564.090 + 0017634.*
YAMAHA XSR 700/900/1300	16/18	0013046. + 0017634.*	0017564.090 + 0017634.*
YAMAHA XSR 700/900	18/19	0013046. + 0017634.*	0017564.090 + 0017634.*
YAMAHA XT 660 R	10/16	/	0017564.090 + 0017572.*
YAMAHA XT 660 X	10/16	/	0017564.090
YAMAHA XT 660 Z TENERE CF	10/16	/	0017564.090 + 0017634.*
YAMAHA MAJESTIC 400	10/16	/	0017564.090 + 0017634.*
YAMAHA TRICITY 155	17/18	0013046.	0017564.090 + 0017634.*
YAMAHA TRICITY 125	17/19	/	0017564.090

* ADDITIONAL MOUNTING KIT



X-ROAD 2.0 LEVERS PROTECTIONS

- Pair of shift pad brake/clutch to protect the levers from accidental contacts.
- Adjustable lenght to fit all types of lever.
- Precurved design to guarantee maximum freedom of movement.
- Use of high strenght Nylon to ensure stiffness and flexibility in case of contact.
- Large front shield for aerodynamic protection of the lever.
- **EXPANDER MOUNTING KIT INCLUDED FOR HANDLEBARS WITH INSERT FROM Ø 13,6 MM. TO Ø 19 MM.**



SEE APPLICATIONS
AT PAGE 269



code: **0022860.090**

X-ROAD BRAKE LEVER PROTECTION

Per le applicazioni vedi cod. 0022860.090 a pag. 269 - For the applications see cod. 0022860.090 at pag. 269



code: **0021615.090**



APPLICATIONS FOR X-ROAD LEVERS PROTECTIONS

MODEL	YEAR	CODE	OPTIONAL KIT
KYMCO X CITING 400	2019	0022860.090	/
KTM 790/1200 ADVENTURE	18/19	0022860.090	/
KTM 990 SUPERMOTO IE	09/14	0022860.090	/
KTM DUKE 125/200/390/690	09/16	0022860.090	/
KTM DUKE 125	2019	0022860.090	/
KTM DUKE 690	18/19	0022860.090	/
KTM DUKE 390	2019	0022860.090	/
KTM DUKE 390 RC	2016	0022860.090	+ 0017572.*
KTM DUKE 790	2019	0022860.090	/
KTM S.DUKE 990	11/14	0022860.090	/
KTM S.DUKE 1290	18/19	0022860.090	/
KTM S.DUKE 1290 R	13/18	0022860.090	+ 0017572.*
KTM SMC 690	09/13	0022860.090	/
KTM SM 950	06/09	0022860.090	/
KTM SM 990	09/12	0022860.090	/
MORINI CORSARO 1200	08/13	0022860.090	/
MV AGUSTA 910 R	2019	0022860.090	/
MV AGUSTA 1000 F4	10/16	0022860.090	/
MV AGUSTA 1090 RR	2016	0022860.090	/
MV AGUSTA 1090 ESP	2019	0022860.090	/
MV AGUSTA 800 RR	2016	0022860.090	/
MV AGUSTA BRUTALE 675/F3	12/16	0022860.090	/
MV AGUSTA BRUTALE 750 S	03/05	0022860.090	/
MV AGUSTA BRUTALE 800/F3	12/16	0022860.090	/
MV AGUSTA BRUTALE 910 S/R	05/11	0022860.090	/
MV AGUSTA BRUTALE 920	12/13	0022860.090	/
MV AGUSTA BRUTALE 989 R	08/13	0022860.090	/
MV AGUSTA BRUTALE 990	09/13	0022860.090	/
MV AGUSTA BRUTALE 1078 RR	08/13	0022860.090	/
MV AGUSTA BRUTALE 1090	09/16	0022860.090	/
MV AGUSTA DRAGSTER 800	2016	0022860.090	/
MV AGUSTA DRAGSTER 800 RR	2016	0022860.090	/
MV AGUSTA DRAGSTER RR LH44	2016	0022860.090	/
MV AGUSTA F3 675 RC	2016	0022860.090	/
MV AGUSTA F3 800 AGO	2016	0022860.090	/
MV AGUSTA F3 800 RC	2016	0022860.090	/
MV AGUSTA F4 RC	2016	0022860.090	/
MV AGUSTA F4 RR	2016	0022860.090	/
SUZUKI GSX - S 650	18/19	0022860.090	/
SUZUKI GSX - S 1000-F	15/19	0022860.090	/
SUZUKI GSX 125	18/19	0022860.090	/
SUZUKI GSX - R 600/750	08/18	0022860.090	/
SUZUKI GSX - R 1000	08/19	0022860.090	/
SUZUKI BANDIT 650/600 (NO S)	14/17	0022860.090	/
SUZUKI BANDIT GSF 1250	09/17	0022860.090	/
SUZUKI B-KING 1300	09/17	0022860.090	/
SUZUKI GLADIUS 650	09/17	0022860.090	+ 0017572.*
SUZUKI GSR 600	06/17	0022860.090	/
SUZUKI GSR 750	14/17	0022860.090	+ 0017572.*
SUZUKI SV 650	18/19	0022860.090	/
SUZUKI SV 650 X	18/19	0022860.090	/
SUZUKI SV 650 (NO S)	99/17	0022860.090	/
SUZUKI SV 1000 (SCARENATA)	03/05	0022860.090	/
SUZUKI SV	14/17	0022860.090	+ 0017572.*
SUZUKI VAN VAN	14/17	0022860.090	+ 0017572.*
SUZUKI V-STRONG 250	18/19	0022860.090	/
SUZUKI V-STRONG 1000 XT	18/19	0022860.090	/
SUZUKI V-STRONG 650 STAND-XT	18/19	0022860.090	/
SUZUKI KATANA 1000	2019	0022860.090	/
TRIUMPH 800/1200 TIGER	18/19	0022860.090	+ 0017572.*
TRIUMPH 1050 TIGER SPORT	18/19	0022860.090	+ 0017572.*
TRIUMPH BOBBER 1200	18/19	0022860.090	+ 0017572.*
TRIUMPH BONNEVILLE	11/14	0022860.090	+ 0017572.*
TRIUMPH BONNEVILLE T 100	18/19	0022860.090	+ 0017572.*
TRIUMPH BONNEVILLE 120 BLACK	18/19	0022860.090	+ 0017572.*
TRIUMPH SCRAMBLER 1200 XC/XE	18/19	0022860.090	+ 0017572.*
TRIUMPH STREET SCRAMBLER 900	18/19	0022860.090	+ 0017572.*
TRIUMPH STREET CAP	18/19	0022860.090	+ 0017572.*
TRIUMPH STREET TWIN	18/19	0022860.090	+ 0017572.*
TRIUMPH SPEED MASTER B. 1200	2019	0022860.090	+ 0017572.*
TRIUMPH SPEED TRIPLE RS	2019	0022860.090	+ 0017572.*

MODEL	YEAR	CODE	OPTIONAL KIT
TRIUMPH SPEED TRIPLE 1050	01/18	0022860.090	+ 0017572.*
TRIUMPH SPEED TRIPLE 1050 RS	18/19	0022860.090	+ 0017572.*
TRIUMPH STREET TRIPLE 675	07/18	0022860.090	+ 0017572.*
TRIUMPH THRUXTON	16/18	0022860.090	+ 0017572.*
TRIUMPH THRUXTON 1200	18/19	0022860.090	+ 0017572.*
VESPA 6 GIORNI	18/19	0022860.090	+ 0017572.*
YAMAHA FZ1/ FZ6/FZ8	08/16	0022860.090	+ 0017572.*
YAMAHA MT 03	2019	0022860.090	+ 0017572.*
YAMAHA MT 07/09	13/16	0022860.090	+ 0017634.*
YAMAHA MT 07/09/10	2019	0022860.090	+ 0017634.*
YAMAHA MT 125	2019	0022860.090	+ 0017634.*
YAMAHA MT03 660	08/16	0022860.090	+ 0017634.*
YAMAHA R125	2019	0022860.090	+ 0017634.*
YAMAHA R1/R6/R125	08/18	0022860.090	+ 0017572.*
YAMAHA R3	2018	0022860.090	+ 0017572.*
YAMAHA T-MAX 500/530	10/16	0022860.090	+ 0017634.*
YAMAHA XJR 1300	08/16	0022860.090	+ 0017634.*
YAMAHA XT 660 R	10/16	0022860.090	+ 0017572.*
YAMAHA XT 660 X	10/16	0022860.090	/
YAMAHA XT 660 Z	10/16	0022860.090	+ 0017634.*
YAMAHA YZFR 125	15/16	0022860.090	+ 0017634.*
YAMAHA TRACER 900/900GT/700	2019	0022860.090	/
YAMAHA XSR 700	2019	0022860.090	+ 0017634.*
YAMAHA XSR 900	18/19	0022860.090	+ 0017634.*
YAMAHA NIKEN GT	2019	0022860.090	+ 0017634.*
YAMAHA SCR 950	2019	0022860.090	/

* ADDITIONAL MOUNTING KIT





ACERBIS



HEADLIGHTS MASCHERINE



HEADLIGHT MASK

DETAILS:

- High energetic performance for OFFROAD use only
- Perfectly interchangeable with the original mask
- Maximum brightness and depth of detail guaranteed, even in total dark situations
- IP68 waterproof: permanent impermeability up to 3 metres deep
- 16 Led, 48W headlight
- 4320 Lumen
- DC electrical supply from 9 to 32V
- Estimated led lifespan: 50000 hours
- Operating temperatures between between -40° and +85° C
- Easy and fast mounting, using the original headlight's rubber bands
- Developed for enduro KTM/HUSQVARNA bikes from 2017 to 2019



KTM

COD.

0023992.030

APPLICATIONS: EXC 125/250/300

2013-2016

EXC-F 250/350/450/500

2013-2016



KTM

COD.

0023949.011.016

APPLICATIONS: EXC-F 250/350/450 2017-2019

EXC 250/300 2017

EXC 250/300 TPI 2018-2019



HUSQVARNA

COD.

0023948.030

APPLICATIONS: FE 250/350/450 2017-2019

TE 250/300 2017

TE 250I/300I 2018-2019

FULMINE HEADLIGHT

COMPONENTS:

- 80% Polypropylene; 15% Rubber; 5% Others

DETAILS:

- Universal low energy consumption mask ideal for off-road use
- Guarantees maximum brightness and depth of detail in low light / no light conditions
- Waterproof IP68: protection against permanent immersion in water up to 3 meters in depth
- 9 - led 3W (tot.27W) light equal to 155W filament bulb
- Lumen 2430
- DC power supply (direct current) from 9 to 32 V
- Led life expectancy: 50000 hours
- Operating temperatures between -40° and +85° C
- Cold white light approx. 6000K
- Universal, easy and fast mounting with 4 elastic straps fastening onto the forks
- Not suitable for road use



ELBA HEADLIGHT

Retro look headlight with high resistance plastic headlight (polycarbonate) for enduro bike with conventional forks; Easy mounting with 4 elastics; Yellow sticker added for competition race number.



MOUNTING KIT INCLUDED

BULB NOT INCLUDED

OPTIONAL BULB

12 V 35/35 W
BA20D
cod. **0002877**



white
code: **0003020.030**



red
code: **0003020.110**

LED VISION HP HEADLIGHT

55w

DOT - ECE
SAE - TUV
CERTIFIED



MOUNTING KIT INCLUDED



white
code: **0013429.030**



black
code: **0013429.090**



CYCLOPE HEADLIGHT



code: **0003002.090**



DHH CERTIFIED HEADLIGHT

**DOT - ECE
SAE - TÜV
CERTIFIED**



white
code: **0002694.030**



blue 98
code: **0002694.040.098**



black
code: **0002694.090**



ACCESSORIES & REPLACEMENTS

<p>ELBA</p> 	<p>BULB 12 V 35/35 W BA20D cod.0002877</p> 	<p>LED VISION HP</p> 	<p>MOUNTING STRAPS 4 pcs. set cod.0009114.</p> 	<p>LED 2 pcs. set cod.0015620.</p> 	<p>LENS cod.0015622.</p> 	<p>ON/OFF SWITCH cod.0000074.</p> 	<p>NUMBER PLATE BLACK cod.0002160.090 ORANGE cod.0002160.010.098 BLUE cod.0002160.040.098 YELLOW cod.0002160.060.001</p> 
---	--	---	--	---	--	---	---

<p>CYCLOPE</p> 	<p>MOUNTING STRAPS 4 pcs. set cod.0000236.</p> 	<p>HIGH BEAM code: 0007369.</p> 	<p>LOW BEAM bulb included cod.0007370.</p> 	<p>HALOGEN BULB 55 W, cod.0007368.</p> 	<p>LENS cod.0007371.</p> 	<p>ON/OFF SWITCH cod.0000074.</p> 	<p>NUMBER PLATE cod.0002160.090</p> 
--	--	---	--	--	--	---	---

<p>DHH CERTIFIED</p> 	<p>MOUNTING STRAPS 4 pcs. set cod.0000236.</p> 	<p>BULB 12 V 35/35 W BA20D cod.0002877</p> 	<p>SEALED BEAM cod.0007039.</p> 	<p>ON/OFF SWITCH cod.0000074.</p> 
--	--	--	---	---

<p>DHH</p> 	<p>MOUNTING STRAPS 4 pcs. set cod.0000236.</p> 	<p>BULB 10° beam 12 V - 50 W cod.0007032.</p> 	<p>BULB 36° beam 10 V - 35 W cod.0007033.</p> 	<p>ON/OFF SWITCH cod.0000074.</p> 
--	--	---	---	---

<p>FULMINE</p> 	<p>MOUNTING STRAPS 4 pcs. set cod.0000236.</p> 
--	--

60° P113 TAIL LIGHT

**DOT-ECE
SAE-TUV
CERTIFIED**



code: **0016821.090**

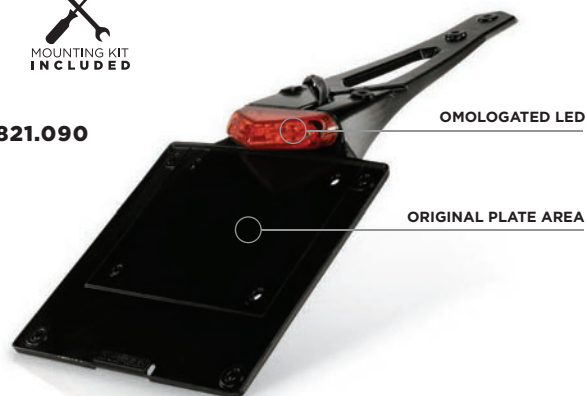

30° LED CE TAIL LIGHT

**DOT-ECE
SAE-TUV
CERTIFIED**



code: **0016822.090**



60° X-LED CE TAIL LIGHT

**DOT-ECE
SAE-TUV
CERTIFIED**



code: **0015941.090**



45° LED CE TAIL LIGHT

**DOT-ECE
SAE-TUV
CERTIFIED**



code: **0012966.090**



60° LED TAILLIGHT



code: **0008326.090**





ACE 73iD

SEATS SELLE



X-AIR SEATS

DETAILS:

- Air cushion pressure adjustment range: +- height/rigidity
- Better stress absorption
- Personalised riding feel
- Constant support over time

CENTRAL DISCHARGE AREA

- Prevents compression of the pelvic area
- Correctly distributes a rider's weight around the pelvis
- Reduces rebound
- Waterproof

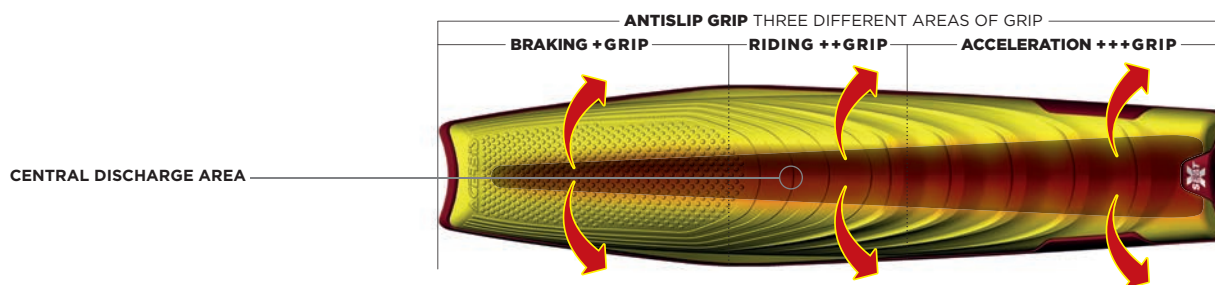

ANTISLIP GRIP

CENTRAL DISCHARGE AREA

INFLATABLE AIR CUSHION
Possibility of pressure regulation:

- \pm support/hardness
- Better stress absorption
- Customizable feeling guide
- Constant support a long

ANTISLIP GRIP

X-AIR SEATS YAMAHA

MODEL	COLORS	YEAR	CODE
YZF 250	BLUE/BLACK	2019	0023437.040.700
	BLACK/BLUE	2019	0023437.090.700
YZF 450	BLUE/BLACK	18/19	0023437.040.700
	BLACK/BLUE	18/19	0023437.090.700



code: **0023437.040.700**



code: **0023437.090.700**

X-AIR SEATS HUSQVARNA

MODEL	COLORS	YEAR	CODE
TC 125/250	BLUE/BLACK	19/20	0023638.040.700
	BLACK/BLUE	19/20	0023638.090.700
FC 250/350/450	BLUE/BLACK	19/20	0023638.040.700
	BLACK/BLUE	19/20	0023638.090.700
TX 125/TE 250 I	BLUE/BLACK	2020	0023638.040.700
	BLACK/BLUE	2020	0023638.090.700
FE 250/350	BLUE/BLACK	2020	0023638.040.700
	BLACK/BLUE	2020	0023638.090.700



code: **0023638.090.700**



code: **0023638.040.700**

X-AIR SEATS KAWASAKI

MODEL	COLORS	YEAR	CODE
KXF 450	BLACK/GREEN	2019	0023767.090.700
	GREEN/BLACK	2019	0023767.130.700



code: **0023767.090.700**



code: **0023767.130.700**

X-AIR SEATS SUZUKI

MODEL	COLORS	YEAR	CODE
RMZ 250	BLUE/YELLOW	2019	0023416.040.700
	YELLOW/BLK.	2019	0023416.060.700
RMZ 450	BLK./YELLOW	2019	0023416.090.700
	BLUE/YELLOW	18/19	0023416.040.700
	YELLOW/BLK.	18/19	0023416.060.700
	BLK./YELLOW	18/19	0023416.090.700



code: **0023416.040.700**



code: **0023416.060.700**



code: **0023416.090.700**

X-AIR SEATS KTM

MODEL	COLORS	YEAR	CODE
SX 125/150/250	BLK./ORANGE	19/20	0023589.090.700
	ORANGE/BLK.	19/20	0023589.010.700
	BLUE/ORANGE	19/20	0023589.041.700
SX-F 250/350/450	BLK./ORANGE	19/20	0023589.090.700
	ORANGE/BLK.	19/20	0023589.010.700
	BLUE/ORANGE	19/20	0023589.041.700
XC-F 250/350/450	BLK./ORANGE	19/20	0023589.090.700
	ORANGE/BLK.	19/20	0023589.010.700
	BLUE/ORANGE	19/20	0023589.041.700
XC 250/300 TPI	BLK./ORANGE	19/20	0023589.090.700
	ORANGE/BLK.	19/20	0023589.010.700
	BLUE/ORANGE	19/20	0023589.041.700
XC-W 125	BLK./ORANGE	2020	0023589.090.700
	ORANGE/BLK.	2020	0023589.010.700
	BLUE/ORANGE	2020	0023589.041.700
XC-W 150 TPI	BLK./ORANGE	2020	0023589.090.700
	ORANGE/BLK.	2020	0023589.010.700
	BLUE/ORANGE	2020	0023589.041.700
/XC-W 250/300 TPI	BLK./ORANGE	2020	0023589.090.700
	ORANGE/BLK.	2020	0023589.010.700
	BLUE/ORANGE	2020	0023589.041.700
EXC-F 250/350	BLK./ORANGE	2020	0023589.090.700
	ORANGE/BLK.	2020	0023589.010.700
	BLUE/ORANGE	2020	0023589.041.700



code: **0023589.090.700**



code: **0023589.010.700**



code: **0023589.041.700**



ACER 33i3
X-SEAT

X-SEATS HARD (RACING)

MODEL	COLORS	YEAR	CODE
YZF 250	BLUE	06/09	0012437.040.700
	BLACK	06/09	0012437.090.700
	BLUE	10/13	0013855.040.700
	BLACK	10/13	0013855.090.700
	BLUE	14/18	0017588.040.700
WRF 250	BLUE	15/18	0017588.040.700
	BLACK	15/18	0017588.090.700
WRF 450	BLUE	16/18	0017588.040.700
	BLACK	16/18	0017588.090.700
YZF 450	BLUE	06/09	0012437.040.700
	BLACK	06/09	0012437.090.700
	BLUE	10/13	0013854.040.700
	BLACK	10/13	0013854.090.700
	BLUE	14/17	0017588.040.700
	BLACK	14/17	0017588.090.700



code: **0012437.040.700**



code: **0012437.090.700**



code: **0013855.040.700**



code: **0013855.090.700**



code: **0017588.040.700**



code: **0017588.090.700**



code: **0013854.040.700**



code: **0013854.090.700**

X-SEATS SOFT (COMFORT)

MODEL	COLORS	YEAR	CODE
YZF 250	BLUE	14/18	0017589.040.700
	BLACK	14/18	0017589.090.700
	BLUE	2019	0023074.040.700
	BLACK	2019	0023074.090.700
WRF 250	BLUE	15/19	0017589.040.700
	BLACK	15/19	0017589.090.700
WRF 450	BLUE	16/18	0017589.040.700
	BLACK	16/18	0017589.090.700
	BLUE	2019	0023074.040.700
	BLACK	2019	0023074.090.700
YZF 450	BLUE	14/17	0017589.040.700
	BLACK	14/17	0017589.090.700
	BLUE	18/19	0023074.040.700
	BLACK	18/19	0023074.090.700



code: **0017589.040.700**



code: **0017589.090.700**

HONDA X-SEATS

X-SEATS HARD (RACING)

MODEL	COLORS	YEAR	CODE
CRF 250/CRE 250F	BLACK	07/09	0013126.090.700
	RED	10/13	0013154.110.700
	BLACK	10/13	0013154.090.700
	RED	14/17	0016952.110.700
	BLACK	14/17	0016952.090.700
CRF 450/CRE 450F	RED	07/08	0013127.110.700
	RED	09/12	0013154.110.700
	BLACK	09/12	0013154.090.700
	RED	13/16	0016952.110.700
	BLACK	13/16	0016952.090.700



code: **0013126.090.700**



code: **0013154.090.700**



code: **0013154.110.700**



code: **0013127.110.700**



code: **0016952.090.700**



code: **0016952.110.700**

X-SEATS SOFT (COMFORT)

MODEL	COLORS	YEAR	CODE
CRE 250 F	BLACK	2018	0022389.090.700
	RED	2018	0022389.110.700
	RED/BLUE	2018	0022389.344.700
CRF 250 R	BLACK	18/19	0022389.090.700
	RED	18/19	0022389.110.700
	RED/BLUE	18/19	0022389.344.700
CRF 250/300 RX	BLACK	2019	0022389.090.700
	RED	2019	0022389.110.700
	RED/BLUE	2019	0022389.344.700
CRF 450 L	BLACK	2019	0022389.090.700
	RED	2019	0022389.110.700
	RED/BLUE	2019	0022389.344.700
CRF 450 R/RX	BLACK	17/19	0022389.090.700
	RED	17/19	0022389.110.700
	RED/BLUE	17/19	0022389.344.700



code: **0022389.110.700**



code: **0022389.344.700**



code: **0022389.090.700**

SUZUKI X-SEATS

X-SEATS HARD (RACING)

MODEL	COLORS	YEARS	CODE
RMZ 250	YELLOW	07/09	0013150.060.700
	BLACK	07/09	0013150.090.700
RMZ 450	YELLOW	08/17	0013149.060.700
	BLACK	08/17	0013149.090.700



code: **0013150.060.700**



code: **0013150.090.700**



code: **0013149.060.700**



code: **0013149.090.700**

X-SEATS SOFT (COMFORT)

MODEL	COLORS	YEARS	CODE
RMZ 250	BLUE	2019	0023068.040.700
	YELLOW	2019	0023068.060.700
	BLACK	2019	0023068.090.700
RMZ 450	BLUE	18/19	0023068.040.700
	YELLOW	18/19	0023068.060.700
	BLACK	18/19	0023068.090.700



code: **0023068.060.700**



code: **0023068.090.700**

X-SEATS HARD (RACING)

MODEL	COLORS	YEAR	CODE
SX-SXF	ORANGE	07/10	0013106.010.700
	BLACK	07/10	0013106.090.700
	ORANGE	11/15	0015618.010.700
	BLACK	11/15	0015618.090.700
SX 125 / 150	ORANGE	16/18	0017444.010.700
	BLUE	16/18	0017444.041.700
	BLACK	16/18	0017444.090.700
SX 250	ORANGE	17/18	0017444.010.700
	BLUE	17/18	0017444.041.700
	BLACK	17/18	0017444.090.700
SXF 250/350/450	ORANGE	16/18	0017444.010.700
	BLUE	16/18	0017444.041.700
	BLACK	16/18	0017444.090.700
EXC-EXCF	ORANGE	08/11	0013106.010.700
	BLACK	08/11	0013106.090.700
	ORANGE	12/16	0015618.010.700
	BLACK	12/16	0015618.090.700
	ORANGE	17/19	0017444.010.700
	BLUE	17/19	0017444.041.700
	BLACK	17/19	0017444.090.700



code: **0013106.010.700**



code: **0013106.090.700**



code: **0015618.010.700**



code: **0015618.090.700**



code: **0017444.010.700**



code: **0017444.041.700**



code: **0017444.090.700**

X-SEATS SOFT (COMFORT)

MODEL	COLORS	YEAR	CODE
SX-SXF	ORANGE	11/15	0017565.010.700
	BLACK	11/15	0017565.090.700
SX 125 / 150	ORANGE	16/18	0017443.010.700
	BLUE	16/18	0017443.041.700
	BLACK	16/18	0017443.090.700
	FULL BLK.	16/18	0017443.091.700
	ORANGE	19/20	0023588.010.700
	BLUE	19/20	0023588.041.700
	BLACK	19/20	0023588.090.700
SX 250	ORANGE	17/18	0017443.010.700
	BLUE	17/18	0017443.041.700
	BLACK	17/18	0017443.090.700
	FULL BLK.	17/18	0017443.091.700
	ORANGE	19/20	0023588.010.700
	BLUE	19/20	0023588.041.700
	BLACK	19/20	0023588.090.700
SX-F 250/350/450	ORANGE	16/18	0017443.010.700
	BLUE	16/18	0017443.041.700
	BLACK	16/18	0017443.090.700
	FULL BLK.	16/18	0017443.091.700
	ORANGE	19/20	0023588.010.700
	BLUE	19/20	0023588.041.700
	BLACK	19/20	0023588.090.700
EXC-EXCF	ORANGE	12/16	0017565.010.700
	BLACK	12/16	0017565.090.700
	ORANGE	17/19	0017443.010.700
	BLUE	17/19	0017443.041.700
	BLACK	17/19	0017443.090.700
	FULL BLK.	17/19	0017443.091.700
XC-F 250/350/450	ORANGE	19/20	0023588.010.700
	BLUE	19/20	0023588.041.700
XC 250/300 TPI	ORANGE	19/20	0023588.010.700
	BLUE	19/20	0023588.041.700
XC-W 125	BLACK	2020	0023588.090.700
	ORANGE	2020	0023588.010.700
XC-W 150 TPI /XC-W 250/300 TPI	BLACK	2020	0023588.090.700
	ORANGE	2020	0023588.010.700
EXC-F 250/350 /450/500	BLACK	2020	0023588.090.700
	ORANGE	2020	0023588.010.700
	BLUE	2020	0023588.041.700



code: **0017443.010.700**



code: **0017443.041.700**



code: **0017443.090.700**



code: **0023588.090.700**



code: **0023588.010.700**



code: **0023588.041.700**



KAWASAKI X-SEATS

X-SEATS HARD (RACING)

MODEL	COLORS	YEAR	CODE
KXF 250	GREEN	09/12	0013153.130.700
	BLACK	09/12	0013153.090.700
	GREEN	13/16	0016305.130.700
	BLACK	13/16	0016305.090.700
	GREEN	17/19	0021877.130.700
	BLACK	17/19	0021877.090.700
KXF 450	GREEN	09/11	0013153.130.700
	BLACK	09/11	0013153.090.700
	GREEN	12/15	0016305.130.700
	BLACK	12/15	0016305.090.700
	GREEN	16/18	0021877.130.700
	BLACK	16/18	0021877.090.700



code: **0013153.090.700**



code: **0013153.130.700**



code: **0016305.090.700**



code: **0016305.130.700**



code: **0021877.090.700**



code: **0021877.130.700**

X-SEATS SOFT (COMFORT)

MODEL	COLORS	YEAR	CODE
KXF 250	GREEN	17/19	0021878.130.700
	BLACK	17/19	0021878.090.700
KXF 450	GREEN	16/18	0021878.130.700
	BLACK	16/18	0021878.090.700
	BLK./GREEN	2019	0023700.090.700
	GREEN/BLK.	2019	0023700.130.700



code: **0021878.090.700**



code: **0021878.130.700**



code: **0023700.090.700**



code: **0023700.130.700**

OLD HUSQVARNA X-SEATS

X-SEATS HARD (RACING)

MODEL	COLORS	YEAR	CODE
WR 125/250 2T	RED	09/13	0013510.110.700
	BLACK	09/13	0013510.090.700
CR 125/250 2T	RED	09/13	0013510.110.700
	BLACK	09/13	0013510.090.700
TC 250 4T	RED	09/13	0013510.110.700
	BLACK	09/13	0013510.090.700
TE 250/310 4T	RED	09/13	0013510.110.700
	BLACK	09/13	0013510.090.700

MODEL	COLORS	YEAR	CODE
TE 450/510 4T	RED	09/10	0013510.110.700
	BLACK	09/10	0013510.090.700
SM 450/510 4T	RED	09/10	0013510.110.700
	BLACK	09/10	0013510.090.700



code: **0013510.110.700**



code: **0013510.090.700**

NEW HUSQVARNA X-SEATS

X-SEATS HARD (RACING)

MODEL	COLORS	YEAR	CODE
FC 250/350/450	BLUE	16/18	0021879.040.700
	BLACK	16/18	0021879.090.700
TC 125	BLUE	16/18	0021879.040.700
	BLACK	16/18	0021879.090.700
TC 250	BLUE	17/18	0021879.040.700
	BLACK	17/18	0021879.090.700
TE 125/250/300	BLUE	17/19	0021879.040.700
	BLACK	17/19	0021879.090.700
FE 250/450/501	BLUE	17/19	0021879.040.700
	BLACK	17/19	0021879.090.700



code: **0021879.040.700**



code: **0021879.090.700**

X-SEATS SOFT (COMFORT)

MODEL	COLORS	YEAR	CODE
FC 250/350/450	BLUE	16/18	0021880.040.700
	YELL./BLUE	16/18	0021880.060.700
	BLACK	16/18	0021880.090.700
	BLUE	2019	0023639.040.700
TC 125	BLACK	2019	0023639.090.700
TC 250	BLUE	16/18	0021880.040.700
	YELLOW	16/18	0021880.060.700
	BLACK	16/18	0021880.090.700
	BLUE	19/20	0023639.040.700
TC 250	BLACK	19/20	0023639.090.700
TE 125/150/250/300	BLUE	17/18	0021880.040.700
	YELL./BLUE	17/18	0021880.060.700
	BLACK	17/18	0021880.090.700
FE 250/350/450/501	BLUE	17/19	0021880.040.700
	YELL./BLUE	17/19	0021880.060.700
	BLACK	17/19	0021880.090.700
	BLUE	2020	0023639.040.700
TX 125/TE 250 I /TE 300 I	BLACK	2020	0023639.090.700
	BLUE/BLK	2020	0023639.040.700



code: **0021880.040.700**



code: **0021880.060.700**



code: **0021880.090.700**



code: **0023639.090.700**



code: **0023639.040.700**

FUEL TANKS SERBATOI



A close-up photograph of a motorcycle's fuel tank. The tank is primarily white with a red section at the top. The Acerbis logo is printed in black on the white section. The background is a blurred outdoor setting.

ACERBIS®

SAHARA

MODEL	COLORS	YEAR	CAPACITY	CODE
XR 650R	RED	04/07	24 lit.	0001615.110
XR 650	RED	00/03	24 lit.	0001615.110



HONDA **XR 650R**
year: **2004/2007**
capacity: **24 lit.**
code: **0001615.110**

CRF 150R

MODEL	COLORS	YEAR	CAPACITY	CODE
CRF 150R	RED	07/19	6,5 lit.	0016495.110.700
	NATURAL	07/19	6,5 lit.	0016495.120.700



HONDA **CRF 150R**
year: **2007/2017**
capacity: **6,5 lit.**
code: **00016495.110**

XR 250R • XR 400R • XR 600R • XR 650L

MODEL	COLORS	YEAR	CAPACITY	CODE
XR 250R	WHITE	96/03	22 lit.	0001601.030
	RED	96/03	22 lit.	0001601.110
	NATURAL	96/03	22 lit.	0001601.120
XR 400R	WHITE	96/04	22 lit.	0001601.030
	RED	96/04	22 lit.	0001601.110
	NATURAL	96/04	22 lit.	0001601.120
XR 600R	WHITE	88/99	22 lit.	0001569.030
XR 650L	WHITE	93/96	22 lit.	0001590.030
	RED	93/96	22 lit.	0001590.110
	NATURAL	93/96	22 lit.	0001590.120



HONDA **XR 650L**
year: **1993/1996**
capacity: **22 lit.**
code: **0001590.110**



HONDA **CRF 250**
year: **2014/2017**
capacity: **10,5 lit.**
code: **0016915.090.700**

CRF 250 • CRF 250R • CRF 200/300RX

MODEL	COLORS	YEAR	CAPACITY	CODE
CRF 250	BLACK	04/09	11 lit.	0007845.090
	WHITE	04/09	11 lit.	0007845.120
	BLACK	10/13	10,5 lit.	0013551.090.700
	WHITE	10/13	10,5 lit.	0013551.120.700
	BLACK	14/17	10,5 lit.	0016915.090.700
CRF 250R	BLACK	18/19	11,5 lit.	0022387.090.700
	NATURAL	18/19	11,5 lit.	0022387.120.700
CRF 250/300RX	BLACK	2019	11,5 lit.	0022761.090.700
	NATURAL	2019	11,5 lit.	0022761.120.700



HONDA **CRF 450**
year: **2013/2016**
capacity: **10,5 lit.**
code: **0016915.120.700**



HONDA **CRF 450X**
year: **2005/2016**
capacity: **25 lit.**
code: **0008429.110**

CRF 450 • CRF 450R

MODEL	COLORS	YEAR	CAPACITY	CODE
CRF 450	BLACK	05/08	12 lit.	0008375.090
	NATURAL	05/08	12 lit.	0008375.120
	BLACK	09/12	10,5 lit.	0013551.090.700
	NATURAL	09/12	10,5 lit.	0013551.120.700
	BLACK	13/16	10,5 lit.	0016915.090.700
CRF 450R	NATURAL	13/16	10,5 lit.	0016915.120.700
	BLACK	17/19	11,5 lit.	0022387.090.700
	NATURAL	17/19	11,5 lit.	0022387.120.700



HONDA **CRF 450R**
year: **2017/2018**
capacity: **11,5 lit.**
code: **0022387.090.700**

CRF 450X • CRF 450 RX

MODEL	COLORS	YEAR	CAPACITY	CODE
CRF 450X	RED	05/16	15,5 lit.	0010999.110.700
	NATURAL	05/16	15,5 lit.	0010999.120.700
	RED	05/16	25 lit.	0008429.110
	NATURAL	05/16	25 lit.	0008429.120
CRF 450RX	BLACK	17/19	11,5 lit.	0022761.090.700
	NATURAL	17/19	11,5 lit.	0022761.120.700



HONDA **CRF 450RX**
year: **2017/2018**
capacity: **11,5 lit.**
code: **0022761.120.700**

FROM MY 2008 TO 2015 FRONT FIXING POINT BRACKET NOT INCLUDED

HONDA FUEL TANKS

DOMINATOR

MODEL	COLORS	YEAR	CAPACITY	CODE
NX/DOMINATOR	WHITE	88/91	23 lit.	0001584.030
	BLACK	88/91	23 lit.	0001584.090
	WHITE	92/94	23 lit.	0001589.030
	BLACK	92/94	23 lit.	0001589.090
	WHITE	95/03	23 lit.	0001603.030
	BLACK	95/03	23 lit.	0001603.090



HONDA **DOMINATOR**
year: **1995/2003**
capacity: **23 lit.**
code: **0001603.090.700**

CRF 250 L/M

MODEL	COLORS	YEAR	CAPACITY	CODE
CRF 250 L/M	BLACK	13/16	12,5 lit.	0022952.090.700
	NATURAL	13/16	12,5 lit.	0022952.120.700
CRF 250 L/M •	BLACK	17/19	12,5 lit.	0022925.090.700
	NATURAL	17/19	12,5 lit.	0022925.120.700



HONDA **CRF 250 L/M**
year: **2013/2016**
capacity: **12,5 lit.**
code: **0022952.090.700**

• WITH/WITHOUT ABS

SUZUKI FUEL TANKS

RMZ 250

MODEL	COLORS	YEAR	CAPACITY	CODE
RMZ 250	BLACK	07/09	11,3 lit.	0011514.090.700
	NATURAL	07/09	11,3 lit.	0011514.120.700



SUZUKI **RMZ 250**
year: **2007/2009**
capacity: **11,3 lit.**
code: **0011514.090.700**

DR 400Z • DR 400S • DR 400SM

MODEL	COLORS	YEAR	CAPACITY	CODE
DR 400Z	YELLOW	00/15	14 lit.	0001604.060
	BLACK	00/15	14 lit.	0001604.090
DR 400S/DR 400SM	BLUE	00/19	15 lit.	0021882.040.700
	YELLOW	00/19	15 lit.	0021882.060.700
	GREY	00/19	15 lit.	0021882.070.700
	BLACK	00/19	15 lit.	0021882.090.700
	NATURAL	00/19	15 lit.	0021882.120.700



SUZUKI **DR 400Z**
year: **2000/2015**
capacity: **14 lit.**
code: **0001604.060**

DR 350

MODEL	COLORS	YEAR	CAPACITY	CODE
DR 350	WHITE	90/99	16 lit.	0001585.030



SUZUKI **DR 350**
year: **1990/1999**
capacity: **16 lit.**
code: **0001585.030**

DR 650

MODEL	COLORS	YEAR	CAPACITY	CODE
DR 650	WHITE	96/19	20 lit.	0016302.030.700
	BLUE	96/19	20 lit.	0016302.040.700
	GREY	96/19	20 lit.	0016302.070.700
	BLACK	96/19	20 lit.	0016302.090.700
	NATURAL	96/19	20 lit.	0016302.120.700
	WHITE	96/19	25 lit.	0017554.030.700
	BLUE	96/19	25 lit.	0017554.040.700
	GREY	96/19	25 lit.	0017554.070.700
	BLACK	96/19	25 lit.	0017554.090.700
	NATURAL	96/19	25 lit.	0017554.120.700



SUZUKI **DR 650**
year: **1996/2018**
capacity: **20 lit.**
code: **0016302.090.700**

DR 650R DJEBEL

MODEL	COLORS	YEAR	CAPACITY	CODE
DR 650R	WHITE	92/95	25 lit.	0001588.030



SUZUKI **DR 650R DJEBEL**
year: **1992/1995**
capacity: **25 lit.**
code: **0001588.030**



MODEL	COLORS	YEAR	CAPACITY	CODE	
EXC 125/XC-W	BLACK	08/11	11 lt.	0011669.090.700	
	NATURAL	08/11	11 lt.	0011669.120.700	
	BLACK	08/11	13 lt.	0011607.090.700	
	ORANGE	08/11	13 lt.	0011607.010.700	
	NATURAL	08/11	13 lt.	0011607.120.700	
	NATURAL	08/11	24 lt.	0010960.120.700	
	ORANGE	08/11	24 lt.	0010960.010.700	
	BLACK	12/16	11,5 lt.	0016334.090.700	
	NATURAL	12/16	11,5 lt.	0016334.120.700	
	BLACK	12/16	15 lt.	0017102.090.700	
	NATURAL	12/16	15 lt.	0017102.120.700	
	BLACK	12/16	20 lt.	0016335.090.700	
	NATURAL	12/16	20 lt.	0016335.120.700	
	BLACK	2017	12 lt.	0023167.090.700	
	NATURAL	2017	12 lt.	0023167.120.700	
	EXC 200	BLACK	08/11	11 lt.	0011669.090.700
NATURAL		08/11	11 lt.	0011669.120.700	
BLACK		08/11	13 lt.	0011607.090.700	
ORANGE		08/11	13 lt.	0011607.010.700	
NATURAL		08/11	13 lt.	0011607.120.700	
NATURAL		08/11	24 lt.	0010960.120.700	
ORANGE		08/11	24 lt.	0010960.010.700	
BLACK		12/16	11,5 lt.	0016334.090.700	
NATURAL		12/16	11,5 lt.	0016334.120.700	
BLACK		12/16	15 lt.	0017102.090.700	
NATURAL		12/16	15 lt.	0017102.120.700	
BLACK		12/16	20 lt.	0016335.090.700	
NATURAL		12/16	20 lt.	0016335.120.700	
EXC 250/ XC-W 250 TPI		ORANGE	06/07	25 lit.	0008430.010
		NATURAL	06/07	25 lit.	0008430.120
		BLACK	08/11	11 lt.	0011669.090.700
	NATURAL	08/11	11 lt.	0011669.120.700	
	BLACK	08/11	13 lt.	0011607.090.700	
	ORANGE	08/11	13 lt.	0011607.010.700	
	NATURAL	08/11	13 lt.	0011607.120.700	
	NATURAL	08/11	24 lt.	0010960.120.700	
	ORANGE	08/11	24 lt.	0010960.010.700	
	BLACK	12/16	11,5 lt.	0016334.090.700	
	NATURAL	12/16	11,5 lt.	0016334.120.700	
	BLACK	12/16	15 lt.	0017102.090.700	
	NATURAL	12/16	15 lt.	0017102.120.700	
	BLACK	12/16	20 lt.	0016335.090.700	
	NATURAL	12/16	20 lt.	0016335.120.700	
	EXC 300/ XC-W 300 TPI	BLACK	08/11	11 lt.	0011669.090.700
NATURAL		08/11	11 lt.	0011669.120.700	
BLACK		08/11	13 lt.	0011607.090.700	
ORANGE		08/11	13 lt.	0011607.010.700	
NATURAL		08/11	13 lt.	0011607.120.700	
NATURAL		08/11	24 lt.	0010960.120.700	
ORANGE		08/11	24 lt.	0010960.010.700	
BLACK		12/16	11,5 lt.	0016334.090.700	
NATURAL		12/16	11,5 lt.	0016334.120.700	
BLACK		12/16	15 lt.	0017102.090.700	
NATURAL		12/16	15 lt.	0017102.120.700	
BLACK		12/16	20 lt.	0016335.090.700	
NATURAL		12/16	20 lt.	0016335.120.700	
BLACK		2017	12 lt.	0023167.090.700	
NATURAL		2017	12 lt.	0023167.120.700	
EXC 250/ XC-W 250 TPI		BLACK	18/19	12 lt.	0023172.090.700
	NATURAL	18/19	12 lt.	0023172.120.700	
	BLACK	2020	12 lt.	0023956.090.700	
	NATURAL	2020	12 lt.	0023956.120.700	
	BLACK	2020	12 lt.	0023950.090.700	
	NATURAL	2020	12 lt.	0023950.120.700	



KTM EXC
year: **2012/2016**
capacity: **11,5 lit.**
code: **0016334.090.700**



KTM EXC
year: **2012/2016**
capacity: **20 lit.**
code: **0016335.120.700**



KTM EXC
KTM EXC-F
year: **2008/2011**
capacity: **13 lit.**
code: **0011607.010.700**



KTM EXC
KTM EXC-F
year: **2008/2011**
capacity: **24 lit.**
code: **0010960.120.700**



KTM EXC-F
year: **2012/2016**
capacity: **11,5 lit.**
code: **0016299.120.700**

MODEL	COLORS	YEAR	CAPACITY	CODE
	BLACK	2020	12 lt.	0023956.090.700
	NATURAL	2020	12 lt.	0023956.120.700
EXC 400/450	ORANGE	05/07	25 lit.	0008430.010
	NATURAL	05/07	25 lit.	0008430.120
EXC 525	ORANGE	06/07	25 lit.	0008430.010
	NATURAL	06/07	25 lit.	0008430.120
EXC-F 250	BLACK	08/11	11 lt.	0011669.090.700
	NATURAL	08/11	11 lt.	0011669.120.700
	BLACK	08/11	13 lt.	0011607.090.700
	ORANGE	08/11	13 lt.	0011607.010.700
	NATURAL	08/11	13 lt.	0011607.120.700
	NATURAL	08/11	24 lt.	0010960.120.700
	ORANGE	08/11	24 lt.	0010960.010.700
	BLACK	12/16	11,5 lt.	0016299.090.700
	NATURAL	12/16	11,5 lt.	0016299.120.700
	BLACK	12/16	15 lt.	0017101.090.700
	NATURAL	12/16	15 lt.	0017101.120.700
	BLACK	12/16	20 lt.	0016301.090.700
	NATURAL	12/16	20 lt.	0016301.120.700
	BLACK	17/19	12 lt.	0023172.090.700
	NATURAL	17/19	12 lt.	0023172.120.700
	BLACK	17/19	15 lt.	0021871.090.700
	NATURAL	17/19	15 lt.	0021871.120.700
	BLACK	2020	12 lt.	0023956.090.700
	NATURAL	2020	12 lt.	0023956.120.700
	BLACK	2020	15 lt.	0023957.090.700
	NATURAL	2020	15 lt.	0023957.120.700
EXC-F 350	BLACK	12/16	11,5 lt.	0016299.090.700
	NATURAL	12/16	11,5 lt.	0016299.120.700
	BLACK	12/16	15 lt.	0017101.090.700
	NATURAL	12/16	15 lt.	0017101.120.700
	BLACK	12/16	20 lt.	0016301.090.700
	NATURAL	12/16	20 lt.	0016301.120.700
	BLACK	17/19	12 lt.	0023172.090.700
	NATURAL	17/19	12 lt.	0023172.120.700
	BLACK	17/19	15 lt.	0021871.090.700
	NATURAL	17/19	15 lt.	0021871.120.700
	BLACK	2020	12 lt.	0023956.090.700
	NATURAL	2020	12 lt.	0023956.120.700
	BLACK	2020	15 lt.	0023957.090.700
	NATURAL	2020	15 lt.	0023957.120.700
EXC-F 400/450	BLACK	08/11	11 lt.	0011669.090.700
	NATURAL	08/11	11 lt.	0011669.120.700
	BLACK	08/11	13 lt.	0011607.090.700
	ORANGE	08/11	13 lt.	0011607.010.700
	NATURAL	08/11	13 lt.	0011607.120.700
	NATURAL	08/11	24 lt.	0010960.120.700
	ORANGE	08/11	24 lt.	0010960.010.700
	BLACK	12/16	15 lt.	0017101.090.700
	NATURAL	12/16	15 lt.	0017101.120.700
EXC-F 450/500	BLACK	12/16	11,5 lt.	0016299.090.700
	NATURAL	12/16	11,5 lt.	0016299.120.700
	BLACK	12/16	15 lt.	0017101.090.700
	NATURAL	12/16	15 lt.	0017101.120.700
	BLACK	12/16	20 lt.	0016301.090.700
	NATURAL	12/16	20 lt.	0016301.120.700
	BLACK	17/19	12 lt.	0023172.090.700
	NATURAL	17/19	12 lt.	0023172.120.700
	BLACK	17/19	15 lt.	0021871.090.700
	NATURAL	17/19	15 lt.	0021871.120.700
	BLACK	2020	12 lt.	0023956.090.700
	NATURAL	2020	12 lt.	0023956.120.700
	BLACK	2020	15 lt.	0023957.090.700
	NATURAL	2020	15 lt.	0023957.120.700
EXC-F 530	BLACK	08/11	11 lt.	0011669.090.700
	NATURAL	08/11	11 lt.	0011669.120.700
	BLACK	08/10	13 lt.	0011607.090.700
	NATURAL	08/10	13 lt.	0011607.120.700



KTM **EXC 400/450**
year: **2005/2007**
capacity: **25 lit.**
code: **0008430.010**



KTM **EXC-F**
year: **2012/2016**
capacity: **20 lit.**
code: **0016301.090.700**



KTM **EXC**
KTM **EXC-F**
year: **2008/2011**
capacity: **13 lit.**
code: **0011607.120.700**



KTM **EXC**
KTM **EXC-F**
year: **2008/2011**
capacity: **24 lit.**
code: **0010960.010.700**



KTM **EXC-F**
year: **2012/2016**
capacity: **20 lit.**
code: **0016301.090.700**



MODEL	COLORS	YEAR	CAPACITY	CODE
	ORANGE	08/10	13 lt.	0011607.010.700
	NATURAL	08/11	24 lt.	0010960.120.700
	ORANGE	08/11	24 lt.	0010960.010.700
SX 125	BLACK	07/10	11 lt.	0011669.090.700
	NATURAL	07/10	11 lt.	0011669.120.700
	BLACK	08/10	13 lt.	0011607.090.700
	ORANGE	08/10	13 lt.	0011607.010.700
	NATURAL	08/10	13 lt.	0011607.120.700
	NATURAL	07/10	24 lt.	0010960.120.700
	ORANGE	07/10	24 lt.	0010960.010.700
	BLACK	11/15	11,5 lt.	0016334.090.700
	NATURAL	11/15	11,5 lt.	0016334.120.700
	BLACK	11/15	15 lt.	0017102.090.700
	NATURAL	11/15	15 lt.	0017102.120.700
	BLACK	11/15	20 lt.	0016335.090.700
	NATURAL	11/15	20 lt.	0016335.120.700
	BLACK	16/18	12 lt.	0023167.090.700
	NATURAL	16/18	12 lt.	0023167.120.700
	BLACK	19/20	12 lt.	0023950.090.700
	NATURAL	19/20	12 lt.	0023950.120.700
SX 150	BLACK	2008	11 lt.	0011669.090.700
	NATURAL	2008	11 lt.	0011669.120.700
	NATURAL	2008	24 lt.	0010960.120.700
	ORANGE	2008	24 lt.	0010960.010.700
	BLACK	08/10	13 lt.	0011607.090.700
	ORANGE	08/10	13 lt.	0011607.010.700
	NATURAL	08/10	13 lt.	0011607.120.700
	BLACK	11/15	11,5 lt.	0016334.090.700
	NATURAL	11/15	11,5 lt.	0016334.120.700
	BLACK	11/15	15 lt.	0017102.090.700
	NATURAL	11/15	15 lt.	0017102.120.700
	BLACK	11/15	20 lt.	0016335.090.700
	NATURAL	11/15	20 lt.	0016335.120.700
	BLACK	16/18	12 lt.	0023167.090.700
	NATURAL	16/18	12 lt.	0023167.120.700
	BLACK	19/20	12 lt.	0023950.090.700
	NATURAL	19/20	12 lt.	0023950.120.700
SX 250	BLACK	07/10	11 lt.	0011669.090.700
	NATURAL	07/10	11 lt.	0011669.120.700
	BLACK	08/10	13 lt.	0011607.090.700
	ORANGE	08/10	13 lt.	0011607.010.700
	NATURAL	08/10	13 lt.	0011607.120.700
	NATURAL	07/10	24 lt.	0010960.120.700
	ORANGE	07/10	24 lt.	0010960.010.700
	BLACK	11/16	11,5 lt.	0016334.090.700
	NATURAL	11/16	11,5 lt.	0016334.120.700
	BLACK	11/16	15 lt.	0017102.090.700
	NATURAL	11/16	15 lt.	0017102.120.700
	BLACK	11/16	20 lt.	0016335.090.700
	NATURAL	11/16	20 lt.	0016335.120.700
	BLACK	17/18	12 lt.	0023167.090.700
	NATURAL	17/18	12 lt.	0023167.120.700
	BLACK	19/20	12 lt.	0023950.090.700
	NATURAL	19/20	12 lt.	0023950.120.700
SX-F 250	BLACK	11/12	11,5 lt.	0016298.090.700
	NATURAL	11/12	11,5 lt.	0016298.120.700
	BLACK	11/12	20 lt.	0016300.090.700
	NATURAL	11/12	20 lt.	0016300.120.700
	BLACK	13/14	11,5 lt.	0016299.090.700
	NATURAL	13/15	11,5 lt.	0016299.120.700
	BLACK	13/15	20 lt.	0016301.090.700
	NATURAL	13/15	20 lt.	0016301.120.700
	BLACK	16/18	12 lt.	0023172.090.700
	NATURAL	16/18	12 lt.	0023172.120.700
	BLACK	16/18	15 lt.	0021871.090.700
	NATURAL	16/18	15 lt.	0021871.120.700
	BLACK	19/20	12 lt.	0023564.090.700
	NATURAL	19/20	12 lt.	0023564.120.700
	BLACK	19/20	15 lt.	0023565.090.700
	NATURAL	19/20	15 lt.	0023565.120.700



KTM **EXC**
KTM **EXC-F**
year: **2008/2011**
capacity: **13 lit.**
code: **0011607.120.700**



KTM **SX**
KTM **SX-F 450**
year: **2007/2010**
capacity: **11 lit.**
code: **0011669.090.700**



KTM **SX**
year: **2011/2015**
capacity: **11,5 lit.**
code: **0016334.090.700**



KTM **SX-F**
year: **2013/2015**
capacity: **11,5 lit.**
code: **0016299.120.700**

MODEL	COLORS	YEAR	CAPACITY	CODE	
SX-F 350	BLACK	11/12	11,5 lt.	0016298.090.700	
	NATURAL	11/12	11,5 lt.	0016298.120.700	
	BLACK	11/12	20 lt.	0016300.090.700	
	NATURAL	11/12	20 lt.	0016300.120.700	
	BLACK	13/15	11,5 lt.	0016299.090.700	
	NATURAL	13/15	11,5 lt.	0016299.120.700	
	BLACK	13/15	15 lt.	0017101.090.700	
	NATURAL	13/15	15 lt.	0017101.120.700	
	BLACK	13/15	20 lt.	0016301.090.700	
	NATURAL	13/15	20 lt.	0016301.120.700	
	BLACK	16/18	12 lt.	0023172.090.700	
	NATURAL	16/18	12 lt.	0023172.120.700	
	BLACK	16/18	15 lt.	0021871.090.700	
	NATURAL	16/18	15 lt.	0021871.120.700	
	BLACK	19/20	12 lt.	0023564.090.700	
	NATURAL	19/20	12 lt.	0023564.120.700	
SX-F 450	BLACK	07/10	11 lt.	0011669.090.700	
	NATURAL	07/10	11 lt.	0011669.120.700	
	NATURAL	07/10	24 lt.	0010960.120.700	
	ORANGE	07/10	24 lt.	0010960.010.700	
	BLACK	08/10	13 lt.	0011607.090.700	
	ORANGE	08/10	13 lt.	0011607.010.700	
	NATURAL	08/10	13 lt.	0011607.120.700	
	BLACK	11/12	11,5 lt.	0016334.090.700	
	NATURAL	11/12	11,5 lt.	0016334.120.700	
	BLACK	11/12	20 lt.	0016335.090.700	
	NATURAL	11/12	20 lt.	0016335.120.700	
	BLACK	13/15	11,5 lt.	0016299.090.700	
	NATURAL	13/15	11,5 lt.	0016299.120.700	
	BLACK	13/15	15 lt.	0017101.090.700	
	NATURAL	13/15	15 lt.	0017101.120.700	
	SX-F 505	BLACK	07/08	11 lt.	0011669.090.700
NATURAL		07/08	11 lt.	0011669.120.700	
NATURAL		07/08	24 lt.	0010960.120.700	
ORANGE		07/08	24 lt.	0010960.010.700	
BLACK		08/10	13 lt.	0011607.090.700	
ORANGE		08/10	13 lt.	0011607.010.700	
NATURAL		08/10	13 lt.	0011607.120.700	
BLACK		13/15	15 lt.	0017101.090.700	
NATURAL		13/15	15 lt.	0017101.120.700	
XC-F 250/350/450		BLACK	2020	12 lt.	0023956.090.700
		NATURAL	2020	12 lt.	0023956.120.700
		BLACK	2020	15 lt.	0023957.090.700
		NATURAL	2020	15 lt.	0023957.120.700
XC 250/300 TPI		BLACK	2020	12 lt.	0023956.090.700
		NATURAL	2020	12 lt.	0023956.120.700



KTM **SX**
KTM **SX-F 450**
year: **2008/2010**
capacity: **13 lit.**
code: **0011607.120.700**



KTM **SXF**
year: **2016/2017**
capacity: **12 lit.**
code: **0023172.120.700**



KTM **SXF**
year: **2016/2017**
capacity: **12 lit.**
code: **0023172.090.700**



KTM **SXF**
year: **2017**
capacity: **15 lit.**
code: **0021871.120.700**



YZ 85

MODEL	COLORS	YEAR	CAPACITY	CODE
YZ 85	WHITE	07/18	8,5 lit.	0016494.030.700
	BLUE	07/18	8,5 lit.	0016494.040.700
	BLACK	07/18	8,5 lit.	0016494.090.700



YAMAHA **YZF 85**
 year: **2007/2018**
 capacity: **8,5 lit.**
 code: **0016494.040.700**

YZF 250 • YZF 450 • WRF250 • WRF 450

MODEL	COLORS	YEAR	CAPACITY	CODE
YZF 250/450	BLUE 98	03/05	12,5 lit.	0007457.040
	NATURAL	03/05	12,5 lit.	0007457.120
	BLUE 98	06/09	12,5 lit.	0010930.040.700
	NATURAL	06/09	12,5 lit.	0010930.120.700
YZF 250	BLACK	14/18	11,3 lit.	0017586.090.700
	NATURAL	14/18	11,3 lit.	0017586.120.700
	BLACK	2019	10 lit.	0023305.040.700
	NATURAL	2019	10 lit.	0023305.120.700
YZF 450	BLACK	10/13	9,1 lit.	0015619.090.700
	NATURAL	10/13	9,1 lit.	0015619.120.700
	BLACK	14/17	11,3 lit.	0017586.090.700
	NATURAL	14/17	11,3 lit.	0017586.120.700
	BLUE	18/19	10 lit.	0023305.040.700
	NATURAL	18/19	10 lit.	0023305.120.700
● WRF 250/450	BLUE 98	03/06	12,5 lit.	0007457.040
	NATURAL	03/06	12,5 lit.	0007457.120
	● BLUE	04/06	25 lit.	0008595.040
	● BLUE 98	07/09	12,5 lit.	0010930.040.700
	● NATURAL	07/09	12,5 lit.	0010930.120.700



YAMAHA **YZF 250/450**
 year: **2014/2017**
 capacity: **11,3 lit.**
 code: **0017586.090.700**



YAMAHA **YZF 450**
 year: **2010/2013**
 capacity: **9,1 lit.**
 code: **0015619.090.700**



YAMAHA **YZF 450**
 year: **2018**
 capacity: **10 lit.**
 code: **0023305.040.700**

● FITS YZF 250/450 RADIATOR SCOOPS **CODE: 0003666.**

YZ 250 • YZ 400 • WR 250 • WR 400 • YZ 426 F • WR 426 F

MODEL	COLORS	YEAR	CAPACITY	CODE
WR/YZ 125/250	BLUE	05/19	12 lit.	0023657.040.700
	NATURAL	05/19	12 lit.	0023657.120.700
	BLACK	05/19	12 lit.	0023657.090.700
WR/YZ 400 F	BLUE 98	1999	13 lit.	0001612.040.098
	NATURAL	1999	13 lit.	0001612.120
WR/YZ 426 F	BLUE 98	00/02	13 lit.	0001612.040.098
	NATURAL	00/02	13 lit.	0001612.120
WR 250 F	BLUE 98	01/02	13 lit.	0001612.040.098
	NATURAL	01/02	13 lit.	0001612.120



YAMAHA **WR/YZ 125/250**
 year: **2005/2017**
 capacity: **12 lit.**
 code: **0015911.040.700**

● FITS YZF 250/450 RADIATOR SCOOPS **CODE: 0003666.**

XT 600

MODEL	COLORS	YEARS	CAPACITY	CODE
XT 600	WHITE	95/03	23 lit.	0001599.030
	BLACK	95/03	23 lit.	0001599.090



YAMAHA **XT 600**
 year: **1995/2003**
 capacity: **23 lit.**
 code: **0001599.090**

YAMAHA FUEL TANKS

TT 600

MODEL	COLORS	YEARS	CAPACITY	CODE
● TT 600	WHITE	93/97	23 lit.	0001593.030
○	WHITE	98/03	23 lit.	0001593.030
TT 600 R	WHITE	98/04	20 lit.	0001614.030

- KICK STARTER
- ELETRIC STARTER



YAMAHA **TT 600**
 year: **1993/2003**
 capacity: **23 lit.**
 code: **0001593.030**

KAWASAKI FUEL TANKS

KLX 450

MODEL	COLORS	YEAR	CAPACITY	CODE
KLX 450	BLACK	08/18	12,5 lit.	0011602.090.700
	NATURAL	08/18	12,5 lit.	0011602.120.700
	BLACK	08/18	16 lit.	0012438.090.700
	NATURAL	08/18	16 lit.	0012438.120.700



KAWASAKI **KLX 450**
 year: **2008/2018**
 capacity: **12,5 lit.**
 code: **0011602.090.700**



KAWASAKI **KLX 450**
 year: **2008/2018**
 capacity: **16 lit.**
 code: **0012438.120.700**

KLX 250 C/R • KLX 300

MODEL	COLORS	YEARS	CAPACITY	CODE
KLX 250 C/R	GREEN	93/96	14 lit.	0001594.130
	BLACK	93/96	14 lit.	0001594.090
KLX 300	GREEN	99/02	14 lit.	0001594.130
	BLACK	99/02	14 lit.	0001594.090
	GREEN	2004	14 lit.	0001594.130
	BLACK	2004	14 lit.	0001594.090



KAWASAKI **KLX 250 C/R**
 year: **93/96**
 capacity: **14 lit.**
 code: **0001594.090**



KAWASAKI FUEL TANKS

KLX 400

MODEL	COLORS	YEAR	CAPACITY	CODE
KLX 400	BLACK	03/04	14 lit.	0001604.090
	YELLOW	03/04	14 lit.	0001604.060



KAWASAKI **KLX 400**
 year: **2003/2004**
 capacity: **14 lit.**
 code: **001604.090.**

KXF 450

MODEL	COLORS	YEAR	CAPACITY	CODE
KXF 450	NATURAL	09/11	10,5 lit.	0013541.120.700
	NATURAL	12/15	10,5 lit.	0016448.120.700
	BLACK	12/15	10,5 lit.	0016448.090.700
	NATURAL	06/08	12,5 lit.	0011673.120.700
	BLACK	06/08	12,5 lit.	0011673.090.700
	NATURAL	16/18	11,5 lit.	0021881.120.700
	BLACK	16/18	11,5 lit.	0021881.090.700
	NATURAL	2019	11 lit.	0023703.090.700
	BLACK	2019	11 lit.	0023703.120.700



KAWASAKI **KLX 450**
 year: **2006/2008**
 capacity: **12,5 lit.**
 code: **0011673.090.700**

KXF 250

MODEL	COLORS	YEAR	CAPACITY	CODE
KXF 250	NATURAL	09/10	14 lit.	0013542.120.700
	BLACK	09/10	14 lit.	0013542.090.700
KXF 250	NATURAL	17/19	11 lit.	0022566.120.700
	BLACK	17/19	11 lit.	0022566.090.700



KAWASAKI **KXF 250**
 year: **2017**
 capacity: **11 lit.**
 code: **0022566.120.700**

HUSQVARNA FUEL TANKS

FC 250 • FC 350 • FC 450 • FE 250 • FE 350 • FE 450 • FE 501

MODEL	COLORS	YEAR	CAPACITY	CODE
FC 250/350/450	NATURAL	16/18	12 lit.	0023173.120.700
	BLACK	16/18	12 lit.	0023173.090.700
	NATURAL	16/18	15 lit.	0022113.120.700
	BLACK	16/18	15 lit.	0022113.090.700
	NATURAL	19/20	12 lit.	0023566.120.700
	BLACK	19/20	12 lit.	0023566.090.700
	NATURAL	19/20	15 lit.	0023567.120.700
	BLACK	19/20	15 lit.	0023567.090.700
FE 250/350/450/501	NATURAL	17/19	12 lit.	0023173.120.700
	BLACK	17/19	12 lit.	0023173.090.700
	NATURAL	17/19	15 lit.	0022113.120.700
	BLACK	17/19	15 lit.	0022113.090.700
	NATURAL	2020	12 lit.	0023958.120.700
	BLACK	2020	12 lit.	0023958.090.700
	NATURAL	2020	15 lit.	0023959.120.700
	BLACK	2020	15 lit.	0023959.090.700
TE 250/ 300	NATURAL	18/19	12 lit.	0023173.120.700
	BLACK	18/19	12 lit.	0023173.090.700
TX 125	NATURAL	2018	12 lit.	0023173.120.700
	BLACK	2018	12 lit.	0023173.090.700
TE 250/ 300 I	NATURAL	2020	12 lit.	0023958.120.700
	BLACK	2020	12 lit.	0023958.090.700
	NATURAL	2020	15 lit.	0023959.120.700
	BLACK	2020	15 lit.	0023959.090.700



HUSQVARNA **FC 250/350/450**
 year: **2016/2017**
 capacity: **12 lit.**
 code: **0021872.090.700**



HUSQVARNA **FC 250/350/450**
 year: **2016/2017**
 capacity: **12 lit.**
 code: **0021872.120.700**

SPEEDY FUEL TANKS

	COLOR TANK	CAPACITY TANK	Ø KIT	CODE
● TANK + SMALL KIT	YELLOW	15 lit.	39,5 mm.	0008175.
SMALL KIT	//	//	39,5 mm.	0011616.

● MDR CAP INCLUDED

MDR CAP
code: **0011670.090**



**QUICK
FILL
SYSTEM**

TANK

SMALL KIT
Ø 39,5 mm.



QUICK FILL FUEL TANKS

	CAPACITY	CODE
QUICK FILL SYSTEM	16 lit.	0001555.
QUICK FILL STAND	//	0000099.

QUICK FILL SYSTEM
code: **0001555.**

QUICK FILL STAND
code: **0000099.**



AUXILIARY FUEL TANKS

HANDLEBAR TANK

CAPACITY	COLORS	CODE
2,1 lit.	WHITE	0016462.030.700

height 150 mm. - width 390 mm. - depth 140 mm.



OPTIONAL SIPHON KIT

code: **0001105.**



FRONT FUEL TANK

CAPACITY	COLORS	CODE
3 lit.	WHITE	0002684.030
5 lit.	WHITE	0002685.030

3 lit.: height 270 mm. - width 240 mm. - depth 80 mm.
5 lit.: height 270 mm. - width 240 mm. - depth 130 mm.



FRONT FUEL TANK
 capacity: **5 lit.**
 code: **0002685.030**

OPTIONAL SIPHON KIT

code: **0001105.**



REAR FUEL TANK

CAPACITY	COLORS	CODE
6 lit.	WHITE	0001609.030

height 170 mm. - width 300 mm. - depth 240 mm.



REAR FUEL TANK
 capacity: **6 lit.**
 code: **0001609.030**

18L CONTAINER

CAPACITY	COLORS	CODE
18 lit.	WHITE	0001044.030



18L CONTAINER
 capacity: **18 lit.**
 code: **0001044.030**

10L CONTAINER

CAPACITY	COLORS	CODE
10 lit.	YELLOW	0022714.060

DETAILS:

- 10L capacity
- Quick re-fueling with stop when tank is full
- Safety closing of the nozzle
- Two large handles for easy vertical filling and transport

DETTAGLI:

- Capacità 10L
- Rifornimento rapido con stop a serbatoio pieno
- Chiusura di sicurezza del bocchettone
- Due ampie maniglie per facilitare riempimento verticale e il trasporto

REPLACEMENT TANK CAP

code: **0023501.323**



CONTAINER
 capacity: **10 lit.**
 code: **0022714.060**

TANK CAPS

ONLY FOR ACERBIS TANKS

BIG CAP ACERBIS "C"

code: **0016833.090**
models: • ACERBIS • CLARKE • ATK • YAMAHA XT



SMALL CAP

code: **0001111.090**
models: • ACERBIS
• KTM 2 STROKE 93/04



ACERBIS CAP

code: **0001201.090**
models: • ACERBIS
• AUXILIARY TANK



BIG LOOKING CAP

code: **0001121.**



SMALL LOOKING CAP

code: **0001119.**



MDR CAP

code: **0011670.090**



ADAPTER FOR MDR AND DRY BRAKE SYSTEM

code: **0013423.090**



GASKET FOR 0016833 AND BIG CAP ACERBIS "C"

code: **0001102.**



GASKET FOR 1111 AND 1201

code: **0001202.090**



- BIG CAP
- MDR CAP

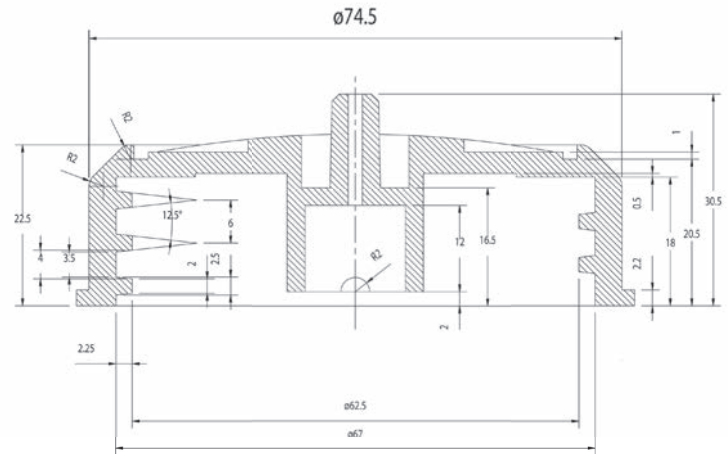
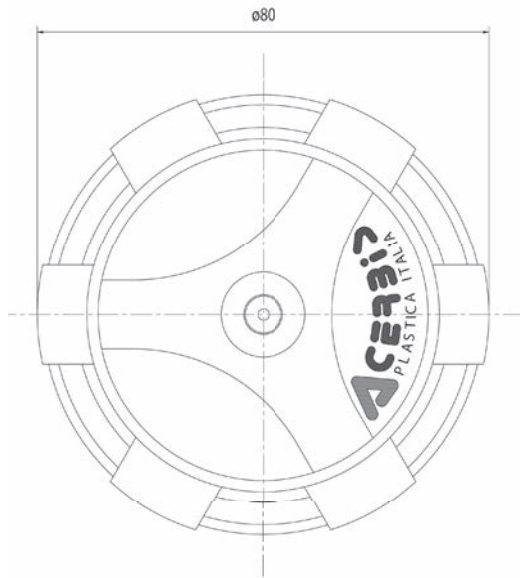

- SMALL CAP
- ACERBIS CAP

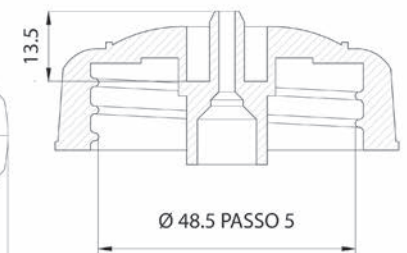
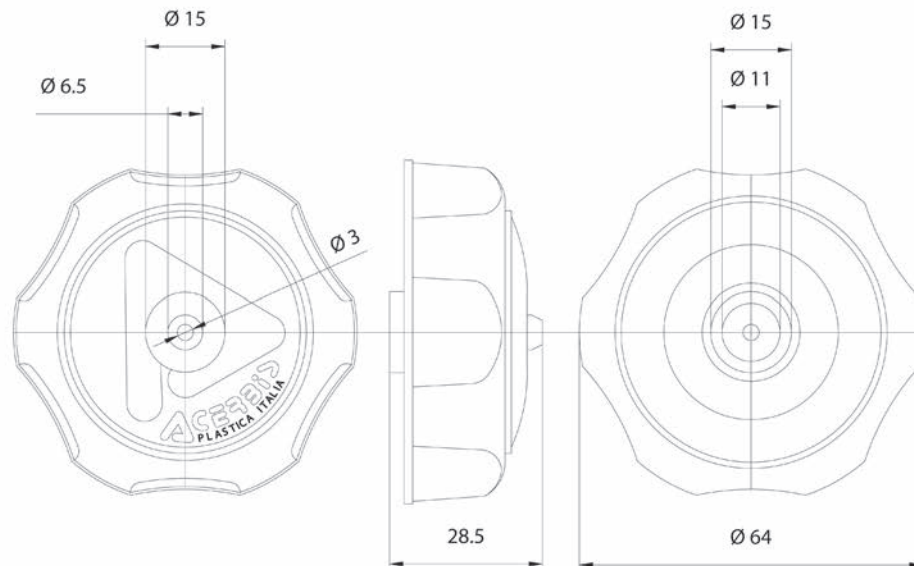

TANK PETCOCKS AND PARTS

ONLY FOR ACERBIS TANKS

UNIVERSAL TANK PETCOCKS

code: **0001203.**



TANK PETCOCKS DX

code: **0003083.**



TANK PETCOCKS SX

code: **0003084.**



TANK PETCOCKS

code: **0022294.**



O-RING

code: **0001112.**
10 pcs. set



BREATHER VENT HOSE

code: **0000027.**
10 mt.





FUEL TANKS/SERBATOI





ACERBIS PLASTICS PLASTICHE ACERBIS



CARBON X-BRAKE VENTED FRONT DISC COVER

- material: **CARBON**
- ø max disc 280 mm.
- mounting kit sold separately



X-BRAKE FRONT DISC COVER

- material: **PLASTIC**
- ø max disc 280 mm.
- mounting kit sold separately



APPLICATIONS X-BRAKE FRONT DISC COVER

MOUNTING KIT



MODEL	YEAR	CODE
YAMAHA YZ 125/250	04/19	0020080.
YAMAHA YZF 250/450	04/13	0020080.
	14/19	0017566.
YAMAHA WRF 250	04/19	0020080.
YAMAHA WRF 450	04/18	0020080.
	2019	0017566.
YAMAHA WR 125/250	04/18	0020080.
YAMAHA WR 250X	16/18	0020080.
HONDA CR 125/250	04/07	0020081.
HONDA CRF 250/450 R	04/19	0020081.
HONDA CRF 250X	04/19	0020081.
HONDA CRF 450X	05/19	0020081.
HONDA CRF 250/300 RX	2019	0020081.
HONDA CRF 450 RX	17/19	0020081.
SUZUKI RM 125/250	04/13	0020077.
SUZUKI RMZ 250	04/06	0007645.
	07/19	0009802.
SUZUKI RMZ 450	05/19	0009802.
KAWASAKI KXF 450	16/18	0009803.
	2019	0023663.
KAWASAKI KX 250F/450F	06/19	0009803.
KAWASAKI KLX 450	08/15	0009803.
KAWASAKI KXF 250	04/05	0007645.

MODEL	YEAR	CODE
KTM XC-W/XC/XC-F	19/20	0017827.
KTM SX/SXF	04/14	0020079.
	15/20	0017827.
KTM EXC/EXCF	04/15	0020079.
	16/19	0017827.
KTM FREERIDE 2T/4T	13/19	0021875.
HUSQVARNA TE/FE	14/15	0020079.
	16/20	0017827.
HUSQVARNA TC/FC	2014	0020079.
	15/20	0017827.
HUSABERG	13/14	0020079.
BETA RR 2T 250/300	13/19	0021729.
BETA RR 4T 350/400/450/498	13/14	0021729.
BETA RR 4T 350/430/480	15/19	0021729.
SHERCO SE-R/SEF-R	12/16	0022291.
SHERCO FACTORY	17/18	0007645.
GAS GAS EC 250/300 GP	17/18	0023389.
GAS GAS EC R 250 SIX DAYS	17/18	0023389.
GAS GAS EC R 250/300 E4	17/18	0023389.
GAS GAS XC 250/300	17/18	0023389.

X-BRAKE 2.0 FRONT DISC COVER

- material: **PLASTIC**
- ø max disc 280 mm.
- mounting kit sold separately



KTM orange 2016
code: **0021846.011.016**



white/black
code: **0021846.030**



white/orange
code: **0021846.031**



blue/white
code: **0021846.040**



yellow/white
code: **0021846.060**



fluo yellow/white
code: **0021846.061**



black/white
code: **0021846.090**



red/white
code: **0021846.110**



green/white
code: **0021846.130**



black/orange
code: **0021846.313**



black/green
code: **0021846.325**



red/blue
code: **0021846.344**

APPLICATIONS X-BRAKE 2.0 FRONT DISC COVER

MOUNTING KIT



MODEL	YEAR	CODE
YAMAHA YZ 125/250	04/19	0020080.
YAMAHA YZF 250/450	04/13	0020080.
	14/19	0017566.
YAMAHA WRF 250	04/19	0020080.
YAMAHA WRF 450	04/18	0020080.
	2019	0017566.
YAMAHA WR 125/250	04/18	0020080.
YAMAHA WR 250X	16/18	0020080.
HONDA CR 125/250	04/07	0020081.
HONDA CRF 250/450 R	04/19	0020081.
HONDA CRF 250X	04/19	0020081.
HONDA CRF 450X	05/19	0020081.
HONDA CRF 250/300 RX	2019	0020081.
HONDA CRF 450 RX	17/19	0020081.
SUZUKI RM 125/250	04/13	0020077.
SUZUKI RMZ 250	04/06	0007645.
	07/19	0009802.
SUZUKI RMZ 450	05/19	0009802.
KAWASAKI KXF 450	16/18	0009803.
	2019	0023663.
KAWASAKI KX 250F/450F	06/19	0009803.
KAWASAKI KLX 450	08/15	0009803.
KAWASAKI KXF 250	04/05	0007645.

MODEL	YEAR	CODE
KTM XC-W/XC/XC-F	19/20	0017827.
KTM SX/SXF	04/14	0020079.
	15/20	0017827.
KTM EXC/EXCF	04/15	0020079.
	16/19	0017827.
KTM FREERIDE 2T/4T	13/19	0021875.
HUSQVARNA TE/FE	14/15	0020079.
	16/20	0017827.
HUSQVARNA TC/FC	2014	0020079.
	15/20	0017827.
HUSABERG	13/14	0020079.
BETA RR 2T 250/300	13/19	0021729.
BETA RR 4T 350/400/450/498	13/14	0021729.
BETA RR 4T 350/430/480	15/19	0021729.
SHERCO SE-R/SEF-R	12/16	0022291.
SHERCO FACTORY	17/18	0007645.
GAS GAS EC 250/300 GP	17/18	0023389.
GAS GAS EC R 250 SIX DAYS	17/18	0023389.
GAS GAS EC R 250/300 E4	17/18	0023389.
GAS GAS XC 250/300	17/18	0023389.



X-BRAKE 2.0 245 MM FRONT DISC COVER

- material: **PLASTIC**
- ø max disc 245 mm.
- mounting kit sold separately



orange/white
code: **0022264.203**



white/black
code: **0022264.237**



blue/white
code: **0022264.245**



black/orange
code: **0022264.313**



black/white
code: **0022264.315**



APPLICATIONS X-BRAKE 245 MM FRONT DISC COVER

MOUNTING KIT



MODEL	YEAR	CODE
KTM SX 85	09/20	0021875.
HUSQVARNA TC 85	14/20	0021875.

MODEL	YEAR	CODE
FREERIDE 2T/4T	13/19	0021875.



RAPTOR FRONT NUMBER PLATE

MATERIALS: 65% Polypropylene; 35% Rubber

DETAILS:

- New design studied for a greater protection of the lower triple clamp
- Made of a shock absorbing rubber material

HONDA RAPTOR FRONT NUMBER PLATE

MODEL	COLOR	YEAR	CODE
CRF 250R	WHITE/RED	14/17	0022142.239
	BLACK/WHITE	14/17	0022142.315
	RED/WHITE	14/17	0022142.343
	RED	18/19	0022391.110
	WHITE/RED	18/19	0022391.239
	BLACK/WHITE	18/19	0022391.315
	RED/WHITE	18/19	0022391.343
	RED/BLUE	18/19	0022391.344
	WHITE	18/19	0022391.030
CRF 450R	WHITE/RED	13/16	0022142.239
	BLACK/WHITE	13/16	0022142.315
	RED/WHITE	13/16	0022142.343

MODEL	COLOR	YEAR	CODE
CRF 450R / RX	RED	17/19	0022391.110
	WHITE/RED	17/19	0022391.239
	BLACK/WHITE	17/19	0022391.315
	RED/WHITE	17/19	0022391.343
	RED/BLUE	17/19	0022391.344
	WHITE	17/19	0022391.030
CRF 250/300RX	BLACK	17/19	0022391.090
	RED	2019	0022391.315
	WHITE/RED	2019	0022391.343
	BLACK/WHITE	2019	0022391.344
	WHITE	2019	0022391.030
	BLACK	2019	0022391.090



KAWASAKI RAPTOR FRONT NUMBER PLATE

MODEL	COLOR	YEAR	CODE
KXF 250	WHITE/GREEN	17/19	0022312.241
	BLACK/WHITE	17/19	0022312.315
	GREEN/WHITE	17/19	0022312.371
	GREEN	17/19	0022312.130
	WHITE	17/19	0022312.030
	BLACK	17/19	0022312.090

MODEL	COLOR	YEAR	CODE
KXF 450	WHITE/GREEN	16/19	0022312.241
	BLACK/WHITE	16/19	0022312.315
	GREEN/WHITE	16/19	0022312.371
	GREEN	16/19	0022312.130
	WHITE	16/19	0022312.030
	BLACK	16/19	0022312.090



KTM RAPTOR FRONT NUMBER PLATE

MODEL	COLOR	YEAR	CODE
SX 125/150	ORANGE	16/19	0022313.010
	ORANGE/WHITE	16/19	0022313.203
	WHITE/BLUE	16/19	0022313.232
	BLACK/WHITE	16/19	0022313.315
	WHITE	16/19	0022313.030
	BLACK	16/19	0022313.090
	BLACK	2020	0024252.090
	WHITE	2020	0024252.030
	WHITE 20	2020	0024252.031
	ORANGE 16	2020	0024252.011.016
SX 250	ORANGE	17/19	0022313.010
	ORANGE/WHITE	17/19	0022313.203
	WHITE/BLUE	17/19	0022313.232
	BLACK/WHITE	17/19	0022313.315
	WHITE	17/19	0022313.030
	BLACK	17/19	0022313.090
	WHITE	2020	0024252.030
BLACK	2020	0024252.090	

MODEL	COLOR	YEAR	CODE
SX 250	WHITE 20	2020	0024252.031
	ORANGE 16	2020	0024252.011.016
SXF 250/350/450	ORANGE	16/19	0022313.010
	ORANGE/WHITE	16/19	0022313.203
	WHITE/BLUE	16/19	0022313.232
	BLACK/WHITE	16/19	0022313.315
	WHITE	16/19	0022313.030
	BLACK	16/19	0022313.090
	WHITE	2020	0024252.030
	BLACK	2020	0024252.090
	WHITE 20	2020	0024252.031
	ORANGE 16	2020	0024252.011.016
XC 250/300 TPI /XC-F 250/350/450	WHITE	2020	0024252.030
	BLACK	2020	0024252.090
	WHITE 20	2020	0024252.031
	ORANGE 16	2020	0024252.011.016



orange
code: **0022313.010**



orange/white
code: **0022313.203**



white/blue
code: **0022313.232**



black/white
code: **0022313.315**

SUZUKI RAPTOR FRONT NUMBER PLATE

MODEL	COLOR	YEAR	CODE
RMZ 250	YELLOW/WHITE	10/18	0022514.273
	YELLOW/BLACK	10/18	0022514.279
	YELLOW/YELLOW	2019	0023101.276
	YELLOW/BLACK	2019	0023101.279
	WHITE/YELLOW	2019	0023101.234
	WHITE	2019	0023101.030
	YELLOW	2019	0023101.060

MODEL	COLOR	YEAR	CODE
RMZ 450	YELLOW/WHITE	08/17	0022514.273
	YELLOW/BLACK	08/17	0022514.279
	YELLOW/YELLOW	18/19	0023101.276
	YELLOW/BLACK	18/19	0023101.279
	WHITE/YELLOW	18/19	0023101.234
	WHITE	18/19	0023101.030
	YELLOW	18/19	0023101.060



yellow/white
code: **0022514.273**



yellow/black
code: **0022514.279**



yellow/yellow
code: **0023101.276**



yellow/black
code: **0023101.279**



white/yellow
code: **0023101.234**

YAMAHA RAPTOR FRONT NUMBER PLATE

MODEL	COLOR	YEAR	CODE
YZ 125/250	WHITE/BLUE	05/19	0022298.232
	BLUE/WHITE	05/19	0022298.245
	BLACK/WHITE	05/19	0022298.315
	BLUE	05/19	0022298.040
YZF 250	BLACK	05/19	0022298.090
	WHITE/BLUE	10/18	0022298.232
	BLUE/WHITE	10/18	0022298.245
	BLACK/WHITE	10/18	0022298.315
	BLUE	10/18	0022298.040
	BLACK	10/18	0022298.090
YZF 250	WHITE/BLUE	2019	0023094.232
	BLUE/WHITE	2019	0023094.245
	BLACK/WHITE	2019	0023094.315
	BLACK/WHITE	2019	0023094.315

MODEL	COLOR	YEAR	CODE
YZF 250	WHITE	2019	0023094.030
	BLUE	2019	0023094.040
	BLACK	2019	0023094.090
YZF 450	WHITE/BLUE	10/17	0022298.232
	BLUE/WHITE	10/17	0022298.245
	BLACK/WHITE	10/17	0022298.315
	BLUE	10/17	0022298.040
	BLACK	10/17	0022298.090
	BLUE	2019	0023094.040
	WHITE/BLUE	2019	0023094.232
	BLUE/WHITE	2019	0023094.245
	BLACK/WHITE	2019	0023094.315
	WHITE	2019	0023094.030
BLACK	2019	0023094.090	



blue
code: **0023094.040**



white/blue
code: **0023094.232**



blue/white
code: **0023094.245**



black/white
code: **0023094.315**

HUSQVARNA RAPTOR FRONT NUMBERPLATE

MODEL	COLOR	YEAR	CODE
TC 125	ORANGE	16/19	0022313.010 •
	WHITE	16/19	0022313.030 •
	BLACK	16/19	0022313.090 •
	ORANGE/WHITE	16/19	0022313.203 •
	WHITE/BLUE	16/19	0022313.232 •
	BLACK/WHITE	16/19	0022313.315 •
	WHITE	2020	0024258.030
	WHITE 20	2020	0024258.031
TC 250	BLACK	2020	0024258.090
	ORANGE	17/19	0022313.010 •
	WHITE	17/19	0022313.030 •
	BLACK	17/19	0022313.090 •
	ORANGE/WHITE	17/19	0022313.203 •
	WHITE/BLUE	17/19	0022313.232 •

MODEL	COLOR	YEAR	CODE
TC 250	BLACK/WHITE	17/19	0022313.315 •
	WHITE	2020	0024258.030
	WHITE 20	2020	0024258.031
	BLACK	2020	0024258.090
FC 250/350/450	ORANGE	16/19	0022313.010 •
	WHITE	16/19	0022313.030 •
	BLACK	16/19	0022313.090 •
	ORANGE/WHITE	16/19	0022313.203 •
	WHITE/BLUE	16/19	0022313.232 •
	BLACK/WHITE	16/19	0022313.315 •
	WHITE	2020	0024258.030
	WHITE 20	2020	0024258.031
BLACK	2020	0024258.090	

• KTM Style



orange/white
code: **0022313.203**



white/blue
code: **0022313.232**



black/white
code: **0022313.315**



SUPERMOTO FRONT FENDER



orange
code: **0008033.010.098**



white
code: **0008033.030**



blue 98
code: **0008033.040.098**



yellow 01
code: **0008033.060.001**



black
code: **0008033.090**



red
code: **0008033.110.990**



green 03
code: **0008033.130.003**

SUPERMOTO EVO FRONT FENDER



black
code: **0009708.090**

NOST FRONT FENDER



white
code: **0008200.030**



black
code: **0008200.090**

NOST REAR FENDER



white
code: **0008055.030**



black
code: **0008055.090**

BAJA REAR FENDER



white
code: **0008013.030**

LINK GUARD UNIVERSAL SKID PLATE



orange
code: **0023828.010**



white
code: **0023828.030**



blue
code: **0023828.040**



yellow
code: **0023828.060**



black
code: **0023828.090**



red
code: **0023828.110**



green
code: **0023828.130**

KTM SKID PLATES



MODEL	COLOR	YEAR	CODE	
SX 85	ORANGE	13/17	0022320.011	
	WHITE	13/17	0022320.030	
	BLACK	13/17	0022320.090	
	ORANGE	18/20	0022895.011	
	WHITE	18/20	0022895.030	
SX 125/150	BLACK	18/20	0022895.090	
	BLACK	11/15	0015950.090	
	ORANGE	16/20	0022319.011	
	WHITE	16/20	0022319.030	
	BLACK	16/20	0022319.090	
SX 250	BLACK	06/16	0013683.090	
	ORANGE	06/16	0013683.010	
	ORANGE	17/18	0022332.011	
	WHITE	17/18	0022332.030	
	BLACK	17/18	0022332.090	
	OR./BLK.	19/20	0023660.209	
	WH./BLK.	19/20	0023660.237	
	BLK./OR.	19/20	0023660.313	
	BLK./WH.	19/20	0023660.315	
	SXF 250	BLACK	11/12	0015937.090
BLACK		13/15	0015936.090	
ORANGE		13/15	0015936.010	
BLACK		16/18	0021727.090	
ORANGE		16/18	0021727.011	
WHITE		16/18	0021727.030	
OR./BLK.		19/20	0023661.209	
WH./BLK.		19/20	0023661.237	
BLK./OR.		19/20	0023661.313	
BLK./WH.		19/20	0023661.315	
SXF 350		BLACK	11/15	0015936.090
		ORANGE	11/15	0015936.010
	BLACK	16/18	0021727.090	
	ORANGE	16/18	0021727.011	
	WHITE	16/18	0021727.030	
	OR./BLK.	19/20	0023661.209	
	WH./BLK.	19/20	0023661.237	
	BLK./OR.	19/20	0023661.313	
	BLK./WH.	19/20	0023661.315	
	SXF 450	BLACK	13/15	0016312.090
ORANGE		13/15	0016312.010	
BLACK		16/18	0021755.090	
BLK./WHT.		16/18	0021755.091	
ORANGE		16/18	0021755.011	
OR./WH.		19/20	0023601.203	
WH./BLUE		19/20	0023601.232	
BLK./OR.		19/20	0023601.313	
BLK./WH.		19/20	0023601.315	
XC 250/300 TPI		OR./BLK.	2020	0023660.209
	WH./BLK.	2020	0023660.237	
	BLK./OR.	2020	0023660.313	
	BLK./WH.	2020	0023660.315	

MODEL	COLOR	YEAR	CODE	
EXC 125/200	BLACK	12/16	0015950.090	
	ORANGE	17/19	0022319.011	
	WHITE	17/19	0022319.030	
	BLACK	17/19	0022319.090	
EXC 250	BLACK	06/16	0013683.090	
	ORANGE	06/16	0013683.010	
	ORANGE	17/19	0022318.011	
	WHITE	17/19	0022318.030	
	BLACK	17/19	0022318.090	
EXC 300	BLACK	06/16	0013683.090	
	ORANGE	06/16	0013683.010	
	ORANGE	17/19	0022318.011	
	WHITE	17/19	0022318.030	
	BLACK	17/19	0022318.090	
EXC-F 250	BLACK	12/13	0016311.090	
	ORANGE	14/16	0016310.010	
	BLACK	14/16	0016310.090	
	ORANGE	17/19	0022823.011	
	WHITE	17/19	0022823.030	
	BLACK	17/19	0022823.090	
	ORANGE	2020	0024021.010	
	BLACK	2020	0024021.090	
	EXC-F 350	BLACK	12/16	0016310.090
		ORANGE	12/16	0016310.010
ORANGE		17/19	0022823.011	
WHITE		17/19	0022823.030	
	BLACK	17/19	0022823.090	
	ORANGE	2020	0024021.010	
	BLACK	2020	0024021.090	
	EXC-F 450/500	BLACK	08/11	0011687.090
BLACK		12/16	0016312.090	
ORANGE		12/16	0016312.010	
ORANGE		17/19	0022309.011	
BLACK		17/19	0022309.090	
BLK./OR.		2020	0024253.313	
	OR./WH.	2020	0024253.203	
	XC-F 250/350	BLK./WH.	2020	0024255.313
OR./BLK.		2020	0024255.209	
XC-F 450	OR./WH.	2020	0023601.203	
	WH./BLUE	2020	0023601.232	
	BLK./OR.	2020	0023601.313	
	BLK./WH.	2020	0023601.315	
XC-W 125 /XC-W 150 TPI	ORANGE	2020	0022319.011	
	WHITE	2020	0022319.030	
	BLACK	2020	0022319.090	
EXC/XC-W 250 /300 TPI	BLACK	2020	0023764.090	
	ORANGE	2020	0023764.010	



MX STYLE/ENDURO STYLE
code: **0022319.011**



MX STYLE/ENDURO STYLE
code: **0022319.030**



MX STYLE/ENDURO STYLE
code: **0022319.090**



MX STYLE
code: **0022320.011**



MX STYLE
code: **0022320.030**



MX STYLE
code: **0022320.090**



MX STYLE
code: **0022332.030**



MX STYLE
code: **0022332.090**



MX STYLE
code: **0022332.011**



KTM SKID PLATES



MX STYLE
code: **0021755.011**



MX STYLE
code: **0021755.090**



MX STYLE
code: **0021755.091**



ENDURO STYLE
code: **0022318.010**



ENDURO STYLE
code: **0022318.030**



ENDURO STYLE
code: **0022318.090**



ENDURO STYLE
code: **0016311.090**



ENDURO STYLE
code: **0016310.010**



ENDURO STYLE
code: **0016310.090**



ENDURO STYLE
code: **0022309.010**



ENDURO STYLE
code: **0022309.090**



ENDURO STYLE
code: **0022823.090**

KAWASAKI SKID PLATES



MODEL	COLOR	YEAR	CODE
MX STYLE			
KXF 250	BLACK	09/19	0013821.090
KXF 450	BLACK	09/15	0013820.090

MODEL	COLOR	YEAR	CODE
ENDURO STYLE			
KXF 250	BLACK	09/16	0013519.090
	GREY	09/16	0013519.020
	BLACK	17/19	0022502.090
KXF 450	GREY	17/19	0022502.020
	BLACK	09/15	0013539.090
	GREY	09/15	0013539.020
	GREY	16/18	0021932.020
	BLACK	16/18	0021932.090
KLX 450	BLK./WH.	2019	0023701.315
	BLK./GREEN	2019	0023701.325
	BLACK	08/18	0011678.090



MX STYLE
code: **0013821.090**



MX STYLE
code: **0013820.090**



ENDURO STYLE
code: **0013519.020**



ENDURO STYLE
code: **0013519.090**



ENDURO STYLE
code: **0022502.020**



ENDURO STYLE
code: **0022502.090**



ENDURO STYLE
code: **0013539.020**



ENDURO STYLE
code: **0013539.090**



ENDURO STYLE
code: **0021932.020**



ENDURO STYLE
code: **0021932.090**



ENDURO STYLE
code: **0011678.090**

YAMAHA SKID PLATES



MODEL	COLOR	YEAR	CODE
MX STYLE			
YZF 250	BLACK	14/18	0017574.090
	BLUE	2019	0023108.040
	BLACK	2019	0023108.090
	WHITE	2019	0023108.030
YZF 450	BLACK	10/13	0013985.090
	BLACK	14/17	0017574.090
	WHITE	18/19	0023108.030
	BLUE	18/19	0023108.040
	BLACK	18/19	0023108.090
YZ 250	BLUE	05/19	0022400.040
	BLACK	05/19	0022400.090

MODEL	COLOR	YEAR	CODE
YZ 125	WH./BLK.	06/19	0023922.237
	BLUE/WH.	06/19	0023922.245
	BLK./WH.	06/19	0023922.315
ENDURO STYLE			
WRF 250	BLACK	07/18	0011678.090
WRF 450	BLACK	07/18	0011678.090
	WHITE	2019	0023108.030
	BLUE	2019	0023108.040
	BLACK	2019	0023108.090



MX STYLE
code: **0023108.030**



MX STYLE
code: **0023108.040**



MX STYLE
code: **0023108.090**



MX STYLE
code: **0022400.040**



MX STYLE
code: **0022400.090**



ENDURO STYLE
code: **0011678.090**

HONDA SKID PLATES



MODEL	COLOR	YEAR	CODE
MX STYLE			
CRF 250/300RX	BLACK	2019	0023291.090
	RED	2019	0023291.110
CRF 250R	BLACK	10/17	0013922.090
	GREY	10/17	0013922.020
	BLACK	18/19	0023291.090
	RED	18/19	0023291.110
CRF 450R	BLACK	09/16	0013922.090
	GREY	09/16	0013922.020
CRF 450R/RX	BLACK	17/19	0022656.090
	RED	17/19	0022656.110

MODEL	COLOR	YEAR	CODE
ENDURO STYLE			
CRF 250/300RX	BLACK	2019	0023290.090
	RED	2019	0023290.110
CRF 250X	BLACK	04/17	0011685.090
	GREY	04/17	0011685.020
CRF 250L	BLACK	13/18	0022822.090
CRF 250R	BLACK	04/09	0011685.090
	GREY	04/09	0011685.020
	BLACK	10/17	0013540.090
	GREY	10/17	0013540.020
	BLACK	18/19	0023290.090
CRF 450X	BLACK	05/16	0011684.090
	GREY	05/16	0011684.020
CRF 450R	BLACK	05/08	0011684.090
	GREY	05/08	0011684.020
	BLACK	09/16	0013540.090
	GREY	09/16	0013540.020



MX STYLE
code: **0022656.090**



MX STYLE
code: **0022656.110**



ENDURO STYLE
code: **0022388.090**



ENDURO STYLE
code: **0022388.110**



ENDURO STYLE
code: **0022822.090**



ENDURO STYLE
code: **0013540.020**



ENDURO STYLE
code: **0013540.090**



SUZUKI SKID PLATES



MODEL	COLOR	YEAR	CODE
RMZ 250	BLACK	10/18	0015909.090
	BLK./WH.	2019	0023735.315
	BLK./YE.	2019	0023735.318



code: **0015909.090**



code: **0015908.090**



code: **0015908.090**



code: **0021527.090**



code: **0023069.090**

MODEL	COLOR	YEAR	CODE
RMZ 450	BLACK	08/17	0015908.090
	BLACK	18/19	0023069.090
DR 650	BLACK	96/18	0021527.090

HUSQVARNA SKID PLATES



MODEL	COLOR	YEAR	CODE
TC 85	WHITE	14/17	0022320.030
	BLACK	14/17	0022320.090
	BLACK	18/20	0022895.090
	WHITE	18/20	0022895.030
TC 125/TX 125	BLACK	14/15	0015950.090
	WHITE	16/20	0022319.030
	BLACK	16/20	0022319.090
TC 250	BLACK	2009	0013650.090
	BLACK	14/16	0013683.090
	WHITE	17/18	0022332.030
	BLACK	17/18	0022332.090
	OR./BLK.	19/20	0023660.209
	WH./BLK.	19/20	0023660.237
	BLK./OR.	19/20	0023660.313
BLK./WH.	19/20	0023660.315	
TC 450	BLACK	2009	0013650.090
FC 250/350	BLACK	14/15	0015936.090
	WHITE	16/18	0021727.030
	BLACK	16/18	0021727.090
	OR./BLK.	19/20	0023661.209
	WH./BLK.	19/20	0023661.237
	BLK./OR.	19/20	0023661.313
	BLK./WH.	19/20	0023661.315
FC 450	BLACK	14/15	0016312.090
	BLK./WHT.	16/18	0021755.091
	WHT./BL.	16/18	0021755.232



code: **0022320.030**



code: **0022320.090**



code: **0022823.090**



code: **0022332.030**



code: **0022332.090**



code: **0022319.030**



code: **0022319.090**



code: **0021727.030**



code: **0021727.090**



code: **0021755.091**



code: **0021755.232**

MODEL	COLOR	YEAR	CODE
FC 450	OR./WH.	19/20	0023601.203
	WH./BLUE	19/20	0023601.232
	BLK./OR.	19/20	0023601.313
	BLK./WH.	19/20	0023601.315
TE 125/TX	BLACK	14/16	0015950.090
	WHITE	17/20	0022319.030
	BLACK	17/20	0022319.090
TE 250	BLACK	2009	0013650.090
TE 250/300	BLACK	14/16	0013683.090
	WHITE	17/19	0022318.030
	BLACK	17/19	0022318.090
TE 250/300 I	WH./BLK.	2020	0024022.237
	BLK./WH.	2020	0024022.315
TE 310/450/510	BLACK	09/10	0013650.090
FE 250/350	BLACK	14/16	0016310.090
	ORANGE	17/19	0022823.011
	WHITE	17/19	0022823.030
	BLACK	17/19	0022823.090
	WH./BLK.	2020	0024023.237
	BLK./WH.	2020	0024023.315
FE 450/501	BLACK	14/16	0016312.090
	BLK./WHT.	17/19	0021755.091
	WHT./BL.	17/19	0021755.232
	WH./BLUE	2020	0024254.232
BLK./WHT.	2020	0024254.315	
SM 450/510/530	BLACK	09/10	0013650.090

BETA SKID PLATES



MODEL	COLOR	YEAR	CODE
RR/RACING 250	BLACK	13/17	0022816.090
	RED	13/17	0022816.110
	BLACK	2018	0022892.090
	RED	2018	0022892.110

MODEL	COLOR	YEAR	CODE
RR 2T 250/300 RC	BLACK	18/19	0023920.090
	RED	18/19	0023920.110
RR/RC 250/300	BLACK	18/19	0023920.090
	RED	18/19	0023920.110



code: **0022816.090**



code: **0022816.110**



code: **0022892.090**



code: **0022892.110**

X-GRIP FRAME PROTECTOR HONDA

MODEL	YEAR	COLOR	CODE
CRF 250	14/17	GREY	0017573.020
	14/17	WHITE	0017573.030
	14/17	RED	0017573.110
	14/17	SILVER/RED	0017573.225
	18/19	GREY	0022386.020
	18/19	WHITE	0022386.030
	18/19	RED	0022386.110
	18/19	RED/BLUE	0022386.344
CRF 250 L-M	13/18	BLACK/RED	0023405.323
	13/18	GREY/RED	0023405.295
CRF 250/300RX	2019	WHITE	0022386.030
	2019	RED	0022386.110
	2019	RED/BLUE	0022386.344
	2019	GREY	0022386.020

MODEL	YEAR	COLOR	CODE
CRF 250 RALLY	17/18	BLACK/RED	0023405.323
	17/18	GREY/RED	0023405.295
CRF 450	13/16	GREY	0017573.020
	13/16	WHITE	0017573.030
	13/16	RED	0017573.110
	13/16	SILVER/RED	0017573.225
	17/18	GREY	0022386.020
	17/18	WHITE	0022386.030
	17/18	RED	0022386.110
	17/18	RED/BLUE	0022386.344
	2019	GREY/BLACK	0023664.293
	2019	RED/BLACK	0023664.349
CRF 450 RX	2019	GREY/BLACK	0023664.293
	2019	RED/BLACK	0023664.349



code: **0022386.020**



code: **0022386.030**



code: **0022386.110**



code: **0022386.344**



code: **0023405.295**



code: **0023405.323**

X-GRIP FRAME PROTECTOR KAWASAKI

MODEL	YEAR	COLOR	CODE
KXF 250	15/19	WHITE/BLK.	0022574.237
	15/19	GREY/BLK.	0022574.293
	15/19	GREY/GREEN	0022574.297
	15/19	GREEN/BLK.	0022574.377

MODEL	YEAR	COLOR	CODE
KXF 450	09/18	GREY	0017814.020
	09/18	WHITE	0017814.030
	09/18	GREEN	0017814.130
	09/18	SILVE./GREE.	0017814.227
	2019	WHITE/BLK.	0023693.237
	2019	GREY/BLK.	0023693.293
	2019	GREY/GREEN	0023693.297
	2019	GREEN/BLK..	0023693.377



code: **0022574.237**



code: **0022574.293**



code: **0022574.297**



code: **0022574.377**



X-GRIP FRAME PROTECTOR KTM

MODEL	YEAR	COLOR	CODE
SX 65	14/20	ORANGE	0022896.011
	14/20	WHITE	0022896.090
	14/20	BLK./ORAN.	0022896.313
SX 85	13/17	ORANGE	0021869.010
	13/17	WHITE	0021869.030
	13/17	ORANGE 16	0021869.011.016
	18/20	ORANGE	0022893.010
	18/20	WHITE	0022893.030
	18/20	ORANGE 16	0022893.011.016
SXF 250/350/450	11/15	ORANGE	0017813.010
	11/15	WHITE	0017813.030
	16/18	ORANGE 16	0021726.011.016
SXF 250/350/450	16/18	WHITE	0021726.030
	16/18	BLK./ORAN.	0021726.313
	19/20	OR./BLK.	0023599.209
	19/20	WHITE/BLK.	0023599.237
	19/20	BLK./ORAN.	0023599.313
SX 250	17/18	ORANGE 16	0021726.011.016
	17/18	WHITE	0021726.030
	17/18	BLK./ORAN.	0021726.313
	19/20	OR./BLK.	0023599.209
	19/20	WHITE/BLK.	0023599.237
	19/20	BLK./ORAN.	0023599.313



code: **0021726.011.016**



code: **0021726.030**



code: **0021726.313**

X-GRIP FRAME PROTECTOR SUZUKI

MODEL	YEAR	COLOR	CODE
RMZ 450	08/17	YELL./GREY	0022347.277
	08/17	YELL./BLACK	0022347.279
	08/17	GREY/YELL.	0022347.290
	18/19	YELL./GREY	0023070.277



code: **0022347.277**



code: **0022347.279**



code: **0022347.290**

MODEL	YEAR	COLOR	CODE	
SX 125/150	16/18	ORANGE 16	0021726.011.016	
	16/18	WHITE	0021726.030	
	16/18	BLK./ORAN.	0021726.313	
	19/20	OR./BLK.	0023599.209	
	19/20	WHITE/BLK.	0023599.237	
	19/20	BLK./ORAN.	0023599.313	
EXC/EXCF	12/16	ORANGE	0017813.010	
	12/16	WHITE	0017813.030	
	17/19	ORANGE 16	0021726.011.016	
	17/19	WHITE	0021726.030	
	17/19	BLK./ORAN.	0021726.313	
	2020	OR./BLK.	0024009.209	
	2020	WHITE/BLK.	0024009.237	
	2020	BLK./ORAN.	0024009.313	
	XC 250/300 TPI	2020	OR./BLK.	0023599.209
		2020	WHITE/BLK.	0023599.237
2020		BLK./ORAN.	0023599.313	
XC-F 350/450	2020	OR./BLK.	0023599.209	
	2020	WHITE/BLK.	0023599.237	
	2020	BLK./ORAN.	0023599.313	
XC-W 125 /XC-W 150 TPI	2020	OR./BLK.	0024009.209	
	2020	WHITE/BLK.	0024009.237	
	2020	BLK./ORAN.	0024009.313	
XC-W 250/300 TPI	2020	OR./BLK.	0023599.209	
	2020	WHITE/BLK.	0023599.237	
	2020	BLK./ORAN.	0023599.313	

MODEL	YEAR	COLOR	CODE
RMZ 450	18/19	YELL./BLACK	0023070.279
	18/19	GREY/YELL.	0023070.290
RMZ 250	10/18	YELL./GREY	0022879.277
	10/18	YELL./BLACK	0022879.279
	10/18	GREY/YELL.	0022879.290
	2019	YELL./BLACK	0023070.279
	2019	GREY/YELL.	0023070.290
2019	YELL./GREY	0023070.277	

X-GRIP FRAME PROTECTOR YAMAHA

MODEL	YEAR	COLOR	CODE
YZ 125/250	06/19	SILVER	0021669.020
	06/19	BLUE	0021669.040
	06/19	SILVER/BLUE	0021669.218
WR 125/250	06/19	SILVER	0021669.020
	06/19	BLUE	0021669.040
	06/19	SILVER/BLUE	0021669.218
YZF 250	14/16	SILVER	0017778.020
	14/16	WHITE	0017778.030
	14/16	BLUE	0017778.040
	14/16	SILVER/BLUE	0017778.218
	17/18	SILVER	0022444.020
YZF 250	17/18	WHITE	0022444.030
	17/18	BLUE	0022444.040
	17/18	SILVER/BLUE	0022444.218

MODEL	YEAR	COLOR	CODE
YZF 250	2019	SILVER	0023093.020
	2019	WHITE	0023093.030
	2019	BLUE	0023093.040
	2019	SILVER/BLUE	0023093.218
YZF 450	14/15	SILVER	0017778.020
	14/15	WHITE	0017778.030
	14/15	BLUE	0017778.040
	14/15	SILVER/BLUE	0017778.218
	16/17	SILVER	0022444.020
	16/17	WHITE	0022444.030
	16/17	BLUE	0022444.040
16/17	SILVER/BLUE	0022444.218	
18/19	SILVER	0023093.020	

X-GRIP FRAME PROTECTOR YAMAHA

MODEL	YEAR	COLOR	CODE
YZ 65	2019	WHITE/BLK.	0023676.237
	2019	BLACK/BLUE	0023676.316
YZ 85	2019	WHITE/BLK.	0023677.237
	2019	BLACK/BLUE	0023677.316
YZF 450	18/19	WHITE	0023093.030
	18/19	BLUE	0023093.040
	18/19	SILVER/BLUE	0023093.218
WRF 250	15/18	SILVER	0017778.020
	15/18	WHITE	0017778.030
	2019	SILVER	0022444.020
	2019	WHITE	0022444.030

MODEL	YEAR	COLOR	CODE
WRF 250	2019	BLUE	0022444.040
	2019	SILVER/BLUE	0022444.218
	15/18	BLUE	0017778.040
WRF 450	15/18	SILVER/BLUE	0017778.218
	16/18	SILVER	0022444.020
	16/18	WHITE	0022444.030
	16/18	BLUE	0022444.040
	16/18	SILVER/BLUE	0022444.218
	2019	SILVER	0023093.020
	2019	WHITE	0023093.030
2019	BLUE	0023093.040	
2019	SILVER/BLUE	0023093.218	



code: **0021669.020**

code: **0021669.040**

code: **0021669.218**

code: **0022444.020**

code: **0022444.030**

code: **0022444.040**

code: **0022444.218**

X-GRIP FRAME PROTECTOR HUSQVARNA

MODEL	YEAR	COLOR	CODE
TC 65	16/20	BLACK	0022896.090
TC 85	14/17	WHITE	0021869.030
	18/20	WHITE	0022893.030
TC 125/ TC 125 TX	16/18	WHITE	0021726.030
	16/18	WHITE/BLUE	0021726.232
	16/18	WHITE/YELL.	0021726.234
	19/20	BLUE/GREY	0023600.249
	19/20	BLUE/WHITE	0023600.315
	19/20	BLUE/YELL.	0023600.318
	19/20	BLK./WHITE	0023600.726
	19/20	WHITE/BLK.	0023600.878
TC 250	17/18	WHITE	0021726.030
	17/18	WHITE/BLUE	0021726.232
	17/18	WHITE/YELL.	0021726.234
	19/20	BLUE/GREY	0023600.249
	19/20	BLUE/WHITE	0023600.315
	19/20	BLUE/YELL.	0023600.318
	19/20	BLK./WHITE	0023600.726
	19/20	WHITE/BLK.	0023600.878
FC250/350/450	16/18	WHITE	0021726.030
	16/18	WHITE/BLUE	0021726.232
	16/18	WHITE/YELL.	0021726.234
	19/20	BLUE/GREY	0023600.249

MODEL	YEAR	COLOR	CODE	
FC250/350/450	19/20	BLUE/WHITE	0023600.315	
	19/20	BLUE/YELL.	0023600.318	
	19/20	BLK./WHITE	0023600.726	
	19/20	WHITE/BLK.	0023600.878	
TE/FE	17/19	WHITE	0021726.030	
	17/19	WHITE/BLUE	0021726.232	
TE 250/350/450/501	17/19	WHITE/YELL.	0021726.234	
	2020	BLUE/GREY	0023600.249	
	2020	BLUE/WHITE	0023600.315	
	2020	BLUE/YELL.	0023600.318	
	2020	BLK./WHITE	0023600.726	
	2020	WHITE/BLK.	0023600.878	
	TE 250/300 I	2020	BLUE/GREY	0023600.249
		2020	BLUE/WHITE	0023600.315
2020		BLUE/YELL.	0023600.318	
2020		BLK./WHITE	0023600.726	
2020	WHITE/BLK.	0023600.878		



code: **0021869.030**



code: **0021726.030**



code: **0021726.232**



code: **0021726.234**

X-GRIP FRAME PROTECTOR BETA

MODEL	YEAR	COLOR	CODE
RR 250/300 (2T)	13/18	RED/BLACK	0022894.349

MODEL	YEAR	COLOR	CODE
RR 350/498 (4T)	13/18	RED/BLACK	0022894.349
RR 2T 125	BLACK	18/19	0023679.090
	RED	18/19	0023679.110
RR 2T 200	BLACK	2019	0023679.090
	RED	2019	0023679.110



code: **0022894.349**



ACERBIS CHAIN GUIDE/SLIDER KIT HONDA

MODEL	YEAR	COLOR	CODE
CRF 250R	10/13	WHITE	0021685.030
	10/13	BLACK	0021685.090
	14/17	WHITE	0021689.030
	14/17	BLACK	0021689.090
	18/19	WHITE	0022712.030
	18/19	BLACK	0022712.090
CRF 450R	18/19	RED	0022712.110
	09/12	WHITE	0021685.030
	09/12	BLACK	0021685.090
	13/16	WHITE	0021689.030
	13/16	BLACK	0021689.090
	17/18	WHITE	0022712.030

MODEL	YEAR	COLOR	CODE
CRF 450R	17/18	BLACK	0022712.090
	17/18	RED	0022712.110
	2019	WHITE	0023728.030
	2019	BLACK	0023728.090
	2019	RED	0023728.110
CRF250/300RX	2019	WHITE	0022712.030
	2019	BLACK	0022712.090
	2019	RED	0022712.110
CRF 450 RX	2019	WHITE	0023728.030
	2019	BLACK	0023728.090
	2019	RED	0023728.110



code: **0021685.030**



code: **0021685.090**



code: **0021689.030**



code: **0021689.090**

ACERBIS CHAIN GUIDES HONDA

MODEL	YEAR	COLOR	CODE
CRF 250R/250X	07/19	WHITE	0017949.030
	07/19	BLACK	0017949.090
	07/19	RED	0017949.110
CRF 450R/450X	07/19	WHITE	0017949.030
	07/19	BLACK	0017949.090
	07/19	RED	0017949.110

MODEL	YEAR	COLOR	CODE
CRF 450 RX	17/19	WHITE	0017949.030
	17/19	BLACK	0017949.090
	17/19	RED	0017949.110
CRF250/300RX	2019	WHITE	0017949.030
	2019	BLACK	0017949.090
	2019	RED	0017949.110



code: **0017949.030**



code: **0017949.090**



code: **0017949.110**

REPLACEMENT INSERTS



code: **0017953.030**



code: **0017953.090**



code: **0017953.110**

ACERBIS CHAIN SLIDERS HONDA

MODEL	YEAR	COLOR	CODE
CR 125	98/01	BLACK	0005027.090
	02/07	BLACK	0006674.090
CR 250	98/99	BLACK	0005027.090
	00/07	BLACK	0006674.090
CRF 250X	07/17	BLACK	0006674.090
CRF 250R	04/09	BLACK	0006674.090
	10/13	WHITE	0013503.030
	10/13	BLACK	0013503.090
	14/17	WHITE	0016982.030
	14/17	BLACK	0016982.090
	18/19	WHITE	0022711.030
	18/19	BLACK	0022711.090
	18/19	RED	0022711.110

MODEL	YEAR	COLOR	CODE
CRF 450R	02/08	BLACK	0006674.090
	09/12	WHITE	0013503.030
	09/12	BLACK	0013503.090
	13/16	WHITE	0016982.030
	13/16	BLACK	0016982.090
	17/18	WHITE	0022711.030
	17/18	BLACK	0022711.090
	17/18	RED	0022711.110
	2019	WHITE	0023727.030
	2019	BLACK	0023727.090
	2019	RED	0023727.110
CRF 450 X	05/16	BLACK	0006674.090
CRE 125/250	98/99	BLACK	0005027.090
	00/06	BLACK	0006674.090
CRE 450F	04/06	BLACK	0006674.090
CRF250/300RX	2019	WHITE	0022711.030
	2019	BLACK	0022711.090
	2019	RED	0022711.110
CRF 450 RX	2019	WHITE	0023727.030
	2019	BLACK	0023727.090
	2019	RED	0023727.110



code: **0016982.030**



code: **0016982.090**

ACERBIS CHAIN GUIDE/SLIDER KIT KAWASAKI

MODEL	YEAR	COLOR	CODE
KX 250F	09/19	BLACK	0021688.090
	09/19	GREEN	0021688.130

MODEL	YEAR	COLOR	CODE
KX 450F	09/15	BLACK	0021688.090
	09/15	GREEN	0021688.130
	16/18	BLACK	0021891.090
	16/18	GREEN	0021891.130
	2019	BLACK	002362.090
	2019	GREEN	002362.130



code: **0021688.090**



code: **0021688.130**

ACERBIS CHAIN GUIDES KAWASAKI

MODEL	YEAR	COLOR	CODE
KX-F 250	09/19	WHITE	0017950.030
	09/19	BLACK	0017950.090
	09/19	GREEN	0017950.130

MODEL	YEAR	COLOR	CODE
KX-F 450	09/19	WHITE	0017950.030
	09/19	BLACK	0017950.090
	09/19	GREEN	0017950.130



code: **0017950.030**



code: **0017950.090**



code: **0017950.130**

REPLACEMENT INSERTS



code: **0017953.030**



code: **0017953.090**



code: **0017953.130**

ACERBIS CHAIN SLIDERS KAWASAKI

MODEL	YEAR	COLOR	CODE
KX 85/100	02/19	BLACK	0017855.090
	02/19	GREEN	0017855.130
KX 125/250	94/08	BLACK	0005025.090
KX-F 250	04/05	BLACK	0010068.090
	06/08	BLACK	0010239.090
	09/16	BLACK	0013152.090
	09/16	GREEN	0013152.130
	17/19	BLACK	0021890.090
17/19	GREEN	0021890.130	

MODEL	YEAR	COLOR	CODE
KX-F 450	06/08	BLACK	0010239.090
	09/15	BLACK	0013152.090
	09/15	GREEN	0013152.130
	16/18	BLACK	0021890.090
	16/18	GREEN	0021890.130
	2019	BLACK	0023659.090
2019	GREEN	0023659.130	
KLX 450	08/09	BLACK	0010239.090
SM 125/250	03/06	BLACK	0010239.090
KXE 125/250	03/06	BLACK	0010239.090



code: **0017855.090**



code: **0017855.130**



code: **0005025.090**



code: **0010068.090**



code: **0010239.090**



code: **0013152.090**



code: **0013152.130**



ACERBIS CHAIN GUIDE/SLIDER KIT KTM

MODEL	YEAR	COLOR	CODE
SX 125/144/150	11/15	ORANGE	0016856.010
	11/15	BLACK	0016856.090
	16/20	ORANGE	0021833.010
	16/20	BLACK	0021833.090
SX 250	11/16	ORANGE	0016856.010
	11/16	BLACK	0016856.090
	17/20	ORANGE	0021833.010
	17/20	BLACK	0021833.090



code: **0016856.010**



code: **0016856.090**



code: **0022349.010**



code: **0022349.090**

MODEL	YEAR	COLOR	CODE
SXF 250/350/450	11/15	ORANGE	0016856.010
	11/15	BLACK	0016856.090
	16/20	ORANGE	0021833.010
	16/20	BLACK	0021833.090
EXC/EXC-F	12/16	ORANGE	0016847.010
	12/16	BLACK	0016847.090
	17/20	ORANGE	0022349.010
	17/20	BLACK	0022349.090
XC/XC-F	2020	ORANGE	0021833.010
	2020	BLACK	0021833.090
XC-W	2020	ORANGE	0022349.010
	2020	BLACK	0022349.090



code: **0016847.010**



code: **0016847.090**

ACERBIS CHAIN GUIDE/SLIDER KIT KTM

MODEL	YEAR	COLOR	CODE
SX 85	06/14	ORANGE	0017853.010
	06/14	BLACK	0017853.090



code: **0017853.010**



code: **0017853.090**



code: **0021515.010**



code: **0021515.030**



code: **0021515.090**

ACERBIS CHAIN GUIDES KTM

MODEL	YEAR	COLOR	CODE
SX/SXF	11/20	ORANGE	0016451.010
	11/20	WHITE	0016451.030
	11/20	BLACK	0016451.090
EXC/EXC-F	12/20	ORANGE	0016451.010
	12/20	WHITE	0016451.030
	12/20	BLACK	0016451.090



code: **0016451.010**



code: **0016451.030**



code: **0016451.090**



code: **0017852.010**



code: **0017852.090**

MODEL	YEAR	COLOR	CODE
SX 85	06/14	ORANGE	0017852.010
		BLACK	0017852.090
	15/20	ORANGE	0016451.010
		WHITE	0016451.030
		BLACK	0016451.090
XC/XC-F	2020	ORANGE	0016451.010
	2020	WHITE	0016451.030
	2020	BLACK	0016451.090
XC-W	2020	ORANGE	0016451.010
	2020	WHITE	0016451.030
	2020	BLACK	0016451.090

REPLACEMENT INSERTS ONLY FOR 0021515/0016451



code: **0016510.010**



code: **0016510.090**

ACERBIS CHAIN SLIDERS KTM

MODEL	YEAR	COLOR	CODE
SX 125/144/150	00/06	BLACK	0010069.090
	07/10	BLACK	0012218.090
	11/15	ORANGE	0015916.010
	11/15	BLACK	0015916.090
	16/20	ORANGE	0021832.010
	16/20	BLACK	0021832.090
SX 250	00/06	BLACK	0010069.090
	07/10	BLACK	0012218.090
	11/16	ORANGE	0015916.010
	11/16	BLACK	0015916.090
	17/20	ORANGE	0021832.010
	17/20	BLACK	0021832.090
SXF 250/350/450	00/06	BLACK	0010069.090
	07/10	BLACK	0012218.090
	11/15	ORANGE	0015916.010
	11/15	BLACK	0015916.090
	16/20	ORANGE	0021832.010
	16/20	BLACK	0021832.090

MODEL	YEAR	COLOR	CODE
XC/XC-F	2020	ORANGE	0021832.010
	2020	BLACK	0021832.090
EXC/EXC-F	00/07	BLACK	0010069.090
	08/11	BLACK	0012218.090
	12/16	ORANGE	0016857.010
	12/16	BLACK	0016857.090
	17/20	ORANGE	0022348.010
	17/20	BLACK	0022348.090
XC-W	2020	ORANGE	0022348.010
	2020	BLACK	0022348.090



code: **0022348.010**



code: **0022348.090**



code: **0016857.090**



code: **0021832.090**

ACERBIS CHAIN SLIDERS KTM

MODEL	YEAR	COLOR	CODE
SX 85	06/14	ORANGE	0017856.010
	06/14	BLACK	0017856.090

MODEL	YEAR	COLOR	CODE
SX 85	15/20	ORANGE	0021514.010
	15/20	WHITE	0021514.030
	15/20	BLACK	0021514.090



code **0017856.010**



code **0017856.090**



code **0021514.010**



code **0021514.030**



code **0021514.090**



ACERBIS CHAIN GUIDE/SLIDER KIT SUZUKI

MODEL	YEAR	COLOR	CODE
RMZ 250	10/18	YELLOW	0021686.060
	10/18	BLACK	0021686.090
	2019	YELLOW	0023073.060
	2019	BLACK	0023073.090

MODEL	YEAR	COLOR	CODE
RMZ 450	10/17	YELLOW	0021686.060
	10/17	BLACK	0021686.090
	18/19	YELLOW	0023073.060
	18/19	BLACK	0023073.090



code: **0021686.060**



code: **0021686.090**

ACERBIS CHAIN GUIDES SUZUKI

MODEL	YEAR	COLOR	CODE
RM 125/250	07/08	WHITE	0017951.030
	07/08	YELLOW	0017951.060
	07/08	BLACK	0017951.090
RM-Z 250	08/19	WHITE	0017951.030
	08/19	YELLOW	0017951.060
	08/19	BLACK	0017951.090
RM-Z 450	05/17	WHITE	0017951.030
	05/17	YELLOW	0017951.060
	05/17	BLACK	0017951.090

MODEL	YEAR	COLOR	CODE
RMZX	10/17	WHITE	0017951.030
	10/17	YELLOW	0017951.060
	10/17	BLACK	0017951.090
	18/19	WHITE	0023072.030
	18/19	YELLOW	0023072.060
	18/19	BLACK	0023072.090



code: **0017951.030**



code: **0017951.060**



code: **0017951.090**

REPLACEMENT INSERTS



code: **0017954.030**



code: **0017954.060**



code: **0017954.090**

ACERBIS CHAIN SLIDERS SUZUKI

MODEL	YEAR	COLOR	CODE
RM 125/250	01/08	BLACK	0010064.090
RM-Z 250	07/09	BLACK	0010064.090
	10/18	YELLOW	0012217.060
	10/18	BLACK	0012217.090
	2019	YELLOW	0023071.060
	2019	BLACK	0023071.090

MODEL	YEAR	COLOR	CODE
RM-Z 450	05/06	BLACK	0010064.090
	2007	YELLOW	0012217.060
	2007	BLACK	0012217.090
	08/09	BLACK	0010064.090
	10/17	YELLOW	0012217.060
	10/17	BLACK	0012217.090
	18/19	YELLOW	0023071.060
	18/19	BLACK	0023071.090



code: **0010064.090**



code: **0012217.060**



code: **0012217.090**

ACERBIS CHAIN GUIDE/SLIDER KIT YAMAHA

MODEL	YEAR	COLOR	CODE
YZ 250F	09/19	BLUE	0021687.040
	09/19	BLACK	0021687.090

MODEL	YEAR	COLOR	CODE
YZ 450F	09/19	BLUE	0021687.040
	09/19	BLACK	0021687.090
WRF 450	2019	BLUE	0021687.040
	2019	BLACK	0021687.090



code: **0021687.040**



code: **0021687.090**

ACERBIS CHAIN GUIDES YAMAHA

MODEL	YEAR	COLOR	CODE
YZ 125/250	05/19	WHITE	0017952.030
	05/19	BLUE	0017952.040
	05/19	BLACK	0017952.090
YZF 250	03/19	WHITE	0017952.030
	03/19	BLUE	0017952.040
	03/19	BLACK	0017952.090

MODEL	YEAR	COLOR	CODE
YZF 450	03/19	WHITE	0017952.030
	03/19	BLUE	0017952.040
	03/19	BLACK	0017952.090
WRF 250/450	03/19	WHITE	0017952.030
	03/19	BLUE	0017952.040
	03/19	BLACK	0017952.090



code: **0017952.030**



code: **0017952.040**



code: **0017952.090**

REPLACEMENT INSERTS



code: **0017953.030**



code: **0017953.040**



code: **0017953.090**

ACERBIS CHAIN SLIDERS YAMAHA

MODEL	YEAR	COLOR	CODE
YZ 125/250	97/01	BLACK	0005026.090
	02/04	BLACK	0010240.090
	05/19	BLACK	0010241.090
YZF 250	05/08	BLACK	0010241.090
	09/19	BLUE	0015918.040
	09/19	BLACK	0015918.090
YZF 450	05/08	BLACK	0010241.090
	09/19	BLUE	0015918.040
	09/19	BLACK	0015918.090

MODEL	YEAR	COLOR	CODE
WR 125/250	96/01	BLACK	0005026.090
	05/14	BLACK	0010241.090
WRF 250/450	05/08	BLACK	0010241.090
	09/19	BLUE	0015918.040
	09/19	BLACK	0015918.090
YZ 65	2019	BLACK	0023915.090



code: **0005026.090**



code: **0015918.040**



code: **0015918.090**

ACERBIS CHAIN GUIDE GAS GAS

MODEL	YEAR	COLOR	CODE
EC 250/300 GP	2018	WHITE	0016451.030
	2018	BLACK	0016451.090
ECR 250 SIX DAYS	2018	WHITE	0016451.030
	2018	BLACK	0016451.090

MODEL	YEAR	COLOR	CODE
EC R 250/300 E4	2018	WHITE	0016451.030
	2018	BLACK	0016451.090



code: **0016451.030**



code: **0016451.090**



ACERBIS CHAIN GUIDE/SLIDER KIT HUSQVARNA

MODEL	YEAR	COLOR	CODE
TC 125	14/15	BLACK	0016856.090
	16/20	BLACK	0021833.090
TC 250	14/16	BLACK	0016856.090
	17/20	BLACK	0021833.090

MODEL	YEAR	COLOR	CODE
FC 250/350/450	14/15	BLACK	0016856.090
	16/20	BLACK	0021833.090
TE / FE	14/16	BLACK	0016856.090
	17/20	BLACK	0021833.090



code: **0016856.090**

ACERBIS CHAIN GUIDE/SLIDER KIT HUSQVARNA

MODEL	YEAR	COLOR	CODE
TC 85	15/20	WHITE	0021515.030

MODEL	YEAR	COLOR	CODE
TC 85	15/20	BLACK	0021515.090



code: **0021515.030**



code: **0021515.090**

ACERBIS CHAIN GUIDES HUSQVARNA

MODEL	YEAR	COLOR	CODE
TC/FC -TE/FE	14/20	WHITE	0016451.030
	14/20	BLACK	0016451.090

MODEL	YEAR	COLOR	CODE
TC 85	15/20	WHITE	0016451.030
	15/20	BLACK	0016451.090



code: **0016451.030**



code: **0016451.090**

REPLACEMENT INSERTS



code: **0016510.090**

ACERBIS CHAIN SLIDERS HUSQVARNA

MODEL	YEAR	COLOR	CODE
TC 85	15/20	WHITE	0021514.030
	15/20	BLACK	0021514.090
TC 125	14/15	BLACK	0015916.090
	16/20	BLACK	0021832.090
TC 250	14/16	BLACK	0015916.090
	17/20	BLACK	0021832.090

MODEL	YEAR	COLOR	CODE
FC 250/350/450	14/15	BLACK	0015916.090
	16/20	BLACK	0021832.090
TE / FE	14/16	BLACK	0015916.090
	17/20	BLACK	0021832.090



code **0021514.030**



code **0021514.090**



code: **0015916.090**



code: **0021832.090**

SILENCER PROTECTOR

MATERIALS:

- 100% Silicone

DETAILS:

- Silencer protection against bumps and scratches
- Circumference 200/400 mm
- Locking system through micrometric closing bands
- Heat resistant till 200°C



orange
0022754.010



silver
0022754.020



blue
0022754.040



yellow
0022754.060



black
0022754.090



red
0022754.110



green
0022754.130

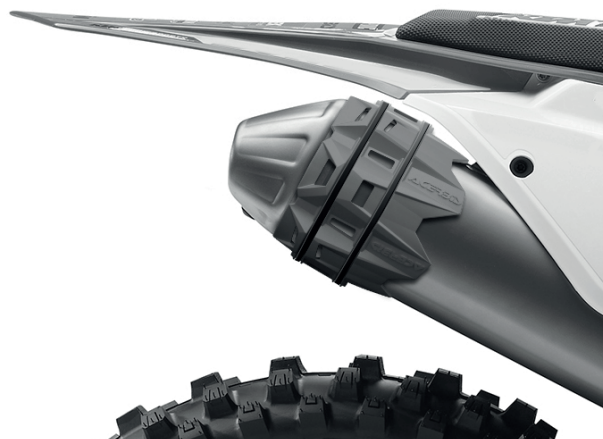

X-POWER KIT

- Motor Crankcase and Ignition/Clutch covers that protect against wear from boots, impacts, dirt, mud, and other debris
- **Right side:** provides protection for the clutch cover, water pump, and lower casing
- **Left side:** provides protection to the ignition cover and clutch actuator
- Molded openings to access the filter cover and oil cap
- Easy to install by utilizing the original crankcase and ignition/clutch cover bolts
- Resistant to high temperatures
- Designed not to interfere with boots
- Compatible with ACERBIS skid plates



orange
code: **0023468.011.016**



white
code: **0023468.030**



black
code: **0023468.090**

APPLICATIONS X-POWER KIT KTM

MODEL	YEAR	COLOR	CODE
SX 250	17/19	ORANGE 16	0023468.011.016
	17/19	WHITE	0023468.030
	17/19	BLACK	0023468.090
	2020	ORANGE 16	0023674.011.016
	2020	WHITE	0023674.030
	2020	BLACK	0023674.090
SX-F 250/350	16/20	ORANGE 16	0023573.011.016
	16/20	WHITE	0023573.030
	16/20	BLACK	0023573.090
SX-F 450	16/20	ORANGE 16	0023153.011.016
	16/20	SILVER	0023153.020
	16/20	FLUO YELL.	0023153.061
	16/20	BLACK	0023153.090
EXC 250/300	17/19	ORANGE 16	0023468.011.016
	17/19	WHITE	0023468.030
	17/19	BLACK	0023468.090
	2020	ORANGE 16	0023674.011.016
	2020	WHITE	0023674.030
	2020	BLACK	0023674.090
EXC-F 250/350	17/20	ORANGE 16	0023469.011.016
	17/20	WHITE	0023469.030
	17/20	BLACK	0023469.090
EXC-F 450	17/20	ORANGE 16	0023153.011.016
	17/20	SILVER	0023153.020
	17/20	FLUO YELL.	0023153.061
	17/20	BLACK	0023153.090
XC 250/300 TPI	2020	ORANGE 16	0023674.011.016
	2020	WHITE	0023674.030
	2020	BLACK	0023674.090
XC-F 250/350	2020	ORANGE 16	0023573.011.016
	2020	WHITE	0023573.030
	2020	BLACK	0023573.090
XC-F 450	2020	ORANGE 16	0023153.011.016
	2020	SILVER	0023153.020
	2020	FLUO YELL.	0023153.061
	2020	BLACK	0023153.090
XC-W 250/300 TPI	2020	ORANGE 16	0023674.011.016
	2020	WHITE	0023674.030
	2020	BLACK	0023674.090

APPLICATIONS X-POWER KIT YAMAHA

MODEL	YEAR	COLOR	CODE
YZ 125	03/19	BLACK	0023961.090
	03/19	BLUE	0023961.040

APPLICATIONS X-POWER KIT HUSQVARNA

MODEL	YEAR	COLOR	CODE
TC 250	17/19	ORANGE 16	0023468.011.016
	17/19	WHITE	0023468.030
	17/19	BLACK	0023468.090
	2020	ORANGE 16	0023674.011.016
	2020	WHITE	0023674.030
	2020	BLACK	0023674.090
FC 250/350	16/20	ORANGE 16	0023573.011.016
	16/20	WHITE	0023573.030
	16/20	BLACK	0023573.090
FC 450	16/20	ORANGE 16	0023153.011.016
	16/20	SILVER	0023153.020
	16/20	FLUO YELL.	0023153.061
	16/20	BLACK	0023153.090
TE 250/300	17/19	ORANGE 16	0023468.011.016
	17/19	WHITE	0023468.030
	17/19	BLACK	0023468.090
TE 250/300 I	2020	ORANGE 16	0023674.011.016
	2020	WHITE	0023674.030
	2020	BLACK	0023674.090
FE 250/350	17/20	ORANGE 16	0023469.011.016
	17/20	WHITE	0023469.030
	17/20	BLACK	0023469.090
FE 450	17/20	ORANGE 16	0023153.011.016
	17/20	SILVER	0023153.020
	17/20	FLUO YELL.	0023153.061
	17/20	BLACK	0023153.090

APPLICATIONS X-POWER KIT HUSQVARNA

MODEL	YEAR	COLOR	CODE
RR 2T 250/300 RC	18/19	ORANGE 16	0023673.
	18/19	WHITE	0023673.
RR/RC 250/300	18/19	ORANGE 16	0023673.
	18/19	WHITE	0023673.
RR 2T 250/300 X-T	18/19	ORANGE 16	0023673.
	18/19	WHITE	0023673.

FORK SHOE COVER

- Protects the lower forks against impact and damage
- Easy to install by utilizing the original front axle/fork lug screws
- Provides easy access to the axle nut and fork lug bolts



FORK SHOE COVER HONDA

MODEL	YEAR	COLOR	CODE
CRF 250 R	09/19	SILVER	0023197.020
	09/19	WHITE	0023197.030
	09/19	BLACK	0023197.090
	09/19	RED	0023197.110
CRF 250 X	09/17	SILVER	0023197.020
	09/17	WHITE	0023197.030
	09/17	BLACK	0023197.090
	09/17	RED	0023197.110

MODEL	YEAR	COLOR	CODE
CRF 450 RX	17/19	SILVER	0023197.020
	17/19	WHITE	0023197.030
	17/19	BLACK	0023197.090
	17/19	RED	0023197.110
CRF 450 X	09/16	SILVER	0023197.020
	09/16	WHITE	0023197.030
	09/16	BLACK	0023197.090
	09/16	RED	0023197.110
CRF 250/300 RX	2019	SILVER	0023197.020
	2019	WHITE	0023197.030
	2019	BLACK	0023197.090
	2019	RED	0023197.110



FORK SHOE COVER KAWASAKI

MODEL	YEAR	COLOR	CODE
KXF 250	09/19	SILVER	0023197.020
	09/19	WHITE	0023197.030
	09/19	BLACK	0023197.090
	09/19	GREEN	0023197.130

MODEL	YEAR	COLOR	CODE
KXF 450	09/19	SILVER	0023197.020
	09/19	WHITE	0023197.030
	09/19	BLACK	0023197.090
	09/19	GREEN	0023197.130



FORK SHOE COVER SUZUKI

MODEL	YEAR	COLOR	CODE
RM-Z 250	09/19	SILVER	0023195.020
	09/19	WHITE	0023195.030
	09/19	YELLOW	0023195.060
	09/19	BLACK	0023195.090

MODEL	YEAR	COLOR	CODE
RM-Z 450	09/19	SILVER	0023195.020
	09/19	WHITE	0023195.030
	09/19	YELLOW	0023195.060
	09/19	BLACK	0023195.090



FORK SHOE COVER YAMAHA

MODEL	YEAR	COLOR	CODE
YZ 125/250	08/19	SILVER	0023194.020
	08/19	WHITE	0023194.030
	08/19	BLUE	0023194.040
	08/19	BLACK	0023194.090
YZF 125/450	07/19	SILVER	0023194.020
	07/19	WHITE	0023194.030

MODEL	YEAR	COLOR	CODE
YZF 125/450	07/19	BLUE	0023194.040
	07/19	BLACK	0023194.090
WR 125/250 2T	08/19	SILVER	0023194.020
	08/19	WHITE	0023194.030
	08/19	BLUE	0023194.040
	08/19	BLACK	0023194.090



FORK SHOE COVER KTM/HUSQVARNA/SHERCO

MODEL	YEAR	COLOR	CODE
KTM			
SX 125/150	16/20	ORANGE 016	0023196.011.016
	16/20	SILVER	0023196.020
	16/20	WHITE	0023196.030
	16/20	BLACK	0023196.090
SX 250	17/20	ORANGE 016	0023196.011.016
	17/20	SILVER	0023196.020
	17/20	WHITE	0023196.030
	17/20	BLACK	0023196.090
SX-F 250/350/ 450/505	16/20	ORANGE 016	0023196.011.016
	16/20	SILVER	0023196.020
	16/20	WHITE	0023196.030
	16/20	BLACK	0023196.090
EXC 125/200/250/300 /EXC-F 250/350/450/505	16/20	ORANGE 016	0023196.011.016
	16/20	SILVER	0023196.020
	16/20	WHITE	0023196.030
	16/20	BLACK	0023196.090
XC 250/300 TPI /XC-F 250/350/450	19/20	ORANGE 016	0023196.011.016
	19/20	SILVER	0023196.020
	19/20	WHITE	0023196.030
	19/20	BLACK	0023196.090
HUSQVARNA			
FC 250/350/450	16/20	ORANGE 016	0023196.011.016
	16/20	SILVER	0023196.020
	16/20	WHITE	0023196.030
	16/20	BLACK	0023196.090

MODEL	YEAR	COLOR	CODE
TC 125/125TX	16/20	ORANGE 016	0023196.011.016
	16/20	SILVER	0023196.020
	16/20	WHITE	0023196.030
	16/20	BLACK	0023196.090
TC 250	17/20	ORANGE 016	0023196.011.016
	17/20	SILVER	0023196.020
	17/20	WHITE	0023196.030
	17/20	BLACK	0023196.090
TE 125/250/300 /FE 250/350/450/501	17/20	ORANGE 016	0023196.011.016
	17/20	SILVER	0023196.020
	17/20	WHITE	0023196.030
	17/20	BLACK	0023196.090
TE 250/300 I	19/20	ORANGE 016	0023196.011.016
	19/20	SILVER	0023196.020
	19/20	WHITE	0023196.030
	19/20	BLACK	0023196.090
SHERCO			
SE-R 125	2018	ORANGE 016	0023196.011.016
	2018	SILVER	0023196.020
	2018	WHITE	0023196.030
	2018	BLACK	0023196.090
SE-R 125/250/300 SIX D. /SEF-R 250/300/450 SIX D.	2018	ORANGE 016	0023196.011.016
	2018	SILVER	0023196.020
	2018	WHITE	0023196.030
	2018	BLACK	0023196.090



FORK SHOE COVER BETA

MODEL	YEAR	COLOR	CODE
RR 2T 250/300 RC	12/18	WHITE	0023502.030
	12/18	BLACK	0023502.090
	12/18	RED	0023502.110
	2019	WHITE	0023680.030
	2019	BLACK	0023680.090
	2019	RED	0023680.110
RR 4T 350/400/430	12/18	WHITE	0023502.030
	12/18	BLACK	0023502.090
	12/18	RED	0023502.110
	2019	WHITE	0023680.030
	2019	BLACK	0023680.090
	2019	RED	0023680.110
RR 4T 450/480/498	12/18	WHITE	0023502.030
	12/18	BLACK	0023502.090

MODEL	YEAR	COLOR	CODE
RR 4T 450/480/498	12/18	RED	0023502.110
	2019	WHITE	0023680.030
	2019	BLACK	0023680.090
	2019	RED	0023680.110
RR/RACING 250/300	12/18	WHITE	0023502.030
	12/18	BLACK	0023502.090
	12/18	RED	0023502.110
	2019	WHITE	0023680.030
	2019	BLACK	0023680.090
RR 2T 250/300 X-TRAINER	12/18	WHITE	0023502.030
	12/18	BLACK	0023502.090
	12/18	RED	0023502.110
RR 2T 125/200	2019	WHITE	0023680.030
	2019	BLACK	0023680.090
	2019	RED	0023680.110



BREMBO PUMP COVERS

- Polypropylene pump cover;
- Protection for Brembo clutches and brake master cylinders manufactured after 2014;
- Shock resistant and reduces wear of the plates;
- O-Ring fixing;
- **INSTALLATION DOESN'T REQUIRE LOOSENING ANY SCREWS;**



FOOT PEG COVER



orange
0011469.010



grey
0011469.020



black
0011469.090

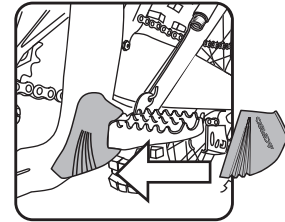

UPPER FORK COVERS

- Rubber fork protections with carbon effect finishing.
- Protects against track debris and reduces wear to the upper fork.
- **QUICK INSTALLATION AND NO NEED TO REMOVE THE FORKS BECAUSE OF THE HOOK AND LOOP FASTENERS STRAPS**



UPPER FORK COVERS
• ø 43/48 mm.

hook and loop fastener



orange
code: 0021750.010



blue
code: 0021750.040



yellow
code: 0021750.060



black
code: 0021750.090



red
code: 0021750.110



green
code: 0021750.130

FORK GAITERS



hook and loop fastener

**SHORT HOOK AND LOOP FASTENERS
FORK GAITERS**
• 145 mm.
• ø 45/50 mm.

code: 0016976.090



**NEOPRENE
FORK GAITERS**
• 365 mm.
• ø 40/50 mm

code: 0005094.090

X-MUD

- Suitable for fork with diameter 46/49 mm.
- Maximum fork movement.
- Protects the shaft from mud, sand and dust.
- Simple installation.
- Protects the fork shaft from dirt that, in critical or challenging conditions, might compromise oil seal function, resulting in an oil leak or affecting fork performance.



X-TYRE COVER

COMPOSITION:

- 50% Polyester
- 50% PVC

USE: Wheel covers are used to avoid getting the bike's tyres dirty in the presence of mud and/or sand (for example after washing the bike), or before a competition at the starting grid, to avoid clogging the tyre treads, allowing the rider to have a fast start with the best possible grip and riding control.

APPLICATION: The kit consists of two Tyre covers: one for 21" front wheel and one for 18" and 19" rear wheel.

FITTING: The tyre covers can be quickly and intuitively fitted thanks to the hook and loop fastener.

MAINTENANCE AND WASHING: by washing machine at 30 ° or high pressure washer (cold water)

MATERIALS: Polyester and PVC fabric resistant to wear and tear.



X-GUARD SWINGARM COVERS HONDA - KAWASAKI - SUZUKI - YAMAHA

- Rubber swingarm covers with carbon effect finishing
- Protects against track debris
- **QUICK INSTALLATION BECAUSE OF STICKER STRAPS**



white
code: **0022890.030**



blue
code: **0022890.040**



yellow
code: **0022890.060**



black
code: **0022890.090**



red
code: **0022890.110**



green
code: **0022890.130**

APPLICATIONS HONDA - KAWASAKI - SUZUKI - YAMAHA

MODEL	YEAR	COLOR	CODE
CRF 250/450	02/18	WHITE	0022890.030
	02/18	BLUE	0022890.040
	02/18	YELLOW	0022890.060
	02/18	BLACK	0022890.090
	02/18	RED	0022890.110
RX 450	02/18	GREEN	0022890.130
	17/18	WHITE	0022890.030
	17/18	BLUE	0022890.040
	17/18	YELLOW	0022890.060
	17/18	BLACK	0022890.090
KXF 250/450	17/18	RED	0022890.110
	17/18	GREEN	0022890.130
	10/18	WHITE	0022890.030
	10/18	BLUE	0022890.040
	10/18	YELLOW	0022890.060
10/18	BLACK	0022890.090	

MODEL	YEAR	COLOR	CODE
KXF 250/450	10/18	RED	0022890.110
	10/18	GREEN	0022890.130
RMZ 250/450	08/18	WHITE	0022890.030
	08/18	BLUE	0022890.040
	08/18	YELLOW	0022890.060
	08/18	BLACK	0022890.090
	08/18	RED	0022890.110
YZF 250/450	08/18	GREEN	0022890.130
	09/18	WHITE	0022890.030
	09/18	BLUE	0022890.040
	09/18	YELLOW	0022890.060
	09/18	BLACK	0022890.090
09/18	RED	0022890.110	
09/18	GREEN	0022890.130	

X-GUARD SWINGARM COVERS KTM



KTM orange 2016
code: **0023103.011.016**



white
code: **0023103.030**



black
code: **0023103.090**

APPLICATIONS KTM

MODEL	YEAR	COLOR	CODE
SX 125	16/20	ORANGE 16	0023103.011.016
	16/20	WHITE	0023103.030
	16/20	BLACK	0023103.090
SX 250	17/20	ORANGE 16	0023103.011.016
	17/20	WHITE	0023103.030
	17/20	BLACK	0023103.090

MODEL	YEAR	COLOR	CODE
SXF 250/350/450	16/20	ORANGE 16	0023103.011.016
	16/20	WHITE	0023103.030
	16/20	BLACK	0023103.090
XC/XC-F	2020	ORANGE 16	0023103.011.016
	2020	WHITE	0023103.030
	2020	BLACK	0023103.090



MODEL	YEAR	CODE
HONDA		
CR 85	03/10	0015671.
CRF 150 R	07/19	0015672.
CR 125 - 250	02/08	0001193.
CRF 250 R	04/09	0007751.
	10/13	0016078.
	14/17	0016909.
	18/19	0022622.
CRF 250 X	04/16	0007751.
CRF 450 R	03/08	0007751.
	09/12	0016078.
	13/16	0016909.
CRF 450 R/RX	17/19	0022622.
CRF 450 X	03/16	0007751.
XR 250/400/600	85/08	0001194.
CRF 250/300 RX	2019	0022622.
KAWASAKI		
KX 85	01/19	0015677.
KX 125 - 250	02/08	0001199.
KXF 250	06/16	0007841.
	17/19	0021893.
KXF 450	06/15	0007841.
	16/18	0021893.
	2019	0023547.
YAMAHA		
YZ 65	2019	0023548.
YZ 85	00/19	0015673.
YZ 125 - 250	97/19	0001212.
YZ 250 F	01/13	0001212.
	14/18	0017576.
	2019	0022982.
YZ 450 F	03/09	0001212.
	10/13	0015674.
	14/17	0017576.
	18/19	0022982.
WR 250 F	01/02	0001212.
	03/10	0011657.
	15/19	0017576.
WR 450 F	03/10	0011657.
	16/18	0017576.
	2019	0022982.
YZ/WR 400 F	98/99	0001212.
WR 426 F	00/02	0001212.
KTM		
SX 65	97/20	0023549.
SX 85	2004	0001213.
	05/12	0011653.
	13/17	0015675.
	18/20	0022980.
SX 125/144	98/03	0001213.
	04/06	0011653.
	07/10	0011654.
	11/15	0015675.
	16/20	0021752.
SX 150	09/10	0011654.
	11/15	0015675.
	16/20	0021752.
SX 250	98/03	0001213.
	04/06	0011653.
	07/10	0011654.
	11/16	0015675.
	17/20	0021752.
SX-F 250	2006	0011653.
	07/10	0011654.
	11/15	0015675.
	16/18	0021752.
SXF-F 350	11/15	0015675.
	16/20	0021752.
SXF-F 450	03/06	0011653.
	07/10	0011654.
	11/15	0015675.
	16/20	0021752.
EXC 125	98/03	0001213.
	04/06	0011653.
	07/11	0011654.

MODEL	YEAR	CODE
	12/16	0015675.
	17/20	0021752
EXC 200	98/03	0001213.
	04/06	0011653.
EXC 250	98/03	0001213.
	04/06	0011653.
	07/11	0011654.
	12/16	0015675.
	17/20	0021752
EXC 300	98/03	0001213.
	04/07	0011653.
	08/11	0011654.
	12/16	0015675.
	17/20	0021752
EXC-F 250	07/11	0011654.
	12/16	0015675.
	17/20	0021752
EXC-F 350/450	12/16	0015675.
	17/20	0021752.
EXC-F 400/520/525/540	01/06	0011653.
LC4 400	00/03	0001213.
LC4 520	00/02	0001213.
LC4 525	2003	0001213.
XC/XC-F/XC-W	2020	0021752.
SUZUKI		
RM 85-85 L	02/14	0015676.
RM 125	02/03	0011655.
	04/09	0011656.
RM 250	2002	0011655.
	03/10	0011656.
RMZ 250	07/18	0011656.
	2019	0022981.
RMZ 450	05/17	0011656.
	18/19	0022981.
HUSQVARNA		
CR/WR 125 - 250	92/11	0001206.
CR/WR 360	92/03	0001206.
WRE 410/610	97/05	0001206.
TC 65	17/19	0023549.
TC 85	14/17	0015675.
	18/20	0022980.
TC 125	14/15	0015675.
	16/20	0021752.
TC 250	02/13	0001206.
	14/16	0015675.
	17/20	0021752.
TC 450	02/10	0001206.
TCX 450	02/10	0001206.
TC 510	03/09	0001206.
TE 125	13/16	0015675.
	17/20	0021752.
TE 250	02/12	0001206.
	13/16	0015675.
	17/20	0021752.
TE 300	13/16	0015675.
	17/20	0021752.
TE 410	97/05	0001206.
TE 450	02/10	0001206.
TE 510	03/09	0001206.
TE 610	97/05	0001206.
FE 250/350/450/501	13/16	0015675.
	17/20	0021752.
FC 250/350/450/501	14/15	0015675.
	16/20	0021752.
HUSABERG		
TE 125/250/300	11/12	0011654.
TE 125/250/300	13/14	0015675.
FE 250/350/450	13/14	0015675.
BETA		
RR 2T 250/300	13/18	0022398.
RR4T 350-498	13/18	0022398.





code: **0008320.090**

FILTER COVER

MATERIAL:

- 100% rubber.

DETAILS:

- Universal lid in rubber.
- Protects the suction body during washing.
- Also compatible with KTM e HUSQVARNA from 2016.

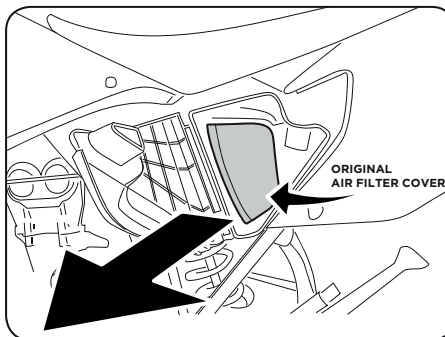

1. Remove the filter with cage.

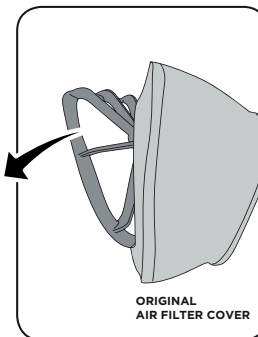

2. Remove the filter from the cage.

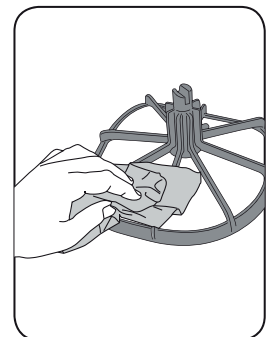

3. Clean the cage with a clean cloth.



code: **0022709.010**



code: **0022709.090**

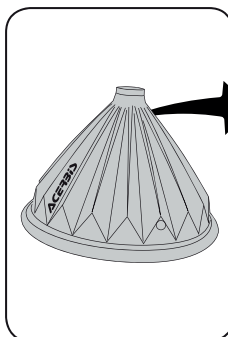

4. Fit the universal protection on to the cage.

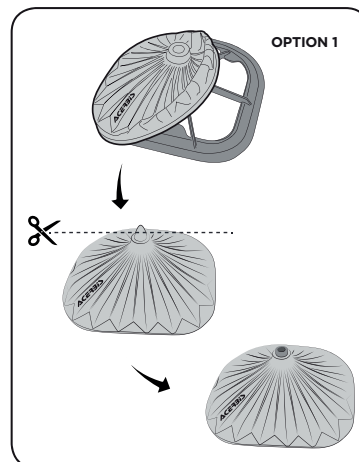

5. Cut the rubber in the area of maximum pressure of the pin, allowing for spillage.

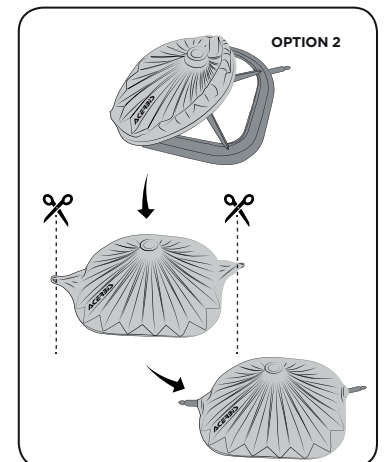

6. Cut the rubber in the area of maximum pressure of the pins, allowing for spillage.



X-EXHAUST PROTECTOR

X-EXHAUST

code: **0024259.011.016** (Orange 16)
0024259.090 (Black)



APPLICATIONS:

SXF 250/350/450 - 19/20
FC 250/350/450 - 19/20



TENAY BELT

TENAY BELT(2 PCS.)

DETAILS:

- **Length : 170 cm x 25mm**
- Maximum tensile load: 80kg
- Set of two belts equipped with non-slip safety metal buckle



grey
code: **0023893.070**



black
code: **0023893.090**



TA-TIRE BELT

TA-TIRE BELT

- One size
- Misura universale

black
code: **0023578.090**



TIE DOWNS

TIE DOWNS 35 mm. (2 PCS.)

Lunghezza fibbia : 185 mm
Lunghezza compresa di ganci : 205 mm



blue

code: **0010355.040**



yellow

code: **0010355.060**



black

code: **0010355.090**



red

code: **0010355.111**

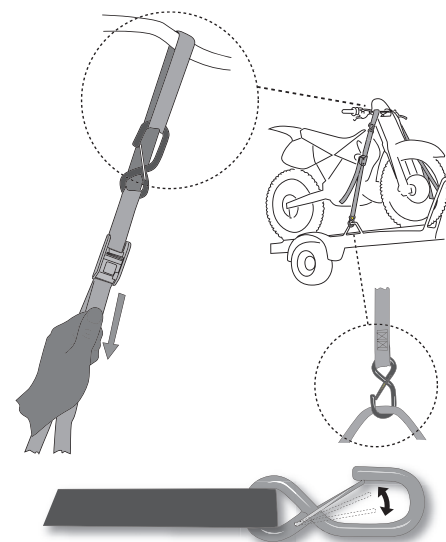

TIE DOWNS 25 mm. (2 PCS.)

Lunghezza fibbia : 177 mm
Lunghezza compresa di ganci : 200 mm



blue

code: **0009266.040**



yellow

code: **0009266.060**



black

code: **0009266.090**



red

code: **0009266.111**



orange

code: **0009266.010**



LIQUID BREAKERS

	CAPACITY	CODE
1	500 ml.	0001010.
2	1000 ml.	0001011.
3	500 ml.	0000045.
4	250 ml.	0000030.
5	250 ml.	0000648.



X-BAR BAR PAD



black/orange
code: **0023450.313**



black/white
code: **0023450.315**



black/grey
code: **0023450.319**

ACERBIS LOGO CROSS BAR PAD



code: **0016279.090**

711 STAND

Maximum load:
160 Kg



orange
code: **0023453.010**



blue
code: **0023453.040**



yellow
code: **0023453.060**



black
code: **0023453.090**



red
code: **0023453.110**



green
code: **0023453.130**



YOGA STAND

- folding stand
- cavalletto pieghevole

Maximum load:
150 Kg



white
code: **0023580.030**



black
code: **0023580.090**



SILENCER END CAP
2/4 STROKES
code: **0009601.090**



HANDLEBAR END CAP
pcs: **10 pcs. set**
code: **0012989.090**



SILENCER END CAP DISPLAY
2/4 STROKES
pcs: **36 pcs. set** (18 yellow / 18 black)
code: **0011550.120**



USA DUCT TAPE
length: **10 mt**
wide: **5 cm.**
code: **0000033.090**



REAR VIEW MIRROR
LEFT
code: **0000541.090**



REAR VIEW MIRROR
RIGHT
code: **0000587.090**

ELEVATOR BIKE STAND

DETAILS:

- Steel constructed Lift-Stand with an additional damper to slow the period of descent when lowering.
- Rubber upper deck with adjustable height to adapt to most full-size off-road dirt-bikes as well as youth/mini bikes.
- Rotating upper deck to allow movement of the bike during maintenance.
- Locking mechanism to secure the stand and prevent accidental lowering of the bike.
- Maximum height of the bike: adjustable from 33 to 46 cm / 13" to 18".
- Minimum height of the bike: adjustable from 23,5 to 36 cm / 9 ¼" to 14" for minicross
- Maximum load: 160 Kg / 352lb.



Maximum load:
160 Kg



black
code: **0023860.090**



ACERBIS PHONE DISPLAY

code: **0024241**



orange
code: **.010**



blue
code: **.040**



black
code: **.090**



red
code: **.110**



MINI NUMBERS PLATE

code: **0002159.**



black
0002159.090



white
0002159.030



orange
0002159.010



fluo orange
0002159.014



blue
0002159.040



yellow
0002159.060



green
0002159.130



fluo green
0002159.131



red
0002159.110

ACERBIS MEDICAL BAG

code: **0022758.090**



ACERBIS LAUNDRY BAG

code: **0022759.090**



ACERBIS TOWEL 80x140cm

code: **0022715.090**



TRI-ANGOL HELMET DISPLAY

code: **0023590.090**



ACERBIS BIB (5 PIECES PACK)

code: **0017020**



yellow
code: **.060**



orange
code: **.010**



fluo light blue
code: **.047**



green
code: **.130**



fucsia
code: **.141**

SIZES

S	code: .062	XXL	code: .069
L	code: .066		



ACERBIS TNT BANNER

size: **580 x 80 cm.** (1 logo)
code: **0020068.**



• with 6 rings and 6 ties • con 6 anelli e sei fascette

ACERBIS TNT BANNER

size: **52,20 x 0,80 mt.** (9 logos)
code: **0020065.**



TENT ACERBIS ROOF

code: **0022946.060**
ONLY COVER



ACERBIS TENT

size: **3x3 mt.**
code: **0012490.060**

OTTANO FLAG

height: **± 4,5 mt.**
code: **0022760.040**



TRACK MARKER

code: **0009606.060**

56pcs PACK

code: **0016905**



RACE TAPE

size: **500 mt.**
code: **0020066.**



OTTANO RACE TAPE

size: **500 mt.**
code: **0022747.030**



IN ACTION TAPE

size: **250 mt.**
code: **0024261.**



WEB TAPE

size: **250 mt.**
code: **0024260.**



ACERBIS FLAG

height: **± 4,5 mt.**
code: **0012213.279**



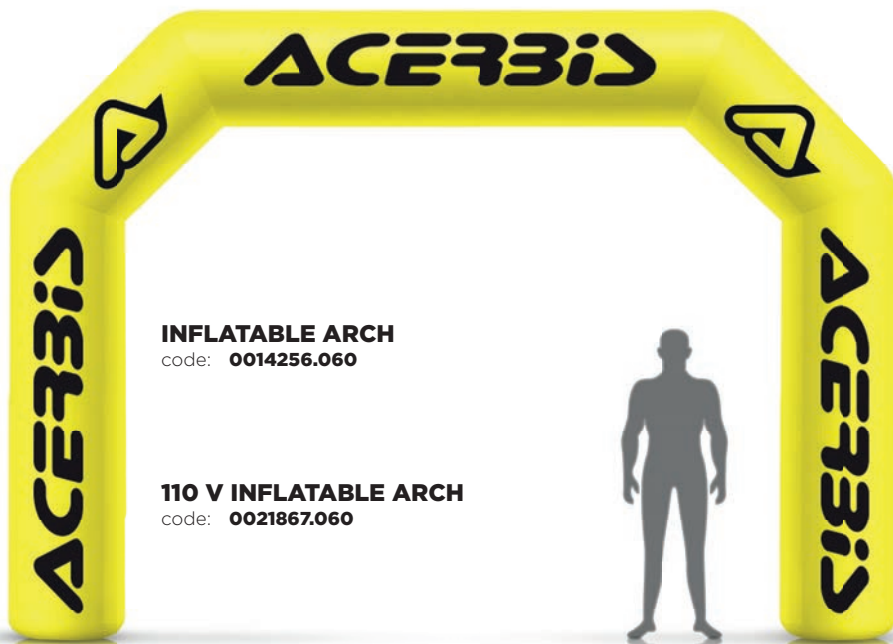

INFLATABLE ARCH
code: **0014256.060**

110 V INFLATABLE ARCH
code: **0021867.060**

PIT BOARD
code: **0011526.090**



COTTON GLOVES INCLUDED

COTTON GLOVES
code: **0016429.060**



MECHANIC BUT
code: **0023827.279**

SIZES			
S	code: .062	XL	code: .068
M	code: .064	XXL	code: .069
L	code: .066		

GOSIT BOTTLE



white code: **0023458.030** blue code: **0023458.040** yellow code: **0023458.060** red code: **0023458.110**

ACERBIS PLATE STICKER



red/white
code: **0022497.110**



green/white
code: **0022497.131**



orange/white
code: **0022497.203**



white/orange
code: **0022497.229**



white/blue
code: **0022497.232**



white/black
code: **0022497.237**



white/red
code: **0022497.239**



white/green
code: **0022497.241**



blue/white
code: **0022497.245**



light blue/red
code: **0022497.253**



black/orange
code: **0022497.313**



black/white
code: **0022497.315**



black/blue
code: **0022497.316**



black/yellow
code: **0022497.318**

MARKERS

5 pcs. set
colors: **YELLOW**
code: **0012965.060**



OOSET BOOTS
code: **0023859.060**
sizes from 40 to 47





ACERBIS RACE UMBRELLA

size: ø 120 cm.
code: 0013889.



SBK RACE UMBRELLA

size: ø 120 cm.
code: 0022361.090

**MOTO CARPET
RACE CERTIFIED**

size: 200 x 100 cm.
code: 0021696.318



**SBK MOTO CARPET
RACE CERTIFIED**

size: 200 x 100 cm.
code: 0022360.090



MOTORBIKE COVER

code: 0020086.060



CORPORATE MOTORBIKE COVER

code: 0022505.090

COMPOSITION:

- 100% Water repellent polyester

DETAILS:

- Stretch cuff on the bottom to envelop the bike
- Suitable for internal and external use
- Closure at the bottom for attaching the cover to the bike
- Silver Acerbis Logo
- For super sport, touring sport, touring, adventure, naked motor cycle
- Cover with zip



SBK MOTORBIKE COVER

code: 0022359.090

COMPOSITION:

- 100% Water repellent polyester

DETAILS:

- Stretch cuff on the bottom to envelop the bike
- Suitable for internal and external use
- Closure at the bottom for attaching the cover to the bike
- Acerbis SBK Logo
- For super sport, touring sport, touring, adventure, naked motor cycle
- Cover with zip



KIT DECAL LOGO ACERBIS

code **0017848.**
 colors **BLACK/YELLOW** code **318.**
YELLOW/BLACK **279.**



black/yellow
0017848.318



yellow/black
0017848.279



USB KEY
 capacity: **4 GB.**
 code: **0021835.070**

ACERBIS LOGO DECAL SHEET

pcs: **5 pcs. set**
 code: **0006144.**



ACERBIS LOGO DECALS

SIZE	PCS.	CODE
150 cm.	2 pcs. set	0006057.
90 cm.	5 pcs. set	0006056.
60 cm.	5 pcs. set	0006054.

SIZE	PCS.	CODE
30 cm.	10 pcs. set	0006053.
13 cm	100 pcs. set	0006051.



PLASTIC BAGS

pcs: **100 pcs. set**
 code: **0023988.090**



SHOES BAGS

pcs: **50 pcs. set**
 code: **0021818.060**



DUMMY

code **0013038.030**



INFLATABLE HALF-BUST MANNEQUIN

code **0023846.070**

- Hanging inflatable half-bust mannequin
- Specific for body armour and jackets
- 1 pcs /set

