

WORKBOOK 2021

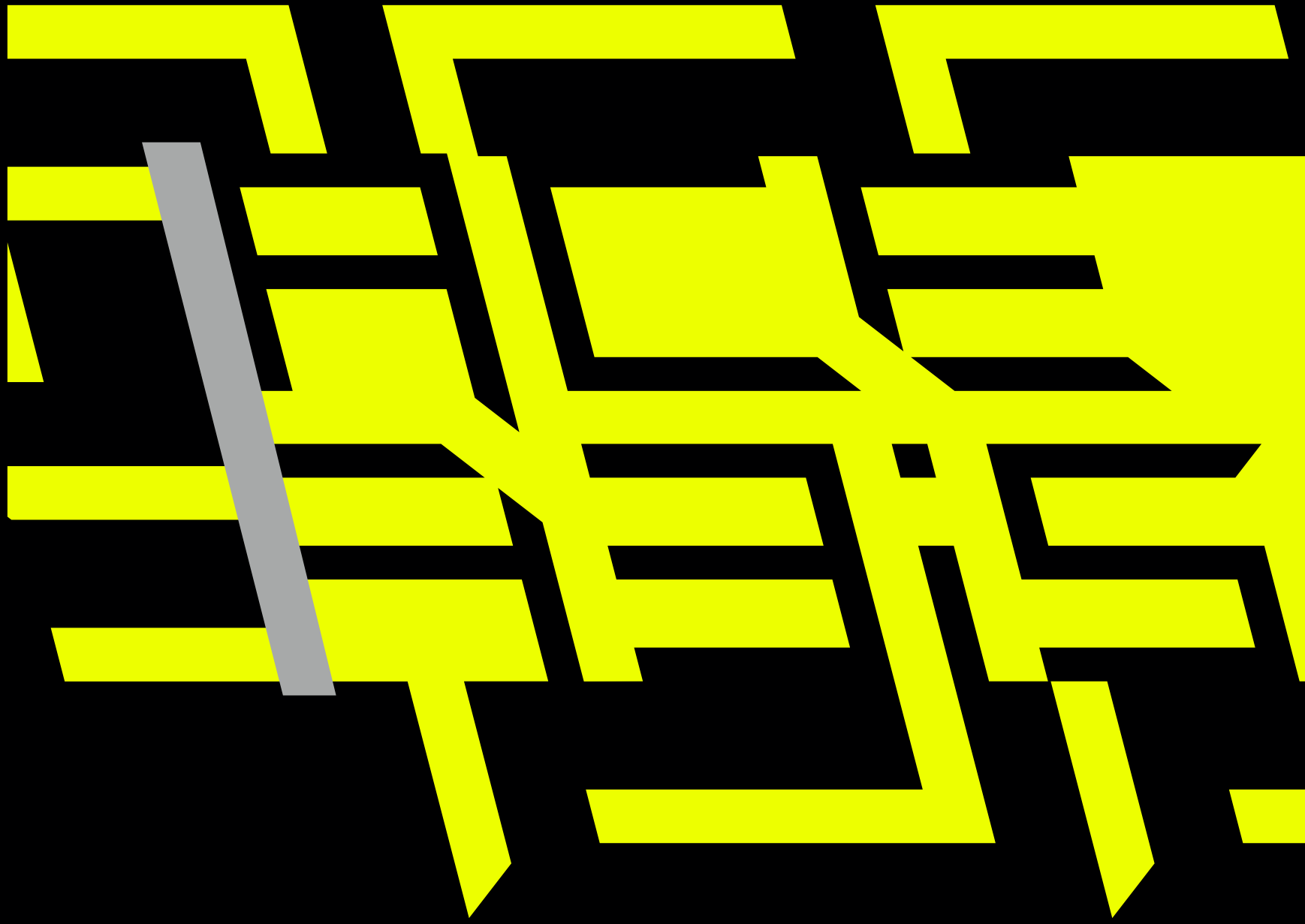

ACE3iD

ACERBIS

SOUL AND PASSION



ENJOY THE ROAD

DUST AND MUD

2W2F



Racing

FREEDOM IS OUR DOPE



SOUL AND PASSION

BEWARE

THE

HELL

2W2F



DUST

Racing



MUD

73



DUST AND MUD



Racing

ACERBIS

2W2F



ACERBIS

SOUL AND PASSION

SP CLUB
73

2
W
2

Racing

Safe Speeds

DUST AND MUD

SP73 CLUB

AND
MUD

DUST AND MUD

SP

73

SOUL AND PASSION

SOUL AND PASSION

DUST
AND
MUD

73

SP73 CLUB

73

73

ACERBIS LEGENDARY

SP

FREEDOM IS OUR DOPE

WE ARE THE
HELL

SP CLUB
73

INDICE INDEX

P. 4 - 41
P. 42 - 99
P. 100 - 119
P. 120 - 135
P. 136 - 181
P. 182 - 209
P. 210 - 229

HELMETS
GEAR
GLOVES
BOOTS
PROTECTIONS
BAGS
CASUAL

P. 230 - 271
P. 272 - 281
P. 282 - 291
P. 292 - 307
P. 308 - 351
P. 352 - 359
P. 360 - 369

HANDGUARDS
HEADLIGHTS
SEATS
FUEL TANKS
ACERBIS PLASTICS
MERCHANDISING
OVERVIEW

HELMETS CASCHI

- P. 6** Steel Carbon
- P. 8** X-Racer VTR
- P. 10** X-Track VTR
- P. 14** Profile 4
- P. 16** Linear
- P. 18** Steel Junior
- P. 20** Tarmak
- P. 22** Full Face X-Street
- P. 24** Reactive VTR
- P. 26** Flip FS-606
- P. 28** Rederwel P/J
- P. 30** Serel
- P. 32** Ottano Jet
- P. 33** Firstway
- P. 34** Jet Aria
- P. 36** Carlino Kid
- P. 37** Jet Bamby
- P. 38** Accessories





STEEL CARBON HELMET

MATERIALS:

- **Outer shell:** Carbon fibre.
- **ECE/ONU APPROVAL 22-05**
- Double outer shell, double inner shell
- WEIGHT 940g +- 50g in size "M".

DETAILS:

- A design ensuring great protection and helmet balance on the head as well with outstanding ergonomics
- Chin/nose area which provides complete protection of the nose from branches or debris.
- Adjustable aerodynamic visor
- Double ring strap closure.
- Shell compatible with Neck Brace

FRONT VENTILATION:

- Excellent central chin vent area,
- Air vent on the lower/lateral part of the helmet to facilitate the extraction of hot air / humidity from the helmet

REAR VENTILATION:

- Rear fin for increased air extraction
- Extensive lower and upper ventilation in the nape area

INTERIOR:

- Soft touch interior for effective humidity release
- Removable, hypo-allergenic and washable interior.
- Complete Comfort System cheek pads that cover the fastening strap, ensure optimum helmet fit and stability



0023424.020.
BLACK/SILVER



REPLACEMENTS

name	code
VISOR	0023432
FRONT AIR VENT	0023433
INNER LINING	0023434
SCREWS	0023435

see pictures in b2b system

SIZES

XS	53-54 cm	code: .061	L	59-60 cm	code: .066
S	55-56 cm	code: .062	XL	61-62 cm	code: .068
M	57-58 cm	code: .064	XXL	63-64 cm	code: .069



0023424.001.
WHITE/BLACK



0023424.204.
ORANGE/BLUE



0023424.234.
BLACK/YELLOW



0023424.071.
LIGHT GREY



X-RACER VTR HELMET

MATERIALS:

- **Outer shell:** fibreglass.
- **ECE/ONU APPROVAL 22-05**
- Double outer shell, double inner shell
- **WEIGHT** 1190g +- 50g in size "M".

DETAILS:

- Chin/nose area which provides complete protection of the nose from branches or debris.
- Adjustable aerodynamic visor
- Visor with removable appendix
- A design ensuring great protection and helmet balance on the head
- Double ring strap closure.
- Shell compatible with Neck Brace

FRONT VENTILATION:

- Excellent central chin vent area,
- Air vent on the lower/lateral part of the helmet to facilitate the extraction of hot air / humidity from the helmet

REAR VENTILATION:

- Rear fin for air extraction
- Extensive ventilation in the nape area

INTERIOR:

- Soft touch interior for effective humidity release
- Removable, hypo-allergenic and washable interior.
- Padding, complete with Comfort System cheek pads that cover the fastening strap, ensures optimum helmet fit and stability and is also easy to remove and wash.



0023444.319.

BLACK/GREY



REPLACEMENTS

name	code
VISOR	0023445
FRONT AIR VENT	0023446
BACK AIR VENT	0023447
INNER LINING	0023448
SCREWS	0023449

see pictures in b2b system

SIZES

XS	54 cm	code: .061	L	59-60 cm	code: .066
S	55-56 cm	code: .062	XL	61-62 cm	code: .068
M	57-58 cm	code: .064	XXL	63-64 cm	code: .069



0023444.201.
ORANGE



0023444.237.
WHITE/BLACK



0023444.344.
DARK BLUE/WHITE



X-TRACK VTR HELMET

MATERIALS:

- **Outer shell:** fibreglass.
- **ECE/ONU APPROVAL 22-05**
- Double outer shell, double inner shell
- WEIGHT 1050g ± 50g in size "M"

DETAILS:

- A design ensuring great protection and helmet balance on the head as well with outstanding ergonomics
- Chin/nose area which provides complete protection of the nose from branches or debris.
- Adjustable aerodynamic visor
- Double ring strap closure.
- Shell compatible with Neck Brace

FRONT VENTILATION:

- Excellent central chin vent area,
- Air vent on the lower/lateral part of the helmet to facilitate the extraction of hot air / humidity from the helmet

REAR AIRFLOW:

- Rear fin for increased air extraction
- Extensive lower and upper ventilation in the nape area

INTERIOR:

- Soft touch interior for effective humidity release
- Removable, hypo-allergenic and washable interior.
- Complete Comfort System cheek pads that cover the fastening strap, ensure optimum helmet fit and stability



002390 1.457.
BLACK/FLUO YELLOW



REPLACEMENTS

name	code
VISOR	0023900
FRONT AIR VENT	0024026
INNER LINING	0023434
SCREWS	0023435

see pictures in b2b system

SIZES

XS	53-54 cm	code: .061	L	59-60 cm	code: .066
S	55-56 cm	code: .062	XL	61-62 cm	code: .068
M	57-58 cm	code: .064	XXL	63-64 cm	code: .069



0023901.239.
WHITE/RED



0023901.204.
ORANGE/BLUE





0023901.400.
WHITE/BLACK



0023901.462.
LIGHT BLUE/FLUO YELLOW



0023901.315.
BLACK/WHITE



0023901.343.
RED/WHITE



0023901.070.
GREY



PROFILE 4 HELMET

MATERIALS:

- **Shell:** thermoplastic.
- **ECE/ONU APPROVAL 22-05**
- Double outer shell, double inner shell
- WEIGHT 1,290 ± 60 gr. (size M)

DETAILS:

- A design ensuring great protection and helmet balance on the head as well with outstanding ergonomics
- Chin/nose area which provides complete protection of the nose from branches or debris.
- Adjustable aerodynamic visor
- Double ring strap closure.
- Shell compatible with Neck Brace

FRONT VENTILATION:

- Excellent central chin vent area,
- Air vent on the lower/lateral part of the helmet to facilitate the extraction of hot air / humidity from the helmet

REAR AIRFLOW:

- Rear fin for increased air extraction
- Extensive lower and upper ventilation in the nape area.



0022821.034.
WHITE/BLUE/RED



REPLACEMENTS

name	code
VISOR	0022828
FRONT AIR VENT	0022829
INNER LINING	0022830
SCREWS	0022835

see pictures in b2b system

SIZES

XS	54 cm	code: .061	L	59-60 cm	code: .066
S	55-56 cm	code: .062	XL	61-62 cm	code: .068
M	57-58 cm	code: .064	XXL	63-64 cm	code: .069



0022821.319.
BLACK/GREY



0022821.203.
ORANGE/WHITE



0022821.455.
FLUO YELLOW/WHITE



0022821.091.
MATT BLACK



LINEAR HELMET

MATERIALS:

- **Shell:** thermoplastic
- **ECE/ONU 22-05 APPROVAL**
- One outer shell, three inner shells
- **WEIGHT** 1350G+-50

DETAILS:

- Chin/nose area which provides complete protection of the nose from branches or debris.
- Double ring strap closure.
- Shell compatible with Neck Brace

FRONT VENTILATION:

- Excellent central chin vent area

REAR VENTILATION:

- Rear air vents for increased air extraction
- Extensive lower and upper ventilation in the nape area.

INTERIOR:

- Removable, hypo-allergenic and washable interior.



0024473.274.
YELLOW/BLUE



REPLACEMENTS

name	code
VISOR	0024506
INNER LINING	0024505
SCREWS	0024507

see pictures in b2b system

SIZES

XS	53-54 cm	code: .061	L	59-60 cm	code: .066
S	55-56 cm	code: .062	XL	61-62 cm	code: .068
M	57-58 cm	code: .064	XXL	63-64 cm	code: .069



0024473.232.
WHITE/BLUE



0024473.245.
BLUE/WHITE



0024473.893.
WHITE/LIGHT BLUE



0024473.343.
RED/WHITE



0024473.203.
ORANGE/WHITE



STEEL JUNIOR HELMET

MATERIALS:

- **Shell:** thermoplastic.
- One outer shell and one inner shell
- **ECE/ONU 22 05 APPROVAL**
- WEIGHT 1050g +- 60g in size "YL".

DETAILS:

- Helmet for children
- A design ensuring great protection and helmet balance on the head as well with outstanding ergonomics
- Chin/nose area which provides complete protection of the nose from branches or debris.
- Adjustable aerodynamic visor
- Double ring strap closure.
- Shell compatible with Neck Brace

FRONT VENTILATION:

- Excellent central chin vent area,
- Air vent on the lower/lateral part of the helmet to facilitate the extraction of hot air / humidity from the helmet

REAR AIRFLOW:

- Rear fin for increased air extraction
- Extensive lower and upper ventilation in the nape area

INTERIOR:

- Soft touch interior for effective humidity release
- Removable, hypo-allergenic and washable interior.
- Complete Comfort System cheek pads that cover the fastening strap, ensure optimum helmet fit and stability



0023425.232.
WHITE/BLUE



REPLACEMENTS

name	code
VISOR	0023308
FRONT AIR VENT	0023306
INNER LINING	0023307
SCREWS	0023436

see pictures in b2b system

SIZES

Y/S	47-48 cm.	code: .050	Y/L	51-52 cm.	code: .054
Y/M	49-50 cm.	code: .052			



0023425.207.
ORANGE/GREY



0023425.347.
RED/GREY



0023425.249.
BLUE/GREY



0023425.253.
BLUE/RED



0023425.237.
WHITE/BLACK



TARMAK HELMET

MATERIALS:

- **Shell:** Carbon fibre
- **ECE/ONU 22 -05 APPROVAL**
- 2 outer shells and 2 inner shells
- Weight 1190gr ± 50 gr (Size M)

DETAILS:

- Lightweight and comfortable Carbon Full-face Helmet
- Adjustable and removable polycarbonate outer visor
- Integrated sun visor operated by a slider
- Ring closure
- Designed for PINLOCK 70 MAX VISION accessory installation
- PINLOCK MAX VISION included in the box

FRONT VENTILATION:

- Central chin vent area with slider for opening and closing
- Central air vents on the shell with a slider for opening and closing

REAR VENTILATION:

- Rear extraction for increased air circulation

INTERIOR:

- Inner lining in hypo-allergenic and breathable material, wraparound removable and washable.
- Removable chin curtain
- Removable breath guard



0024518.090.

BLACK/GREY



REPLACEMENTS

name	code
PINLOCK MAXVISION 70 TARMAK VISOR	0024544
TRANSPARENT VISOR	0024531
INNER LINING	0024530
SUN VISOR	0024532
VISOR MECHANISM	0024533

see pictures in b2b system

SIZES

XS	53-54 cm	code: .061	L	59-60 cm	code: .066
S	55-56 cm	code: .062	XL	61-62 cm	code: .068
M	57-58 cm	code: .064	XXL	63-64 cm	code: .069



0024518.290.
GREY/YELLOW



Serel helmet



FULL FACE X-STREET HELMET

MATERIALS:

- **Shell:** thermoplastic.
- **ECE/ONU APPROVAL 22-05**
- One outer shells and one inner shells
- Weight 1450gr+-50 (Size M).

DETAILS:

- Adjustable, scratch-resistant and removable polycarbonate outer visor
- Integrated sun visor operated by a slider
- Micro-adjustable quick release fastener

FRONT VENTILATION:

- Central chin vent area with slider for opening and closing
- Air vents on the shell with a slider for opening and closing
- Predisposition for PINLOCK 70 accessories

REAR AIRFLOW:

- Rear fin for increased air extraction

INTERIOR:

- Removable and washable hypoallergenic and breathable interior material.
- Removable chincurtain
- Removable breathguard



REPLACEMENTS

name	code
SUN VISOR	0024012
TRANSP. VISOR PINS	0024268
INNER LINING	0024016
SCREWS	0024017

see pictures in b2b system

ACCESSORIES

name	code
PINLOCK LENS	0024266

see pictures in b2b system

PINLOCK®
COMPATIBLE

0023960.091.

BLACK



SIZES

XS	53-54 cm	code: .061	L	59-60 cm	code: .066
S	55-56 cm	code: .062	XL	61-62 cm	code: .068
M	57-58 cm	code: .064	XXL	63-64 cm	code: .069



0023960.251.
BLUE/BLACK



0023960.277.
YELLOW/GREY



0023960.349.
RED/BLACK



0023960.203.
ORANGE/WHITE



SPINLOCK®
COMPATIBLE

0023960.030.
WHITE



REACTIVE VTR HELMET

MATERIALS:

- **Shell:** fibreglass.
- **ECE/ONU APPROVAL 22-05**
- 2 outer shells and 2 inner shells
- **WEIGHT** 1.350gr ± 50 gr (size M)

DETAILS:

- Max-Enduro helmet specific for ENDURO ROAD, MOTARD and ATV
- Adjustable and removable polycarbonate outer visor
- Aerodynamic visor
- Integrated sun visor operated by a slider
- Micro-adjustable quick release fastener

FRONT VENTILATION:

- Central chin vent area with slider for opening and closing
- Air vents on the shell with a slider for opening and closing

REAR AIRFLOW:

- Rear fin for increased air extraction

INTERIOR:

- Removable and washable hypoallergenic and breathable interior material.
- Removable chincurtain



0023466.343.

RED/WHITE



REPLACEMENTS

name	code
VISOR	0022700
SUN VISOR	0022703
TRANSPARENT VISOR	0022701
INNER LINING	0022702
SCREWS	0022704

see pictures in b2b system

SIZES

XS	53-54 cm	code: .061	L	59-60 cm	code: .066
S	55-56 cm	code: .062	XL	61-62 cm	code: .068
M	57-58 cm	code: .064	XXL	63-64 cm	code: .069



0023466.319.
BLACK/GREY



0022513.091.
BLACK



FLIP FS-606 HELMET

MATERIALS:

- **Shell:** Thermoplastic.
- **ECE/ONU 22 2205 APPROVAL**
- One outer shells and two inner shells
- Weight 1560gr (size M)

DETAILS:

- Specific off-road helmet ENDURO ROAD, MOTARD AND ATV
- Upper visor **REMOVABLE AND WITH APPROPRIATE KIT** for use as a full face helmet
- Adjustable, scratch-resistant and removable polycarbonate outer visor
- Integrated sun visor operated by a slider
- Micro-adjustable quick release fastener
- Predisposition for PINLOCK 70 accessories

FRONT VENTILATION:

- Central chin vent area with slider for opening and closing
- Air vents on the shell with a slider for opening and closing

REAR AIRFLOW:

- Rear fin for increased air extraction

INTERIOR:

- Removable and washable hypoallergenic and breathable interior material.
- Removable chincurtain
- Removable breathguard



REMOVABLE
TRANSPARENT VISOR

REPLACEMENTS

name	code
VISOR	0022315
SUN VISOR	0022323
TRANSP. VISOR PINS	0024269
INNER LINING	0022324
KIT COVER	0023123
SCREWS	0022317

see pictures in b2b system

ACCESSORIES

name	code
PINLOCK LENS	0024266

see pictures in b2b system

PINLOCK
COMPATIBLE

0022310.319.
BLACK/GREY



SIZES

XS	53-54 cm	code: .061	L	59-60 cm	code: .066
S	55-56 cm	code: .062	XL	61-62 cm	code: .068
M	57-58 cm	code: .064	XXL	63-64 cm	code: .069



SPINLOCK
COMPATIBLE

0022310.295.
GREY/RED



SPINLOCK
COMPATIBLE

0022310.034.
WHITE/BLUE/RED



0022310.030.
WHITE



0022310.061.
FLUO YELLOW



0022310.091.
BLACK



REDERWEL P/J HELMET

MATERIALS:

- **Shell:** thermoplastic.
- **ECE/ONU 22 -05 approval**
- 2 outer shells and 2 inner shells
- Weight 1650gr ± 50 gr (Size M)

DETAILS

- Modular helmet
- Central button chin guard opening
- Adjustable and removable polycarbonate outer visor
- Integrated sun visor operated by a slider
- Micro-adjustable quick release fastener
- Designed for PINLOCK 70 accessory installation
- P/J Certified,
- This helmet can be used with the chin guard opened (J configuration), with a manually operated lock.

FRONT VENTILATION

- Central chin vent area with slider for opening and closing
- Air vents on the shell with a slider for opening and closing

REAR VENTILATION:

- Rear opening for increased air extraction

INTERIOR:

- Removable and washable hypo-allergenic and breathable interior material.
- Removable chin curtain
- Removable breath guard



CHIN GUARD
OPENING



REPLACEMENTS

name	code
SUN VISOR	0024523
TRANSP. VISOR PIN	0024524
INNER LINING	0024525
VISOR MECHANISM	0024522

see pictures in b2b system

ACCESSORIES

name	code
PINLOCK LENS	0024266

see pictures in b2b system

PINLOCK®
COMPATIBLE

0024516.030.

WHITE



SIZES

XS	53-54 cm	code: .061	L	59-60 cm	code: .066
S	55-56 cm	code: .062	XL	61-62 cm	code: .068
M	57-58 cm	code: .064	XXL	63-64 cm	code: .069



PINLOCK®
COMPATIBLE

0024516.030.
WHITE



PINLOCK®
COMPATIBLE

0024516.290.
GREY/YELLOW



PINLOCK®
COMPATIBLE

0024516.090.
BLACK



PINLOCK®
COMPATIBLE

0024516.239.
WHITE/RED



SEREL HELMET

MATERIALS:

- **Shell:** thermoplastic.
- **ECE/ONU 22 05 APPROVAL**
- One outer shells and one inner shells
- **WEIGHT** 1500g ± 50g in size "M"

DETAILS:

- Modular helmet
- Central button chin guard opening
- Adjustable and removable polycarbonate outer visor
- Integrated sun visor operated by a slider
- Micro-adjustable quick release fastener
- Designed for PINLOCK 70 accessory installation

FRONT VENTILATION:

- Central chin vent area with slider for opening and closing
- Air vents on the shell with a slider for opening and closing

REAR AIRFLOW:

- Rear opening for increased air extraction

INTERIOR:

- Removable and washable hypoallergenic and breathable interior material.
- Removable chincurtain
- Removable breathguard



CHIN GUARD
OPENING



REPLACEMENTS

name	code
SUN VISOR	0023935
TRANSPARENT VISOR	0023932
TRANSP. VISOR PINS	0024423
INNER LINING	0023934
VISOR MECHANISM	0023933

see pictures in b2b system

ACCESSORIES

name	code
PINLOCK LENS	0024266

see pictures in b2b system

PINLOCK
COMPATIBLE

0023929.319.
BLACK/GREY



SIZES

XS	53-54 cm	code: .061	L	59-60 cm	code: .066
S	55-56 cm	code: .062	XL	61 cm	code: .068
M	57-58 cm	code: .064			



SPINLOCK
COMPATIBLE

0023929.444.
BLACK/FLUO YELLOW



SPINLOCK
COMPATIBLE

0023929.323.
BLACK/RED



0023929.061.
FLUO YELLOW



0023929.030.
WHITE



0023929.091.
BLACK



OTTANO JET HELMET

Open-face helmet in ABS with a very compact shell (in three sizes and six different measurements), weight 1000 g ± 50, homologated ECE/ONU 2205. Closure with strap and double D-ring, sun protection visor (available in three colours) included



0022995.070.

GREY



0022995.250.

BLUE/GREEN



REPLACEMENTS

name	code
VISOR	0022213
see pag 41	

see pictures in b2b system

SIZES

XS	code: .061	L	code: .066
S	code: .062	XL	code: .068
M	code: .064	XXL	code: .069

FIRSTWAY HELMET

MATERIALS:

- **Shell:** thermoplastic.
- **ECE/ONU APPROVAL 22-05**
- One outer shell and one inner shell
- WEIGHT 1340g ± 50 g in size "M".

DETAILS:

- Adjustable, scratch-proof and removable polycarbonate outer visor with extended protection up to the chin
- Integrated sun visor operated by a slider
- Micro-adjustable quick release fastener

FRONT VENTILATION:

- Air vents on the shell with a slider for opening and closing

REAR AIRFLOW:

- Rear openings for increased air extraction

INTERIOR:

- Removable and washable hypoallergenic and breathable interior material.



0023758.090.

BLACK



0023758.031.

WHITE



REPLACEMENTS

name	code
SUN VISOR	0023761
TRANSPARENT VISOR	0023760
INNER LINING	0023759

see pictures in b2b system

SIZES

XS	53-54 cm	code: .061	L	59-60 cm	code: .066
S	55-56 cm	code: .062	XL	61 cm	code: .068
M	57-58 cm	code: .064			



JET ARIA HELMET

MATERIALS:

- **Shell:** thermoplastic.
- **ECE/ONU APPROVAL 22205**
- One outer shell and two inner shells
- Weight 1110 ± 50 gr. (size M)

DETAILS:

- Removable upper visor
- Integrated sun visor operated by a slider
- Micro-adjustable quick release fastener

FRONT VENTILATION:

- Air vents on the shell with a slider for opening and closing

REAR AIRFLOW:

- Rear openings for increased air extraction

INTERIOR:

- Removable and washable hypoallergenic and breathable interior material.



REMOVABLE
SUN VISOR

REPLACEMENTS

name	code
VISOR	0022570
SUN VISOR	0022571
TRANSPARENT VISOR	0022623
INNER LINING	0022572
SCREWS	0022573

see pictures in b2b system



0022569.091.

BLACK



0022569.070.

GREY



0022569.030.

WHITE



SIZES

XS	53-54 cm	code: .061	L	59-60 cm	code: .066
S	55-56 cm	code: .062	XL	61 cm	code: .068
M	57-58 cm	code: .064			



0022569.376.
CAMOUFLAGE ARMY



0022569.061.
FLUO YELLOW



0022569.743.
CAMOUFLAGE



0022569.112.
RED TANGERINE



0022569.060.
YELLOW



0022569.223.
SILVER/BLACK



0022569.043.
BLUE



0022569.582.
ARMY GREEN



CARLINO KID HELMET

MATERIALS:

- **Shell:** thermoplastic.
- **ECE/ONU APPROVAL 22-05**
- One outer shell and one inner shell
- WEIGHT 1230+-50g (size M)

DETAILS:

- Children's helmet
- Adjustable, scratch-resistant and removable polycarbonate outer visor
- Micro-adjustable quick release fastener
- Kit of stickers (for children) to personalise the helmet

FRONT VENTILATION:

- Central chin vent area with slider for opening and closing
- Air vents on the shell with a slider for opening and closing

REAR AIRFLOW:

- Rear fin for increased air extraction

INTERIOR:

- Removable and washable hypoallergenic and breathable interior material.
- Removable chincurtain
- Removable breathguard



DECALS INCLUDED ADESIVI INCLUSI

- Stickers kit (for kids) to personalise the helmet.
- Kit Adesivi (per bambini) per la personalizzazione del casco.



REPLACEMENTS

name	code
TRANSPARENT VISOR	0023765
INNER LINING	0023766

see pictures in b2b system

002368 1.030.

WHITE



SIZES

Y/S	47-48 cm.	code: .050	Y/L	51-52 cm.	code: .054
Y/M	49-50 cm.	code: .052			

JET BAMBY HELMET

MATERIALS:

- **Shell:** thermoplastic.
- **ECE/ONU 22-05 APPROVAL**
- one outer shell and one inner shell
- **WEIGHT** 750+-50g (size M)

SPECIFICATIONS:

- Children's helmet
- Adjustable, scratch-resistant and removable polycarbonate outer visor
- Micro-adjustable quick release fastener
- Kit of stickers (for children) to personalise the helmet

FRONT VENTILATION

- Aerators across the entire shell

INTERIOR:

- Hypo-allergenic and breathable inner lining material



DECALS INCLUDED ADESIVI INCLUSI

- Stickers kit (for kids) to personalise the helmet.
- Kit adesivi (per bambini) per la personalizzazione del casco.



REPLACEMENTS

name	code
TRANSPARENT VISOR	0024528
VISOR MECHANISM	0024529

see pictures in b2b system

0024517.030.

WHITE



SIZES

Y/S	48-49 cm.	code: .050	Y/L*	52-53 cm.	code: .054
Y/M	50-51 cm.	code: .052			

* Lady size



LADHER FACE MASK

COMPONENTS: 95% Polyamide, 5% Elastane

MATERIALS:

Yarn for face mask in polyamide: termic, comfort and light. It dries quickly



SIZES

ONE SIZE



0023913.090
BLACK

BRETHA

COMPONENTS: 95% Polyamide, 5% Elastane

MATERIALS:

Yarn for underhelmet in polyamide: termic, comfort and light. It dries quickly



SIZES

ONE SIZE



0023914.090
BLACK



BRIDE FACE MASK
0016527.090

COMPONENTS: 50% Nylon, 45% Neoprene, 5% Elastan
Made of Neoprene and Nylon. Good protection for cold weather. Elastic Neoprene inserts for better comfort. Good for any weather conditions. Protects from wind and keeps you dry. Printed Acerbis logo.

SIZES			
S/M	code: .063	L/XL	code: .067



GIANSEY FACE MASK
0016531.090

COMPONENTS: 99% Polyester, 1% Elastan
Made of Polyester. Inner lining in soft pile for a better comfort. Breathable inserts. Printed logo, very light and perfect fitting.

SIZES			
S/M	code: .063	L/XL	code: .067



DALBY NECK WARMER
0016529.090

COMPONENTS: 99% Polyester, 1% Elastan
Wind breaker collar is produced with a laminated and breathable membrane, offering a good wind protection. Soft inner lining for better comfort, this wind breaker collar gives good service in all weather conditions. Back closure by hook and loop fastener with Logo.

SIZES			
S/M	code: .063	L/XL	code: .067



KITTERLAND FACE MASK
0016530.090

COMPONENTS: 90% Neoprene, 8% Nylon, 2% Elastan
Made of Neoprene for a better protection against cold weather. Breathable neoprene inserts good for any weather conditions. Back hook and loop fastener closure. Printed logo.

SIZES			
S/M	code: .063	L/XL	code: .067



REGABY FACE MASK
0016528.090

COMPONENTS: 99% Polyester, 1% Elastan
Made of anti-wind laminated and breathable soft fabric. Good for any weather condition. hook and loop fastener closure. Printed logo.

SIZES			
S/M	code: .063	L/XL	code: .067



SWEAT 2 GO
0013748.090

COMPONENTS: 70% Cotton, 27% Polyester, 3% Elastan

SIZES			
S/M	code: .063	L/XL	code: .067



ACCESSORIES

CORPORATE NECK WARMER

COMPONENTS: 100% polyester

SIZES

ONE SIZE



0024280.090
BLACK

CORPORATE NECK WARMER DISPLAY

COMPONENTS: 100% polyester

10 PCS



0024299.090
BLACK

SP CLUB NECK WARMER

COMPONENTS: 100% polyester

SIZES

ONE SIZE



0910281.076
WINGS



0910282.073
ACROBAT



0910283.872
SHIELD



0910284.591
STREET



0910285.090
RUSH

SP CLUB NECK WARMER DISPLAY

COMPONENTS: 100% polyester

2 PCS. WINGS
2 PCS. ACROBAT
2 PCS. SHIELD
2 PCS. STREET
2 PCS. RUSH



0910286.315

ACCESSORIES

PINLOCK 70 LENS



DETAILS:

- Pinlock 70 lens increases the visor's fogging resistance.
- The Pinlock 70 lens design fits perfectly to all ACERBIS helmet visor designs.



0024266.120
TRANSPARENT

PINLOCK MAXVISION 70 TARMAK LENS



DETAILS:

- Pinlock 70 MAX VISION lens increases the visor's fogging resistance.
- The Pinlock® 100% Max Vision® lenses provide full coverage of the helmet's visor and thanks to the customized cavity fitting system they fit and adapt perfectly to the visor.



0024544.120
TRANSPARENT

VISOR REPLACEMENT



0022213.030
WHITE



0022213.040
BLUE



0022213.090
BLACK

HELMET BAG

DETAILS:

- Designed to easily hold off-road or on-road helmets.
- Fabric exterior and soft internal lining to protect the helmet.
- Equipped with a practical carrying handle.
- Easy opening with a double slide zipper.
- Ventilated for breathability.
- Side pocket for accessories.



0023262.318
BLACK/FLUO YELLOW



QUICK STRAP



0000127.030
WHITE



0000127.090
BLACK

EVO NECK WARMER

5 PIECES PACK

CONFEZIONE DA 5 PEZZI

MATERIALS:

100% POLYESTER

Colorways Available:



0022197.040
BLUE



0022197.090
BLACK



GEAR

ABBIGLIAMENTO

- P. 44** X-Flex Gear
- P. 48** LTD Gear
- P. 52** Vented Gear
- P. 55** Ottano 2.0 Racing Pants
- P. 56** Kid Gear
- P. 60** Track Softshell
- P. 61** X-Wind Softshell
- P. 62** Mx One 1 Jacket
- P. 64** Enduro One Jacket
- P. 65** Enduro One Baggy
- P. 66** **MTB Gear**
- P. 74** CE X-Tour Jacket
- P. 75** CE Discovery Safari Jacket
- P. 76** CE Discovery Forest Jacket
- P. 77** CE Discovery Forest Lady Jacket
- P. 78** CE Discovery Ghibly Jacket
- P. 79** CE Discovery Ghibly Lady Jacket
- P. 80** CE Ramsey Vented Jacket
- P. 81** CE Ramsey Vented Lady Jacket
- P. 82** Jacket Accessories
- P. 84** CE X-Tour Pants
- P. 85** CE Discovery Pants
- P. 86** CE Discovery Lady Pants
- P. 87** CE Ramsey Vented Pants
- P. 88** CE Pack Jeans
- P. 89** CE Pack Lady Jeans
- P. 90** Rain Deck Jacket
- P. 91** Rain Deck Vest
- P. 92** Rain Pro Transparent 3.0 Jacket
- P. 93** Rain Transparent 3.0 Set
- P. 94** Rain Transparent 3.0 Kid Jacket
- P. 95** Rain Set Mat-X 3.0
- P. 96** Rain Suit Logo
- P. 97** Elettra Rain Jacket
- P. 97** Corporate Raincoat
- P. 97** H2O Rain Gloves Cover
- P. 98** H2O Rain Boot Cover
- P. 98** Light Rain Boot Cover



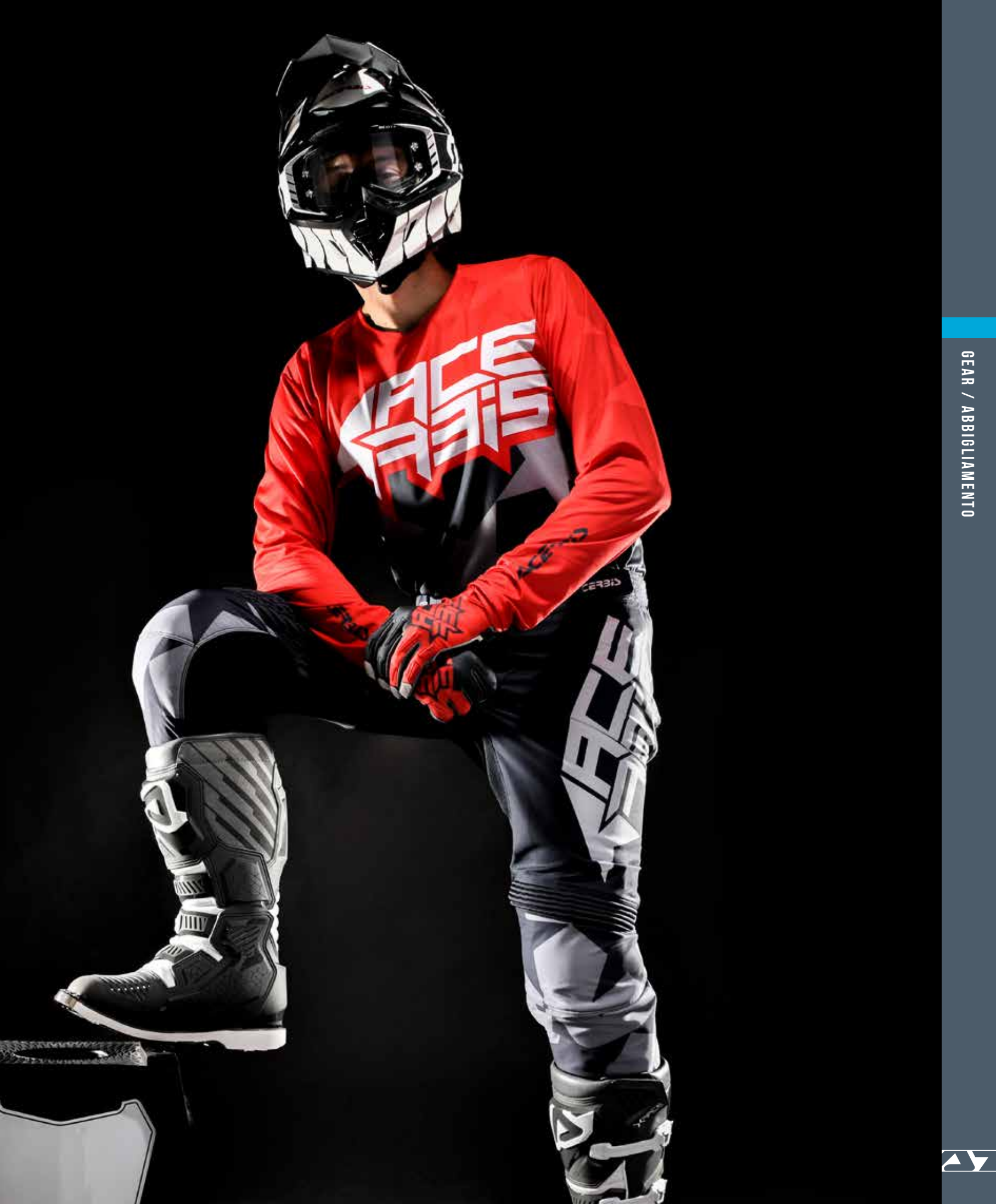

X-FLEX JERSEY

COMPONENTS:

- 88% polyester, 12% elastane.

MATERIALS:

- High-density polyester.
- Mesh inserts in the chest, armpit and kidney areas.

DETAILS:

- Innovative Acerbis X-Flex technology: lightweight and totally stretch fabrics for revolutionary comfort.
- Mesh inserts for wearing the garment with or without (even the most voluminous) protections.
- Weight 210 g.



SIZES

S	code: .062	XL	code: .068
M	code: .064	XXL	code: .069
L	code: .066	3XL	code: .070

SIZE	S	M	L	XL	2XL	3XL
Chest	90-95 cm.	95-101 cm.	101-108 cm.	108-116 cm.	116-123 cm.	123-129 cm.
Sleeve	60-61 cm.	62-63 cm.	64-65 cm.	66-67 cm.	68-69 cm.	70-72 cm.

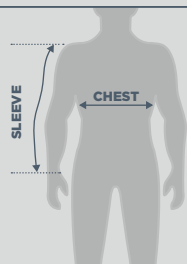

X-FLEX PANTS - PRODUCT FEATURES - CARATTERISTICHE DEL PRODOTTO:

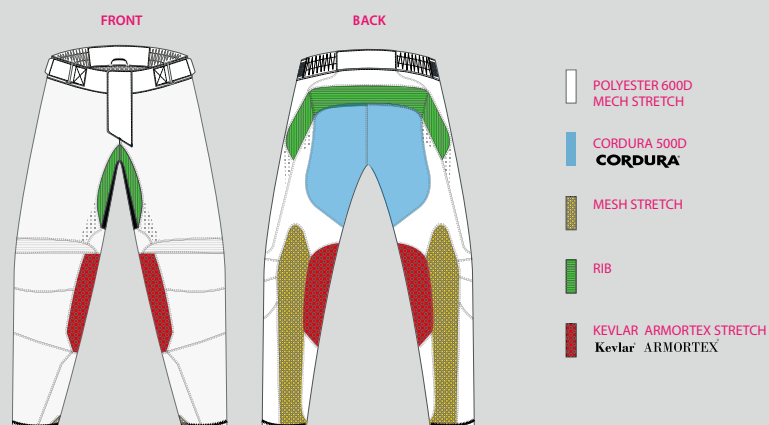

X-FLEX PANTS

COMPONENTS:

- **Shell:** 81.7% Polyester, 6.7% Nylon, 5.2% PU, 3.1% Kevlar, 2.6% Synthetic leather, 0.7% Spandex.
- **Lining:** 100% Polyester.

MATERIALS:

- **Inner:** reinforcement in Stretch Kevlar® Armortex® and innovative AX Suede fabric inside pants.
- **Outer:** high-density 600D Polyester, fully elasticized. 500D Cordura inserts in the area in contact with the seat.

DETAILS:

- Innovative ACERBIS X-Flex technology: fully elasticized material.
- Foam padding in knees area.
- Laser perforation in key areas for perfect ventilation.
- Can take any type of knee guard thanks to stretch mesh in the calf area.
- Double waist adjustments with hook and loop fastener.
- Closure with hook and button.
- Weight 650 g



Kevlar®

CORDURA®

ARMORTEX®

SIZES

28	code: .028	34	code: .034
30	code: .030	36	code: .036
32	code: .032	38	code: .038

SIZE	28	30	32	34	36	38
Waist	74-79 cm.	79-84 cm.	84-89 cm.	89-94 cm.	94-99 cm.	99-104 cm.
Hip	89-94 cm.	94-99 cm.	99-104 cm.	104-109 cm.	109-114 cm.	114-119 cm.
Inseam	72-74 cm.	74-76 cm.	76-78 cm.	78-80 cm.	80-82 cm.	82-84 cm.

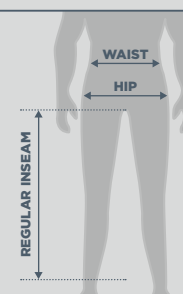



X-FLEX STARCHASER

RED/GREY
JERSEY COD. 0024323.347.

X-FLEX STARWAY

GREY/DARK GREY
PANTS COD. 0023904.899.



X-FLEX STARCHASER

BLUE/GREY
JERSEY COD. 0024323.249.

X-FLEX STARWAY

GREY/DARK GREY
PANTS COD. 0023904.899.

BACK



BACK



X-FLEX STARCHASER

ORANGE/GREY
JERSEY COD. 0024323.207.

X-FLEX STARWAY

GREY/DARK GREY
PANTS COD. 0023904.899.



BACK



X-FLEX STARCHASER

GREY/GREY
JERSEY COD. 0024323.291.

X-FLEX STARWAY

GREY/DARK GREY
PANTS COD. 0023904.899.



BACK



LTD JERSEY

COMPONENTS:

- 100% Polyester.

DETAILS:

- Broad mesh area from hip to armpit.
- Mesh area on inner sleeve.
- Lightweight and totally stretch fabrics for good comfort.
- Reviewed slim-fit for wearing the garment with or without (even the most voluminous) protections.
- Weight 180 g



SIZES

S	code: .062	XL	code: .068
M	code: .064	XXL	code: .069
L	code: .066	3XL	code: .070

SIZE	S	M	L	XL	2XL	3XL
Chest	90-95 cm.	95-101 cm.	101-108 cm.	108-116 cm.	116-123 cm.	123-129 cm.
Sleeve	60-61 cm.	62-63 cm.	64-65 cm.	66-67 cm.	68-69 cm.	70-72 cm.

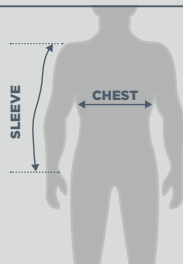

LTD PANTS - PRODUCT FEATURES - CARATTERISTICHE DEL PRODOTTO:

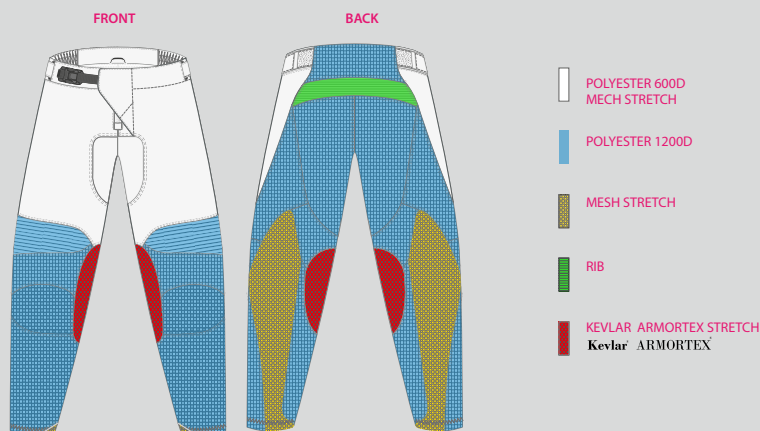

LTD PANTS

COMPONENTS:

- **Shell:** 88% Polyester; 2,8% Nylon; 2,7% Kevlar; 2,7% synthetic leather; 2,3% PU; 1,5% spandex.

- **Lining:** 100% Polyester

MATERIALS:

- **Outer:** High-density 600D Polyester, fully elasticized above the knee; 1200D polyester below the knee.

- **Inner:** Kevlar® Armortex® and AX Suede reinforcement inside pants.

DETAILS:

- Innovative ACERBIS X-Flex technology: fully elasticized material on waist.
- Foam padding in the knee area.
- Can take any type of knee guard thanks to stretch mesh in the calf area.
- Double waist adjustments with hook and loop fastener.
- Closure with hook button and fly cam micro adjustment in plastic.
- Excellent ventilation thanks to mesh in the calf area and above the knee.
- Weight 700 g.



Kevlar®

ARMORTEX®

SIZES

28	code: .028	34	code: .034
30	code: .030	36	code: .036
32	code: .032	38	code: .038

SIZE	28	30	32	34	36	38
Waist	74-79 cm.	79-84 cm.	84-89 cm.	89-94 cm.	94-99 cm.	99-104 cm.
Hip	89-94 cm.	94-99 cm.	99-104 cm.	104-109 cm.	109-114 cm.	114-119 cm.
Inseam	72-74 cm.	74-76 cm.	76-78 cm.	78-80 cm.	80-82 cm.	82-84 cm.

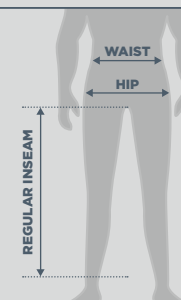



LTD MUUH
BLACK/GREY
JERSEY COD. 0024431.315.

MX TRACK
DARK GREY
PANTS COD. 0024130.073.
BLACK
PANTS COD. 0024130.090.

BACK

WITH GREY PANTS



LTD OUTFIT
ORANGE/BLACK
JERSEY COD. 0024238.209.

MX TRACK
DARK GREY
PANTS COD. 0024130.073.
BLACK
PANTS COD. 0024130.090.

BACK

WITH GREY PANTS





LTD OUTRUN

BLUE/GREY
JERSEY COD. 0024238.249.

MX TRACK

DARK GREY
PANTS COD. 0024130.073.
BLACK
PANTS COD. 0024130.090.



LTD OUTRUN

GREY/BLACK
JERSEY COD. 0024238.293.

MX TRACK

DARK GREY
PANTS COD. 0024130.073.
BLACK
PANTS COD. 0024130.090.

BACK

WITH GREY PANTS

BACK

WITH GREY PANTS





LTD OUTRUN

BLACK/FLUO YELLOW
 JERSEY COD. 0024238.318.

MX TRACK

DARK GREY
 PANTS COD. 0024130.073.
 BLACK
 PANTS COD. 0024130.090.



LTD OUTRUN

RED/BLACK
 JERSEY COD. 0024238.349.

MX TRACK

DARK GREY
 PANTS COD. 0024130.073.
 BLACK
 PANTS COD. 0024130.090.

BACK

WITH GREY PANTS

BACK

WITH GREY PANTS



VENTED JERSEY

COMPONENTS:

- 100% Polyester.

DETAILS:

- Fully vented jersey.
- Stretch fabric inserts on the cuff and neck.
- Lightweight and totally stretch fabrics for good comfort.
- Reviewed slim-fit for wearing the garment with or without (even the most voluminous) protections.
- Weight 180 g.



SIZES

S	code: .062	XL	code: .068
M	code: .064	XXL	code: .069
L	code: .066	3XL	code: .070

SIZE	S	M	L	XL	2XL	3XL
Chest	90-95 cm.	95-101 cm.	101-108 cm.	108-116 cm.	116-123 cm.	123-129 cm.
Sleeve	60-61 cm.	62-63 cm.	64-65 cm.	66-67 cm.	68-69 cm.	70-72 cm.

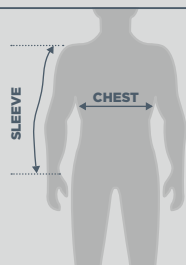

VENTED PANTS - PRODUCT FEATURES - CARATTERISTICHE DEL PRODOTTO:

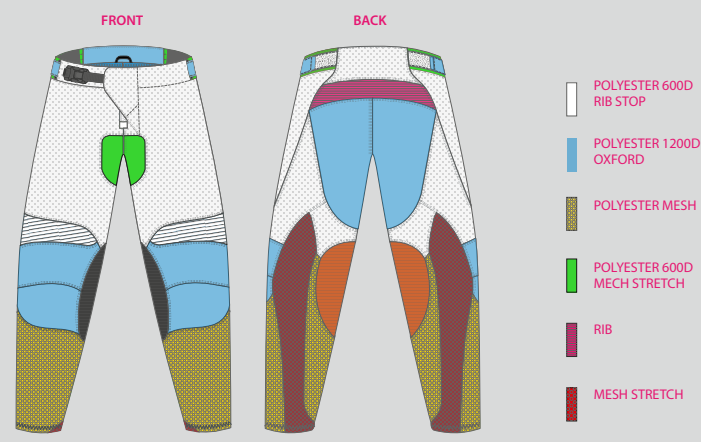

VENTED PANTS

COMPONENTS:

- **Shell:** 88% Polyester; 2.8% Nylon; 2.7% Kevlar; 2.7% synthetic leather; 2.3% PU; 1.5% spandex

- **Lining:** 100% Polyester

MATERIALS:

- **Outer:** High-density 600D Polyester, fully elasticized above the knee; 1200D polyester below the knee for excellent wear resistance.
- **Inner:** Kevlar® Armortex® and AX Suede™ reinforcement inside pants. **DETAILS:**
- Fully ventilated pants.
- Elastic bands on the crotch and back area for maximum mobility.
- Can take any type of knee guard thanks to stretch mesh in the calf area.
- Double waist adjustments with hook and loop fastener.
- Closure with hook button and fly cam micro adjustment in plastic.
- Weight 700 g.



Kevlar® ARMORTEX®

SIZES

28	code: .028	34	code: .034
30	code: .030	36	code: .036
32	code: .032	38	code: .038

SIZE	28	30	32	34	36	38
Waist	74-79 cm.	79-84 cm.	84-89 cm.	89-94 cm.	94-99 cm.	99-104 cm.
Hip	89-94 cm.	94-99 cm.	99-104 cm.	104-109 cm.	109-114 cm.	114-119 cm.
Inseam	72-74 cm.	74-76 cm.	76-78 cm.	78-80 cm.	80-82 cm.	82-84 cm.

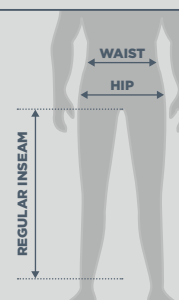

VENTED HELIOS

BLUE/WHITE
JERSEY COD. 0023905.245.
GREY/WHITE
PANTS COD. 0023906.287.



BACK



VENTED HELIOS

GREY/WHITE
JERSEY COD. 0023905.287.
GREY/WHITE
PANTS COD. 0023906.287.



BACK



VENTED HELIOS

ORANGE/WHITE
JERSEY COD. 0023905.203.
GREY/WHITE
PANTS COD. 0023906.287.



BACK



VENTED HELIOS

RED/WHITE
JERSEY COD. 0023905.343.
GREY/WHITE
PANTS COD. 0023906.287.



BACK



OTTANO 2.0 RACING PANTS

COMPONENTS:

Shell: 86,5% Nylon; 12,0% Polyester; 1,5% spandex

Lining: 100% Polyester

DETAILS:

Enduro technical trousers in nylon/Cordura with stretch X-FLEX inserts and two-way stretch fabric sections on the back of the legs. Kevlar Shoeller fabric reinforcement and vulcanised rubber inside the right knee, Kevlar on left knee.



Kevlar® ARMORTEX®

SIZES

28	code: .028	34	code: .034
30	code: .030	36	code: .036
32	code: .032	38	code: .038

SIZES	28	30	32	34	36	38
Waist	74-79 cm.	79-84 cm.	84-89 cm.	89-94 cm.	94-99 cm.	99-104 cm.
Hip	89-94 cm.	94-98 cm.	98-102 cm.	102-106 cm.	106-114 cm.	114-118 cm.
Inseam	72-74 cm.	77-79 cm.	79-80 cm.	80-81 cm.	81-82 cm.	82-83 cm.

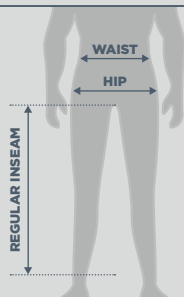

0023125.030.

WHITE



KID JERSEY

COMPONENTS: 100% polyester

MATERIALS:

- Inner polyester.
- Outer 100% Polyester

DETAILS:

- Pre-curved fitting for better movement when chest protector worn under the jersey.
- Stretch fabric inserts.
- Weight 140 g.



SIZES

XS	code: .061	L	code: .066
S	code: .062	XL	code: .068
M	code: .064	XXL	code: .069

SIZE	XS	S	M	L	XL	2XL
Chest	62-66 cm.	66-70 cm.	70-75 cm.	75-80 cm.	80-85 cm.	85-90 cm.
Sleeve	39-43 cm.	43-47 cm.	47-51 cm.	51-55 cm.	55-58 cm.	58-60 cm.

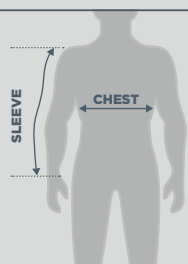

KID PANTS - PRODUCT FEATURES - CARATTERISTICHE DEL PRODOTTO:

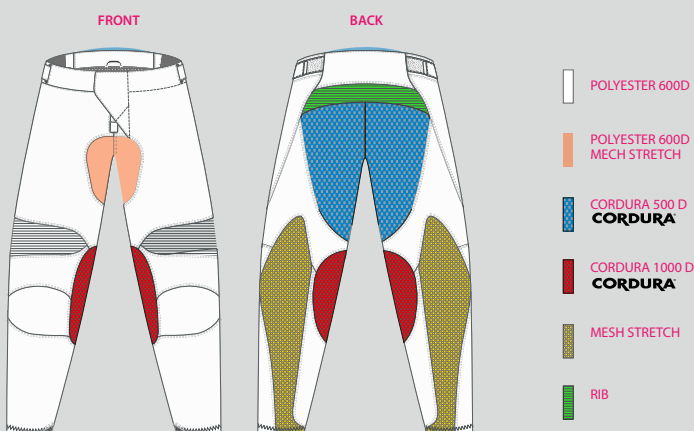

KID PANTS

COMPONENTS:

- Shell 93% polyester; 5,70% nylon; 1,30% spandex
- Lining 100% polyester

MATERIALS:

- Inner Mesh lining to the knee.
- Outer High density polyester 600D.

DETAILS:

- Zip closure, snap and plastic micro adjustments.
- Double waist adjustments with tape and hook and loop fastener.
- Reinforcement with Cordura® for the inside of the knee.
- Foam reinforcements on the knee.
- High-density polyester in the area of contact with the seat to provide greater grip, comfort and durability.
- Elastic bands above the knee, front, lower back and calf area for maximum mobility.
- Innovative digital technology that has the ability to obtain fluorescent colors.
- Double and triple stitching in critical areas.
- Weight 450 g.



CORDURA®

SIZES

18	code: .018	24	code: .024
20	code: .020	26	code: .026
22	code: .022	28	code: .028

SIZE	18	20	22	24	26	28
Waist	53-56 cm.	56-59 cm.	59-63 cm.	63-66 cm.	66-70 cm.	70-74 cm.
Hip	63-68 cm.	68-73 cm.	73-78 cm.	78-83 cm.	83-88 cm.	88-93 cm.
Inseam	38-42 cm.	42-47 cm.	47-53 cm.	53-58 cm.	58-64 cm.	64-70 cm.

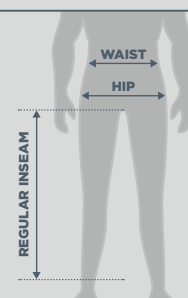

MX OUTRUN KID

ORANGE/BLACK
JERSEY COD. 0024477.209.

MX TRACK KID

BLACK
PANTS COD. 0024476.090.



BACK



MX OUTRUN KID

BLUE/GREY
JERSEY COD. 0024477.249.

MX TRACK KID

BLACK
PANTS COD. 0024476.090.



BACK



MX OUTRUN KID

GREY/BLACK
JERSEY COD. 0024477.293.

MX TRACK KID

BLACK
PANTS COD. 0024476.090.

DESERT STORM KID

CAMOUFLAGE
JERSEY COD. 0023473.743.



BACK



BACK



TRACK SOFTSHELL JACKET

AVAILABLE FROM JANUARY 2021

COMPONENTS: Polyester 96%; Spandex 4%

MATERIALS:

Outer:

- Softshell no wind and waterproof in polyester 5K/1K: breathable, resistant to tearing and abrasion, water repellent
- Powerstretch in polyester for side insert

Inner:

- Inner in microfleece with doobby effect

DETAILS: Off Road fit

- Softshell jacket with removable sleeve
- The garment is is studied to be wear with or without (even the most voluminous) protectors.
- Fabric with soft inner pile in doobby effect
- Stretch fabric as on sides as on inner area os sleeves
- Reflective Acerbis logo and applications on the front, sleeve and back
- 2 front pockets and 1 rear pocket with zippers
- Stretchable neck , cuff and armhole
- Weight 580gr

Removable Sleeves
Maniche Staccabili



SIZES

S	code: .062	XL	code: .068
M	code: .064	XXL	code: .069
L	code: .066	3XL	code: .070

SIZES	S	M	L	XL	2XL	3XL
Chest	88-94 cm.	94-100 cm.	100-106 cm.	106-112 cm.	112-118 cm.	118-124 cm.
Waist	78-84 cm.	84-90 cm.	90-96 cm.	96-102 cm.	102-108 cm.	108-114 cm.
Sleeve	65-66 cm.	66-67 cm.	67-68 cm.	68-69 cm.	69-70 cm.	70-71 cm.

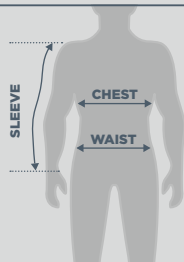

0024320.319.

BLACK/GREY

SOFTSHELL X-WIND VEST

COMPOSITION: Polyester 100%.

MATERIALS:

- **Outer:** Softshell no wind WINDTEX SHIELD VAGOTEX in polyester: breathable, resistant to tearing and abrasion, water repellent, Powerstretch Carvico in polyester for side insert.
- **Inner:** Microfleece.

DETAILS:

- Off-Road fit.
- Vest with digital print.
- 2 front pockets and 1 back pocket with zip.



SIZES

S	code: .062	XL	code: .068
M	code: .064	XXL	code: .069
L	code: .066	3XL	code: .070

SIZES	S	M	L	XL	2XL	3XL
Chest	90-95 cm.	95-101 cm.	101-108 cm.	108-116 cm.	116-123 cm.	123-129 cm.

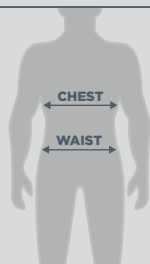

0023441.319.
BLACK/GREY



0023441.246.
BLUE



0023441.799.
GREY/ORANGE



MX ONE 1 JACKET

COMPONENTS:

- 92% Polyester; 8% Elastane

A NEW JACKET MADE OF SOFTSHELL, A NEW TYPE OF MATERIAL that, due to its special structure and use of a wind-blocking elastic membrane provides three key features: Wind protection, water protection (up to 8000 ml.) and breathability. It is extremely soft, very elastic and waisted, following the lines of the body, making it particularly comfortable. Removable sleeves, adjustable wrists with hook and loop fastener closure, front pockets with zipper.



SIZES			
M	code: .064	XL	code: .068
L	code: .066	XXL	code: .069

SIZES	M	L	XL	2XL		
Chest	95-99 cm.	99-103 cm.	103-107 cm.	107-111 cm.		
Waist	63-65 cm.	65-67 cm.	67-68 cm.	68-69 cm.		
Sleeve	89-93 cm.	93-97 cm.	97-101 cm.	101-105 cm.		

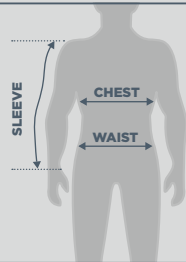

0017030.090.

BLACK



ELNATH SOFTSHELL JACKET
0910081.

See at casual - page 213

ENDURO ONE JACKET

COMPOSITION:

- 100% Polyester

MATERIALS:

Inner mesh lining

Outer High density Polyester.

DETAILS:

- Enduro technical jacket
- Sport fit
- Designed for the use with protections
- Adjustable waist with drawstring
- Adjustments on the bottom with hook and loop fastener
- Removable sleeves with zip
- 5 pockets - 3 front, 1 wide rear pocket, 1 inside
- Reflective customization



SIZES

S	code: .062	XL	code: .068
M	code: .064	XXL	code: .069
L	code: .066	3XL	code: .070

SIZES	S	M	L	XL	2XL	3XL
Chest	91-95 cm.	95-99 cm.	99-105 cm.	105-111 cm.	111-117 cm.	117-123 cm.
Waist	87-91 cm.	91-95 cm.	95-101 cm.	101-105 cm.	105-111 cm.	111-117 cm.
Sleeve	61-63 cm.	63-65 cm.	65-67 cm.	67-68 cm.	68-69 cm.	69-70 cm.

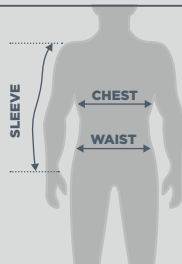

0022169.313.

BLACK/FLUO ORANGE



0022169.318.

BLACK/FLUO YELLOW



0022169.319.

BLACK/GREY

SEE ALSO

X-ENDURO GLOVES

code: **.0023993**

page: **102**

ENDURO ONE BAGGY

COMPOSITION:

Exterior: 85.60% polyester, 6.80% nylon, 6.30% Kevlar, 1.30% Spandex

Interior: 99.80% polyester, 0.20% Spandex

MATERIALS:

Exterior: high density polyester

Interior: net lining

DETAILS:

- Sport wearability
- Dual regulation on waist with band and hook and loop fastener
- Safety closure on waist with hook and button
- Knee volume regulation with tape
- Wide-bottomed adjustable pants
- Inserts in elasticized fabric that envelop the knees front and back
- Inserts in elasticized fabric on rear
- Use of fluorescent and reflecting details
- 3 large front pockets, easy to reach (2 on waist and 1 on thigh)
- Use of Kevlar reinforcement along the entire inner knee area and bottom
- Possible to wear pants both inside and outside boot
- Cordura reinforcement on seat panels area



0022424.318

BLACK/FLUO YELLOW



Kevlar®

CORDURA®

ARMORTEX®

SIZES

30	code: .030	36	code: .036
32	code: .032	38	code: .038
34	code: .034	40	code: .040

SIZES	30	32	34	36	38	40
Waist	79-84 cm.	84-89 cm.	89-94 cm.	94-99 cm.	99-104 cm.	104-109 cm.
Hip	94-98 cm.	98-102 cm.	102-106 cm.	106-114 cm.	114-118 cm.	118-122 cm.
Inseam	77-79 cm.	79-80 cm.	80-81 cm.	81-82 cm.	82-83 cm.	83-84 cm.

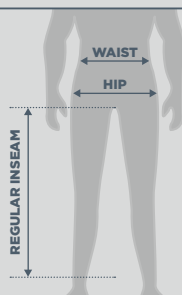

ENDURO ONE BAGGY - PRODUCT FEATURES - CARATTERISTICHE DEL PRODOTTO:

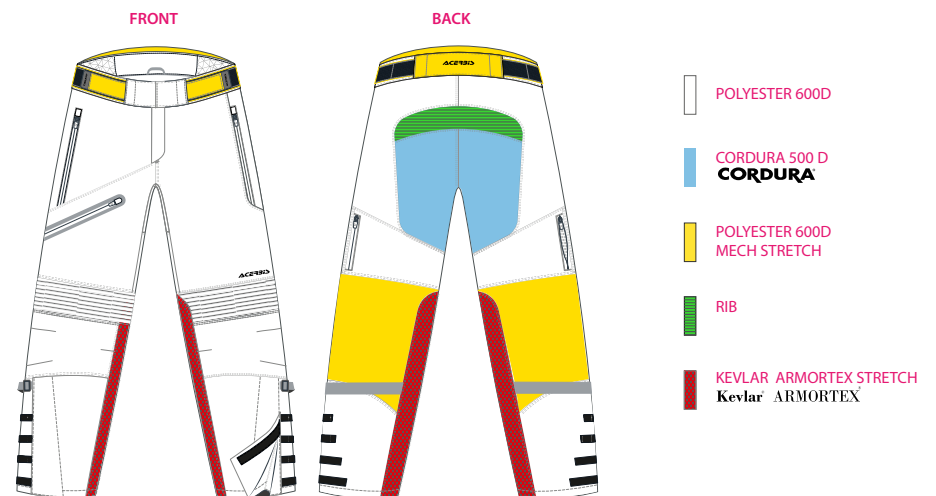

SEE ALSO

X-ENDURO GLOVES

code: **.0023993**

page: **102**





MTB GEAR / ABBIGLIAMENTO MTB



SPEEDER MTB JERSEY

COMPONENTS:

Shell 98% Polyester; 2% Elastane

MATERIALS:

Outer

- Microfresh fabric , high-tech breathable, absorb sweat and quick dry
- 100% Vented Jersey

DETAILS:

- Slim-fit for wearing the garment with or without (even the most voluminous) protections.
- Back pocket with zipper
- Weight 200 gr



SIZES

S	code: .062	XL	code: .068
M	code: .064	XXL	code: .069
L	code: .066	3XL	code: .070



0023909.316.
BLACK/BLUE

SIZES	S	M	L	XL	2XL	3XL
Chest	90-95 cm.	95-101 cm.	101-108 cm.	108-116 cm.	116-123 cm.	123-129 cm.
Sleeve	60-61 cm.	62-63 cm.	64-65 cm.	66-67 cm.	68-69 cm.	70-72 cm.

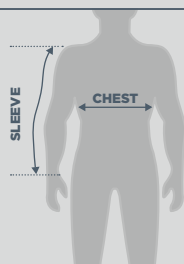

0023909.347.
RED/GREY



0023909.319.
BLACK/GREY

COMBAT MTB JERSEY

COMPONENTS:

Shell 100% Polyester

MATERIALS:

Outer

- Microfresh fabric , high-tech breathable , absorb sweat and quick dry
- 100% Vented Jersey

DETAILS:

- Slim-fit for wearing the garment with or without (even the most voluminous) protections.
- Back pocket with zipper
- Weight 160 gr



SIZES

S	code: .062	XL	code: .068
M	code: .064	XXL	code: .069
L	code: .066	3XL	code: .070

SIZES	S	M	L	XL	2XL	3XL
Chest	90-95 cm.	95-101 cm.	101-108 cm.	108-116 cm.	116-123 cm.	123-129 cm.
Sleeve	60-61 cm.	62-63 cm.	64-65 cm.	66-67 cm.	68-69 cm.	70-72 cm.

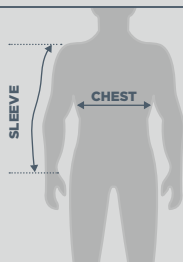

0023911.319.

BLACK/GREY



LEGACY MTB PANTS

COMPONENTS:

Outshell 91% polyester, 7% nylon, 2% spandex

Lining 100% polyester

MATERIALS:

Outer

- High-density 600D Polyester , fully elasticized

DETAILS:

- Innovative ACERBIS X-flex technology: fully elasticized and water repellent
- Mesh inner lining till knee with stretchable fabric on waist for better comfort
- Can take any type of knee guard thanks to stretch mesh in the calf area
- Double waist adjustment with hook and loop fastener
- Double closure with button and hook button
- Excellent ventilation thanks to laser holes and mesh in the back area
- 2 Pockets with zippers in the thigh area



SIZES

28	code: .028	34	code: .034
30	code: .030	36	code: .036
32	code: .032	38	code: .038

SIZES	28	30	32	34	36	38
Waist	74-79 cm.	79-84 cm.	84-89 cm.	89-94 cm.	94-99 cm.	99-104 cm.
Hip	89-94 cm.	94-99 cm.	99-104 cm.	104-109 cm.	109-114 cm.	114-119 cm.
Inseam	72-74 cm.	74-76 cm.	76-78 cm.	78-80 cm.	80-82 cm.	82-84 cm.

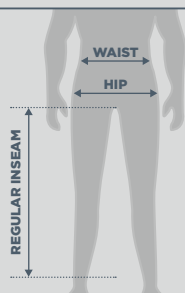

0023910.319.

BLACK/GREY

LEGEND MTB SHORTS

COMPONENTS:

Outshell 83.5% polyester, 11% spandex, 5.5% nylon

MATERIALS:

Outer

- High-density 500D Polyester, fully elasticized

DETAILS:

- Innovative ACERBIS X-flex technology: fully elasticized and water repellent.
- Without inner lining in order to have lighter shorts
- Can take any type of knee guard thanks to stretch mesh in the back area.
- Double waist adjustment with hook and loop fastener.
- Double closure with button and hook button.
- Excellent ventilation thanks to laser holes and mesh in the back area .
- 2 Pockets with zippers in the thigh area.



SIZES

28	code: .028	34	code: .034
30	code: .030	36	code: .036
32	code: .032	38	code: .038

SIZES	28	30	32	34	36	38
Waist	74-79 cm.	79-84 cm.	84-89 cm.	89-94 cm.	94-99 cm.	99-104 cm.
Hip	89-94 cm.	94-99 cm.	99-104 cm.	104-109 cm.	109-114 cm.	114-119 cm.
Inseam	72-74 cm.	74-76 cm.	76-78 cm.	78-80 cm	80-82 cm.	82-84 cm.

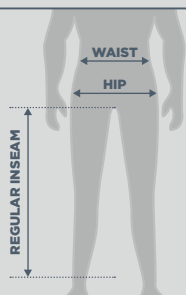

0023912.319.

BLACK/GREY

CE X-TOUR JACKET

COMPONENTS:

Jacket: Shell: 99% Polyester, 1% Polyamide
Lining: 64% Polyester, 36% Polyamide

Membrane and Padding: 100% Polyester

MATERIALS:

Outer

- Fabric for jacket 600D in polyester resistant to tearing and abrasion, water repellent
- Front, side and sleeve insert 600D RIPSTOP in polyester
- Collar, shoulder, back and elbow insert 1200D in polyester
- Collar insert in nylon stretch

Inner

- Inner collar in fabric
- Detachable inner membrane waterproof and breathable 10K/10K, windproof, seams totally taped. Also to be worn separately
- Detachable inner padding gr.120

DETAILS: Touring fit

- CE JACKET **FprEN 17092-3:2018 class AA**
- CE SHOULDER & ELBOW PROTECTORS **EN 1621-1: 2012 Type A Level 2**
- Predisposition for CE BACK PROTECTOR **EN 1621-2: 2014 Type FB Level 2**
- Body and sleeve ventilations in mesh completely openable with zip
- 3 pockets outside and 1 zip pocket inside the jacket waterproof totally taped
- 1 pocket inside detachable membrane and padding
- Cuff, sleeve, waist and bottom regulation
- Zip connection inside for pants
- Reflective Acerbis logo and applications on the front, sleeve and back



Detachable Inner Membrane
see description



SIZES

S	code: .062	XL	code: .068
M	code: .064	XXL	code: .069
L	code: .066	3XL	code: .070

SIZES	S	M	L	XL	2XL	3XL
Chest	88-94 cm.	94-100 cm.	100-106 cm.	106-112 cm.	112-118 cm.	118-124 cm.
Waist	78-84 cm.	84-90 cm.	90-96 cm.	96-102 cm.	102-108 cm.	108-114 cm.
Sleeve	65-66 cm.	66-67 cm.	67-68 cm.	68-69 cm.	69-70 cm.	70-71 cm.

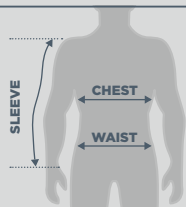

0023684.076.

LIGHT GREY



0023684.090.

BLACK

0023684.708.

BEIGE

ACCESSORIES



PROTECTOR CE XY905S FB LEV 2
CODE: 0023994.060
SIZE: S
FOR: MAN JACKET (S,M,L)

PROTECTOR CE XY905M FB LEV 2
CODE: 0023995.060
SIZE: M
FOR: MAN JACKET (XL,2XL,3XL)

CE DISCOVERY SAFARY JACKET

COMPONENTS:

Shell 100% Polyester Lining 90% Polyamide, 10% Polyester

MATERIALS:

Outer

- Fabric for jacket 600D in polyester resistant to tearing and abrasion, water repellent
- Color Fluo Yellow: it respects the norm **HIGH VISIBILITY (EN ISO 20471: 2013+A1: 2016)**
- Fabric for elbow insert 1200D in polyester
- Collar insert in nylon stretch

Inner

- Inner collar in microfleece
- Waterproof and breathable coating applied inside the lining, seams totally taped
- Detachable inner padding gr. 90

DETAILS: Touring fit

- CERTIFIED JACKET **FprEN 17092-3:2018 class AA**
- CERTIFIED SHOULDER & ELBOW PROTECTORS **EN 1621-1: 2012 Type A Lev 2**
- Predisposition for CERTIFIED BACK PROTECTOR **EN 1621-2: 2014 Type FB Level 2** (separately sold)
- Front and back ventilation in mesh with zip
- 5 pockets outside waterproof totally taped, 1 pocket inside the jacket and 1 pocket inside the detachable padding
- Cuff, sleeve, waist and bottom regulation
- Reflective Acerbis logo and applications on the front, sleeve and back



0023739.319.

BLACK/DARK GREY



0023739.090.

BLACK



0023739.318.

BLACK/FLUO YELLOW



SIZES

S	code: .062	XL	code: .068
M	code: .064	XXL	code: .069
L	code: .066	3XL	code: .070

SIZES	S	M	L	XL	2XL	3XL
Chest	88-94 cm.	94-100 cm.	100-106 cm.	106-112 cm.	112-118 cm.	118-124 cm.
Waist	78-84 cm.	84-90 cm.	90-96 cm.	96-102 cm.	102-108 cm.	108-114 cm.
Sleeve	65-66 cm.	66-67 cm.	67-68 cm.	68-69 cm.	69-70 cm.	70-71 cm.

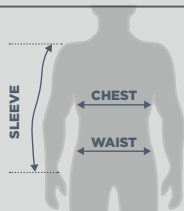

ACCESSORIES



PROTECTOR CE XY905S FB LEV 2
CODE: 0023994.060
SIZE: S
FOR: MAN JACKET (S,M,L)

PROTECTOR CE XY905M FB LEV 2
CODE: 0023995.060
SIZE: M
FOR: MAN JACKET (XL,2XL,3XL)



CE DISCOVERY FOREST JACKET

COMPONENTS:

Shell 100% Polyester Lining 90% Polyamide, 10% Polyester

MATERIALS:

Outer

- Fabric for jacket 600D in polyester resistant to tearing and abrasion, water repellent
- Color Fluo Yellow: it respects the norm **HIGH VISIBILITY (EN ISO 20471: 2013+A1: 2016)**
- Fabric for elbow insert 1200D in polyester
- Collar insert in nylon stretch

Inner

- Inner collar in microfleece
- Waterproof and breathable coating applied inside the lining, seams totally taped
- Detachable inner padding gr. 90

DETAILS:

- Touring fit
- CERTIFIED JACKET **FprEN 17092-3:2018 class AA**
- CERTIFIED SHOULDER & ELBOW PROTECTORS **EN 1621-1: 2012 Type A Level 2**
- Predisposition for CERTIFIED BACK PROTECTOR **EN 1621-2: 2014 Type FB Level 2** (separately sold)
- Shoulder and back ventilation in mesh with zip
- 2 pockets outside waterproof totally taped, 1 pocket inside the jacket and 1 pocket inside the detachable padding
- Cuff, sleeve, waist and bottom regulation
- Reflective Acerbis logo and applications on the front, sleeve and back



0023740.318.

BLACK/FLUO YELLOW



SIZES

S	code: .062	XL	code: .068
M	code: .064	XXL	code: .069
L	code: .066	3XL	code: .070

SIZES	S	M	L	XL	2XL	3XL
Chest	88-94 cm.	94-100 cm.	100-106 cm.	106-112 cm.	112-118 cm.	118-124 cm.
Waist	78-84 cm.	84-90 cm.	90-96 cm.	96-102 cm.	102-108 cm.	108-114 cm.
Sleeve	65-66 cm.	66-67 cm.	67-68 cm.	68-69 cm.	69-70 cm.	70-71 cm.

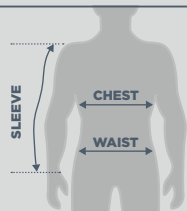

0023740.090.

BLACK



0023740.319.

BLACK/DARK GREY

ACCESSORIES



PROTECTOR CE XY905S FB LEV 2
CODE: 0023994.060
SIZE: S
FOR: MAN JACKET (S,M,L)

PROTECTOR CE XY905M FB LEV 2
CODE: 0023995.060
SIZE: M
FOR: MAN JACKET (XL,2XL,3XL)

CE DISCOVERY FOREST LADY JACKET

COMPONENTS:

Shell 100% Polyester **Lining** 90% Polyamide, 10% Polyester

MATERIALS:

Outer

- Fabric for jacket 600D in polyester resistant to tearing and abrasion, water repellent
- Color Fluo Yellow: it respects the norm **HIGH VISIBILITY (EN ISO 20471: 2013+A1: 2016)**
- Fabric for elbow insert 1200D in polyester
- Collar insert in nylon stretch

Inner

- Inner collar in microfleece
- Waterproof and breathable coating applied inside the lining, seams totally taped
- Detachable inner padding gr. 90

DETAILS:

- Touring fit
- CERTIFIED JACKET **FprEN 17092-3:2018 class AA**
- CERTIFIED SHOULDER & ELBOW PROTECTORS **EN 1621-1: 2012 Type A Level 2**
- Predisposition for CERTIFIED BACK PROTECTOR **EN 1621-2: 2014 Type FB Level 2** (separately sold)
- Shoulder and back ventilation in mesh with zip
- 2 pockets outside waterproof totally taped, 1 pocket inside the jacket and 1 pocket inside the detachable padding
- Cuff, sleeve, waist and bottom regulation
- Reflective Acerbis logo and applications on the front, sleeve and back



0023741.318.

BLACK/FLUO YELLOW



0023741.090.

BLACK



0023741.319.

BLACK/DARK GREY



SIZES

XS	code: .061	L	code: .066
S	code: .062	XL	code: .068
M	code: .064	XXL	code: .069

SIZES	XS	S	M	L	XL	2XL
Chest	80-84 cm.	84-88 cm.	88-92 cm.	92-96 cm.	96-101 cm.	101-106 cm.
Waist	64-68 cm.	68-72 cm.	72-76 cm.	76-80 cm.	80-85 cm.	85-90 cm.
Sleeve	59-60 cm.	60-61 cm.	61-62 cm.	62-63 cm.	63-64 cm.	64-65 cm.

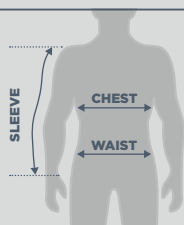

ACCESSORIES



PROTECTOR CE XY905S FB LEV 2
 CODE: 0023994.060
 SIZE: S
 FOR: LADY JACKET (XS,S,M,L,XL,2XL)



CE DISCOVERY GIBLY JACKET

COMPONENTS:

Shell 100% Polyester Lining 100% Polyester

MATERIALS:

Outer

- Fabric for jacket 600D in polyester resistant to tearing and abrasion, water repellent
- Color Fluo Yellow: it respects the norm **HIGH VISIBILITY (EN ISO 20471: 2013+A1: 2016)**
- Fabric for shoulder and elbow insert 1200D in polyester
- Collar insert in nylon stretch

Inner

- Inner collar in microfleece
- Lining in mesh
- Detachable inner padding gr. 90
- Predisposition for waterproof and breathable membrane (separately sold)

DETAILS: Sport fit

- CERTIFIED JACKET **FprEN 17092-3:2018 class AA**
- CERTIFIED SHOULDER & ELBOW PROTECTORS **EN 1621-1: 2012 Type A Lev 2**
- Predisposition for CERTIFIED BACK PROTECTOR **EN 1621-2: 2014 Type FB Lev 2** (separately sold)
- Shoulder and back ventilation in mesh with zip
- 2 pockets outside, 1 pocket inside the jacket and 1 pocket inside the detachable padding
- Cuff, sleeve and bottom regulation
- Reflective Acerbis logo and applications on the front, sleeve and back



0023742.090.

BLACK



0023742.318.

BLACK/FLUO YELLOW



0023742.319.

BLACK/DARK GREY



SIZES

S	code: .062	XL	code: .068
M	code: .064	XXL	code: .069
L	code: .066	3XL	code: .070

SIZES	S	M	L	XL	2XL	3XL
Chest	88-94 cm.	94-100 cm.	100-106 cm.	106-112 cm.	112-118 cm.	118-124 cm.
Waist	78-84 cm.	84-90 cm.	90-96 cm.	96-102 cm.	102-108 cm.	108-114 cm.
Sleeve	65-66 cm.	66-67 cm.	67-68 cm.	68-69 cm.	69-70 cm.	70-71 cm.

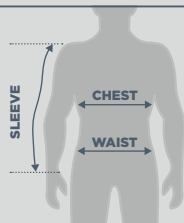

ACCESSORIES



PROTECTOR CE XY905S FB LEV 2
CODE: 0023994.060
SIZE: S
FOR: MAN JACKET (S,M,L)

PROTECTOR CE XY905M FB LEV 2
CODE: 0023995.060
SIZE: M
FOR: MAN JACKET (XL,2XL,3XL)



DISCOVERY GIBLY
MEMBRANE
CODE: 0022884.090

CE DISCOVERY GIBLY LADY JACKET

COMPONENTS:

Shell 100% Polyester **Lining** 100% Polyester

MATERIALS:

Outer

- Fabric for jacket 600D in polyester resistant to tearing and abrasion, water repellent
- Color Fluo Yellow: it respects the norm **HIGH VISIBILITY (EN ISO 20471: 2013+A1: 2016)**
- Fabric for shoulder and elbow insert 1200D in polyester
- Collar insert in nylon stretch

Inner

- Inner collar in microfleece
- Lining in mesh
- Detachable inner padding gr. 90
- Predisposition for waterproof and breathable membrane (separately sold)

DETAILS:

Sport fit

• CERTIFIED JACKET **FprEN 17092-3:2018 class AA**

• CERTIFIED SHOULDER & ELBOW PROTECTORS

EN 1621-1: 2012 Type A Level 2

• Predisposition for CERTIFIED BACK PROTECTOR

EN 1621-2: 2014 Type FB Level 2 (separately sold)

• Shoulder and back ventilation in mesh with zip

• 2 pockets outside, 1 pocket inside the jacket and 1 pocket inside the detachable padding

• Cuff, sleeve and bottom regulation

• Reflective Acerbis logo and applications on the front, sleeve and back



0023743.090.

BLACK



0023743.318.

BLACK/FLUO YELLOW



0023743.319.

BLACK/DARK GREY



SIZES

XS	code: .061	L	code: .066
S	code: .062	XL	code: .068
M	code: .064	XXL	code: .069

SIZES	XS	S	M	L	XL	2XL
Chest	80-84 cm.	84-88 cm.	88-92 cm.	92-96 cm.	96-101 cm.	101-106 cm.
Waist	64-68 cm.	68-72 cm.	72-76 cm.	76-80 cm.	80-85 cm.	85-90 cm.
Sleeve	59-60 cm.	60-61 cm.	61-62 cm.	62-63 cm.	63-64 cm.	64-65 cm.

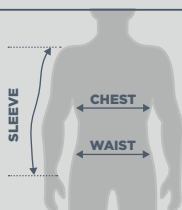

ACCESSORIES



PROTECTOR CE XY905S FB LEV 2
CODE: 0023994.060
 SIZE: S
 FOR: LADY JACKET (XS,S,M,L,XL,2XL)



DISCOVERY GIBLY LADY
 MEMBRANE
CODE: 0022885.090



CE RAMSEY VENTED JACKET

COMPONENTS:

- **Shell:** 100% Polyester
- **Lining:** 100% Polyester

MATERIALS:

- **Outer:**
 - Fabric for jacket and shoulder insert 450D in polyester resistant to tearing and abrasion, water repellent
 - Body, sleeve and cuff inserts in heavy mesh resistant to tearing and abrasion
 - Collar insert in polyester stretch
- **Inner:**
 - Inner collar in microfleece
 - Lining in mesh
 - Predisposition for waterproof and breathable membrane (separately sold)

DETTAGLI:

- Sport fit
- CERTIFIED JACKET **FprEN 17092-3:2018 class AA**
- CERTIFIED SHOULDER & ELBOW PROTECTORS **EN 1621-1: 2012 Type A Level 1**
- Predisposition for CERTIFIED BACK PROTECTOR **EN 1621-2: 2014 Type FB Level 2** (separately sold)
- 2 pockets outside and 1 pocket inside the jacket
- Cuff, sleeve and bottom regulation
- Reflective Acerbis logo and applications on the front, sleeve and back



0023744.290.

GREY/FLUO YELLOW



SIZES

S	code: .062	XL	code: .068
M	code: .064	XXL	code: .069
L	code: .066	3XL	code: .070

SIZES	S	M	L	XL	2XL	3XL
Chest	88-94 cm.	94-100 cm.	100-106 cm.	106-112 cm.	112-118 cm.	118-124 cm.
Waist	78-84 cm.	84-90 cm.	90-96 cm.	96-102 cm.	102-108 cm.	108-114 cm.
Sleeve	65-66 cm.	66-67 cm.	67-68 cm.	68-69 cm.	69-70 cm.	70-71 cm.

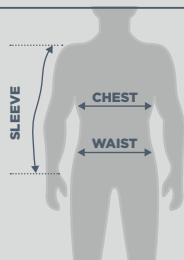

0023744.090.

BLACK



0023744.318.

BLACK/FLUO YELLOW



0023744.323.

BLACK/RED

ACCESSORIES



PROTECTOR CE XY905S FB LEV 2
CODE: 0023994.060
SIZE: S
FOR: MAN JACKET (S,M,L)

PROTECTOR CE XY905M FB LEV 2
CODE: 0023995.060
SIZE: M
FOR: MAN JACKET (XL,2XL,3XL)



RAMSEY VENTED MEMBRANE
CODE: 0022649.090

CE RAMSEY VENTED LADY JACKET



COMPONENTS:

- **Shell:** 100% Polyester
- **Lining:** 100% Polyester

MATERIALS:

- **Outer:**
 - Fabric for jacket and shoulder insert 450D in polyester resistant to tearing and abrasion, water repellent
 - Body, sleeve and cuff inserts in heavy mesh resistant to tearing and abrasion
 - Collar insert in polyester stretch
- **Inner:**
 - Inner collar in microfleece
 - Lining in mesh
 - Predisposition for waterproof and breathable membrane (separately sold)

DETTAGLI:

- Sport fit
- CERTIFIED JACKET **FprEN 17092-3:2018 class AA**
- CERTIFIED SHOULDER & ELBOW PROTECTORS **EN 1621-1: 2012 Type A Level 1**
- Predisposition for CERTIFIED BACK PROTECTOR **EN 1621-2: 2014 Type FB Level 2** (separately sold)
- 2 pockets outside and 1 pocket inside the jacket
- Cuff, sleeve and bottom regulation
- Reflective Acerbis logo and applications on the front, sleeve and back



0023745.723.

BLACK/PINK



0023745.090.

BLACK



0023745.290.

GREY/FLUO YELLOW



SIZES

XS	code: .061	L	code: .066
S	code: .062	XL	code: .068
M	code: .064	XXL	code: .069

SIZES	XS	S	M	L	XL	2XL
Chest	80-84 cm.	84-88 cm.	88-92 cm.	92-96 cm.	96-101 cm.	101-106 cm.
Waist	64-68 cm.	68-72 cm.	72-76 cm.	76-80 cm.	80-85 cm.	85-90 cm.
Sleeve	59-60 cm.	60-61 cm.	61-62 cm.	62-63 cm.	63-64 cm.	64-65 cm.

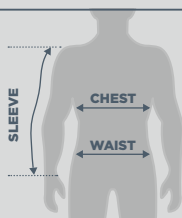

ACCESSORIES



PROTECTOR CE XY905S FB LEV 2
CODE: 0023994.060
SIZE: S
FOR: LADY JACKET (XS,S,M,L,XL,2XL)



RAMSEY VENTED LADY MEMBRANE
CODE: 0023420.090



JACKET ACCESSORIES

DISCOVERY GIBLY MEMBRANE

MAN 0022884.090. / LADY 0022885.090.

COMPONENTS:

Shell 100% Polyamide

MATERIALS:

Outer

Fabric waterproof and breathable, seams totally taped

DETAILS:

Predisposition for the sport jacket (separately sold)

Inner pocket



MAN VERSION 0022884.090.

ONLY FOR: CE DISCOVERY GIBLY JACKET

SIZES

S	code: .062	XL	code: .068
M	code: .064	XXL	code: .069
L	code: .066	3XL	code: .070



LADY VERSION 0022885.090.

ONLY FOR: CE DISCOVERY GIBLY LADY JACKET



SIZES

XS	code: .061	L	code: .066
S	code: .062	XL	code: .068
M	code: .064	XXL	code: .069



RAMSEY VENTED MEMBRANE

MAN 0022649.090. / LADY 0023420.090

COMPONENTS:

Shell 100% Polyester

MATERIALS:

Outer

Fabric waterproof and breathable, seams totally taped

DETAILS:

Predisposition for the vented jacket (separately sold)

Inner pocket



MAN VERSION 0022649.090.

ONLY FOR: CE RAMSEY VENTED JACKET

SIZES

S	code: .062	XL	code: .068
M	code: .064	XXL	code: .069
L	code: .066	3XL	code: .070



LADY VERSION 0023420.090.

ONLY FOR: CE RAMSEY VENTED LADY JACKET



SIZES

XS	code: .061	L	code: .066
S	code: .062	XL	code: .068
M	code: .064	XXL	code: .069



JACKET ACCESSORIES

OPTIONAL BACK PROTECTOR

COMPONENTS:

Shell: 100% Polyurethane

MATERIAL:

Memory PU

DETAILS:

CERTIFIED BACK PROTECTOR **EN 1621-2: 2014 Type FB Level 2**

Partially perforated

Ergonomic, soft, light and comfort



CE XY905S FB LEV 2

CODE 0023994.060

SIZE S

MEASUREMENT

A: 29 cm

B: 40 cm

C: 19 cm

D: 17 cm

CE XY905M FB LEV 2

CODE 0023995.060

SIZE M

MEASUREMENT

A: 32 cm

B: 45 cm

C: 21 cm

D: 19 cm

CE XY905L FB LEV 2

CODE 0024248.060

SIZE L

MEASUREMENT

A: 34 cm

B: 50 cm

C: 23 cm

D: 21 cm

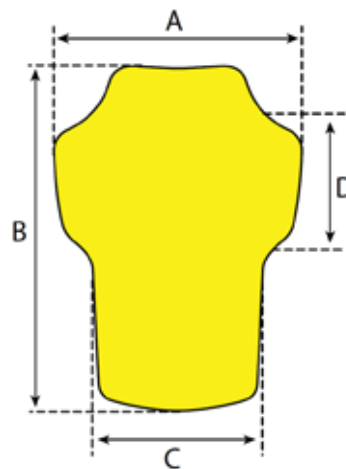

JACKET AND PANTS ACCESSORIES

PROTECTORS

COMPONENTS:

Shell: 100% Polyurethane

CERTIFIED SHOULDER, ELBOW, KNEE AND UPPER TIBIA PROTECTORS EN 1621-1: 2012 Type A Level 1



PROTECTORS CE XY805 TYPE A LEV1

CODE: 0023768.090

PROTECTORS CE XY806 TYPE A LEV1

CODE: 0023769.090



CE X-TOUR PANTS



COMPONENTS:

Shell: 100% Polyester

Lining: 82% Polyester 18% Polyamide

MATERIALS:

Outer:

- Fabric for pants 600D in polyester resistant to tearing and abrasion, water repellent
- Back and bottom inserts 1200D in polyester

Inner:

- Lining in mesh
- Detachable inner membrane waterproof and breathable 10K/10K, windproof, seams totally taped
- Detachable inner padding gr.90

DETAILS: Touring fit

- **CERTIFIED PANTS EN 17092-4:2020 class A**
- **CERTIFIED KNEE PROTECTORS EN 1621-1: 2012 Type B Level 2**
- Leg ventilations in mesh completely openable with zip
- 2 side pockets waterproof totally taped
- Waist regulation
- Bottom leg opening with regulation
- Reflective Acerbis logo and applications on the legs



0024273.076.

LIGHT GREY



SIZES

S	code: .062	XL	code: .068
M	code: .064	XXL	code: .069
L	code: .066	3XL	code: .070

SIZES	S	M	L	XL	XXL	3XL
Waist	79-84 cm.	84-89 cm.	89-94 cm.	94-99 cm.	99-104 cm.	104-109 cm.
Hip	93-98 cm.	98-103 cm.	103-108 cm.	108-113 cm.	113-118 cm.	118-123 cm.
Inseam	80-85 cm.	80-85 cm.	80-85 cm.	83-88 cm.	83-88 cm.	83-88 cm.

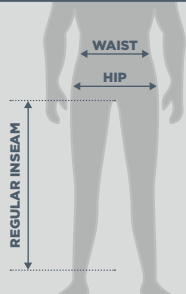

0024273.090.

BLACK

CE DISCOVERY PANTS

COMPONENTS:

Shell: 100% Polyester

Lining: 58% Polyamide 42% Polyester

MATERIALS:

Outer:

- Fabric for pants 600D in polyester resistant to tearing and abrasion, water repellent

Inner:

- Inner waistband in microfleece
- Waterproof and breathable coating applied inside the lining, between main fabric and mesh. Seams totally taped
- Detachable inner padding gr.60

DETAILS:

- Touring fit
- **CERTIFIED PANTS EN 17092-4:2020 class A**
- **CERTIFIED KNEE PROTECTORS EN 1621-1: 2012 Type B Level 2**
- 2 side pockets waterproof totally taped
- Waist regulation
- Bottom leg opening
- Reflective Acerbis logo and applications on the legs



SIZES

S	code: .062	XL	code: .068
M	code: .064	XXL	code: .069
L	code: .066	3XL	code: .070

SIZES	S	M	L	XL	XXL	3XL
Waist	79-84 cm.	84-89 cm.	89-94 cm.	94-99 cm.	99-104 cm.	104-109 cm.
Hip	93-98 cm.	98-103 cm.	103-108 cm.	108-113 cm.	113-118 cm.	118-123 cm.
Inseam	80-85 cm.	80-85 cm.	80-85 cm.	83-88 cm.	83-88 cm.	83-88 cm.

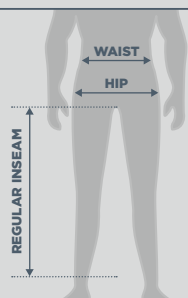

0023682.090.

BLACK



CE DISCOVERY LADY PANTS



COMPONENTS:

Shell: 100% Polyester

Lining: 58% Polyamide 42% Polyester

MATERIALS:

Outer:

- Fabric for pants 600D in polyester resistant to tearing and abrasion, water repellent

Inner:

- Inner waistband in microfleece
- Waterproof and breathable coating applied inside the lining, between main fabric and mesh. Seams totally taped
- Detachable inner padding gr.60

DETAILS: Touring fit

- **CERTIFIED PANTS EN 17092-4:2020 class A**
- **CERTIFIED KNEE PROTECTORS EN 1621-1: 2012 Type A Level 2**
- 2 side pockets waterproof totally taped
- Waist regulation
- Bottom leg opening
- Reflective Acerbis logo and applications on the legs

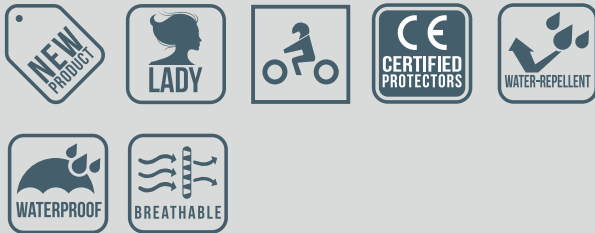

SIZES

XS	code: .061	L	code: .066
S	code: .062	XL	code: .068
M	code: .064	XXL	code: .069

SIZES	XS	S	M	L	XL	XXL
Waist	65-70 cm.	70-75 cm.	75-80 cm.	80-85 cm.	85-90 cm.	90-95 cm.
Hip	87-92 cm.	92-97 cm.	97-102 cm.	102-107 cm.	107-112 cm.	112-117 cm.
Inseam	77-83 cm.	77-83 cm.	81-86 cm.	81-86 cm.	81-86 cm.	81-86 cm.

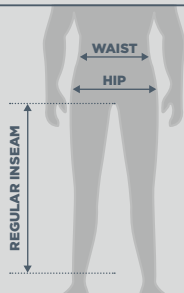

0023683.090.

BLACK

CE RAMSEY VENTED PANTS

COMPONENTS:

Shell: 100% Polyester

Lining: 100% Polyester

MATERIALS:

Outer:

- Fabric for pants 450D in polyester resistant to tearing and abrasion, water repellent
- Leg inserts in heavy mesh resistant to tearing and abrasion

Inner:

- Lining in mesh
- Detachable inner membrane waterproof and breathable. Seams totally taped

DETAILS:

Touring fit

- **CERTIFIED PANTS EN 17092-4:2020 class A**
- **CERTIFIED KNEE PROTECTORS EN 1621-1: 2012 Type A Level 1**
- 2 side pockets
- Waist regulation
- Bottom leg opening with regulation
- Reflective Acerbis logo and applications on the legs



0024293.076.

LIGHT GREY



SIZES

S	code: .062	XL	code: .068
M	code: .064	XXL	code: .069
L	code: .066	3XL	code: .070

SIZES	S	M	L	XL	XXL	3XL
Waist	79-84 cm.	84-89 cm.	89-94 cm.	94-99 cm.	99-104 cm.	104-109 cm.
Hip	93-98 cm.	98-103 cm.	103-108 cm.	108-113 cm.	113-118 cm.	118-123 cm.
Inseam	80-85 cm.	80-85 cm.	80-85 cm.	83-88 cm.	83-88 cm.	83-88 cm.

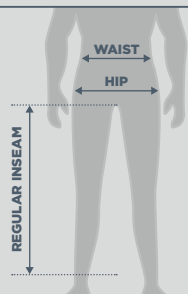

0024293.090.

BLACK



CE PACK JEANS

COMPONENTS:

Shell 98% Cotton 2% Elastane

Lining 80% Polyester 20% Cotton

Insert 72% Polyester, 28% Aramid

MATERIALS:

Outer

- Fabric for pants in denim 11.05 oz stretch made up to recycled materials

Inner

- Reinforcement in aramid fiber on the hips and back

DETAILS:

- Jeans 4 seasons
- CERTIFIED PANTS **FprEN 17092-4:2018 class A**
- CERTIFIED KNEE PROTECTORS **EN 1621-1: 2012 Type A Level 1**
- 3 front pockets and 2 back pockets



SIZES

28	code: .028	36	code: .036
30	code: .030	38	code: .038
32	code: .032	40	code: .040
33	code: .033		
34	code: .034		

SIZES	28	30	32	33	34	36
Waist	74-79 cm.	79-82 cm.	82-87 cm.	86-89 cm.	89-94 cm.	94-99 cm.
Hip	88-93 cm.	93-96 cm.	96-101 cm.	100-103 cm.	103-108 cm.	108-113 cm.
Inseam	80-85 cm.	80-85 cm.	80-85 cm.	80-85 cm.	83-88 cm.	83-88 cm.

SIZES	38	40
Waist	99-104 cm.	104-109 cm.
Hip	113-118 cm.	118-123 cm.
Inseam	83-88 cm.	83-88 cm.

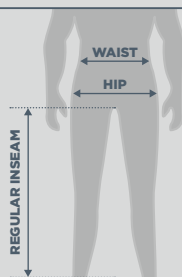

0023746.040.

BLUE

FRONT

BACK

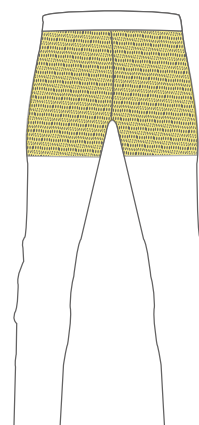
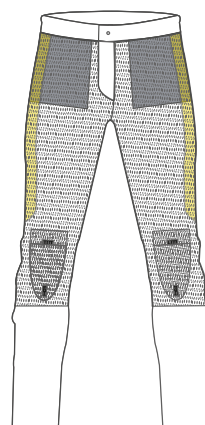

JEANS

LINING (SIDE POCKETS)
FODERA (TASCHE LATERALI)

ARAMID FIBER (HIPS & BACK REINFORCEMENT) FIBRA
ARAMIDICA (RINFORZO FIANCHI & DIETRO)

MESH (FRONT & BACK)
RETE (DAVANTI E DIETRO)

MESH + hook and loop fastener (KNEE PROTECTOR
POCKETS)
RETE + hook and loop fastener (TASCHE PROTEZIONI
GINOCCHIO)

CE PACK LADY JEANS

COMPONENTS:

Shell 98% Cotton 2% Elastane

Lining 80% Polyester 20% Cotton

Insert 72% Polyester, 28% Aramid

MATERIALS:

Outer

- Fabric for pants in denim 11.05 oz stretch made up to recycled materials

Inner

- Reinforcement in aramid fiber on the hips and back

DETAILS:

- Jeans 4 seasons
- CERTIFIED PANTS **FprEN 17092-4:2018 class A**
- CERTIFIED KNEE PROTECTORS **EN 1621-1: 2012 Type A Level 1**
- 3 front pockets and 2 back pockets



SIZES

25	code: .025	30	code: .030
26	code: .026	31	code: .031
27	code: .027	32	code: .032
28	code: .028	33	code: .033
29	code: .029		

SIZES	25	26	27	28	29	30
Waist	62-65 cm.	65-68 cm.	67-70 cm.	70-73 cm.	72-75 cm.	75-78 cm.
Hip	84-87 cm.	87-90 cm.	89-92 cm.	92-95 cm.	94-97 cm.	97-100 cm.
Inseam	77-83 cm.	77-83 cm.	77-83 cm.	77-83 cm.	77-83 cm.	81-86 cm.

SIZES	31	32	33			
Waist	77-80 cm.	80-83 cm.	82-85 cm.			
Hip	99-102 cm.	102-105 cm.	104-107 cm.			
Inseam	81-86 cm.	81-86 cm.	81-86 cm.			

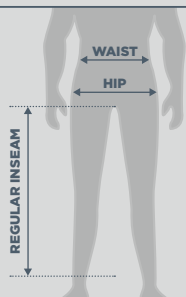

0023747.040.

BLUE

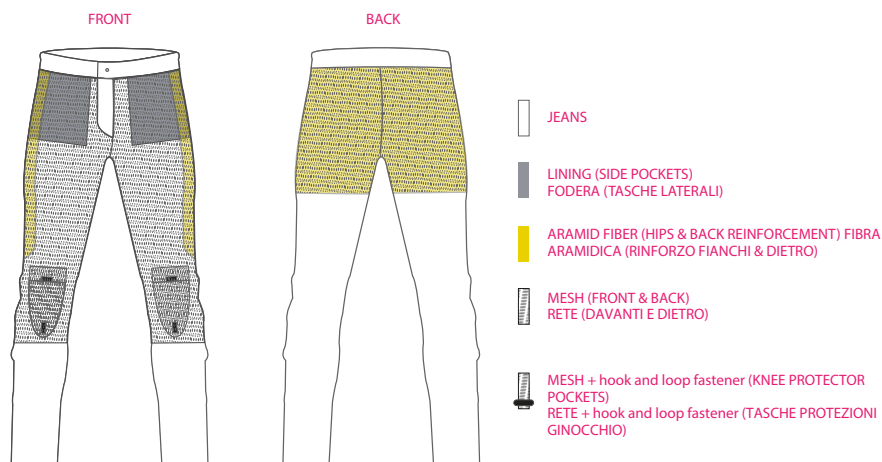

RAIN DEK PACK JACKET

COMPOSITION:

Main Fabric: 100% Polyester

Coating: 100% Thermoplastic Polyurethan (TPU)

MATERIALS:

Outer: Membrane waterproof and breathable 5K/1K, windproof, seams totally taped

DETAILS:

- Sport fit, the garment is is studied to be wear with or without (even the most voluminous) protectors.
- Pocket on chest area to can pack item inside them , with fixing way through strap
- Race numer perfectly visible in all the colorways
- Stretchable neck and cuff with Acerbis silicon logo details
- Reflective Acerbis logo and applications on the front, sleeve and back
- Weight 160 gr



SIZES			
S	code: .062	XL	code: .068
M	code: .064	XXL	code: .069
L	code: .066	3XL	code: .070

SIZES	S	M	L	XL	2XL	3XL
Chest	88-94 cm.	94-100 cm.	100-106 cm.	106-112 cm.	112-118 cm.	118-124 cm.
Waist	78-84 cm.	84-90 cm.	90-96 cm.	96-102 cm.	102-108 cm.	108-114 cm.
Sleeve	65-66 cm.	66-67 cm.	67-68 cm.	68-69 cm.	69-70 cm.	70-71 cm.

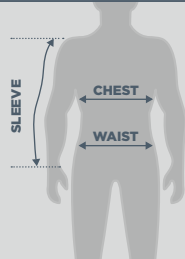

0023691.060.

FLUO YELLOW



0023691.030.

WHITE



0023691.090.

BLACK

RAIN DEK PACK VEST

COMPOSITION:

Main Fabric: 100% Polyester

Coating: 100% Thermoplastic Polyurethan (TPU)

MATERIALS:

Outer: Membrane waterproof and breathable 5K/1K, windproof, seams totally taped

DETAILS:

- Sport fit, the garment is studied to be wear with or without protectors
- Pocket on chest area to can pack item inside them
- Race number perfectly visible
- Stretchable neck and cuff with Acerbis silicon logo details
- Reflective Acerbis logo and applications on the front and back
- Weight 140 gr



SIZES

S	code: .062	XL	code: .068
M	code: .064	XXL	code: .069
L	code: .066	3XL	code: .070

SIZES	S	M	L	XL	2XL	3XL
Chest	88-94 cm.	94-100 cm.	100-106 cm.	106-112 cm.	112-118 cm.	118-124 cm.
Waist	78-84 cm.	84-90 cm.	90-96 cm.	96-102 cm.	102-108 cm.	108-114 cm.

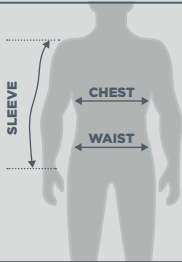

0024215.030.

WHITE



RAIN PRO TRANSPARENT 3.0 JACKET

COMPOSITION:

- 100% chlorofibre

DETAILS:

- Transparent rain jacket
- Central zip closure
- Mesh inserts on the sides in contrasting color
- Bottom and cuffs with elastic and contrasting color
- Neoprene collar with contrasting color
- Custom ACERBIS logos



SIZES

S/M	code: .063	XXL	code: .069
L/XL	code: .067	3XL	code: .070

SIZES	S/M	L/XL	XXL	3XL		
Chest	90-101 cm.	101-116 cm.	116-123 cm.	123-129 cm.		
Sleeve	60-63 cm.	64-67 cm.	68-69 cm.	70-72 cm.		

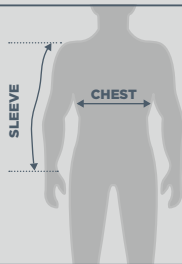

0022174.120.

TRANSPARENT

RAIN TRANSPARENT 3.0 JACKET

COMPOSITION:

- 100% chlorofibre

DETAILS:

- Transparent rain jacket
- Central zip closure
- Ventilation eyelets under the armpit
- Raglan sleeve cut
- Elastic on the bottom with contrast colour
- Custom ACERBIS logos



SIZES

S/M	code: .063	XXL	code: .069
L/XL	code: .067	3XL	code: .070

SIZES	S/M	L/XL	XXL	3XL		
Chest	90-101 cm.	101-116 cm.	116-123 cm.	123-129 cm.		
Sleeve	60-63 cm.	64-67 cm.	68-69 cm.	70-72 cm.		

RAIN TRANSPARENT 3.0 PANTS

COMPOSITION:

- 100% chlorofibre

DETAILS:

- Transparent rain pant
- Elastic on the waist with contrast colour
- Custom ACERBIS logos

COMPOSIZIONE:

- 100% clorofibra

DETTAGLI:

- Pantalone rain trasparente
- Elastico in vita colore a contrasto nero
- Presenza di loghi personalizzati ACERBIS



SIZES

S/M	code: .063	XXL	code: .069
L/XL	code: .067	3XL	code: .070

SIZES	S/M	L/XL	XXL	3XL		
Waist	79-89 cm.	89-99 cm.	99-104 cm.	104-107 cm.		
Hip	94-104 cm.	104-114 cm.	114-120 cm.	120-126 cm.		
Inseam	74-78 cm.	78-82 cm.	82-84 cm.	84-85 cm.		

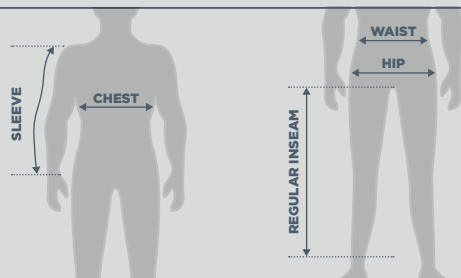

TRANSPARENT
 JACKET COD. 0022172.120.
 PANTS COD. 0022173.120.



RAIN TRANSPARENT 3.0 KID JACKET

COMPOSITION:

- 100% chlorofibre

DETAILS:

- Transparent rain jacket
- Central zip closure
- Ventilation eyelets under the armpit
- Raglan sleeve cut
- Elastic on the bottom with contrast colour
- Custom ACERBIS logos



SIZES

S/M	code: .063	XXL	code: .069
L/XL	code: .067		

SIZES	S/M	L/XL	XXL			
Chest	66-75 cm.	75-85 cm.	85-90 cm.			
Sleeve	43-51 cm.	51-58 cm.	58-60 cm.			

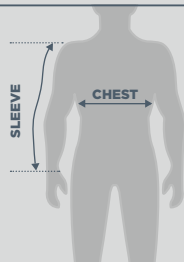

0023191.120.
TRANSPARENT

RAIN SET MAT-X 3.0

COMPOSITION:

- 100% Polyester.

DETAILS:

- Rain suit with jacket and pant
- Central zip closure and hook and loop fastener flap
- Adjustable waist with hook and loop fastener flap
- 2 front pockets
- Internal waistband on the bottom
- Reflective ACERBIS logo on the back
- Pant with elastic waist
- Pocket on right leg
- Bottom leg closure with hook and loop fastener flap
- Adjustable with zip on the bottom
- Reflective custom logos



SIZES

S	code: .062	XL	code: .068
M	code: .064	2XL	code: .069
L	code: .066	3XL	code: .070

SIZE	S	M	L	XL
Chest	95-98 cm.	98-105 cm.	105-109 cm.	109-113 cm.
Sleeve	61-63 cm.	63-65 cm.	65-67 cm.	67-68 cm.
SIZE	S	M	L	XL
Waist	80-84 cm.	84-88 cm.	88-92 cm.	92-96 cm.
Hip	95-99 cm.	99-103 cm.	103-107 cm.	107-111 cm.
Inseam	76-77 cm.	77-79 cm.	79-81 cm.	81-82 cm.

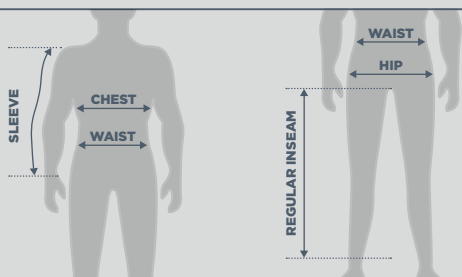

0022167.090.

BLACK



RAIN SUIT LOGO

COMPONENTS: 70% PVC, 30% polyester

MATERIALS:

Inner Polyester.

Outer Polyester and PVC.

DETAILS: Adjustable cuffs with elastic panel and hook and loop fastener.

Elastic material on the waist for better comfort.

Zip closure at the end of the pants for an easy fit.

REFLECTIVE FABRICS EN ISO 20471 APPROVED.

Waterproof pocket on the front of the jacket. Hooded zipper.

Ventilation and reflective details on the back of jacket.



SIZES

XS	code: .061	XL	code: .068
S	code: .062	XXL	code: .069
M	code: .064	3XL	code: .070
L	code: .066		

SIZES	XS	S	M	L	XL
Chest	92-95 cm.	95-98 cm.	98-105 cm.	105-109 cm.	109-113 cm.
Sleeve	60-61 cm.	61-63 cm.	63-65 cm.	65-67 cm.	67-68 cm.

SIZES	XS	S	M	L	XL
Waist	76-80 cm.	80-84 cm.	84-88 cm.	88-92 cm.	92-96 cm.
Hip	93-95 cm.	95-99 cm.	99-103 cm.	103-107 cm.	107-111 cm.
Inseam	75-76 cm.	76-77 cm.	77-79 cm.	79-81 cm.	81-82 cm.

SIZES	2XL	3XL
Chest	113-116 cm.	116-119 cm.
Sleeve	68-69 cm.	69-70 cm.

SIZES	2XL	3XL
Waist	96-100 cm.	100-104 cm.
Hip	111-115 cm.	115-119 cm.
Inseam	82-83 cm.	83-84 cm.

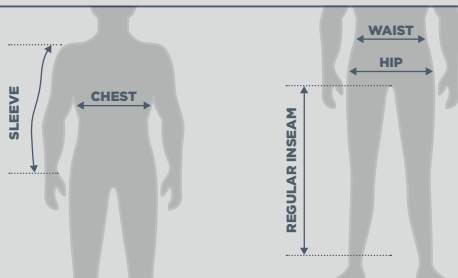

0016428.318.
FLUO YELLOW/BLACK



0016428.090.
BLACK

0016428.349.
RED/BLACK

ELETTRA RAIN JACKET

MATERIAL: 100% POLYESTER
285 GR.M²



Colorways Available:
see pictures in B2B



SIZES

4XS	code: .071	L	code: .066
3XS	code: .059	XL	code: .068
XXS	code: .060	XXL	code: .069
XS	code: .061	3XL	code: .070
S	code: .062	4XL	code: .076
M	code: .064		

CORPORATE RAINCOAT

MATERIAL: 100% POLYESTER



SIZES

M	code: .064	XL	code: .068
L	code: .066	XXL	code: .069

H2O RAIN GLOVES COVER

COMPONENTS: 100% Polyester

MATERIALS:

- Fabric in polyester: waterproof

DETAILS:

- Packable glove cover
- With opening and cuff elastic
- Seams totally taped
- Reflective Acerbis logo on the front

COMPOSIZIONE: 100% Poliestere

MATERIALI:

- Tessuto in poliestere: impermeabile

DETTAGLI:

- Copri guanto impacchettabile
- Con apertura e polso elastici
- Cuciture totalmente nastrate
- Logo Acerbis riflettente davanti



SIZES

S/M	code: .063	XXL	code: .069
L/XL	code: .067		



0910079.



0011506.090.

BLACK



0024256.090.

BLACK



H2O RAIN BOOT COVER

COMPONENTS: 80% Polyester 20% Rubber

MATERIALS:

- Fabric in polyester: waterproof
- Rubber sole: skidproof and flexible

DETAILS:

- Packable boot cover
- Openable on the side with rubber elastic, zip and hook and loop fastener
- Adjustable elastic on the foot
- Seams totally taped
- Reflective Acerbis logo and applications outside and back



SIZES

S (37-38)	code: .062	XL (43-44)	code: .068
M (39-40)	code: .064	2XL (45-46-47)	code: .069
L (41-42)	code: .066		

LIGHT RAIN BOOT COVER

COMPONENTS:

Shell: 100% Polyester;

Coating: 100% Polyurethan

MATERIALS:

- Light fabric in polyester: waterproof and breathable 10K/5K
- Color Fluo Yellow: it respects the norm **HIGH VISIBILITY (UNI EN ISO 20471:2017)**
- Reinforcement on the left boot cover for gear changing and sole.

DETAILS:

- Packable boot cover
- Boot cover opening and foot adjustable
- Seams totally taped
- Reflective Acerbis logo outside

COMPOSIZIONE:

Esterno: 100% Poliestere;

Rivestimento: 100% Poliuretano

MATERIALI:

- Tessuto leggero in poliestere: impermeabile e traspirante 10K/5K
- Colore Giallo Fluo: rispetta la normativa **ALTA VISIBILITA' (UNI EN ISO 20471:2017)**
- Rinforzo sul copristivale sinistro per il cambio. E per la suola.

DETTAGLI:

- Copri stivale impacchettabile
- Apertura copri stivale e caviglia regolabile
- Cuciture totalmente nastrate
- Logo Acerbis e applicazioni riflettenti sul lato esterno



SIZES

S (37-38)	code: .062	XL (43-44)	code: .068
M (39-40)	code: .064	2XL (45-46-47)	code: .069
L (41-42)	code: .066		



0024257.090.

BLACK



0023507.063.

FLUO YELLOW





GLOVES GUANTI

- P. 102** CE X-Enduro
- P. 103** Mx-Wp Homologated
- P. 104** Mx X-H
- P. 106** CE Mx X-K Kid
- P. 107** Palmino Underglove
- P. 108** CE Neoprene 3.0
- P. 109** CE Zero Degree 3.0
- P. 110** CE Adventure
- P. 111** CE Carbon "G" 3.0
- P. 112** CE X-Tour
- P. 113** CE Discovery
- P. 114** CE Ramsey Leather
- P. 115** CE Scrambler
- P. 116** CE X-Street
- P. 117** CE Urban WP 2
- P. 118** CE Ramsey My Vented



CE X-ENDURO GLOVES

COMPONENTS: 85% Polyester, 8% Neoprene, 5% Polyurethane, 2% Spandex.

MATERIALS:

- **Back of hand** Stretch fabric, Neoprene Insert, Soft rubber reinforcement
- **Palm** Single panel in AX[®] Suede Matmarket, double reinforcement on bottom. Outer reinforcement in synthetic leather, padding 3MM and inner reinforcement resistant to tearing and abrasion

DETAILS:

- Enduro fit
- **CERTIFIED GLOVES CE EN 13594:2015 Lev 1**
- Glove fit extremely precurved and comfortable without stitching on the fingertips
- Cuff regulation
- Rubber reinforcement over the back and fingers
- Silicon insert under the fingertips for a better grip
- Touch Screen Printing on index and thumb fingers
- Double reinforcement on bottom palm



0023993.090.

BLACK



SIZES

S	code: .062	XL	code: .068
M	code: .064	XXL	code: .069
L	code: .066	3XL	code: .070

SIZES	S	M	L	XL	XXL	3XL
Palm	17,7-20,2cm.	20,2-21,7cm.	21,7-23cm.	23-24,3cm.	24,3-25,6cm.	25,6-28,1cm.

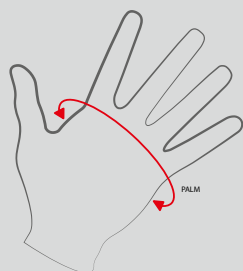

0023993.318.
BLACK/FLUO YELLOW



0023993.899.
GREY/DARK GREY

MX-WP HOMOLOGATED GLOVES

COMPONENTS: 57% Polyester, 40% Polyurethane, 3% Nylon.

MATERIALS:

- **Back of hand** Stretch fabric
- **Palm** Single panel in Nanofront®, Outer reinforcement in Synthetic leather, padding 3MM and inner reinforcement resistant to tearing and abrasion.
- **Lining** Waterproof and breathable HIPORA® membrane, fully taped seams.

DETAILS:

- Enduro fit.
- **CERTIFIED GLOVES CE EN 13594:2015 Lev 1**
- Glove with extreme precurved and comfortable fit without stitching on the fingertips.
- Cuff adjustment.
- Rubber reinforcement over the fingers.
- Silicon insert under the fingertips for a better grip.



SIZES

S	code: .062	XL	code: .068
M	code: .064	XXL	code: .069
L	code: .066		

SIZES	S	M	L	XL	XXL
Palm	17,7-20,2cm.	20,2-21,7cm.	21,7-23cm.	23-24,3cm.	24,3-25,6cm.

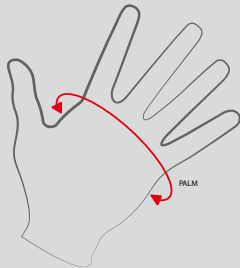

0023419.207.
ORANGE/GREY



0023419.293.
GREY/BLACK



0023419.426.
LIGHT BLUE/BLUE



0023419.318.
BLACK/FLUO YELLOW



MX X-H GLOVES

COMPONENTS: 70% Polyester, 20% Polyurethane, 10% Nylon.

MATERIALS:

- **Back of hand** Stretch fabric.
- **Palm** Single panel in Nanofront®, outer reinforcement in tear- and abrasion-resistant synthetic leather, 3 mm padding and tear- and abrasion-resistant inner reinforcement.

DETAILS:

- Enduro fit.
- **CERTIFIED GLOVES CE EN 13594:2015 Lev 1**
- Glove with extreme precurved and comfortable fit without stitching on the fingertips
- Cuff adjustment
- Rubber reinforcement over the fingers
- Touchscreen gloves



0023409.315.

BLACK/WHITE



NANOFONT®

SIZES

S	code: .062	XL	code: .068
M	code: .064	XXL	code: .069
L	code: .066		

SIZES	S	M	L	XL	XXL
Palm	17,7-20,2cm.	20,2-21,7cm.	21,7-23cm.	23-24,3cm.	24,3-25,6cm.

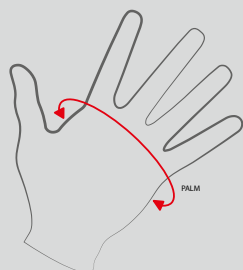

0023409.207.

ORANGE/GREY



0023409.249.

BLUE/GREY



0023409.347.

RED/GREY



0023409.291.

GREY/GREY



0023409.293.

GREY/BLACK



CE MX X-K KID GLOVES

COMPONENTS: 80% Polyester, 10% Polyurethane, 10% Nylon.

MATERIALS:

- **Back of hand** Stretch fabric, Soft rubber reinforcement
- **Palm** Single panel in Nanofront Outer reinforcement synthetic leather, padding 3MM and inner reinforcement resistant to tearing and abrasion

DETAILS:

- Enduro fit
- **CERTIFIED GLOVES CE EN 13594:2015 Lev 1**
- Glove fit extremely precurved and comfortable without stitching on the fingertips
- Cuff regulation
- Rubber reinforcement over the fingers
- Touchscreen Gloves



SIZES

XS	code: .061	L	code: .066
S	code: .062	XL	code: .068
M	code: .064	XXL	code: .069

SIZES	XS	S	M	L	XL	XXL
Palm	13,5-14,5cm.	14,5-15,5cm.	15,5-16,5cm.	16,5-17,5cm.	17,5-18,5cm.	18,5-19,5cm.
Kid Age	3/4 years	5/6 years	7/8 years	9/10 years	11/12 years	13/14 years

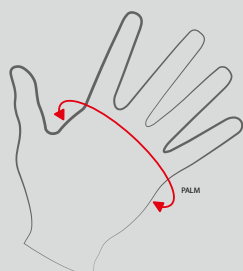

0024281.207.
ORANGE/GREY



0024281.249.
BLUE/GREY



0024281.899.
GREY/DARK GREY



0024281.293.
GREY/BLACK

PALMINO UNDERGLOVE

COMPONENTS:

- 60% Polyester; 40% Neoprene

DETAILS:

- Made using a thin material
- Perfect for protecting against blisters and for absorbing vibrations from the handlebars



SIZES

S/M	code: .063	L/XL	code: .067
------------	-------------------	-------------	-------------------



0022717.010.

ORANGE



0022717.040.

BLUE



0022717.090.

BLACK



0022717.110.

RED

CE NEOPRENE 3.0 GLOVES

COMPOSITION:

37% Nylon, 30% Polyester, 30% Neoprene, 3% Polyurethane

MATERIALS:

Back hand:

- Neoprene with digital printing features

Palm:

- Single panel in Synthetic Leather, double reinforcement on bottom
- Outer reinforcement in synthetic leather, padding 3MM and inner reinforcement resistant to tearing and abrasion

DETTAGLI: Enduro fit

• CERTIFIED GLOVES CE EN 13594:2015 Lev 1

- Glove fit extremely precurved and comfortable without stitching on the fingertips
- Cuff regulation
- Touch Screen Printing on index and thumb fingers
- Refractive Insert on outer side of little finger
- Double reinforcement on bottom palm



SIZES

S	code: .062	XL	code: .068
M	code: .064	XXL	code: .069
L	code: .066	3XL	code: .070

SIZES	S	M	L	XL	XXL	3XL
Palm	17,7-20,2cm	20,2-21,7cm	21,7-23cm	23-24,3cm	24,3-25,6cm	25,6-28,1cm

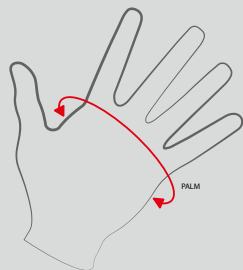

0024283.318.

BLACK/FLUO YELLOW



0024283.319.

BLACK/GREY

CE ZERO DEGREE 3.0 GLOVES

COMPOSITION:

65% Polyester, 32% Nylon, 3% Polyurethane

MATERIALS:

Back hand:

- No-wind fabric with digital printing features

Palm:

- Single panel in Synthetic Leather, double reinforcement on bottom
- Outer reinforcement in synthetic leather, padding 3MM and inner reinforcement resistant to tearing and abrasion

DETAILS:

Enduro fit

• CERTIFIED GLOVES CE EN 13594:2015 Lev 1

- Glove fit extremely precurved and comfortable without stitching on the fingertips
- Cuff regulation
- Touch Screen Printing on index and thumb fingers
- Refractive Insert on outer side of little finger
- Double reinforcement on bottom palm



0024282.318.

BLACK/FLUO YELLOW



SIZES

S	code: .062	XL	code: .068
M	code: .064	XXL	code: .069
L	code: .066	3XL	code: .070

SIZES	S	M	L	XL	XXL	3XL
Palm	17,7-20,2cm.	20,2-21,7cm.	21,7-23cm.	23-24,3cm.	24,3-25,6cm.	25,6-28,1cm.

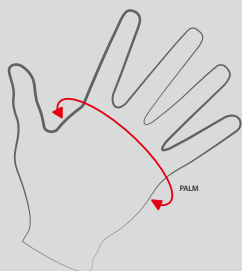

0024282.319.

BLACK/GREY



CE ADVENTURE GLOVES

COMPOSITION:

BLACK 090 43% Nylon, 32% Polyurethane, 23% Polyester, 2% Neoprene
BLACK/GREY 319 50% Polyester, 25% Nylon, 23% Polyurethane, 2% Neoprene

MATERIALS:

Backhand: Highly abrasion-resistant fabric

Palm: Single panel in Nanofront

DETAILS:

• CERTIFIED GLOVES EN 13594:2015 Lev 1 KP

- Touchscreen gloves
- Foam reinforcement on palm and on the back of the thumb
- Reinforcement on fingers
- Protection on knuckles
- Gloves combined to the ADVENTURE suit



NANOFRONT® **Carino™**

SIZES

S	code: .062	XL	code: .068
M	code: .064	XXL	code: .069
L	code: .066		

SIZES	S	M	L	XL	XXL
Palm	17,7-20,2cm.	20,2-21,7cm.	21,7-23cm.	23-24,3cm.	24,3-25,6cm.

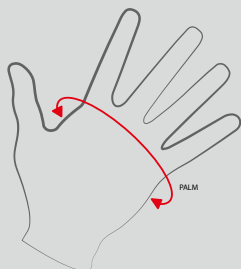

0023487.319.
BLACK/GREY



0023487.090.
BLACK

CE CARBON "G" 3.0 GLOVES

COMPOSITION:

- 40% Polyester; 30% Nylon; 10% Polyurethane; 10% Neoprene; 10% Goat Leather

MATERIALS:

Backhand: Neoprene panel

Palm: Single panel in vented Nanofront

DETAILS:

- **CERTIFIED GLOVES CE EN 13594:2015 Lev 1 KP**
- Silicone inserts on fingertips to get the maximum grip
- No seams on fingertips
- Wrist closure with soft rubber patches
- Carbon effect protection knuckles
- Soft rubber reinforcements on fingers
- Reflective piping
- Use of fluo colours
- Touchscreen gloves.



NANOFRONT *Carino*™

SIZES

S	code: .062	XL	code: .068
M	code: .064	XXL	code: .069
L	code: .066		

SIZES	S	M	L	XL	XXL	
Palm	17,7-20,2cm.	20,2-21,7cm.	21,7-23cm.	23-24,3cm.	24,3-25,6cm.	

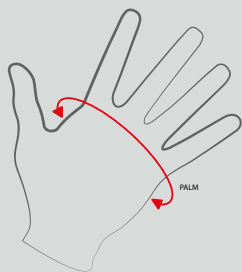

0022214.279.

FLUO YELLOW/BLACK



0022214.319.

BLACK/GREY



CE X-TOUR GLOVES

COMPONENTS:

70% Polyester, 20% Nylon, 10% Elastane

MATERIALS:

Back of hand: Water Repellent Nylon Rib stop fabric

Palm:

- Single panel in Synthetic Leather AX® Suede Matmarket, double reinforcement on bottom
- Outer reinforcement in synthetic leather, padding 3mm and inner reinforcement resistant to tearing and abrasion

DETAILS:

- Touring fit
- **CERTIFIED GLOVES CE EN 13594:2015 Lev 1 KP**
- The glove also passed the Impact Test on knuckle (KP)
- Glove fit extremely precurved and comfortable
- Inner Hipora® Membrane for waterproof glove
- Thinsulate™ 100gr Padding for cold season
- Personalized Knuckle protector
- Rubber Wiping System on index finger to clean the visor
- Double Cuff regulation
- Silicon printing on palm, on fingertips and on inside index finger in the area grips for better grip
- Touch Screen Insert on index and thumb fingers
- Reflective Insert on back and thumb
- Double reinforcement on bottom palm
- Personalised Slider on palm



HIPORA® 3M **Thinsulate**
INSULATION

SIZES

S	code: .062	XL	code: .068
M	code: .064	XXL	code: .069
L	code: .066	3XL	code: .070

SIZES	S	M	L	XL	XXL	3XL
Palm	17,7-20,2cm.	20,2-21,7cm.	21,7-23cm.	23-24,3cm.	24,3-25,6cm.	25,6-28,1cm.

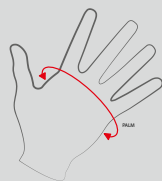

0023986.090.

BLACK

CE DISCOVERY GLOVES

COMPONENTS:

85% Polyester, 10% Elastane, 5% Nylon

MATERIALS:

Back hand:

- Water Repellent Softshell fabric

Palm:

- Single panel in Synthetic Leather AX® Suede Matmarket, double reinforcement on bottom
- Outer reinforcement in synthetic leather, padding 3mm and inner reinforcement resistant to tearing and abrasion

DETAILS: Touring fit

• CERTIFIED GLOVES CE EN 13594:2015 Lev 1 KP

- The glove also passed the Impact Test on knuckle (KP)
- Glove fit extremely precurved and comfortable
- Inner Hipora® Membrane for waterproof glove
- Personalized Knuckle protector
- Cuff regulation
- Silicon printing on fingertips and on inside index finger in the area grips for better grip
- Touch Screen Insert on index and thumb fingers
- Refractive Insert on outer side of the glove
- Double reinforcement on bottom palm
- Personalised Rubber Slider on palm



HIPORA®

SIZES

S	code: .062	XL	code: .068
M	code: .064	XXL	code: .069
L	code: .066	3XL	code: .070

SIZES	S	M	L	XL	XXL	3XL
Palm	17,7-20,2cm.	20,2-21,7cm.	21,7-23cm.	23-24,3cm.	24,3-25,6cm.	25,6-28,1cm.

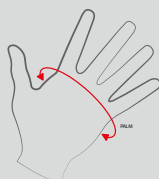

0023987.090.

BLACK



CE RAMSEY LEATHER GLOVES

COMPONENTS:

65% Goat Leather, 20% Neoprene, 15% Polyurethane

MATERIALS:

Back hand:

- Goat Leather, Beathable Mesh Insert, ABS reinforcement

Palm:

- Panels in Goat Leather
- Outer reinforcement in synthetic leather, padding 3MM and inner reinforcement resistant to tearing and abrasion

DETAILS: Sport fit

- **CERTIFIED GLOVES CE EN 13594:2015 Lev 1 KP**
- The glove also passed the Impact Test on knuckle (KP)
- Glove fit extremely precurved and comfortable
- Cuff regulation
- ABS reinforcement on knuckle and rubber padding over the fingers
- Touch Screen Inserts on index and thumb finger
- Double reinforcement on bottom palm

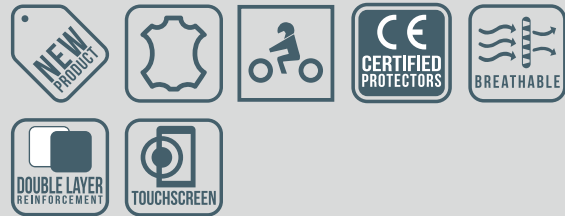

SIZES			
S	code: .062	XL	code: .068
M	code: .064	XXL	code: .069
L	code: .066	3XL	code: .070

SIZES	S	M	L	XL	XXL	3XL
Palm	17,7-20,2cm.	20,2-21,7cm.	21,7-23cm.	23-24,3cm.	24,3-25,6cm.	25,6-28,1cm.

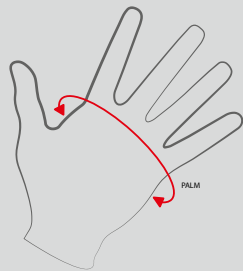

0024360.090.
BLACK

CE SCRAMBLER GLOVES

COMPONENTS:

60% Polyester, 30% Nylon, 10% Spandex

MATERIALS:

Back hand:

- Water Repellent Nylon Rib stop fabric

Palm:

- Single panel in Synthetic Leather AX® Suede Matmarket double reinforcement on bottom
- Outer reinforcement in synthetic leather, padding 3mm and inner reinforcement resistant to tearing and abrasion

DETAILS: Sport fit

• CERTIFIED GLOVES CE EN 13594:2015 Lev 1 KP

- The glove also passed the Impact Test on knuckle (KP)
- Glove fit extremely precurved and comfortable
- Cuff regulation
- Touch Screen Insert on index and thumb fingers
- Reflective Print on back
- Double reinforcement on bottom palm



0024265.318.

BLACK/FLUO YELLOW



SIZES

S	code: .062	XL	code: .068
M	code: .064	XXL	code: .069
L	code: .066	3XL	code: .070

SIZES	S	M	L	XL	XXL	3XL
Palm	17,7-20,2cm.	20,2-21,7cm.	21,7-23cm.	23-24,3cm.	24,3-25,6cm.	25,6-28,1cm.

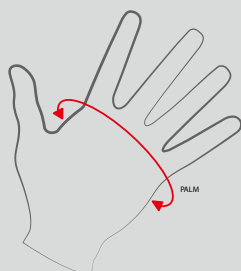

0024265.319.

BLACK/GREY



CE X-STREET GLOVES

COMPONENTS: 45% Polyester, 40% Nylon, 15% Elastane

MATERIALS:

Back hand:

- Stretch spandex fabric

Palm:

- Single panel in Synthetic Leather AX® Suede Matmarket double reinforcement on bottom
- Outer reinforcement in synthetic leather, padding 3mm and inner reinforcement resistant to tearing and abrasion

DETAILS: Sport fit

- **CERTIFIED GLOVES CE EN 13594:2015 Lev 1 KP**
- The glove also passed the Impact Test on knuckle (KP)
- Glove fit extremely precurved and comfortable
- Personalized Knuckle protector
- Cuff regulation
- Silicon printing on fingertips for better grip
- Touch Screen Insert on index and thumb figers
- Double reinforcement on bottom palm
- Personalised Slider on palm



SIZES

S	code: .062	XL	code: .068
M	code: .064	XXL	code: .069
L	code: .066	3XL	code: .070

SIZES	S	M	L	XL	XXL	3XL
Palm	17,7-20,2cm.	20,2-21,7cm.	21,7-23cm.	23-24,3cm.	24,3-25,6cm.	25,6-28,1cm.

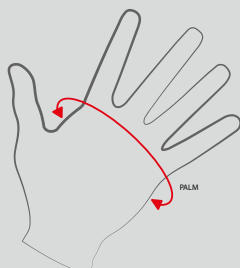

0024019.090.

BLACK

CE URBAN WP 2 GLOVES

COMPONENTS:

80% Nylon, 20% Polyurethane

MATERIALS:

Back hand:

- Water Repellent Nylon fabric

Palm:

- Single panel in Synthetic Leather AX® Suede Matmarket double reinforcement on bottom
- Outer reinforcement in synthetic leather, padding 3mm and inner reinforcement resistant to tearing and abrasion

DETAILS: Sport fit

- **CERTIFIED GLOVES CE EN 13594:2015 Lev 1**
- Glove fit extremely precurved and comfortable
- Inner Hipora® Membrane for waterproof glove
- Cuff regulation
- Silicon printing on fingertips for better grip
- Touch Screen Insert on index and thumb fingers
- Double reinforcement on bottom palm



SIZES

S	code: .062	XL	code: .068
M	code: .064	XXL	code: .069
L	code: .066	3XL	code: .070

SIZES	S	M	L	XL	XXL	3XL
Palm	17,7-20,2cm.	20,2-21,7cm.	21,7-23cm.	23-24,3cm.	24,3-25,6cm.	25,6-28,1cm.

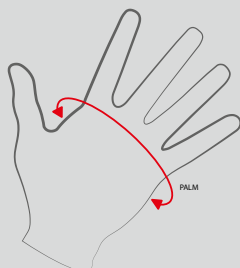

0024018.090.

BLACK

CE RAMSEY MY VENTED GLOVES

COMPONENTS:

70% Polyester, 25% Polyurethane, 5% Neoprene

MATERIALS:

Back of hand Synthetic leather and mesh.

Palm Synthetic leather.

DETAILS:

- **CERTIFIED GLOVES EN 13594:2015 Lev 1 KP**
- Extremely breathable thanks to the mesh on the back and on the fingers' sides
- Pre-curved fit
- Palm and fingers tips made of a synthetic leather single panel
- Padding on the back of the fingers
- Carbon look ABS reinforcements on the knuckles
- Wrist closure through soft rubber strap
- Rubber personalization on the back of the wrist
- Available in 3 color ways to match the Ramsey My Vented Jacket
- Gloves for motorcycle use
- Touch Screen Insert on index finger and thumb
- Double reinforcement on palm for abrasion resistance.



0023478.318.

BLACK/FLUO YELLOW



SIZES

S	code: .062	XL	code: .068
M	code: .064	XXL	code: .069
L	code: .066	3XL	code: .070



0023478.090.

BLACK



0023478.110.

RED

SIZES	S	M	L	XL	XXL	3XL
Palm	17,7-20,2cm.	20,2-21,7cm.	21,7-23cm.	23-24,3cm.	24,3-25,6cm.	25,6-28,1cm.

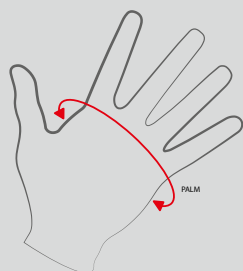



BOOTS STIVALI

- P. 122 X-Rock MM
- P. 124 X-Race
- P. 126 E-Team All Black
- P. 128 X-Team
- P. 131 X-Team Kid
- P. 132 X-Stradhu
- P. 133 Asphalt Boots
- P. 134 Step Shoes
- P. 134 Key Sneaker
- P. 135 OOSet Boots
- P. 135 X-Kal Shoes





X-ROCK MM BOOTS

MATERIALS:

Real Leather 3%, Microfiber 26%, Rubber 13%,
Alluminium 2%, TPU 55%, Others 1%

DETAILS:

- Cut and abrasion-resistant leather and microfiber uppers.
- Hinge in the ankle area.
- Protection of the shinbone with upper and lower anatomically-shaped shin guards.
- Shaped heel guard to make changing gears easier when starting.
- Protection of the midfoot and toe area in plastic with ribbing for improved impact absorption.
- TPU Insert in differentiated density in the gear change area for maximum control.
- Burn Guard Grip in heat and wear-resistant vulcanized rubber.
- Fastens with 4 buckles with large, new aluminum levers.
- Shin gaiters in permeable microfiber.
- **Vibram® wear-resistant sole in shock-proof "Double Composite" rubber EN 13634:2010 certified.**
- Shock absorbing antibacterial insole with multilayered structure.
- Inner made of 3D Mesh for optimum comfort and sweat absorption.
- Insole made of composite plastic/steel material to guarantee greater rigidity and absorption of the foot against compression impacts Reinforced steel toe.
- **EN 13634: 2017 CERTIFIED.**



SIZES

39	code: .039	44	code: .044
40	code: .040	45	code: .045
41	code: .041	46	code: .046
42	code: .042	47	code: .047
43	code: .043		

REPLACEMENTS

name	code
STRAPS SET	0022442
BUCKLE KIT	0022443
RECEIVER	0023486
TOE PLATE	0013781
SOLE	0024539

see pictures in b2b system

0024289.030.

WHITE





0024289.090.
BLACK



0024289.319.
BLACK/GREY



X-RACE BOOTS

MATERIALS:

Action Leather 41%, Cow Suede 10%, Tpu 34%, Fabric 15%

DETAILS:

- Lightweight, protective, anatomical boot
- Cut and abrasion resistant leather and microfibre upper
- Hinge in the ankle area between the protection of midfoot and calf cuff ensuring rotational flexibility of the foot and axial leg control
- Protection of the shin bone with anatomically-shaped and reinforced shin guards
- Shaped heel guard to speed up gear shifting when starting
- Midfoot protection and extended toe cap on the inside and outside made of plastic with ribbing for improved impact absorption.
- Differentiated texture in the gear shifting area for maximum control during gear changes
- Grip Burn Guard in heat and wear resistant suede leather
- Fastens with 4 large aluminium levers
- Soft and enveloping microfibre shin gaiter
- Unidirectional upper hook and loop fastener allowing a perfect fit of the gaiter to the leg, by simply closing the upper lever
- Exclusive Acerbis shock proof sole, resistant to oils, gasoline and wear: "Double Composite" ensuring extraordinary control when in contact with the footrests
- Wider sole surface area for increased grip on the footrests
- Antibacterial shock absorbing pre-shape insole
- Inner material in 3d Mesh for excellent comfort and ventilation
- Foam padding around the ankles
- Reinforced steel toe
- **CERTIFICATION EN 13634: 2017**



SIZES

39	code: .039	44	code: .044
40	code: .040	45	code: .045
41	code: .041	46	code: .046
42	code: .042	47	code: .047
43	code: .043		

REPLACEMENTS

name	code
BUCKLE KIT	0024379
RECEIVER	0024380
STRAPS SET	0024378
TOE PLATE	0024381
SOLE	0024539

see pictures in b2b system

0024359.070.

GREY



0024359.090.
BLACK



0024359.207.
ORANGE/GREY



0024359.249.
BLUE/GREY



0024359.347.
RED/GREY



E-TEAM ALL BLACK BOOTS

MATERIALS:

Micro Fabric 30%, Tpu 15%, Tpr 3%, Polyurethane 21%, Air Mesh 18%, Jersey 7%, Bk Mesh 3%, Rubber 3%

DETAILS:

- Protective form-fitting boot that offers extreme lightness
- Upper resistant to cutting and abrasion
- Heel protection made of elastomeric material for greater comfort and shock absorption
- Differentiated structure TPU inserts in the tibia, ankle and gear-changing areas for maximum protection
- 4-clasp closure with buckles for micrometric adjustment and hook and loop fastener on the gaiter
- Suede material heat protection
- Gaiter and tibial folds in soft microfiber which is resistant to cutting and abrasion.
- Exclusive Acerbis shock proof sole, resistant to oils, gasoline and wear: "Double Composite" ensuring extraordinary control when in contact with the footrests
- Inner material in 3d Mesh for excellent comfort and perspiration absorption
- **CERTIFICATION EN 13634: 2017**



SIZES

41	code: .041	44	code: .044
42	code: .042	45	code: .045
43	code: .043	46	code: .046

REPLACEMENTS

name	code
STRAPS SET	0023289

see pictures in b2b system

0024551.090.

BLACK



X-TEAM BOOTS

MATERIALS:

Micro Fabric 30%, Tpu 15%, Tpr 3%, Polyurethane 21%, Air Mesh 18%
Jersey 7%, Bk Mesh 3%, Rubber 3%

DETAILS:

- Protective boots that are extremely lightweight
- Cut and abrasion-resistant uppers
- Heel protection in elastomeric material for improved comfort and shock absorption
- Differentiated structure TPU inserts in the area of the tibia, ankle and gear-change for maximum protection
- 4-clasp fastening with buckles for micrometric adjustment and hook and loop fastener on the gaiter.
- Heat protection in suede
- Gaiter and tibial folds in soft cut and abrasion-proof microfiber
- Highly abrasion-resistant dual-density rubber sole
- Interior made of 3D Mesh for improved comfort and sweat absorption
- **CERTIFICATION EN 13634: 2017**



SIZES

39	code: .039	44	code: .044
40	code: .040	45	code: .045
41	code: .041	46	code: .046
42	code: .042	47	code: .047
43	code: .043		

REPLACEMENTS

name	code
STRAPS SET	0023289

see pictures in b2b system

0022999.315.

BLACK/WHITE



0022999.319.
BLACK/GREY



0022999.305.
BROWN/GREY



0022999.243.
BLUE/ORANGE



0022999.030.
WHITE



0022999.343.
RED/WHITE



0022999.290.
GREY/YELLOW





0022999.245.
BLUE/WHITE



0022999.203.
ORANGE/WHITE



X-TEAM KID BOOTS

MATERIALS:

Micro Fabric 30%, Tpu 15%, Tpr 3%, Polyurethane 21%, Air Mesh 18%
Jersey 7%, Bk Mesh 3%, Rubber 3%

DETAILS:

- Protective boots that are extremely lightweight
- Cut and abrasion-resistant uppers
- Heel protection in elastomeric material for improved comfort and shock absorption
- Differentiated structure TPU inserts in the area of the tibia, ankle and gear-change for maximum protection
- 3-clasp fastening with buckles for micrometric adjustment and hook and loop fastener on the gaiter
- Heat protection in suede
- Gaiter and tibial folds in soft cut and abrasion-proof microfiber
- Highly abrasion-resistant dual-density rubber sole
- Interior made of 3D Mesh for improved comfort and sweat absorption
- **CERTIFICATION EN 13634: 2017** - fully exceeds the 3 homologation levels (LEVEL 2)



0024249.207.

ORANGE/GREY



0024249.249.

BLUE/GREY

SIZES

33	code: .033	37	code: .037
34	code: .034	38	code: .038
35	code: .035	39	code: .039
36	code: .036		



SIZE	A (cm)	B (cm)
33	31	27
34	31	27
35	31	27
36	32,5	28,5
37	32,5	28,5
38	32,5	28,5
39	32,5	28,5



0024249.319.

BLACK/GREY

REPLACEMENTS

name	code
STRAPS SET	0024538

see pictures in b2b system



X-STRADHU BOOTS

MATERIALS:

Leather 57%, Polyurethane 17%, Microfiber 17%, Tpu 9%

DETAILS:

- Touring or road/dualroad leather boot.
- New rubber sole design with specific grip areas, oil and petrol resistant. Characterised by a special compound providing extra stability and grip on all types of terrain.
- 2 plastic hooks with micro metrically adjustable straps and adjustable top hook and loop fastener fastener.
- Abrasion-resistant heat protection.
- Injection moulded pre-bent shin bone protection
- Plastic lever guards
- Waterproof and breathable inner membrane.
- Ankle, toe cap and heel protection
- Reflective inserts on the back of the boot
- Anatomical and removable insole
- **CERTIFICATION EN 13634:2017**



SIZES

39	code: .039	44	code: .044
40	code: .040	45	code: .045
41	code: .041	46	code: .046
42	code: .042	47	code: .047
43	code: .043		



REPLACEMENTS

name	code
STRAPS SET	0023289

see pictures in b2b system

0024316.090.

BLACK

ASFALT BOOTS

MATERIALS:

Rubber 100%, Microfiber Leather 79%
Mesh 15%, Rubber 5%, Nylon 1%

DETAILS:

- Touring fit
- Waterproof membrane
- Hypoallergenic fabric lining
- Reinforced protection for shin, Ankle, & heels
- TPU inserts
- YKK zipper and hook and loop fastener closure
- **CERTIFIED EN 13634:2017**



SIZES

37	code: .037	43	code: .043
38	code: .038	44	code: .044
39	code: .039	45	code: .045
40	code: .040	46	code: .046
41	code: .041	47	code: .047
42	code: .042		



0023927.090.

BLACK



STEP SHOES

MATERIALS:

Microfabric Leather 57%, Rubber 29%, Air Mesh 12%, PVC 1%, Polypropylene 1%

DETAILS:

- Suede synthetic leather bike shoes
- 100% waterproof
- Ankle and toes protection inserts
- Extra resistance tissue at shifter
- Anti slip sole
- Soft hypoallergenic inner liner
- Resistant to oil and petrol abrasion
- **Certified EN13634:2017**



SIZES

40	code: .040	44	code: .044
41	code: .041	45	code: .045
42	code: .042	46	code: .046
43	code: .043	47	code: .047

KEY SNEAKER

MATERIALS:

50% Nylon; 25% Real leather; 25% Polyurethane

DETAILS:

- Snakers shoes ergonomic with technical and sport details
- Reflective insert on sides
- Ventilation through side zipper
- Suede synthetic leather insert in the toe area
- Iron texture insert reinforcement
- Double closure with string and hook and loop fastener strap



SIZES

41	code: .041	44	code: .044
42	code: .042	45	code: .045
43	code: .043	46	code: .046



0023928.090.

BLACK



0021896.070.

GREY

OOSET BOOTS

MATERIALS:

Pvc 95%, Others 5%

DETAILS:

- EN ISO 20345:2011 certified
- Water, mud, oil and grease protection
- Maximum protection against crushing of the toes thanks to the steel cap and maximum protection against penetration
- Outsole with grip



SIZES

40	code: .040	44	code: .044
41	code: .041	45	code: .045
42	code: .042	46	code: .046
43	code: .043	47	code: .047

X-KAL SHOES

MATERIALS:

Upper 80% Polyester; 10% Synthetic; 10% TPU

Lining 100% Polyester

Insole 100% Polyester

Outsole 80% Phylon + 20% TPR

DETAILS:

- Jacquard Seamless upper shoes with personalized design
- Thermoformed and Perforated Insole with Breathable Mesh
- Sole with Rubber insert in areas with increased wear



SIZES

41	code: .041	44	code: .044
42	code: .042	45	code: .045
43	code: .043	46	code: .046



0023859.060.

YELLOW



0023613.030.

WHITE



0023613.090.

BLACK



PROTECTIONS

PROTEZIONI

- P. 138** Galaxy Body Armour
- P. 140** Jump Mx Chest Protector
- P. 140** Galaxy Jacket
- P. 142** Specktrum Lev 2 Body Armour
- P. 144** Plasma Lev 2 Body Armour
- P. 146** X-Fit Future Lev 2 Body Armour
- P. 147** Scudo 3.0 Body Armour
- P. 147** Koerta 2.0 Body Armour
- P. 148** X-Air Lev 2 Body Armour
- P. 149** X-Air Lev 2Vest
- P. 150** Gravity Lev 2 Body Armour
- P. 151** Gravity Body Armour
- P. 152** Profile Chest Protector
- P. 153** Pulsar Back Protector
- P. 154** Back Comfort 2.0 Back Protector
- P. 155** Blazar Back Protector
- P. 156** Gorilla Lev 2 Knee Guards
- P. 157** X- Strong Lev 2 Knee Guards
- P. 158** Impact Evo 3.0 Knee Guards
- P. 158** Profile 2.0 Knee Guards
- P. 159** X-Zip Knee Guards
- P. 160** Soft 3.0 Elbow Guards
- P. 160** Soft 3.0 Knee Guards
- P. 161** X-Fit Future Lev 2 Kid Body Armour
- P. 162** Specktrum Kid Body Armour
- P. 163** Scudo Junior 2.0 Body Armour
- P. 164** Gravity Kid Lev 2 Body Armour
- P. 165** Gravity Kid Roost Reflector
- P. 166** Impact Junior Knee Guards
- P. 166** Profile 2.0 Junior Knee Guards
- P. 167** Soft Kid Elbow Guard
- P. 167** Soft Kid Knee Guards
- P. 168** Moto Brand 2.0 Belt
- P. 168** Moto Brand 2.0 Junior Belt
- P. 168** Profile 2.0 Belt
- P. 169** K-Belt Belt
- P. 169** X-Roll
- P. 169** X-Roll Junior
- P. 170** X-Round Collar
- P. 170** X-Round Kid Collar
- P. 171** Soft Rush Pants
- P. 172** X-Fit Pants L Riding Pants
- P. 173** X-Fit Pants S Riding Pants
- P. 174** Windstopper Technical Undergear
- P. 175** Evo Technical Undergear
- P. 175** Evo Pants Undergear
- P. 175** Evo Shorts Undergear
- P. 176** X-Knee Geco Underwear Reinforcement
- P. 176** Tube Knee Leech Reinforcement
- P. 177** Elastic Socks
- P. 177** X-Leg Pro Socks
- P. 178** No Wet Socks
- P. 178** Mx Pro Socks
- P. 179** Mx Impact Socks
- P. 179** Mx Impact Junior Socks
- P. 180** Ultra Socks
- P. 181** Cotton Socks
- P. 181** Sport Socks





GALAXY BODY ARMOUR

MATERIALS:

Polyurethane 45%, Polypropylene 30%, Polyester 11%, Spandex 3%, Steel 3%, Aluminium 2%, Nylon 3%, Rubber 2%, Others 1%

DETAILS:

- Innovative nest-texture for the plastic parts: ventilation and protection guaranteed.
- Solid plates enclosed in a soft memory foam for a better shock-absorbing protection.
- Front/Back protection and lower plate removable, to accommodate the Neck brace.
- Shoulder band closure with hook and loop fastener adjustments
- Coccyx-shield removable cover.
- Waist band closure with hook and loop fastener adjustments
- **CHEST PROTECTION IS EN 1621-3/2017 CERTIFIED**
- **BACK PROTECTION IS EN 1621-2/2014 LEVEL 2 CERTIFIED**
- Extra insert for hips protection
- Separated elastic body armour for maximum ventilation, with **CERTIFIED (1621/1) REMOVABLE SHOULDER AND ELBOW PADS** made of memory foam
- Side YKK zipper

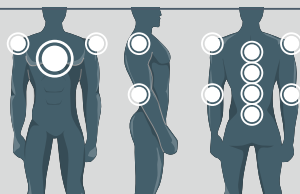

6 PROTECTIVE AREAS

SIZES

S/M	160-175 cm - 65/75 Kg	code: .063
L/XL	175-190 cm - 75/90 Kg	code: .067
XXL	190-200 cm - 90/105 Kg	code: .069

0023731.293.

GREY/BLACK



0023731.232.
WHITE/BLUE

0023731.237.
WHITE/BLACK



JUMP MX CHEST PROTECTOR

MATERIALS:

Polyurethane 41%, Polypropylene 36%, Polyester 5%, Spandex 2%, Steel 6%, Aluminium 4%, Nylon 2%, Rubber 1%, Others 3%

DETAILS:

- Innovative nest-texture for the plastic parts: ventilation and protection guaranteed.
- Solid plates enclosed in a soft memory foam for a better shock-absorbing protection.
- Front/Back protection and lower plate removable, to accommodate the Neck brace.
- Shoulder band closure with hook and loop fastener adjustments
- Coccyx-shield removable cover.
- Waist band closure with hook and loop fastener adjustments
- **CHEST PROTECTION IS EN 1621-3/2017 CERTIFIED**
- **BACK PROTECTION IS EN 1621-2/2014 LEVEL 2 CERTIFIED**
- Extra insert for hips protection



SIZES

ONE SIZE height 160 - 200cm weight 65 - 105kg

GALAXY JACKET

MATERIALS:

Polyurethane 42%, Polyester 40%, Spandex 9%, Nylon 7%, Rubber 2%

DETAILS:

- Separated elastic body armour for maximum ventilation, with **CERTIFIED (1621/1) REMOVABLE SHOULDER AND ELBOW PADS** made of memory foam
- Side YKK zipper



SIZES

S/M	160-175 cm - 65/75 Kg	code: .063
L/XL	175-190 cm - 75/90 Kg	code: .067
XXL	190-200 cm - 90/105 Kg	code: .069



0023729.293.
GREY/BLACK



0023729.237.
WHITE/BLACK



0023729.232.
WHITE/BLUE



0023730.293.
GREY/BLACK



SPEKTRUM LEVEL 2 BODY ARMOUR

COMPONENTS:

Polypropylene 38%, EVA 33%, Polyurethane 20%, Polyester 3%, Spandex 2%
Aluminium 2%, Steel 1%, Others 1%

MANUFACTURING AND DESIGN:

- innovative nest-texture for plastic parts: ventilation, protection, light weight
- plastic plates adapting to the body, fitted on soft biofoam, for a better shock-absorbing protection and body-fitting
- the innovative design combines the light weight/ventilation of a cross chest protector and a body armour protection: the shoulder and elbow protectors are fitted on sleeves of perforated stretch fabric, designed to guarantee high breathability and adherence to the arms. The sleeves themselves are attached to the padded shoulder straps of the chest protector, leaving the hips free of fabric to increase heat exchange and breathability.
- Waist elastic band
- removable back and front protection to accommodate the neck-brace
- adaptability to different body sizes thanks to adjustments on the sides and waistband

BODY PROTECTION:

- chest protection with EN 1621-3 CE LEVEL 2 approval
- back protector with EN 1621-2 CE LEVEL 2 approval
- shoulder and elbow protection extended in soft material with EN 1621-1 approval
- semi-rigid hip protectors with stone shield approval EN 14021:2003

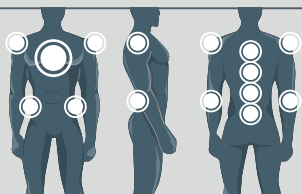

8 PROTECTIVE AREAS

SIZES

S/M	160-175 cm - 65/75 Kg	code: .063
L/XL	175-190 cm - 75/90 Kg	code: .067
XXL	190-200 cm - 90/105 Kg	code: .069

0024510.318.

BLACK/FLUO YELLOW



PLASMA LEVEL 2 BODY ARMOUR

MATERIALS:

EVA 55%, Polyurethane 25%, Polyester 12%, Spandex 6%, Nylon 1%, Others 1%

MANUFACTURING AND DESIGN:

- Innovative multi-layer soft materials with high impact absorption: ventilation, protection, lightness, and flexibility.
- The soft torso protectors adapt to the body, three viscoelastic layers are bound by semi-rigid external biofoam, providing better shock absorbing protection, fitting and wear resistance.
- The innovative design combines the versatility of a cross chest protector and the extended and enhanced protection of a body armour: the removable shoulder and elbow protectors, are fitted with perforated stretch fabric sleeves, designed to ensure high breathability and adherence to the arms. The sleeves themselves are attached to the padded shoulder straps of the chest protector, leaving the hips free of fabric to increase heat exchange and breathability.
- Waist elastic band
- The low thickness and the softness of the torso and back protection are designed to accommodate the neck-brace.
- adaptability to different body sizes thanks to elastic adjustments on the sides and waistband

BODY PROTECTION:

- chest protection with EN 1621-3 CE LEVEL 2 approval
- back protector with EN 1621-2 CE LEVEL 2 approval
- shoulder and elbow protection extended in soft material with EN 1621-1 CE LEVEL 2 approval
- padded hip protection

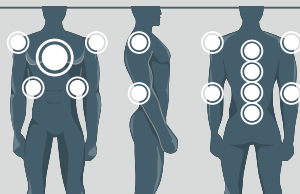
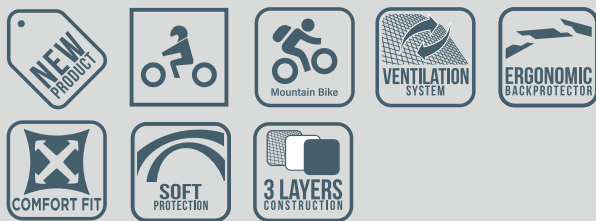

8 PROTECTIVE AREAS

0024515.318.

BLACK/ FLUO YELLOW

SIZES

S/M	160-175 cm - 65/75 Kg	code: .063
L/XL	175-190 cm - 75/90 Kg	code: .067
XXL	190-200 cm - 90/105 Kg	code: .069



X-FIT FUTURE LEVEL 2 BODY ARMOUR

COMPOSITION:

Polypropilene 55%, Polyamide 40%, Elastane 5%, Polyurethane 100%

DETAILS:

- Protective summer / winter underwear
- Highly breathable Dryarn technology fabric with incredible elasticity and softness.
- Bacteriostatic.
- Side zip closure
- Compatible with Neck Brace
- Removable P.O.I. technology protections in Visco - Elastic material
- Chest / back / shoulder / elbow protectors more ergonomic, soft and thin
- Added Memory Foam hips protection
- New "cold hand" woven fabric
- Mesh fabric is fitted at the highest perspiration points (arms / hips / armpits / chest / back) for optimal ventilation.

BODY PROTECTION:

- **chest protection with EN 1621-3 LEVEL 2 approval**
- **back protector with EN-1621-2 EC LEVEL 2 approval**
- **shoulder and elbow protection extended in soft material with EN-1621-1 EC LEVEL 2 approval**
- hip protectors in two-layer viscoelastic perforated material

COMPOSIZIONE:

Polypropilene 55%, Polyamide 40%, Elastane 5%, Polyurethane 100%

DETTAGLI:

- Intimo protettivo estate / inverno



Dryarn
THE FEEL GOOD FIBRE
BY AQUATIC

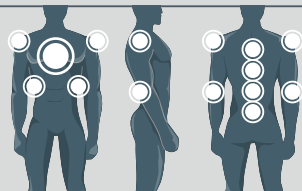

8 PROTECTIVE AREAS

SIZES

S/M	160-175 cm - 65/75 Kg	code: .063
L/XL	175-190 cm - 75/90 Kg	code: .067
XXL	190-200 cm - 90/105 Kg	code: .069



0024534.318.

BLACK/FLUO YELLOW

SCUDO 3.0 BODY ARMOUR

COMPONENTS:

Polypropylene 29%; EVA 27%; Polyurethane 25%; Polyester 15%; Other 4%

DETAILS:

- Elastic strap on the waist with hook and loop fastener closure
- 2 shoulder straps with front and back adjustment
- Chest protection made of plastic cover and polyester PE multilayer foam with **CERTIFICATION 1621-3**
- **Side protection** in memory foam for high impact absorption
- Protection of shoulders and elbows in memory foam for high impact absorption, with **CERTIFICATION EN 1621-1/2012**
- Padding on back in multilayer expanded plastic plates with **CERTIFICATION EN 1621-1/2014**
- Sleeves in perforated elastic material with high breathability
- Body armour in elastic mesh to increase comfort and breathability
- Side YKK zipper



0022777.070.

GREY

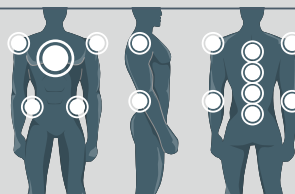

6 PROTECTIVE AREAS

SIZES

S/M	160-175 cm - 65/75 Kg	code: .063
L/XL	175-190 cm - 75/90 Kg	code: .067
XXL	190-200 cm - 90/105 Kg	code: .069

KOERTA 2.0 BODY ARMOUR

DETAILS:

- Ergonomically designed for full protection.
- **BACK PROTECTOR EN 1621-02:2014 CERTIFIED.**
- **ELBOW AND SHOULDER PROTECTIONS EN 1621 - 1/2012 CERTIFIED.**
- **STONE SHIELD HOMOLOGATED EN 14021.**
- Double hook and loop fastener waist adjustment.
- Made of polypropylene, inner lining, stretch mesh for perfect ventilation.
- Double back padding is removable and washable.
- Removable collarbone protection.



0017756.319.

BLACK/RED

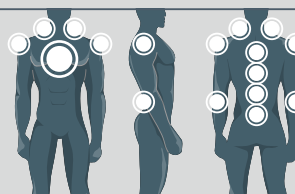

8 PROTECTIVE AREAS

SIZES

S/M	170-180 cm - 65/75 Kg	code: .063
L/XL	180-190 cm - 75/85 Kg	code: .067
XXL	190-200 cm - 85/100 Kg	code: .069



X-AIR LEVEL 2 BODY ARMOUR

MATERIALS:

Polyurethane 72%, Polyester 21%, Spandex 4%, Nylon 2%, Rubber 1%

DETAILS:

- Elastic, breathable and ventilated mesh fabric protection
- Side opening with YKK zipper with puller on the zipper slider
- Removable protections for a thorough washing of the mesh
- P.O.I. protections technology in Visco - Elastic material
- Ergonomic, soft and slim chest / back / shoulder / elbow protectors.
- The low thickness and the softness of the torso and back protection are designed to accommodate the neck-brace.

BODY PROTECTION:

- chest protection with EN 1621-3 CE LEVEL 2 approval
- back protector with EN 1621-2 CE LEVEL 2 approval
- shoulder and elbow protection extended in soft material with EN 1621-1 CE LEVEL 2 approval

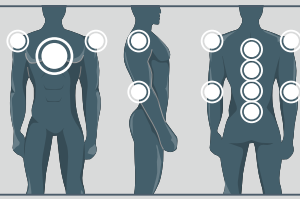

6 PROTECTIVE AREAS

SIZES

S/M	160-175 cm - 65/75 Kg	code: .063
L/XL	175-190 cm - 75/90 Kg	code: .067
XXL	190-200 cm - 90/105 Kg	code: .069

0024536.318.
BLACK/FLUO YELLOW

X-AIR LEVEL 2 VEST

MATERIALS:

Polyurethane 58%, Polyester 34%, Spandex 5%,
Nylon 2%, Rubber 1%

DETAILS:

- Elastic, breathable and ventilated mesh fabric protection
- Side opening with YKK zipper with puller on the zipper slider
- Removable protections for a thorough washing of the mesh
- P.O.I. protections technology in Visco - Elastic material
- Soft and thin chest/back protectors.
- The low thickness and the softness of the torso and back protection are designed to accommodate the neck-brace.

BODY PROTECTION

- chest protection with EN 1621-3 CE LEVEL 2 approval
- back protector with EN 1621-2 CE LEVEL 2 approval

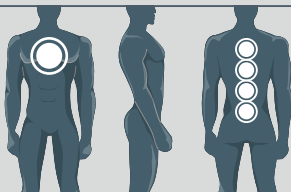

2 PROTECTIVE AREAS

SIZES

S/M	160-175 cm - 65/75 Kg	code: .063
L/XL	175-190 cm - 75/90 Kg	code: .067
XXL	190-200 cm - 90/105 Kg	code: .069



0024537.318.
BLACK/FLUO YELLOW



GRAVITY LEVEL 2 BODY ARMOUR

MATERIALS:

Polypropylene 43%, Eva 42%, Polyester 5%, Alluminium 3%, Steel 3%
Spandex 2%, Nylon 1%, Others 1%

DETAILS:

- Molded in an innovative nest-texture construction to increase ventilation and protection while reducing weight
- Plastics plates that adapt to the body, fixed on the soft Bio-foam, to increase shock absorption and to improve the fit
- Back and front protector with removable lower plate to accommodate a neck brace
- Stone shield protections
- Hip protections
- Adjustable sizes thanks to shoulder regulation
- CHEST PROTECTOR **EN 1621-3:2018 CE LEVEL 2**
- BACK PROTECTOR **EN 1621-2 CE LEVEL 2**
- SHOULDER PROTECTION **EN 14021:2003 STONE SHIELD CERTIFIED**
- HIP PROTECTION **EN 14021:2003 STONE SHIELD CERTIFIED**
- Adjustable and removable shoulders protectors



0024292.090.

BLACK



0024292.010.

ORANGE



0024292.030.

WHITE

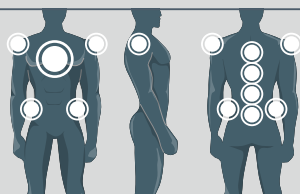

4 PROTECTIVE AREAS

SIZES

ONE SIZE height 160 - 200cm weight 65 - 105kg

GRAVITY BODY ARMOUR

MATERIALS:

Polypropylene 58%, Eva 22%, Polyester 8%, Steel 6%, Spandex 2%

DETAILS:

- Molded in an innovative nest-texture construction to increase ventilation and protection while reducing weight
- Plastics plates that adapt to the body, fixed on the soft Bio-foam, to increase shock absorption and to improve the fit
- Back and front protectors with removable lower plate to accommodate a neck brace
- Stone shield protections
- Hip protections
- Adjustable sizes thanks to shoulder regulation
- CHEST PROTECTOR **EN 14021:2003 STONE SHIELD CERTIFIED**
- BACK PROTECTOR **EN 14021:2003 STONE SHIELD CERTIFIED**
- SHOULDER PROTECTION **EN 14021:2003 STONE SHIELD CERTIFIED**
- HIP PROTECTION **EN 14021:2003 STONE SHIELD CERTIFIED**
- Adjustable and removable shoulders protectors



0023898.010.

ORANGE



0023898.030.

WHITE



0023898.090.

BLACK



0023898.040.

BLUE



0023898.120.

TRANSPARENT



0023898.110.

RED

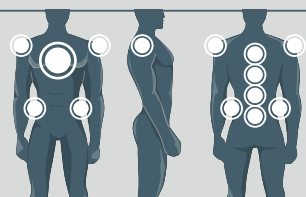

4 PROTECTIVE AREAS

SIZES

ONE SIZE height 160 - 200cm weight 65 - 105kg



PROFILE CHEST PROTECTOR

DETAILS:

- Comfortable and light, designed for riders between 160 cm. to 185 cm.
- Protects the back and chest.
- Good ventilation.
- The shoulders are made of a soft material for more ergonomic fit.
- Adjustable elastic fasteners on the side.
- **EN 14021 STONE SHIELD CERTIFIED.**

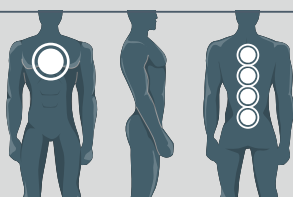

2 PROTECTIVE AREAS

SIZES

ONE SIZE height 160 - 200cm weight 65 - 105kg



0016987.110.

RED



0016987.014.

FLUO ORANGE



0016987.030.

WHITE



0016987.040.

BLUE



0016987.090.

BLACK

PULSAR BACK PROTECTOR

MATERIALS:

Shell: 100% Polyester

Lining: 90% Polyamide 10% Polyester

DETAILS:

- **BACK PROTECTOR EN 1621-2/2014 LEVEL 2**
- **HIP PROTECTION EN 14021:2003 STONE SHIELD CERTIFIED**
- Innovative plastic parts nest-texture: guaranteed ventilation and protection
- Solid plates enclosed in soft memory foam, for a better shock-absorbing protection
- Adjustable and removable hips protections
- Removable cover for Neck-Brace use
- X-shaped adjustment system which does not weigh heavily on the underarm area, with central quick release and 4 hook and loop fastener straps adjustment
- Waist elastic band closure with double hook and loop fastener adjustment.



0024057.090.

BLACK

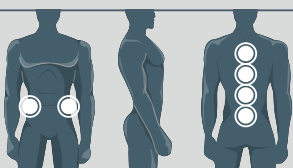

2 PROTECTIVE AREAS

SIZES

S/M*	160-175 cm	code: .063
L/XL	176-195 cm.	code: .067

*Lady size



BACK COMFORT 2.0 BACK PROTECTOR

DETAILS:

- Ergonomic design.
- Protection created with ML.SP, a honeycomb pattern material that guarantees a perfect fit and protection whilst allowing full freedom of movement.
- Elastic waist belt, adjustable with hook and loop fastener straps.
- Elastically adjustable and removable shoulder.
- **BACK PROTECTOR EN 1621-2 / 14 CERTIFIED.**

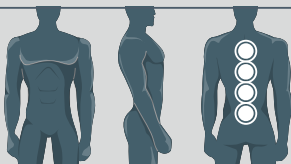

1 PROTECTIVE AREA

SIZES

S/M*	160-175 cm	code: .063
L/XL	175-195 cm.	code: .067

*Lady size



0017172.323.
BLACK/RED

BLAZAR LEVEL 2 BACK PROTECTOR

COMPOSITION:

Polyurethane 75%, Polyester 13%, Spandex 6%, Nylon 3%, Rubber 2%, Others 1%

DETAILS:

- The soft back protection in memory foam adapts to the body: the viscoelastic technology provides a better shock-absorbent protection and better fitting.
- There are large openings on the back protector that guarantee ventilation, lightness and flexibility.
- the innovative design combines the versatility of a soft and flexible back with an additional, increased level of protection, enclosed on the outside by a perforated elastic fabric offering excellent durability over time. A highly breathable 3D mesh is in contact with the back to provide optimal comfort even in the hottest seasons.
- perforated waistband with elastics on the hips.
- adaptability to different body sizes thanks to elastic adjustments on the shoulders and waistband
- the design, is suitable for both female and male anatomy, excellent for motor sports, cycling, horse riding, winter sports and in all those situations where a higher level of protection is required.

• **Back PROTECTIONS EN 1621-2 LEVEL 2**

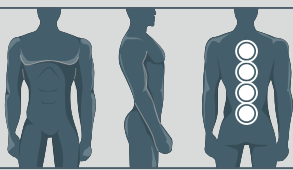

1 PROTECTIVE AREA

SIZES

S/M*	150-165 cm - 65/75 Kg	code: .063
L/XL	165-180 cm - 75/90 Kg	code: .067
XXL	180-200 cm - 90/105 Kg	code: .069

*Lady and Kid size



0024526.318.

BLACK/YELLOW

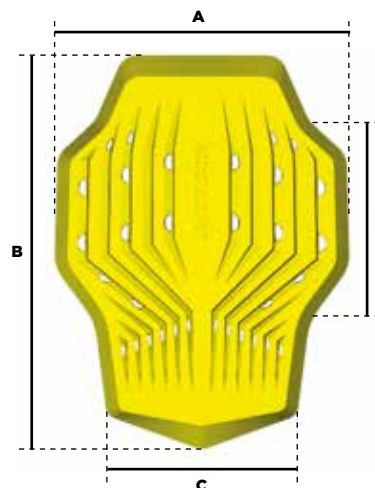

S/M MEASUREMENT

A: 282 mm
B: 376 mm
C: 205 mm
D: 99 mm

L/XL MEASUREMENT

A: 290 mm
B: 438 mm
C: 210 mm
D: 181 mm

XXL MEASUREMENT

A: 299 mm
B: 520 mm
C: 220 mm
D: 230 mm



GORILLA LEVEL 2 KNEE GUARDS

COMPOSITION:

- 10% Steel; 35% Epdm; 35% Polypropylene; 15% Neoprene; 5% Other fibers

DETTAGLI:

- Pairs of knee guards dx + sx
- High end Knee Guard
- Kneecap, tibia and lower femur guard made of elastomer material in order to adapt to the leg's anatomy and to absorb the shocks
- Extreme freedom of movement and excellent torsional and flexural rigidity of the knee guaranteed by the double articulation system realized by combining technopolymeric materials and steel inserts
- Movable kneecap shell ensures wide range of movement
- Removable and washable padding in soft neoprene
- 3 adjustable straps

- **EN 1621-1/12 HOMOLOGATED LEVEL 2**



SIZES

ONE SIZE

Designed for riders who need a knee brace with more flexibility and torsional protection compared to a conventional knee brace. Knee cap, tibia and the lower femur protections consist of an elastomeric material which allows impact to be absorbed and makes the central area of the knee brace flexible, guaranteeing a perfect fit. The double articulation system on the sides is made from a combination of various technopolymers and stainless steel inserts which in turn guarantees maximum freedom of movement and at the same time gives excellent torsional rigidity and high flexibility of the knee. The kneecap shell guarantees freedom of movement and a comfortable fit, it is also adjustable. The interior is made of a soft neoprene material which is removable and washable. A perfect fit is assured by the 3 adjustable straps, numbered in the correct closing order. Protection of the knee, tibia and femur **HOMOLOGATION EN 1621-1/12 LEVEL 2**



0022114.318.

BLACK/FLUO YELLOW

OPTIONALS



ELASTIC SOCKS
0016947.318



TUBE KNEE LEECH
0022734.090



X-KNEE GECO
0022716.319

X-STRONG LEVEL 2 KNEE GUARDS

COMPOSITION:

Polypropylene 44%, Rubber 27%, Eva 18%, Others 4%, Polyester 7%

DETAILS:

- The kneecap, tibia, and the low part of the femur are constructed in a sandwich of thermoplastic material and a padding that allows high energy absorption from shock (**P.O.I. TECHNOLOGY**).
- The **system is double articulated** and it is well adaptable to the knee anatomy, ensures maximum movement with a great torsional stiffness, also through the fixing system made of 2 big neoprene bands.
- **TRANSPORT BAG AND ELASTIC SOCKS (cod. 0016947) INCLUDED.**
- **K+L EN 1621-1/2012 LEVEL 2 CERTIFIED FOR KNEE AND TIBIA.**



SIZES

ONE SIZE



INCLUDED
IN DOTAZIONE

ELASTIC SOCKS
0016947.318



0016810.318.

BLACK/YELLOW

OPTIONALS



TUBE KNEE LEECH
0022734.090



X-KNEE GECO
0022716.319



IMPACT EVO 3.0 KNEE GUARDS

COMPOSITION:

Polypropylene 55%, Eva 24%, Nylon 13%, Polyester 3%, Polyethylene 4%
Others 1%

DETAILS:

- Knee, tibia and femur protection in plastic and EVA padding.
- Air vents to increase ventilation of knee and shinbone.
- Pre-shaped, asymmetrical design for comfort and fit.
- **Double pivot system** to facilitate movement of the knee.
- Removable padding, soft and comfortable fabric, hypoallergenic and breathable.
- Adjustable, elastic straps with hook and loop fastener closure.
- **EN 1621-1/2012 CERTIFIED.**



SIZES

ONE SIZE



0021608.318.

BLACK/FLUO YELLOW

OPTIONALS

ELASTIC SOCKS
0016947.318

TUBE KNEE LEECH
0022734.090

X-KNEE GECO
0022716.319

PROFILE 2.0 KNEE GUARDS

COMPOSITION:

Polypropylene 49%, Eva 25%, Polyester 13%, Rubber 7%, Nylon 3%, Pvc 3%

DETAILS:

- Plastic protections extended on the knee and shinbone.
- Soft and comfortable padding made of hypoallergenic and breathable fabric.
- Pre-shaped, asymmetrical design for comfort and fit.
- Air vents to increase ventilation of knee and shinbone.
- Adjustable double straps with hook and loop fastener closure.
- **EN 1621-1/2012 CERTIFIED.**



SIZES

ONE SIZE



0017757.090.

BLACK

X-ZIP KNEE GUARDS

COMPONENTS:

Polyurethane 39%, Spandex 1%, Nylon 29%, Polyester 18%, Rubber 5%, Eva 8%

DETAILS:

- Excellent comfort, maximum lightness and minimum dimension
- High resistance and abrasion resistant fabric combined with knee protection
- Curved design to perfectly suit the anatomy of the knee
- Silicon lining to provide optimal fit
- Lateral zipper ensuring a quick fit by following the ergonomic features of the body and the joints, reducing the folding and bundling of the material
- Breathable elastic mesh on the back for extra comfort and lightness
- Elastic straps for maximum adherence to the leg
- Removable protections

• **APPROVAL: EN 1621-1**



0024331.090.

BLACK



SIZES

ONE SIZE



SOFT 3.0 ELBOW GUARDS

COMPONENTS:

- 34% Polyurethane; 27% Neoprene; 20% Nylon;
8% Polyester; 5% Polyethylene; 5% Rubber; 1% Polypropylene

DETAILS:

- Breathable and perforated technical fabric
- Curved construction to perfectly suit the anatomy of the elbow
- Silicon straps for maximum adherence
- Padded material around the vulnerable elbow areas
- **EN 1621-1: 2012 CERTIFIED**



SIZES

ONE SIZE



0023456.323.

BLACK/RED

SOFT 3.0 KNEE GUARDS

COMPONENTS:

- 34% Nylon; 29% Polyurethane; 20% Neoprene; 6% Polyester;
4% Polyethylene; 4% Rubber; 2% EVA; 1% Polypropylene

DETAILS:

- Durable fabric for high breathability and for impact and abrasion protection
- Curved construction to perfectly suit the anatomy of the knee
- Silicon straps for maximum adherence
- Protection on the knee and on the upper side of the shinbone
- Padded material around the vulnerable knee areas
- **EN 1621-1 CERTIFIED**



SIZES

ONE SIZE



0023454.323.

BLACK/RED

X-FIT FUTURE KID LEVEL 2 BODY ARMOUR

COMPOSITION:

Polypropilene 55%, Polyammide 40%, Elastane 5%, Polyurethane 100%

DETAILS:

- Protective summer / winter underwear
- Highly breathable Dryarn technology fabric with incredible elasticity and softness.
- Bacteriostatic.
- Side zip closure
- Compatible with Neck Brace
- Removable P.O.I. technology protections in Visco - Elastic material
- Chest / back / shoulder / elbow protectors more ergonomic, soft and thin
- New "cold hand" woven fabric
- Mesh fabric is fitted at the highest perspiration points (arms / hips / armpits / chest / back) for optimal ventilation.

BODY PROTECTION:

- **chest protection with EN 1621-3 LEVEL 2 approval**
- **back protector with EN-1621-2 EC LEVEL 2 approval**
- **shoulder and elbow protection extended in soft material with EN-1621-1 EC LEVEL 2 approval**

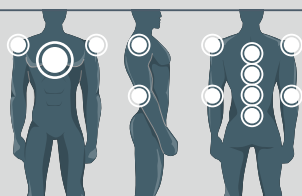

6 PROTECTIVE AREAS

SIZES

S/M	yrs 7/10 125-145 cm.	code: .063
L/XL	yrs 11/13 145-160 cm.	code: .067

0024535.318.

BLACK/FLUO YELLOW



SPECKTRUM KID BODY ARMOUR

COMPONENTS:

Polypropylene 25%, EVA 30%, Polyurethane 10%, Polyester 22%, Polyamide 8%, Others 5%

DETAILS:

- innovative nest-texture for plastic parts: ventilation, protection, light weight
- plastic plates adapting to the body, fitted on soft biofoam, for a better shock-absorbing protection and body-fitting
- the innovative design combines the light weight/ventilation of a cross chest protector and a body armour protection: the shoulder and elbow protectors are fitted on sleeves of perforated stretch fabric, designed to guarantee high breathability and adherence to the arms. The sleeves themselves are attached to the padded shoulder straps of the chest protector, leaving the hips free of fabric to increase heat exchange and breathability.
- removable back and front protection to accommodate the neck-brace
- adaptability to different body sizes thanks to adjustments on the sides

BODY PROTECTIONS:

- chest protection EN1621-3:2018 LEVEL 2 CERTIFIED
- back protector EN1621-2:2014 EC LEVEL 2 CERTIFIED
- shoulder and elbow protection extended in soft material EN1621-1:2012 LEVEL 2 CERTIFIED
- semi-rigid hip protectors with stone shield approval EN 14021:2003

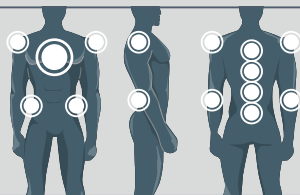

8 PROTECTIVE AREAS

SIZES

S/M	yrs 7/10 125-145 cm.	code: .063
L/XL	yrs 11/13 145-160 cm.	code: .067

0024545.318.

BLACK/FLUO YELLOW

SCUDO JUNIOR 2.0 BODY ARMOUR

DETAILS:

- **EN 1621-3 CERTIFIED FRONT PROTECTOR** with cover in plastics and expanded PU padding.
- **EN 1621- 2 CERTIFIED BACK PROTECTION** with cover in plastics and expanded PU padding.
- Elbow and shoulder guards.
- Side closure with zip and adjustable and removable elastic waist belt with double hook and loop fastener closure.
- Jacket made of fully vented stretch mesh fabric.
- Elastic cuffs to ensure perfect fit.
- 4 straps to regulate the tension on shoulders and arms.

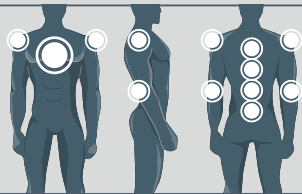

6 PROTECTIVE AREAS

SIZES

S/M	yrs 7/8/9	115-130 cm.	code: .063
L/XL	yrs 10/11/12	130-140 cm.	code: .067
XXL	yrs 13/14	140-160 cm.	code: .069



0017767.319.

BLACK/RED



GRAVITY KID LEVEL 2 BODY ARMOUR

COMPONENTS:

Polypropylene 40%, EVA 32%, Nylon 12%, TPE 11%, Others 5%

DETAILS:

- Innovative plastic parts nest-texture: guaranteed ventilation, protection, lightness
- Plastic plates adapting to the child's body, fitted on soft Biofoam, for better shock-absorbing protection and fitting
- Hip protection
- Adaptability to different body sizes thanks to adjustments on the shoulders (8 - 13 years old high from 125 to 160 cm)
- **CHEST PROTECTION EN1621-3:2018 LEVEL 2 STONE SHIELD CERTIFIED**
- **BACK PROTECTION EN1621-2:2014 LEVEL 2 STONE SHIELD CERTIFIED**
- **SHOULDERS PROTECTION EN 14021:2003 STONE SHIELD CERTIFIED**
- **HIPS PROTECTION EN 14021:2003 STONE SHIELD CERTIFIED**

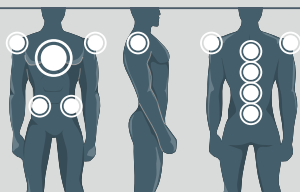

4 PROTECTIVE AREAS

SIZES

ONE SIZE

(da 7 a 13anni altezza da 125 a 160cm)



0024500.010.

ORANGE

GRAVITY KID ROOST DEFLECTOR

COMPONENTS:

Polypropylene 40%, Eva 32%, Nylon 12%, Tpe 11%, Others 5%

DETAILS:

- Molded in an innovative nest-texture construction to increase ventilation and protection while reducing weight
- Plastics plates that adapt to the body, fixed on the soft Bio-foam, to increase shock absorption and to improve the fit
- Adjustable and removable shoulders protections
- Hip protections
- Adjustable sizes thanks to shoulder regulation
- CHEST PROTECTOR **EN 14021:2003 STONE SHIELD CERTIFIED**
- BACK PROTECTOR **EN 14021:2003 STONE SHIELD CERTIFIED**
- SHOULDER PROTECTION **EN 14021:2003 STONE SHIELD CERTIFIED**
- HIP PROTECTION **EN 14021:2003 STONE SHIELD CERTIFIED**

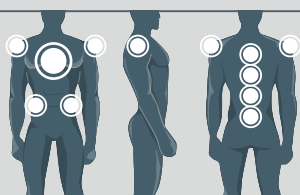
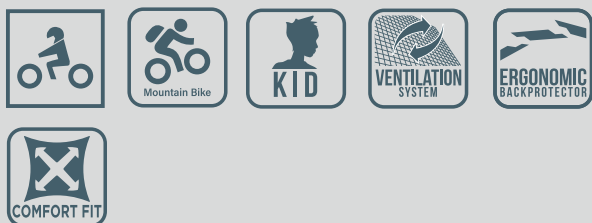

4 PROTECTIVE AREAS

SIZES

ONE SIZE (da 7 a 13anni altezza da 125 a 160cm)



0023899.010.

ORANGE



0023899.040.

BLUE



0023899.120.

TRANSPARENT



IMPACT JUNIOR KNEE GUARDS

COMPONENTS:

Polypropylene 55%, Eva 24%, Nylon 13%, Polyester 3%, Polyethylene 4%
Others 1%

DETAILS:

- Knee, tibia and femur protection in plastic and EVA padding.
- Pre-shaped, asymmetrical design for comfort and fit.
- **Double pivot system** to facilitate movement of the knee.
- Removable padding, comfortable and hypoallergenic fabric.
- Adjustable, elastic straps with hook and loop fastener closure.
- **EN 1621-1/2012 CERTIFIED.**



SIZES

ONE SIZE



0023918.323.

BLACK/RED

PROFILE 2.0 JUNIOR KNEE GUARDS

COMPONENTS:

Polypropylene 49%, Eva 25%, Polyester 13%, Rubber 7%, Nylon 3%, Pvc 3%

DETAILS:

- Plastic protections extended on the knee and shinbone.
- Soft and comfortable padding made of hypoallergenic and breathable fabric.
- Flexible knee protection
- Adjustable double elastic straps with hook and loop fastener closure.
- **EN 1621-1/2012 CERTIFIED.**



SIZES

ONE SIZE



0017758.090.

BLACK

SOFT KID ELBOW GUARD

COMPONENTS:

- 34% Polyurethane; 27% Neoprene; 20% Nylon;
8% Polyester; 5% Polyethylene; 5% Rubber; 1% Polypropylene

DETAILS:

- Breathable and perforated technical fabric
- Curved construction to perfectly suit the anatomy of the elbow
- Silicon straps for maximum adherence
- Padded material around the vulnerable elbow areas
- **EN 1621-1: 2012 CERTIFIED**



SIZES

ONE SIZE

SOFT KID KNEE GUARDS

COMPONENTS:

- 34% Nylon; 29% Polyurethane; 20% Neoprene; 6% Polyester;
4% Polyethylene; 4% Rubber; 2% EVA; 1% Polypropylene

DETAILS:

- Durable fabric for high breathability and for impact and abrasion protection
- Curved construction to perfectly suit the anatomy of the knee
- Silicon straps for maximum adherence
- Protection on the knee and on the upper side of the shinbone
- Padded material around the vulnerable knee areas
- **EN 1621-1 CERTIFIED**



SIZES

ONE SIZE



0023457.323.

BLACK/RED



0023455.323.

BLACK/RED



MOTOBRAND 2.0 BELT

DETAILS:

- Hypoallergenic stretch waist band with hook and loop fastener closure.
- Double braided elastic insert to follow and wrap the lumbar area.
- Articulated soft rubber back panels for ergonomic support.



SIZES

S/M	28 to 32	code: .063	L/XL	34 to 38	code: .067
------------	----------	-------------------	-------------	----------	-------------------



0017763.090.

BLACK

MOTOBRAND 2.0 JUNIOR BELT

DETAILS:

- Antiallergic stretch waist band with hook and loop fastener closure.
- Double braided elastic insert to follow and wrap the lumbar area.
- Articulated soft rubber back panels for ergonomic support.



SIZES

ONE SIZE	18 to 28
-----------------	----------



0017764.090.

BLACK

PROFILE 2.0 BELT

DETAILS:

- Stretch elastic waist band with double hook and loop fastener closure
- Triple stretch insert and TPU insert to follow and support the lumbar area
- Several mesh inserts for breathability



SIZES

S/M	28 to 32	code: .063	L/XL	34 to 38	code: .067
------------	----------	-------------------	-------------	----------	-------------------



0017765.090.

BLACK

K-BELT BELT

COMPONENTS: 95% Neoprene; 5% Others.

DETAILS:

- hook and loop fastener closure
- Soft inner lining and washable exterior
- 6 flexible ribs for added support to the lumbar region
- Designed to increase breathability and counteract air blows thanks to the double-lined perforated neoprene structure



SIZES

S/M 28 to 32 code: **.063** **L/XL** 34 to 36 code: **.067**

X-ROLL

COMPONENTS: Polyurethane 70%, Nylon 17%, Spandex 10%, Others 3%

DETAILS:

- The ergonomically shaped stabilization collar is made of hypoallergenic, soft, comfortable and breathable materials.
- The collar is equipped with removable fastening system to ensure a comfortable, but secure fit.
- The collar padding is completely removable and washable.



SIZES

ONE SIZE

X-ROLL JUNIOR



SIZES

ONE SIZE



0022774.319.

BLACK



0017193.323.

BLACK/RED



0017194.323.

BLACK/RED



X-ROUND COLLAR

COMPONENTS:

Polyurethane 50%, Polystyrene 45%, Nylon 5%

DETAILS:

- Characterised by an ergonomic design
- Soft padding
- Easily removable and washable lining
- Easy to wear
- Strap fast to close



SIZES

ONE SIZE

X-ROUND KID COLLAR

COMPONENTS:

Polyurethane 50%, Polystyrene 45%, Nylon 5%

DETAILS:

- Characterised by an ergonomic design
- Soft padding
- Easily removable and washable lining
- Easy to wear
- Strap fast to close



SIZES

ONE SIZE



0023930.323.

BLACK/RED



0023931.323.

BLACK/RED

SOFT RUSH PANTS

COMPOSITION:

Polyurethane 25%, Nylon 20%, Synthetic Resin 17%, Polyester 15%, EVA 13%
Rubber 5%, Polyethylene 4%, Polypropylene 1%

MANUFACTURING AND DESIGN:

- Innovative multi-layer soft materials with high impact absorption: ventilation, protection, lightness and flexibility.
- On the upper thigh and part of the gluteal area, three layers of viscoelastic material fitted on elastic mesh extremely resistant to tears and wear, which guarantees: ventilation, protection, lightness.
- Protective EVA plates placed on the coccyx and lower lateral/front thigh.
- Biofoam padding for upper side hip protection
- The innovative three-layer fabric design combines light weight/ventilation and ease of movement, facilitating heat exchange and breathability.
- Elastic bands on thighs with silicone inserts.

GLUTEUS PADDING:

- The unisex style, is suitable for women and men, excellent for off-road cycling and motorcycling.
- Designed for off-road terrain with special high density inserts in the ischiatic area, specially positioned to optimize comfort and performance on all terrain.
- Quick-drying fabric guaranteeing excellent breathability during the most strenuous activities.



0024527.318.

BLACK/YELLOW

SIZES

S	28 to 30	code: .062	XL	35 to 36	code: .068
M	31 to 32	code: .064	2XL	37 to 38	code: .069
L	32 to 34	code: .066			



X-BODY WINTER TECHNICAL UNDERWEAR

COMPOSITION:

- 75% Dryarn Polypropylene; 20% Polyamide; 5% Elastane

DETAILS:

- Polypropylene **DRYARN**® is considered the lightest fabric existent in nature (10 km. of fabric weight 1 gr).
- The word **DRYARN**® derives from the ability of the fabric to not absorb water.
- Long technical undergear
- Use of high breathability Dryarn fabric
- 3D setting allows the sweat out
- Keeps the body temperature and improves the performances consequently
- Provides thermal insulation even during the resting phase



Dryarn
THE FEEL GOOD MICROFIBER
BY AQUARATI

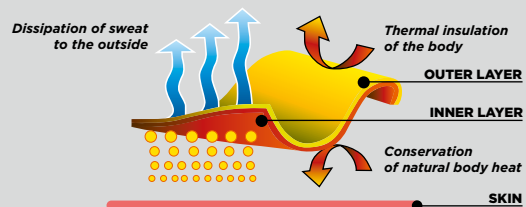

SIZES

S/M	code: .063	XXL	code: .069
L/XL	code: .067		



JERSEY

0021912.323.

BLACK/RED



PANTS

0021913.323.

BLACK/RED

X-BODY SUMMER TECHNICAL UNDERWEAR

COMPOSITION:

- 70% Dryarn Polypropylene; 25% Polyamide; 5% Elastane

DETAILS:

- Polypropylene **DRYARN®** is considered the lightest fabric existent in nature (10 km. of fabric weight 1 gr).
- The word **DRYARN®** derives from the ability of the fabric to not absorb water.
- Light technical underwear
- Use of high breathability Dryarn fabric
- Keeps the body temperature and improves the performances consequently



Dryarn
THE FEEL GOOD MICROFIBRE
BY POLYPROPYLENE

Dissipation of sweat to the outside

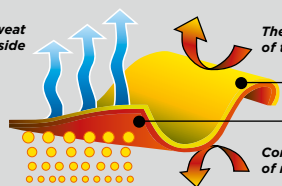

Thermal insulation of the body

OUTER LAYER

INNER LAYER

Conservation of natural body heat

SKIN

SIZES

S/M	code: .063	XXL	code: .069
L/XL	code: .067		



JERSEY

0021910.323.

BLACK/RED



SHORTS

0021911.323.

BLACK/RED



X-WIND TECHNICAL UNDERWEAR

COMPOSITION:

- 94% Polyamide; 6% Elastane

MATERIALS:

- Yarn for technical layer in polyamide: termic, breathable, comfort and light. It dries quickly
- Membrane for front insert: winproof and breathable



SIZES

S/M	code: .063	XXL	code: .069
L/XL	code: .067		



JERSEY

0024315.090.

BLACK

EVO JERSEY TECHNICAL UNDERWEAR

COMPOSITION:

95% Polyamide; 5% Elastane



Colorways Available:
see pictures in B2B



With carton box for display:

0021715

SIZES

4XS/3XS	code: .081	S/M	code: .063
XXS/XS	code: .082	L/XL	code: .067



0017845.

EVO SHORTS TECHNICAL UNDERWEAR

COMPOSITION:

92% Polyamide; 8% Elastane



Colorways Available:
see pictures in B2B



SIZES

4XS/3XS	code: .081	S/M	code: .063
XXS/XS	code: .082	L/XL	code: .067



0910030.

EVO PANTS TECHNICAL UNDERWEAR

COMPOSITION:

92% Polyamide; 8% Elastane



Colorways Available:
see pictures in B2B



SIZES

S/M	code: .063	
L/XL	code: .067	



0910031.



X-KNEE GECO UNDERWEAR

COMPONENTS:

- 60% Polyester; 30% Nylon; 10% PU

DETAILS:

- Stretch fabric to wear protections (even the most voluminous)
- Abrasion resistance AX Suede reinforcement, against the most cumbersome knee guards, including orthopedic guards
- Containing function to allow faster and less bothersome pulling on of any type of pants
- Extremely comfortable and fast drying thanks to technical fabric
- Mesh insert in the calf area



SIZES

S/M	code: .063	XXL	code: .069
L/XL	code: .067		



0022716.319.
BLACK/GREY

TUBE KNEE LEECH UNDERWEAR

COMPONENTS:

- 85% Nylon, 10% PU, 5% Polyester

DETAILS:

- Stretch fabric to wear protections (even the most voluminous)
- Abrasion resistance AX Suede reinforcement, against the most cumbersome knee guards, including orthopedic guards
- Containing function to allow faster and less bothersome pulling on of any type of pants
- Extremely comfortable and fast drying thanks to technical fabric
- Mesh insert in the calf area
- Tube version adapts perfectly around the knee area



SIZES

S/M	code: .063	L/XL	code: .067
------------	-------------------	-------------	-------------------



0022734.090.
BLACK

ELASTIC SOCKS

COMPOSITION:

- 100% Polyester.

DETAILS:

- Washable knee legging
- To be worn under the knee-guard for better comfort



SIZES

ONE SIZE

X-LEG PRO SOCKS

MATERIALS: 80% Polyamide Meryl® Skinlife; 10% Polypropylene Dryarn; 10% elastane.

DETAILS:

- Long sock designed for use with knee guards and knee braces.
- Silicone edge to maintain the fit of the sock.
- Reinforcements around the shin and ankle.
- Zone compression for better blood circulation.
- Breathable insert on the instep.
- Reinforcements on the toe and heel.
- Flat seam at the toe line.

Dryarn
THE FEEL GOOD PROTECTION



SIZES

S/M	39-41	code: .063	XXL	45-47	code: .069
L/XL	42-44	code: .067			



0016947.318.

BLACK/YELLOW



0021693.313.

BLACK/FLUO ORANGE



0021693.316.

BLACK/BLUE



0021693.318.

BLACK/FLUO YELLOW



0021693.323.

BLACK/RED



NO-WET SOCKS

COMPOSITION:

Outer Layer: 82% Nylon, 16% Polyester, 2% Spandex

Middle Layer: 100% Polytetrafluoroethylene

Inner Layer: 54% Polyester, 44% Cotton, 2% Spandex

DETAILS:

- Knee high sport socks
- Membrane waterproof and breathable Membrana 20K/18K, windproof
- Use of technical yarns
- Flat seam on the toe line
- Weight 110 gr



SIZES

S/M	39-41	code: .063	XXL	45-47	code: .069
L/XL	42-44	code: .067			

MX PRO SOCKS

COMPOSITION: 60% acrylic; 20% polyamide; 10% polypropylene; 10% elasthan.

DETAILS:

- Knee-high sport socks
- Realized with a thicker frame and studied with reinforcements in the most critical areas like toe tips, malleolus and tibia.
- Soft sponge padding
- Use of technical yarns
- Patterns developed with Dryarn fabric to improve breathability
- Flat seam a the toe line

Dryarn
THE FEEL GOOD FIBRE



SIZES

S/M	39-41	code: .063	XXL	45-47	code: .069
L/XL	42-44	code: .067			



0023916.319.

BLACK/GREY



0022077.313.

BLUE/RED



0022077.316.

BLACK/BLUE



0022077.318.

BLACK/FLUO YELL.



0022077.323.

BLACK/RED

ACCESSORIES

SOCKS DISPLAY
CODE: 0021677.366



MX IMPACT SOCKS

MATERIALS: 85% Polyamide Meryl® Skinlife; 10% Polypropylene Dryarn® 5% Elastane

DETAILS:

- Reinforcements around the shin and ankle.
- Fabrics designed to regulate body temperature and dissipate moisture easily.
- Breathable inserts on the instep.
- Reinforcements on the toe and heel.
- Flat seam at the toe line.

Dryarn
THE FEEL GOOD MICROFIBRE
BY AQUATIC



SIZES

S/M	39-41	code: .063	XXL	45-47	code: .069
L/XL	42-44	code: .067			



0021633.010.
ORANGE



0021633.040.
BLUE



0021633.110.
RED



0021633.204.
FLUO ORAN./BLUE



0021633.323.
BLACK/RED



0021633.243.
BLUE/FLUO ORAN.



MX IMPACT JUNIOR SOCKS

MATERIALS: 85% Polyamide Meryl® Skinlife; 10% Polypropylene Dryarn® 5% Elastane

DETAILS:

- Reinforcements around the shin and ankle.
- Fabrics designed to regulate body temperature and dissipate moisture easily.
- Breathable inserts on the instep.
- Reinforcements on the toe and heel.
- Flat seam at the toe line.



Dryarn
THE FEEL GOOD MICROFIBRE
BY AQUATIC



SIZES

S/M	32-34	code: .063	L/XL	35-38	code: .067
------------	-------	-------------------	-------------	-------	-------------------



0021909.204.
FLUO ORAN./BLUE



0021909.206.
FLUO ORAN./FLUO YELL.



0021909.323.
BLACK/RED

ACCESSORIES

SOCKS DISPLAY
CODE: 0021677.366



ULTRA SOCKS MTB

COMPOSITION:

90% Polyester; 7% Polyamide; 3% Elastane
215 gr.m²



SIZES

S	34-38	code: .062	L	42-46	code: .066
M	38-42	code: .064	XL	46-50	code: .068



0910258.030.

WHITE



0910258.090.

BLACK

COTTON SOCKS

COMPOSIZIONE: 67% Cotton; 27% Polyamide; 6% Elastane

DETTAGLI:

- Ankle-length sock
- Heel and under foot area in terry toweling to protect and amortize
- Upper part developed in ribbing 2/2
- Part of the instep in ribbing 1/1
- Personalized with jacquard logo in contrasting color from front part



SIZES

S/M	39-41	code: .063	XXL	45-47	code: .069
L/XL	42-44	code: .067			



0022491.014.

FLUO ORANGE



0022491.030.

WHITE



0022491.063.

FLUO YELLOW



0022491.090.

BLACK



0022491.110.

RED

SPORT SOCKS

COMPOSITION: 80% Poliammide Meryl® Skinlife; 10% Polipropilene Dryarn. 10% Elastan.

DETTAGLI:

- Short technical socks
- Toe and hill in a contrasting colour
- Developed with Skinlife Polyamide which guarantees the natural balance of the skin at any activity level

Dryarn
THE FEEL GOOD MICROFIBER
BY AQUATIC



0022168.030.

WHITE



0022168.090.

BLACK

SIZES

ONE SIZE



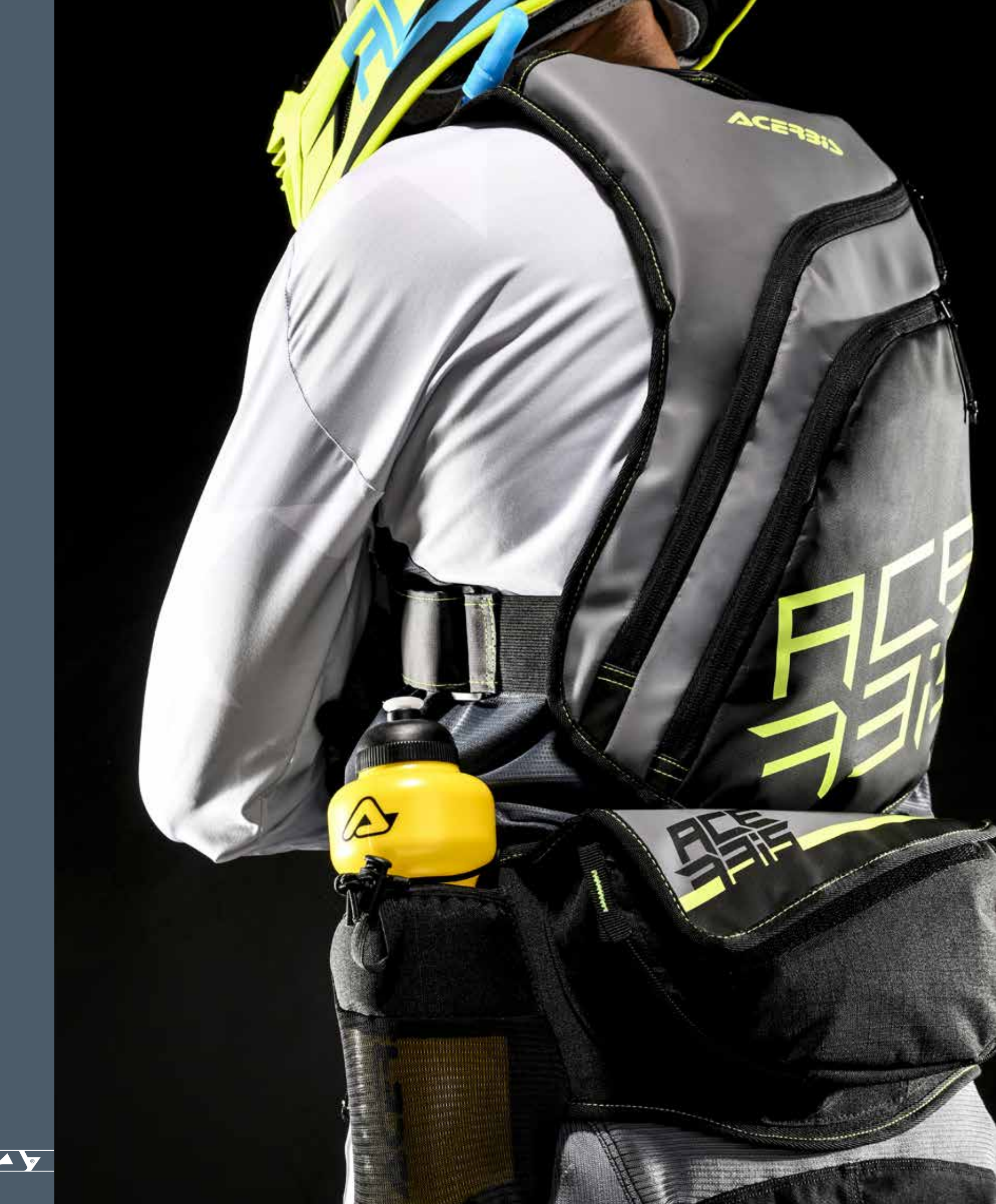

BAGS

BORSE

- P. 184** X-Storm Drink Bag
- P. 185** H2O Drink Backpack
- P. 186** Water Satuh Drink Backpack
- P. 187** Acqua Drink Bag
- P. 188** Dromy Drink Waistpack
- P. 189** Impact Waistpack
- P. 189** Profile Waistpack
- P. 190** Ram Pro H2O Waistpack
- P. 190** Ram Waistpack
- P. 191** Ottano Waistpack
- P. 191** Fanny Waistpack
- P. 192** Manubag Tool Bag
- P. 192** Telepass Holder Case X-KL
- P. 193** Tools Bag Rear Fender
- P. 193** Tools Bag Front Fender
- P. 194** X-Explore 35 L Backpack
- P. 195** Shadow 38 L Backpack
- P. 196** Track 15 L Backpack
- P. 197** Alhena 25 L Backpack
- P. 197** Atlantis 45 L Backpack
- P. 198** X-Water 28 L Backpack
- P. 198** Root 8 L Backpack
- P. 199** X-Water 40 L Horizontal Bag
- P. 199** X-Water 30 L Vertical Bag
- P. 200** No Water 6 L Waistpack
- P. 200** No Water 4 L Waistpack
- P. 201** No Water 3 L Waistpack
- P. 201** No Water 12 L Bag
- P. 202** No Water 2 L Trip Bag
- P. 202** X-Side 1 L Bag
- P. 204** X- Moto Bag
- P. 205** X-Trip Bag
- P. 206** Go Home Trolley
- P. 206** Cargo Bag
- P. 207** Jerla Bag
- P. 208** Profile Bag
- P. 208** Alhena Small Sport Bag
- P. 209** Boots Bag
- P. 209** Helmet Bag



X-STORM DRINK BAG

COMPONENTS: 95% Polyester; 5% Others

DETTAGLI:

- Back pack capacity: 14.5 liters
- Hydro bag capacity: 2.5 liters
- Easy to clean thanks to the large cap
- Drinking straw with adjustable opening and closing valve
- Ideal for those who need a supply of water and want to replace the carrier with a back pack
- Pocket for tools
- The innovative "X" closure system, with central quick release and 4 hook and loop fastener adjustments, eliminates the **"Dancing Monkey"** effect and simultaneously distributes the pressure of the shoulder straps evenly over the chest and not over the shoulders, ensuring a free and unobstructed ride.
- Breathable fabric in the area in contact with the back
- Water bag exclusion available. The glove boxes turns in two carry flasks
- Waist belt

CAPACITY

BACK PACK CAPACITY	14,5 lt.
HYDRO BAG CAPACITY	2,5 lt.



0022818.318

BLACK/FLUO YELLOW



REPLACEMENTS



2,5 L HYDRO BAG
CODE: 0022883.
CAPACITY: 2,5 LT.



2,5 L HYDRO BAG VALVE
CODE: 0022891.

H2O DRINK BACKPACK

COMPONENTS: 95% polyester; 5% Others fibres

DETAILS:

- Capacity 10 litres (including hydro bag of 2 litres.)
- Dorsal part, in contact with the back is made of breathable fabric.
- Hydro bag of 2 litres, with adjustable opening and closing valve easy to clean.
- Adjustable waist belt with quick release buckle.
- Adjustable shoulder straps, pre-shaped for spine Outer compartment.
- Numerous pockets: inside pocket and small storage pocket, net outer pocket to hold original motorcycle license plate, a small external pocket with zip closure, internal tool holder.

CAPACITY

BACK PACK CAPACITY	10 lt.
HYDRO BAG CAPACITY	2 lt.



0017046.318

BLACK/FLUO YELLOW



REPLACEMENTS



HYDRO BAG
CODE: 0016863.
CAPACITY: 2 LT.



2,5 L HYDRO BAG VALVE
CODE: 0022891.



WATER SATUH DRINK BAG

COMPONENTS: 48% PVC, 48% Polyester; 4% Others

DETAILS:

- Capacity 9 litres.
- Water bag capacity 2.5 litres.
- Easy to clean water bag thanks to its large cap.
- Straw with adjustable opening and closing valve.
- Using rubber coated fabric to facilitate the cleaning of the backpack with a wet sponge, and increasing water resistance.
- Ideal for those requiring a water supply and wish to replace the waist pack with a comfortable backpack.
- Removable tool pocket and large utensils holder.
- Internal elastic net pocket for storage and/or smartphone.
- The innovative "X" closure system, with central quick release and 4 hook and loop fastener adjustments, eliminates the "Dancing Monkey" effect and simultaneously distributes the pressure of the shoulder straps evenly over the chest and not over the shoulders, ensuring a free and unobstructed ride.
- Use of breathable fabric in back contact area
- Water bag can be removed.
- The magnet is embedded in the fabric of the tool holder. The magnet traps steel screws and wrenches in all those situations, such as mechanical interventions in the woods, where it is easy to lose parts in the vegetation.
- Ideal for off-road use MOTOCROSS / ENDURO / ATV / TRIAL, E-BIKE / MTB.



CAPACITY

BACK PACK CAPACITY	9 lt.
HYDRO BAG CAPACITY	2,5 lt.



0024547.318

BLACK/FLUO YELLOW



REPLACEMENTS



2,5 L HYDRO BAG
CODE: 0022883.
CAPACITY: 2,5 LT.



2,5 L HYDRO BAG VALVE
CODE: 0022891.

ACQUA DRINK BAG

COMPONENTS: 95% polyester; 5% Others fibres

DETAILS:

- **Back pack capacity: 5 liters.**
- **Hydro bag capacity: 2 liters.**
- Easy to clean thanks to the large cap.
- Drinking straw with adjustable opening and closing valve.
- Ideal for those who need a supply of water and want to replace the carrier with a back pack.
- Removable pocket and trousse for tools bag.
- The innovative "X" closure system, with central quick release and 4 hook and loop fastener adjustments, eliminates the **"Dancing Monkey"** effect and simultaneously distributes the pressure of the shoulder straps evenly over the chest and not over the shoulders, ensuring a free and unobstructed ride.
- Breathable fabric in the area in contact with the back.



CAPACITY

BACK PACK CAPACITY	5 lt.
HYDRO BAG CAPACITY	2 lt.



0017071.318
BLACK/FLUO YELLOW



REPLACEMENTS



HYDRO BAG
CODE: 0016863.
CAPACITY: 2 LT.



2,5 L HYDRO BAG VALVE
CODE: 0022891.



DROMY DRINK WAISTPACK

COMPONENTS:

Waistpack 95 % Polyester; 5 % Other Materials

Hydro Bag 95 % TPU; 5 % Other Materials

DETAILS:

- **Waistpack capacity: 6,5 liters.**
- **Hydro bag capacity: 1.5 liters.**
- Quick release buckle and hook and loop fastener closure.
- Drinking straw integrates with helmet.
- Pocket for documents on the belt.
- Side storage compartment with hook and loop fastener/zipper.
- Transparent document holders.
- Identification label on the inside of the belt.
- Contact areas shaped for added breathability.

CAPACITY

WAISTPACK CAPACITY	6,5 lt.
HYDRO BAG CAPACITY	1,5 lt.



0021643.318
BLACK/FLUO YELLOW



REPLACEMENTS



HYDRO BAG
CODE: 0021649.
CAPACITY: 1.5 LT.



EASY LOCKING SYSTEM



HELMET MOUNTING SYSTEM

IMPACT WAIST PACK

COMPONENTS: 95% polyester; 5% Others fibres

DETAILS:

- **Capacity 5 liters.**
- Double closure through elastic belt with hook and loop fastener and plastic buckle.
- Rubber patch on the lower back to ensure a perfect fit.
- Belt with pocket for driving license or stamp card, with internal rider identifying label.
- Numerous pockets: back pocket for tools and extra pocket including an extra pocket for compass, which is easily accessible from the outside.
- Removable side pocket for water bottle, removable accessories side pocket and transparent pocket for documents.

CAPACITY

WAIST PACK CAPACITY	5 lt.
---------------------	--------------

PROFILE WAIST PACK

COMPONENTS: 95% polyester; 5% Others fibres

DETAILS:

- **Capacity 3 liters.**
- Double closure through elastic belt with hook and loop fastener and plastic buckle.
- Rubber patch on the lower back to ensure a perfect fit.
- Belt with pocket for driving license or stamp card, with internal rider identifying label.
- Numerous pockets: back pocket for tools and extra pocket including an extra pocket for compass, which is easily accessible from the outside.
- Removable side pocket for water bottle, removable accessories side pocket and transparent pocket for documents.

CAPACITY

WAIST PACK CAPACITY	3 lt.
---------------------	--------------



0017032.318
BLACK/FLUO YELLOW



0017033.318
BLACK/FLUO YELLOW



RAM PRO H2O WAIST PACK

COMPONENTS: 95% polyester; 5% Others fibres

DETAILS: Capacity 2 litres.

- Drink holder.
- Double waist fastening using an elastic band with hook and loop fastener and plastic buckle, guaranteeing excellent adherence to the body and eliminating the possibility of losing the pouch during sports activities.
- Perforated EVA inserts in the lumbar area to ensure a perfect fit, comfort and breathability.
- Belt with pocket for driving license or stamp card, with internal rider identifying label.
- PCV cover on waterproof and easy-to-clean tool pockets
- Back tool pocket with inside small transparent pocket for socket wrenches/screws.
- Small side pocket for objects.
- Magnet fitted into the waist pack fabric: the magnet holds the steel screws and spanners placed on the waist pack, whenever it is easy to lose screws in the vegetation (e.g. during mechanical intervention in the woods).



CAPACITY

WAIST PACK CAPACITY	2 lt.
---------------------	--------------

RAM WAIST PACK

COMPONENTS: 95% polyester; 5% Others fibres

DETAILS:

- **Capacity 2 liters.**
- Double closure through elastic belt with hook and loop fastener and plastic buckle.
- Rubber patch on the lower back to ensure a perfect fit.
- Belt with pocket for driving license or stamp card, with internal rider identifying label.
- Numerous pockets: back pocket for tools including an extra compass pocket, two side pockets for other riding essentials.

CAPACITY

WAIST PACK CAPACITY	2 lt.
---------------------	--------------



Perforated EVA inserts

0024546.318

BLACK/FLUO YELLOW



0017031.318

BLACK/FLUO YELLOW



OTTANO WAIST PACK

COMPONENTS:

100% Polyester

DETAILS:

Polyester waist-pack with wide band waist strap, hook and loop fastener adjustment system and plastic buckle for secure closure. Inner transparent pocket for documents.



0022159.030

WHITE

FANNY WAIST PACK

COMPONENTS: 95% polyester; 5% Others fibres

DETAILS:

- Front zip closure.
- Adjustable waist strap and a handy plastic clip.

CAPACITY

WAIST PACK CAPACITY

4 lt.



0000087.318

BLACK/YELLOW



MANUBAG TOOL BAG

COMPONENTS: 95% polyester; 5% Others fibres

DETAILS:

- Handlebar bags specially designed for Dual Enduro road and Enduro racing models.
- Opening with hook and loop fastener fastener and plastic buckle.
- The main compartment is closed by a waterproof and dirt-resistant zip, inside there is a removable tool bag.
- A pocket for holding credit cards, highway card, etc.
- A transparent top pocket where it is possible to place a smartphone, which can be used in navigation mode
- E-CONNECT access: The Smartphone can stay charged thanks to the **Power** (original, not included) passing from the inside to the outside, through a waterproof rubber opening.
- Reinforcements and anti-vibration padding are provided to ensure stability during all riding conditions (on and off-road).
- 4 hook and loop fastener straps provide stable anchorage to handlebars with and without crossbar.
- **Dimensions (Length 30cm / Height 13cm / 8cm)**
- **Volume 2.5L**



CAPACITY

TOOLS BAG CAPACITY	2,5 lt.
--------------------	----------------

TELEPASS HOLDER CASE X-KL

COMPOSITION: 85% Pvc; 15% Polyester;

DETAILS:

- Adjustable hook and loop fastener strap to fit on the handlebar or the wrist
- waterproof case for electronic highway toll payment devices
- hook and loop fastener quick coupling/release fastener
- Dimensions: 100 x 70 x 50 mm
- Fitting anywhere on the handlebar
- Reflective material inserts
- Easy grip zipper pull



FRONT VIEW



BACK VIEW



TOP VIEW



00245 14.319

BLACK/GREY



00245 19.319

BLACK/GREY

TOOLS BAG FRONT FENDER

COMPONENTS: 95% polyester; 5% Others fibres

DETAILS:

- **Capacity: 2 liters.**
- Compact tool bag
- Fast locking system to the front fender with 4 metallic hooks
- Closure with adjustable straps
- Rubber base for a better grip
- Wide internal tools pocket
- Clear internal pocket for bushings



CAPACITY

TOOLS BAG CAPACITY	2 lt.
--------------------	--------------

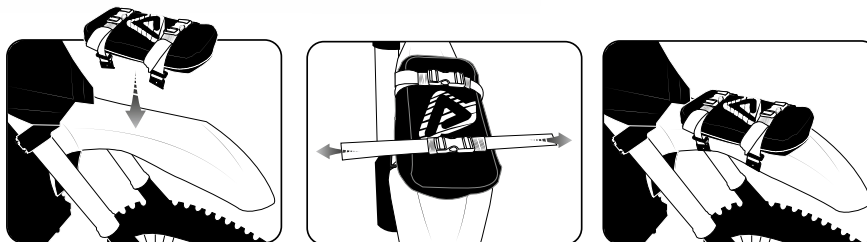

0022013.318

BLACK/FLUO YELLOW



TOOLS BAG REAR FENDER

COMPONENTS: 95% polyester; 5% Others fibres

DETAILS:

- **Capacity: 2 Liters**
- Made of polyester.
- Triple locking system: zip, hook and loop fastener and buckles.
- Internal tools pocket and small outside pocket, bottom transparent.
- Printed front logo. To be mounted with 4 screws on rear fender.

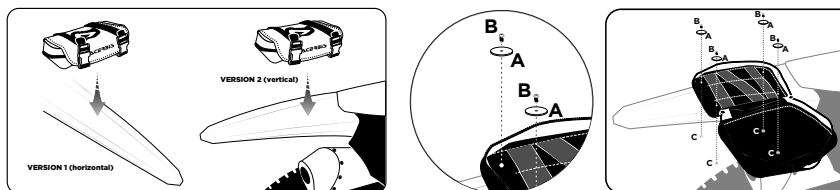

CAPACITY

TOOLS BAG CAPACITY	2 lt.
--------------------	--------------

0012972.318

BLACK/FLUO YELLOW



X-EXPLORE 35L BACKPACK

COMPONENTS:

Shell: 100% Polyester

Lining: 100% Polyester

MATERIALS:

Outer: Polyester 600D Oxford

Inner: Lining in polyester with pockets

DETAILS:

- Dimensions 32 x 23,5 x 48 cm. Volume 35 Lt. Weight 1,2 Kg
- Separate padded pocket with zipper for tablet or labtop till 17" dimensions 26X40 cm , quick access from the outside
- Main zipper to easy log into the total volume of backpack
- Pocket with zipper in thermoformed EVA to put delicate object and easy to catch
- Mesh pockets with stretch insert
- Personalized padded back panel with different thickness for perfect ventilation
- Ergonomic padded shoulders straps with chest regulation
- Waist regulation with buckle and straps to keep backpack in position
- Waterproof cover from bottom separate pocket
- Padded main handle in neoprene



CAPACITY	
BACKPACK CAPACITY	35 lt.



0024013.090

BLACK

SHADOW 38L BACKPACK

COMPONENTS: 100% polyester

MATERIALS:

- Polyester 600D.

DETAILS:

- **Capacity: 38 liters - Weight: 1.27 kg.**
- Reinforced, breathable mesh inserts in the back.
- Internal bottom and side straps in nylon.
- Waist closure with padded hip strap to secure grip and comfort.
- Adjustable shoulder straps.
- Pre-shaped for spine.
- Removable internal reinforcement.
- Easy opening with zip-cast.
- Numerous pockets: three stretch net outside pockets, double outside pocket with welt closure and top pocket.
- Stretch panels for transportation of mechanic equipment.



CAPACITY

BACKPACK CAPACITY

38 lt.



0017045.318
BLACK/FLUO YELLOW



TRACK 15L BACKPACK

COMPONENTS:

Shell: 100% Polyester

Lining: 100% Polyester

MATERIALS:

Outer: Polyester 600D Oxford

Inner: Lining in polyester with pockets

DETAILS:

- Dimensions 31 x 17 x 44 cm. Volume 15 Lt. Weight 0,550 Kg
- Padded pocket for tablet or labtop till 14" dimensions 23X34 cm
- Inner phone pocket
- Main zipper to easy log into the total volume of backpack
- Mesh pockets with stretch insert
- Padded back panel in breathable mesh
- Ergonomics and adjustables padded shoulders straps
- Waterproof cover quick access from bottom separate pocket



CAPACITY

BACKPACK CAPACITY

15 lt.



0024014.070

GREY

ALHENA 25L BACKPACK

COMPONENTS: 100% polyester RIP-STOP 420D
SIZE: 42 x 31 x 20 cm

Colorways Available:
see pictures in B2B



CAPACITY

BACKPACK CAPACITY	25 lt.
-------------------	--------



0022266

ATLANTIS 45L BACKPACK

COMPONENTS: 100% polyester 600D
SIZE: 48 x 37 x 26 cm

Colorways Available:
see pictures in B2B



CAPACITY

BACKPACK CAPACITY	45 lt.
-------------------	--------



0016401



X-WATER 28L BACKPACK

COMPONENTS: 85% PVC; 15% Other fibers

DETAILS:

- WATERPROOF backpack ideal for motorcyclists, mtb bikers, e-bikers
- Capacity 28 L.
- Heat-sealed external stitching and water-resistant zippers.
- Interior compartment with fully waterproof storage pockets, useful for storing items such as tablets and/or notebook
- External mesh pockets
- Adjustable external spider net to hold objects
- Breathable padding in the back area.
- Padded shoulder straps and backpack adjustment straps
- Resistant to temperatures ranging from +70° - 30°.
- Abrasion resistant



CAPACITY

BACKPACK CAPACITY	28 lt.
-------------------	---------------

ROOT 8L BACKPACK

COMPONENTS: 90% polyester, 10% Pu

DETAILS:

- 8L capacity
- Waterproof
- Easy to transport (packable)
- Roll top closure with hook fastening
- Maximum lightness
- External zip pocket
- Ideal for MTB and Motorcycles usage



CAPACITY

BACKPACK CAPACITY	8 lt.
-------------------	--------------



0024542.319

BLACK/GREY



0024107.090

BLACK

X-WATER 40L HORIZONTAL BAG

COMPOSITION: 15% Polyester; 85% Pvc;

DETAILS:

- WATERPROOF large bag ideal for motorcyclists.
- Capacity 40 L.
- Heat-sealed external stitching.
- Useful for storing large objects (Max 60x33 cm).
- Practical and flexible.
- Resistant to temperatures ranging from +70° - 30°.
- Abrasion resistant
- Bike fastening by rings and 4 belts
- Shoulder strap
- Air Valve for max compression



CAPACITY

BAG CAPACITY	40 lt.
--------------	---------------

X-WATER 30L VERTICAL BAG

COMPOSITION: 15% Polyester; 85% Pvc;

DETAILS:

- WATERPROOF roller bag ideal for motorcyclists.
- Capacity 30 L.
- Heat-sealed external stitching.
- Shoulder strap.
- Bike fastening by rings and 4 belts
- Useful for storing large objects (max 60x30 cm).
- Practical and flexible.
- Resistant to temperatures ranging from +70° - 30°.
- Abrasion resistant
- Air Valve for max compression



CAPACITY

BAG CAPACITY	30 lt.
--------------	---------------



0024540.319

BLACK/GREY

ACCESSORIES

TENAY BELT
GREY

Length : 170 cm

0023893.070



TENAY BELT
BLACK

Length : 170 cm

0023893.090



0024541.319

BLACK/GREY

ACCESSORIES

TENAY BELT
GREY

Length : 170 cm

0023893.070



TENAY BELT
BLACK

Length : 170 cm

0023893.090



NO WATER 4L WAIST PACK

COMPONENTS: 95% PVC; 5% Others fibres

DETAILS:

- 4 litre WATERPROOF waistpack.
- Taped seams and zippers, water-resistant exterior.
- Completely waterproof internal pockets, useful for storing items such as tablets and/or a laptop with a maximum size of 21x32 cm.



CAPACITY

WAIST PACK CAPACITY

4 lt.



0022858.319

BLACK/GREY



NO WATER 3L WAIST PACK

COMPONENTS: 95% PVC; 5% Others fibres

DETAILS:

- 3 litre WATERPROOF waistpack.
- Taped seams and zippers, water-resistant exterior.
- Completely waterproof internal pockets, useful for storing items such as tablets with a maximum size of 21x17 cm.



CAPACITY

WAIST PACK CAPACITY	3 lt.
---------------------	--------------



0023418.319

BLACK/GREY



NO WATER 12L BAG

COMPONENTS: 95% PVC; 5% Others fibres

DETAILS:

- 12 litre WATERPROOF bag.
- Taped seams and zippers, water-resistant exterior.
- Internal compartment with completely waterproof pockets, useful for storing items such as tablets and/or a laptop with a maximum size of 24x35 cm.
- Adjustable waist strap.



CAPACITY

BAG CAPACITY	12 lt.
--------------	---------------



0021646.319

BLACK/GREY



NO WATER 2L TRIP BAG

COMPOSITION: 10% Polyester; 90% Pvc;

DETAILS:

- Legpack
- 2lt. capacity
- External heat-sealed seams
- Fully waterproof inner part
- Fixing with double adjustable strap
- Useful for storing small items like smartphone (max 17x11)
- Practical and flexible
- Especially useful on rainy days



CAPACITY

TRIP BAG CAPACITY

2 lt.

X-SIDE 1L BAG

COMPOSITION: 100% Polyester

DETAILS:

- Right and left legs bag
- Adjustable strap on the waist and on the thigh
- 1L capacity
- Removable waterproof cover
- One size
- Reflective inserts
- Internal compartments for phone / wallet / documents
- Keys hook



CAPACITY

TRIP BAG CAPACITY

1 lt.



0022228.319

BLACK/GREY



0024216.090

BLACK



X-MOTO BAG

COMPONENTS: 100% polyester

MATERIALS:

- **Inner** Lining and mesh inserts.
- **Outer** Rip resistant high density polyester.

DETAILS:

- **Dimensions 96x46x43 cm. Capacity 190 lt. Weight 7 kg.**
- Central zip closure to divide two main areas and straps for volume adjustment.
- Two handles for easy movement.
- Telescopic main handle.
- Reinforced fabric on the bottom and in the back side.
- Pull out mat on side pocket.

CAPACITY

BAG CAPACITY

190 lt.



0017669.110

RED



0017669.010

ORANGE



0017669.040

BLUE



0017669.319

BLACK/GREY

X-TRIP BAG

COMPONENTS: 100% polyester

MATERIALS:

- **Inner** Lining and mesh inserts.
- **Outer** Rip resistant high density polyester.

DETAILS:

- **Dimensions 75x45x35 cm; Capacity 105 lt.; Weight 5,5 kg.**
- Central zip closure to divide two main areas and straps for volume adjustemet.
- Two handles for easy movement.
- Telescopic main handle.
- Reinforced fabric on the bottom and in the back side.

CAPACITY

BAG CAPACITY

105 lt.



0017668.319

BLACK/GREY



0017668.010

ORANGE



0017668.040

BLUE



0017668.110

RED

GO-HOME TROLLEY

COMPONENTS:

Shell: 100% ABS

Lining: 100% Polyester

MATERIALS:

- **Outer** Hard Shell in ABS
- **Inner** Lining in polyester with pockets

DETAILS:

- **Dimensions 55X38X21 cm. Volume 35 Lt. Weight 2,5 Kg**
- Double tube telescopic handle system
- Double handles one on the top and one on the side.
- 4 Multidirectionals wheels
- Lockable Main Zippers
- Top compartment with pocket and bottom compartment with divider pad and ribbons

CAPACITY

BAG CAPACITY

35 lt.

CARGO BAG

COMPONENTS: 100% Polyester

DETAILS:

- **Dimensions 90x40x50 cm.; Capacity 180 Lt.; Weight 1.9 kg.**
- Top-loading bag
- Shoulder strap and double handles to make moving easier
- Large side pockets for boots and helmets
- Large central zip
- Check-list as reference to contain all accessories

CAPACITY

BAG CAPACITY

180 lt.



0023702.090

BLACK



0022517.318

BLACK/FLUO YELLOW



JERLA BAG

COMPONENTS:

96% Polyester, 4% Others

DETAILS:

- **Backpack-bag capacity 102 litres.**
- **Dimensions 59cm x 52cm x 36cm**
- **weight 2Kg**
- The backpack bag holds all the specific equipment for sportsmen and women practising off-road disciplines: motocross/Enduro/trial/motard.
- Thanks to the backpack design, it is possible to transport all the necessary equipment up and down stairs or paddocks in rough terrain.
- The vertical structure reduces the overall bulk of the backpack, in the trunk of the car and van.
- Made with two comfortable external side pockets in breathable fabric, designed to store the boots separately from the other contents of the backpack-bag.
- A deep central compartment holds all the necessary equipment: helmet, chest protector, knee pads, trousers, jersey, mask, gloves, etc...
- A top compartment divider keeps off-road clothing separate from the change of clothes, preventing them from getting dirty.
- The front pocket, useful for storing small objects once opened, becomes a comfortable footrest allowing you to get dressed while keeping your feet dry and clean.
- Sliding adjustable straps distribute the weight evenly on the chest and not on the shoulders.
- Use of breathable fabric in back contact area
- Ideal for off-road use MOTOCROSS / ENDURO / ATV / TRIAL/ MOTARD.



CAPACITY

BAG CAPACITY

102 lt.

0024428.318

BLACK/FLUO YELLOW



PROFILE BAG

COMPONENTS: 100% Polyester

DETAILS:

- Dimensions: 30X28X60cm; Volume: 50 lt; Weight: 1.1 kg.
- Central compartment with zipper closure.
- Waterproof side pocket.
- Comfortable padded shoulder strap.
- Identification label.
- Internal plastic base to give the bag a rigid structure.

CAPACITY

BAG CAPACITY	50 lt.
--------------	---------------



0021678.090

BLACK



0021678.349

RED/BLACK



0021678.743

CAMOUFLAGE



ALHENA SMALL SPORT BAG

COMPONENTS: 100% polyester 600D

SIZE: 45 x 29 x 25 cm

Colorways Available:
see pictures in B2B



CAPACITY

BACKPACK CAPACITY	30 lt.
-------------------	---------------



0022366.

BOOTS BAG

DETAILS:

- Dimensions: 46X26X36cm;
- Designed to easily hold off-road and on-road boots, from the smallest size up to size 47
- Washable by hand
- Equipped with a practical carrying handle
- Easy opening with double slider
- Ventilation for breathability



0023865.318
BLACK/FLUO YELLOW



HELMET BAG

COMPOSITION: 100% Polyester

DETAILS:

- Designed to easily hold off-road or on-road helmets
- Fabric exterior and soft internal lining to protect the helmet
- Equipped with a practical carrying handle
- Easy opening with a double slide zipper
- Ventilated for breathability
- Side pocket for accessories



0023262.318
BLACK/FLUO YELLOW



ACERBIS S. 73!!

PROTECTED
TO THE
BONE...

BEV
T
H



73



WARE
HE
ELL!!



CASUAL SP CLUB

- P. 212** Hill 035 Jacket
- P. 213** Artax Bomber Jacket
- P. 213** Artax Padding Vest
- P. 213** Elnath Softshell Jacket
- P. 214** Wind Sp Club Jacket
- P. 216** Great River Shirt
- P. 216** Team Shirt
- P. 216** Team Lady Shirt
- P. 217** Kemari Polo
- P. 217** Kemari Woman Polo
- P. 217** Belatrix Polo
- P. 218** Belatrix Woman Polo
- P. 218** Easy T-Shirt
- P. 218** Kemari Tracksuit Jacket
- P. 219** Kemari Woman Tracksuit Jacket
- P. 219** Kemari Hoodie
- P. 219** Belatrix Hoodie Sweatshirt
- P. 220** Belatrix Woman Tracksuit Jacket
- P. 220** Easy Hoodie Sweatshirt
- P. 220** Easy Pants
- P. 221** Woden Training Bermuda
- P. 221** Balden Training Bermuda
- P. 221** Eir Woman Shorts
- P. 222** Ottano 2.0 Sweater
- P. 223** Street Sp Club Sweatshirt
- P. 223** Paint Sp Club Sweatshirt
- P. 223** Heaven SP Club Lady Sweatshirt
- P. 224** Paint Sp Club T-Shirt
- P. 224** Wings Sp Club T- Shirt
- P. 224** Acrobat Sp Club T- Shirt
- P. 225** Shield Sp Club T-Shirt
- P. 225** Street Sp Club T-Shirt
- P. 225** V Street Sp Club T-Shirt
- P. 226** Wings Sp Club Lady T-Shirt
- P. 226** Rush Sp Club Lady T-Shirt
- P. 226** University Sp Club Lady Top
- P. 226** Wings Sp Club Kid T-Shirt
- P. 226** Acrobat Sp Club Kid T-Shirt
- P. 226** Shield Sp Club Kid T-Shirt
- P. 227** Acerbis Lady Jeans
- P. 228** Camou Sp Club Bermuda
- P. 228** Cargo Sp Club Bermuda
- P. 229** Podium Cap
- P. 229** Podium Beanie
- P. 229** Float Sam Cap
- P. 229** Roadrace SP Club Cap
- P. 229** Fancy SP Club Cap
- P. 229** Acerbis Wallet
- P. 229** Acerbis Belt



HILL 035 JACKET

COMPONENTS:

Shell 100% Polyamide

Lining 100% Polyamide

Padding 100% Polyester

MATERIALS:

Outer

- Fabric for jacket in polyamide matt and water repellent

Inner

- Lining in polyamide
- Padding in polyester down effect

DETAILS:

- Packable jacket
- With fixed hood
- Front opening and side pockets with zip
- Elastic tape to border hood, cuffs and bottom



SIZES

S	code: .062	XL	code: .068
M	code: .064	XXL	code: .069
L	code: .066		



0023413.318.

BLACK/YELLOW

ARTAX BOMBER



COMPONENTS:
100% Polyester
70 gr.m²

SIZES

4XS code: .071	L code: .066
3XS code: .059	XL code: .068
XXS code: .060	XXL code: .069
XS code: .061	3XL code: .070
S code: .062	4XL code: .076
M code: .064	



0910255.040

BLUE



0910255.090

BLACK

ARTAX PADDING VEST



COMPONENTS:
100% Polyester
70 gr.m²

SIZES

S code: .062	XXL code: .069
M code: .064	3XL code: .070
L code: .066	4XL code: .076
XL code: .068	



0910256.040

BLUE



0910256.090

BLACK

ELNATH SOFTSHELL JACKET



COMPONENTS:
100% Polyester
285 gr.m²

SIZES

4XS code: .071	L code: .066
3XS code: .059	XL code: .068
XXS code: .060	XXL code: .069
XS code: .061	3XL code: .070
S code: .062	4XL code: .076
M code: .064	



0910081.040

BLUE



0910081.090

BLACK



WIND SP CLUB JACKET

COMPONENTS:

Shell 100% Polyamide

Lining 100% Polyamide

MATERIALS:

Outer

- Fabric for jacket in polyamide water repellent

Inner

- Lining in polyamide

DETAILS:

- Emergency hood in the back collar pocket with coulisse regulation
- Front opening and side pockets with waterproof zip
- Cuffs and bottom in rib



SIZES

S	code: .062	XL	code: .068
M	code: .064	XXL	code: .069
L	code: .066		



0023020.073.

DARK GREY



0023020.793.

GREY WORKS



0023020.872.

URBAN GREEN

Soul and Passion

ACERBIS

SP CLUB 73



GREAT RIVER SHIRT

MATERIAL: 100% COTTON

SIZES

S	code: .062	XL	code: .068
M	code: .064	XXL	code: .069
L	code: .066	3XL	code: .070



0021914.040.

BLUE

TEAM SHIRT

MATERIAL: 100% COTTON

SIZES

S	code: .062	XL	code: .068
M	code: .064	XXL	code: .069
L	code: .066	3XL	code: .070



0023584.237.

WHITE/BLACK



0023584.232.

WHITE/BLUE



0023584.239.

WHITE/RED

TEAM LADY SHIRT

MATERIAL: 100% COTTON

SIZES

S	code: .062	XL	code: .068
M	code: .064	XXL	code: .069
L	code: .066		



0023585.237.

WHITE/BLACK

KEMARI POLO



COMPONENTS:

100% Polyester
160 gr.m²

Colorways Available:
see pictures in B2B



SIZES

5XS code: .057	M code: .064
4XS code: .071	L code: .066
3XS code: .059	XL code: .068
XXS code: .060	XXL code: .069
XS code: .061	3XL code: .070
S code: .062	4XL code: .076



0910252.

KEMARI WOMAN POLO



COMPONENTS:

100% Polyester
160 gr.m²

Colorways Available:
see pictures in B2B



SIZES

4XS code: .071	L code: .066
3XS code: .059	XL code: .068
XXS code: .060	XXL code: .069
XS code: .061	3XL code: .070
S code: .062	
M code: .064	



0910253.

BELATRIX POLO



COMPONENTS:

70% Cotton, 30% Polyester
210 gr.m²

Colorways Available:
see pictures in B2B



SIZES

4XS code: .071	L code: .066
3XS code: .059	XL code: .068
XXS code: .060	XXL code: .069
XS code: .061	3XL code: .070
S code: .062	4XL code: .076
M code: .064	



0022188.



BELATRIX WOMAN POLO



COMPONENTS:

70% Cotton, 30% Polyester
210 gr.m²

Colorways Available:
see pictures in B2B



SIZES

3XS code: .059	M code: .064
XXS code: .060	L code: .066
XS code: .061	XL code: .068
S code: .062	XXL code: .069



0022189.

EASY T-SHIRT



COMPONENTS:

100% Polyester
160 gr.m²

Colorways Available:
see pictures in B2B



SIZES

5XS code: .057	M code: .064
4XS code: .071	L code: .066
3XS code: .059	XL code: .068
XXS code: .060	XXL code: .069
XS code: .061	3XL code: .070
S code: .062	4XL code: .076



0910018.

KEMARI TRACKSUIT JACKET



COMPONENTS:

100% Polyester
190 gr.m²

Colorways Available:
see pictures in B2B



SIZES

5XS code: .057	M code: .064
4XS code: .071	L code: .066
3XS code: .059	XL code: .068
XXS code: .060	XXL code: .069
XS code: .061	3XL code: .070
S code: .062	4XL code: .076



0910241.

KEMARI WOMAN TRACKSUIT JACKET

COMPONENTS:

100% Polyester
190 gr.m²

Colorways Available:
see pictures in B2B



0910254.

SIZES

4XS code: .071	M code: .064
3XS code: .059	L code: .066
XXS code: .060	XL code: .068
XS code: .061	XXL code: .069
S code: .062	3XL code: .070

KEMARI HOODIE

COMPONENTS:

65% Polyester, 35% Cotton
360 gr.m²

Colorways Available:
see pictures in B2B



0910238.

SIZES

S code: .062	XXL code: .069
M code: .064	3XL code: .070
L code: .066	4XL code: .076
XL code: .068	

BELATRIX HOODIE SWEATSHIRT

COMPONENTS:

70% Cotton, 30% Polyester
300 gr.m²

Colorways Available:
see pictures in B2B



0022194.

SIZES

S code: .062	XXL code: .069
M code: .064	3XL code: .070
L code: .066	4XL code: .076
XL code: .068	



BELATRIX WOMAN TRACKSUIT JACKET

COMPONENTS:

100% Polyester
240 gr.m²

Colorways Available:
see pictures in B2B



0022180.

SIZES

3XS code: .059	M code: .064
XXS code: .060	L code: .066
XS code: .061	XL code: .068
S code: .062	XXL code: .069

EASY HOODIE SWEATSHIRT

COMPONENTS:

65% Polyester, 35% Cotton
360 gr.m²

Colorways Available:
see pictures in B2B



0910015.

SIZES

4XS code: .071	L code: .066
3XS code: .059	XL code: .068
XXS code: .060	XXL code: .069
XS code: .061	3XL code: .070
S code: .062	4XL code: .076
M code: .064	

EASY PANTS

COMPONENTS:

65% Polyester, 35% Cotton
360 gr.m²

Colorways Available:
see pictures in B2B



0910016.

SIZES

4XS code: .071	L code: .066
3XS code: .059	XL code: .068
XXS code: .060	XXL code: .069
XS code: .061	3XL code: .070
S code: .062	4XL code: .076
M code: .064	

WODEN TRAINING BERMUDA



COMPONENTS:

100% Polyester
190 gr.m²

Colorways Available:
see pictures in B2B



SIZES

4XS code: .071	L code: .066
3XS code: .059	XL code: .068
XXS code: .060	XXL code: .069
XS code: .061	3XL code: .070
S code: .062	4XL code: .076
M code: .064	



0910012.

BALDER TRAINING BERMUDA



COMPONENTS:

92% Polyester, 8% Elastan
160 gr.m²

Colorways Available:
see pictures in B2B



SIZES

5XS code: .057	M code: .064
4XS code: .071	L code: .066
3XS code: .059	XL code: .068
XXS code: .060	XXL code: .069
XS code: .061	3XL code: .070
S code: .062	4XL code: .076



0910014.

EIR WOMAN SHORTS



COMPONENTS:

100% Polyester
160 gr.m²

Colorways Available:
see pictures in B2B



SIZES

4XS code: .071	M code: .064
3XS code: .059	L code: .066
XXS code: .060	XL code: .068
XS code: .061	XXL code: .069
S code: .062	



0910068.



OTTANO 2.0 SWEATER

COMPONENTS:

100% Cotton

DETAILS:

- Fit: Slim
- Long-sleeve polo neck jersey
- Blue twill fabric appliques on shoulders and over the heart
- Printed Ottano logo in contrasting colours



SIZES

S	code: .062	XL	code: .068
M	code: .064	XXL	code: .069
L	code: .066		



0023124.040.

BLUE

STREET SP CLUB SWEATSHIRT

MATERIAL: 100% COTTON



0910406.591.

GRAPHITE



0910406.899.

GREY/DARK GREY

SIZES

S	code: .062	XL	code: .068
M	code: .064	XXL	code: .069
L	code: .066		

PAINT SP CLUB SWEATSHIRT

MATERIAL: 100% COTTON



0910276.899.

GREY/DARK GREY



SIZES

M	code: .064	XXL	code: .069
L	code: .066		
XL	code: .068		

HEAVEN SP CLUB LADY SWEATSHIRT

MATERIAL: 100% COTTON



0910278.076.

LIGHT GREY



SIZES

XS	code: .061	L	code: .066
S	code: .062	XL	code: .068
M	code: .064		



PAINT SP CLUB T-SHIRT

MATERIAL: 100% COTTON

SIZES

S	code: .062	XL	code: .068
M	code: .064	XXL	code: .069
L	code: .066		



0910277.899.

GREY/DARK GREY

WINGS SP CLUB T-SHIRT

MATERIAL: 100% COTTON

SIZES

S	code: .062	XL	code: .068
M	code: .064	XXL	code: .069
L	code: .066		



0910262.030.

WHITE



0910262.073.

DARK GREY



0910262.076.

LIGHT GREY

ACROBAT SP CLUB T-SHIRT

MATERIAL: 100% COTTON

SIZES

S	code: .062	XL	code: .068
M	code: .064	XXL	code: .069
L	code: .066		



0910266.030.

WHITE



0910266.073.

DARK GREY



0910266.591.

GRAPHITE

SHIELD SP CLUB T-SHIRT

MATERIAL: 100% COTTON

SIZES

S	code: .062	XL	code: .068
M	code: .064	XXL	code: .069
L	code: .066		



0910267.030.

WHITE



0910267.042.

ROYAL BLUE



0910267.591.

GRAPHITE

STREET SP CLUB T-SHIRT

MATERIAL: 100% COTTON



0910268.591.

GRAPHITE

SIZES

S	code: .062	XL	code: .068
M	code: .064	XXL	code: .069
L	code: .066		

V STREET SP CLUB T-SHIRT

MATERIAL: 100% COTTON



0910269.872.

URBAN GREEN

SIZES

S	code: .062	XL	code: .068
M	code: .064	XXL	code: .069
L	code: .066		



WINGS SP CLUB LADY T-SHIRT

MATERIAL: 95% COTTON, 5% ELASTANE



0910270.030.

WHITE

SIZES

XS code: .061	L code: .066
S code: .062	XL code: .068
M code: .064	

RUSH SP CLUB LADY T-SHIRT

MATERIAL: 95% COTTON, 5% ELASTANE



0910271.076.

LIGHT GREY



0910271.141.

FUCHSIA

SIZES

XS code: .061	L code: .066
S code: .062	XL code: .068
M code: .064	

UNIVERSITY SP CLUB LADY TOP

MATERIAL: 95% COTTON, 5% ELASTANE



0910272.591.

GRAPHITE

SIZES

XS code: .061	L code: .066
S code: .062	XL code: .068
M code: .064	

WINGS SP CLUB KID T-SHIRT

MATERIAL: 100% COTTON



0910273.073.

DARK GREY

SIZES

M code: .064	XXL code: .069
L code: .066	
XL code: .068	

ACROBAT SP CLUB KID T-SHIRT

MATERIAL: 100% COTTON



0910274.042.

ROYAL BLUE

SIZES

M code: .064	XXL code: .069
L code: .066	
XL code: .068	

SHIELD SP CLUB KID T-SHIRT

MATERIAL: 100% COTTON



0910275.591.

GRAPHITE

SIZES

M code: .064	XXL code: .069
L code: .066	
XL code: .068	

ACERBIS LADY JEANS

COMPONENTS:

Shell 98% Cotton, 2% Elastan

Lining 65% Poliestere 35% Cotone

COMPOSIZIONE:

Esterno 98% Cotone, 2% Elastane

Fodera 65% Poliestere 35% Cotone



SIZES

25	code: .025	30	code: .030
26	code: .026	31	code: .031
27	code: .027	32	code: .032
28	code: .028	33	code: .033
29	code: .029		



LADY
0023423.040.
BLUE



CAMOU SP CLUB BERMUDA
MATERIAL: 97% COTTON, 3% ELASTANE

SIZES

30	code: .030	34	code: .034
31	code: .031	36	code: .036
32	code: .032	38	code: .038
33	code: .033		



0910279.899.
GREY/DARK GREY

CARGO SP CLUB BERMUDA
MATERIAL: 97% COTTON, 3% ELASTANE

SIZES

30	code: .030	34	code: .034
31	code: .031	36	code: .036
32	code: .032	38	code: .038
33	code: .033		



0910280.073.
DARK GREY



0910280.872.
URBAN GREEN

PODIUM CAP

MATERIAL: 95% POLYESTER; 5% ELASTAN



0017186.090.

BLACK

SIZES

S/M code: .063 L/XL code: .067

PODIUM BEANIE

MATERIAL: 95% POLYESTER; 5% ELASTAN



0021712.090.

BLACK

SIZES

ONE SIZE

FLOATSAM CAP

MATERIAL: 85% POLYESTER; 15% ELASTAN



0022814.090.

BLACK

SIZES

S/M code: .063 L/XL code: .067

ROADRACE SP CLUB CAP

MATERIAL: 100% POLYESTER



0024494.090.

BLACK

SIZES

ONE SIZE

FANCY SP CLUB CAP

MATERIAL: 100% POLYESTER



0024495.070.

GREY

SIZES

ONE SIZE

ACERBIS WALLET

COMPONENTS:

SHELL: 100% LEATHER

LINING: 100% POLYESTER



0024468.090

BLACK

ACERBIS BELT

COMPONENTS:

SHELL: 50% LEATHER; 50% POLYURETHANE

OUTER LAYER: 100% NIKEL FREE



0024470.090

BLACK

SIZES

ONE SIZE



HANDGUARDS PARAMANI





X-FUTURE HANDGUARDS

MATERIALS:

30% Nylon, 60% Polypropylene, 10% Steel

DESCRIPTION:

- Openhand guard with universal fixing bracelet
- Adjustable horizontally in two different positions
- Maximum ventilation
- Dual-injection cover for maximum impact resistance
- Easy mount by collar
- Lightweight, compact and flexible handguard
- Flap designed to protect the brake and clutch pumps



UNIVERSAL MOUNTING KIT
code: **0024362.090**



orange/white
code: **0024296.203**



orange/black
code: **0024296.209**



white/blue
code: **0024296.232**



white/yellow
code: **0024296.234**



white/black
code: **0024296.237**



white/red
code: **0024296.239**



white/green
code: **0024296.241**



blue/white
code: **0024296.245**



blue/black
code: **0024296.251**



yellow/white
code: **0024296.273**



yellow/black
code: **0024296.279**



black/orange
code: **0024296.313**



black/white
code: **0024296.315**



black/grey
code: **0024296.319**



red/white
code: **0024296.343**



red/black
code: **0024296.349**



green/white
code: **0024296.371**



green/black
code: **0024296.377**



White/blue
code: **0024296.879**



MOUNTING INSTRUCTIONS:

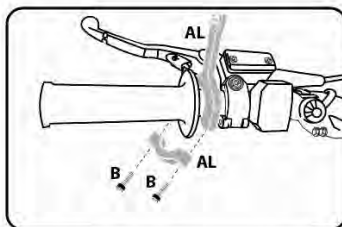

1- Attach the Left side mount (AL) to the handlebar using the screws (B).

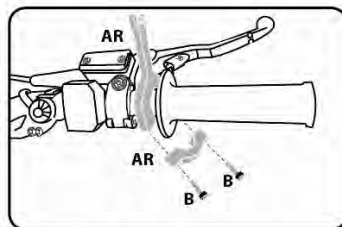

1- Repeat the process with the Right side mount (AR). The mounts should extend over the top of the levers.

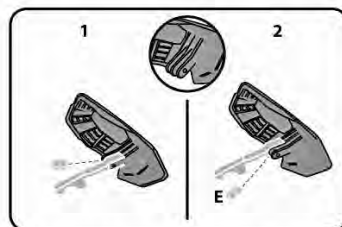

2- Depending on your mounting location on the bars, attach the shields to the mounts utilizing the internal or external mounting points.

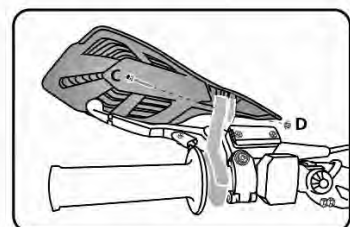

3- Insert and tighten the screw C and the nut (D) to attach the shields to the mount. Check the bolts (B) on the mount to ensure they are also tight.



K-FUTURE HANDGUARDS

MATERIALS:
30% Nylon, 60% Polypropylene, 10% Steel

- DESCRIPTION:**
- Maximum ventilation
 - Dual-injection cover for maximum impact resistance
 - Lightweight, compact and flexible handguard
 - Flap designed to protect brake / clutch pumps
 - Direct fixing to Brembo / Magura pumps (see application at acerbis.com)
 - Mounting kit included
 - Open handguard, applicable keeping the original position of the button panel



K-FUTURE MOUNTING KIT
code: **0024361.090**



orange/white
code: **0024297.203**



orange/black
code: **0024297.209**



white/orange
code: **0024297.229**



black/orange
code: **0024297.313**



black/white
code: **0024297.315**



black/grey
code: **0024297.319**



white/black
code: **0024297.237**



White/blue
code: **0024297.879**



MOUNTING INSTRUCTIONS:

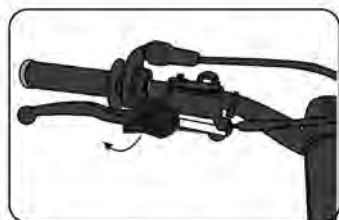

1- Remove the rubber protections.

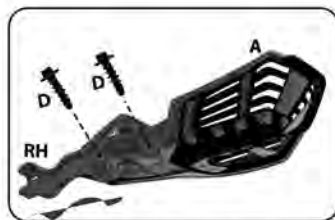

3- Fix the handguards (A) to the side mount brackets (LH)/ (RH) with the screws (D).

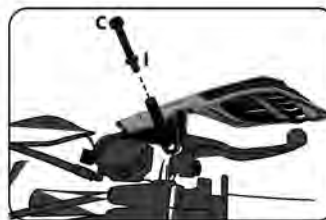

4- Attach the handguards to the handlebar using the bushings (see tab.1), the screws (C) and the washers (I).

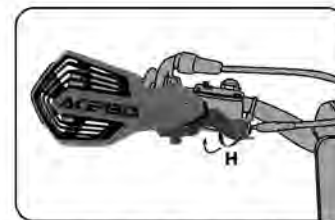

5- Fix the brackets with the bands (H).

MODEL	YEAR	CODE
HUSQVARNA		
FC 250/350/450	14/20	0024297.315
		0024297.319
		0024297.237
		0024297.879
FE 250/350/450/501	14/20	0024297.315
		0024297.319
		0024297.237
		0024297.879
TC 125	17/20	0024297.315
		0024297.319
		0024297.237
		0024297.879
TC 250	14/20	0024297.315
		0024297.319
		0024297.237
		0024297.879
TE 250/300	14/17	0024297.315
		0024297.319
		0024297.237
		0024297.879
TE 250 I/300 I	18/20	0024297.315
		0024297.319
		0024297.237
		0024297.879
KTM		
EXC 250/300	14/17	0024297.203
		0024297.209
		0024297.229
		0024297.313
		0024297.315
EXC 250/300 TPI	18/20	0024297.203
		0024297.209
		0024297.229
		0024297.313
		0024297.315
EXC-F 250/350/450/500	14/20	0024297.203
		0024297.209
		0024297.229
		0024297.313
		0024297.315
SX 125/150	17/20	0024297.203
		0024297.209
		0024297.229
		0024297.313
		0024297.315

MODEL	YEAR	CODE
SX 250	14/20	0024297.203
		0024297.209
		0024297.229
		0024297.313
		0024297.315
		0024297.319
SX-F 250/350/450	14/20	0024297.203
		0024297.209
		0024297.229
		0024297.313
		0024297.315
		0024297.319
XC 250/300 TPI	19/20	0024297.203
		0024297.209
		0024297.229
		0024297.313
		0024297.315
		0024297.319
XC-F 250/350/450	19/20	0024297.203
		0024297.209
		0024297.229
		0024297.313
		0024297.315
		0024297.319
XC-W 125	17/20	0024297.203
		0024297.209
		0024297.229
		0024297.313
		0024297.315
		0024297.319
XC-W 150/250/300 TPI	19/20	0024297.203
		0024297.209
		0024297.229
		0024297.313
		0024297.315
		0024297.319
XCF-W 350/500	2020	0024297.203
		0024297.209
		0024297.229
		0024297.313
		0024297.315
		0024297.319
SHERCO		
SE 250/300 FACTORY	18/20	0024297.315
		0024297.319
		0024297.237
		0024297.879

MODEL	YEAR	CODE
SE-R 125	2020	0024297.315
		0024297.319
		0024297.237
		0024297.879
SE-R 250/300	15/20	0024297.315
		0024297.319
		0024297.237
		0024297.879
SE-SD 250/300 SIX DAYS	18/20	0024297.315
		0024297.319
		0024297.237
		0024297.879
SEF 250/300/450 FACTORY	18/20	0024297.315
		0024297.319

MODEL	YEAR	CODE
		0024297.237
		0024297.879
SEF-R 250/300/450	15/20	0024297.315
		0024297.319
		0024297.879
SEF-R 500	2020	0024297.315
		0024297.319
		0024297.879
SEF-SD 250/300/450 SIX DAYS	18/20	0024297.315
		0024297.319
		0024297.879



X-ELITE HANDGUARDS

MATERIALS:

20% Nylon, 70% Polypropylene, 10% Other

DESCRIPTION:

- Handguard protecting hands (branches, debris, cold, etc.) and E-BIKE/ MTB / MINICROSS handlebar control units
- Manufactured in thermoplastic: lightweight, compact and crash-resistant
- universal fixing bracelet for all E-BIKE/ MTB / MINICROSS handlebars
- Easy mounting by openable collar, not requiring the handlebar control units to be disassembled
- Spoiler (also removable) designed to protect the brake and/or clutch pumps.
- Manufactured to be used on all E-BIKE/ MTB / MINICROSS



UNIVERSAL MOUNTING KIT
code: **0024513.**



white
code: **0024489.030**



orange/black
code: **0024489.209**



blue/white
code: **0024489.245**



black/white
code: **0024489.315**



black/orange
code: **0024489.313**



black
code: **0024489.090**



white/black
code: **0024489.237**



black/yellow
code: **0024489.318**



X-ULTIMATE HANDGUARDS

- Open hand guard: applicable, while it maintains the original position of the button panel
- Nylon Bracelets
- Upper and lower lids removable for maximum ventilation
- Universal mounting behind the pump
- Horizontally adjustable
- **Application: handlebars external diameter from 22 mm. to 28 mm. and twinwall**



MOUNTING KIT
code: **0022480.**



UNIVERSAL
MOUNTING BEHIND
THE PUMP



HORIZONTALLY
ADJUSTABLE

WITH SPOILER

← REMOVABLE SPOILER

WITHOUT SPOILER



orange/white
code: **0022115.203**



orange/black
code: **0022115.209**



white/orange
code: **0022115.229**



white/blue
code: **0022115.232**



white/yellow
code: **0022115.234**



white/black
code: **0022115.237**



white/red
code: **0022115.239**



blue/white
code: **0022115.245**



yellow/blue
code: **0022115.274**



yellow/black
code: **0022115.279**



black/orange
code: **0022115.313**



black/white
code: **0022115.315**



black/green
code: **0022115.325**



red/white
code: **0022115.343**



red/blue/white
code: **0022115.344**



red/black
code: **0022115.349**



green/black
code: **0022115.377**



scan for
more info

REPLACEMENTS COVERS



orange
code: **0022479.010**



white
code: **0022479.030**



blue
code: **0022479.040**



dark blue
code: **0022479.041**



yellow
code: **0022479.060**



black
code: **0022479.090**



red
code: **0022479.110**



green
code: **0022479.130**



X-OPEN HANDGUARDS

DESCRIPTION:

- Handguard designed for Enduro and Cross
- The kit can be mounted on motocross, enduro, motard and ATVs.
- Very flexible, resistant to impact and debris thrown by the preceding motorcycles



white
code: **0016967.030**



blue
code: **0016967.040**



red
code: **0016967.110**



green
code: **0016967.130**

REPLACEMENTS



PLASTICS
model: **X-OPEN BRE / X-OPEN**
code: **0016633.**
colors: WHITE **030** / BLACK **090**



BRACELETS
2 bracelets + screws
model: **X-OPEN BRE**
code: **0017886.**



BRACELETS
2 bracelets + screws
model: **X-OPEN**
code: **0016632.090**

X-FORCE HANDGUARDS

DESCRIPTION:

- Made of polypropylene with nylon bracelets having two vertical fixing points
- Extremely light and ventilated
- Comes with a removable spoiler that provides additional protection from stones, impacts and weather conditions
- Easy and quick installation, with universal mounting system which can be positioned both below and above the lever
- Universal mounting kit included



UNIVERSAL MOUNTING KIT
code: **0013741.**



REMOVABLE SPOILER INCLUDED



scan for more info



orange
code: **0013709.010**

KTM orange 2016/white
code: **0013709.011.016**

fluo orange /white
code: **0013709.014.016**

white
code: **0013709.030**

blue
code: **0013709.040**

yellow
code: **0013709.060**



fluo yellow
code: **0013709.061**

black
code: **0013709.090**

red
code: **0013709.110**

green
code: **0013709.130**

pink
code: **0013709.140**

black/green
code: **0013709.325**

REPLACEMENTS



SPOILER

model: **X-FORCE**
code: **0013801.**

colors: ORANGE **010** / KTM ORANGE 2016 **011.016** / WHITE **030** / BLUE **040** / YELLOW **060**
BLACK **090** / RED **110** / GREEN **130**



MX UNIKO HANDGUARDS

DESCRIPTION:

- Made of polypropylene with nylon bracelets having two solid and flexible fixing points to resist shocks and deformations
- Extremely light and protective
- Quick and easy installation with universal mounting system.
- Universal mounting kit included



UNIVERSAL MOUNTING KIT
code: **0008158.090**



orange
code: **0008159.010**



KTM orange 2016
code: **0008159.011.016**



white
code: **0008159.030**



blue
code: **0008159.040**



yellow
code: **0008159.060**



black
code: **0008159.090**



red
code: **0008159.110**



red/black
code: **0008159.112**



green
code: **0008159.130**



orange/white
code: **0008159.203**

MOUNTING KIT ► PAG. 255/256



X-FACTOR HANDGUARDS

X-Factor is the new ultra-resistant handguard made for people looking for more protection, in extreme enduro, but also for maxi-enduro users.

- (1) Featured with an ANTICORODAL bar with 35 mm. "C" section, that ensures a resistance 5 times higher than a classic aluminum handguard.
- (2) The bracelet has an increased thickness from 15 mm to 19 mm, offering not only increased rigidity, but also increases torsional strength, this is guaranteed by the expander made entirely of steel.
- (3) The broader bi-injection cover protects almost all of the riders hands.
- (4) Finally the pre-shaped slits allow increased the ventilation.

APPLICATION: All off-road aluminum handlebars with an internal diameter of 13.5 mm. to 16 mm. and an outside diameter of 22 mm. Fatbar and Twinwall with an external diameter of 28 mm.



UNIVERSAL MOUNTING KIT
code: **0017631.**

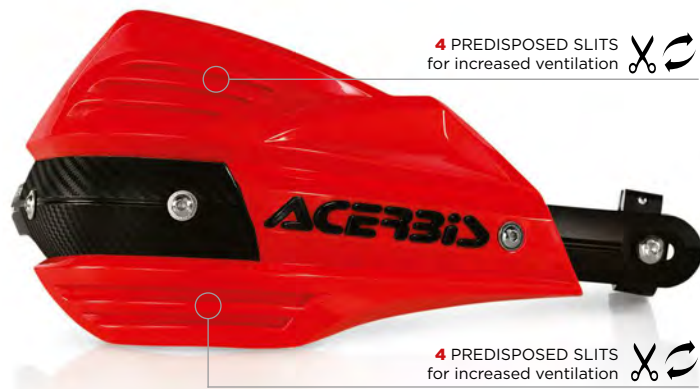

4 PREDISPOSED SLITS for increased ventilation

4 PREDISPOSED SLITS for increased ventilation



2 BRACELETS 15mm. to 19 mm. thickness

1 ANTICORODAL BAR with a "C" section

3 BROADER COVER for protection



orange
code: **0017557.010**



orange/white
code: **0017557.011**



KTM orange 2016
code: **0017557.011.016**



white
code: **0017557.030**



blue
code: **0017557.040**



yellow
code: **0017557.060**



black
code: **0017557.090**



red
code: **0017557.110**



green
code: **0017557.130**



red/white
code: **0017557.343**

REPLACEMENTS



PLASTICS

model: **X-FACTOR**
code: **0017632.**

colors: ORANGE **010** / ORANGE/WHITE **011** / KTM ORANGE 2016 **011.016**
WHITE **030** / BLUE **040** / YELLOW **060** / BLACK **090** / RED **110** / GREEN **130**
RED/WHITE **343**



BARS

model: **X-FACTOR**
code: **0017633.090**

X-FACTORY HANDGUARDS

- Closed hand guard
- Steel bar printed on its surface in different colours
- Anticorrosion armbands to fasten the hand guard to the handlebar
- Steel expander for tighter fastening and to oppose torsion in case of impact.
- Dual-injection covers
- Application: on handlebars with inner diameter from 13.5 mm. to 16 mm. and outside diameter from 22 mm. to 28 mm.



MOUNTING KIT
code: **0022427.**



orange/white
code: **0022397.203**



orange/black
code: **0022397.209**



white/orange
code: **0022397.229**



white/blue
code: **0022397.232**



white/yellow
code: **0022397.234**



white/black
code: **0022397.237**



white/red
code: **0022397.239**



blue/white
code: **0022397.245**



yellow/black
code: **0022397.279**



black/orange
code: **0022397.313**



black/white
code: **0022397.315**



black/green
code: **0022397.325**



red/white
code: **0022397.343**



red/black
code: **0022397.349**



green/black
code: **0022397.377**



black/black
code: **0022397.321**

REPLACEMENTS COVERS



orange/white
code: **0022399.203**



orange/black
code: **0022399.209**



white/orange
code: **0022399.229**



white/blue
code: **0022399.232**



white/yellow
code: **0022399.234**



white/black
code: **0022399.237**



white/red
code: **0022399.239**



blue/white
code: **0022399.245**



yellow/black
code: **0022399.279**



black/orange
code: **0022399.313**



black/white
code: **0022399.315**



black/green
code: **0022399.325**



red/white
code: **0022399.343**



red/black
code: **0022399.349**



green/black
code: **0022399.377**

REPLACEMENTS BARS



orange
code: **0022394.010**



fluo orange
code: **0022394.014**



white
code: **0022394.030**



blue
code: **0022394.040**



yellow
code: **0022394.060**



fluo yellow
code: **0022394.061**



black
code: **0022394.090**



red
code: **0022394.110**



green
code: **0022394.130**



fluo green
code: **0022394.131**



MULTIPLIO "E" HANDGUARDS

DESCRIPTION:

- Highly impact-resistant, anti-corodal aluminium bar with side fold in the hand area
- Bracelets for fixing handguard to handlebar in anti-corodal material
- Steel expander to increase fastening and counteract bending in case of impact
- Aluminium/plastic bi-material cover
- Application: handlebars with internal diameter ranging from 13.5 mm. to 18 mm. and external diameter from 22 mm. to 28 mm.



MOUNTING KIT
INCLUDED



KIT X-STRONG
code: **0013060.090**



KTM orange 2016
code: **0013056.011.016**



white
code: **0013056.030**



blue
code: **0013056.040**



black
code: **0013056.090**

REPLACEMENTS



PLASTICS "E"

model: **MULTIPLIO "E"**

code: **0007982.**

colors: WHITE **030** / BLUE **040** / BLACK **090** / RED **110**



PLASTICS "T"

model: **MULTIPLIO "E"**

code: **0007981.**

colors: BLACK **090**

ENDURANCE HANDGUARDS

DESCRIPTION:

- Highly impact-resistant, anti-corodal aluminium bar with side fold in the hand area
- Bracelets for fixing handguard to handlebar in anti-corodal material
- Steel expander to increase fastening and counteract bending in case of impact
- Plastic cover with wide protection and ventilation
- Application: handlebars with internal diameter ranging from 13.5 mm. to 18 mm. and external diameter from 22 mm. to 28 mm.



MOUNTING KIT
INCLUDED



KIT X-STRONG
code: **0013060.090**



orange
code: **0016865.010**



KTM orange 2016
code: **0016865.011.016**



white
code: **0016865.030**



blue
code: **0016865.040**



black
code: **0016865.090**



red
code: **0016865.110**



SUPERMOTO HANDGUARDS



MOUNTING KIT
INCLUDED



UNIVERSAL MOUNTING KIT
code: **0013060.090**



white
code: **0013063.030**



black
code: **0013063.090**

REPLACEMENTS



BARS

model: **MULTICONCEPT**
code: **0015642.090**



SLIDERS

model: **SUPERMOTO**
code: **0009791.090**



RALLY PRO HANDGUARDS

DESCRIPTION:

- Aluminium bar overprinted in different colours
- Bracelets for fixing handguard to handlebar in anti-corodal material
- Steel expander to increase fastening and counteract bending in case of impact
- Application: handlebars with internal diameter ranging from 13.5 mm. to 18 mm. and external diameter from 22 mm. to 28 mm.



KIT X-STRONG
code: **0013060.090**



orange
code: **0013054.010.098**



KTM orange 2016
code: **0013054.011.016**



white
code: **0013054.030**



blue
code: **0013054.040.098**



black
code: **0013054.090**



red
code: **0013054.110**



red 00
code: **0013054.110.990**

REPLACEMENTS

PLASTICS

model: **RALLY PRO**

code: **0003094.**

colors: ORANGE **010.098** / KTM ORANGE 2016 **011.016** / WHITE **030** / BLUE **040.098** / BLACK **090** / RED **110** / RED 00 **110.990**



SPOILER

model: **RALLY PRO**

code: **0001501.090**



UNIKO ATV HANDGUARDS

DESCRIPTION:

- Designed for ATV use. Does not interfere with brake and clutch pumps
- Does not rotate when loaded
- The mounting kit contains 2 expanders for mounting on aluminium and steel handlebars with an internal diameter of 16 mm and 19 mm.



HANDLEBARS Ø BETWEEN
16 mm. AND 19 mm.



white
code: **0009463.030**



black
code: **0009463.090**

TRI FIT HANDGUARDS

Made of Nylon. This innovative, multi-functional handguard kit allows 4 different configurations:

- (1) STRONG closed
- (2) MX open
- (3) ATV without bracelet
- (4) Strong closed without bar and cover.

It can be fitted on Cross bikes, dirt bikes, motard, and ATV. Great flexibility of use. The mounting kit is included (for aluminum handlebar).

• **MIN. ø 13,6 mm. - MAX. ø 14,6 mm.**

1 > STRONG CLOSED



2 > MX OPEN



3 > ATV

WITHOUT BRACELET



4 > STRONG CLOSED

WITHOUT COVER



orange
code: **0016508.010**



KTM orange 2016
code: **0016508.011.016**



white
code: **0016508.030**



blue
code: **0016508.040**



yellow
code: **0016508.060**



black
code: **0016508.090**



red
code: **0016508.110**



green
code: **0016508.130**

REPLACEMENTS

PLASTICS

model: **TRI FIT**
code: **0016633.**
colors: ORANGE **010** / KTM ORANGE 2016 **011.016**
WHITE **030** / BLUE **040** / YELLOW **060**
BLACK **090** / RED **110** / GREEN **130**



BRACELETS

2 bracelets + screws
model: **TRI FIT**
code: **0016632.090**



EXPANDER

for handlebars ø from 15 mm to 16 mm
model: **TRI FIT**
code: **0016943.**



X OPEN > PAG. 256

RALLY PROFILE HANDGUARDS

DESCRIPTION:

- Polypropylene cover that guarantees protection and the utmost lightness
- Application: handlebars with internal diameter ranging from 13.5 mm. to 16 mm. and external diameter from 22 mm. to 28 mm.

MOUNTING KIT
INCLUDED



X-RALLY
code: **0013437.**



orange
code: **0013057.010**



KTM orange 2016
code: **0013057.011.016**



white
code: **0013057.030**



blue
code: **0013057.040**



yellow
code: **0013057.060**



black
code: **0013057.090**



red
code: **0013057.110**



green
code: **0013057.130**

REPLACEMENTS



EXPANDER

for handlebars \varnothing from 15 mm to 16 mm
model: **RALLY PROFILE**
code: **0016943.**



PLASTICS

model: **RALLY PROFILE**
code: **0010932.**

colors: ORANGE **010** / KTM ORANGE 2016 **011.016** / WHITE **030** / BLUE **040** / YELLOW **060** / BLACK **090** / RED **110** / GREEN **130**



RALLY BRUSH HANDGUARDS

DESCRIPTION:

- Nylon cover that guarantees protection and extraordinary impact resistance along with utmost lightness
- Application: handlebars with internal diameter ranging from 13.6 mm. to 14.6 mm. and external diameter from 22 mm. to 28 mm.



X-RALLY
code: **0013437.**



white
code: **0000528.030**



black
code: **0000528.090**

REPLACEMENTS



SPOILER

model: **RALLY BRUSH**
code: **0000607.090**



EXPANDER

for handlebars \varnothing from 15 mm to 16 mm
model: **RALLY BRUSH**
code: **0016943.**

X-FACTOR

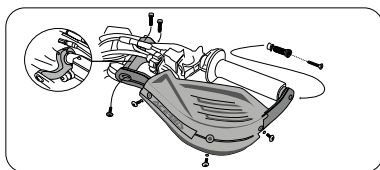

X-FACTOR MOUNTING KIT
for handlebars
internal \varnothing from 13,5 mm to 16 mm
esternal \varnothing from 22 mm to 28 mm
code: **0017631**.



TRI FIT

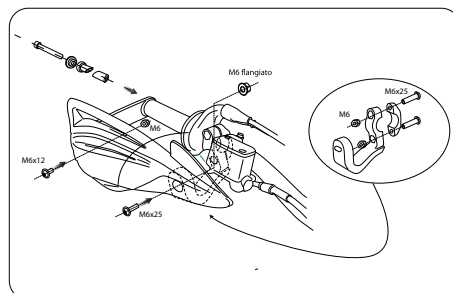

BRACELETS
2 bracelets + screws
code: **0016632.090**

SPACERS KIT
insert for \varnothing 14,5 mm.
handlebar
code: **0013061**.

EXPANDER
for handlebars \varnothing
from 15 mm to 16 mm
code: **0016943**.

X-OPEN



X-OPEN BRE



BRACELETS
2 bracelets + screws
code: **0017886**.



RALLY III

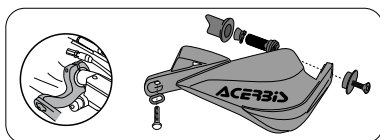

KIT X-STRONG
code: **0013060.090**



MULTIPL0 "E"



MULTIPL0 "R"



ENDURANCE



RALLY PRO



SUPERMOTO



MULTICONCEPT

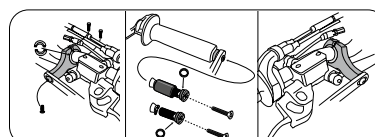

KIT X-STRONG
for handlebars
internal \varnothing from 13,5 mm to 19 mm
esternal \varnothing from 22 mm to 28 mm
code: **0013060.090**



SPACERS
code: **0006832**.



EXPANDER complete
for handlebars internal \varnothing
from 13,5 mm to 17,5 mm
code: **0006773**.



X-FACTORY



KIT X-FACTORY
code: **0022427**.



EXPANDER complete
for handlebars internal \varnothing
from 13,5 mm to 16 mm
code: **0023109**.



X-ULTIMATE



KIT X-ULTIMATE
code: **0022480**.



MOUNTING KIT HANDGUARDS

RALLY PROFILE



RALLY BRUSH

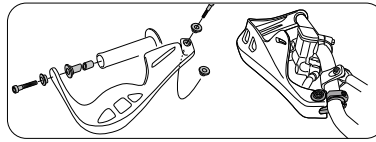

UNIVERSAL MOUNTING KIT X-RALLY

for handlebars
internal \varnothing from 13,5 mm to 14,5 mm
external \varnothing from 22 mm to 28 mm
material: **Aluminium**
code: **0013018.**



UNIVERSAL MOUNTING KIT X-RALLY

for handlebars
internal \varnothing from 13,5 mm to 14,5 mm
external \varnothing from 22 mm to 28 mm
material: **Plastic**
code: **0013437.**



SPACERS KIT

for handlebars
internal \varnothing from 13,5 mm to 14,5 mm
code: **0013061.**



EXPANDER

for handlebars
internal \varnothing from 15 mm to 16 mm
code: **0016943.**



MOUNTING KIT FOR STEEL BARS

for handlebars
internal \varnothing from 17,5 mm to 18,5 mm
external \varnothing from 22 mm to 28 mm
code: **0017819.**



UNIKO ATV

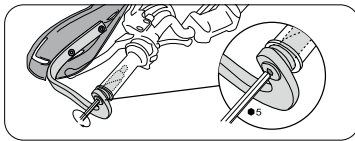

MOUNTING KIT KOREN

for handlebars
internal \varnothing from 13 mm to 14,6 mm
code: **0009790.**



X-FORCE

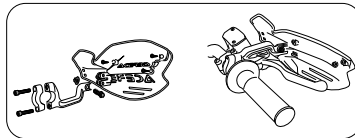

UNIVERSAL MOUNTING KIT

code: **0013741.**



MX UNIKO

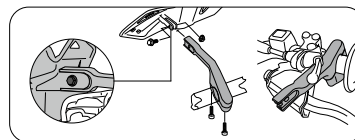

UNIVERSAL MOUNTING KIT

code: **0008158.090**

material: **Plastic**



UNIVERSAL MOUNTING KIT

code: **0008141.**

material: **Aluminium**



X-FUTURE

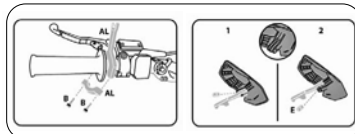

UNIVERSAL MOUNTING KIT

code: **0024362.090**



K-FUTURE



UNIVERSAL MOUNTING KIT

code: **0024361.090**



AFRICA TWIN MOUNTING KIT

AFRICA TWIN MOUNTING KIT
code: **0023417.**



MODEL	YEAR	CODE	OPTIONAL KIT
AFRICA TWIN CRF 1000L	16/18	0023417.	/
AFRICA TWIN ADVENTURE SPORTS	16/18	0023417.	/
AFRICA TWIN TRAVEL EDITION	16/18	0023417.	/

COMPATIBLE FOR:

X-FACTORY



MULTIPL0 "E"



ENDURANCE



SUPERMOTO



RALLY PRO



X-FACTOR



X-TARMAC HANDGUARDS

- A unique handguard designed for road use. X-TARMAC combines style, safety and convenience.
- Featuring a futuristic flat light that easy to connect to the lighting system (12v).
- This hand guard is trimmed with a transparent removable spoiler, designed to increase the deflection of air and rain.
- **X-TARMAC CAN BE FITTED ON ALL THE BIKES WITH HANDLEBAR THAT HAS AN INTERNAL DIAMETER FROM 13,6 MM TO 19 MM. (thanks to the mounting kit included)**
- The hinged side allows the front cover to be rotated horizontally ensuring an optimal adaptation.
- The aerodynamic design is co-injected with metal insert to provide a considerable rigidity.
- There is an optional kit, sold separately, for installation on handlebars with a different diameter type.



- Paramano dal design innovativo pensato per l'impiego stradale. X-TARMAC coniuga stile, sicurezza e praticità.
- Dotato di un'avveniristica lampada di segnalazione Flat, facilmente collegabile all'impianto luci o frecce (12v).
- questo paramano è arricchito da uno spoiler trasparente removibile, pensato per aumentare il riparo da aria e pioggia.
- **X-TARMAC PUÒ ESSERE MONTATO SU TUTTE LE MOTO IL CUI MANUBRIO ABBA UN DIAMETRO INTERNO DA 13,6 MM. A 19 MM. (grazie al kit montaggio incluso)**
- Lo snodo laterale permette alla cover anteriore di essere ruotata orizzontalmente garantendone un ottimale adattamento.
- Il Design aerodinamico e un sistema con inserto metallico coiniettato, garantiscono una considerevole attenuazione delle vibrazioni.
- Kit opzionale (a parte) per installazione su manubri con sistemi di montaggio differenti rispetto ai tradizionali cavi con diam. interno da 13.6 a 19mm



code: **0017564.090**

REMOVABLE SPOILER

JOINT FOR HANDGUARDS REGULATION

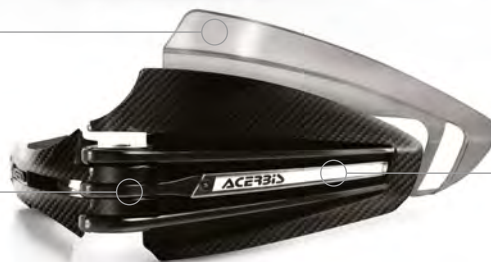

ELECTROLUMINESCENT INSERTS INCLUDED

X-TARMAC WITHOUT ELECTROLUMINESCENT INSERTS



code: **0017931.090**

REPLACEMENTS



ELECTROLUMINESCENT INSERTS (2 pcs)
code: **0017575.**



MOUNTING KIT
code: **0015644.**

DUAL ROAD HANDGUARDS

- Antivibration bar inserts
- Aerodynamic design
- Bar made of nylon PA66
- Spoiler made of polycarbonate
- Removable spoiler
- Led (sold separately)
- **CAN BE FITTED ON ALL THE BIKES WITH HANDLEBAR THAT HAS AN INTERNAL DIAMETER FROM 13,6 MM TO 19 MM.**



DUAL ROAD WITHOUT MOUNTING KIT

MOUNTING KIT SOLD SEPARATELY



OPTIONALS



LED (2 pcs)
code: **0013081.**

REPLACEMENTS



MOUNTING KIT
code: **0015644.**





APPLICATIONS FOR X-TARMAC / DUAL ROAD HANDGUARDS

MODEL	YEAR	COD. DUAL ROAD	COD. X-TARMAC
APRILIA			
1100 FACTORY	2016	0013046.	0017564.090
CAPONORD 1200	15/16	0013046. + 0017572.*	0017564.090 + 0017572.*
CAPONORD RALLY	2016	0013046.	0017564.090
DORSODURO 750	08/18	0013046. + 0017572.*	0017564.090 + 0017572.*
DORSODURO 900	17/18	0013046. + 0017568.*	0017564.090 + 0017634.*
DORSODURO 900	18/20	0013046. +0017572*	0017564.090 +0017572*
MANA 850	08/16	0013046. + 0017572.*	0017564.090 + 0017572.*
PEGASO 650	07/09	0013046. + 0017572.*	0017564.090 + 0017572.*
SCARABEO 300 S	16/18	0013046. + 0017572.*	0017564.090 + 0017572.*
SCARABEO 200/500	07/14	0013046. + 0017572.*	0017564.090 + 0017572.*
SHIVER 750	08/18	0013046. + 0017572.*	0017564.090 + 0017572.*
SHIVER 900	17/18	0013046. + 0017568.*	0017564.090 + 0017634.*
SHIVER 900	18/19	0013046. +0017572*	0017564.090 +0017572*
SPORTCITY 125/200/250	07/14	0013046.	0017564.090
SRV 850	12/16	0013046. + 0017572.*	0017564.090 + 0017572.*
SRV 900	17/18	0013046. + 0017572.*	0017564.090 + 0017572.*
SX 50	2020	0013046. + 0023386.	0017564.090 + 0023386.
TUONO 125	17/18	0013046. + 0017634.*	0017564.090 + 0017634.*
TUONO 125	18/19	0013046. +0017572*	0017564.090 +0017572*
TUONO 1000	08/18	0013046. + 0017572.*	0017564.090 + 0017572.*
TUONO 1100	17/18	0013046. /	0017564.090 + 0017634.*
FACTORY TUONO 1100	18/19	0013046. +0017572*	0017564.090 +0017572*
BENELLI			
502 C	2020	0013046.	0017564.090
752 S	2020	0013046.	0017564.090
BN 251/302	17/20	0013046.	0017564.090
BN125/BN250	18/20	0013046.	0017564.090
GRANPASSO	09/10	0013046.	0017564.090
IMPERIALE 400	2020	0013046.	0017564.090
LEONCINO 250	2020	0013046.	0017564.090
LEONCINO 500	17/20	0013046.	0017564.090
LEONCINO TRAIL	2020	0013046.	0017564.090
TRK 250	17/20	0013046.	0017564.090
TRK 502	17/20	/	0017564.090
TRK 502 X	2020	0013046.	0017564.090
TNT 125 NAKED	17/19	0013046.	0017564.090
TNT 899	08/12	0013046.	0017564.090
TNT SPORT EVO 1130	09/12	0013046.	0017564.090
TORNADO NAKED 1130	08/12	0013046.	0017564.090
TORNADO NAKED 125			

MODEL	YEAR	COD. DUAL ROAD	COD. X-TARMAC
TRE AMAZONAS 898	08/12	0013046.	0017564.090
BIMOTA			
BIMOTA DB6 DELIRIO	09/10	0013046.	0017564.090
BMW			
G 310 GS	17/19	0013046. + 0023386.*	0017564.090 + 0023386.*
	2020	/	0017564.090
		/	+ 0023386.*
G 320 GS	2019	0013046. + 0023386.*	0017564.090 + 0023386.*
C 400 GT-X	2019	/	0017564.090
		/	+ 0023386.*
C 650 SPORT	2019	0013046. + 0023386.*	0017564.090 + 0023386.*
C 650 GT	2019		0017564.090
			+ 0023386.*
F 650 GS	07/14	0013046. + 0017567.*	0017564.090 + 0017567.*
F 650 GT	2017	0013046. + 0021716.*	0017564.090 + 0017567.*
F 700 GS	12/16	/	0017564.090
		/	+ 0017568.*
	2017	0013046. /	0017564.090 + 0017568.*
F 750 GS	18/20	0013046. +0017835*	0017564.090 +0017835*
F 800 GS	08/12	0013046. + 0017567.*	0017564.090 + 0017567.*
	13/17	0013046. + 0017568.*	0017564.090 + 0017568.*
F 850 GS	2020	0013046. +0017835*	0017564.090 +0017835*
F 800 ST	09/17	0013046. + 0017568.*	0017564.090 + 0017568.*
F 800 R	09/13	0013046. + 0017567.*	0017564.090 + 0017567.*
F 800 R	18/19	0013046. +0021716*	0017564.090 +0021716*
	14/17	0013046. + 0021716.*	0017564.090 + 0021716.*
F 850 GS	18/19	0013046. +0017835*	0017564.090 + 0017568.*
F 900 XR	2020	0013046. +0017835*	0017564.090 +0017835*
G 310 R	2020	0013046. + 0023386.*	0017564.090 + 0023386.*
G 650 GS	14/16	/	0017564.090
	2017	0013046. + 0021716.*	0017564.090 + 0017572.*
K 1200 R	06/16	0013046. + 0017568.*	0017564.090 + 0017568.*
K 1300 R / S	09/17	0013046. + 0017568.*	0017564.090 + 0017568.*
K 1300 GT	10/14	0013046. + 0017569.*	0017564.090 + 0017569.*
K 1600 B/GT/GT-L	17/18	/	0017564.090
		/	+ 0017571.*
R 1200 GS	07/12	0013046. + 0017570.*	0017564.090 + 0017570.*

* ADDITIONAL MOUNTING KIT / KIT DI MONTAGGIO OPZIONALE



APPLICATIONS FOR X-TARMAC / DUAL ROAD HANDGUARDS

MODEL	YEAR	COD. DUAL ROAD	COD. X-TARMAC
	13/18	0013046.	0017564.090
		+ 0017835.*	+ 0017835.*
R 1200 GS ADVENTURE	07/13	0013046.	0017564.090
		+ 0017570.*	+ 0017570.*
	14/18	0013046.	0017564.090
		+ 0017835.*	+ 0017835.*
R 1250 GS	18/20	/	0017564.090
		/	+0017835*
R 1200 R	07/14	0013046.	0017564.090
		+ 0017568.*	+ 0017568.*
	15/19	0013046.	0017564.090
		+ 0017835.*	+ 0017835*
R 1200 RS	15/18	/	0017564.090
		/	+ 0017568.*
R 1200 RT	07/09	0013046.	0017564.090
		+ 0017569.*	+ 0017569.*
	10/18	0013046.	0017564.090
		+ 0017568.*	+ 0017568.*
R NINE T	2020	0013046.	0017564.090
		+ 0021716.*	+ 0021716.*
R NINE T SCRAMBLER	15/19	/	0017564.090
		/	+ 0021716.*
R NINE T SCRAMBLER	2020	0013046.	0017564.090
		+ 0021716.*	+ 0021716.*
R NINE T RACER	2020	0013046.	0017564.090
		+ 0021716.*	+ 0021716.*
R NINE T PURE	2020	0013046.	0017564.090
		+ 0021716.*	+ 0021716.*
R NINE T URBAN G/S	2020	0013046.	0017564.090
		+ 0021716.*	+ 0021716.*
S 1000 XR	15/18	/	0017564.090
		/	+ 0017835.*
S 1000 R	15/18	0013046.	0017564.090
		+ 0021716.*	+ 0021716.*
BRIXTON			
FELSBURG 125	2020	0013046.	0017564.090
FELSBURG 250	2020	0013046.	0017564.090
FELSBURG 125 XC	2020	0013046.	0017564.090
BX 125	2020	0013046.	0017564.090
CROMWELL 125	2020	0013046.	0017564.090
CROMWELL 250	2020	0013046.	0017564.090
GLANVILLE 250	2020	0013046.	0017564.090
SAXBY 250	2020	0013046.	0017564.090
BUELL			
BUELL 1125 CR	08/11	0013046.	0017564.090
DUCATI			
DIAVEL	12/19	0013046.	0017564.090
HYPERMOT. 1100	08/09	0013046.	0017564.090
HYPERMOT. 1100 EVO/821	10/17	0013046.	0017564.090
		+ 0017572.*	+ 0017572.*
HYPERMOTARD 939 SP	16/18	0013046.	0017564.090
HYPERMOTARD 950	2019	0013046.	0017564.090
MONSTER 696/796	08/19	0013046.	0017564.090
MONSTER 797	08/20	0013046.	0017564.090
MONSTER 821	14/20	0013046.	0017564.090
MONSTER 821 STEALTH	2020	0013046.	0017564.090
MONSTER 1200	16/20	0013046.	0017564.090
MONSTER 1200 S	2020	0013046.	0017564.090

MODEL	YEAR	COD. DUAL ROAD	COD. X-TARMAC
MONSTER S 1100	08/17	0013046.	0017564.090
MONSTER S 1100 EVO	08/17	0013046.	0017564.090
MULTISTRADA 950	2020	0013046.	0017564.090
MULTISTRADA 950 S	19/20	0013046.	0017564.090
MULTISTRADA 1100	08/18	0013046.	0017564.090
MULTISTRADA 1100 S	08/18	0013046.	0017564.090
MULTISTRADA 1200 S	12/18	0013046.	0017564.090
MULTISTRADA 1260 S	2019	0013046.	0017564.090
PANIGALE	2019	0013046.	0017564.090
SCRAMBLER 803	2019	0013046.	0017564.090
SCRAMBLER 1100	2019	0013046.	0017564.090
SPORTCLASSIC	15/18	0013046.	0017564.090
SPORTCLASSIC	10/18	0013046.	0017564.090
STREETFIGHTER 848/1098	09/17	0013046.	0017564.090
STREETFIGHTER V4	2020	0013046.	0017564.090
SUPERSPORT	18/20	0013046.	0017564.090
SUPERSPORT S	2020	0013046.	0017564.090
V4 S	2020	0013046.	0017564.090
X DIAVEL	2020	0013046.	0017564.090
X DIAVEL S	2020	0013046.	0017564.090
FANTIC			
SCRAMBLER 125	18/19	0013046.	0017564.090
SCRAMBLER 250	18/20	0013046.	0017564.090
SCRAMBLER 500	19/20	0013046.	0017564.090
GILERA			
FUOCO 500	08/15	0013046.	0017564.090
GUZZI			
1200 SPORT	08/16	0013046.	0017564.090
		+ 0017572.*	+ 0017572.*
AUDACE	16/17	0013046.	0017564.090
		+ 0017572.*	+ 0017572.*
BELLAGIO	07/18	0013046.	0017564.090
		+ 0017572.*	+ 0017572.*
BREVA 850	08/18	0013046.	0017564.090
		+ 0017572.*	+ 0017572.*
BREVA 1200	08/18	0013046.	0017564.090
		+ 0017572.*	+ 0017572.*
CALIFORNIA 1400 TOURING	16/20	0013046.	0017564.090
		+ 0017572.*	+ 0017572.*
GRISO 1200 8V	11/18	0013046.	0017564.090
		+ 0017572.*	+ 0017572.*
NORGE 1200 8V	11/18	0013046.	0017564.090
		+ 0017572.*	+ 0017572.*
NEVADA 1000	08/20	0013046.	0017564.090
		+ 0017572.*	+ 0017572.*
STELVIO 1200	08/18	0013046.	0017564.090
		+ 0017572.*	+ 0017572.*
V 7 II	16/17	0013046.	0017564.090
		+ 0017572.*	+ 0017572.*
V 7 II SPECIAL	16/17	0013046.	0017564.090
		+ 0017572.*	+ 0017572.*
V 7 III STONE	18/20	0013046.	0017564.090
		+ 0017572.*	+ 0017572.*
V 7 III CARBON	2018	0013046.	0017564.090
		+ 0017572.*	+ 0017572.*
V 7 III SPECIAL	18/20	0013046.	0017564.090
		+ 0017572.*	+ 0017572.*
V 7 III ROUGH	18/20	0013046.	0017564.090

* ADDITIONAL MOUNTING KIT / KIT DI MONTAGGIO OPZIONALE



APPLICATIONS FOR X-TARMAC / DUAL ROAD HANDGUARDS

MODEL	YEAR	COD. DUAL ROAD	COD. X-TARMAC
		+ 0017572.*	+ 0017572.*
V 7 STONE	11/17	0013046.	0017564.090
		+ 0017572.*	+ 0017572.*
V 7 SPECIAL	13/17	0013046.	0017564.090
		+ 0017572.*	+ 0017572.*
V 7 STORNELLO	16/18	0013046.	0017564.090
		+ 0017572.*	+ 0017572.*
V 85 TT	18/20	0013046.	0017564.090
		+ 0017572.*	+ 0017572.*
V 9 BOBBER	16/18	0013046.	0017564.090
		+ 0017572.*	+ 0017572.*
V 9 ROAMER	16/20	0013046.	0017564.090
		+ 0017572.*	+ 0017572.*
HONDA			
HM CITY/LOCUSTA 125/200	11/14	0013046.	0017564.090
HM CRE 50	05/17	0013046.	0017564.090
HM CRM 50 DERA-PAGE	05/17	0013046.	0017564.090
HM CRM F 125 2T/4T	10/17	0013046.	0017564.090
AFRICA TWIN	16/18	0013046.	0017564.090
AFRICA TWIN AD-VENTURE	18/19	0013046.	0017564.090
ADV 750	17/18	/	0017564.090
X-ADV	18/20	0013046.	0017564.090
CB 125 F	19/20	0013046.	0017564.090
CB 125 R	2020	0013046.	0017564.090
CBR 125 R	2019	0013046.	0017564.090
CB 300 R	18/20	0013046.	0017564.090
CB 500 F	14/17	0013046.	0017564.090
CB 500 X	13/15	/	0017564.090
		/	+ 0017572.*
CB 500 X	16/20	0013046.	0017564.090
CB 600 F HORNET	04/17	0013046.	0017564.090
	2020	/	0017564.090
CB 650 F	15/18	0013046.	0017564.090
CB 1000 R	08/18	/	0017564.090
	2020	0013046.	0017564.090
CB 1100	17/20	0013046.	/
CB 1100 / EX	10/18	0013046.	0017564.090
CB 1300	08/17	0013046.	0017564.090
CBR 500 R	18/20	0013046.	0017564.090
CBR 650 R	18/20	0013046.	0017564.090
CBF 600 N	08/18	0013046.	0017564.090
CBF 1000	09/17	/	0017564.090
CBR 1000 R	2019	0013046.	0017564.090
CMX 500 REBEL	19/20	0013046.	0017564.090
CROSSRUNNER	11/16	0013046.	0017564.090
	17/18	0013046.	0017564.090
		+ 0017572.*	+ 0017572.*
	19/20	0013046.	0017564.090
CROSSTOURER	16/17	/	0017564.090
	19/20	0013046.	0017564.090
CRF 250 L-M	12/18	0013046.	0017564.090
CR-F 250/450 X	05/18	0013046.	0017564.090
CR-F 450 RX SUPER-MOTO	10/19	0013046.	0017564.090
CRF 450 XR	2020	0013046.	0017564.090
CRF 600/650	19/20	0013046.	/
CTX 700	12/17	0013046.	0017564.090
DEAUVILLE 700	11/17	/	0017564.090
HORNET 600	2008/13	/	0017564.090
INTEGRA SE/XP	19/20	0013046.	0017564.090
MONKEY	18/20	0013046.	0017564.090
		+ 0017572.*	+ 0017572.*

MODEL	YEAR	COD. DUAL ROAD	COD. X-TARMAC
NC 700/750	12/20	/	0017564.090
NC 700 X/ NC 750 X	16/18	/	0017564.090
NC 750 S	16/19	/	0017564.090
PCX	2014/20	/	0017564.090
		/	+ 0017572.*
SHADOW VT 750 S	2016	0013046.	0017564.090
	2020	0013046.	0017564.090
SH 125/150/300	09/20	0013046.	0017564.090
		+ 0017572.*	+ 0017572.*
TRANSALP	2008/13	/	0017564.090
	2020	/	0017564.090
TRANSALP 700	06/16	0013046.	0017564.090
		+ 0017572.*	+ 0017572.*
VFR 1200F	09/20	/	0017564.090
VULTUS NM4	19/20	0013046.	/
HUSQVARNA			
701 SUPERMOTO	2018	0013046.	/
VITPILEN 401	18/20	0013046.	0017564.090
VITPILEN 701	18/20	0013046.	0017564.090
SVARTPILEN 401	19/20	0013046.	0017564.090
SVARTPILEN 701	19/20	0013046.	0017564.090
NUDA 900	08/14	0013046.	0017564.090
SM/TE 125	08/14	0013046.	0017564.090
SMR 460/610	08/12	0013046.	0017564.090
SMR 511	11/13	0013046.	0017564.090
		+ 0017572.*	+ 0017572.*
SMR 630	11/13	0013046.	0017564.090
TERRA/STRADA 650	12/13	0013046.	0017564.090
		+ 0017572.*	+ 0017572.*
KAWASAKI			
S 125/300	14/19	0013046.	0017564.090
		+ 0017571. *	+ 0017571. *
ER 5 500	96/06	0013046.	0017564.090
		+ 0017571. *	+ 0017571. *
ER 6N	09/16	0013046.	0017564.090
		+ 0017571. *	+ 0017571. *
NINJA 650	2019	0013046.	0017564.090
		+ 0017571. *	+ 0017571. *
VERSYS 300	18/19	0013046.	0017564.090
VERSYS-X 300	2020	0013046.	0017564.090
		+ 0017571. *	+ 0017571. *
VERSYS-X 300 UR-BAN	2020	0013046.	0017564.090
		+ 0017571. *	+ 0017571. *
VERSYS-X 300 AD-VENTURE	2020	0013046.	0017564.090
		+ 0017571. *	+ 0017571. *
VERSYS 650	08/17	/	0017564.090
		/	+ 0017571. *
	18/19	0013046.	0017564.090
		+ 0017571. *	+ 0017571. *
VERSYS 650 TOURER PLUS	2020	0013046.	0017564.090
		+ 0017571. *	+ 0017571. *
VERSYS 650 GRAND TOURER	2020	0013046.	0017564.090
		+ 0017571. *	+ 0017571. *
VERSYS 1000	11/17	/	0017564.090
		/	+ 0017571. *
VERSYS 1000	18/19	0013046.	0017564.090
		+ 0017571. *	+ 0017571. *

* ADDITIONAL MOUNTING KIT / KIT DI MONTAGGIO OPZIONALE



APPLICATIONS FOR X-TARMAC / DUAL ROAD HANDGUARDS

MODEL	YEAR	COD. DUAL ROAD	COD. X-TARMAC
VN 900-1200	09/19	0013046.	0017564.090
VULCAN 650 S	08/20	0013046. + 0017571. *	0017564.090 + 0017571. *
Z 125	19/20	0013046. + 0017571. *	0017564.090 + 0017571. *
Z 125 PERFORMANCE	2020	0013046. + 0017571. *	0017564.090 + 0017571. *
Z 300	15/19	0013046. + 0017571. *	0017564.090 + 0017571. *
Z 400	18/20	0013046. + 0017571. *	0017564.090 + 0017571. *
Z 400 PERFORMANCE	2020	0013046. + 0017571. *	0017564.090 + 0017571. *
Z 650	2020	0013046. + 0017571. *	0017564.090 + 0017571. *
Z 650 PERFORMANCE	2020	0013046. + 0017571. *	0017564.090 + 0017571. *
Z 750	08/14	0013046. + 0017571. *	0017564.090 + 0017571. *
Z 800	13/16	0013046. + 0017571. *	0017564.090 + 0017571. *
Z 900	16/20	0013046. + 0017571. *	0017564.090 + 0017571. *
Z 900 PERFORMANCE	2020	0013046. + 0017571. *	0017564.090 + 0017571. *
Z 900 RS	2020	0013046. + 0017571. *	0017564.090 + 0017571. *
Z 900 RS PERFORMANCE	2020	0013046. + 0017571. *	0017564.090 + 0017571. *
Z 1000	08/19	0013046. + 0017571. *	0017564.090 + 0017571. *
Z 1000 EDITION	2020	0013046. + 0017571. *	0017564.090 + 0017571. *
KTM			
390 ADVENTURE	2020	0013046. + 0017572.*	0017564.090 + 0017572.*
790 ADVENTURE	18/20	0013046.	0017564.090
790 ADVENTURE R RALLY	2020	0013046.	0017564.090
790 ADVENTURE R	2020	0013046.	0017564.090
ADVENTURE 950/990	05/12	0013046.	0017564.090
ADVENTURE 1090R	17/18	0013046.	0017564.090
ADVENTURE R 1190/1050/1290	12/19	0013046.	0017564.090
1290 SUPER ADVENTURE R	2020	0013046.	0017564.090
1290 SUPER ADVENTURE S	2020	0013046.	0017564.090
DUKE 125	13/18	0013046. /	0017564.090 + 0017572.*
DUKE 200/390/690	09/18	0013046. + 0017572.*	0017564.090 + 0017572.*
DUKE 390	16/20	0013046. + 0017572.*	0017564.090 + 0017572.*
DUKE 690	2016	0013046.	0017564.090
790 DUKE	2020	/	0017564.090
790 DUKE L (A2)	2020	/	0017564.090
890 DUKE R	2020	/	0017564.090
SUPERDUKE 790/1290/1290 R/1300	13/18	0013046. + 0017572.*	0017564.090 + 0017572.*
SUPERDUKE 990	11/14	0013046.	0017564.090
1290 SUPER DUKE GT	2020	0013046.	0017564.090

MODEL	YEAR	COD. DUAL ROAD	COD. X-TARMAC
1290 SUPER DUKE R	2020	0013046.	0017564.090
SMC 690	09/15	0013046.	0017564.090
SM 950	06/09	0013046.	0017564.090
SM 990	09/12	0013046.	0017564.090
990 SUPERMOTO IE	09/14	0013046.	0017564.090
KYMCO			
AGILITY 125 CARRY E4	2020	/	0017564.090
AGILITY 125I R16 +	2020	/	0017564.090
AGILITY 150I R16 + ABS	2020	/	0017564.090
AGILITY 200I R16 + ABS	2020	/	0017564.090
AGILITY 50 CARRY E4	2020	0013046.	0017564.090
AGILITY 50 R12 E4	2020	0013046.	0017564.090
AGILITY 50/125/150	2019	/	0017564.090
AK 550	2019	0013046.	0017564.090
AK 550 2020	2020	0013046.	0017564.090
AK 550 ABS	2020	0013046.	0017564.090
DOWNTOWN 350 I ABS E4	2020	/	0017564.090
G DINK 300	2019	/	0017564.090
G-DINK 300I ABS	2020	0013046.	0017564.090
GTI 125	2019	/	0017564.090
GTI 300	2019	/	0017564.090
PEOPLE GTI 300 ABS E4	2020	/	0017564.090
X CITING 400	2019	0013046.	0017564.090
XCITING 400I ABS E4 II	2020	0013046.	0017564.090
XCITING 400I S	2020	0013046.	0017564.090
MALAGUTI			
PHANTOM 50	08/10	0013046.	0017564.090
MONTE 125	2020	0013046. + 0017572.*	0017564.090 + 0017572.*
MORINI			
CORSARO 1200	08/15	0013046.	0017564.090
GRANPASSO	09/15	0013046.	0017564.090
MV AGUSTA			
BRUTALE 675	12/14	0013046.	0017564.090
BRUTALE 675 RR	18/20	/	0017564.090 + 0017634.*
BRUTALE 750 S	03/05	0013046.	0017564.090
BRUTALE 800	12/15	0013046.	0017564.090
BRUTALE RR 800	18/20	/	0017564.090 + 0017634.*
BRUTALE 800 ROSSO	2020	/	0017564.090 + 0017572.*
BRUTALE 910 S/R	05/11	0013046.	0017564.090
910 R	2019	0013046.	0017564.090
BRUTALE 920	12/13	0013046.	0017564.090
BRUTALE 989 R	08/13	0013046.	0017564.090
BRUTALE 990	09/13	0013046.	0017564.090
BRUTALE 1078 RR	08/13	0013046.	0017564.090
BRUTALE 1090	09/14	0013046.	0017564.090
DRAGSTER 800 RR	19/20	/	0017564.090 + 0017634.*
PIAGGIO			
6 GIORNI 300	2018	/	0017564.090 + 0017572.*

* ADDITIONAL MOUNTING KIT / KIT DI MONTAGGIO OPZIONALE



APPLICATIONS FOR X-TARMAC / DUAL ROAD HANDGUARDS

MODEL	YEAR	COD. DUAL ROAD	COD. X-TARMAC
BEVERLY 125	12/15	0013046.	0017564.090
		+ 0017572. *	+ 0017572. *
BEVERLY 250	08/18	0013046.	0017564.090
		+ 0017572. *	+ 0017572. *
BEVERLY S 300 ABS ASR	2020	0013046.	0017564.090
		+ 0017572. *	+ 0017572. *
BEVERLY S 350 S ABS	2020	0013046.	0017564.090
		+ 0017572. *	+ 0017572. *
BEVERLY 500	08/18	0013046.	0017564.090
		+ 0017572. *	+ 0017572. *
BEVERLY 350/300 E.I	11/17	0013046.	0017564.090
		+ 0017572.*	+ 0017572.*
BEVERLY 350	18/19	/	0017564.090
		/	+ 0017572.*
BEVERLY 500 E.I	11/16	0013046.	0017564.090
		+ 0017572.*	+ 0017572.*
BEVERLY POLICE	16/19	0013046.	0017564.090
		+ 0017572. *	+ 0017572. *
BEVERLY S	16/17	0013046.	0017564.090
		+ 0017572. *	+ 0017572. *
BEVERLY S	2018/19	/	0017564.090
		/	+ 0017572. *
CARNABY 300	12/14	0013046.	0017564.090
		+ 0017572.*	+ 0017572.*
FLY 125	08/14	0013046.	0017564.090
		+ 0017572.*	+ 0017572.*
GTS 300	2020	/	0017564.090
		/	+ 0017572. *
YOURBAN 300	11/18	0013046.	0017564.090
		+ 0017572.*	+ 0017572.*
LIBERTY 125 POSTE	11/18	0013046.	0017564.090
		+ 0017572.*	+ 0017572.*
LIBERTY 125/150	08/17	0013046.	0017564.090
MEDLEY 125/150	16/18	0013046.	0017564.090
		+ 0017572. *	+ 0017572. *
	19/20	/	0017564.090
		/	+ 0017572. *
MEDLEY S	18/20	/	0017564.090
		/	+ 0017572. *
MP3 300 / 500	11/19	/	0017564.090
		/	+ 0017572.*
SPORT / BUSINESS	11/18	/	0017564.090
		/	+ 0017572.*
VESPA GTS 300	18/19	/	0017564.090
		/	+ 0017572.*
VESPA GTS SUPER	18/19	/	0017564.090
		/	+ 0017572.*
VESPA 6 GIORNI	18/19	0013046.	0017564.090
		+ 0017572. *	+ 0017572.*
SUZUKI			
BANDIT 650/600 (NO S)	14/18	0013046.	0017564.090
BANDIT GSF 1250	09/18	0013046.	0017564.090
B-KING 1300	09/16	0013046.	0017564.090
BURGMAN 400	2018	/	0017564.090
	2020	0013046.	0017564.090
BURGMAN 125/200/650	08/18	0013046.	0017564.090
		+ 0017571. *	+ 0017571. *
BURGMAN EXECUTIVE 650	18/19	/	0017564.090
DRZ 125 SM	08/13	0013046.	0017564.090
GLADIUS 650	09/17	0013046.	0017564.090

MODEL	YEAR	COD. DUAL ROAD	COD. X-TARMAC
		+ 0017572.*	+ 0017572.*
GSR 600	08/18	0013046.	0017564.090
GSR 750	08/19	0013046.	0017564.090
GSX-S 750/1000	15/20	0013046.	0017564.090
GSX-S1000F	2020	0013046.	0017564.090
GSX-S125	2020	0013046.	0017564.090
INAZUMA 250	13/17	0013046.	0017564.090
SV 650 (NO S)	99/20	0013046.	0017564.090
SV 650 X	2020	0013046.	0017564.090
SV 1000 (NAKED)	03/05	0013046.	0017564.090
VANVAN RV 125	09/17	0013046.	0017564.090
V STROM	04/20	0013046.	0017564.090
1000 R	17/19	/	0017564.090
KATANA 1000	19/20	0013046.	0017564.090
SWM			
SUPER DUAL 650 T	2020	0013046.	0017564.090
		+ 0017634.*	+ 0017634.*
SUPER DUAL 650 X	2020	0013046.	0017564.090
		+ 0017634.*	+ 0017634.*
TRIUMPH			
BOBBER 1200	2019	0013046.	0017564.090
		+ 0017572.*	+ 0017572.*
BONNEVILLE 1200	11/20	0013046.	0017564.090
		+ 0017572.*	+ 0017572.*
BONNEVILLE SCRAMBLER 900	17/18	0013046.	0017564.090
		+ 0017572.*	+ 0017572.*
BONNEVILLE T100	17/20	0013046.	0017564.090
		+ 0017572.*	+ 0017572.*
BONNEVILLE T120	16/20	0013046.	0017564.090
		+ 0017572.*	+ 0017572.*
THRUXTON	16/19	0013046.	0017564.090
		+ 0017572.*	+ 0017572.*
SPEED TRIPLE 1050	01/19	0013046.	0017564.090
		+ 0017572.*	+ 0017572.*
SPEED MASTER BONNEVILLE 1200	18/20	0013046.	0017564.090
		+ 0017572.*	+ 0017572.*
SPEED TWIN	2020	0013046.	0017564.090
		+ 0017572.*	+ 0017572.*
STREET CUP 900	16/19	0013046.	0017564.090
		+ 0017572.*	+ 0017572.*
STREET TRIPLE 675	07/18	0013046.	0017564.090
		+ 0017572.*	+ 0017572.*
STREET TRIPLE 765/767/1050	17/18	0013046.	0017564.090
		+ 0017572.*	+ 0017572.*
STREET TRIPLE R/S	2020	0013046.	0017564.090
		+ 0017572.*	+ 0017572.*
STREET TWIN 900	16/20	0013046.	0017564.090
		+ 0017572.*	+ 0017572.*
TIGER 1050 SPORT	07/19	0013046.	0017564.090
		+ 0017572.*	+ 0017572.*
	2020	/	0017564.090
		/	+ 0017572.*
TIGER EXPLORER	13/18	0013046.	0017564.090
		+ 0017572.*	+ 0017572.*
TIGER 800	2020	/	0017564.090
		/	+ 0017572.*
TIGER 800 XRX/XCX	10/19	0013046.	0017564.090

* ADDITIONAL MOUNTING KIT / KIT DI MONTAGGIO OPZIONALE



APPLICATIONS FOR X-TARMAC / DUAL ROAD HANDGUARDS

MODEL	YEAR	COD. DUAL ROAD + 0017572.*	COD. X-TARMAC + 0017572.*
TIGER 900	2020	/	0017564.090
TIGER 1200	18/19	0013046. + 0017572.*	0017564.090 + 0017572.*
	2020	/	0017564.090
SCRAMBLER 900	18/20	0013046. + 0017572.*	0017564.090 + 0017572.*
SCRAMBLER 1200 XC/XE	18/20	0013046. + 0017572.*	0017564.090 + 0017572.*
YAMAHA			
DT 50	03/13	0013046. + 0017634.*	0017564.090 + 0017634.*
FZ1	08/16	0013046.	0017564.090
FZ6/FZ8	06/16	0013046.	0017564.090
J 125	2018	/	0017564.090
J 600	08/14	0013046. + 0017634.*	0017564.090 + 0017634.*
MT 03	19/20	0013046. + 0017572.*	0017564.090 + 0017572.*
MT 07/09/10	13/20	0013046. + 0017634.*	0017564.090 + 0017634.*
MT 09 SP	2020	0013046. + 0017634.*	0017564.090 + 0017634.*
MT 125	2018/19	0013046. + 0017534.*	0017564.090 + 0017534.*
TRACER 900	16/18	0013046. + 0017634.*	0017564.090 + 0017634.*
TRACER 900/900GT/700	2019	0013046.	0017564.090
MT03 660	08/18	0013046. + 0017572.*	0017564.090 + 0017572.*
TDM 900	08/18	0013046.	0017564.090

MODEL	YEAR	COD. DUAL ROAD + 0017634.*	COD. X-TARMAC + 0017634.*
SCR 950	19/20	0013046.	0017564.090
XJ6	10/14	0013046. + 0017634.*	0017564.090 + 0017634.*
XJR 1300	08/18	0013046. + 0017634.*	0017564.090 + 0017634.*
XSR 700/900/1300	16/20	0013046. + 0017634.*	0017564.090 + 0017634.*
XSR 700 XTRIBUTE	2020	0013046. + 0017634.*	0017564.090 + 0017634.*
XT 660 R	10/16	/	0017564.090
XT 660 X	10/16	/	0017564.090
XT 660 Z TENERE CF	10/16	/	0017564.090
TENERE 700	2019	0013046. + 0017634.*	0017564.090 + 0017634.*
SUPER TENERE 1200	10/18	0013046.	0017564.090
SUPER TENERE 1200	2019	/	0017564.090
N-MAX	17/19	/	0017564.090
NEOS 50	08/10	0013046. + 0017634.*	0017564.090 + 0017634.*
MAJESTIC 400	10/16	/	0017564.090
TRICITY 125/155	17/19	/	0017564.090
X-MAX 300/400	2019	/	0017564.090
T-MAX 500/530	01/19	0013046. + 0017634.*	0017564.090 + 0017634.*
T-MAX 560	2020	0013046. + 0017634.*	0017564.090 + 0017634.*
NIKEN GT	19/20	0013046. + 0017634.*	0017564.090 + 0017634.*



X-ROAD 2.0 LEVERS PROTECTIONS

- Pair of shift pad brake/clutch to protect the levers from accidental contacts.
- Adjustable lenght to fit all types of lever.
- Precurved design to guarantee maximum freedom of movement.
- Use of high strenght Nylon to ensure stiffness and flexibility in case of contact.
- Large front shield for aerodynamic protection of the lever.
- **EXPANDER MOUNTING KIT INCLUDED FOR HANDLEBARS WITH INSERT FROM Ø 13,6 MM. TO Ø 19 MM.**



SEE APPLICATIONS
AT PAGE 268/269/270



code: **0022860.090**

X-ROAD BRAKE LEVER PROTECTION

Per le applicazioni vedi cod. 0022860.090 a pag. 266/267 - For the applications see cod. 0022860.090 at pag. 268/269/270



code: **0021615.090**

APPLICATIONS FOR X-ROAD LEVERS PROTECTIONS

MODEL	YEAR	CODE	OPTIONAL KIT
APRILIA			
123 RS	17/18	0022860.090	+ 0017572.*
DORSODURO 750/900	08/18	0022860.090	+ 0017572.*
DORSODURO 900	2020	0022860.090	+ 0017572.*
FACTORY 1100	2017	0022860.090	+ 0017572.*
MANA 850	08/16	0022860.090	+ 0017572.*
RSV 4	17/18	0022860.090	+ 0017572.*
RSV4 RR 1100 FACTORY	2020	0022860.090	/
SCARABEO 300 S	16/18	0022860.090	+ 0017572.*
SHIVER 750/900	08/17	0022860.090	+ 0017572.*
SX 50	2020	0022860.090	+ 0023386.
TUONO 1000/1100/125	08/18	0022860.090	+ 0017572.*
TUONO V4 1100 FACTORY	2020	0022860.090	+ 0017572.*
BENELLI			
302S	2020	0022860.090	/
502C	2020	0022860.090	/
752S	2020	0022860.090	/
BN 251/302	17/18	0022860.090	/
BN125	2020	0022860.090	/
BN251	2020	0022860.090	/
GRANPASSO	09/10	0022860.090	/
IMPERIALE 400	2020	0022860.090	/
LEONCINO 250	2020	0022860.090	/
LEONCINO 500	17/20	0022860.090	/
LEONCINO TRAIL	2020	0022860.090	/
TNT 125 NAKED	17/18	0022860.090	/
TORNADO NAKED 125	2020	0022860.090	/
TRE AMAZONAS 898	08/12	0022860.090	/
TRK 251	2020	0022860.090	/
TRK 502	17/20	0022860.090	/
TRK 502X	2020	0022860.090	/
BMW			
C 650 SPORT	2019	0022860.090	+ 0023386.*
G 310 GS	17/19	0022860.090	+ 0023386.*
G 310 R	19/20	0022860.090	+ 0023386.*
F 700 GS	12/17	0022860.090	+ 0017568.*
F 750 GS	18/20	0022860.090	+ 0017835.*
F 800 GS	13/17	0022860.090	+ 0017567.*
F 800 R	09/13	0022860.090	+ 0017567.*
	14/19	0022860.090	+ 0021716.*
F 850 GS	18/20	0022860.090	+ 0017835.*
F 900 XR	2020	0022860.090	+ 0017835.*
K 1200 R	06/17	0022860.090	+ 0017568.*
K 1300 R	09/17	0022860.090	+ 0017568.*
K 1600 B/GT/GT-L	17/18	0022860.090	+ 0017571.*
R 1200 R	07/14	0022860.090	+ 0017568.*
R 1200 R	15/18	0022860.090	+ 0017835.*
R 1250 R	18/19	0022860.090	+ 0017835.*
R 1200 RS	15/18	0022860.090	+ 0017568.*
R 1250 GS	2020	0022860.090	+ 0017835.*
R NINE T	15/20	0022860.090	+ 0021716.*
R NINE T SCRAMBLER	2020	0022860.090	+ 0021716.*
R NINE T RACER	2020	0022860.090	+ 0021716.*
R NINE T PURE	2020	0022860.090	+ 0021716.*
R NINE T URBAN G/S	2020	0022860.090	+ 0021716.*
S 1000 RR	09/18	0022860.090	+ 0017568.*
S 1000 R	09/19	0022860.090	+ 0021716.*
HP4	09/17	0022860.090	+ 0017568.*
BRIXTON			
FELSBURG 125	2020	0022860.090	/
FELSBURG 250	2020	0022860.090	/
FELSBURG 125 XC	2020	0022860.090	/

MODEL	YEAR	CODE	OPTIONAL KIT
BX 125	2020	0022860.090	/
CROMWELL 125	2020	0022860.090	/
CROMWELL 250	2020	0022860.090	/
GLANVILLE 250	2020	0022860.090	/
SAXBY 250	2020	0022860.090	/
FANTIC			
CABALLERO SCRAMBLER 125	18/19	0022860.090	/
CABALLERO SCRAMBLER 250	2020	0022860.090	/
CABALLERO SCRAMBLER 500	19/20	0022860.090	/
DUCATI			
DIAVEL	12/19	0022860.090	/
HYPERMOTARD 1100	08/09	0022860.090	/
HYPERMOTARD 1100 EVO/821	10/17	0022860.090	+ 0017572.*
HYPERMOTARD 950	2019	0022860.090	/
HYPERSTRADA 1000/1200	2014	0022860.090	/
MONSTER 1100 S	08/18	0022860.090	/
MONSTER 1100 S EVO	08/17	0022860.090	/
MONSTER 1200	2020	0022860.090	/
MONSTER 1200 S	08/20	0022860.090	/
MONSTER 696/796/797	08/14	0022860.090	/
MONSTER 797	19/20	0022860.090	/
MONSTER 821	14/20	0022860.090	/
MONSTER 821 STEALTH	2020	0022860.090	/
MULTISTRADA 950	19/20	0022860.090	/
MULTISTRADA 950 S	19/20	0022860.090	/
MULTISTRADA 1260 S	2019	0022860.090	/
PANIGALE	2019	0022860.090	/
PAGINALE 25° ANNIVERSARIO 916	2020	0022860.090	/
PANIGALE 899/1199/1299	13/16	0022860.090	+ 0017572.*
PAGINALE 1299 R FINAL EDITION	2020	0022860.090	/
PANIGALE 959	2019	0022860.090	/
PANIGALE V2	2020	0022860.090	/
PANIGALE V4	2020	0022860.090	/
PANIGALE V4 R	2020	0022860.090	/
PANIGALE V4 S	19/20	0022860.090	/
SCRAMBLER 803/1100	2019	0022860.090	/
STREETFIGHTER 848/1098	09/17	0022860.090	/
STREETFIGHTER V4	2020	0022860.090	/
SUPERSPORT	19/20	0022860.090	/
SUPERSPORT S	2020	0022860.090	/
X DIAVEL	2020	0022860.090	/
X DIAVEL S	2020	0022860.090	/
GILERA			
FUOCO 500	08/15	0022860.090	/
GUZZI			
1200 SPORT	08/16	0022860.090	+ 0017572.*
BREVA 850	08/18	0022860.090	+ 0017572.*
BREVA 1200	08/18	0022860.090	+ 0017572.*
CALIFORNIA 1400 TOURING	18/20	0022860.090	+ 0017572.*
NEVADA	2020	0022860.090	+ 0017572.*
V 7 STONE	11/17	0022860.090	+ 0017572.*
V 7 III STONE	18/20	0022860.090	+ 0017572.*
V 7 SPECIAL	13/17	0022860.090	+ 0017572.*
V 7 III SPECIAL	18/20	0022860.090	+ 0017572.*
V 7 III ROUGH	18/20	0022860.090	+ 0017572.*
V 9 BOBBER	17/18	0022860.090	+ 0017572.*
V 9 ROAMER	17/20	0022860.090	+ 0017572.*
V 85 TT	18/20	0022860.090	+ 0017572.*

* ADDITIONAL MOUNTING KIT / KIT DI MONTAGGIO OPZIONALE



MODEL	YEAR	CODE	OPTIONAL KIT
HONDA			
ADV 750	17/18	0022860.090	/
AFRICA TWIN ADVENTURE	18/19	0022860.090	/
CB 1000 R	08/20	0022860.090	/
CB 1100	17/20	0022860.090	/
CB 1100/EX	10/18	0022860.090	/
CB 125 F/R	19/20	0022860.090	/
CB 1300	08/17	0022860.090	/
CB 300 R	18/20	0022860.090	/
CB 500 F/R	14/17	0022860.090	/
CB 500 X	13/20	0022860.090	/
CB 600 F HORNET	04/17	0022860.090	/
CB 650 F	14/18	0022860.090	/
CBF 1000	09/17	0022860.090	/
CBF 600 N	08/18	0022860.090	/
CBR 1000 R	19/20	0022860.090	/
CBR 250	19/20	0022860.090	/
CBR 300 R	15/20	0022860.090	/
CBR 500 R	15/20	0022860.090	/
CBR 600 R	18/19	0022860.090	/
CBR 600/1000 RR	08/18	0022860.090	/
CBR 650 F	08/18	0022860.090	/
CBR 650 R	2020	0022860.090	/
CBR FIREBLADE	13/18	0022860.090	/
CMX 500 REBEL	19/20	0022860.090	/
CRF 450 RX SUPERMOTO	10/18	0022860.090	/
CRF 450 XR	19/20	0022860.090	/
CRF 600/650	19/20	0022860.090	/
CROSSRUNNER	19/20	0022860.090	/
CROSTURER	19/20	0022860.090	/
INTEGRA SE/XP	19/20	0022860.090	/
MONKEY	18/20	0022860.090	+ 0017572.*
SH 300	19/20	0022860.090	+ 0017572.*
VFR 1200 F	2018	0022860.090	/
VFR 750 S SHADOW	2016	0022860.090	/
VFR 800/1200 F	08/17	0022860.090	/
VT 750 S SHADOW	2020	0022860.090	/
VULTUS	18/20	0022860.090	/
X-ADV	18/20	0022860.090	/
HUSQVARNA			
NUDA 900	08/14	0022860.090	/
SM/TE 125	08/14	0022860.090	/
SMR 460/610	08/12	0022860.090	/
SMR 511	11/13	0022860.090	+ 0017572.*
SMR 630	11/13	0022860.090	/
TERRA/STRADA 650	12/13	0022860.090	+ 0017572.*
VITPILEN 401	18/20	0022860.090	/
VITPILEN 701	18/20	0022860.090	/
SVARTPILEN 401	19/20	0022860.090	/
SVARTPILEN 701	19/20	0022860.090	/
KAWASAKI			
300/Z 800/800E/1000	13/18	0022860.090	+ 0017571.*
ER 6F	2019	0022860.090	+ 0017571.*
ER 6N	09/16	0022860.090	+ 0017571.*
ER 6N 650	07/18	0022860.090	+ 0017571.*
NINJA	18/19	0022860.090	/
NINJA 2HR	2020	0022860.090	+ 0017571.*
NINJA 2HR CARBON	2020	0022860.090	+ 0017571.*
NINJA 300/400	2019	0022860.090	/
NINJA 300/600/636	09/18	0022860.090	+ 0017571.*
NINJA 400	2018	0022860.090	+ 0017571.*
NINJA 650	2019	0022860.090	+ 0017571.*

MODEL	YEAR	CODE	OPTIONAL KIT
NINJA ZX	15/18	0022860.090	+ 0017571.*
NINJA ZX10 R	2019	0022860.090	+ 0017571.*
NINJA ZX-10RR	2020	0022860.090	+ 0017571.*
NINJA ZX-6 R	2020	0022860.090	/
NINJA ZX-6 R 600	2019	0022860.090	+ 0017571.*
NINJA ZX-6 R PERFORMANCE	2020	0022860.090	/
S 125/300	14/19	0022860.090	+ 0017571.*
VERSYS 1000	18/19	0022860.090	+ 0017571.*
VERSYS-X 300	18/19	0022860.090	/
	2020	0022860.090	+ 0017571.*
VERSYS-X 300 URBAN	2020	0022860.090	+ 0017571.*
VERSYS-X 300 ADVENTURE	2020	0022860.090	+ 0017571.*
VERSYS 650	17/20	0022860.090	+ 0017571.*
VERSYS 650 TOURER PLUS	2020	0022860.090	+ 0017571.*
VERSYS 650 GRAND TOURER	2020	0022860.090	+ 0017571.*
VN 900/1200	09/19	0022860.090	/
VULCAN 650 S	08/20	0022860.090	+ 0017571.*
Z 1000	08/20	0022860.090	+ 0017571.*
Z 1000 EDITION	2020	0022860.090	+ 0017571.*
Z 1000/SX	07/18	0022860.090	+ 0017571.*
Z 125	19/20	0022860.090	+ 0017571.*
Z 125 PERFORMANCE	2020	0022860.090	+ 0017571.*
Z 300	15/19	0022860.090	+ 0017571.*
Z 400	18/20	0022860.090	+ 0017571.*
Z 400 PERFORMANCE	2020	0022860.090	+ 0017571.*
Z 650	17/18	0022860.090	/
	2020	0022860.090	+ 0017571.*
Z 650 PERFORMANCE	2020	0022860.090	+ 0017571.*
Z 750	02/14	0022860.090	+ 0017571.*
Z 800	13/16	0022860.090	+ 0017571.*
Z 900	16/19	0022860.090	+ 0017571.*
Z 900 RS PERFORMANCE	2020	0022860.090	+ 0017571.*
Z 900 RS	18/20	0022860.090	+ 0017571.*
KYMCO			
550	2019	0022860.090	/
AGILITY 125 CARRY E4	2020	0022860.090	/
AGILITY 125I R16 +	2020	0022860.090	/
AGILITY 150I R16 + ABS	2020	0022860.090	/
AGILITY 200I R16 + ABS	2020	0022860.090	/
AGILITY 50 CARRY E4	2020	0022860.090	/
AGILITY 50 R12 E4	2020	0022860.090	/
AK550 2020	2020	0022860.090	/
AK550 ABS	2020	0022860.090	/
G-DINK 300I ABS	2020	0022860.090	/
PEOPLE GTI 300 ABS E4	2020	0022860.090	/
X CITING 400	2019	0022860.090	/
XCITING 400I ABS E4 II	2020	0022860.090	/
XCITING 400I S	2020	0022860.090	/
KTM			
1290 SUPER ADVENTURE R	18/20	0022860.090	/
1290 SUPER ADVENTURE S	18/20	0022860.090	/
790 ADVENTURE R RALLY	18/20	0022860.090	/
790 ADVENTURE R	18/20	0022860.090	/
790 ADVENTURE	18/20	0022860.090	/
390 ADVENTURE	2020	0022860.090	+ 0017572.*
990 SUPERMOTO IE	09/14	0022860.090	/
DUKE 125/200/390/690	09/16	0022860.090	/
DUKE 125	2019	0022860.090	/
DUKE 690	18/19	0022860.090	/
DUKE 390	2019	0022860.090	/
	2020	0022860.090	+ 0017572.*
DUKE 390 RC	2016	0022860.090	+ 0017572.*
DUKE 790	19/20	0022860.090	/

* ADDITIONAL MOUNTING KIT / KIT DI MONTAGGIO OPZIONALE



APPLICATIONS FOR X-ROAD LEVERS PROTECTIONS

MODEL	YEAR	CODE	OPTIONAL KIT
DUKE 790 L (A2)	2020	0022860.090	/
DUKE 890 R	2020	0022860.090	/
SUPER DUKE 990	11/14	0022860.090	/
SUPER DUKE 1290	18/19	0022860.090	/
SUPER DUKE 1290 R	13/18	0022860.090	+ 0017572.*
	2020	0022860.090	/
SUPER DUKE 1290 GT	2020	0022860.090	/
SMC 690	09/13	0022860.090	/
SM 950	06/09	0022860.090	/
SM 990	09/12	0022860.090	/
MORINI			
MORINI CORSARO 1200	08/13	0022860.090	/
MV AGUSTA			
910 R	2019	0022860.090	/
1000 F4	10/16	0022860.090	/
1090 RR	2016	0022860.090	/
1090 ESP	2019	0022860.090	/
800 RR	2016	0022860.090	/
BRUTALE 675/F3	12/16	0022860.090	/
BRUTALE 750 S	03/05	0022860.090	/
BRUTALE 800/F3	12/16	0022860.090	/
BRUTALE 910 S/R	05/11	0022860.090	/
BRUTALE 920	12/13	0022860.090	/
BRUTALE 989 R	08/13	0022860.090	/
BRUTALE 990	09/13	0022860.090	/
BRUTALE 1078 RR	08/13	0022860.090	/
BRUTALE 1090	09/16	0022860.090	/
DRAGSTER 800	2016	0022860.090	/
DRAGSTER 800 RR	2016	0022860.090	/
DRAGSTER RR LH44	2016	0022860.090	/
F3 675 RC	2016	0022860.090	/
F3 800 AGO	2016	0022860.090	/
F3 800 RC	2016	0022860.090	/
F4 RC	2016	0022860.090	/
F4 RR	2016	0022860.090	/
MALAGUTI			
MONTE 125	2020	0022860.090	+ 0017572.*
PIAGGIO			
VESPA 6 GIORNI	18/19	0022860.090	+ 0017572.*
BEVERLY S 300 ABS ASR	2020	0022860.090	+ 0017572.*
BEVERLY S 350 S ABS	2020	0022860.090	+ 0017572.*
SUZUKI			
BANDIT 650/600 (NO S)	14/17	0022860.090	/
BANDIT GSF 1250	09/17	0022860.090	/
BURGMAN 400	2020	0022860.090	/
B-KING 1300	09/17	0022860.090	/
GLADIUS 650	09/17	0022860.090	+ 0017572.*
GSR 600	06/17	0022860.090	/
GSR 750	14/17	0022860.090	+ 0017572.*
GSX - R 1000	08/19	0022860.090	/
GSX - R 600/750	08/18	0022860.090	/
GSX - S 1000	2020	0022860.090	/
GSX - S 1000-F	15/20	0022860.090	/
GSX - S 650	18/19	0022860.090	/
GSX - S 750	2020	0022860.090	/
GSX 125	18/19	0022860.090	/
GSX - S 125	2020	0022860.090	/
KATANA 1000	19/20	0022860.090	/
SV	14/17	0022860.090	+ 0017572.*

MODEL	YEAR	CODE	OPTIONAL KIT
SV 1000 (SCARENATA)	03/05	0022860.090	/
SV 650	18/20	0022860.090	/
SV 650 (NO S)	99/17	0022860.090	/
SV 650 X	18/20	0022860.090	/
VAN VAN	14/17	0022860.090	+ 0017572.*
V-STORM 1050/XT	2020	0022860.090	/
V-STORM 650/XT	2020	0022860.090	/
V-STORM 250	2020	0022860.090	/
V-STRONG 1000 XT	18/19	0022860.090	/
V-STRONG 250	18/19	0022860.090	/
V-STRONG 650 STAND-XT	18/19	0022860.090	/
SWM			
SUPER DUAL 650 T	2020	0022860.090	+ 0017634.*
SUPER DUAL 650 X	2020	0022860.090	+ 0017634.*
TRIUMPH			
1050 TIGER SPORT	18/20	0022860.090	+ 0017572.*
800/1200 TIGER	18/20	0022860.090	+ 0017572.*
900 TIGER	2020	0022860.090	+ 0017572.*
BOBBER 1200	18/19	0022860.090	+ 0017572.*
BONNEVILLE	11/14	0022860.090	+ 0017572.*
BONNEVILLE 1200 BLACK	18/20	0022860.090	+ 0017572.*
BONNEVILLE T 100	18/20	0022860.090	+ 0017572.*
BONNEVILLE T 120	2020	0022860.090	+ 0017572.*
SCRAMBLER 1200 XC/XE	18/20	0022860.090	+ 0017572.*
SPEED MASTER BONNEVILLE 1200	19/20	0022860.090	+ 0017572.*
SPEED TRIPLE 1050	01/18	0022860.090	+ 0017572.*
SPEED TRIPLE 1050 RS	18/19	0022860.090	+ 0017572.*
SPEED TRIPLE R/S	19/20	0022860.090	+ 0017572.*
SPEED TWIN	2020	0022860.090	+ 0017572.*
STREET CAP	18/19	0022860.090	+ 0017572.*
STREET SCRAMBLER 900	18/20	0022860.090	+ 0017572.*
STREET TRIPLE 675	07/18	0022860.090	+ 0017572.*
STREET TWIN	18/19	0022860.090	+ 0017572.*
THRUXTON	16/18	0022860.090	+ 0017572.*
THRUXTON 1200	18/19	0022860.090	+ 0017572.*
YAMAHA			
FZ1/ FZ6/FZ8	08/16	0022860.090	+ 0017572.*
MT 03	19/20	0022860.090	+ 0017572.*
MT 07/09	13/16	0022860.090	+ 0017634.*
MT 07/09/10	19/20	0022860.090	+ 0017634.*
MT 125	2019	0022860.090	+ 0017634.*
MT03 660	08/16	0022860.090	+ 0017634.*
NIKEN GT	19/20	0022860.090	+ 0017634.*
R1/R6/R125	08/18	0022860.090	+ 0017572.*
R125	2019	0022860.090	+ 0017634.*
R3	2018	0022860.090	+ 0017572.*
SCR 950	19/20	0022860.090	/
T-MAX 500/530	10/16	0022860.090	+ 0017634.*
T-MAX 560	2020	0022860.090	+ 0017634.*
TRACER 900/900GT/700	2019	0022860.090	/
XJR 1300	08/16	0022860.090	+ 0017634.*
XSR 700	19/20	0022860.090	+ 0017634.*
XSR 700 XTRIBUTE	2020	0022860.090	+ 0017634.*
XSR 900	18/19	0022860.090	+ 0017634.*
XT 660 R	10/16	0022860.090	+ 0017572.*
XT 660 X	10/16	0022860.090	/
XT 660 Z	10/16	0022860.090	+ 0017634.*
YZFR 125	15/16	0022860.090	+ 0017634.*

* ADDITIONAL MOUNTING KIT / KIT DI MONTAGGIO OPZIONALE







ACERBIS



HEADLIGHTS MASCHERINE



HEADLIGHT MASK VSL FIT ALL

MATERIALS:

Alluminium 70%, Others 2%, Rubber 8%, Polypropylene 20%

DETAILS:

- High energetic performance mask for OFFROAD use only.
- Maximum brightness and depth of detail guaranteed, even in dark conditions
- IP68 waterproof: permanent impermeability up to 3 metres deep.
- 16 Led, 48W headlight.
- 4320 Lumen.
- DC electrical supply from 9 to 32V.
- Estimated led lifespan: 50000 hours.
- Operating temperatures between between -40° and +85° C.
- Easy and fast mounting, using the included headlight's rubber bands.
- Designed for all enduro battery-powered models



HEADLIGHT MASK VSL HUSQVARNA 2020

DETAILS:

- High energetic performance for OFFROAD use only.
- Maximum brightness and depth of detail guaranteed, even in total dark situations.
- IP68 waterproof: permanent impermeability up to 3 metres deep.
- 16 Led, 48W headlight.
- 4320 Lumen.
- DC electrical supply from 9 to 32V.
- Estimated led lifespan: 50000 hours.
- Operating temperatures between between -40° and +85° C.
- Easy and fast mounting, using the original headlight's rubber bands.
- Developed for enduro 2020 Husqvarna bikes



HUSQVARNA

COD. 0024302.030
APPLICATIONS: FE 250/350/450/501
TE 150/250/300

FROM 2020
FROM 2020

HEADLIGHT MASK VSL KTM 2020

DETAILS:

- High energetic performance for OFFROAD use only.
- Maximum brightness and depth of detail guaranteed, even in total dark situations.
- IP68 waterproof: permanent impermeability up to 3 metres deep.
- 16 Led, 48W headlight.
- 4320 Lumen.
- DC electrical supply from 9 to 32V.
- Estimated led lifespan: 50000 hours.
- Operating temperatures between between -40° and +85° C.
- Easy and fast mounting, using the original headlight's rubber bands.
- Developed for enduro 2020 KTM bikes



KTM

COD. 0024303.011
APPLICATIONS: EXC 150/250/300 TPI
EXC-F 250/350/450/500
XC-W 150/250/300 TPI
XCF-W 350/500

FROM 2020
FROM 2020
FROM 2020
FROM 2020



HEADLIGHT MASK

DETAILS:

- High energetic performance for OFFROAD use only
- Perfectly interchangeable with the original mask
- Maximum brightness and depth of detail guaranteed, even in total dark situations
- IP68 waterproof: permanent impermeability up to 3 metres deep
- 16 Led, 48W headlight
- 4320 Lumen
- DC electrical supply from 9 to 32V
- Estimated led lifespan: 50000 hours
- Operating temperatures between between -40° and +85° C
- Easy and fast mounting, using the original headlight's rubber bands
- Developed for enduro KTM/HUSQVARNA bikes from 2013 to 2019



KTM

COD.

0023992.030

APPLICATIONS: EXC 250/300 2012-2016

EXC-F 250/350/450/500 2012-2016



KTM

COD.

0023949.011.016

APPLICATIONS: EXC-F 250/350/450 2017-2019

EXC 250/300 2017

EXC 250/300 TPI 2018-2019



HUSQVARNA

COD.

0023948.030

APPLICATIONS: FE 250/350/450 2017-2019

TE 250/300 2017

TE 250I/300I 2018-2019

FULMINE HEADLIGHT

COMPONENTS:

- 80% Polypropylene; 15% Rubber; 5% Others

DETAILS:

- Universal low energy consumption mask ideal for off-road use
- Guarantees maximum brightness and depth of detail in low light / no light conditions
- Waterproof IP68: protection against permanent immersion in water up to 3 meters in depth
- 9 - led 3W (tot.27W) light equal to 155W filament bulb
- Lumen 2430
- DC power supply (direct current) from 9 to 32 V
- Led life expectancy: 50000 hours
- Operating temperatures between -40° and +85° C
- Cold white light approx. 6000K
- Universal, easy and fast mounting with 4 elastic straps fastening onto the forks
- Not suitable for road use



white
0022772.030



black
0022772.090

ELBA HEADLIGHT

Retro look headlight with high resistance plastic headlight (polycarbonate) for enduro bike with conventional forks; Easy mounting with 4 elastics; Yellow sticker added for competition race number.



MOUNTING KIT
INCLUDED

BULB
NOT INCLUDED

OPTIONAL BULB

12 V 35/35 W
BA20D
cod. **0002877**



white
code: **0003020.030**



red
code: **0003020.110**

LED VISION HP HEADLIGHT

55w

DOT - ECE
SAE - TUV
CERTIFIED



MOUNTING KIT
INCLUDED



white
code: **0013429.030**



black
code: **0013429.090**



CYCLOPE HEADLIGHT



MOUNTING KIT
INCLUDED

code: **0003002.090**



DHH CERTIFIED HEADLIGHT

**DOT - ECE
SAE - TUV
CERTIFIED**



MOUNTING KIT
INCLUDED



white

code: **0002694.030**



black

code: **0002694.090**



ELBA



BULB

12 V 35/35 W
BA20D
cod.**0002877**



ELASTICI

cod.**0024552**.

LED VISION HP



MOUNTING STRAPS

4 pcs. set
cod.**0009114**.



ON/OFF SWITCH

cod.**0000074**.



CYCLOPE



MOUNTING STRAPS

4 pcs. set
cod.**0000236**.



LOW BEAM

bulb
included
cod.**0007370**.



HALOGEN BULB

55 W,
cod.**0007368**.



ON/OFF SWITCH

cod.**0000074**.



NUMBER PLATE

BLACK cod.**0002160.090**
ORANGE cod.**0002160.010.098**
BLUE cod.**0002160.040.098**
YELLOW cod.**0002160.060.001**



DHH CERTIFIED



MOUNTING STRAPS

4 pcs. set
cod.**0000236**.



BULB

12 V 35/35 W
BA20D
cod.**0002877**



SEALED BEAM

cod.**0007039**.



ON/OFF SWITCH

cod.**0000074**.



DHH



MOUNTING STRAPS

4 pcs. set
cod.**0000236**.



BULB

10° beam
12 V - 50 W
cod.**0007032**.



BULB

36° beam
10 V - 35 W
cod.**0007033**.



ON/OFF SWITCH

cod.**0000074**.



FULMINE



MOUNTING STRAPS

4 pcs. set
cod.**0000236**.



60° P113 TAIL LIGHT

**DOT-ECE
SAE-TUV
CERTIFIED**



code: **0016821.090**

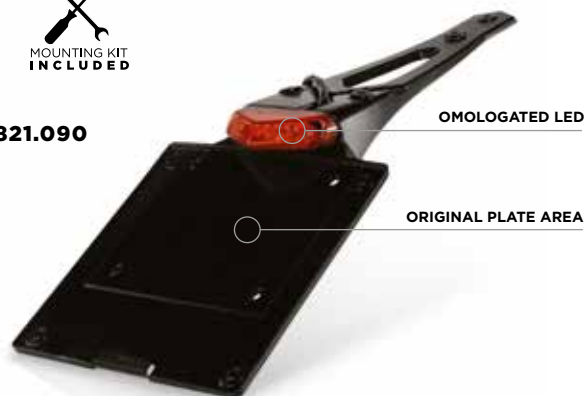

30° LED CE TAIL LIGHT

**DOT-ECE
SAE-TUV
CERTIFIED**



code: **0016822.090**



60° X-LED CE TAIL LIGHT

**DOT-ECE
SAE-TUV
CERTIFIED**



code: **0015941.090**



45° LED CE TAIL LIGHT

**DOT-ECE
SAE-TUV
CERTIFIED**



code: **0012966.090**



60° LED TAILLIGHT



code: **0008326.090**





ACE73iD

SEATS SELLE



X-AIR SEATS

DETAILS:

- Air cushion pressure adjustment range: +- height/rigidity
- Better stress absorption
- Personalised riding feel
- Constant support over time

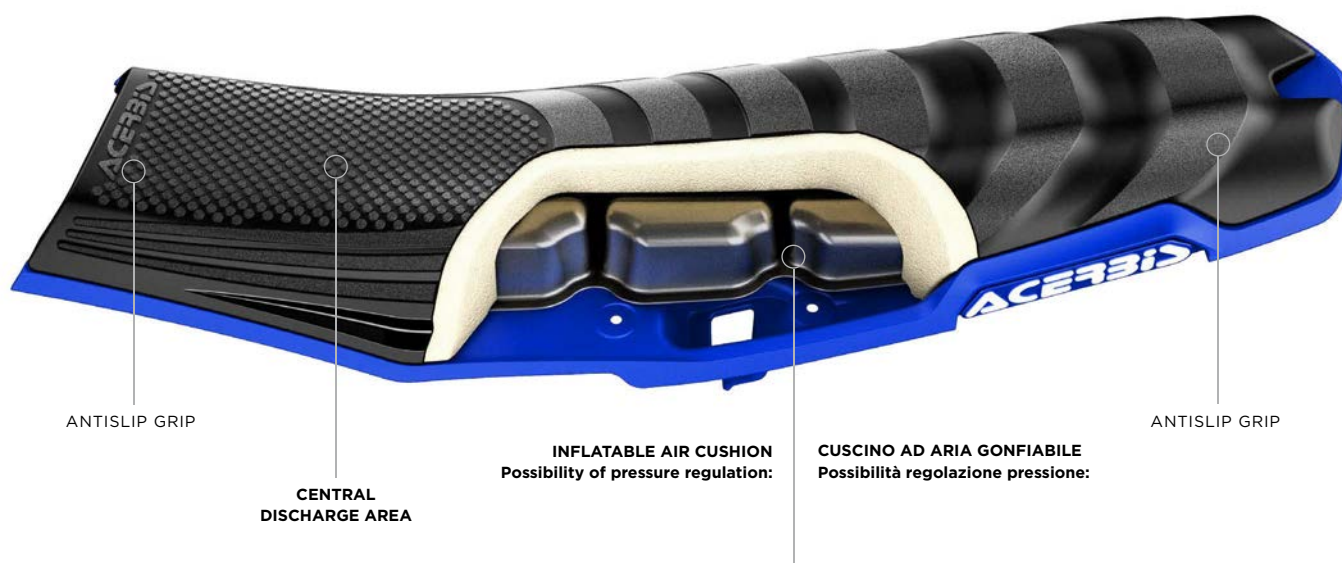
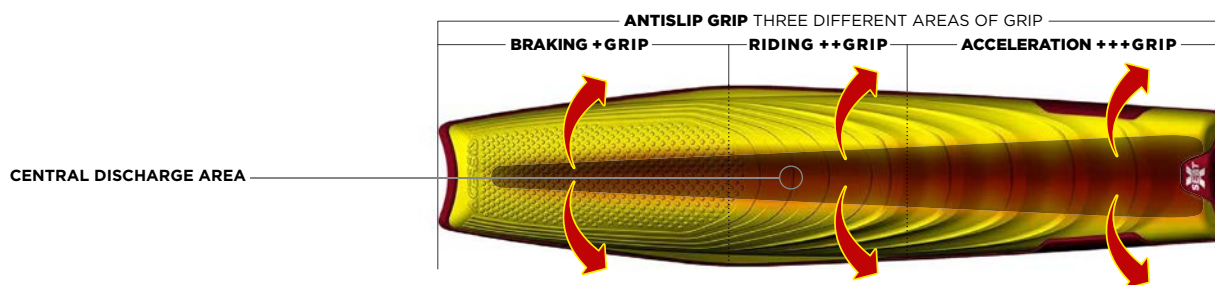

X-AIR SEATS YAMAHA

MODEL	COLORS	YEAR	CODE
YZF 250	BLUE/BLACK	19/20	0023437.040.700
	BLACK/BLUE	19/20	0023437.090.700
YZF 450	BLUE/BLACK	19/20	0023437.040.700
	BLACK/BLUE	19/20	0023437.090.700
WRF 250	BLUE/BLACK	2020	0023437.040.700
	BLACK/BLUE	2020	0023437.090.700
WRF 450	BLUE/BLACK	19/20	0023437.040.700
	BLACK/BLUE	19/20	0023437.090.700



code: **0023437.040.700**



code: **0023437.090.700**

X-AIR SEATS HUSQVARNA

MODEL	COLORS	YEAR	CODE
TC 125/250	BLUE/BLACK	19/20	0023638.040.700
	BLACK/BLUE	19/20	0023638.090.700
FC 250/350/450	BLUE/BLACK	19/20	0023638.040.700
	BLACK/BLUE	19/20	0023638.090.700
FE 250/350/450/501	BLUE/BLACK	2020	0023638.040.700
	BLACK/BLUE	2020	0023638.090.700



code: **0023638.090.700**



code: **0023638.040.700**

X-AIR SEATS KAWASAKI

MODEL	COLORS	YEAR	CODE
KXF 450	BLACK/GREEN	2019	0023767.090.700
	GREEN/BLACK	2019	0023767.130.700
KX 450 4T	BLACK/GREEN	2020	0023767.090.700
	GREEN/BLACK	2020	0023767.130.700



code: **0023767.090.700**



code: **0023767.130.700**

X-AIR SEATS SUZUKI

MODEL	COLORS	YEAR	CODE
RMZ 250	BLUE/YELLOW	19/20	0023416.040.700
	YELLOW/BLK.	19/20	0023416.060.700
RMZ 450	BLK./YELLOW	19/20	0023416.090.700
	BLUE/YELLOW	18/20	0023416.040.700
	YELLOW/BLK.	18/20	0023416.060.700
	BLK./YELLOW	18/20	0023416.090.700



code: **0023416.040.700**



code: **0023416.060.700**



code: **0023416.090.700**

X-AIR SEATS KTM

MODEL	COLORS	YEAR	CODE
SX 125/150/250	BLACK/ORANGE	19/20	0023589.090.700
	ORANGE/BLACK	19/20	0023589.010.700
	BLUE/ORANGE	19/20	0023589.041.700
SX-F 250/350/450	BLACK/ORANGE	19/20	0023589.090.700
	ORANGE/BLACK	19/20	0023589.010.700
EXC 150/250/300 TPI	BLUE/ORANGE	19/20	0023589.041.700
	BLACK/ORANGE	2020	0023589.090.700
EXC-F 250/350/450/500	ORANGE/BLACK	2020	0023589.010.700
	BLUE/ORANGE	2020	0023589.041.700
	BLACK/ORANGE	2020	0023589.090.700
XC 250/300 TPI	ORANGE/BLACK	2020	0023589.010.700
	BLUE/ORANGE	2020	0023589.041.700
XC-F 250/350/450	BLACK/ORANGE	19/20	0023589.090.700
	ORANGE/BLACK	19/20	0023589.010.700
XC-W 125	BLUE/ORANGE	19/20	0023589.041.700
	BLACK/ORANGE	2020	0023589.090.700
XC-W 150/250/300 TPI	ORANGE/BLACK	2020	0023589.010.700
	BLUE/ORANGE	2020	0023589.041.700
	BLACK/ORANGE	2020	0023589.090.700
XCF-W 350/500	ORANGE/BLACK	2020	0023589.010.700
	BLUE/ORANGE	2020	0023589.041.700



code: **0023589.090.700**



code: **0023589.041.700**



code: **0023589.010.700**





MODEL	TYPE	COLORS	YEAR	CODE
YZF 250	HARD	BLUE	06/09	0012437.040.700
	HARD	BLACK	06/09	0012437.090.700
	HARD	BLACK	10/13	0013855.090.700
	HARD	BLUE	14/18	0017588.040.700
	HARD	BLACK	14/18	0017588.090.700
	SOFT	BLUE	14/18	0017589.040.700
	SOFT	BLACK	14/18	0017589.090.700
	SOFT	BLUE	19/20	0023074.040.700
	SOFT	BLACK	19/20	0023074.090.700
YZF 450	HARD	BLUE	06/09	0012437.040.700
	HARD	BLACK	06/09	0012437.090.700
	HARD	BLACK	10/13	0013854.090.700
	HARD	BLUE	14/17	0017588.040.700
	HARD	BLACK	14/17	0017588.090.700
	SOFT	BLUE	14/17	0017589.040.700
	SOFT	BLACK	14/17	0017589.090.700
	SOFT	BLUE	18/20	0023074.040.700
	SOFT	BLACK	18/20	0023074.090.700

MODEL	TYPE	COLORS	YEAR	CODE
WRF 250	HARD	BLUE	15/19	0017588.040.700
	HARD	BLACK	15/19	0017588.090.700
	SOFT	BLUE	15/19	0017589.040.700
	SOFT	BLACK	15/19	0017589.090.700
	SOFT	BLUE	2020	0023074.040.700
	SOFT	BLACK	2020	0023074.090.700
WRF 450	HARD	BLUE	16/18	0017588.040.700
	HARD	BLACK	16/18	0017588.090.700
	SOFT	BLUE	16/18	0017589.040.700
	SOFT	BLACK	16/18	0017589.090.700
	SOFT	BLUE	19/20	0023074.040.700
	SOFT	BLACK	19/20	0023074.090.700

X-SEATS HARD (RACING)



code: **0012437.040.700**



code: **0012437.090.700**



code: **0017588.040.700**



code: **0017588.090.700**

X-SEATS SOFT (COMFORT)



code: **0017589.040.700**



code: **0017589.090.700**

HONDA X-SEATS

MODEL	TYPE	COLORS	YEAR	CODE
CRF 250 R	HARD	RED	10/13	0013154.110.700
	HARD	BLACK	10/13	0013154.090.700
	HARD	RED	14/17	0016952.110.700
	HARD	BLACK	14/17	0016952.090.700
	SOFT	BLACK	18/20	0022389.090.700
	SOFT	RED	18/20	0022389.110.700
CRF 450 R	SOFT	RED/BLUE	18/20	0022389.344.700
	HARD	RED	07/08	0013127.110.700
	HARD	RED	09/12	0013154.110.700
	HARD	BLACK	09/12	0013154.090.700
	HARD	RED	13/16	0016952.110.700
	HARD	BLACK	13/16	0016952.090.700
CRE 250 F	SOFT	BLACK	17/20	0022389.090.700
	SOFT	RED	17/20	0022389.110.700
	SOFT	RED/BLUE	17/20	0022389.344.700
	HARD	RED	10/13	0013154.110.700
	HARD	BLACK	10/13	0013154.090.700
	HARD	RED	14/16	0016952.110.700
CRF 250/300 RX	HARD	BLACK	14/16	0016952.090.700
	SOFT	BLACK	19/20	0022389.090.700
	SOFT	RED	19/20	0022389.110.700
CRF 450 RX	SOFT	RED/BLUE	19/20	0022389.344.700
	SOFT	BLACK	17/20	0022389.090.700
	SOFT	RED	17/20	0022389.110.700
CRF 450 L	SOFT	RED/BLUE	17/20	0022389.344.700
	SOFT	BLACK	19/20	0022389.090.700
	SOFT	RED	19/20	0022389.110.700
CRE 450 F	SOFT	RED/BLUE	19/20	0022389.344.700
	SOFT	BLACK	19/20	0022389.090.700
	SOFT	RED	19/20	0022389.110.700

MODEL	TYPE	COLORS	YEAR	CODE
CRE 450 F	SOFT	BLACK	2018	0022389.090.700
	SOFT	RED	2018	0022389.110.700
	SOFT	RED/BLUE	2018	0022389.344.700
CRF 450 RX	HARD	RED	07/08	0013127.110.700
	HARD	RED	09/12	0013154.110.700
	HARD	BLACK	09/12	0013154.090.700
CRF 450 L	HARD	RED	13/16	0016952.110.700
	HARD	BLACK	13/16	0016952.090.700
	SOFT	BLACK	19/20	0022389.090.700
CRF 250/300 RX	SOFT	RED	19/20	0022389.110.700
	SOFT	RED/BLUE	19/20	0022389.344.700
	SOFT	BLACK	19/20	0022389.090.700
CRF 450 RX	SOFT	BLACK	17/20	0022389.090.700
	SOFT	RED	17/20	0022389.110.700
	SOFT	RED/BLUE	17/20	0022389.344.700
CRF 450 L	SOFT	BLACK	19/20	0022389.090.700
	SOFT	RED	19/20	0022389.110.700
	SOFT	RED/BLUE	19/20	0022389.344.700

X-SEATS HARD (RACING)



code: **0013154.110.700**



code: **0013154.090.700**



code: **0016952.090.700**



code: **0016952.110.700**

X-SEATS SOFT (COMFORT)



code: **0022389.344.700**



code: **0022389.090.700**



code: **0022389.110.700**

SUZUKI X-SEATS

MODEL	TYPE	COLORS	YEAR	CODE
RMZ 250	HARD	YELLOW	07/09	0013150.060.700
	HARD	BLACK	07/09	0013150.090.700
	SOFT	BLUE	19/20	0023068.040.700
	SOFT	YELLOW	19/20	0023068.060.700
	SOFT	BLACK	19/20	0023068.090.700

MODEL	TYPE	COLORS	YEAR	CODE
RMZ 450	HARD	YELLOW	08/17	0013149.060.700
	HARD	BLACK	08/17	0013149.090.700
	SOFT	BLUE	18/20	0023068.040.700
	SOFT	YELLOW	18/20	0023068.060.700
	SOFT	BLACK	18/20	0023068.090.700

X-SEATS HARD (RACING)



code: **0013150.060.700**



code: **0013150.090.700**



code: **0013149.060.700**



code: **0013149.090.700**

X-SEATS SOFT (COMFORT)



code: **0023068.060.700**



code: **0023068.090.700**

MODEL	TYPE	COLORS	YEAR	CODE
SX-SXF	HARD	ORANGE	07/10	0013106.010.700
	HARD	BLACK	07/10	0013106.090.700
	HARD	ORANGE	11/15	0015618.010.700
	HARD	BLACK	11/15	0015618.090.700
	SOFT	ORANGE	11/15	0017565.010.700
	SOFT	BLACK	11/15	0017565.090.700
SX 125 / 150	HARD	ORANGE	16/18	0017444.010.700
	HARD	BLUE	16/18	0017444.041.700
	HARD	BLACK	16/18	0017444.090.700
	SOFT	ORANGE	16/18	0017443.010.700
	SOFT	BLUE	16/18	0017443.041.700
	SOFT	BLACK	16/18	0017443.090.700
	SOFT	FULL BLK.	16/18	0017443.091.700
	SOFT	ORANGE	19/20	0023588.010.700
	SOFT	BLUE	19/20	0023588.041.700
	SOFT	BLACK	19/20	0023588.090.700
	SOFT	BLACK 2	19/20	0023588.091.700
SX 250	HARD	ORANGE	17/18	0017444.010.700
	HARD	BLUE	17/18	0017444.041.700
	HARD	BLACK	17/18	0017444.090.700
	SOFT	ORANGE	17/18	0017443.010.700
	SOFT	BLUE	17/18	0017443.041.700
	SOFT	BLACK	17/18	0017443.090.700
	SOFT	FULL BLK.	17/18	0017443.091.700
	SOFT	ORANGE	19/20	0023588.010.700
	SOFT	BLUE	19/20	0023588.041.700
	SOFT	BLACK	19/20	0023588.090.700
	SOFT	BLACK 2	19/20	0023588.091.700
SXF 250/350/450	HARD	ORANGE	16/18	0017444.010.700
	HARD	BLUE	16/18	0017444.041.700
	HARD	BLACK	16/18	0017444.090.700
	SOFT	ORANGE	16/18	0017443.010.700
	SOFT	BLUE	16/18	0017443.041.700
	SOFT	BLACK	16/18	0017443.090.700
	SOFT	FULL BLK.	16/18	0017443.091.700
	SOFT	ORANGE	19/20	0023588.010.700
	SOFT	BLUE	19/20	0023588.041.700
	SOFT	BLACK	19/20	0023588.090.700
	SOFT	BLACK 2	19/20	0023588.091.700
EXC-EXCF	HARD	ORANGE	08/11	0013106.010.700
	HARD	BLACK	08/11	0013106.090.700
	HARD	ORANGE	12/16	0015618.010.700
	HARD	BLACK	12/16	0015618.090.700
	SOFT	ORANGE	12/16	0017565.010.700
	SOFT	BLACK	12/16	0017565.090.700
EXC 150 TPI	HARD	ORANGE	2019	0017444.010.700
	HARD	BLUE	2019	0017444.041.700
	HARD	BLACK	2019	0017444.090.700
	SOFT	ORANGE	2019	0017443.010.700
	SOFT	BLUE	2019	0017443.041.700
	SOFT	BLACK	2019	0017443.090.700
	SOFT	FULL BLK.	2019	0017443.091.700
	SOFT	ORANGE	2020	0023588.010.700
	SOFT	BLUE	2020	0023588.041.700
	SOFT	BLACK	2020	0023588.090.700
	SOFT	BLACK 2	2020	0023588.091.700
EXC 250/300	HARD	ORANGE	2017	0017444.010.700
	HARD	BLUE	2017	0017444.041.700
	HARD	BLACK	2017	0017444.090.700
	SOFT	ORANGE	2017	0017443.010.700
	SOFT	BLUE	2017	0017443.041.700

MODEL	TYPE	COLORS	YEAR	CODE
	SOFT	BLACK	2017	0017443.090.700
	SOFT	FULL BLK.	2017	0017443.091.700
EXC 250/300 TPI	HARD	ORANGE	18/19	0017444.010.700
	HARD	BLUE	18/19	0017444.041.700
	HARD	BLACK	18/19	0017444.090.700
	SOFT	ORANGE	18/19	0017443.010.700
	SOFT	BLUE	18/19	0017443.041.700
	SOFT	BLACK	18/19	0017443.090.700
	SOFT	FULL BLK.	18/19	0017443.091.700
	SOFT	ORANGE	2020	0023588.010.700
	SOFT	BLUE	2020	0023588.041.700
	SOFT	BLACK	2020	0023588.090.700
	SOFT	BLACK 2	2020	0023588.091.700
EXC-F 250/350/450/500	HARD	ORANGE	17/19	0017444.010.700
	HARD	BLUE	17/19	0017444.041.700
	HARD	BLACK	17/19	0017444.090.700
	SOFT	ORANGE	17/19	0017443.010.700
	SOFT	BLUE	17/19	0017443.041.700
	SOFT	BLACK	17/19	0017443.090.700
	SOFT	FULL BLK.	17/19	0017443.091.700
	SOFT	ORANGE	2020	0023588.010.700
	SOFT	BLUE	2020	0023588.041.700
	SOFT	BLACK	2020	0023588.090.700
	SOFT	BLACK 2	2020	0023588.091.700
XC 250/300 TPI	SOFT	ORANGE	19/20	0023588.010.700
	SOFT	BLUE	19/20	0023588.041.700
	SOFT	BLACK	19/20	0023588.090.700
	SOFT	BLACK 2	19/20	0023588.091.700
XC-F 250/350/450	SOFT	ORANGE	19/20	0023588.010.700
	SOFT	BLUE	19/20	0023588.041.700
	SOFT	BLACK	19/20	0023588.090.700
	SOFT	BLACK 2	19/20	0023588.091.700
XC-W 125	HARD	ORANGE	17/19	0017444.010.700
	HARD	BLUE	17/19	0017444.041.700
	HARD	BLACK	17/19	0017444.090.700
	SOFT	ORANGE	17/19	0017443.010.700
	SOFT	BLUE	17/19	0017443.041.700
	SOFT	BLACK	17/19	0017443.090.700
	SOFT	FULL BLK.	17/19	0017443.091.700
	SOFT	BLACK	2020	0023588.090.700
	SOFT	ORANGE	2020	0023588.010.700
	SOFT	BLUE	2020	0023588.041.700
	SOFT	BLACK 2	2020	0023588.091.700
XC-W 150/250/300 TPI	HARD	ORANGE	2019	0017444.010.700
	HARD	BLUE	2019	0017444.041.700
	HARD	BLACK	2019	0017444.090.700
	SOFT	ORANGE	2019	0017443.010.700
	SOFT	BLUE	2019	0017443.041.700
	SOFT	BLACK	2019	0017443.090.700
	SOFT	FULL BLK.	2019	0017443.091.700
	SOFT	BLACK	2020	0023588.090.700
	SOFT	ORANGE	2020	0023588.010.700
	SOFT	BLUE	2020	0023588.041.700
	SOFT	BLACK 2	2020	0023588.091.700
XC-F-W 350/500	SOFT	BLACK	2020	0023588.090.700
	SOFT	ORANGE	2020	0023588.010.700
	SOFT	BLUE	2020	0023588.041.700
	SOFT	BLACK 2	2020	0023588.091.700



KTM X-SEATS

X-SEATS HARD (RACING)



code: **0015618.010.700**



code: **0015618.090.700**



code: **0017444.010.700**



code: **0017444.041.700**



code: **0017444.090.700**

X-SEATS SOFT (COMFORT)



code: **0017443.010.700**



code: **0017443.041.700**



code: **0017443.090.700**



code: **0023588.090.700**



code: **0023588.010.700**



code: **0023588.041.700**

KAWASAKI X-SEATS

MODEL	TYPE	COLORS	YEAR	CODE
KXF 250	HARD	GREEN	09/12	0013153.130.700
	HARD	GREEN	13/16	0016305.130.700
	HARD	BLACK	13/16	0016305.090.700
	HARD	GREEN	17/19	0021877.130.700
	HARD	BLACK	17/19	0021877.090.700
	SOFT	GREEN	17/19	0021878.130.700
	SOFT	BLACK	17/19	0021878.090.700
KX 250 4T	HARD	GREEN	2020	0021877.130.700
	HARD	BLACK	2020	0021877.090.700
	SOFT	GREEN	2020	0021878.130.700
	SOFT	BLACK	2020	0021878.090.700
KXF 450	HARD	GREEN	09/11	0013153.130.700

MODEL	TYPE	COLORS	YEAR	CODE
	HARD	GREEN	12/15	0016305.130.700
	HARD	BLACK	12/15	0016305.090.700
	HARD	GREEN	16/18	0021877.130.700
	HARD	BLACK	16/18	0021877.090.700
	SOFT	GREEN	16/18	0021878.130.700
	SOFT	BLACK	16/18	0021878.090.700
	SOFT	BLACK/ GREEN	2019	0023700.090.700
	SOFT	GREEN/ BLACK	2019	0023700.130.700
KX 450 4T	SOFT	BLACK/ GREEN	2020	0023700.090.700
	SOFT	GREEN/ BLACK	2020	0023700.130.700

X-SEATS HARD (RACING)



code: **0016305.090.700**



code: **0016305.130.700**



code: **0021877.090.700**



code: **0021877.130.700**

X-SEATS SOFT (COMFORT)



code: **0023700.090.700**



code: **0023700.130.700**

MODEL	TYPE	COLORS	YEAR	CODE
CR 125/250 2T	HARD	RED	09/13	0013510.110.700
	HARD	BLACK	09/13	0013510.090.700
FC 250/350/450	HARD	BLUE	16/18	0021879.040.700
	HARD	BLACK	16/18	0021879.090.700
	SOFT	BLUE	16/18	0021880.040.700
	SOFT	YELLOW/ BLUE	16/18	0021880.060.700
	SOFT	BLACK	16/18	0021880.090.700
	SOFT	BLUE	19/20	0023639.040.700
	SOFT	BLACK	19/20	0023639.090.700
	SOFT	BLACK 2	19/20	0023639.091.700
FE 250/350/450/501	HARD	BLUE	17/19	0021879.040.700
	HARD	BLACK	17/19	0021879.090.700
	SOFT	BLUE	17/19	0021880.040.700
	SOFT	YELLOW/ BLUE	17/19	0021880.060.700
	SOFT	BLACK	17/19	0021880.090.700
	SOFT	BLUE	2020	0023639.040.700
	SOFT	BLACK	2020	0023639.090.700
	SOFT	BLACK 2	2020	0023639.091.700
SM 450/510 4T	HARD	RED	09/10	0013510.110.700
	HARD	BLACK	09/10	0013510.090.700
TC 125	HARD	BLUE	16/18	0021879.040.700
	HARD	BLACK	16/18	0021879.090.700
	SOFT	BLUE	16/18	0021880.040.700
	SOFT	YELLOW	16/18	0021880.060.700
	SOFT	BLACK	16/18	0021880.090.700
	SOFT	BLUE	19/20	0023639.040.700
	SOFT	BLACK	19/20	0023639.090.700
	SOFT	BLACK 2	19/20	0023639.091.700
TC 250	HARD	RED	09/13	0013510.110.700
	HARD	BLACK	09/13	0013510.090.700
	HARD	BLUE	17/18	0021879.040.700
	HARD	BLACK	17/18	0021879.090.700
	SOFT	BLUE	17/18	0021880.040.700
	SOFT	YELLOW/ BLUE	17/18	0021880.060.700
	SOFT	BLACK	17/18	0021880.090.700
	SOFT	BLUE	19/20	0023639.040.700
SOFT	BLACK	19/20	0023639.090.700	

MODEL	TYPE	COLORS	YEAR	CODE
TE 150 I	SOFT	BLACK 2	19/20	0023639.091.700
	SOFT	BLUE	2020	0023639.040.700
	SOFT	BLACK	2020	0023639.090.700
TE 250	SOFT	BLACK 2	2020	0023639.091.700
	HARD	RED	09/13	0013510.110.700
	HARD	BLACK	09/13	0013510.090.700
	HARD	BLUE	2017	0021879.040.700
	HARD	BLACK	2017	0021879.090.700
	SOFT	BLUE	2017	0021880.040.700
TE 250 I/300 I	SOFT	YELLOW/ BLUE	2017	0021880.060.700
	SOFT	BLACK	2017	0021880.090.700
	HARD	BLUE	2017	0021879.040.700
	HARD	BLACK	2017	0021879.090.700
	SOFT	BLUE	2017	0021880.040.700
	SOFT	YELLOW/ BLUE	2017	0021880.060.700
TE 300	SOFT	BLACK	2017	0021880.090.700
	HARD	BLUE	2017	0021879.040.700
	HARD	BLACK	2017	0021879.090.700
	SOFT	BLUE	2017	0021880.040.700
	SOFT	YELLOW/ BLUE	2017	0021880.060.700
	SOFT	BLACK	2017	0021880.090.700
TE 250 I/300 I	HARD	BLUE	18/19	0021879.040.700
	HARD	BLACK	18/19	0021879.090.700
	SOFT	BLUE	18/19	0021880.040.700
	SOFT	YELLOW/ BLUE	18/19	0021880.060.700
	SOFT	BLACK	18/19	0021880.090.700
	SOFT	BLACK/ BLUE	18/19	0023639.040.700
TE 310 4T	SOFT	BLUE/ BLACK	18/19	0023639.090.700
	SOFT	BLACK	18/19	0021880.090.700
TE 450/510 4T	HARD	RED	09/13	0013510.110.700
	HARD	BLACK	09/13	0013510.090.700
TX 125	HARD	RED	09/10	0013510.110.700
	HARD	BLACK	09/10	0013510.090.700
WR 125/250 2T	HARD	BLUE	17/19	0021879.040.700
	HARD	BLACK	17/19	0021879.090.700
	SOFT	BLUE	17/19	0021880.040.700
WR 125/250 2T	SOFT	YELLOW/ BLUE	17/19	0021880.060.700
	SOFT	BLACK	17/19	0021880.090.700
	HARD	RED	09/13	0013510.110.700
HARD	BLACK	09/13	0013510.090.700	

X-SEATS HARD (RACING)



code: **0021879.040.700**



code: **0021879.090.700**



code: **0013510.110.700**



code: **0013510.090.700**

X-SEATS SOFT (COMFORT)



code: **0021880.040.700**



code: **0021880.060.700**



code: **0021880.090.700**



code: **0023639.090.700**



code: **0023639.040.700**



code: **0023639.091.700**





FUEL TANKS
SERBATOI



HONDA FUEL TANKS

MODEL	COLORS	YEAR	CAPACITY	CODE
XR 650R	RED	04/07	24 LIT.	0001615.110
XR 650	RED	00/03	24 LIT.	0001615.110
CRF 150R	RED	07/20	6,5 LIT.	0016495.110.700
	NATURAL	07/20	6,5 LIT.	0016495.120.700
XR 250R	WHITE	96/03	22 LIT.	0001601.030
	RED	96/03	22 LIT.	0001601.110
	NATURAL	96/03	22 LIT.	0001601.120
XR 400R	WHITE	96/04	22 LIT.	0001601.030
	RED	96/04	22 LIT.	0001601.110
	NATURAL	96/04	22 LIT.	0001601.120
XR 600R	WHITE	88/99	22 LIT.	0001569.030
XR 650L	WHITE	93/96	22 LIT.	0001590.030
	RED	93/96	22 LIT.	0001590.110
CRF 250R	BLACK	04/09	11 LIT.	0007845.090
	WHITE	04/09	11 LIT.	0007845.120
	BLACK	10/13	10,5 LIT.	0013551.090.700
	WHITE	10/13	10,5 LIT.	0013551.120.700
	BLACK	14/17	10,5 LIT.	0016915.090.700
	NATURAL	14/17	10,5 LIT.	0016915.120.700
	BLACK	18/20	11,5 LIT.	0022387.090.700
NATURAL	18/20	11,5 LIT.	0022387.120.700	
CRF 250/300RX	BLACK	19/20	11,5 LIT.	0022761.090.700
	NATURAL	19/20	11,5 LIT.	0022761.120.700
CRF 450R	BLACK	05/08	12 LIT.	0008375.090
	NATURAL	05/08	12 LIT.	0008375.120
	BLACK	09/12	10,5 LIT.	0013551.090.700
	NATURAL	09/12	10,5 LIT.	0013551.120.700
	BLACK	13/16	10,5 LIT.	0016915.090.700
	NATURAL	13/16	10,5 LIT.	0016915.120.700
	BLACK	17/20	11,5 LIT.	0022387.090.700
NATURAL	17/20	11,5 LIT.	0022387.120.700	
CRF 450X	RED	05/16	15,5 LIT.	0010999.110.700
	NATURAL	05/16	15,5 LIT.	0010999.120.700
	RED	05/16	25 LIT.	0008429.110
	NATURAL	05/16	25 LIT.	0008429.120
CRF 450RX	BLACK	17/20	11,5 LIT.	0022761.090.700
	NATURAL	17/20	11,5 LIT.	0022761.120.700
NX/DOMINATOR	WHITE	88/91	23 LIT.	0001584.030
	BLACK	88/91	23 LIT.	0001584.090
	WHITE	92/94	23 LIT.	0001589.030
	BLACK	92/94	23 LIT.	0001589.090
	WHITE	95/03	23 LIT.	0001603.030
BLACK	95/03	23 LIT.	0001603.090	
CRF 250L/M	BLACK	13/16	12,5 LIT.	0022952.090.700
	NATURAL	13/16	12,5 LIT.	0022952.120.700
	BLACK	17/19 •	12,5 LIT.	0022925.090.700
	NATURAL	17/19 •	12,5 LIT.	0022925.120.700

• WITH/WITHOUT ABS

FROM MY 2008 TO 2015 FRONT FIXING POINT BRACKET NOT INCLUDED



HONDA **XR 650R**
year: **2004/2007**
capacity: **24 lit.**
code: **0001615.110**



HONDA **CRF 150R**
year: **2007/2017**
capacity: **6,5 lit.**
code: **00016495.110**



HONDA **CRF 250**
year: **2014/2017**
capacity: **10,5 lit.**
code: **0016915.090.700**



HONDA **CRF 450**
year: **2013/2016**
capacity: **10,5 lit.**
code: **0016915.120.700**



HONDA **CRF 450X**
year: **2005/2016**
capacity: **25 lit.**
code: **0008429.110**



HONDA **CRF 450R**
year: **2017/2018**
capacity: **11,5 lit.**
code: **0022387.090.700**



HONDA **CRF 450RX**
year: **2017/2018**
capacity: **11,5 lit.**
code: **0022761.120.700**



HONDA **CRF 250 L/M**
year: **2013/2016**
capacity: **12,5 lit.**
code: **0022952.090.700**

SUZUKI FUEL TANKS

MODEL	COLORS	YEAR	CAPACITY	CODE
RMZ 250	BLACK	07/09	11,3 LT.	0011514.090.700
	NATURAL	07/09	11,3 LT.	0011514.120.700
	YELLOW	07/09	11,3 LT.	0011514.060.700
DR 400Z	YELLOW	00/15	14 LT.	0001604.060
	BLACK	00/15	14 LT.	0001604.090
DR 400S/DR 400SM	BLUE	00/19	15 LT.	0021882.040.700
	YELLOW	00/19	15 LT.	0021882.060.700
	GREY	00/19	15 LT.	0021882.070.700
	BLACK	00/19	15 LT.	0021882.090.700
	NATURAL	00/19	15 LT.	0021882.120.700
DR 350	WHITE	90/99	16 LT.	0001585.030
DR 650	WHITE	96/19	20 LT.	0016302.030.700
	BLUE	96/19	20 LT.	0016302.040.700
	GREY	96/19	20 LT.	0016302.070.700
	BLACK	96/19	20 LT.	0016302.090.700
	NATURAL	96/19	20 LT.	0016302.120.700
	WHITE	96/20	25 LT.	0017554.030.700
	BLUE	96/20	25 LT.	0017554.040.700
	GREY	96/20	25 LT.	0017554.070.700
	BLACK	96/20	25 LT.	0017554.090.700
	NATURAL	96/20	25 LT.	0017554.120.700
DR 650R	WHITE	92/95	25 LT.	0001588.030



SUZUKI **RMZ 250**
year: **2007/2009**
capacity: **11,3 lit.**
code: **0011514.090.700**



SUZUKI **DR 400Z**
year: **2000/2015**
capacity: **14 lit.**
code: **0001604.060**



SUZUKI **DR 350**
year: **1990/1999**
capacity: **16 lit.**
code: **0001585.030**



SUZUKI **DR 650**
year: **1996/2018**
capacity: **20 lit.**
code: **0016302.090.700**



SUZUKI **DR 650R DJEBEL**
year: **1992/1995**
capacity: **25 lit.**
code: **0001588.030**

KTM FUEL TANKS

MODEL	COLORS	YEAR	CAPACITY	CODE
EXC 125	BLACK	08/11	11 LT.	0011669.090.700
	NATURAL	08/11	11 LT.	0011669.120.700
	BLACK	08/11	13 LT.	0011607.090.700
	ORANGE	08/11	13 LT.	0011607.010.700
	NATURAL	08/11	13 LT.	0011607.120.700
	NATURAL	08/11	24 LT.	0010960.120.700
	ORANGE	08/11	24 LT.	0010960.010.700
	BLACK	12/16	11,5 LT.	0016334.090.700
	NATURAL	12/16	11,5 LT.	0016334.120.700
	BLACK	12/16	15,5 LT.	0017102.090.700
	NATURAL	12/16	15,5 LT.	0017102.120.700
	BLACK	12/16	20 LT.	0016335.090.700
	NATURAL	12/16	20 LT.	0016335.120.700
XC-W 125	BLACK	2017	12 LT.	0023167.090.700
	NATURAL	2017	12 LT.	0023167.120.700
	BLACK	18/19	12 LT.	0023172.090.700
	NATURAL	18/19	12 LT.	0023172.120.700
	BLACK	2020	12 LT.	0023950.090.700
XC-W 125	NATURAL	2020	12 LT.	0023950.120.700
EXC 150 TPI	BLACK	2020	12 LT.	0023956.090.700
	NATURAL	2020	12 LT.	0023956.120.700



KTM **EXC**
year: **2012/2016**
capacity: **11,5 lit.**
code: **0016334.090.700**



KTM **EXC**
year: **2012/2016**
capacity: **20 lit.**
code: **0016335.120.700**



MODEL	COLORS	YEAR	CAPACITY	CODE
EXC 200	BLACK	08/11	11 LT.	0011669.090.700
	NATURAL	08/11	11 LT.	0011669.120.700
	BLACK	08/11	13 LT.	0011607.090.700
	ORANGE	08/11	13 LT.	0011607.010.700
	NATURAL	08/11	13 LT.	0011607.120.700
	NATURAL	08/11	24 LT.	0010960.120.700
	ORANGE	08/11	24 LT.	0010960.010.700
	BLACK	12/16	11,5 LT.	0016334.090.700
	NATURAL	12/16	11,5 LT.	0016334.120.700
	BLACK	12/16	15,5 LT.	0017102.090.700
	NATURAL	12/16	15,5 LT.	0017102.120.700
	BLACK	12/16	20 LT.	0016335.090.700
	NATURAL	12/16	20 LT.	0016335.120.700
EXC 250	ORANGE	06/07	25 LT.	0008430.010
	NATURAL	06/07	25 LT.	0008430.120
	BLACK	08/11	11 LT.	0011669.090.700
	NATURAL	08/11	11 LT.	0011669.120.700
	BLACK	08/11	13 LT.	0011607.090.700
	ORANGE	08/11	13 LT.	0011607.010.700
	NATURAL	08/11	13 LT.	0011607.120.700
	NATURAL	08/11	24 LT.	0010960.120.700
	ORANGE	08/11	24 LT.	0010960.010.700
	BLACK	12/16	11,5 LT.	0016334.090.700
	NATURAL	12/16	11,5 LT.	0016334.120.700
	BLACK	12/16	15,5 LT.	0017102.090.700
	NATURAL	12/16	15,5 LT.	0017102.120.700
	BLACK	12/16	20 LT.	0016335.090.700
	NATURAL	12/16	20 LT.	0016335.120.700
EXC 250 TPI	BLACK	18/19	12 LT.	0023172.090.700
	NATURAL	18/19	12 LT.	0023172.120.700
	BLACK	2020	12 LT.	0023956.090.700
	NATURAL	2020	12 LT.	0023956.120.700
EXC 300	BLACK	08/11	11 LT.	0011669.090.700
	NATURAL	08/11	11 LT.	0011669.120.700
	BLACK	08/11	13 LT.	0011607.090.700
	ORANGE	08/11	13 LT.	0011607.010.700
	NATURAL	08/11	13 LT.	0011607.120.700
	NATURAL	08/11	24 LT.	0010960.120.700
	ORANGE	08/11	24 LT.	0010960.010.700
	BLACK	12/16	11,5 LT.	0016334.090.700
	NATURAL	12/16	11,5 LT.	0016334.120.700
	BLACK	12/16	15,5 LT.	0017102.090.700
	NATURAL	12/16	15,5 LT.	0017102.120.700
	BLACK	12/16	20 LT.	0016335.090.700
	NATURAL	12/16	20 LT.	0016335.120.700
	BLACK	2017	12 LT.	0023167.090.700
	NATURAL	2017	12 LT.	0023167.120.700
EXC 300 TPI	BLACK	18/19	12 LT.	0023172.090.700
	NATURAL	18/19	12 LT.	0023172.120.700
	BLACK	2020	12 LT.	0023956.090.700
	NATURAL	2020	12 LT.	0023956.120.700
EXC-F 525	ORANGE	06/07	25 LT.	0008430.010
	NATURAL	06/07	25 LT.	0008430.120
EXC-F 250	BLACK	08/11	11 LT.	0011669.090.700
	NATURAL	08/11	11 LT.	0011669.120.700
	BLACK	08/11	13 LT.	0011607.090.700
	ORANGE	08/11	13 LT.	0011607.010.700
	NATURAL	08/11	24 LT.	0010960.120.700



KTM **EXC**
KTM **EXC-F**
year: **2008/2011**
capacity: **13 lit.**
code: **0011607.010.700**



KTM **EXC**
KTM **EXC-F**
year: **2008/2011**
capacity: **24 lit.**
code: **0010960.120.700**



KTM **EXC-F**
year: **2012/2016**
capacity: **11,5 lit.**
code: **0016299.120.700**



KTM **EXC 400/450**
year: **2005/2007**
capacity: **25 lit.**
code: **0008430.010**



KTM **EXC-F**
year: **2012/2016**
capacity: **20 lit.**
code: **0016301.090.700**

MODEL	COLORS	YEAR	CAPACITY	CODE
	ORANGE	08/11	24 LT.	0010960.010.700
	BLACK	12/16	11,5 LT.	0016299.090.700
	NATURAL	12/16	11,5 LT.	0016299.120.700
	BLACK	12/16	15,5 LT.	0017101.090.700
	NATURAL	12/16	15,5 LT.	0017101.120.700
	BLACK	12/16	20 LT.	0016301.090.700
	NATURAL	12/16	20 LT.	0016301.120.700
	BLACK	17/19	12 LT.	0023172.090.700
	NATURAL	17/19	12 LT.	0023172.120.700
	BLACK	17/19	15 LT.	0021871.090.700
	NATURAL	17/19	15 LT.	0021871.120.700
	BLACK	2020	12 LT.	0023956.090.700
	NATURAL	2020	12 LT.	0023956.120.700
	BLACK	2020	15 LT.	0023957.090.700
	NATURAL	2020	15 LT.	0023957.120.700
EXC-F 350	BLACK	12/16	11,5 LT.	0016299.090.700
	NATURAL	12/16	11,5 LT.	0016299.120.700
	BLACK	12/16	15,5 LT.	0017101.090.700
	NATURAL	12/16	15,5 LT.	0017101.120.700
	BLACK	12/16	20 LT.	0016301.090.700
	NATURAL	12/16	20 LT.	0016301.120.700
	BLACK	17/19	12 LT.	0023172.090.700
	NATURAL	17/19	12 LT.	0023172.120.700
	BLACK	17/19	15 LT.	0021871.090.700
	NATURAL	17/19	15 LT.	0021871.120.700
	BLACK	2020	12 LT.	0023956.090.700
	NATURAL	2020	12 LT.	0023956.120.700
	BLACK	2020	15 LT.	0023957.090.700
	NATURAL	2020	15 LT.	0023957.120.700
EXC-F 400/450	ORANGE	05/07	25 LT.	0008430.010
	NATURAL	05/07	25 LT.	0008430.120
	BLACK	08/11	11 LT.	0011669.090.700
	NATURAL	08/11	11 LT.	0011669.120.700
	BLACK	08/11	13 LT.	0011607.090.700
	ORANGE	08/11	13 LT.	0011607.010.700
	NATURAL	08/11	13 LT.	0011607.120.700
	NATURAL	08/11	24 LT.	0010960.120.700
	ORANGE	08/11	24 LT.	0010960.010.700
	BLACK	12/16	15,5 LT.	0017101.090.700
	NATURAL	12/16	15,5 LT.	0017101.120.700
EXC-F 450/500	BLACK	12/16	11,5 LT.	0016299.090.700
	NATURAL	12/16	11,5 LT.	0016299.120.700
	BLACK	12/16	15,5 LT.	0017101.090.700
	NATURAL	12/16	15,5 LT.	0017101.120.700
	BLACK	12/16	20 LT.	0016301.090.700
	NATURAL	12/16	20 LT.	0016301.120.700
	BLACK	17/19	12 LT.	0023172.090.700
	NATURAL	17/19	12 LT.	0023172.120.700
	BLACK	17/19	15 LT.	0021871.090.700
	NATURAL	17/19	15 LT.	0021871.120.700
	BLACK	2020	12 LT.	0023956.090.700
	NATURAL	2020	12 LT.	0023956.120.700
	BLACK	2020	15 LT.	0023957.090.700
	NATURAL	2020	15 LT.	0023957.120.700
EXC-F 530	BLACK	08/11	11 LT.	0011669.090.700
	NATURAL	08/11	11 LT.	0011669.120.700
	BLACK	08/10	13 LT.	0011607.090.700
	NATURAL	08/10	13 LT.	0011607.120.700
	ORANGE	08/10	13 LT.	0011607.010.700
	NATURAL	08/11	24 LT.	0010960.120.700
	ORANGE	08/11	24 LT.	0010960.010.700
SX 125	BLACK	07/10	11 LT.	0011669.090.700
	NATURAL	07/10	11 LT.	0011669.120.700



KTM **EXC**
KTM **EXC-F**
year: **2008/2011**
capacity: **13 lit.**
code: **0011607.120.700**



KTM **EXC**
KTM **EXC-F**
year: **2008/2011**
capacity: **24 lit.**
code: **0010960.010.700**



KTM **EXC-F**
year: **2012/2016**
capacity: **20 lit.**
code: **0016301.090.700**



KTM **EXC**
KTM **EXC-F**
year: **2008/2011**
capacity: **13 lit.**
code: **0011607.120.700**



KTM **SX**
KTM **SX-F 450**
year: **2007/2010**
capacity: **11 lit.**
code: **0011669.090.700**



MODEL	COLORS	YEAR	CAPACITY	CODE
	BLACK	08/10	13 LT.	0011607.090.700
	ORANGE	08/10	13 LT.	0011607.010.700
	NATURAL	08/10	13 LT.	0011607.120.700
	NATURAL	07/10	24 LT.	0010960.120.700
	ORANGE	07/10	24 LT.	0010960.010.700
	BLACK	11/15	11,5 LT.	0016334.090.700
	NATURAL	11/15	11,5 LT.	0016334.120.700
	BLACK	11/15	15,5 LT.	0017102.090.700
	NATURAL	11/15	15,5 LT.	0017102.120.700
	BLACK	11/15	20 LT.	0016335.090.700
	NATURAL	11/15	20 LT.	0016335.120.700
	BLACK	16/18	12 LT.	0023167.090.700
	NATURAL	16/18	12 LT.	0023167.120.700
	BLACK	19/20	12 LT.	0023950.090.700
	NATURAL	19/20	12 LT.	0023950.120.700
SX 150	BLACK	2008	11 LT.	0011669.090.700
	NATURAL	2008	11 LT.	0011669.120.700
	NATURAL	2008	24 LT.	0010960.120.700
	ORANGE	2008	24 LT.	0010960.010.700
	BLACK	08/10	13 LT.	0011607.090.700
	ORANGE	08/10	13 LT.	0011607.010.700
	NATURAL	08/10	13 LT.	0011607.120.700
	BLACK	11/15	11,5 LT.	0016334.090.700
	NATURAL	11/15	11,5 LT.	0016334.120.700
	BLACK	11/15	15,5 LT.	0017102.090.700
	NATURAL	11/15	15,5 LT.	0017102.120.700
	BLACK	11/15	20 LT.	0016335.090.700
	NATURAL	11/15	20 LT.	0016335.120.700
	BLACK	16/18	12 LT.	0023167.090.700
	NATURAL	16/18	12 LT.	0023167.120.700
	BLACK	2019	12 LT.	0023950.090.700
	NATURAL	2019	12 LT.	0023950.120.700
SX 250	BLACK	07/10	11 LT.	0011669.090.700
	NATURAL	07/10	11 LT.	0011669.120.700
	BLACK	08/10	13 LT.	0011607.090.700
	ORANGE	08/10	13 LT.	0011607.010.700
	NATURAL	08/10	13 LT.	0011607.120.700
	NATURAL	07/10	24 LT.	0010960.120.700
	ORANGE	07/10	24 LT.	0010960.010.700
	BLACK	11/16	11,5 LT.	0016334.090.700
	NATURAL	11/16	11,5 LT.	0016334.120.700
	BLACK	11/16	15,5 LT.	0017102.090.700
	NATURAL	11/16	15,5 LT.	0017102.120.700
	BLACK	11/16	20 LT.	0016335.090.700
	NATURAL	11/16	20 LT.	0016335.120.700
	BLACK	17/18	12 LT.	0023167.090.700
	NATURAL	17/18	12 LT.	0023167.120.700
	BLACK	19/20	12 LT.	0023950.090.700
	NATURAL	19/20	12 LT.	0023950.120.700
SX-F 250	BLACK	11/12	11,5 LT.	0016298.090.700
	NATURAL	11/12	11,5 LT.	0016298.120.700
	BLACK	11/12	20 LT.	0016300.090.700
	NATURAL	11/12	20 LT.	0016300.120.700
	BLACK	13/15	11,5 LT.	0016299.090.700
	NATURAL	13/15	11,5 LT.	0016299.120.700
	BLACK	13/15	20 LT.	0016301.090.700
	NATURAL	13/15	20 LT.	0016301.120.700
	BLACK	16/18	12 LT.	0023172.090.700
	NATURAL	16/18	12 LT.	0023172.120.700
	BLACK	16/18	15 LT.	0021871.090.700
	NATURAL	16/18	15 LT.	0021871.120.700
	BLACK	19/20	12 LT.	0023564.090.700
	NATURAL	19/20	12 LT.	0023564.120.700



KTM **SX**
year: **2011/2015**
capacity: **11,5 lit.**
code: **0016334.090.700**



KTM **SX-F**
year: **2013/2015**
capacity: **11,5 lit.**
code: **0016299.120.700**



KTM **SX**
KTM **SX-F 450**
year: **2008/2010**
capacity: **13 lit.**
code: **0011607.120.700**



KTM **SXF**
year: **2016/2017**
capacity: **12 lit.**
code: **0023172.120.700**



KTM **SXF**
year: **2016/2017**
capacity: **12 lit.**
code: **0023172.090.700**

MODEL	COLORS	YEAR	CAPACITY	CODE
	BLACK	19/20	15 LT.	0023565.090.700
	NATURAL	19/20	15 LT.	0023565.120.700
SX-F 350	BLACK	11/12	11,5 LT.	0016298.090.700
	NATURAL	11/12	11,5 LT.	0016298.120.700
	BLACK	11/12	20 LT.	0016300.090.700
	NATURAL	11/12	20 LT.	0016300.120.700
	BLACK	13/15	11,5 LT.	0016299.090.700
	NATURAL	13/15	11,5 LT.	0016299.120.700
	BLACK	13/15	15,5 LT.	0017101.090.700
	NATURAL	13/15	15,5 LT.	0017101.120.700
	BLACK	13/15	20 LT.	0016301.090.700
	NATURAL	13/15	20 LT.	0016301.120.700
	BLACK	16/18	12 LT.	0023172.090.700
	NATURAL	16/18	12 LT.	0023172.120.700
	BLACK	16/18	15 LT.	0021871.090.700
	NATURAL	16/18	15 LT.	0021871.120.700
	BLACK	19/20	12 LT.	0023564.090.700
	NATURAL	19/20	12 LT.	0023564.120.700
	BLACK	19/20	15 LT.	0023565.090.700
	NATURAL	19/20	15 LT.	0023565.120.700
SX-F 450	BLACK	07/10	11 LT.	0011669.090.700
	NATURAL	07/10	11 LT.	0011669.120.700
	NATURAL	07/10	24 LT.	0010960.120.700
	ORANGE	07/10	24 LT.	0010960.010.700
	BLACK	08/10	13 LT.	0011607.090.700
	ORANGE	08/10	13 LT.	0011607.010.700
	NATURAL	08/10	13 LT.	0011607.120.700
	BLACK	11/12	11,5 LT.	0016334.090.700
	NATURAL	11/12	11,5 LT.	0016334.120.700
	BLACK	11/12	20 LT.	0016335.090.700
	NATURAL	11/12	20 LT.	0016335.120.700
	BLACK	13/15	11,5 LT.	0016299.090.700
	NATURAL	13/15	11,5 LT.	0016299.120.700
	BLACK	13/15	15,5 LT.	0017101.090.700
	NATURAL	13/15	15,5 LT.	0017101.120.700
	BLACK	13/15	20 LT.	0016301.090.700
	NATURAL	13/15	20 LT.	0016301.120.700
	BLACK	16/18	12 LT.	0023172.090.700
	NATURAL	16/18	12 LT.	0023172.120.700
	BLACK	16/18	15 LT.	0021871.090.700
	NATURAL	16/18	15 LT.	0021871.120.700
	BLACK	19/20	12 LT.	0023564.090.700
	NATURAL	19/20	12 LT.	0023564.120.700
	BLACK	19/20	15 LT.	0023565.090.700
	NATURAL	19/20	15 LT.	0023565.120.700
SX-F 505	BLACK	07/08	11 LT.	0011669.090.700
	NATURAL	07/08	11 LT.	0011669.120.700
	NATURAL	07/08	24 LT.	0010960.120.700
	ORANGE	07/08	24 LT.	0010960.010.700
	BLACK	08/10	13 LT.	0011607.090.700
	ORANGE	08/10	13 LT.	0011607.010.700
	NATURAL	08/10	13 LT.	0011607.120.700
	BLACK	13/15	15,5 LT.	0017101.090.700
	NATURAL	13/15	15,5 LT.	0017101.120.700
XC-F 250/350/450	BLACK	2020	12 LT.	0023956.090.700
	NATURAL	2020	12 LT.	0023956.120.700
	BLACK	2020	15 LT.	0023957.090.700
	NATURAL	2020	15 LT.	0023957.120.700
XC 250/300 TPI	BLACK	2020	12 LT.	0023956.090.700
	NATURAL	2020	12 LT.	0023956.120.700



KTM **SXF**
 year: **2017**
 capacity: **15 lit.**
 code: **0021871.120.700**



MODEL	COLORS	YEAR	CAPACITY	CODE
YZ 85	WHITE	07/20	8,5 LIT.	0016494.030.700
	BLUE	07/20	8,5 LIT.	0016494.040.700
	BLACK	07/20	8,5 LIT.	0016494.090.700
YZF 250/450	BLUE 98	03/05	12,5 LIT.	0007457.040
	NATURAL	03/05	12,5 LIT.	0007457.120
	BLUE 98	06/09	12,5 LIT.	0010930.040.700
	NATURAL	06/09	12,5 LIT.	0010930.120.700
YZF 250	BLACK	14/18	11,3 LIT.	0017586.090.700
	NATURAL	14/18	11,3 LIT.	0017586.120.700
	BLACK	19/20	10,5 LIT.	0023305.040.700 **
	NATURAL	19/20	10,5 LIT.	0023305.120.700 **
YZF 450	BLACK	10/13	9,1 LIT.	0015619.090.700
	NATURAL	10/13	9,1 LIT.	0015619.120.700
	BLACK	14/17	11,3 LIT.	0017586.090.700
	NATURAL	14/17	11,3 LIT.	0017586.120.700
	BLUE	18/20	10,5 LIT.	0023305.040.700 **
	NATURAL	18/20	10,5 LIT.	0023305.120.700 **
WRF 250/450	BLUE 98	03/06	12,5 LIT.	0007457.040 •
	NATURAL	03/06	12,5 LIT.	0007457.120 •
	BLUE	04/06	25 LIT.	0008595.040 •
	BLUE 98	07/09	12,5 LIT.	0010930.040.700
	NATURAL	07/09	12,5 LIT.	0010930.120.700
WR/YZ 125/250	BLUE	05/20	12 LIT.	0023657.040.700
	NATURAL	05/20	12 LIT.	0023657.120.700
	BLACK	05/20	12 LIT.	0023657.090.700
WRF 400	BLUE 98	1999	13 LIT.	0001612.040.098
	NATURAL	1999	13 LIT.	0001612.120
YZF 400	BLUE 98	98/99	13 LIT.	0001612.040.098
	NATURAL	98/99	13 LIT.	0001612.120
WR/YZ 426 F	BLUE 98	00/02	13 LIT.	0001612.040.098
	NATURAL	00/02	13 LIT.	0001612.120
WR 250 F	BLUE 98	01/02	13 LIT.	0001612.040.098
	NATURAL	01/02	13 LIT.	0001612.120
XT 600	WHITE	95/03	23 LIT.	0001599.030
	BLACK	95/03	23 LIT.	0001599.090
TT 600 KICK STARTER	WHITE	93/97	23 LIT.	0001593.030
TT 600 ELECTRIC STARTER	WHITE	98/03	23 LIT.	0001593.030
TT 600 R	WHITE	98/04	20 LIT.	0001614.030



YAMAHA **YZF 85**
year: **2007/2018**
capacity: **8,5 lit.**
code: **0016494.040.700**



YAMAHA **YZF 250/450**
year: **2014/2017**
capacity: **11,3 lit.**
code: **0017586.090.700**



YAMAHA **YZF 450**
year: **2010/2013**
capacity: **9,1 lit.**
code: **0015619.090.700**



YAMAHA **YZF 450**
year: **2018**
capacity: **10 lit.**
code: **0023305.040.700**



YAMAHA **WR/YZ 125/250**
year: **2005/2017**
capacity: **12 lit.**
code: **0015911.040.700**



YAMAHA **XT 600**
year: **1995/2003**
capacity: **23 lit.**
code: **0001599.090**



YAMAHA **TT 600**
year: **1993/2003**
capacity: **23 lit.**
code: **0001593.030**

- FITS YZF 250/450 RADIATOR SCOOPS **CODE: 0003666.**
- AIR BOX COVER DEDICATED INCLUDED **CODE: 0023305.**

MODEL	COLORS	YEAR	CAPACITY	CODE
KLX 450	BLACK	08/18	12,5 LIT.	0011602.090.700
	NATURAL	08/18	12,5 LIT.	0011602.120.700
	BLACK	08/18	16 LIT.	0012438.090.700
KLX 250 C/R	GREEN	93/96	14 LIT.	0001594.130
	BLACK	93/96	14 LIT.	0001594.090
KLX 300	GREEN	99/02	14 LIT.	0001594.130
	BLACK	99/02	14 LIT.	0001594.090
	GREEN	2004	14 LIT.	0001594.130
	BLACK	2004	14 LIT.	0001594.090
KLX 400	BLACK	03/04	14 LIT.	0001604.090
	YELLOW	03/04	14 LIT.	0001604.060
KXF 450	NATURAL	09/11	10,5 LIT.	0013541.120.700
	NATURAL	12/15	10,5 LIT.	0016448.120.700
	BLACK	12/15	10,5 LIT.	0016448.090.700
	NATURAL	06/08	12,5 LIT.	0011673.120.700
	NATURAL	16/18	11,5 LIT.	0021881.120.700
	BLACK	16/18	11,5 LIT.	0021881.090.700
	NATURAL	2019	11 LIT.	0023703.090.700
KX 450 4T	NATURAL	2020	11 LIT.	0023703.090.700
	BLACK	2020	11 LIT.	0023703.120.700
KXF 250	BLACK	09/10	14 LIT.	0013542.090.700
	NATURAL	17/19	11 LIT.	0022566.120.700
	BLACK	17/19	11 LIT.	0022566.090.700
KX 250 4T	NATURAL	2020	11 LIT.	0022566.120.700
	BLACK	2020	11 LIT.	0022566.090.700



KAWASAKI **KLX 450**
 year: **2008/2018**
 capacity: **12,5 lit.**
 code: **0011602.090.700**



KAWASAKI **KLX 450**
 year: **2004**
 capacity: **16 lit.**
 code: **0012438.090.700**



KAWASAKI **KLX 250 C/R**
 year: **93/96**
 capacity: **14 lit.**
 code: **0001594.090**



KAWASAKI **KLX 400**
 year: **2003/2004**
 capacity: **14 lit.**
 code: **001604.090.**



KAWASAKI **KLX 450**
 year: **2006/2008**
 capacity: **12,5 lit.**
 code: **0011673.120.700**



KAWASAKI **KXF 250**
 year: **2017**
 capacity: **11 lit.**
 code: **0022566.120.700**



HUSQVARNA FUEL TANKS

MODEL	COLORS	YEAR	CAPACITY	CODE
FC 250/350/450	BLACK	17/18	12 LIT.	0021872.090.700
	NATURAL	16/18	12 LIT.	0023173.120.700
	BLACK	16/18	12 LIT.	0023173.090.700
	NATURAL	16/18	15 LIT.	0022113.120.700
	BLACK	16/18	15 LIT.	0022113.090.700
	NATURAL	19/20	12 LIT.	0023566.120.700
	BLACK	19/20	12 LIT.	0023566.090.700
	NATURAL	19/20	15 LIT.	0023567.120.700
	BLACK	19/20	15 LIT.	0023567.090.700
	FE 250/350/450/501	BLACK	17/18	12 LIT.
NATURAL		17/19	12 LIT.	0023173.120.700
BLACK		17/19	12 LIT.	0023173.090.700
NATURAL		17/19	15 LIT.	0022113.120.700
BLACK		17/19	15 LIT.	0022113.090.700
NATURAL		2020	12 LIT.	0023958.120.700
BLACK		2020	12 LIT.	0023958.090.700
NATURAL		2020	15 LIT.	0023959.120.700
BLACK		2020	15 LIT.	0023959.090.700
TX 125		NATURAL	2018	12 LIT.
	BLACK	2018	12 LIT.	0023173.090.700
TE 250 I/ 300 I	NATURAL	18/19	12 LIT.	0023173.120.700
	BLACK	18/19	12 LIT.	0023173.090.700
	NATURAL	2020	12 LIT.	0023958.120.700
	BLACK	2020	12 LIT.	0023958.090.700
	NATURAL	2020	15 LIT.	0023959.120.700
BLACK	2020	15 LIT.	0023959.090.700	



HUSQVARNA **FC 250/350/450**
year: **2016/2017**
capacity: **12 lit.**
code: **0021872.090.700**



HUSQVARNA **FC 250/350/450**
year: **2016/2017**
capacity: **12 lit.**
code: **0021872.120.700**

QUICK FILL FUEL TANKS

QUICK FILL SYSTEM	CAPACITY	CODE
QUICK FILL SYSTEM	16 lit.	0001555.
QUICK FILL STAND	//	0000099.

QUICK FILL SYSTEM
code: **0001555.**

QUICK FILL STAND
code: **0000099.**



AUXILIARY FUEL TANKS

HANDLEBAR TANK

CAPACITY	COLORS	CODE
2,1 lit.	WHITE	0016462.030.700

height 150 mm. - width 390 mm. - depth 140 mm.



OPTIONAL SIPHON KIT

code: **0001105.**



FRONT FUEL TANK

CAPACITY	COLORS	CODE
3 lit.	WHITE	0002684.030
5 lit.	WHITE	0002685.030

3 lit.: height 270 mm. - width 240 mm. - depth 80 mm.
5 lit.: height 270 mm. - width 240 mm. - depth 130 mm.



FRONT FUEL TANK
 capacity: **5 lit.**
 code: **0002685.030**

OPTIONAL SIPHON KIT

code: **0001105.**



REAR FUEL TANK

CAPACITY	COLORS	CODE
6 lit.	WHITE	0001609.030

height 170 mm. - width 300 mm. - depth 240 mm.



REAR FUEL TANK
 capacity: **6 lit.**
 code: **0001609.030**

18L CONTAINER

CAPACITY	COLORS	CODE
18 lit.	WHITE	0001044.030



18L CONTAINER
 capacity: **18 lit.**
 code: **0001044.030**

10L CONTAINER

CAPACITY	COLORS	CODE
10 lit.	YELLOW	0022714.060

DETAILS:

- 10L capacity
- Quick re-fueling with stop when tank is full
- Safety closing of the nozzle
- Two large handles for easy vertical filling and transport

DETTAGLI:

- Capacità 10L
- Rifornimento rapido con stop a serbatoio pieno
- Chiusura di sicurezza del bocchettone
- Due ampie maniglie per facilitare riempimento verticale e il trasporto

REPLACEMENT TANK CAP
 code: **0023501.323**



CONTAINER
 capacity: **10 lit.**
 code: **0022714.060**

TANK CAPS

ONLY FOR ACERBIS TANKS

• **BIG CAP** ø80mm

• **SMALL CAP** ø64mm

BIG CAP ACERBIS "C"

code: **0016833.090**

models: • ACERBIS • CLARKE • ATK • YAMAHA XT



SMALL CAP

code: **0001111.090**

models: • ACERBIS
• KTM 2 STROKE 93/04



ACERBIS CAP

code: **0001201.090**

models: • ACERBIS
• AUXILIARY TANK



BIG LOCKING CAP

code: **0001121.**



SMALL LOCKING CAP

code: **0001119.**



ADAPTER FOR MDR AND DRY BRAKE SYSTEM

code: **0013423.090**



GASKET FOR 0016833 AND BIG CAP ACERBIS "C"

code: **0001102.**



GASKET FOR 1111 AND 1201

code: **0001202.090**



UNIVERSAL TANK PETCOCKS

code: **0001203.**



TANK PETCOCKS DX

code: **0003083.**



TANK PETCOCKS SX

code: **0003084.**



TANK PETCOCKS

code: **0022294.**



O-RING

code: **0001112.**
10 pcs. set

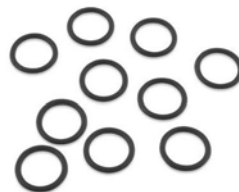

BREATHER VENT HOSE

code: **0000027.**
10 mt.



AFT FUEL TANK FILTER

ONLY FOR ACERBIS FUEL TANKS

FUEL TANK FILTER

code: **0024279.030**

APPLICATION

Fuel tank filter just for ACERBIS tanks with BIG CAP and BIG LOCKING CAP

DETAILS

- It traps dirt and debris that could come from dirty canisters during refueling
- It avoids dirt to enter and compromise the fuel system (especially injectors and fuel pumps)
- It can catch particles from a minimum size of 40 micron
- You must remove the filter regularly to clean it



OEM FUEL TANK FILTER

ONLY FOR OEM FUEL TANKS

FUEL TANK FILTER KTM/HSQ OEM SX-F/FC

code: **0024511.030**

FUEL TANK FILTER KTM/HSQ OEM FE/TE/EXC/EXC-F/SX-F/XC-F/XC-W

code: **0024512.030**

DETAILS

- It collects dirt and debris coming from poorly cleaned cans during refuelling
- Prevents dirt from entering the fuel system (cause of fuel pumps and injectors breakage)
- They capture particles as small as 40 microns
- Remove the filter periodically, turning it upside down and cleaning it.
- Designed for OEM tank



APPLICATION 0024511.030

- HUSQVARNA FC 250 2014 2015 2016 2017 2018 2019 2020
- HUSQVARNA FC 350 2014 2015 2016 2017 2018 2019 2020
- HUSQVARNA FC 450 2014 2015 2016 2017 2018 2019 2020
- KTM SX-F 250 2013 2014 2015 2016 2017 2018 2019 2020
- KTM SX-F 350 2013 2014 2015 2016 2017 2018 2019 2020
- KTM SX-F 450 2016 2017 2018 2019 2020

APPLICATION 0024512.030

- HUSQVARNA FE 250 2014 2015 2016 2017 2018 2019 2020
- HUSQVARNA FE 350 2014 2015 2016 2017 2018 2019 2020
- HUSQVARNA FE 450 2014 2015 2016 2017 2018 2019 2020
- HUSQVARNA FE 501 2014 2015 2016 2017 2018 2019 2020
- HUSQVARNA TE 250I 2018 2019 2020
- HUSQVARNA TE 300I 2018 2019 2020
- KTM EXC 250 TPI 2018 2019 2020
- KTM EXC 300 TPI 2018 2019 2020
- KTM EXC-F 250 2011 2012 2013 2014 2015 2016 2017 2018 2019 2020
- KTM EXC-F 350 2011 2012 2013 2014 2015 2016 2017 2018 2019 2020
- KTM EXC-F 450 2011 2012 2013 2014 2015 2016 2017 2018 2019 2020
- KTM EXC-F 500 2011 2012 2013 2014 2015 2016 2017 2018 2019 2020
- KTM SX-F 250 2011 2012
- KTM SX-F 350 2011 2012
- KTM SX-F 450 2011 2012
- KTM XC-F 250 2011 2012 2013 2014 2015 2016 2017 2018 2019 2020
- KTM XC-F 350 2011 2012 2013 2014 2015 2016 2017 2018 2019 2020
- KTM XC-F 450 2011 2012 2013 2014 2015 2016 2017 2018 2019 2020
- KTM XC-W 150 TPI 2018 2019 2020
- KTM XC-W 250 TPI 2018 2019 2020
- KTM XC-W 300 TPI 2018 2019 2020





ACER 33iD



ACERBIS
PLASTICS
PLASTICHE
ACERBIS





X-FUTURE FRONT DISC COVER

MATERIALS:

95% Polypropylene

5% Other

DETAILS:

Extended cover for maximum protection of the disc and the brake caliper to protect them from mud, stones and debris

Designed for the best resistance to impacts

Air intakes designed to ensure airflow to the braking system

Easy and intuitive assembly

Maximum diameter of the disc: 275 mm

Diameter of plastic: 280 mm

Light and resistant

Mounting kits sold separately



orange
code: **0024328.011**



KTM orange 2016
code: **0024328.011.016**



white
code: **0024328.030**



blue
code: **0024328.040**



yellow
code: **0024328.060**



fluo yellow
code: **0024328.061**



black
code: **0024328.090**



red
code: **0024328.110**



green
code: **0024328.130**



CARBON X-BRAKE VENTED FRONT DISC COVER

- material: **CARBON**
- Maximum diameter of the disc: 275 mm
- Diameter of plastic: 280 mm
- mounting kit sold separately



carbon
code: **0022705.070**

X-BRAKE FRONT DISC COVER

- material: **PLASTIC**
- Maximum diameter of the disc: 275 mm
- Diameter of plastic: 280 mm
- mounting kit sold separately



red
code: **0016057.110**



orange
code: **0016057.010**



KTM orange 2016
code: **0016057.011.016**



white
code: **0016057.030**



blue
code: **0016057.040**



fluo yellow
code: **0016057.061**



black
code: **0016057.090**

X-BRAKE 2.0 FRONT DISC COVER

- material: **PLASTIC**
- ø max disc 280 mm.
- mounting kit sold separately



X-BRAKE 2.0 FRONT DISC COVER



blue/white
code: **0021846.040**



yellow/white
code: **0021846.060**



fluo yellow/white
code: **0021846.061**



KTM orange 2016
code: **0021846.011.016**



white/black
code: **0021846.030**



white/orange
code: **0021846.031**



black/white
code: **0021846.090**



red/white
code: **0021846.110**



green/white
code: **0021846.130**



black/orange
code: **0021846.313**



black/green
code: **0021846.325**



red/blue
code: **0021846.344**

APPLICATION ACERBIS FRONT DISC COVERS

MOUNTING KIT

MODEL	YEAR	CODE
YAMAHA		
YZ 125/250	04/20	0020080.
YZF 250/450	04/13	0020080.
	14/20	0017566.
WRF 250	04/20	0020080.
WRF 450	04/20	0020080.
	2019	0017566.
WR 125	04/19	0020080.
WR 250	04/20	0020080.
WR 250X	16/18	0020080.
HONDA		
CR 125/250	04/07	0020081.
CRF 250R	04/20	0020081.
CRF 450R	05/20	0020081.
CRF 250X	04/18	0020081.
CRF 450X	05/18	0020081.
CRF 250/300 RX	19/20	0020081.
CRF 450 RX	17/20	0020081.
SUZUKI		
RM 125/250	04/13	0020077.
RMZ 250	04/06	0007645.
	07/20	0009802.
RMZ 450	05/20	0009802.
KAWASAKI		
KXF 250	04/05	0007645.
	06/19	0009803.
KX 250 4T	2020	0009803.
KXF 450	06/19	0009803.
	2019	0023663.
KX 450 4T	2020	0023663.
KLX 450	08/15	0009803.
KTM		
EXC 125	2016	0017827.
	04/15	0020079.
EXC 150 TPI	19/20	0017827.
EXC 200/380	16/18	0017827.
	04/15	0020079.
EXC 250/300	16/17	0017827.

MODEL	YEAR	CODE
	04/15	0020079.
EXC 250/300 TPI	18/20	0017827.
EXC-F 250/350/450/500	16/20	0017827.
	04/15	0020079.
EXC-F 400/520/525/540	16/18	0017827.
	04/15	0020079.
SX 125	16/20	0017827.
	04/14	0020079.
SX 150/250	15/20	0017827.
	04/14	0020079.
SX 200	15/18	0017827.
	04/14	0020079.
SX-F 250/350/450	15/20	0017827.
	04/14	0020079.
SX-F 505	15/18	0017827.
	04/14	0020079.
XC 250/300 TPI	19/20	0017827.
XC-F 250/350/450	19/20	0017827.
XC-W 125	17/20	0017827.
XC-W 150/250/300 TPI	19/20	0017827.
XCF-W 350/500	2020	0017827.
HUSQVARNA		
FC 250/350/450	2014	0020079.
	15/20	0017827.
FE 250/350/450/501	14/15	0020079.
	16/20	0017827.
TC 125/250	2014	0020079.
	15/20	0017827.
TC 300	15/18	0017827.
TE 125	14/15	0020079.
	2016	0017827.
TE 150 I	2020	0017827.
TE 250/300	14/15	0020079.
	16/17	0017827.
TE 250/300 I	18/20	0017827.
TX 125	17/19	0017827.
WR 360	2004	0020079.
BETA		
RR 2T 125/200	19/21	0021729.

MODEL	YEAR	CODE
RR 2T 125 RC	2021	0021729.
RR 2T 250/300	2021	0021729.
RR 2T 250/300 RC	13/21	0021729.
RR 4T 350	13/21	0021729.
RR 4T 350/390 RC	2021	0021729.
RR 4T 390	2020	0021729.
RR 4T 400/450/498	13/19	0021729.
RR 4T 430/480	15/20	0021729.
RR 4T 430/480 RC	2021	0021729.
SHERCO		
SE-R/SEF-R	12/16	0022291.
SE 125 FACTORY	18/20	0007645.
SE 250 FACTORY	18/20	0007645.
SE 300 FACTORY	18/20	0007645.
SE-R 125	2020	0007645.
SE-R 250/300	12/18	0022291.
	19/20	0007645.
SE-SD 125 SIX DAYS	2018	0007645.
SE-SD 250 SIX DAYS	2018	0007645.
SE-SD 300 SIX DAYS	2018	0007645.
SEF 250 FACTORY	18/20	0007645.
SEF 300 FACTORY	18/20	0007645.
SEF 450 FACTORY	18/20	0007645.
SEF-R 250/300/450/500	12/18	0022291.
	19/20	0007645.
SEF-SD 250 SIX DAYS	2018	0007645.
SEF-SD 300 SIX DAYS	2018	0007645.
SEF-SD 450 SIX DAYS	2018	0007645.
GAS GAS		
EC 250/300 GP	17/18	0023389.
EC R 250 SIX DAYS	17/18	0023389.
EC R 250/300 E4	17/18	0023389.
XC 250/300	17/18	0023389.



X-BRAKE 2.0 245 MM FRONT DISC COVER

- material: **PLASTIC**
- ø max disc 245 mm.
- mounting kit sold separately



orange/white
code: **0022264.203**



white/black
code: **0022264.237**



blue/white
code: **0022264.245**



black/orange
code: **0022264.313**



black/white
code: **0022264.315**



APPLICATIONS X-BRAKE 245 MM FRONT DISC COVER

MOUNTING KIT



MODEL	YEAR	CODE
KTM SX 85	09/21	0021875.
HUSQVARNA TC 85	14/21	0021875.
FREERIDE 2T/4T	13/20	0021875.



RAPTOR FRONT NUMBER PLATE

MATERIALS: 65% Polypropylene; 35% Rubber

DETAILS:

- New design studied for a greater protection of the lower triple clamp
- Made of a shock absorbing rubber material

HONDA RAPTOR FRONT NUMBER PLATE

MODEL	COLOR	YEAR	CODE
CRF 250R	WHITE/RED	14/17	0022142.239
	BLACK/WHITE	14/17	0022142.315
	RED/WHITE	14/17	0022142.343
	RED	18/20	0022391.110
	WHITE/RED	18/20	0022391.239
	BLACK/WHITE	18/20	0022391.315
	RED/BLUE	18/20	0022391.344
	WHITE	18/20	0022391.030
	BLACK	18/20	0022391.090
CRF 450R	WHITE/RED	13/16	0022142.239
	BLACK/WHITE	13/16	0022142.315
	RED/WHITE	13/16	0022142.343

MODEL	COLOR	YEAR	CODE
CRF 450RX	RED	17/20	0022391.110
	WHITE/RED	17/20	0022391.239
	BLACK/WHITE	17/20	0022391.315
	RED/BLUE	17/20	0022391.344
	WHITE	17/20	0022391.030
	BLACK	17/20	0022391.090
CRF 250/300RX	RED	19/20	0022391.315
	BLACK/WHITE	19/20	0022391.344
	WHITE	19/20	0022391.030
	BLACK	19/20	0022391.090



red
code: **0022391.110**



white/red
code: **0022391.239**



black/white
code: **0022391.315**



red/white
code: **0022391.343**



red/blue
code: **0022391.344**

KAWASAKI RAPTOR FRONT NUMBER PLATE

MODEL	COLOR	YEAR	CODE
KXF 250	WHITE/GREEN	17/19	0022312.241
	BLACK/WHITE	17/19	0022312.315
	GREEN/WHITE	17/19	0022312.371
	GREEN	17/19	0022312.130
	WHITE	17/19	0022312.030
	BLACK	17/19	0022312.090
KX 250 4T	WHITE/GREEN	2020	0022312.241
	BLACK/WHITE	2020	0022312.315
	GREEN/WHITE	2020	0022312.371
	GREEN	2020	0022312.130
	WHITE	2020	0022312.030
	BLACK	2020	0022312.090

MODEL	COLOR	YEAR	CODE
KXF 450	WHITE/GREEN	16/19	0022312.241
	BLACK/WHITE	16/19	0022312.315
	GREEN/WHITE	16/19	0022312.371
	GREEN	16/19	0022312.130
	WHITE	16/19	0022312.030
	BLACK	16/19	0022312.090
KX 450 4T	WHITE/GREEN	2020	0022312.241
	BLACK/WHITE	2020	0022312.315
	GREEN/WHITE	2020	0022312.371
	GREEN	2020	0022312.130
	WHITE	2020	0022312.030
	BLACK	2020	0022312.090



green
code: **0022312.130**



black/white
code: **0022312.315**



green/white
code: **0022312.371**



white/green
code: **0022312.241**



KTM RAPTOR FRONT NUMBER PLATE

MODEL	COLOR	YEAR	CODE
SX 125	ORANGE	16/20	0022313.010
	WHITE/BLUE	16/20	0022313.232
	WHITE	16/20	0022313.030
	BLACK	16/20	0022313.090
	BLACK	19/20	0024252.090
	WHITE	19/20	0024252.030
	WHITE 20	19/20	0024252.031
	ORANGE 16	19/20	0024252.011.016
SX 150	ORANGE	19/20	0022313.010
	WHITE/BLUE	19/20	0022313.232
	WHITE	19/20	0022313.030
	BLACK	19/20	0022313.090
SX 250	ORANGE	17/19	0022313.010
	WHITE/BLUE	17/19	0022313.232
	WHITE	17/19	0022313.030
	BLACK	17/19	0022313.090
	WHITE	19/20	0024252.030
	BLACK	19/20	0024252.090
	WHITE 20	19/20	0024252.031

MODEL	COLOR	YEAR	CODE
	ORANGE 16	19/20	0024252.011.016
SXF 250/350/450	ORANGE	16/19	0022313.010
	WHITE/BLUE	16/19	0022313.232
	WHITE	16/19	0022313.030
	BLACK	16/19	0022313.090
	WHITE	19/20	0024252.030
	BLACK	19/20	0024252.090
	WHITE 20	19/20	0024252.031
	ORANGE 16	19/20	0024252.011.016
XC 250/300 TPI	WHITE	19/20	0024252.030
	BLACK	19/20	0024252.090
	WHITE 20	19/20	0024252.031
	ORANGE 16	19/20	0024252.011.016
XC-F 250/350/450	WHITE	19/20	0024252.030
	BLACK	19/20	0024252.090
	WHITE 20	19/20	0024252.031
	ORANGE 16	19/20	0024252.011.016



orange
code: **0022313.010**



white
code: **0024252.030**



white 2
code: **0024252.031**



black
code: **0024252.090**

SUZUKI RAPTOR FRONT NUMBER PLATE

MODEL	COLOR	YEAR	CODE
RMZ 250	WHITE	10/18	0022514.030
	YELLOW	10/18	0022514.060
	YELLOW/WHITE	10/18	0022514.273
	YELLOW/BLACK	10/18	0022514.279
	WHITE/YELLOW	2019	0023101.234
	WHITE	19/20	0023101.030

MODEL	COLOR	YEAR	CODE
RMZ 450	WHITE	08/17	0022514.030
	YELLOW	08/17	0022514.060
	YELLOW/WHITE	08/17	0022514.273
	YELLOW/BLACK	08/17	0022514.279
	WHITE/YELLOW	18/19	0023101.234
	WHITE	18/20	0023101.030



white
code: **0022514.030**



yellow
code: **0022514.060**



yellow/white
code: **0022514.273**



yellow/black
code: **0022514.279**



yellow/yellow
code: **0023101.276**



white/yellow
code: **0023101.234**

YAMAHA RAPTOR FRONT NUMBER PLATE

MODEL	COLOR	YEAR	CODE
YZ 125/250	BLACK/WHITE	05/20	0022298.315
	WHITE	05/20	0022298.030
	BLUE	05/20	0022298.040
	BLACK	05/20	0022298.090
YZF 250	BLACK/WHITE	10/18	0022298.315
	WHITE	10/18	0022298.030
	BLUE	10/18	0022298.040
	BLACK	10/18	0022298.090
	WHITE/BLUE	19/20	0023094.232
	BLUE/WHITE	19/20	0023094.245
	BLACK/WHITE	19/20	0023094.315
WHITE	19/20	0023094.030	

MODEL	COLOR	YEAR	CODE
	BLUE	19/20	0023094.040
	BLACK	19/20	0023094.090
YZF 450	BLACK/WHITE	10/17	0022298.315
	WHITE	10/17	0022298.030
	BLUE	10/17	0022298.040
	BLACK	10/17	0022298.090
	BLUE	18/20	0023094.040
	WHITE/BLUE	18/20	0023094.232
	BLUE/WHITE	18/20	0023094.245
	BLACK/WHITE	18/20	0023094.315
	WHITE	18/20	0023094.030
	BLACK	18/20	0023094.090



HUSQVARNA RAPTOR FRONT NUMBERPLATE

MODEL	COLOR	YEAR	CODE
TC 125	ORANGE	16/19	0022313.010 •
	WHITE	16/19	0022313.030 •
	BLACK	16/19	0022313.090 •
	ORANGE/WHITE	16/19	0022313.203 •
	WHITE/BLUE	16/19	0022313.232 •
	WHITE	19/20	0024258.030
	WHITE 20	19/20	0024258.031
TC 250	BLACK	19/20	0024258.090
	ORANGE	17/19	0022313.010 •
	WHITE	17/19	0022313.030 •
	BLACK	17/19	0022313.090 •
	ORANGE/WHITE	17/19	0022313.203 •
WHITE/BLUE	17/19	0022313.232 •	

MODEL	COLOR	YEAR	CODE
TC 250	WHITE	19/20	0024258.030
	WHITE 20	19/20	0024258.031
	BLACK	19/20	0024258.090
FC 250/350/450	ORANGE	16/19	0022313.010 •
	WHITE	16/19	0022313.030 •
	BLACK	16/19	0022313.090 •
	ORANGE/WHITE	16/19	0022313.203 •
	WHITE/BLUE	16/19	0022313.232 •
	WHITE	19/20	0024258.030
	WHITE 20	19/20	0024258.031
BLACK	19/20	0024258.090	

• KTM Style



SUPERMOTO FRONT FENDER



orange
code: **0008033.010.098**



white
code: **0008033.030**



blue 98
code: **0008033.040.098**



yellow 01
code: **0008033.060.001**



black
code: **0008033.090**



red
code: **0008033.110.990**



green 03
code: **0008033.130.003**

SUPERMOTO EVO FRONT FENDER



black
code: **0009708.090**



white
code: **0008200.030**



black
code: **0008200.090**

BAJA REAR FENDER



white
code: **0008013.030**

LINK GUARD UNIVERSAL SKID PLATE



orange
code: **0023828.010**



white
code: **0023828.030**



blue
code: **0023828.040**



yellow
code: **0023828.060**



black
code: **0023828.090**



red
code: **0023828.110**



green
code: **0023828.130**

EXAMPLE IMAGE SHOWING A LINK GUARD MOUNTED ON A BETA SKID PLATE



NOST REAR FENDER



white
code: **0008055.030**



black
code: **0008055.090**



MODEL	COLOR	YEAR	CODE
SX 85	ORANGE	13/17	0022320.011
	WHITE	13/17	0022320.030
	BLACK	13/17	0022320.090
	ORANGE	18/20	0022895.011
	WHITE	18/20	0022895.030
	BLACK	18/20	0022895.090
SX 125/150	BLACK	11/15	0015950.090
	ORANGE	16/20	0022319.011
	WHITE	16/20	0022319.030
	BLACK	16/20	0022319.090
SX 250	BLACK	06/16	0013683.090
	ORANGE	06/16	0013683.010
	ORANGE	17/18	0022332.011
	WHITE	17/18	0022332.030
	BLACK	17/18	0022332.090
	OR./BLK.	19/20	0023660.209
	WH./BLK.	19/20	0023660.237
	BLK./OR.	19/20	0023660.313
	BLK./WH.	19/20	0023660.315
SXF 250	BLACK	13/15	0015936.090
	ORANGE	13/15	0015936.010
	BLACK	16/18	0021727.090
	ORANGE	16/18	0021727.011
	WHITE	16/18	0021727.030
	OR./BLK.	19/20	0023661.209
	WH./BLK.	19/20	0023661.237
	BLK./OR.	19/20	0023661.313
	BLK./WH.	19/20	0023661.315
SXF 350	BLACK	11/15	0015936.090
	ORANGE	11/15	0015936.010
	BLACK	16/18	0021727.090
	ORANGE	16/18	0021727.011
	WHITE	16/18	0021727.030
	OR./BLK.	19/20	0023661.209
	WH./BLK.	19/20	0023661.237
	BLK./OR.	19/20	0023661.313
	BLK./WH.	19/20	0023661.315
SXF 450	BLACK	13/15	0016312.090
	ORANGE	13/15	0016312.010
	BLACK	16/18	0021755.090
	BLK./WHT.	16/18	0021755.091
	ORANGE	16/18	0021755.011
	OR./WH.	19/20	0023601.203
	WH./BLUE	19/20	0023601.232
	BLK./OR.	19/20	0023601.313
	BLK./WH.	19/20	0023601.315
XC 250/300 TPI	OR./BLK.	19/20	0023660.209
	WH./BLK.	19/20	0023660.237
	BLK./OR.	19/20	0023660.313
	BLK./WH.	19/20	0023660.315
EXC 125/200	BLACK	12/16	0015950.090
EXC 150 TPI	ORANGE	19/20	0022319.011
	WHITE	19/20	0022319.030
	BLACK	19/20	0022319.090
EXC 250	BLACK	06/16	0013683.090
	ORANGE	06/16	0013683.010
	ORANGE	2017	0022318.011
	WHITE	2017	0022318.030
	BLACK	2017	0022318.090
EXC 250 TPI	ORANGE	18/19	0022318.011
	WHITE	18/19	0022318.030

MODEL	COLOR	YEAR	CODE
	BLACK	18/19	0022318.090
	BLACK	2020	0023764.090
	ORANGE	2020	0023764.010
EXC 300	BLACK	06/16	0013683.090
	ORANGE	06/16	0013683.010
	ORANGE	2017	0022318.011
	WHITE	2017	0022318.030
	BLACK	2017	0022318.090
EXC 300 TPI	ORANGE	18/19	0022318.011
	WHITE	18/19	0022318.030
	BLACK	18/19	0022318.090
	BLACK	2020	0023764.090
	ORANGE	2020	0023764.010
EXC-F 250	BLACK	12/13	0016311.090
	ORANGE	14/16	0016310.010
	BLACK	14/16	0016310.090
	ORANGE	17/19	0022823.011
	WHITE	17/19	0022823.030
	BLACK	17/19	0022823.090
	ORANGE	2020	0024021.010
	BLACK	2020	0024021.090
EXC-F 350	BLACK	12/16	0016310.090
	ORANGE	12/16	0016310.010
	ORANGE	17/19	0022823.011
	WHITE	17/19	0022823.030
	BLACK	17/19	0022823.090
	ORANGE	2020	0024021.010
	BLACK	2020	0024021.090
EXC-F 450/500	BLACK	08/11	0011687.090
	BLACK	12/16	0016312.090
	ORANGE	12/16	0016312.010
	ORANGE	17/19	0022309.011
	BLACK	17/19	0022309.090
	BLK./OR.	2020	0024253.313
	OR./WH.	2020	0024253.203
XC-F 250/350	OR./BLK.	2019	0023661.209
	WH./BLK.	2019	0023661.237
	BLK./OR.	2019	0023661.313
	BLK./WH.	2019	0023661.315
	BLK./WH.	2020	0024255.313
	OR./BLK.	2020	0024255.209
XC-F 450	OR./WH.	19/20	0023601.203
	WH./BLUE	19/20	0023601.232
	BLK./OR.	19/20	0023601.313
	BLK./WH.	19/20	0023601.315
XC-W 125	ORANGE	17/20	0022319.011
	WHITE	17/20	0022319.030
	BLACK	17/20	0022319.090
XC-W 150 TPI	ORANGE	19/20	0022319.011
	WHITE	19/20	0022319.030
	BLACK	19/20	0022319.090
XC-W 250/300 TPI	ORANGE	2019	0022318.011
	WHITE	2019	0022318.030
	BLACK	2019	0022318.090
	BLACK	2020	0023764.090
	ORANGE	2020	0023764.010
XCF-W 500	BLK./OR.	2020	0024253.313
	OR./WH.	2020	0024253.203



KTM SKID PLATES



MX STYLE/ENDURO STYLE
code: **0023660.209**



MX STYLE/ENDURO STYLE
code: **0023660.237**



MX STYLE/ENDURO STYLE
code: **0023660.313**



MX STYLE/ENDURO STYLE
code: **0023661.209**



MX STYLE/ENDURO STYLE
code: **0023661.237**



MX STYLE/ENDURO STYLE
code: **0023661.313**



MX STYLE/ENDURO STYLE
code: **0023661.315**



MX STYLE/ENDURO STYLE
code: **0024255.209**



MX STYLE/ENDURO STYLE
code: **0024255.313**



MX STYLE
code: **0022332.030**



MX STYLE
code: **0022332.090**



MX STYLE
code: **0022332.011**



ENDURO STYLE
code: **0022309.010**



ENDURO STYLE
code: **0022309.090**



ENDURO STYLE
code: **0022823.090**



MX STYLE
code: **0022320.011**



MX STYLE
code: **0022320.030**



MX STYLE
code: **0022320.090**

KAWASAKI SKID PLATES



MODEL	TYPE	COLOR	YEAR	CODE
KXF 250	MX STYLE	BLACK	09/19	0013821.090
	ENDURO STYLE	BLACK	09/16	0013519.090
	ENDURO STYLE	GREY	09/16	0013519.020
	ENDURO STYLE	BLACK	17/19	0022502.090
	ENDURO STYLE	GREY	17/19	0022502.020
KX 250 4T	MX STYLE	BLACK	2020	0013821.090
	ENDURO STYLE	BLACK	2020	0022502.090
	ENDURO STYLE	GREY	2020	0022502.020
KXF 450	ENDURO STYLE	BLACK	09/15	0013539.090
	ENDURO STYLE	GREY	09/15	0013539.020
	ENDURO STYLE	GREY	16/18	0021932.020
	ENDURO STYLE	BLACK	16/18	0021932.090
	ENDURO STYLE	BLK./WH.	2019	0023701.315
KX 450 4T	ENDURO STYLE	BLK./WH.	2020	0023701.315
	ENDURO STYLE	BLK./GREEN	2020	0023701.325
KLX 450	ENDURO STYLE	BLACK	08/18	0011678.090



MX STYLE
code: **0013821.090**



MX STYLE
code: **0013820.090**

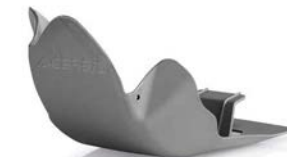

ENDURO STYLE
code: **0013519.020**



ENDURO STYLE
code: **0013519.090**



ENDURO STYLE
code: **0022502.020**



ENDURO STYLE
code: **0022502.090**



ENDURO STYLE
code: **0011678.090**



ENDURO STYLE
code: **0021932.090**



ENDURO STYLE
code: **0021932.020**



ENDURO STYLE
code: **0013539.020**



ENDURO STYLE
code: **0013539.090**



ENDURO STYLE
code: **0023701.315**



ENDURO STYLE
code: **0023701.325**

YAMAHA SKID PLATES

MODEL	TYPE	COLOR	YEAR	CODE
YZ 125	MX STYLE	WHITE/BLACK	06/20	0023922.237
	MX STYLE	BLUE/WHITE	06/20	0023922.245
	MX STYLE	BLACK/WHITE	06/20	0023922.315
YZ 250	MX STYLE	BLUE	05/20	0022400.040
	MX STYLE	BLACK	05/20	0022400.090
YZF 250	MX STYLE	BLACK	14/18	0017574.090
	MX STYLE	BLUE	19/20	0023108.040
	MX STYLE	BLACK	19/20	0023108.090
	MX STYLE	WHITE	19/20	0023108.030
YZF 450	MX STYLE	BLACK	14/17	0017574.090
	MX STYLE	WHITE	18/20	0023108.030
	MX STYLE	BLUE	18/20	0023108.040

MODEL	TYPE	COLOR	YEAR	CODE
	MX STYLE	BLACK	18/20	0023108.090
WRF 250	ENDURO STYLE	BLACK	07/19	0011678.090
	ENDURO STYLE	BLUE	2020	0023108.040
	ENDURO STYLE	BLACK	2020	0023108.090
	ENDURO STYLE	WHITE	2020	0023108.030
WRF 450	ENDURO STYLE	BLACK	07/18	0011678.090
	ENDURO STYLE	WHITE	19/20	0023108.030
	ENDURO STYLE	BLUE	19/20	0023108.040
	ENDURO STYLE	BLACK	19/20	0023108.090
	ENDURO STYLE	BLUE	19/20	0023108.040
	ENDURO STYLE	BLACK	19/20	0023108.090
	ENDURO STYLE	WHITE	19/20	0023108.030



MX STYLE
code: **0023108.030**

MX STYLE
code: **0023108.040**

MX STYLE
code: **0023108.090**

MX STYLE
code: **0022400.040**

MX STYLE
code: **0022400.090**

ENDURO STYLE
code: **0011678.090**

MX STYLE
code: **0023922.237**

MX STYLE
code: **0023922.245**

MX STYLE
code: **0023922.315**

HONDA SKID PLATES

MODEL	TYPE	COLOR	YEAR	CODE
CRF 250R	ENDURO STYLE	BLACK	04/09	0011685.090
	ENDURO STYLE	GREY	04/09	0011685.020
	ENDURO STYLE	BLACK	10/17	0013540.090
	MX STYLE	BLACK	10/17	0013922.090
	ENDURO STYLE	BLACK	18/20	0023290.090
	MX STYLE	RED	18/20	0023291.110
CRF 450R	ENDURO STYLE	BLACK	05/08	0011684.090
	ENDURO STYLE	GREY	05/08	0011684.020
	ENDURO STYLE	BLACK	09/16	0013540.090
	MX STYLE	BLACK	09/16	0013922.090
	MX STYLE	BLACK	17/20	0022656.090
	MX STYLE	RED	17/20	0022656.110
	ENDURO STYLE	BLACK	17/20	0022388.090
	ENDURO STYLE	RED	17/20	0022388.110

MODEL	TYPE	COLOR	YEAR	CODE
CRF 250/300RX	ENDURO STYLE	BLACK	19/20	0023290.090
	MX STYLE	RED	19/20	0023291.110
CRF 450RX	MX STYLE	BLACK	17/20	0022656.090
	MX STYLE	RED	17/20	0022656.110
	ENDURO STYLE	BLACK	17/20	0022388.090
	ENDURO STYLE	RED	17/20	0022388.110
CRF 250X	ENDURO STYLE	BLACK	04/17	0011685.090
	ENDURO STYLE	GREY	04/17	0011685.020
CRF 450X	ENDURO STYLE	BLACK	05/16	0011684.090
	ENDURO STYLE	GREY	05/16	0011684.020
CRF 250L	ENDURO STYLE	BLACK	13/18	0022822.090



MX STYLE
code: **0022656.090**

MX STYLE
code: **0022656.110**

ENDURO STYLE
code: **0022388.090**

ENDURO STYLE
code: **0022388.110**

ENDURO STYLE
code: **0022822.090**

ENDURO STYLE
code: **0013540.020**

ENDURO STYLE
code: **0013540.090**



SUZUKI SKID PLATES



MODEL	COLOR	YEAR	CODE
RMZ 250	BLACK	10/18	0015909.090
	BLK./WH.	19/20	0023735.315
	BLK./YE.	19/20	0023735.318

MODEL	COLOR	YEAR	CODE
RMZ 450	BLACK	08/17	0015908.090
	BLACK	18/20	0023069.090
DR 650	BLACK	96/18	0021527.090



code: **0015909.090**



code: **0015908.090**



code: **0021527.090**



code: **0023069.090**



code: **0023735.318**



code: **0023735.315**

HUSQVARNA SKID PLATES



MODEL	COLOR	YEAR	CODE
TC 85	WHITE	14/17	0022320.030
	BLACK	14/17	0022320.090
	BLACK	18/20	0022895.090
TC 125/TX 125	BLACK	14/15	0015950.090
	WHITE	16/20	0022319.030
	BLACK	16/20	0022319.090
TC 250	BLACK	14/16	0013683.090
	WHITE	17/18	0022332.030
	BLACK	17/18	0022332.090
	OR./BLK.	19/20	0023660.209
	WH./BLK.	19/20	0023660.237
	BLK./OR.	19/20	0023660.313
FC 250/350	BLACK	14/15	0015936.090
	WHITE	16/18	0021727.030
	BLACK	16/18	0021727.090
	OR./BLK.	19/20	0023661.209
	WH./BLK.	19/20	0023661.237
	BLK./OR.	19/20	0023661.313
FC 450	BLACK	14/15	0016312.090
	BLK./WHT.	16/18	0021755.091
	WHT./BL.	16/18	0021755.232
	OR./WH.	19/20	0023601.203

MODEL	COLOR	YEAR	CODE
	WH./BLUE	19/20	0023601.232
	BLK./OR.	19/20	0023601.313
	BLK./WH.	19/20	0023601.315
TE 125/TX	BLACK	14/16	0015950.090
	WHITE	17/19	0022319.030
	BLACK	17/19	0022319.090
TE 150 I	WHITE	2020	0022319.030
	BLACK	2020	0022319.090
TE 250/300	BLACK	14/16	0013683.090
	WHITE	2017	0022318.030
	BLACK	2017	0022318.090
TE 250/300 I	WHITE	18/19	0022318.030
	BLACK	18/19	0022318.090
	WH./BLK.	2020	0024022.237
FE 250/350	BLK./WH.	2020	0024022.315
	BLACK	14/16	0016310.090
	ORANGE	17/19	0022823.011
	WHITE	17/19	0022823.030
	BLACK	17/19	0022823.090
FE 450/501	WH./BLK.	2020	0024023.237
	BLK./WH.	2020	0024023.315
	BLACK	14/16	0016312.090
	BLK./WHT.	17/19	0021755.091
	WHT./BL.	17/19	0021755.232
	WH./BLUE	2020	0024254.232
	BLK./WHT.	2020	0024254.315



code: **0022320.030**



code: **0022320.090**



code: **0024022.237**



code: **0024022.315**



code: **0024023.237**



code: **0024023.315**



code: **0022823.090**



code: **0022332.030**



code: **0022332.090**



code: **0022319.030**



code: **0022319.090**

BETA SKID PLATES



MODEL	COLOR	YEAR	CODE
RR 2T 250/300	BLACK	2020	0024291.090
	RED	2020	0024291.110
RR 2T 250/300 RC	BLACK	13/17	0022816.090
	RED	13/17	0022816.110
	BLACK	18/19	0022892.090
	RED	18/19	0022892.110
	BLACK	18/19	0023920.090

MODEL	COLOR	YEAR	CODE
	RED	18/19	0023920.110
	BLACK	2020	0024291.090
	RED	2020	0024291.110
RR 2T 300 X-TRAINER	BLACK	13/17	0022816.090
	RED	13/17	0022816.110



code: **0022816.090**



code: **0022816.110**



code: **0022892.090**



code: **0022892.110**



code: **0024291.090**



code: **0024291.110**

X-GRIP FRAME PROTECTOR HONDA

MODEL	YEAR	COLOR	CODE
CRF 250R	14/17	GREY	0017573.020
	14/17	WHITE	0017573.030
	14/17	RED	0017573.110
	14/17	SILVER/RED	0017573.225
	18/19	GREY	0022386.020
	18/19	WHITE	0022386.030
	18/19	RED	0022386.110
	2020	GREY/BLACK	0023664.293
2020	RED/BLACK	0023664.349	
CRF 250 L-M	13/20	BLACK/RED	0023405.323
	13/20	GREY/RED	0023405.295
CRF 250/300RX	2019	WHITE	0022386.030
	2019	RED	0022386.110
	2019	GREY	0022386.020

MODEL	YEAR	COLOR	CODE
	2020	GREY/BLACK	0023664.293
	2020	RED/BLACK	0023664.349
CRF 450R	13/16	GREY	0017573.020
	13/16	WHITE	0017573.030
	13/16	RED	0017573.110
	13/16	SILVER/RED	0017573.225
	17/18	GREY	0022386.020
	17/18	WHITE	0022386.030
	17/18	RED	0022386.110
	19/20	GREY/BLACK	0023664.293
	19/20	RED/BLACK	0023664.349
	CRF 450 RX	19/20	GREY/BLACK
19/20	RED/BLACK	0023664.349	



code: **0022386.020**



code: **0022386.030**



code: **0022386.110**



code: **0022386.344**



code: **0023405.295**



code: **0023405.323**

X-GRIP FRAME PROTECTOR KAWASAKI

MODEL	YEAR	COLOR	CODE
KXF 250	15/19	WHITE/BLACK	0022574.237
	15/19	GREY/BLACK	0022574.293
	15/19	GREY/GREEN	0022574.297
	15/19	GREEN/BLACK	0022574.377
KX 250 4T	2020	WHITE/BLK.	0022574.237
	2020	GREY/BLK.	0022574.293
	2020	GREY/GREEN	0022574.297
	2020	GREEN/BLK.	0022574.377
KXF 450	09/18	GREY	0017814.020
	09/18	WHITE	0017814.030

MODEL	YEAR	COLOR	CODE
	09/18	GREEN	0017814.130
	09/18	SILVER/GREEN	0017814.227
	2019	WHITE/BLACK	0023693.237
	2019	GREY/BLACK	0023693.293
	2019	GREY/GREEN	0023693.297
	2019	GREEN/BLACK	0023693.377
KX 450 4T	2020	WHITE/BLACK	0023693.237
	2020	GREY/BLACK	0023693.293
	2020	GREY/GREEN	0023693.297
	2020	GREEN/BLACK	0023693.377



code: **0022574.237**



code: **0022574.293**



code: **0022574.297**



code: **0022574.377**



X-GRIP FRAME PROTECTOR KTM

MODEL	YEAR	COLOR	CODE
SX 65	14/20	ORANGE	0022896.011
	14/20	WHITE	0022896.090
	14/20	BLACK/ORANGE	0022896.313
SX 85	13/17	ORANGE	0021869.010
	13/17	WHITE	0021869.030
	13/17	ORANGE 16	0021869.011.016
	18/20	WHITE	0022893.030
	18/20	ORANGE 16	0022893.011.016
SX 125/150	11/15	ORANGE	0017813.010
	11/15	WHITE	0017813.030
	16/18	ORANGE 16	0021726.011.016
	16/18	WHITE	0021726.030
	16/18	BLACK/ORANGE	0021726.313
	19/20	ORANGE/BLACK	0023599.209
	19/20	BLACK/ORANGE	0023599.313
19/20	BLACK/GREY	0023599.319	
SX 250	17/18	ORANGE 16	0021726.011.016
	17/18	WHITE	0021726.030
	17/18	BLACK/ORANGE	0021726.313
	19/20	ORANGE/BLACK	0023599.209
	19/20	BLACK/ORANGE	0023599.313
	19/20	BLACK/GREY	0023599.319
SX-F 250/350/450	11/15	ORANGE	0017813.010
	11/15	WHITE	0017813.030
	16/18	ORANGE 16	0021726.011.016
	16/18	WHITE	0021726.030
	19/20	ORANGE/BLACK	0023599.209
	19/20	BLACK/ORANGE	0023599.313
19/20	BLACK/GREY	0023599.319	
SX-F 505	16/17	ORANGE 16	0021726.011.016
	16/17	WHITE	0021726.030
	16/17	BLACK/ORANGE	0021726.313
EXC 150 TPI	2019	ORANGE 16	0021726.011.016
	2019	WHITE	0021726.030
	2019	BLACK/ORANGE	0021726.313
	2020	ORANGE/BLACK	0024009.209
	2020	WHITE/BLACK	0024009.237
	2020	BLACK/ORANGE	0024009.313
EXC 250/300	12/16	ORANGE	0017813.010

MODEL	YEAR	COLOR	CODE
	12/16	WHITE	0017813.030
	2017	ORANGE 16	0021726.011.016
	2017	WHITE	0021726.030
	2017	BLACK/ORANGE	0021726.313
EXC 250/300 TPI	18/19	ORANGE 16	0021726.011.016
	18/19	WHITE	0021726.030
	18/19	BLACK/ORANGE	0021726.313
	2020	ORANGE/BLACK	0024009.209
	2020	WHITE/BLACK	0024009.237
	2020	BLACK/ORANGE	0024009.313
EXC-F 250/350/450/500	12/16	ORANGE	0017813.010
	12/16	WHITE	0017813.030
	17/19	ORANGE 16	0021726.011.016
	17/19	WHITE	0021726.030
	17/19	BLACK/ORANGE	0021726.313
	2020	ORANGE/BLACK	0024009.209
	2020	WHITE/BLACK	0024009.237
	2020	BLACK/ORANGE	0024009.313
XC 250/300 TPI	19/20	ORANGE/BLACK	0023599.209
	19/20	BLACK/ORANGE	0023599.313
	19/20	BLACK/GREY	0023599.319
XC-F 350/450	19/20	ORANGE/BLACK	0023599.209
	19/20	BLACK/ORANGE	0023599.313
	19/20	BLACK/GREY	0023599.319
XC-W 125	17/19	ORANGE 16	0021726.011.016
	17/19	WHITE	0021726.030
	17/19	BLACK/ORANGE	0021726.313
	2020	ORANGE/BLACK	0024009.209
	2020	WHITE/BLACK	0024009.237
2020	BLACK/ORANGE	0024009.313	
XC-W 150/250/300 TPI	2019	ORANGE 16	0021726.011.016
	2019	WHITE	0021726.030
	2019	BLACK/ORANGE	0021726.313
	2020	ORANGE/BLACK	0024009.209
	2020	WHITE/BLACK	0024009.237
	2020	BLACK/ORANGE	0024009.313
XCF-W 350/500	2020	ORANGE/BLACK	0024009.209
	2020	WHITE/BLACK	0024009.237
	2020	BLACK/ORANGE	0024009.313



code: **0021726.011.016**



code: **0021726.030**



code: **0021726.313**

X-GRIP FRAME PROTECTOR SUZUKI

MODEL	YEAR	COLOR	CODE
RMZ 450	08/17	YELLOW/BLACK	0022347.279
	08/17	GREY/YELLOW	0022347.290
	18/20	YELLOW/GREY	0023070.277
	18/20	YELLOW/BLACK	0023070.279
	18/20	GREY/YELLOW	0023070.290

MODEL	YEAR	COLOR	CODE
RMZ 250	10/18	YELLOW/GREY	0022879.277
	10/18	YELLOW/BLACK	0022879.279
	10/18	GREY/YELLOW	0022879.290
	19/20	YELLOW/BLACK	0023070.279
	19/20	GREY/YELLOW	0023070.290
	19/20	YELLOW/GREY	0023070.277



code: **0022347.277**



code: **0022347.279**



code: **0022347.290**

X-GRIP FRAME PROTECTOR YAMAHA

MODEL	YEAR	COLOR	CODE
YZ 65	19/20	WHITE/BLACK	0023676.237
	19/20	BLACK/BLUE	0023676.316
YZ 85	19/20	BLACK/BLUE	0023677.316
YZ 125/250	06/20	SILVER	0021669.020
	06/20	BLUE	0021669.040
	06/20	SILVER/BLUE	0021669.218
YZF 250	14/16	SILVER	0017778.020
	14/16	WHITE	0017778.030
	14/16	BLUE	0017778.040
	14/16	SILVER/BLUE	0017778.218
	17/18	SILVER	0022444.020
	17/18	WHITE	0022444.030
	17/18	BLUE	0022444.040
	17/18	SILVER/BLUE	0022444.218
	19/20	SILVER	0023093.020
	19/20	WHITE	0023093.030
	19/20	BLUE	0023093.040
	19/20	SILVER/BLUE	0023093.218
YZF 450	14/15	SILVER	0017778.020
	14/15	WHITE	0017778.030
	14/15	BLUE	0017778.040
	14/15	SILVER/BLUE	0017778.218
	16/17	SILVER	0022444.020
	16/17	WHITE	0022444.030
	16/17	BLUE	0022444.040
	16/17	SILVER/BLUE	0022444.218
	18/20	SILVER	0023093.020
	18/20	WHITE	0023093.030
	18/20	BLUE	0023093.040

MODEL	YEAR	COLOR	CODE
	18/20	SILVER/BLUE	0023093.218
WR 125	06/20	SILVER	0021669.020
	06/20	BLUE	0021669.040
	06/20	SILVER/BLUE	0021669.218
WR 250	06/19	SILVER	0021669.020
	06/19	BLUE	0021669.040
	06/19	SILVER/BLUE	0021669.218
WRF 250	15/16	SILVER	0017778.020
	15/16	WHITE	0017778.030
	15/16	BLUE	0017778.040
	15/16	SILVER/BLUE	0017778.218
	17/19	SILVER	0022444.020
	17/19	WHITE	0022444.030
	17/19	BLUE	0022444.040
	17/19	SILVER/BLUE	0022444.218
	15/18	BLUE	0017778.040
	15/18	SILVER/BLUE	0017778.218
	2020	SILVER	0023093.020
	2020	WHITE	0023093.030
	2020	BLUE	0023093.040
	2020	SILVER/BLUE	0023093.218
WRF 450	16/18	SILVER	0022444.020
	16/18	WHITE	0022444.030
	16/18	BLUE	0022444.040
	16/18	SILVER/BLUE	0022444.218
	19/20	SILVER	0023093.020
	19/20	WHITE	0023093.030
	19/20	BLUE	0023093.040
	19/20	SILVER/BLUE	0023093.218



code: **0021669.020**



code: **0021669.040**



code: **0021669.218**



code: **0022444.020**



code: **0022444.030**



code: **0022444.040**



code: **0022444.218**



X-GRIP FRAME PROTECTOR HUSQVARNA

MODEL	YEAR	COLOR	CODE
TC 65	16/20	BLACK	0022896.090
TC 85	14/17	WHITE	0021869.030
	18/20	WHITE	0022893.030
TC 125	16/18	WHITE	0021726.030
	16/18	WHITE/BLUE	0021726.232
	16/18	WHITE/YELLOW	0021726.234
	19/20	BLUE/GREY	0023600.249
	19/20	BLUE/WHITE	0023600.315
	19/20	BLACK/GREY	0023600.319
	19/20	BLACK/WHITE	0023600.726
TC 250	17/18	WHITE	0021726.030
	17/18	WHITE/BLUE	0021726.232
	17/18	WHITE/YELLOW	0021726.234
	19/20	BLUE/GREY	0023600.249
	19/20	BLUE/WHITE	0023600.315
	19/20	BLACK/GREY	0023600.319
	19/20	BLACK/WHITE	0023600.726
TX 125	17/19	WHITE	0021726.030
	17/19	WHITE/BLUE	0021726.232
	17/19	WHITE/YELLOW	0021726.234
FC 250/350/450	16/18	WHITE	0021726.030
	16/18	WHITE/BLUE	0021726.232
	16/18	WHITE/YELLOW	0021726.234
	19/20	BLUE/GREY	0023600.249
	19/20	BLUE/WHITE	0023600.315
	19/20	BLACK/GREY	0023600.319
	19/20	BLACK/WHITE	0023600.726
FE 250/350/450/501	17/19	WHITE	0021726.030

MODEL	YEAR	COLOR	CODE	
	17/19	WHITE/BLUE	0021726.232	
	17/19	WHITE/YELLOW	0021726.234	
	2020	BLUE/GREY	0023600.249	
	2020	BLUE/WHITE	0023600.315	
	2020	BLACK/GREY	0023600.319	
	2020	BLACK/WHITE	0023600.726	
	2020	WHITE/BLACK	0023600.878	
	TE 250/300	2017	WHITE	0021726.030
	2017	WHITE/BLUE	0021726.232	
	2017	WHITE/YELLOW	0021726.234	
	2020	BLUE/GREY	0023600.249	
	2020	BLUE/WHITE	0023600.315	
	19/20	BLACK/GREY	0023600.319	
	2020	BLACK/WHITE	0023600.726	
	2020	WHITE/BLACK	0023600.878	
TE 350/450/501	2020	BLUE/GREY	0023600.249	
	2020	BLUE/WHITE	0023600.315	
	19/20	BLACK/GREY	0023600.319	
	2020	BLACK/WHITE	0023600.726	
	2020	WHITE/BLACK	0023600.878	
	TE 150 I	2020	BLUE/GREY	0023600.249
2020	BLUE/WHITE	0023600.315		
2020	BLACK/GREY	0023600.319		
2020	BLACK/WHITE	0023600.726		
2020	WHITE/BLACK	0023600.878		
TE 250 I/300 I	18/19	WHITE	0021726.030	
	18/19	WHITE/BLUE	0021726.232	
	18/19	WHITE/YELLOW	0021726.234	
	2020	BLUE/GREY	0023600.249	
	2020	BLUE/WHITE	0023600.315	
	2020	BLACK/GREY	0023600.319	
	2020	BLACK/WHITE	0023600.726	
	2020	WHITE/BLACK	0023600.878	



X-GRIP FRAME PROTECTOR BETA



code: **0022894.349**



code: **0024290.349**

MODEL	YEAR	COLOR	CODE
RR 2T 125	18/19	BLACK	0023679.090
	18/19	RED	0023679.110
	20/21	RED/BLACK	0024290.349
RR 2T 125 RC	20/21	RED/BLACK	0024290.349
RR 2T 200	2019	BLACK	0023679.090
	2019	RED	0023679.110
	20/21	RED/BLACK	0024290.349
RR 2T 250/300	20/21	RED/BLACK	0024290.349
RR 2T 250/300 RC	13/19	RED/BLACK	0022894.349
	2020	RED/BLACK	0024290.349
RR 4T 350/400/450/498	13/19	RED/BLACK	0022894.349
	20/21	RED/BLACK	0024290.349
RR 4T 430/480	15/19	RED/BLACK	0022894.349
RR 4T 350/390/430/480 RC	20/21	RED/BLACK	0024290.349

X-GRIP MAXI ENDURO

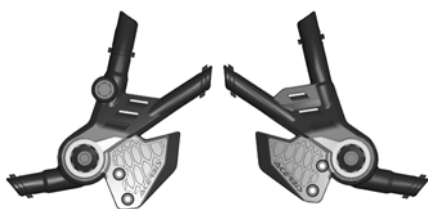

code: **0024555.314**



MODEL	YEAR	COLOR	CODE
BMW			
R 1250 GS	18/20	BLACK/SILVER	0024555.314
	18/20	BLACK/WHITE	0024555.315
R 1250 GS ADVENTURE	18/20	BLACK/SILVER	0024555.314
	18/20	BLACK/WHITE	0024555.315

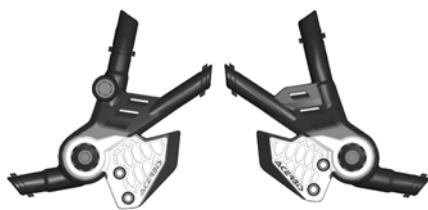

code: **0024555.315**



MODEL	YEAR	COLOR	CODE
HONDA			
CRF 250 RALLY	17/18	BLACK/RED	0023405.323
	17/18	GREY/RED	0023405.295
CRF 1000 L AFRICA TWIN	2020	WHITE/BLACK	0024554.237
	2020	BLACK/RED	0024554.323



code: **0024554.323**



MODEL	YEAR	COLOR	CODE
SUZUKI			
DR 650	96/20	SILVER/BLACK	0024288.223
	96/20	BLACK/SILVER	0024288.314

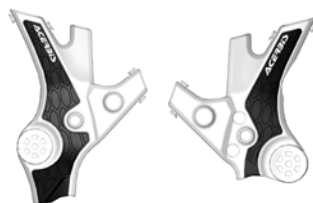

code: **0024554.237**



code: **0024288.223**



code: **0024288.314**



code: **0024405.295**



code: **0024405.323**



ACERBIS CHAIN GUIDE/SLIDER KIT HONDA

MODEL	YEAR	COLOR	CODE
CRF 250R	10/13	WHITE	0021685.030
	10/13	BLACK	0021685.090
	14/17	WHITE	0021689.030
	14/17	BLACK	0021689.090
	18/19	WHITE	0022712.030
	18/19	BLACK	0022712.090
	18/19	RED	0022712.110
	2020	WHITE	0023728.030
	2020	BLACK	0023728.090
CRF 450R	09/12	WHITE	0021685.030
	09/12	BLACK	0021685.090
	13/16	WHITE	0021689.030
	13/16	BLACK	0021689.090
	17/18	WHITE	0022712.030

MODEL	YEAR	COLOR	CODE
CRF250/300RX	17/18	BLACK	0022712.090
	17/18	RED	0022712.110
	19/20	WHITE	0023728.030
	19/20	BLACK	0023728.090
	19/20	RED	0023728.110
	2019	WHITE	0022712.030
	2019	BLACK	0022712.090
	2019	RED	0022712.110
	2020	WHITE	0023728.030
CRF 450 RX	2020	BLACK	0023728.090
	2020	RED	0023728.110
	19/20	WHITE	0023728.030
	19/20	BLACK	0023728.090
	19/20	RED	0023728.110



code: **0021685.030**



code: **0021685.090**



code: **0021689.030**



code: **0021689.090**

ACERBIS CHAIN GUIDES HONDA

MODEL	YEAR	COLOR	CODE
CRF 250 R	07/20	WHITE	0017949.030
	07/20	BLACK	0017949.090
	07/20	RED	0017949.110
CRF 250 X	07/18	WHITE	0017949.030
	07/18	BLACK	0017949.090
	07/18	RED	0017949.110
CRF 450 R	07/20	WHITE	0017949.030
	07/20	BLACK	0017949.090
	07/20	RED	0017949.110
CRF 450 X	07/18	WHITE	0017949.030
	07/18	BLACK	0017949.090
	07/18	RED	0017949.110
CRF 450 RX	17/20	WHITE	0017949.030
	17/20	BLACK	0017949.090
	17/20	RED	0017949.110
CRF250/300 RX	19/20	WHITE	0017949.030
	19/20	BLACK	0017949.090
	19/20	RED	0017949.110
OEM CHAIN GUIDES			
CR 125 R	92/99	BLACK	0005086.090
	99/04	BLACK	0006860.090
	05/06	BLACK	0008125.090
	2007	BLACK	0011533.090
CR 250 R	95/99	BLACK	0005086.090
	00/04	BLACK	0006860.090

MODEL	YEAR	COLOR	CODE
	05/06	BLACK	0008125.090
	2007	BLACK	0011533.090
CRE 125 R	92/99	BLACK	0005086.090
	99/04	BLACK	0006860.090
	05/06	BLACK	0008125.090
CRE 250 R	2007	BLACK	0011533.090
	95/99	BLACK	0005086.090
	00/04	BLACK	0006860.090
	05/06	BLACK	0008125.090
	2007	BLACK	0011533.090
CRF 250 R	2004	BLACK	0006860.090
	05/06	BLACK	0008125.090
	07/18	BLACK	0011533.090
CRF 250 X	05/06	BLACK	0008125.090
	07/18	BLACK	0011533.090
CRE 450 F	05/06	BLACK	0008125.090
CRF 450 R	02/04	BLACK	0006860.090
	05/06	BLACK	0008125.090
	07/18	BLACK	0011533.090
CRF 450 RX	07/18	BLACK	0011533.090
CRF 450 X	05/06	BLACK	0008125.090
	07/16	BLACK	0011533.090



code: **0017949.030**



code: **0017949.090**



code: **0017949.110**

REPLACEMENT INSERTS



code: **0017953.030**



code: **0017953.090**



code: **0017953.110**

ACERBIS CHAIN SLIDERS HONDA

MODEL	YEAR	COLOR	CODE	MODEL	YEAR	COLOR	CODE
CR 125 R	98/01	BLACK	0005027.090		17/18	WHITE	0022711.030
	02/07	BLACK	0006674.090		17/18	BLACK	0022711.090
CR 250 R	98/99	BLACK	0005027.090		17/18	RED	0022711.110
	00/07	BLACK	0006674.090		19/20	WHITE	0023727.030
					19/20	BLACK	0023727.090
				19/20	RED	0023727.110	
CRF 250 X	07/17	BLACK	0006674.090	CRF 450 X	05/16	BLACK	0006674.090
CRF 250 R	04/09	BLACK	0006674.090	CRE 125 R/250 R	98/99	BLACK	0005027.090
	10/13	WHITE	0013503.030		00/06	BLACK	0006674.090
	10/13	BLACK	0013503.090	CRE 450F	04/06	BLACK	0006674.090
	14/17	WHITE	0016982.030	CRF 250 RX/300 RX	2019	WHITE	0022711.030
	14/17	BLACK	0016982.090		2019	BLACK	0022711.090
	18/19	WHITE	0022711.030		2019	RED	0022711.110
CRF 450 R	18/19	BLACK	0022711.090	CRF 450 RX	19/20	WHITE	0023727.030
	18/19	RED	0022711.110		19/20	BLACK	0023727.090
	02/08	BLACK	0006674.090		19/20	RED	0023727.110
	09/12	WHITE	0013503.030				
	09/12	BLACK	0013503.090				
	13/16	WHITE	0016982.030				
	13/16	BLACK	0016982.090				



code: **0016982.030**



code: **0016982.090**

ACERBIS CHAIN GUIDE/SLIDER KIT KAWASAKI

MODEL	YEAR	COLOR	CODE	MODEL	YEAR	COLOR	CODE
KX 250F	09/19	BLACK	0021688.090		2019	GREEN	0023662.130
	09/19	GREEN	0021688.130	KX 250 4T	2020	BLACK	0021688.090
KX 450F					2020	GREEN	0021688.130
	09/15	BLACK	0021688.090	KX 450 4T	2020	BLACK	0023662.090
	09/15	GREEN	0021688.130		2020	GREEN	0023662.130
	16/18	BLACK	0021891.090				
	16/18	GREEN	0021891.130				
	2019	BLACK	0023662.090				



Mounting kit included



code: **0021688.090**



code: **0021688.130**

ACERBIS CHAIN GUIDES KAWASAKI

MODEL	YEAR	COLOR	CODE	MODEL	YEAR	COLOR	CODE
KX-F 250	09/19	WHITE	0017950.030	OEM CHAIN GUIDES			
	09/19	BLACK	0017950.090	KX 85	14/18	BLACK	0017854.090
	09/19	GREEN	0017950.130	KX 125/250	97/02	BLACK	0005087.090
KX 250 4T	2020	WHITE	0017950.030		03/08	BLACK	0010071.090
	2020	BLACK	0017950.090	KXE 125/250	03/08	BLACK	0010071.090
	2020	GREEN	0017950.130	KX-F 250	06/08	BLACK	0010070.090
KX-F 450	09/19	WHITE	0017950.030		09/19	BLACK	0013151.090
	09/19	BLACK	0017950.090	KX-F 450	06/08	BLACK	0010070.090
	09/19	GREEN	0017950.130		09/19	BLACK	0013151.090
KX 450 4T	2020	WHITE	0017950.030	KLX 450	08/09	BLACK	0010070.090
	2020	BLACK	0017950.090				
	2020	GREEN	0017950.130				



Mounting kit included



code: **0017950.030**



code: **0017950.090**



code: **0017950.130**

REPLACEMENT INSERTS



code: **0017953.030**



code: **0017953.090**



code: **0017953.130**



ACERBIS CHAIN SLIDERS KAWASAKI

MODEL	YEAR	COLOR	CODE
KX 85/100	02/20	BLACK	0017855.090
	02/20	GREEN	0017855.130
KX 125/250	94/08	BLACK	0005025.090
KX-F 250	04/05	BLACK	0010068.090
	06/08	BLACK	0010239.090
	09/16	BLACK	0013152.090
	09/16	GREEN	0013152.130
	17/19	BLACK	0021890.090
	17/19	GREEN	0021890.130
KX 250 4T	2020	BLACK	0021890.090
	2020	GREEN	0021890.130

MODEL	YEAR	COLOR	CODE
KX-F 450	06/08	BLACK	0010239.090
	09/15	BLACK	0013152.090
	09/15	GREEN	0013152.130
	16/18	BLACK	0021890.090
	16/18	GREEN	0021890.130
	2019	BLACK	0023659.090
	2019	GREEN	0023659.130
KLX 450	08/09	BLACK	0010239.090
SM 125/250	03/06	BLACK	0010239.090
KXE 125/250	03/06	BLACK	0010239.090



code: **0017855.090**



code: **0017855.130**



code: **0005025.090**



code: **0010068.090**



code: **0010239.090**



code: **0013152.090**



code: **0013152.130**

ACERBIS CHAIN GUIDE/SLIDER KIT KTM

MODEL	YEAR	COLOR	CODE
SX 85	06/14	ORANGE	0017853.010
	06/14	BLACK	0017853.090
	15/20	ORANGE	0021515.010
	15/20	WHITE	0021515.030
	15/20	BLACK	0021515.090
SX 125/144	11/15	ORANGE	0016856.010
	11/15	BLACK	0016856.090
	16/20	ORANGE	0021833.010
	16/20	BLACK	0021833.090
SX 150	19/20	ORANGE	0021833.010
	19/20	BLACK	0021833.090
SX 250	11/16	ORANGE	0016856.010
	11/16	BLACK	0016856.090
	17/20	ORANGE	0021833.010
	17/20	BLACK	0021833.090
SXF 250/350/450	11/15	ORANGE	0016856.010
	11/15	BLACK	0016856.090
	16/20	ORANGE	0021833.010
	16/20	BLACK	0021833.090

MODEL	YEAR	COLOR	CODE
EXC 125/200/250/300	12/16	ORANGE	0016847.010
	12/16	BLACK	0016847.090
EXC 250/300	2017	ORANGE	0022349.010
	2017	BLACK	0022349.090
EXC-F 250/350/450/500	17/20	ORANGE	0022349.010
	17/20	BLACK	0022349.090
EXC 150 TPI	19/20	ORANGE	0022349.010
	19/20	BLACK	0022349.090
XC 250/300 TPI	19/20	ORANGE	0021833.010
	19/20	BLACK	0021833.090
XC-F 250/350/450	19/20	ORANGE	0021833.010
	19/20	BLACK	0021833.090
XC-W 150/250/300 TPI	19/20	ORANGE	0022349.010
	19/20	BLACK	0022349.090
XCF-W 350/500	2020	ORANGE	0022349.010
	2020	BLACK	0022349.090



MOUNTING KIT INCLUDED



code: **0016856.010**



code: **0016856.090**



code: **0022349.010**



code: **0022349.090**



code: **0016847.010**



code: **0016847.090**

ACERBIS CHAIN GUIDE/SLIDER KIT KTM

MODEL	YEAR	COLOR	CODE
SX 85	06/14	ORANGE	0017853.010
	06/14	BLACK	0017853.090
	15/20	ORANGE	0021515.010
	15/20	WHITE	0021515.030
	15/20	BLACK	0021515.090
SX 125/144	11/15	ORANGE	0016856.010
	11/15	BLACK	0016856.090
	16/20	ORANGE	0021833.010
	16/20	BLACK	0021833.090
SX 150	19/20	ORANGE	0021833.010
	19/20	BLACK	0021833.090
SX 250	11/16	ORANGE	0016856.010
	11/16	BLACK	0016856.090
	17/20	ORANGE	0021833.010
	17/20	BLACK	0021833.090
SXF 250/350/450	11/15	ORANGE	0016856.010
	11/15	BLACK	0016856.090
	16/20	ORANGE	0021833.010
	16/20	BLACK	0021833.090

MODEL	YEAR	COLOR	CODE
EXC 125/200/250/300	12/16	ORANGE	0016847.010
	12/16	BLACK	0016847.090
EXC 250/300	2017	ORANGE	0022349.010
	2017	BLACK	0022349.090
EXC-F 250/350/450/500	17/20	ORANGE	0022349.010
	17/20	BLACK	0022349.090
EXC 150 TPI	19/20	ORANGE	0022349.010
	19/20	BLACK	0022349.090
XC 250/300 TPI	19/20	ORANGE	0021833.010
	19/20	BLACK	0021833.090
XC-F 250/350/450	19/20	ORANGE	0021833.010
	19/20	BLACK	0021833.090
XC-W 150/250/300 TPI	19/20	ORANGE	0022349.010
	19/20	BLACK	0022349.090
XCF-W 350/500	2020	ORANGE	0022349.010
	2020	BLACK	0022349.090



code: **0021515.010**



code: **0021515.030**



code: **0021515.090**

ACERBIS CHAIN GUIDES KTM

MODEL	YEAR	COLOR	CODE
SX/SXF	11/20	ORANGE	0016451.010
	11/20	WHITE	0016451.030
	11/20	BLACK	0016451.090
SX 85	06/14	ORANGE	0017852.010
	06/14	BLACK	0017852.090
	15/20	ORANGE	0016451.010
	15/20	WHITE	0016451.030
	15/20	BLACK	0016451.090
SX 200	11/19	ORANGE	0016451.010
	11/19	WHITE	0016451.030
	11/19	BLACK	0016451.090
SX-F 505	11/19	ORANGE	0016451.010
	11/19	WHITE	0016451.030
	11/19	BLACK	0016451.090
EXC-F	12/20	ORANGE	0016451.010
	12/20	WHITE	0016451.030
	12/20	BLACK	0016451.090
EXC 125	12/16	ORANGE	0016451.010
	12/16	WHITE	0016451.030
	12/16	BLACK	0016451.090
EXC 150 TPI	19/20	ORANGE	0016451.010
	19/20	WHITE	0016451.030
	19/20	BLACK	0016451.090
EXC 200	12/19	ORANGE	0016451.010
	12/19	WHITE	0016451.030
	12/19	BLACK	0016451.090
EXC 250/300	12/17	ORANGE	0016451.010
	12/17	WHITE	0016451.030
	12/17	BLACK	0016451.090
EXC 250/300 TPI	18/20	ORANGE	0016451.010
	18/20	WHITE	0016451.030
	18/20	BLACK	0016451.090
XC/XC-F	19/20	ORANGE	0016451.010

MODEL	YEAR	COLOR	CODE
XC-W	19/20	WHITE	0016451.030
	19/20	BLACK	0016451.090
	19/20	ORANGE	0016451.010
XC-W 125	19/20	WHITE	0016451.030
	19/20	BLACK	0016451.090
	17/20	ORANGE	0016451.010
XCF-W 350/500	17/20	ORANGE	0016451.010
	17/20	WHITE	0016451.030
	17/20	BLACK	0016451.090
XCF-W 350/500	2020	ORANGE	0016451.010
	2020	WHITE	0016451.030
	2020	BLACK	0016451.090
FREERIDE 4T	2019	ORANGE	0016451.010
	2019	WHITE	0016451.030
	2019	BLACK	0016451.090
OEM CHAIN GUIDES			
SX 65	00/06	BLACK	0010229.090
	07/10	BLACK	0012211.090
SX 85	00/06	BLACK	0010229.090
	07/10	BLACK	0012211.090
	15/19	BLACK	0015914.090
SX 125/150	00/06	BLACK	0010229.090
	07/10	BLACK	0012211.090
SX 200	11/19	BLACK	0015914.090
	00/06	BLACK	0010229.090
	07/10	BLACK	0012211.090
SX 250	11/17	BLACK	0015914.090
	00/06	BLACK	0010229.090
	07/10	BLACK	0012211.090
SX-F 250	11/19	BLACK	0015914.090
	00/06	BLACK	0010229.090
	07/10	BLACK	0012211.090
SX-F 350/450	00/06	BLACK	0010229.090
	00/06	BLACK	0010229.090



ACERBIS CHAIN GUIDES KTM

MODEL	YEAR	COLOR	CODE
	07/10	BLACK	0012211.090
	11/19	BLACK	0015914.090
SX-F 505	00/06	BLACK	0010229.090
	07/10	BLACK	0012211.090
	11/17	BLACK	0015914.090
EXC 125	00/07	BLACK	0010229.090
	08/16	BLACK	0012211.090
EXC 200	00/07	BLACK	0010229.090
	08/17	BLACK	0012211.090
EXC 250/300	00/07	BLACK	0010229.090
	08/17	BLACK	0012211.090

MODEL	YEAR	COLOR	CODE
EXC 250/300 TPI	18/19	BLACK	0012211.090
EXC 380	00/07	BLACK	0010229.090
	08/17	BLACK	0012211.090
EXC-F 250	00/07	BLACK	0010229.090
	08/19	BLACK	0012211.090
EXC-F 350/400/450/500	00/07	BLACK	0010229.090
	08/19	BLACK	0012211.090
EXC-F 520/525/540	00/07	BLACK	0010229.090
	08/17	BLACK	0012211.090
XC-W 125	17/19	BLACK	0012211.090



MOUNTING KIT INCLUDED



code: **0016451.010**



code: **0016451.030**



code: **0016451.090**



code: **0017852.010**



code: **0017852.090**

REPLACEMENT INSERTS ONLY FOR 0021515/0016451



code: **0016510.010**



code: **0016510.090**

ACERBIS CHAIN SLIDERS KTM

MODEL	YEAR	COLOR	CODE
SX 85	06/14	ORANGE	0017856.010
	06/14	BLACK	0017856.090
	15/20	ORANGE	0021514.010
	15/20	WHITE	0021514.030
	15/20	BLACK	0021514.090
SX 125/144	00/06	BLACK	0010069.090
	07/10	BLACK	0012218.090
	11/15	ORANGE	0015916.010
	11/15	BLACK	0015916.090
	16/20	ORANGE	0021832.010
	16/20	BLACK	0021832.090
SX 150	00/06	BLACK	0010069.090
	07/10	BLACK	0012218.090
	11/15	ORANGE	0015916.010
	11/15	BLACK	0015916.090
	19/20	ORANGE	0021832.010
	19/20	BLACK	0021832.090
SX 200	03/04	BLACK	0010069.090
SX 250	00/06	BLACK	0010069.090
	07/10	BLACK	0012218.090
	11/16	ORANGE	0015916.010
	11/16	BLACK	0015916.090
	17/20	ORANGE	0021832.010

MODEL	YEAR	COLOR	CODE
	17/20	BLACK	0021832.090
SXF 250/350/450	00/06	BLACK	0010069.090
	07/10	BLACK	0012218.090
	11/15	ORANGE	0015916.010
	11/15	BLACK	0015916.090
	16/20	ORANGE	0021832.010
	16/20	BLACK	0021832.090
XC/XC-F	19/20	ORANGE	0021832.010
	19/20	BLACK	0021832.090
EXC/EXC-F	00/07	BLACK	0010069.090
	08/11	BLACK	0012218.090
	12/16	ORANGE	0016857.010
	12/16	BLACK	0016857.090
	2017	ORANGE	0022348.010
	2017	BLACK	0022348.090
EXC 150 TPI	19/20	ORANGE	0022348.010
	19/20	BLACK	0022348.090
EXC 250/300 TPI	18/20	ORANGE	0022348.010
	18/20	BLACK	0022348.090
XC-W	19/20	ORANGE	0022348.010
	19/20	BLACK	0022348.090
XCF-W	2020	ORANGE	0022348.010
	2020	BLACK	0022348.090



code: **0022348.010**



code: **0022348.090**



code: **0021832.090**



code: **0021514.010**



code: **0021514.030**



code: **0021514.090**

ACERBIS CHAIN GUIDE/SLIDER KIT SUZUKI

MODEL	YEAR	COLOR	CODE
RMZ 250	10/18	YELLOW	0021686.060
	10/18	BLACK	0021686.090
	19/20	YELLOW	0023073.060
	19/20	BLACK	0023073.090

MODEL	YEAR	COLOR	CODE
RMZ 450	10/17	YELLOW	0021686.060
	10/17	BLACK	0021686.090
	18/20	YELLOW	0023073.060
	18/20	BLACK	0023073.090



MOUNTING KIT INCLUDED



code: **0021686.060**



code: **0021686.090**

ACERBIS CHAIN GUIDES SUZUKI

MODEL	YEAR	COLOR	CODE
RM 125/250	07/08	WHITE	0017951.030
	07/08	YELLOW	0017951.060
	07/08	BLACK	0017951.090
RM-Z 250	08/20	WHITE	0017951.030
	08/20	YELLOW	0017951.060
	08/20	BLACK	0017951.090
	19/20	WHITE	0023072.030
	19/20	YELLOW	0023072.060
RM-Z 450	05/20	WHITE	0017951.030
	05/20	YELLOW	0017951.060
	05/20	BLACK	0017951.090
	18/20	WHITE	0023072.030
	18/20	YELLOW	0023072.060

MODEL	YEAR	COLOR	CODE
	18/20	BLACK	0023072.090
RMZX	10/17	WHITE	0017951.030
	10/17	YELLOW	0017951.060
	10/17	BLACK	0017951.090
OEM CHAIN GUIDES			
RM 125/250	96/98	WHITE	0005084.030
	99/11	BLACK	0005085.090
RM-Z 250	07/17	BLACK	0005085.090
	05/17	BLACK	0005085.090
RM-Z 450	2018	BLACK	0023095.090
RMZX	2010	BLACK	0005085.090



code: **0017951.030**



code: **0017951.060**



code: **0017951.090**

REPLACEMENT INSERTS



code: **0017954.030**



code: **0017954.060**



code: **0017954.090**

ACERBIS CHAIN SLIDERS SUZUKI

MODEL	YEAR	COLOR	CODE
RM 125/250	01/08	BLACK	0010064.090
RM-Z 250	07/09	BLACK	0010064.090
	10/18	YELLOW	0012217.060
	10/18	BLACK	0012217.090
	19/20	WHITE	0023071.030
	19/20	YELLOW	0023071.060
	19/20	BLACK	0023071.090

MODEL	YEAR	COLOR	CODE
RM-Z 450	05/09	BLACK	0010064.090
	07/17	YELLOW	0012217.060
	07/17	BLACK	0012217.090
	08/09	BLACK	0010064.090
	10/17	YELLOW	0012217.060
	10/17	BLACK	0012217.090
	18/20	WHITE	0023071.030
	18/20	YELLOW	0023071.060
	18/20	BLACK	0023071.090



code: **0010064.090**



code: **0012217.060**



code: **0012217.090**

ACERBIS CHAIN GUIDE/SLIDER KIT YAMAHA

MODEL	YEAR	COLOR	CODE
YZ 250F	09/20	BLUE	0021687.040
	09/20	BLACK	0021687.090
YZ 450F	09/20	BLUE	0021687.040
	09/20	BLACK	0021687.090

MODEL	YEAR	COLOR	CODE
WRF 250	2020	BLUE	0021687.040
	2020	BLACK	0021687.090
WRF 450	19/20	BLUE	0021687.040
	19/20	BLACK	0021687.090



code: **0021687.040**



code: **0021687.090**



ACERBIS CHAIN GUIDES YAMAHA

MODEL	YEAR	COLOR	CODE
YZ 125/250	05/20	WHITE	0017952.030
	05/20	BLUE	0017952.040
	05/20	BLACK	0017952.090
YZF 250/450	03/20	WHITE	0017952.030
	03/20	BLUE	0017952.040
	03/20	BLACK	0017952.090
WRF 250/450	03/20	WHITE	0017952.030
	03/20	BLUE	0017952.040
	03/20	BLACK	0017952.090
OEM CHAIN GUIDES			
YZ 65	19/20	BLACK	0023535.090
YZ 125	97/08	BLACK	0005085.090
	08/15	BLACK	0012210.090

MODEL	YEAR	COLOR	CODE
YZ 250	97/08	BLACK	0005085.090
	07/17	BLACK	0012210.090
YZF 250/450	01/06	BLACK	0005085.090
	07/19	BLACK	0012210.090
YZF 426	00/02	BLACK	0005085.090
WR 125	97/07	BLACK	0005085.090
WR 250	08/17	BLACK	0012210.090
	97/07	BLACK	0005085.090
WR 426	08/20	BLACK	0012210.090
	00/02	BLACK	0005085.090
WRF 250/450	05/06	BLACK	0005085.090
	07/08	BLACK	0012210.090
WRF 400	00/02	BLACK	0005085.090



code: **0017952.030**



code: **0017952.040**



code: **0017952.090**

REPLACEMENT INSERTS



code: **0017953.030**



code: **0017953.040**



code: **0017953.090**

ACERBIS CHAIN SLIDERS YAMAHA

MODEL	YEAR	COLOR	CODE
YZ 125/250	97/01	BLACK	0005026.090
	02/04	BLACK	0010240.090
	05/20	BLACK	0010241.090
YZF 250	05/08	BLACK	0010241.090
	09/20	BLUE	0015918.040
	09/20	BLACK	0015918.090
YZF 450	05/08	BLACK	0010241.090
	09/20	BLUE	0015918.040

MODEL	YEAR	COLOR	CODE
WR 125/250	09/20	BLACK	0015918.090
	96/01	BLACK	0005026.090
	05/20	BLACK	0010241.090
WRF 250/450	05/08	BLACK	0010241.090
	09/20	BLUE	0015918.040
	09/20	BLACK	0015918.090
YZ 65	19/20	BLACK	0023919.090



code: **0005026.090**



code: **0015918.040**



code: **0015918.090**

ACERBIS CHAIN GUIDE GAS GAS

MODEL	YEAR	COLOR	CODE
EC 250/300 GP	2018	WHITE	0016451.030
	2018	BLACK	0016451.090
EC R 250 SIX DAYS	2018	WHITE	0016451.030
	2018	BLACK	0016451.090
EC R 250/300 E4	2018	WHITE	0016451.030
	2018	BLACK	0016451.090



code: **0016451.030**



code: **0016451.090**



ACERBIS CHAIN GUIDE/SLIDER KIT HUSQVARNA

MODEL	YEAR	COLOR	CODE
TC 85	15/20	WHITE	0021515.030
	15/20	BLACK	0021515.090
TC 125	14/15	BLACK	0016856.090
	16/20	BLACK	0021833.090
TC 250	14/16	BLACK	0016856.090
	17/20	BLACK	0021833.090
FC 250/350/450	14/15	BLACK	0016856.090
	16/20	BLACK	0021833.090

MODEL	YEAR	COLOR	CODE
FE 250/350/450/501	14/16	BLACK	0016856.090
	17/20	BLACK	0021833.090
TE 250/300	14/16	BLACK	0016856.090
	2017	BLACK	0021833.090
TE 150 I	2020	BLACK	0021833.090
TE 250 I/300 I	18/20	BLACK	0021833.090
TX 125	17/19	BLACK	0021833.090



code: **0016856.090**



code: **0021515.030**



code: **0021515.090**

ACERBIS CHAIN GUIDES HUSQVARNA

MODEL	YEAR	COLOR	CODE
TC/FC -TE/FE	14/20	WHITE	0016451.030
	14/20	BLACK	0016451.090
TC 300	14/18	WHITE	0016451.030
	14/18	BLACK	0016451.090
TC 85	15/20	WHITE	0016451.030
	15/20	BLACK	0016451.090
TE 150 I	2020	WHITE	0016451.030
	2020	BLACK	0016451.090
TE 250	14/17	WHITE	0016451.030
	14/17	BLACK	0016451.090
TE 250 I	18/20	WHITE	0016451.030
	18/20	BLACK	0016451.090
TE 300	14/17	WHITE	0016451.030
	14/17	BLACK	0016451.090
TE 300 I	18/20	WHITE	0016451.030
	18/20	BLACK	0016451.090
TX 125	17/19	WHITE	0016451.030
	17/19	BLACK	0016451.090

MODEL	YEAR	COLOR	CODE
OEM CHAIN GUIDES			
FC 250	14/19	BLACK	0015914.090
FC 350	14/19	BLACK	0015914.090
FC 450	14/19	BLACK	0015914.090
FE 250/350/501	14/19	BLACK	0012211.090
	14/19	BLACK	0012211.090
FE 450	14/15	BLACK	0015914.090
	14/19	BLACK	0015914.090
TC 125	14/19	BLACK	0015914.090
TC 250	14/19	BLACK	0015914.090
TC 300	14/17	BLACK	0015914.090
TE 125	14/16	BLACK	0012211.090
TE 250	14/17	BLACK	0012211.090
TE 250 I	18/19	BLACK	0012211.090
TE 300/310	14/17	BLACK	0012211.090
TX 125	17/19	BLACK	0012211.090



code: **0016451.030**



code: **0016451.090**

REPLACEMENT INSERTS



code: **0016510.090**

ACERBIS CHAIN SLIDERS HUSQVARNA

MODEL	YEAR	COLOR	CODE
TC 85	15/20	WHITE	0021514.030
	15/20	BLACK	0021514.090
TC 125	14/15	BLACK	0015916.090
	16/20	BLACK	0021832.090
TC 250	14/16	BLACK	0015916.090
	17/20	BLACK	0021832.090
FC 250/350/450	14/15	BLACK	0015916.090
	16/20	BLACK	0021832.090

MODEL	YEAR	COLOR	CODE
FE 250/350/450/501	14/16	BLACK	0015916.090
	17/20	BLACK	0021832.090
TE 125/450	14/16	BLACK	0015916.090
TE 250/300	14/16	BLACK	0015916.090
	2017	BLACK	0021832.090
TE 150 I	2020	BLACK	0021832.090
TE 250 I/ 300 I	18/20	BLACK	0021832.090



code **0021514.030**



code **0021514.090**



code: **0015916.090**



code: **0021832.090**



X-PLOCK LINK SAVER

MATERIALS:

Nylon 95%, Others 5%

DETAILS:

- Made of highly resistant thermoplastic to protect the most exposed part of the shock absorber link from impacts and scraping on stones, tree trunks and obstacles.
- Allows the motorbike to slide over tree trunks, boulders and earth obstacles.
- Assembly is quick and easy using a screw, which ensures protection in position despite the severest impacts with rough terrain.
- Resistant and light



orange
0024497.010



white
0024497.030

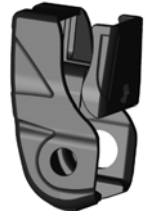

black
0024497.090

MODEL	YEAR	COLOR	CODE
KTM			
SX 125/250	16/21	ORANGE	0024497.010
	16/21	WHITE	0024497.030
	16/21	BLACK	0024497.090
SXF 250/350/450	16/21	ORANGE	0024497.010
	16/21	WHITE	0024497.030
	16/21	BLACK	0024497.090
XC 125/250/300	16/21	ORANGE	0024497.010
	16/21	WHITE	0024497.030
	16/21	BLACK	0024497.090
XCF 250/350/450	16/21	ORANGE	0024497.010
	16/21	WHITE	0024497.030
	16/21	BLACK	0024497.090

MODEL	YEAR	COLOR	CODE
HUSQVARNA			
TE-TX 125	17/20	ORANGE	0024497.010
	17/20	WHITE	0024497.030
	17/20	BLACK	0024497.090
TE-TX 250/250	17/20	ORANGE	0024497.010
	17/20	WHITE	0024497.030
	17/20	BLACK	0024497.090
FE-FX 250/350/450/501	17/20	ORANGE	0024497.010
	17/20	WHITE	0024497.030
	17/20	BLACK	0024497.090
TC 125/250	16/20	ORANGE	0024497.010
	16/20	WHITE	0024497.030
	16/20	BLACK	0024497.090
FC 250/350/450	16/20	ORANGE	0024497.010
	16/20	WHITE	0024497.030
	16/20	BLACK	0024497.090



SILENCER PROTECTOR

MATERIALS:

- 100% Silicone

DETAILS:

- Silencer protection against bumps and scratches
- Circumference 200/400 mm
- Locking system through micrometric closing bands
- Heat resistant till 200°C



orange
0022754.010



blue
0022754.040



black
0022754.090



red
0022754.110



X-POWER KIT

- Motor Crankcase and Ignition/Clutch covers that protect against wear from boots, impacts, dirt, mud, and other debris
- **Right side:** provides protection for the clutch cover, water pump, and lower casing
- **Left side:** provides protection to the ignition cover and clutch actuator
- Molded openings to access the filter cover and oil cap
- Easy to install by utilizing the original crankcase and ignition/clutch cover bolts
- Resistant to high temperatures
- Designed not to interfere with boots
- Compatible with ACERBIS skid plates



KTM
code: 0023674.011.016



HONDA
code: 0024435.110



YAMAHA
code: 0024024.040



BETA
code: 0023763.090

APPLICATIONS X-POWER KIT KTM

MODEL	YEAR	COLOR	CODE
SX 250	17/18	ORANGE 16	0023468.011.016
	17/18	WHITE	0023468.030
	17/18	BLACK	0023468.090
	2020	ORANGE 16	0023674.011.016
	2020	WHITE	0023674.030
SX-F 250/350	2020	BLACK	0023674.090
	16/20	ORANGE 16	0023573.011.016
	16/20	WHITE	0023573.030
SX-F 450	16/20	BLACK	0023573.090
	16/20	ORANGE 16	0023153.011.016
	16/20	FLUO YELL.	0023153.061
EXC 250/300	16/20	BLACK	0023153.090
	2017	ORANGE 16	0023468.011.016
	2017	WHITE	0023468.030
EXC 250/300 TPI	2017	BLACK	0023468.090
	18/19	ORANGE 16	0023468.011.016
	18/19	WHITE	0023468.030
EXC-F 250/350	18/19	BLACK	0023468.090
	18/19	ORANGE 16	0023674.011.016
	2020	ORANGE 16	0023674.011.016
	2020	WHITE	0023674.030
	2020	BLACK	0023674.090
EXC-F 450/500	17/20	ORANGE 16	0023469.011.016
	17/20	WHITE	0023469.030
	17/20	BLACK	0023469.090
XC 250/300 TPI	17/20	ORANGE 16	0023153.011.016
	17/20	SILVER	0023153.020
	17/20	FLUO YELL.	0023153.061
	17/20	BLACK	0023153.090
XC-F 250/350	2020	ORANGE 16	0023674.011.016
	2020	WHITE	0023674.030
	2020	BLACK	0023674.090
XC-F 450	2020	ORANGE 16	0023573.011.016
	2020	WHITE	0023573.030
	2020	BLACK	0023573.090
	2020	ORANGE 16	0023153.011.016
XC-W 250/300 TPI	2020	SILVER	0023153.020
	2020	FLUO YELL.	0023153.061
	2020	BLACK	0023153.090
XCF-W 350	2020	ORANGE 16	0023674.011.016
	2020	WHITE	0023674.030
	2020	BLACK	0023674.090
XCF-W 500	2020	ORANGE 16	0023469.011.016
	2020	WHITE	0023469.030
	2020	BLACK	0023469.090
FREERIDE 4T	2020	ORANGE 16	0023153.011.016
	2020	FLUO YELL.	0023153.061
	2020	BLACK	0023153.090
YZ 125	2019	ORANGE 16	0023469.011.016
	2019	WHITE	0023469.030
	2019	BLACK	0023469.090

APPLICATIONS X-POWER KIT YAMAHA

MODEL	YEAR	COLOR	CODE
YZ 125	05/20	BLACK	0023961.090
	05/20	BLUE	0023961.040
YZ 250	05/20	BLACK	0023962.090
	05/20	BLUE	0023962.040
YZF 450	18/20	BLACK	0024024.090
	18/20	BLUE	0024024.040

APPLICATIONS X-POWER KIT HUSQVARNA

MODEL	YEAR	COLOR	CODE
TC 250	17/18	ORANGE 16	0023468.011.016
	17/18	WHITE	0023468.030
	17/18	BLACK	0023468.090
	19/20	ORANGE 16	0023674.011.016
	19/20	WHITE	0023674.030
FC 250/350	19/20	BLACK	0023674.090
	16/20	ORANGE 16	0023573.011.016
	16/20	WHITE	0023573.030
FC 450	16/20	BLACK	0023573.090
	16/20	ORANGE 16	0023153.011.016
	16/20	FLUO YELL.	0023153.061
TE 250/300	16/20	BLACK	0023153.090
	2017	ORANGE 16	0023468.011.016
	2017	WHITE	0023468.030
TE 250 I/300 I	2017	BLACK	0023468.090
	18/19	ORANGE 16	0023468.011.016
	18/19	WHITE	0023468.030
FE 250/350	18/19	BLACK	0023468.090
	18/19	ORANGE 16	0023674.011.016
	2020	ORANGE 16	0023674.011.016
	2020	WHITE	0023674.030
	2020	BLACK	0023674.090
FE 450	17/20	ORANGE 16	0023469.011.016
	17/20	WHITE	0023469.030
	17/20	BLACK	0023469.090
FE 501	17/20	ORANGE 16	0023153.011.016
	17/20	SILVER	0023153.020
	17/20	FLUO YELL.	0023153.061
	17/20	BLACK	0023153.090
RR 2T 250/300	19/20	ORANGE 16	0023153.011.016
	19/20	SILVER	0023153.020
	19/20	FLUO YELL.	0023153.061
RR 2T 250/300 X-TRAINER	19/20	BLACK	0023153.090
	18/21	RED	0023763.110
	18/21	BLACK	0023763.090

APPLICATIONS X-POWER KIT BETA

MODEL	YEAR	COLOR	CODE
RR 2T 250/300	20/21	BLACK	0023763.090
	20/21	RED	0023763.110
RR 2T 250/300 RC	18/21	BLACK	0023763.090
	18/21	RED	0023763.110
RR 2T 250/300 X-TRAINER	18/21	BLACK	0023763.090
	18/21	RED	0023763.110

APPLICATIONS X-POWER KIT HONDA

MODEL	YEAR	COLOR	CODE
CRF 250 R	18/20	BLACK	0024435.090
	18/20	RED	0024435.110
CRF 250/300 RX	19/20	BLACK	0024435.090
	19/20	RED	0024435.110
CRF 450 R	17/20	BLACK	0024274.090
	17/20	RED	0024274.110
CRF 450 RX	19/20	BLACK	0024274.090
	17/20	RED	0024274.110



FORK SHOE COVER

- Protects the lower forks against impact and damage
- Easy to install by utilizing the original front axle/fork lug screws
- Provides easy access to the axle nut and fork lug bolts



FORK SHOE COVER HONDA

MODEL	YEAR	COLOR	CODE
CRF 250 R	09/20	SILVER	0023197.020
	09/20	WHITE	0023197.030
	09/20	BLACK	0023197.090
	09/20	RED	0023197.110
CRF 250 X	09/17	SILVER	0023197.020
	09/17	WHITE	0023197.030
	09/17	BLACK	0023197.090
	09/17	RED	0023197.110

MODEL	YEAR	COLOR	CODE
CRF 450 RX	17/20	SILVER	0023197.020
	17/20	WHITE	0023197.030
	17/20	BLACK	0023197.090
	17/20	RED	0023197.110
CRF 450 X	09/16	SILVER	0023197.020
	09/16	WHITE	0023197.030
	09/16	BLACK	0023197.090
	09/16	RED	0023197.110
CRF 250/300 RX	19/20	SILVER	0023197.020
	19/20	WHITE	0023197.030
	19/20	BLACK	0023197.090
	19/20	RED	0023197.110



FORK SHOE COVER KAWASAKI

MODEL	YEAR	COLOR	CODE
KXF 250	09/19	SILVER	0023197.020
	09/19	WHITE	0023197.030
	09/19	BLACK	0023197.090
	09/19	GREEN	0023197.130
KX 250 4T	2020	SILVER	0023197.020
	2020	WHITE	0023197.030

MODEL	YEAR	COLOR	CODE
	2020	BLACK	0023197.090
	2020	GREEN	0023197.130
KXF 450	09/19	SILVER	0023197.020
	09/19	WHITE	0023197.030
	09/19	BLACK	0023197.090
	09/19	GREEN	0023197.130
KX 450 4T	2020	SILVER	0023197.020
	2020	WHITE	0023197.030
	2020	BLACK	0023197.090
	2020	GREEN	0023197.130



FORK SHOE COVER SUZUKI

MODEL	YEAR	COLOR	CODE
RM-Z 250	09/20	SILVER	0023195.020
	09/20	WHITE	0023195.030

MODEL	YEAR	COLOR	CODE
	09/20	YELLOW	0023195.060
	09/20	BLACK	0023195.090
RM-Z 450	09/20	SILVER	0023195.020
	09/20	WHITE	0023195.030
	09/20	YELLOW	0023195.060
	09/20	BLACK	0023195.090



FORK SHOE COVER YAMAHA

MODEL	YEAR	COLOR	CODE
YZ 125/250	08/20	SILVER	0023194.020
	08/20	WHITE	0023194.030
	08/20	BLUE	0023194.040
	08/20	BLACK	0023194.090
YZF 250/450	07/20	SILVER	0023194.020
	07/20	WHITE	0023194.030

MODEL	YEAR	COLOR	CODE
	07/20	BLUE	0023194.040
	07/20	BLACK	0023194.090
WR 125/250 2T	08/20	SILVER	0023194.020
	08/20	WHITE	0023194.030
	08/20	BLUE	0023194.040
	08/20	BLACK	0023194.090



silver
0023194.020



white
0023194.030



blue
0023194.040



black
0023194.090

FORK SHOE COVER KTM/HUSQVARNA/SHERCO

MODEL	YEAR	COLOR	CODE
KTM			
SX 125/150	16/20	ORANGE 016	0023196.011.016
	16/20	SILVER	0023196.020
	16/20	WHITE	0023196.030
	16/20	BLACK	0023196.090
	19/20	ORANGE 016	0023196.011.016
	19/20	SILVER	0023196.020
SX 150	19/20	WHITE	0023196.030
	19/20	BLACK	0023196.090
	19/20	ORANGE 016	0023196.011.016
SX 250	17/20	SILVER	0023196.020
	17/20	WHITE	0023196.030
	17/20	BLACK	0023196.090
SX-F 250/350/ 450/505	16/20	ORANGE 016	0023196.011.016
	16/20	SILVER	0023196.020
	16/20	WHITE	0023196.030
	16/20	BLACK	0023196.090
EXC 250/300	2017	ORANGE 016	0023196.011.016
	2017	SILVER	0023196.020
	2017	WHITE	0023196.030
	2017	BLACK	0023196.090
EXC 150 TPI	19/20	ORANGE 016	0023196.011.016
	19/20	SILVER	0023196.020
	19/20	WHITE	0023196.030
	19/20	BLACK	0023196.090
EXC 250/300 TPI	18/20	ORANGE 016	0023196.011.016
	18/20	SILVER	0023196.020
	18/20	WHITE	0023196.030
	18/20	BLACK	0023196.090
EXC-F 250/350/450	17/20	ORANGE 016	0023196.011.016
	17/20	SILVER	0023196.020
	17/20	WHITE	0023196.030
	17/20	BLACK	0023196.090
	19/20	ORANGE 016	0023196.011.016
	19/20	SILVER	0023196.020
	19/20	WHITE	0023196.030
	19/20	BLACK	0023196.090
	XC-F 250/350/450	19/20	ORANGE 016
19/20		SILVER	0023196.020
19/20		WHITE	0023196.030
19/20		BLACK	0023196.090



orange 16
0023196.011.016



silver
0023196.020



white
0023196.030



black
0023196.090

MODEL	YEAR	COLOR	CODE
HUSQVARNA			
FC 250/350/450	16/20	ORANGE 016	0023196.011.016
	16/20	SILVER	0023196.020
	16/20	WHITE	0023196.030
	16/20	BLACK	0023196.090
TC 125	16/20	ORANGE 016	0023196.011.016
	16/20	SILVER	0023196.020
	16/20	WHITE	0023196.030
	16/20	BLACK	0023196.090
TX 125	17/19	ORANGE 016	0023196.011.016
	17/19	SILVER	0023196.020
	17/19	WHITE	0023196.030
	17/19	BLACK	0023196.090
TC 250	17/20	ORANGE 016	0023196.011.016
	17/20	SILVER	0023196.020
	17/20	WHITE	0023196.030
	17/20	BLACK	0023196.090
TE 125/250/300	2017	ORANGE 016	0023196.011.016
	2017	SILVER	0023196.020
	2017	WHITE	0023196.030
	2017	BLACK	0023196.090
FE 250/350/450/501	17/20	ORANGE 016	0023196.011.016
	17/20	SILVER	0023196.020
	17/20	WHITE	0023196.030
	17/20	BLACK	0023196.090
TE 150 I	2020	ORANGE 016	0023196.011.016
	2020	SILVER	0023196.020
	2020	WHITE	0023196.030
	2020	BLACK	0023196.090
TE 250 I/300 I	18/20	ORANGE 016	0023196.011.016
	18/20	SILVER	0023196.020
	18/20	WHITE	0023196.030
	18/20	BLACK	0023196.090
SHERCO			
SE-R 125/250/300	2020	ORANGE 016	0023196.011.016
	2020	SILVER	0023196.020
	2020	WHITE	0023196.030
	2020	BLACK	0023196.090
SE-R 125/250/300 SIX D.	2018	ORANGE 016	0023196.011.016
	2018	SILVER	0023196.020
	2018	WHITE	0023196.030
	2018	BLACK	0023196.090
SEF-R 250/300/450 SIX D.	2018	ORANGE 016	0023196.011.016
	2018	SILVER	0023196.020
	2018	WHITE	0023196.030
	2018	BLACK	0023196.090



FORK SHOE COVER BETA

MODEL	YEAR	COLOR	CODE
RR 2T 125/200	2018	WHITE	0023502.030
	2018	BLACK	0023502.090
	2018	RED	0023502.110
	19/20	WHITE	0023680.030
	19/21	BLACK	0023680.090
	19/21	RED	0023680.110
RR 2T 125 RC	20/21	SILVER	0023197.020
	20/21	WHITE	0023197.030
	20/21	BLACK	0023197.090
	20/21	RED	0023197.110
RR 2T 250/300	20/21	WHITE	0023680.030
	20/21	BLACK	0023680.090
	20/21	RED	0023680.110
RR 2T 250/300 RC	12/18	WHITE	0023502.030
	12/18	BLACK	0023502.090
	12/18	RED	0023502.110
	2019	WHITE	0023680.030
	2019	BLACK	0023680.090
	2019	RED	0023680.110
	20/21	SILVER	0023197.020
	20/21	WHITE	0023197.030
	20/21	BLACK	0023197.090
20/21	RED	0023197.110	
RR 4T 350/430	12/18	WHITE	0023502.030
	12/18	BLACK	0023502.090
	12/18	RED	0023502.110
	19/21	WHITE	0023680.030
	19/21	BLACK	0023680.090
19/21	RED	0023680.110	

MODEL	YEAR	COLOR	CODE
RR 4T 390	20/21	WHITE	0023680.030
	20/21	BLACK	0023680.090
	20/21	RED	0023680.110
RR 4T 400	12/18	WHITE	0023502.030
	12/18	BLACK	0023502.090
	12/18	RED	0023502.110
	2019	WHITE	0023680.030
	2019	BLACK	0023680.090
2019	RED	0023680.110	
RR 4T 450/498	12/18	WHITE	0023502.030
	12/18	BLACK	0023502.090
	12/18	RED	0023502.110
	2019	WHITE	0023680.030
	2019	BLACK	0023680.090
2019	RED	0023680.110	
RR 4T 480	12/18	WHITE	0023502.030
	12/18	BLACK	0023502.090
	12/18	RED	0023502.110
	19/21	WHITE	0023680.030
	19/21	BLACK	0023680.090
19/21	RED	0023680.110	
RR 4T 350/390/430/480 RC	20/21	SILVER	0023197.020
	20/21	WHITE	0023197.030
	20/21	BLACK	0023197.090
	20/21	RED	0023197.110



BREMBO PUMP COVERS

- Polypropylene pump cover;
- Protection for Brembo clutches and brake master cylinders manufactured after 2014;
- Shock resistant and reduces wear of the plates;
- O-Ring fixing;
- **INSTALLATION DOESN'T REQUIRE LOOSENING ANY SCREWS;**



FOOT PEG COVER



orange
code: **0011469.010**



grey
code: **0011469.020**



black
code: **0011469.090**

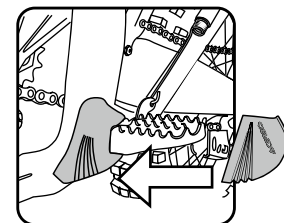

UPPER FORK COVERS

- Rubber fork protections with carbon effect finishing.
- Protects against track debris and reduces wear to the upper fork.
- **QUICK INSTALLATION AND NO NEED TO REMOVE THE FORKS BECAUSE OF THE hook and loop fastener STRAPS**

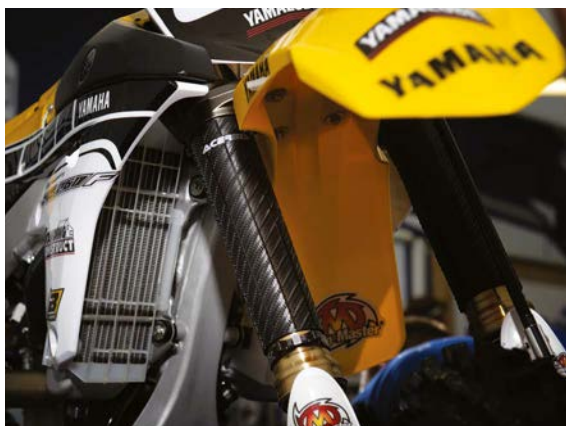

UPPER FORK COVERS
• ø 43/50 mm.

hook and loop fastener



orange
code: **0021750.010**



blue
code: **0021750.040**



yellow
code: **0021750.060**



black
code: **0021750.090**



red
code: **0021750.110**



green
code: **0021750.130**

FORK GAITERS



hook and loop fastener

SHORT hook and loop fastener FORK GAITERS
• ø 45/50 mm.

code: **0016976.090**



NEOPRENE FORK GAITERS
• 365 mm.
• ø 40/50 mm

code: **0005094.090**



Z-MUD FORK GAITERS

- Protects the shaft from mud, sand and dust.
- Maximum fork movement.
- Suitable for (upside down) fork with diameter Ø 46/50 mm.
- Simple installation and Maintenance thanks to the zip fastening system



X-TYRE COVER

COMPOSITION:

- 50% Polyester
- 50% PVC

USE: Wheel covers are used to avoid getting the bike's tyres dirty in the presence of mud and/or sand (for example after washing the bike), or before a competition at the starting grid, to avoid clogging the tyre treads, allowing the rider to have a fast start with the best possible grip and riding control.

APPLICATION: The kit consists of two Tyre covers: one for 21" front wheel and one for 18" and 19" rear wheel.

FITTING: The tyre covers can be quickly and intuitively fitted thanks to the hook and loop fastener.

MAINTENANCE AND WASHING: by washing machine at 30 ° or high pressure washer (cold water)

MATERIALS: Polyester and PVC fabric resistant to wear and tear.





MODEL	YEAR	CODE
HONDA		
CR 85 R	03/10	0015671.
CRF 150 R	07/20	0015672.
CR 125/250 R	02/08	0001193.
CRF 250 R	04/09	0007751.
	10/13	0016078.
	14/17	0016909.
	18/20	0022622.
CRF 250 X	04/16	0007751.
CRF 450 R	03/08	0007751.
	09/12	0016078.
	13/16	0016909.
CRF 450 R/RX	17/20	0022622.
CRF 450 X	03/16	0007751.
XR 250 R/400 R/600 R	85/08	0001194.
CRF 250/300 RX	19/20	0022622.
CRE 450 F	05/06	0007751.
KAWASAKI		
KX 85	01/20	0015677.
KX 125 - 250	02/08	0001199.
KXF 250	06/16	0007841.
	17/19	0021893.
KXF 450	06/15	0007841.
	16/18	0021893.
	2019	0023547.
KX 450 4T	2020	0021893.
	2020	0023547.
YAMAHA		
YZ 65	19/20	0023548.
YZ 85	00/20	0015673.
YZ 125 - 250	97/20	0001212.
YZ 250 F	01/13	0001212.
	14/18	0017576.
	19/20	0022982.
YZ 450 F	03/09	0001212.
	10/13	0015674.
	14/17	0017576.
	18/20	0022982.
WR 250 F	01/02	0001212.
	03/10	0011657.
	15/19	0017576.
WR 450 F	03/10	0011657.
	16/18	0017576.
	19/20	0022982.
YZ/WR 400 F	98/99	0001212.
WR 426 F	00/02	0001212.
KTM		
SX 65	97/20	0023549.
SX 85	2004	0001213.
	05/12	0011653.
	13/17	0015675.
	18/20	0022980.
SX 125	98/03	0001213.
	04/06	0011653.
	07/10	0011654.
	11/15	0015675.
	16/20	0021752.
SX 150	09/10	0011654.
	11/15	0015675.
	19/20	0021752.
SX 250	98/03	0001213.
	04/06	0011653.
	07/10	0011654.
	11/16	0015675.
	17/20	0021752.
SX-F 250	2006	0011653.
	07/10	0011654.
	11/15	0015675.

MODEL	YEAR	CODE
	16/20	0021752.
SX-F 350	11/15	0015675.
	16/20	0021752.
SX-F 450	03/06	0011653.
	07/10	0011654.
	11/15	0015675.
	16/20	0021752.
EXC 125	98/03	0001213.
	04/06	0011653.
	07/11	0011654.
	12/16	0015675.
EXC 150 TPI	2020	0021752.
EXC 200	98/03	0001213.
	04/06	0011653.
EXC 250	98/03	0001213.
	04/06	0011653.
	07/11	0011654.
	12/16	0015675.
	2017	0021752.
EXC 250 TPI	18/20	0021752.
EXC 300	98/03	0001213.
	04/07	0011653.
	08/11	0011654.
	12/16	0015675.
	2017	0021752.
EXC 300 TPI	18/20	0021752.
EXC-F 250	04/07	0011653.
	07/11	0011654.
	12/16	0015675.
	17/20	0021752.
EXC-F 350/450	12/16	0015675.
	17/20	0021752.
EXC-F 400	12/16	0015675.
EXC-F 450	03/06	0011653.
EXC-F 500	17/20	0021752.
EXC-F 400/520/525/540	01/06	0011653.
LC4 400	00/03	0001213.
LC4 520	00/02	0001213.
LC4 525	2003	0001213.
XC 250/300 TPI	2020	0021752.
XC-F 250/350/450	2020	0021752.
XC-W 125	17/20	0021752.
XC-W 150/250/300 TPI	2020	0021752.
XCF-W 350/500	2020	0021752.
SUZUKI		
RM 85-85 L	02/14	0015676.
RM 125	04/09	0011656.
RM 250	03/10	0011656.
RMZ 250	07/18	0011656.
	19/20	0022981.
RMZ 450	05/17	0011656.
	28/20	0022981.
HUSQVARNA		
CR/WR 125 - 250	92/11	0001206.
CR/WR 360	92/03	0001206.
WRE 410/610	97/05	0001205.
TC 65	17/20	0023549.
TC 85	14/17	0015675.
	18/20	0022980.
TC 125	14/18	0015675.
	16/20	0021752.
TC 250	02/11	0001206.
	15/18	0015675.
	16/20	0021752.
TC 300	14/18	0015675.
TC 450	02/10	0001206.
TC 510	03/09	0001206.
TE 125	14/16	0015675.



AIR FILTERS

MODEL	YEAR	CODE
TE 150 I	2020	0021752.
TE 250	02/11	0001206.
	14/16	0015675.
TE 250 I	17/20	0021752.
TE 300	14/16	0015675.
TE 300 I	17/20	0021752.
	18/19	0015675.
TE 410	97/05	0001206.
TE 450	02/10	0001206.
TE 510	03/09	0001206.
TE 610	97/05	0001206.
TX 125	17/19	0015675.
	17/19	0021752.
FE 250/350/450/501	14/17	0015675.
	14/20	0021752.
FC 250/350/450	14/20	0021752.
HUSABERG		
TE 125/250/300	11/12	0011654.
TE 125/250/300	13/14	0015675.
FE 250/350/450	13/14	0015675.
BETA		
RR 2T 125/200	2020	0024310.
RR 2T 125/250 RC	2020	0024310.
RR 2T 250/300	13/18	0022398.
	2020	0024310.

MODEL	YEAR	CODE
RR 2T 250/300 RC	2020	0024310.
RR 2T 250/300 X-TRAINER	2020	0024310.
RR 4T	13/18	0022398.
350/390/400/430/450/480/498		
RR 4T 350/390/430/480 RC	2020	0024310.
RR 4T 430/480	15/18	0022398.

UNIVERSAL MUD FLAP



code: **0008320.090**

FILTER COVER

MATERIAL:

- 100% rubber.

DETAILS:

- Universal lid in rubber.
- Protects the suction body during washing.
- Also compatible with KTM e HUSQVARNA from 2016.

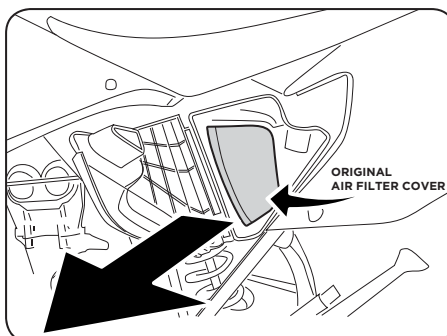

1. Rimuovere il filtro con gabbia.
Remove the filter with cage.

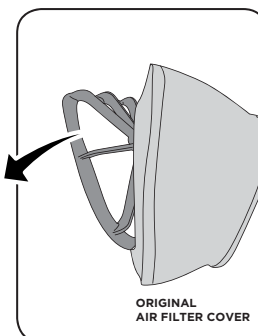

2. Sfilare il filtro dalla gabbia.
Remove the filter from the cage.

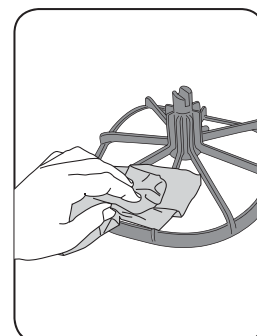

3. Pulire la gabbia con un panno pulito.
Clean the cage with a clean cloth.



code: **0022709.090**

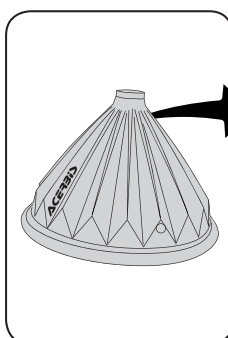

4. Calzare la protezione universale sulla gabbia.
Fit the universal protection on to the cage.

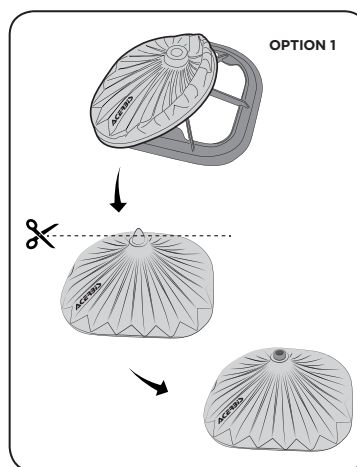

5. Incidere la gomma nella zona di massima pressione del perno, permettendone la fuoriuscita.
Cut the rubber in the area of maximum pressure of the pin, allowing for spillage.

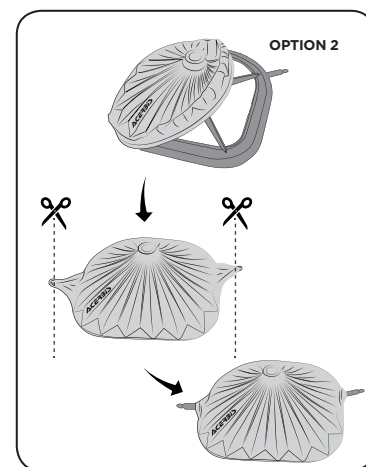

6. Incidere la gomma nella zona di massima pressione dei perni, permettendone la fuoriuscita.
Cut the rubber in the area of maximum pressure of the pins, allowing for spillage.

X-EXHAUST PROTECTOR

X-EXHAUST

DETAILS

- Easy to mount with adjustable metal clamps
- Resistant to high temperatures
- Avoid contact of trousers and boots with hot exhaust



Orange 16
code: **0024259.011.016**



Black
code: **0024259.090**

MODEL	YEAR	COLOR	CODE
BETA			
RR 4T 350/390/430/480	12/20	ORANGE	0024259.011.16
	12/20	BLACK	0024259.090
HUSQVARNA			
FC 250/350/450	14/20	ORANGE	0024259.011.16
	14/20	BLACK	0024259.090
FE 250/350/450/501	14/20	ORANGE	0024259.011.16
	14/20	BLACK	0024259.090
FX 350/450	2020	ORANGE	0024259.011.16
	2020	BLACK	0024259.090
KTM			
EXC-F 250/350/450/500	12/20	ORANGE	0024259.011.16
	12/20	BLACK	0024259.090
SX-F 250/350/450	12/20	ORANGE	0024259.011.16
	12/20	BLACK	0024259.090
SHERCO			
SEF-R 250/300/450	12/20	ORANGE	0024259.011.16
	12/20	BLACK	0024259.090
SEF-R 500	2020	ORANGE	0024259.011.16
	2020	BLACK	0024259.090



TA-TIRE BELT

TA-TIRE BELT

DETAILS:

- Ultra resistant Nylon structure
- Designed to lift the motorcycle in case of extreme difficulty
- Easy installation on the forks of the bike
- Strong and easy to handle
- One size

black
code: **0023578.090**



TA-TIRE DRE BELT FOR KTM AND HUSQVARNA

TA-TIRE DRE BELT

DETAILS:

- Ultra resistant Nylon structure
- Designed to lift the motorcycle in case of extreme difficulty
- Easy installation to the rear frame using the bushings included in the package
- Length adjustable strap
- Strong and easy to handle



black
code: **0024499.090**



MODEL	YEAR	COLOR	CODE
HUSQVARNA			
FE 250/350/450/501	2020	BLACK	0024499.090
TE 150 I/250 I/300 I	2020	BLACK	0024499.090
KTM			
EXC 150/250/300 TPI	2020	BLACK	0024499.090
EXC-F 250/350/450/500	2020	BLACK	0024499.090
XC-W 125	2020	BLACK	0024499.090
XC-W 150/250/300 TPI	2020	BLACK	0024499.090
XCF-W 350/500	2020	BLACK	0024499.090

KIGNOL TIE-DOWN

MATERIALS:

Nylon 100,00%

DETAILS:

- Limits pressure on the fork during transport, when the hydraulic seals of the suspension are under strain from the pressure exerted by the motorbike straps
- Is easily positioned by fastening and snapping it into place to the forks, between the front wheel and the front mudguard, making the motorbike stabler
- Can be used for transport with a trailer, van or pick-up
- Tab sticker in the middle with the possibility of customising with a marker
- Includes bar ends and a wall guard cap, to prevent chafing between the bar and the side wall of the van or walls and where bars come into contact with each other when transporting several motorcycles on the trailer
- The bar end can be used with closed and open handguards
- Resistant and light
- Quick installation



orange
code: **0024498.010**



white
code: **0024498.030**



black
code: **0024498.090**

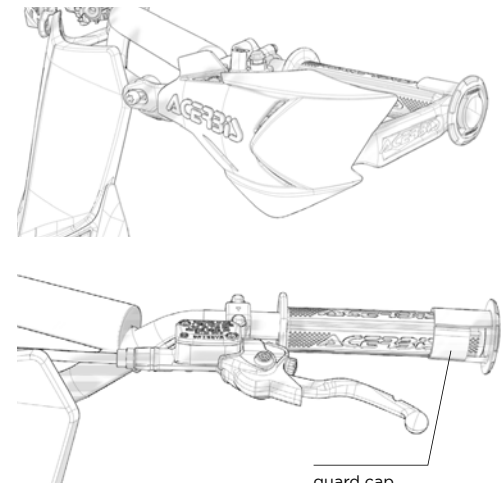

TIE DOWNS

TIE DOWNS 35 mm. (2 PCS.)

Lunghezza fibbia : 185 mm
Lunghezza compresa di ganci : 205 mm



blue

code: **0010355.040**



yellow

code: **0010355.060**



black

code: **0010355.090**



red

code: **0010355.111**

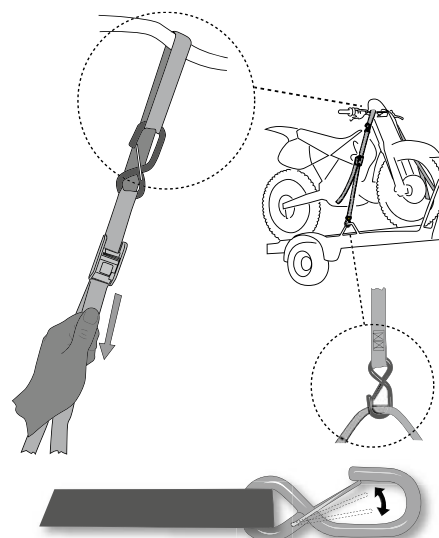

TIE DOWNS 25 mm. (2 PCS.)

Lunghezza fibbia : 177 mm
Lunghezza compresa di ganci : 200 mm



blue

code: **0009266.040**



yellow

code: **0009266.060**



black

code: **0009266.090**



red

code: **0009266.111**



orange

code: **0009266.010**



TENAY BELT

TENAY BELT (2 PCS.)

DETAILS:

- Length : 170 cm x 25mm
- Maximum tensile load: 80kg
- Set of two belts equipped with non-slip safety metal buckle



grey
code: **0023893.070**



black
code: **0023893.090**



REROY HOUR METER



DETAILS:

- No power supply required
- Simple installation with double-sided tape
- Battery included
- It turns on automatically with the engine's vibrations
- 2 hour-counter functions: 1 total + 1 partially resettable
- Lock function to prevent its activation during transport
- Waterproof IP68
- Possibility to improve or reduce sensitivity
- 0.1 hour resolution
- Wireless operation



black
code: **0024275.090**

APPLICATION:

Can be mounted on cross / enduro / motard / ATV / moped / maxi enduro / trial

APPLICATION:

Può essere montato su cross / enduro / motard / ATV / scooter / enduro stradali / trial

UHR BAR PAD



COMPOSITION:

70% Polyvinyl chloride, 26% ethylene-co-vinyl acetate, 4% Polyamide

DETAILS:

- With small compartment (75x50x40mm) for storing car keys; paper towels, etc. with zippered closure.
- TPR cover with excellent resistance to tearing.
- Made of foam material to reduce shock in case of impact
- Extremely light
- hook and loop fastener fastening
- Permanent wash-proof graphics

Provided with a microcomputer with the following functions:

- Watch
- Stopwatch
- Timer
- n.3 hour counter: 1 cumulative (non-resettable) and 2 partial resettable
- SVC: Scheduled maintenance alert
- The hour counter is activated automatically by the vibrations of the engine when the motorcycle is moving.
- Lock function to prevent the hour counter from being activated while the motorcycle is being transported
- Waterproof -- IP68
- No external power supply required - Battery included



black/grey
code: **0024501.315**



X-BAR BAR PAD

DETAILS:

- Cover in highly resistant TPR
- Created in foam material to absorb the blow in case of an impact
- Extremely lightweight
- hook and loop fastener fastening
- Permanent wash-proof graphics



black/orange
code: **0023450.313**



black/white
code: **0023450.315**



black/grey
code: **0023450.319**

ACERBIS LOGO CROSS BAR PAD



code: **0016279.090**

LIQUID BREAKERS

	CAPACITY	CODE
1	500 ml.	0001010.
2	1000 ml.	0001011.
3	500 ml.	0000045.
4	250 ml.	0000030.
5	250 ml.	0000648.



01
500 ml.

02
1000 ml.

03
500 ml.

04
250 ml.

05
250 ml.



ELEVATOR BIKE STAND

DETAILS:

- Steel constructed Lift-Stand with an additional damper to slow the period of descent when lowering.
- Rubber upper deck with adjustable height to adapt to most full-size off-road dirt-bikes as well as youth/mini bikes.
- Rotating upper deck to allow movement of the bike during maintenance.
- Locking mechanism to secure the stand and prevent accidental lowering of the bike.
- Maximum height of the bike: adjustable from 33 to 46 cm / 13" to 18".
- Minimum height of the bike: adjustable from 23,5 to 36 cm / 9 1/4" to 14" for minicross
- Maximum load: 160 Kg / 352lb.



black
code: **0023860.090**



Maximum load:

160 Kg

Capacità max di carico:

160 Kg

711 STAND

Maximum load:

220 Kg

Capacità max di carico:

220 Kg



orange
code: **0023453.010**



blue
code: **0023453.040**



grey
code: **0023453.070**



black
code: **0023453.090**



red
code: **0023453.110**



green
code: **0023453.130**

YOGA STAND

- folding stand
- cavalletto pieghevole

Maximum load:
150 Kg

**Capacità max
di carico:**
150 Kg



white
code: **0023580.030**



black
code: **0023580.090**



SILENCER END CAP
2/4 STROKES
code: **0009601.090**



HANDLEBAR END CAP
pcs: **10 pcs. set**
code: **0012989.090**



SILENCER END CAP DISPLAY
2/4 STROKES
pcs: **36 pcs. set** (18 yellow / 18 black)
code: **0011550.120**



REAR VIEW MIRROR
LEFT
code: **0000541.090**



REAR VIEW MIRROR
RIGHT
code: **0000587.090**



ACERBIS PHONE STAND

code: **0024241**



orange
code: **.010**

blue
code: **.040**

black
code: **.090**

red
code: **.110**



CASE TABLET CORPORATE 10.5"

code: **0024300.090**



COMPONENTS:

Shell: 88% Neoprene, 4% Nylon, 8% Others

Padding: 100% Polyester



MINI NUMBER PLATES

code: **0002159.**



black
0002159.090



white
0002159.030



orange
0002159.010



green
0002159.130



fluo green
0002159.131



red
0002159.110



fluo orange
0002159.014



blue
0002159.040



yellow
0002159.060

ACERBIS MEDICAL BAG

code: **0022758.090**



ACERBIS LAUNDRY BAG

code: **0022759.090**



ACERBIS TOWEL 80x140cm

code: **0022715.040**



TRI-ANGOL HELMET DISPLAY

code: **0023590.090**



ACERBIS BIB (5 PIECES PACK)

code: **0017020**



yellow
code: **.060**



orange
code: **.010**



fluo light blue
code: **.047**



green
code: **.130**



fucsia
code: **.141**

SIZES

S	code: .062	XXL	code: .069
L	code: .066		



ACERBIS TNT BANNER

size: **580 x 80 cm.** (1 logo)
code: **0020068.**



• with 6 rings and 6 ties • con 6 anelli e sei fascette

ACERBIS TNT BANNER

size: **52,20 x 0,80 mt.** (9 logos)
code: **0020065.**



TENT ACERBIS ROOF

code: **0022946.060**
ONLY COVER



ACERBIS TENT

size: **3x3 mt.**
code: **0012490.060**



TRACK MARKER
code: **0009606.060**

56pcs PACK

orange: **0016905.010**
white: **0016905.030**
blue: **0016905.040**
yellow: **0016905.060**



RACE TAPE

size: **500 mt.**
code: **0020066.**

IN ACTION TAPE

size: **250 mt.**
code: **0024261.**



WEB TAPE

size: **250 mt.**
code: **0024260.**



ACERBIS FLAG

height: **± 4,5 mt.**
code: **0012213.279**

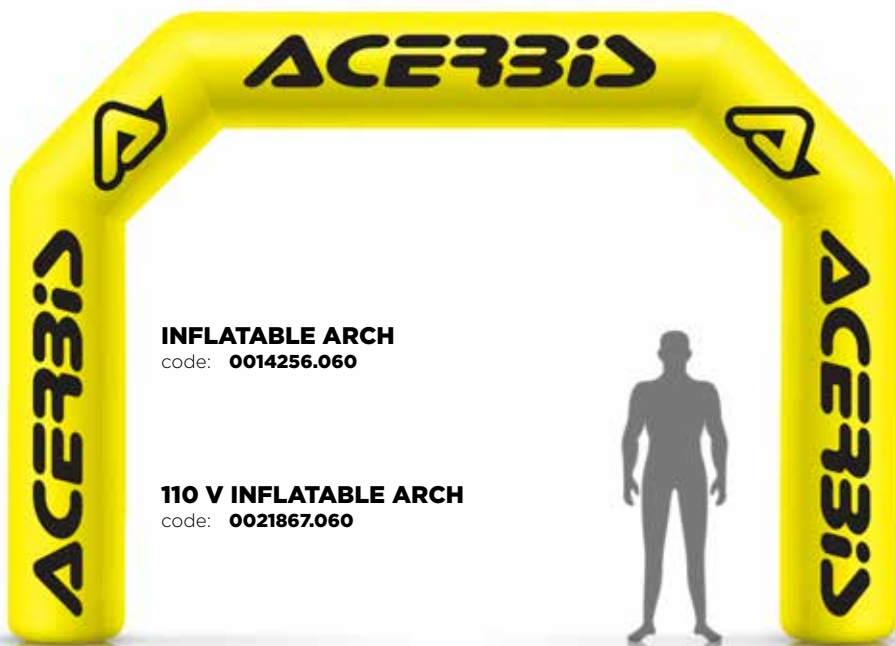

INFLATABLE ARCH
code: **0014256.060**

110 V INFLATABLE ARCH
code: **0021867.060**

PIT BOARD
code: **0011526.090**



COTTON GLOVES INCLUDED

COTTON GLOVES
code: **0016429.060**



MARKERS

5 pcs. set
colors: **YELLOW**
code: **0012965.060**



MECHANIC BUT
code: **0023827.279**

SIZES

S	code: .062	XL	code: .068
M	code: .064	XXL	code: .069
L	code: .066		



OOSET BOOTS
code: **0023859.060**
sizes from 40 to 47



light blue/white
code: **0022497.432**

ACERBIS PLATE STICKER



red/white
code: **0022497.110**



green/white
code: **0022497.131**



orange/white
code: **0022497.203**



white/orange
code: **0022497.229**



white/blue
code: **0022497.232**



white/black
code: **0022497.237**



white/red
code: **0022497.239**



white/green
code: **0022497.241**



blue/white
code: **0022497.245**



black/orange
code: **0022497.313**



black/white
code: **0022497.315**



black/blue
code: **0022497.316**



black/yellow
code: **0022497.318**

GOSIT BOTTLE
Capacity: **0,5L**



white
code: **0023458.030**



blue
code: **0023458.040**



yellow
code: **0023458.060**



red
code: **0023458.110**



ACERBIS RACE UMBRELLA

size: **ø 120 cm.**
code: **0013889.**



MOTO CARPET
RACE CERTIFIED

size: **200 x 100 cm.**
code: **0021696.318**



MOTORBIKE COVER

code: 0020086.060



CORPORATE MOTORBIKE COVER

code: 0022505.090

COMPOSITION:

- 100% Water repellent polyester

DETAILS:

- Stretch cuff on the bottom to envelop the bike
- Suitable for internal and external use
- Closure at the bottom for attaching the cover to the bike
- Silver Acerbis Logo
- For super sport, touring sport, touring, adventure, naked motor cycle
- Cover with zip



SBK MOTORBIKE COVER

code: 0022359.090

COMPOSITION:

- 100% Water repellent polyester

DETAILS:

- Stretch cuff on the bottom to envelop the bike
- Suitable for internal and external use
- Closure at the bottom for attaching the cover to the bike
- Acerbis SBK Logo
- For super sport, touring sport, touring, adventure, naked motor cycle
- Cover with zip



SHOPPER BAGS

pcs: **100 pcs. set**
code: **0023988.090**

COMPOSITION:
100% Polyethilene



SHOES BAGS

pcs: **50 pcs. set**
code: **0021818.060**

pcs: **5 pcs. set**
code: **0022549.060**



EVO WATER BOTTLE

100% PE
Capacity: **0,75L**
code: **0022923.060**



EVO SWIMMING TRUNKS

80% POLYAMIDE - 20% ELASTOMER
code: **0009794.040**

SIZES

M	code: .064	L	code: .066
----------	-------------------	----------	-------------------



EVO WATER BOTTLE CARRIER

100% PE
Sizes: **27,5x18x33 cm**
code: **0022922.090**



EVO SLIPPERS

100% PVC
code: **0021672.090**

SIZES

40	code: .040	43	code: .043
41	code: .041	44	code: .044
42	code: .042	45	code: .045



DUMMY

code **0013038.030**



INFLATABLE HALF-BUST MANNEQUIN

code **0023846.070**

- Hanging inflatable half-bust mannequin
- Specific for body armour and jackets
- 1 pcs /set



MECHANIC SUIT OTTANO 2.0

code: **0023193.**



GILET FOTOGRAFO ACERBIS

code: **0024270.**

COMPONENTS:

Shell: 70% Nylon, 30% Polyester

Lining: 100% Polyester



SIZES

M	code: .064	XL	code: .068
L	code: .066	XXL	code: .069



dark grey
0024270.073