



# 2020 MOTORCYCLE ACCESSORIES

 **ariete**®

MANUFACTURED IN ITALY  Since 1947

WELCOME TO



MANUFACTURED IN ITALY  Since 1947

Rosco Felcher/MX\_WAR - Photo CIPPO68



## UK EXCLUSION OF LIABILITY

Ariete, ARI and Harri's products, while being of very high quality, may be subject to damage in case of impact or accident. Before using Ariete, Ari or Harri's products, please carefully read the instructions for use and installation. Sandro Mentasti Srl makes every effort to ensure that the information contained in this catalogue is correct and easy to understand, with some information specific to individual products, but accepts no responsibility for any misinterpretation. In any event, Sandro Mentasti Srl is not liable for any damage to property and/or persons caused during the use of its products, and neither for any damage resulting from incorrect use and/or use other than that for which the product was originally intended, and damage resulting from assembly errors and/or incorrect installation.

Sandro Mentasti Srl manufactures its products directly, and markets them with the ARIETE, ARI and HARRI'S brands. The use contained within the catalogues of any original product codes bearing brands other than those mentioned above is intended as merely descriptive, as well as the possible use of trademarks and / or names of other manufacturers (for example, PIAGGIO®, HONDA®, YAMAHA®, SUZUKI®, KAWASAKI®, BMW®, VESPA®, KYMCO®) which Sandro Mentasti Srl is in no way connected. The only purpose of this use is to describe the accessory and/or the part.

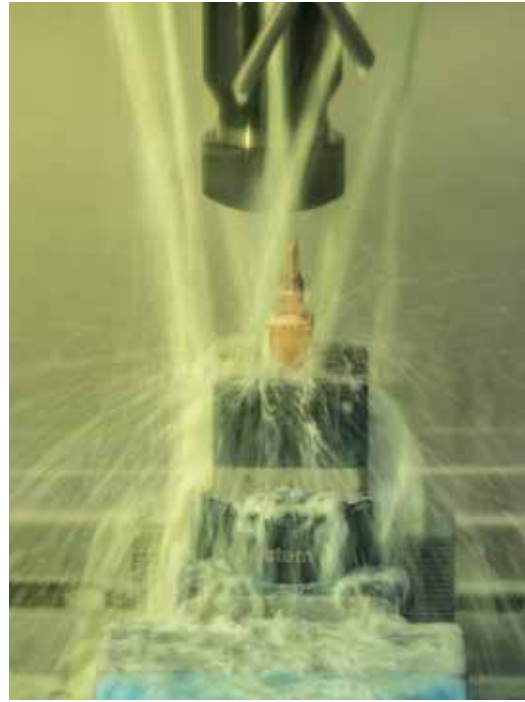

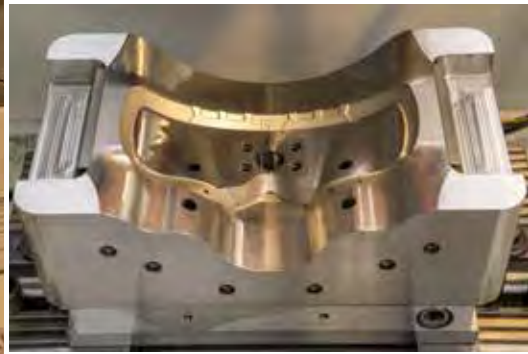

OFF-ROAD GOGGLES

LIGHT ENDURO ROAD GOGGLES

OFF-ROAD GRIPS/ACCESSORIES

ROAD GRIPS/ACCESSORIES

TECHNICAL PARTS/ACCESSORIES



- Mudmax Goggles
- Mudmax Enduro Goggles
- Mudmax Anvil Goggles
- Mudmax Easy Goggles
- Adrenaline Primis Plus Goggles
- Adrenaline Profi Plus Goggles
- RC Flow Goggles
- Rally Goggles
- Snowmobile Goggles
- 07 Next Gen Goggles
- Lenses for Adrenaline – RC – Mudmax
- Lenses for 07 Next Gen
- Tear-offs
- Big/XL Roll-off
- RC Spare parts
- Merchandising
- Mudmax Racer Goggles
- Mudmax Racer Special Goggles
- Feather Goggles
- Feather Lite Goggles
- Vintage Goggles
- Vulcan grips
- Trinity grips
- Duality Grips
- Unity Grips
- Kids Grips
- ATV-Cycle | Trial | Rally | Classic Grips
- Off-Road Accessories
- Fork Gaiters
- Ariram Grips
- Aries Grips
- Estoril Road Grips
- Standard road Grips
- Ariete Heritage Grips
- Grips by Brand
- Scooter Grips
- Harri's Grips & Tank protectors
- Aluminium Racing Valves
- ARI The Original Fork Oil Seals
- Brake Caliper – Master Cylinder Seal Kits
- DOT3-DOT4 Fluid pipe
- Fuel Pipes
- Merchandising

## UK CERTIFICATIONS

Our Quality is the result of 70 years of work

The quality starts and progresses into a management system that integrates checks on products and processes.

The full control over all the manufacturing steps allows us to fully comply with the Client's requirements, but more importantly, enables us to offer the guarantee of a flawless service, at any moment.

Sandro Mentasti Srl has received the certification issued by the **TUV THURINGEN e.V** Certification Body, for its own Quality and Safety Management System.



#I\_AM\_ARIETE\_ORIGINAL



**UK |** Be assured that the original ARIETE® products guarantee compliance with the highest measures of quality and Environmental protection set by the strict standards of Sandro Mentasti Srl.

Recently, many imitations of our Ariete® products have been put on the market, also imitations of our HARRI'S® and ARI®-the original fork oil seals. These low-quality models pose a risk to the user's safety both on the road and off-road.

**WARNING: DO NOT BUY COUNTERFEIT and NON-ORIGINAL PRODUCTS**

In order to find out whether the purchased item is original by Ariete® or is counterfeit, we apply a hologram to the original packaging to check its authenticity in a few easy steps.



# WE HAVE A GREEN HEART

Sandro Mentasti Environmental Protection Program. This project, founded in 2007, is born out of the desire to promote and apply a more environmentally friendly business culture based on the compatibility between our industry and environmental protection. The commitment aims at reducing energy consumption in production, at eliminating toxic materials, and looks at a proper development of research and technological innovation with the goal of respecting the natural environment. All of our products marketed with Ariete, Harri's and ARI brands are the expression of our philosophy of dialogue between ecology and industry. Concrete results have already been achieved in the company's energy saving through ecologically certified electrical transformers, in the management of special waste disposed of in compliance with law by specialized and homologated companies, in the management of recycling, in the drastic reduction in water consumption by means of a closed loop system for the thermo-conditioning of presses and equipment, in the optimization of the heating system of the departments and offices thanks to new thermal condensing boilers with almost zero emissions in the atmosphere, in the considerable saving of paper for internal use (forms, photocopies, e-mail prints, etc.), and the adoption of packaging of ecologically classified products, with catalogs printed strictly on "certified" recycled paper.

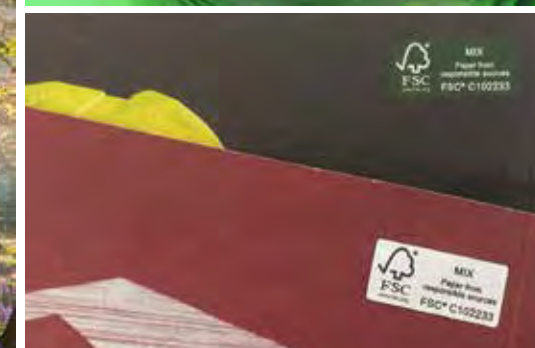



### **RACE-BASED DEVELOPMENT**

**UK** Each project is refined and tested by Ariete riders in relevant off-road world championship events. Rider feedback is agreed and incorporated into the final design before this is submitted to the certifying authority for approval.

### **ERGONOMICS AND AVANT-GARDE DESIGN**

**UK** The shape of Ariete goggle frames was born from experience under extreme conditions. Ariete technicians have focused on the ergonomics of the frame to ensure that it perfectly fits the rider's face.

### **HIGH TECHNOLOGY**

**UK** Ariete goggle frames and ancillary components are made with the best technology available. The quality of the tooling ensures that the finish achieved is exemplary.



## FINE MATERIALS

**UK** The search for new materials is never-ending. Ariete has for years worked with the world's best-known petro-chemical companies. The materials used are the result of research carried out by these companies, and are the best we can find.

## SAFETY

**UK** The ARIETE lens will withstand a 6 mm. steel ball hitting it at 135 miles per hour!  
The anti-fog treatment withstands more than twice the minimum requirement of standard 168: 2001.16

## CERTIFICATIONS & MARKING

**UK** Ariete goggles and lenses are certified according to European standards EN 1938:2010; they are provided with Anti-fog treatment, which is optional under European standard EN 1938:2010; they pass the "High Mass" and "High velocity" impact tests provided for by American ANSI standard Z87.1-2003; they meet the requirements of American standard VESC-8. The label on the goggles provides the transparency categories of Ariete lenses.





The Ariete Ventilation System uses carefully chosen areas for the intake and exhaust of cooling air. Airflow from the goggles, whose upper front profile is specially lowered to aid this process, enters the collecting vents at the front of the helmet, flows across the rider's head, and leaves the back of the helmet in a continuous process.

## ARIETE VENTILATION SYSTEM

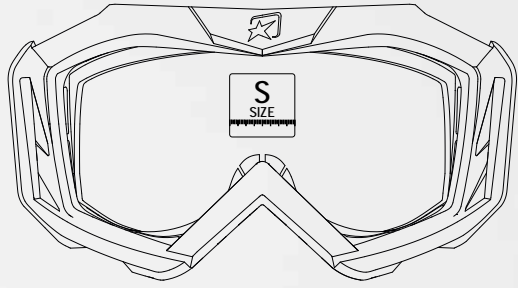

## 07 NEXT GEN

Tight comfort  
Compact structure

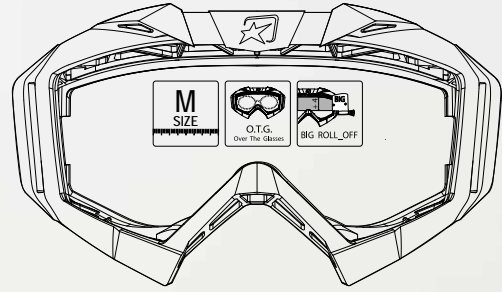

## ADRENALINE

Extra Ventilation

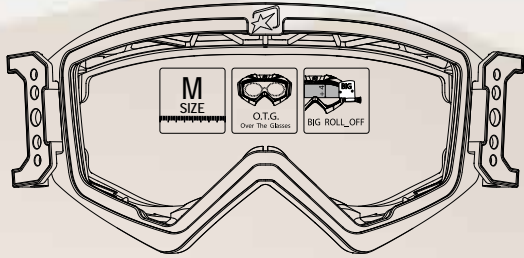

## MUDMAX

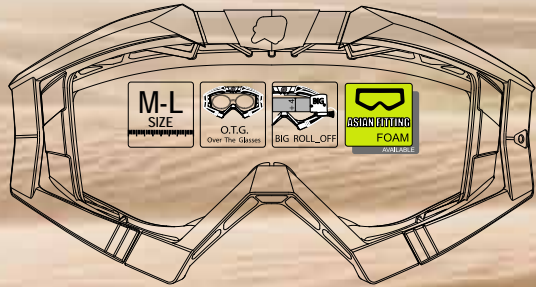

## RIDING CROWS

3D Thermoformed Foam For Improved Fit  
Adjustable Outriggers For Perfect Helmet Fit

### UK One lens fits all Ariete goggles

- ★ UV rays total protection
- ★ Best Anti fog coating
- ★ Distortion-free lenses
- ★ Lexan® lenses
- ★ AVS Ariete Ventilation System
- ★ Hypo-allergenic foams in contact with the skin
- ★ Elastic strap with anti-slip silicone bead
- ★ Double buckle for quick adjustment
- ★ Safety and Certifications
- ★ Made in Italy

## GOGGLES FEATURES GUIDE

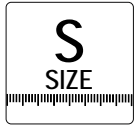

Size S

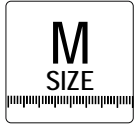

Size M

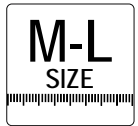

Size M-L

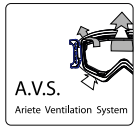

Ventilation System



Comfortably Fits Glasses

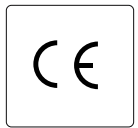

Safety and Certifications



Hand made padding



Elastic strap with anti-slip silicone

## FRAME FEATURES GUIDE

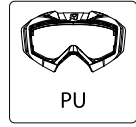

Polyurethane

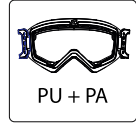

Polyurethane + Polyamide



Polyamide + Polycarbonate

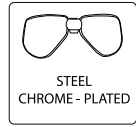

Steel chrome-plated frame



Adjustable Outriggers For Perfect Helmet Fit



Ultra Lightweight frame

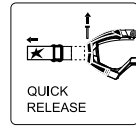

Quick release

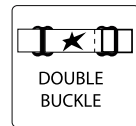

Double buckle for quick adjustment

## FOAM FEATURES GUIDE

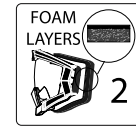

2 layer face foam specification

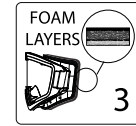

3 layer face foam specification



Layer of red hypo-allergenic CARBON X

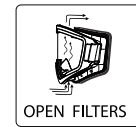

Open filters

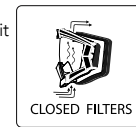

Closed filters



Extra-thick foam



fitting foam version available Disponibile



3D thermoformed foam

## LENSES FEATURES GUIDE

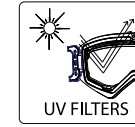

UV rays total protection



Best Anti fog coating

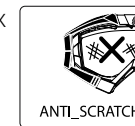

Anti-scratch treatment



Spherical lens



Photochromic lens cat.0—>1



Double, cylindrical, ventilated lens

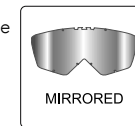

Mirrored multi-layer lens cat.2



Mirrored smoked lens "Plus" cat. 1

**UK Antistatic - Bacteriostatic - Heat regulating and moisture transfer - Natural - Reflective**

- High Performance
- Heat regulating and moisture transfer - Speeds up the evaporation process of perspiration and slows down the formation of humidity on the skin to help keep the temperature constant.
- Antistatic - Reacting to natural conductivity in nature, the fiber absorbs and disperses electric charges accumulated from the environment or during physical exercise, to prevent shock and the attraction of dust particles to the product.
- Bacteriostatic - Protects the skin from bacteria and pollutant dusts, eliminating the risk of annoying allergies.
- Natural - 100% natural, non-toxic and does not contain chemicals.
- Reflective - Protects the body from absorbing static energy, electrosmog, and UV rays.



## HIGH PERFORMANCE

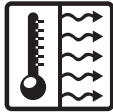

Heat regulating and moisture transfer



Performance



Antistatic



Natural



Bacteriostatic



Reflective





Tommaso Montanari - Photo C. Morello



## UK

### 1 FRAME

- Medium Fit
- Enhanced vision field on the lower lens for downhill riding
- Comfortably Fits Glasses (O.T.G.)
- Tough PUR frame for low-temperature flexibility
- Anti-UV colours
- Compatible with BIG/XL Roll-Off Kit 12962-RCRO

### 2 LENS

- Mirrored multi-layer lens cat.2
- No optical distortion
- Best anti-fog treatment
- UV radiations total protection

### 3 VENT SYSTEM

- A.V.S. Ariete Ventilation System
- Extra Ventilation
- Open filters

### 4 FOAM

- Three-layer face foam specification composed of :
  - 1st layer is technical foam with closed cells
  - 2nd layer is super-soft technical foam with open cells
  - 3rd layer of red hypo-allergenic CARBON X in contact with the skin

### 5 ELASTIC STRAP

- 45 mm height elastic strap with anti-slip silicone
- Pin to suit tear-off
- Double buckle for quick adjustment

### INCLUDED ACCESSORIES

- Lexan® clear lens, CE, anti-scratch treatment, cod.12961-RCCH equipped with clips
- Microfibre bag with internal pocket for a spare lens



14940-BSG

CAT. 2   SINGLE



14940-BAA

CAT. 2   SINGLE



14940-BRR

CAT. 2   SINGLE



14940-BVN

CAT. 2   SINGLE



14940-BCG

CAT. 0   SINGLE



14940-BSB

CAT. 0   SINGLE

FEATURES

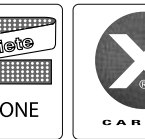
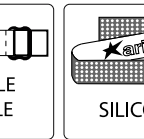
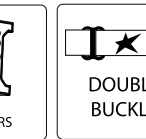
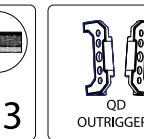
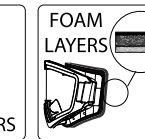
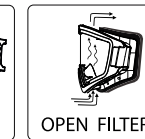
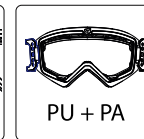
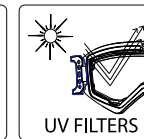
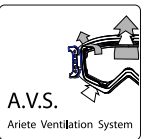

INCLUDED

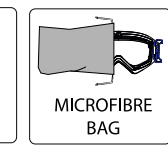
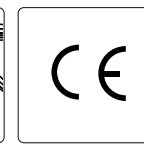

OPTIONAL

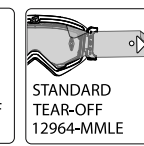
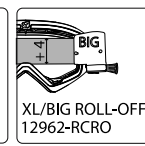



14940-NSG

CAT. 2   SINGLE



14940-NRR

CAT. 2   SINGLE



14940-NAA

CAT. 2   SINGLE



14940-NVN

CAT. 2   SINGLE



14940-NCN











CAT. 0   SINGLE





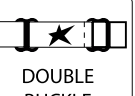

14940-NSN

CAT. 0   SINGLE

FEATURES

 A.V.S. Ariete Ventilation System	 O.T.G. Over The Glasses	 UV FILTERS	 ANTI_FOG	 PU + PA	 OPEN FILTERS	 FOAM LAYERS 3	 QD OUTRIGGERS	 DOUBLE BUCKLE	 SILICONE	 CARBON
--	---	---	---	--	--	---	---	---	---	---

INCLUDED

 LENS 12961-RCCH	 ANTI_SCRATCH	 CE	 MICROFIBRE BAG
---	---	---	--

OPTIONAL

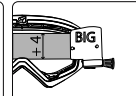
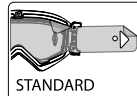
 One Size Fits All ARIETE LENS	 XL/BIG ROLL-OFF 12962-RCRO	 STANDARD TEAR-OFF 12964-MMLE
---	--	---





14940-BDV

CAT. 0 



14940-BDO

CAT. 1 



14940-BDA

CAT. 1 



14940-NDV

CAT. 0 



14940-NDO

CAT. 1 



14940-NDG

CAT. 1 



FEATURES

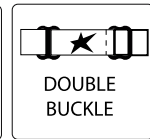
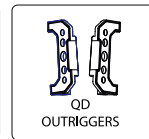
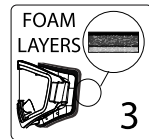
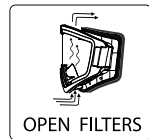
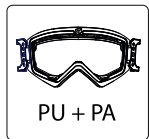
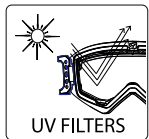
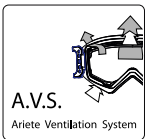

FEATURES



OPTIONAL

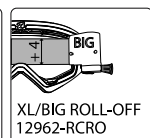

Mark Mamo - Photo W.Cachia/Juwill Productions



ARIETE GOGGLES | 2020



14940-NAV

CAT. 0 



SINGLE



FEATURES

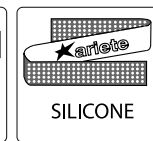
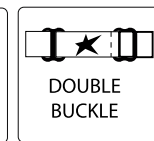
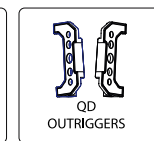
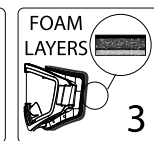
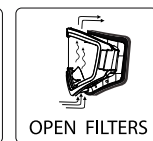
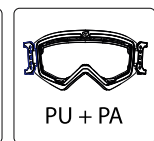
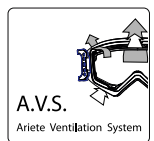

FEATURES

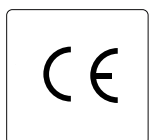

INCLUDED



OPTIONAL

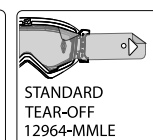
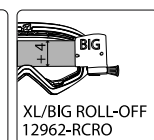
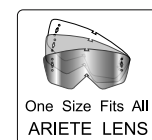







# MUDMAX EASY

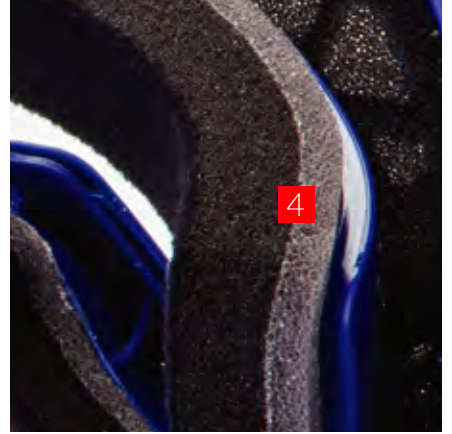

# UK

## 1 FRAME

- Medium Fit
- Enhanced vision field on the lower lens for downhill riding
- Comfortably Fits Glasses (O.T.G.)
- Tough PUR frame for low-temperature flexibility
- Anti-UV colours
- Compatible with BIG/XL Roll-Off Kit 12962-RCRO
- CE approved

## 2 LENS

- Lexan® clear lens cod. 12961-SCCH
- No optical distortion
- Best anti-fog treatment
- Anti-scratch treatment
- UV radiations total protection

## 3 VENT SYSTEM

- A.V.S. Ariete Ventilation System
- Extra Ventilation
- Open filters

## 4 FOAM

- Three-layer face foam specification composed of :
  - 1 super-soft technical foam layer with open cells
  - 1 medium density foam layer
  - 1 hypo-allergenic foam layer in contact with the skin

## 5 ELASTIC STRAP

- 40 mm height elastic strap with anti-slip silicone
- Pin to suit tear-off
- Double buckle for quick adjustment



14940-ENNG

CAT. 0 SINGLE



14940-EABA

CAT. 0 SINGLE



14940-EBBP

CAT. 0 SINGLE



14940-ENNR

CAT. 0 SINGLE



14940-EBBV

CAT. 0 SINGLE



14940-ENGO

CAT. 0 SINGLE

FEATURES

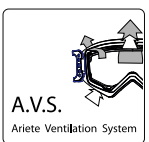

A.V.S.  
Ariete Ventilation System



O.T.G.  
Over The Glasses



UV FILTERS



ANTI\_FOG

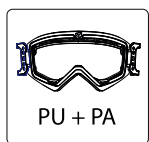

PU + PA

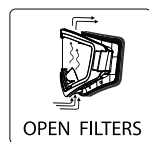

OPEN FILTERS

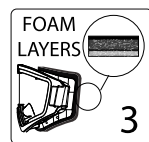

FOAM LAYERS  
3



QD  
OUTRIGGERS

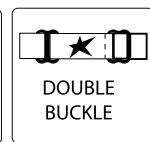

DOUBLE  
BUCKLE



SILICONE



CARBON

FEATURES



ANTI\_SCRATCH

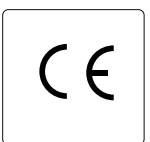

CE

OPTIONAL



One Size Fits All  
ARIETE LENS

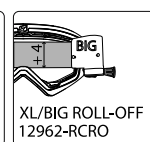

XL/BIG ROLL-OFF  
12962-RCRO

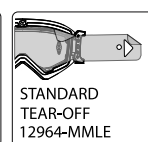

STANDARD  
TEAR-OFF  
12964-MMLE





Angelo Enduroblogger-Photo L. Refrigeri Photography



# ADRENALINE PRIMIS PLUS

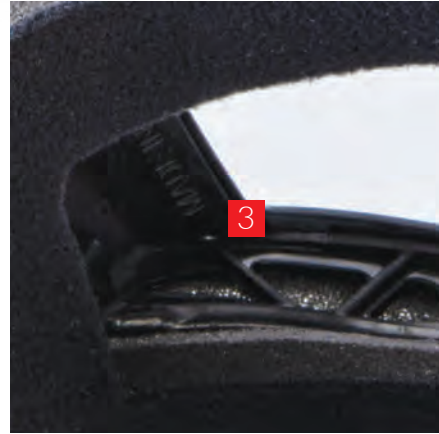

## UK

### 1 FRAME

- Medium Fit
- Comfortably Fits Glasses (O.T.G.)
- Compatible with BIG/XL Roll-Off Kit cod. 12962-RCRO
- Tough PUR frame for low-temperature flexibility
- Anti - UV colours
- CE approved

### 2 LENS

- Mirrored smoked lens "Plus" cat. 1 cod.12961-SCPL
- No optical distortion
- Best anti-fog treatment
- UV radiations total protection

### 3 VENT SYSTEM

- A.V.S. Ariete Ventilation System
- Extra Ventilation
- Open filters

### 4 FOAM

- Three-layer face foam specification composed of :
  - 1 super-soft technical foam layer with open cells
  - 1 medium density foam layer
  - 1 hypo-allergenic foam layer in contact with the skin

### 5 ELASTIC STRAP

- Elastic strap with anti-slip silicone
- Pin to suit tear-off cod. 12964-RCLE
- Double buckle for quick adjustment



14001-APGF

IVA/VAT

CAT. 1 SINGLE



14001-APGO

CAT. 1 SINGLE



14001-APPA

CAT. 1 SINGLE



14001-APPB

CAT. 1 SINGLE



14001-APPO

CAT. 1 SINGLE



14001-APPR

CAT. 1 SINGLE

FEATURES

A.V.S.  
Ariete Ventilation System

O.T.G.  
Over The Glasses

UV FILTERS

ANTI\_FOG

PU

OPEN FILTERS

FOAM LAYERS  
3

DOUBLE BUCKLE

SILICONE

CE

OPTIONAL

XL/BIG ROLL-OFF  
12962-RCRO

TEAR-OFF FOR  
BIG ROLL-OFF  
12964-RCRO

STANDARD TEAR-OFF  
12964-RCLE

One Size Fits All  
ARIETE LENS



Danilo Petrucci - Photo A. Farinelli







# ADRENALINE PROFI PLUS



# UK

## 1 FRAME

- Medium Fit
- Comfortably Fits Glasses (O.T.G.)
- Compatible with BIG/XL Roll-Off Kit cod. 12962-RCRO
- Tough PUR frame for low-temperature flexibility
- Anti - UV colours
- CE approved

## 2 LENS

- Mirrored smoked lens "Plus" cat. 1 cod.12961-SCPL
- No optical distortion
- Best anti-fog treatment
- UV radiations total protection

## 3 VENT SYSTEM

- A.V.S. Ariete Ventilation System
- Extra Ventilation
- Open filters

## 4 FOAM

- Three-layer face foam specification composed of:
  - 1st layer is technical foam with closed cells
  - 2nd layer is super-soft technical foam with open cells
  - 3rd layer of red hypo-allergenic CARBON X in contact with the skin

## 5 ELASTIC STRAP

- Elastic strap with anti-slip silicone
- Pin to suit tear-off cod. 12964-RCLE
- Double buckle for quick adjustment

## INCLUDED ACCESSORIES

- Lexan® Clear Lens cod.12961-RCCH equipped with clips
- Microfibre bag with internal pocket for a spare lens



14001-PARA

CAT.1 SINGLE



14001-PRRA

CAT.1 SINGLE



14001-PBRA

CAT.1 SINGLE



14001-PNGF

CAT.1 SINGLE



14001-PBGF

CAT.1 SINGLE



14001-PGRO

CAT.1 SINGLE

FEATURES

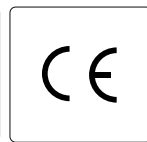
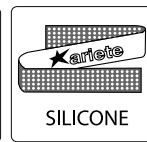
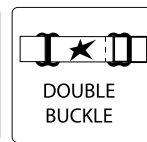
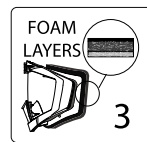
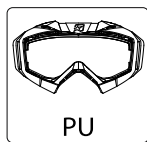
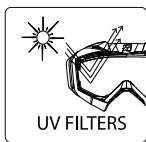
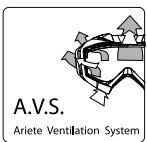

INCLUDED



OPTIONAL

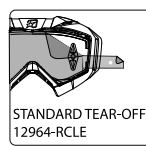
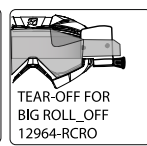
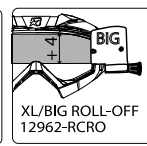



Kevin Horgmo - Photo JP Acevedo / CreyMert Racing





RC FLOW



## UK

### 1 FRAME

- Medium/Large Fit
- Tough PUR frame for low-temperature flexibility
- Anti - UV colours
- Logo in lacquered metal
- Adjustable outriggers for perfect helmet fit
- Comfortably Fits Glasses (O.T.G.)
- Compatible with BIG/XL Roll-Off Kit cod. 12962-RCRO

### 2 LENS

- Lexan® double, cylindrical and ventilated clear lens cod. 12961-DCV
- Best anti-fog treatment
- Anti-scratch treatment
- No optical distortion
- UV radiations total protection

### 3 VENT SYSTEM

- A.V.S. Ariete Ventilation System
- Extra Ventilation
- Open filters

### 4 FOAM

- 3D thermoformed foam
- 2 layer face foam specification composed of:
  - 1 super-soft technical foam layer with open cells
  - 1 hypo-allergenic foam layer in contact with the skin
- Asian fitting foam version available

### 5 ELASTIC STRAP

- Elastic strap with 1 anti-slip silicone bead
- Double buckle for quick adjustment



13950-FBO

13953-FBO ASIAN FITTING FOAM

CAT.0



DOUBLE



13950-FGA

13953-FGA ASIAN FITTING FOAM

CAT.0



DOUBLE



13950-FGB

13953-FGB ASIAN FITTING FOAM

CAT.0



DOUBLE



13950-FGN

13953-FGN ASIAN FITTING FOAM

CAT.0



DOUBLE



13950-FNG

13953-FNG ASIAN FITTING FOAM

CAT.0



DOUBLE



13950-FRB

13953-FRB ASIAN FITTING FOAM

CAT.0



DOUBLE

FEATURES

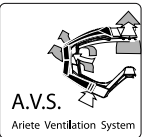

A.V.S.  
Ariete Ventilation System



O.T.G.  
Over The Glasses

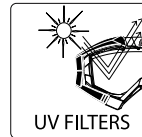

UV FILTERS



ANTI\_FOG

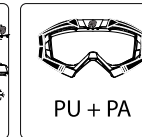

PU + PA

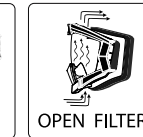

OPEN FILTERS

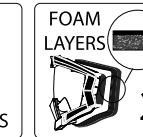

FOAM LAYERS  
2

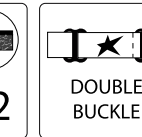

DOUBLE BUCKLE

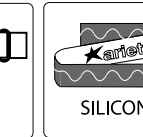

SILICONE

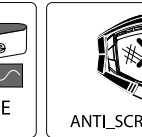

ANTI\_SCRATCH

FEATURES



QUICK RELEASE



3D FOAM



ASIAN FITTING FOAM

AVAILABLE

OPTIONAL



NOSE GUARD

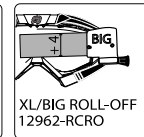

XL/BIG ROLL-OFF  
12962-RCRO

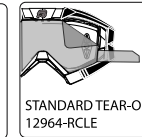

STANDARD TEAR-OFF  
12964-RCLE

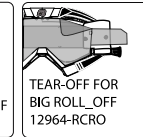

TEAR-OFF FOR BIG ROLL-OFF  
12964-RCRO

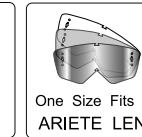

One Size Fits All  
ARIETE LENS



# GOGGLES RALLY



FEATURES	A.V.S. Ariete Ventilation System	O.T.G. Over The Glasses	UV FILTERS	ANTI_FOG	PU + PA	CLOSED FILTERS	FOAM LAYERS 3	DOUBLE BUCKLE	SILICONE	CARBON
	CD OUTRIGGERS		INCLUDED		MICROFIBRE BAG	OPTIONAL		One Size Fits All ARIE TE LENS	XL/BIG ROLL-OFF 12962-RCRO	STANDARD TEAR-OFF 12964-MMLE



14940-NDS

CAT. 3 SINGLE



FEATURES	A.V.S. Ariete Ventilation System	O.T.G. Over The Glasses	PU + PA	CLOSED FILTERS	ANTI_FOG	UV FILTERS	FOAM LAYERS 3	3D FOAM	QUICK RELEASE	SILICONE
	DOUBLE BUCKLE	CE	INCLUDED		MICROFIBRE BAG	OPTIONAL		One Size Fits All ARIE TE LENS	NOSE GUARD	XL/BIG ROLL-OFF 12962-RCRO



13950-DNGS

CAT. 2 SINGLE

**SPECIAL FOR DESERT**



Alberto Ravardino



# SNOWMOBILE

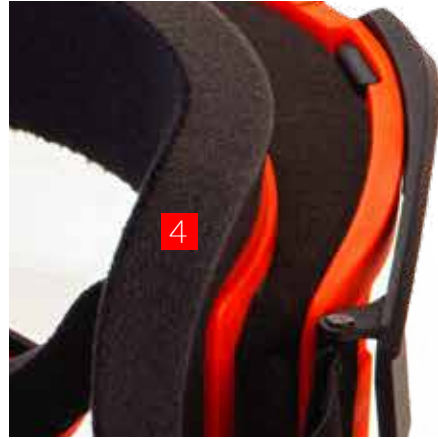
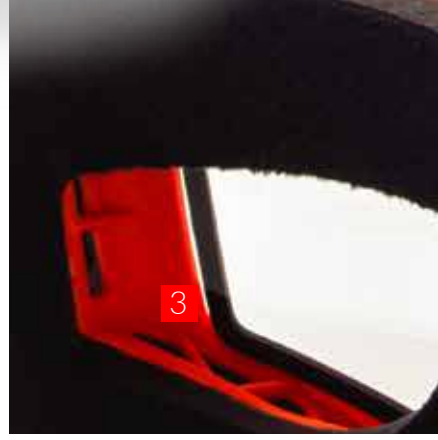

# UK

## 1 FRAME

- Medium/Large Fitment
- O.T.G. (Over The Glasses) Design
- Compatible with BIG/XL Roll-Off Kit
- Tough PUR frame for low-temperature flexibility
- Anti-UV lacquered frame

## 2 LENS

- Double, cylindrical, ventilated lens
- Distortion-free lens
- Anti-fog inner lens
- UV rays total protection

## 3 VENT SYSTEM

- A.V.S. Ariete Ventilation System
- Extra Ventilation
- Closed filters

## 4 FOAM

- Sponge lining for unmatched comfort and feel
- Hypo-allergenic foam in contact with the skin
- Extra-thick foam

## 5 ELASTIC STRAP

- Elastic strap with anti-slip silicone
- Pin to suit tear-off use
- Double buckle



14001-MB19 ADRENALINE

CAT.0



DOUBLE



14001-MBRA ADRENALINE

CAT.1



DOUBLE



14001-MNGG ADRENALINE

CAT.1



DOUBLE



13950-MBNA RC

CAT.1



DOUBLE



13950-MONC RC

CAT.0



DOUBLE



13950-MNOO RC

CAT.1



DOUBLE

COMMON FEATURES

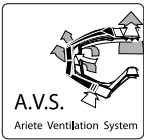

A.V.S.  
Ariete Ventilation System



O.T.G.  
Over The Glasses

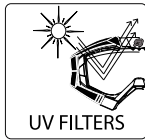

UV FILTERS



ANTI\_FOG



CLOSED FILTERS



ANTI\_SCRATCH

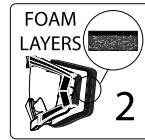

FOAM LAYERS  
2



EXTRA FOAM

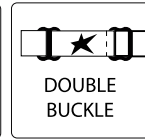

DOUBLE BUCKLE



SILICONE

RC FEATURES



PU + PA



QUICK RELEASE



3D FOAM



NOSE GUARD



ASIAN FITTING FOAM  
AVAILABLE

OPTIONAL



One Size Fits All ARIETE LENS

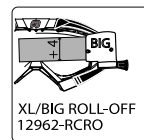

XL/BIG ROLL-OFF 12962-RCRO

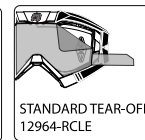

STANDARD TEAR-OFF 12964-RCLE



TEAR-OFF FOR BIG ROLL-OFF 12964-RCRO



13950-MTNR RC

CAT. 3   DOUBLE



14940-MBAS MUDMAX

CAT. 3   DOUBLE



14940-MBRR MUDMAX

CAT. 3   DOUBLE

COMMON FEATURES

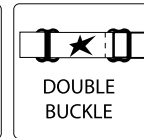
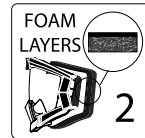
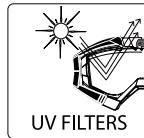
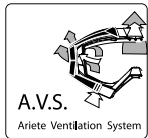

RC FEATURES

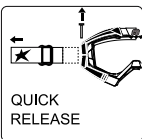
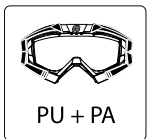

OPTIONAL

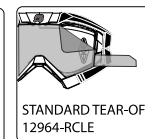
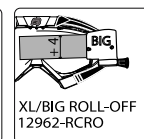



07 NEXT GEN



## UK

### 1 FRAME

- Tough PUR frame for low-temperature flexibility
- Anti - UV colours
- Small Fit
- Suitable on helmets for children/Kids

### 2 LENS

- Clear lens in polycarbonate
- Best anti-fog treatment
- Anti-scratch treatment
- No optical distortion
- UV radiations total protection

### 3 VENT SYSTEM

- A.V.S. Ariete Ventilation System
- Open filters

### 4 FOAM

- 2 foam layers composed of:
  - 1 super-soft technical foam layer with open cells
  - 1 hypo-allergenic foam layer in contact with the skin

### 5 ELASTIC STRAP

- Anti-slip silicone
- Double buckle for quick adjustment



12960-BNB

CAT.0 



SINGLE



12960-NNB

CAT.0 



SINGLE



12960-NGNR

CAT.0 



SINGLE



12960-NGNA

CAT.0 



SINGLE



12960-NGNO

CAT.0 



SINGLE

FEATURES

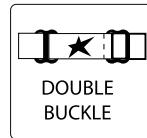
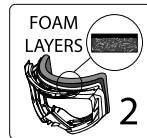
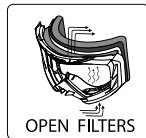
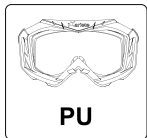
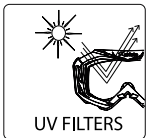
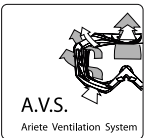









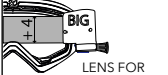
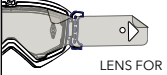



































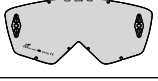





























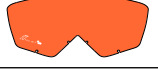

























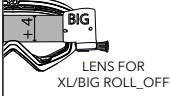
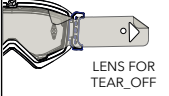













































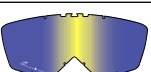



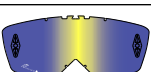



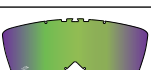



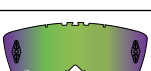





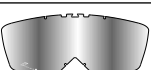





OPTIONAL























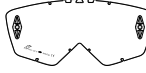





















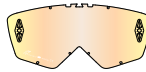

































































		<b>GOGGLES ADRENALINE RC MUDMAX</b>	<b>XL/Big Roll-off</b>  LENS FOR XL/BIG ROLL-OFF	<b>Mudmax</b>  LENS FOR TEAR_OFF	<b>Adrenaline/RC</b>  LENS FOR TEAR_OFF											
<b>CAT. 0</b>		CLEAR AIR 12961-RCFR		Suitable For Big/xl Roll-off <b>12962-RCRO</b>	Standard Tear-offs <b>12964-MMLE</b> Tear-offs For Roll-off <b>12964-RCRO</b>	Standard Tear-offs <b>12964-RCLE</b> Tear-offs For Roll-off <b>12964-RCRO</b>										
		CLEAR AIR 12961-RCCH		Suitable For Big/xl Roll-off <b>12962-RCRO</b>	Standard Tear-offs <b>12964-MMLE</b> Tear-offs For Roll-off <b>12964-RCRO</b>	Standard Tear-offs <b>12964-RCLE</b> Tear-offs For Roll-off <b>12964-RCRO</b>										
		CLEAR AIR 12961-SCCH														
		CLEAR AIR 12961-DCV														
<b>CAT. 1</b>		PLUS 12961-RCPL		Suitable For Big/xl Roll-off <b>12962-RCRO</b>	Standard Tear-offs <b>12964-MMLE</b> Tear-offs For Roll-off <b>12964-RCRO</b>	Standard Tear-offs <b>12964-RCLE</b> Tear-offs For Roll-off <b>12964-RCRO</b>										
		PLUS 12961-SCPL														
		YELLOW DESERT 12961-RCG		Suitable For Big/xl Roll-off <b>12962-RCRO</b>	Standard Tear-offs <b>12964-MMLE</b> Tear-offs For Roll-off <b>12964-RCRO</b>	Standard Tear-offs <b>12964-RCLE</b> Tear-offs For Roll-off <b>12964-RCRO</b>										
		YELLOW DESERT 12961-DCGV														
		LIGHT CORAL 12961-RCAR		Suitable For Big/xl Roll-off <b>12962-RCRO</b>	Standard Tear-offs <b>12964-MMLE</b> Tear-offs For Roll-off <b>12964-RCRO</b>	Standard Tear-offs <b>12964-RCLE</b> Tear-offs For Roll-off <b>12964-RCRO</b>										
		LIGHT CORAL 12961-SCAR														
		LIGHT CORAL 12961-DCOV														
		BLUE CREEK 12961-RCFA		Suitable For Big/xl Roll-off <b>12962-RCRO</b>	Standard Tear-offs <b>12964-MMLE</b> Tear-offs For Roll-off <b>12964-RCRO</b>	Standard Tear-offs <b>12964-RCLE</b> Tear-offs For Roll-off <b>12964-RCRO</b>										
	BLUE CREEK 12961-SCFA															































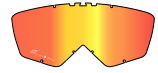











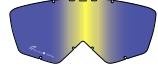





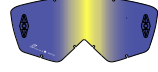







GOGGLES ADRENALINE RC MUDMAX		XL/Big Roll-off  LENS FOR XL/BIG ROLL_OFF	Mudmax  LENS FOR TEAR_OFF	Adrenaline/RC  LENS FOR TEAR_OFF	 SINGLE	 DOUBLE	 100% UV FILTERS	 NO FOG	 ANTI-SCRATCH	 VENTILATED	 MULTILAYERS TREATMENT	 MIRRORED	 EUROPEAN CONFORMITY
CAT. 2 	BLUE CREEK 12961-DCFA 												
	SILVER CHROME 12961-RCSP 	Suitable For Big/xl Roll-off <b>12962-RCRO</b>	Standard Tear-offs <b>12964-MMLE</b> Tear-offs For Roll-off <b>12964-RCRO</b>	Standard Tear-offs <b>12964-RCLE</b> Tear-offs For Roll-off <b>12964-RCRO</b>									
	SILVER CHROME 12961-SCSC 												
	SILVER CHROME 12961-DCSV 												
	MULTI LAYER RED 12961-MLR 												
	MULTI LAYER RED 12961-RMRC 	Suitable For Big/xl Roll-off <b>12962-RCRO</b>	Standard Tear-offs <b>12964-MMLE</b> Tear-offs For Roll-off <b>12964-RCRO</b>	Standard Tear-offs <b>12964-RCLE</b> Tear-offs For Roll-off <b>12964-RCRO</b>									
	MULTI LAYER BLUE 12961-MLA 												
	MULTI LAYER BLUE 12961-RMAC 	Suitable For Big/xl Roll-off <b>12962-RCRO</b>	Standard Tear-offs <b>12964-MMLE</b> Tear-offs For Roll-off <b>12964-RCRO</b>	Standard Tear-offs <b>12964-RCLE</b> Tear-offs For Roll-off <b>12964-RCRO</b>									
	MULTI LAYER GREEN 12961-MLV 												
	MULTI LAYER GREEN 12961-RMVC 	Suitable For Big/xl Roll-off <b>12962-RCRO</b>	Standard Tear-offs <b>12964-MMLE</b> Tear-offs For Roll-off <b>12964-RCRO</b>	Standard Tear-offs <b>12964-RCLE</b> Tear-offs For Roll-off <b>12964-RCRO</b>									
CAT. 3 	SILVER CHROME 12961-SCST 												
	SILVER CHROME 12961-DCST 												
	MULTI LAYER 12961-DMLR 												

GOGGLES 07 NEXTGEN only NO XL/BIG ROLL-OFF													
		LENS FOR TEAR-OFF	SINGLE	DOUBLE	100% UV FILTERS	NO FOG	ANTI-SCRATCH	VENTILATED	One Size Fits All ARIETE FRAMES	MULTILAYERS TREATMENT	MIRRORED	EUROPEAN CONFORMITY	
CAT. 0	 CLEAR AIR 12961-PCCH 	STANDARD TEAR-OFFS 12964 TOLE											
	CLEAR AIR 12961-SCCH 												
	CLEAR AIR 12961-DCV 												
CAT. 1	 MULTI LAYER RAINBOW 12961-MUAZ 	STANDARD TEAR-OFFS 12964 TOLE											
	BLUE SKY 12961-PCAZ 	STANDARD TEAR-OFFS 12964 TOLE											
	YELLOW DESERT 12961-PCG 	STANDARD TEAR-OFFS 12964 TOLE											
	YELLOW DESERT 12961-DCGV 												
	LIGHT CORAL 12961-PCAR 	STANDARD TEAR-OFFS 12964 TOLE											
	LIGHT CORAL 12961-SCAR 												
	LIGHT CORAL 12961-DCOV 												
	BLUE CREEK 12961-PCFA 	STANDARD TEAR-OFFS 12964 TOLE											
	BLUE CREEK 12961-SCFA 												
	BLUE CREEK 12961-DCFA 												





















GOGGLES  
**07 NEXTGEN** only  
 NO XL/BIG ROLL-OFF

 LENS FOR TEAR_OFF	 SINGLE	 DOUBLE	 100% UV FILTERS	 NO FOG	 ANTI_SCRATCH	 VENTILATED	 One Size Fits All ARIETE FRAMES	 MULTILAYERS TREATMENT	 MIRRORED	 EUROPEAN CONFORMITY
---	---	---	--	--	--	--	--	--	---	--

CAT. 2 

SILVER CHROME 12961-PCSP		STANDARD TEAR-OFFS 12964 TOLE								
SILVER CHROME 12961-SCSC										
SILVER CHROME 12961-DCSV										
MULTI LAYER RED 12961-MLR										
MULTI LAYER RED 12961-MLRC		STANDARD TEAR-OFFS 12964 TOLE								
MULTI LAYER BLUE 12961-MLA										
MULTI LAYER BLUE 12961-MLAC		STANDARD TEAR-OFFS 12964 TOLE								
MULTI LAYER GREEN 12961-MLV										
MULTI LAYER GREEN 12961-MLVC		STANDARD TEAR-OFFS 12964 TOLE								

CAT. 3 

SILVER CHROME 12961-SCST										
SILVER CHROME 12961-DCST										
MULTI LAYER 12961-DMLR										



**STANDARD TEAR-OFFS**

**12964-TOLE**

Suitable for:

**07-ADRENALINE-RC**

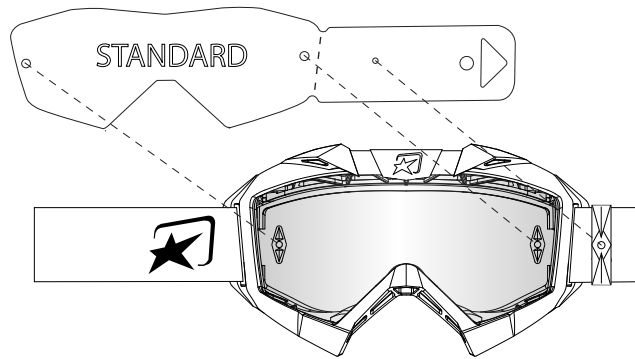

Kit 5 stacks, 6 Tear-offs/stack Standard tear-offs to place on the lenses.

**RELATED LENSES**

- 12961-PCCH
- 12961-PCG
- 12961-PCAR
- 12961-PCFA
- 12961-PCAZ
- 12961-PCSP
- 12961-MUAZ
- 12961-MLAC
- 12961-MLRC
- 12961-MLVC

COMPATIBLE



**STANDARD TEAR-OFFS**

**12964-RCLE**

Suitable for:

**ADRENALINE-RC**

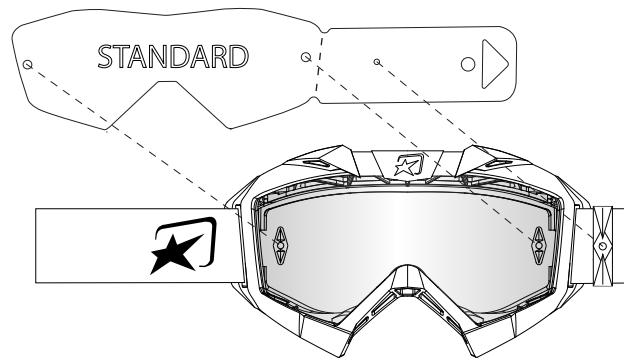

Kit 5 stacks, 6 Tear-offs/stack Standard tear-offs to place on the lenses.

**RELATED LENSES**

- 12961-RCCH
- 12961-RCG
- 12961-RCAR
- 12961-RCFA
- 12961-RCSP
- 12961-RMAC
- 12961-RMRC
- 12961-RMVC
- 12961-RCPL

OPTIMIZED



**STANDARD TEAR-OFFS**

**12964-MMLE**

Suitable for:

**MUDMAX**

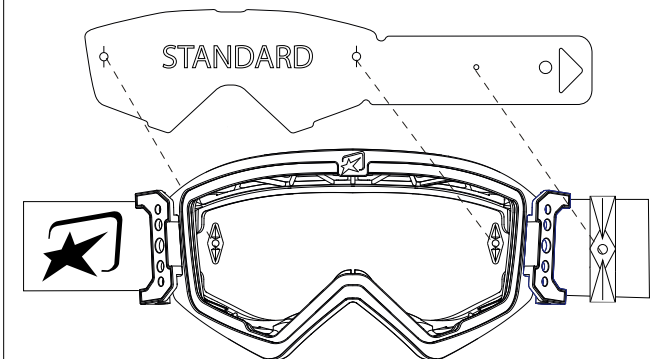

Kit 5 stacks, 6 Tear-offs/stack Standard tear-offs to place on the lenses.

**RELATED LENSES**

- 12961-RCCH
- 12961-RCG
- 12961-RCAR
- 12961-RCFA
- 12961-RCSP
- 12961-RMAC
- 12961-RMRC
- 12961-RMVC
- 12961-RCPL

OPTIMIZED





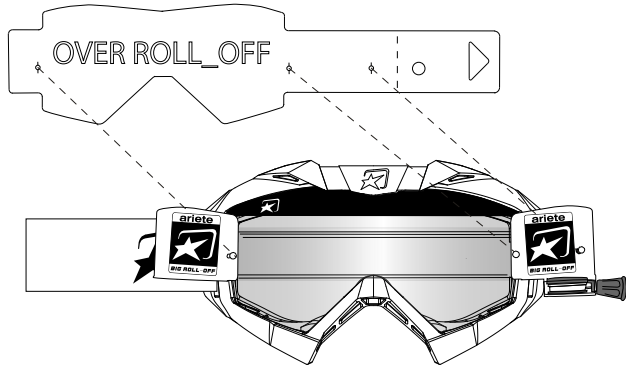





**TEAR-OFF FOR XL/BIG ROLL\_OFF**  
**12964-RCRO**  
**ADRENALINE-RC-MUDMAX**



Kit 3 stacks, 6 Tear-offs/stack. Specific tear-offs to place on the Roll-off system.

**RELATED LENSES**

-  12961-RCCH
-  12961-RCG
-  12961-RCAR
-  12961-RCFA
-  12961-RCSP
-  12961-RMAC
-  12961-RMRC
-  12961-RMVC
-  12961-RCPL

OPTIMIZED  

**TEAR-OFF RACING PINS**  
**12964-RE**  
**07 - ADRENALINE - RC - MUDMAX**

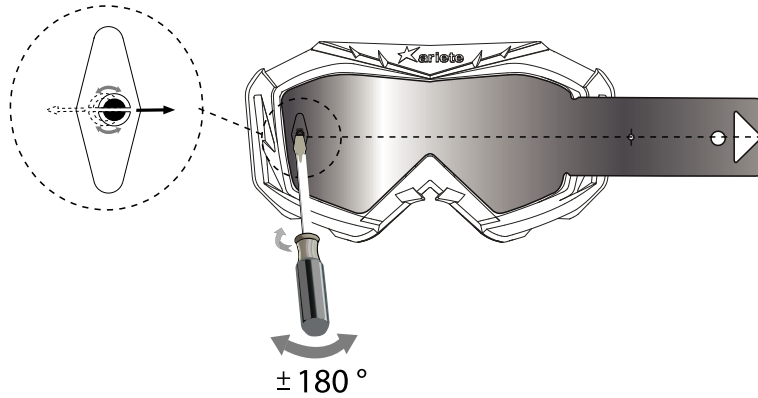

Eccentric pins for precise tear-off adjustment to avoid dust between lens and tearoff, sold in pairs, professional use.

**RELATED LENSES**

All the lenses Ariete

OPTIMIZED  

# APPLICATIONS

 07 NEXT GEN  ADRENALINE  RC  MUDMAX



## KIT BIG/XL ROLL-OFF

2 canisters / 2 rolls of film / 1 anti-stick slide rail / 1 mud flap

12962-RCRO **RC/ADRENALINE/MUDMAX**



## ASSEMBLED LENS BIG/XL ROLL-OFF

1 lens 12961-RCFR for BIG/XL Roll-Off / 2 assembled canisters / 2 rolls of film / 1 anti-stick slide rail / 1 mud flap / 6 Tear-offs for Roll-Off for free

12961-RCRO **RC/ADRENALINE/MUDMAX**





MUD FLAPS



12963-RCMF 3 pcs. **RC/ADRENALINE**  
12963-MMMF 3pcs. **MUDMAX**

SLIDING RAILS

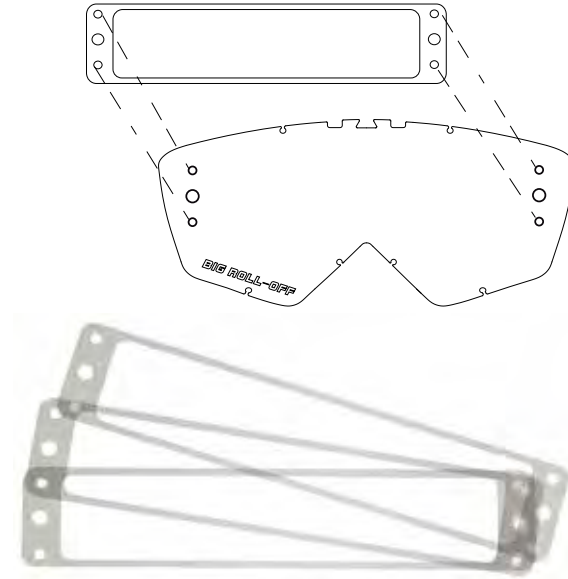

12967-RC 3 pcs. **RC/ADRENALINE/MUDMAX**

BIG/XL ROLL-OFF FILMS

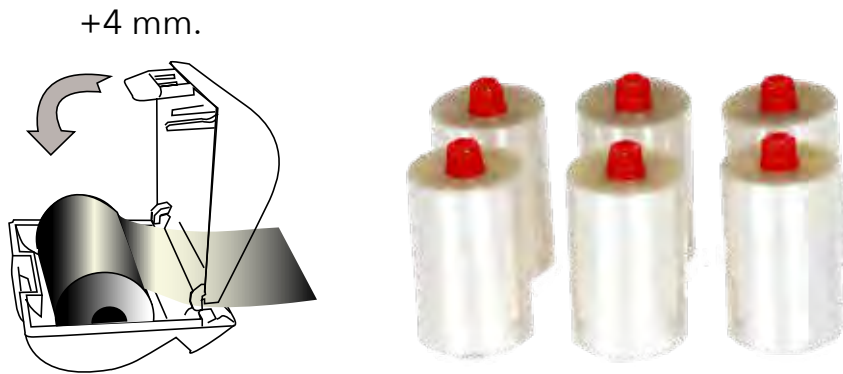

12962-RCRU 6 pcs. **RC/ADRENALINE/MUDMAX**

BIG/XL ROLL-OFF LENS

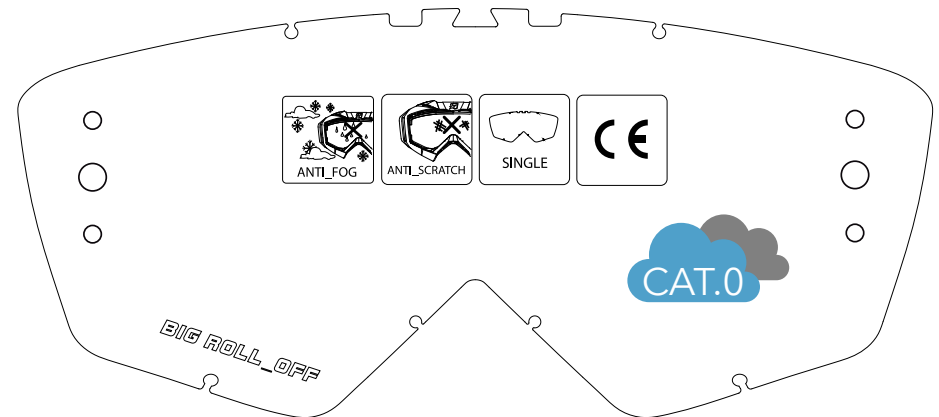

12961-RCFR **RC/ADRENALINE/MUDMAX**



14001-RO

BIG/XL ROLL-OFF **ADRENALINE** GOGGLES



14940-BRO

BIG/XL ROLL-OFF **MUDMAX** GOGGLES



13950-RO

13953-RO

BIG/XL ROLL-OFF **RC** GOGGLES



14940-NRO

BIG/XL ROLL-OFF **MUDMAX** GOGGLES



Spare QD outriggers for head-band attachment, pair of pins included

13951-ATL



FLUO COLOR

FLUO COLOR

13951-GLF

13951-OLF

13951-R

13951-N

13951-B

13951-A

13951-GR



13952

4 spare pins for QD outriggers



12966-RC

Noseguard



Microfibre bag with internal pocket for a spare lens

12965-B

---

---



- 1 large pocket with zip closure for tear-offs
- 1 open pocket for lenses
- 3 pockets in varied sizes
- 4 removable internal dividers with hook and loop fastener

12965/A

---

---

RK HOOB

# MUDMAX RACER



## 1 FRAME

- Medium Fit
- Enhanced vision field on the lower lens for downhill riding
- Comfortably Fits Glasses (O.T.G.)
- Tough PUR frame for low-temperature flexibility
- Anti-UV colours
- Compatible with BIG/XL Roll-Off Kit 12962-RCRO
- CE approved

## 2 LENS

- Mirrored smoked lens "Plus" cat. 1 cod.12961-SCPL
- Best anti-fog treatment
- No optical distortion
- UV radiations total protection

## 3 VENT SYSTEM

- A.V.S. Ariete Ventilation System
- Extra Ventilation
- Open filters

## 4 FOAM

- Three-layer face foam specification composed of:
  - 1 super-soft technical foam layer with open cells
  - 1 medium density foam layer
  - 1 hypo-allergenic foam layer in contact with the skin

## 5 ELASTIC STRAP

- 30 mm height elastic strap with 1 anti-slip silicone
- Double buckle for quick adjustment

## INCLUDED ACCESSORIES

Microfibre bag with internal pocket for a spare lens



14940-NGR

CAT. 1 SINGLE



14940-BRA

CAT. 1 SINGLE



14940-CMV

CAT. 1 SINGLE



14940-NBC

CAT. 1 SINGLE



14940-VVC

CAT. 1 SINGLE



14940-BBG

CAT. 1 SINGLE

FEATURES

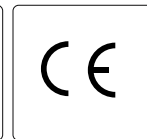
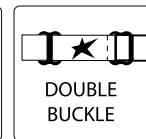
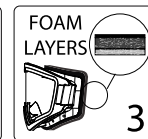
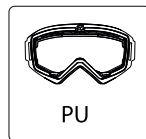
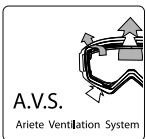

INCLUDED



OPTIONAL

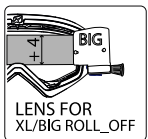



14940-MVV

CAT. 2 



SINGLE



14940-MAA

CAT. 2 



SINGLE



14940-MSA

CAT. 2 



SINGLE



14940-MRS

CAT. 2 



SINGLE



Lucia Vazquez - Photo: 5special







Photo RK HOOB



FEATHER

## **1** FRAME

- Frameless goggles
- Medium Fitment
- Ultra Lightweight (67 grams)

## **2** LENS

- Photochromic cat.0→1
- Spherical
- Machined
- Ventilated lens
- Mirrored lens
- PU + Light-sensitive film
- Distortion-free lens
- UV rays total protection

## **3** VENT SYSTEM

- A.V.S. Ariete Ventilation System
- Open filters

## **4** ELASTIC STRAP

- 30 mm Height
- Anti-slip silicone bead
- Double buckle for quick adjustment

## **5** 3-LAYER FACE FOAM

- 1st technical foam layer with closed cells
- 2nd super-soft technical foam layer with open cells
- 3rd hypo-allergenic pile layer in contact with the skin
- 3D Thermo-formed sponge lining for unmatched comfort and feel

## INCLUDED ACCESSORIES

- Microfibre bag



14920-BN BG

CAT. 0 - 1    SINGLE



14920-MVC

CAT. 0 - 1    SINGLE



14920-TNB

CAT. 0 - 1    SINGLE



14920-TCCR

CAT. 0 - 1    SINGLE



14920-TNGR

CAT. 0 - 1    SINGLE



14920-MMV

CAT. 0 - 1    SINGLE

FEATURES

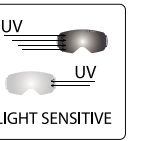
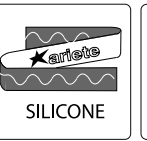
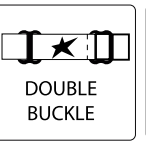
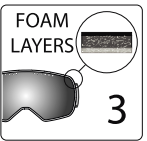
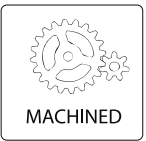
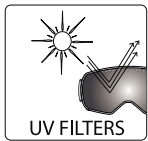
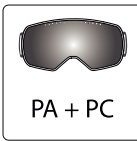

FEATURES

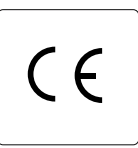

INCLUDED





Ivan Fiori - Photo @scrambike



ARIETE GOGGLES | 2020

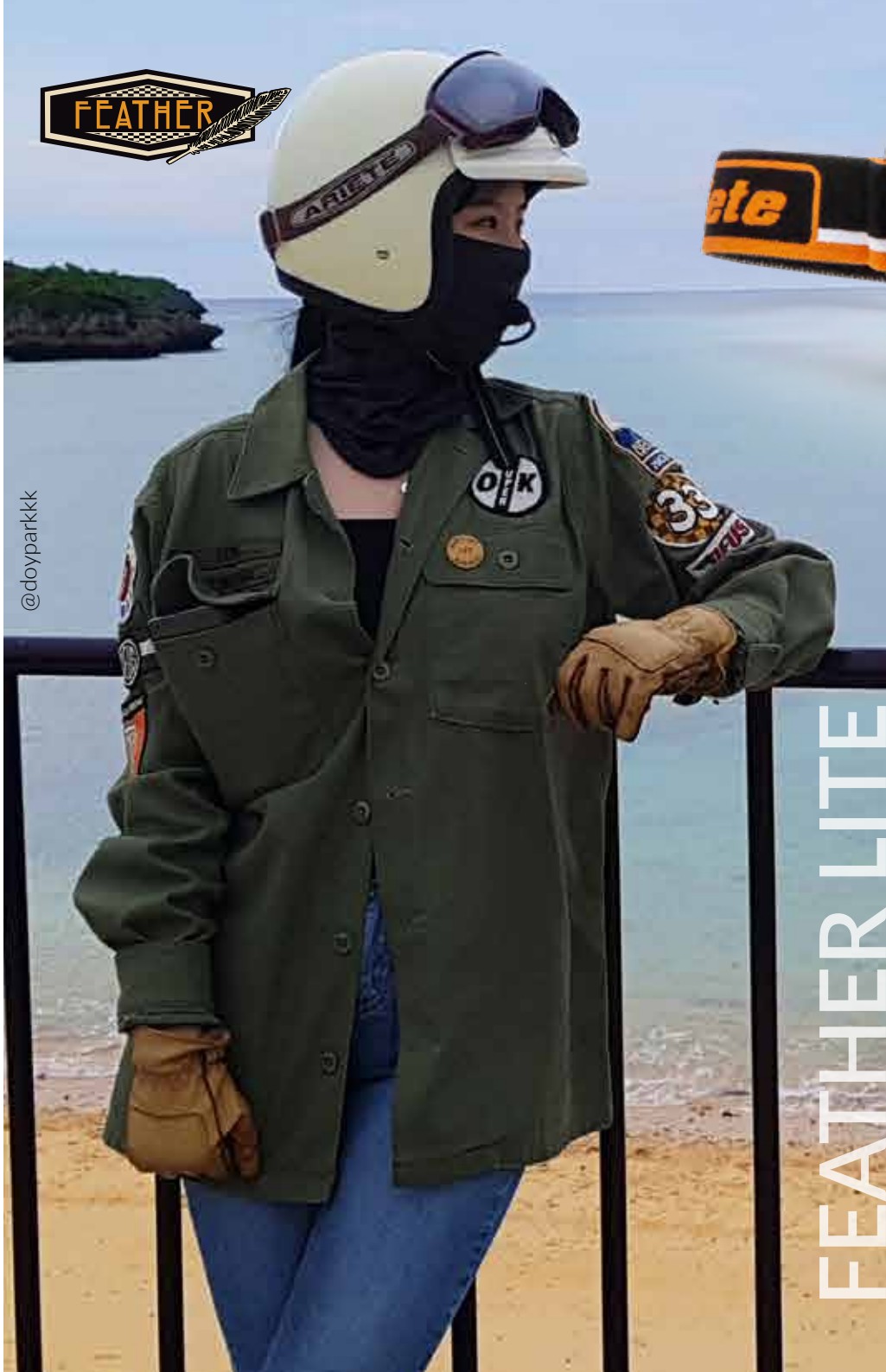

FEATHER LITE



## **1** FRAME

- Frameless goggles
- Medium Fitment
- Ultra Lightweight (67 grams)

## **2** LENS

- Lens cat.2
- Spherical
- Machined
- Ventilated lens
- Distortion-free lens
- UV rays total protection

## **3** VENT SYSTEM

- A.V.S. Ariete Ventilation System
- Open filters

## **4** ELASTIC STRAP

- 30 mm Height
- Anti-slip silicone bead
- Double buckle for quick adjustment

## **5** 3-LAYER FACE FOAM

- 1st technical foam layer with closed cells
- 2nd super-soft technical foam layer with open cells
- 3rd hypo-allergenic pile layer in contact with the skin
- 3D Thermo-formed sponge lining for unmatched comfort and feel

## **INCLUDED ACCESSORIES**

Microfibre bag



14920-LNBC

CAT. 2 SINGLE



14920-LANV

CAT. 2 SINGLE



14920-LNNO

CAT. 2 SINGLE



14920-LNBL

CAT. 2 SINGLE



14920-LGCG

CAT. 2 SINGLE



14920-LNRA

CAT. 2 SINGLE

FEATURES

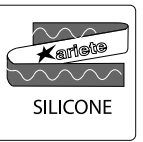
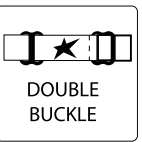
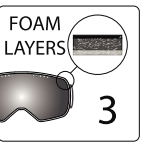
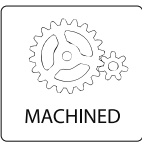
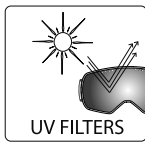

FEATURES

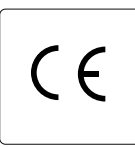

INCLUDED





Giorgio De Angelis - Photo VD Photo



ARIETE GOGGLES | 2020





Aspronia - Photo B. Gori

# VINTAGE



## 1 FRAME

- Steel chrome-plated frame
- Hand made padding composed of:
- Inner surface made from hand-sewn natural leather for unmatched comfort
- Outer surface made of eco-leather treated to provide enhanced weatherproofing
- CE approved

## 2 LENS

- Smoked lenses cat. 2
- No optical distortion
- Best anti-fog treatment
- Anti-scratch treatment
- UV radiations total protection

## 3 VENT SYSTEM

- Frame made of chromium-plated steel with side venting for comfort s

## 4 ELASTIC STRAP

- Elastic strap with 1 anti-slip silicone bead
- 30 mm height elastic strap in pure vintage style
- Double buckle for quick adjustment

## INCLUDED ACCESSORIES

Microfibre bag



13990-NR

CAT. 2   SINGLE



13990-MC

CAT. 2   SINGLE

FEATURES



VENTILATED



UV FILTERS



ANTI\_FOG



GENUINE  
LEATHER



DARK LENS  
CAT. 2



STEEL  
CHROME - PLATED



Hand Made

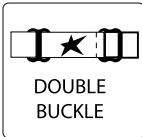

DOUBLE  
BUCKLE



SILICONE

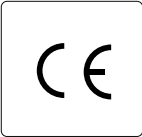

INCLUDED



MICROFIBRE  
BAG





Aspronia - Photo B. Gori



GOGGLES ARIETE VINTAGE | 2020

# VULCAN GRIPS

- 1 -Pyramid shapes with a triangular base in varying height:
  - micro Pyramids in the thumb/index finger area
  - large Pyramids for extra grip in the palm area
  - contoured Pyramids in the outer palm area, for extra comfort and support through corners and turns
- 2 The principle pressure point areas of the grip are reinforced for longevity;
- 3 Chassis in semi-rigid torque-limited elastomer;
- 4 Outer flange pre-marked for piercing with a cutting guide for use with all-round hand guards;
- 5 -four grooves for steel wire give extra security

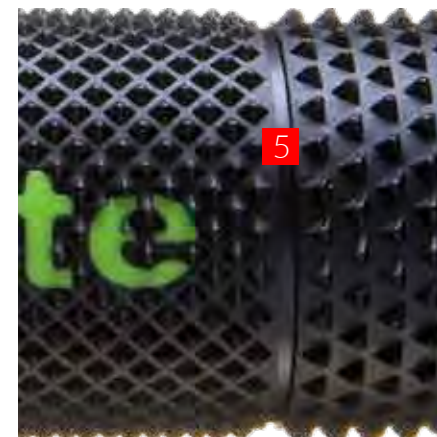
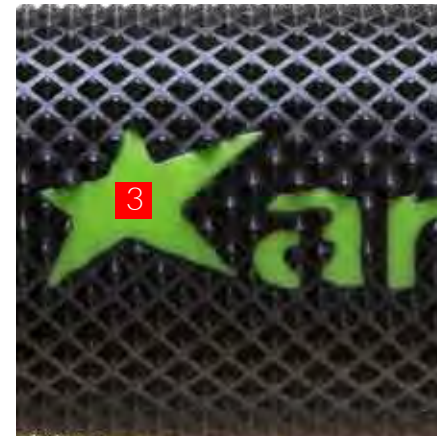

## TECHNOLOGY



02643-ARGR



02643-ARN



02643-BA



02643-GN



02643-GRN



02643-NB



02643-RN



02643-VN



# TRINITY GRIPS

- 1 Chassis in semi-rigid torque-limited elastomer
- 2 Palm in legendary Supersoft, critical finger-grip area with half-waffle surface
- 3 Anatomically profiled cot-out on the right side for thumb and forefinger
- 4 Four grooves for steel wire give extra security
- 5 The fourth groove is situated at the extreme outer end of the grip to prevent grit from being trapped between bar and grip or bar and twist grip when used with hand guards
- 6 Outer flange pre-marked for piercing with a cutting guide for use with all-round hand guards
- 7 Pronounced inner flange with internal reinforcement, coated in extra-soft XTouch

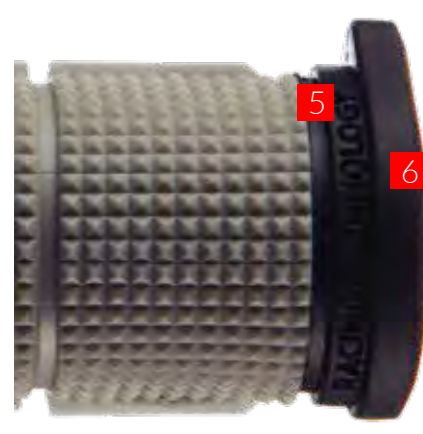

## TECHNOLOGY



02614-GRAR

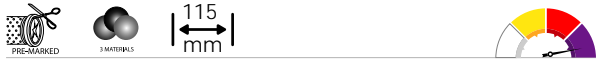

02614-GRRN



02614-GRNB



02614-BNR



02614-GRAN





# DUALITY GRIPS



02629-GRN



02629-NR



02629-NA



02629-NAR



02629-NG



# UNITY SLIMLINE GRIPS



02619 Soft



02619/H Medium



02619-N Soft



# UNITY HALF-WAFFLE GRIPS



02621-N Soft



02621/H Medium



# UNITY HALF-WAFFLE ASP GRIPS

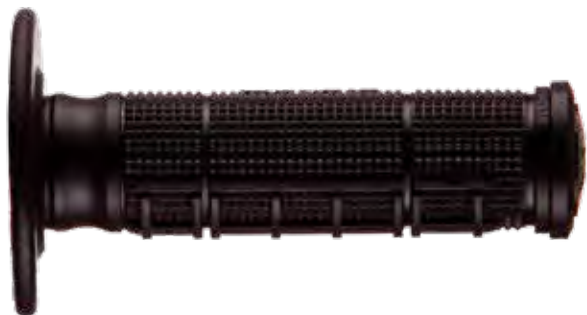

02621/A-N

PRE-MARKED 1 MATERIAL 115 mm

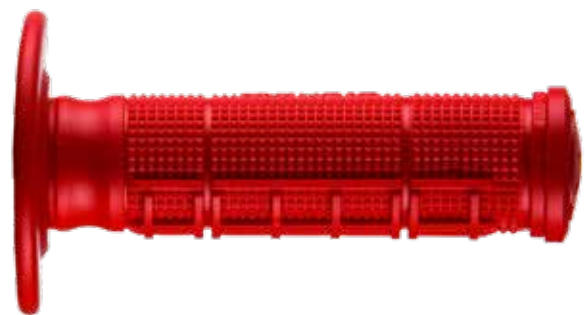

02621/A-R

PRE-MARKED 1 MATERIAL 115 mm



02621/A-A

PRE-MARKED 1 MATERIAL 115 mm

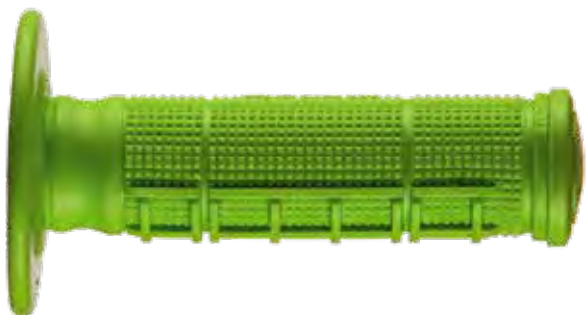

02621/A-L

PRE-MARKED 1 MATERIAL 115 mm



02621/A-GF

PRE-MARKED 1 MATERIAL 115 mm

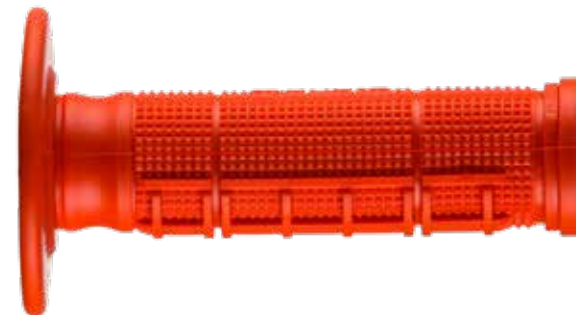

02621/A-AR

PRE-MARKED 1 MATERIAL 115 mm

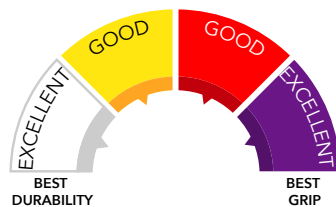



Mattia Cuminetti



KIDS

YAMAHA PWs - HONDA CRF 50 F  
OFF-ROAD



02641



02641-R



02641-A



GRIPS AVT-CYCLE



Front

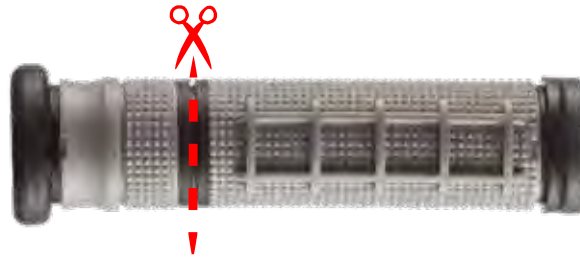

Back



02630-NGR



02620

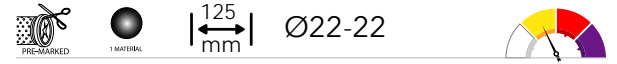

GRIPS TRIAL



01651/SS



02617



GRIPS RALLY



02616 Tech. Foam +TP Caps



GRIPS CLASSIC MX



01671



BRAKE LOCK

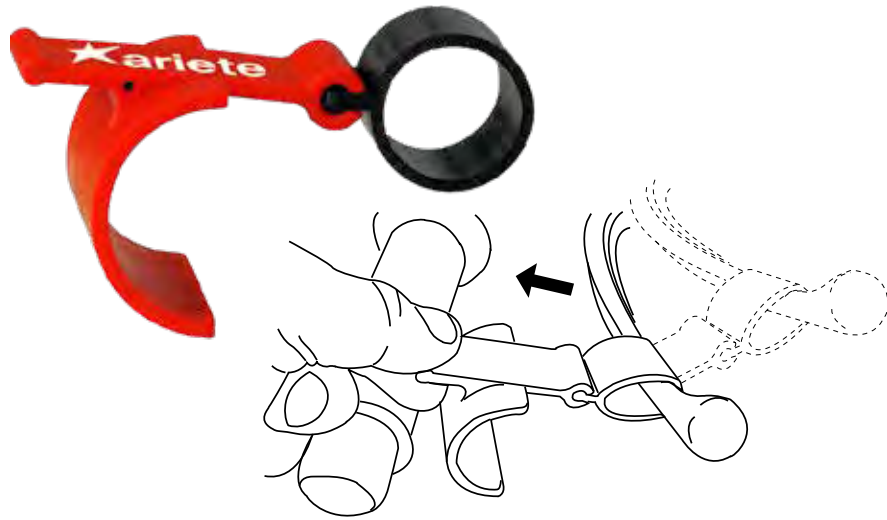

12951

BIG FOOT Pack 10 pcs.



11993 Pack 10 pcs.

11993-R Pack 10 pcs.

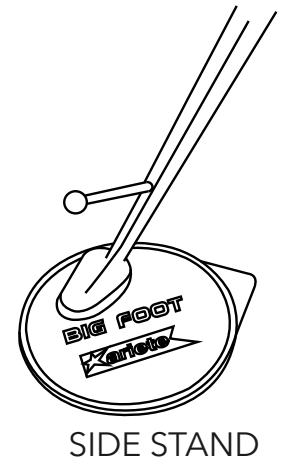

MUD SCRAPER

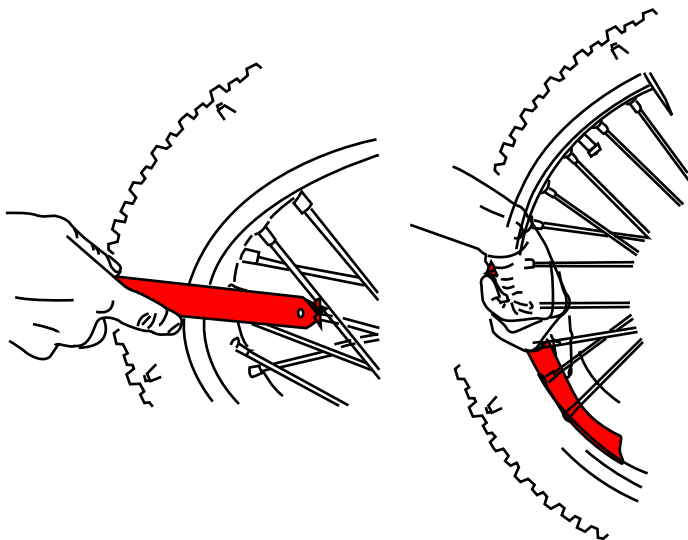

12952

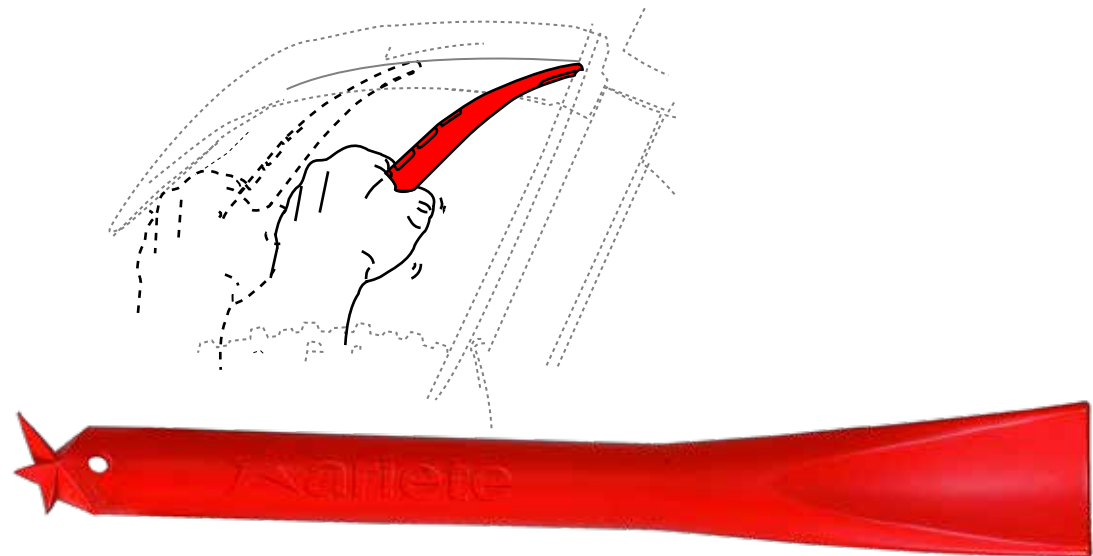

SUPER FAST GRIP GLUE 20gr.



12992

Dries in 30 to 90 seconds, high viscosity



10936

Tank breather vent pipe – Air valve included

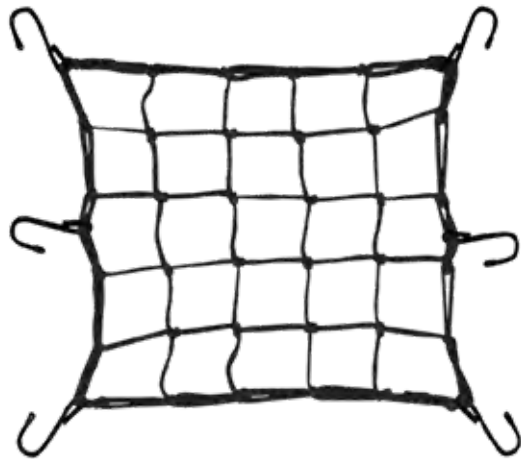

09957



10915 1,60"  
10916 1,85"  
10917 2,15"

10915 1,60"

10916 1,85"

10917 2,15"



10901

13904

10901 Ø 19-38

13904 Ø 24-48



RACING

12949/S	silicone	5000 Ohm	OPTIMIZED ★★★★★
12949	EPDM	High performance ø 6,3	



12949/S  
silicone

12949/S



12949  
EPDM

12949



04999 small ø 3,9  
silicone  
04999/A standard ø 6,3  
silicone



04999 ø 3,9

04999/A ø 6,3



09965  
silicone



09965-A  
silicone



















09965 /A  
silicone

09965 ø 6,3 min. 5 pcs.

09965-A ø 6,3 min. 5 pcs.

09965 /A ø 6,3 min. 5 pcs.



	Ø TUBE	Ø SLIDER	L. MIN	L. MAX	COLOUR	CODE
	28/30	46/48	50	215	Black	<b>07907</b>
	28/32	52/54	55	310	Black	<b>09941</b>
	32/34	52/54	65	250	Black	<b>06962</b>
	33/38	50/55	100	335	Black	<b>09942/A</b>
	33/38	50/55	100	335	Blue	<b>09942/A-A</b>
	35/38	56/59	85	440	Black	<b>09943</b>
	35/38	56/60	85	440	Black	<b>07901</b>
	38/41	58/62	95	430	Black	<b>07995</b>
	38/41	58/62	95	430	Blue	<b>07995-A</b>
	38/41	58/62	95	430	Red	<b>07995-R</b>
	39/41	58/60	105	290	Black	<b>09981</b>
	40/43	57/60	75	500	Black	<b>09932</b>
	40/43	57/60	75	500	Blue	<b>09932-A</b>
	40/43	57/60	75	500	Red	<b>09932-R</b>
	43/45	57/60	70	240	Black	<b>09974</b>
	43/46	58/63	90	600	Black	<b>09950</b>

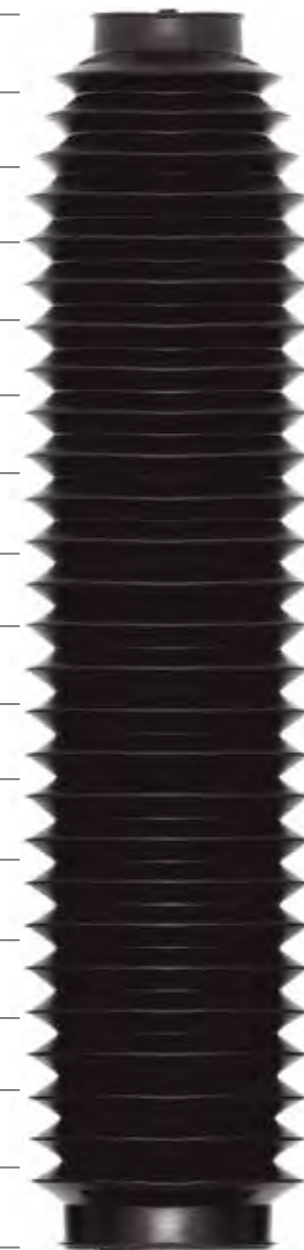



# ARIRAM GRIPS

- 1 Cylindrical shape with consistent parallel wall thickness;
- 2 Chassis in semi-rigid torque-limited elastomer;
- 3 Smooth and comfortable palm area with textured finger grip on opposite face;
- 4 Conical base to accommodate bar end weights;
- 5 Cleverly-designed to give exceptional grip and absorb vibration;
- 6 Four grooves for steel wire give extra security

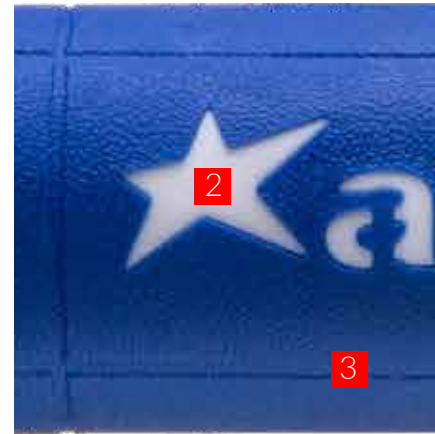

## TECHNOLOGY



02642-RN



02642-ARN



02642-BA



02642-GN



02642-GRN



02642-NG



02642-NR



02642-VN



# ARIES GRIPS

- 1 Built-in wire-on grooves with space to tighten the wire
- 2 Outer flange for lateral grip
- 3 Acute pyramid edges
- 4 Laser engineered mold
- 5 Optimized for throttle pipe
- 6 Slimline shape
- 7 Optimized for bar weights

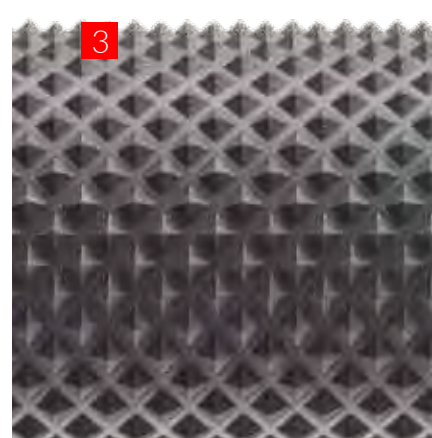
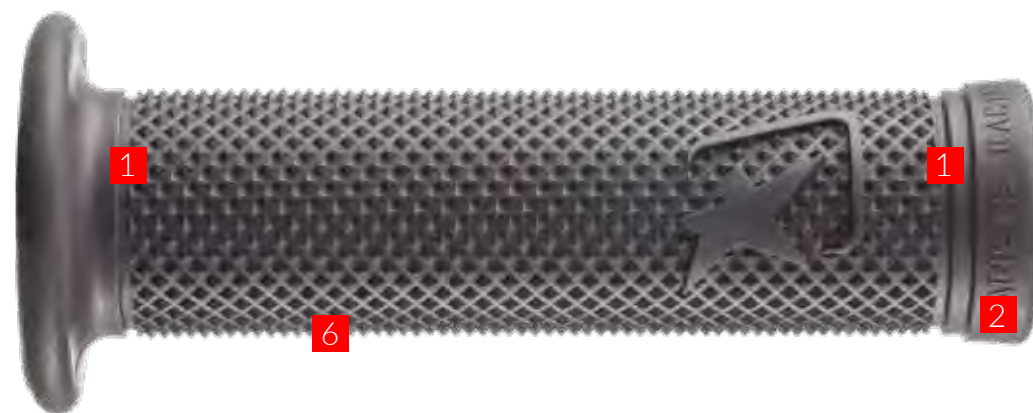

## TECHNOLOGY

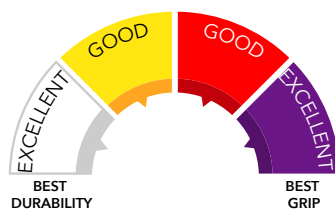



02636 Soft







02636/H Medium







02636-N Soft







02636/Gold Medium







02636/C-N Soft





ESTORIL ROAD GRIPS

SUPERBIKE GEL



02615-SBK Super soft







02615-A Soft







02615-R Soft







# STANDARD GRIPS



02640/SSF



01663/SSF



02637/SSF



01661/SSF



01686/SSF



01681/SSF



01685/SSF



01686/SS



01681/A





# STANDARD GRIPS



01680/SSF



01694/SSF



01679/SSF



02623/SSF



02625/SSF



02639/SSF



# STANDARD GRIPS



02626/SSF



02626/SS



02626/A/F



02626/A



01682/SSF



01616 Foam Plus + TP Caps



02636



02636/H



02636-N



02636/C-N



# STANDARD GRIPS



01690/F



02613-N



01612



02638/SSF



13917 Foam Grips Cover



EST. 1947  
*Ariete Heritage*  
GRIPS COLLECTION

Marco Belli Photo @marcorenieri

GRIPS ARIETE HERITAGE | 2020



# ARIETE HERITAGE GRIPS

ROAD 1"



00680-CFN

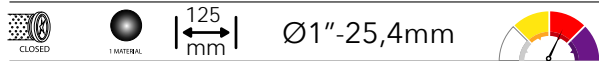

00680-CFR

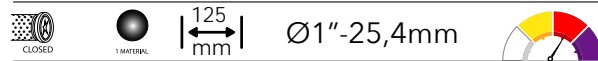

00680-CFM

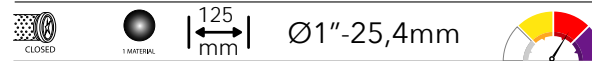

VEGA OFF-ROAD



01628-CFN



01628-CFR



01628-CFM



OFF-ROAD



01604-CFN



01604-CFR



01604-CFM



# ARIETE HERITAGE GRIPS

EST. 1947  
*Ariete Heritage*  
GRIPS COLLECTION

GRIPS ARIETE HERITAGE | 2020



00691-CFN



00691-CFR



00691-CFM



01683-CFN



01683-CFR



01683-CFM



01621-CFN



01621-CFR



01621-CFM



# ARIETE HERITAGE GRIPS

ROAD



01617/A-P



01617/A



01617-CFN



ROAD



01617/A-R



01617-CFR



01617-CFM

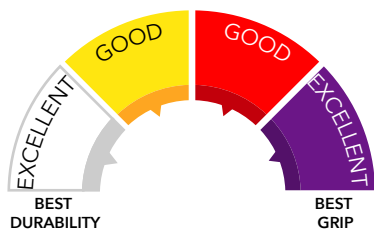

Right grip, rear side



Front side

# ARIETE HERITAGE GRIPS

EST. 1947  
*Ariete Heritage*  
GRIPS COLLECTION

GRIPS ARIETE HERITAGE | 2020

VEGA ROAD



01629-CFN



01629-CFR



01629-CFM



OFF-ROAD



00699-CFN



00699-CFR



00699-CFM



ROAD



00692-CFN



00692-CFR













00692-CFM













# SUITABLE FOR BMW GRIPS





- |   |   |   |  |   |
|---|---|---|--|---|
| 02624/L   | Ø26-26  |   |  |   |
|  |  | for heated controls till -->2013  | 125 mm   |           |
| 02624/C   | Ø26-26  |   |  |   |
|  |  | for heated controls till -->2013  | 125 mm   |           |
| 02624/LN  | Ø26-26  |   |  |   |
|  |  |  | for heated controls, for multi-controller navigator system since 2014--> | 125 mm    |



- |   |   |   |  |  |
|---|---|---|--|--|
| 01690/F   | Ø22-26  |   |  |  |
|  |   |   | 125 mm   |           |
| 01690/F/24  | Ø26-26  |   |  |  |
|  |  | for heated controls   | 125 mm   |           |
| 01690/F24N  | Ø26-26  |   |  |  |
|  |  |  | for heated controls, for multi-controller navigator system | 125 mm    |



- |   |   |        |                                |  |
|---|---|--------|--------------------------------|--|
| 02634   | <i>Old Models</i>   | Ø22-26 | Rubber                         |  |
|  |  | 130 mm | for K Series since -----> 1977 |  |

**SUITABLE FOR MULTI-CONTROLLER NAVIGATOR SYSTEM**



# SUITABLE FOR BMW

TELELEVER BMW BOXER



13911

**BMW CC. : 850, 1100, 1150, 1200 BMW SERIES: R, RS, RT, S, GS, GS ADVENTURE**

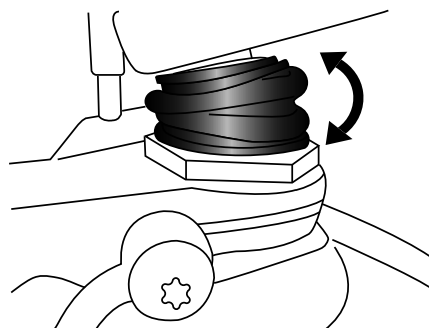

Ball joint boot



09974

PAIR FORK GAITERS K100

**EPDM HP**  
*Special Compound*

Brake calipers Seal kit

BRAKE CALIPERS SEAL KIT



13855-PI

**BMW SERIES: R65 (85-95), R80 (81-95), R100 (77-84)  
R1100 (92-2001), K75 (85-95), K100 (83-92), K1100 (92-96)**



13919

SILENTBLOCK M/M 8MA



13918

SILENTBLOCK 25/15 M/F 6MA

# SUITABLE FOR HONDA GRIPS



02640/SSF



02637/SSF



01687-C2R



01661/SSF



01686/SSF



01682/SSF



01612



01612/SS



01686/SS



09981

PAIR FORK GAITERS TRANSALP 600

# SUITABLE FOR KAWASAKI GRIPS



01685/SSF

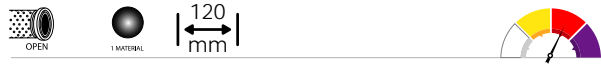

01679/SSF



02625/SSF



01687-NJ



01687-ZX



# SUITABLE FOR YAMAHA GRIPS



01663/SSF



01687-R1



01694/SSF



01681/SSF



02626/SSF 02626/SS



02638/SSF



01681/A



02626/A/F 02626/A



07907

PAIR OF FORK GAITERS DT 125

# SUITABLE FOR YAMAHA GRIPS

YAMAHA PW 50



02641



02641-R



02641-A



# SUITABLE FOR SUZUKI GRIPS



01685/SSF



01679/SSF



01687-GSRA



# SUITABLE FOR KYMCO GRIPS



02639/SSF



# SCOOTER GRIPS



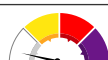

01678



 120 mm
 



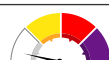

01683



 125 mm
 





01683-M



 125 mm
 



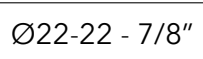
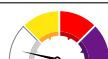

01609/V Vespa



 125 mm
  Ø22-22 - 7/8"
 

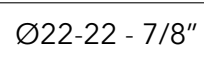
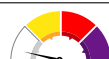

01626/V Vespa



 130 mm
  Ø22-22 - 7/8"
 



01670



 120 mm
 



01670-A



 120 mm
 



01668/A



 120 mm
 

# ARIES ASP GRIPS



02636/A/FA



02636/A-A



02636/A/FN



02636/A-N



02636/AFGF



02636/A-GF



02636/A/FR



02636/A-R



FLUO COLOR





# SCOOTER ASP GRIPS



01686/A-N



01686/A/FN



01686/A-A



01686/A/FA



01686/A-R



01686/A/FR



01686/A-GF



01686/A/FGF



01686/A-OF



01686/A/FOF



# SCOOTER ASP GRIPS



02605/A/FN



02605/A/FA



02605/A/FR



02605/AFGF



02605/AFOF

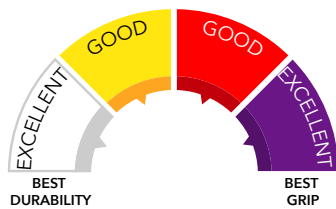

# HARRI'S ROAD GRIPS



01687-HRR

Diagram showing grip details: an "OPEN" icon, a "1 MATERIAL" icon, a "120 mm" length indicator, and a color-coded gauge.



01687-HRGR

Diagram showing grip details: an "OPEN" icon, a "1 MATERIAL" icon, a "120 mm" length indicator, and a color-coded gauge.



01687/F-NC

Diagram showing grip details: an "OPEN" icon, a "1 MATERIAL" icon, a "120 mm" length indicator, and a color-coded gauge.

01687-NC

Diagram showing grip details: a "CLOSED" icon, a "1 MATERIAL" icon, a "120 mm" length indicator, and a color-coded gauge.



01687

Diagram showing grip details: a "CLOSED" icon, a "1 MATERIAL" icon, a "120 mm" length indicator, and a color-coded gauge.

01687/F

Diagram showing grip details: an "OPEN" icon, a "1 MATERIAL" icon, a "120 mm" length indicator, and a color-coded gauge.



01687/LF

Diagram showing grip details: an "OPEN" icon, a "1 MATERIAL" icon, a "125 mm" length indicator, and a color-coded gauge.

# PUZZLE TANK PROTECTORS

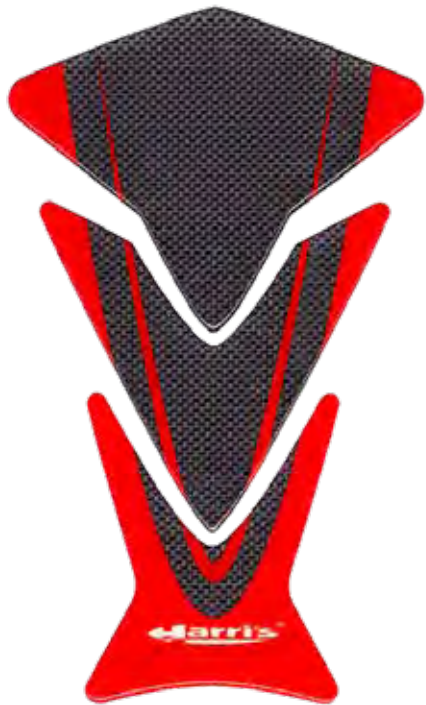

12970-R



12970



12970-T

Trasparente - Transparent



12970-TR

Trasparente - carbonio  
Transparent - carbon look

- Perfectly UV-resistant transparent resin - Anti-scratch and long-lasting material - Top quality adhesive (no damage to fuel tank)

# RACING VALVES FOR TUBELESS

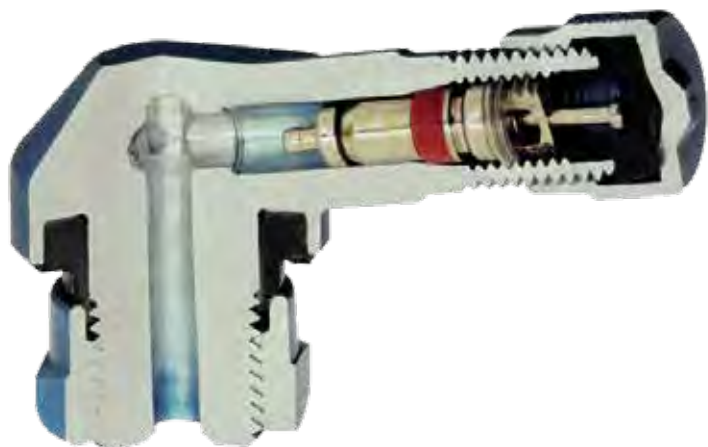

- Safety valve in aluminium for tubeless wheels
- Practical access for inflation
- No loss of pressure in the tyre
- Sold in pairs

TUV TA - MAN - 9084/03

**cod.11970= Ø 11,3 STANDARD RIMS**

**cod.11971= Ø 8,3 SPECIAL RIMS Antera, Brembo, Marchesini, Marvic, OZ Racing**



11970-GOLD

Ø 11,3

11970-R

Ø 11,3

11970

Ø 11,3

11971-N

Ø 8,3

11970-N

Ø 11,3

11971-ALL

Ø 8,3

11970-ALL

Ø 11,3

# ARI<sup>®</sup>

THE ORIGINAL  
FORK OIL SEALS

 **ariete**<sup>®</sup>



# ARI THE ORIGINAL FORK OIL SEALS

**AVOID ARI SEAL FAKES** 7 STEPS TO IDENTIFY AN ORIGINAL ARI BY ARIETE



FINE GROUND MATT INNER LIP,  
NO FLASH



STEEL SPRING



ARIETE NAME ON EVERY SEAL



# ARI THE ORIGINAL FORK OIL SEALS

**Ariete** fork oil-seals are the best you can get. This claim is justified by the quality of the materials used, and attention to detail in their design and manufacture. The **ARI** range has more than 170 different seal sizes. These cover more than 35,000 different motorcycle models with both traditional and upside-down forks. We have seals for classic 1960s telescopic forks extending through to the air forks now common both on- and off-road.

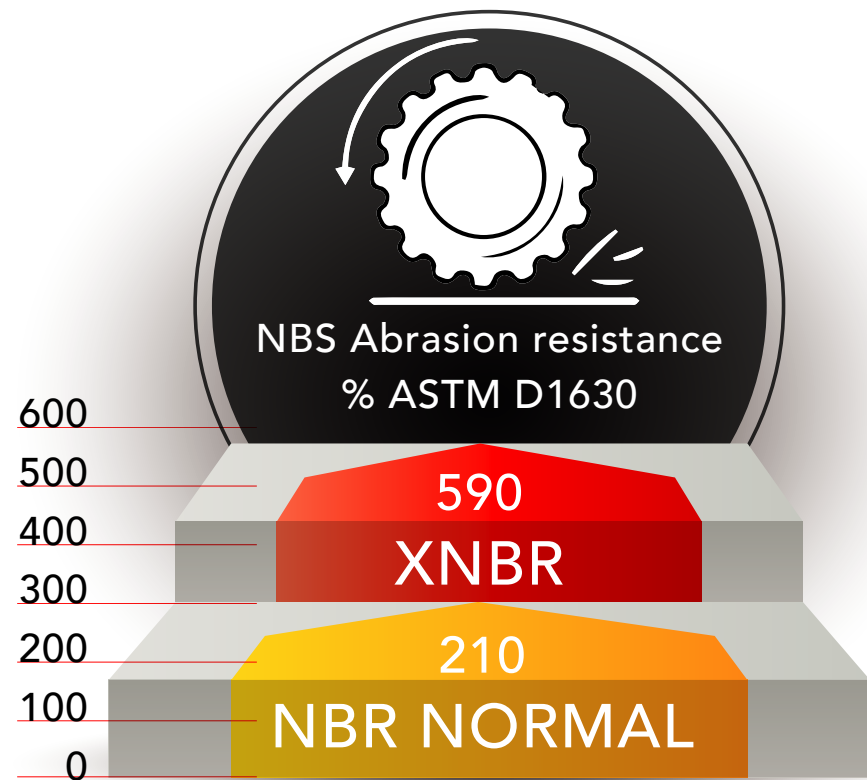
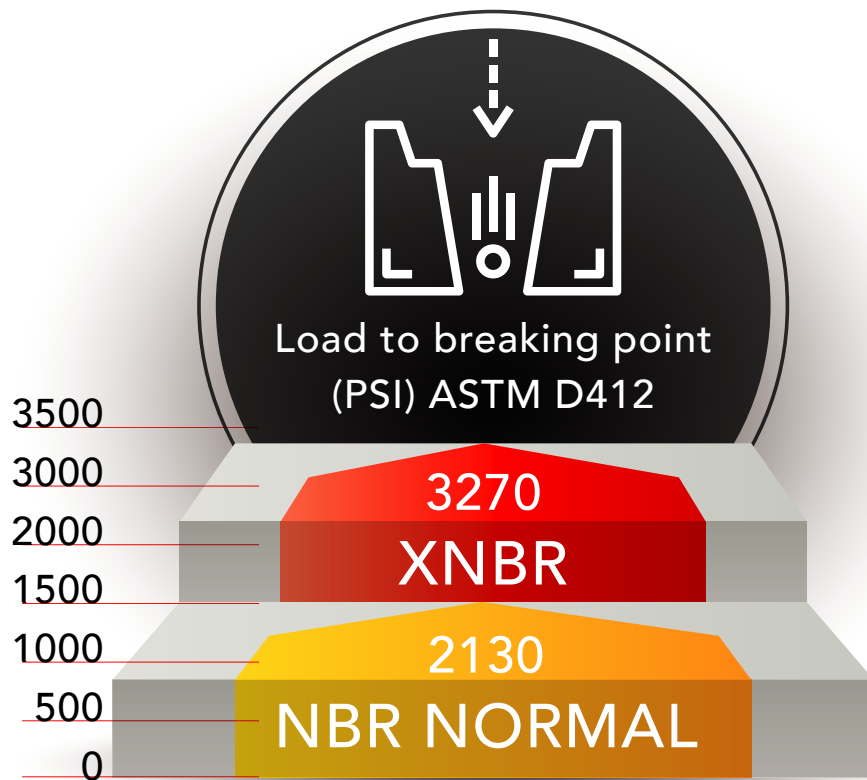



# ARI THE ORIGINAL FORK OIL SEALS **XNBR**

## **ARIETE FORK OIL SEALS, custom-made for your fork**

Ariete fork oil seals are different! The quality of their execution is matched by the unique nature of the material used: the carboxylated elastomer known as **XNBR**.

This compound offers unique characteristics of resistance to abrasion, to high temperatures, and to the complex lubricants with numerous additives, which are used in modern forks as fitted to motorcycles and scooters. The reciprocating action of the fork tube against the seal subjects it to a notable degree of abrasion, which is complicated by the heat generated as a result of hydraulic displacement within the fork, plus the friction of the components involved. This mechanical wear and tear leads to accelerated ageing of the rubber which is also obliged to deal with the chemical action of the various additives in the lubricant. Oil seals are normally made from a nitrile rubber, known as NBR. This is used because it is cheap, and plentiful, not because NBR is the best material for the job. Our technical staff have accumulated 70 years of experience in the rubber industry, and have spent many years looking for a better material for the manufacture of oil seals. In our view, the carboxylated elastomer known as **XNBR** has the following major advantages when compared with NBR:

Although the cost of **XNBR** is almost twice that of NBR, the sophisticated technology used to make our oil seals enables us to put them on the market at highly competitive prices. In this way, the Ariete Customer enjoys the benefits of a very high quality product, which satisfies the most demanding requirements, at a competitive price.

# ARI THE ORIGINAL FORK OIL SEALS

ARISIL special oil seal lubricant. ARI fork oil seals are made from a rubber compound specifically developed to work with the lubricants used in front forks, with all their various additives. This compound is completely different from that normally used for rotating shaft seals, since the physical environment inside a fork with its reciprocating movement, and the specialist lubricants, are completely different. We have designed ARI oil seals with a variety of lip profiles to make them longer lasting, while reducing to a minimum the friction effect against the moving shaft. Over the years, we have discovered the key role of a separating lubricant between the fork tube and the rubber of the oil seal to reduce to a minimum the surface friction, without affecting the function of the oil seal. After exhaustive testing, we have chosen a lubricant which is produced in the USA, and devised specifically as a rubber/metal lubricant for mechanical components used in the NASA space program. The advantage of this special grease, which we call ARISIL, is that it extends the life of the oil seal, and helps it retain its vital characteristics of flexibility and chemical resistance. For this reason, every set of ARI FORK OIL SEALS contains a single dose sachet of ARISIL, sufficient to lubricate the two oil seals supplied.

## TYPICAL CHARACTERISTICS

Product type:	<b>GREASE</b>
Colour:	<b>WHITE</b>
Composition:	<b>SILICONE LUBRICANT WITH ADDITIVES</b>
Temperature range	<b>-65° degrees c =&gt; +175° degrees c</b>
Coefficient of friction	<b>0.003 - load 6.3 n at 10 mm per second 24h</b>
USA military specification	<b>G-4343 C</b>



**10945** 1 gr. - 0,03527 ounces



**12950** 100 gr. - 3,527 ounces



# ARI THE ORIGINAL FORK OIL SEALS

The Split fork seal driver is a tool used for changing the fork seals on conventional and upside down forks. Available for fork seals in 35 mm thru 51 mm configurations. Manufactured from plated carbon steel, featuring split design and weighted body. Weight range from 800 to 1.000 gr. Sold individually.

CODE	TUBE Ø mm	CODE	TUBE Ø mm
12930/35	Ø 35	12930/44	Ø 44
12930/36	Ø 36	12930/45	Ø 45
12930/37	Ø 37	12930/46	Ø 46
12930/38	Ø 38	12930/47	Ø 47
12930/39	Ø 39	12930/48	Ø 48
12930/40	Ø 40	12930/49	Ø 49
12930/41	Ø 41	12930/50	Ø 50
12930/42	Ø 42	12930/51	Ø 51
12930/43	Ø 43		



Sherco Factory Racing - Photo Jean-Marie Pouget



## ARI THE ORIGINAL FORK OIL SEALS

## LIST BY SIZE

SIZE	TYPE	CODE	SIZE	TYPE	CODE	SIZE	TYPE	CODE
24 X 32 X 7/7,5	KCY	ARI.110	33 X 45 X 8/10,5	TCL	ARI.071	37,8 X 48 X 6/6,5	TCY	ARI.017
25,7 X 37 X 10,5	TC4	ARI.075	33 X 45 X 8/10,5	DC4Y	ARI.100	38 X 48 X 10	TC4	ARI.094
26 X 35,5/37,7 X 6/13,5	Y	ARI.076	33 X 45,5/49,7 X 4,5/13,8	Y	ARI.121	38 X 49,1/54 X 6/15,5	Y	ARI.092
26 X 37 X 10,5	TC4	ARI.052	33 X 46 X 10,5	TC4	ARI.004	38 X 50 X 10,5	TC4	ARI.021
26 X 37,5/43 X 14	XICY	ARI.175	33 X 46 X 11	DCY	ARI.073	38 X 50 X 11	TC4	ARI.062
27 X 39 X 10,5	TC4	ARI.009	33 X 46 X 11	DC4	ARI.096	38 X 50 X 7/8	TCL	ARI.029
28 X 38 X 7	SC	ARI.010	33 X 46,5/53 X 5,8/15	XICY	ARI.140	38 X 50 X 8/9,5	TCY	ARI.032
28 X 40 X 8	TC4	ARI.111	33,34 X 49,21 X 12,7/17,5	TCY	ARI.038	38 X 52 X 11	DCY	ARI.059
28,5 X 40 X 7/11	TC3Y	ARI.160	34 X 46 X 10,5	TB4	ARI.002	38,5 X 48 X 7/8,7	TBCL	ARI.084
29 X 41 X 11	DCY	ARI.055	35 X 46 X 11	DC4Y-2	ARI.149	39 X 51 X 10,5/12	TCL	ARI.070
29,8 X 40 X 7	TC4	ARI.098	35 X 46 X 8/11	DC4Y-1	ARI.171	39 X 51 X 8/10,5	TCL	ARI.058
30 X 39/43 X 12	DG5Y	ARI.112	35 X 46,8/51,3 X 5/12,5	SG5Y	ARI.148	39 X 51 X 8/10,5	DC4Y-1	ARI.156
30 X 40 X 7/8	KCY	ARI.080	35 X 47 X 10	DCY	ARI.040	39 X 51 X 8/9,5	TCL+Y	ARI.068
30 X 40 X 7/9	TCY	ARI.020	35 X 47 X 10/10,5	TCL	ARI.022	+ 39 X 51,1/55,6 X 4,7/11,5		
30 X 40 X 8/12	TC6YI	ARI.113	35 X 47 X 7,5/10	DCY	ARI.066	39 X 51,5 X 4,8/14	XICY	ARI.154
30 X 40 X 8/9	TCY	ARI.079	35 X 47 X 7/9	TCY	ARI.012	39 X 52 X 11	DCY	ARI.037
30 X 40,5 X 10,5/12	TCL	ARI.048	35 X 47 X 9,5/10,5	TC4Y	ARI.051	40 X 49,5 X 7/9,5	DC4Y	ARI.035
30 X 42 X 10,5	TB4	ARI.016	35 X 48 X 10,5	TC4	ARI.024	40 X 52 X 10	DC4	ARI.157
30 X 42 X 8/11	DCY1	ARI.142	35 X 48 X 11	DCY	ARI.003T	40 X 52 X 10/10,5	TCL	ARI.023
31 X 43 X 10,5	DCY	ARI.005	35 X 48 X 13/14,5	TCL	ARI.003R	40 X 52 X 8/10,5	TCL	ARI.063
31 X 43,5 X 5,6/14	XICY	ARI.173	35 X 48 X 8/10,5	TCL	ARI.061	40 X 52 X 8/9,5	TCY	ARI.033
31,5 X 45 X 7,1	TG4	ARI.161	35 X 48 X 8/9,5	TCY	ARI.049	40 X 52,5 X 4,6/14	Y	ARI.124
31,7 X 42 X 7/9	TCL	ARI.078	35 X 48,2 X 8/10,2	DC4Y	ARI.141	40 X 56,5 X 14	Y-2	ARI.166
31,74 X 42 X 9	TC4	ARI.103	35 X 48,5/53 X 5,8/15	XICY	ARI.130	41 X 51 X 6	SC4	ARI.045
31,75 X 42,8/48 X 7,6/11,6	Y+TCL	ARI.077	36 X 46 X 7/9	TCY	ARI.043	41 X 52,2 X 11	DCY1	ARI.143
+ 31,7 X 42 X 7/9			36 X 48 X 10,5	TC4	ARI.001	41 X 52,5 X 4,6/14	Y-2	ARI.150
31,8 X 42 X 7	TC4	ARI.133	36 X 48 X 11	TC4-1	ARI.114	41 X 53 X 10,5	TC4	ARI.041
32 X 42 X 7	SC	ARI.013	36 X 48 X 11/12,5	TCL	ARI.025	41 X 53 X 11	TC4	ARI.132
32 X 42 X 7/9	TCY	ARI.011	36 X 48 X 8/9,5	TCL	ARI.046	41 X 53 X 8/10,5	TCL	ARI.057
32 X 42 X 8/9	TCY	ARI.014	36 X 48,5/52,5 X 6/14	Y	ARI.115	41 X 53 X 8/10,5	DC	ARI.102
32 X 43 X 12,5	TB4	ARI.031	37 X 47 X 11	DCY1	ARI.169	41 X 53 X 8/9,5 (EX ARI.064)	TCY	ARI.056
32 X 44 X 10,5	TC4	ARI.060	37 X 47,4 X 4,6/14	Y-1	ARI.170	41 X 53,5/58 X 4,8/14	XICY	ARI.138
32 X 45 X 7	TC	ARI.122	37 X 49 X 8/10	DCY	ARI.050	41 X 53,7 X 5/10	YC	ARI.128
32 X 45 X 9/11	TCL	ARI.074	37 X 49/49,4 X 8/9,5	TCL	ARI.027	41 X 54 X 11	DCY	ARI.047
33 X 43 X 6,5/7,5	TCL	ARI.015	37 X 50 X 11	DCY	ARI.044	41 X 54 X 5,6/12,7	Y-24	ARI.151
33 X 45 X 10	TC4	ARI.135	37 X 50,5 X 5,6/12,8	Y-2	ARI.162	41 X 54,3 X 5,8/15	Y	ARI.153
33 X 45 X 11	TC4	ARI.101	37 X 50,5 X 5,8/15	Y-24A	ARI.174	41,3 X 54 X 13/14	TACY-6	ARI.089

FORK OIL SEAL -

DUST SEAL

# ARI THE ORIGINAL FORK OIL SEALS

# LIST BY SIZE

SIZE	TYPE	CODE	SIZE	TYPE	CODE
41,7 X 55 X 10/10,5	TCL	ARI.028	48 X 58,2 X 8,5/10,5	DC4Y	ARI.117
41,7 X 55 X 7,5/10	DCY	ARI.083	48 X 58,4 X 5,8/13	Y-2	ARI.176
41,7 X 55 X 8/10,5	TC4Y	ARI.034	48 X 58,5/62 X 6/11,5	Y-1	ARI.126
42 X 55,5 X 6/11	VCY	ARI.164	48 X 60 X 9,5/10,5	DC4Y-1	ARI.167
43 X 52,7 X 9,5/10,5	TCY	ARI.107	48 X 60,5/64,7 X 5/14	Y	ARI.168
43 X 52,9 X 9,2	DC4Y-1	ARI.158	48 X 61 X 11	TC4	ARI.134
43 X 53,4 X 6/13	Y-1	ARI.159	48 X 61 X 6/15	Y-2	ARI.165
43 X 54 X 11	TC4	ARI.053	49 X 60 X 10	TC4	ARI.104
43 X 54 X 11	DCY	ARI.118	49 X 60,5 X 6/10,5	Y-1	ARI.163
43 X 54 X 9,5/10,5	TCL	ARI.090	50 X 59,6 X 7/10,5	DC4Y	ARI.085
43 X 54,2/59,8 X 6/11	Y-11	ARI.129	50 X 60/63 X 7/13	Y	ARI.086
43 X 54,3 X 6/13	Y-1	ARI.152	50 X 62 X 9,5/11,5	DC4Y	ARI.125
43 X 54,3 X 6/15,4	Y	ARI.155	50 X 63 X 11	TGY	ARI.093
43 X 54,4 X 4,6/14	Y	ARI.119	50 X 63 X 11	DCY	ARI.136
43 X 55 X 10,5/12	TCL	ARI.036	50 X 63,4 X 4,6/14	SG5Y	ARI.137
43 X 55 X 11	TC4	ARI.123			
43 X 55 X 11/14	TCL	ARI.127			
43 X 55 X 9,5/10,5	TCL	ARI.072			
43 X 55 X 9,5/10,5	DC4Y	ARI.109			
43 X 55,7/60 X 5/14	XICY	ARI.144			
45 X 57 X 11	DCY	ARI.067			
45 X 57,3/62 X 6/13	SG5Y	ARI.091			
45 X 58 X 11	DCY	ARI.120			
45 X 58 X 8,5/11	DG4Y	ARI.082			
45 X 58,3/62,3 X 4,5/11	Y-9	ARI.081			
46 X 58 X 10,5	DC4	ARI.108			
46 X 58 X 8,5/11,5	DC4Y-1	ARI.146			
46 X 58,1 X 9,5/11,5	DCY	ARI.087			
46 X 58,5 X 4,8/14	XICY	ARI.172			
46 X 58,5 X 5/10	YC	ARI.131			
46 X 58,5/62,3 X 5,8/13,2	Y-9	ARI.147			
46 X 58,5/62,5 X 5/11,5	Y	ARI.088			
47 X 58 X 10	TC4	ARI.105			
47 X 58,5/62 X 6/10,3	SG5	ARI.106			
48 X 57,7 X 9,5/10,3	TCL1	ARI.116			
48 X 57,91 X 9,5/11,5	DC4Y	ARI.139			
48 X 58 X 9/9,8	TCL1	ARI.145			



■ FORK OIL SEAL
 ■ DUST SEAL



# MX APPLICATION LIST X No Bike - Not Available

BIKE	2019	2018	2017	2016	2015	2014	2013	2012	2011	2010	2009	2008	2007	2006	2005	2004	2003	2002	2001	2000	1999	
<b>Kawasaki KX</b>																						
125/250	x	x	x	x	x	x	x	x	x	x	x	ARI.117	ARI.117	ARI.117	ARI.117	ARI.117	ARI.117	ARI.117	ARI.087	ARI.087	ARI.087	
CAP	x	x	x	x	x	x	x	x	x	x	x	ARI.126	ARI.126	ARI.126	ARI.126	ARI.126	ARI.126	ARI.126	ARI.088	ARI.088	ARI.088	
250/F	ARI.117	ARI.117	ARI.117	ARI.117	ARI.117	ARI.117	ARI.117	ARI.105	ARI.105	ARI.105	ARI.105	ARI.105	ARI.105	ARI.105	ARI.117	x	x	x	x	x	x	
CAP	ARI.126	ARI.126	ARI.126	ARI.126	ARI.126	ARI.126	ARI.126	ARI.106	ARI.106	ARI.106	ARI.106	ARI.106	ARI.106	ARI.106	ARI.126	x	x	x	x	x	x	
450/F	ARI.104	ARI.104	ARI.104	ARI.104	ARI.104	ARI.145	ARI.145	ARI.145	ARI.145	ARI.145	ARI.117	ARI.117	ARI.117	ARI.117	x	x	x	x	x	x	x	
CAP	ARI.163	ARI.163	ARI.163	ARI.163	ARI.163	ARI.126	ARI.126	ARI.126	ARI.126	ARI.126	ARI.126	ARI.126	ARI.126	ARI.126	x	x	x	x	x	x	x	
<b>Suzuki RM</b>																						
80/85	ARI.044	ARI.044	ARI.044	ARI.044	ARI.044	ARI.044	ARI.044	ARI.044	ARI.044	ARI.044	ARI.044	ARI.044	ARI.044	ARI.044	ARI.044	ARI.044	ARI.044	ARI.044	ARI.044	ARI.044	x	
CAP	ARI.162	ARI.162	ARI.162	ARI.162	ARI.162	ARI.162	ARI.162	ARI.162	ARI.162	ARI.162	ARI.162	ARI.162	ARI.162	ARI.162	ARI.162	ARI.162	ARI.162	ARI.162	ARI.162	ARI.162	ARI.162	x
125	x	x	x	x	x	x	x	ARI.105	ARI.105	ARI.105	ARI.105	ARI.105	ARI.105	ARI.105	ARI.105	ARI.105	ARI.105	ARI.105	ARI.105	ARI.105	ARI.104	ARI.104
CAP	x	x	x	x	x	x	x	ARI.106	ARI.106	ARI.106	ARI.106	ARI.106	ARI.106	ARI.106	ARI.106	ARI.106	ARI.106	ARI.106	ARI.106	ARI.106	ARI.163	ARI.163
250	x	x	x	x	x	x	x	x	x	x	x	ARI.105	ARI.105	ARI.105	ARI.105	ARI.105	ARI.105	ARI.105	ARI.105	ARI.105	ARI.104	ARI.104
CAP	x	x	x	x	x	x	x	x	x	x	x	ARI.106	ARI.106	ARI.106	ARI.106	ARI.106	ARI.106	ARI.106	ARI.106	ARI.106	ARI.163	ARI.163
250/Z	ARI.117	ARI.117	ARI.117	ARI.117	ARI.117	ARI.117	ARI.117	ARI.105	ARI.105	ARI.105	ARI.105	ARI.105	ARI.105	ARI.117	ARI.105	ARI.105	ARI.105	x	x	x	x	
CAP	ARI.126	ARI.126	ARI.126	ARI.126	ARI.126	ARI.126	ARI.126	ARI.106	ARI.106	ARI.106	ARI.106	ARI.106	ARI.106	ARI.126	ARI.106	ARI.106	ARI.106	x	x	x	x	
450/Z	ARI.104	ARI.104	ARI.104	ARI.104	ARI.104	ARI.117	ARI.117	ARI.105	ARI.105	ARI.105	ARI.105	ARI.105	ARI.105	ARI.105	x	x	x	x	x	x	x	
CAP	ARI.163	ARI.163	ARI.163	ARI.163	ARI.163	ARI.126	ARI.126	ARI.106	ARI.106	ARI.106	ARI.106	ARI.106	ARI.106	ARI.106	x	x	x	x	x	x	x	
<b>Ktm SX</b>																						
125	ARI.178	ARI.139	ARI.139	ARI.139	ARI.139	ARI.139	ARI.139	ARI.139	ARI.139	ARI.139	ARI.116	ARI.116	ARI.107	ARI.116	ARI.116	ARI.116	ARI.116	ARI.116	ARI.116	ARI.116	ARI.107	ARI.082
CAP	ARI.176	ARI.176	ARI.176	ARI.126	ARI.126	ARI.126	ARI.126	ARI.126	ARI.126	ARI.126	ARI.126	ARI.126	-	ARI.126	ARI.126	ARI.126	ARI.126	ARI.126	ARI.126	ARI.126	-	ARI.081
250	ARI.178	ARI.139	ARI.139	ARI.139	ARI.139	ARI.139	ARI.139	ARI.139	ARI.139	ARI.139	ARI.116	ARI.116	ARI.116	ARI.116	ARI.116	ARI.116	ARI.116	ARI.116	ARI.116	ARI.116	ARI.107	ARI.085
CAP	ARI.176	ARI.176	ARI.176	ARI.176	ARI.126	ARI.126	ARI.126	ARI.126	ARI.126	ARI.126	ARI.126	ARI.126	ARI.126	ARI.126	ARI.126	ARI.126	ARI.126	ARI.126	ARI.126	ARI.126	-	ARI.086
400/450/525	ARI.139	ARI.139	ARI.139	ARI.139	ARI.139	ARI.139	ARI.139	ARI.139	ARI.139	ARI.139	ARI.116	ARI.116	ARI.116	ARI.116	ARI.116	ARI.116	ARI.116	ARI.116	ARI.116	ARI.116	ARI.107	ARI.085
CAP	ARI.176	ARI.176	ARI.176	ARI.176	ARI.126	ARI.126	ARI.126	ARI.126	ARI.126	ARI.126	ARI.126	ARI.126	ARI.126	ARI.126	ARI.126	ARI.126	ARI.126	ARI.126	ARI.126	ARI.126	-	ARI.086
<b>Husqvarna</b>																						
<b>TC</b>																						
85	ARI.158	ARI.107	ARI.158	ARI.158	ARI.158	x	x	x	x	x	x	x	x	x	x	x	x	x	x	x	x	x
CAP	ARI.159	ARI.159	ARI.159	ARI.159	ARI.159	x	x	x	x	x	x	x	x	x	x	x	x	x	x	x	x	x
125	x	ARI.139	ARI.139	ARI.139	ARI.139	ARI.139	ARI.139	x	x	x	x	x	x	x	x	x	x	x	x	x	x	x
CAP	x	ARI.176	ARI.176	ARI.126	ARI.126	ARI.126	ARI.126	x	x	x	x	x	x	x	x	x	x	x	x	x	x	x
250	ARI.178	ARI.139	ARI.139	ARI.139	ARI.139	ARI.139	ARI.139	x	x	x	x	x	x	x	x	x	x	x	x	x	x	x
CAP	ARI.176	ARI.176	ARI.176	ARI.126	ARI.126	ARI.126	ARI.126	x	x	x	x	x	x	x	x	x	x	x	x	x	x	x
<b>Husqvarna</b>																						
<b>FC</b>																						
250	ARI.178	ARI.139	ARI.139	ARI.139	ARI.139	ARI.139	ARI.139	x	x	x	x	x	x	x	x	x	x	x	x	x	x	x
CAP	ARI.176	ARI.176	ARI.176	ARI.126	ARI.126	ARI.126	ARI.126	x	x	x	x	x	x	x	x	x	x	x	x	x	x	x
350	ARI.178	ARI.139	ARI.139	ARI.139	ARI.139	ARI.139	ARI.139	x	x	x	x	x	x	x	x	x	x	x	x	x	x	x
CAP	ARI.176	ARI.176	ARI.176	ARI.126	ARI.126	ARI.126	ARI.126	x	x	x	x	x	x	x	x	x	x	x	x	x	x	x
450	ARI.178	ARI.139	ARI.139	ARI.139	ARI.139	ARI.139	ARI.139	x	x	x	x	x	x	x	x	x	x	x	x	x	x	x
CAP	ARI.176	ARI.176	ARI.176	ARI.126	ARI.126	ARI.126	ARI.126	x	x	x	x	x	x	x	x	x	x	x	x	x	x	x





# TECHNICAL ACCESSORIES

MASTER CYLINDER SEAL KITS



Brake Master-cylinders Seal Kit

**EPDM HP**  
*Special Compound*

The rubber brake seals in this kit are made in Italy by Ariete. After final grinding of the working surfaces, they are individually tested to guarantee their efficiency once fitted to the user's vehicle.

**⚠ WARNING**  
Use only DOT3 or DOT4 brake fluid

Brake calipers Seal kit



BRAKE CALIPERS SEAL KITS

**Ariete** introduces a new line of seal kits to suit brake calipers and master-cylinders for motorcycles and scooters. These are after-market replacements which fit many of the most popular models on the market.

The material used for the seals is a special compound of EPDM HP, developed by Ariete and fully compatible with the most common brake fluids (DOT3 and DOT4).

**Ask for our special catalogue covering applications for different models of motorcycles and scooters.**

# DOT3 - DOT4 FLUID PIPE























Low-pressure hydraulic pipe to fit between remote reservoir and master cylinder, suits DOT3 - DOT4

12978/5























6x10 mm Pack. 5 mt. - 16' 5" black



# FUEL PIPES

Size	Code	Color	Pack	Use	Structure
<b>1,5 x 4</b>	11949/10		10 mt. - 32' 10"	CARBURETTOR	
<b>1,5 x 4</b>	11949/10-T		10 mt. - 32' 10"	CARBURETTOR	
<b>2 x 5</b>	03998/10		10 mt. - 32' 10"	CARBURETTOR	
<b>2 x 5</b>	03998/10-T		10 mt. - 32' 10"	CARBURETTOR	
<b>3 x 6</b>	03999/10		10 mt. - 32' 10"	CARBURETTOR	
<b>3 x 6</b>	03999/10-T		10 mt. - 32' 10"	CARBURETTOR	
<b>4 x 7</b>	01925/10		10 mt. - 32' 10"		
<b>4 x 7</b>	01925/10-S		10 mt. - 32' 10"	UNLEADED FUEL	DOUBLE
<b>4 x 7</b>	01925/10-V		10 mt. - 32' 10"		
<b>4 x 7</b>	01925-V		100 mt. - 328'		
<b>4,5 x 9</b>	01958/10		10 mt. - 32' 10"		
<b>4,5 x 9</b>	01958/10-V		10 mt. - 32' 10"		
<b>4,5 x 9</b>	01958-V		100 mt. - 328'		
<b>4,8 x 9</b>	11922/10-S		10 mt. - 32' 10"	UNLEADED FUEL	DOUBLE
<b>5 x 8</b>	01922		100 mt. - 328'		
<b>5 x 8</b>	01922/10		10 mt. - 32' 10"		
<b>5 x 8</b>	01922/10-V		10 mt. - 32' 10"		
<b>5 x 8</b>	01922-V		100 mt. - 328'		
<b>5,5 x 10</b>	03904/10		10 mt. - 32' 10"		
<b>5,5 x 10</b>	03904/10-S		10 mt. - 32' 10"	UNLEADED FUEL	DOUBLE

# FUEL PIPES

Size	Code	Color	Pack	Use	Structure
<b>5,5 x 10</b>	03904/10-V		10 mt. - 32' 10"		
<b>6 x 9</b>	01958/A		100 mt. - 328'		
<b>6 x 9</b>	01958/A/10		10 mt. - 32' 10"		
<b>6 x 9</b>	01958/A10G		10 mt. - 32' 10"	UNLEADED FUEL	MONO
<b>6 x 9</b>	01958/A10S		10 mt. - 32' 10"	UNLEADED FUEL	DOUBLE
<b>6 x 9</b>	01958/A10V		10 mt. - 32' 10"		
<b>6 x 9</b>	01958/A-V		100 mt. - 328'		
<b>6 x 9</b>	09970/5		5 mt. - 16' 5"		DOUBLE
<b>6 x 9</b>	13909/10EN		10 mt. - 32' 10"	E10 FUEL	DOUBLE
<b>6 x 9</b>	13909/10EV		10 mt. - 32' 10"	E10 FUEL	DOUBLE
<b>6 X 13</b>	01902/10		10 mt. - 32' 10"		
<b>6 X 13</b>	01902/10-V		10 mt. - 32' 10"		
<b>6 X 13</b>	01902-V		50 mt. - 164'		
<b>6,5 X 11</b>	11923/10-S		10 mt. - 32' 10"	UNLEADED FUEL	DOUBLE
<b>7 x 10</b>	01922/A		100 mt. - 328'		
<b>7 x 10</b>	01922/A/10		10 mt. - 32' 10"		
<b>7 x 10</b>	01922/A10V		10 mt. - 32' 10"		
<b>7 x 10</b>	01922/A-V		100 mt. - 328'		
<b>8 x 13</b>	11932/10-V		10 mt. - 32' 10"		
<b>8 x 13</b>	13912/10EN		10 mt. - 32' 10"	E10 FUEL	DOUBLE
<b>8 x 13</b>	13912/10EV		10 mt. - 32' 10"	E10 FUEL	DOUBLE
<b>10 x 15</b>	11934/10-V		10 mt. - 32' 10"		



13908-A BLUE

13908-R RED



13908 BLACK

13908-AR ORANGE



OFF-ROAD GOGGLES



OFF-ROAD GRIPS



12933-A BLUE

12933-R RED



12933 BLACK

12933-AR ORANGE



12932-A BLUE

12932-R RED



12932 BLACK

12932-AR ORANGE



ROAD GRIPS



Photo M. Crivellari

13980-CB

↕ 2,80 m



DIS-10

↕ 50 cm Display stand grips not included





12969-BS

---

---



12969-RO

---

---



12969-NS

---

---



12971-TCN

---

---



12971-CCG

---

---



12971-SCB

---

---



12971-BLN

---

---



FRONT

**ART OF SPEED**

BACK

14906-MAS size S

14906-MAM size M

14906-MAL size L

14906-MAXL size XL

14906-MXXL size XXL



**OFFICIAL-BLUE**

14902-OAS size S

14902-OAM size M

14902-OAL size L

14902-OAXL size XL



**OFFICIAL**

14902-OS size S

14902-OM size M

14902-OL size L

14902-OXL size XL

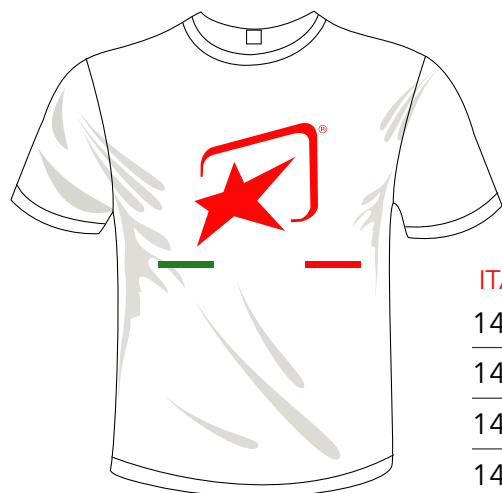

**ITALIA**

14903-IS size S

14903-IM size M

14903-IL size L

14903-IXL size XL



**HERITAGE Original Vintage T-shirt**

14905-HES size S

14905-HEM size M

14905-HEL size L

14905-HEXL size XL





