

COMETIC
GASKET



DOMESTIC AND IMPORT AUTOMOTIVE
**PERFORMANCE
GASKETS**





Automotive Gaskets

Cometic Gasket - An Exclusive NASCAR Performance Product

Carburetor Gaskets

Designed by engineers, validated by the winners circle. Cometic carburetor gaskets are manufactured from performance grade materials that resist swelling from various types of fuel. Can be custom ordered to your exact specifications.

Part #	Application	Material
C15184	HOLLEY 2 BBL CARB OPEN PLENUM	.039" FIBER
C5282	HOLLEY 2 BBL CARB 2 HOLE 1.750"	.047" FIBER
C5263	HOLLEY 4150 4BBL CARB OPEN PLENUM	.047" FIBER
C5262	HOLLEY 4150 4BBL 4 HOLE 1.750"	.047" FIBER
C15238	HOLLEY 4500 4BBL CARB OPEN PLENUM	.047" FIBER
C15239	HOLLEY 4500 4BBL 4 HOLE 1.750" GASKET	.047" FIBER
C5280	HOLLEY 390 CFM 4BBL CARB 4 HOLE 1-19/32"	.047" FIBER
C15181	CARTER AFB 4BBL SQUARE BORE 4 HOLE	.039" FIBER
C15183	ROCHESTERQUADRAJET 4BBL SPREAD BORE	.039" FIBER
C15240	WEBER48MMCARB	.047" FIBER
C5388	HOLLEY AIRHORN CARB	.060" FIBER
C15241	HOLLEY FLOAT BOWL	.062" MP
C15242	HOLLEY 2 CIRCUIT METERING BLOCK	.062" MP
C15243	HOLLEY 3 CIRCUIT METERING BLOCK	.062" MP
C15244	HOLLEY/QUIKFUEL POWER VALVE	.062"MP



Differential Gaskets

Cometic Differential Gaskets are offered for the most popular differentials in the industry. Made from performance inspired materials and engineered to be the best sealing gasket you can find. Don't see what you are looking for? Simply send us your used gasket and we can custom make exactly what you need!

Part #	Application	Material
C15212	AMC12BOLT	.125" FIBER
C15213	DANA 25,27,30 10 BOLT	.032" AFM
C15214	DANA 35 10 BOLT	.060" AFM
C15215	DANA 44	.060" AFM
C15216	DANA 44/GM 8.75" CORVETTE/VIPER	.032"AFM
C15217	DANA 60/70	.060" AFM
C15218	DANA 80 10 BOLT	.032" AFM
C15219	DODGE7.25"10BOLT FRONT AXLE	.032" AFM
C15220	DODGE8.25"10BOLT REAR AXLE	.032" AFM
C15221	FORD10.5"12BOLT	.032"AFM
C15222	FORD8"10BOLT	.032" AFM
C15223	FORD8.8"10BOLT	.060" AFM
C15224	FORD9"10BOLT .040"	FormedSilicone
C5848-032	FORD9"10BOLT	.032" AFM
C15225	FORD9.75"12BOLT	.060" AFM
C15226	GM"O" AXLE 12 BOLT IRREGULAR	.060" AFM
C15227	GM1/2 TON 12 BOLT	.032"AFM
C15228	GM12BOLT	.060" AFM
C15229	GM7.5"10 BOLT REAR AXLE	.032"AFM
C15230	GM7.75"9BOLT FRONT AXLE	.032" AFM
C15231	GM8.5"1/2&3/4 TON 10 BOLT	.032"AFM
C15232	GM8.5"10BOLT	.060"AFM
C15233	GM9.5"1/2&3/4 TON 14 BOLT	.060"AFM
C15234	GM TRUCK 14 BOLT	.060"AFM
C15235	LEGENDCAR10BOLT	.032" AFM
C15236	SPRINT MIDGET 10-BOLT QUICK CHANGE	.060" AFM
C15237	WINTERQUICKCHANGE10BOLT	.060" AFM

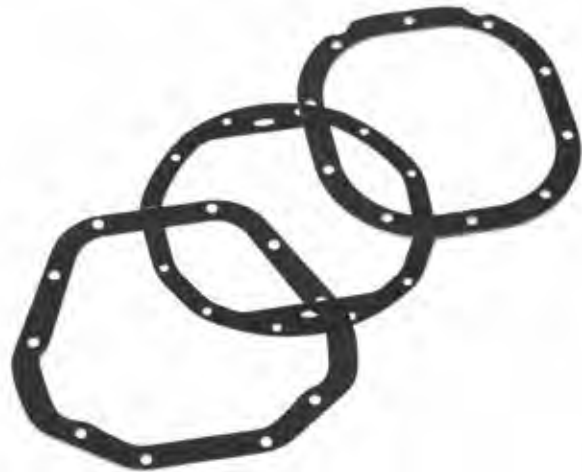

Transmission Gaskets

Why trust your expensive transmission to some flimsy paper gasket? Keep your transmission fluid and gear lube where it belongs with our Aluminum Foamet Material (AFM) Gaskets. AFM consists of an aluminum core and features a foam rubber coating bonded to both sides. Ideal for sealing less than perfect surfaces and can be installed without the use of additional sealers!

Part #	Application	Material
C15246	DODGE727/46REPAN	.060" AFM
C15247	FORD A4LD/4R44E/4R55E 1993-05	.060" AFM
C15248	FORDC-4/C-511 BOLT 1970-86	.060" AFM
C15249	FORDC-63SPEED17BOLT	.060" AFM
C15250	GM4L80E1991-10	.060" AFM
C15251	GM TH700-R4/4L60E 1982-03	.060" AFM
C15252	GMPOWERGLIDE2SPD TRANS PAN	.075" AFM
C15253	GM TURBO 400 TRANS PAN	.075" AFM
C15254	GM TURBO 350 PAN TRANS	.075" AFM
C15255	MUNCIEM21 GASKET KIT - NO SEALS	AFM

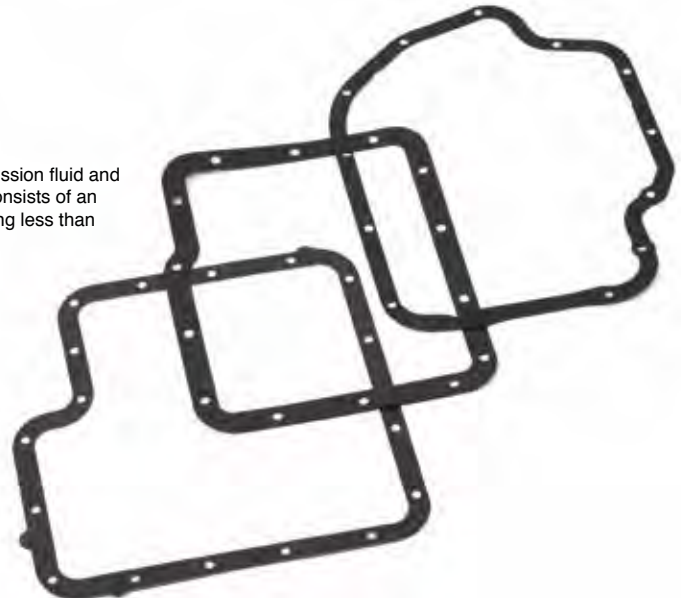

Valve Cover Gaskets & Sets

Race inspired designs and materials ensure that these valve cover gaskets will perform well above the OE standard. Cosmetic valve cover gaskets surpass the quality and ability of typical cork or paper gaskets offered by other manufactures. Withstands blowing out, over tightening, and high vacuum all at an affordable price.

DOMESTIC

Part #	Application
C5976	CHRYSLER 426 HEMI V8
C5983	CHRYSLER BIG BLOCK WEDGE
C5193	CHRYSLER/DODGE 5.7/6.1L HEMI 2003+UP SET - 1 HEAD
C5177	FORD 4.6L DOHC 1996-98
C5178	FORD 4.6L SOHC 1996-04
C5179	FORD 4.6L SOHC 2002-04 TRUCK
C5974	FORD SMALL BLOCK 289,302,351W
C5975	GM BIG BLOCK MARK 4/5/6
C15245	GM LS V8 GEN III/IV 1999-14
C5973	GM SMALL BLOCK 18/23* V8
C5044	PONT 265/301/350/400/428/455

SPORT COMPACT

Part #	Application
C4643	FORD ZETEC 2.0L DOHC 1995-97 / SET
C4644	FORD ZETEC 2.0L DOHC 1998-04 / SET
C4653	FORD 2300 2.3L SOHC 1974-93 / SET
C4701	HONDA 1.5L 4 CYL 88-95 / SET
C4628	HONDA B16A2/3 & B18C1/C5 94-01 / SET
C4665	HONDA D16Y5/7/8 96-00 / SET
C4655	HONDA D16Z6 VTEC 92-95 / SET
C4706	HONDA DOHC 1.6L 86-89 / SET
C4679	HONDA/ACURA B18A1/B1 1990-01 / SET
C4781	MAZDA B6 1.6L 1989-93 / SET
C4788	MAZDA MX-6 FS-DE 2.0L 91-97 / SET
C4722	MINI COOPER DOHC 2.0L 91-00 / SET
C4691	MITSUBISHI ECLIPSE 2.0L 89-94 / SET
C4713	MITSUBISHI GALANT SOHC 2.4V 3.0L 88-96 / SET
C15046	MINI COOPER DOHC 2.0L 95-99 / SET
C4607	NISSAN CA18DE/DET 1989-1993 / SET
C4906	NISSAN E15T 1.5L SOHC 1983-84 / SET
C4631	NISSAN KA24DE 2.4L 1993-01 FWD / SET
C4761	NISSAN KA24DE 2.4L DOHC 1991-94 / SET
C4766	NISSAN KA24DE 2.4L DOHC 1995-98 / SET
C4552	NISSAN RB20/25/26 1988-02 / SET
C4730	NISSAN SR16/20VE 1.6L 1997-01 / SET
C4747	NISSAN SR20DE 2.0L DOHC 1991-96 FWD / SET
C4753	NISSAN SR20DET S13 DOHC 88-93 / SET
C4755	NISSAN SR20DET S14 DOHC 94-98 / SET
C4773	NISSAN VG30DE 3.0L V6 90-99 / SET
C4871	SUBARU EJ22E SOHC 90-96 / SET
C4880	SUBARU EJ255 DOHC 06-07 / LEFT
C4881	SUBARU EJ255 DOHC 06-07 / RIGHT

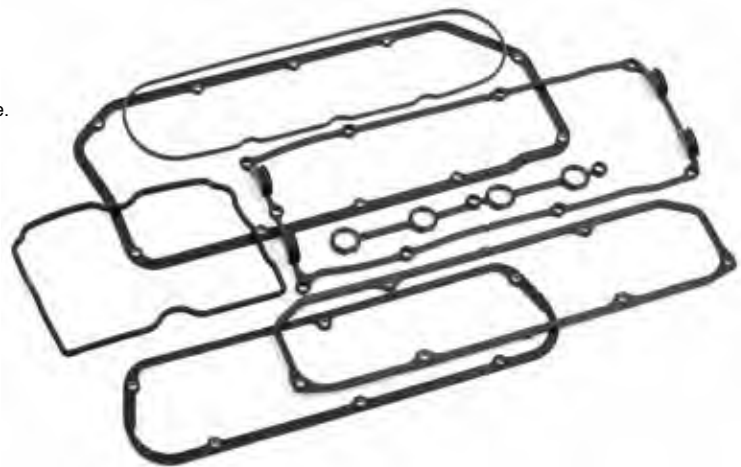

SPORT COMPACT

Part #	Application
C4873	SUBARU EJ25D DOHC 96-99 / SET
C4863	SUBARU WRX EJ205 02-05 / RIGHT
C4864	SUBARU WRX EJ205 02-05 / LEFT
C4642	SUBARU EJ25 SOHC 1999-05 / SET
C4928	SUBARU EJ257 DOHC 2004-06 / LEFT
C4929	SUBARU EJ257 DOHC 2004-06 / RIGHT
C4935	TOYOTA 22R/RE/REC 81-85 / SET
C4830	TOYOTA 2RZ-FE 2.4L 4 CYL 95-02 / SET
C4807	TOYOTA 4A-GE 1.6L 84-92 / SET
C4820	TOYOTA 5S-FE 2.2L 4 CYL 90-97 / SET
C4851	TOYOTA SUPRA 2JZ-GE/GTE 93-97 / SET
C4838	TOYOTA SUPRA 7M-GTE 87-92 / SET
C4608	TOYOTA 3S-GTE 1991-1995 / SET

DIESEL

Part #	Application
C15056	CUMMINS 3.9L 4BT 4CYL DIESEL / SET
C5614	CUMMINS 5.9L 24V DIESEL 1998.5-02 / SET
C15066	CUMMINS 5.9L 12V DIESEL 1992-98 / SET
C15070	CUMMINS 5.9L 24VCR DIESEL 2003-07 / SET
C15143	FORD 6.0L POWERSTROKE 2003-08 / SET
C15151	FORD 6.4L POWERSTROKE 2008-10 / SET
C15162	FORD 7.3L POWERSTROKE 1994-97 / EACH
C15163	FORD 7.3L POWERSTROKE 1998-02 / EACH

Turbo Gaskets

Manufactured from a high grade stainless steel, these turbocharger gaskets get the job done the first time! The embossed spring steel maintains a torque set and won't burn through or push out. Does not require additional sealers.

Part #	Application
C4514	TURBO INLET FLANGE T3 GARRETT
C4515	TURBO INLET FLANGE T25 GARRETT
C4516	TURBO INLET FLANGE T4 GARRETT
C4513	TURBO INLET FLANGE T4 DIVIDED
C4517	TURBO INLET FLANGE T6 GARRETT
C5723-030	SUBARU WRX TURBO TO UP PIPE
C5736-030	SUBARU WRX TURBO TO DOWNPIPE
C15154	FORD 6.4L POWERSTROKE 2008-10



Valve Stem Seals

New age engine builds require new age valve stem seals and we have them! These viton steel body (VSB) seals are available for most applications ranging from automotive to off road dirt bikes. Sold in packs of 16. [See page 145 for additional Valve Stem Seals](#)

Part#	Valve Stem O.D.	Guide O.D.	Height	Overall O.D.
3225V-16	6mm	11mm	9.3mm	13.4mm
3262V-16	7mm	11mm	9.5mm	14.4mm
3516P-16	8mm	.492"	.470"	.616"
3237V-16	5/16"	.500"	.517"	.562"
3235V-16	5/16"	.531"	.516"	.677"
3188V-16	11/32"	.500"	.531"	.623"
3228V-16	11/32"	.530"	.527"	.674"
3195V-16	3/8"	.500"	.531"	.623"
3198V-16	3/8"	.625"	.531"	.742"





Made in the U.S.A.

MLS Multi Layer Steel

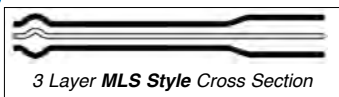

3 Layer *MLS Style* Cross Section

Available thickness:

.027", .030", .036", .040", .045", .051", .056", .060", .066", .070", .075", .080", .086", .092", .098", 120", .140"

TABLE OF CONTENTS

MLS Gaskets are comprised of multiple embossed layers of both AMP (Advanced Multi-Polymer Coating) and uncoated stainless steel. The embossed outer layers of the gaskets meet the demands of a variety of harsh sealing environments, load conditions and surface finishes.

This design requires less clamp load creating less bore distortion and conforms load distribution across the sealing area. The center or shim layer is an uncoated stainless steel layer which can be varied to accommodate multiple thickness requirements. No sealants or re-torque required.

MLS Head Gaskets

Make	Pg.	Make	Pg.	Make	Pg.
Austin	64	Ford Diesel	58	Pontiac	62
AMC	5	Ford/Lotus/Cosworth	71	Porsche	116
BMW	64	Honda/Acura	77	Renault	118
Buick	6	Hyundai	88	Rover	118
Cadillac	7	Jaguar	88	Subaru	119
Chevrolet	8	Mazda	93	Toyota	130
Chevrolet Diesel	23	Mercedes Benz	95	Triumph	140
Chrysler/Dodge	25	MG	96	TVR	141
Coventry Climax	69	Mini	96	Vauxhall/Opel	141
Cummins Diesel	37	Mitsubishi	97	VW/Audi	142
Ferrari	70	Nissan	100	Volvo	143
Fiat/Lancia	70	Oldsmobile	61		
Ford	42	Peugeot/Citroen	116		

MLx Multi Layer Xtreme

Utilizes an integrated "stopper" layer for combustion chamber sealing and improved clamp load around the cylinder without increasing bore distortion. MLx technology can be found in the applications below and are made from the same materials as our MLS Head Gaskets.

No sealants or re-torque required.



3 Layer *MLx Style* Cross Section



4 Layer *MLx Style* Cross Section



5 Layer *MLx Style* Cross Section

MLx Head Gaskets

Application	Pg.	Application	Pg.	Application	Pg.
LSJ Ecotec 2.0L	8, 76	Cummins 5.9L CR	40	Nissan 2.0L SR20DE/DET S14	105
3.6L LY7/LLT/LFX	10	Cummins 6.7L	41	Nissan GT-R VR38DETT	114
SBC w/All Pro Heads	13	Ford 3.5L EcoBoost	46	Nissan TB48DE	115
Chevy R07.2	14	Ford 4.6/5.4L SOHC/DOHC	47	Nissan VK56DE 5.6L	115
LS1/LS2/LS3/LS6	15	Ford 5.8L Trinity V8	49	Porsche 3.6L 997TT	117
LS7	16	Ford 302/351	51	Rover 5.0L V8 LR-V8	118
LS9/LSA	17	Ford FR9 V8	54	Subaru FA20	119
LSX	17	Ford 6.0L Powerstroke	58	Subaru EJ205	119
LT1 6.2L	19	Ford 6.4L Powerstroke	59	Subaru EJ25D DOHC	122
GM 5.2 Prostock	23	Ford 6.7L Scorpion	60	Subaru EJ251/EJ253	123
6.1L Hemi	31	Honda/Acura K20/24	85	Subaru EJ255	124
Chry/Dodge R6 V8	32	Hyundai 2.0L DOHC V6	88	Subaru EJ257	126
6.4L Hemi	30	Hyundai 3.8L DOHC V6	88	Toyota 2ZZ-GE 1.8L	132
Viper V10	36	Jaguar AJ133 5.0L	92	Toyota 1FZ-FE 4.5L	139
Cummins 4BT	37	Mini 1.6L Turbo Prince	96	Toyota PH11 V8	140
Cummins 6BT 12v	38	Mitsu EVO X 4B11T	99	Vauxhall 16V	141
Cummins ISB 24v	39	Mitsu 2.0L 4G63/4G63T	97,98		

STREETpro by Cometic Gasket

StreetPro is a product line of Cometic Gasket manufactured by Cometic Gasket. StreetPro is geared toward the street-rodder who is looking to purchase a kit with all necessary gaskets and seals needed for your rebuild.

Make	Pg.	Make	Pg.	Make	Pg.
BMW	65,67	Ford Diesel	59,60,61	Oldsmobile	62
Buick	7	Honda/Acura	77,78,79,81,82,83,84	Pontiac	63
Chevrolet	10,12,16,18,20	Mazda	93,94	Subaru	120,121,122,123,125,126,127,128
Chevrolet Diesel	24	Mitsubishi	97,99,100	Toyota	131,132,134,135,137,138
Chrysler/Dodge	25,28,29,30,33,34,35	Nissan	102,103,104,105,106,107,108,109,111,112,113		
Cummins	38,39,40,41,42				
Ford	44,45,47,52,56,57				

Miscellaneous Gaskets & Accessories

Make	Pg.	Make	Pg.	Make	Pg.
Molded Rubber Valve Cover Gaskets	3	Carburetor Gaskets	2	Timing Cover Sets	146
MLS Exhaust Gaskets	144	Fuel Cell Gasket Kit	146	Damper Rebuild O-rings	146
Valve Stem Seals	145	High Vacuum Crank Seals	146	Cometic Block & Head Cleaner	147
2PC Rear Main Seals	146	Turbo Gaskets	3,144	Klotz Lubricants	147
Rear End Gaskets	2			Transmission Gaskets	2



Cometic Gasket - An Exclusive NASCAR Performance Product

AMC

4.0L Inline 6 242ci 1987-2006

87-01 Cherokee, 93-04 Grand Cherokee, 87-90 Wagoneer, 87-92 Comanche, 91-06 Wrangler

Head Gaskets

MLS Head Gaskets

Bore	Thickness	Pkg Qty	Part #
3.950	.050"	1	C5987-050
4.000	.050"	1	C5988-050
4.060	.050"	1	C5989-050

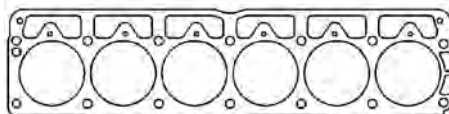

Additional thicknesses available see page 4

Individual Gaskets

Timing Cover Set

Application	Part #
3.8/4.0/4.2L I6 1965-2006	C5047

290-401ci V8

Head Gaskets

MLS Head Gaskets

Fits: 290 1966-69, 304 1970-78, 343 1967-69, 360 1970-91

Bore	Thickness	Pkg Qty	Part #
3.810"	.040"	1	C5669-040
4.140"	.040"	1	C5674-040

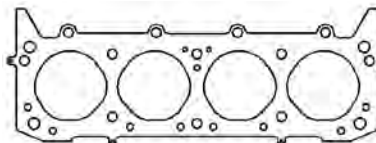

Additional thicknesses available see page 4

MLS Head Gaskets

Fits: 390 1970 & 401 1972-74

Bore	Thickness	Pkg Qty	Part #
4.250"	.040"	1	C5937-040
4.380"	.040"	1	C5938-040

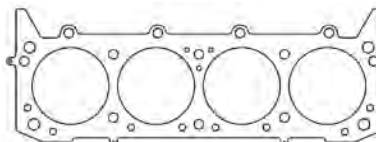

MLS Head Gaskets

Fits: INDY 401 Aluminum Heads

Bore	Thickness	Pkg Qty	Part #
4.380"	.040"	1	C5409-040

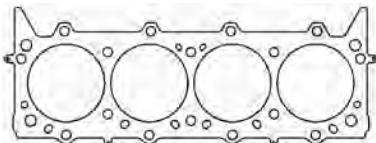

Individual Gaskets

Exhaust Gasket Set

Application	Part #
304-401ci w/Dogleg Ports	C5161-064
304-401ci w/Rectangle Ports	C5101-064

Intake Gasket Set

Application	Part #
290-401 V8 1970-91 1.13" x 2.22"	C15002-060
390/401 Indy Head 1.20" x 2.30"	C15003-060

Valve Cover Gasket (sold individually)

Application	Part #
390/401ci V8 Indy Head	C5115-188

Timing Cover Set

Application	Part #
290-401ci V8 1966-88	C5046



Cometic Gasket - An Exclusive NASCAR Performance Product

BUICK

192, 231, 252ci V6 Stock, Stage I, and Stage II

Head Gaskets

MLS Head Gaskets

Bore	Thickness	Pkg Qty	Part #
3.860"	.040"	1	C5691-040
4.020"	.040"	1	C5692-040
4.090"	.040"	1	C5693-040

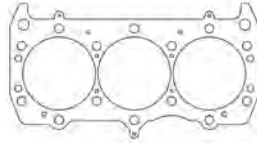

Additional thicknesses available see page 4

Individual Gaskets

Exhaust Gasket Set

Application	Part #
Stock & Stage I Ports	C5696-064
Stage II Ports	C5791-064

Valve Cover Gasket (sold individually)

Application	Part #
Iron & Aluminum Heads	C5697-188

Intake Gasket Set

Application	Part #
Stock & Stage I Ports	C5694-060
Stage II Ports	C5792-060

Timing Cover Set

Application	Part #
66-87 V6/Small V8 w/Rope Seal	C5048
66-87 V6/Small V8 w/Radial Seal	C5049

Oil Pan Gasket

Application	Part #
20 Bolt	C5700-094

Rear Main Seal

Application	Part #
2 Piece w/Side Rails	C5707

3800 Series II V6 1996-2003

Head Gaskets

MLS Head Gasket - Left Side

Bore	Thickness	Pkg Qty	Part #
3.840"	.066"	1	C5720-066

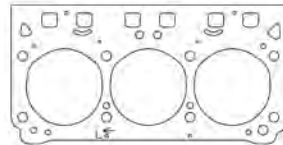

Additional thicknesses available see page 4

MLS Head Gasket - Right Side

Bore	Thickness	Pkg Qty	Part #
3.840"	.066"	1	C5721-066

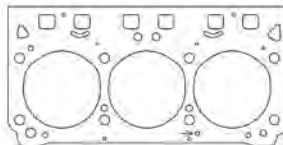



Cometic Gasket - An Exclusive NASCAR Performance Product

BUICK

400, 430 & 455 V8 - All Years

Head Gaskets

MLS Head Gaskets			
Bore	Thickness	Pkg Qty	Part #
4.312"	.040"	1	C5753-040
4.385"	.040"	1	C5754-040
4.400"	.040"	1	C5755-040

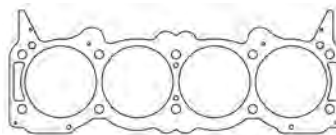

Additional thicknesses available see page 4

Individual Gaskets

Exhaust Gasket Set	
Application	Part #
All Years	C5776-064

Valve Cover Gasket (sold individually)	
Application	Part #
All Years	C5774-094

Intake Gasket Set	
Application	Part #
1967-71 1.172" x 2.453" Port.....	C5143-060
1972-76 1.156" x 2.420" Port.....	C5775-060

Timing Cover Set	
Application	Part #
1967-76 Water Pump Gasket.....	C5144-031
1970-76 455 Water Outlet Gasket.....	C15004-031

Oil Pan Gasket	
Application	Part #
1967-76 4pc Set	C5145

Timing Cover Set	
Application	Part #
67-74 400, 430, 455 V8	C5050

Gasket Kits



To purchase a complete gasket kit order both top end and bottom end gasket kit

TOP END GASKET KIT



Application	Part #
Big Block 455ci 1970-76 4.385" Bore.....	PRO1011T

BOTTOM END GASKET KIT



Application	Part #
Big Block 455ci 1970-76.....	PRO1011B

CADILLAC

Northstar 4.6L 32v V8 1993-2011

Head Gaskets

MLS Head Gasket - Left Side			
Bore	Thickness	Pkg Qty	Part #
3.700"	.066"	1	C5717-066

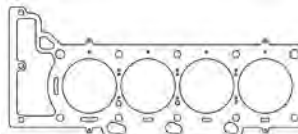

Additional thicknesses available see page 4

See page 8 for additional gaskets



Cometic Gasket - An Exclusive NASCAR Performance Product

CADILLAC

Northstar 4.6L 32v V8 1993-2011

Head Gaskets

MLS Head Gasket - Right Side

Bore	Thickness	Pkg Qty	Part #
3.700"	.066"	1	C5716-066

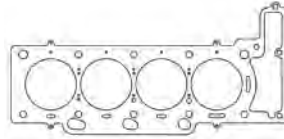

Additional thicknesses available
see page 4

CHEVROLET / GM

ECOTEC 4 Cylinder

Head Gaskets

MLS Head Gasket - LSJ 2.0L

Bore	Thickness	Pkg Qty	Part #
87mm	.027"	1	C5921-027

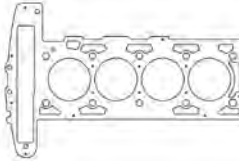

Additional thicknesses available
see page 4

MLx Head Gasket - LSJ 2.0L

Bore	Thickness	Pkg Qty	Part #
87mm	.040"	1	C5032-040

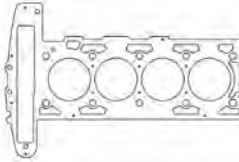

MLx Head Gasket - LNF 2.0L 08-10

Bore	Thickness	Pkg Qty	Part #
88mm	.032"	1	C15256-032

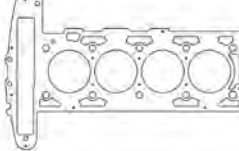

MLx Head Gasket - LTG 2.0L DOHC

Bore	Thickness	Pkg Qty	Part #
87mm	.028"	1	C4964-028

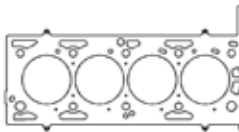

MLS Head Gaskets - L61/L42 2.2L DOHC

Bore	Thickness	Pkg Qty	Part #
87mm	.040"	1	C5768-040
89mm	.040"	1	C5804-040

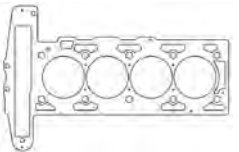

Individual Gaskets

MLS Exhaust Gasket

Application	Part #
2000-2009 2.2/2.4L	C4150-030

2.2L 134ci "LN2": Cavalier/Sunfire FWD 1998-02, S-10/Sonoma RWD 1994-03

Head Gaskets

MLS Head Gaskets

Bore	Thickness	Pkg Qty	Part #
90mm	.030"	1	C5914-030
93mm	.030"	1	C5915-030

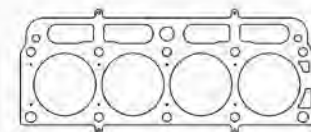

Additional thicknesses available
see page 4



Cometic Gasket - An Exclusive NASCAR Performance Product

CHEVROLET / GM

2.4L 146ci "LD9" Twin Cam 1996-2001

Head Gaskets

MLS Head Gasket - 1996-99 w/EGR			
Bore	Thickness	Pkg Qty	Part #
3.595"	.030"	1	C5298-030

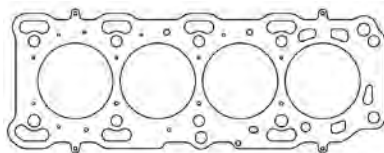

Additional thicknesses available see page 4

MLS Head Gaskets - 1999-01 w/o EGR			
Bore	Thickness	Pkg Qty	Part #
3.595"	.030"	1	C5866-030
3.595"	.075"	1	C5866-075

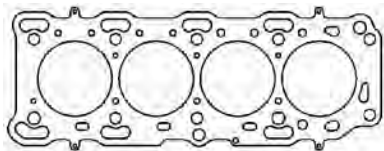

2.5L 153ci 1965-1979/3.0L VORTEC 3000 (Marine)

Head Gasket

MLS Head Gasket			
Bore	Thickness	Pkg Qty	Part #
4.100"	.045"	1	C5956-045

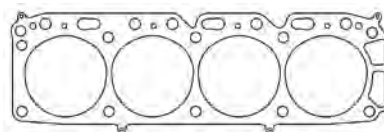

Additional thicknesses available see page 4

3.1/3.4/3.9L 60 Degree V6

Head Gaskets

MLS Head Gasket - 3.1L 1993-99			
Bore	Thickness	Pkg Qty	Part #
91mm	.051"	1	C5220-051

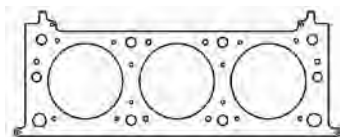

Additional thicknesses available see page 4

MLS Head Gasket - 3.4L 1993-05			
Bore	Thickness	Pkg Qty	Part #
91mm	.051"	1	C5266-051

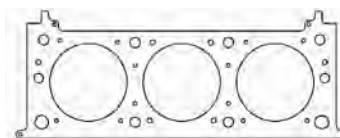

MLS Head Gasket - 3.9L 2006-11 Left Side			
Bore	Thickness	Pkg Qty	Part #
101mm	.051"	1	C5226-051

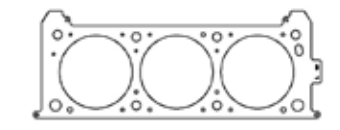

MLS Head Gasket - 3.9L 2006-11 Right Side			
Bore	Thickness	Pkg Qty	Part #
101mm	.051"	1	C5227-051

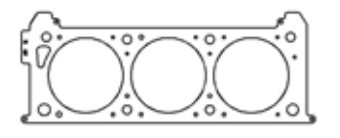

Individual Gaskets

Exhaust Gasket Set	
Application	Part #
1993-05 3.1/3.4L V6	C15005-064



Cometic Gasket - An Exclusive NASCAR Performance Product

CHEVROLET / GM

3.6L LY7/LLT/LFX V6 2004-Present

Head Gaskets

MLx Head Gasket - Left Side

Bore	Thickness	Pkg Qty	Part #
98mm	.044"	1	C5029-044

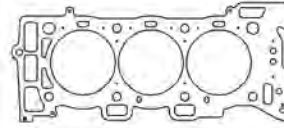

Additional thicknesses available see page 4

MLx Head Gasket - Right Side

Bore	Thickness	Pkg Qty	Part #
98mm	.044"	1	C5028-044

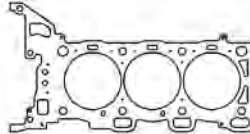

4.3L 229/262ci 90 Degree V6 1985-2009

Head Gaskets

MLS Head Gaskets

Bore	Thickness	Pkg Qty	Part #
4.060"	.040"	1	C5739-040
4.120"	.040"	1	C5740-040
4.155"	.040"	1	C5741-040

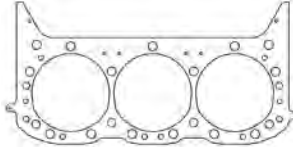

Additional thicknesses available see page 4

Individual Gaskets

Valve Cover Gasket (sold individually)

Application	Part #
4.3L V6 .188" ML Material	C15006-188

Timing Cover Set

Application	Part #
1985-95 w/Thick Front OP Seal	C5051

Intake Gasket Set

Application	Part #
4.3L V6 .060" Fiber	C15007-060

Water Pump Gasket

Application	Part #
.018" AFM Material	C5299-018

Exhaust Gasket Set

Application	Part #
1985-92 4.3L V6 .064" AM	C15008-064

Oil Pan Gasket

Application	Part #
4 Piece Set	C5496

Fuel Pump Mounting Gasket

Application	Part #
1985-96 4.3L V6 .020" Fiber	C15009-020

Rear Main Seal Kit

Application	Part #
1 Piece Design	C5106

Gasket Kits



To purchase a complete gasket kit order both top end and bottom end gasket kit

TOP END GASKET KIT



Application	Part #
4.3L V6 1985-93 4.120" Bore	PRO1006T

BOTTOM END GASKET KIT



Application	Part #
4.3L V6 1985-93	PRO1006B



Cometic Gasket - An Exclusive NASCAR Performance Product

CHEVROLET / GM

194, 230, 250, 292 Inline 6 1962-84

Head Gaskets

MLS Head Gasket			
Bore	Thickness	Pkg Qty	Part #
4.125"	.040"	1	C5699-040

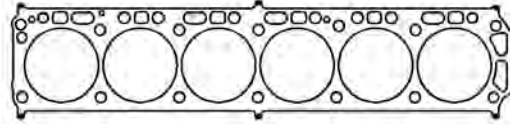

Individual Gaskets

Intake Gasket Set	
Application	Part #
292 I6 Intake .059" CFM	C15010-059

Timing Cover Set	
Application	Part #
4/6 Cyl 151/230/250/292	C5053

18/23 Degree Small Block V8 262-400ci (*has steam holes)

Head Gaskets

MLS Head Gaskets - Round Bore			
Bore	Thickness	Pkg Qty	Part #
4.060"	.040"	1	C5245-040
4.100"	.040"	1	C5246-040
4.125"	.040"	1	C5247-040*
4.165"	.040"	1	C5248-040*
4.200"	.040"	1	C5249-040*

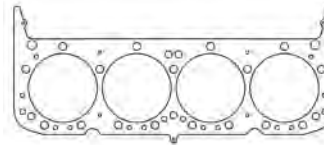

MLS Head Gaskets - Valve Pocketed Bore			
Bore	Thickness	Pkg Qty	Part #
4.060"	.040"	1	C5269-040
4.100"	.040"	1	C5270-040
4.125"	.040"	1	C5271-040*
4.165"	.040"	1	C5272-040*
4.200"	.040"	1	C5273-040*

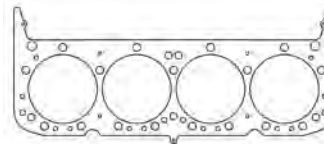

MLx Head Gaskets - Round Bore			
Bore	Thickness	Pkg Qty	Part #
4.165"	.040"	1	C5031-040
4.220"	.040"	1	C5786-040

Individual Gaskets

Valve Cover Gaskets (sold individually)	
Application	Part #
18/23° Molded Rubber	C5973
Splayed Valve Heads	C5390-094

Oil Pan Gasket Kit	
Application	Part #
1955-79 LH Dipstick 4pc Kit	C5295-094
1980-85 RH Dipstick 4pc Kit	C5294
1986-97 1 pc Molded Rubber	C5072

Intake Gasket Set	
Application	Part #
18° Heads 1.35" X 2.25" Port	C5541-060
23° Heads 1.24" X 1.97" Port	C5544-060
23° Heads 1.24" x 2.10" Port	C5545-060
23° Heads 1.28" x 2.17" Port	C5528-060
305/350 w/TPI 85-92 Set	C15198
China Rail Gaskets	C5536-060

Exhaust Gasket Set	
Application	Part #
18° 1.50" x 1.47" .064" AM	C5314-064
23° 1.45" x 1.48" .030" MLS	C5892-030
23° 1.50" Round .030" MLS	C5891-030
23° 1.45" x 1.60" .030" MLS	C5894-030
23° 1.625" Round .030" MLS	C5893-030
23° 1.55" x 1.45" .030" MLS	C15190-030

Timing Cover Set	
Application	Part #
1957-74 w/Thin Front OP Seal	C5052
1975-95 w/Thick Front OP Seal	C5051

Fuel Pump Mounting Gaskets	
Application	Part #
2 Bolt - .032" AFM	C5389-032
4 Bolt - .032" AFM	C15012-032

Water Pump Gaskets	
Application	Part #
Water Pump MTG Gasket	C5299-018
Water Pump Backing Plate Gasket	C15011-032

Rear Main Seal Kit	
Application	Part #
2 Piece Viton	C5680
1 Piece Viton	C5106

See page 12 for additional gaskets



Cometic Gasket - An Exclusive NASCAR Performance Product

CHEVROLET / GM

18/23 Degree Small Block V8 262-400ci (*has steam holes)

Individual Gaskets

Thermostat Gasket

Application	Part #
.047" Fiber	C5538-047

Distributor Gasket

Application	Part #
.060" Fiber	C5531-060

Gasket Kits



To purchase a complete gasket kit order both top end and bottom end gasket kit

TOP END GASKET KIT



Application	Part #
350ci (67-85) & 400ci (70-76) 4.165" Bore ...	PRO1003T
350ci TPI (87-92), TBI (86-93) 4.100" Bore..	PRO1004T
ZZ4 Crate Engine 4.080" Bore	PRO1026T

BOTTOM END GASKET KIT

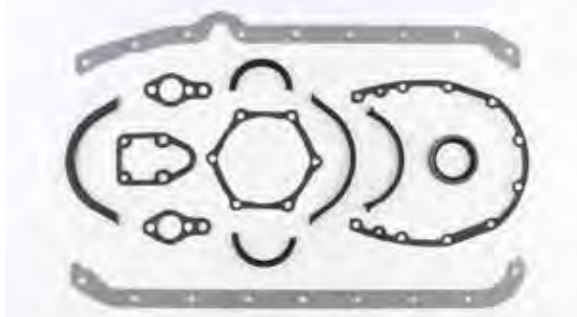

Application	Part #
350ci (67-85) & 400ci (70-76).....	PRO1003B
350ci (86-93) 1pc Rear Main	PRO1004B

Small Block V8 - Aftermarket & Race

Head Gaskets

MLS Head Gaskets - Vortec Head

Bore	Thickness	Pkg Qty	Part #
4.080"040"	1	C5474-040
4.165"040"	1	C5410-040

MLS Head Gasket - Edelbrock RPM Heads

Bore	Thickness	Pkg Qty	Part #
4.135"040"	1	C5274-040

MLS Head Gaskets - Brodix BD2000

Bore	Thickness	Pkg Qty	Part #
4.030"040"	1	C5404-040
4.125"040"	1	C5405-040
4.135"040"	1	C5406-040
4.160"040"	1	C5407-040
4.200"040"	1	C5408-040

MLS Head Gaskets - Brodix Heads

Bore	Thickness	Pkg Qty	Part #
4.030"040"	1	C5399-040
4.125"040"	1	C5400-040
4.135"040"	1	C5401-040
4.160"040"	1	C5402-040
4.200"040"	1	C5403-040

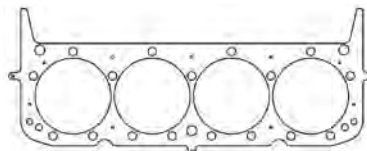
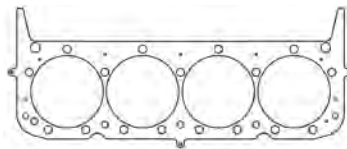
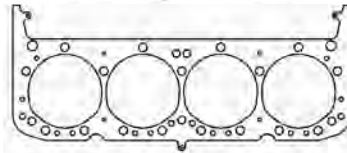
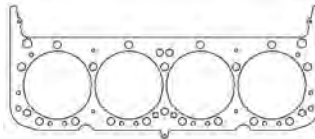

Additional thicknesses available
see page 4



Cometic Gasket - An Exclusive NASCAR Performance Product

CHEVROLET / GM

Small Block V8 - Aftermarket & Race (con't)

Head Gaskets

MLx Head Gasket - All Pro Heads			
Bore	Thickness	Pkg Qty	Part #
4.220"	.040"	1	C5551-040

MLS Head Gasket - Dart/Brodix 4.5" Bore Spacing			
Bore	Thickness	Pkg Qty	Part #
4.270"	.040"	1	C5215-040

MLx Head Gasket - Dart/Brodix 4.5" Bore Spacing			
Bore	Thickness	Pkg Qty	Part #
4.310"	.040"	1	C15208-040

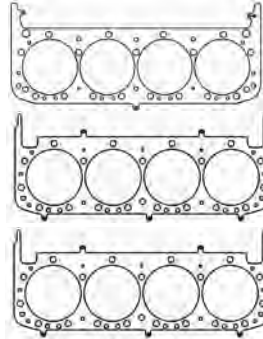

Additional thicknesses available see page 4

Individual Gaskets

Intake Manifold Gaskets	
Application	Part #
23° Dart Cast Iron	C5528-060
Brodix BD2000	C5421-060
Brodix WP 12S	C5425-059
Brodix WP 247	C5426-059
Brodix WP 262	C5427-059
Brodix GB 2000	C5423-059
Brodix Track 1 & Spec Head	C5414-059
Brodix Street	C5416-059
China Rail Gaskets	C5536-060

Exhaust Manifold Gaskets	
Application	Part #
Brodix GB 2000 - .064" AM	C5422-064
Brodix Track 1 - .064" AM	C5415-064
Brodix Street - .064" AM	C5417-064
Brodix/All Pro 286 (7 Bolt) MLS	C5040-030
Brodix/Dart 13° 4.4/4.5" Spacing	C5039-030

Oil Pan Gasket	
Application	Part #
Dart Iron Eagle/Rocket Block	C5104-094

350 & 400 SB2 Race V8

Head Gaskets

MLS Head Gaskets			
Bore	Thickness	Pkg Qty	Part #
4.125"	.040"	1	C5321-040
4.165"	.040"	1	C5323-040
4.190"	.040"	1	C5472-040
4.200"	.040"	1	C5324-040

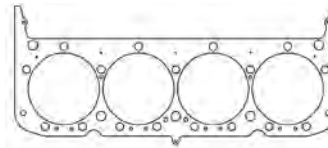

Additional thicknesses available see page 4

Individual Gaskets

Valve Cover Gasket (sold individually)	
Application	Part #
SB2 - .188" Thickness	C5235-188

Timing Cover Gasket	
Application	Part #
SB2 - .020" RC	C5533-020

Intake Manifold Set	
Application	Part #
SB2 - 2.085" x 1.560" Ports	C5311-031
SB2 - MLS	C5819-040

Water Pump Gasket	
Application	Part #
Water Pump MTG Gasket	C5299-018
Water Pump Backing Plate Gasket	C15011-032

Intake Valley Plate Gaskets	
Application	Part #
Stock Opening - .060" AFM	C5647-060
.970" Holes - .060" AFM	C5308-060
.625"/.750" Holes - .060" AFM	C5307-060

Exhaust Manifold Gaskets	
Application	Part #
1.50" x 1.60" Ports - MLS	C5552-065
1.90" x 1.63" Ports - MLS	C5836-030

Rear Main Seal	
Application	Part #
Dual Lip/High Vacuum	C5379

Oil Pan Gasket	
Application	Part #
SB2 - 4pc Set	C5553-060

Distributor Gasket	
Application	Part #
.060" Fiber	C5531-060

Fuel Pump Mounting Gasket	
Application	Part #
4 Bolt - .032" AFM	C15012-032



Cometic Gasket - An Exclusive NASCAR Performance Product

CHEVROLET / GM

R07.2 Race V8

Head Gasket

MLx Head Gasket			
Bore	Thickness	Pkg Qty	Part #
4.220"	.040"	1	C5577-040

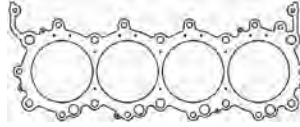

Additional thicknesses available see page 4

Individual Gaskets

Rubber Seal/O-Ring Kit	
Application	Part #
R07.2	C5979

Valve Cover Gasket (sold individually)	
Application	Part #
Nitrile Formed Rubber O-Ring	C15013

LT1/LT4 350ci 1992-1996

Head Gaskets

MLS Head Gaskets			
Bore	Thickness	Pkg Qty	Part #
4.040"	.040"	1	C5645-040
4.100"	.040"	1	C5646-040

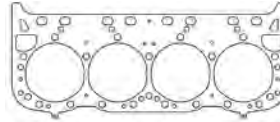

Additional thicknesses available see page 4

Individual Gaskets

Valve Cover Gasket (sold individually)	
Application	Part #
.094" Thickness	C15014-094

Exhaust Manifold Gaskets	
Application	Part #
1.52" x 1.51" Ports, MLS	C5895-030

Intake Manifold Set	
Application	Part #
LT1/LT4 - 2.085" x 1.560" Ports	C15015-060

Throttle Body Gasket Gasket	
Application	Part #
1992-97 LT1/LT4	C15016-060

Oil Pan Gasket Set	
Application	Part #
1992-97 1 pc Molded Rubber	C5072

Rear Main Seal Kit	
Application	Part #
1 Piece Viton	C5106

Exhaust Pipe Gaskets	
Application	Part #
Header Collector Gasket	C15017-064
Y-Pipe Gasket	C15018-064

Timing Cover Sets	
Application	Part #
1992-94	C5054
1994-97	C5055

Water Pump Gasket	
Application	Part #
Water Pump Mounting Gasket	C15019-031



Cometic Gasket - An Exclusive NASCAR Performance Product

CHEVROLET / GM

LS1/LS6 5.7L, LS2 6.0L, & LS3 6.2L

Head Gaskets

MLS Head Gaskets

Bore	Thickness	Pkg Qty	Part #
3.910"	.051"	1	C5475-0518
4.060"	.051"	1	C5751-051
4.100"	.051"	1	C5489-051
4.130"	.051"	1	C5317-051
4.160"	.051"	1	C5318-051
4.190"	.051"	1	C5319-051

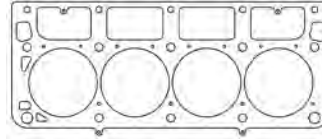

Additional thicknesses available
see page 4

MLx Head Gaskets

Bore	Thickness	Pkg Qty	Part #
4.040"	0.051"	1	C5505-051
4.150"	.052"	1	C5014-052

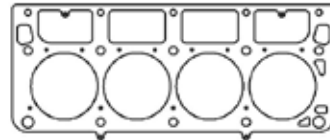

Individual Gaskets

Valve Cover Gasket (sold individually)

Application	Part #
99-14 LS V8 - Center Bolt	C5170
Valve Cover Grommet Set	C15030

Exhaust Manifold Gaskets

Application	Part #
97-13 LS V8 - Round Port	C5818-030

Intake Manifold Gaskets

Application	Part #
99-05 5.7/6.0L Car Intake	C5165
99-05 5.3/6.0L Truck Intake	C5166
LS3/L92 Carb Intake Gaskets	C15022-060
08-13 LS3 6.2L Car Intake	C5037
07-13 6.0/6.2L Truck Intake	C15024
Gen III LS1/LS6 Valley Gasket	C15026
Gen IV LS w/D.O.D. Valley Gasket	C15023
Gen IV LS w/o D.O.D. Valley Gasket	C15025

Throttle Body Gaskets

Application	Part #
97-05 4.8/5.3/5.7L	C5168
99-05 6.0L	C5169
2005 5.3/6.0L SUV	C15020
06-13 4.8/5.3/6.0/6.2L	C15021

Rear Main Seal Kit

Application	Part #
1997-13 LS V8	C5172

Fuel Injector O-Ring Set

Application	Part #
Upper and Lower O-Rings	C15027

Oil Pan Gasket Set

Application	Part #
97-13 LS V8 (not Vette)	C5173

Exhaust Pipe Gaskets

Application	Part #
Graphite Exhaust Pipe	C15028
Metal Ring Exhaust Pipe	C15029

Valve Stem Seals

Application	Part #
97-01 LS V8	3516PB-16
02-13 LS V8 - Hat Style	3256V-16

Cooling/Water Pump Gaskets

Application	Part #
99-13 LS V8 (pair) Molded	C5174
99-13 LS V8 (pair) .031" Fiber	C15032-031
99-13 Water Pump Backing O-ring	C15033
97-13 Coolant Bypass Seals	C15034

Timing Cover Set

Application	Part #
1997-13 LS V8	C5056

Cam Plate Gasket

Application	Part #
with Recessed Bolts	C15031

Knock Sensor Grommet Kit

Application	Part #
1999-2013 - 2 Pack	C15035

Thermostat Seal

Application	Part #
2004-13 Gen IV	C15036



Cometic Gasket - An Exclusive NASCAR Performance Product

CHEVROLET / GM

LS1/LS6 5.7L, LS2 6.0L, & LS3 6.2L

Gasket Kits



To purchase a complete gasket kit order both top end and bottom end gasket kit

TOP END GASKET KIT



Application	Part #
1997-05 LS1 5.7L (Car Only) 4.100" Bore.....	PRO1007T
LS3/L92 6.2L Carbureted 4.060" Bore	PRO1035T
1999-01 6.0L (Truck Only) 4.100" Bore	PRO1008T
2001-10 4.8/5.3L Truck/Van/SUV 3.840" Bore	PRO1040T
2001-07 6.0L Truck/Van/SUV 4.100" Bore	PRO1041T
2005-07 6.0L Truck/Van/SUV 4.100" Bore	PRO1037T
2007-10 6.0/6.2L Truck/Van/SUV 4.100" Bore	PRO1036T
2009-11 LS3 6.2L (Car Only).....	PRO1043T

BOTTOM END GASKET KIT



Application	Part #
4.8/5.3/5.7/6.0/6.2L LS V8	PRO1040B
with flat mount Cam Plate bolts	
4.8/5.3/5.7/6.0/6.2L LS V8	PRO1036B
with recessed Cam Plate bolts	

LS7 7.0L V8

Head Gaskets

MLS Head Gasket

Bore	Thickness	Pkg Qty	Part #
4.150"051"1	C5889-051

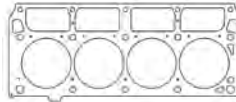

Additional thicknesses available see page 4

MLx Head Gasket

Bore	Thickness	Pkg Qty	Part #
4.150"052"1	C5030-052

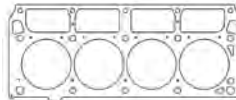

Individual Gaskets

Valve Cover Gasket (sold individually)

Application	Part #
99-13 LS V8 - Center Bolt	C5170
Valve Cover Grommet Set.....	C15030

Intake Manifold Gaskets

Application	Part #
LS7 2006-13 w/Carb Intake.....	C5167-060
Gen IV LS w/o D.O.D. Valley Gasket	C15025

Exhaust Manifold Gaskets

Application	Part #
2006-13 D-Port - MLS	C5073-030

Valve Stem Seals

Application	Part #
05-13 LS7 V8 - Hat Style.....	3256V-16

Fuel Injector O-Ring Set

Application	Part #
Upper and Lower O-Rings.....	C15027

Timing Cover Set

Application	Part #
1997-13 LS V8.....	C5056

Cooling/Water Pump Gaskets

Application	Part #
99-13 LS V8 (pair) Molded	C5174
99-13 LS V8 (pair) .031" Fiber.....	C15032-031
99-13 Water Pump Backing O-ring.....	C15033
97-13 Coolant Bypass Seals	C15034

Rear Main Seal Kit

Application	Part #
1997-13 LS V8.....	C5172



Cometic Gasket - An Exclusive NASCAR Performance Product

CHEVROLET / GM

LS9/LSA 6.2L 2009-2013

Head Gaskets

MLx Head Gasket - Right Side

Bore	Thickness	Pkg Qty	Part #
4.100"	.051"	1	C5985-051

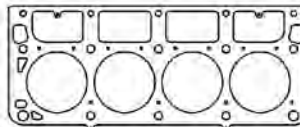

Additional thicknesses available
see page 4

MLx Head Gasket - Left Side

Bore	Thickness	Pkg Qty	Part #
4.100"	.051"	1	C5986-051

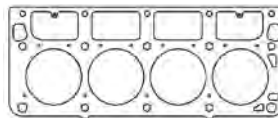

Individual Gaskets

Valve Cover Gasket (sold individually)

Application	Part #
99-13 LS V8 - Center Bolt	C5170
Valve Cover Grommet Set	C15030

Valve Stem Seals

Application	Part #
09-13 LS V8 - Hat Style	3256V-16

Exhaust Manifold Gaskets

Application	Part #
09-13 LS V8 - Round Port	C5818-030

Oil Pan Gasket Set

Application	Part #
97-13 LS V8 (Pan to Block)	C5173

Intake Manifold Gaskets

Application	Part #
Gen IV LS w/o D.O.D. Valley Gasket	C15025

Timing Cover Set

Application	Part #
1997-13 LS V8	C5056

Cooling/Water Pump Gaskets

Application	Part #
99-13 LS V8 (pair) Molded	C5174
99-13 LS V8 (pair) .031" Fiber	C15032-031
99-13 Water Pump Backing O-ring	C15033
97-13 Coolant Bypass Seals	C15034

Rear Main Seal Kit

Application	Part #
1997-13 LS V8	C5172

LSX RACE BLOCK

Head Gaskets

MLS Head Gaskets - Right Side

Bore	Thickness	Pkg Qty	Part #
4.125"	.051"	1	C5933-051
4.185"	.051"	1	C5935-051

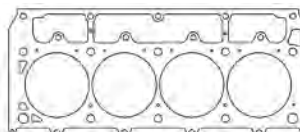

Additional thicknesses available
see page 4

MLS Head Gaskets - Left Side

Bore	Thickness	Pkg Qty	Part #
4.125"	.051"	1	C5934-051
4.185"	.051"	1	C5936-051

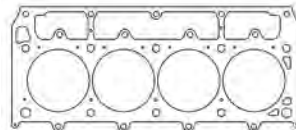

MLx Head Gaskets - Right Side

Bore	Thickness	Pkg Qty	Part #
4.100"	.040"	1	C5075-040
4.150"	.040"	1	C5702-040
4.200"	.040"	1	C5077-040

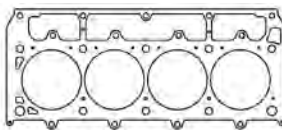

MLx Head Gaskets - Left Side

Bore	Thickness	Pkg Qty	Part #
4.100"	.040"	1	C5076-040
4.150"	.040"	1	C5703-040
4.200"	.040"	1	C5078-040

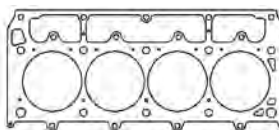

See page 18 for additional gaskets



Cometic Gasket - An Exclusive NASCAR Performance Product

CHEVROLET / GM

LSX RACE BLOCK

Individual Gaskets

Valve Cover Gasket (sold individually)

Application	Part #
99-13 LS V8 - Center Bolt	C5170
Valve Cover Grommet Set.....	C15030

Exhaust Manifold Gaskets

Application	Part #
2006-13 D-Port - MLS	C5073-030
LSX-DR .064" AM	C15038-064

Intake Manifold Gaskets

Application	Part #
LS7 2006-13 w/Carb Intake.....	C5167-060.
LSX-DR Head - Lrg Port.....	C15037-060
Gen IV LS w/o D.O.D. Valley Gasket	C15025

Valve Stem Seals

Application	Part #
09-13 LS V8 - Hat Style.....	3256V-16

Oil Pan Gasket Set

Application	Part #
97-13 LS V8 (Pan to Block).....	C5173

Timing Cover Set

Application	Part #
1997-13 LS V8.....	C5056

Cooling/Water Pump Gaskets

Application	Part #
99-13 LS V8 (pair) Molded	C5174.
99-13 LS V8 (pair) .031" Fiber.....	C15032-031
99-13 Water Pump Backing O-ring.....	C15033
97-13 Coolant Bypass Seals	C15034

Gasket Kits



To purchase a complete gasket kit order both top end and bottom end gasket kit

TOP END GASKET KIT



Application	Part #
LSX w/LS7 Carb Intake 4.125" Bore	PRO1025T

BOTTOM END GASKET KIT



Application	Part #
LSX V8.....	PRO1025B

LS1/LS6 5.7L, LS2 6.0L, & LS3 6.2L w/Darton M.I.D. Sleeves

Head Gaskets

MLS Head Gasket

Bore	Thickness	Pkg Qty	Part #
3.910"040"	1	C5788-040
4.125"040"	1	C5789-040
4.165"040"	1	C5790-040

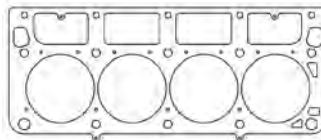

Additional thicknesses available see page 4



Cometic Gasket - An Exclusive NASCAR Performance Product

CHEVROLET / GM

LT1 6.2L V8 2014+UP

Head Gasket

MLx Head Gasket			
Bore	Thickness	Pkg Qty	Part #
4.100"	.051"	1	C5038-051
4.150"	.051"	1	C15203-051
4.200"	.051"	1	C15202-051

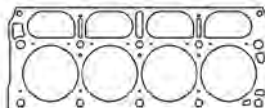

Additional thicknesses available
see page 4

Individual Gaskets

Exhaust Manifold Gasket	
Application	Part #
2014+ 1.920" Port - .021" MLS	C5020-021

Holden 308 V8

Head Gaskets

MLS Head Gaskets			
Bore	Thickness	Pkg Qty	Part #
4.100"	.040"	1	C5806-040
4.200"	.040"	1	C5807-040

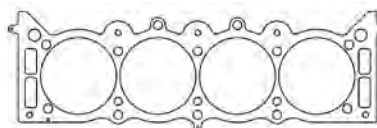

Additional thicknesses available
see page 4

348ci 1958-61/409ci 1961-65 "W" V8

Head Gaskets

MLS Head Gaskets			
Bore	Thickness	Pkg Qty	Part #
4.200"	.040"	1	C5255-040
4.375"	.040"	1	C5256-040
4.437"	.040"	1	C5219-040

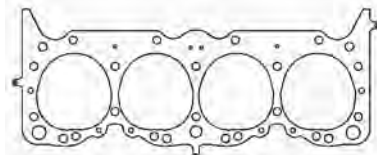

Additional thicknesses available
see page 4

Individual Gaskets

Intake Manifold Gasket	
Application	Part #
409ci V8 - .059" CFM	C15039-059

Exhaust Manifold Gasket	
Application	Part #
409ci V8 - .064" AM	C15040-064



Cometic Gasket - An Exclusive NASCAR Performance Product

CHEVROLET / GM

Big Block V8 - Gen4 1965-90 396,402,427,454ci

Head Gaskets

MLS Head Gaskets

Bore	Thickness	Pkg Qty	Part #
4.320"	.040"	1	C5816-040
4.375"	.040"	1	C5329-040
4.540"	.040"	1	C5330-040
4.630"	.040"	1	C5331-040

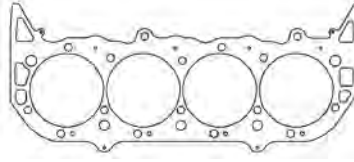

Additional thicknesses available see page 4

Individual Gaskets

Valve Cover Gasket (sold individually)

Application	Part #
Molded Rubber .188"	C5975

Intake Manifold Gaskets

Application	Part #
Rect Port 1.75" x 2.50" - .060" KF	C5649-060
Oval Port 1.82" x 2.05" - .060" KF	C15041-060

Rear Main Seal Kit

Application	Part #
2pc 1965-90 - Silicone	C5086
2pc 1965-90 - Viton	C5682

Timing Cover Sets

Application	Part #
1965-95 BBC V8	C5057

Exhaust Manifold Gaskets

Application	Part #
1.85" x 1.90" Sq Port - MLS	C5897-030
1.920" Round Port - MLS	C5896-030
2.000" Round Port - MLS	C5349-030
2.130" Round Port - MLS	C5996-030
2.200" Round Port - MLS	C5350-030
2.250" Round Port - MLS	C5251-030

Cooling/Water Pump Gaskets

Application	Part #
Water Pump Mounting - Req 2	C5347-039
Water Outlet	C5346-047

Oil Pan Gasket Set

Application	Part #
4pc Kit	C5344

Gasket Kits



To purchase a complete gasket kit order both top end and bottom end gasket kit

TOP END GASKET KIT



Application	Part #
454ci 1970-85 4.275" Bore	PRO1005T

BOTTOM END GASKET KIT



Application	Part #
Big Block Gen4	PRO1005B



Cometic Gasket - An Exclusive NASCAR Performance Product

CHEVROLET / GM

Big Block V8 - Gen5/6 1991-00 454, 502ci

Head Gaskets

MLS Head Gaskets

Bore	Thickness	Pkg Qty	Part #
4.320"	.040"	1	C5817-040
4.375"	.040"	1	C5332-040
4.540"	.040"	1	C5333-040
4.630"	.040"	1	C5334-040

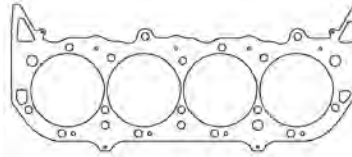

Additional thicknesses available see page 4

Individual Gaskets

Valve Cover Gasket (sold individually)

Application	Part #
Molded Rubber .188"	C5975

Intake Manifold Gaskets

Application	Part #
Rect Port 1.75" x 2.50" - .060" KF	C5649-060
Oval Port 1.82" x 2.05" - .060" KF	C15041-060

Exhaust Manifold Gaskets

Application	Part #
1.85" x 1.90" Sq Port - MLS	C5897-030
1.920" Round Port - MLS	C5896-030
2.000" Round Port - MLS	C5349-030
2.130" Round Port - MLS	C5996-030
2.200" Round Port - MLS	C5350-030
2.250" Round Port - MLS	C5251-030

Timing Cover Sets

Application	Part #
1990-95 BBC V8	C5057
1996-00 BBC V8	C5058

Cooling/Water Pump Gaskets

Application	Part #
Water Pump Mounting - Req 2	C5347-039
Water Outlet	C5346-047

Rear Main Seal Kit

Application	Part #
1pc 1991-00 Gen 5/6 - Viton	C5087

Oil Pan Gasket Set

Application	Part #
1pc Molded Rubber	C15077

Big Block V8 - Aftermarket, Race, & Marine Blocks

Head Gaskets

MLS Head Gaskets - Mercury Gen4/5/6 w/4 Bolts in Lifter Valley

Bore	Thickness	Pkg Qty	Part #
4.500"	.051"	1	C5634-051
4.530"	.051"	1	C5635-051
4.580"	.051"	1	C5636-051
4.600"	.051"	1	C5637-051

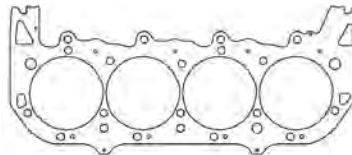

Additional thicknesses available see page 4

MLS Head Gaskets - Mercury 1050 Gen 4 w/2 Slotted Lifter Valley Bolts

Bore	Thickness	Pkg Qty	Part #
4.500"	.051"	1	C5638-051
4.530"	.051"	1	C5639-051
4.580"	.051"	1	C5640-051
4.600"	.051"	1	C5641-051

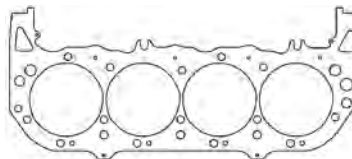

MLS Head Gaskets - Mercury 8.1L 496 - Right Side

Bore	Thickness	Pkg Qty	Part #
4.280"	.051"	1	C5761-051
4.350"	.051"	1	C5762-051
4.450"	.051"	1	C5763-051

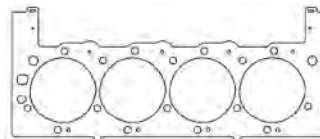

See page 22 for additional gaskets



Cometic Gasket - An Exclusive NASCAR Performance Product

CHEVROLET / GM

Big Block V8 - Aftermarket, Race, & Marine Blocks

Head Gaskets

MLS Head Gaskets - Mercury 8.1L 496 - Left Side

Bore	Thickness	Pkg Qty	Part #
4.280"	.051"	1	C5764-051
4.350"	.051"	1	C5765-051
4.450"	.051"	1	C5766-051

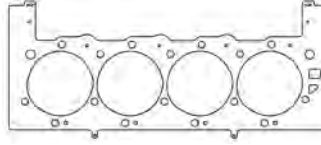

Additional thicknesses available
see page 4

MLS Head Gaskets - Brodix Big Duke/Big Brodie

Bore	Thickness	Pkg Qty	Part #
4.310"	.040"	1	C5432-040
4.570"	.040"	1	C5433-040
4.630"	.040"	1	C5434-040

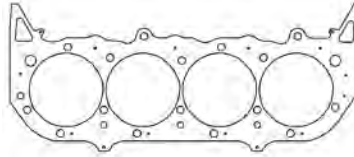

MLS Head Gaskets - ZL1 1969 7.0L 427ci Aluminum Round Bore

Bore	Thickness	Pkg Qty	Part #
4.250"	.040"	1	C5746-040
4.300"	.040"	1	C5747-040
4.375"	.040"	1	C5759-040

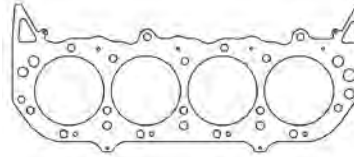

Individual Gaskets

Valve Cover Gasket (sold individually)

Application	Part #
Molded Rubber .188"	C5975

Exhaust Manifold Gaskets

Application	Part #
Brodix Big Brodie - .064" AM	C5429-064
Brodix Big Duke - .064" AM	C5418-064
Mercury 1050 - MLS	C5820-051

Timing Cover Sets

Application	Part #
1965-95 BBC V8	C5057
1996-00 BBC V8	C5058

Cooling/Water Pump Gaskets

Application	Part #
Water Pump Mounting - Req 2	C5347-039
Water Outlet	C5346-047

Intake Manifold Gaskets

Application	Part #
Brodix Big Brodie Oval - .060" KF	C5430-060
Brodix Big Brodie Rectangle-.060" KF	C5428-060
Brodix Big Duke - .060" KF	C5419-060
Mercury 1050 - MLS	C5821-051

Rear Main Seal Kits

Application	Part #
2pc 1965-90 - Silicone	C5086
2pc 1965-90 - Viton	C5682
1pc 1991-00 Gen 5/6 - Viton	C5087

Oil Pan Gasket Set

Application	Part #
4pc Kit 1965-90	C5344
4pc Kit Bolt Holes@Mains	C5254
1pc Molded Rubber 91-00	C15077



Cometic Gasket - An Exclusive NASCAR Performance Product

CHEVROLET / GM

Prostock Racing V8

Head Gaskets

MLS Head Gaskets - DRCE-2 4.900" Bore Centers 500ci			
Bore	Thickness	Pkg Qty	Part #
4.675"	.051"	1	C5449-051
4.700"	.051"	1	C5450-051
4.780"	.051"	1	C5451-051

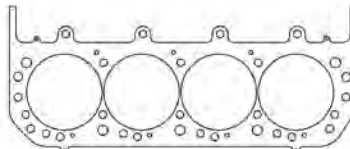

Additional thicknesses available see page 4

MLS Head Gaskets - DRCE-3 4.900" Bore Centers 500ci			
Bore	Thickness	Pkg Qty	Part #
4.700"	.051"	1	C5797-051
4.780"	.051"	1	C5798-051

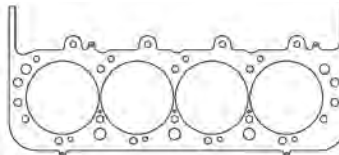

MLS Head Gasket - IHRA 5.00" Bore Centers 800ci			
Bore	Thickness	Pkg Qty	Part #
4.755"	.040"	1	C5850-040

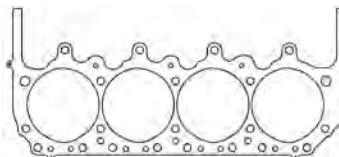

MLx Head Gasket - 5.20" Bore Centers			
Bore	Thickness	Pkg Qty	Part #
4.860"	.040"	1	C5013-040

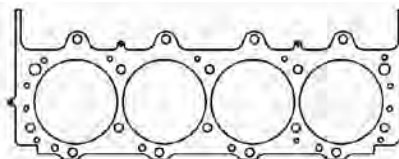

6.5L Diesel V8 1992-00

Head Gaskets

MLS Head Gaskets - Right Side			
Bore	Thickness	Pkg Qty	Part #
4.100"	.045"	1	C5885-045

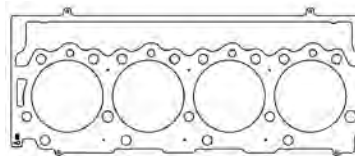

Additional thicknesses available see page 4

MLS Head Gaskets - Left Side			
Bore	Thickness	Pkg Qty	Part #
4.100"	.045"	1	C5884-045

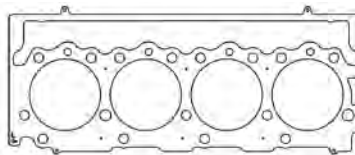

Head Bolt Kit	
Bore	Part #
ARP 190,000 psi	COM-0001



Cometic Gasket - An Exclusive NASCAR Performance Product

CHEVROLET / GM

6.6L Duramax Diesel V8 2001-07

Head Gaskets

MLS Head Gaskets - Right Side

Bore	Thickness	Pkg Qty	Part #
4.100"	.040"	1	C5882-040

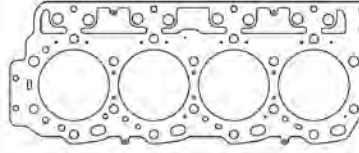

Additional thicknesses available see page 4

MLS Head Gaskets - Left Side

Bore	Thickness	Pkg Qty	Part #
4.100"	.0740"	1	C5883-040

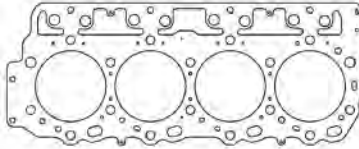

Individual Gaskets

Exhaust Manifold Gaskets

Application	Part #
2001-04 8mm Bolts - MLS	C15042-030

Rear Main Seal Kit

Application	Part #
2001-07	C15044

Timing Cover Set

Application	Part #
2001-07	C15045

Oil Pan Gasket Set

Application	Part #
2001-06 17 Bolt - .060" KF	C15043

Gasket Kits



To purchase a complete gasket kit order both top end and bottom end gasket kit

TOP END GASKET KITS



Application	Part #
6.6L Duramax 2001-04 4.100" Bore	PRO3008T
6.6L Duramax 2004-07 4.100" Bore	PRO3009T

BOTTOM END GASKET KIT



Application	Part #
6.6L Duramax 2001-07	PRO3008B



Cometic Gasket - An Exclusive NASCAR Performance Product

CHRYSLER / DODGE

2.0L DOHC 4cyl ECC/420A 1995-99

Head Gaskets

MLS Head Gaskets			
Bore	Thickness	Pkg Qty	Part #
87.5mm	.040"	1	C5497-040
88.5mm	.040"	1	C5498-04088

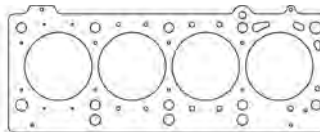

Additional thicknesses available see page 4

Individual Gaskets

Valve Cover Gasket Set	
Application	Part #
1995-99 2.0L DOHC	C15046

Cam Seal Set	
Application	Part #
Pair - 48 x 35 x 7	C15049

Intake Manifold Gaskets	
Application	Part #
Intake Manifold Gasket - .060" AFM	C15047-060
Intake Plenum Gasket - .031" Fiber	C15048-031

Front Crank Seal Set	
Application	Part #
1995-99 2.0L DOHC	C15053

Exhaust Manifold Gasket	
Application	Part #
2.040" X 1.100" Port - MLS	C4161-030

Oil Pan Gasket Set	
Application	Part #
Molded Rubber	C15050

Throttle Body Gasket	
Application	Part #
Molded Rubber	C15051

Rear Main Seal	
Application	Part #
1995-99 2.0L DOHC	C15052

Valve Stem Seal Set (16 Pack)	
Application	Part #
5 x 10.8 x 18.3 x 16.9 - Hat Style	3180V-16

Gasket Kits



To purchase a complete gasket kit order both top end and bottom end gasket kit

TOP END GASKET KIT



Application	Part #
1995-99 420A 2.0L DOHC 87.5mm Bore	PRO2005T

BOTTOM END GASKET KIT



Application	Part #
1995-99 420A 2.0L DOHC	PRO2005B



Cometic Gasket - An Exclusive NASCAR Performance Product

CHRYSLER / DODGE

2.4L DOHC Turbo 4cyl "SRT4" 2003-05

Head Gaskets

MLS Head Gaskets

Bore	Thickness	Pkg Qty	Part #
87.5mm030"1	C4548-030
90mm030"1	C4549-030

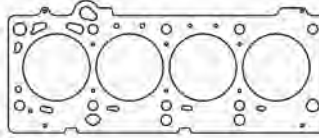

Additional thicknesses available see page 4

2.2L DOHC 4cyl 1991-93

Head Gaskets

MLS Head Gaskets

Bore	Thickness	Pkg Qty	Part #
89.5mm066"1	C5733-066

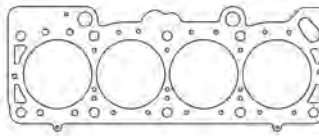

Additional thicknesses available see page 4

2.2L SOHC 4cyl 1982-90, 2.5L SOHC 4cyl 1986-95

Head Gaskets

MLS Head Gaskets

Bore	Thickness	Pkg Qty	Part #
89.5mm066"1	C5734-066

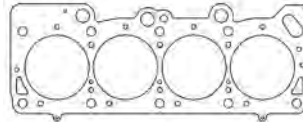

Additional thicknesses available see page 4

3.5L SOHC V6 1999-10, 4.0L SOHC V6 2007-11

Head Gaskets

MLS Head Gasket - Right Side

Bore	Thickness	Pkg Qty	Part #
96.5mm075"1	C5015-075

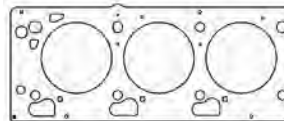

Additional thicknesses available see page 4

MLS Head Gasket - Left Side

Bore	Thickness	Pkg Qty	Part #
96.5mm075"1	C5016-075

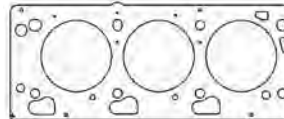

3.7L SOHC V6 2002-13 Powertech "EKG"

Head Gaskets

MLS Head Gasket

Bore	Thickness	Pkg Qty	Part #
95mm030"1	C5794-030

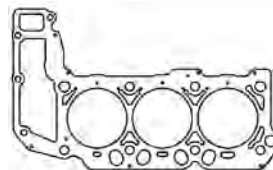

Additional thicknesses available see page 4



Cometic Gasket - An Exclusive NASCAR Performance Product

CHRYSLER / DODGE

4.0L Inline 6 242ci 1987-2006

87-01 Cherokee, 93-04 Grand Cherokee, 87-90 Wagoneer, 87-92 Comanche, 91-06 Wrangler

Head Gaskets

MLS Head Gaskets			
Bore	Thickness	Pkg Qty	Part #
3.950	.050"	1	C5987-050
4.000	.050"	1	C5988-050
4.060	.050"	1	C5989-050

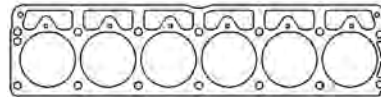

Additional thicknesses available
see page 4

Individual Gaskets

Timing Cover Set	
Application	Part #
3.8/4.0/4.2L I6 1965-2006	C5047

4.7L SOHC V8 1999-13 Powertech

Head Gaskets

MLS Head Gaskets - 1999-07			
Bore	Thickness	Pkg Qty	Part #
93mm	.030"	1	C5213-030
95mm	.030"	1	C5214-030

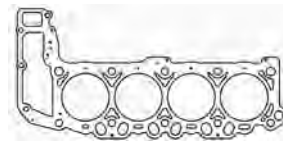

Additional thicknesses available
see page 4

MLS Head Gasket - 2008-13			
Bore	Thickness	Pkg Qty	Part #
94mm	.030"	1	C5803-0307

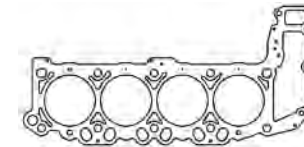

5.2L & 5.9L Magnum V8 1992-03

Head Gaskets

MLS Head Gaskets			
Bore	Thickness	Pkg Qty	Part #
4.040"	.040"	1	C5554-040
4.040"	.040"	1	C5565-120

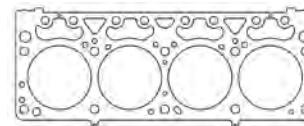

Additional thicknesses available
see page 4

Individual Gaskets

Valve Cover Gasket (sold individually)	
Application	Part #
10 Bolt - .047" KF	C5557-047

Oil Pan Gasket Set	
Application	Part #
4pc Set	C5560-094

Intake Manifold Gaskets	
Application	Part #
2.150" x 1.140" Port - .047" KF	C5555-047
China Rail Gaskets	C5556-047

Timing Cover Sets	
Application	Part #
1992-96	C5059
1997-03	C5060

Exhaust Manifold Gasket	
Application	Part #
1.195" x 1.675" - .064" AM	C5558-064

Rear Main Seal	
Application	Part #
2pc Viton	C5564

Cooling/Water Pump Gaskets	
Application	Part #
Water Pump Cover Gasket	C5561-018
Thermostat Gasket	C5562-018

Fuel Pump Gasket	
Application	Part #
Fuel Pump to Block	C5642-031



Cometic Gasket - An Exclusive NASCAR Performance Product

CHRYSLER / DODGE

318/340/360ci V8 "LA" 1964-92

Head Gaskets

MLS Head Gaskets			
Bore	Thickness	Pkg Qty	Part #
4.040"	.040"	1	C5633-040
4.080"	.040"	1	C5622-040
4.125"	.040"	1	C5457-040
4.180"	.040"	1	C5456-040

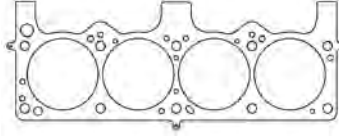

Additional thicknesses available see page 4

MLS Head Gaskets - w/318A Engine Quest or Edelbrock Heads			
Bore	Thickness	Pkg Qty	Part #
4.040"	.040"	1	C5916-040
4.080"	.040"	1	C5917-040
4.125"	.040"	1	C5918-040
4.180"	.040"	1	C5919-040

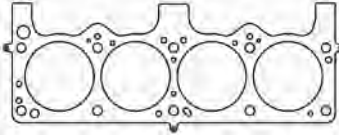

Individual Gaskets

Valve Cover Gasket (sold individually)	
Application	Part #
5 Bolt - .094" KF	C5623-094

Timing Cover Set	
Application	Part #
1964-91 Set	C5061

Intake Manifold Gaskets	
Application	Part #
1.170" x 2.300" - .060" KF	C5624-060
China Rail Gaskets	C5625-060

Oil Pan Gasket Sets	
Application	Part #
4pc 318/340ci V8	C5627-094
4pc 360ci V8	C5508-094

Exhaust Manifold Gaskets	
Application	Part #
1.205" x 1.845" - .064" AM	C5628-064
1.310" x 1.640" - MLS	C5901-030

Rear Main Seal Kit	
Application	Part #
273/318/340ci 2pc - Viton	C5683
360ci 2pc - Viton	C5684

Cooling / Water Pump Gaskets	
Application	Part #
Water Pump Gasket	C15054-060
Thermostat Gasket	C5574-018

Fuel Pump Gasket	
Application	Part #
Fuel Pump to Block	C5642-031

Gasket Kits



To purchase a complete gasket kit order both top end and bottom end gasket kit

TOP END GASKET KIT



Application	Part #
1968-89 318, 1968-73 340, 1971-80 360	PRO1000T

BOTTOM END GASKET KITS



Application	Part #
360ci V8	PRO1000B
318/340ci V8	PRO1002B



Cometic Gasket - An Exclusive NASCAR Performance Product

CHRYSLER / DODGE

5.7L Hemi V8 2003-15

Head Gaskets

MLS Head Gaskets - Right Side

Bore	Thickness	Pkg Qty	Part #
3.950"	.027"	1	C5467-027
4.100"	.027"	1	C5749-027

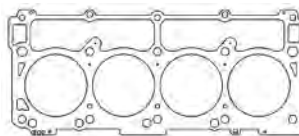

Additional thicknesses available see page 4

MLS Head Gaskets - Left Side

Bore	Thickness	Pkg Qty	Part #
3.950"	.027"	1	C5468-027
4.100"	.027"	1	C5750-027

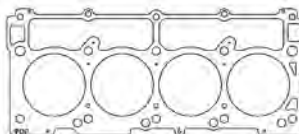

Individual Gaskets

Valve Cover Gasket (sold individually)

Application	Part #
Molded Rubber (Need 2)	C5193

Thermostat Housing Gasket

Application	Part #
Molded Rubber	C5198

Intake Manifold Gasket Set

Application	Part #
Molded Rubber - Set of 8	C5196

Oil Pan Gasket Set

Application	Part #
Intergrated Windage Tray	C5201

Throttle Body Gasket

Application	Part #
Molded Rubber	C5199

Timing Cover Set

Application	Part #
2003-15 5.7L Hemi	C5202

Exhaust Gaskets

Application	Part #
MLS Exhaust Gaskets - Pair	C5854-030

Rear Main Seal Kit

Application	Part #
Seal and Housing Gasket	C5203

Valve Stem Seal Set (16 Pack)

Application	Part #
Hat Style - Viton Steel Body	3260V-16

Water Pump Gasket

Application	Part #
Molded Rubber	C5204

Gasket Kits



To purchase a complete gasket kit order both top end and bottom end gasket kit

TOP END GASKET KIT



Application	Part #
2003-08 5.7L V8 3.950 Bore	PRO1022T

BOTTOM END GASKET KIT



Application	Part #
2003-08 5.7L V8	PRO1022B



Cometic Gasket - An Exclusive NASCAR Performance Product

CHRYSLER / DODGE

6.1L Hemi V8 2005-10

Head Gaskets

MLS Head Gaskets

Bore	Thickness	Pkg Qty	Part #
4.100"	.040"	1	C5876-040
4.125"	.040"	1	C5441-040
4.185"	.040"	1	C5042-040
4.250"	.040"	1	C5890-040

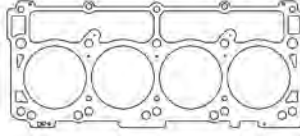

Additional thicknesses available see page 4

MLx Head Gasket

Bore	Thickness	Pkg Qty	Part #
4.100"	.040"	1	C15149-040

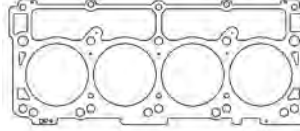

MLS Head Gaskets - Aluminum Sleeved Block

Bore	Thickness	Pkg Qty	Part #
4.055"	.040"	1	C5525-040
4.125"	.040"	1	C5526-040
4.185"	.040"	1	C5527-040

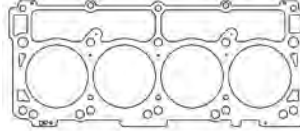

Individual Gaskets

Valve Cover Gasket (sold individually)

Application	Part #
Molded Rubber (Need 2)	C5193

Thermostat Housing Gasket

Application	Part #
Molded Rubber	C5198

Intake Manifold Gasket Set

Application	Part #
6.1L - .060" KF	C5197

Oil Pan Gasket Set

Application	Part #
Intergrated Windage Tray	C5201

Throttle Body Gasket

Application	Part #
Molded Rubber	C5199

Timing Cover Set

Application	Part #
2003-15 6.1L Hemi	C5202

Exhaust Gaskets

Application	Part #
MLS Exhaust Gaskets - Pair	C5872-030

Rear Main Seal Kit

Application	Part #
Seal and Housing Gasket	C5203

Valve Stem Seal Set (16 Pack)

Application	Part #
Hat Style - Viton Steel Body EXH	3260V-16
Hat Style - Viton Steel Body INT	3261V-16

Water Pump Gasket

Application	Part #
Molded Rubber	C5204

Gasket Kits



To purchase a complete gasket kit order both top end and bottom end gasket kit

TOP END GASKET KIT



Application	Part #
2005-10 6.1L Hemi V8 4.125" Bore	PRO1023T

BOTTOM END GASKET KIT



Representative image

Application	Part #
2005-10 6.1L Hemi V8	PRO1023B



Cometic Gasket - An Exclusive NASCAR Performance Product

CHRYSLER / DODGE

6.4L Hemi V8 2011-Present "Apache"

Head Gaskets

MLS Head Gasket - Right Side			
Bore	Thickness	Pkg Qty	Part #
4.120"	.040"	1	C5026-040

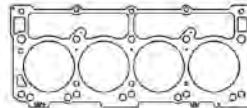

Additional thicknesses available
see page 4

MLS Head Gasket - Left Side			
Bore	Thickness	Pkg Qty	Part #
4.120"	.040"	1	C5027-040

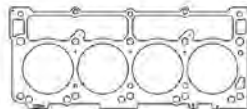

MLx Head Gasket - Right Side			
Bore	Thickness	Pkg Qty	Part #
4.150"	.040"	1	C15172-040

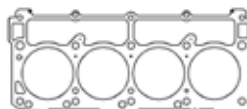

MLx Head Gasket - Left Side			
Bore	Thickness	Pkg Qty	Part #
4.150"	.040"	1	C15173-040

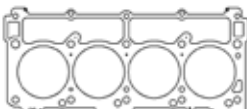

Small Block V8 - A-8 Sprint & A-4 Midget

Head Gaskets

MLS Head Gaskets - A-8 Sprint Block			
Bore	Thickness	Pkg Qty	Part #
4.165"	.040"	1	C5828-040
4.200"	.040"	1	C5829-040
4.250"	.040"	1	C5830-040

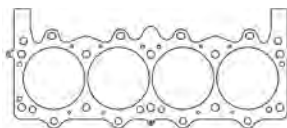

Additional thicknesses available
see page 4

MLS Head Gaskets - A-4 Midget Block			
Bore	Thickness	Pkg Qty	Part #
4.165"	.040"	1	C5831-040
4.200"	.040"	1	C5832-040

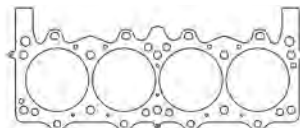

Individual Gaskets

Valve Cover Gasket (sold individually)	
Application	Part #
Midget & Sprint Head	C5784-060

Oil Pan Gasket Set	
Application	Part #
Midget Block - .060" AFM	C5596-060

Intake Manifold Gasket	
Application	Part #
A-4 Midget Intake Gasket	C5590



Cometic Gasket - An Exclusive NASCAR Performance Product

CHRYSLER / DODGE

Small Block V8 - R3 Block w/W2, W7, W8, or W9 Heads

Head Gaskets

MLS Head Gaskets - R3 Block w/W2 Heads

Bore	Thickness	Pkg Qty	Part #
4.100"	.040"	1	C5567-040
4.200"	.040"	1	C5466-040

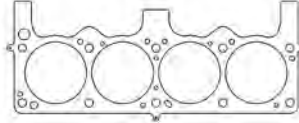

Additional thicknesses available see page 4

MLS Head Gaskets - R3 Block w/W7, W8, W9 Heads

Bore	Thickness	Pkg Qty	Part #
4.060"	.040"	1	C5579-040
4.100"	.040"	1	C5580-040
4.165"	.040"	1	C5581-040
4.185"	.040"	1	C5582-040

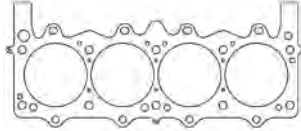

Individual Gaskets

Valve Cover Gaskets (sold individually)

Application	Part #
W2/W5/W7/W9 Heads	C5568-094
W8 Heads	C5592-094

Thermostat Gasket

Application	Part #
R3 Block	C5574-018

Intake Manifold Gaskets

Application	Part #
W2 Heads 1.35" x 2.07"	C5569-060
W7/W8/W9 Heads 1.45" x 2.20"	C5586-031
China Rail Gaskets	C5625-060

Oil Pan Gasket

Application	Part #
R3 Block - Rails Only	C5575-094

Exhaust Gaskets

Application	Part #
W2 Heads 1.47" x 1.45"	C5571-064
W7/W8/W9 Heads D-Port	C5593-064

Timing Cover Gasket

Application	Part #
R3 Block - .018" AFM	C5576-018

Water Pump Gasket

Application	Part #
R3 Block	C5573-018

Fuel Pump Gasket

Application	Part #
R3 Block - .031" Fiber	C5642-031

Small Block V8 - R4 Block w/P5 Heads

Head Gaskets

MLS Head Gaskets

Bore	Thickness	Pkg Qty	Part #
4.200"	.040"	1	C5801-040
4.250"	.040"	1	C5800-040

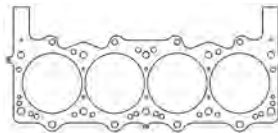

Additional thicknesses available see page 4

Small Block V8 - R6 Race Block

Head Gaskets

MLx Head Gasket - Right Side

Bore	Thickness	Pkg Qty	Part #
4.220"	.040"	1	C5670-040

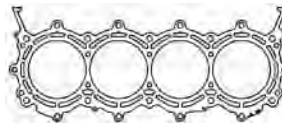

Additional thicknesses available see page 4

MLx Head Gasket - Left Side

Bore	Thickness	Pkg Qty	Part #
4.220"	.040"	1	C5671-040

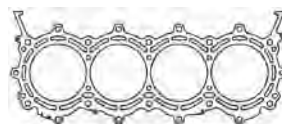



Cometic Gasket - An Exclusive NASCAR Performance Product

CHRYSLER / DODGE

Big Block Wedge 361, 383, 400, 413, 426, & 440ci V8

Head Gaskets

MLS Head Gaskets			
Bore	Thickness	Pkg Qty	Part #
4.250"	.040"	1	C5459-040
4.350"	.040"	1	C5460-040
4.380"	.040"	1	C5461-040
4.410"	.040"	1	C5462-040
4.500"	.040"	1	C5464-040
4.600"	.040"	1	C5799-040

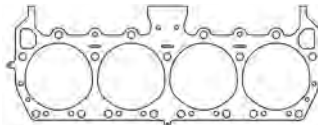

Additional thicknesses available see page 4

Individual Gaskets

Valve Cover Gasket (sold individually)	
Application	Part #
Molded Rubber	C5983

Oil Pan Gasket	
Application	Part #
Big Block Wedge V8-.060"AFM	C5617-060

Intake Manifold Gaskets	
Application	Part #
2.31" x 1.23" - .060" KF	C5611-060

Exhaust Gaskets	
Application	Part #
1.85" x 1.35" - .064" AM	C5619-064
1.78" x 1.46" - .030" MLS	C5902-030

Water Pump Gaskets	
Application	Part #
Pump to Block - Pair	C5615-032

Timing Cover Gasket Set	
Application	Part #
Big Block Wedge V8	C5062

Thermostat Gasket	
Application	Part #
Big Block Wedge V8	C5616-018

Fuel Pump Gasket	
Application	Part #
Fuel Pump to Block	C5642-031

Rear Main Seal Kit	
Application	Part #
2pc Viton	C5686

Gasket Kits



To purchase a complete gasket kit order both top end and bottom end gasket kit

TOP END GASKET KIT



Application	Part #
Big Block Wedge V8 4.410" Bore	PRO1001T

BOTTOM END GASKET KIT



Application	Part #
Big Block Wedge V8	PRO1001B



Cometic Gasket - An Exclusive NASCAR Performance Product

CHRYSLER / DODGE

392 Hemi V8 1957-58

Head Gaskets

MLS Head Gaskets

Bore	Thickness	Pkg Qty	Part #
4.000"	.040"	1	C5210-045
4.100"	.040"	1	C5211-045

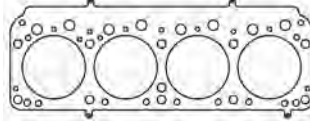

Additional thicknesses available see page 4

Individual Gaskets

Valve Cover Gaskets

Application	Part #
392 Hemi - 188" ML (pair)	C5236-188

Oil Pan Gasket Set

Application	Part #
1958-59 4pc Set	C15055

Intake Manifold Gasket Set

Application	Part #
Includes Valley Gasket	C5237

Distributor Gasket

Application	Part #
392 Hemi - .031" Fiber	C5239-031

Exhaust Gaskets

Application	Part #
1957-58 - .064" AM	C5238-064

Timing Cover Gasket Set

Application	Part #
1955-59 Early Hemi	C5063

Cooling/Water Pump Gaskets

Application	Part #
Pump to Block - 4 Pack	C5228-060
Water Outlet	C5229-060
Water Inlet	C5230-032

Carburetor Gasket Kits

Application	Part #
392 Hemi 2bbl Kit	C5240
392 Hemi 4bbl Kit	C5241

Gasket Kits



To purchase a complete gasket kit order both top end and bottom end gasket kit

TOP END GASKET KIT



Application	Part #
392 Hemi V8 1957-58 4.100" Bore	PRO1028T

BOTTOM END GASKET KIT



Application	Part #
392 Hemi V8 1957-58	PRO1028B



Cometic Gasket - An Exclusive NASCAR Performance Product

CHRYSLER / DODGE

426 Hemi 1966 & Later (Gasket bores .060" larger than listed)

Head Gaskets

MLS Head Gaskets			
Bore	Thickness	Pkg Qty	Part #
4.250"	.040"	1	C5445-040
4.280"	.040"	1	C5454-040
4.310"	.040"	1	C5455-040
4.375"	.040"	1	C5446-040
4.500"	.040"	1	C5447-040

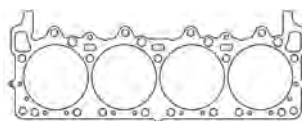

Additional thicknesses available see page 4

Individual Gaskets

Valve Cover Gasket (sold individually)	
Application	Part #
Molded Rubber	C5976

Oil Pump Gasket	
Application	Part #
426 Hemi	C5604-032

Intake Manifold Gaskets	
Application	Part #
1.85" x 2.00" - .047" KF	C5598-047

Oil Pan Gasket	
Application	Part #
426 Hemi - .060" AFM	C5606-060

Exhaust Gaskets	
Application	Part #
1.84" x 1.89" - .030" MLS	C5965-030

Fuel Pump Gasket	
Application	Part #
Fuel Pump to Block	C5642-031

Cooling / Water Pump Gaskets	
Application	Part #
Pump to Block - Pair	C5601-018
Pump to Housing	C5602-032
Thermostat Gasket	C5603-018

Distributor Gasket	
Application	Part #
426 Hemi	C5607-060

Rear Main Seal Kit	
Application	Part #
2pc Viton	C5686

Gasket Kits



To purchase a complete gasket kit order both top end and bottom end gasket kit

TOP END GASKET KIT



Application	Part #
426 Hemi 7.0L 1966-71 4.100" Bore	PRO1021T

BOTTOM END GASKET KIT



Application	Part #
426 Hemi 7.0L 1966-71	PRO1021B



Cometic Gasket - An Exclusive NASCAR Performance Product

CHRYSLER / DODGE

8.0L V10 1992-Early 96, (Gen 1 Viper)

Head Gaskets

MLS Head Gaskets

Bore	Thickness	Pkg Qty	Part #
4.030"	.051"	1	C5113-051
4.165"	.051"	1	C5114-051

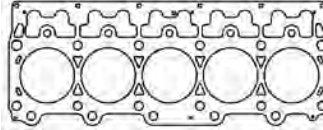

Additional thicknesses available
see page 4

Individual Gaskets

Intake Manifold Gaskets

Application	Part #
1992+Up - .039" Fiber	C5827-039

Exhaust Manifold Gaskets

Application	Part #
1992-E96 - .030" MLS	C5679-030

8.0/8.3L V10 Late 1996-07, (Gen 2/3 Viper)

Head Gaskets

MLS Head Gasket

Bore	Thickness	Pkg Qty	Part #
4.060"	.051"	1	C5814-051
4.125"	.051"	1	C5815-051
4.165"	.051"	1	C5816-051

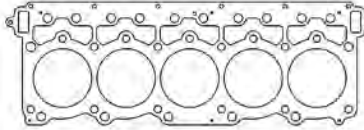

Additional thicknesses available
see page 4

MLx Head Gasket w/1/2" Studs

Bore	Thickness	Pkg Qty	Part #
4.125"	.054"	1	C5585-054

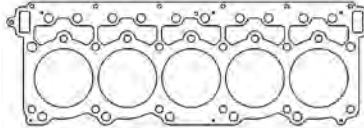

MLx Head Gasket w/9/16" Studs

Bore	Thickness	Pkg Qty	Part #
4.125"	.054"	1	C5487-054

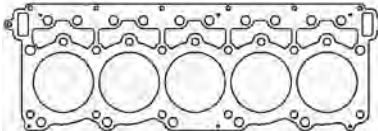

Individual Gaskets

Intake Manifold Gasket

Application	Part #
1992-Up - .039" Fiber	C5827-039

Exhaust Manifold Gaskets

Application	Part #
1996-03 Gen 2 - .020" MLS	C5825-020
2004-05 Gen 3 - .030" MLS	C5865-030

8.4L V10 2008-Up, (Gen 4 Viper)

Head Gaskets

MLS Head Gasket

Bore	Thickness	Pkg Qty	Part #
4.125"	.045"	1	C5107-045

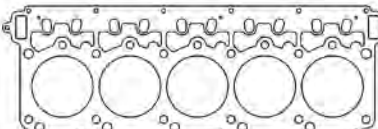

Additional thicknesses available
see page 4

MLx Head Gasket w/9/16" Studs

Bore	Thickness	Pkg Qty	Part #
4.125"	.054"	1	C5504-054

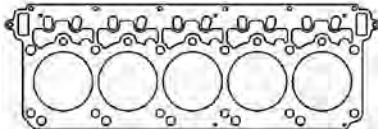

Individual Gaskets

Exhaust Manifold Gasket Set

Application	Part #
2010 - Up MLS	C15150-040



Cometic Gasket - An Exclusive NASCAR Performance Product

CHRYSLER / DODGE

Prostock Hemi 500ci V8

Head Gaskets

MLS Head Gaskets - Gen1 Hemi 99			
Bore	Thickness	Pkg Qty	Part #
4.660"	.051"	1	C5444-051
4.685"	.051"	1	C5443-051
4.700"	.051"	1	C5442-051
4.720"	.051"	1	C5438-051

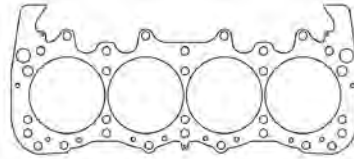

Additional thicknesses available
see page 4

MLS Head Gaskets - Gen2 "DPS2"			
Bore	Thickness	Pkg Qty	Part #
4.750"	.050"	1	C5045-050

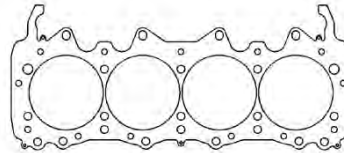

CUMMINS

3.9L 4BT Diesel 4cyl 1983+

Head Gasket

MLx Head Gasket			
Bore	Thickness	Pkg Qty	Part #
4.100"	.061"	1	C5591-061

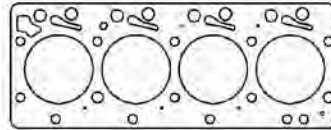

Additional thicknesses available
see page 4

Individual Gaskets

Valve Cover Gasket Set	
Application	Part #
3.9L 4BT	C15056

Thermostat Housing Seal	
Application	Part #
3.9L 4BT	C15059

Intake Manifold Gaskets	
Application	Part #
3.9L 4BT	C15057

Oil Pan Gasket	
Application	Part #
3.9L 4BT - .031" Fiber	C15060

Exhaust Manifold Gaskets Set	
Application	Part #
3.9L 4BT - 4 Pack	C15058

Rear Main Seal	
Application	Part #
3.9L 4BT	C15062

Valve Stem Seal	
Application	Part #
8x12.3x12x17 Viton - Need 8	3164V

Pushrod Cover Gasket	
Application	Part #
3.9L 4BT 1983-97	C15064

Timing Cover Seal	
Application	Part #
3.9L 4BT	C15063

Fuel Pump Gaskets	
Application	Part #
Fuel Pump Gasket	C5389-032
Injection Pump Gasket	C15061

Water Pump Gasket	
Application	Part #
3.9L 4BT 1983-97 - O-Ring	C15065



Cometic Gasket - An Exclusive NASCAR Performance Product

CUMMINS

3.9L 4BT Diesel 4cyl 1983+

Gasket Kits



To purchase a complete gasket kit order both top end and bottom end gasket kit

TOP END GASKET KIT



Application	Part #
3.9L 4BT 4cyl Diesel 4.100" Bore	PRO3000T

BOTTOM END GASKET KIT



Application	Part #
3.9L 4BT 4cyl Diesel	PRO3000B

5.9L 12v 6BT Inline 6 Diesel 1992-98

Head Gasket

MLx Head Gasket

Bore	Thickness	Pkg Qty	Part #
4.100"061"	1	C5955-061

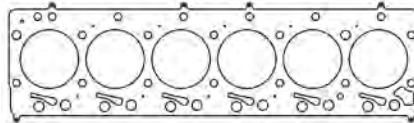

Additional thicknesses available see page 4

Individual Gaskets

Valve Cover Gasket Set

Application	Part #
5.9L 6BT 1992-98	C15066

Thermostat Housing Seal

Application	Part #
5.9L 6BT 1992-98	C15059

Intake Manifold Gasket Set

Application	Part #
5.9L 6BT 1992-98	C15067

Oil Pan Gasket

Application	Part #
5.9L 6BT 1992-98	C15068

Exhaust Manifold Gaskets Set

Application	Part #
5.9L 6BT 1992-98 - .040" MLS	C5725-040

Rear Main Seal

Application	Part #
5.9L 6BT 1992-98	C15062

Valve Stem Seal

Application	Part #
8x12.3x12x17 Viton - Need 12	3164V

Pushrod Cover Gasket

Application	Part #
5.9L 6BT 1989-99	C15069

Timing Cover Seal

Application	Part #
5.9L 6BT 1992-98	C15063

Fuel Pump Gasket

Application	Part #
Fuel Pump Gasket	C5389-032
Injection Pump Gasket	C15061

Water Pump Gasket

Application	Part #
3.9L 4BT 1983-98 - O-Ring	C15065

See page 39 for StreetPro gasket kits



Cometic Gasket - An Exclusive NASCAR Performance Product

CUMMINS

5.9L 12v 6BT Inline 6 Diesel 1992-97

Gasket Kits



To purchase a complete gasket kit order both top end and bottom end gasket kit

TOP END GASKET KIT

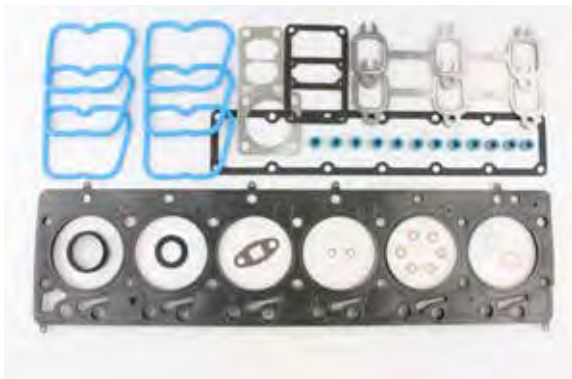

Application	Part #
5.9L 6BT I6 Diesel 92-98 4.100" Bore	PRO3001T

BOTTOM END GASKET KIT



Application	Part #
5.9L 6BT I6 Diesel 92-98	PRO3001B

5.9L 24v ISB Inline 6 Diesel 1998.5-02

Head Gasket

MLx Head Gasket			
Bore	Thickness	Pkg Qty	Part #
4.100"	.061"	1	C5855-061

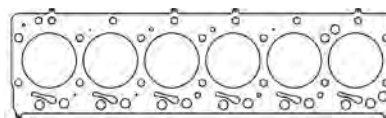

Additional thicknesses available see page 4

Individual Gaskets

Valve Cover Gasket Set	
Application	Part #
5.9L ISB 1998.5-02	C5614

Oil Pan Gasket	
Application	Part #
5.9L 6BT 1998.5-02	C15068

Intake Manifold Gasket Set	
Application	Part #
5.9L ISB 1998.5-02	C15067

Rear Main Seal	
Application	Part #
5.9L 6BT 1998.5-02	C15062

Exhaust Manifold Gaskets Set	
Application	Part #
5.9L ISB 1998.5-02	C5726-040

Pushrod Cover Gasket	
Application	Part #
5.9L 6BT 1998.5-02	C15069

Valve Stem Seals	
Application	Part #
Intake VSS - Yellow (Need 12)	3214V
Exhaust VSS-Green(Need 12)	3215V

Water Pump Gasket	
Application	Part #
3.9L 4BT 1998.5-02 - O-Ring	C15065

Timing Cover Seal	
Application	Part #
5.9L 6BT 1998.5-02	C15063

See page 40 for StreetPro gasket kits



Cometic Gasket - An Exclusive NASCAR Performance Product

CUMMINS

5.9L 24v ISB Inline 6 Diesel 1998.5-02

Gasket Kit



To purchase a complete gasket kit order both top end and bottom end gasket kit

TOP END GASKET KIT

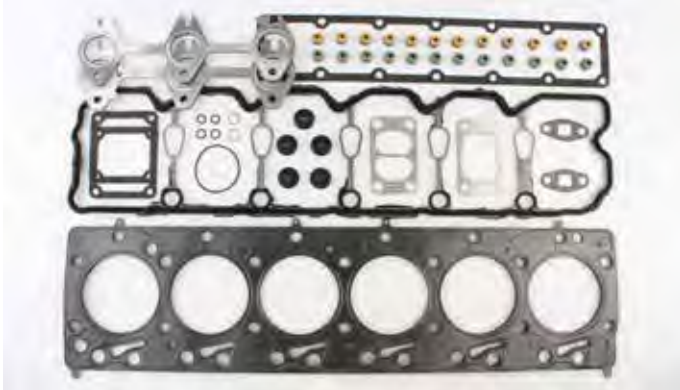

Application	Part #
5.9L 24v ISB 6cyl 1998.5-02	PRO3002T

BOTTOM END GASKET KIT



Application	Part #
5.9L 24v ISB 6cyl 1998.5-02	PRO3002B

5.9L 24v ISB Common Rail Inline 6 Diesel 2003-07

Head Gasket

MLx Head Gasket

Bore	Thickness	Pkg Qty	Part #
4.100"061"1	C5597-061

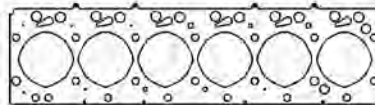

Additional thicknesses available see page 4

Individual Gaskets

Fuel Injector Seal Kit

Application	Part #
5.9L Common Rail 2003-07	C15072

Valve Stem Seals

Application	Part #
Intake VSS - Yellow (Need 12)	3218V
Exhaust VSS-Green(Need 12)	3219V

Valve Cover Gasket Set

Application	Part #
5.9L Common Rail 2003-07	C15070

Pushrod Cover Gasket

Application	Part #
5.9L Common Rail 2003-07	C15071

Intake Manifold Gasket Set

Application	Part #
5.9L Common Rail 2003-07	C15067

Thermostat Seal

Application	Part #
5.9L Common Rail 2003-07	C15073

Exhaust Manifold Gaskets Set

Application	Part #
5.9L Common Rail 2003-07	C5726-040

See page 41 for StreetPro gasket kits



Cometic Gasket - An Exclusive NASCAR Performance Product

CUMMINS

5.9L 24v ISB Common Rail Inline 6 Diesel 2003-07

Gasket Kit



To purchase a complete gasket kit order both top end and bottom end gasket kit

TOP END GASKET KIT

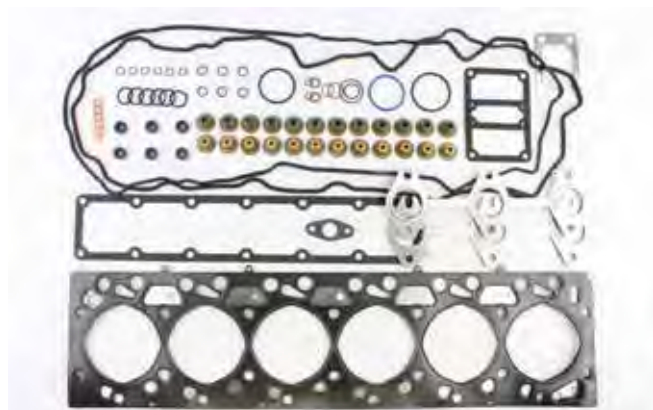

Application	Part #
5.9L 24v Common Rail 03-07	PRO3003T

6.7L 24v ISB Inline 6 Diesel 2007.5+Up

Head Gasket

MLx Head Gasket			
Bore	Thickness	Pkg Qty	Part #
4.312"052"	1	C5609-052

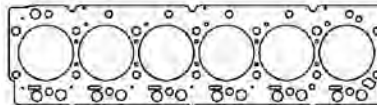

Additional thicknesses available see page 4

Individual Gaskets

Valve Stem Seal	
Application	Part #
VSS - Yellow (Need 24)	3218V

Rear Main Seal	
Application	Part #
6.7L 24v ISB 2007.5+Up	C15062

Intake Gasket Set	
Application	Part #
6.7L 24v ISB 2007.5+Up	C15076

Timing Cover Seal	
Application	Part #
6.7L 24v ISB 2007.5+Up	C15063

Exhaust Manifold Gaskets Set	
Application	Part #
6.7L 24v ISB 2007.5+Up (MLS)	C5726-040

Water Pump Gasket	
Application	Part #
6.7L 24v ISB 2007.5+Up	C15065

Thermostat Seal	
Application	Part #
6.7L 24v ISB 2007.5+Up	C15073

Oil Cooler Gasket Set	
Application	Part #
6.7L 24v ISB 2007.5+Up	C15075

Oil Pan Gasket	
Application	Part #
6.7L 24v ISB 2007.5+Up	C15074

Pushrod Cover Gasket	
Application	Part #
6.7L 24v ISB 2007.5+Up	C15071

See page 42 for StreetPro gasket kits



Cometic Gasket - An Exclusive NASCAR Performance Product

CUMMINS

6.7L 24v ISB Inline 6 Diesel 2007.5+Up

Gasket Kits



To purchase a complete gasket kit order both top end and bottom end gasket kit

TOP END GASKET KIT

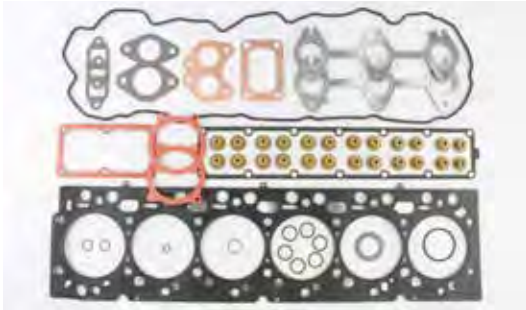

Application: 6.7L 24v ISB 6cyl 2007.5+Up 4.312" Bore Part #: **PRO3004T**

BOTTOM END GASKET KIT



Application: 6.7L 24v ISB 6cyl 2007.5+Up Part #: **PRO3004B**

FORD

1.6L Sigma 2011-16

Head Gasket

MLx Head Gasket

Bore	Thickness	Pkg Qty	Part #
82mm028"1	C4963-028

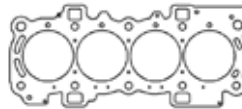

Additional thicknesses available see page 4

1.6L & 1.8L CVH 4cyl 1985-93

Head Gasket

MLS Head Gasket

Bore	Thickness	Pkg Qty	Part #
83mm051"1	C5756-051

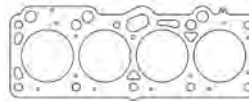

Additional thicknesses available see page 4

1.9L CVH 4cyl 1985-96

Head Gasket

MLS Head Gasket

Bore	Thickness	Pkg Qty	Part #
82mm051"1	C5136-051

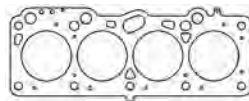

Additional thicknesses available see page 4

2.0L SOHC/DOHC NEP/YB Group A

Head Gasket

MLS Head Gasket

Bore	Thickness	Pkg Qty	Part #
92.5mm040"1	C4218-040

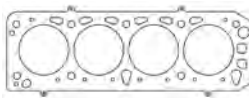

Additional thicknesses available see page 4

See page 43 for additional gaskets



Cometic Gasket - An Exclusive NASCAR Performance Product

FORD

2.0L SOHC/DOHC NEP/YB Group A

Individual Gaskets

Intake Gasket Set	
Application	Part #
Cosworth YB	C4502

Oil Pan Gasket	
Application	Part #
Cosworth YB Rails only	C4640

Exhaust Manifold Gasket Set	
Application	Part #
Cosworth YB	C4334

Front Cover Gasket	
Application	Part #
Cosworth YB.....	C4641

Valve Cover Gaskets	
Application	Part #
Early YB Engine - .060" AFM.....	C4635
Late YB Engine - .060" AFM.....	C4636

Cooling/Water Pump Gasket	
Application	Part #
Water Pump Gasket	C4637
Water Outlet Gasket	C4638
Thermostat Gasket.....	C4639

2.0L ZETEC DOHC 4cyl 1995-04

Head Gasket

MLS Head Gasket			
Bore	Thickness	Pkg Qty	Part #
87mm027"	1.....	C4279-027

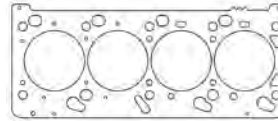

Additional thicknesses available
see page 4

Individual Gaskets

Valve Cover Gaskets	
Application	Part #
2.0L Zetec DOHC 1995-97	C4643
2.0L Zetec DOHC 1998-04.....	C4644

Valve Stem Seals	
Application	Part #
2.0L Zetec 1995-97 (16pk)	3181V-16
2.0L Zetec 1998-04 (16pk)	3182V-16

Exhaust Manifold Gasket Set	
Application	Part #
2.0L Zetec 1994-04	C4645

Oil Pan Gasket	
Application	Part #
2.0L Zetec 1995-04	C4649

Intake Gasket Sets	
Application	Part #
2.0L Zetec 1998-04	C4646
2.0L Zetec 1995-97	C4647

Thermostat Gaskets	
Application	Part #
2.0L Zetec 1995-04 - Seal	C4651
2.0L Zetec 1995-04 - Housing	C4652

Cam Seal	
Application	Part #
2.0L Zetec 1994-04	C4648

Rear Main Seal Set	
Application	Part #
2.0L Zetec 1995-04	C4650



Cometic Gasket - An Exclusive NASCAR Performance Product

FORD

2.0L ZETEC DOHC 4cyl 1995-04

Gasket Kits



To purchase a complete gasket kit order both top end and bottom end gasket kit

TOP END GASKET KITS



Application	Part #
2.0L Zetec DOHC 1995-97 87mm Bore	PRO2029T
2.0L Zetec DOHC 1998-04 87mm Bore	PRO2030T

BOTTOM END GASKET KITS



Application	Part #
2.0L Zetec DOHC 1995-97	PRO2029B
2.0L Zetec DOHC 1998-04	PRO2030B

2.3L "2300" SOHC 1974-97 4cyl

Head Gaskets

MLS Head Gaskets

Bore	Thickness	Pkg Qty	Part #
3.830"	.040"	1	C5369-040
3.940"	.040"	1	C5709-040

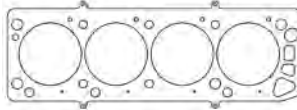

Additional thicknesses available see page 4

Individual Gaskets

Valve Cover Gaskets

Application	Part #
2300 2.3L 1974-93	C4653

Exhaust Manifold Gasket Set

Application	Part #
2300 2.3L 1974-93	C5372-064

Intake Gasket Set

Application	Part #
2300 2.3L	C5371-060

Oil Pan Gaskets

Application	Part #
2300 2.3L 1974-2/19/86	C5373
2300 2.3L 2/20/86-1990	C4669
2300 2.3L 1991-92	C4741
2300 2.3L 1993	C4778

Valve Stem Seals

Application	Part #
2300 2.3L 1974-93 (need 8)	3168V

Rear Main Seal Sets

Application	Part #
2300 2.3L 1974-81 2pc	C5688
2300 2.3L 1982-93 1pc	C5189

Water Pump Gasket

Application	Part #
2300 2.3L 1974-93	C4654

See page 45 for StreetPro gasket kits



Cometic Gasket - An Exclusive NASCAR Performance Product

FORD

2.3L "2300" SOHC 1974-97 4cyl

Gasket Kits



To purchase a complete gasket kit order both top end and bottom end gasket kit

TOP END GASKET KIT



Application	Part #
2300 2.3L 1974-97 3.830" Bore.....	PRO2031T

BOTTOM END GASKET KIT



Application	Part #
2300 2.3L 1974-97	PRO2031B

2.0L 2003-11 & 2.3L 2003-08 Duratec DOHC

Head Gaskets

MLS Head Gasket

Bore	Thickness	Pkg Qty	Part #
89.5mm018"	1	C5843-018
92mm018"	1	C5842-018

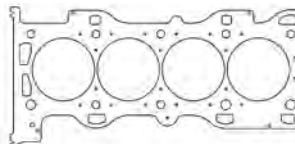

Additional thicknesses available see page 4

Individual Gaskets

Intake Gasket Set

Application	Part #
2.3L Duratec 2003-08.....	C4842-060

Exhaust Manifold Gaskets

Application	Part #
2.3L Duratec (w/ extra port).....	C4840-064
2.3L Duratec (w/o extra port).....	C4841-064

2.5L Duratec DOHC 2009 - Present

Head Gasket

MLS Head Gasket

Bore	Thickness	Pkg Qty	Part #
90mm040"	1	C5906-040

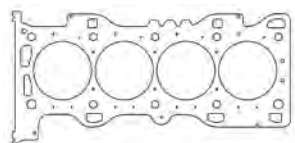

Additional thicknesses available see page 4



Cometic Gasket - An Exclusive NASCAR Performance Product

FORD

3.5L EcoBoost V6 2010-Present

Head Gaskets

MLx Head Gasket - Right Side

Bore	Thickness	Pkg Qty	Part #
92.5mm040"1	C5452-040

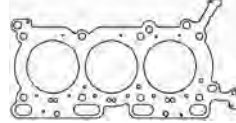

Additional thicknesses available see page 4

MLx Head Gasket - Left Side

Bore	Thickness	Pkg Qty	Part #
92.5mm040"1	C5453-040

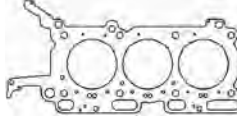

3.9L AJ35 DOHC V8 2003-06

Head Gaskets

MLS Head Gasket - Right Side

Bore	Thickness	Pkg Qty	Part #
87mm030"1	C5770-030
93mm030"1	C5771-030

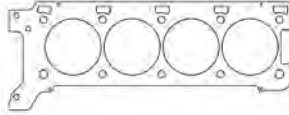

Additional thicknesses available see page 4

MLS Head Gasket - Left Side

Bore	Thickness	Pkg Qty	Part #
87mm030"1	C5772-030
93mm030"1	C5773-030

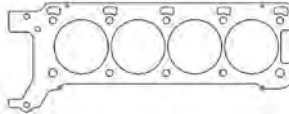

4.0L Falcon Inline 6 1998-02

Head Gasket

MLS Head Gasket

Bore	Thickness	Pkg Qty	Part #
3.695"040"1	C4597-040

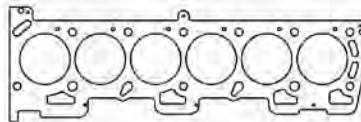

Additional thicknesses available see page 4

4.0L Barra Inline 6 DOHC 2002-Present

Head Gasket

MLS Head Gasket

Bore	Thickness	Pkg Qty	Part #
93mm030"1	C5957-030

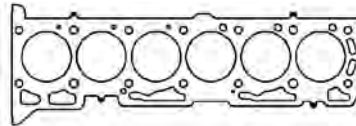

Additional thicknesses available see page 4

4.6L & 5.4L SOHC/DOHC Modular V8

Head Gaskets

MLS Head Gaskets - Right Side

Bore	Thickness	Pkg Qty	Part #
92mm030"1	C5119-030
94mm030"1	C5503-030

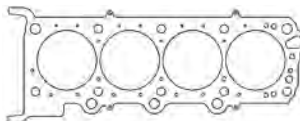

Additional thicknesses available see page 4

MLS Head Gaskets - Left Side

Bore	Thickness	Pkg Qty	Part #
92mm030"1	C5118-030
94mm030"1	C5502-030

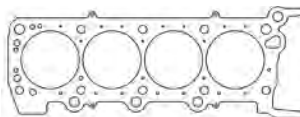



Cometic Gasket - An Exclusive NASCAR Performance Product

FORD

4.6L & 5.4L SOHC/DOHC Modular V8

Head Gaskets

MLx Head Gaskets - Right Side

Bore	Thickness	Pkg Qty	Part #
92mm	.032"	1	C15258-032
94mm	.032"	1	C15260-032

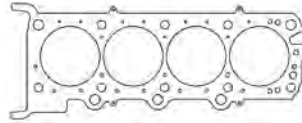

Additional thicknesses available see page 4

MLx Head Gaskets - Left Side

Bore	Thickness	Pkg Qty	Part #
92mm	.032"	1	C15259-032
94mm	.032"	1	C15261-032

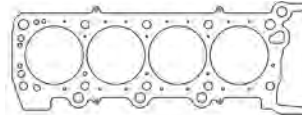

Individual Gaskets

Valve Cover Gasket Sets

Application	Part #
4.6L DOHC 1996-98	C5177
4.6L SOHC 1996-04	C5178
4.6L SOHC 2002-04 Truck	C5179

Throttle Body Gaskets

Application	Part #
SOHC 1996-01 Spacer-TB	C15078
DOHC 1996-98 .020" Fiber	C15079
SOHC 1996-00 Spacer-Manifold	C15080
4.6L SOHC 1999-11 - Rubber	C15081

Intake Gaskets

Application	Part #
4.6L DOHC 1998	C5180
4.6L DOHC 1996-97	C5181
4.6L DOHC 1996-98 - Cover	C5182
4.6L DOHC 1996-98 - Plenum	C5183
4.6L SOHC 1995-00	C5184
4.6L SOHC 2000-04 Truck	C5185
4.6L SOHC 00-04 Truck Plenum	C5186
4.6L SOHC 97-99 Truck Plenum	C5187

Oil Pan Gasket

Application	Part #
4.6/5.4L 1996-04	C5188

Rear Main Seal

Application	Part #
4.6/5.4L 1996-04 - 1pc	C5189

Front Crank Seals

Application	Part #
4.6/5.4L SOHC/DOHC 1996-99	C5192
4.6/5.4L SOHC 2000-04	C5191

Exhaust Gaskets

Application	Part #
4.6/5.4L SOHC 1991-01	C5853-030
4.6L DOHC 1993-99	C5012-030
5.4L Shelby Mustang 2007	C5805-030

Water Pump O-Ring

Application	Part #
4.6/5.4L SOHC/DOHC 1992-09	C5190

Gasket Kits



To purchase a complete gasket kit order both top end and bottom end gasket kit

TOP END GASKET KITS



Application	Part #
4.6L DOHC 1996-98 92mm Bore	PRO1017T
4.6L SOHC 1996-98 92mm Bore	PRO1018T
4.6L SOHC 1999-04 92mm Bore	PRO1019T
4.6L SOHC 1997-04 Truck 92mm Bore	PRO1020T

BOTTOM END GASKET KITS

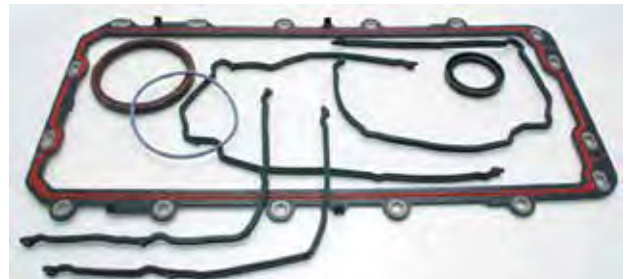

Application	Part #
4.6L DOHC 1996-98	PRO1017B
4.6L SOHC 1996-98	PRO1018B
4.6L SOHC 1999-04	PRO1019B
4.6L SOHC 1997-04 Truck	PRO1020B



Cometic Gasket - An Exclusive NASCAR Performance Product

FORD

4.6L SOHC 3v Heads Modular 2005-10

Head Gaskets

MLS Head Gasket - Right Side

Bore	Thickness	Pkg Qty	Part #
94mm030"1	C5970-030

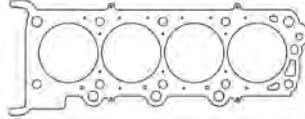

Additional thicknesses available see page 4

MLS Head Gasket - Left Side

Bore	Thickness	Pkg Qty	Part #
94mm030"1	C5969-030

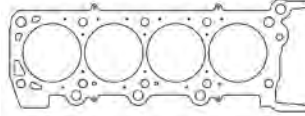

Individual Gaskets

Exhaust Gaskets

Application	Part #
4.6/5.4L 3V Heads - MLS D-Port.....	C5997-030
4.6/5.4L 3V Heads - MLS	C5852-030

5.4L SOHC 3v Heads Modular 2004-14

Head Gaskets

MLS Head Gasket - Right Side

Bore	Thickness	Pkg Qty	Part #
94mm030"1	C5972-030

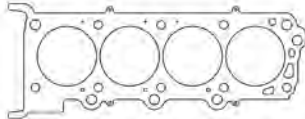

Additional thicknesses available see page 4

MLS Head Gasket - Left Side

Bore	Thickness	Pkg Qty	Part #
94mm030"1	C5971-030

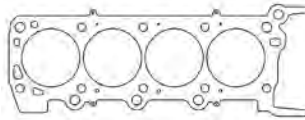

Individual Gaskets

Exhaust Gaskets

Application	Part #
4.6/5.4L 3V Heads - MLS D-Port.....	C5997-030
4.6/5.4L 3V Heads - MLS	C5852-030

5.0L "Coyote" DOHC Modular V8 2011-Present

Head Gaskets

MLS Head Gasket - Left Side

Bore	Thickness	Pkg Qty	Part #
94mm040"1	C5287-040

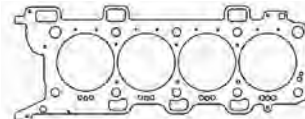

Additional thicknesses available see page 4

MLS Head Gasket - Right Side

Bore	Thickness	Pkg Qty	Part #
94mm040"1	C5286-040

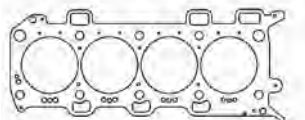

Individual Gaskets

Exhaust Gaskets

Application	Part #
5.0L DOHC Coyote - MLS	C5392-030



Cometic Gasket - An Exclusive NASCAR Performance Product

FORD

5.8L "Trinity" DOHC Modular V8 2013-14

Head Gaskets

MLx Head Gasket - Left Side

Bore	Thickness	Pkg Qty	Part #
95.25mm051"1	C5017-051

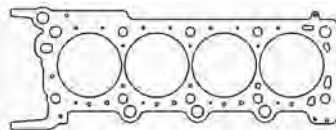

Additional thicknesses available see page 4

MLx Head Gasket - Right Side

Bore	Thickness	Pkg Qty	Part #
95.25mm030"1	C5018-051

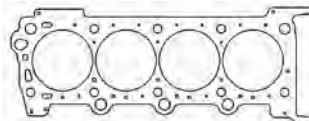

4.6/5.4L 2v/4v Modular V8 w/Darton Solid Sleeves

Head Gaskets

MLS Head Gasket - Left Side

Bore	Thickness	Pkg Qty	Part #
95.25mm040"1	C5856-040

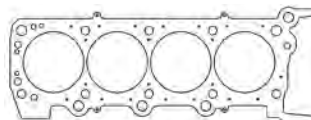

Additional thicknesses available see page 4

MLS Head Gasket - Right Side

Bore	Thickness	Pkg Qty	Part #
95.25mm030"1	C5857-040

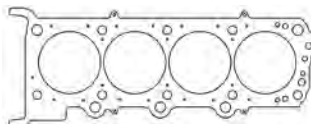

4.6/5.4L 2v/4v Modular V8 w/Darton M.I.D. Sleeves

Head Gaskets

MLS Head Gasket - Left Side

Bore	Thickness	Pkg Qty	Part #
95.25mm040"1	C5858-040

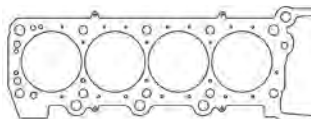

Additional thicknesses available see page 4

MLS Head Gasket - Right Side

Bore	Thickness	Pkg Qty	Part #
95.25mm030"1	C5859-040

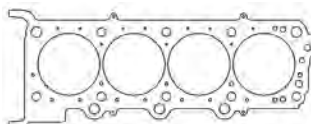



Cometic Gasket - An Exclusive NASCAR Performance Product

FORD

239, 256, 272, 292, 312 Y-Block V8 1956-64

Head Gasket

MLS Head Gasket - Left Side

Bore	Thickness	Pkg Qty	Part #
3.860"	.040"	1	C15170-040

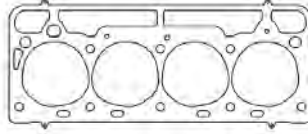

Additional thicknesses available see page 4

MLS Head Gasket - Right Side

Bore	Thickness	Pkg Qty	Part #
3.860"	.040"	1	C15171-040

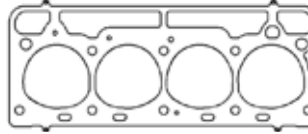

Individual Gaskets

Exhaust Gasket Set

Application	Part #
Y-Block 1956-64	C15082-064

Oil Pan Gasket

Application	Part #
Y-Block 1956-64	C15084

Intake Gasket Set

Application	Part #
Y-Block 1956-64	C15083

Timing Cover Gasket

Application	Part #
Y-Block 1956-64	C15085

Valve Cover Gasket (sold individually)

Application	Part #
Y-Block 1956-64	C15086

Water Pump O-Ring

Application	Part #
Y-Block 1956-64	C15087

Gasket Kits



To purchase a complete gasket kit order both top end and bottom end gasket kit

TOP END GASKET KIT



Application	Part #
239-312 Y-Block 1956-64 3.860" Bore	PRO1039T

BOTTOM END GASKET KIT

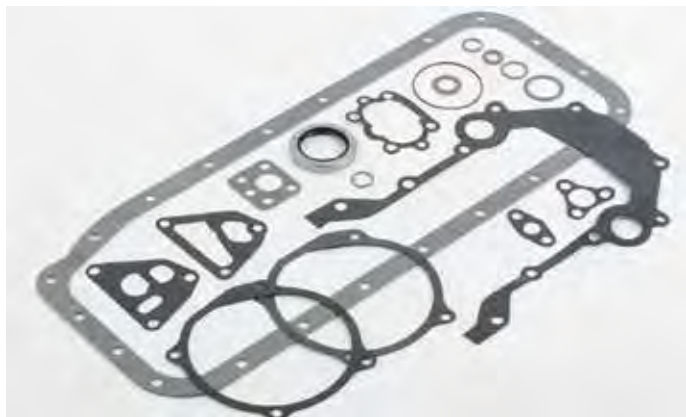

Application	Part #
239-312 Y-Block 1956-64	PRO1039B



Cometic Gasket - An Exclusive NASCAR Performance Product

FORD

Windsor Small Block V8 SVO & non-SVO 1962-00

Head Gaskets

MLS Head Gaskets - SVO Round Bore			
Bore	Thickness	Pkg Qty	Part #
4.030"	.040"	1	C5478-040
4.060"	.040"	1	C5479-040
4.080"	.040"	1	C5480-040
4.100"	.040"	1	C5481-040
4.155"	.040"	1	C5483-040
4.195"	.051"	1	C5509-051
4.200"	.040"	1	C5485-040

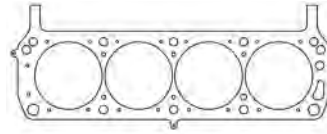

Additional thicknesses available
see page 4

MLx Head Gasket - SVO Round Bore			
Bore	Thickness	Pkg Qty	Part #
4.200"	.040"	1	C5757-040

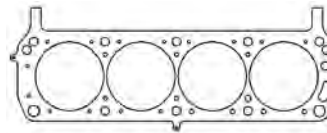

MLS Head Gaskets - non SVO Round Bore			
Bore	Thickness	Pkg Qty	Part #
4.030"	.040"	1	C5511-040
4.060"	.040"	1	C5512-040
4.080"	.040"	1	C5513-040
4.100"	.040"	1	C5514-040
4.155"	.040"	1	C5515-040
4.200"	.040"	1	C5517-040

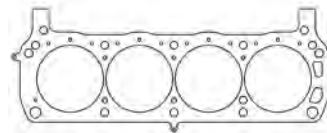

MLx Head Gasket - non-SVO Round Bore			
Bore	Thickness	Pkg Qty	Part #
4.200"	.040"	1	C5025-040

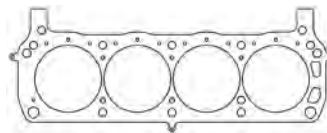

Individual Gaskets

Valve Cover Gasket (sold individually)	
Application	Part #
289/302/351-Molded Rubber.....	C5974
SVO, M6049 Heads .094" KF.....	C5659-094

Timing Cover Sets	
Application	Part #
260/289/302/351W 1962-78.....	C5064
302/351W 1979-97.....	C5065

Intake Manifold Gaskets	
Application	Part #
N351 2.120" x 1.280".....	C5652-060
M6049 Yates 3C 2.00" x 1.35".....	C5268-047
China Rail Gaskets.....	C5653-060

Oil Pan Gasket Sets	
Application	Part #
289/302 4pc Kit.....	C15091
351W 4pc Kit.....	C5279-094
351W 4pc Kit - For Stokers.....	C15092

Exhaust Manifold Gaskets	
Application	Part #
N351 1.585" x 1.681" .064" AM.....	C5655-064
351W 1.52" x 1.57" MLS.....	C15176-030
N351 1.127" x 1.750" MLS.....	C5899-030
Yates 1.725" x 1.890" .064" AM.....	C5357-064
Yates MLS Ind Ports (8 pcs).....	C5665-040

Rear Main Seals	
Application	Part #
289/302 Viton 2pc 1968-82.....	C5688
351W Viton 2pc 1969-83.....	C5689
289/302 1pc 1983-01.....	C5189
351W 1pc 1983-01.....	C15090
351W w/302 Crank.....	C5384

Carb/Throttle Body Gaskets	
Application	Part #
Holley 4bbl Open Plenum Carb.....	C5263
5.0L 1986-93 TB Gasket.....	C15099
5.0/5.8L 85-97 Truck TB Gasket.....	C15100
3.8/5.0L 89-95 TB Gasket.....	C15101

Water Pump Gaskets	
Application	Part #
289/302/351W 67-91 WP Gasket.....	C5662-060
302/351W 69-85 Cover Plate.....	C5353
289/302 63-65.5 Plate to Block.....	C15093
289/302/351W 63-69 Pump to Plate.....	C15094
351W 80-87 Water Pump Plate.....	C15095
302/351W 86-97 Pump to Plate.....	C15096
351W 88-95 Pump to Block.....	C15097
302 91-01 Plate to Block Gasket.....	C15098

Fuel Pump Gasket	
Application	Part #
Small Block Ford.....	C5389-060

See page 52 for StreetPro gasket kits



Cometic Gasket - An Exclusive NASCAR Performance Product

FORD

Windsor Small Block V8 SVO & non-SVO 1965-00

Gasket Kits



To purchase a complete gasket kit order both top end and bottom end gasket kit

TOP END GASKET KITS



Application	Part #
289ci 65-68 & 302ci 68-85 4.100" Bore.....	PRO1015T
302ci EFI 86-95 4.100" Bore	PRO1016T
351ci Windsor 69-87 4.100" Bore.....	PRO1013T
351ci Windsor EFI 88-95 4.100" Bore	PRO1014T

BOTTOM END GASKET KITS



Application	Part #
289/302ci 65-95.....	PRO1015B
351ci Windsor 69-95.....	PRO1013B

Small Block Ford V8 - Aftermarket & Race

Head Gaskets

MLS Head Gaskets-SVO Yates w/Valve Pockets-LHS

Bore	Thickness	Pkg Qty	Part #
4.100"	.040"	1	C5358-040
4.180"	.040"	1	C5364-040
4.200"	.040"	1	C5366-040

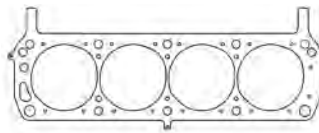

Additional thicknesses available
see page 4

MLS Head Gaskets-SVO Yates w/Valve Pockets-RHS

Bore	Thickness	Pkg Qty	Part #
4.100"	.040"	1	C5359-040
4.180"	.040"	1	C5365-040
4.200"	.040"	1	C5367-040

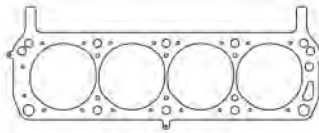

MLS Head Gaskets - Brodix Track 1, Edelbrock RPM Performer, AFR Heads w/Coolant Channels

Bore	Thickness	Pkg Qty	Part #
4.030"	.040"	1	C5909-040
4.080"	.040"	1	C5910-040
4.100"	.040"	1	C5911-040
4.155"	.040"	1	C5912-040
4.200"	.040"	1	C5913-040

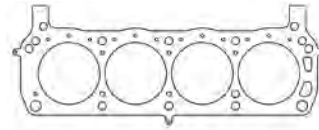

MLS Head Gaskets - New Boss 302 Blocks (will not work with OEM non-SVO heads)

Bore	Thickness	Pkg Qty	Part #
4.030"	.040"	1	C5958-040
4.080"	.040"	1	C5959-040
4.100"	.040"	1	C5960-040
4.155"	.040"	1	C5961-040
4.200"	.040"	1	C5962-040

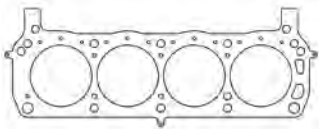

See page 53 for additional gaskets



Cometic Gasket - An Exclusive NASCAR Performance Product

FORD

Small Block Ford V8 - Aftermarket & Race

Head Gaskets

MLS Head Gasket - World Products Man-o-War 10 Degree Heads-6 Bolts per Cylinder			
Bore	Thickness	Pkg Qty	Part #
4.080"	.040"	1	C5132-040
4.100"	.040"	1	C5133-040
4.155"	.040"	1	C5134-040
4.180"	.040"	1	C5135-040

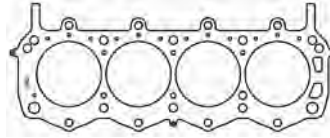

Additional thicknesses available see page 4

MLS Head Gasket-Brodix ASCS Head/R452 Block			
Bore	Thickness	Pkg Qty	Part #
4.125"	.040"	1	C5217-040

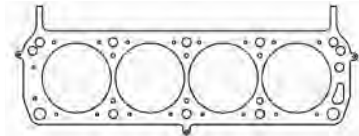

351 Cleveland, 351 Modified, & 400ci V8

Head Gasket

MLS Head Gasket			
Bore	Thickness	Pkg Qty	Part #
4.100"	.040"	1	C5871-040

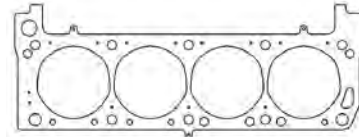

Additional thicknesses available see page 4

Individual Gaskets

Valve Cover Gasket (sold individually)	
Application	Part #
351C/351M/400 .125" KF	C5659-125

Oil Pan Gasket Set	
Application	Part #
351C/351M/400 1970-81	C5278-094

Intake Manifold Gaskets	
Application	Part #
351C/351M/400 4bbl Heads	C15102
351C/351M/400 2bbl Heads	C15103

Water Pump Gaskets	
Application	Part #
Backing Plate Gasket	C5353
Water Pump Gasket w/Cast Iron Pump	C5662-060

Exhaust Manifold Gasket	
Application	Part #
351C/351M/400 4bbl Heads	C15104

Timing Cover Set	
Application	Part #
351C/351M/400 1970-81	C5066

Fuel Pump Gasket	
Application	Part #
351C/351M/400 .031" Fiber	C15105

Rear Main Seals	
Application	Part #
351C/351M/400 - 2pc Poly	C5088
351C/351M/400 - 2pc Viton	C5689



Cometic Gasket - An Exclusive NASCAR Performance Product

FORD

Ford FR9 Race V8

Head Gaskets

MLx Head Gaskets - Right Side

Bore	Thickness	Pkg Qty	Part #
4.190"	.040"	1	C5587-040

MLx Head Gaskets - Left Side

Bore	Thickness	Pkg Qty	Part #
4.190"	.040"	1	C5588-040

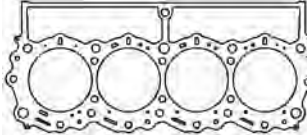
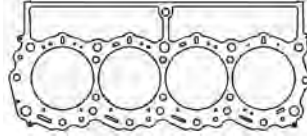

Additional thicknesses available
see page 4

Individual Gaskets

Intake Manifold Gaskets

Application	Part #
FR9 V8 - 2.05" x 1.39" .060" KF	C15106-060

Exhaust Manifold Gaskets

Application	Part #
FR9 V8 - .030" MLS	C15107-030

Ford Flathead V8 1932-53

Head Gaskets

MLS Head Gasket - 1932-38 21 Bolt

Bore	Thickness	Pkg Qty	Part #
3.156"	.040"	1	C5870-040

MLS Head Gasket - 1938-48 24 Bolt

Bore	Thickness	Pkg Qty	Part #
3.250"	.051"	1	C5908-051
3.375"	.051"	1	C5108-051

MLS Head Gasket - 1949-53 24 Bolt - RHS

Bore	Thickness	Pkg Qty	Part #
3.375"	.051"	1	C15088-051

MLS Head Gasket - 1949-53 24 Bolt - LHS

Bore	Thickness	Pkg Qty	Part #
3.375"	.051"	1	C15089-051

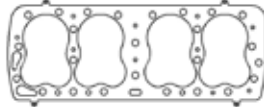
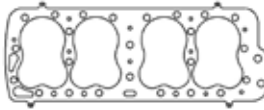
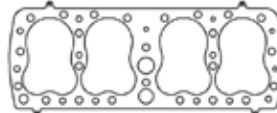
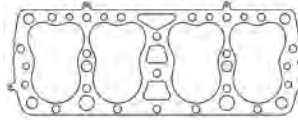

Additional thicknesses available
see page 4

Individual Gaskets

Carburetor Gaskets (sold individually)

Application	Part #
Holley Air Cleaner Gasket	C15108
59A, 8BA, 8CM 2bbl Gasket	C15109

Timing Cover Gaskets

Application	Part #
59A 1945-48 .015" Fiber	C15134
8BA/8CM 1948-53 .015" Fiber	C15135

Intake Manifold Gaskets

Application	Part #
59A 1945-48 .060" KF	C15120
8BA/8CM 1948-53 .060" KF	C15121

Water Pump Gaskets

Application	Part #
59A 1945-48 .015" Fiber	C15136
8BA/8CM 1948-53 .015" Fiber	C15137

Exhaust Manifold Gaskets

Application	Part #
59A, 8BA, 8CM 1945-53 8PK	C15116

Fuel Pump Gaskets

Application	Part #
59A 45-48 Fuel Pump Stand	C15117
59A 46-53 Fuel Pump Cover	C15118
8BA/8CM 48-53 Fuel Pump Mount	C15119

See page 55 for additional gaskets



Cometic Gasket - An Exclusive NASCAR Performance Product

FORD

Ford Flathead V8 1932-53

Individual Gaskets

Distributor Gaskets	
Application	Part #
59A 45-48 Distributor Base.....	C15110
59A 45-48 Distributor Cap Cover.....	C15111
59A Distributor Terminal Housing.....	C15112
59A 32-41 Distributor Base.....	C15113
59A 32-41 Distributor Cap Cover.....	C15114
59A Distributor Coil Base.....	C15115

Oil Pump/Pan Gaskets	
Application	Part #
59A 32-41 Oil Pump Drive Cover	C15122
59A 45-48 Oil Pump Drive Cover	C15123
59A 45-48 Oil Pump Mounting.....	C15126
59A 45-48 Oil Pump Screen Cover	C15127
8BA/8CM 48-53 Oil Pump Drive Cover	C15130
8BA/8CM 48-53 Oil Pump Relief Nut	C15132
59A 45-48 Drain Plug Gasket.....	C15124
59A 1938 Drain Plug Gasket.....	C15125
8BA/8CM 48-53 Drain Plug Gasket.....	C15133
8BA/8CM Oil Pan Clean Out	C15128
8BA/8CM Oil Pan Gasket.....	C15129
8BA/8CM Dipstick Tube Gasket	C15131

352, 390, 406, 410, 427, & 428 FE V8

Head Gaskets

MLS Head Gaskets - Top Oiler			
Bore	Thickness	Pkg Qty	Part #
4.080"	.040"	1	C5833-040
4.165"	.040"	1	C5834-040
4.250"	.040"	1	C5835-040
4.300"	.040"	1	C5523-040
4.400"	.040"	1	C5840-040

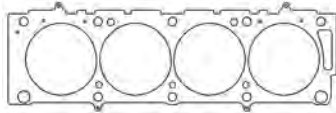

Additional thicknesses available see page 4

MLS Head Gasket - SOHC Side Oiler			
Bore	Thickness	Pkg Qty	Part #
4.400"	.040"	1	C5841-040

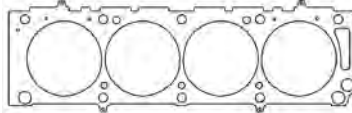

Individual Gaskets

Valve Cover Gaskets (sold individually)	
Application	Part #
All FE & 428CJ/SCJ	C5138-188
427 SOHC LHS	C15138-188
427 SOHC RHS.....	C15139-188

Timing Cover Sets	
Application	Part #
352/360 1958-60	C5067
332-428 1961-71	C5068

Intake Manifold Gaskets	
Application	Part #
STD/Low Riser 428CJ/SCJ	C5137-060
427 SOHC	C15140-060

Oil Pan Gasket	
Application	Part #
FE V8 1961-71	C5141-125

Exhaust Manifold Gaskets	
Application	Part #
352-410 FE & 428CJ/SCJ MLS.....	C5922-030
427 SOHC .064" AM.....	C15141-064

Rear Main Seal	
Application	Part #
FE V8 1961-71	C5142

Water Pump Gaskets	
Application	Part #
FE V8 1961-71 (Pair).....	C5140-031



Cometic Gasket - An Exclusive NASCAR Performance Product

FORD

352, 390, 406, 410, 427, & 428 FE V8

Gasket Kits



To purchase a complete gasket kit order both top end and bottom end gasket kit

TOP END GASKET KIT



Application	Part #
352, 390, 410, 428 FE V8 4.300" Bore.....	PRO1027T

BOTTOM END GASKET KIT



Application	Part #
352, 390, 410, 428 FE V8.....	PRO1027B

429ci 7.0L & 460ci 7.5L Big Block V8

Head Gaskets

MLS Head Gaskets

Bore	Thickness	Pkg Qty	Part #
4.400"	.040"	1	C5666-040
4.500"	.040"	1	C5667-040
4.600"	.040"	1	C15142-040
4.670"	.040"	1	C5668-040

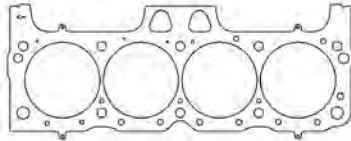

Additional thicknesses available see page 4

Individual Gaskets

Valve Cover Gaskets (sold individually)

Application	Part #
429/460 Big Block .125" KF.....	C5205-125

Timing Cover Set

Application	Part #
429/460 1968-85	C5069

Intake Manifold Gaskets

Application	Part #
Stock 429/460 Heads	C5043-060
CJ/SCJ 2.24" x 2.60" Port.....	C5206-060

Oil Pan Gasket

Application	Part #
429/460 4 pc set.....	C5125-094

Exhaust Manifold Gaskets

Application	Part #
429/460 Oval Port - .030" MLS.....	C5900-030

Rear Main Seal

Application	Part #
429/460 Big Block 2pc.....	C5208

Water Pump Gaskets

Application	Part #
429/460 Big Block.....	C5209-031

See page 57 for StreetPro gasket kits



Cometic Gasket - An Exclusive NASCAR Performance Product

FORD

429ci 7.0L & 460ci 7.5L Big Block V8

Gasket Kits



To purchase a complete gasket kit order both top end and bottom end gasket kit

TOP END GASKET KIT



Application: 429/460ci Big Block V8 68-78 4.500" Bore..... Part #: **PRO1012T**

BOTTOM END GASKET KIT



Application: 429/460ci Big Block V8 68-78 Part #: **PRO1012B**

Prostock Racing V8

Head Gaskets

MLS Head Gaskets - D/E460 PROSTOCK			
Bore	Thickness	Pkg Qty	Part #
4.600"	.045"	1	C5731-045
4.685"	.045"	1	C5732-045

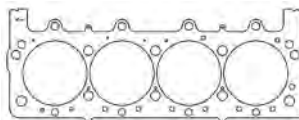

Additional thicknesses available see page 4

MLS Head Gaskets - A460/C460 PROSTOCK			
Bore	Thickness	Pkg Qty	Part #
4.400"	.045"	1	C5745-045
4.600"	.045"	1	C5743-045
4.685"	.045"	1	C5744-045

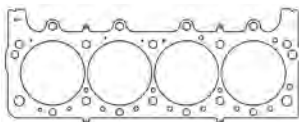

MLS Head Gaskets- A500 PROSTOCK - LHS			
Bore	Thickness	Pkg Qty	Part #
4.600"	.045"	1	C5727-045
4.685"	.045"	1	C5729-045

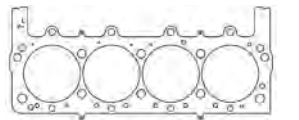

MLS Head Gaskets - A500 PROSTOCK - RHS			
Bore	Thickness	Pkg Qty	Part #
4.600"	.045"	1	C5728-045
4.685"	.045"	1	C5730-045

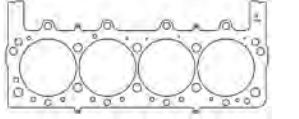

MLS Head Gasket - 460 w/Hemi 14 Bolt Head			
Bore	Thickness	Pkg Qty	Part #
4.700"	.040"	1	C5888-040

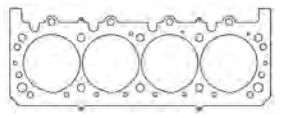

MLS Head Gasket - JC50 500ci PROSTOCK - LHS			
Bore	Thickness	Pkg Qty	Part #
4.735"	.052"	1	C5284-052

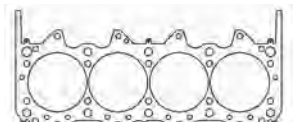

MLS Head Gasket - JC50 500ci PROSTOCK - RHS			
Bore	Thickness	Pkg Qty	Part #
4.735"	.052"	1	C5285-052

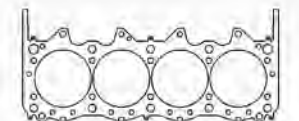

See page 58 for additional gaskets



Cometic Gasket - An Exclusive NASCAR Performance Product

FORD

Prostock Racing V8

Head Gaskets

MLS Head Gaskets - 800ci W/5.0" Bore Centers

Bore	Thickness	Pkg Qty	Part #
4.770"	.040"	1	C5875-040
4.770"	.040"	1	C5875-051

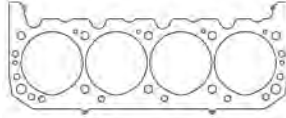

Additional thicknesses available
see page 4

Individual Gaskets

Exhaust Manifold Gaskets

Application	Part #
JC50 500ci - .030" MLS	C5257-030

6.0L Powerstroke Diesel 2003-08

Head Gaskets

MLx Head Gasket - 2003-06 18mm Dowels

Bore	Thickness	Pkg Qty	Part #
96mm	.062"	1	C5589-062

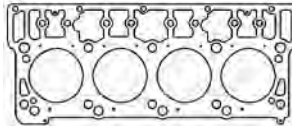

Additional thicknesses available
see page 4

MLx Head Gasket - 2007-08 20mm Dowels

Bore	Thickness	Pkg Qty	Part #
96mm	.062"	1	C5984-062

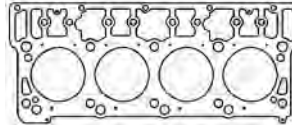

Individual Gaskets

Valve Cover Gasket Set

Application	Part #
6.0L Powerstroke 03-08	C15143

HPOP Cover Gasket

Application	Part #
6.0L Powerstroke 03-07	C15145

Intake Manifold Gasket Set

Application	Part #
6.0L Powerstroke 03-08	C15144

Oil Cooler O-Ring Kit

Application	Part #
6.0L Powerstroke 03-07	C15146

Exhaust Manifold Gasket

Application	Part #
6.0L Powerstroke 03-08 - MLS	C5089-030

Cylinder Head Dowels (sold individually)

Application	Part #
6.0L Powerstroke 03-06 18mm	C15147
6.0L Powerstroke 07-08 20mm	C15148

Valve Stem Seals (sold individually)

Application	Part #
6.0L Powerstroke 03-08 (Req 32)	3217V

See page 59 for StreetPro gasket kits



Cometic Gasket - An Exclusive NASCAR Performance Product

FORD

6.0L Powerstroke Diesel 2003-08

Gasket Kits



To purchase a complete gasket kit order both top end and bottom end gasket kit

TOP END GASKET KITS

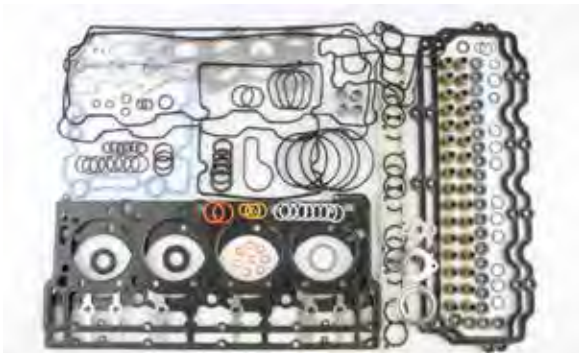

Application	Part #
6.0L Powerstroke 03-06 96mm Bore.....	PRO3005T
6.0L Powerstroke 07-08 96mm Bore.....	PRO3006T

BOTTOM END GASKET KIT



Application	Part #
6.0L Powerstroke 03-08	PRO3005B.

6.4L Powerstroke Diesel 2008-10

Head Gasket

MLx Head Gasket			
Bore	Thickness	Pkg Qty	Part #
99mm	.062"	1	C5610-062

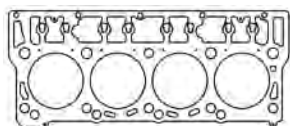

Additional thicknesses available see page 4

MLx Head Gasket - REV B			
Bore	Thickness	Pkg Qty	Part #
103mm	.062"	1	C15175-062

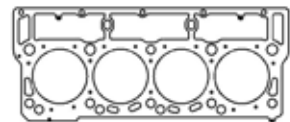

Individual Gaskets

Valve Cover Gasket Set	
Application	Part #
6.4L Powerstroke 08-10	C15151

Turbo Mounting Kit	
Application	Part #
6.4L Powerstroke 08-10	C15154.

Intake Manifold Gasket Set	
Application	Part #
6.4L Powerstroke 08-10	C15152

Fuel Injector Seal Kit	
Application	Part #
6.4L Powerstroke 08-10 (does 8)	C15155

Exhaust Manifold Gasket	
Application	Part #
6.4L Powerstroke 08-10 - MLS.....	C5089-030

Oil Cooler O-Ring Kit	
Application	Part #
6.4L Powerstroke 08-10	C15156

Valve Stem Seals (sold individually)	
Application	Part #
6.4L Powerstroke 08-10 (Req 32)	3217V

Cooling/Water Pump Gaskets	
Application	Part #
Thermostat Housing Seal.....	C15157.
Lower Coolant Hose Gasket.....	C15158
Upper Coolant hose Gasket.....	C15159

See page 60 for StreetPro gasket kits



Cometic Gasket - An Exclusive NASCAR Performance Product

FORD

6.4L Powerstroke Diesel 2008-10

Gasket Kits



To purchase a complete gasket kit order both top end and bottom end gasket kit

TOP END GASKET KIT

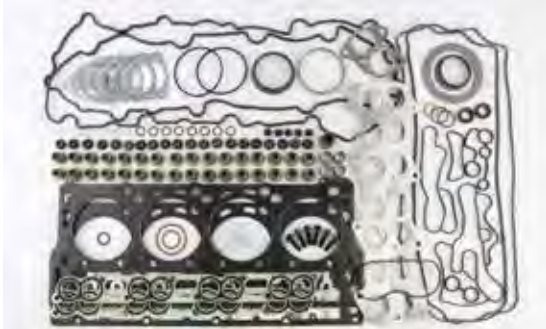

Application	Part #
6.4L Powerstroke 08-10 99mm Bore.....	PRO3007T

BOTTOM END GASKET KIT



Application	Part #
6.4L Powerstroke 08-10	PRO3007B

6.7L Scorpion Diesel 2011-Up

Head Gaskets

MLx Head Gasket - RHS

Bore	Thickness	Pkg Qty	Part #
100mm	.053"	1	C15160-053

MLx Head Gasket - LHS

Bore	Thickness	Pkg Qty	Part #
100mm	.053"	1	C15161-053

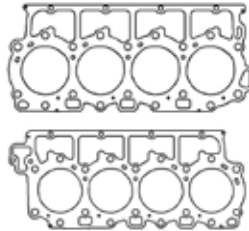

Additional thicknesses available
see page 4

7.3L Powerstroke Diesel 1994-03

Head Gasket

MLS Head Gasket

Bore	Thickness	Pkg Qty	Part #
4.140"	.066"	1	C5839-066

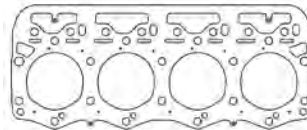

Additional thicknesses available
see page 4

Individual Gaskets

Valve Cover Gaskets (sold individually)

Application	Part #
7.3L Powerstroke 94-97	C15162
7.3L Powerstroke 98-03	C15163

HPOP Gaskets

Application	Part #
7.3L Powerstroke 94-95	C15164
7.3L Powerstroke 96-03	C15165

Intake Manifold Gasket Set

Application	Part #
7.3L Powerstroke .060" AFM	C5090-060

Valve Stem Seals (sold individually)

Application	Part #
7.3L Powerstroke (need 16)	3216V

Exhaust Manifold Gaskets

Application	Part #
7.3L Powerstroke .064" AM	C5091-064

See page 61 for StreetPro gasket kits



Cometic Gasket - An Exclusive NASCAR Performance Product

FORD

7.3L Powerstroke Diesel 1994-03

Gasket Kits



To purchase a complete gasket kit order both top end and bottom end gasket kit

TOP END GASKET KIT



Application	Part #
7.3L Powerstroke 1994-03 4.140" Bore.....	PRO3010T

BOTTOM END GASKET KIT



Application	Part #
7.3L Powerstroke 1994-03	PRO3010B

OLDSMOBILE

330, 350, 400, 403, & 455ci V8

Head Gasket

MLS Head Gaskets			
Bore	Thickness	Pkg Qty	Part #
4.125"	.040"	1	C5808-040
4.200"	.040"	1	C5809-040
4.270"	.040"	1	C5811-040
4.400"	.040"	1	C5810-040

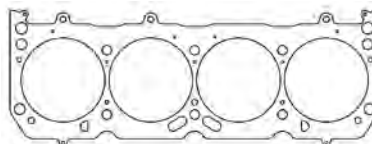

Additional thicknesses available see page 4

Individual Gaskets

Valve Cover Gasket (sold individually)	
Application	Part #
330-455ci Olds V8 .188" ML.....	C5824-188

Timing Cover Set	
Application	Part #
330-455ci Olds V8 1964-90.....	C5070

Intake Manifold Gaskets	
Application	Part #
330, 350, & 403 Small V8.....	C5216-030
400 & 455 Big V8.....	C5813-060

Water Pump Gaskets	
Application	Part #
330-455ci V8 1968-76 w/AC.....	C15166
330-455ci V8 1964-90	C15167

Exhaust Manifold Gaskets	
Application	Part #
330-455ci V8 Stock Port .064" AM	C5812-064
330-455ci V8 1.45"x1.92" MLS.....	C5904-030

Oil Pan Gasket Kit	
Application	Part #
330-455ci Olds V8 4pc Kit.....	C5822-094

See page 62 for StreetPro gasket kits



Cometic Gasket - An Exclusive NASCAR Performance Product

OLDSMOBILE

330, 350, 400, 403, & 455ci V8

Gasket Kits



To purchase a complete gasket kit order both top end and bottom end gasket kit

TOP END GASKET KIT



Application	Part #
Olds 455ci V8 1968-76 4.200" Bore	PRO1009T

BOTTOM END GASKET KIT



Application	Part #
Olds 455ci V8 1968-76	PRO1009B

371 J-2 Golden Rocket 1957-58

Head Gasket

MLS Head Gasket

Bore	Thickness	Pkg Qty	Part #
4.190"040"	1	C5129-040

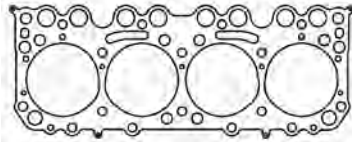

Additional thicknesses available see page 4

Individual Gaskets

Intake Manifold Gaskets

Application	Part #
371 J-2 Golden Rocket .060" KF	C5130-060

Exhaust Manifold Gasket Set

Application	Part #
371 J-2 Golden Rocket .059" CFM	C5131-059

PONTIAC

389 & 421ci V8

Head Gaskets

MLS Head Gaskets-389 (63-67) & 421 (63-66)

Bore	Thickness	Pkg Qty	Part #
4.300"040"	1	C15262-040

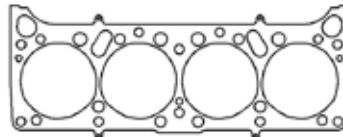

Additional thicknesses available see page 4



Cometic Gasket - An Exclusive NASCAR Performance Product

PONTIAC

326, 350, 400, 428, & 455ci V8

Head Gaskets

MLS Head Gaskets-326 (63-67) & 350 (68-77)			
Bore	Thickness	Pkg Qty	Part #
3.750"	.040"	1	C5767-040
3.950"	.040"	1	C5710-040

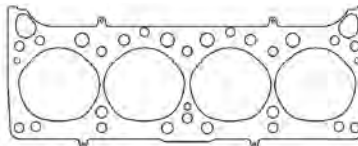

Additional thicknesses available see page 4

MLS Head Gaskets-400 (68-79), 428 (68-69), 455 (70-76)			
Bore	Thickness	Pkg Qty	Part #
4.160"	.040"	1	C5711-040
4.200"	.040"	1	C5769-040
4.300"	.040"	1	C5712-040
4.380"	.040"	1	C5846-040
4.400"	.040"	1	C5847-040

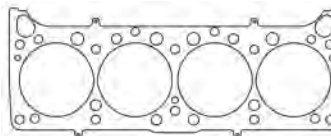

Individual Gaskets

Molded Rubber Valve Cover Gaskets (sold individually)	
Application	Part #
All Models w/Stock Heads	C5044

Timing Cover Set	
Application	Part #
265-455ci V8 193-81	C5071

Intake Manifold Gaskets	
Application	Part #
400, 428, & 455ci .060" KF	C5778-060
326-455ci .060" HTS w/o EGR	C15197-060

Oil Pan Gasket Kit	
Application	Part #
400, 428, & 455ci 4 pc kit	C5176-094

Exhaust Manifold Gaskets	
Application	Part #
400, 428, & 455ci .064" AM	C5147-064
400, 428, & 455ci D-Port MLS	C5905-030

Water Pump Gasket	
Application	Part #
400, 428, & 455ci .031" Fiber	C5149-031

Gasket Kits



To purchase a complete gasket kit order both top end and bottom end gasket kit

TOP END GASKET KIT



Application	Part #
Big Block 455ci 7.5L 1970-76 4.200" Bore	PRO1010T

BOTTOM END GASKET KIT



Application	Part #
Big Block 455ci 7.5L 1970-76	PRO1010B



Cometic Gasket - An Exclusive NASCAR Performance Product

AUSTIN

1000cc 4 Cylinder 1958-65 Healey Sprite Mark I & II

Head Gasket

Copper Head Gasket

Bore	Thickness	Pkg Qty	Part #
67.5mm	.043"	1	C4145-043

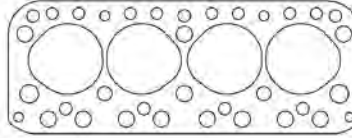

Additional thicknesses available see page 4

1300cc 4 Cylinder Austin Mini

Head Gasket

MLS Head Gasket

Bore	Thickness	Pkg Qty	Part #
73mm	.030"	1	C4146-030

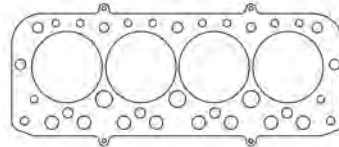

Additional thicknesses available see page 4

BMW

M10 4 Cylinder

Head Gaskets

MLS Head Gasket - 1573/1773cc 1963-77

Bore	Thickness	Pkg Qty	Part #
86mm	.051"	1	C4292-051

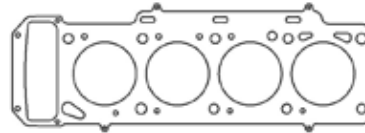

Additional thicknesses available see page 4

MLS Head Gasket - 1766/1990cc M10B18/M10B20 1975-88

Bore	Thickness	Pkg Qty	Part #
90mm	.051"	1	C4293-051

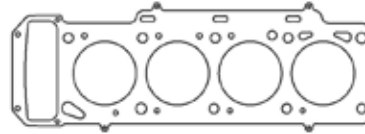

Additional thicknesses available see page 4

Individual Gaskets

Valve Cover Gasket

Application	Part #
BMW M10B18/B20 .125" Cork	C4794-125

Oil Pan Gasket Kit

Application	Part #
BMW M10B18/B20 .062" KF	C4796-062

Intake Manifold Gasket Set

Application	Part #
BMW M10B18/B20 .060" KF	C4793

Rear Main Seal

Application	Part #
BMW M10B18/B20	C4797

Exhaust Manifold Gasket Set

Application	Part #
BMW M10B18/B20 .064" AM	C4883

Thermostat Gasket

Application	Part #
BMW M10B18/B20 .031" Fiber	C4795-031

See page 65 for StreetPro gasket kits



Cometic Gasket - An Exclusive NASCAR Performance Product

BMW

M10 4 Cylinder

Gasket Kits



To purchase a complete gasket kit order both top end and bottom end gasket kit

TOP END GASKET KIT



Application	Part #
M10 1.8/2.0L 1966-88 90mm Bore.....	PRO2027T

BOTTOM END GASKET KIT



Application	Part #
M10 1.8/2.0L 1966-88	PRO2027B

M42 1.8L, M44 1.9L 318is 1989-00, 318ti 1992-00, Z3 1996-01

Head Gaskets

MLS Head Gaskets

Bore	Thickness	Pkg Qty	Part #
85mm060"	1.....	C4348-060
86mm060"	1.....	C4349-060

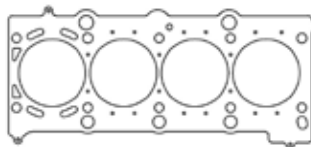

Additional thicknesses available see page 4

S14B20 1990cc 1986-91, S14B23 2302cc 1986-91 M3 86-91, 320is 1988-91

Head Gaskets

MLS Head Gaskets

Bore	Thickness	Pkg Qty	Part #
93.4mm051"	1.....	C4294-051
94.5mm051"	1.....	C4295-051

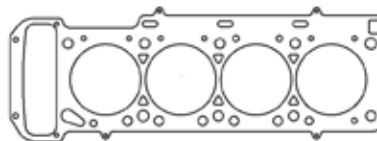

Additional thicknesses available see page 4

M50B20 2.0L 1989-98 320i 1991-95, 520i 1991-95

Head Gasket

MLS Head Gasket

Bore	Thickness	Pkg Qty	Part #
82mm070"	1.....	C4332-070

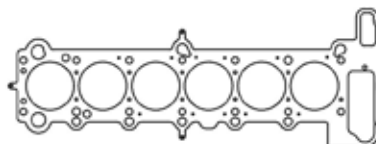

Additional thicknesses available see page 4



Cometic Gasket - An Exclusive NASCAR Performance Product

BMW

M54tuB22 2.2L 1999-Up 320i, 320ci, 520i 00-03, Z3 01-02, Z4 03-Up

Head Gasket

MLS Head Gasket			
Bore	Thickness	Pkg Qty	Part #
81mm	.030"	1	C4351-030

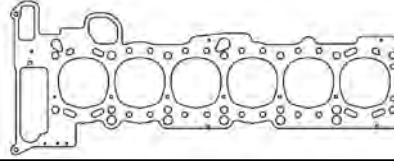

Additional thicknesses available see page 4

M20B20 SOHC 12v 2.0L Inline 6 320 1977-82, 520 1977-81

Head Gasket

MLS Head Gasket			
Bore	Thickness	Pkg Qty	Part #
81mm	.070"	1	C4393-070

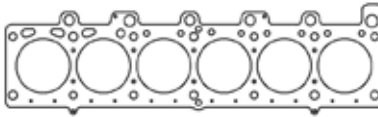

Additional thicknesses available see page 4

M20B25/27 SOHC 12v 2.5/2.7L Inline 6 323i 77-86, Z1 88-93, 525e 83-87, 528e 1981, 325e 83-87

Head Gasket

MLS Head Gasket			
Bore	Thickness	Pkg Qty	Part #
85mm	.070"	1	C4394-070

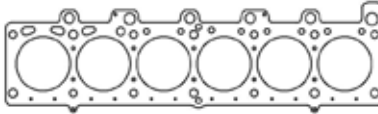

Additional thicknesses available see page 4

Individual Gaskets

Valve Cover Gasket	
Application	Part #
BMW M20 2.5/2.7L .059" CFM	C4800-059

Oil Pan Gasket	
Application	Part #
BMW M20 2.5/2.7L	C4801-060

Intake Manifold Gasket Set	
Application	Part #
325e 1984-87 Small Port	C4884
325/325is 87-93 Normal Ports	C4885

Rear Main Seal	
Application	Part #
BMW M20 2.5/2.7L	C4802

Exhaust Manifold Gasket Set	
Application	Part #
BMW M20 2.5/2.7L .064" AM	C4798-064

Timing Cover Set	
Application	Part #
BMW M20 2.5/2.7L	C4803

Thermostat Gasket	
Application	Part #
BMW M20 2.5/2.7L	C4799

Water Pump Gasket	
Application	Part #
BMW M20 2.5/2.7L .020" Fiber	C4804-020



Cometic Gasket - An Exclusive NASCAR Performance Product

BMW

M20B25/27 SOHC 12v 2.5/2.7L Inline 6 323i 77-86, Z1 88-93, 525e 83-87, 528e 1981, 325e 83-87

Gasket Kits



To purchase a complete gasket kit order both top end and bottom end gasket kit

TOP END GASKET KIT



Application	Part #
BMW M20 2.5/2.7L 85mm Bore	PRO2028T

BOTTOM END GASKET KIT



Application	Part #
M10 1.8/2.0L 1966-88	PRO2027B

M30B25/B28 2.5/2.8L Inline 6, 628Csi 79-81, 525 73-78, 525i 78-81, 525 73-81

Head Gasket

MLS Head Gasket			
Bore	Thickness	Pkg Qty	Part #
88mm070"	1	C4475-070

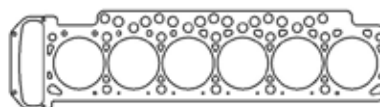

Additional thicknesses available see page 4

M50B25/28 2.5/2.8L Inline 6, 328i 95-00, 528i 95-99, 728i 95-99, Z3 97-99, 325i 91-95, 525i 92-95, 525ix 92-95

Head Gasket

MLS Head Gasket			
Bore	Thickness	Pkg Qty	Part #
85mm070"	1	C4328-070

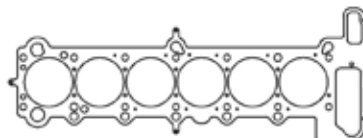

Additional thicknesses available see page 4

M54tuB25/B28 2.5/2.8L & M52B25/M54B30 325i 01-05, 325xi 01-05, 325Ci 01-06, 525i 01-03, Z3 01-06, X5 01-06

Head Gasket

MLS Head Gasket			
Bore	Thickness	Pkg Qty	Part #
85mm030"	1	C4352-030

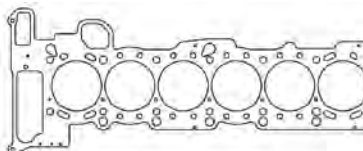

Additional thicknesses available see page 4



Cometic Gasket - An Exclusive NASCAR Performance Product

BMW

M30B30/B32 3.0/3.2L Inline 6 635Csi 76-84, 630Cs 1979, 633Csi 76-79

Head Gasket

MLS Head Gasket			
Bore	Thickness	Pkg Qty	Part #
90mm070"1	C4476-070

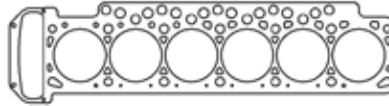

Additional thicknesses available see page 4

S50B30/S52B32 3.0/3.2L Inline 6 (E36) M3 96-99, M Roadster 96-00, M Coupe 96-00 (US Models ONLY)

Head Gasket

MLS Head Gasket			
Bore	Thickness	Pkg Qty	Part #
87mm070"1	C4329-070

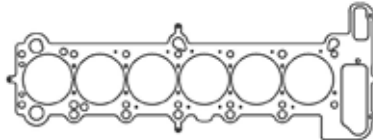

Additional thicknesses available see page 4

S50B30/S52B32 3.0/3.2L Inline 6 (E36) M3 92-00 (Euro Models Only)

Head Gasket

MLS Head Gasket			
Bore	Thickness	Pkg Qty	Part #
87mm070"1	C4508-070

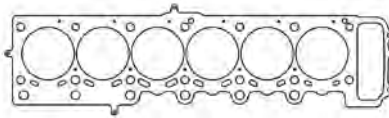

Additional thicknesses available see page 4

S54B32 3.2L Inline 6 M3 (E46) 01-06, Z3 (E36) 01-02, Z4 (E85) 06-Up

Head Gasket

MLS Head Gasket			
Bore	Thickness	Pkg Qty	Part #
87.5mm070"1	C4505-070

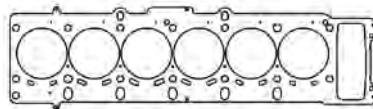

Additional thicknesses available see page 4

M30B34 3.4L Inline 6, 5 Series 85-88, 6 Series 85-87, 7 Series 85-87

Head Gasket

MLS Head Gasket			
Bore	Thickness	Pkg Qty	Part #
93mm070"1	C4477-070

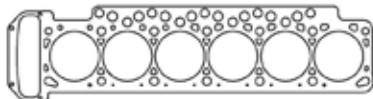

Additional thicknesses available see page 4

S38B35 3.5L Inline 6 M5 84-92, M5i 84-92, M6 84-92

Head Gasket

MLS Head Gasket			
Bore	Thickness	Pkg Qty	Part #
95mm070"1	C4478-070

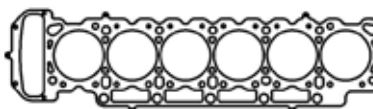

Additional thicknesses available see page 4



Cometic Gasket - An Exclusive NASCAR Performance Product

BMW

S65B40 4.0L V8 M3 (E90, E92, E93) 2007+Up

Head Gaskets

MLS Head Gaskets			
Bore	Thickness	Pkg Qty	Part #
93mm	.027"	1	C5111-027
94mm	.027"	1	C5112-027

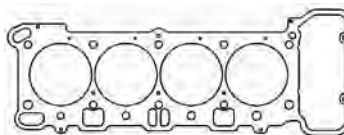

Additional thicknesses available see page 4

N62 4.4L V8 X5 04, 745i 04, 745Ci 04, 545i 04, 645Ci 04

Head Gasket

MLS Head Gasket			
Bore	Thickness	Pkg Qty	Part #
94mm	.027"	1	C4374-027

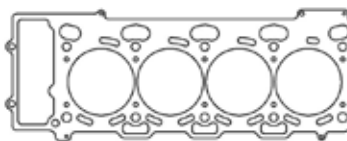

Additional thicknesses available see page 4

S85B50 5.0L V10 M5 05-Up, M6 05-Up

Head Gaskets

MLS Head Gaskets			
Bore	Thickness	Pkg Qty	Part #
93mm	.027"	1	C4528-027
94.5mm	.027"	1	C4529-027

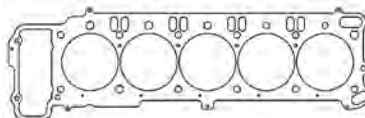

Additional thicknesses available see page 4

COVENTRY CLIMAX

FWA SOHC 1.1L 1098cc

Head Gasket

CFM-20 Head Gasket			
Bore	Thickness	Pkg Qty	Part #
74mm	.059"	1	C4301-059

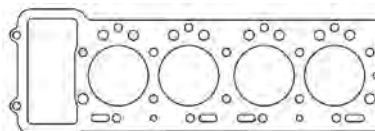

Additional thicknesses available see page 4

FWB/FWE SOHC 1.2L & 1.5L

Head Gasket

CFM-20 Head Gasket			
Bore	Thickness	Pkg Qty	Part #
78mm	.043"	1	C4139-043

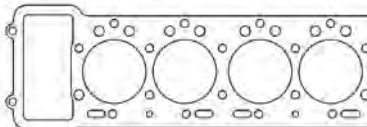

Additional thicknesses available see page 4

FWA/FWB/FWE SOHC 2.0L

Head Gasket

CFM-20 Head Gasket			
Bore	Thickness	Pkg Qty	Part #
80mm	.043"	1	C4229-043

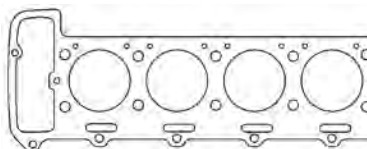

Additional thicknesses available see page 4



Cometic Gasket - An Exclusive NASCAR Performance Product

COVENTRY CLIMAX

FPF DOHC 2.0L

Head Gasket

CFM-20 Head Gasket

Bore	Thickness	Pkg Qty	Part #
82mm	.059"	1	C4267-059

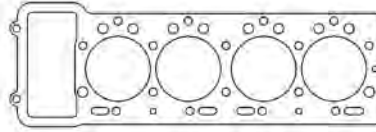

Additional thicknesses available see page 4

FERRARI

308 V8 2v 1974-81

Head Gaskets

MLS Head Gaskets

Bore	Thickness	Pkg Qty	Part #
81mm	.045"	1	C4430-045
89mm	.045"	1	C4395-045

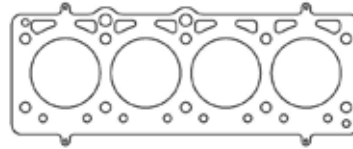

Additional thicknesses available see page 4

308 V8 4v 1982-84

Head Gaskets

MLS Head Gaskets

Bore	Thickness	Pkg Qty	Part #
83mm	.045"	1	C4428-045
89mm	.045"	1	C4429-045

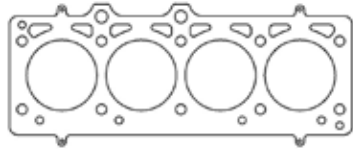

Additional thicknesses available see page 4

F40 2.9L Twin Turbo V8 1987-92

Head Gasket

MLS Head Gasket

Bore	Thickness	Pkg Qty	Part #
84mm	.060"	1	C4482-060

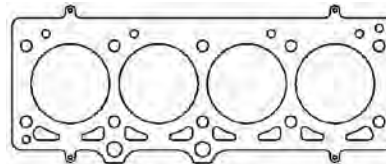

Additional thicknesses available see page 4

FIAT / LANCIA

138.A2 1.5L 1498cc 14 Bolt Head:1986-88 X1/9

Head Gasket

MLS Head Gasket

Bore	Thickness	Pkg Qty	Part #
88mm	.044"	1	C4952-044

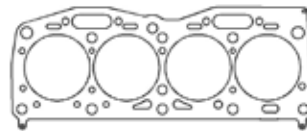

Additional thicknesses available see page 4

D50

Head Gasket

CFM-20 Head Gasket

Bore	Thickness	Pkg Qty	Part #
79mm	.059"	1	C4131-059

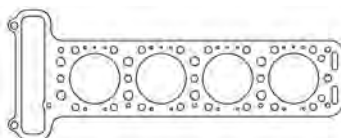

Additional thicknesses available see page 4



Cometic Gasket - An Exclusive NASCAR Performance Product

FIAT / LANCIA

D50 Long Block

Head Gasket

CFM-20 Head Gasket			
Bore	Thickness	Pkg Qty	Part #
79mm	.059"	1	C4307-059

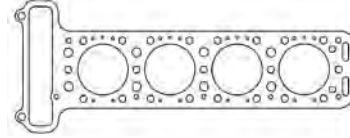

Additional thicknesses available
see page 4

Lancia Delta

Head Gasket

MLS Head Gasket			
Bore	Thickness	Pkg Qty	Part #
85mm	.040"	1	C4124-040

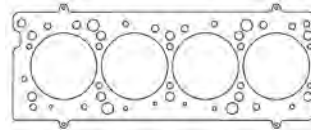

Additional thicknesses available
see page 4

FORD / LOTUS

1.6L Sigma 2011-16

Head Gasket

MLx Head Gasket			
Bore	Thickness	Pkg Qty	Part #
82mm	.028"	1	C4963-028

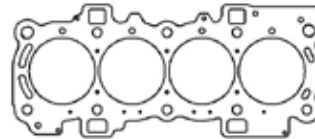

Additional thicknesses available
see page 4

1.7L Zetec-S 1997-02 Puma

Head Gasket

MLS Head Gasket			
Bore	Thickness	Pkg Qty	Part #
83mm	.010"	1	C4223-010

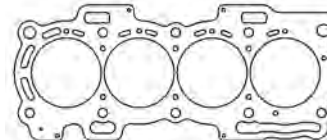

Additional thicknesses available
see page 4

2.0L SOHC/DOHC NEP/YB Group A

Head Gasket

MLS Head Gasket			
Bore	Thickness	Pkg Qty	Part #
92.5mm	.040"	1	C4218-040

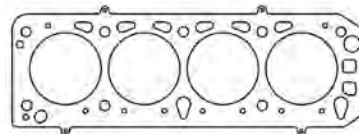

Additional thicknesses available
see page 4

Individual Gaskets

Intake Gasket Set	
Application	Part #
Cosworth YB	C4502

Oil Pan Gasket	
Application	Part #
Cosworth YB Rails only	C4640

Exhaust Manifold Gasket Set	
Application	Part #
Cosworth YB	C4334

Front Cover Gasket	
Application	Part #
Cosworth YB	C4641

See page 72 for additional gaskets



Cometic Gasket - An Exclusive NASCAR Performance Product

FORD / LOTUS

2.0L SOHC/DOHC NEP/YB Group A

Valve Cover Gaskets	
Application	Part #
Early YB Engine - .060" AFM.....	C4635
Late YB Engine - .060" AFM.....	C4636

Cooling/Water Pump Gasket	
Application	Part #
Water Pump Gasket	C4637
Water Outlet Gasket.....	C4638
Thermostat Gasket.....	C4639

Cosworth Ford 4cyl - BDG Belt Driven

Head Gasket

MLS Head Gasket			
Bore	Thickness	Pkg Qty	Part #
91mm040"	1.....	C4494-040

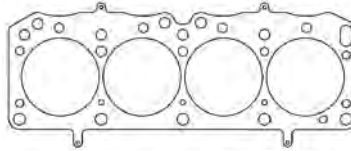

Additional thicknesses available see page 4

Individual Gaskets

Valve Cover Gasket	
Application	Part #
BDG - Belt Driven .060" AFM	C4886

Cosworth Ford 4cyl - FVA 1.6L/FVC 1.8L Gear Driven

Head Gaskets

MLS Head Gaskets			
Bore	Thickness	Pkg Qty	Part #
87mm040"	1.....	C4138-040
88mm040"	1.....	C4135-040

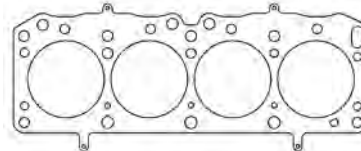

Additional thicknesses available see page 4

Individual Gaskets

Valve Cover Gasket	
Application	Part #
FVA/FVC .060" AFM	C4887

Oil Pan Gasket	
Application	Part #
FVA/FVC .060" AFM (Rails only).....	C4891

Exhaust Gasket Set	
Application	Part #
FVA/FVC .064" AM (4 Pack).....	C4888

Rear Cover Gasket	
Application	Part #
FVA/FVC .060" AFM.....	C4892

Thermostat Housing Gasket	
Application	Part #
FVA/FVC .060" AFM	C4889

Oil Pump Gasket	
Application	Part #
FVA/FVC .060" AFM	C4893

Front Cylinder Head Cover Gasket	
Application	Part #
FVA/FVC .060" AFM	C4890

Front Lower Cover Gasket	
Application	Part #
FVA/FVC .012" Fiber	C4894



Cometic Gasket - An Exclusive NASCAR Performance Product

FORD / LOTUS

Cosworth Ford 4cyl 1.1-2.0L - BDA Series/Lotus Twin Cam, All Pushrod, Chain, & Belt Driven

Head Gaskets

MLS Head Gaskets			
Bore	Thickness	Pkg Qty	Part #
82mm	.040"	1	C4102-040
83mm	.040"	1	C4103-040
84mm	.040"	1	C4140-040
85mm	.040"	1	C4133-040
86mm	.040"	1	C4142-040
87mm	.040"	1	C4143-040

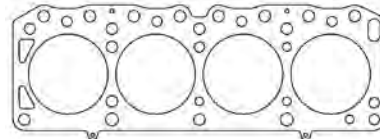

Additional thicknesses available see page 4

Individual Gaskets

Valve Cover Gaskets	
Application	Part #
Lotus Twin Cam Chain Driven	C4895
BDA Belt Driven .060" AFM	C4896

Oil Pan Gasket	
Application	Part #
BDA Series .060" AFM (Rails only)	C4891

Exhaust Gasket Sets	
Application	Part #
Lotus Twin Cam 2 Bolt (4pk)	C4355-064
BDA 4 Bolt (4pk)	C4353-064
BDA 3 Bolt (4pk)	C4354-064

Rear Cover Gasket	
Application	Part #
FBDA Series .060" AFM	C4892

Intake Gasket Set	
Application	Part #
BDA Series	C4897

Oil Pump Gasket	
Application	Part #
BDA Series .060" AFM	C4893

Thermostat Housing Gasket	
Application	Part #
BDA Series .060" AFM	C4889

Front Lower Cover Gasket	
Application	Part #
BDA Series .012" Fiber	C4894

2.0L ZETEC DOHC 4cyl 1995-04

Head Gasket

MLS Head Gasket			
Bore	Thickness	Pkg Qty	Part #
87mm	.027"	1	C4279-027

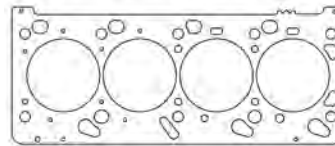

Additional thicknesses available see page 4

Individual Gaskets

Valve Cover Gaskets	
Application	Part #
2.0L Zetec DOHC 1995-97	C4643
2.0L Zetec DOHC 1998-04	C4644

Valve Stem Seals	
Application	Part #
2.0L Zetec 1995-97 (16pk)	3181V-16
2.0L Zetec 1998-04 (16pk)	3182V-16

Exhaust Gasket Sets	
Application	Part #
2.0L Zetec 1994-04	C4645

Oil Pan Gasket	
Application	Part #
2.0L Zetec 1995-04	C4649

See page 74 for additional gaskets



Cometic Gasket - An Exclusive NASCAR Performance Product

FORD / LOTUS

2.0L ZETEC DOHC 4cyl 1995-04

Individual Gaskets

Intake Gasket Set

Application	Part #
2.0L Zetec 1998-04	C4646
2.0L Zetec 1995-97	C4647

Thermostat Gaskets

Application	Part #
2.0L Zetec 1995-04 - Seal	C4651
2.0L Zetec 1995-04 - Housing	C4652

Cam Seal Set

Application	Part #
2.0L Zetec 1994-04	C4648

Rear Main Seal Set

Application	Part #
2.0L Zetec 1995-04	C4650

Gasket Kits



To purchase a complete gasket kit order both top end and bottom end gasket kit

TOP END GASKET KITS



Application	Part #
2.0L Zetec DOHC 1995-97 87mm Bore	PRO2029T
2.0L Zetec DOHC 1998-04 87mm Bore	PRO2030T

BOTTOM END GASKET KITS



Application	Part #
2.0L Zetec DOHC 1995-97	PRO2029B
2.0L Zetec DOHC 1998-04	PRO2030B

2.3L "2300" SOHC 1974-97 4cyl

Head Gaskets

MLS Head Gaskets

Bore	Thickness	Pkg Qty	Part #
3.830"	.040"	1	C5369-040
3.940"	.040"	1	C5709-040

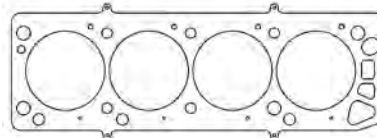

Additional thicknesses available see page 4

Individual Gaskets

Valve Cover Gasket

Application	Part #
2300 2.3L 1974-93	C4653

Oil Pan Gaskets

Application	Part #
2300 2.3L 1974-2/19/86	C5373
2300 2.3L 2/20/86-1990	C4669
2300 2.3L 1991-92	C4741
2300 2.3L 1993	C4778

Exhaust Gasket Set

Application	Part #
2300 2.3L 1974-93	C5372-064

Intake Gasket

Application	Part #
2300 2.3L	C5371-060

Rear Main Seal Sets

Application	Part #
2300 2.3L 1974-81 2pc	C5688
2300 2.3L 1982-93 1pc	C5189

Valve Stem Seals

Application	Part #
2300 2.3L 1974-93 (need 8)	3168V

Water Pump Gasket

Application	Part #
2300 2.3L 1974-93	C4654

See page 75 for StreetPro gasket kits



Cometic Gasket - An Exclusive NASCAR Performance Product

FORD / LOTUS

2.3L "2300" SOHC 1974-97 4cyl

Gasket Kits



To purchase a complete gasket kit order both top end and bottom end gasket kit

TOP END GASKET KIT



Application	Part #
2300 2.3L 1974-97 3.830" Bore.....	PRO2031T

BOTTOM END GASKET KIT



Application	Part #
2300 2.3L 1974-97	PRO2031B

2.0L 2003-11 & 2.3L 2003-08 Duratec DOHC

Head Gaskets

MLS Head Gaskets

Bore	Thickness	Pkg Qty	Part #
89.5mm.....	.018"	1.....	C5843-018
92mm.....	.018"	1.....	C5842-018

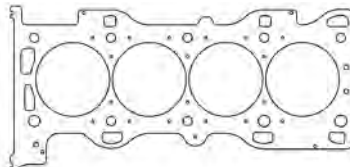

Additional thicknesses available see page 4

Individual Gaskets

Intake Gasket

Application	Part #
2.3L Duratec 2003-08.....	C4842-060

Exhaust Manifold Gaskets

Application	Part #
2.3L Duratec (w/ extra port).....	C4840-064
2.3L Duratec (w/o extra port).....	C4841-064

2.5L Duratec DOHC 2009 - Present

Head Gasket

MLS Head Gasket

Bore	Thickness	Pkg Qty	Part #
90mm.....	.040"	1.....	C5906-040

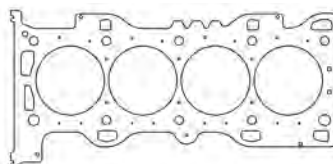

Additional thicknesses available see page 4



Cometic Gasket - An Exclusive NASCAR Performance Product

CHEVROLET / GM

ECOTEC 4 Cylinder

Head Gaskets

MLS Head Gasket - LSJ 2.0L

Bore	Thickness	Pkg Qty	Part #
87mm027"1	C5921-027

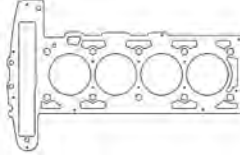

Additional thicknesses available see page 4

MLx Head Gasket - LSJ 2.0L

Bore	Thickness	Pkg Qty	Part #
87mm040"1	C5032-040

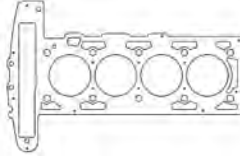

MLx Head Gasket - LNF 2.0L 08-10

Bore	Thickness	Pkg Qty	Part #
88mm032"1	C15256-032

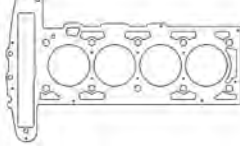

MLx Head Gasket - LTG 2.0L DOHC

Bore	Thickness	Pkg Qty	Part #
87mm028"1	C4964-028

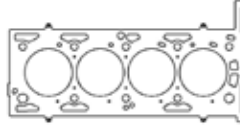

MLS Head Gaskets - L61/L42 2.2L DOHC

Bore	Thickness	Pkg Qty	Part #
87mm040"1	C5768-040
89mm040"1	C5804-040

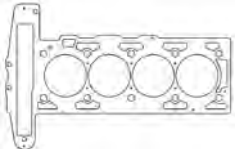

Individual Gaskets

MLS Exhaust Gasket

Application	Part #
2000-2009 2.2/2.4L	C4150-030

2.2L 134ci "LN2": Cavalier/Sunfire FWD 1998-02, S-10/Sonoma RWD 1994-03

Head Gaskets

MLS Head Gaskets

Bore	Thickness	Pkg Qty	Part #
90mm030"1	C5914-030
93mm030"1	C5915-030

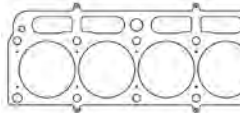

Additional thicknesses available see page 4

2.4L 146ci "LD9" Twin Cam 1996-2001

Head Gaskets

MLS Head Gasket - 1996-99 w/EGR

Bore	Thickness	Pkg Qty	Part #
3.595"030"1	C5298-030

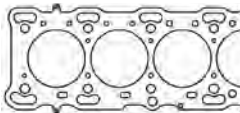

Additional thicknesses available see page 4

MLS Head Gaskets - 1999-01 w/o EGR

Bore	Thickness	Pkg Qty	Part #
3.595"030"1	C5866-030
3.595"075"1	C5866-075

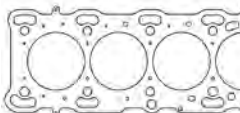



Cometic Gasket - An Exclusive NASCAR Performance Product

HONDA

D15B1/B2/B7 1988-95, D16A6/A7 1988-91 SOHC

Head Gaskets

MLS Head Gaskets			
Bore	Thickness	Pkg Qty	Part #
75.5mm	.030"	1	C4117-030
76mm	.030"	1	C4118-030
77mm	.030"	1	C4119-030
78mm	.030"	1	C4120-030
79mm	.030"	1	C4121-030

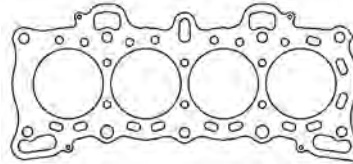

Additional thicknesses available see page 4

Individual Gaskets

Valve Cover Gasket Set	
Application	Part #
D15B1/B2/B7, D16A6/A7	C4701

Oil Pan Gasket	
Application	Part #
D15B1/B2/B7, D16A6/A7	C4660

Intake Gasket	
Application	Part #
D15B1/B2/B7, D16A6/A7	C4702-060

Rear Main Seal Set	
Application	Part #
D15B1/B2/B7, D16A6/A7	C4663

Exhaust Manifold Gasket	
Application	Part #
D15B1/B2/B7, D16A6/A7 - MLS	C4164-030

Front Crank/Oil Pump Seal	
Application	Part #
D15B1/B2/B7, D16A6/A7	C4664

Valve Stem Seals (sold individually)	
Application	Part #
D15B1/B2/B7, D16A6/A7	3170V

Timing Cover Dust Seal Sets	
Application	Part #
D15B1/B2/B7, D16A6/A7 - Lower	C4661
D15B1/B2/B7, D16A6/A8 - Upper	C4898

Cam Seal	
Application	Part #
D15B1/B2/B7, D16A6/A7	C4703

Thermostat Seal Set	
Application	Part #
D15B1/B2/B7, D16A6/A7	C4704

Water Pump Mounting O-ring	
Application	Part #
D15B1/B2/B7, D16A6/A7	C4700

Gasket Kits



To purchase a complete gasket kit order both top end and bottom end gasket kit

TOP END GASKET KITS



Application	Part #
D15B1/B2/B7 88-95 76mm Bore	PRO2032T
D16A6/A7 88-91 76mm Bore	PRO2034T

BOTTOM END GASKET KIT



Application	Part #
D15B1/B2/B7, D16A6/A7	PRO2032B



Cometic Gasket - An Exclusive NASCAR Performance Product

HONDA

D16A1/A9 DOHC 1986-89

Head Gaskets

MLS Head Gaskets			
Bore	Thickness	Pkg Qty	Part #
75.5mm	.030"	1	C4522-030
76mm	.030"	1	C4524-030
77mm	.030"	1	C4525-030
78mm	.030"	1	C4526-030

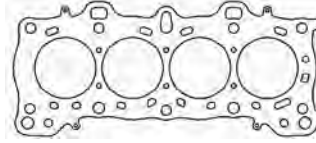

Additional thicknesses available see page 4

Individual Gaskets

Valve Cover Gasket Set	
Application	Part #
D16A1/A9 1986-89	C4706

Oil Pan Gasket	
Application	Part #
D16A1/A9 1986-89	C4660

Intake Gasket	
Application	Part #
D16A1/A9 1986-89	C4707-046

Rear Main Seal Set	
Application	Part #
D16A1/A9 1986-89	C4663

Exhaust Manifold Gasket	
Application	Part #
D16A1/A9 1986-89	C4708

Front Crank/Oil Pump Seal	
Application	Part #
D16A1/A9 1986-89	C4664

Valve Stem Seals (sold individually)	
Application	Part #
D16A1/A9 1986-89	3177V

Water Pump Mounting O-ring	
Application	Part #
D16A1/A9 1986-89	C4700

Cam Seal	
Application	Part #
D16A1/A9 1986-89	C4709

Thermostat Seal	
Application	Part #
D16A1/A9 1986-89	C4710

Gasket Kits



To purchase a complete gasket kit order both top end and bottom end gasket kit

TOP END GASKET KIT



Application	Part #
D16A1/A9 1986-89 76mm Bore	PRO2033T

BOTTOM END GASKET KIT



Application	Part #
D16A1/A9 1986-89	PRO2033B



Cometic Gasket - An Exclusive NASCAR Performance Product

HONDA

D16Z6, D16Y5/Y7/Y8, D15Z1 1992-00 SOHC

Head Gaskets

MLS Head Gaskets			
Bore	Thickness	Pkg Qty	Part #
75.5mm	.030"	1	C4251-030
76mm	.030"	1	C4195-030
77mm	.030"	1	C4196-030
78mm	.030"	1	C4167-030
79mm	.030"	1	C4197-030

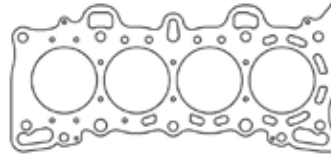

Additional thicknesses available see page 4

Individual Gaskets

Valve Cover Gasket Sets	
Application	Part #
D16Z6 1992-95	C4655
D16Y5/Y7/Y8 1996-00	C4665

Throttle Body Gaskets	
Application	Part #
D16Z6 1992-95	C4657-032
D16Y5/Y7/Y8 1996-00	C4667-032

Intake Gaskets	
Application	Part #
D16Z6 1992-95	C4702-060
D16Y5/Y7/Y8 1996-00	C4666

Oil Pan Gaskets	
Application	Part #
D16Z6 1992-95	C4660
D16Y5/Y8 1996-00	C4670
D16Y7 1996-00	C4899

Exhaust Manifold Gasket	
Application	Part #
D16Z6, D16Y5/Y7/Y8 - MLS	C4164-030

Rear Main Seal Set	
Application	Part #
D16Z6, D16Y5/Y7/Y8	C4663

Valve Stem Seals (sold individually)	
Application	Part #
D16Z6, D16Y5/Y7/Y8	3170V

Front Crank/Oil Pump Seal	
Application	Part #
D16Z6, D16Y5/Y7/Y8	C4664

Cam Seal	
Application	Part #
D16Z6, D16Y5/Y7/Y8	C4658

Timing Cover Dust Seal Set	
Application	Part #
D16Z6, D16Y5/Y7/Y8 - Lower	C4661

Thermostat Seal	
Application	Part #
D16Z6, D16Y5/Y7/Y8	C4659

Water Pump Mounting O-ring	
Application	Part #
D16Z6, D16Y5/Y7/Y8	C4662

Gasket Kits



To purchase a complete gasket kit order both top end and bottom end gasket kit

TOP END GASKET KITS



Application	Part #
D16Z6 1992-95 76mm Bore	PRO2000T
D16Y5/Y7/Y8 1996-00 76mm Bore	PRO2001T

BOTTOM END GASKET KIT



Application	Part #
D16Z6 1992-95	PRO2000B
D16Y5/Y7/Y8 1996-00	PRO2001B



Cometic Gasket - An Exclusive NASCAR Performance Product

HONDA

D17A1, A2, A6 1.7L SOHC 2001-05

Head Gaskets

MLS Head Gaskets

Bore	Thickness	Pkg Qty	Part #
76mm	.027"	1	C4474-027
77mm	.027"	1	C4473-027
78mm	.027"	1	C4472-027
79mm	.027"	1	C4471-027

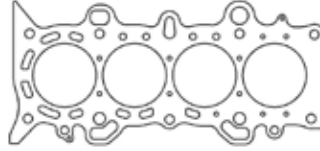

Additional thicknesses available
see page 4

Individual Gaskets

Valve Stem Seals (sold individually)

Application	Part #
D17A1/A2/A6	3170V

Rear Main Seal

Application	Part #
D17A1/A2/A6	C4678

Cam Seal

Application	Part #
D17A1/A2/A6	C4658

Water Pump Mounting O-ring

Application	Part #
D17A1/A2/A6	C4662

B16A2/A3, B18C1/C5 1.6/1.8L DOHC VTEC

Head Gaskets

MLS Head Gaskets

Bore	Thickness	Pkg Qty	Part #
81mm	.030"	1	C4231-030
81.5mm	.030"	1	C4232-030
82mm	.030"	1	C4168-030
83mm	.030"	1	C4189-030
84mm	.030"	1	C4188-030

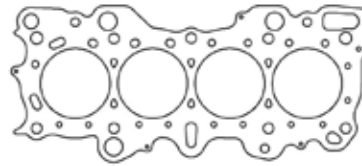

Additional thicknesses available
see page 4

Individual Gaskets

Valve Cover Gasket Set

Application	Part #
B16A2/A3 & B18C1/C5	C4628

Thermostat Seal

Application	Part #
B16A2/A3 & B18C1/C5	C4659

Intake Gaskets

Application	Part #
B16A2/A3 & B18C5	C4671-060
B18C1	C4674

Throttle Body Gaskets

Application	Part #
B16A3/B18C1 94-95	C4672-032
B16A2/B18C1/C5 96-01	C4656-032

Exhaust Manifold Gasket

Application	Part #
B16A2/A3 & B18C1/C5 - MLS	C4151-030

Oil Pan Gasket

Application	Part #
B16A2/A3 & B18C1/C5	C4676

Valve Stem Seals (sold individually)

Application	Part #
D16Z6, D16Y5/Y7/Y8	3170V

Rear Main Seal

Application	Part #
B16A2/A3 & B18C1/C5	C4678

Cam Seal Set

Application	Part #
B16A2/A3 & B18C1/C5	C4675

Water Pump Mounting O-ring

Application	Part #
B16A2/A3 & B18C1/C5	C4677

See page 81 for StreetPro gasket kits



Cometic Gasket - An Exclusive NASCAR Performance Product

HONDA

B16A2/A3, B18C1/C5 1.6/1.8L DOHC VTEC

Gasket Kits



To purchase a complete gasket kit order both top end and bottom end gasket kit

TOP END GASKET KIT



Application	Part #
B16A2/A3, B18C5 82mm Bore.....	PRO2002T
B18C1 GS-R 82mm Bore.....	PRO2003T

BOTTOM END GASKET KIT



Application	Part #
B16A2/A3, B18C1/C5.....	PRO2003B1

B18A1/B18B1 1.8L DOHC non-VTEC 1990-01

Head Gaskets

MLS Head Gaskets

Bore	Thickness	Pkg Qty	Part #
81mm	.030"	1	C4238-030
81.5mm	.030"	1	C4239-030
82mm	.030"	1	C4173-030
83mm	.030"	1	C4181-030
84mm	.030"	1	C4180-030
85mm	.030"	1	C4175-030

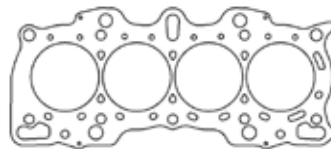

Additional thicknesses available see page 4

Individual Gaskets

Valve Cover Gasket Set	
Application	Part #
B18A1/B1	C4679

Throttle Body Gasket	
Application	Part #
B18A1/B1	C4681

Intake Gasket	
Application	Part #
B18A1/B1 .094" KF.....	C4680-094

Thermostat Seal	
Application	Part #
B18A1/B1	C4659

Exhaust Manifold Gasket	
Application	Part #
B18A1/B1 - .030" MLS.....	C4151-030

Oil Pan Gasket Set	
Application	Part #
B18A1/B1	C4676

Valve Stem Seals (sold individually)	
Application	Part #
B18A1/B1	3177V

Rear Main Seal Set	
Application	Part #
B18A1/B1	C4678

Cam Seal Set	
Application	Part #
B18A1/B1	C4709

Water Pump Mounting O-ring	
Application	Part #
B18A1/B1	C4677

See page 82 for StreetPro gasket kits



Cometic Gasket - An Exclusive NASCAR Performance Product

HONDA

B18A1/B18B1 1.8L DOHC non-VTEC 1990-01

Gasket Kits



To purchase a complete gasket kit order both top end and bottom end gasket kit

TOP END GASKET KIT



Application	Part #
B18A1/B1 1990-01 82mm Bore.....	PRO2004T

BOTTOM END GASKET KIT



Application	Part #
B18A1/B1 1990-01	PRO2004B

B Series Hybrid (VTEC Head/non-VTEC Block)

Head Gaskets

MLS Head Gaskets

Bore	Thickness	Pkg Qty	Part #
81mm	.030"	1	C4237-030
81.5mm	.030"	1	C4236-030
82mm	.030"	1	C4191-030
83mm	.030"	1	C4192-030
84mm	.030"	1	C4193-030
84.5mm	.030"	1	C4241-030
85mm	.030"	1	C4194-030

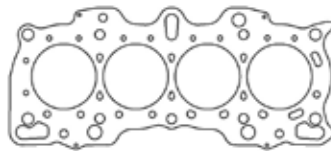

Additional thicknesses available see page 4

Individual Gaskets

Valve Cover Gasket Set

Application	Part #
B16A2/A3 & B18C1/C5	C4628

Thermostat Seal

Application	Part #
B Series	C4659

Intake Gaskets

Application	Part #
B16A2/A3 & B18C5	C4674
B18C1	C4671-060

Throttle Body Gaskets

Application	Part #
B16A3/B18C1 94-95.....	C4672-032
B16A2/B18C1/C5 96-01.....	C4656-032

Exhaust Manifold Gasket

Application	Part #
B16A2/A3 & B18C1/C5 - MLS.....	C4151-030

Oil Pan Gasket Set

Application	Part #
B Series	C4676

Valve Stem Seals (sold individually)

Application	Part #
B16A2/A3 & B18C1/C5	3170V

Rear Main Seal Set

Application	Part #
B Series	C4678

Cam Seal Set

Application	Part #
D16A1/A9 1986-89	C4709

Water Pump Mounting O-ring

Application	Part #
B Series	C4677

See page 83 for StreetPro gasket kits



Cometic Gasket - An Exclusive NASCAR Performance Product

HONDA

B Series Hybrid (VTEC Head/non-VTEC Block)

Gasket Kits



To purchase a complete gasket kit order both top end and bottom end gasket kit

TOP END GASKET KITS



Application	Part #
B20 w/B18C1 Head (GS-R) 84.5mm Bore	PRO2049T
B20 w/B16A2/A3/B18C5 Head 84.5mm Bore ..	PRO2050T

BOTTOM END GASKET KIT



Application	Part #
B Series	PRO2004B

B20B4, B20Z2 2.0L DOHC non-VTEC 1997-01

Head Gasket

MLS Head Gasket			
Bore	Thickness	Pkg Qty	Part #
85mm030"	1	C4250-030

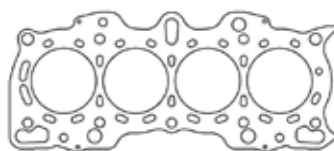

Additional thicknesses available see page 4

Individual Gaskets

Valve Cover Gasket Set	
Application	Part #
B20B4, B20Z2	C4679

Thermostat Seal	
Application	Part #
B20B4, B20Z2	C4659

Intake Gasket	
Application	Part #
B20B4, B20Z2 .094" KF	C4680-094

Oil Pan Gasket Set	
Application	Part #
B18A1/B1	C4676

Exhaust Manifold Gasket	
Application	Part #
B20B4, B20Z2 - .030" MLS	C4151-030

Rear Main Seal	
Application	Part #
B20B4, B20Z2	C4678

Valve Stem Seals (sold individually)	
Application	Part #
B20B4, B20Z2	3177V

Water Pump Mounting O-ring	
Application	Part #
B20B4, B20Z2	C4677

Cam Seal Set	
Application	Part #
B20B4, B20Z2	C4709

See page 84 for StreetPro gasket kits



Cometic Gasket - An Exclusive NASCAR Performance Product

HONDA

B20B4, B20Z2 2.0L DOHC non-VTEC 1997-01

Gasket Kits



To purchase a complete gasket kit order both top end and bottom end gasket kit

TOP END GASKET KIT



Application: B20B4, B20Z2 85mm Bore
Part #: PRO2035T

BOTTOM END GASKET KIT



Application: B Series
Part #: PRO2004B

B20A5 2.0L 1988-91

Head Gaskets

MLS Head Gaskets

Bore	Thickness	Pkg Qty	Part #
81.5mm	.045"	1	C4564-045
82mm	.045"	1	C4565-045
83mm	.045"	1	C4566-045
84mm	.045"	1	C4567-045

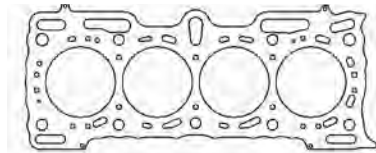

Additional thicknesses available see page 4

F20B 2.0L DOHC 1997-01

Head Gasket

MLS Head Gasket

Bore	Thickness	Pkg Qty	Part #
86mm	.027"	1	C4634-027

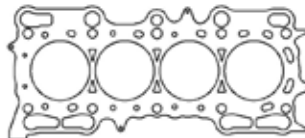

Additional thicknesses available see page 4

B21A1 2.1L 1990-91

Head Gaskets

MLS Head Gaskets

Bore	Thickness	Pkg Qty	Part #
83mm	.045"	1	C4585-045
84mm	.045"	1	C4586-045

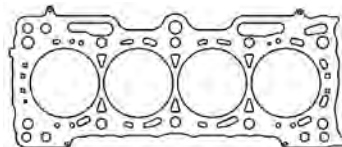

Additional thicknesses available see page 4



Cometic Gasket - An Exclusive NASCAR Performance Product

HONDA

K20A1, K20A2, K20A3 2.0L 2001+, K24A 2.4L 2003+

Head Gaskets

MLS Head Gaskets

Bore	Thickness	Pkg Qty	Part #
86mm	.030"	1	C4300-030
87mm	.030"	1	C4311-030
88mm	.030"	1	C4312-030
89mm	.030"	1	C4313-030

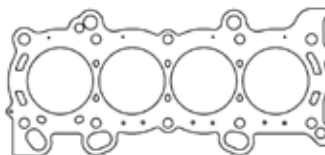

Additional thicknesses available see page 4

MLx Head Gaskets

Bore	Thickness	Pkg Qty	Part #
89mm	.032"	1	C4596-032

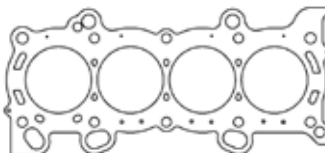

Additional thicknesses available see page 4

Individual Gaskets

Exhaust Manifold Gaskets

Application	Part #
K20A1/A3 2002-04 - MLS	C4160-030
K20A2 - MLS	C4162-030

Rear Main Seal

Application	Part #
K-Series 2002+	C4705

Intake Gasket

Application	Part #
K20A2/A3 2001+	C4668

K20Z3 2.0L 2006-09

Head Gaskets

MLS Head Gaskets

Bore	Thickness	Pkg Qty	Part #
86mm	.030"	1	C4561-030
87mm	.030"	1	C4562-030

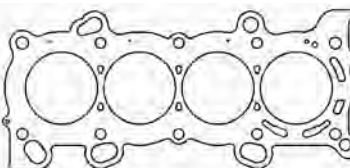

Additional thicknesses available see page 4

Individual Gaskets

Rear Main Seal

Application	Part #
K-Series 2002+	C4705

K24Z2/K24Z7 2.4L 2012+

Head Gaskets

MLS Head Gaskets

Bore	Thickness	Pkg Qty	Part #
87mm	.030"	1	C4594-030
89mm	.030"	1	C4595-030

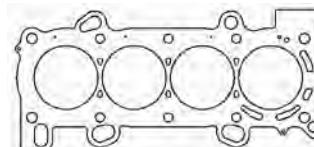

Additional thicknesses available see page 4

Individual Gaskets

Rear Main Seal

Application	Part #
K-Series 2002+	C4705



Cometic Gasket - An Exclusive NASCAR Performance Product

HONDA

H22A1/H22A2 2.2L DOHC VTEC 1992-96

Head Gaskets

MLS Head Gaskets

Bore	Thickness	Pkg Qty	Part #
87mm	.030"	1	C4255-030
88mm	.030"	1	C4198-030
89mm	0.03	1	C4185-030

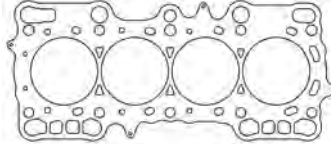

Additional thicknesses available
see page 4

Individual Gaskets

Exhaust Manifold Gasket

Application	Part #
H22A1/H22A2 - MLS	C4155-030

Water Pump Gasket

Application	Part #
H22A1/H22A2	C4244

Valve Stem Seals (sold individually)

Application	Part #
H22A1/H22A2	3170V

Oil Pan Gasket Set

Application	Part #
H22A1/H22A2	C4158

Thermostat Seal

Application	Part #
H22A1/H22A2	C4659

Rear Main Seal

Application	Part #
H22A1/H22A2	C4678

H22A4 1997-01, H22A7 1998-03 2.2L DOHC

Head Gaskets

MLS Head Gaskets

Bore	Thickness	Pkg Qty	Part #
87mm	.030"	1	C4252-030
88mm	.030"	1	C4253-030
89mm	.030"	1	C4254-030

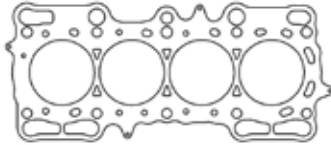

Additional thicknesses available
see page 4

Individual Gaskets

Exhaust Manifold Gasket

Application	Part #
H22A4/H22A7 - MLS	C4155-030

Water Pump Gasket

Application	Part #
H22A4/H22A7	C4244

Valve Stem Seals (sold individually)

Application	Part #
H22A4/H22A7	3170V

Oil Pan Gasket Set

Application	Part #
H22A4/H22A7	C4158

Thermostat Seal

Application	Part #
H22A4/H22A7	C4659

Rear Main Seal

Application	Part #
H22A4/H22A7	C4678

H23A1 2.3L DOHC VTEC 1992-96

Head Gaskets

MLS Head Gaskets

Bore	Thickness	Pkg Qty	Part #
87.5mm	.030"	1	C4553-030
88mm	.030"	1	C4554-030
89mm	0.03	1	C4555-030

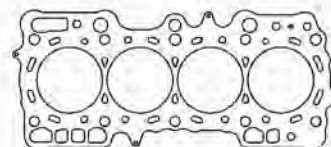

Additional thicknesses available
see page 4



Cometic Gasket - An Exclusive NASCAR Performance Product

HONDA

F22B1/B4/B5/B8 2.2L SOHC 1994-97, *F23A1 1998-02

Head Gaskets

MLS Head Gaskets

Bore	Thickness	Pkg Qty	Part #
86mm	.027"	1	C4618-027
87mm	.027"	1	C4619-027
88mm	.027"	1	C4620-027
89mm	.027"	1	C4621-027

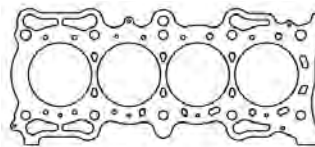

Additional thicknesses available see page 4

Individual Gaskets

Exhaust Manifold Gasket

Application	Part #
F22B1/F23A1 1994-01 .064" AM.....	C4190-064

F20C1/C2, F22C1 2.0/2.2L DOHC VTEC 1999-09

Head Gaskets

MLS Head Gaskets

Bore	Thickness	Pkg Qty	Part #
87.5mm	.030"	1	C4625-030
88mm	.030"	1	C4626-030
88.5mm	.030"	1	C4627-030
89mm	.030"	1	C4335-030

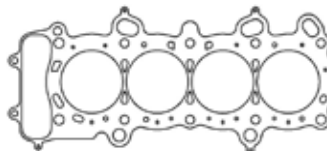

Additional thicknesses available see page 4

Individual Gaskets

Exhaust Manifold Gasket

Application	Part #
F20C1/C2 99-09 - MLS	C4159-030

C30A1, C32B1 DOHC 3.0/3.2L V6 1991-05

Head Gaskets

MLS Head Gaskets

Bore	Thickness	Pkg Qty	Part #
91mm	.030"	1	C4550-030
93mm	.030"	1	C4551-030
95mm	.030"	1	C4277-030

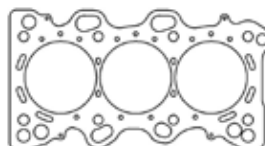

Additional thicknesses available see page 4

J32A2 3.5L DOHC V6 2001-03 Stock and Darton Sleeves

Head Gaskets

MLS Head Gasket

Bore	Thickness	Pkg Qty	Part #
90mm	.027"	1	C4382-027

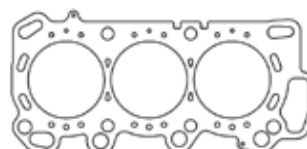

Additional thicknesses available see page 4



Cometic Gasket - An Exclusive NASCAR Performance Product

HYUNDAI

2.0L Theta II Turbo 4 Cylinder

2010-Up Genesis Coupe, 2011 Sonata Limited, 2009-2013 Kia Forte

Head Gaskets

MLx Head Gasket - Left Side

Bore	Thickness	Pkg Qty	Part #
88mm	.032"	1	C4953-032

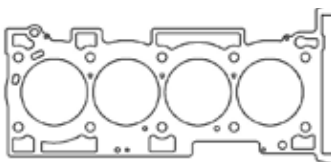

Additional thicknesses available see page 4

3.8L G6DA DOHC V6

2007-09 Azera, 2007-09 Entourage, 2009+Up Genesis, 2007-09 Veracruz

Head Gaskets

MLx Head Gasket - Left Side

Bore	Thickness	Pkg Qty	Part #
98mm	.032"	1	C4632-032

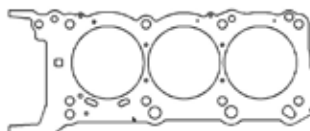

Additional thicknesses available see page 4

MLx Head Gasket - Right Side

Bore	Thickness	Pkg Qty	Part #
98mm	.032"	1	C4633-032

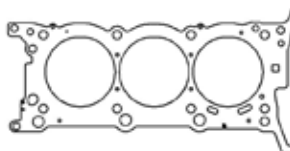

Additional thicknesses available see page 4

JAGUAR

3.4L DOHC Inline 6

48-53 XK120, 54-57 XK140, 57-61 XK150, 50-57 Mark VII, 56-58 Mark VIII, 57-59 Mark I, 59-67 Mark II, 67-68 340 Mark II, 63-68 S-Type

Head Gaskets

MLS Head Gaskets

Bore	Thickness	Pkg Qty	Part #
83mm	.040"	1	C4281-040
85mm	.040"	1	C4303-040

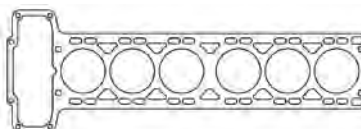

Additional thicknesses available see page 4

CFM-20 Head Gasket

Bore	Thickness	Pkg Qty	Part #
83mm	.059"	1	C4302-059
85mm	.059"	1	C4304-059

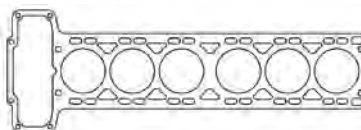

Additional thicknesses available see page 4

Individual Gaskets

Cam Cover Gasket Set

Application	Part #
3.4/3.8/4.2L (Trim to Fit)	C4545-060

Oil Pan Gasket

Application	Part #
3.4/3.8/4.2L .060" AFM	C4259-060

Intake Manifold Gaskets

Application	Part #
3.8/4.2L Str Port Head	C4230-060
3.4/3.8L B Type Head	C4244-060

Engine Cover Gaskets

Application	Part #
Front Main Seal Gasket	C4290-188
Rear Main Seal Gasket	C4291-188

See page 89 for additional gaskets



Cometic Gasket - An Exclusive NASCAR Performance Product

JAGUAR

3.4L DOHC Inline 6

48-53 XK120, 54-57 XK140, 57-61 XK150, 50-57 Mark VII, 56-58 Mark VIII, 57-59 Mark I,
59-67 Mark II, 67-68 340 Mark II, 63-68 S-Type

Individual Gaskets

Exhaust Manifold Gasket	
Application	Part #
3.4/3.8/4.2L.....	C4217-059

Timing Cover Gasket	
Application	Part #
3.4/3.8/E4.2L .018" AFM.....	C4336-018

Thermostat Gaskets	
Application	Part #
Series 1 1965-67	C4375-060
Series 2 1968-71	C4379-060

Engine Oil Gaskets	
Application	Part #
Oil Feed Gasket.....	C4177-032
Oil Filter Housing Gasket.....	C4179-032

Breather Cover Gasket Set	
Application	Part #
3.4/3.8/4.2L.....	C4544-060

Water Pump Gasket	
Application	Part #
3.4/3.8/E4.2L .018" AFM.....	C4337-018

3.8L DOHC Inline 6

58-61 XK150 3.8, 58-61 XK150 3.8S, 58-61 Mark IX, 61-64 Mark X 3.8, 59-67 Mark II, 61-64 E-Type Series 1 3.8,
63-68 S-Type 3.8

Head Gaskets

MLS Head Gaskets			
Bore	Thickness	Pkg Qty	Part #
88mm	.040"	1	C4282-040
89mm	.040"	1	C4306-040

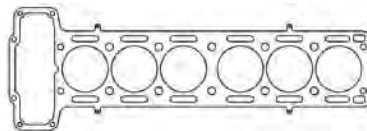

Additional thicknesses available
see page 4

CFM-20 Head Gasket			
Bore	Thickness	Pkg Qty	Part #
87mm	.059"	1	C4305-059
89mm	.059"	1	C4125-059

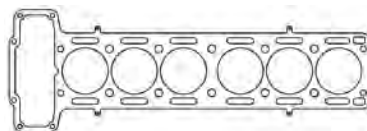

Additional thicknesses available
see page 4

Individual Gaskets

Cam Cover Gasket Set	
Application	Part #
3.4/3.8/4.2L (Trim to Fit)	C4545-060

Oil Pan Gasket	
Application	Part #
3.4/3.8/4.2L .060" AFM.....	C4259-060

Intake Manifold Gaskets	
Application	Part #
3.8/4.2L Str Port Head.....	C4230-060
3.4/3.8L B Type Head.....	C4244-060

Engine Cover Gaskets	
Application	Part #
Front Main Seal Gasket.....	C4290-188
Rear Main Seal Gasket	C4291-188

Exhaust Manifold Gasket	
Application	Part #
3.4/3.8/4.2L.....	C4217-059

Timing Cover Gasket	
Application	Part #
3.4/3.8/E4.2L .018" AFM.....	C4336-018

Thermostat Gaskets	
Application	Part #
Series 1 1965-67	C4375-060
Series 2 1968-71	C4379-060

Engine Oil Gaskets	
Application	Part #
Oil Feed Gasket.....	C4177-032
Oil Filter Housing Gasket.....	C4179-032

Breather Cover Gasket Set	
Application	Part #
3.4/3.8/4.2L.....	C4544-060

Water Pump Gasket	
Application	Part #
3.4/3.8/E4.2L .018" AFM.....	C4337-018



Cometic Gasket - An Exclusive NASCAR Performance Product

JAGUAR

3.9/4.2L AJ33 V8 UK Engine

Head Gaskets

MLS Head Gasket - Left Side			
Bore	Thickness	Pkg Qty	Part #
93mm	.030"	1	C4376-030

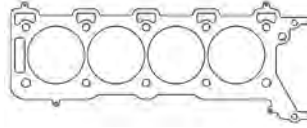

Additional thicknesses available see page 4

MLS Head Gasket - Right Side			
Bore	Thickness	Pkg Qty	Part #
93mm	.030"	1	C4377-030

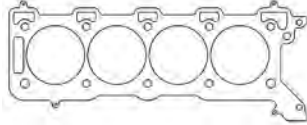

Additional thicknesses available see page 4

3.9/4.2L AJ30/AJ35 V8 US Engine

Head Gaskets

MLS Head Gaskets - Left Side			
Bore	Thickness	Pkg Qty	Part #
87mm	.030"	1	C5772-030
93mm	.030"	1	C5773-030

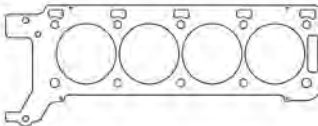

Additional thicknesses available see page 4

MLS Head Gaskets - Right Side			
Bore	Thickness	Pkg Qty	Part #
87mm	.030"	1	C5770-030
93mm	.030"	1	C5771-030

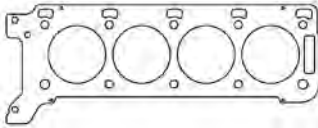

Additional thicknesses available see page 4

4.2L Inline 6 65-67 Series 1, 64-66 Mark X 4.2, 66-68 420

Head Gaskets

CFM-20 Head Gasket			
Bore	Thickness	Pkg Qty	Part #
93mm	.059"	1	C4338-059

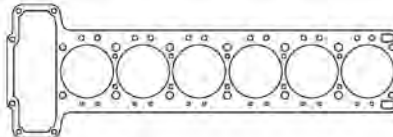

Additional thicknesses available see page 4

Individual Gaskets

Cam Cover Gasket Set	
Application	Part #
3.4/3.8/4.2L (Trim to Fit)	C4545-060

Oil Pan Gasket	
Application	Part #
3.4/3.8/4.2L .060" AFM	C4259-060

Intake Manifold Gaskets	
Application	Part #
3.8/4.2L Str Port Head	C4230-060
3.4/3.8L B Type Head	C4244-060

Engine Cover Gaskets	
Application	Part #
Front Main Seal Gasket	C4902-018
Rear Main Seal Gasket	C4901-188

Exhaust Manifold Gasket	
Application	Part #
3.4/3.8/4.2L	C4217-059

Timing Cover Gasket	
Application	Part #
3.4/3.8/E4.2L .018" AFM	C4336-018

Thermostat Gaskets	
Application	Part #
Series 1 1965-67	C4375-060
Series 2 1968-71	C4379-060

Engine Oil Gaskets	
Application	Part #
Oil Feed Gasket	C4949-032
Oil Filter Housing Gasket	C4179-032

Breather Cover Gasket Set	
Application	Part #
3.4/3.8/4.2L	C4544-060

Water Pump Gasket	
Application	Part #
3.4/3.8/E4.2L .018" AFM	C4337-018



Cometic Gasket - An Exclusive NASCAR Performance Product

JAGUAR

4.2L Inline 6 68-70 E-Type Series 2, 68-73 XJ6 4.2 Series 1

Head Gaskets

CFM-20 Head Gasket			
Bore	Thickness	Pkg Qty	Part #
93mm	.059"	1	C4220-059

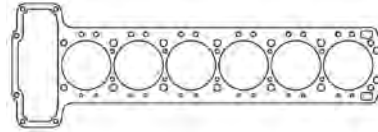

Additional thicknesses available
see page 4

Individual Gaskets

Cam Cover Gasket Set	
Application	Part #
3.4/3.8/4.2L (Trim to Fit)	C4545-060

Oil Pan Gasket	
Application	Part #
3.4/3.8/4.2L .060" AFM	C4259-060

Intake Manifold Gaskets	
Application	Part #
3.8/4.2L Str Port Head	C4230-060
3.4/3.8L B Type Head	C4244-060

Engine Cover Gaskets	
Application	Part #
Front Main Seal Gasket	C4290-188
Rear Main Seal Gasket	C4291-188

Exhaust Manifold Gasket	
Application	Part #
3.4/3.8/4.2L	C4217-059

Timing Cover Gasket	
Application	Part #
3.4/3.8/E4.2L .018" AFM	C4336-018
4.2L 1970+Up .018" AFM	C4902-018

Thermostat Gaskets	
Application	Part #
Series 1 1965-67	C4375-060
Series 2 1968-71	C4379-060

Engine Oil Gaskets	
Application	Part #
Oil Feed Gasket	C4177-032
Oil Filter Housing Gasket	C4179-032

Breather Cover Gasket Set	
Application	Part #
3.4/3.8/4.2L	C4544-060

Water Pump Gasket	
Application	Part #
3.4/3.8/E4.2L .018" AFM	C4337-018
4.2L 1970+Up .018" AFM	C4903-018

4.2L Hi-Performance Inline 6 1973-87 XJ6 4.2 Series 3

Head Gaskets

MLS Head Gaskets			
Bore	Thickness	Pkg Qty	Part #
3.670"	.040"	1	C4128-040
3.690"	.040"	1	C4127-040

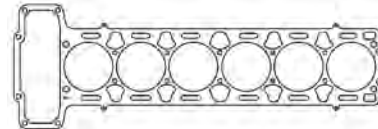

Additional thicknesses available
see page 4

Individual Gaskets

Cam Cover Gasket Set	
Application	Part #
3.4/3.8/4.2L (Trim to Fit)	C4545-060

Oil Pan Gasket	
Application	Part #
3.4/3.8/4.2L .060" AFM	C4259-060

Intake Manifold Gaskets	
Application	Part #
3.8/4.2L Str Port Head	C4230-060
3.4/3.8L B Type Head	C4244-060

Engine Cover Gaskets	
Application	Part #
Front Main Seal Gasket	C4290-188
Rear Main Seal Gasket	C4291-188



Cometic Gasket - An Exclusive NASCAR Performance Product

JAGUAR

4.2L Hi-Performance Inline 6 1973-87 XJ6 4.2 Series 3

Individual Gaskets

Exhaust Manifold Gasket	
Application	Part #
3.4/3.8/4.2L.....	C4217-059

Timing Cover Gasket	
Application	Part #
4.2L 1970+Up .018" AFM	C4902-018

Thermostat Gaskets	
Application	Part #
Series 1 1965-67	C4375-060
Series 2 1968-71	C4379-060

Engine Oil Gaskets	
Application	Part #
Oil Feed Gasket.....	C4177-032
Oil Filter Housing Gasket.....	C4179-032

Breather Cover Gasket Set	
Application	Part #
3.4/3.8/4.2L.....	C4544-060

Water Pump Gasket	
Application	Part #
4.2L 1970+Up .018" AFM	C4903-018

5.0L V8 AJ133 2009+Up XF, XJ, XK, XFR, XJR, XKR, 2011+Up XKR-S, 2013+Up XFR-S, F-Type Convertible, 2014+Up F-Type Coupe

Head Gaskets

MLx Head Gasket - Left Side			
Bore	Thickness	Pkg Qty	Part #
93mm040"	1	C15001-040

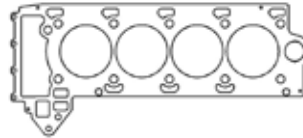

Additional thicknesses available see page 4

MLx Head Gasket - Right Side			
Bore	Thickness	Pkg Qty	Part #
93mm040"	1	C15000-040

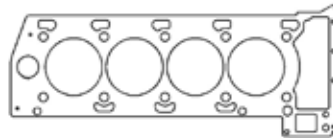

Additional thicknesses available see page 4

5.3L V12 1971-93

Head Gaskets

CFM-20 Head Gaskets - Left Side			
Bore	Thickness	Pkg Qty	Part #
93mm059"	1	C4330-059
97mm059"	1	C4221-059

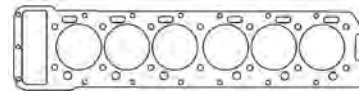

Additional thicknesses available see page 4

CFM-20 Head Gaskets - Right Side			
Bore	Thickness	Pkg Qty	Part #
93mm059"	1	C4331-059
97mm059"	1	C4222-059

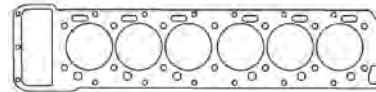

Additional thicknesses available see page 4



Cometic Gasket - An Exclusive NASCAR Performance Product

MAZDA

B6 1.6L DOHC 16V 1989-93 1597cc

Head Gaskets

MLS Head Gasket			
Bore	Thickness	Pkg Qty	Part #
80mm	.040"	1	C4122-040

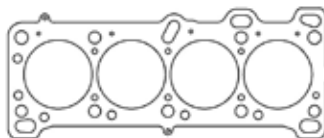

Additional thicknesses available see page 4

Individual Gaskets

Valve Cover Gasket Set	
Application	Part #
B6 1.6L 89-93	C4781

Rear Main Seal Set	
Application	Part #
B6 1.6L 89-93	C4783

Intake Manifold Gasket	
Application	Part #
B6 1.6L 89-93 .060" KF	C4779-060

Oil Pump Gasket Set	
Application	Part #
B6 1.6L 89-93	C4784

Exhaust Manifold Gasket	
Application	Part #
B6 1.6L 89-93 .030" MLS	C4165-030

Oil Pan Gasket Set	
Application	Part #
B6 1.6L 89-93 (Requires RTV)	C4785

Cam Seal Set	
Application	Part #
B6 1.6L 89-93 (2 Pack)	C4780

Water Pump Gasket	
Application	Part #
B6 1.6L 89-93	C4786

Valve Stem Seals (sold individually)	
Application	Part #
B6 1.6L 89-93	3169V

Thermostat Gasket	
Application	Part #
B6 1.6L 89-93 .046" Fiber	C4782-046

Gasket Kits



To purchase a complete gasket kit order both top end and bottom end gasket kit

TOP END GASKET KIT



Application	Part #
B6 1.6L 89-93 80mm Bore	PRO2036T

BOTTOM END GASKET KIT



Application	Part #
B6 1.6L 89-93	PRO2036B



Cometic Gasket - An Exclusive NASCAR Performance Product

MAZDA

BP 1.8L DOHC 16V 1994-97 1839cc

Head Gaskets

MLS Head Gaskets

Bore	Thickness	Pkg Qty	Part #
83mm	.040"	1	C4560-040
84mm	.040"	1	C4568-040
85mm	.040"	1	C4569-040

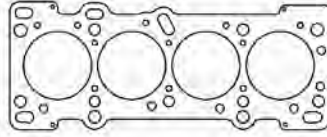

Additional thicknesses available see page 4

FS-DE 2.0L DOHC 16V 1993-03 1991cc

Head Gaskets

MLS Head Gaskets

Bore	Thickness	Pkg Qty	Part #
84mm	.030"	1	C5844-030
84.5mm	.027"	1	C5845-027

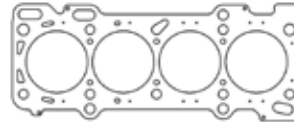

Additional thicknesses available see page 4

Individual Gaskets

Valve Cover Gasket Set

Application	Part #
FS-DE 2.0L DOHC	C4788

Oil Pan Gasket Set

Application	Part #
FS-DE 2.0L DOHC	C4790-062

Intake Manifold Gasket

Application	Part #
FS-DE 2.0L DOHC	C4787-046

Rear Main Seal Set

Application	Part #
FS-DE 2.0L DOHC	C4791

Exhaust Manifold Gasket

Application	Part #
FS-DE 2.0L DOHC .030" MLS	C4171-030

Water Pump Gasket

Application	Part #
FS-DE 2.0L DOHC	C4792-031

Cam Seal Set

Application	Part #
FS-DE 2.0L DOHC (2 Pack)	C4780

Thermostat Gasket

Application	Part #
FS-DE 2.0L DOHC	C4789

Valve Stem Seals (sold individually)

Application	Part #
FS-DE 2.0L DOHC	3225V

Gasket Kits



To purchase a complete gasket kit order both top end and bottom end gasket kit

TOP END GASKET KIT



Application	Part #
FS-DE 2.0L DOHC 93-03 84mm Bore	PRO2037T

BOTTOM END GASKET KIT



Application	Part #
FS-DE 2.0L DOHC 93-03	PRO2037B



Cometic Gasket - An Exclusive NASCAR Performance Product

MAZDA

MZR 2.3L DOHC 16V 2261cc 2006-08

Head Gasket

MLS Head Gasket			
Bore	Thickness	Pkg Qty	Part #
89mm030"1	C4481-030

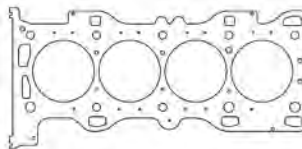

Additional thicknesses available see page 4

MZR 2.5L DISI DOHC 16V 2488cc 2009

Head Gasket

MLS Head Gasket			
Bore	Thickness	Pkg Qty	Part #
90mm040"1	C5906-040

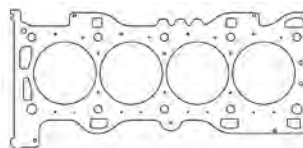

Additional thicknesses available see page 4

MERCEDES BENZ

M120 6.0/7.0L V12 1992 600SEC, 600SEL, 600SL, 1997 CLK-GTR

Head Gaskets

MLS Head Gasket - Left Side			
Bore	Thickness	Pkg Qty	Part #
90mm051"1	C4501-051

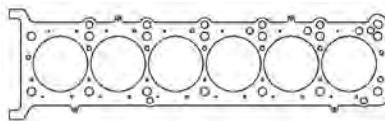

Additional thicknesses available see page 4

MLS Head Gasket - Right Side			
Bore	Thickness	Pkg Qty	Part #
90mm051"1	C4500-051

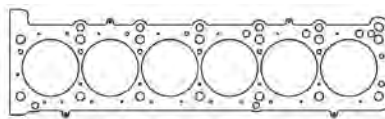

Additional thicknesses available see page 4

M120 7.3L V12 99-05 Pagani Zonda, 99-05 AMG SL73

Head Gaskets

MLS Head Gasket - Left Side			
Bore	Thickness	Pkg Qty	Part #
91.5mm051"1	C4504-051

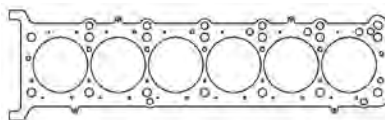

Additional thicknesses available see page 4

MLS Head Gasket - Right Side			
Bore	Thickness	Pkg Qty	Part #
91.5mm051"1	C4503-051

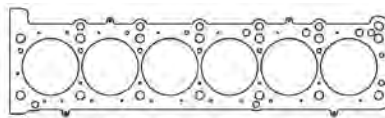

Additional thicknesses available see page 4



Cometic Gasket - An Exclusive NASCAR Performance Product

MG

Midget 1275cc Austin Series A

Head Gasket

MLS Head Gasket

Bore	Thickness	Pkg Qty	Part #
74mm	.040"	1	C4148-040

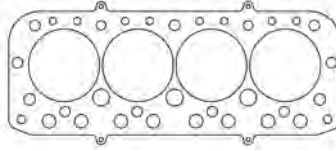

Additional thicknesses available see page 4

MGA1500/1600/1600 MKII Series B

Head Gasket

MLS Head Gasket

Bore	Thickness	Pkg Qty	Part #
74mm	.040"	1	C4359-040

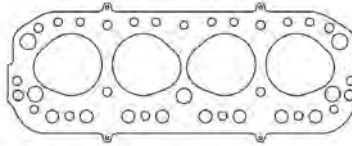

Additional thicknesses available see page 4

MGB 1.8L 18G/18GA

Head Gasket

MLS Head Gasket

Bore	Thickness	Pkg Qty	Part #
83mm	.040"	1	C4147-040

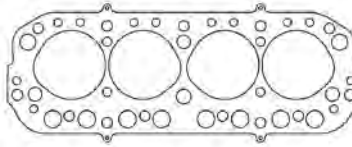

Additional thicknesses available see page 4

MINI

1.6L Tritec/Pentagon 1999-06

Head Gasket

MLS Head Gasket

Bore	Thickness	Pkg Qty	Part #
78.5mm	.027"	1	C4308-027

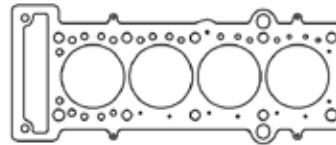

Additional thicknesses available see page 4

1.6L Turbo Prince/N14B16C/N14B16A 07-12

Head Gasket

MLx Head Gasket

Bore	Thickness	Pkg Qty	Part #
78mm	.036"	1	C4617-036

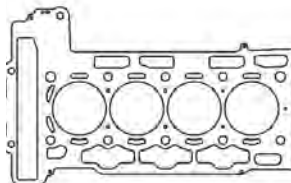

Additional thicknesses available see page 4



Cometic Gasket - An Exclusive NASCAR Performance Product

MITSUBISHI

2.0L 4G63/4G63-T DOHC Eclipse 90-99, Galant 89-92, EVO 1-3 92-95

Head Gaskets

MLS Head Gaskets			
Bore	Thickness	Pkg Qty	Part #
85.5mm	.051"	1	C4233-051
86mm	.051"	1	C4234-051
87mm	.051"	1	C4235-051

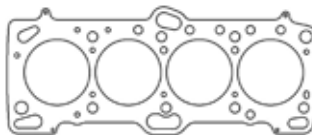

Additional thicknesses available see page 4

MLX Head Gasket			
Bore	Thickness	Pkg Qty	Part #
87mm	.050"	1	C4957-050

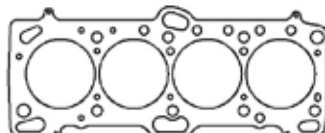

Additional thicknesses available see page 4

Individual Gaskets

Valve Cover Gasket Set	
Application	Part #
4G63/T 89-94	C4691

Throttle Body Gaskets	
Application	Part #
4G63/T 91-94	C4693
4G63/T 95-97	C4904

Intake Manifold Gasket	
Application	Part #
4G63/T 89-94	C4692-060

Oil Pan Gaskets	
Application	Part #
4G63/T 89-92	C4695
4G63/T 93-94	C4698

Exhaust Manifold Gasket	
Application	Part #
4G63/T 89-94 .030" MLS	C4199-030

Water Pump Gasket Set	
Application	Part #
4G63/T 89-94	C4696

Cam Seal Set	
Application	Part #
4G63/T 89-94 (2 Pack)	C4905

Rear Main Seal Set	
Application	Part #
4G63/T 89-92	C4697
4G63/T 93-94	C4699

Valve Stem Seals (sold individually)	
Application	Part #
4G63/T 89-94	3173V

Thermostat Gasket Set	
Application	Part #
4G63/T 89-94	C4694

Gasket Kits



To purchase a complete gasket kit order both top end and bottom end gasket kit

TOP END GASKET KIT



Application	Part #
4G63/T 89-94 84mm Bore	PRO2006T

BOTTOM END GASKET KITS



Application	Part #
4G63/T 89-92	PRO2006B
4G63/T 93-94	PRO2007B



Cometic Gasket - An Exclusive NASCAR Performance Product

MITSUBISHI

2.0L 4G63/4G63-T DOHC:EVO 4-8 96-05

Head Gaskets

MLS Head Gaskets

Bore	Thickness	Pkg Qty	Part #
85mm	.051"	1	C4157-051
86mm	.051"	1	C4156-051
87mm	.051"	1	C4591-051

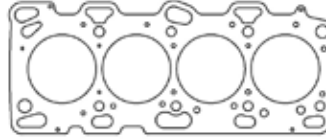

Additional thicknesses available
see page 4

MLX Head Gasket

Bore	Thickness	Pkg Qty	Part #
87mm	.050"	1	C4956-050

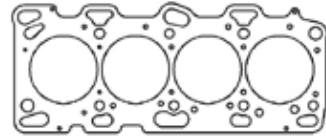

Additional thicknesses available
see page 4

2.0L DOHC 4cyl ECC/420A 1995-99

Head Gaskets

MLS Head Gaskets

Bore	Thickness	Pkg Qty	Part #
87.5mm	.040"	1	C5497-040
88.5mm	.040"	1	C5498-040

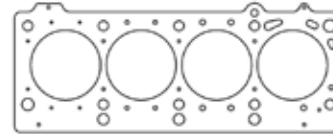

Additional thicknesses available
see page 4

Individual Gaskets

Valve Cover Gasket Set

Application	Part #
1995-99 2.0L DOHC	C15046

Cam Seal Set

Application	Part #
Pair - 48 x 35 x 7	C15049

Intake Manifold Gaskets

Application	Part #
Intake Manifold Gasket - .060" AFM	C15047-060
Intake Plenum Gasket - .031" Fiber	C15048-031

Front Crank Seal Set

Application	Part #
1995-99 2.0L DOHC	C15053

Exhaust Manifold Gasket

Application	Part #
2.040" X 1.100" Port - MLS	C4161-030

Oil Pan Gasket

Application	Part #
Molded Rubber	C15050

Throttle Body Gasket

Application	Part #
Molded Rubber	C15051

Rear Main Seal

Application	Part #
1995-99 2.0L DOHC	C15052

Valve Stem Seals Set (16 Pack)

Application	Part #
5 x 10.8 x 18.3 x 16.9 - Hat Style	3180V-16

See page 99 for StreetPro gasket kits



Cometic Gasket - An Exclusive NASCAR Performance Product

MITSUBISHI

2.0L DOHC 4cyl ECC/420A 1995-99

Gasket Kits



To purchase a complete gasket kit order both top end and bottom end gasket kit

TOP END GASKET KIT



Application
1995-99 420A 2.0L DOHC 88.5mm Bore**PRO2005T**

BOTTOM END GASKET KIT



Application
1995-99 420A 2.0L DOHC.....**PRO2005B**

2.0L 4B11T Turbo 2007+: EVO X 2007+

Head Gaskets

MLx Head Gaskets

Bore	Thickness	Pkg Qty	Part #
88mm	.044"	1	C4483-044
90mm	.044"	1	C4484-044

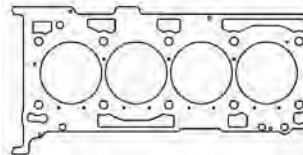

Additional thicknesses available
see page 4

3.0L 6G72 SOHC/DOHC 24v V6 1988-00

Head Gaskets

MLS Head Gaskets

Bore	Thickness	Pkg Qty	Part #
93mm	.051"	1	C4243-051
95mm	.051"	1	C4240-051

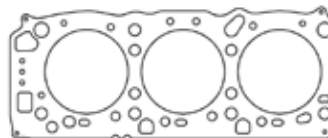

Additional thicknesses available
see page 4

Individual Gaskets

Valve Cover Gasket Sets

Application	Part #
1988-96 3.0L V6 SOHC.....	C4713
1991-00 3.0L V6 DOHC	C4722

Oil Pan Gaskets

Application	Part #
1988-96 3.0L V6 SOHC.....	C4717
1991-00 3.0L V6 DOHC	C4727

Intake Manifold Gasket Sets

Application	Part #
1988-96 3.0L V6 SOHC.....	C4714
1991-00 3.0L V6 DOHC	C4723

Water Pump Gasket Sets

Application	Part #
1988-96 3.0L V6 SOHC.....	C4719
1991-00 3.0L V6 DOHC	C4728-020

Exhaust Manifold Gasket Sets

Application	Part #
1988-96 3.0L V6 SOHC.....	C4714
1991-00 3.0L V6 DOHC	C4723

Rear Main Seal Set

Application	Part #
1988-00 3.0L V6 SOHC/DOHC	C4720

See page 100 for additional gaskets



Cometic Gasket - An Exclusive NASCAR Performance Product

MITSUBISHI

3.0L 6G72 SOHC/DOHC 24v V6 1988-00

Individual Gaskets

Cam Seal Sets

Application	Part #
1988-96 3.0L V6 SOHC (2)	C4905
1991-00 3.0L V6 DOHC (4)	C4725

Oil Pump Gasket Kits

Application	Part #
1988-96 3.0L V6 SOHC.....	C4721
1991-00 3.0L V6 DOHC	C4729

Valve Stem Seals (sold individually)

Application	Part #
1988-96 3.0L V6 SOHC.....	3157V
1991-00 3.0L V6 DOHC	3163V

Thermostat Gaskets

Application	Part #
1988-96 3.0L V6 SOHC.....	C4716-032
1991-00 3.0L V6 DOHC	C4726

Gasket Kits



To purchase a complete gasket kit order both top end and bottom end gasket kit

TOP END GASKET KITS



Application	Part #
1988-96 3.0L V6 SOHC 93mm Bore	PRO2038T
1991-00 3.0L V6 DOHC 93mm Bore	PRO2039T

BOTTOM END GASKET KITS



Application	Part #
1988-96 3.0L V6 SOHC.....	PRO2038B
1991-00 3.0L V6 DOHC	PRO2039B

NISSAN

1.5L E15, E15S, E15T SOHC Pulsar 80-86, Ninja Gayin 84-94, Sunny 80-86

Head Gasket

MLS Head Gasket

Bore	Thickness	Pkg Qty	Part #
77.5mm040"	1.....	C4178-040



Additional thicknesses available
see page 4

Individual Gaskets

Valve Cover Gasket Set

Application	Part #
E15T 1983-84.....	C4906

Cam Seal

Application	Part #
E15T 1983-84.....	C4910

Intake Manifold Gasket

Application	Part #
E15T 1983-84.....	C4907

Rear Main Seal Set

Application	Part #
E15T 1983-84.....	C4763

See page 101 for additional gaskets



Cometic Gasket - An Exclusive NASCAR Performance Product

NISSAN

1.5L E15, E15S, E15T SOHC Pulsar 80-86, Ninja Gayin 84-94, Sunny 80-86

Individual Gaskets

Exhaust Manifold Gaskets

Application	Part #
1982-83 E15S SOHC	C4908
1983-84 E15T SOHC	C4909

Front Crank Set

Application	Part #
E15T 1983-84	C4912

Valve Stem Seals (sold individually)

Application	Part #
E15T 1983-84	3159V

Water Pump Gasket Set

Application	Part #
E15T 1983-84	C4913

1.8L CA18 SOHC

Skyline R31 88-90, Skyline R32 GXi 88-90, Skyline HR31 85-91, Silvia Turbo 84-89, 180SX 81-83, 200SX 84-88, Bluebird Turbo 91-93, Bluebird 83-85, 200SX Turbo 84-87, Pulsar 81-83, Sunny 88-91

Head Gaskets

MLS Head Gasket

Bore	Thickness	Pkg Qty	Part #
85mm051"	1	C4479-051

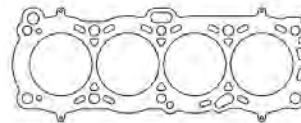

Additional thicknesses available
see page 4

1.8L CA18 DOHC

Skyline HR31 85-91, Silvia Turbo 89-90, 180SX P/S13 89-90, 200SX S13-U 89-93, Bluebird Turbo 87-89, Bluebird 87-89, 200SX Turbo 89-93, Pulsar, Sunny N13/B12 Coupe mid 80s

Head Gaskets

MLS Head Gasket

Bore	Thickness	Pkg Qty	Part #
85mm051"	1	C4480-051

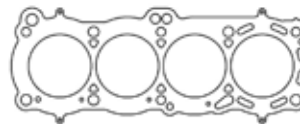

Additional thicknesses available
see page 4

Individual Gaskets

Valve Cover Gasket Set

Application	Part #
CA18DE/DET 1.8L	C4607

Throttle Body Gaskets

Application	Part #
CA18DE/DET 1.8L (pair)	C4740-032

Intake Manifold Gasket Set

Application	Part #
CA18DE/DET 1.8L	C4742

Rear Main Seal Set

Application	Part #
CA18DE/DET 1.8L	C4737

Exhaust Manifold Gasket Set

Application	Part #
CA18DE/DET 1.8L MLS 4pcs	C4523

Water Pump Gasket

Application	Part #
CA18DE/DET 1.8L	C4736-018

Cam Seal Set

Application	Part #
CA18DE/DET 1.8L (pair)	C4739

Oil Pump Gasket

Application	Part #
CA18DE/DET 1.8L	C4738-020

See page 102 for additional gaskets



Cometic Gasket - An Exclusive NASCAR Performance Product

NISSAN

1.8L CA18 DOHC

Skyline HR31 85-91, Silvia Turbo 89-90, 180SX P/S13 89-90, 200SX S13-U 89-93, Bluebird Turbo 87-89, Bluebird 87-89, 200SX Turbo 89-93, Pulsar, Sunny N13/B12 Coupe mid 80s

Individual Gaskets

Valve Stem Seals (sold individually)

Application	Part #
CA18DE/DET 1.8L.....	3175V

Front Crank Seal

Application	Part #
CA18DE/DET 1.8L.....	C4914

Gasket Kits



To purchase a complete gasket kit order both top end and bottom end gasket kit

TOP END GASKET KIT



Application	Part #
CA18DE/DET 1.8L 85mm Bore.....	PRO2018T

BOTTOM END GASKET KIT



Application	Part #
CA18DE/DET 1.8L.....	PRO2018B

2.0L FJ20E/ET 240RS 83-85, Skyline DR30 83-85, Silvia 83-85

Head Gaskets

MLS Head Gaskets

Bore	Thickness	Pkg Qty	Part #
90mm051"	1	C4326-051
91mm051"	1	C4327-051

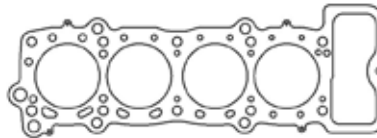

Additional thicknesses available see page 4

1.6L SR16VE/2.0L SR20VE DOHC 97-01 Pulsar, Lucino, Primera, Bluebird, Wingroad, Sunny

Head Gasket

MLS Head Gaskets

Bore	Thickness	Pkg Qty	Part #
87mm040"	1	C4600-040
88mm040"	1	C4601-040

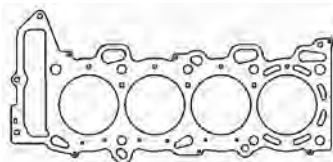

Additional thicknesses available see page 4

Individual Gaskets

Valve Cover Gasket Set

Application	Part #
SR16VE/SR20VE.....	C4730.

Throttle Body Gasket

Application	Part #
SR16VE/SR20VE.....	C4733-018

See page 103 for additional gaskets



Cometic Gasket - An Exclusive NASCAR Performance Product

NISSAN

1.6L SR16VE/2.0L SR20VE DOHC 97-01 Pulsar, Lucino, Primera, Bluebird, Wingroad, Sunny

Individual Gaskets

Intake Manifold Gasket Set	
Application	Part #
SR16VE/SR20VE	C4731

Rear Main Seal	
Application	Part #
SR16VE/SR20VE	C4734

Exhaust Manifold Gasket Set	
Application	Part #
SR16VE/SR20VE	C4732-064

Oil Pump Gasket	
Application	Part #
SR16VE/SR20VE	C4735-020

Valve Stem Seals (sold individually)	
Application	Part #
SR16VE/SR20VE	3175V

Front Crank Seal	
Application	Part #
SR16VE/SR20VE	C4915

Gasket Kits



To purchase a complete gasket kit order both top end and bottom end gasket kit

TOP END GASKET KIT



Application	Part #
SR16VE/SR20VE 88mm Bore	PRO2053T

BOTTOM END GASKET KIT



Application	Part #
SR16VE/SR20VE	PRO2053B

2.0L SR20DE/DET DOHC FWD 91-92/94-97 180SX, 95-98 200SX SE-R, 96-98 Almera, 90/92-95/97-01 Avenir, 89/91-93/95-98 Bluebird, 98-00 Liberty, 91-02 Infinity G20, 91-93 NX2000, 91-00 Pulsar, 91-94/98-01 Sentra

Head Gaskets

MLS Head Gaskets			
Bore	Thickness	Pkg Qty	Part #
87mm030"	1	C4575-030
88.5mm030"	1	C4130-030



Additional thicknesses available see page 4

Individual Gaskets

Valve Cover Gasket Sets	
Application	Part #
SR20DE/DET FWD 91-96	C4747
SR20DE/DET FWD 97-01	C4730

Thermostat Gasket Set	
Application	Part #
SR20DE/DET FWD 91-01	C4916

See page 104 for additional gaskets



Cometic Gasket - An Exclusive NASCAR Performance Product

NISSAN

2.0L SR20DE/DET DOHC FWD

91-92/94-97 180SX, 95-98 200SX SE-R, 96-98 Almera, 90/92-95/97-01 Avenir, 89/91-93/95-98 Bluebird, 98-00 Liberty, 91-02 Infinity G20, 91-93 NX2000, 91-00 Pulsar, 91-94/98-01 Sentra

Individual Gaskets

Intake Manifold Gaskets

Application	Part #
SR20DE/DET FWD 91-93	C4746
SR20DE/DET FWD 94-01	C4749

Oil Pan Gasket

Application	Part #
SR20DE/DET FWD 91-01	C4744-156

Exhaust Manifold Gasket Set

Application	Part #
SR20DE/DET FWD 91-01 MLS.....	C4200-030

Water Pump Gasket

Application	Part #
SR20DE/DET FWD 91-01	C4745-031

Throttle Body Gasket

Application	Part #
SR20DE/DET FWD 91-01	C4733-018

Oil Pump Gasket

Application	Part #
SR20DE/DET FWD 91-01	C4743

Valve Stem Seals (sold individually)

Application	Part #
SR20DE/DET FWD 91-01	3175V

Front Crank Seal

Application	Part #
SR20DE/DET FWD 91-01	C4915

Gasket Kits



To purchase a complete gasket kit order both top end and bottom end gasket kit

TOP END GASKET KIT

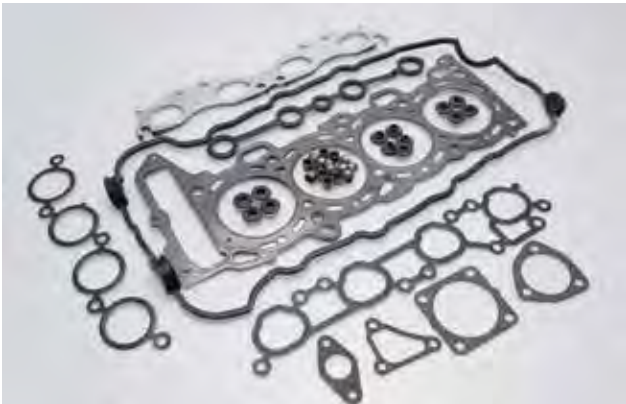

Application	Part #
SR20DE/DET FWD 91-96 87mm Bore	PRO2012T
SR20DE/DET FWD 97-01 87mm Bore	PRO2011T

BOTTOM END GASKET KIT



Application	Part #
SR20DE/DET FWD 91-01	PRO2012B

2.0L SR20DE/DET DOHC S13 1989-93

Head Gasket

MLS Head Gasket

Bore	Thickness	Pkg Qty	Part #
87.5mm045"	1	C4324-045



Additional thicknesses available see page 4

See page 105 for additional gaskets



Cometic Gasket - An Exclusive NASCAR Performance Product

NISSAN

2.0L SR20DE/DET DOHC S13 1989-93

Individual Gaskets

Valve Cover Gasket Set	
Application	Part #
SR20DE/DET S13 89-93.....	C4753

Throttle Body Gasket	
Application	Part #
SR20DE/DET S13 89-93.....	C4750-018

Intake Manifold Gasket Set	
Application	Part #
SR20DE/DET S13 89-93.....	C4752

Thermostat Gasket Set	
Application	Part #
SR20DE/DET S13 89-93.....	C4758

Exhaust Manifold Gasket Set	
Application	Part #
SR20DE/DET S13 89-93 MLS	C4200-030

Rear Main Seal Set	
Application	Part #
SR20DE/DET S13 89-93.....	C4743

Valve Stem Seals (sold individually)	
Application	Part #
SR20DE/DET S13 - EXH	3158V
SR20DE/DET S13 - INT	3175V

Front Crank Seal	
Application	Part #
SR20DE/DET S13 89-93.....	C4915

Gasket Kits



To purchase a complete gasket kit order both top end and bottom end gasket kit

TOP END GASKET KIT



Application	Part #
SR20DE/DET S13 w/o VC Set 87.5mm Bore ..	PRO2008T
SR20DE/DET S13 89-93 88mm Bore	PRO2053T

BOTTOM END GASKET KIT



Application	Part #
SR20DE/DET S13 89-93.....	PRO2010B

2.0L SR20DE/DET DOHC S14 1994-98

Head Gaskets

MLS Head Gaskets			
Bore	Thickness	Pkg Qty	Part #
87.5mm045"	1.....	C4576-045
88.5mm045"	1.....	C4283-045

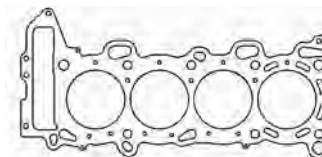

Additional thicknesses available see page 4

MLx Head Gaskets			
Bore	Thickness	Pkg Qty	Part #
87mm040"	1.....	C4950-040
88mm040"	1.....	C4951-040



Additional thicknesses available see page 4

See page 106 for additional gaskets



Cometic Gasket - An Exclusive NASCAR Performance Product

NISSAN

2.0L SR20DE/DET DOHC S14 1994-98

Individual Gaskets

Valve Cover Gasket Set	
Application	Part #
SR20DE/DET S14 94-98.....	C4755

Throttle Body Gasket	
Application	Part #
SR20DE/DET S14 94-98.....	C4754-032

Intake Manifold Gasket Set	
Application	Part #
SR20DE/DET S14 94-98.....	C4749

Thermostat Gasket Set	
Application	Part #
SR20DE/DET S14 94-98.....	C4758

Exhaust Manifold Gasket Set	
Application	Part #
SR20DE/DET S14 94-98 MLS	C4200-030

Rear Main Seal Set	
Application	Part #
SR20DE/DET S14 94-98.....	C4743

Valve Stem Seals (sold individually)	
Application	Part #
SR20DE/DET S14 - EXH	3158V
SR20DE/DET S14 - INT	3175V

Front Crank Seal	
Application	Part #
SR20DE/DET S14 94-98.....	C4915

Gasket Kit



To purchase a complete gasket kit order both top end and bottom end gasket kit

TOP END GASKET KIT



Application	Part #
SR20DE/DET S14 94-98 87.5mm Bore	PRO2009T

BOTTOM END GASKET KIT



Application	Part #
SR20DE/DET S14 94-98.....	PRO2010B

2.0L SR20DE/DET DOHC GTiR RNN14 AWD 1990-94

Head Gaskets

MLS Head Gaskets			
Bore	Thickness	Pkg Qty	Part #
87.5mm.....	.040"	1.....	C4543-040
88mm.....	.040"	1.....	C4577-040

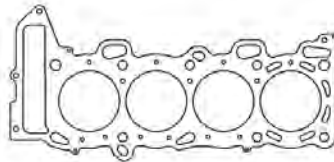

Additional thicknesses available see page 4

Individual Gaskets

Valve Cover Gasket Set	
Application	Part #
SR20DE/DET GTiR RNN14	C4747

Throttle Body Gasket	
Application	Part #
SR20DE/DET GTiR RNN14	C4756-018

See page 107 for additional gaskets



Cometic Gasket - An Exclusive NASCAR Performance Product

NISSAN

2.0L SR20DE/DET DOHC GTiR RNN14 AWD 1990-94

Individual Gaskets

Intake Manifold Gasket Set	
Application	Part #
SR20DE/DET GTiR RNN14	C4757-018

Thermostat Gasket Set	
Application	Part #
SR20DE/DET GTiR RNN14	C4758

Exhaust Manifold Gasket Set	
Application	Part #
SR20DE/DET GTiR RNN14 MLS	C4200-030

Rear Main Seal Set	
Application	Part #
SR20DE/DET GTiR RNN14	C4743

Valve Stem Seals (sold individually)	
Application	Part #
SR20DE/DET GTiR - EXH	3158V
SR20DE/DET GTiR - INT	3175V

Front Crank Seal	
Application	Part #
SR20DE/DET GTiR RNN14	C4915

Gasket Kits



To purchase a complete gasket kit order both top end and bottom end gasket kit

TOP END GASKET KIT



Application	Part #
SR20DE/DET GTiR RNN14 87.5mm Bore	PRO2010T

BOTTOM END GASKET KIT



Application	Part #
SR20DE/DET GTiR RNN14	PRO2010B

2.0L RB20E/DE/DET Inline 6 Laurel 1988-93, Skyline R32 1988-93, Cefiro 1988-93

Head Gaskets

MLS Head Gaskets			
Bore	Thickness	Pkg Qty	Part #
80mm040"	1	C4495-040

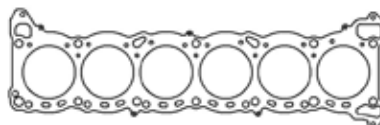

Additional thicknesses available see page 4

Individual Gaskets

Valve Cover Gasket Set	
Application	Part #
RB20E/DE/DET 88-93	C4552

Throttle Body Gasket	
Application	Part #
RB20E/DE/DET 88-93	C4733-018

Intake Manifold Gasket Set	
Application	Part #
RB20E/DE/DET 88-93	C4759

Rear Main Seal	
Application	Part #
RB20E/DE/DET 88-93	C4770

See page 108 for additional gaskets



Cometic Gasket - An Exclusive NASCAR Performance Product

NISSAN

2.0L RB20E/DE/DET Inline 6 Laurel 1988-93, Skyline R32 1988-93, Cefiro 1988-93

Individual Gaskets

Exhaust Manifold Gasket	
Application	Part #
RB20E/DE/DET 88-93 MLS	C4177-030

Oil Pump Gasket	
Application	Part #
RB20E/DE/DET 88-93	C4769-020

Cam Seal Set	
Application	Part #
RB20E/DE/DET 88-93 (pair)	C4739

Front Crank Seal	
Application	Part #
RB20E/DE/DET 88-93	C4914

Valve Stem Seals (sold individually)	
Application	Part #
RB20E/DE/DET 88-93	3175V

Gasket Kits



To purchase a complete gasket kit order both top end and bottom end gasket kit

TOP END GASKET KIT



Application	Part #
RB20E/DE/DET 88-93 88mm Bore	PRO2015T

BOTTOM END GASKET KIT



Application	Part #
RB20E/DE/DET 88-93	PRO2017B

2.4L KA24DE DOHC: 1991-98 240SX

Head Gaskets

MLS Head Gaskets			
Bore	Thickness	Pkg Qty	Part #
90mm	.040"	1	C4285-040
91mm	.040"	1	C4286-040

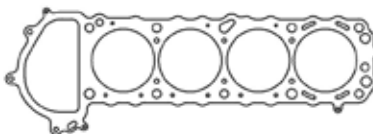

Additional thicknesses available see page 4

Individual Gaskets

Valve Cover Gasket Sets	
Application	Part #
KA24DE 1991-94	C4761
KA24DE 1995-98	C4766

Oil Pan Gasket	
Application	Part #
KA24DE 1991-98	C4764-060

Intake Manifold Gasket Set	
Application	Part #
KA24DE 1991-98	C4760

Water Pump Gasket	
Application	Part #
KA24DE 1991-98	C4765-031

See page 109 for additional gaskets



Cometic Gasket - An Exclusive NASCAR Performance Product

NISSAN

2.4L KA24DE DOHC: 1991-98 240SX

Individual Gaskets

Exhaust Manifold Gasket	
Application	Part #
KA24DE 1991-98 MLS	C4201-030

Rear Main Seal Set	
Application	Part #
KA24DE 1991-98.....	C4763

Throttle Body Gasket	
Application	Part #
KA24DE 1991-98.....	C4733-018

Thermostat Gasket Set	
Application	Part #
KA24DE 1991-98.....	C4762

Valve Stem Seals (sold individually)	
Application	Part #
KA24DE 1991-98.....	3158V

Front Crank Seal	
Application	Part #
KA24DE 1991-98.....	C4915

Gasket Kits



To purchase a complete gasket kit order both top end and bottom end gasket kit

TOP END GASKET KITS



Application	Part #
KA24DE 1991-94 90mm Bore	PRO2014T
KA24DE 1995-98 90mm Bore	PRO2013T

BOTTOM END GASKET KIT



Application	Part #
KA24DE 1991-98.....	PRO2014B

2.5L QR25DE DOHC 2002-06 FWD *Sentra SE-R/SE-R Spec V, Altima Base/S/SL*

Head Gasket

MLS Head Gasket			
Bore	Thickness	Pkg Qty	Part #
90mm030"	1.....	C4615-030

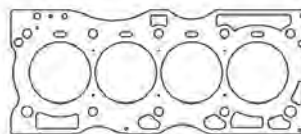

Additional thicknesses available see page 4

Individual Gaskets

Intake Manifold Gasket Set	
Application	Part #
QR25DE FWD 02-06.....	C4748

Throttle Body Gasket	
Application	Part #
QR25DE FWD 02-06.....	C4911



Cometic Gasket - An Exclusive NASCAR Performance Product

NISSAN

2.5L QR25DE DOHC 2007-12 FWD *Sentra SE-R/SE-R Spec V, Altima Base/S/Hybrid, Rogue S/SL/S Krom/SV*

Head Gasket

MLS Head Gasket

Bore	Thickness	Pkg Qty	Part #
90mm	.030"	1	C4614-030

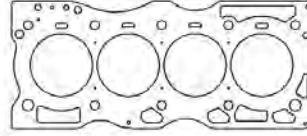

Additional thicknesses available see page 4

Individual Gaskets

Water Inlet Gasket

Application	Part #
QR25DE FWD 07-12	C4751

Water Outlet Gasket

Application	Part #
QR25DE FWD 07-12	C4917

2.5L QR25DE DOHC 2005-12 RWD

05-10 Frontier XE, 08-10 Frontier SE, 05 X-Trail LE/SE/XE, 11-12 Frontier S/SV

Head Gasket

MLS Head Gasket

Bore	Thickness	Pkg Qty	Part #
90mm	.030"	1	C4616-030

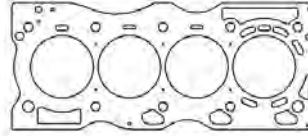

Additional thicknesses available see page 4

Individual Gaskets

Water Outlet Gasket

Application	Part #
QR25DE RWD 05-12	C4918

Water Pump Gasket Set

Application	Part #
QR25DE RWD 05-12	C4919

L23, L24S, L24E, L26 Non-Turbo Inline 6 1970-83 *240/260/280Z, Cedric, Fairlady, Datsun 810*

Head Gasket

MLS Head Gasket

Bore	Thickness	Pkg Qty	Part #
85mm	.040"	1	C4579-040

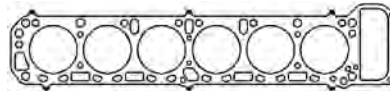

Additional thicknesses available see page 4

L28E, L28S, L28ES Non-Turbo Inline 6 1975-80 *280Z, Patrol, Fairlady, Dedic, Laurel*

Head Gasket

MLS Head Gasket

Bore	Thickness	Pkg Qty	Part #
89mm	.040"	1	C4580-040

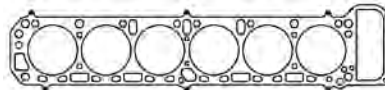

Additional thicknesses available see page 4



Cometic Gasket - An Exclusive NASCAR Performance Product

NISSAN

RB25DET 2.5L Inline 6 *Patrol 89-93, Skyline 89-93, Skyline GT-R 89-02*

Head Gaskets

MLS Head Gaskets			
Bore	Thickness	Pkg Qty	Part #
86mm	.051"	1	C4317-051
87mm	.051"	1	C4318-051

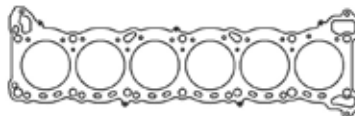

Additional thicknesses available see page 4

Individual Gaskets

Valve Cover Gasket Set	
Application	Part #
RB25DET	C4552

Throttle Body Gasket	
Application	Part #
RB25DET	C4767

Intake Manifold Gasket Set	
Application	Part #
RB25DET	C4768

Rear Main Seal	
Application	Part #
RB25DET	C4770

Exhaust Manifold Gasket	
Application	Part #
RB25DET MLS	C4177-030

Oil Pump Gasket	
Application	Part #
RB25DET	C4769-020

Cam Seal Set	
Application	Part #
RB25DET (pair)	C4739

Front Crank Seal	
Application	Part #
RB25DET	C4914

Valve Stem Seals (sold individually)	
Application	Part #
RB25DET	3175V

Gasket Kits



To purchase a complete gasket kit order both top end and bottom end gasket kit

TOP END GASKET KIT

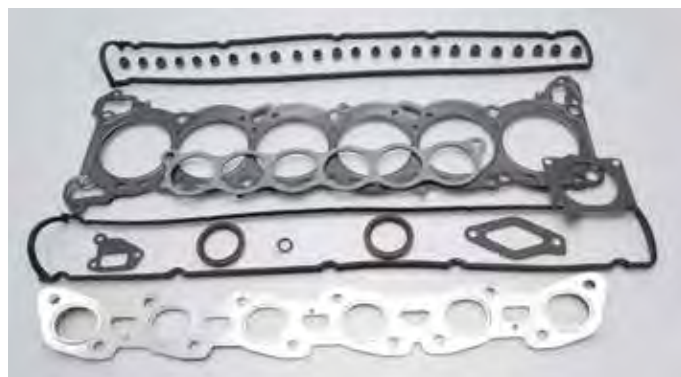

Application	Part #
RB25DET 87mm Bore	PRO2016T

BOTTOM END GASKET KIT



Application	Part #
RB25DET	PRO2017B



Cometic Gasket - An Exclusive NASCAR Performance Product

NISSAN

RB26DET 2.6L DOHC Inline 6 Patrol 89-93, Skyline 89-93, Skyline GT-R 89-02

Head Gaskets

MLS Head Gaskets

Bore	Thickness	Pkg Qty	Part #
86mm051"1	C4319-051
87mm051"1	C4320-051
88mm051"1	C4321-051

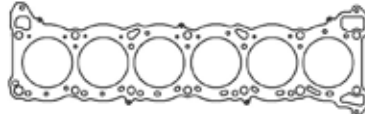

Additional thicknesses available see page 4

Individual Gaskets

Valve Cover Gasket Set

Application	Part #
RB26DET	C4552

Throttle Body Gasket Set

Application	Part #
RB26DET - 6 Pack	C4920

Intake Manifold Gasket

Application	Part #
RB26DET	C4372

Rear Main Seal

Application	Part #
RB26DET	C4770

Exhaust Manifold Gasket

Application	Part #
RB26DET MLS	C4202-030

Oil Pump Gasket

Application	Part #
RB20E/DE/DET 88-93	C4769-020

Cam Seal Set

Application	Part #
RB26DET (pair)	C4739

Front Crank Seal

Application	Part #
RB20E/DE/DET 88-93	C4914

Valve Stem Seals (sold individually)

Application	Part #
RB25DET - EXH	3158V
RB25DET - INT	3175V

Gasket Kits



To purchase a complete gasket kit order both top end and bottom end gasket kit

TOP END GASKET KIT



Application	Part #
RB26DET 87mm Bore	PRO2017T

BOTTOM END GASKET KIT



Application	Part #
RB26DET	PRO2017B



Cometic Gasket - An Exclusive NASCAR Performance Product

NISSAN

RB30DE 3.0L DOHC Inline 6 Patrol 89-93

Head Gaskets

MLS Head Gaskets			
Bore	Thickness	Pkg Qty	Part #
86mm	.051"	1	C4322-051
87mm	.051"	1	C4323-051

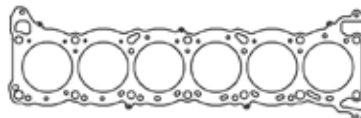

Additional thicknesses available see page 4

VG30DE/DETT 3.0L 24v DOHC V6 1990-99

Head Gaskets

MLS Head Gaskets			
Bore	Thickness	Pkg Qty	Part #
88mm	.045"	1	C4346-045
90mm	.045"	1	C4347-045

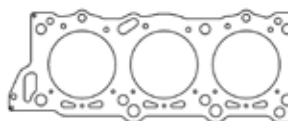

Additional thicknesses available see page 4

Valve Cover Gasket Set	
Application	Part #
VG30DE/DETT	C4773

Oil Pan Gasket	
Application	Part #
VG30DE/DETT	C4776

Intake Manifold Gasket Set	
Application	Part #
VG30DE/DETT	C4772

Rear Main Seal Set	
Application	Part #
VG30DE/DETT	C4775

Exhaust Manifold Gasket Set	
Application	Part #
VG30DE/DETT	C4771-064

Front Crank Seal	
Application	Part #
VG30DE/DETT	C4914

Thermostat Gasket	
Application	Part #
VG30DE/DETT	C4774-031

Water Pump Gasket	
Application	Part #
VG30DE/DETT	C4777-015

Cam Seals (sold in pairs)	
Application	Part #
VG30DE/DETT (need 2 pairs)	C4739

Gasket Kits



To purchase a complete gasket kit order both top end and bottom end gasket kit

TOP END GASKET KIT



Application	Part #
VG30DE/DETT 88mm Bore	PRO2040T

BOTTOM END GASKET KIT



Application	Part #
VG30DE/DETT	PRO2040B



Cometic Gasket - An Exclusive NASCAR Performance Product

NISSAN

VQ30DE/VQ35DE 3.0/3.5L DOHC V6

350Z 03-06, G35 03-06, Altima 02-06, I35 02-04, Maxima 02-04, Pathfinder 01-04, Skyline 01-06

Head Gaskets

MLS Head Gaskets - Left Side

Bore	Thickness	Pkg Qty	Part #
96mm	.030"	1	C4345-030
98mm	.030"	1	C4344-030
100mm	.030"	1	C4343-030
101.5mm	.030"	1	C4381-030

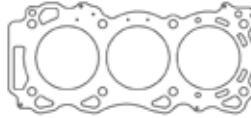

Additional thicknesses available see page 4

MLS Head Gaskets - Right Side

Bore	Thickness	Pkg Qty	Part #
96mm	.030"	1	C4361-030
98mm	.030"	1	C4362-030
100mm	.030"	1	C4363-030
101.5mm	.030"	1	C4380-030

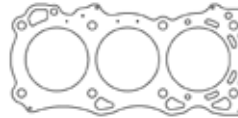

Additional thicknesses available see page 4

Individual Gaskets

Exhaust Manifold Gasket Set

Application	Part #
VQ30DE/VQ35DE	C4921-064

VQ35HR/VQ37VHR 3.5/3.7L DOHC V6 G35 07-08, 350Z 07-08, G37 08-Up, 370Z 09-Up

Head Gaskets

MLS Head Gasket - Left Side

Bore	Thickness	Pkg Qty	Part #
97mm	.030"	1	C4593-030

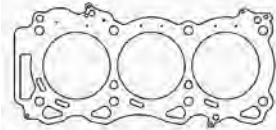

Additional thicknesses available see page 4

MLS Head Gasket - Right Side

Bore	Thickness	Pkg Qty	Part #
97mm	.030"	1	C4592-030

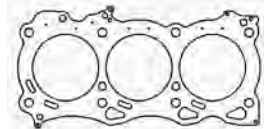

Additional thicknesses available see page 4

Individual Gaskets

Exhaust Manifold Gasket Set

Application	Part #
VQ35HR/VQ37VHR	C4921-064

VR38DETT 3.8L DOHC V6 GT-R 08-Up

Head Gaskets

MLx Head Gaskets - Left Side

Bore	Thickness	Pkg Qty	Part #
96mm	.032"	1	C4570-032
100mm	.032"	1	C4572-032

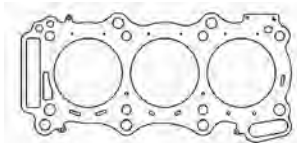

Additional thicknesses available see page 4

MLx Head Gaskets - Right Side

Bore	Thickness	Pkg Qty	Part #
96mm	.032"	1	C4571-032
100mm	.032"	1	C4573-032

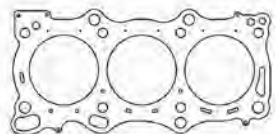

Additional thicknesses available see page 4



Cometic Gasket - An Exclusive NASCAR Performance Product

NISSAN

VK45DE 4.5L V8 Infinity Q45 02-06

Head Gaskets

MLS Head Gasket - Left Side			
Bore	Thickness	Pkg Qty	Part #
93.5mm036"1	C4486-036

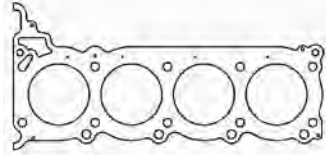

Additional thicknesses available see page 4

MLS Head Gasket - Right Side			
Bore	Thickness	Pkg Qty	Part #
93.5mm036"1	C4485-036

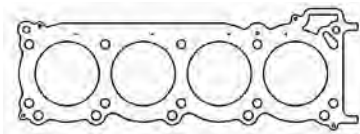

Additional thicknesses available see page 4

TB48DE 4.8L DOHC Inline 6 2001-Up

Head Gaskets

MLS Head Gasket			
Bore	Thickness	Pkg Qty	Part #
100.5mm030"1	C4511-030

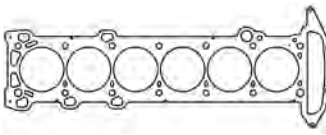

Additional thicknesses available see page 4

MLx Head Gasket			
Bore	Thickness	Pkg Qty	Part #
100.5mm040"1	C4599-040

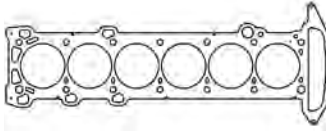

VK56DE 5.6L DOHC V8 2004-Up Armada, 2004-Up Titan, 2004-10 QX56, 2008-12 Pathfinder

Head Gaskets

MLS Head Gasket - Left Side			
Bore	Thickness	Pkg Qty	Part #
100mm040"1	C4922-040

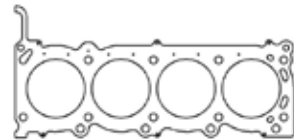

Additional thicknesses available see page 4

MLS Head Gasket - Right Side			
Bore	Thickness	Pkg Qty	Part #
100mm040"1	C4923-040

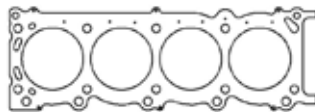

Additional thicknesses available see page 4

MLx Head Gasket - Left Side			
Bore	Thickness	Pkg Qty	Part #
102.7mm040"1	C4610-040

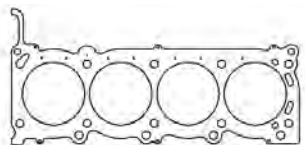

Additional thicknesses available see page 4

MLx Head Gasket - Right Side			
Bore	Thickness	Pkg Qty	Part #
102.7mm040"1	C4609-040

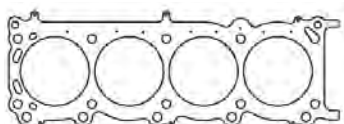

Additional thicknesses available see page 4

Individual Gaskets

Exhaust Manifold Gasket Set	
Application	Part #
VK56VD 2010-2016 MLS	C4959-030

Exhaust Manifold Gasket Set	
Application	Part #
VK56DE 2004-09 Oval Port MLS	C4961-030



Cometic Gasket - An Exclusive NASCAR Performance Product

PEUGEOT/CITROEN

TU5J4 1.6L 16v: 106 1997-05

Head Gaskets

MLS Head Gasket

Bore	Thickness	Pkg Qty	Part #
79mm060"1	C4493-060

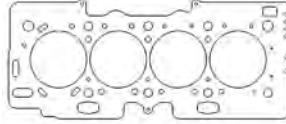

Additional thicknesses available see page 4

XU9J4, XU9J4Z 1.9L DOHC, XU10J2, XU10J4 2.0L 405 M1-16, 605 S/SR1

Head Gaskets

MLS Head Gaskets

Bore	Thickness	Pkg Qty	Part #
84mm051"1	C4225-051
85mm051"1	C4226-051
86.5mm051"1	C4227-051
88mm051"1	C4228-051

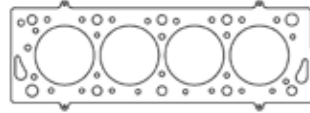

Additional thicknesses available see page 4

PORSCHE

924 2.0L 1976-85

Head Gasket

MLS Head Gasket

Bore	Thickness	Pkg Qty	Part #
88mm050"1	C4542-050

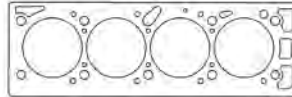

Additional thicknesses available see page 4

944 2.5L 1982-91

Head Gaskets

MLS Head Gasket

Bore	Thickness	Pkg Qty	Part #
100.5mm040"1	C4272-040
103mm040"1	C4273-040

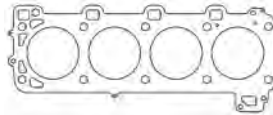

Additional thicknesses available see page 4

Cam Cover Gasket

Application	Part #
944 2.5L 82-91	C4925

Intake Manifold Gasket Set

Application	Part #
944 2.5L 82-91 - 4pcs	C4924

944 2.7L 1989, 3.0L 1989-91

Head Gasket

MLS Head Gasket

Bore	Thickness	Pkg Qty	Part #
106mm040"1	C4274-040

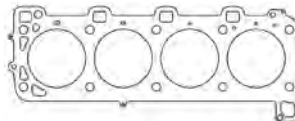

Additional thicknesses available see page 4

Cam Cover Gasket

Application	Part #
944 2.7/3.0L	C4925

Intake Manifold Gasket Set

Application	Part #
944 2.7/3.0L - 4pcs	C4924



Cometic Gasket - An Exclusive NASCAR Performance Product

PORSCHE

996 3.6L Twin Turbo 2001-04

Head Gasket

MLS Head Gasket

Bore	Thickness	Pkg Qty	Part #
102mm040"1	C4492-040

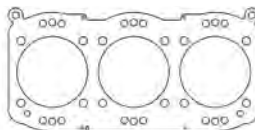

Additional thicknesses available
see page 4

997 3.6L Twin Turbo 2006-08

Head Gasket

MLx Head Gasket

Bore	Thickness	Pkg Qty	Part #
102mm032"1	C4926-032

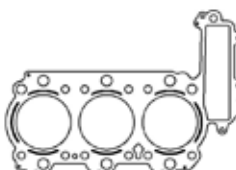

Additional thicknesses available
see page 4

Cayenne GTS 4.5L 2003-06 V8

Head Gaskets

MLS Head Gasket - Left Side

Bore	Thickness	Pkg Qty	Part #
95mm027"1	C4535-027

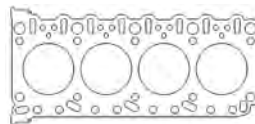

Additional thicknesses available
see page 4

MLS Head Gasket - Right Side

Bore	Thickness	Pkg Qty	Part #
95mm027"1	C4536-027

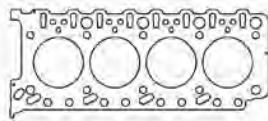

Additional thicknesses available
see page 4

Intake Manifold Gasket Set

Application	Part #
Cayenne 4.5L 03-06 (pair)	C4927

928 4.7/5.0L 1983-97

Head Gaskets

MLS Head Gaskets - Left Side

Bore	Thickness	Pkg Qty	Part #
100mm045"1	C5781-045
104mm045"1	C5783-045

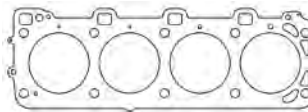

Additional thicknesses available
see page 4

MLS Head Gaskets - Right Side

Bore	Thickness	Pkg Qty	Part #
100mm045"1	C5780-045
104mm045"1	C5782-045

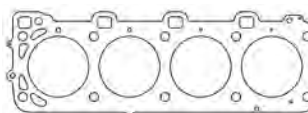

Additional thicknesses available
see page 4



Cometic Gasket - An Exclusive NASCAR Performance Product

RENAULT

F4P 16v 1.8L, F4R 16v 2.0L Laguna 98-Up, Clio 01-Up

Head Gaskets

MLS Head Gaskets

Bore	Thickness	Pkg Qty	Part #
83mm	.030"	1	C4518-030
84.5mm	.030"	1	C4519-030

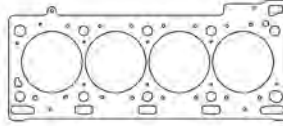

Additional thicknesses available see page 4

F7P 16v 1.8L, F7R 16v 2.0L

R19 89-96, Clio 91-97, Megane Coupe 95-99, Clio Williams 93-95, Spider Sport 1995

Head Gaskets

MLS Head Gaskets

Bore	Thickness	Pkg Qty	Part #
83mm	.051"	1	C4539-051
84mm	.051"	1	C4540-051

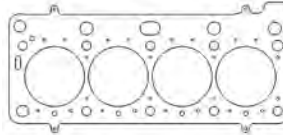

Additional thicknesses available see page 4

ROVER

15G V8 1970-93, 21D-25D V8 1970-93, 35D-38D 1970-93

Range Rover 1970-89, Discovery 1989-93

Head Gaskets

MLS Head Gasket

Bore	Thickness	Pkg Qty	Part #
89mm	.040"	1	C4367-040
94mm	.040"	1	C4368-040
96mm	.040"	1	C4369-040

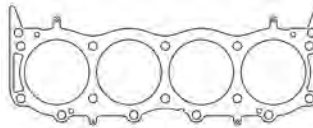

Additional thicknesses available see page 4

35D-38D, 40D, 42D-46D V8 1994-Up Discovery 1994-Up

Head Gaskets

MLS Head Gaskets

Bore	Thickness	Pkg Qty	Part #
89mm	.040"	1	C4366-040
94mm	.040"	1	C4365-040
96mm	.040"	1	C4364-040



Additional thicknesses available see page 4

5.0L V8 "LR-V8"

2009-Up Discovery, Range Rover Sport, Range Rover Sport SC, Range Rover, Range Rover SC

Head Gaskets

MLx Head Gaskets - Left Side

Bore	Thickness	Pkg Qty	Part #
93mm	.040"	1	C15001-040

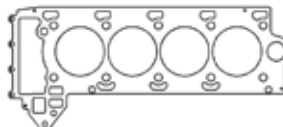

Additional thicknesses available see page 4

MLx Head Gaskets - Right Side

Bore	Thickness	Pkg Qty	Part #
93mm	.040"	1	C15000-040

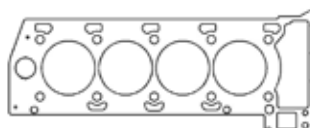

Additional thicknesses available see page 4



Cometic Gasket - An Exclusive NASCAR Performance Product

SUBARU

FA20DIT DOHC 2.0L: 2015+Up WRX

Head Gaskets

MLx Head Gasket - Left Side			
Bore	Thickness	Pkg Qty	Part #
89.5mm032"1	C4954-032

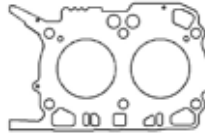

Additional thicknesses available see page 4

MLx Head Gasket - Right Side			
Bore	Thickness	Pkg Qty	Part #
89.5mm032"1	C4955-032

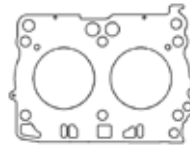

Additional thicknesses available see page 4

FA20 DOHC 2.0L 2012+Up BRZ

Head Gaskets

MLx Head Gasket - Left Side			
Bore	Thickness	Pkg Qty	Part #
89.5mm032"1	C4589-032

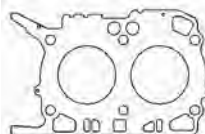

Additional thicknesses available see page 4

MLx Head Gasket - Right Side			
Bore	Thickness	Pkg Qty	Part #
89.5mm032"1	C4588-032

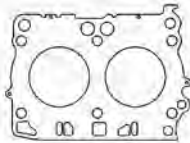

Additional thicknesses available see page 4

EJ20E SOHC 2.0L 16v JDM 1990-97 Legacy, 1995-97 Impreza

Head Gasket

MLS Head Gasket			
Bore	Thickness	Pkg Qty	Part #
93mm040"1	C4260-040

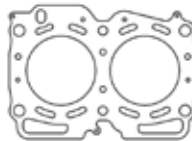

Additional thicknesses available see page 4

EJ205 DOHC 2.0L 16V 2002-05 WRX, 2004-05 Saab 9-2X Aero

Head Gasket

MLx Head Gasket			
Bore	Thickness	Pkg Qty	Part #
93mm041"1	C4590-041

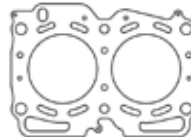

Additional thicknesses available see page 4

Individual Gaskets

Valve Cover Gasket Sets	
Application	Part #
EJ205 02-05 - Left Side	C4863
EJ205 02-05 - Right Side	C4864

Valve Stem Seals (sold individually)	
Application	Part #
EJ205 02-05 - Exhaust (Brown)	3264V
EJ205 02-05 - Intake (Black)	3265V

Intake Manifold Gaskets	
Application	Part #
EJ205 02-05	C4857-039

Rear Main Seal	
Application	Part #
EJ205 02-05	C4856

See page 120 for additional gaskets



Cometic Gasket - An Exclusive NASCAR Performance Product

SUBARU

EJ205 DOHC 2.0L 16V 2002-05 WRX, 2004-05 Saab 9-2X Aero

Individual Gaskets

Exhaust Gaskets

Application	Part #
EJ205 02-05 Manifold MLS (2).....	C4204-030
EJ205 02-05 Exhaust Pipe (2).....	C4856-064
EJ205 02-05 Crossover (2)	C4859-064

Front Crank Seal

Application	Part #
EJ205 02-05.....	C4857

Throttle Body Gasket

Application	Part #
EJ205 02-05	C4855-060

Water Pump Gasket

Application	Part #
EJ205 02-05.....	C4860-018

Cam Seal Set

Application	Part #
EJ205 02-05 - 4 Pack.....	C4858

Thermostat Gasket

Application	Part #
EJ205 02-05.....	C4861

Gasket Kits



GASKET KIT



Application	Part #
EJ205 02-03 93.5mm Bore.....	PRO2044C

GASKET KIT

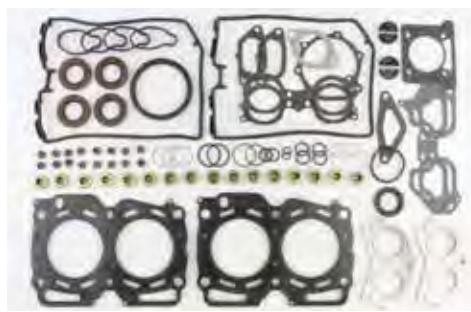

Application	Part #
EJ205 04-05	PRO2023C

EJ22E SOHC 2.2L 16V 1990-96 Legacy, 1993-96 Impreza

Head Gasket

MLS Head Gasket

Bore	Thickness	Pkg Qty	Part #
98mm040"1.....	C4262-040

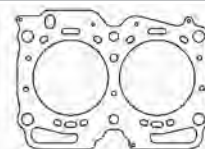

Additional thicknesses available
see page 4

Individual Gaskets

Valve Cover Gasket Set

Application	Part #
EJ22E SOHC.....	C4871

Thermostat Gasket

Application	Part #
EJ22E SOHC.....	C4861

Intake Manifold Gasket Set

Application	Part #
EJ22E SOHC.....	C4868-060

Oil Pan Gasket

Application	Part #
EJ22E SOHC - Cork.....	C4869-125

Exhaust Gaskets

Application	Part #
EJ22E SOHC MLS	C4204-030

Rear Main Seal

Application	Part #
EJ22E SOHC.....	C4856

See page 121 for additional gaskets



Cometic Gasket - An Exclusive NASCAR Performance Product

SUBARU

EJ22E SOHC 2.2L 16v 1990-96 Legacy, 1993-96 Impreza

Throttle Body Gasket	
Application	Part #
EJ22E SOHC.....	C4867-060

Front Crank Seal	
Application	Part #
EJ22E SOHC.....	C4857

Cam Seal Set	
Application	Part #
EJ22E SOHC - 2 pack.....	C4870

Water Pump Gasket	
Application	Part #
EJ22E SOHC.....	C4860-018

Valve Stem Seals (sold individually)	
Application	Part #
EJ22E SOHC - Exhaust (Brown).....	3264V
EJ22E SOHC - Intake (Black).....	3265V

Timing Cover Set	
Application	Part #
EJ22E SOHC.....	C4862

Gasket Kit



GASKET KIT



Application	Part #
EJ22E SOHC 98mm Bore.....	PRO2026C

EJ22ET SOHC 2.2L 16v Turbo 1991-94 Legacy

Head Gasket

MLS Head Gasket			
Bore	Thickness	Pkg Qty	Part #
98mm051"1	C4263-051

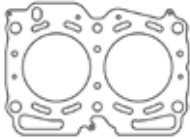

Additional thicknesses available see page 4

Individual Gaskets

Valve Cover Gasket Set	
Application	Part #
EJ22ET SOHC Turbo.....	C4871

Oil Pan Gasket	
Application	Part #
EJ22ET SOHC Turbo.....	C4869-125

Intake Manifold Gasket Set	
Application	Part #
EJ22ET SOHC Turbo.....	C4868-060

Rear Main Seal	
Application	Part #
EJ22ET SOHC Turbo.....	C4856

Cam Seal Set	
Application	Part #
EJ22ET SOHC Turbo - 2pcs.....	C4870

Front Crank Seal	
Application	Part #
EJ22ET SOHC Turbo.....	C4857

Valve Stem Seals (sold individually)	
Application	Part #
EJ22ET SOHC - Exhaust (Brown).....	3264V
EJ22ET SOHC - Intake (Black).....	3265V

Water Pump Gasket	
Application	Part #
EJ22ET SOHC Turbo.....	C4860-018



Cometic Gasket - An Exclusive NASCAR Performance Product

SUBARU

EJ25D DOHC 2.5L 16V 1998 Impreza RS, 1996-99 Legacy/Outback, 1998 Forester

Head Gasket

MLx Head Gasket			
Bore	Thickness	Pkg Qty	Part #
101mm051"1	C4578-051

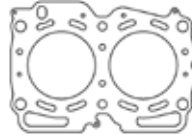

Additional thicknesses available see page 4

Individual Gaskets

Valve Cover Gasket Set	
Application	Part #
EJ25D DOHC	C4873

Thermostat Gasket	
Application	Part #
EJ25D DOHC	C4861

Intake Manifold Gasket Set	
Application	Part #
EJ25D DOHC	C4872-059

Oil Pan Gasket	
Application	Part #
EJ25D DOHC - Cork	C4869-125

Exhaust Gaskets	
Application	Part #
EJ25D DOHC MLS	C4204-030

Timing Cover Set	
Application	Part #
EJ25D DOHC	C4862

Throttle Body Gasket	
Application	Part #
EJ25D DOHC	C4867-060

Rear Main Seal	
Application	Part #
EJ25D DOHC	C4856

Cam Seal Set	
Application	Part #
EJ25D DOHC - 4pcs	C4866

Front Crank Seal	
Application	Part #
EJ25D DOHC	C4857

Valve Stem Seals (sold individually)	
Application	Part #
EJ25D DOHC - Exhaust (Brown)	3264V
EJ25D DOHC - Intake (Black)	3265V

Water Pump Gasket	
Application	Part #
EJ25D DOHC	C4860-018

Gasket Kit



GASKET KIT



Application	Part #
EJ25D DOHC 1996-99 101mm Bore	PRO2025C



Cometic Gasket - An Exclusive NASCAR Performance Product

SUBARU

EJ251/EJ253 SOHC 2.5L 16v

(EJ251): 09/00-03/03 Impreza, 00-02,04 Outback Sport, 11/01-03/04 Forester, 06/99-06/06 Legacy/Outback, 06/02-04/06 Baja

(EJ253): 01/04-Up Forester, 04/03+Up Impreza, 11/03-04/09 Legacy/Outback

Head Gasket

MLx Head Gasket			
Bore	Thickness	Pkg Qty	Part #
101mm032"1	C4578-032

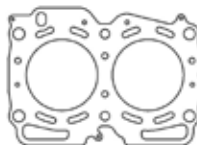

Additional thicknesses available see page 4

Individual Gaskets

Valve Cover Gasket Set	
Application	Part #
EJ251 SOHC	C4642

Throttle Body Gasket	
Application	Part #
EJ251 SOHC	C4874-060

Intake Manifold Gasket Set	
Application	Part #
EJ251 SOHC	C4875-060

Thermostat Gasket	
Application	Part #
EJ251 SOHC	C4861

Exhaust Gaskets	
Application	Part #
EJ251 SOHC MLS	C4204-030

Rear Main Seal	
Application	Part #
EJ251 SOHC	C4856

Cam Seal Set	
Application	Part #
EJ251 SOHC 2pcs	C4870

Front Crank Seal	
Application	Part #
EJ251 SOHC	C4857

Valve Stem Seals (sold individually)	
Application	Part #
EJ251 SOHC - Exhaust (Brown)	3264V
EJ251 SOHC - Intake (Black)	3265V

Water Pump Gasket	
Application	Part #
EJ251 SOHC	C4860-018

Gasket Kit



GASKET KIT



Application	Part #
EJ251 SOHC 1999-05 101mm Bore	PRO2022C



Cometic Gasket - An Exclusive NASCAR Performance Product

SUBARU

EJ253 SOHC 2.5L 16v 02/09-12/14 Legacy/Outback non-turbo

Head Gaskets

MLx Head Gasket - "Improved Cooling Heads"			
Bore	Thickness	Pkg Qty	Part #
101mm032"1	C4622-032

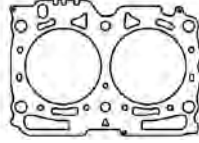

Additional thicknesses available see page 4

Individual Gaskets

Intake Manifold Gasket Set	
Application	Part #
EJ253 SOHC	C4875-060

Thermostat Gasket	
Application	Part #
EJ253 SOHC	C4861

Exhaust Gaskets	
Application	Part #
EJ253 SOHC MLS	C4204-030

Rear Main Seal	
Application	Part #
EJ253 SOHC	C4856

Cam Seal Set	
Application	Part #
EJ253 SOHC 2pcs	C4870

Front Crank Seal	
Application	Part #
EJ253 SOHC	C4857

Valve Stem Seals (sold individually)	
Application	Part #
EJ253 SOHC - Exhaust (Brown)	3264V
EJ253 SOHC - Intake (Black)	3265V

Water Pump Gasket	
Application	Part #
EJ253 SOHC	C4860-018

EJ255 DOHC 2.5L 16v Turbo 02/03-04/06 Baja Turbo3-03/05 Forester XT, 02/03-06/06 Legacy/Outback Turbo

Head Gasket

MLx Head Gasket			
Bore	Thickness	Pkg Qty	Part #
101mm032"1	C4578-032

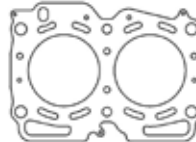

Additional thicknesses available see page 4

EJ255 DOHC 2.5L 16v Turbo 01/05-03/08 Forester XT, 04/05-03/08 Impreza WRX, 11/05-04/09 Legacy/Outback Turbo

Head Gasket

MLx Head Gasket - "Improved Cooling Heads"			
Bore	Thickness	Pkg Qty	Part #
101mm032"1	C4622-032

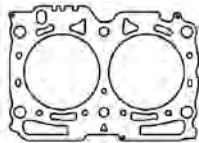

Additional thicknesses available see page 4

Individual Gaskets

Valve Cover Gasket Sets	
Application	Part #
EJ255 06-07 - Left Side	C4880
EJ255 06-07 - Right Side	C4881

Throttle Body Gasket	
Application	Part #
EJ255 DOHC 06-07	C4877-060

Intake Manifold Gasket Set	
Application	Part #
EJ255 DOHC 06-07	C4857-039

Thermostat Gasket	
Application	Part #
EJ255 DOHC 06-07	C4861

See page 125 for additional gaskets



Cometic Gasket - An Exclusive NASCAR Performance Product

SUBARU

EJ255 DOHC 2.5L 16v Turbo 01/05-03/08 Forester XT, 04/05-03/08 Impreza WRX,
11/05-04/09 Legacy/Outback Turbo

Individual Gaskets

Exhaust Gaskets

Application	Part #
EJ255 06-07 Manifold MLS (2).....	C4204-030
EJ255 06-07 Crossover (2).....	C4859-064

Cam Seal Sets

Application	Part #
EJ255 06-07 Exhaust Seals (2).....	C4878
EJ255 06-07 Intake Seals (2).....	C4879

Valve Stem Seals (sold individually)

Application	Part #
EJ255 DOHC - Exhaust (Brown).....	3264V
EJ255 DOHC - Intake (Black).....	3265V

Rear Main Seal

Application	Part #
EJ255 DOHC 06-07.....	C4856

Front Crank Seal

Application	Part #
EJ255 DOHC 06-07.....	C4857

Water Pump Gasket

Application	Part #
EJ255 DOHC 06-07.....	C4860-018

Timing Cover Set

Application	Part #
EJ255 DOHC 06-07.....	C4862

Gasket Kit



GASKET KIT



Application	Part #
EJ255 DOHC 2006-07 101mm Bore.....	PRO2045C

EJ255 DOHC 2.5L 16v Turbo 04/08-Up Forester XT, 04/08-Up Impreza WRX, 02/09-Up Legacy/Outback Turbo

Head Gasket

MLx Head Gasket

Bore	Thickness	Pkg Qty	Part #
101mm032"1.....	C4587-032

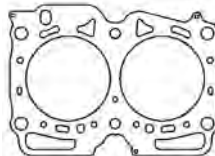

Additional thicknesses available
see page 4

Individual Gaskets

Valve Cover Gasket Sets

Application	Part #
EJ255 08-Up - Left Side.....	C4880
EJ255 08-Up - Right Side.....	C4881

Throttle Body Gasket

Application	Part #
EJ255 DOHC 08-Up.....	C4882

See page 126 for additional gaskets



Cometic Gasket - An Exclusive NASCAR Performance Product

SUBARU

EJ255 DOHC 2.5L 16v Turbo 04/08-Up Forester XT, 04/08-Up Impreza WRX, 02/09-Up Legacy/Outback Turbo

Individual Gaskets

Intake Manifold Gasket Set

Application	Part #
EJ255 DOHC 08-Up	C4857-039

Thermostat Gasket

Application	Part #
EJ255 DOHC 08-Up	C4861

Exhaust Gaskets

Application	Part #
EJ255 08-Up Manifold MLS (2)	C4204-030

Rear Main Seal

Application	Part #
EJ255 DOHC 08-Up	C4856

Cam Seal Sets

Application	Part #
EJ255 08-Up Exh Seals (2)	C4878
EJ255 08-Up Intake Seals (2)	C4879

Front Crank Seal

Application	Part #
EJ255 DOHC 08-Up	C4857

Valve Stem Seals (sold individually)

Application	Part #
EJ255 DOHC - Exhaust (Brown)	3264V
EJ255 DOHC - Intake (Black)	3265V

Water Pump Gasket

Application	Part #
EJ255 DOHC 08-Up	C4860-018

Gasket Kit



GASKET KIT



Application	Part #
EJ255 DOHC 2008-Up 101mm Bore	PRO2046C

EJ257 DOHC 2.5L 16v Turbo 10/02-06/07 Impreza STI

Head Gasket

MLx Head Gasket

Bore	Thickness	Pkg Qty	Part #
101mm032"	1	C4578-032



Additional thicknesses available
see page 4

See page 127 for additional gaskets



Cometic Gasket - An Exclusive NASCAR Performance Product

SUBARU

EJ257 DOHC 2.5L 16v Turbo 10/02-06/07 Impreza STi

Individual Gaskets

Valve Cover Gasket Sets	
Application	Part #
EJ257 04-06 - Left Side.....	C4928
EJ257 04-06 - Right Side.....	C4929
EJ257 2007 - Left Side.....	C4880
EJ257 2007 - Right Side.....	C4881

Throttle Body Gasket	
Application	Part #
EJ257 DOHC 04-07.....	C4877-060

Intake Manifold Gasket Set	
Application	Part #
EJ257 DOHC 04-07.....	C4857-039

Thermostat Gasket	
Application	Part #
EJ257 DOHC 04-07.....	C4861

Exhaust Gaskets	
Application	Part #
EJ257 04-07 Manifold MLS (2).....	C4204-030
EJ257 04-07 Crossover (1).....	C5718

Timing Cover Set	
Application	Part #
EJ257 DOHC 2007.....	C4862

Cam Seal Sets	
Application	Part #
EJ257 04-07 Exh Seals (2).....	C4878
EJ257 04-07 Intake Seals (2).....	C4879

Rear Main Seal	
Application	Part #
EJ257 DOHC 04-07.....	C4856

Valve Stem Seals (sold individually)	
Application	Part #
EJ257 DOHC - Exhaust (Brown).....	3264V
EJ257 DOHC - Intake (Black).....	3265V

Front Crank Seal	
Application	Part #
EJ257 DOHC 04-07.....	C4857

Water Pump Gasket	
Application	Part #
EJ257 DOHC 04-07.....	C4860-018

Gasket Kits



GASKET KIT



Application	Part #
EJ257 DOHC 04-06 101mm Bore.....	PRO2024C

GASKET KIT



Application	Part #
EJ257 DOHC 2007 101mm Bore.....	PRO2047C



Cometic Gasket - An Exclusive NASCAR Performance Product

SUBARU

EJ257 DOHC 2.5L 16v Turbo 04/07-Up Impreza Sti

Head Gasket

MLx Head Gasket			
Bore	Thickness	Pkg Qty	Part #
101mm032"1	C4587-032

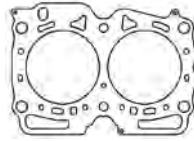

Additional thicknesses available see page 4

Individual Gaskets

Valve Cover Gasket Sets

Application	Part #
EJ257 08+Up - Left Side	C4880
EJ257 08-Up - Right Side	C4881

Throttle Body Gasket

Application	Part #
EJ257 DOHC 08-Up	C4877-060

Intake Manifold Gasket Set

Application	Part #
EJ257 DOHC 08-Up	C4857-039

Thermostat Gasket

Application	Part #
EJ257 DOHC 08-Up	C4861

Exhaust Gaskets

Application	Part #
EJ257 08-Up Manifold MLS (2)	C4204-030
EJ257 08-Up Crossover (1)	C5718

Timing Cover Set

Application	Part #
EJ257 DOHC 08-Up	C4862

Cam Seal Set

Application	Part #
EJ257 08+Up 4pcs	C4876

Rear Main Seal

Application	Part #
EJ257 DOHC 08-Up	C4856

Valve Stem Seals (sold individually)

Application	Part #
EJ257 DOHC - Exhaust (Brown)	3264V
EJ257 DOHC - Intake (Black)	3265V

Front Crank Seal

Application	Part #
EJ257 DOHC 08-Up	C4857

Water Pump Gasket

Application	Part #
EJ257 DOHC 08-Up	C4860-018

Gasket Kit



GASKET KIT



Application	Part #
EJ257 DOHC 08-Up 101mm Bore	PRO2048C



Cometic Gasket - An Exclusive NASCAR Performance Product

SUBARU

EZ30 3.0L Flat 6 Legacy/Outback

Head Gaskets

MLS Head Gasket - Left Side			
Bore	Thickness	Pkg Qty	Part #
90mm040"1	C5861-040

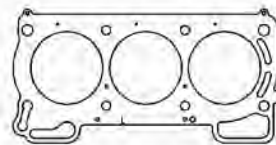

Additional thicknesses available see page 4

MLS Head Gasket - Right Side			
Bore	Thickness	Pkg Qty	Part #
90mm040"1	C5860-040

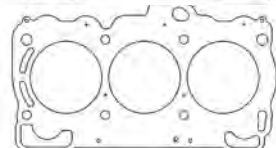

Additional thicknesses available see page 4

EZ30D 3.0L Flat 6 2003-09 Legacy/Outback, 2006-07 Tirbeca

Head Gaskets

MLS Head Gasket - Left Side			
Bore	Thickness	Pkg Qty	Part #
90mm040"1	C4623-040

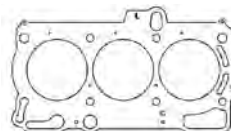

Additional thicknesses available see page 4

MLS Head Gasket - Right Side			
Bore	Thickness	Pkg Qty	Part #
90mm040"1	C4624-040



Additional thicknesses available see page 4

EG33 3.3L Flat 6 3318cc 1992-96 SVX

Head Gaskets

MLS Head Gaskets			
Bore	Thickness	Pkg Qty	Part #
98mm066"1	C4340-066
100mm066"1	C4341-066
102mm066"1	C4342-066

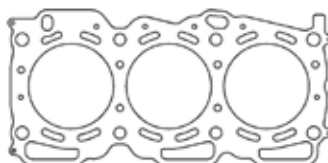

Additional thicknesses available see page 4



Cometic Gasket - An Exclusive NASCAR Performance Product

TOYOTA

3E 1.5L, 4E 1.3L, 5E 1.5L 1986-98 Corolla, Corona, Starlet, Tercel, Paseo, Sera

Head Gaskets

MLS Head Gaskets

Bore	Thickness	Pkg Qty	Part #
75mm	.040"	1	C4602-040
76mm	.040"	1	C4603-040

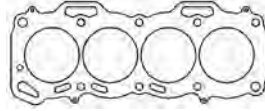

Additional thicknesses available see page 4

2T 1.6l, 2TC 1.6L, 3T 1.8L, 3TC 1.8L 1970-84 Corolla, 1970-76 Sprinter, 1970-76 Celica, 1970-76 Carina, 1970-84 Corona, 1978-84 Camry

Head Gaskets

MLS Head Gaskets

Bore	Thickness	Pkg Qty	Part #
87mm	.040"	1	C4258-040
89mm	.040"	1	C4176-040

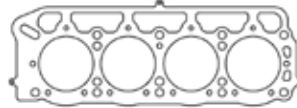

Additional thicknesses available see page 4

Exhaust Manifold Gasket

Application	Part #
3TC 1.8L	C4930

4A-GE, 4A-GEC, 4A-GELC 16v 1587cc 1984-92 Corolla, 1989 Carina, 1989 Sprinter, 1984-89 MR2, 1989-89 Celica

Head Gaskets

MLS Head Gaskets

Bore	Thickness	Pkg Qty	Part #
81mm	.040"	1	C4170-040
83mm	.040"	1	C4166-040

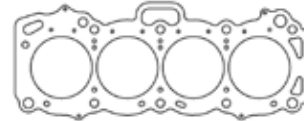

Additional thicknesses available see page 4

Individual Gaskets

Valve Cover Gasket Set

Application	Part #
4A-GE 84-92 16v	C4807

Thermostat Gasket

Application	Part #
4A-GE 84-92 16v	C4809

Intake Gasket Set

Application	Part #
4A-GE 84-92 16v	C4806

Timing Cover Dust Seal Set

Application	Part #
4A-GE 84-92 16v	C4811

Exhaust Manifold Gasket

Application	Part #
4A-GE 84-92 16v .042" AM	C4805-042

Rear Main Seal

Application	Part #
4A-GE 84-92 16v	C4810

Cam Seal Set

Application	Part #
4A-GE 84-92 16v 2pcs	C4808

Front Crank Seal

Application	Part #
4A-GE 84-92 16v	C4931

Valve Stem Seals (sold individually)

Application	Part #
4A-GE 84-92 16v	3225V

Water Pump Gasket

Application	Part #
4A-GE 84-92 16v	C4812-039

See page 131 for StreetPro gasket kits



Cometic Gasket - An Exclusive NASCAR Performance Product

TOYOTA

4A-GE, 4A-GEC, 4A-GELC 16v 1587CC 1984-92 Corolla, 1989 Carina, 1989 Sprinter,
1984-89 MR2, 1989-89 Celica

Gasket Kits

TOP END GASKET KIT

TOP END GASKET KIT



Application	Part #
4A-GE 84-92 16v 81mm Bore	PRO2041T

Application	Part #
4A-GE 84-92 16v.....	PRO2041B

4A-GE 1.6L 20v 1587CC 1991-95 Corolla, 1996-01 Carina, 1991-00 Sprinter

Head Gaskets

MLS Head Gaskets			
Bore	Thickness	Pkg Qty	Part #
81mm	.040"	1	C4604-040
83mm	.040"	1	C4605-040

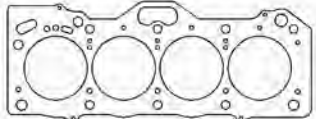

Additional thicknesses available see page 4

Individual Gaskets

Intake Manifold Gasket	
Application	Part #
4A-GE 20v Small Port	C4932-031

Exhaust Manifold Gasket	
Application	Part #
4A-GE 20v .064" AM.....	C4933-064

1ZZ-FE 1.8L DOHC 1997-08

Head Gaskets

MLS Head Gaskets			
Bore	Thickness	Pkg Qty	Part #
80mm	.027"	1	C4496-027
82mm	.027"	1	C4497-027

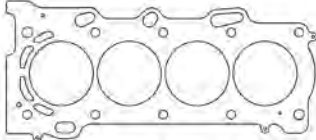

Additional thicknesses available see page 4

Individual Gaskets

Intake Manifold Gasket	
Application	Part #
1ZZ-FE .032" AFM	C4934-032

Exhaust Manifold Gasket	
Application	Part #
1ZZ-FE 98-02 .030" MLS.....	C4205-030



Cometic Gasket - An Exclusive NASCAR Performance Product

TOYOTA

2ZZ-GE 1.8L DOHC 1795cc:

2000-05 Celica, 2005-06 Corolla, 2003-06 Matrix/Vibe, 2005-11 Lotus Elise, 2006-10 Lotus Exige

Head Gasket

MLx Head Gasket

Bore	Thickness	Pkg Qty	Part #
82.5mm028"1	C4962-028

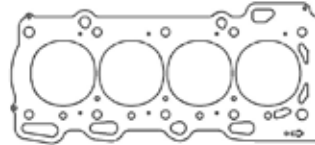

Additional thicknesses available see page 4

3S-GE/3S-GTE 2.0L DOHC Turbo 1998cc 1989-94 Celica, 1990-94 MR2

Head Gasket

MLS Head Gasket

Bore	Thickness	Pkg Qty	Part #
87mm040"1	C4314-040

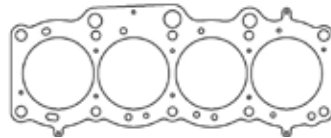

Additional thicknesses available see page 4

Individual Gaskets

Valve Cover Gasket Set

Application	Part #
3S-GT/GTE 91-95	C4608

Oil Pan Gasket

Application	Part #
3S-GT/GTE 91-95	C4817-062

Intake Manifold Gasket Set

Application	Part #
3S-GT/GTE 88-95	C4813

Timing Cover Dust Seal Set

Application	Part #
3S-GT/GTE 89-94	C4811

Exhaust Manifold Gasket

Application	Part #
3S-GT/GTE 89-95 MLS	C4206-030

Water Pump Gasket

Application	Part #
3S-GT/GTE 89-94	C4818-031

Cam Seal Set

Application	Part #
3S-GT/GTE 89-95	C4808

Rear Main Seal Set

Application	Part #
3S-GT/GTE 89-94	C4815

Valve Stem Seals (sold individually)

Application	Part #
3S-GT/GTE 89-95	3225V

Oil Pump Gasket Set

Application	Part #
3S-GT/GTE 89-94	C4816

Gasket Kits



TOP END GASKET KIT



Application	Part #
3S-GT/GTE 89-94 87mm Bore	PRO2019T

BOTTOM END GASKET KIT



Application	Part #
3S-GT/GTE 89-94	PRO2019B



Cometic Gasket - An Exclusive NASCAR Performance Product

TOYOTA

3S-GE/3S-GTE 2.0L DOHC Turbo 3rd Gen, ST205 1994-99

Head Gasket

MLS Head Gasket			
Bore	Thickness	Pkg Qty	Part #
87mm	.040"	1	C4606-040

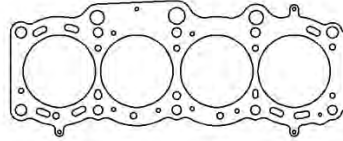

Additional thicknesses available see page 4

20R 2.2L 1974-81 Corona, 1974-81 Celica, 1974-81 Hi-Lux

Head Gasket

MLS Head Gasket			
Bore	Thickness	Pkg Qty	Part #
92mm	.040"	1	C4268-040

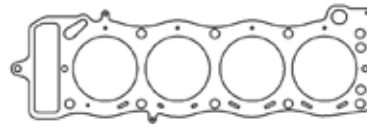

Additional thicknesses available see page 4

5S-FE 2.2L 2164CC 1990-97 Camry, 1990-97 Celica, 1990-97 MR2

Head Gasket

MLS Head Gasket			
Bore	Thickness	Pkg Qty	Part #
88mm	.040"	1	C4315-040

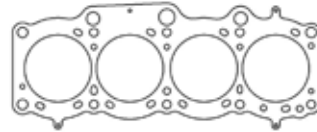

Additional thicknesses available see page 4

Individual Gaskets

Valve Cover Gasket Set	
Application	Part #
5S-FE 1990-97	C4820

Oil Pan Gasket	
Application	Part #
5S-FE 1990-97	C4817-062

Intake Manifold Gasket Set	
Application	Part #
5S-FE 1990-97	C4819-046

Water Pump Gasket	
Application	Part #
5S-FE 1990-97	C4825-031

Exhaust Manifold Gasket	
Application	Part #
5S-FE 1990-97 MLS	C4206-030

Rear Main Seal Set	
Application	Part #
5S-FE 1990-97	C4823

Cam Seal Set	
Application	Part #
5S-FE 1990-97	C4821

Oil Pump Gasket Set	
Application	Part #
5S-FE 1990-97	C4824

Valve Stem Seals (sold individually)	
Application	Part #
5S-FE 1990-97	3225V

Thermostat Gasket Set	
Application	Part #
5S-FE 1990-97	C4822



Cometic Gasket - An Exclusive NASCAR Performance Product

TOYOTA

5S-FE 2.2L 2164CC 1990-97 Camry, 1990-97 Celica, 1990-97 MR2

Gasket Kits



TOP END GASKET KIT



Application	Part #
5S-FE 1990-97 88mm Bore.....	PRO2042T

BOTTOM END GASKET KIT



Application	Part #
5S-FE 1990-97	PRO2042B

22R/22R-TEC 2.4L 1982-85 Celica, 1981-95 Hi-Lux, 1981-82 Corona, 1984-95 4 Runner

Head Gasket

MLS Head Gasket

Bore	Thickness	Pkg Qty	Part #
95mm040"	1.....	C4269-040

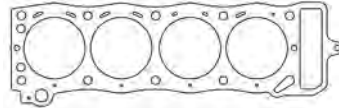

Additional thicknesses available
see page 4

Individual Gaskets

Valve Cover Gasket Set

Application	Part #
22R 2.4L 81-85.....	C4935

Oil Pan Gasket

Application	Part #
22R 2.4L 81-85.....	C4940

Intake Manifold Gasket Set

Application	Part #
22R 2.4L 81-85.....	C4936

Water Pump Gasket Set

Application	Part #
22R 2.4L 81-85.....	C4941

Exhaust Manifold Gaskets

Application	Part #
22R 2.4L 81-82.....	C4937-064
22R 2.4L 83-84.....	C4938-064
22R 2.4L 85-87.....	C4939-064

Timing Cover Sets

Application	Part #
22R 2.4L 81-84.....	C4942
22R 2.4L 1985	C4943

Valve Stem Seals (sold individually)

Application	Part #
22R 2.4L 81-85.....	3157V

Oil Pan Gasket

Application	Part #
22R 2.4L 81-85.....	C4944



Cometic Gasket - An Exclusive NASCAR Performance Product

TOYOTA

2RZ-FE 2.4L 1995-04, 3RZ-FE 2.7L 1997-04

Head Gaskets

MLS Head Gaskets			
Bore	Thickness	Pkg Qty	Part #
96mm040"1	C4598-040
97mm040"1	C4245-040

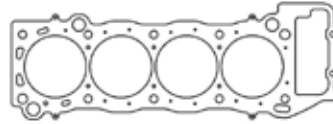

Additional thicknesses available see page 4

Individual Gaskets

Valve Cover Gasket Set	
Application	Part #
2RZ/3RZ 97-04.....	C4830

Thermostat Gasket Set	
Application	Part #
2RZ/3RZ 97-04.....	C4831

Intake Manifold Gaskets	
Application	Part #
2RZ/3RZ 95-99	C4826-018
2RZ/3RZ 95-99 Plenum.....	C4827-032
2RZ/3RZ 99-04.....	C4828-032
2RZ/3RZ 99-04 Plenum.....	C4829-032

Oil Pan Gasket	
Application	Part #
2RZ/3RZ 97-04.....	C4834

Exhaust Manifold Gasket	
Application	Part #
2RZ/3RZ 97-04 MLS	C4207-030

Timing Cover Sets	
Application	Part #
2RZ/3RZ 97-04.....	C4833

Valve Stem Seals (sold individually)	
Application	Part #
2RZ/3RZ 97-04.....	3225V

Water Pump Gasket	
Application	Part #
2RZ/3RZ 97-04.....	C4835-020

Rear Main Seal Set	
Application	Part #
2RZ/3RZ 97-04.....	C4835-020

Gasket Kits



TOP END GASKET KIT



Application	Part #
2RZ/3RZ 97-04 97mm Bore	PRO2043T

BOTTOM END GASKET KIT



Application	Part #
2RZ/3RZ 97-04.....	PRO2043B



Cometic Gasket - An Exclusive NASCAR Performance Product

TOYOTA

2AZ-FE 2.4L DOHC 2002-09 Camry, 2009-11 Matrix, 2009-10 Pontiac Vibe, 2009-11 Corolla ZRS,
2002-09 Solara, 2004-08 RAV4, 2001-08 Highlander, 2005-10 Scion tC, 2008-12 Scion xB

Head Gaskets

MLS Head Gaskets

Bore	Thickness	Pkg Qty	Part #
89mm	.027"	1	C4507-027
92mm	.027"	1	C4506-027

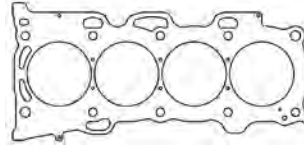

Additional thicknesses available
see page 4

Individual Gaskets

Exhaust Manifold Gasket

Application	Part #
2AZ-FE .030" MLS	C4203-030

7M-GE/7M-GTE 3.0L Inline 6 24v 2954cc 1986-92 Supra, 1988-92 Cressida

Head Gaskets

MLS Head Gaskets

Bore	Thickness	Pkg Qty	Part #
84mm	.051"	1	C4278-051
86mm	.051"	1	C4275-051

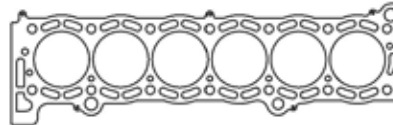

Additional thicknesses available
see page 4

Individual Gaskets

Valve Cover Gasket Set

Application	Part #
7M-GE/GTE 86-92	C4838

Thermostat Gasket

Application	Part #
7M-GE/GTE 86-92	C4839

Intake Manifold Gasket Set

Application	Part #
7M-GE/GTE 86-92	C4837-031

Oil Pan Gasket

Application	Part #
7M-GE/GTE 86-92	C4845-062

Exhaust Manifold Gasket

Application	Part #
7M-GE/GTE 86-92 MLS	C4208-030

Timing Cover Set

Application	Part #
7M-GE/GTE 86-92	C4844

Cam Seal Set

Application	Part #
7M-GE/GTE 86-92 2pcs	C4808

Water Pump Gasket Set

Application	Part #
7M-GE/GTE 86-92	C4846-031

Valve Stem Seals (sold individually)

Application	Part #
7M-GE/GTE 86-92	3225V

Rear Main Seal Set

Application	Part #
7M-GE/GTE 86-92	C4843

Throttle Body Gasket

Application	Part #
7M-GE/GTE 86-92	C4836-032

Front Crank/Balance Shaft Seals

Application	Part #
7M-GE/GTE 86-92 Front Crank	C4945
7M-GE/GTE 86-92 Balance Shaft	C4946

See page 137 for StreetPro gasket kits



Cometic Gasket - An Exclusive NASCAR Performance Product

TOYOTA

7M-GE/7M-GTE 3.0L Inline 6 24v 2954cc 1986-92 Supra, 1988-92 Cressida

Gasket Kits



TOP END GASKET KIT



Application	Part #
7M-GE/GTE 86-92 84mm Bore.....	PRO2020T

BOTTOM END GASKET KIT



Application	Part #
7M-GE/GTE 86-92.....	PRO2020B

2JZ-GE/GTE 3.0L Inline 6 24v 1993-02 Supra, 1993-95 GS300, 1993-00 SC300

Head Gasket

MLS Head Gasket

Bore	Thickness	Pkg Qty	Part #
87mm	.051"	1	C4276-051

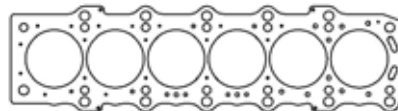

Additional thicknesses available see page 4

Individual Gaskets

Valve Cover Gasket Set

Application	Part #
2JZ-GE/GTE.....	C4851

Throttle Body Gasket

Application	Part #
2JZ-GE.....	C4848

Intake Manifold Gasket

Application	Part #
2JZ-GE.....	C4849

Thermostat Gasket Set

Application	Part #
2JZ-GE/GTE.....	C4852

Exhaust Manifold Gaskets

Application	Part #
2JZ-GE .064" AM.....	C4847-064
2JZ-GTE .030" MLS.....	C4209-030

Water Pump Gasket

Application	Part #
2JZ-GE/GTE.....	C4854-031

Cam Seal Set

Application	Part #
2JZ-GE.....	C4849

Rear Main Seal

Application	Part #
2JZ-GE/GTE.....	C4853

Valve Stem Seals (sold individually)

Application	Part #
2JZ-GE/GTE.....	3225V

See page 138 for additional gaskets



Cometic Gasket - An Exclusive NASCAR Performance Product

TOYOTA

2JZ-GE/GTE 3.0L Inline 6 24v 1993-02 Supra, 1993-95 GS300, 1993-00 SC300

Gasket Kits



TOP END GASKET KIT



Application	Part #
2JZ-GE 93-98 87mm Bore	PRO2021T

BOTTOM END GASKET KIT



Application	Part #
2JZ-GE/GTE 93-98.....	PRO2021B

5VZ-FE 3.4L V6 95-99 Tacoma, 95-98 T100, 95-99 4 Runner, 00 Tundra, 96-99 Landcruiser, 00 Hi-Lux

Head Gaskets

MLS Head Gasket - Left Side

Bore	Thickness	Pkg Qty	Part #
98mm040"	1.....	C4215-040

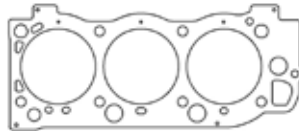

Additional thicknesses available see page 4

MLS Head Gasket - Right Side

Bore	Thickness	Pkg Qty	Part #
98mm040"	1.....	C4214-040

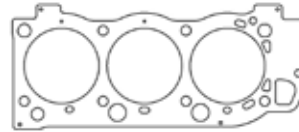

Additional thicknesses available see page 4

1UZ-FE 4.0L 32v V8 w/o VVTi 98-00 GS400, 91-00 LS400, 91-97 SC400

Head Gaskets

MLS Head Gasket - Left Side

Bore	Thickness	Pkg Qty	Part #
92.5mm051"	1.....	C4137-051

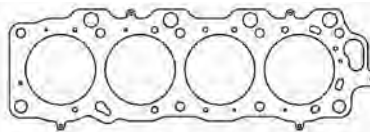

Additional thicknesses available see page 4

MLS Head Gasket - Right Side

Bore	Thickness	Pkg Qty	Part #
92.5mm051"	1.....	C4136-051

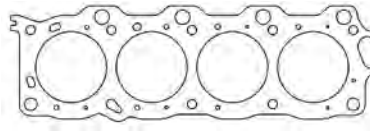

Additional thicknesses available see page 4



Cometic Gasket - An Exclusive NASCAR Performance Product

TOYOTA

2GR-FE 3.5L V6 3456CC 2005 Avalon, 2006 RAV4, 2008 Highlander

Head Gaskets

MLS Head Gasket - Left Side			
Bore	Thickness	Pkg Qty	Part #
94.5mm045"1	C4582-045

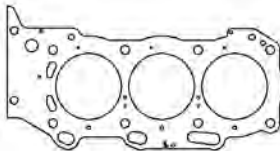

Additional thicknesses available see page 4

MLS Head Gasket - Right Side			
Bore	Thickness	Pkg Qty	Part #
94.5mm045"1	C4581-045



Additional thicknesses available see page 4

1GR-FE 4.0L V6 2002-Up FJ Cruiser, Landcruiser

Head Gaskets

MLS Head Gasket - Left Side			
Bore	Thickness	Pkg Qty	Part #
95.5mm027"1	C4556-027

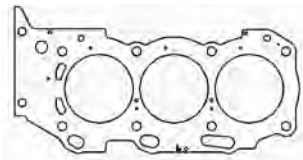

Additional thicknesses available see page 4

MLS Head Gasket - Right Side			
Bore	Thickness	Pkg Qty	Part #
95.5mm027"1	C4557-027

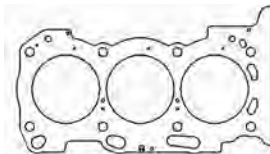

Additional thicknesses available see page 4

1FZ-FE 4.5L DOHC Inline 6 1995-98 Landcruiser, 1995-98 Lexus 450

Head Gaskets

MLS Head Gasket			
Bore	Thickness	Pkg Qty	Part #
101.5mm053"1	C4530-053

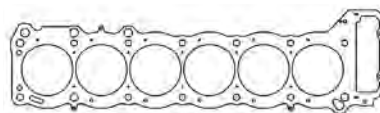

Additional thicknesses available see page 4

MLx Head Gasket			
Bore	Thickness	Pkg Qty	Part #
101.5mm040"1	C4611-040

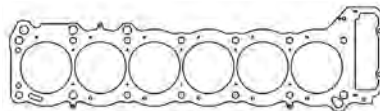

Additional thicknesses available see page 4



Cometic Gasket - An Exclusive NASCAR Performance Product

TOYOTA

2UZ-FE 4.7L 32v V8 1998 Landcruiser, 2004 GX470, 2004 4 Runner, 2001-04 Tundra,
2001-04 Sequoia, 1998-00 LX470

Head Gaskets

MLS Head Gaskets - Left Side

Bore	Thickness	Pkg Qty	Part #
92mm040"1	C4358-040
98mm040"1	C4212-040

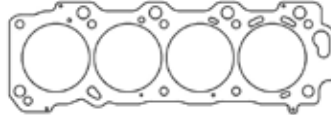

Additional thicknesses available
see page 4

MLS Head Gaskets - Right Side

Bore	Thickness	Pkg Qty	Part #
92mm040"1	C4357-040
98mm040"1	C4211-040

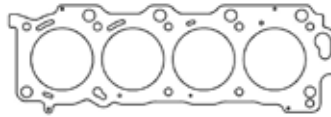

Additional thicknesses available
see page 4

PH11 Race V8

Head Gaskets

MLS Head Gasket - Left Side

Bore	Thickness	Pkg Qty	Part #
4.200"040"1	C5584-040

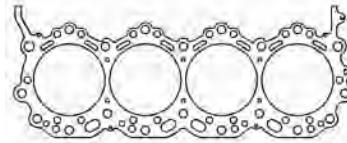

Additional thicknesses available
see page 4

MLS Head Gasket - Right Side

Bore	Thickness	Pkg Qty	Part #
4.200"040"1	C5583-040

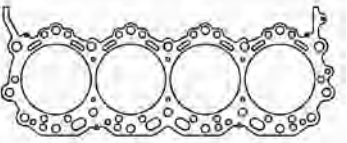

Additional thicknesses available
see page 4

TRIUMPH

1966-74 Spitfire 1500cc

Head Gasket

Copper Head Gasket

Bore	Thickness	Pkg Qty	Part #
74mm043"1	C4153-043

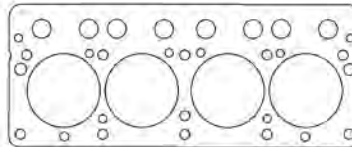

Additional thicknesses available
see page 4

1961-65 TR4 2138cc Pushrod

Head Gasket

CFM-20 Head Gasket

Bore	Thickness	Pkg Qty	Part #
88mm043"1	C4152-043

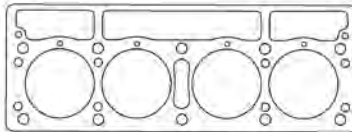

Additional thicknesses available
see page 4

1969-71 TR6 2498cc Inline 6 Pushrod

Head Gasket

Copper Head Gasket

Bore	Thickness	Pkg Qty	Part #
76mm043"1	C4154-043

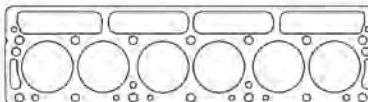

Additional thicknesses available
see page 4



Cometic Gasket - An Exclusive NASCAR Performance Product

TVR

Speed 6 3.6/4.0L 1999-06 Tuscon, 1996-06 Cerbera, 2002-06 Tamora, 2002-06 T350, 2004-06 Sagaris

Head Gaskets

MLS Head Gasket			
Bore	Thickness	Pkg Qty	Part #
96.5mm060"1	C4527-060

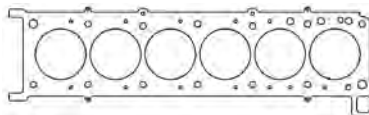

Additional thicknesses available see page 4

VAUXHALL/OPEL

C16XE, X16XE/X16XEL, Y16XE 1994-98 Astra, 1993-94 Corsa B GSI, 1994-00 Tigra 16v

Head Gasket

MLS Head Gasket			
Bore	Thickness	Pkg Qty	Part #
82mm051"1	C4257-051

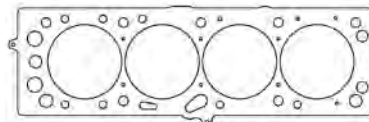

Additional thicknesses available see page 4

20XE/C20XE/X20LET 1992-97 Calibra Turbo, 1987-91 Kadett E 16v, 1993-95 Vectra A Turbo

Head Gasket

MLS Head Gasket			
Bore	Thickness	Pkg Qty	Part #
88mm051"1	C4216-051

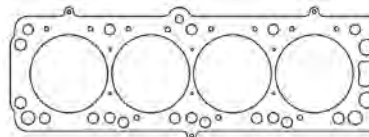

Additional thicknesses available see page 4

MLx Head Gasket			
Bore	Thickness	Pkg Qty	Part #
88mm050"1	C4960-050

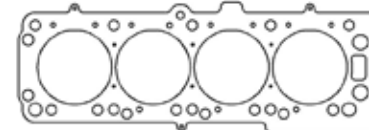

Additional thicknesses available see page 4

CIH/E, CIH/S, CIH/S/E 2.0L 1983-88 Manta B, 1978-81 Ascona, 1976-80 Rekord, 1983-84 Monza, 1977-79 Kadett,

Head Gasket

MLS Head Gasket			
Bore	Thickness	Pkg Qty	Part #
97mm051"1	C4512-051

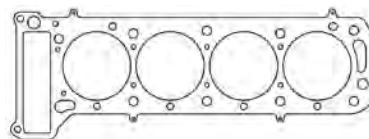

Additional thicknesses available see page 4



Cometic Gasket - An Exclusive NASCAR Performance Product

VOLKSWAGEN/AUDI

1.8L

AGB, 2H, GX, HT, JH, JN, MZ, PG, PF, RD, RV, PL 2.0L: 9A - Golf Mk2/Mk3, Jetta Mk2/Mk3, Passat B2/B3/B4, Audi 80/100, Seat Ibiza Mk2

Head Gaskets

MLS Head Gaskets

Bore	Thickness	Pkg Qty	Part #
83mm051"1	C4247-051
85mm051"1	C4246-051

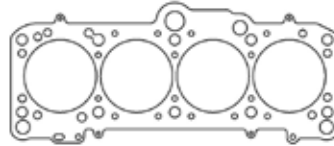

Additional thicknesses available see page 4

Individual Gaskets

Exhaust Manifold Gasket Sets

Application	Part #
1.8L 8v MLS - 4pcs.....	C4163-030
1.8L 16v MLS - 4pcs.....	C4210-030

1.8L Turbo 1998-06

AEB, AGU, AJH, APH, ARX, ARZ, ATW, AUM, AVC, AWD, AWL, AWT, AWW, BJX, BKF, BKV, CFMA, AYP, CED, AMB, AWM, AJQ, APP, ARY, ATC, AUQ, AWP, BEK, BNU, BEX, BVR, AMU, AMK, BAM, BEA

Head Gaskets

MLS Head Gaskets

Bore	Thickness	Pkg Qty	Part #
82mm051"1	C4558-051
85mm051"1	C4559-051

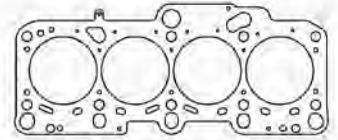

Additional thicknesses available see page 4

2.0L TFSI 16v DOHC

Golf GTI 2004-Up, A3, A4, A6, Jetta, Passat 2005-Up, TT, EOS 2006-Up, Seat Leon 2005-Up (AXX, BPY, BWA, BPJ, BUL, BWE, BRC, BWT, BYK)

Head Gasket

MLS Head Gasket

Bore	Thickness	Pkg Qty	Part #
83.5mm051"1	C4541-051

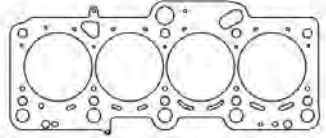

Additional thicknesses available see page 4



Cometic Gasket - An Exclusive NASCAR Performance Product

VOLVO

B18A/B/D 1.8L 1961-68, B20A/B/E/F 2.0L 1969-81

Head Gasket

MLS Head Gasket			
Bore	Thickness	Pkg Qty	Part #
86mm045"1	C4287-045
90mm045"1	C4288-045
92mm045"1	C4289-045

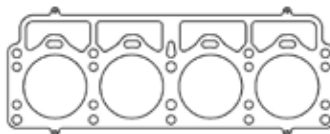

Additional thicknesses available see page 4

B19A/E/ET 2.0L 1976-84, B20E/F/K/ET/FT 2.0L 1985-95, B21E/F/T/FT 2.1L 1975-85

Head Gasket

MLS Head Gasket			
Bore	Thickness	Pkg Qty	Part #
92mm045"1	C4498-045

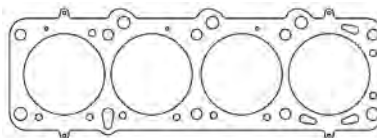

Additional thicknesses available see page 4

B23AE/E/F/FT 2.3L 1978-84, B230A/E/F/FT/K 2.3L 1985-98, B243F 1989-95

Head Gasket

MLS Head Gasket			
Bore	Thickness	Pkg Qty	Part #
97mm045"1	C4499-045

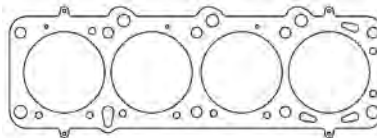

Additional thicknesses available see page 4



Cometic Gasket - An Exclusive NASCAR Performance Product

MLS

Exhaust Manifold Gaskets

- Designed for extreme cylinder pressures
- Maintains a torque set
- Resists corrosion, will not burn through or push out
- Withstands different combinations of cylinder head & exhaust manifold materials
- No sealants are required



Domestic Exhaust Gaskets

Description	Material	Pkg Qty	Part#
CHRYSLER / DODGE			
318, 340 & 360			
1.310" x 1.640" Port	MLS .030"	2	C5901-030
361, 383, 400, 413, 426 & 440			
1.780" x 1.460" Port	MLS .030"	2	C5902-030
426 Hemi			
1.840" x 1.890" Port Stock	MLS .030"	2	C5965-030
2.310" x 2.810" Port Top Fuel	MLS .030"	2	C5903-030
5.7L Hemi V8			
1.460" x 1.390" Port	MLS .030"	2	C5854-030
6.1L Hemi V8			
2.082" x 1.508" Port	MLS .030"	2	C5872-030
Viper V10			
Gen I 1992-96	MLS .030"	2	C5679-030
Gen II 1996-02	MLS .020"	2	C5825-020
Gen III 2003-07	MLS .030"	2	C5865-030
Gen IV 2008-12	MLS .040"	2	C15150-040
CUMMINS			
5.9L 12V I6 Diesel 92-97	MLS .040"	2	C5725-040
5.9L 24V / Common Rail 98-08	MLS .040"	2	C5726-040
FORD			
289, 302 & 351			
1.120" x 1.480" Port Square	MLS .030"	2	C5898-030
1.127" x 1.750" Port Oval	MLS .030"	2	C5899-030
All Yates Head 3 Piece Spring Steel	MLS .040"	8	C5665-040
332 & 390			
1.560" x 2.320" Port	MLS .030"	1	C5922-030
4.6L DOHC & SOHC, 5.4L SOHC			
4.6L / 5.4L 3V Head	MLS .030"	2	C5852-030
4.6L / 5.4L 3V Head D-Ports	MLS .030"	2	C5997-030
4.6L SOHC 1991-01, 5.4L Triton 99-Up	MLS .030"	2	C5853-030
4.6L / 5.4L DOHC 93-99	MLS .030"	2	C5012-030
5.0L Modular V8 2011	MLS .030"	2	C5392-030
5.4L Shelby Mustang 2007	MLS .030"	2	C5805-030
6.2L "BOSS" V8 2010+	MLS .030"	2	C5041-030
429 & 460			
1.250" x 2.080" Oval Port	MLS .030"	2	C5900-030
1.550" x 2.350" Oval Port	MLS .030"	2	C5998-030
RACE			
JC50 500ci - Pro Stock	MLS .030"	2	C5257-030
FR9 V8	MLS .030"	2	C15107-030
DIESEL			
6.0/6.4L Powerstroke	MLS .300"	2	C5089-030
GM			
V8 Small Block 262, 265, 283, 302, 307, 327, 350, 400 & LT1			
1.400" Square Port	MLS .030"	2	C5548-030
1.500" Round Port	MLS .030"	2	C5891-030
1.450" x 1.480" Port	MLS .030"	2	C5892-030
1.625" Round Port	MLS .030"	2	C5893-030
1.450" x 1.600" Port	MLS .030"	2	C5894-030
LT1 1.520" x 1.510" Port	MLS .030"	2	C5895-030
Brodix 12B Raised D Port	MLS .030"	2	C5927-030
Brodix / Weldtech 12 x 12 D Port	MLS .030"	2	C5928-030
GM/Brodix 13 Degree 4.4/4.5" Spacing	MLS .030"	2	C5039-030
Brodix/All Pro 286	MLS .030"	2	C5040-030
SB2 Race			
1.500" x 1.600"	MLS .065"	2	C5552-065
SB2	MLS .030"	2	C5836-030
Big Block			
1.920" Round Port	MLS .030"	2	C5896-030
2.000" Round Port	MLS .030"	2	C5349-030
2.130" Round Port	MLS .030"	2	C5996-030
2.200" Round Port	MLS .030"	2	C5350-030
2.250" Round Port	MLS .030"	2	C5251-030
1.850" x 1.900" Port	MLS .030"	2	C5897-030
Mercury Big Block 1050	MLS .051"	2	C5820-051

Description	Material	Pkg Qty	Part#
GM			
LS Series V8			
LS Series V8	MLS .030"	2	C5818-030
LS7 D-Port 06-14	MLS .030"	2	C5073-030
GEN V LT1 6.2L 1.920" Port	MLS .021"	2	C5020-021
DIESEL			
6.6L Duramax 01-04	MLS .030"	2	C15042-030
Pontiac V8 326, 350, 400, 421, 428 & 455			
D Port	MLS .030"	2	C5905-030
OLDS			
330, 350, 400, 403 & 455			
1.450" x 1.920" Port	MLS .030"	2	C5904-030
UNIVERSAL Header Collector			
3.000" Dia. x 3.875" Bolt Circle	MLS .030"	1	C5907-030

Import Exhaust Gaskets

Description	Material	Pkg Qty	Part#
GM			
Ecotec 2.2L - 1.720" x 1.090" 00-Up	MLS .030"	1	C4150-030
HONDA			
All B Series - 1.850" x 1.340" 94-01			
H22A1/A2/A4 - 1.770" x 1.380" 92-01	MLS .030"	1	C4155-030
F20C1/C2 - 2.030" x 1.730" 00-Up	MLS .030"	1	C4159-030
K20A1/A3 - 1.820" x 1.540" 01-04	MLS .030"	1	C4160-030
K20A2 - 1.975" x 1.730" 02-06	MLS .030"	1	C4162-030
D15/16 - 1.860" x 1.390" 92-00	MLS .030"	1	C4164-030
MAZDA			
B6 16V - 1.765" x 1.020" 89-93	MLS .030"	1	C4165-030
FS-DE - 2.045" x 1.375" 91-03	MLS .030"	1	C4171-030
MITSUBISHI			
4G63T/4G64 - 2.287" x 1.615" 89-99	MLS .030"	1	C4199-030
420A - 2.040" x 1.100" 95-98	MLS .030"	1	C4161-030
NISSAN			
CA18 DOHC - 1.621" x 1.232"	MLS .030"	1	C4523
SR20DE/T - 2.050" x 1.580" 91-02	MLS .030"	1	C4200-030
KA24DE - 1.575" Square 91-98	MLS .030"	1	C4201-030
RB26 - 1.665" x 1.420" 89-02	MLS .030"	2	C4202-030
RB20/RB25 - 1.340" x 1.575"	MLS .030"	1	C4177-030
SCION			
2AZ-FE 2.4L - 1.890" Round 01-Up	MLS .030"	1	C4203-030
SUBARU			
All EJ Motors - 1.825" Round 93-Up	MLS .030"	2	C4204-030
TOYOTA			
1ZZFE - 1.732" Round 98-02	MLS .030"	1	C4205-030
3S-GTE/5S-FE - 1.690" x 1.415" 89-97	MLS .030"	1	C4206-030
2RZ/3RZ-FE - 1.730" x 1.460" 95-Up	MLS .030"	1	C4207-030
7MGTE - 1.412" Round 87-92	MLS .030"	1	C4208-030
2JZGTE - 1.600" x 1.220" 93-Up	MLS .030"	2	C4209-030
VW			
1.8L 8V - 1.060" x 1.480" 77-99	MLS .030"	4	C4163-030
1.8L 16V - 1.525" Round 85-96	MLS .030"	4	C4210-030

Turbo Flange Gaskets

Description	Material	Pkg Qty	Part#
Garrett T25 Turbo	.010" S/S	1	C4515
Garrett T4 Turbo	.010" S/S	1	C4516
T3/T4 Turbo	.010" S/S	1	C4514
T6 Turbo	.010" S/S	1	C4517
T Series/Super T Turbo	.010" S/S	1	C4513



Cometic Gasket - An Exclusive NASCAR Performance Product

Valve Stem Seals

Available for most applications ranging from automotive to off road dirt bikes. Valve stem seals are defined first by the actual measurement of the valve stem OD itself then by the guide OD. Proper seal height and width will be determined by valve spring clearance. **Sold in packs of sixteen.**



Umbrella



Positive All Rubber



Positive Ring & Spring



Positive Ring & Band



O-Ring



Metal Jacket



Metal Jacket "Hat"

Metric Valve Stem

Part #	Stem OD	Guide OD	Height	OD	Type / Matl.
3154V-16	8.0mm	12.0mm	9.6mm	15.5mm	Metal Jacket/Viton
3158V-16	6.0mm	10.7mm	11.5mm	13.8mm	Metal Jacket/Viton
3159V-16	6.0mm	11.75mm	15.0mm	14.6mm	Metal Jacket/Viton
3162V-16	7.0mm	15.0mm	14.0mm	14.3mm	Metal Jacket/Viton
3163V-16	5.5mm	11.8mm	12.0mm	14.8mm	Metal Jacket/Viton
3164V-16	8.0mm	12.3mm	12.0mm	17.0mm	Ring & Band/Viton
3168V-16	7.5mm	14.0mm	13.0mm	16.8mm	Metal Jacket/Viton
3169V-16	5.5mm	12.0mm	13.8mm	14.5mm	Metal Jacket/Viton (no int rubber)
3170V-16	5.0mm	11.0mm	10.0mm	12.85mm	Metal Jacket/Viton
3172V-16	6.0mm	9.8mm	10.0mm	13.2mm	Metal Jacket/Viton
3173V-16	5.5mm	11.8mm	12.0mm	14.75mm	Metal Jacket/Viton
3225V-16	6mm	11mm	9.3mm	13.4mm	Metal Jacket/Viton
3174V-16	8.5mm	12.5mm	2.0mm	11.9mm	O-ring/Viton
3175V-16	5.5mm	9.5mm	11.4mm	12.75mm	Metal Jacket/Viton
3176V-16	5.0mm	10.6mm	11.6mm	14.15mm	Metal Jacket/Viton
3177V-16	6.0mm	12.0mm	10.0mm	13.7mm	Metal Jacket/Viton
3180V-16	5.0mm	10.8mm	18.3mm	16.9mm	Metal Jacket (Hat)/Viton
3181V-16	5.5mm	11.6mm	20.2mm	17.2mm	Metal Jacket (Hat)/Viton
3182V-16	5.0mm	11.8mm	21.0mm	17.15mm	Metal Jacket (Hat)/Viton
3262V-16	7.0mm	11mm	9.5mm	14.4mm	Metal Jacket/Viton
3264V-16	5.0mm	11mm	8mm	13.4mm	Metal Jacket EXH/Viton
3265V-16	5.0mm	11mm	8mm	13.4mm	Metal Jacket INT/Viton
3516P-16	8.0mm	0.492	0.470	0.616	Metal Jacket/Polyc

1/4" Valve Stem

Part #	Stem OD	Guide OD	Height	OD	Type / Matl.
3184V-16	1/4	0.435	0.392	0.531	Metal Jacket/Viton
3232V-16	1/4	0.476	0.517	0.562	Metal Jacket/Viton (no int rubber)
3258V-16	1/4	0.476	0.646	1.106	Metal Jacket (Hat)/Viton
3259V-16	1/4	0.48	0.794	1.106	Metal Jacket (Hat)/Viton

5/16" Valve Stem

Part #	Stem OD	Guide OD	Height	OD	Type / Matl.
3057V-16	5/16	0.438	0.445	0.600	Ring & Band/Viton
3060V-16	5/16	0.562	0.461	0.710	Ring & Band/Viton
3061V-16	5/16	0.562	0.461	0.710	Ring & Band/Viton
3064V-16	5/16	0.563	0.580	0.712	Metal Jacket/Viton
3222V-16	5/16	0.514	0.403	0.610	Metal Jacket/Viton
3235V-16	5/16	0.531	0.516	0.677	Metal Body/Viton
3236V-16	5/16	0.491	0.531	0.623	Metal Body/Viton
3237V-16	5/16	0.476	0.517	0.562	Metal Body/Viton (no int rubber)
3216V-16	5/16	0.562	1.085	1.3888	Metal Jacket (Hat)/Viton

11/32" Valve Stem

Part #	Stem OD	Guide OD	Height	OD	Type / Matl.
3012V1-16	11/32	0.500	0.540	0.640	Ring & Band/Viton
3013N1-16	11/32	0.520	0.470	0.690	Positive 2-Ring/Nitrile
3014N1-16	11/32	0.530	0.485	0.710	Ring & Band/Nitrile
3024V1-16	11/32	0.530	0.485	0.710	Ring & Band/Viton
3066V1-16	11/32	0.563	0.470	0.690	Ring & Band/Viton
3188V-16	11/32	0.500	0.531	0.623	Metal Jacket/Viton
3192V-16	11/32	0.562	0.485	0.677	Ring & Band/Viton
3223V-16	11/32	0.472	0.435	0.677	Metal Jacket/Viton
3228V-16	11/32	0.530	0.527	0.674	Metal Jacket/Viton
3245V-16	11/32	0.583	0.400	0.740	Metal Jacket/Viton

3/8" Valve Stem

Part #	Stem OD	Guide OD	Height	OD	Type / Matl.
3017N1-16	3/8	0.623	0.470	0.790	Positive-2-Ring/Nitrile
3050V-16	3/8	0.750	0.830	0.875	Umbrella Seal/Viton
3185T-16	3/8	0.562	0.415	0.66	Teflon Steel Body/Teflon
3195V-16	3/8	0.500	0.531	0.623	Metal Jacket/Viton
3196V-16	3/8	0.530	0.516	0.677	Metal Jacket/Viton
3197V-16	3/8	0.562	0.516	0.661	Metal Jacket/Viton
3198V-16	3/8	0.625	0.531	0.742	Metal Jacket/Viton

Misc. Valve Stem

Part #	Stem OD	Guide OD	Height	OD	Type / Matl.
3199V-16	276	0.476	0.517	0.562	Metal Jacket/Viton (no int rubber)
3240V-16			0.975	0.970	Metal Jacket (Hat)/Viton
3255V-16	0.287	0.49	0.887	1.185	Metal Jacket (Hat) INT/Viton
3256V-16	0.287	0.49	0.887	1.185	Metal Jacket (Hat) EXH/Viton
3260V-16	0.281	0.53	1.035	1.372	Metal Jacket (Hat)/Viton
3261V-16	0.281	0.53	1.14	1.255	Metal Jacket (Hat)/Viton
3214V-16	0.265	0.500	0.555	0.645	Metal Jacket /Intake
3215V-16	0.265	0.500	0.555	0.638	Metal Jacket /Exhaust
3217V-16	0.265		1.020	1.000	Metal Jacket (Hat)/Viton
3218V-16	0.265	0.500	0.635	1.126	Metal Jacket /Intake/Yellow
3219V-16	0.265	0.500	0.635	0.645	Metal Jacket /Exhaust/Green
3246V-16	0.198	0.334	0.390	0.482	Metal Jacket /Viton
3257V-16	0.204		0.555	0.645	Metal Jacket /



Cometic Gasket - An Exclusive NASCAR Performance Product

Miscellaneous Gaskets & Seals

2 Pc Viton Rear Main Seals

Description	Part #	Description	Part #
Buick W / Side Rails 196,231,252	C5707	Chrysler 360	C5684
Chevy 283-400	C5680	Chrysler 361-440 & Hemi	C5686
Chevy BB 396-454	C5682	Ford 289,302,	C5688
Chrysler 273,318,340	C5683	Ford 351C,M,351W	C5689

Timing Cover Gasket Sets

Description	Part #	Description	Part #
AMC 290-401 V8 66-88	C5046	CHRYSLER MAGNUM V6/V8 97-98	C5060
AMC 4/6 CYL 2.5/3.8/4.0/4.2L 65-06	C5047	CHRYSLER LA SMALL BLOCK V8 64-91	C5061
BUICK V6/SMALL V8 66-87 (Rope Seal)	C5048	CHRYSLER 5.7/6.1L HEMI 03-UP	C5202
BUICK V6/SMALL V8 66-87 (Radial Seal)	C5049	CHRYSLER WEDGE/426 HEMI V8 58-79	C5062
BUICK 400/430/455 V8 67-74	C5050	CHRYSLER EARLY HEMI V8 55-59	C5063
GM SMALL BLOCK V8/V6 75-95 (Thick Front Seal)	C5051	FORD SMALL BLOCK V8 62-78	C5064
GM SMALL BLOCK V8 57-74 (Thin Front Seal)	C5052	FORD SMALL BLOCK V8 79-97	C5065
GM 4/6 CYL 151/230/250/192 63-89	C5053	FORD 351C/351M/400 V8 70-81	C5066
GM SMALL BLOCK LT1 V8 92-94	C5054	FORD 352/360 FE V8 58-60	C5067
GM SMALL BLOCK LT1 V8 92-97	C5055	FORD 332-428 FE V8 61-71	C5068
GM SMALL BLOCK LS V8 98-11	C5056	FORD 429/460 BIG BLOCK 68-85	C5069
GM BIG BLOCK V8 65-95	C5057	OLDS 260-455 V8 64-90	C5070
GM BIG BLOCK V8 96-00	C5058	PONTIAC 265-455 V8 63-81	C5071
CHRYSLER MAGNUM V6/V8 92-96	C5059		

Engine Crankshaft Seals for Wet & Dry Sump Applications

Description	Signal Part #	TTS Part #	Cometic Part #	Description	Signal Part #	TTS Part #	Cometic Part #
JESEL Small Block Crank B/Drive F.C.	86587	T-13527	C5376	Ford Rear Crankseal W/302 Crank	85472	T-13584	C5384
JESEL Big Block Crank B/Drive F.C.	86622	T13553 Rev. B ..	C5377	Ford Rear Crankseal 302	13610	T-13610	C5385
JESEL (SEL 38000) Cam	86586	T13561 Rev. B ..	C5435	Ford Front Crankseal 302 & 351	85338	T-13690	C5386
Aluminum GM Sprint 400 Main	86410	T-13675	C5672	Ford R.R. Crankseal 351	85339	T-14053	C5391
Chevy Small Block Rear Split Seal	86625	T-13675-DL	C5379	Ford 351 Front Crank Yates Drive	85741	T-14276	C5490
Chevy Big Block Rear Split Seal	86665	T-13676	C5381	GM Small Block Front Crankseal	86990	T-13852	C5378
Dodge R5 Small Block Rear Crank	14255	T-14255	C5396				

Fuel Cell Gasket Kit

Description	Part #
Vent Neck Gasket .059" CFM20	C5507
8 Bolt Vent Gasket .059" CFM20	
Fill Plate Gasket .059" CFM20	

ATI Damper Re-build Viton O-Rings

Description	Part #
6" Damper Rebuild Kit (3-Ring)	C5393
7" Damper Rebuild Kit (3-Ring)	C5486
6" Damper Rebuild Kit (4-Ring)	C5632



Promotional Items



Part #	Description
DC15	Package Decal 5.25" x 1.75"
DC06	Decal Sheet 5.5" x 8.5"
DC10	Embroidered Patch 2" x 5"
DC04	Trailer Decal 6" x 19"
DC03	Decal 3.125" x 9"
DC11	Banner 3' x 8'
DC17	StreetPro Decal 1.625" x 9"
DC13	Dealer Open House Kit
	(100) DC01, (2) DC04, (2) DC11, (2) DC12,
	(10) 40% Off Retail Certificates, (25) Catalogs
DC12	Adjustable Embroidered Hat



Klotz Synthetic Lubricants are designed and engineered to be the best lubricants in the motorsports industry. Race tested and formulated for all engine types, Klotz offers a full line of Estorlin Synthetic Racing Oils, Power Additives, and Aerosols needed to keep your engine protected and performing at an optimal level. Racers, engine builders, and performance enthusiasts around the world rely on Klotz to get them to the checkered flag. Be Fast, Be First with Klotz Synthetic Lubricants.



ESTORLIN® RACING PERFORMANCE SYNTHETIC ENGINE LUBRICANT

Part#	Desc.
KE-900	0WT Qt.
KE-902	2WTQt.
KE-904	0W/40 Qt.
KE-905	0W/5 Qt.
KE-910	10WT Qt.
KE-920	0W/20 Qt.
KE-925	5W/20 Qt.
KE-930	10W/30 Qt.
KE-935	5W/30 Qt.
KE-940	10W/40 Qt.
KE-950	20W/50 Qt.
KE-954	15W/40 Qt.
KE-955	15W/50 Qt.
KE-915	15W/55 Qt.

Also available by the Case & 5 Gallon Pail



UPLON® FUEL LUBE

- Provides upper cylinder and fuel pump lubrication
- Blends with methanol alcohol, ethanol, nitromethane and gasoline
- Maintains constant fuel pressure

Part#	Desc.
KL-106	Pint
KL-107	Quart

Also available by the Case



4STREETROD MUSCLE CAR FLAT TAPPET LUBE

Part#	Desc.
10W30-SRM	10W/30 Qt.
10W40-SRM	10W/40 Qt.
15W40-SRM	15W/40 Qt.

Also available by the Case & 5 Gallon Pail



4STREETROD PERFORMANCE MOTOR OIL

Part#	Desc.
10W30-SRP	10W/30 Qt.
10W40-SRP	10W/40 Qt.
15W40-SRP	15W/40 Qt.

Also available by the Case & 5 Gallon Pail



ESTORLIN® FREE-GEAR® HYPOID SYNTHETIC GEAR LUBRICANT

Part#	Desc.
KE-956	75W/60 Qt.
KE-960	75W/75 Qt.
KE-970	75W/80 Qt.

Also available by the Case & 5 Gallon Pail



ESTORLIN® FREE-GEAR® MANUAL TRANSMISSION SYNTHETIC GEAR LUBRICANT

Part#	Desc.
KE-961	75W/55 Qt.
KE-962	75W/60 Qt.
KE-963	75W/65 Qt.
KE-964	75W/70 Qt.
KE-965	75W/75 Qt.
KE-975	75W/80 Qt.
KE-980	75W/90 Qt.
KE-990	80W/90 Qt.
KE-994	75W/140 Qt.
KE-995	75W/110 Qt.

Also available by the Case & 5 Gallon Pail

Additives & Aerosols

	Part #	Size
Assembly Lube	KL-311	12oz.
Fogon - Storage & Afterrun Lubricant	KL-612	6oz.
.....	KL-610	16oz.
Foam Air Filter Oil	KL-606	15.25oz
Fabric Air Filter Oil	KL-607	15.25
Air Filter Cleaner	KL-608	15.25oz
Plug & Contact Cleaner	KL-609	12.5oz
Ethanol Gasoline Fazeseperation Treatment	KL-603	16oz.
Storbilizer	KL-613	16oz.
Cometic Engine Block & Head Surface Cleaner	C1047	15.25oz



Product Development

Cometic provides our customers with quality products, born of exhaustive research and development. Cometic's new Superflow 902S dynamometer positions us at the forefront of gasket design and technology. Our state-of-the-art testing facilities and processes provide Cometic with the resources necessary to analyze gasket designs and materials in the most extreme conditions, ensuring that your gasket won't fail when you need it the most.

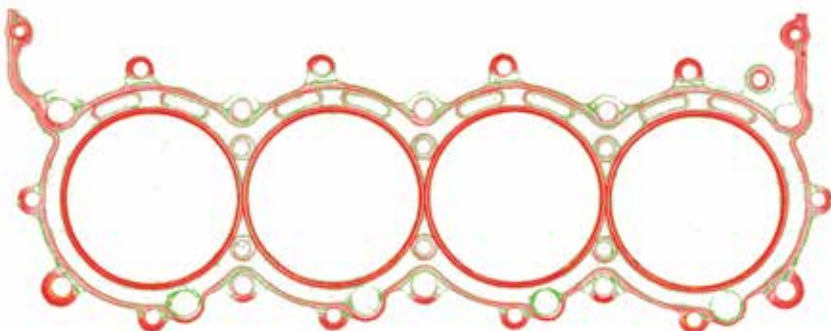
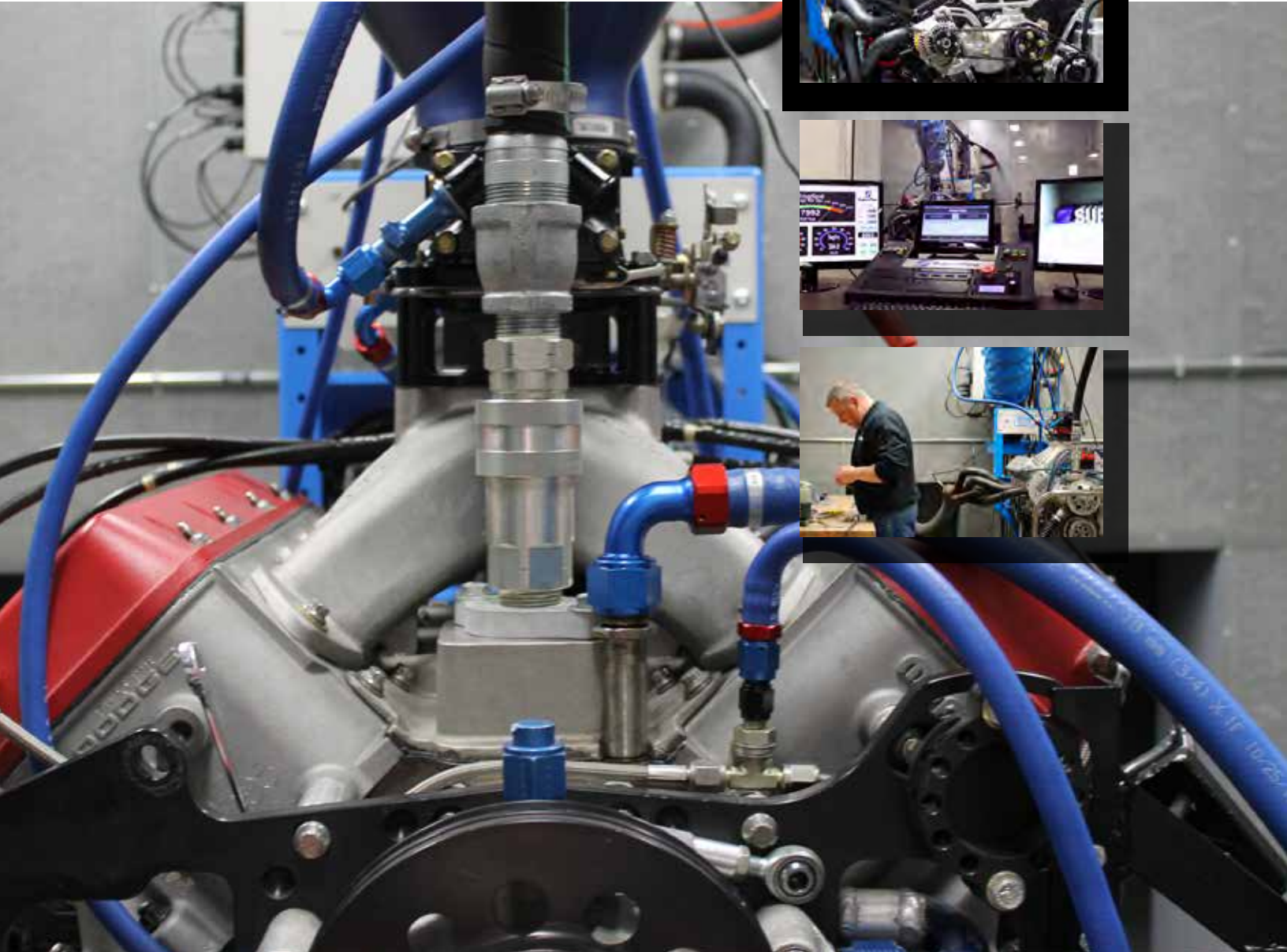
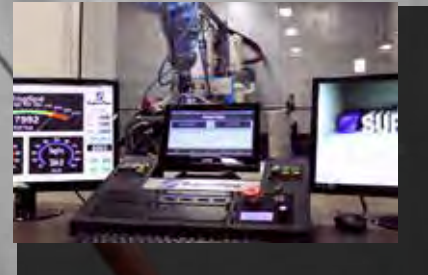

Gasket contact pressure is validated by Fuji film at our in-house research and development center.

View other license performance engine cooling on our website.