

OE FIX

— GUIDE —



DORMAN®

DESCRIPTION	MATERIAL
	SEE PLY



Featured Fix

Get the story behind our new OE FIX differential cover
page 6

Cover Photo

Our 600-405 4WD hub locking actuator delete
page 18



What's an OE FIX? It's an exclusive, Dorman-engineered part that delivers value in one or more of the following ways:

- Corrects a specific failure in an original part.
- Allows replacement of only a failed part, instead of replacing a full assembly.
- Modifies design to significantly reduce installation time.

Road to Innovation..... 4

A tour of Dorman's headquarters

Featured Fix..... 6

Fixing troublesome Toyota truck differential covers

Body..... 8

Exterior and interior solutions

Chassis 10

Suspension, steering and frame solutions

Electronics 12

Control module and actuator solutions

Engine 14

Gasket and hardware solutions

HVAC 20

Hose, valve and seal solutions

Undercar 21

Axle, brake and hub solutions

Proving Grounds..... 23

The steps we take to ensure quality



See this icon?

It means we have a video for that part on DormanProducts.com/OEFIX.





Ideation

Our ideation team works with technicians, warehouse distributors, jobbers, OEM dealers and salvage yards across North America to uncover failure-prone original parts and gather new ideas.



Road to INNOVATION



Design

Our design team uses the latest technologies to accurately analyze and develop new solutions. **Pictured: a 3D-printed valve cover prototype.**



Quality and Testing

From development to production, our engineers run countless tests and collect original OEM performance data every step of the way to ensure our parts meet our quality standards. **Learn more about our product testing on page 23.**



Engineering

We have 130 engineers who not only reverse-engineer original parts, but also seek to deeply understand what makes original systems fail and engineer innovative fixes. **Pictured: engineer using Creaform scanner.**



Manufacturing

In addition to demanding top-notch quality from our suppliers, we maintain our own manufacturing and remanufacturing facilities for some of our most specialized and advanced products.



Tech Support

We want to make sure you have a great experience with our products. Our Tech Support team of ASE Blue Seal Certified experts is ready to answer any product questions you have. Just call 1-866-933-2911.

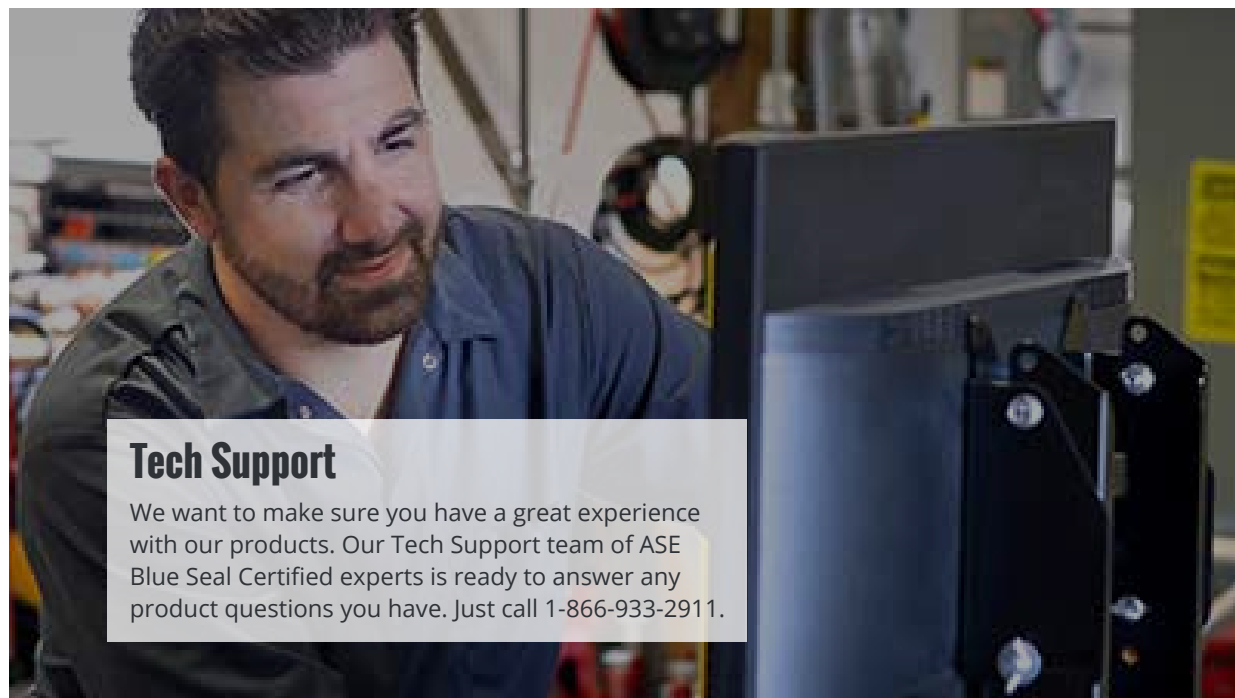

Differential Thinking

This exclusive has you covered

Toyota trucks may be legendary for their toughness and reliability, but their solid axles have a weak spot that often sends owners to salvage yards and online forums in search of answers.

Underneath 4Runner, FJ Cruiser, Tacoma and Tundra vehicles, the cap that covers the differential is made of thin-gauge stamped steel, which lets rust eat away at it faster than other areas.

The first sign of failure is typically a wet spot on the outside of the cover, or a small drip on the ground under the axle. Left to corrode further, the axle loses fluid, or water gets into the housing, mixing with the gear lube.

Fixing it hasn't always been simple.



These covers are welded in place, not bolted on like other trucks, so they're tough to replace by themselves. In the past, you'd

Differential Cover

926-993

Toyota 4Runner 2002-96,

Tacoma 2004-95

90% Parts Cost Savings



OE PROBLEM:

The differential covers on Toyota trucks are made of thin-gauge steel that corrodes faster than the rest of the rear axle housing. With their weld-on design, the dealer's only solution is an entire new axle assembly.

OE FIX:

We built a replacement differential cover that can be welded on while preserving the original axle assembly. It also features heavier-gauge steel for a longer service life, and arrives ready to install with a weld-through primer finish.

have to get a whole new axle from the dealership, replace the axle with a rust-free salvage part, or fabricate a replacement cover by hand.

We've seen these homemade diff cover patches. They aren't easy or pretty. And if you live in a rust-prone area, odds are salvaged axles near you will also be rusted. That means you have to source an axle from outside your region, which can get pricey.

That's why Dorman designed OE FIX replacement differential covers for Toyota trucks. They're made of heavier stamped steel for greater rust resistance, and come pre-primed.

Installing this solution still requires cutting off the old cover and welding on the new one. On the next page, we show you how to do that.

With this exclusive fix in your arsenal, Toyota truck owners won't be searching forums and salvage yards for solutions - they'll be searching for the number to your shop.

Not Sure How To Install It? Here's How.



1 Remove the axle unit from the vehicle, following the workshop manual. After removing the axle shafts and differential, drain the gear lube.



2 Carefully cut through the original differential cover using an electric or pneumatic cutoff wheel, around the circumference of the cover.



3 Use an angle grinder to clean up the mating surface where the new cover will be installed.



4 Carefully position the new cover in place, being sure to orient it correctly. Using an appropriate welder, tack the new cap in position initially.



5 Run a continuous bead weld around the circumference of the new cover, making sure there are no gaps in the weld.



6 Once cool, degrease the work with a pre-paint solvent. Apply self-etching primer, and finish with a coat of chassis paint to prevent future corrosion.

SAFETY WARNING: Please use caution when performing this service. Always support the vehicle securely before beginning work. Eye and hand protection should be worn at all times. Work only in a well-lit, well-ventilated workspace. This procedure is only to demonstrate how the replacement part is installed. Follow factory-approved workshop manual for all removal, installation and other assembly procedures.

Door Latch Cable Repair Kit

926-111 Ford trucks 2017-92



OE PROBLEM:

Door latches often fail because of simple faulty latch cable ends. Trouble is, there's usually no easy way to fix just those failed pieces. You're stuck replacing the whole assembly.

OE FIX:

This door latch cable repair kit includes four door cable ends for easy repairs of this common failure, saving time and money.

Ignition Lock Cylinder

924-784 Chrysler 2007-98, Dodge 2009-98, Jeep 2005-98, Plymouth 2001-97



1+ Hour Time Savings

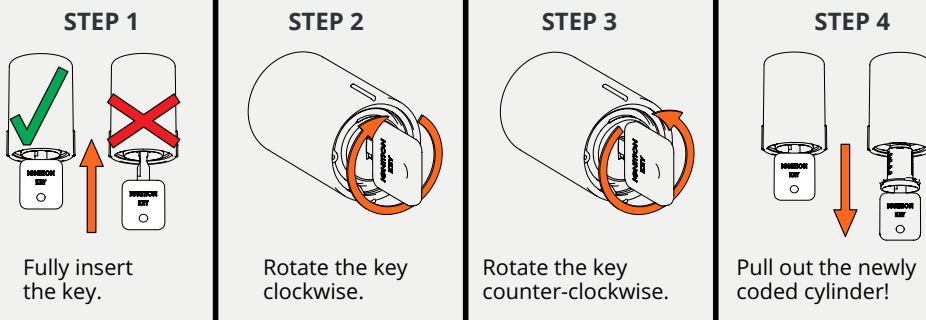

OE PROBLEM:

Replacing an ignition lock cylinder usually requires the tedious, manual process of disassembling and reassembling individual lock wafers in order to maintain the original key.

OE FIX:

This patent-pending design revolutionizes the process of replacing and recoding an ignition lock cylinder. Insert the key into the lock cylinder, turn it twice and remove the cylinder. No time wasted at the dealer to get the new cylinder matched to the original key.



“ This thing is genius. It's crazy no one thought of it before. ”

- Dave Duchesne, Warren's Auto Repair, Monroe, Louisiana

Liftgate Release Switch Seal

926-098 Lexus 2012-04, Scion 2010-05, Toyota 2017-03



OE PROBLEM:

Liftgate switch seals often wear out, letting in water, dirt and debris, which can damage the switch. It's a simple piece of rubber, but you usually have to replace the whole switch just to get the seal replaced.

OE FIX:

We reverse-engineered the exact seals on certain vehicles' liftgate release switches, allowing for a cost-effective, simple fix.

Puddle Light

926-107 Ford, Lincoln 2018-03, Mercury 2009-08, Mercury 2005-03



Original burns out quickly.

OE PROBLEM:

The original puddle light on certain vehicles has an incandescent bulb that burns out quickly, making for an annoying recurring problem.

OE FIX:

We upgraded the bulb to an LED, offering increased brightness and longevity.

Truck Bed Floor Support

926-988 Ford Super Duty - 6.5-ft. bed, F-250, F-350 2017-99

ALSO AVAILABLE:

926-989: Ford Super Duty - 8-ft. bed, F-250, F-350 2018-99, Ford F-450 Super Duty 2016-08

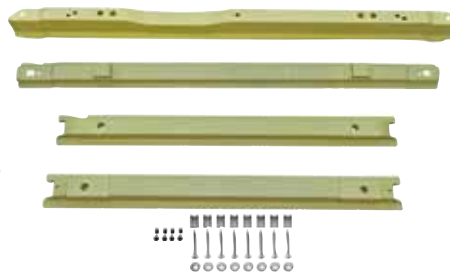

80% Cost Savings

OE PROBLEM:

Ford Super Duty truck beds take a beating ... until the floor supports rust away. When that happens, the dealer's only solution is to replace the entire bed for thousands of dollars.

OE FIX:

This bed cross member kit allows you to replace only the damaged floor supports while preserving the rest of the bed. We finish the new supports in weldable primer and include new bed mounting hardware.

Coil Spring Mount Kit

523-280 Jeep Wrangler 2015-07



OE PROBLEM:

When a coil spring mount breaks or corrodes, you usually only have one choice - replace the entire axle assembly. That's a lot of unnecessary time and expense.

OE FIX:

We reverse-engineered the coil spring mounts, allowing you to simply replace the failed original part. We also coated them with weldable primer to ensure a clean installation.

Frame Repair Kit

523-282 Jeep Wrangler 2003-97



OTHER FRAME REPAIR KIT APPLICATIONS:

523-203: Ford Ranger 2003-98

523-204: Ford Ranger 2003-98

523-217: Chevrolet, GMC 2007-99

OE PROBLEM:

Frames rust from both regular use as well as off-roading. Although common, fixing a rusted frame has typically been an expensive repair.

OE FIX:

Our frame repair kit makes it simpler to replace a failed frame section. Made of heavy-gauge steel and finished in weldable primer, it includes all OE hardware mounting positions, with redesigned drainage to prevent future corrosion buildup.

Axle Bearing & Hub Assembly

Pre-Pressed Hub Assembly

950-001 Lexus, Toyota, 4Runner, GX460, GX470 2018-03



ORIGINAL COMPONENTS



Only available separately from the dealer

3+ Hour Time Savings

OE PROBLEM:

Replacing an original axle bearing and hub assembly can be difficult and time-consuming because the dealer sells every component separately.

OE FIX:

Our pre-pressed hub assemblies come complete with all critical components, ready for installation right out of the box, saving valuable bay time.

// Pressing out rusted bearings was the biggest waste of my time. I use these OE FIX pre-pressed hub assemblies all the time now. I'll never go back. //

- Steve Godshall, Godshall's Auto Service, Hatfield, Pennsylvania

RELATED DIRECT REPLACEMENTS

Shock Mount

Wheel Well

924-358 Ford Escape 2012-01, Mazda Tribute 2011-08, Tribute 2006-01, Mercury Mariner 2011-05

- Solution for repairing rusted shock mount point
- Powder-coated finish helps prevent future rust and corrosion
- Bushings included



Suspension or Steering Knuckle

Loaded Knuckles

We've heard from countless technicians that replacing rusty knuckles and pressing out corroded bearings is a grueling job. Not only does it potentially cause hours of frustration using a shop press, but if you break something unexpectedly in the process, you have to call the customer back with bad news.

To make these jobs faster and more consistent for shops, we've pre-assembled wheel bearing and hub assemblies so they're ready to install right out of the box, no shop press necessary. Like with our OE FIX pre-pressed hubs (see opposite page), these loaded knuckles include all the necessary components for a complete repair, saving you as much two hours per job.



No Shop Press Required

698-012 [R]
Ford Explorer, Mercury Mountaineer 2005-02

2+ Hour Time Savings

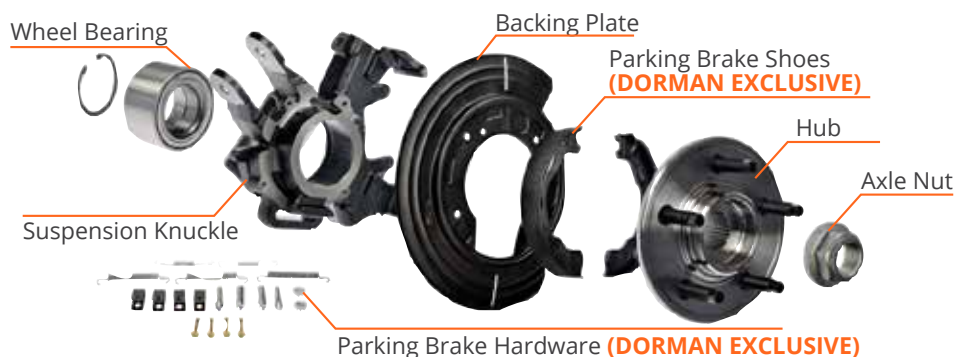

Most Comprehensive Coverage:

698-012[R], 698-013[L]: Ford Explorer, Mercury Mountaineer 2005-02

698-388[R], 698-389[L]: Toyota Corolla 2008-03

698-404[R], 698-405[L]: Ford Escape 2012-05, Mazda Tribute 2011-08, 2006-05, Mercury Mariner 2011-05

698-406[R], 698-407[L]: Ford Focus 2011-06

698-408[R], 968-409[L]: Ford Fusion 2012-06, Lincoln MKZ 2012-07, Lincoln Zephyr 2006, Mercury Milan 2011-06

698-422[R], 698-423[L]: Nissan Altima 2006-02

Fuel Pump Driver Module

601-022 Chevrolet, GMC, Cadillac, Hummer trucks 2009-03; gas engine

NO Programming Required



OE PROBLEM:

When the original fuel pump modules on certain vehicles fail, they require special dealership calibration and SPS programming.

OE FIX:

We created a plug-and-play solution that requires no programming. We also built it with an upgraded microcontroller, new active electronics, and a protective seal to keep out water and debris. Screws included for easy installation.

Steering Column Lock Actuator

601-037 Infiniti 2013-09, Nissan 2017-07



OE PROBLEM:

The steering column lock actuators on many vehicles fail because their internal gear teeth wear out. When that happens, it prevents the starter interlock switch from disengaging and the car won't start.

OE FIX:

We upgraded the gear teeth to a stronger compound for longer service life, tested to more than 15,000 cycles. We also updated the software to adjust the gear speed and minimize gear teeth wear in the future.

Trailer Brake Control Module Circuit Board

601-226 GM trucks; Silverado, Sierra, Escalade 2017-07



OE PROBLEM:

When the original module fails, the only solution is to replace the complete module assembly.

OE FIX:

We offer a separate replacement circuit board, restoring proportional braking and other critical functions, at a fraction of the cost.

Transmission Control Module TEHCM

609-004 Corvette 2007-06, GMC Yukon 2007, Cadillac Escalade, STS, SRX, XLR 2007-06

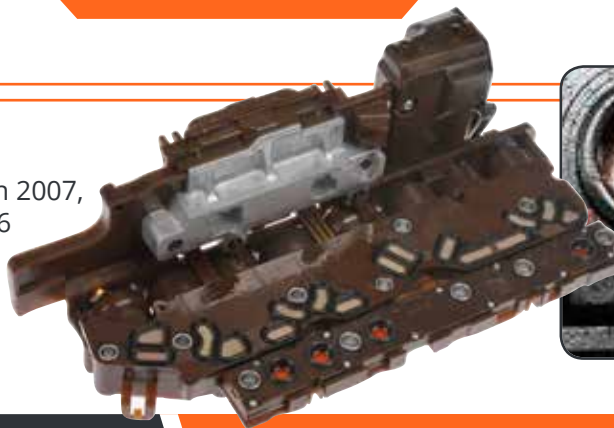

OE PROBLEM:

TEHCMs frequently fail due to excessive heat and debris contamination.

OE FIX:

We implemented an extensive remanufacturing process that includes adding brand new components and upgrading pressure switches with stronger PEEK plastic for longer life.

RELATED DIRECT REPLACEMENTS

Electronic Throttle Body Module

599-959 GM trucks; Topkick, Kodiak, Workhorse, 2009-05; gas engine

- Direct replacement, thoroughly remanufactured solution, with high-grade electronic components that withstand extreme heat and cold
- Quality, reliable alternative to buying new



HVAC Control Module

599-211 Buick 2007-04, Cadillac 2006-03, Chevrolet 2009-02, GMC 2009-02, Hummer 2007-03, Oldsmobile 2004-02

- Consolidates seven different climate controls into one seamless part
- Upgraded LED bulbs for long-lasting backlighting
- Easy install and setup instructions
- 100% newly manufactured





Engine Timing Chain Guide Bolt

917-954 GM, Saab 2017-00;
2.0L, 2.2L, 2.4L engine



OE PROBLEM:

It's usually bad news when the timing chain guide bolt shears off. It typically means replacing the entire cylinder head during installation, a long, expensive process.

OE FIX:

We designed our bolt to eliminate the need for labor-intensive drilling and tapping by incorporating the plug and bolt as one piece, rather than servicing both separately.

Engine Variable Valve Timing (VVT) Solenoid Gasket Kit

VANOS Repair Kit

918-058 BMW 2006-96

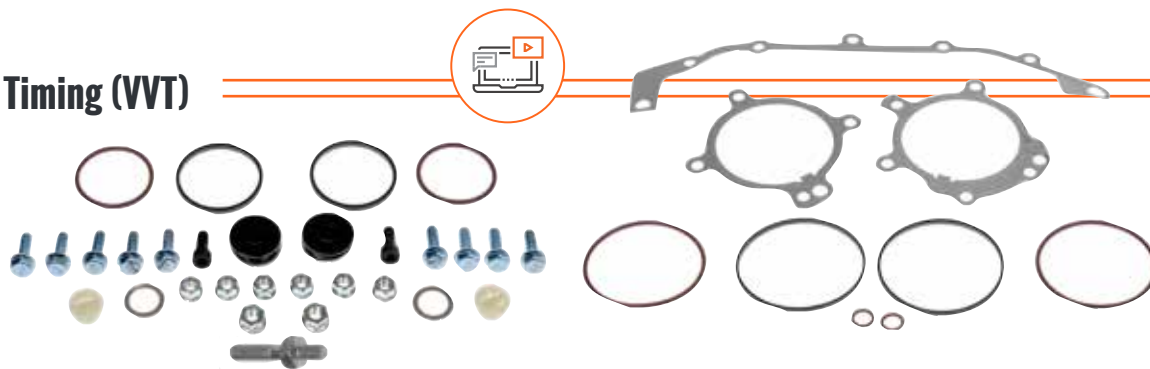

OE PROBLEM:

BMW VANOS VVT systems frequently fail when original seals go bad.

OE FIX:

Having seen this failure constantly in the field, our engineers created this VANOS-specific repair kit, complete with all new O-rings, gaskets and hardware. It's a must-have item for shops that frequently work on BMWs, or even owners with troublesome systems.

Exhaust Manifold to Cylinder Head Repair Clamp

917-108 GM trucks 2009-99; 4.8L, 5.3L, 6.0L engine

11+ Hour Install Savings



OE PROBLEM:

When a manifold bolt breaks, you usually have to remove the entire cylinder head.

OE FIX:

This exhaust manifold to cylinder head clamp is our exclusive solution, allowing you to fix exhaust leaks without removing the broken manifold studs, and create a firm seal between the exhaust manifold. The clamp comes with bolts for a complete repair.



Engine Oil Filter Bypass Valve

917-992 Chrysler, Dodge, Jeep 2013-11, Ram 2013-12; 3.6L engine

90% Cost Savings **3+** Hour Install Savings



OE PROBLEM:

The original valve becomes brittle and typically breaks when servicing the oil filter. The dealer requires replacing the entire filter housing.

OE FIX:

We offer the valve separately, so when the original part fails, you only have to replace the valve. That allows you to offer customers a smart, inexpensive repair.

A Quick, Simple Fix While You're In There. Here's How.

Replacing an oil filter bypass valve is simple. It takes just seconds to perform when you're changing the oil filter, and you can show your customers you saved them money.



1 Remove the filter, and examine the tip of the bypass valve. The tip may be deformed or will be resting in a tilted position.



2 Grab the spring-loaded tip near its edge, using a pair of pliers, and carefully pull upward to release it.

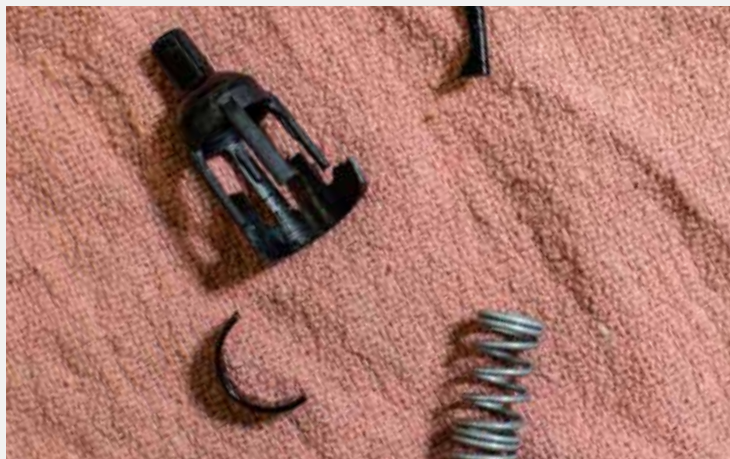

3 Remove the original spring and discard it, removing any broken pieces of the original tip from the filter housing.



4 Insert the new spring into the valve support, and press the new tip into place before replacing the oil filter.



Fuel Injection Throttle Body

977-025 Chrysler 2014-07, Dodge 2017-07, Jeep 2017-07



OE PROBLEM:

Electronic throttle body assemblies frequently require replacement due to internal electronic sensor and gear failures.

OE FIX:

We redesigned the electronic board, adding a new Hall effect sensor for increased reliability and a longer service life.

Fuel Line Kit

Stainless Steel Fuel Lines



919-810 Chevrolet Silverado 1500, GMC Sierra 1500 2003-99; gas engine

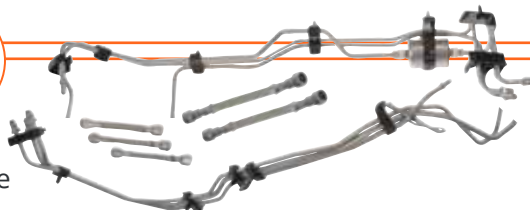

OE PROBLEM:

When the original fuel lines corrode, replacing them with new full-length, pre-formed lines requires time-consuming disassembly of major undercar components.

OE FIX:

We specifically made our pre-formed stainless steel fuel lines to save you time, and they're made of strengthened materials for extended life.

RELATED DIRECT REPLACEMENTS

Alternator Bracket

926-099 Honda Accord 2002-00, Odyssey 2004-00, Pilot 2004-03

- Aftermarket-exclusive, direct replacement metal bracket, restoring tension to alternator belt
- Includes mounting bolt for easy install



Diesel Exhaust Fluid (DEF) Heater

904-372 Ford 2016-11

- Includes all necessary gaskets and O-rings needed for a complete replacement
- DEF pumps also available separately





Engine Oil Cooler Gasket Set

917-191 Nissan Altima 2013-06, Rogue 2018-08, Sentra 2010-07, X-Trail 2014-07; 2.5L engine

- Must-have kit for any shop that regularly services oil coolers, with all gaskets and O-rings necessary for complete repair



AWD Coupling Oil Pump

699-002 Ford Five Hundred, Mercury Montego 2007-05, Volvo 2010-03

- Quality direct replacement of original AWD coupling oil pump, with O-rings included for complete repair
- Easy installation - just plug into the mating components

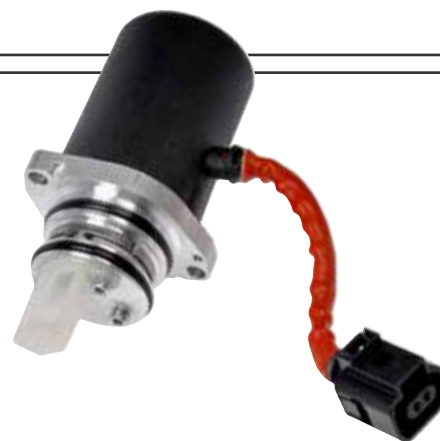

Evaporative Emissions System Pressure Sensor

911-260 Ford 2014-00, Lincoln 2009-07, Mercury 2010-02

- Direct replacement for failed air pressure sensor, restoring engine performance and fuel efficiency

OTHER APPLICATIONS:

911-259: Ford Focus 2007-05



Engine Mount Bracket

917-189 Lexus 2008-96, Toyota 2009-94; 3.0L, 3.3L engines

- Re-engineered direct replacement, made of ductile iron, rather than aluminum, for durability



Connection Correction

A creative alternative to stock hub actuators

When someone with a Ford F-150, Ford Expedition or Lincoln Navigator comes into the shop, complaining about a grinding sound from the four-wheel drive, there's a common diagnosis: a bad vacuum-activated front axle hub actuator.

The internal diaphragm on these parts wears out from regular use, or cracks from lack of use, as well as poor internal lubrication. The grinding happens when the splined actuator doesn't have the vacuum it needs to fully engage the axle shaft. Eventually the vacuum leak expands, preventing the system from working at all.

NOTE:
DIMEN



4WD Hub Locking Actuator Delete

600-405

Ford Expedition 2015-03,
F-150 2015-04, Lincoln Mark LT
2008-06, Navigator 2015-03

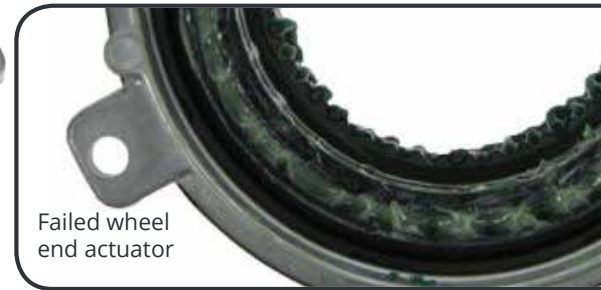

Failed wheel end actuator

OE PROBLEM:

The original wheel end actuator on certain vehicles is highly failure prone, leading to a loss of vacuum, and an inoperable 4WD system.

OE FIX:

We found that the hub locking actuator created significant problems without adding much value for many owners. This patent-pending vacuum delete kit restores critical operation, while eliminating failure-prone features, and adding increased durability and serviceability.

driveline efficiency, in exchange for greater dependability, by eliminating the troublesome functionality.

With that realization, our engineers built a first-of-its-kind independent wheel end coupler vacuum delete kit. Designed to be replaced as a pair, this patent-pending product looks and fits like the original, but simply establishes a robust, permanent connection between the two components. It also includes vacuum caps on the hub, for holding the remnant vacuum lines, in case the owner ever wants to revert to the original design in the future.

“We have a lot of respect for OEMs. It’s just that sometimes they make engineering tradeoffs for various reasons, and the designs can be more trouble than they’re worth,” said Steve Butcher, a Product Manager in our Undercar unit. “This is a good example where we were able to give vehicle owners more freedom to fix their vehicle however they choose.”

Knowing how commonly they fail, we made a direct replacement, but our engineers wanted to find another solution. They wanted a different method for activating the hub locks. The thing is, with the actuator sandwiched between the hub and axle, designing a whole new system would be impractical.

However, most people assume that locking the hubs also engages the four-wheel drive. That’s actually not the case. They’re two dependent, but separate, operations.

The hub actuators connect the axle shaft to the wheel hub automatically when 4WD is

selected. More accurately, they disconnect the axle and hub when the 4WD system is not engaged, reducing driveline loss caused by spinning an otherwise non-rotating axle.

“Our engineers wanted to find another solution.”

So, while the hubs must be locked for 4WD to be engaged, they can also be locked when the vehicle is in 2WD. Doing that sacrifices a small amount of

Engine Coolant Thermostat Housing Flange Repair Kit

904-486 Ford trucks 2003-94
7.3L diesel engine

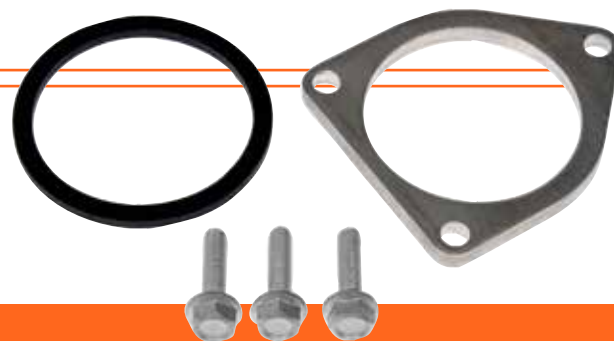

OE PROBLEM:

Thermostat housing warps and results in a coolant leak.

OE FIX:

We designed this add-on flange repair kit to strengthen and support the original housing, eliminating the warping associated with original leaks.

HVAC Heater Hose Assembly

626-541 Ford F-150 2017-11,
Mustang 2018-11, Lincoln Mark LT 2014-11;
5.0L engine



OE PROBLEM:

The Y-connectors on many HVAC heater hoses are made of brittle plastic that eventually cracks and leaks. These simple pieces can become big headaches if you're replacing them again and again.

OE FIX:

We upgraded the plastic Y-connector to aluminum specifically to save installers frustration and so they don't have to worry about customer come-backs.

RELATED DIRECT REPLACEMENTS



Engine Coolant Bypass Valve

Water Control Valve

902-055 Ford Escape 2016-13, Fiesta 2018-14,
Fusion 2014-13, Transit Connect 2016-14; 1.6L
turbo engine

- Aftermarket-exclusive solution for failure-prone coolant bypass valves, preventing leaks and turning off the check engine light



Radiator Shutter Assembly

Active Grille Shutters

601-322 Ford Explorer, Police Interceptor Utility 2016-13

- High-quality aftermarket replacements for increasingly common active grille shutters
- Great way to offer customers a less expensive solution for maintaining optimal vehicle performance

4WD Actuator Fork

600-114 GMC Envoy, Chevrolet Trailblazer, Saab 9-7X, Isuzu Ascender 2009-02

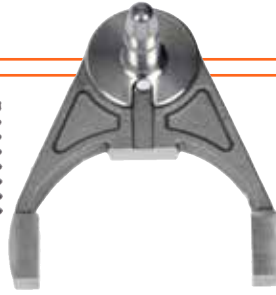

OE PROBLEM:

4WD actuator forks routinely fail when the alignment pins break and the contact pads become worn out.

OE FIX:

We engineered our replacement shift forks with extended alignment pins to prevent future breakage, a third contact pad for greater support around the bearing area, and forged aluminum instead of brittle cast aluminum.

Automatic Transmission Oil Pan

265-853 BMW 2018-10, Chrysler 2018-12, Jaguar 2019-13

Replacement Filter Also Available:
265-853F

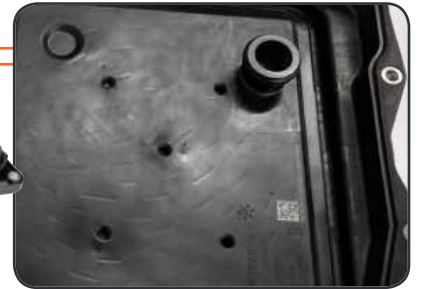

OE PROBLEM:

When the original transmission fluid filter on certain vehicles requires service, you're usually stuck replacing the entire transmission oil pan.

OE FIX:

We re-engineered the oil pan to be serviceable with a replaceable filter. We also designed it as a complete conversion kit with new pan, filter, gasket and bolts for an easy installation.

Automatic Transmission Shift Linkage Clip

14908 Ford 2018-97, Lincoln 2012-11, 2006-99, Mercury 2011-04



OE PROBLEM:

The transmission shift linkage clips on many Ford models break easily, disabling the shifter mechanism. You usually don't have a choice but to buy a whole new shifter cable assembly.

OE FIX:

We make the linkage clip available as a separate piece, so it's an inexpensive, easy fix.

Brake Dust Shield
Brake Backing Plate

924-662 Ford Escape,
Mercury Mariner 2007-05

3+ Hour Time Savings



OE PROBLEM:

Brake dust shields do a good job of keeping debris out of a vehicle's brakes, but when the shields themselves corrode, replacing them can be labor intensive if you have to remove the whole axle shaft and the wheel hubs.

OE FIX:

Our exclusive fix saves hours of work by simply re-engineering the dust shield into two pieces that can be assembled around the axle shaft. Just cut off the old one, and connect the new one.

// *These two-piece brake backing plates literally made a four-hour job less than an hour. They're awesome.*

- Dan Dempster, Dempsters Quality Auto Care, Hatboro, Pennsylvania

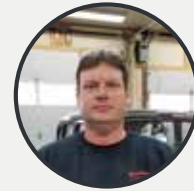

RELATED DIRECT REPLACEMENTS

Axle Shaft Seal

926-129 Ford Transit 150, 250, 350 2018-15

- Aftermarket-exclusive solution preventing axle fluid leaks from forming around wheel hubs

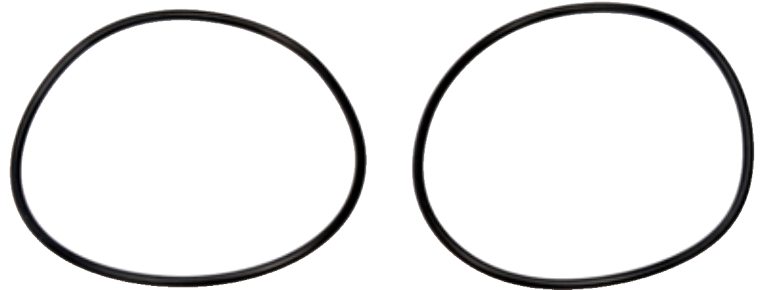

Transfer Case Shift Linkage

926-884 Dodge Ram 1500 2004-02, Ram 2500, 3500 2005-03

- Direct replacement for failure-prone original transfer case shift linkage, with bushings included for complete installation



Dorman PROVING GROUND

We run our parts through rigorous testing to ensure they meet or exceed industry standards, government regulations and our own high expectations. Here are just a few examples.



Tensile Test

Ensures part strength meets or exceeds competitor performance.



Hydrostatic Burst Test

Pressure testing ensures hydraulic and pneumatic components perform to design standards.

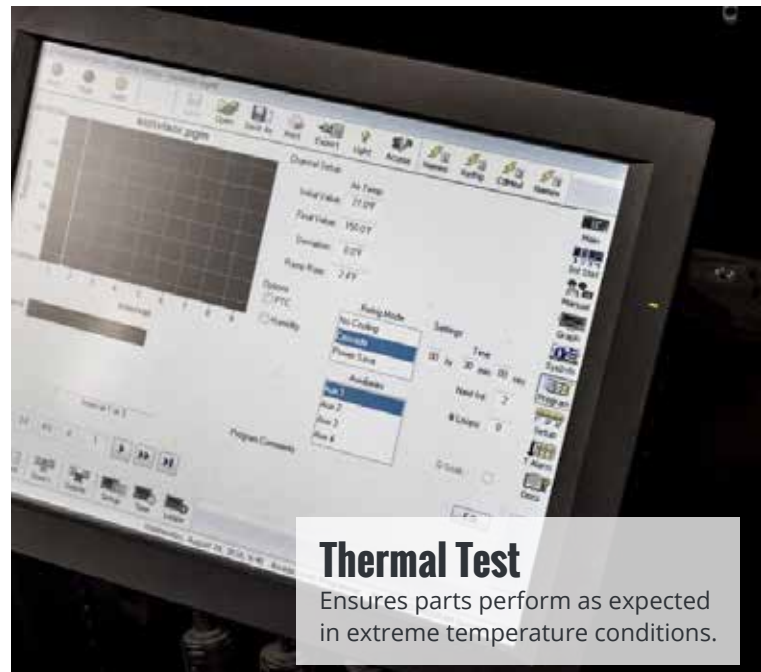

Thermal Test

Ensures parts perform as expected in extreme temperature conditions.



Salt Fog Test

Corrosion testing ensures durability under harsh environmental conditions.

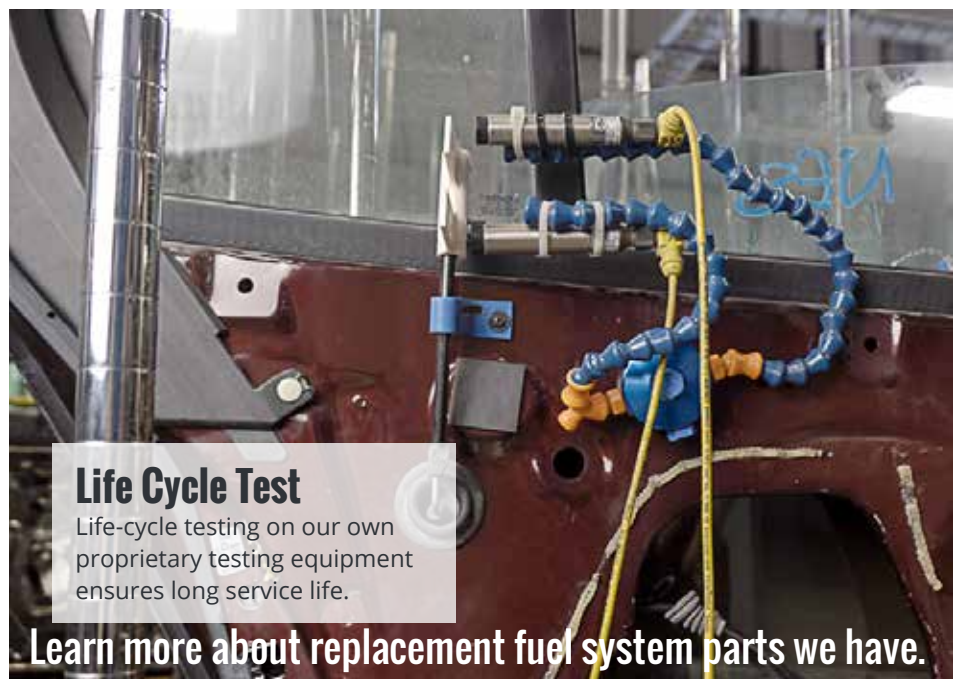

Life Cycle Test

Life-cycle testing on our own proprietary testing equipment ensures long service life.

Learn more about replacement fuel system parts we have.