

# 2021 NEW PRODUCTS

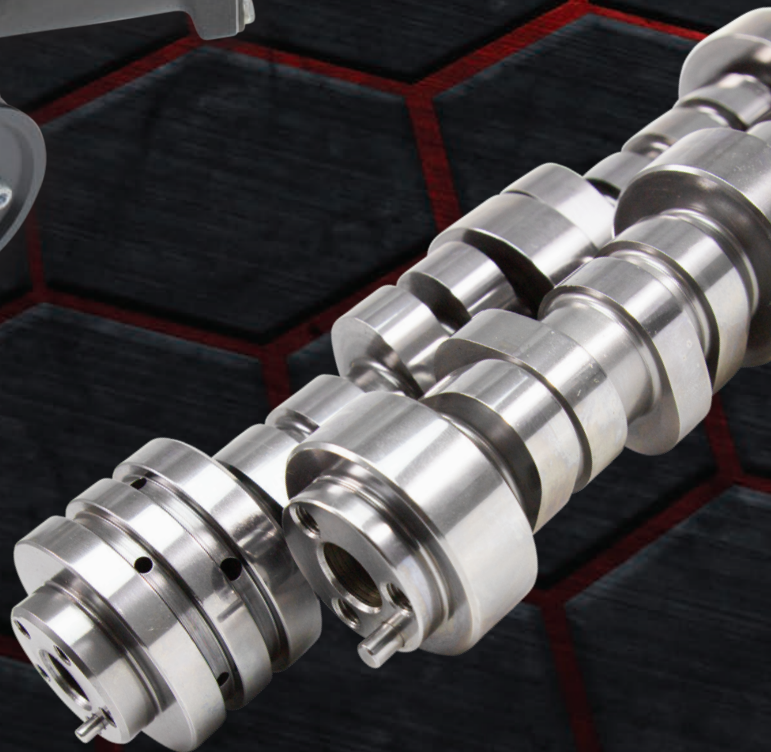



One of the biggest mergers in the history of the automotive aftermarket opened an exciting new chapter for five iconic aftermarket brands. COMP Cams<sup>®</sup>, Edelbrock<sup>®</sup>, FAST<sup>®</sup>, Russell Performance<sup>®</sup> and TCI Automotive<sup>®</sup> are now moving forward as the Edelbrock Group<sup>™</sup>.

This is our first official presentation of new products as the Edelbrock Group<sup>™</sup> and we are proud to introduce the results of what our engineering and manufacturing teams have been diligently working on for the past 12 months. As innovators and enthusiasts, we are extremely passionate about each and every one of the new products for 2021 and there are many more to follow in the months ahead.

We gladly bid farewell to 2020 but not without a strong sense of awareness and gratitude that we successfully came together as a team. The past months have proven one thing: Strong companies with the passion for performance can join together and become stronger. We are the Edelbrock Group<sup>™</sup>! The absolute leaders in the industry and the future of performance.

## -The Edelbrock Group<sup>™</sup> Management



## Dodge

Supercharger & Cam Power Package for Dodge Gen III HEMI	2
HRT™ Cams & Packages for Turbo & Supercharged Dodge Gen III HEMI	3
SFI 29.1 Flexplate for Dodge Gen III HEMI	6

---

## GM

Supercharger & Cam Power Package for GM LS	8
LST™ Stage 2 Turbo Cam & Package for GM LS 4.8L	10
LST™ Blower Cams & Packages for GM LS	10
Sportsman .904" Solid Roller Lifters for GM LS	12
Race XD™ .904" Bushed Solid Roller Lifters for GM LS	12
Supercharger Kit for GM Gen VI 5.3L/6.2L 2019-2020 V8 Truck	13
Pro Elite™ CNC-Port 6-Bolt Cylinder Heads for GM LS3	14
102mm Black Big Mouth Throttle Body™ for GM LS Gen III/IV	15
Hustler™ Valve Springs for GM 603/604 & CT525 LS-Based Crate Engines	16
Hustler™ Pushrods for GM 603/604 Crate Engines	16

---

## Ford

Stage 2 Supercharger Kit for Ford 2015-2017 Mustang 5.0L GT Coyote V8	17
Stage 2 Supercharger Kit for Ford 2018-2019 Mustang 5.0L GT Coyote V8	18
Performance Lash Adjusters for Ford Modular 4.6L/5.4L	19

---

## Jeep/Off-Road

Supercharger Kit for 2018-2020 Jeep JL & 2020 Gladiator JT Pentastar 3.6L V6	20
Xtreme 4x4 Cams™ for Jeep/AMC 4.0L	21
.450" Lift Ovate Wire Valve Spring Kit for Jeep 4.0L 1988-06	22
High Energy™ Timing Sets for Jeep 4.0L	22
AVS2 Series™ Carburetors for Off-Road & 4x4	23

---

## Diesel

LST™ Cams for GM 6.6L Duramax Diesel	24
.585" Lift Beehive Valve Spring Kits for GM 6.6L Duramax Diesel	25
Hi-Tech™ Pushrod Set for GM 6.6L Duramax Diesel	25
LST™ Cams for Ford 6.0L/6.4L Power Stroke	26
.515" Lift Valve Spring Kit for Ford 6.0L Power Stroke	27
Hi-Tech™ Pushrod Set for Ford 6.0L/6.4L Power Stroke	27

---

## Miscellaneous/Other

Performer RPM Cylinder Heads for Oldsmobile Big Block V8	28
EZ-EFI® -6AN Fuel Return Line Fitting	29
Retainer Degree Gauge Tool	29
Header Bolt Kits	29

# Edelbrock Supercharger Installation

**Important Installation Note:** Supercharger systems without tuners are not eligible for supplemental warranty. Supercharger systems sold without tuners are only emissions legal when used with the correct Edelbrock program. For safety, the Edelbrock supplied program will retain the factory vehicle speed limiter setting.

# SUPERCHARGER & CAM POWER PACKAGE

## FOR DODGE GEN III 5.7L/6.4L HEMI W/ VVT 2011-2018 ENGINES

FAST® introduces a first ever 1000+ HP Supercharger & Cam Power Package, combining an Edelbrock® Supercharger Kit & COMP Cams® Cam Kit for Dodge Gen III HEMI engines.

The FAST® Supercharger & Cam Power Package includes a pump gas friendly supercharger pulley for engine break-in, initial tuning and general performance driving, while a smaller pulley is also included for when maximum power is desired on race fuel or E85. For those wishing to further fine tune boost levels, additional pulley sizes are available. The package includes the basics required to install the supercharger, but necessary accessory items such as fuel injectors, air intake and heat exchanger pump are left up to the installer, providing total flexibility for custom installations.

The Power Package features an Edelbrock 2650 TVS supercharger with a patented, dual-pass, three-core integrated intercooler design featuring 45% more cooling area than competitors' superchargers. This industry leading intercooler design is unrivaled in its ability to generate major power gains through lower inlet air charge temps.

Also included is a COMP Cams® application specific cam kit that contains a state of the art Low Shock Technology™ Camshaft designed specifically for supercharger applications, along with a phaser limiter kit and perfectly matched pushrods, valve springs, retainers, locks, seats and seals.

**Makes up to 1000+ HP**

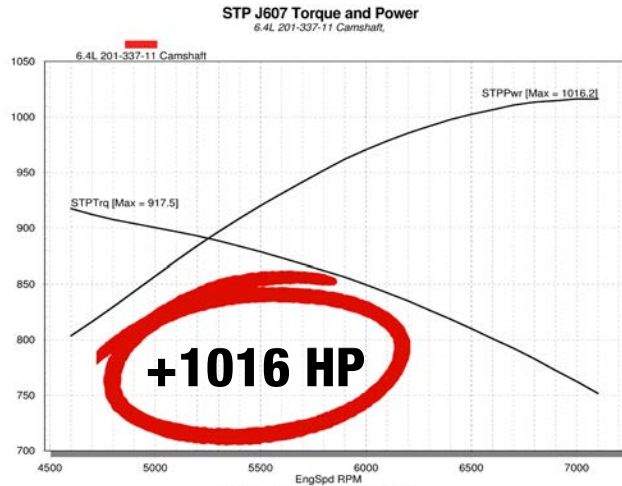

Part #303010 tested on a 6.4L HEMI with COMP Cams® MK201-337-11, Edelbrock® 2650 Supercharger w/ 2.625 Pulley, stock block (4.090 x 3.720), stock crankshaft, upgraded rods & pistons, stock 6.4L cylinder heads, E85 fuel, 16.2 psi boost.

PART #303010 – DODGE GEN III 5.7L/6.4L HEMI W/ VVT 2011-2018		
SUPERCHARGER KIT COMPONENTS	CAM KIT COMPONENTS	CAM KIT COMPONENT PART #
2650 TVS Supercharger w/ Patented Integrated Intercooler	Camshaft	<b>201-337-17</b>
	Phaser Limiter	<b>5761</b>
3.500" SC Pulley	Pushrods	<b>8721-16</b>
	Conical Valve Springs	<b>7230-16</b>
2.625" SC Pulley	Chromemoly Steel Retainers	<b>761-16</b>
	Valve Locks	<b>607-16</b>
Accessory Drive Pulleys	Valve Seals	<b>531-16</b>
	Spring Seats	<b>4678-16</b>
Fuel Lines & Rails	Spring Shims	<b>4815-8, 4813-8</b>
	Installation Hardware	<b>N/A</b>

# HRT™ CAM PACKAGES

## FOR TURBO & SUPERCHARGED DODGE GEN III HEMI ENGINES

COMP Cams® HRT™ Cam Packages for Turbo and Supercharged Dodge Gen III HEMI Applications take the guesswork out of choosing the right valve train upgrade package for your specific engine and desired performance.

HRT™ Cam Packages use the newest and most advanced lobe designs from COMP Cams® in order to produce some of the highest average power and torque increases available for turbo and supercharged engines. The “Low Shock Technology” features lobe profiles designed to maximize horsepower while improving stability at higher RPM. These profiles are also easier on the valve springs, enhancing durability and reducing load loss. HRT™ Camshafts receive the proprietary Micro Surface Enhancement™ (MSE) finishing process as a standard feature, which increases strength and performance by reducing surface peak roughness and provides a 250% improvement in the effective load bearing area, allowing for much higher loads.

Organized into stages, these new package options are ideal for serious performance and heavily modified race-oriented builds. The resulting Stage 1 and Stage 2 HRT™ Cam Packages can add over 180+ HP (depending on the application) and are available as a base Cam Kit (CK-Kit) or a more complete Master Kit (MK-Kit).

### CK-KIT (Cam Kit) INCLUDES:

- Camshaft
- Phaser Limiter (VVT HEMI Only)
- Pushrods
- Beehive or Conical Valve Springs
- Retainers
- Valve Locks
- Spring Seats
- Valve Seals

### MK-KIT (Master Kit) INCLUDES:

- Camshaft
- Phaser Limiter or Lock (VVT HEMI Only)
- Lifters
- Pushrods
- Beehive or Conical Valve Springs
- Retainers
- Valve Locks
- Spring Seats
- Valve Seals

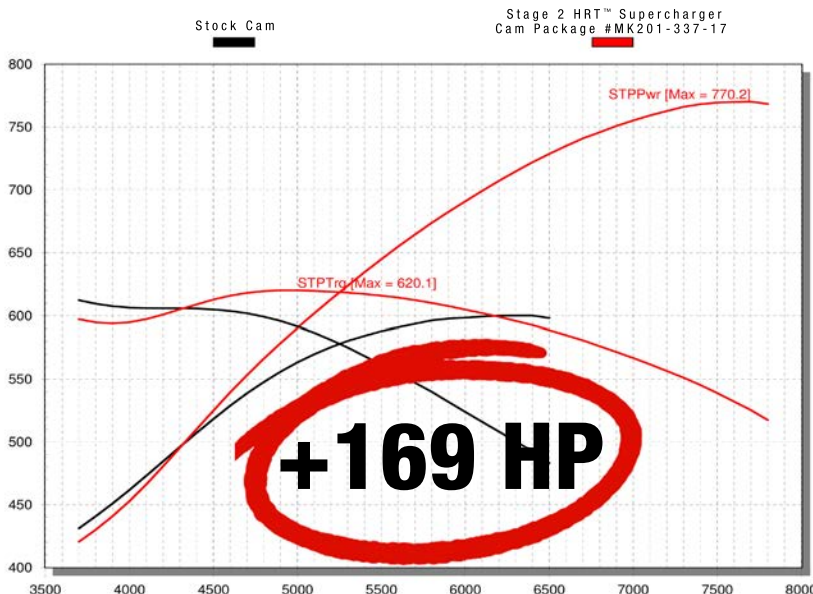

Stage 2 HRT™ Supercharger Camshaft Package #MK201-337-17 tested on Dodge HEMI 5.7L 2009+ w/ unported stock heads, Edelbrock® 2650TVS Supercharger @ 11 psi, 3.25" pulley, FAST™ 87mm Throttle Body

# HRT™ CAM PACKAGES

## FOR TURBO & SUPERCHARGED DODGE GEN III HEMI ENGINES

### HEMI 5.7L 2003-08

STAGE	APPLICATIONS/CAMSHAFTS	VALVE SETTING		RPM OPERATING RANGE	CAM ONLY PART #	DURATION				VALVE LIFT		LOBE SEP. ANGLE
		IN.	EX.			ADVERTISED IN.	ADVERTISED EX.	@ .050" IN.	@ .050" EX.	W/ 1.65 ROCKER IN.	W/ 1.65 ROCKER EX.	
<b>+80 HP</b> Stage 1 Turbo	Hydraulic Roller – Perfect choice for 5.7L stock bottom end with unknown back pressure turbo systems. Excellent throttle response and great power. Requires DOD disabling & #26918 valve springs.	Hyd.	Hyd.	1800-6600	<b>112-330-11</b>	279	287	221	229	.594	.594	115
<b>+110 HP</b> Stage 2 Turbo	Hydraulic Roller – Best camshaft for larger (80mm+) turbochargers with optimized low back pressure systems. Dyno tested to 7500+ RPM. Requires DOD disabling, #7228 springs & phaser lock.	Hyd.	Hyd.	2000-7000	<b>112-332-11</b>	287	295	229	237	.635	.635	116
<b>+100 HP</b> Stage 1 Blower	Hydraulic Roller – Perfect choice for 5.7L stock bottom end and 2.5L or smaller blowers. Excellent throttle response and great power. Requires DOD disabling & #26918 valve springs.	Hyd.	Hyd.	1800-6600	<b>112-335-11</b>	279	291	221	233	.594	.594	116
<b>+118 HP</b> Stage 2 Blower	Hydraulic Roller – Best camshaft for larger blowers and more race-oriented builds. Dyno tested to 7500+ RPM. Requires DOD disabling, #7228 springs & phaser lock.	Hyd.	Hyd.	2000-7000	<b>112-337-11</b>	287	299	229	241	.635	.635	117

### HEMI 5.7L/6.4L w/ VVT 2009+

STAGE	APPLICATIONS/CAMSHAFTS	VALVE SETTING		RPM OPERATING RANGE	CAM ONLY PART #	DURATION				VALVE LIFT		LOBE SEP. ANGLE
		IN.	EX.			ADVERTISED IN.	ADVERTISED EX.	@ .050" IN.	@ .050" EX.	W/ 1.65 ROCKER IN.	W/ 1.65 ROCKER EX.	
<b>+158 HP</b> Stage 1 Turbo	Hydraulic Roller – Perfect choice for 5.7L Eagle or 6.4L Apache with unknown back pressure turbo systems and keeping limited phaser control for off idle response. Requires DOD disabling, #26918 springs & phaser limiter.	Hyd.	Hyd.	1800-6600	<b>201-330-17</b>	279	287	221	229	.594	.594	115
<b>+182 HP</b> Stage 2 Turbo	Hydraulic Roller – Best camshaft for larger (80mm+) turbochargers with optimized low back pressure systems. Dyno tested to 7500+ RPM. Requires DOD disabling, #7230 springs & phaser lock.	Hyd.	Hyd.	2000-7000	<b>201-332-17</b>	287	295	229	237	.635	.635	116
<b>+129 HP</b> Stage 1 Blower	Hydraulic Roller – Perfect for 5.7L Eagle or 6.4L Apache with 2.5L and smaller blowers while keeping limited phaser control for off idle response. Requires DOD disabling, #26918 springs & phaser limiter.	Hyd.	Hyd.	1800-6600	<b>201-335-17</b>	279	291	221	233	.594	.594	116
<b>+169 HP</b> Stage 2 Blower	Hydraulic Roller – Best cam for larger blowers and more race-oriented builds. Dyno tested to 7500+ RPM. Requires DOD disabling, #7230 springs & phaser lock.	Hyd.	Hyd.	2000-7000	<b>201-337-17</b>	287	299	229	241	.635	.635	117

KIT OPTIONS	
CK-KIT (CAM KIT)	MK-KIT (MASTER KIT)

**KIT #CK112-330-11:** Includes Cam #112-330-11, Pushrods #8720-16, Beehive™ Springs #26918-16, Steel Retainers #761-16, Valve Locks #607-16, Spring Seats #4685-16, Valve Seals #532-16

**KIT #MK112-330-11:** Includes Cam #112-330-11, Lifters #856Y-16, Pushrods #8720-16, Beehive™ Springs #26918-16, Steel Retainers #761-16, Valve Locks #607-16, Spring Seats #4685-16, Valve Seals #532-16

**KIT #CK112-332-11:** Includes Cam #112-332-11, Pushrods #8720-16, Conical Springs #7228-16, Steel Retainers #761-16, Valve Locks #607-16, Spring Seats #4801-16, Valve Seals #532-16

**KIT #MK112-332-11:** Includes Cam #112-332-11, Lifters #856Y-16, Pushrods #8720-16, Conical Springs #7228-16, Steel Retainers #761-16, Valve Locks #607-16, Spring Seats #4801-16, Valve Seals #532-16

**KIT #CK112-335-11:** Includes Cam #112-335-11, Pushrods #8720-16, Beehive™ Springs #26918-16, Steel Retainers #761-16, Valve Locks #607-16, Spring Seats #4685-16, Valve Seals #532-16

**KIT #MK112-335-11:** Includes Cam #112-335-11, Lifters #856Y-16, Pushrods #8720-16, Beehive™ Springs #26918-16, Steel Retainers #761-16, Valve Locks #607-16, Spring Seats #4685-16, Valve Seals #532-16

**KIT #CK112-337-11:** Includes Cam #112-337-11, Pushrods #8720-16, Conical Springs #7228-16, Steel Retainers #761-16, Valve Locks #607-16, Spring Seats #4801-16, Valve Seals #532-16

**KIT #MK112-337-11:** Includes Cam #112-337-11, Lifters #856Y-16, Pushrods #8720-16, Conical Springs #7228-16, Steel Retainers #761-16, Valve Locks #607-16, Spring Seats #4801-16, Valve Seals #532-16

KIT OPTIONS	
CK-KIT (CAM KIT)	MK-KIT (MASTER KIT)

**KIT #CK201-330-17:** Includes Cam #201-330-17, Phaser Limiter #5761, Pushrods #7929-8 & 7997-8, Beehive™ Springs #26918-16, Steel Retainers #761-16, Valve Locks #607-16, Spring Seats #4683-16, Valve Seals #531-16, Shims #4815-8 (.060"); #4814-16 (.030"); #4813-8 (.015")

**KIT #MK201-330-17:** Includes Cam #201-330-17, Lifters #856Y-16, Phaser Lock #5760, Pushrods #7929-8 & 7997-8, Beehive™ Springs #26918-16, Steel Retainers #761-16, Valve Locks #607-16, Spring Seats #4683-16, Valve Seals #531-16, Shims #4815-8 (.060"); #4814-16 (.030"); #4813-8 (.015")

**KIT #CK201-332-17:** Includes Cam #201-332-17, Phaser Limiter #5761, Pushrods #7929-8 & 7997-8, Conical Springs #7230-16, Steel Retainers #761-16, Valve Locks #607-16, Spring Seats #4678-16, Valve Seals #531-16, Shims #4815-8 (.060"); #4813-8 (.015")

**KIT #MK201-332-17:** Includes Cam #201-332-17, Lifters #856Y-16, Phaser Limiter #5761, Pushrods #7929-8 & 7997-8, Conical Springs #7230-16, Steel Retainers #761-16, Valve Locks #607-16, Spring Seats #4678-16, Valve Seals #531-16, Shims #4815-8 (.060"); #4813-8 (.015")

**KIT #CK201-335-17:** Includes Cam #201-335-17, Phaser Limiter #5761, Pushrods #7929-8 & 7997-8, Beehive™ Springs #26918-16, Steel Retainers #761-16, Valve Locks #607-16, Spring Seats #4683-16, Valve Seals #531-16, Shims #4815-8 (.060"); #4814-16 (.030"); #4813-8 (.015")

**KIT #MK201-335-17:** Includes Cam #201-335-17, Lifters #856Y-16, Phaser Lock #5760, Pushrods #7929-8 & 7997-8, Beehive™ Springs #26918-16, Steel Retainers #761-16, Valve Locks #607-16, Spring Seats #4683-16, Valve Seals #531-16, Shims #4815-8 (.060"); #4814-16 (.030"); #4813-8 (.015")

**KIT #CK201-337-17:** Includes Cam #201-337-17, Phaser Limiter #5761, Pushrods #7929-8 & 7997-8, Conical Springs #7230-16, Steel Retainers #761-16, Valve Locks #607-16, Spring Seats #4678-16, Valve Seals #531-16, Shims #4815-8 (.060"); #4813-8 (.015")

**KIT #MK201-337-17:** Includes Cam #201-337-17, Lifters #856Y-16, Phaser Limiter #5761, Pushrods #7929-8 & 7997-8, Conical Springs #7230-16, Steel Retainers #761-16, Valve Locks #607-16, Spring Seats #4678-16, Valve Seals #531-16, Shims #4815-8 (.060"); #4813-8 (.015")

# SFI 29.1 FLEXPLATE

## FOR DODGE GEN III HEMI ENGINES

The Gen III HEMI Flexplate from TCI® is SFI 29.1 certified, making it the perfect upgrade for your high horsepower street or competition drag car. It offers heavy-duty strength for high-RPM Dodge Gen III HEMI applications. The high-strength design is 50% thicker than the stock flexplate, ensuring it can handle all the horsepower and torque your Gen III HEMI can produce. Made from chromemoly steel, it also features a double welded ring gear for added strength and rigidity while E-coating offers corrosion protection for durability. Each flexplate is precision balanced for smooth operation at high RPM, and careful manufacturing and strict quality control eliminate excessive runout, ensuring vibration free operation and consistent starter gear engagement.

SFI 29.1 certification ensures all safety requirements are met for major race sanctioning bodies. Built to withstand up to 10,000 RPM, the flexplate is a 131-tooth, 8-bolt, heavy-duty OEM replacement for any Dodge Gen III HEMI 5.7L/6.1L/6.2L/6.4L engine.



**#145210**

DESCRIPTION	PART #
SFI 29.1 Flexplate for Dodge Gen III HEMI	<b>145210</b>





**CONNECT WITH THE FAMILY OF  
EDEL BROCK GROUP™ COMPANIES TODAY!**



# SUPERCHARGER & CAM POWER PACKAGES

## FOR GM LS ENGINES

An Edelbrock® Supercharger Kit and COMP Cams® Cam Kit is the perfect pairing for performance enthusiasts looking for 850+ HP potential from their GM LS engines.

FAST® Supercharger & Cam Power Packages include a pump gas compatible supercharger pulley for break-in, initial tuning and general driving with other smaller pulleys also included for use with race fuel or E85. Additional pulleys are available for further fine tuning boost levels. Package include the basics required to install the superchargers, but other required accessory items such as fuel injectors, air intakes and heat exchanger pumps are NOT included to allow flexibility for custom installations.

The Edelbrock® Supercharger Kits include a 2300 TVS supercharger with an integrated intercooler. The intercooler is a high capacity, dual bar and plate design that enables big power gains through lower inlet air charge temps.

Also included is a COMP Cams® application specific CK-Kit that contains a proprietary Low Shock Technology™ Camshaft designed specifically for GM LS supercharger applications, along with complementing pushrods, dual valve springs, tool steel retainers, locks, seats, seals and installation hardware.



**Make up to 850+ HP w/  
Our First Ever Supercharger &  
Cam Power Packages**

PART #303011 - GM LS1/LS2 CATHEDRAL PORT 4.8L/5.3L/6.0L 1998-2007		
EDELBROCK SUPERCHARGER KIT COMPONENTS	CAM KIT COMPONENTS	CAM KIT COMPONENT PART #
2300 TVS Supercharger w/ Integrated Intercooler	Camshaft	<b>54-337-11</b>
	Pushrods	<b>7639-16</b>
3.875" SC Pulley	Dual Valve Springs	<b>26926-16</b>
	Tool Steel Retainers	<b>1779-16</b>
3.000" SC Pulley	Valve Locks	<b>623-16</b>
	Valve Seals	<b>511-16</b>
Accessory Drive Pulleys	Spring Seats	<b>4695-16</b>
Fuel Lines & Rails	Installation Hardware	-

PART #303012 - GM LS3 RECTANGLE PORT 6.2L 2007-2014		
EDELBROCK SUPERCHARGER KIT COMPONENTS	CAM KIT COMPONENTS	CAM KIT COMPONENT PART #
2300 TVS Supercharger w/ Integrated Intercooler	Camshaft	<b>54-337-11</b>
	Pushrods	<b>7639-16</b>
3.500" SC Pulley	Dual Valve Springs	<b>26926-16</b>
	Tool Steel Retainers	<b>1779-16</b>
2.750" SC Pulley	Valve Locks	<b>623-16</b>
	Valve Seals	<b>511-16</b>
Accessory Drive Pulleys	Spring Seats	<b>4695-16</b>
Fuel Lines & Rails	Installation Hardware	-

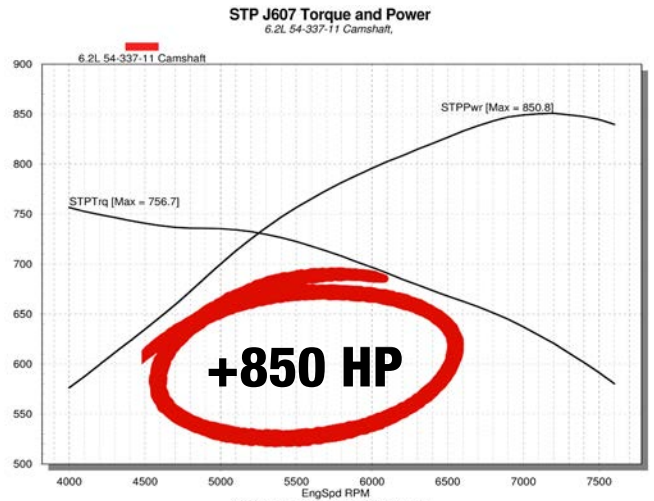
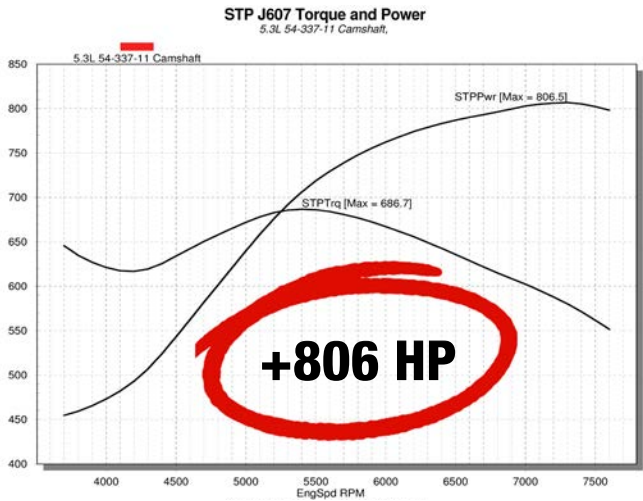

**Part #303011** tested on a 5.3L LM7 with COMP Cams® MK54-337-11, Edelbrock® 2300 Supercharger w/ 3.000 Pulley, stock block (3.800 x 3.622), upgraded rotating assembly, RHS® cylinder heads, E85 fuel, 17.7 psi boost.

**Part #303012** tested on a 6.2L LS3 with COMP Cams® MK54-337-11, Edelbrock® 2300 Supercharger w/ 2.750 Pulley, stock block (4.070 x 3.622), upgraded rotating assembly, stock cylinder heads, E85 fuel, 16.5 psi boost.



# LST™ STAGE 2 TURBO CAM PACKAGES

## FOR GM LS 4.8L ENGINES

COMP Cams® has created valve train packages for its popular LST™ (Low Shock Technology™) line of cams that are perfectly matched for maximum horsepower & boost response in turbo GM LS 4.8L race engines.

- Features Low Shock Technology (LST™) cam lobe profiles for increased horsepower & improved stability at higher RPM
- Spintron® and dyno-tested to ensure maximum power, boost response & reliability
- Packages contain perfectly matched components for maximum horsepower & dependability in turbocharged GM LS 4.8L race engines with low back pressure turbo systems

# LST™ BLOWER CAMS & PACKAGES

## FOR GM LS ENGINES

COMP Cams® now offers LST™ (Low Shock Technology) Cams and complete Cam Packages designed specifically for GM LS blower applications.

- Features Low Shock Technology (LST™) cam lobe profiles for increased horsepower and improved stability at higher RPM
- Spintron® and dyno-tested to ensure maximum power, boost response and reliability
- Packages contain all components for a complete valve train upgrade in supercharged GM LS engines

### GM LS 4.8L

STAGE	APPLICATIONS/CAMSHAFTS	VALVE SETTING		RPM RANGE	CAM ONLY PART #	DURATION				VALVE LIFT		LOBE SEP.
		IN.	EX.			ADVERTISED IN.	EX.	@ .050" IN.	EX.	W/ 1.7 ROCKER IN.	EX.	
Stage 2 Turbo	HYDRAULIC ROLLER – Perfect choice for 4.8L race-style, low back pressure turbo systems. 7400 RPM stability with CK and MK kits.	Hyd.	Hyd.	2500-7400	54-331-11	283	291	225	233	.612	.612	115

### GM LS Gen III/IV Three-Bolt 8 Cyl. 1997-2015

STAGE	APPLICATIONS/CAMSHAFTS	VALVE SETTING		RPM RANGE	CAM ONLY PART #	DURATION				VALVE LIFT		LOBE SEP.
		IN.	EX.			ADVERTISED IN.	EX.	@ .050" IN.	EX.	W/ 1.7 ROCKER IN.	EX.	
Stage 1 Blower	HYDRAULIC ROLLER – Excellent performance with smaller engines or any 5.3L mildly modified blower engine.	Hyd.	Hyd.	2000-7200	54-335-11	283	294	225	239	.612	.612	114
Stage 2 Blower	HYDRAULIC ROLLER – Perfect choice for upgraded GM LS engines with larger displacement or larger blower applications that include more serious additional modifications for higher RPM and more power.	Hyd.	Hyd.	2300-7400	54-337-11	291	302	233	247	.612	.614	115

#CK54-331-11



**CK-KIT (Cam Kit) INCLUDES:**

- Camshaft
- Pushrods
- Dual Valve Springs
- Retainers
- Valve Locks
- Spring Seats
- Valve Seals

**MK-KIT (Master Kit) INCLUDES:**

- Camshaft
- Timing Set
- Lifters
- Pushrods
- Dual Valve Springs
- Retainers
- Valve Locks
- Spring Seats
- Valve Seals

CK-KIT (CAM KIT)	MK-KIT (MASTER KIT)	UPGRADED STOCK ROCKER ARMS	MAX-LIFT BSR SHAFT ROCKER SYSTEMS™	CAM INSTALL KIT
<p><b>KIT #CK54-331-11:</b> Includes Cam #54-331-11, Pushrods #7639-16, Dual Springs #26926-16, Tool Steel Retainers #1779-16, Locks #623-16, Spring Seats #4695-16, Valve Seals #511-16</p> <p><b>KIT #CK54-331-11:</b> Includes Cam #54-331-11, Pushrods #7639-16, Dual Springs #26926-16, Tool Steel Retainers #1779-16, Locks #623-16, Spring Seats #4695-16, Valve Seals #511-16</p>	<p><b>KIT #MK54-331-24</b> (For 24X applications): Includes Cam #54-331-11, Lifters #875-16, Timing Set #7102, Pushrods #7639-16, Dual Springs #26926-16, Tool Steel Retainers #1779-16, Locks #623-16, Spring Seats #4695-16, Valve Seals #511-16</p> <p><b>KIT #MK54-331-58</b> (For 58X applications): Includes Cam #54-331-11, Lifters #875-16, Timing Set #7106, Pushrods #7639-16, Dual Springs #26926-16, Tool Steel Retainers #1779-16, Locks #623-16, Spring Seats #4695-16, Valve Seals #511-16</p>	1477-16	1981-16	5621

CK-KIT (CAM KIT)	MK-KIT (MASTER KIT)	UPGRADED STOCK ROCKER ARMS	MAX-LIFT BSR SHAFT ROCKER SYSTEMS™	CAM INSTALL KIT
<p><b>KIT #CK54-335-11:</b> Includes Cam #54-335-11, Pushrods #7639-16, Dual Springs #26926-16, Tool Steel Retainers #1779-16, Locks #623-16, Spring Seats #4695-16, Valve Seals #511-16</p> <p><b>KIT #CK54-335-11:</b> Includes Cam #54-335-11, Pushrods #7639-16, Dual Springs #26926-16, Tool Steel Retainers #1779-16, Locks #623-16, Spring Seats #4695-16, Valve Seals #511-16</p>	<p><b>KIT #MK54-335-24</b> (For 24X applications): Includes Cam #54-335-11, Lifters #875-16, Timing Set #7102, Pushrods #7639-16, Dual Springs #26926-16, Tool Steel Retainers #1779-16, Locks #623-16, Spring Seats #4695-16, Valve Seals #511-16</p> <p><b>KIT #MK54-335-58</b> (For 58X applications): Includes Cam #54-335-11, Lifters #875-16, Timing Set #7106, Pushrods #7639-16, Dual Springs #26926-16, Tool Steel Retainers #1779-16, Locks #623-16, Spring Seats #4695-16, Valve Seals #511-16</p>	<p>1477-16 (LS1-Style)</p> <p>1478-16 (LS3-Style)</p> <p>1479-16 (LS7-Style)</p>	<p>1981-16 (LS1-Style)</p> <p>1982-16 (LS3-Style)</p> <p>1983-16 (LS7-Style)</p>	<p>5621 (LS1 &amp; 3-Bolt)</p> <p>5622 (LS7 &amp; LS9)</p>
<p><b>KIT #CK54-337-11:</b> Includes Cam #54-337-11, Pushrods #7639-16, Dual Springs #26926-16, Tool Steel Retainers #1779-16, Locks #623-16, Spring Seats #4695-16, Valve Seals #511-16</p> <p><b>KIT #CK54-337-11:</b> Includes Cam #54-337-11, Pushrods #7639-16, Dual Springs #26926-16, Tool Steel Retainers #1779-16, Locks #623-16, Spring Seats #4695-16, Valve Seals #511-16</p>	<p><b>KIT #MK54-337-24</b> (For 24X applications): Includes Cam #54-337-11, Lifters #875-16, Timing Set #7102, Pushrods #7639-16, Dual Springs #26926-16, Tool Steel Retainers #1779-16, Locks #623-16, Spring Seats #4695-16, Valve Seals #511-16</p> <p><b>KIT #MK54-337-58</b> (For 58X applications): Includes Cam #54-337-11, Lifters #875-16, Timing Set #7106, Pushrods #7639-16, Dual Springs #26926-16, Tool Steel Retainers #1779-16, Locks #623-16, Spring Seats #4695-16, Valve Seals #511-16</p>	<p>1477-16 (LS1-Style)</p> <p>1478-16 (LS3-Style)</p> <p>1479-16 (LS7-Style)</p>	<p>1981-16 (LS1-Style)</p> <p>1982-16 (LS3-Style)</p> <p>1983-16 (LS7-Style)</p>	<p>5621 (LS1 &amp; 3-Bolt)</p> <p>5622 (LS7 &amp; LS9)</p>

# SPORTSMAN .904" SOLID ROLLER LIFTERS

## FOR GM LS ENGINES

- .904" Diameter lifter features durable .800" diameter roller wheel & centered pushrod seats
- Tall body style enables use in both standard and .300" tall lifter bore blocks
- Premium 8620 alloy steel construction, lightweight design & needle bearing axles reduce friction
- Triple oiling system with consistent roller & axle lubrication designed to combat oil starvation
- Utilize a tapered & slotted link bar tower for reduced overall weight



DESCRIPTION	DIA.	SET INCLUDES:	PUSHROD SEAT LOCATION	WHEEL DIA.	SEAT HEIGHT	BUSHING/NEEDLE BEARING	PART #
Roller Lifter w/ Needle Bearing	.904"	(8) 96958	8 Pairs Centered	.800"	2.21"	Needle Bearing	96958-16

# RACE XD™ .904" BUSHED SOLID ROLLER LIFTERS

## FOR GM LS ENGINES

- .904" Diameter for serious LS engine builds
- Bronze alloy roller wheel bushing for extreme durability
- Optional interchangeable pushrod seats available in .090" or .180" offsets
- REM-finished bodies reduce lifter bore wear
- Limited Lifetime Warranty Against Breakage

#99958-4



DESCRIPTION	DIA.	PUSHROD SEAT LOCATION	WHEEL DIA.	SEAT HEIGHT	FINISH	PART #
GM LS	.904"	Centered	.800"	2.21" w/ 5/16" Ball; 2.29" w/ 3/8" Ball	REM	99958-16

# SUPERCHARGER KIT

## GM GEN VI 5.3L/6.2L 2019-2020 V8 TRUCK ENGINES

Boost the horsepower and torque of your new generation GM Gen IV truck with one of the most efficient superchargers on the market that is 50-state emissions-legal systems.

This Supercharger System for V8 equipped 2019-2020 Gen VI GM Trucks utilizes the largest Eaton rotor group – the R2650 TVS – a 170-degree high-twist lobe design that can accommodate bigger power builds with unparalleled efficiency and reliability. An increase in horsepower and torque is gained with almost no loss in fuel efficiency due to the integrated bypass valve. The kit also includes an all-new nose drive for this new generation of trucks and features our dual-pass, three core intercooler for incredibly low intake air temperatures. It has also been outfitted with an all new truck specific supercharger lid, with a lower profile in the rear, for easier installation under the cowl. A black powder coated finish completes the OEM look to allow blending into the engine compartment while providing durability and longer life. The 5.3L kit includes a 3.875" supercharger pulley and the 6.2L kit includes a 3.5" supercharger pulley.

- 50-state emissions legal
- Installs with no modifications to the stock body or hood
- Integrated bypass valve for little to no decrease in fuel economy
- High-capacity, dual-pass, triple core air-to-water intercooler
- Dual core low temperature heat exchanger for incredibly low IATs
- Self-contained oiling system with 100,000-mile service interval
- 3-year/36,000-mile powertrain warranty when applicable



YEAR	MODEL	ENGINE	ROTOR	EMISSION CODE	TUNE	NO TUNE
STAGE 1 - STREET SYSTEMS						
2019-2020	GM Gen VI Truck	5.3L V8	R2650	●	#15665	#156650
2019-2020	GM Gen VI Truck	6.2L V8	R2650	●	#15666	#156660

#15666

Condition	536 rwTq (RPM)	575 rwHP (RPM)
Baseline	~3500	~4500
Supercharged	~4500	~5500

\*Representational Photo

**IMPORTANT:** See Installation and Warranty Notes on page 1

### EMISSIONS GUIDE

- 50-STATE LEGAL
- EPA LEGAL
- RACING ONLY
- PRE-POLLUTION CONTROLLED VEHICLES
- STOCK REPLACEMENT
- ENGINE SWAP

# PRO ELITE™ CNC-PORT 6-BOLT CYLINDER HEADS

## FOR GM LS3 ENGINES

RHS® Pro Elite™ CNC-Port 6-Bolt Cylinder Heads for GM LS3 Engines utilize the popular LS 6-bolt head design, making them compatible with the RHS® LS Race Block, GM LSX Block and OEM 4-bolt blocks. The 6-bolt design offers increased clamping capacity over the standard factory 4-bolt configuration and greatly improves head gasket retention, ideal for boosted and high compression engines.

These heads are manufactured with premium materials and machined to the industry's tightest tolerances. Features include an 11° valve angle and fully CNC-machined ports for improved airflow. The CNC-machined runners and chambers, as well as the rolled valve angle, increase overall flow capability, while the revised water jacket design enhances thermal conductivity. The premium .500" bronze valve guides withstand long wear with particular emphasis placed on holding precision tolerances on valve seat concentricity, allowing the valves to seal securely for more power. Finally, the .700" thick deck and reinforced rocker rails make these cylinder heads ideal for high horsepower and boosted LS3 applications.

All RHS® cylinder heads feature patented Clean Cast Technology™, a revolutionary process that eliminates casting flaws and promotes a smoother internal surface finish for greater air and coolant flow. These benefits provide more power and cooling, right out of the box.

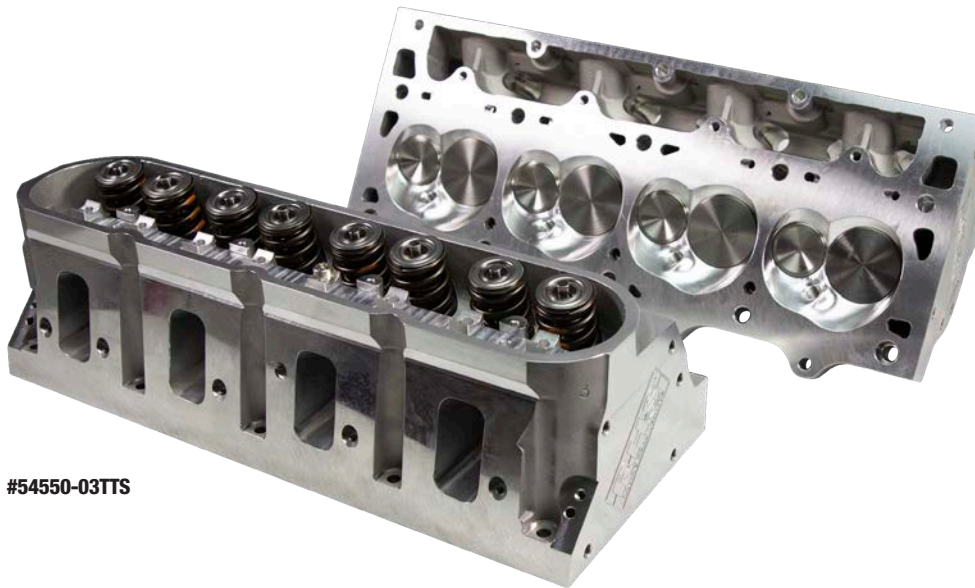

#54550-03TTS

PART #	RUNNER	CHAMBER	SPARK-PLUGS	VALVE SIZE		VALVE TRAIN	MAX LIFT	VALVE SPRINGS	RETAINERS		INT./EXH. VALVE MATERIAL
				IN.	EX.				PART #	MATERIAL	
<b>54550-03TTS</b>	263cc	68cc	Angle	2.165"	1.600"	Solid Roller	.700"	<b>943-16</b>	<b>1731-16</b>	Tool Steel	Titanium Int./Inconel Exh.
<b>54550-03STS</b>	263cc	68cc	Angle	2.165"	1.600"	Solid Roller	.700"	<b>943-16</b>	<b>1731-16</b>	Tool Steel	Stainless Steel Int./Inconel Exh.
<b>54550-05SCS</b>	263cc	68cc	Angle	2.165"	1.600"	Hyd. Roller	.660"	<b>26925-16</b>	<b>713-16</b>	Chromemoly Steel	Stainless Steel Int./Exh.
<b>54550</b>	263cc	68cc	Angle	2.165"	1.600"	-	-	-	-	-	-



# 102mm BLACK BIG MOUTH THROTTLE BODY™

## FOR GM LS GEN III/IV ENGINES

Designed to maximize performance upgrades on all GM Gen III and Gen IV engines with cable driven throttle bodies, the FAST® 102mm Big Mouth Throttle Body™ is now available with an anodized black finish. With an opening nearly 40% larger than stock, the FAST® 102mm Big Mouth Throttle Body™ is ideal for use with the FAST® LSX<sub>R</sub>™, LSX<sub>RT</sub>™ and LSX<sub>HR</sub>™ intake manifolds, as well as any other manifold with a 102mm or larger inlet.

- Increased blade thickness eliminates deflection when used in boosted applications
- Offset blade pivot improves throttle response; beefed up linkage w/ dual throttle spring mechanism ensures total control
- Designed to maximize performance upgrades on all GM Gen III & Gen IV engines with cable driven throttle bodies

DESCRIPTION	PART #
102mm Big Mouth Throttle Body™ w/o TPS & IAC	54106
102mm Big Mouth Throttle Body™ w/ TPS & IAC	54107

#54107



# HUSTLER™ VALVE SPRINGS

## FOR GM 603/604 AND CT525 LS-BASED CRATE ENGINES

- Improved dynamic control over GM Small Block Chevy 603/604 & CT525 LS Crate Engines "blue" LS6 valve springs with 4% higher seat and open loads
- Extra .020" lift capability over stock
- High quality wire & small batch manufacturing processes provide quality & durability
- Painted blue for similar appearance to OEM springs
- Perfect to pair up with COMP Cams® Hustler™ Cams, Lifters and Pushrods

H604-1



SPRING SPECS	O.D.	I.D.	SEAT LOAD	OPEN LOAD	COIL BIND	RATE (LBS./IN.)	PART #
	DIA. 1	DIA. 2					
Top	1.077"	.655"	92 @ 1.800"	304 @ 1.250	1.181"	386	H604-16
Bottom	1.282"	.860"					

# HUSTLER™ PUSHRODS

## FOR GM 603/604 CRATE ENGINES

- .075" Wall thickness greatly increases stiffness over factory .060" wall pushrod
- Hardened tube for use with guide plates meets or exceeds OE specs
- Less valve train deflection improves performance
- 7.122" long pushrod precisely matches factory length
- Perfect complement to COMP Cams® Hustler™ Cam, Lifters & Valve Springs

#7817-16



DESCRIPTION	WALL THICKNESS	DIAMETER	LENGTH	END TYPES	PART #
GM 603/604 Crate Engines	.075"	5/16"	7.122"	5/16" Oil Through Welded Ball	7817-16

# SUPERCHARGER KIT

## FOR 2015-2017 FORD MUSTANG 5.0L GT COYOTE V8 ENGINES

Are you ready to add serious horsepower under the hood of your 2015-2017 Ford Mustang Gen 2 Coyote V8 engine? The new Edelbrock Supercharger Kit is a 50-state emissions-legal systems that is dyno-proven to produce 616 horsepower and 505 ft/lbs of torque to the rear wheels with no other modifications required.

The new Stage 2 Supercharger for the Mustang 5.0L Gen II Coyote V8 utilizes the high-efficiency Eaton R2650 TVS rotor assembly with a high-twist lobe design to deliver an ultra-smooth and linear torque curve with more usable performance at all points in the power band. This kit includes a 103mm throttle body, high-flow 113mm air intake system, upgraded 78 lb/hr port fuel injectors and a 400 LPH in-tank fuel cartridge. A black powder-coated finish provides the ultimate underhood appeal that installs easily without having to modify the hood, making this one of the best true bolt-on and horsepower-per-dollar investments available.

- 50-state emissions legal
- Installs with no modifications to the body or hood
- Integrated bypass valve for maximum fuel efficiency
- High-capacity, dual-pass, triple core air-to-water intercooler
- High-flow cold-air intake system including lifetime filter
- Self-contained oiling system with 100,000-mile service interval
- 3-year/36,000-mile powertrain warranty when applicable



YEAR	MODEL	ENGINE	ROTOR	HP	TORQUE (FT/LBS)	EMISSION CODE	TUNE	NO TUNE
STAGE 2 - STREET SYSTEMS								
2015-2017	Ford Mustang	5.0L 4V	R2650	610WHP	499WTQ	●	#15839	#158390

**610<sub>rw</sub>HP**  
**499<sub>rw</sub>Tq**

#15839

**IMPORTANT:** See Installation and Warranty Notes on page 1

### EMISSIONS GUIDE

● 50-STATE LEGAL   ● EPA LEGAL   ● RACING ONLY   ● PRE-POLLUTION CONTROLLED VEHICLES   ● STOCK REPLACEMENT   ● ENGINE SWAP

# SUPERCHARGER KIT

## FOR 2018-2019 FORD MUSTANG 5.0L GT COYOTE V8 ENGINES

Add serious horsepower under the hood of your 2018-2019 Ford Mustang GT 5.0L Coyote V8 engine with a new 50-state emissions-legal system that requires no modifications.

The new Stage 2 Supercharger for the 2018-2019 Mustang GT 5.0L Coyote V8 utilizes the high-efficiency Eaton R2650 TVS rotor assembly with a high-twist lobe design along with bigger bearings and beefier timing gears to deliver an ultra-smooth and linear torque curve with more usable performance at all points in the power band. This kit includes a 103mm throttle body, high-flow 113mm air intake system, upgraded 50 lb/hr port fuel injectors, an 8-rib supercharger belt drive and a plug-and-play fuel pump voltage booster. A black powder-coated finish provides the ultimate underhood appeal that installs easily without having to modify the hood, making this an excellent bolt-on investment.

- 50-state emissions legal
- Installs with no modifications to the body or hood
- Integrated bypass valve for maximum fuel efficiency
- High-capacity, dual-pass, triple core air-to-water intercooler
- 8-Rib supercharger belt drive versus the OEM 6-rib belt drive
- Plug-and-play fuel pump voltage booster
- Self-contained oiling system with 100,000-mile service interval
- 3-year/36,000-mile powertrain warranty when applicable



YEAR	MODEL	ENGINE	ROTOR	HP	TORQUE (FT/LBS)	EMISSION CODE	TUNE	NO TUNE
STAGE 2 - STREET SYSTEMS								
2018-2019	Ford Mustang	5.0L 4V	R2650	685WHP	533WTQ	●	#15388	#153880

#15388

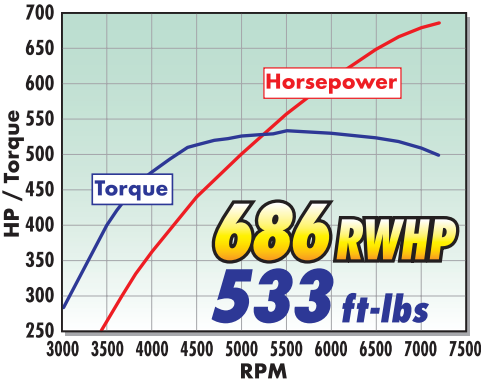

**IMPORTANT:** See Installation and Warranty Notes on page 1

### EMISSIONS GUIDE

● 50-STATE LEGAL   ● EPA LEGAL   ● RACING ONLY   ● PRE-POLLUTION CONTROLLED VEHICLES   ● STOCK REPLACEMENT   ● ENGINE SWAP

# PERFORMANCE LASH ADJUSTERS

## FOR FORD MODULAR 4.6L/5.4L APPLICATIONS

COMP Cams® Performance Lash Adjusters for Ford Modular Engines transfer more lift and duration to the valves, while also improving valve train stability and high RPM durability.

Just like lifters in a pushrod motor, lash adjusters in Ford Modular motors can leak down under high RPM, causing lost duration and lift, as well as more valve train wear. The COMP Cams® Ford Mod Motor Performance Lash Adjusters are engineered to have a slower leak down rate when compared to stock lash adjusters. This provides more lift and duration when aggressive performance camshafts and heavy-duty valve springs are installed.

Additionally, because they better resist collapsing than stock lash adjusters, these Performance Lash Adjusters provide far better valve train stability and high RPM durability. Finally, the black oxide finish prevents rust and corrosion while contributing to increased durability and life span.

#84031-16

DESCRIPTION	DIAMETER	QTY.	PART #
4.6L/5.4L SOHC 2V, 1996-2004	16mm	16	<b>84031-16</b>
4.6L DOHC 4V, 1992-2011	16mm	32	<b>84031-32</b>
4.6L SOHC 3V, 2005-2010	16mm	24	<b>84032-24</b>
5.4L SOHC 3V, 2005-2010	16mm	24	<b>84032-24</b>
6.8L V10 3V, 2005-2010	16mm	24	<b>84032-24</b>



# SUPERCHARGER KIT

## FOR 2018-2019 JEEP WRANGLER JL & 2020 GLADIATOR JT PENTASTAR 3.6L V6 ENGINES

Now you can get an Edelbrock Supercharger Kit for your 2018-2020 Jeep Wrangler JL and Gladiator JT with 3.6L Pentastar engine that places minimal stress on the stock engine.

The new Jeep supercharger kit is a blow down system for the 2018-20 Jeep JL and 2020 Gladiator JT with 3.6L V6 Pentastar engine. This front inlet, front drive system uses the Edelbrock supercharger head unit with Eaton's 1320 TVS rotor assembly to increase torque for improved towing and off-road performance while still being an excellent daily driver.

The supercharger housing is mated to a lower manifold assembly that features a dual pass intercooler for reduced air temperatures. All the necessary hardware and hoses needed for installation are included.

- 50-state emissions legal
- Installs with no modifications to the stock body or hood
- Low boost pressure for minimal stress on stock engine
- Integrated bypass valve for little to no decrease in fuel economy
- Dual core low temperature heat exchanger for low intake air temperatures
- Self-contained oiling system with 100,000-mile service interval
- 3-year/36,000-mile powertrain warranty when applicable



YEAR	MODEL	ENGINE	ROTOR	HP	TORQUE (FT/LBS)	EMISSION CODE	TUNE	NO TUNE
STAGE 1 - STREET SYSTEMS								
2018-2020	Jeep	3.6L	1320	330	272	●	#15284	#152840

**330 rwHP**  
**272 rwTq**

2018 JEEP WRANGLER JL

BASELINE: Hp (red), Tq (blue)  
SUPERCHARGED: Hp (red), Tq (blue)

#163-201-5

**IMPORTANT:** See Installation and Warranty Notes on page 1

### EMISSIONS GUIDE

● 50-STATE LEGAL ● EPA LEGAL ● RACING ONLY ● PRE-POLLUTION CONTROLLED VEHICLES ● STOCK REPLACEMENT ● ENGINE SWAP

# XTREME 4X4 CAMSHAFTS™

## FOR JEEP/AMC 4.0L ENGINES

Designed for both the everyday enthusiast and the serious off-roader, these new Xtreme 4x4 camshafts get the most out of Jeep 4.0L engines.

COMP Cams® has released grinds that tailor to some of the most common applications of this proven motor. These camshafts feature new lobe designs specific to the 4.0L that allow for more duration and valve lift within the constraints of the 4.0L design. This results in better torque and mid-range power for both carbureted and EFI applications.

- Each cam designed for a specific use
- Grinds designed for EFI stock and aftermarket heads
- Specific cams designed for EFI or carbureted applications

### Jeep/AMC 4.0L 6 Cyl. 1964-1998

APPLICATIONS/CAMSHAFTS	VALVE SETTING		RPM OPERATING RANGE	CAM ONLY PART #	CAM GRIND#	DURATION				VALVE LIFT		LOBE SEP. ANGLE
	IN.	EX.				ADVERTISED IN.	EX.	@ .050" IN.	EX.	W/ 1.7 ROCKER IN.	EX.	
<b>XTREME 4X4 Hydraulic Flat Tappet Camshafts</b>												
HYDRAULIC – Excellent torque and throttle response for rock crawler applications. Works with stock heads and EFI.	Hyd.	Hyd.	750-5000	68-501-5	<b>X4 242H-8</b>	242	246	197	201	.450	.450	108
HYDRAULIC – Excellent torque and throttle response, best with aftermarket aluminum heads in EFI applications.	Hyd.	Hyd.	900-5500	68-301-5	<b>X4 250H-13</b>	250	258	205	213	.488	.507	113
HYDRAULIC – Excellent torque and throttle response, best with aftermarket aluminum heads in carbureted applications.	Hyd.	Hyd.	1000-5500	68-401-5	<b>X4 254H-10</b>	254	258	209	213	.498	.507	110

### Jeep/AMC 4.0L 6 Cyl. 1999-2006

APPLICATIONS/CAMSHAFTS	VALVE SETTING		RPM OPERATING RANGE	CAM ONLY PART #	CAM GRIND#	DURATION				VALVE LIFT		LOBE SEP. ANGLE
	IN.	EX.				ADVERTISED IN.	EX.	@ .050" IN.	EX.	W/ 1.7 ROCKER IN.	EX.	
<b>XTREME 4X4 Hydraulic Flat Tappet Camshafts</b>												
HYDRAULIC – No Springs Required (NSR) upgrade for stock cam in EFI applications. Excellent torque and throttle response.	Hyd.	Hyd.	900-5500	163-201-5	<b>J4.0 X4 250H-13</b>	250	258	205	213	.450	.450	113
HYDRAULIC – Excellent torque and throttle response, ideal for use with Edelbrock aluminum heads in EFI applications.	Hyd.	Hyd.	900-5500	163-301-5	<b>J4.0 X4 250L-13</b>	250	258	205	213	.488	.507	113

#163-201-5



#163-201-5

# .450" LIFT OVATE WIRE VALVE SPRING KIT

## FOR JEEP 4.0L 1988-2006 ENGINES

Ovate wire .450" lift valve springs & seals are now available in kit form for Jeep 4.0L 1988-2006 engines to easily increase performance & reliability.

- .450" Valve lift capability
- Kit includes valve springs and seals while using your stock retainers
- Provides increased valve train control for higher RPM stability
- Excellent spring upgrade for everything from stock rebuilds to high performance

SPRING SPECS	O.D. DIA. 1	I.D. DIA. 2	SEAT LOAD	OPEN LOAD	COIL BIND	RATE (LBS./IN.)	PART #
Top	1.260"	.836"	105 @ 1.700	310 @ 1.200	1.150"	410	983-12*

COMPONENTS	COMPONENT PART #	KIT PART #
.450" Lift Ovate Wire Valve Spring	983-12	983J-KIT*
Valve Seals	516-12	

\*All applications must cut down the spring seat step diameter from .938" to under .830"



# HIGH ENERGY™ TIMING SETS

## FOR JEEP 4.0L ENGINES

High Energy™ Timing Sets for Jeep 4.0L applications provide exceptional durability in any stock to mild performance application. These two performance upgrades exceed all original equipment timing chain set specifications without breaking the bank and improve durability when replacing a worn out or stretched stock timing chain set.

Part #3237 for Jeep 4.0L 1999-2006 applications features a precision cast iron camshaft gear, a steel crank sprocket and a durable link belt chain – a perfect option for stock to mild performance builds. Part #3219 is for the Jeep 4.0L 1964-1998 and features a wider link belt chain for less stretch and a stronger tooth design on both the cam and crank sprockets for improved durability. The #3219 is ideal for heavy-duty applications but is also the perfect upgrade for stock type rebuilds.

DESCRIPTION	PART #
High Energy Timing Set for Jeep 4.0L 1964-1998	3219
High Energy Timing Set for Jeep 4.0L 1999-2006	3237

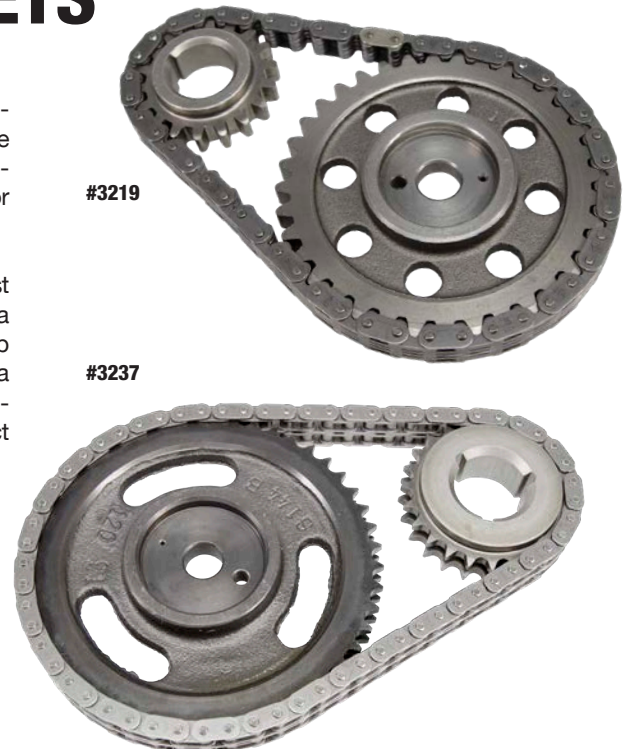



# AVS2 SERIES™ CARBURETORS

## FOR OFF-ROAD & 4X4 ENGINES

Performance carbs for off-roaders and 4X4s deliver total fuel control when the going gets rough.

Edelbrock, a leading manufacturer and distributor of aftermarket performance parts, has introduced a special version of their AVS2 Performance Carburetor designed for the growing overland adventure market. Called the AVS2 Off-Road Carb, the carburetor delivers total fuel control during off-roading and rough road conditions. The AVS2 Off-Road Carb comes in two versions: Part #1915 with a manual choke, and Part #1916 with an electric choke. Both versions are 650 CFM, have a satin finish, and are non-EGR.

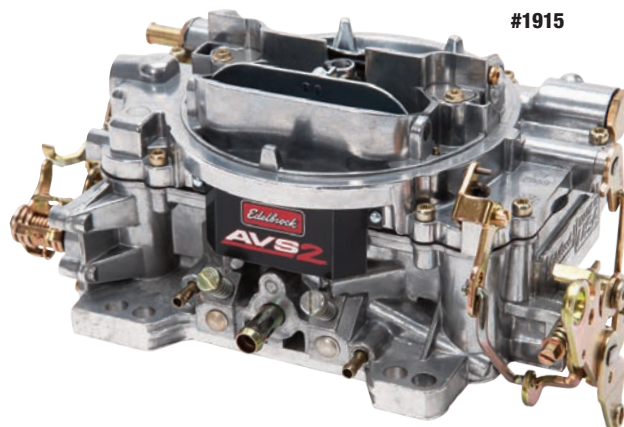

#1915

DESCRIPTION	PART #
650 cfm, Square Flange, Manual Choke (non-EGR)	#1915
650 cfm, Square Flange, Electric Choke (non-EGR)	#1916

- Proven AVS2 technology enhanced for off-road applications
- Spring-loaded needle and seat for rough terrain
- Spring-loaded anti-syphon discharge ball eliminates fuel drip
- Annular Flow Boosters for superior throttle response
- 650 CFM with electric or manual choke
- Perfectly sized for most V8 truck and 4x4 applications
- Designed and manufactured by Edelbrock in the USA

# AVS2

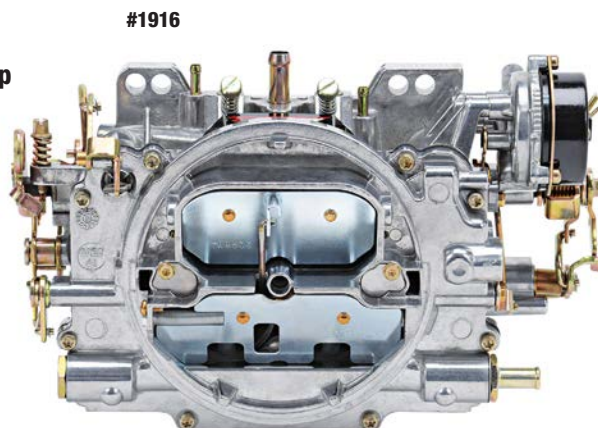

#1916

### WHY IS AN ANNULAR BOOSTER BETTER?



Nozzle Booster

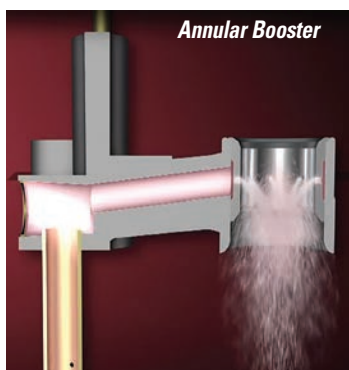

Annular Booster

Annular boosters (right) feature eight equally spaced smaller holes for better fuel atomization. This improves flat spots when the carb transitions from idle to part throttle for better low RPM performance. Annular boosters can potentially offer improved mileage.

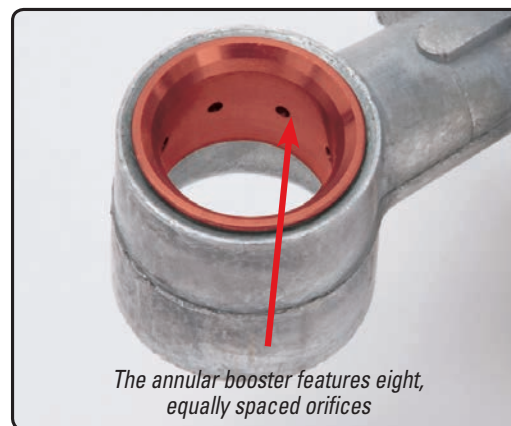

The annular booster features eight, equally spaced orifices

# LST™ CAMSHAFTS

## FOR GM 6.6L DURAMAX DIESEL ENGINES



The LST™ Camshaft Series brings COMP's newest, most powerful Low Shock Technology lobe designs to GM Duramax 2001-05 (LB7/LLY) and 2006-16 (LBZ/LMM/LML/L5P) diesel platforms.

These new lobes provide the potential for major increases in power and torque in Duramax engines when combined with the appropriate tuning. The "Low Shock Technology" features lobe profiles designed to maximize additional engine airflow, which reduces harmful EGTs, while improving stability at higher RPM. These profiles are also easier on the valve springs, enhancing durability and reducing load loss.

Organized into stages that allow you to choose your level of performance, Stage 1 Camshafts are No Springs Required and run well with the factory or a performance tune. Stage 2 and 3 camshafts require a COMP Cams® #26125 Beehive™ Valve Spring Kit upgrade but do produce the greatest potential for additional power and RPM when matched with maximum effort tuning.

# .585" LIFT BEEHIVE® VALVE SPRING KITS

## FOR GM 6.6L DURAMAX DIESEL ENGINES

.585" Lift Beehive® Valve Spring Kits for GM 6.6L Duramax Diesel 2001-05 (LB7/LLY) and 2006-16 (LBZ/LMM/LML/L5P) applications are now available to ensure valve train control under high boost conditions. Kits include everything needed to upgrade from stock springs: Beehive® Valve Springs, steel retainers, spring seats and valve seals. Beehive® Valve Springs feature a reduced diameter at the top of the spring to allow the use of a smaller and lighter retainer, reducing overall valve train weight. The lighter valve train combined with the stronger spring allows the engine to rev higher without concerns of valve float while an increased spring rate maintains valve train stability at elevated RPM to allow the use of more aggressive camshafts. The unique Beehive® shape has a higher load and is more dynamically stable than the factory spring, ensuring valve train stability at elevated RPM and boost pressures.

SPRING SPECS	O.D.	I.D.	SEAT LOAD	OPEN LOAD	COIL BIND	RATE (LBS./IN.)	PART #
	DIA. 1	DIA. 2					
<b>Top</b>	1.013	.650	120 @ 1.640	275 @ 1.040	.970	258	<b>26125</b>
<b>Bottom</b>	1.101	.738					

COMPONENTS	COMPONENT PART #	KIT PART #
.585" Lift Beehive® Valve Spring	<b>26125-32</b>	<b>26125ACS-KIT</b> (GM Duramax 6.6L, 2001-05, LB7/LLY)
Chromemoly Steel Retainer	<b>701-32</b>	
Valve Seals	<b>534-32</b>	
Spring Seats	<b>4688-32</b>	
.585" Lift Beehive® Valve Spring	<b>26125-32</b>	<b>26125BCS-KIT</b> (GM Duramax 6.6L, 2006-16, LBZ/LMM/LML/L5P)
Chromemoly Steel Retainer	<b>701-32</b>	
Valve Seals	<b>533-32</b>	
Spring Seats	<b>4688-32</b>	

#26125ACS-KIT



STAGE	APPLICATIONS/CAMSHAFTS	VALVE SETTING		RPM OPERATING RANGE	CAM PART #	DURATION				VALVE LIFT		LOBE SEP. ANGLE
		IN.	EX.			IN.	EX.	@ .050"	W/ 1.825 ROCKER	IN.	EX.	
Stage 1	SOLID ROLLER – No Springs Required, this is the grind that should have come from the factory for the Duramax. Great response & power potential. Works with factory or performance tune.	.012	.014	1000-3600	<b>132-300-13</b>	244	268	186	200	.400	.400	108
Stage 2	SOLID ROLLER – Perfect camshaft for most performance engine builds, taking full advantage of additional boost and more aggressive tunes. Ideal for use in modified applications with COMP valve spring kit.	.012	.014	1200-4000	<b>132-302-13</b>	252	276	194	208	.475	.475	107
Stage 3	SOLID ROLLER – All out performance, max effort grind. Requires valve spring upgrade, larger turbo, aftermarket pistons and higher RPM.	.012	.014	1700-5000	<b>132-303-13</b>	264	288	206	220	.500	.500	109

## HI-TECH™ PUSHROD SETS

### FOR GM 6.6L DURAMAX DIESEL ENGINES

- 7/16" Diameter tubing with .120" wall thickness maintains valve train stability at higher RPM & under higher boost pressures
- Two different materials used: heat-treated 4130 chromemoly steel tubing for its excellent strength-to-weight ratio while the tips are CNC-machined from 86L20 for durable wear characteristics
- 9.430" Standard length with ends that match the OEM design are compatible with stock or upgraded valve train components
- 2001-2016 LB7, LLY, LBZ, LMM N& LML engines



#8779-16

DESCRIPTION	WALL THICKNESS	DIAMETER	LENGTH	END TYPES	PART #
GM 6.6L Duramax Diesel	.120"	7/16"	9.430"	12mm Ball/ 12mm Cup	<b>8779-16</b>

# LST™ CAMSHAFTS

## FOR FORD 6.0L/6.4L POWER STROKE ENGINES

LST™ Camshaft Series for Ford 6.0L/6.4L Power Stroke engines features premium steel billet cams that unlock the potential for big power and torque gains. These lobes provide the potential for major increases in power and torque in Power Stroke engines when combined with the appropriate tuning. The “Low Shock Technology” features lobe profiles designed to maximize additional engine airflow, which reduces harmful EGTs, while improving stability at higher RPM. These profiles are also easier on the valve springs, enhancing durability and reducing load loss.

Organized into stages that allow you to choose your level of performance, the Stage 1 Camshaft is No Springs Required and runs well with the factory or a performance tune. Two unique Stage 2 offerings are available - a No Springs Required that produces the greatest potential for additional power and RPM when matched with maximum effort tuning and a High Lift version that requires a spring upgrade.

STAGE	APPLICATIONS/CAMSHAFTS	VALVE SETTING		RPM OPERATING RANGE	CAM PART #	DURATION				VALVE LIFT		LOBE SEP. ANGLE
		IN.	EX.			IN.	EX.	IN.	EX.	IN.	EX.	
Stage 1 NSR	HYDRAULIC ROLLER – No Springs Required (NSR) and works with factory or performance tune. This is the grind that should have come from the factory for 6.0L & 6.4L Power Stroke Fords. Instant response and increased power potential across the board.	Hyd.	Hyd.	1000-4000	<b>435-300-13</b>	245	254	180	198	.367	.371	105
Stage 2 NSR	HYDRAULIC ROLLER – No Springs Required (NSR). Perfect cam for most performance engine builds, taking full advantage of additional boost and more aggressive tunes allowed on modified engines.	Hyd.	Hyd.	1200-4500	<b>435-301-13</b>	251	273	188	206	.390	.384	107
Stage 2 High Lift	HYDRAULIC ROLLER – High Lift. Perfect cam for most performance engine builds, taking full advantage of additional boost and more aggressive tunes allowed on modified engines. Valve spring kit #26124-Kit required.	Hyd.	Hyd.	1200-4500	<b>435-302-13</b>	251	273	188	206	.441	.447	107

#435-300-13



**MAKE SURE YOU ALWAYS HAVE THE PROPER RETAINERS AND LOCKS!**



See Page: 29 for more information!



# .515" LIFT VALVE SPRING KIT

## FOR FORD 6.0L/6.4L POWER STROKE ENGINES

COMP Cams® introduces a premium valve spring kit for Ford 6.0L/6.4L Power Stroke engines that handles aggressive cams up to .515" lift and much higher boost pressures and RPM than factory valve springs.

- .515" Valve lift capability
- Kit includes valve springs, seals and shims while using your stock retainers
- Increased spring rate and load allow for more aggressive camshafts and higher boost levels
- Provides increased valve train control for higher RPM stability

SPRING SPECS	O.D.	I.D.	SEAT LOAD	OPEN LOAD	COIL BIND	RATE (LBS./IN.)	PART #
	DIA. 1	DIA. 2					
Top	1.010"	.647"	140 @ 1.770	300 @ 1.270	1.195	320	26124-32

#26124-KIT



COMPONENTS	COMPONENT PART #	KIT PART #
.500" Lift Ovate Wire Valve Spring	26124-32	26124-KIT
Valve Seals	535-32	
Shims	4809-32	

# HI-TECH™ PUSHROD SETS

## FOR FORD 6.0L/6.4L POWER STROKE ENGINES

- 11/32" Diameter tubing with .120" wall thickness maintains valve train stability at higher RPM & under higher boost pressures while allowing head gasket clearance
- Two different materials used: heat-treated 4130 chromemoly steel tubing for excellent strength-to-weight ratio while tips are CNC-machined from 86L20 for durable wear characteristics
- 9.795" Length works in both Ford 6.0L & 6.4L Power Stroke engines
- 3/8" Ball ends with oiling holes match OEM design for compatibility w/ stock or upgraded valve trains

DESCRIPTION	WALL THICKNESS	DIAMETER	LENGTH	END TYPES	PART #
Ford 6.0L/6.4L Power Stroke	.120"	11/32"	9.795"	3/8" Ball	8786-16

#8786-16



# PERFORMER RPM CYLINDER HEADS

## FOR OLDSMOBILE BIG BLOCK V8 ENGINES

Edelbrock has heard the requests from the Oldsmobile faithful and is responding by releasing a new and improved Performer RPM Cylinder Head for the Big Block Oldsmobile V8. This new head features a modern 77cc combustion chamber, larger 2.150" intake valve and updated ports for improved flow characteristics. The head has an improved water jacket for excellent cooling and to better accommodate a relief for factory style mechanical fuel pumps. It is intended for installation on 1965-1976 Big Block Oldsmobile Engines with non-emission 400-455 c.i.d., with a 4.125" min bore.

Edelbrock has retained the thick 5/8" deck, bronze guides, ductile iron seats, one-piece stainless steel valves, and high-quality rocker studs. The updated ports are excellent out of the box, but porters will rejoice at the thick port walls and added material above the intake port. Designed in-house, these are cast from A356 aluminum, heat-treated to T-6 specs, and machined in Edelbrock's Southern California manufacturing facilities for unsurpassed quality.

- 77cc heart shaped chamber with optimized spark plug position for a more efficient burn, outstanding horsepower & tire-shredding torque
- Factory pedestal-mount valve train upgraded to 7/16" screw-in stud and 3/8" pushrod-slot guide plate for increased valve train stability
- Helicoil inserts in the exhaust & rocker stud threaded holes
- Pre-counterbored head bolt holes for 1/2" diameter studs
- Center exhaust port exit is separate with no heat cross over
- Added material above intake port
- Mechanical fuel pump clearance cut

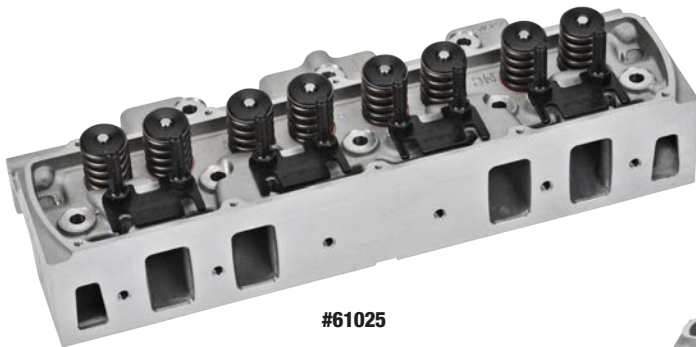

#61025



#61029

PORT VOLUME INTAKE/EXHAUST	COMPLETE (SINGLE)	MAX HP	EXHAUST PORT LOCATION	CHAMBER VOLUME	VALVE SIZES INTAKE/EXHAUST	CAMSHAFT TYPE	MAX LIFT	VALVE SPRING DIAMETER
218/128cc	61025	450-600	Standard	77cc	2.150"/1.680"	Hyd. Roller	.600"	1.460"
218/128cc	61029	450-600	Standard	77cc	2.150"/1.680"	Hyd. Flat	.600"	1.460"

# EZ-EFI® -6AN FUEL RETURN LINE FITTING

- Simple installation of return fuel line fitting to fuel tank using only hand tools and no welding needed
- Installation does not require access to the inside of the fuel tank - simply drill a 1/2" hole & fitting installs against tank from the outside
- Compatible with any tank material up to 1/4" thick
- Can also be used for oil return, power steering line return, vent, etc.
- Fitting assembly includes a billet aluminum body, an anodized -6AN fitting and a Grade 8 installation bolt for your convenience



#307031

DESCRIPTION	PART #
-6AN Fuel Return Line Fitting	307031



# BLACK OXIDE HEADER BOLT KITS

- Three new header bolt kits in various sizes
- Black oxide finish protects from corrosion & maintains durability
- Each kit contains (12) high-quality, flanged header bolts for easy mounting

DESCRIPTION	PART #
3/8"-16 x 3/4" Black Oxide (Set of 12) w/ Allen Socket	8540
3/8"-16 x 1" Black Oxide (Set of 12)	8545
M80-1.25 x 25mm Black Oxide (Set of 12)	8543

#8543



# RETAINER DEGREE GAUGE TOOL

- Quickly and easily identifies valve retainer degrees
- Able to measure 6°, 7°, Super 7 (8°) and 10° retainers
- Anodized and laser etched for durability and visibility
- Helps to avoid dangerous mismatches of valve locks and retainers
- Manufactured in the USA from high-quality aluminum



#POW352005

DESCRIPTION	PART #
Retainer Degree Gauge Tool	POW352005

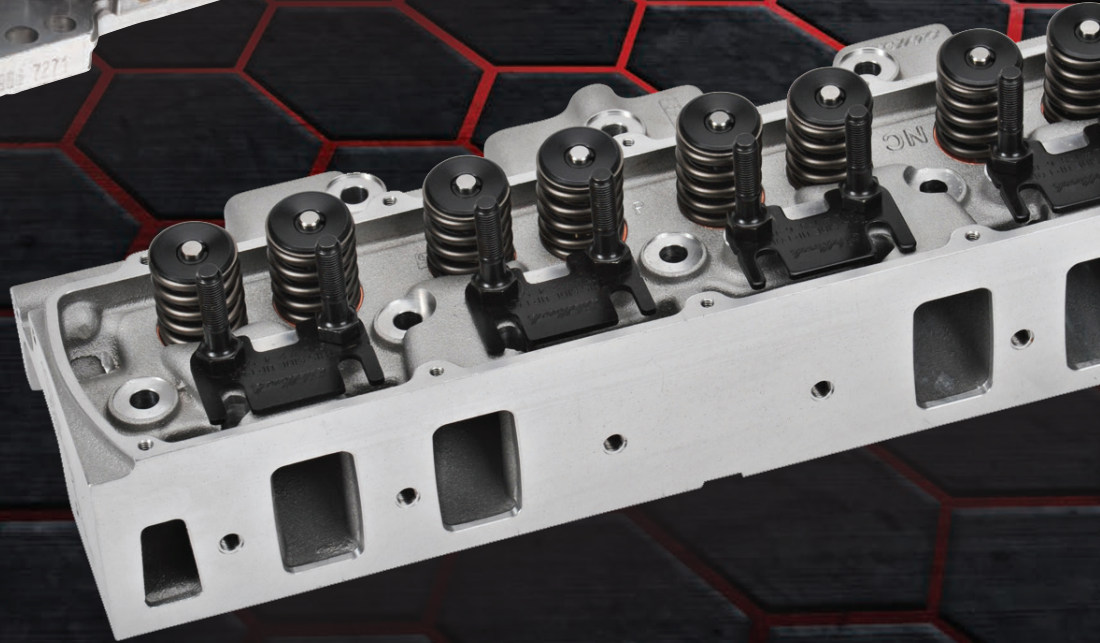
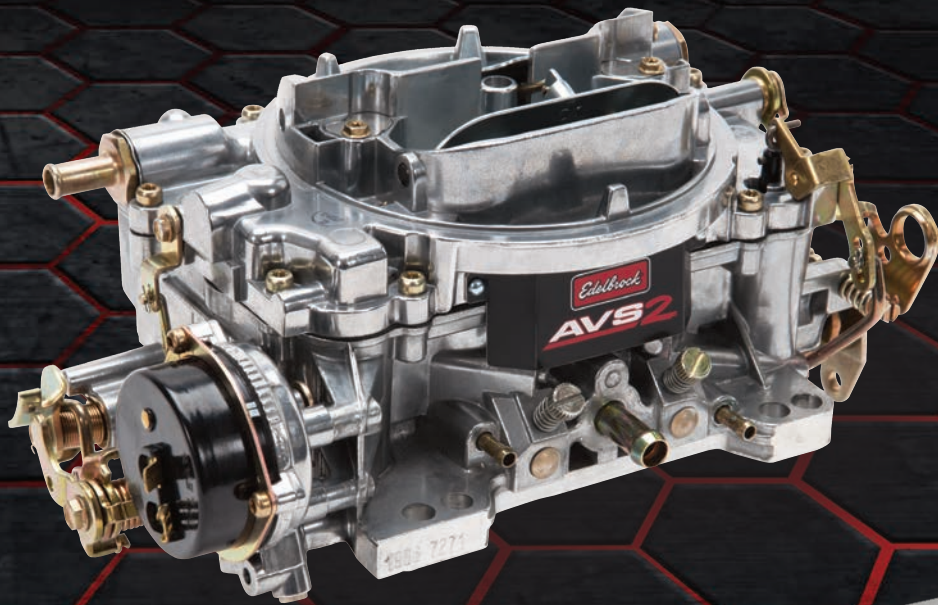

Learn more about performance air intake systems we have.