

Weatherly No. 400
Catalog No. 431-2080
Edition 2014
Supersedes 431-2080 [2010]



HYDRAULIC & FLEET HOSE PRODUCTS

Automotive

DON'T MIX AND MATCH!!!!!!

- > A 3,000 psi coupling on a 3,000 psi hose doesn't always equal a 3,000 psi assembly
- > One of the most important and often times overlooked factors in hydraulic hose assembly performance is the hose/coupling interface.
- > You can't just design a hose.
- > You can't just design a coupling.
- > You must design a system (a **MegaSystem**).

Unless you have a hose and coupling specifically designed for each other, you may end up with a hose assembly with a lower pressure rating, reduced life, or even worse, a catastrophic failure.

Hose outside diameter and crimp outside diameter are only two of the variables affecting assembly performance. As variation or tolerances increase even slightly for each component a significant reduction in hose assembly life is guaranteed and the risk for catastrophic failure increases.

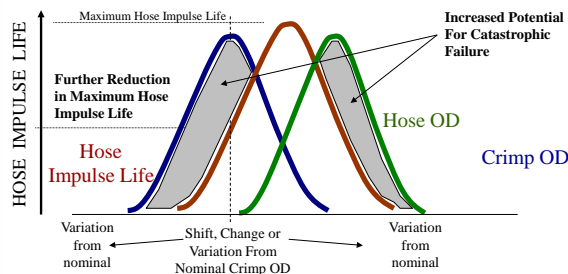
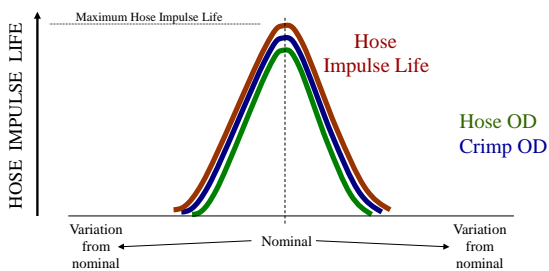

The next time you grab any hose and a coupling ask yourself:

- > Who is the manufacturer of these components?
- > Have these components been designed together? Validated together? And if not, what are the risks I am assuming?
- > Am I willing to accept an assembly with a guarantee for reduced impulse life and performance?
- > Am I willing to risk catastrophic failure?

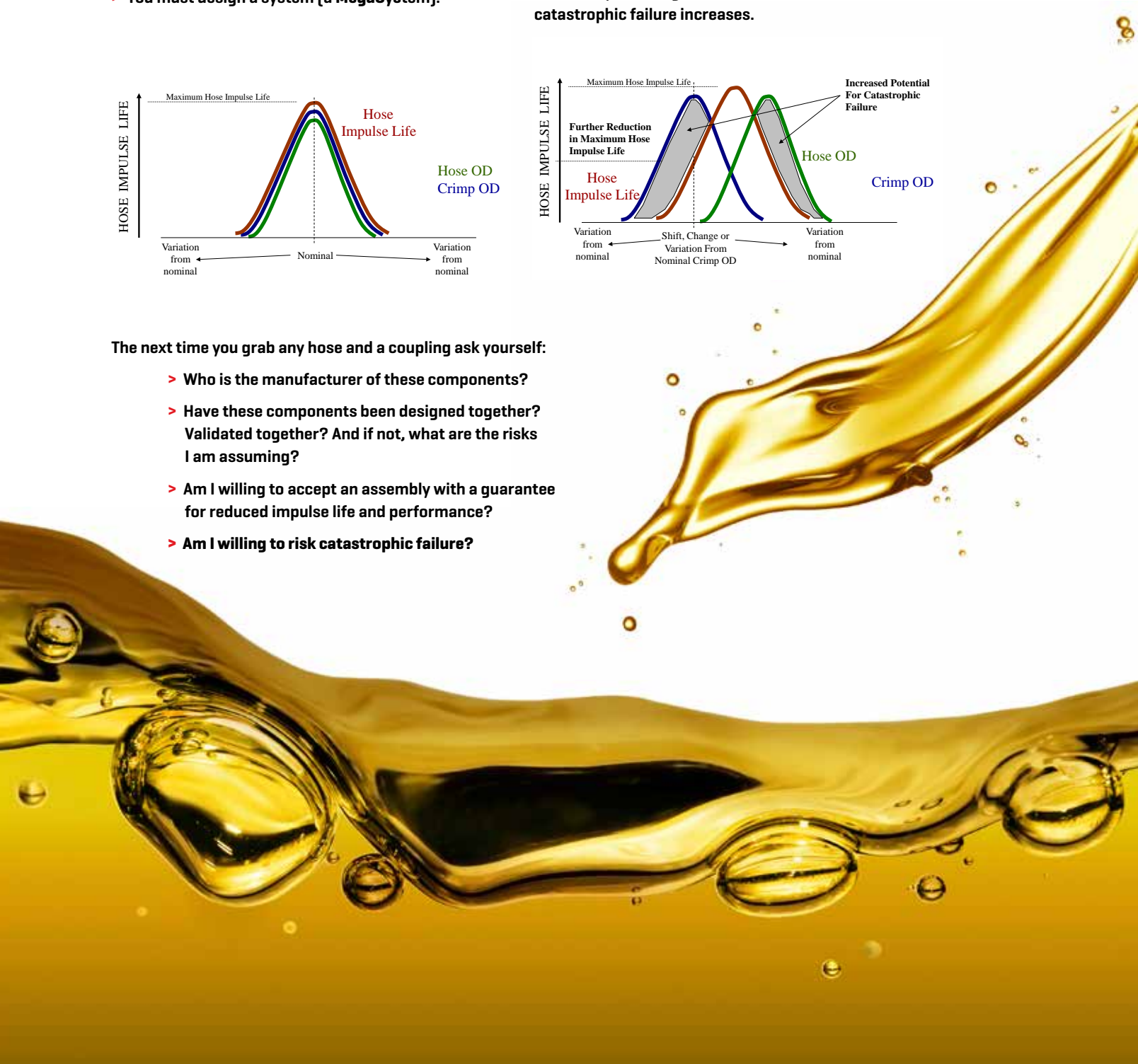

Weatherly No. 400
Catalog No. 431-2080
Edition 2014
Supersedes 431-2080 [2010]

Avoid injury to yourself and others by following these important hose assembly steps:

WARNING

Serious injury, death and destruction of property can result from rupture or blow-apart of a hydraulic hose assembly that is:

- > Damaged or worn out
- > Assembled or installed incorrectly

Never underestimate the power of a blown hydraulic assembly.

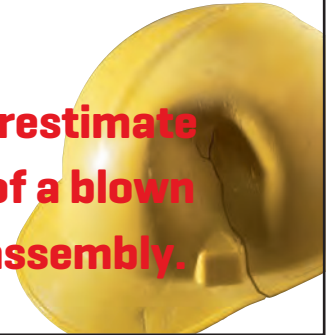

1. Receive hands-on training with Gates recommended equipment.

2. Follow current Gates operating manual and crimp data.

3. Use only new (unused) Gates recommended hose and couplings with Gates crimpers.

4. Wear safety glasses.

Select and Install Assemblies with Care

1. Select proper hose assemblies for the application. Many factors and conditions affecting the inside and outside diameter of the hose must be taken into account.

2. Hose assembly routing must not create an injury hazard or damage hose. Refer to the standards, regulations and directories that apply in the countries where the equipment is sold and used.

3. Select hydraulic components so that the application's temperature, pressure and bend radius do not exceed recommended component limits.

4. Hose must not be stretched, kinked, crushed or twisted during installation or use. Hose must not be bent to less than the minimum bend radius.

5. Use only TH7NC, TH8NC and TH18NC hose for non-conductive applications. For instance: cherry pickers. All other Gates hose are electrically conductive.

6. DO NOT USE HYDRAULIC HOSE TO TRANSMIT HIGH PRESSURE GASES OR STEAM. NOTE ANY PRESSURE ABOVE 500 PSI.

Follow Good Maintenance Practices

1. Establish a program of inspection, testing and replacement of hose assemblies from factors including:

- > Severity of application.
- > Frequency of equipment use.
- > Past performance of hose assemblies.

2. Only properly trained persons should inspect, test or service hose assemblies. Update training periodically.

3. Document maintenance, inspections and testing.



4. AVOID FLUID INJECTION INJURIES

- > Fluid under pressure can cause serious injury. It can be almost invisible escaping from a pinhole and it can pierce the skin into the body.
- > Do not touch a pressurized hydraulic hose assembly with any part of your body.
- > If fluid punctures the skin, even if no pain is felt, a serious emergency exists. Obtain medical assistance immediately. Failure to do so can result in loss of the injured body part or death.

5. Stay out of hazardous areas while testing hose assemblies under pressure. Use proper safety protection.

Other Safety Information

Many factors affect the selection, crimping, installation and maintenance of hose assemblies. This catalog, Gates Corporation, the hydraulic equipment maker and the Society of Automotive Engineers Recommended Practice SAE J1273, have useful information about selecting, crimping, installing and servicing hydraulic hose assemblies.

Gates recommends hose and coupling combinations in this catalog only after completing extensive testing.

Evaluation of a hose and coupling combination requires considerable impulse testing and cannot be determined by a simple burst or pressure hold test. Gates disclaims all liability for any hose assembly made in violation of Gates recommendations, procedures and current crimp data. Crimp data is updated on average every year.

The consumer's exclusive remedy with respect to any claim shall be a refund of the purchase price or replacement of the product at the option of Gates. In no event shall Gates be liable for any incidental or consequential damages whatsoever.

Table of Contents

MegaSys® Hydraulic Hose	A4 - A8	Tightening and Torque Recommendations for Hydraulic Couplings	C74
Abrasion-Resistant Covers	A9	Coupling and Adapter Installation Torque Recommendations	C75
Couplings	A10 - A11	G8K Couplings	D1 - D3
LifeGuard® Line-of-Sight Sleeving System	A12	GlobalSpiral™ Couplings	
Training Opportunities	A13	GlobalSpiral™ Couplings	E1 - E46
Website and International Symbols	A14	GlobalSpiral™ Plus Couplings [GSP].....	E47 - E61
Hydraulic Hose and Assemblies Service Life	A15	GlobalSpiral™ MAX Pressure Couplings [GSM] ..	E62 - E74
Hose Products and Specification Tables	A16 - A69	Stainless Steel Spiral Couplings	F1 - F5
Equipment	B1 - B20	MegaCrimp® Couplings	G1 - G42
Selecting the Proper Hose	C1 - C2	Stainless Steel Braid Couplings	H1 - H6
Agency Specifications and Hose Selection Guide	C3	Power Crimp® Couplings	I1 - I8
Characteristics of Hose Stock Types	C4	Field Attachable G1 and G2 Couplings	J1 - J8
Gates Hydraulic Hose Selection Guide	C5 - C7	Field Attachable C5 Couplings	
Additional Temperature Limits For Gates Hydraulic Hose	C8	Field Attachable for C5CXH, C5C, C5D & C5M Hose....	K1 - K13
SAE Recommended Practices for Hydraulic Hose Assemblies	C9 - C11	Field Attachable for C5E Hose	K14 - K21
Motor Vehicle Safety Standard For Brake Hose	C12	GLX® Couplings	L1 - L4
Brake Hose Registration Application	C13	GL Couplings	M1 - M8
How to Make Hose Assemblies of Specific Lengths ..	C14	C14 Couplings	N1 - N10
How to Describe Gates Hydraulic Hose Assemblies ..	C15 - C16	PCTS Thermoplastic Couplings	O1 - O3
Hose Assembly Routing Tips	C17 - C18	PolarSeal® Couplings	P1 - P41
Installation of LifeGuard® Line-of-Sight Sleeving ..	C19	PolarSeal® II Couplings	Q1 - Q10
Coupling Selection	C20 - C22	Power Steering Couplings	R1
Sealing Types for Hydraulic Couplings	C23 - C25	Adapters	
Coupling/Thread Identification Tools	C26	SAE to SAE.....	S1 - S46
Thread Chart	C27	SAE to SAE - High Pressure.....	S47 - S54
Coupling Identification	C28 - C41	British to SAE.....	S55 - S67
Gates Global Part Numbering System	C42 - C51	Metric Conversion	S68 - S72
Coupling/Thread Configurations	C52 - C55	International to International	S73 - S79
Chemical Resistance Ratings	C56	Japanese Conversion	S80 - S83
Chemical Resistance Table	C57 - C65	Quick Disconnect Couplers	
Nomographic Chart	C66	G940 Series [Agriculture Standard-Ball Valve]... T1 - T2	
Properties of C14 PTFE Tube	C67	G940 and G941 Series [Agricultural].....	T3
Electrostatic Discharge	C68	G941 Series [Agriculture Standard-Poppet Valve] .. T4	
Effusion/Corrosion for PTFE Hose and Hose Assemblies	C69	G942 Series [John Deere Old Style]	T5
Hydraulic System Pressure Drop	C70	G943 Series [International Harvester Old Style] ...T6	
Fahrenheit-Celsius Conversion	C71	G944 Series [J.I. Case Old Style].....	T7
Conversions	C72 - C73	G945 Series [Industrial ISO 7241-1 - Series B].... T8 - T9	
		G949 Series [Flush Face - HTMA].....	T10 - T13
		G950 Series [Flush Face - High Pressure].....	T14 - T15
		G951 Series [Wing Nut]	T16 - T17
		G952 Series [High Pressure Wing Nut]	T18 - T19
		G953 Series [Very High Pressure]	T20

Table of Contents

G956 Series [Industrial ISO 7241 - Series A]..... T21 - T22
 G959 Series [Agriculture QD Adapters].....T23 - T24

Ball Valves

Two Way Block Style U1 - U2
 Two Way Round Style Large ID U3
 Three Way Block StyleU4

Live Swivels V1 - V3

Assembly Fabrication W1 - W7

Accessories

Nylon Protective Sleeve.....X1 - X3
 Hose Guards.....X4 - X6
 HeatGuard® X7 - X8
 Gates OE-Style Clamp CollarsX9
 Vinyl Bend Restrictor.....X10
 Flange FittingsX11 - X13
 O-RingsX14 - X16
 Tube Nuts and SleevesX17 - X20

Equipment and Parts Y1 - Y5

Air Brake

Air Brake Hose AssembliesZ1 - Z2
 Air Brake Copper TubingZ3- Z9
 SureLok™ Air Brake Couplings Z10 - Z23
 SureLok™ Coupling Assortments Z24
 Compression Air BrakeZ25 - Z33
 Air Brake Couplings For Rubber Hose Z34 - Z52

Brass

Brass Lock-On Field Attachable Couplings
 for LOC & LOL Hose..... AA1 - AA7
 Single Bead.....AA8 - AA11
 Barbed StemAA12
 Brass AdaptersAA13- AA42

Kits.....AB1 - AB11

Index..... i - x

GATES CORPORATION LIMITED LIFETIME WARRANTY

The Gates Corporation [“Gates”] product is warranted to be free from defects in material or workmanship from the date of delivery to Customer. Gates will, at its option, replace or repair any merchandise proved defective in material or workmanship, or both. In no event will Gates honor any warranty claim unless it is notified of the claim within six [6] months of the expiration of the warranty period. This shall be the sole remedy for breach of warranty.

This is the exclusive remedy, limited to the Customer’s purchase price of the product. Damage to the product due to abuse, misuse, improper use, inadequate maintenance, or failure to follow published installation, use and service recommendations automatically voids this warranty. For warranty service, please contact the Customer Service Department of Gates Corporation, 1551 Wewatta Street, Denver, Colorado 80202.

ALL OTHER WARRANTIES, EXPRESS OR IMPLIED, INCLUDING, BUT NOT LIMITED TO, WARRANTIES OF MERCHANTABILITY OR FITNESS FOR A PARTICULAR PURPOSE, ARE HEREBY EXPRESSLY DISCLAIMED. IN NO EVENT WILL GATES BE LIABLE TO ANY PARTY FOR CONSEQUENTIAL, INCIDENTAL, SPECIAL, EXEMPLARY AND INDIRECT DAMAGES, INCLUDING BUT NOT LIMITED TO LOST PROFITS, REGARDLESS OF WHETHER SUCH DAMAGES WERE REASONABLY FORESEEABLE, OR WHETHER GATES HAD KNOWLEDGE THAT THEY COULD OCCUR.

Some states do not allow the exclusion or limitation of incidental or consequential damages, and some states do not allow limitations on how long an implied warranty lasts, so the above limitation and exclusion may not apply to you. This warranty gives you specific legal rights, and you may also have other rights which vary from state to state.





MegaSys® Hydraulic Hose



As advanced hydraulic systems are designed and engineered into more and more high-powered, high-pressure equipment, the importance of high-quality, flexible, durable hose assemblies that won't fail has never been more critical.

As the industry leader in hydraulic hose technology, Gates has developed an integrated solution to meet the expanding needs of today's hydraulic systems – and tomorrow's.

Gates MegaSys® hydraulic hose and coupling products offer a combination of technology, performance and flexibility that is unmatched by anything on the market today – or for the foreseeable future!

The fully integrated MegaSys hose line is designed to provide maximum flexibility and performance in a wide range of high-pressure hydraulic applications while simplifying hose selection and assembly fabrication.

MegaSys products and features save time, space and money. Color-coded laylines and constant pressure ratings through all sizes make hose identification and selection easier and faster while reducing inventory requirements. Couplings provide leak-free performance. A bend radius up to one-third the SAE specification enables use of shorter hose lengths and savings of up to 64%. It all adds up to more value for your money.

CONSTANT PRESSURE HOSE

The MegaSys® line consists of constant pressure spiral-wire and wire-braid hose that can be bent up to one-third SAE specifications. Combined with innovative couplings specifically designed to crimp on these hose, leak-free performance is guaranteed up to maximum working pressures as high as 8,000 psi.

MegaSys Benefits

- > Simplifies hose selection with constant pressure ratings
- > Bends up to one-third SAE bend radius specifications
- > Saves overall hose assembly length
- > Facilitates easier routing in tight applications
- > Requires fewer bent tube fittings
- > Eases installation with higher flexibility
- > Lowers inventory requirements
- > Extends life in bending, flexing applications
- > Available with abrasion-resistant XtraTuff™ or MegaTuff® covers
- > Reduces costs by as much as 64 percent



MEGASYS® HOSE LAYLINE SYSTEM

These newly developed laylines are used exclusively on MegaSys hose. Distinctive design and pressure color coding makes MegaSys hose easy to identify in stock or in service.

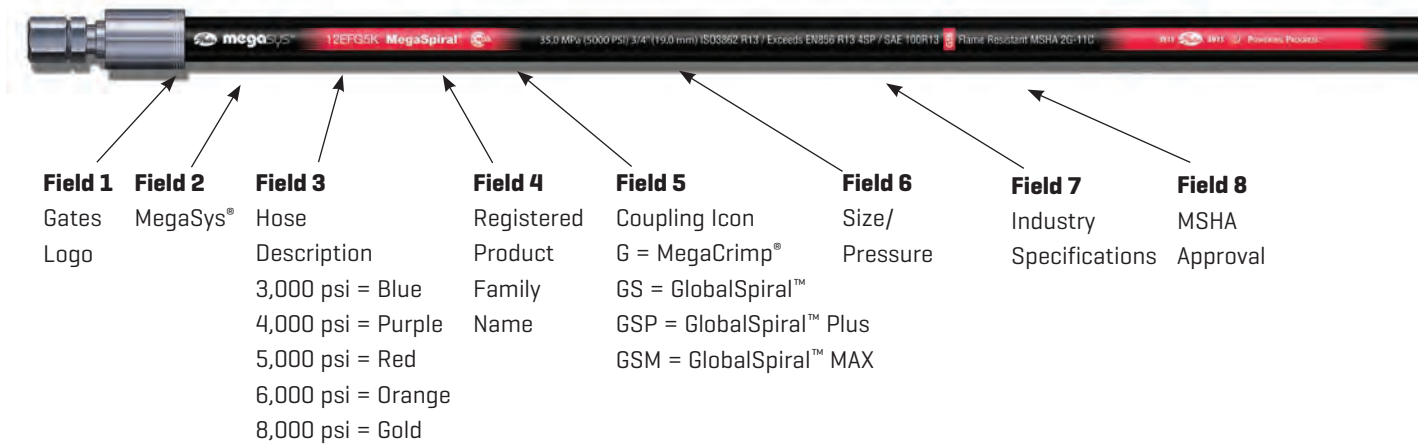

MEGASYS HOSE BEND, BEND – AND BEND SOME MORE

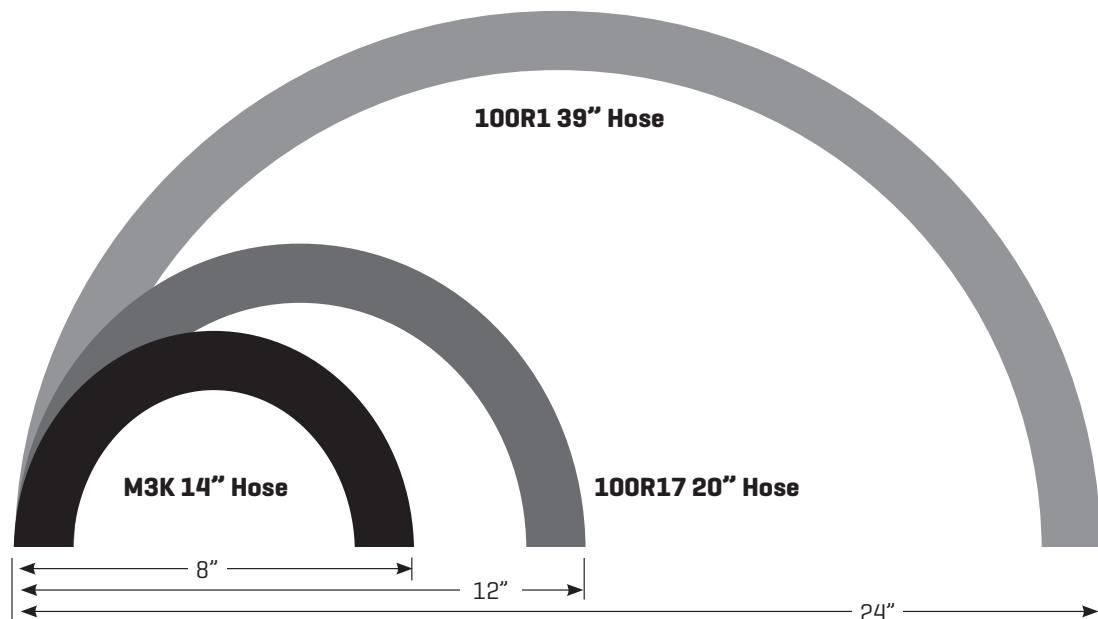

Up to One-Third SAE Bend Radius Specification

Illustration of 16M3K hose flexibility and reduced hose length requirements

The MegaSys® Hose Line

MEGASYS® SPIRAL-WIRE CONSTANT PRESSURE HOSE

EFG3K, EFG4K, EFG5K, EFG6K and G8K Hose

- > Each hose features a constant working pressure
- > Four alternating layers [six in some larger sizes] of spiraled, high tensile steel
- > For use with biodegradable hydraulic fluids
- > Industry-leading tested – 2x SAE Standard impulse cycles
- > Temperature range -40°F to +250°F [-40°C to +121°C]
- > Available with abrasion-resistant MegaTuff® cover

MegaSys Hose Pressure Color Key

3000 psi	M3K/EF63K
4000 psi	M4K/EF64K
5000 psi	M5K/EF65K
6000 psi	M6K/EF66K
8000 psi	G8K



The MegaSys® Hose Line

MEGASYS® WIRE-BRAID CONSTANT PRESSURE HOSE

M3K, M4K, M5K and M6K Hose

- > Each hose features a constant working pressure
- > Two braids of high-tensile steel wire (one braid in M3K -3, -4, -5, -6 and -8 sizes)
- > Nitrile tube for use with biodegradable hydraulic fluids
- > Industry-leading tested – 3x SAE Standard impulse cycles
- > Temperature range -40°F to +212°F [-40°C to +100°C]
- > Available with abrasion-resistant XtraTuff™ or MegaTuff® covers

MegaSys Hose Pressure Color Key

3000 psi	M3K/EF63K
4000 psi	M4K/EF64K
5000 psi	M5K/EF65K
6000 psi	M6K/EF66K



MegaSys® Size/Pressure Matrix

Use the charts below for easy hose selection. Just find the required pressure and the chart will show you which hose meets that pressure in the applicable size.

SAE Specifications [Chart colors do not correspond to MegaSys hose color key system]

I.D.	-4	-5	-6	-8	-10	-12	-16	-20	-24	-32
3000 psi	M3K*	M3K	M3K	M3K	M3K	M3K	M3K	EF63K	EF63K	EF63K
4000 psi	M4K**	M4K	M4K/EF64K	M4K/EF64K	M4K/EF64K	M4K/EF64K	EF64K	EF64K		
5000 psi	M5K	M5K	M5K	M5K/EF65K	EF65K	EF65K	EF65K	EF65K	EF65K	EF65K
6000 psi	M6K		EF66K	EF66K	EF66K	EF66K	EF66K	EF66K	EF66K	EF66K
8000 psi						G8K	G8K			

- Exceeds SAE 100R1
- Exceeds SAE 100R12
- Exceeds SAE 100R13
- Exceeds SAE 100R15
- Exceeds SAE 100R2
- Exceeds SAE 100R17
- Exceeds SAE 100R19

European Norm (EN) Specifications [Chart colors do not correspond to MegaSys hose color key system]

I.D.	04	05	06	08	10	12	16	20	24	32
210bar/3K	M3K	M3K	M3K	M3K	M3K	M3K	M3K	EF63K	EF63K	EF63K
280bar/4K	M4K	M4K	M4K/EF64K	M4K/EF64K	M4K/EF64K	M4K/EF64K	EF64K	EF64K		
350bar/5K	M5K	M5K	M5K	M5K/EF65K	EF65K	EF65K	EF65K	EF65K	EF65K	EF65K
420bar/6K	M6K		EF66K	EF66K	EF66K	EF66K	EF66K	EF66K		
560bar/8K						G8K	G8K			

- Exceeds 1SN/1SC
- Exceeds 4SP
- Exceeds 4SH
- Exceeds 2SN/2SC

TOUGH COVERS THAT EXTEND MEGASYS HOSE LIFE

Gates abrasion-resistant covers available on MegaSys hose are tested and proven to stand up under the harshest operating conditions. These covers increase hose service life, lower maintenance and replacement costs, and eliminate the need for costly hose protectors such as spring guards and nylon sleeves.

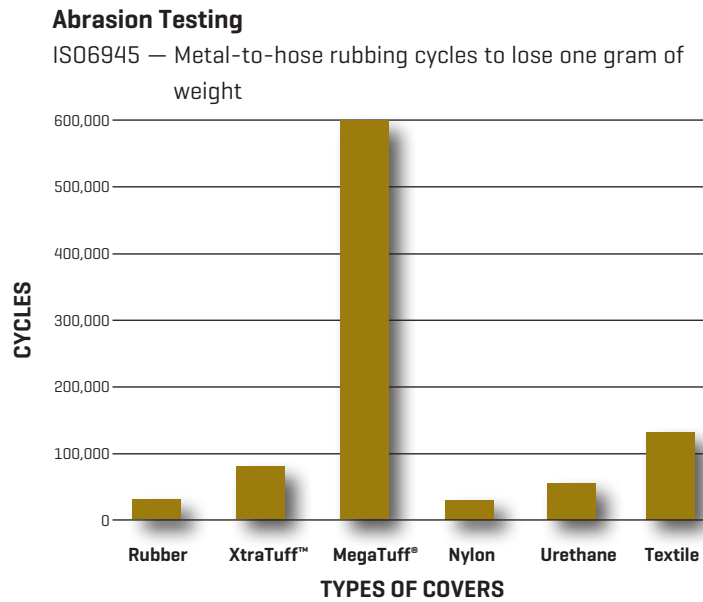

MegaTuff® Hose Cover

- > Super-tough cover solves abrasion and wear problems
- > 300 times the abrasion resistance of standard hose covers
- > Tested to 1,000,000 cycles without failure
- > Resistant to oil, ozone and UV rays
- > Outperforms any other abrasion-resistant hose cover on the market today

XtraTuff™ Hose Cover

- > Mid-range abrasion-resistant cover
- > 25 times the abrasion resistance of standard hose covers
- > Resistant to oil, ozone and UV rays

SOLID, LEAK-FREE COUPLINGS

The majority of hydraulic hose failures occur at the couplings due to blow-offs or leaks. Gates has designed and engineered innovative, robust couplings for MegaSys hose that provide connections you can count on for superior performance – guaranteed.

MegaCrimp® Couplings G25



Key Features

- > Robust “bite-the-wire” crimp
- > Low profile
- > Full-stem insertion
- > Full-length crimp
- > Industry-leading tested – 3x SAE Standard impulse cycles
- > Simplifies inventory management
- > Environmentally-friendly TuffCoat™ plating for 700 percent better corrosion resistance

MegaCrimp - The Versatile “No-Weep” Coupling with the Patented “C” Insert

It’s what’s inside the pre-assembled MegaCrimp coupling that gives it world-class, leak-proof performance. It is designed with a patented “C” insert, attached to the ferrule, that accommodates hose of different constructions and wall thicknesses. The insert’s design ensures crimping forces are evenly distributed to form a concentric seal.

The “C” insert simplifies inventory requirements since one MegaCrimp coupling size can accommodate various hose outside diameters, on both one- and two-wire braid hydraulic hose.

GlobalSpiral™ Couplings G20



GlobalSpiral Couplings

No-Skive Convenience, Reduced Inventory

GlobalSpiral couplings are specially engineered to provide superior performance for extreme high-pressure, high-impulse spiral-wire hydraulic hose applications. They can be used with all Gates MegaSys four- and six-spiral wire hose up to 8,000 psi.

The innovative, two-piece, no-skive design reduces assembly time, labor, fabrication errors and contamination of the fluid power system. The work area stays clean, and the odors and dust normally created by skiving are eliminated. In addition, the two-piece design reduces parts inventory by 30 percent because only one stem is required for all spiral-wire hose types.

Key Features

- > “Bite-the-wire” crimp for improved coupling retention
- > Over 30 thread configurations
- > Industry-leading tested – 2x SAE Standard impulse cycles at +250°F [+121°C]

FULL-TORQUE NUT™ TECHNOLOGY

Over-Torque Protection

Robust swivel joint allows for maximum torque

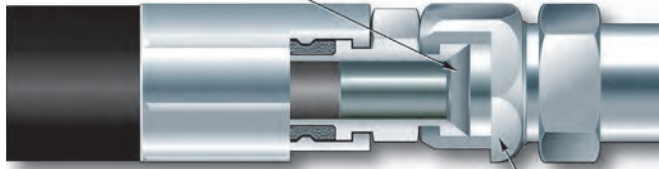

Up to 24,000 psi burst pressure [-16 size G6K]

Staked-nut provides less burst pressure protection

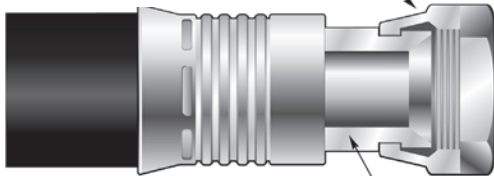

Swivel joint sensitive to over-torquing

One of the most common causes of hydraulic leaks is a cracked coupling nut or seat due to over-torquing.

Gates has engineered a solution – Full-Torque Nut technology which is standard on all MegaCrimp® and GlobalSpiral™ couplings.

Full-Torque Nut couplings are stronger and more durable than traditional staked-nut fittings. A large holding shoulder evenly distributes stress forces at the nut for higher resistance against cracking, even when inadvertently over-torqued. Increase equipment uptime by eliminating damaged couplings and leaks from too much torque.

TUFFCOAT™ PLATING

700 Percent Better than the 72-Hour SAE Standard



TuffCoat plating sets the global standard in both corrosion resistance and environmental friendliness. Gates has removed all hexavalent chromium from its plating process. This metal, common in industrial plating, is toxic to the environment. Gates engineered TuffCoat plating to be stronger and more resistant to corrosion, without the toxicity of hexavalent chromium.

TuffCoat plating is standard on MegaCrimp® and GlobalSpiral™ couplings.



Competitor Gates Competitor Competitor Competitor

Tested under SAE J516 and ASTM-B-117 salt-spray conditions, TuffCoat plating provided more than 500 hours of protection from red rust formation – almost 700 percent better than the 72-hour SAE standard.

The Gates coupling with TuffCoat plating shows no red rust formation. White patches on couplings are salt residue, not corrosion.

THERE'S A BETTER WAY TO PROTECT EQUIPMENT OPERATORS AGAINST HYDRAULIC HOSE FAILURE.

A burst or pinhole leak in a hydraulic system can cause serious problems – especially for anything or anyone located within a three-foot line-of-sight. Personal injury. Fluid burns and injection. Fires and explosions. Electrical shock. Mechanical failure.

Now, Gates has engineered the first effective, economical alternative to costly metal shielding or rerouting of hose lines. The LifeGuard® slewing system is designed to protect operators, equipment and the environment from the hazards of catastrophic hydraulic hose failure – a level of protection previously unavailable.

LIFEGUARD SLEEVE

HOSE ONLY



LIFEGUARD SLEEVE

HOSE ONLY



The LifeGuard sleeve contained and effectively redirected fluid during 10,000 psi [68.9 MPa] burst tests while hose without sleeving exploded, releasing a large amount of fluid in the immediate area.

How the System Works

The LifeGuard sleeve is slipped onto the hose and clamped at each end. If a hose burst or pinhole leak occurs, escaping pressures and fluids are contained by the exceptionally strong sleeving material. Fluids then exit the system via openings created by the specially designed channel clamps at each end. A noticeable pool of leaking fluid serves as positive verification that a failure has occurred so corrective action can be taken immediately to replace the hose assembly. LifeGuard sleeving correlates to a variety of industry standards, including ISO 3457 and MSHA's flame-resistance requirements.

- > Provides containment of up to 10,000 psi [68.9 MPa] bursts.
- > Protects against 5,000 psi [34.5 MPa] pinhole leaks at +212°F [+100°C] for up to five minutes.
- > Handles hydraulic fluids and biodiesel fuel.
- > Allows fluid to safely escape down the length of the assembly.
- > Creates noticeable spill for hose failure detection.
- > Correlates to ISO 3457 and meets MSHA's flame resistance requirements.
- > No other sleeve provides this level of protection.
- > Patent pending system includes Gates hose, couplings, sleeve and channel clamps.

GATES CUSTOMER SOLUTIONS CENTER

– Fluid Power Workshops

The Gates Customer Solutions Center (CSC) is a state-of-the-art facility dedicated to leading the industry in customer-focused product development and training in fluid power technology. Staffed by approximately 45 of the top engineers, scientists and technicians in the industry, the facility is headquarters for understanding and meeting customers' fluid power needs.

TRAINING WORKSHOPS FOR SALES ASSOCIATES

Specially designed for sales associates, these workshops are designed to expand knowledge in fluid power technology, Gates product offerings, and key marketing and selling benefits.









HYDRAULIC

The Hydraulic Products Workshop educates associates about fundamental application engineering skills, hose fabrication principles, thread identification, hose routing and installation, and cleanliness standards. Attendees will be engaged in classroom discussions, hands-on training exercises, a CSC tour, and demonstrations in the technical and test lab.

International Symbols



INTERNATIONAL SYMBOLS USED IN CATALOG COLUMN HEADINGS

Hose:	DESCR	Description
	#	Product Number
		Hose/Tube Inside Diameter (I.D.)
		Hose/Tube Outside Diameter (O.D.)
		Thread Size
		Working Pressure (psi)
		Minimum Burst Pressure (psi)
		Minimum Bend Radius
		Vacuum

Couplings:	A	Hose/Tube Diameter
	C	Cut-Off
	D	Mounting Hole
	F	Flange Head Thickness
	H1	Stem Hex
	H2	Nut Hex
	L	Length
	M	Flange Diameter
	N	Nominal Flange Size
	T	Drop

GETTING THE BEST SERVICE LIFE FROM GATES HYDRAULIC HOSE AND ASSEMBLIES

How long will a hydraulic hose assembly last? It depends on how it's used. This catalog and other Gates literature show the recommended limits for our assemblies (and also the hose and couplings used to make assemblies). These limits include installation, maintenance, and conditions of use. These limits MUST be followed or the assembly can fail resulting in personal injury or property damage. If you do not have this important information, you can get it at no cost from your local Gates distributor or Gates field representative.

Hose assemblies in use should be inspected regularly for leaks, kinks, cover blisters, gouges, abrasion and other damage. Damaged or worn assemblies must be replaced immediately. You can increase assembly life if you do the following:

Hose Assembly Installation¹ – Hydraulic hose assembly installations should comply with hydraulic hose routing and plumbing standards per SAE J1273 for the proper application of hose assemblies. SAE J1273 recommended practices can be found in this catalog.

Working Pressure – The hydraulic system pressure should not exceed the rated working pressure of the hose. Pressure surges or peaks exceeding the rated working pressure are destructive and must be taken into account when selecting a hose.

Minimum Burst Pressure – Burst pressures are pressures referred to in this catalog which were intended for destructive testing purposes and for design safety factors only.

Temperature Range² – Do not expose hose to internal or external temperatures exceeding the recommended limits. Consult additional technical data when hydraulic fluids contain emulsions or solutions. The fluid manufacturer's recommended maximum operating temperature for any given fluid must not be exceeded, regardless of hose temperature range.

Fluid Compatibility – The hydraulic assembly (tube, cover, reinforcement and couplings) must be fluid compatible. The correct hose must be used because phosphate ester and petroleum-based hydraulic fluids have drastically different chemical characteristics. Many hose are compatible with one or the other, but not all fluids. For example, Gates G2XH, MegaTech® and C5D hose are capable of handling phosphate ester and petroleum-based hydraulic fluids.

Minimum Bend Radius – Do not bend or flex hose to a radius smaller than the minimum recommended and do not subject hose to tension or torque. This can place excessive stress on the reinforcement and severely reduce the ability of the hose to withstand pressure.

Hose Size – Hose size (inside diameter) must be capable of handling the required flow volume. Too small an I.D. for a given volume of flow results in excessive fluid pressure and heat generation which can result in tube damage.

Hose Routing – Restrain, protect or guide hose, with clamps if necessary, to minimize the risk of damage due to excessive flexing, whipping or contacting other moving parts or corrosives. Determine hose lengths and configurations that protect from abrasion, snagging or kinking and provide leak-resistant connections.

Hose Length – Correct hose length should include considerations for length changes under pressure, machine vibration and motion, and hose assembly routing.

Hose Applications – Select the proper hose for the application. Suction applications (Gates GMV or G4H) and special fluid or high temperature capabilities are among the applications requiring particular consideration and a specific hose. When additional information is required, contact your local Gates representative.

NOTE: Do not use Gates hydraulic hose in place of permanent piping.

Hose Shelf Life

Storage environment, along with rubber materials can vary the shelf life limit. Shelf life is difficult to quantify as many variables affect the hose. Proper storage precautions can result in three to five years shelf life. Beyond this time there can be a significant service life decrease, depending on storage environment variables. Some variables include:

- > Temperature — Hose should be stored in a cool, dry area never exceeding +100°F [+38°C]. If stored below freezing, pre-warming may be required prior to handling, testing and placing into service.
- > Direct sunlight, rain, heaters or being near electrical equipment
- > Humidity and ozone
- > Oil, solvents, corrosive materials or fumes
- > Insects or rodents
- > Radioactivity
- > Space allowance and bends

Store hose in original container. Never stack hose too high, as its weight can crush hose at the bottom of the stack.

Gates recommends hose in extended storage be visually inspected and tested prior to use. Hose judged marginal should be replaced to avoid potential failure, property damage or bodily injury. Store hose on a first-in/first-out basis. Unusually long storage, or poor storage environment can deteriorate hose, reduce performance and may lead to premature failure.

1 SAE provides helpful video and print information that supplements this summary.

2 Actual service life at temperatures approaching the recommended limit will depend on the particular application and the fluid being used in the hose. Intermittent (up to 10 percent of operating time) refers to momentary temperature surges. Detrimental effects increase with increased exposure to elevated temperatures.

Notes

G8K Spiral Wire Hose Ultra High Pressure

(Meets Flame Resistance Acceptance Designation "MSHA 2G")

Recommended For: Ultra high-pressure, high-impulse applications such as hydrostatic transmissions, for use in the construction, agriculture, forestry, underground or open pit mining, or other industries on applications where extremely high pressure capability is required. G8K hose and couplings offer industry-leading bend radius capability, which leads to ease of routing and installation, longer hose life in flexing applications, and fewer bent tube fitting requirements.

Tube: Black, oil-resistant Neoprene Type A tube material allows for the high pressure, high temperature performance required in these demanding applications. See Hose Stock Characteristics.

Reinforcement: Six alternating layers of high tensile steel wire spiral construction.

Cover: Black, oil resistant, synthetic rubber (Neoprene – Type A), with color coded layline.

Temperature Range: -40°F to +250°F (-40°C to +121°C). For water emulsions see Temperature Limits Table.

Coupling Recommendation (See Crimp Data Manual 428-7365 or E-Crimp):
G8K Couplings (G19) Section D



Part No.	Description	Product No.	Standard Pack					
71096	12G8KXCTN	4651-1639	100	3/4	1.36	8000	32000	9.5
71097	16G8KXCTN	4651-1631	100	1	1.66	8000	32000	12.0

EFG6K Spiral Wire Hose - SAE 100R15 Extremely High Pressure

(Meets Flame Resistance Acceptance Designation "MSHA 2G")
For Biodegradable Hydraulic Fluids

Recommended For: Extremely high-pressure, high-impulse applications such as hydrostatic transmissions. EFG6K is designed to meet or exceed all requirements of SAE 100R15 specifications and performance requirements of EN 856 4SP (-6, -8, -10 and -12), EN 856 4SH (-12, -16, and -20), and ISO 3862 Type R15 (-6, -8, -10, -12, -16, -24). Compatible with biodegradable hydraulic fluids like polyol ester, polyglycol and vegetable oil as well as standard petroleum-based fluids. Available in 121' through 200' continuous lengths.

Tube: Black, oil resistant, synthetic rubber (Nitrile – Type C). See Hose Stock Characteristics.

Reinforcement: Four (six for -20, -24 and -32) alternating layers of spiraled, high-tensile steel.

Cover: Black, oil resistant, synthetic rubber (Neoprene – Type A). Color coded layline. Also available with unique abrasion resistant MegaTuff® cover. See Hose Stock Characteristics.

Temperature Range: -40°F to +250°F (-40°C to +121°C). For water emulsions see Temperature Limits Table.





Coupling Recommendation (See Crimp Data Manual 428-7365 or E-Crimp):
GlobalSpiral™ Couplings (-6 through -20) (G20) Section E
GlobalSpiral™ MAX Pressure Couplings (-24 G24), (-32 G23) Section E
Stainless Steel Spiral Couplings (G18) Section F



Part No.	Description	Product No.	Standard Pack					
70163	6EFG6K X REEL	4651-0123	300	3/8	.80	6000	24000	2.5
85465	6EFG6K X25FT	4651-4032	1	3/8	.80	6000	24000	2.5
70866	6EFG6KXCTN	4651-1396	100	3/8	.80	6000	24000	2.5
70164	8EFG6K X REEL	4651-0124	230	1/2	.95	6000	24000	3.5
85466	8EFG6K X25FT	4651-4033	1	1/2	.95	6000	24000	3.5
70865	8EFG6KXCTN	4651-1371	100	1/2	.95	6000	24000	3.5
70978	8EFG6KXLL	4651-1613	200	1/2	.95	6000	24000	3.5
70165	10EFG6K X REEL	4651-0125	200	5/8	1.09	6000	24000	4.0
85467	10EFG6K X25FT	4651-4034	1	5/8	1.09	6000	24000	4.0
70815	10EFG6KXCTN	4651-1368	100	5/8	1.09	6000	24000	4.0
70735	10EFG6KXLL	4651-1397	200	5/8	1.09	6000	24000	4.0
70168	12EFG6K X REEL	4651-0128	200	3/4	1.24	6000	24000	4.7
85468	12EFG6K X25FT	4651-4035	1	3/4	1.24	6000	24000	4.7
70839	12EFG6KXCTN	4651-1288	100	3/4	1.24	6000	24000	4.7
70736	12EFG6KXLL	4651-1398	200	3/4	1.24	6000	24000	4.7

EFG6K Spiral Wire Hose - SAE 100R15
Extremely High Pressure

Continued

Part No.	Description	Product No.	Standard Pack					
85469	16EFG6K X25FT	4651-4036	1	1	1.53	6000	24000	6.0
70836	16EFG6KXCTN	4651-1289	100	1	1.53	6000	24000	6.0
70737	16EFG6KXLL	4651-1399	200	1	1.53	6000	24000	6.0
85470	20EFG6K X25FT	4651-4037	1	1 1/4	1.97	6000	24000	8.2
70837	20EFG6KXCTN	4651-1290	50	1 1/4	1.97	6000	24000	8.2
70738	20EFG6KXLL	4651-1400	200	1 1/4	1.97	6000	24000	8.2
85426	24EFG6K X25FT	4651-1574	1	1 1/2	2.26	6000	24000	10.0
71065	24EFG6KXCTN	4651-1531	50	1 1/2	2.26	6000	24000	10.0
71100	32EFG6KXCTN	4651-1759	50	2	2.80	6000	24000	25.0
71099	32EFG6KXLL	4651-1758	200	2	2.80	6000	24000	25.0

EFG6K Spiral Wire Hose - SAE 100R15 - MegaTuff® Cover
Extremely High Pressure

(Meets Flame Resistance Acceptance Designation "MSHA 2G")
For Biodegradable Hydraulic Fluids

MegaTuff® hose lasts up to 300 times longer than standard hose during hose-to-hose and hose-to-metal abrasion tests per ISO 6945.

Recommended For: Extremely high-pressure, high-impulse applications such as hydrostatic transmissions. EFG6K is designed to meet or exceed all requirements of SAE 100R15 specifications and performance requirements of EN 856 4SP (-6, -8, -10 and -12), EN 856 4SH (-12, -16, and -20), and ISO 3862 Type R15 (-6, -8, -10, -12, -16, -24). Compatible with biodegradable hydraulic fluids like polyolester, polyglycol and vegetable oil as well as standard petroleum-based fluids. Available in 121' through 200' continuous lengths.

Tube: Black, oil resistant, synthetic rubber (Nitrile - Type C). See Hose Stock Characteristics.

Reinforcement: Four (six for -20, -24 and -32) alternating layers of spiraled, high-tensile steel.

Cover: Black, oil, abrasion and weather resistant MegaTuff® cover with synthetic rubber (Neoprene - Type A) base, with color coded layline. Also available in Standard cover. See Hose Stock Characteristics.

Temperature Range: -40°F to +250°F (-40°C to +121°C). For water emulsions see Temperature Limits Table.





Coupling Recommendation (See Crimp Data Manual 428-7365 or E-Crimp):

GlobalSpiral™ Couplings (-6 through -20) (G20) Section E

GlobalSpiral™ MAX Pressure Couplings (-24 G24), (-32 G23) Section E

Stainless Steel Spiral Couplings (G18) Section F



Part No.	Description	Product No.	Standard Pack					
85471	6EFG6K-MTF X25FT	4651-4038	1	3/8	.80	6000	24000	2.5
70849	6EFG6K-MTFXCTN	4651-1435	100	3/8	.80	6000	24000	2.5
85472	8EFG6K-MTF X25FT	4651-4039	1	1/2	.95	6000	24000	3.5
70867	8EFG6K-MTFXCTN	4651-1609	100	1/2	.95	6000	24000	3.5
85473	10EFG6K-MTF X25FT	4651-4040	1	5/8	1.09	6000	24000	4.0
70880	10EFG6K-MTFXCTN	4651-1416	100	5/8	1.09	6000	24000	4.0
85474	12EFG6K-MTF X25FT	4651-4041	1	3/4	1.24	6000	24000	4.7
70868	12EFG6K-MTFXCTN	4651-1606	100	3/4	1.24	6000	24000	4.7
85475	16EFG6K-MTF X25FT	4651-4042	1	1	1.53	6000	24000	6.0
70869	16EFG6K-MTFXCTN	4651-1604	100	1	1.53	6000	24000	6.0
85476	20EFG6K-MTF X25FT	4651-4043	1	1 1/4	1.97	6000	24000	8.2
70870	20EFG6K-MTFXCTN	4651-1601	50	1 1/4	1.97	6000	24000	8.2
70991	24EFG6K-MTFXCTN	4651-1754	50	1 1/2	2.26	6000	24000	10.0
71098	32EFG6K-MTFXCTN	4651-1757	50	2	2.80	6000	24000	25.0

EFG6KL Low Temp Spiral Wire Hose Extremely High Pressure

Recommended For: Extremely high-pressure hydraulic applications. Compatible with biodegradable hydraulic fluids like polyolester, polyglycol and vegetable oil as well as standard petroleum based fluid.

Tube: Black, oil resistant, synthetic rubber (Nitrile – Type C). See Hose Stock Characteristics.

Reinforcement: Four or Six alternating layers of spiraled, high tensile wire.

Cover: Black, oil resistant, synthetic rubber. (Neoprene – Type A).

Temperature Range: -70°F to +212°F (-57°C to +100°C).

Coupling Recommendation (See Crimp Data Manual 428-7365 or E-Crimp):
GlobalSpiral™ Couplings (G20) Section E



Part No.	Description	Product No.	Standard Pack					
70257	12EFG6KL XCTN	4651-0038	100	3/4	1.24	6000	24000	4.8
70259	16EFG6KL XCTN	4651-0039	100	1	1.53	6000	24000	6.0

EFG5K Spiral Wire Hose - SAE 100R13 Extremely High Pressure

(Meets Flame Resistance Acceptance Designation "MSHA 2G")
For Biodegradable Hydraulic Fluids

Recommended For: Extremely high-pressure hydraulic applications. EFG5K is designed to meet or exceed all requirements of SAE 100R13 specifications and performance requirements of EN 856 4SH (-16 and -20), EN 856 4SP (-10, and -12), EN 856 R13, and ISO 3862 Type R13 (-12, -16, -20, -24, -32). Compatible with biodegradable hydraulic fluids like polyolester, polyglycol and vegetable oil as well as standard petroleum-based fluids. Available in 121' through 200' continuous lengths.

Tube: Black, oil resistant, synthetic rubber (Nitrile – Type C). See Hose Stock Characteristics.

Reinforcement: Four (six for -20, -24 and -32) alternating layers of spiraled, high-tensile steel.

Cover: Black, oil resistant, synthetic rubber (Neoprene – Type A), with color coded layline. Also available with unique abrasion resistant MegaTuff® cover. See Hose Stock Characteristics.

Temperature Range: -40°F to +250°F (-40°C to +121°C). For water emulsions see Temperature Limits Table.





Coupling Recommendation (See Crimp Data Manual 428-7365 or E-Crimp):
GlobalSpiral™ Couplings (-6 through -20) (G20) Section E
GlobalSpiral™ MAX Pressure Couplings (-24 G24), (-32 G23) Section E
Stainless Steel Spiral Couplings (G18) Section F



Part No.	Description	Product No.	Standard Pack					
70160	6EFG5K X REEL	4651-0120	300	3/8	.80	5000	20000	2.5
85453	6EFG5K X25FT	4651-4020	1	3/8	.80	5000	20000	2.5
70871	6EFG5KXCTN	4651-1424	100	3/8	.80	5000	20000	2.5
70161	8EFG5K X REEL	4651-0121	230	1/2	.95	5000	20000	3.5
85454	8EFG5K X25FT	4651-4021	1	1/2	.95	5000	20000	3.5
70864	8EFG5KXCTN	4651-1372	100	1/2	.95	5000	20000	3.5
70977	8EFG5KXLL	4651-1612	200	1/2	.95	5000	20000	3.5
70162	10EFG5K X REEL	4651-0122	200	5/8	1.09	5000	20000	4.0
85455	10EFG5K X25FT	4651-4022	1	5/8	1.09	5000	20000	4.0
70814	10EFG5KXCTN	4651-1340	100	5/8	1.09	5000	20000	4.0
70728	10EFG5KXLL	4651-1390	200	5/8	1.09	5000	20000	4.0
70167	12EFG5K X REEL	4651-0127	200	3/4	1.24	5000	20000	4.7
85456	12EFG5K X25FT	4651-4023	1	3/4	1.24	5000	20000	4.7
70838	12EFG5KXCTN	4651-1285	100	3/4	1.24	5000	20000	4.7
70729	12EFG5KXLL	4651-1391	200	3/4	1.24	5000	20000	4.7
85457	16EFG5K X25FT	4651-4024	1	1	1.53	5000	20000	6.0
70834	16EFG5KXCTN	4651-1286	100	1	1.53	5000	20000	6.0
70730	16EFG5KXLL	4651-1392	200	1	1.53	5000	20000	6.0
85458	20EFG5K X25FT	4651-4025	1	1 1/4	1.97	5000	20000	8.2
70835	20EFG5KXCTN	4651-1287	50	1 1/4	1.97	5000	20000	8.2
70734	20EFG5KXLL	4651-1393	200	1 1/4	1.97	5000	20000	8.2

EFG5K Spiral Wire Hose - SAE 100R13 Extremely High Pressure

Continued

Part No.	Description	Product No.	Standard Pack					
85432	24EFG5K X25FT	4651-1742	1	1 1/2	2.26	5000	20000	10.0
71056	24EFG5KXCTN	4651-1455	50	1 1/2	2.26	5000	20000	10.0
85436	32EFG5K X25FT	4651-1746	1	2	2.80	5000	20000	25.0
71059	32EFG5KXCTN	4651-1456	50	2	2.80	5000	20000	25.0

EFG5K Spiral Wire Hose - SAE 100R13 - MegaTuff® Cover Extremely High Pressure

(Meets Flame Resistance Acceptance Designation "MSHA 2G")
For Biodegradable Hydraulic Fluids

MegaTuff® hose lasts up to 300 times longer than standard hose during hose-to-hose and hose-to-metal abrasion tests per ISO 6945.

Recommended For: Extremely high-pressure hydraulic applications. EFG5K is designed to meet or exceed all requirements of SAE 100R13 specifications and performance requirements of EN 856 4SH (-16 and -20), EN 856 4SP (-10, and -12), EN 856 R13, and ISO 3862 Type R13 (-12, -16, -20, -24, -32). Compatible with biodegradable hydraulic fluids like polyolester, polyglycol and vegetable oil as well as standard petroleum-based fluids. Available in 121' through 200' continuous lengths.

Tube: Black, oil resistant, synthetic rubber (Nitrile - Type C). See Hose Stock Characteristics.





Reinforcement: Four (six for -20, -24 and -32) alternating layers of spiraled, high-tensile steel.

Cover: Black, oil, abrasion and weather resistant MegaTuff® cover with synthetic rubber (Neoprene - Type A) base, with color coded layline. Also available in Standard cover. See Hose Stock Characteristics.

Temperature Range: -40°F to +250°F (-40°C to +121°C). For water emulsions see Temperature Limits Table.

Coupling Recommendation (See Crimp Data Manual 428-7365 or E-Crimp):
GlobalSpiral™ Couplings (-6 through -20) (G20) Section E
GlobalSpiral™ MAX Pressure Couplings (-24 G24), (-32 G23) Section E
Stainless Steel Spiral Couplings (G18) Section F



Part No.	Description	Product No.	Standard Pack					
85459	6EFG5K-MTF X25FT	4651-4026	1	3/8	.80	5000	20000	2.5
70872	6EFG5K-MTFXCTN	4651-1436	100	3/8	.80	5000	20000	2.5
85460	8EFG5K-MTF X25FT	4651-4027	1	1/2	.94	5000	20000	3.5
70873	8EFG5K-MTFXCTN	4651-1608	100	1/2	.94	5000	20000	3.5
70861	8EFG5K-MTFXLL	4651-1573	1200	1/2	.94	5000	20000	3.5
85461	10EFG5K-MTF X25FT	4651-4028	1	5/8	1.09	5000	20000	4.0
70879	10EFG5K-MTFXCTN	4651-1410	100	5/8	1.09	5000	20000	4.0
85462	12EFG5K-MTF X25FT	4651-4029	1	3/4	1.24	5000	20000	4.7
70874	12EFG5K-MTFXCTN	4651-1605	100	3/4	1.24	5000	20000	4.7
85463	16EFG5K-MTF X25FT	4651-4030	1	1	1.53	5000	20000	6.0
70875	16EFG5K-MTFXCTN	4651-1603	100	1	1.53	5000	20000	6.0
70739	16EFG5K-MTFXLL	4651-4001	200	1	1.53	5000	20000	6.0
85464	20EFG5K-MTF X25FT	4651-4031	1	1 1/4	1.97	5000	20000	8.2
70876	20EFG5K-MTFXCTN	4651-1600	50	1 1/4	1.97	5000	20000	8.2
70740	20EFG5K-MTFXLL	4651-4002	200	1 1/4	1.97	5000	20000	8.2
85433	24EFG5K-MTF X25FT	4651-1743	1	1 1/2	2.26	5000	20000	10.0
71055	24EFG5K-MTFXCTN	4651-2203	50	1 1/2	2.26	5000	20000	10.0
85437	32EFG5K-MTF X25FT	4651-1747	1	2	2.80	5000	20000	25.0
71063	32EFG5K-MTFXCTN	4651-1522	50	2	2.80	5000	20000	25.0

EFG5KL Low Temp Spiral Wire Hose Extremely High Pressure

Recommended For: Extremely high-pressure hydraulic applications. Compatible with biodegradable hydraulic fluids like polyolester, polyglycol and vegetable oil as well as standard petroleum based fluid.

Tube: Black, oil resistant, synthetic rubber (Nitrile – Type C). See Hose Stock Characteristics.





Reinforcement: Four or Six alternating layers of spiraled, high tensile wire.

Cover: Black, oil resistant, synthetic rubber. (Neoprene – Type A).

Temperature Range: -70°F to +212°F (-57°C to +100°C).

Coupling Recommendation (See Crimp Data Manual 428-7365 or E-Crimp):
GlobalSpiral™ Couplings (G20) Section E



Part No.	Description	Product No.	Standard Pack					
70256	12EFG5KL XCTN	4651-0020	100	3/4	1.24	5000	20000	4.8
70258	16EFG5KL XCTN	4651-0019	120	1	1.53	5000	20000	6.0

EFG4K Spiral Wire Hose - SAE 100R12 Extremely High Pressure

(Meets Flame Resistance Acceptance Designation "MSHA 2G")
For Biodegradable Hydraulic Fluids

Recommended For: Extremely high-pressure, high-impulse applications. Exceeds all performance requirements for SAE 100R12, EN 856 R12 and ISO 3862 Type R12. Compatible with biodegradable hydraulic fluids like polyolester, polyglycol and vegetable oil as well as standard petroleum-based fluids. Available in 121' through 200' continuous lengths.

Tube: Black, oil resistant, synthetic rubber (Nitrile – Type C). See Hose Stock Characteristics.





Reinforcement: Four alternating layers of spiraled, high-tensile steel wire.

Cover: Black, oil resistant, synthetic rubber (Neoprene – Type A), with color coded layline. Also available with unique abrasion resistant MegaTuff® cover. See Hose Stock Characteristics.

Temperature Range: -40°F to +250°F (-40°C to +121°C). For water emulsions see Temperature Limits Table.





Coupling Recommendation (See Crimp Data Manual 428-7365 or E-Crimp):
GlobalSpiral™ Couplings (G20) Section E
Stainless Steel Spiral Couplings (G18) Section F



Part No.	Description	Product No.	Standard Pack					
70157	6EFG4K X REEL	4651-0117	300	3/8	.80	4000	16000	2.5
85477	6EFG4K X25FT	4651-4005	1	3/8	.80	4000	16000	2.5
85491	6EFG4K X50FT	4651-1430	1	3/8	.80	4000	16000	2.5
70811	6EFG4KXCTN	4651-1338	100	3/8	.80	4000	16000	2.5
70158	8EFG4K X REEL	4651-0118	230	1/2	.94	4000	16000	3.5
85478	8EFG4K X25FT	4651-4006	1	1/2	.94	4000	16000	3.5
85492	8EFG4K X50FT	4651-1431	1	1/2	.94	4000	16000	3.5
70863	8EFG4KXCTN	4651-1339	100	1/2	.94	4000	16000	3.5
70976	8EFG4KXLL	4651-1611	200	1/2	.94	4000	16000	3.5
70159	10EFG4K X REEL	4651-0119	200	5/8	1.09	4000	16000	4.0
85479	10EFG4K X25FT	4651-4007	1	5/8	1.09	4000	16000	4.0
70813	10EFG4KXCTN	4651-1367	100	5/8	1.09	4000	16000	4.0
70166	12EFG4K X REEL	4651-0126	200	3/4	1.21	4000	16000	4.7
85480	12EFG4K X25FT	4651-4011	1	3/4	1.21	4000	16000	4.7
85494	12EFG4K X50FT	4651-1432	1	3/4	1.21	4000	16000	4.7
70831	12EFG4KXCTN	4651-1282	100	3/4	1.21	4000	16000	4.7
70717	12EFG4KXLL	4651-1385	200	3/4	1.21	4000	16000	4.7
85481	16EFG4K X25FT	4651-4012	1	1	1.50	4000	16000	6.0
85495	16EFG4K X50FT	4651-1433	1	1	1.50	4000	16000	6.0
70807	16EFG4K X100FT	4651-1460	100	1	1.50	4000	16000	6.0
70832	16EFG4KXCTN	4651-1283	100	1	1.50	4000	16000	6.0
70718	16EFG4KXLL	4651-1386	200	1	1.50	4000	16000	6.0
85482	20EFG4K X25FT	4651-4013	1	1 1/4	1.85	4000	16000	8.2
85438	20EFG4K X50FT	4651-1520	1	1 1/4	1.85	4000	16000	8.2

EFG4K Spiral Wire Hose - SAE 100R12
Extremely High Pressure

Continued

Part No.	Description	Product No.	Standard Pack					
70833	20EFG4KXCTN	4651-1284	50	1 1/4	1.85	4000	16000	8.2
70719	20EFG4KXLL	4651-1387	200	1 1/4	1.85	4000	16000	8.2

EFG4K Spiral Wire Hose - SAE 100R12 - MegaTuff® Cover
Extremely High Pressure

(Meets Flame Resistance Acceptance Designation "MSHA 2G")
For Biodegradable Hydraulic Fluids

MegaTuff® hose lasts up to 300 times longer than standard hose during hose-to-hose and hose-to-metal abrasion tests per ISO 6945.

Recommended For: Extremely high-pressure, high-impulse applications. Exceeds all performance requirements for SAE 100R12, EN 856 R12 and ISO 3862 Type R12. Compatible with biodegradable hydraulic fluids like polyolester, polyglycol and vegetable oil as well as standard petroleum-based fluids. Available in 121' through 200' continuous lengths.

Tube: Black, oil resistant, synthetic rubber (Nitrile - Type C). See Hose Stock Characteristics.





Reinforcement: Four alternating layers of spiraled, high-tensile steel wire.

Cover: Black, oil, abrasion and weather resistant MegaTuff® cover with synthetic rubber (Neoprene - Type A) base, with color coded layline. Also available in Standard cover. See Hose Stock Characteristics.

Temperature Range: -40°F to +250°F (-40°C to +121°C). For water emulsions see Temperature Limits Table.

Coupling Recommendation (See Crimp Data Manual 428-7365 or E-Crimp):
GlobalSpiral™ Couplings (G20) Section E
Stainless Steel Spiral Couplings (G18) Section F



Part No.	Description	Product No.	Standard Pack					
85483	6EFG4K-MTF X25FT	4651-4014	1	3/8	.80	4000	16000	2.5
70945	6EFG4K-MTFXCTN	4651-1610	100	3/8	.80	4000	16000	2.5
85484	8EFG4K-MTF X25FT	4651-4015	1	1/2	.94	4000	16000	3.5
70946	8EFG4K-MTFXCTN	4651-1607	100	1/2	.94	4000	16000	3.5
85485	10EFG4K-MTF X25FT	4651-4016	1	5/8	1.09	4000	16000	4.0
70947	10EFG4K-MTFXCTN	4651-1404	100	5/8	1.09	4000	16000	4.0
85486	12EFG4K-MTF X25FT	4651-4017	1	3/4	1.21	4000	16000	4.7
70877	12EFG4K-MTFXCTN	4651-1405	100	3/4	1.21	4000	16000	4.7
70726	12EFG4K-MTFXLL	4651-1388	200	3/4	1.21	4000	16000	4.7
85487	16EFG4K-MTF X25FT	4651-4018	1	1	1.50	4000	16000	6.0
70948	16EFG4K-MTFXCTN	4651-1406	100	1	1.50	4000	16000	6.0
70727	16EFG4K-MTFXLL	4651-1389	200	1	1.50	4000	16000	6.0
85488	20EFG4K-MTF X25FT	4651-4019	1	1 1/4	1.85	4000	16000	8.2
70949	20EFG4K-MTFXCTN	4651-1602	50	1 1/4	1.85	4000	16000	8.2

EFG4KL Low Temp Spiral Wire Hose Extremely High Pressure

Recommended For: Extremely high-pressure hydraulic applications. Compatible with biodegradable hydraulic fluids like polyolester, polyglycol and vegetable oil as well as standard petroleum based fluid.

Tube: Black, oil resistant, synthetic rubber (Nitrile – Type C). See Hose Stock Characteristics.





Reinforcement: Four alternating layers of spiraled, high tensile wire.

Cover: Black, oil resistant, synthetic rubber. (Neoprene – Type A).

Temperature Range: –70°F to +212°F (–57°C to +100°C).

Coupling Recommendation (See Crimp Data Manual 428-7365 or E-Crimp):
GlobalSpiral™ Couplings (G20) Section E



Part No.	Description	Product No.	Standard Pack					
77001	12EFG4KL XCTN	4651-0023	100	3/4	1.24	4000	16000	4.8
77002	16EFG4KL XCTN	4651-0024	100	1	1.53	4000	16000	6.0

EFG3K Spiral Wire Hose - SAE 100R12 Extremely High Pressure

(Meets Flame Resistance Acceptance Designation "MSHA 2G")
For Biodegradable Hydraulic Fluids

Recommended For: Extremely high-pressure, high-impulse applications. Exceeds all performance requirements for SAE 100R12, EN 856 R12, performance requirements of EN 856 4SP, and ISO 3862 Type R12. Compatible with biodegradable hydraulic fluids like polyolester, polyglycol and vegetable oil as well as standard petroleum-based fluids. Available in 121' through 200' continuous lengths.

Tube: Black, oil resistant, synthetic rubber (Nitrile – Type C). See Hose Stock Characteristics.

Reinforcement: Four alternating layers of spiraled, high-tensile steel wire.

Cover: Black, oil resistant, synthetic rubber (Neoprene – Type A), with color coded layline. Also available with unique abrasion resistant MegaTuff® cover. See Hose Stock Characteristics.

Temperature Range: –40°F to +250°F (–40°C to +121°C). For water emulsions see Temperature Limits Table.





Coupling Recommendation (See Crimp Data Manual 428-7365 or E-Crimp):

GlobalSpiral™ Couplings (–6 through –20) (G20) Section E

GlobalSpiral™ Plus Couplings (–24 and –32) (G22) Section E

Stainless Steel Spiral Couplings (G18) Section F



Part No.	Description	Product No.	Standard Pack					
85489	20EFG3K X25FT	4651-4003	1	1 1/4	1.85	3000	12000	8.2
85497	20EFG3K X50FT	4651-1434	1	1 1/4	1.85	3000	12000	8.2
70539	20EFG3KXCTN	4651-1381	100	1 1/4	1.85	3000	12000	8.2
70707	20EFG3KXLL	4651-1384	200	1 1/4	1.85	3000	12000	8.2
85430	24EFG3K X25FT	4651-1740	1	1 1/2	2.11	3000	12000	10.0
71054	24EFG3KXCTN	4651-1451	50	1 1/2	2.11	3000	12000	10.0
85434	32EFG3K X25FT	4651-1744	1	2	2.63	3000	12000	25.0
71058	32EFG3KXCTN	4651-1452	50	2	2.63	3000	12000	25.0

EFG3K Spiral Wire Hose - SAE 100R12 - MegaTuff® Cover Extremely High Pressure

(Meets Flame Resistance Acceptance Designation "MSHA 2G")
For Biodegradable Hydraulic Fluids

MegaTuff® hose lasts up to 300 times longer than standard hose during hose-to-hose and hose-to-metal abrasion tests per ISO 6945.

Recommended For: Extremely high-pressure, high-impulse applications. Exceeds all performance requirements for SAE 100R12, EN 856 R12, performance requirements of EN 856 4SP, and ISO 3862 Type R12. Compatible with biodegradable hydraulic fluids like polyolester, polyglycol and vegetable oil as well as standard petroleum-based fluids. Available in 121' through 200' continuous lengths.

Tube: Black, oil resistant, synthetic rubber (Nitrile - Type C). See Hose Stock Characteristics.

Reinforcement: Four alternating layers of spiraled, high-tensile steel wire.

Cover: Black, oil, abrasion and weather resistant MegaTuff® cover with synthetic rubber (Neoprene - Type A) base, with color coded layline. Also available in Standard cover. See Hose Stock Characteristics.

Temperature Range: -40°F to +250°F (-40°C to +121°C). For water emulsions see Temperature Limits Table.

Coupling Recommendation (See Crimp Data Manual 428-7365 or E-Crimp):

GlobalSpiral™ Couplings (G20) Section E

GlobalSpiral™ Plus Couplings (-24 and -32) (G22) Section E

Stainless Steel Spiral Couplings (G18) Section F



Part No.	Description	Product No.	Standard Pack					
85490	20EFG3K-MTF X25FT	4651-4004	1	1 1/4	2.11	3000	12000	8.2
70950	20EFG3K-MTFXCTN	4651-1425	100	1 1/4	2.11	3000	12000	8.2
70951	20EFG3K-MTFXLL	4651-1427	200	1 1/4	2.11	3000	12000	8.2
85431	24EFG3K-MTF X25FT	4651-1741	1	1 1/2	2.11	3000	12000	10.0
71053	24EFG3K-MTFXCTN	4651-2201	50	1 1/2	2.11	3000	12000	10.0
85435	32EFG3K-MTF X25FT	4651-1745	1	2	2.63	3000	12000	25.0
71057	32EFG3K-MTFXCTN	4651-2205	50	2	2.63	3000	12000	25.0

Global M6K Mega6000™ Hose High Pressure

(Meets Flame Resistance Acceptance Designation "MSHA 2G")

Recommended For: High-pressure hydraulic applications. Provides tighter than standard minimum bend radius and greater flexibility for easier plumbing.

Tube: Black, oil resistant, synthetic rubber (Nitrile - Type C). See Hose Stock Characteristics.

Reinforcement: Two braids of high-tensile steel wire.

Cover: Black, oil, abrasion and weather resistant, synthetic rubber (Modified Nitrile - Type C2), with color coded layline. See Hose Stock Characteristics.

Temperature Range: -40°F to +212°F (-40°C to +100°C). For water emulsions see Temperature Limits Table.

Coupling Recommendation (See Crimp Data Manual 428-7365 or E-Crimp):

MegaCrimp® Couplings (G25) Section G

Stainless Steel Braid Couplings (G17) Section H



Part No.	Description	Product No.	Standard Pack					
70599	4M6KXREEL	4657-2697	440	1/4	.58	6000	24000	2.0

Global M5K Mega5000™ Hose High Pressure

(Meets Flame Resistance Acceptance Designation "MSHA 2G")

Recommended For: High-pressure hydraulic applications. Provides tighter than standard minimum bend radius and greater flexibility for easier plumbing.

Tube: Black, oil resistant, synthetic rubber (Nitrile – Type C). See Hose Stock Characteristics.

Reinforcement: Two braids of high-tensile steel wire.

Cover: Black, oil, abrasion and weather resistant, synthetic rubber (Modified Nitrile – Type C2), with color coded layline. Also available with unique abrasion resistant MegaTuff® or XtraTuff™ cover. See Hose Stock Characteristics.

Temperature Range: -40°F to +212°F (-40°C to +100°C). For water emulsions see Temperature Limits Table.





Coupling Recommendation (See Crimp Data Manual 428-7365 or E-Crimp):

GlobalSpiral™ Couplings (G20) Section E

MegaCrimp® Couplings (G25) Section G

Stainless Steel Braid Couplings (G17) Section H



Part No.	Description	Product No.	Standard Pack					
85607	4M5K X50FT	4657-4122	1	1/4	.55	5000	20000	2.0
70596	4M5KXREEL	4657-1100	440	1/4	.55	5000	20000	2.0
70449	5M5KXREEL	4657-8006	350	5/16	.61	5000	20000	2.2
85606	6M5K X50FT	4657-4121	1	3/8	.70	5000	20000	2.5
70597	6M5KXREEL	4657-2695	330	3/8	.70	5000	20000	2.5
85608	8M5K X50FT	4657-4123	1	1/2	.86	5000	20000	3.5
70598	8M5KXREEL	4657-2650	220	1/2	.86	5000	20000	3.5

Global M5K Mega5000™ Hose - MegaTuff® Cover High Pressure

(Meets Flame Resistance Acceptance Designation "MSHA 2G")

Recommended For: High-pressure hydraulic applications. Provides tighter than standard minimum bend radius and greater flexibility for easier plumbing.

Tube: Black, oil resistant, synthetic rubber (Nitrile – Type C). See Hose Stock Characteristics.

Reinforcement: Two braids of high-tensile steel wire.

Cover: Black, oil, abrasion and weather resistant MegaTuff® cover with synthetic rubber (Neoprene – Type A) base, with color coded layline. Also available in Standard or XtraTuff™ cover. See Hose Stock Characteristics.

Temperature Range: -40°F to +212°F (-40°C to +100°C). For water emulsions see Temperature Limits Table.





Coupling Recommendation (See Crimp Data Manual 428-7365 or E-Crimp):

GlobalSpiral™ Couplings (G20) Section E

MegaCrimp® Couplings (G25) Section G

Stainless Steel Braid Couplings (G17) Section H



Part No.	Description	Product No.	Standard Pack					
70386	4M5K-MTFXREEL	4657-8011	440	1/4	.55	5000	20000	2.0
70343	5M5K-MTFXREEL	4657-8012	350	5/16	.61	5000	20000	2.2
70340	6M5K-MTFXREEL	4657-8013	330	3/8	.70	5000	20000	2.5
70329	8M5K-MTFXREEL	4657-8014	220	1/2	.86	5000	20000	3.5

Global M5K Mega5000™ Hose - XtraTuff™ Cover High Pressure

(Meets Flame Resistance Acceptance Designation "MSHA 2G")

Recommended For: High-pressure hydraulic applications. Provides tighter than standard minimum bend radius and greater flexibility for easier plumbing.

Tube: Black, oil resistant, synthetic rubber (Nitrile – Type C). See Hose Stock Characteristics.

Reinforcement: Two braids of high-tensile steel wire.

Cover: Black, oil, abrasion and weather resistant, synthetic rubber (Modified Nitrile – Type C2), with color coded layline. Also available in Standard or MegaTuff® cover. See Hose Stock Characteristics.

Temperature Range: -40°F to +212°F (-40°C to +100°C). For water emulsions see Temperature Limits Table.

Coupling Recommendation (See Crimp Data Manual 428-7365 or E-Crimp):

GlobalSpiral™ Couplings (G20) Section E

MegaCrimp® Couplings (G25) Section G

Stainless Steel Braid Couplings (G17) Section H



Part No.	Description	Product No.	Standard Pack	⌀	Ø	⌚	⌚	⌚
70423	4M5K-XTFXREEL	4657-8007	440	1/4	.55	5000	20000	2.0
70428	5M5K-XTFXREEL	4657-8008	375	5/16	.61	5000	20000	2.2
70430	6M5K-XTFXREEL	4657-8009	330	3/8	.70	5000	20000	2.5
70399	8M5K-XTFXREEL	4657-8010	220	1/2	.86	5000	20000	3.5

Global M4K Mega4000™ Hose - SAE 100R19 High Pressure

(Meets Flame Resistance Acceptance Designation "MSHA 2G", and ISO11237 R19)

Recommended For: High-pressure hydraulic applications. Exceeds SAE 100R19 and ISO11237 R19. Allows for tighter minimum bend radius, increased working pressure and improved impulse cycles than industry standards. Provides greater performance, flexibility, easier routing and plumbing of mobile and stationary hydraulic platforms.

Tube: Black, oil resistant, synthetic rubber (Nitrile – Type C). See Hose Stock Characteristics.

Reinforcement: Two braids of high-tensile steel wire.

Cover: Black, oil, abrasion and weather resistant, synthetic rubber (Modified Nitrile – Type C2), with color coded layline. Also available with unique abrasion resistant MegaTuff® or XtraTuff™ cover. See Hose Stock Characteristics.

Temperature Range: -40°F to +212°F (-40°C to +100°C). For water emulsions see Temperature Limits Table.

Coupling Recommendation (See Crimp Data Manual 428-7365 or E-Crimp):

GlobalSpiral™ Couplings (G20) Section E

MegaCrimp® Couplings (-4 through -12) (G25) Section G

Stainless Steel Braid Couplings (-4 through -8) (G17) Section H

Stainless Steel Spiral Couplings (-10 and -16) (G18) Section F



Part No.	Description	Product No.	Standard Pack	⌀	Ø	⌚	⌚	⌚
85616	4M4K X50FT	4657-1238	1	1/4	.55	4000	16000	1.5
70829	4M4KXREEL	4657-1467	440	1/4	.55	4000	16000	1.5
70457	5M4KXREEL	4657-8015	350	5/16	.61	4000	16000	1.8
85617	6M4K X50FT	4657-4867	1	3/8	.70	4000	16000	2.0
70821	6M4KXREEL	4657-1458	330	3/8	.70	4000	16000	2.0
85618	8M4K X50FT	4657-4868	1	1/2	.82	4000	16000	2.8
70822	8M4KXREEL	4657-1459	220	1/2	.82	4000	16000	2.8
85619	10M4K X50FT	4657-4869	1	5/8	.99	4000	16000	3.0
70823	10M4KXREEL	4657-1460	220	5/8	.99	4000	16000	3.0
85620	12M4K X50FT	4657-4870	1	3/4	1.17	4000	16000	3.8
70824	12M4KXREEL	4657-1461	220	3/4	1.17	4000	16000	3.8
71064	16M4KXREEL	4657-4051	165	1	1.52	4000	16000	4.5

Global M4K Mega4000™ Hose - SAE 100R19 - MegaTuff® Cover High Pressure

(Meets Flame Resistance Acceptance Designation "MSHA 2G", and ISO11237 R19)

MegaTuff® hose lasts up to 300 times longer than standard hose during hose-to-hose and hose-to-metal abrasion tests per ISO 6945.

Recommended For: High-pressure hydraulic applications. Exceeds SAE 100R19 and ISO11237 R19. Allows for tighter minimum bend radius, increased working pressure and improved impulse cycles than industry standards. Provides greater performance, flexibility, easier routing and plumbing of mobile and stationary hydraulic platforms.

Tube: Black, oil resistant, synthetic rubber (Nitrile – Type C). See Hose Stock Characteristics.

Reinforcement: Two braids of high-tensile steel wire.

Cover: Black, oil, abrasion and weather resistant MegaTuff® cover with synthetic rubber (Neoprene – Type A) base, with color coded layline. Also available in Standard or XtraTuff™ cover. See Hose Stock Characteristics.

Temperature Range: –40°F to +212°F (–40°C to +100°C). For water emulsions see Temperature Limits Table.

Coupling Recommendation (See Crimp Data Manual 428-7365 or E-Crimp):

GlobalSpiral™ Couplings (G20) Section E

MegaCrimp® Couplings (–4 through –12) (G25) Section G

Stainless Steel Braid Couplings (–4 through –8) (G17) Section H

Stainless Steel Spiral Couplings (–10 and –16) (G18) Section F



Part No.	Description	Product No.	Standard Pack	⌀	Ø	⌚	⌚	⌚
85519	4M4K-MTF X50FT	4657-1239	1	1/4	.55	4000	16000	1.5
70830	4M4K-MTFXREEL	4657-1477	350	1/4	.55	4000	16000	1.5
70326	5M4K-MTFXREEL	4657-8017	350	5/16	.61	4000	16000	1.8
85520	6M4K-MTF X50FT	4657-4020	1	3/8	.70	4000	16000	2.0
70825	6M4K-MTFXREEL	4657-1479	330	3/8	.70	4000	16000	2.0
85521	8M4K-MTF X50FT	4657-4021	1	1/2	.82	4000	16000	2.8
70826	8M4K-MTFXREEL	4657-1480	220	1/2	.82	4000	16000	2.8
85522	10M4K-MTF X50FT	4657-4022	1	5/8	.99	4000	16000	3.0
70827	10M4K-MTFXREEL	4657-1481	220	5/8	.99	4000	16000	3.0
85524	12M4K-MTF X50FT	4657-4024	1	3/4	1.17	4000	16000	3.8
70828	12M4K-MTFXREEL	4657-1482	190	3/4	1.17	4000	16000	3.8
71103	16M4K-MTFXREEL	4657-4053	165	1	1.52	4000	16000	4.5

Global M4K Mega4000™ Hose - SAE 100R19 - XtraTuff™ Cover High Pressure

(Meets Flame Resistance Acceptance Designation "MSHA 2G", and ISO11237 R19)

XtraTuff™ hose lasts up to 25 times longer than standard hose during hose-to-hose and hose-to-metal abrasion tests per ISO 6945.

Recommended For: High-pressure hydraulic applications. Exceeds SAE 100R19 and ISO11237 R19. Allows for tighter minimum bend radius, increased working pressure and improved impulse cycles than industry standards. Provides greater performance, flexibility, easier routing and plumbing of mobile and stationary hydraulic platforms.

Tube: Black, oil resistant, synthetic rubber (Nitrile – Type C). See Hose Stock Characteristics.

Reinforcement: Two braids of high-tensile steel wire.

Cover: Black, oil, abrasion and weather resistant, synthetic rubber (Modified Nitrile – Type C2), with color coded layline. Also available in Standard or MegaTuff® cover. See Hose Stock Characteristics.

Temperature Range: –40°F to +212°F (–40°C to +100°C). For water emulsions see Temperature Limits Table.

Coupling Recommendation (See Crimp Data Manual 428-7365 or E-Crimp):

GlobalSpiral™ Couplings (G20) Section E

MegaCrimp® Couplings (–4 through –12) (G25) Section G

Stainless Steel Braid Couplings (–4 through –8) (G17) Section H





Stainless Steel Spiral Couplings (–10 and –16) (G18) Section F



Part No.	Description	Product No.	Standard Pack	⌀	Ø	⌚	⌚	⌚
85541	4M4K-XTF X50FT	4657-2616	1	1/4	.55	4000	16000	1.5
70693	4M4K-XTFXREEL	4657-2281	440	1/4	.55	4000	16000	1.5
70459	5M4K-XTFXREEL	4657-8016	350	5/16	.61	4000	16000	1.8
85542	6M4K-XTF X50FT	4657-2615	1	3/8	.70	4000	16000	2.0
70694	6M4K-XTFXREEL	4657-2283	330	3/8	.70	4000	16000	2.0

Global M4K Mega4000™ Hose - SAE 100R19 - XtraTuff™ Cover
High Pressure

Continued

Part No.	Description	Product No.	Standard Pack					
85543	8M4K-XTF X50FT	4657-2614	1	1/2	.82	4000	16000	2.8
70695	8M4K-XTFXREEL	4657-2284	220	1/2	.82	4000	16000	2.8
70696	10M4K-XTFXREEL	4657-2285	220	5/8	.99	4000	16000	3.0
70697	12M4K-XTFXREEL	4657-2286	220	3/4	1.17	4000	16000	3.8
71104	16M4K-XTFXREEL	4657-4052	165	1	1.52	4000	16000	4.5

M4KH Wire Braid Hose - High-Temp - SAE 100R19
High Pressure

(Meets Flame Resistance Acceptance Designation "MSHA 2G", and ISO11237 R19)

Recommended For: High-pressure hydraulic applications. Exceeds SAE 100R19 and ISO11237 R19. Allows for tighter minimum bend radius, increased working pressure and improved impulse cycles than industry standards. Provides greater performance, flexibility, easier routing and plumbing of mobile and stationary hydraulic platforms.

Tube: Black, oil resistant, synthetic rubber (Nitrile - Type C). See Hose Stock Characteristics.





Reinforcement: Two braids of high-tensile steel wire.

Cover: Black, oil, abrasion and weather resistant, thin synthetic rubber (Neoprene - CR), with color coded layline. Flame resistance - MSHA 2G.

Temperature Range: -40°F to +250°F (-40°C to +121°C). For water emulsions see Temperature Limits Table.

Coupling Recommendation (See Crimp Data Manual 428-7365 or E-Crimp):
GlobalSpiral™ Couplings (G20) Section E
MegaCrimp® Couplings (G25) Section G



Part No.	Description	Product No.	Standard Pack					
85540	4M4KH X50FT	4657-4098	1	1/4	.55	4000	16000	2.0
70901	4M4KH XREEL	4657-2381	440	1/4	.55	4000	16000	2.0
85546	6M4KH X50FT	4657-4099	1	3/8	.70	4000	16000	2.5
70902	6M4KH XREEL	4657-2383	330	3/8	.70	4000	16000	2.5
85547	8M4KH X50FT	4657-4100	1	1/2	.82	4000	16000	3.5
70903	8M4KH XREEL	4657-2384	220	1/2	.82	4000	16000	3.5
85548	10M4KH X50FT	4657-4101	1	5/8	.99	4000	16000	4.0
70904	10M4KH XREEL	4657-2385	220	5/8	.99	4000	16000	4.0
85549	12M4KH X50FT	4657-2619	1	3/4	1.17	4000	16000	4.7
70905	12M4KH XREEL	4657-2386	220	3/4	1.17	4000	16000	4.7

M4KH Wire Braid Hose - High-Temp - SAE 100R19 - MegaTuff® Cover High Pressure

(Meets Flame Resistance Acceptance Designation "MSHA 2G", and ISO11237 R19)

MegaTuff® hose lasts up to 300 times longer than standard hose during hose-to-hose and hose-to-metal abrasion tests per ISO 6945.

Recommended For: High-pressure hydraulic applications. Exceeds SAE 100R19 and ISO11237 R19. Allows for tighter minimum bend radius, increased working pressure and improved impulse cycles than industry standards. Provides greater performance, flexibility, easier routing and plumbing of mobile and stationary hydraulic platforms.

Tube: Black, oil resistant, synthetic rubber (Nitrile - Type C). See Hose Stock Characteristics.





Reinforcement: Two braids of high-tensile steel wire.

Cover: Black, oil, abrasion and weather resistant MegaTuff® cover with synthetic rubber (Neoprene - Type A) base, with color coded layline. Flame resistance - MSHA 2G.

Temperature Range: -40°F to +250°F (-40°C to +121°C). For water emulsions see Temperature Limits Table.

Coupling Recommendation (See Crimp Data Manual 428-7365 or E-Crimp):
GlobalSpiral™ Couplings (G20) Section E
MegaCrimp® Couplings (G25) Section G



Part No.	Description	Product No.	Standard Pack					
85448	4M4KH-MTF X50FT	4657-4093	1	1/4	.55	4000	16000	2.0
70956	4M4KH-MTFXREEL	4657-2157	440	1/4	.55	4000	16000	2.0
85449	6M4KH-MTF X50FT	4657-4094	1	3/8	.70	4000	16000	2.5
70957	6M4KH-MTFXREEL	4657-2159	330	3/8	.70	4000	16000	2.5
85450	8M4KH-MTF X50FT	4657-4095	1	1/2	.82	4000	16000	3.5
70958	8M4KH-MTFXREEL	4657-2160	220	1/2	.82	4000	16000	3.5
85451	10M4KH-MTF X50FT	4657-4096	1	5/8	.99	4000	16000	4.0
70959	10M4KH-MTFXREEL	4657-2161	220	5/8	.99	4000	16000	4.0
85452	12M4KH-MTF X50FT	4657-4097	1	3/4	1.17	4000	16000	4.7
70973	12M4KH-MTFXREEL	4657-2396	190	3/4	1.17	4000	16000	4.7

Global M4KL Mega4000™ PolarFlex® Hose - SAE 100R19 High Pressure

(Meets Flame Resistance Acceptance Designation "MSHA 2G")

Recommended For: High-pressure hydraulic applications.

Tube: Black, oil resistant, synthetic rubber (NBR).





Reinforcement: Two braids of high-tensile steel wire.

Cover: Black, oil, abrasion, and weather resistant synthetic rubber. Flame resistance - U.S. MSHA 2G.

Temperature Range: -70°F to +212°F (-57°C to +100°C).

Coupling Recommendation (See Crimp Data Manual 428-7365 or E-Crimp):
Permanent no-skive GlobalSpiral™ (1" only) and MegaCrimp®.
Stainless Steel Couplings (G17 and G18) Section F and H



Part No.	Description	Product No.	Standard Pack					
70148	4M4KL X REEL	4657-4470	440	1/4	.54	4000	16000	2.0
70149	5M4KL X REEL	4657-4471	350	5/16	.60	4000	16000	2.3
70150	6M4KL X REEL	4657-4472	330	3/8	.69	4000	16000	2.5
70151	8M4KL X REEL	4657-4473	220	1/2	.82	4000	16000	3.5
70152	10M4KL X REEL	4657-4474	220	5/8	.98	4000	16000	4.0
70153	12M4KL X REEL	4657-4475	220	3/4	1.16	4000	16000	6.0
70154	16M4KL X REEL	4657-4476	165	1	1.52	4000	16000	6.0

Global M3K Mega3000® Hose - SAE 100R17 High Pressure

(Meets Flame Resistance Acceptance Designation "MSHA 2G", and ISO11237 R17)

Recommended For: High-pressure hydraulic oil lines. Exceeds SAE 100R17 and ISO11237 R17 working pressure, minimum bend radius requirements and performance requirements of EN 857 1SC. M3K hose has smaller exterior dimensions and significantly tighter bend radius than other SAE 100R1 and 100R2 hose.

Tube: Black, oil resistant, synthetic rubber (Nitrile - Type C). See Hose Stock Characteristics.

Reinforcement: Braided, high-tensile steel wire. -4, -5, -6 and -8 sizes are one braid; -10, -12 and -16 sizes are two braid.

Cover: Black, oil, abrasion and weather resistant, synthetic rubber (Modified Nitrile - Type C2), with color coded layline. Also available with unique abrasion resistant MegaTuff® or XtraTuff™ cover. See Hose Stock Characteristics.

Temperature Range: -40°F to +212°F (-40°C to +100°C). For water emulsions see Temperature Limits Table.

Coupling Recommendation (See Crimp Data Manual 428-7365 or E-Crimp):

GlobalSpiral™ Couplings (G20) Section E

MegaCrimp® Couplings (G25) Section G

Power Crimp® Couplings (-3 only) Section I

Stainless Steel Braid Couplings (G17) Section H



Part No.	Description	Product No.	Standard Pack	⌀	Ø	⌚	⌚	⌚
70352	3M3KXREEL	4657-8068	440	3/16	.43	3250	13000	1.3
85624	4M3K X50FT	4657-4874	1	1/4	.48	3250	13000	1.5
70485	4M3KXREEL	4657-1157	440	1/4	.48	3250	13000	1.5
85609	5M3K X50FT	4657-2502	1	5/16	.60	3250	13000	1.8
70575	5M3KXREEL	4657-2216	385	5/16	.60	3250	13000	1.8
85625	6M3K X50FT	4657-4875	1	3/8	.63	3250	13000	2.0
70486	6M3KXREEL	4657-1158	330	3/8	.63	3250	13000	2.0
85626	8M3K X50FT	4657-4876	1	1/2	.80	3250	13000	2.8
70487	8M3KXREEL	4657-1159	220	1/2	.80	3250	13000	2.8
85627	10M3K X50FT	4657-4877	1	5/8	.99	3250	13000	3.0
70488	10M3KXREEL	4657-1173	220	5/8	.99	3250	13000	3.0
85628	12M3K X50FT	4657-4878	1	3/4	1.15	3250	13000	3.8
70489	12M3KXREEL	4657-0679	220	3/4	1.15	3250	13000	3.8
85629	16M3K X50FT	4657-4879	1	1	1.48	3250	13000	4.5
70490	16M3KXREEL	4657-1163	165	1	1.48	3250	13000	4.5

Global M3K Mega3000® Hose - SAE 100R17 - MegaTuff® Cover High Pressure

(Meets Flame Resistance Acceptance Designation "MSHA 2G", and ISO11237 R17)

MegaTuff® hose lasts up to 300 times longer than standard hose during hose-to-hose and hose-to-metal abrasion tests per ISO 6945.

Recommended For: High-pressure hydraulic oil lines. Exceeds SAE 100R17 and ISO11237 R17 working pressure, minimum bend radius requirements and performance requirements of EN 857 1SC. M3K hose has smaller exterior dimensions and significantly tighter bend radius than other SAE 100R1 and 100R2 hose.

Tube: Black, oil resistant, synthetic rubber (Nitrile - Type C). See Hose Stock Characteristics.

Reinforcement: Braided, high-tensile steel wire. -4, -5, -6 and -8 sizes are one braid; -10, -12 and -16 sizes are two braid.

Cover: Black, oil, abrasion and weather resistant MegaTuff® cover with synthetic rubber (Neoprene - Type A) base, with color coded layline. Also available in Standard or XtraTuff™ cover. See Hose Stock Characteristics.

Temperature Range: -40°F to +212°F (-40°C to +100°C). For water emulsions see Temperature Limits Table.

Coupling Recommendation (See Crimp Data Manual 428-7365 or E-Crimp):

GlobalSpiral™ Couplings (G20) Section E

MegaCrimp® Couplings (G25) Section G





Stainless Steel Braid Couplings (G17) Section H



Part No.	Description	Product No.	Standard Pack	⌀	Ø	⌚	⌚	⌚
85525	4M3K-MTF X50FT	4657-4025	1	1/4	.48	3250	13000	1.5
70565	4M3K-MTFXREEL	4657-1181	440	1/4	.48	3250	13000	1.5
85526	6M3K-MTF X50FT	4657-4026	1	3/8	.63	3250	13000	2.0

Global M3K Mega3000® Hose - SAE 100R17 - MegaTuff® Cover
High Pressure

Continued

Part No.	Description	Product No.	Standard Pack					
70566	6M3K-MTFXREEL	4657-1182	330	3/8	.63	3250	13000	2.0
85527	8M3K-MTF X50FT	4657-4027	1	1/2	.80	3250	13000	2.8
70567	8M3K-MTFXREEL	4657-1183	330	1/2	.80	3250	13000	2.8
85528	10M3K-MTF X50FT	4657-4028	1	5/8	.99	3250	13000	3.0
70559	10M3K-MTFXREEL	4657-1184	220	5/8	.99	3250	13000	3.0
85529	12M3K-MTF X50FT	4657-4029	1	3/4	1.15	3250	13000	3.8
70560	12M3K-MTFXREEL	4657-1185	220	3/4	1.15	3250	13000	3.8
85530	16M3K-MTF X50FT	4657-4030	1	1	1.48	3250	13000	4.8
70562	16M3K-MTFXREEL	4657-1186	165	1	1.48	3250	13000	4.8

Global M3K Mega3000® Hose - SAE 100R17 - XtraTuff™ Cover
High Pressure

(Meets Flame Resistance Acceptance Designation "MSHA 2G", and ISO11237 R17)
XtraTuff™ hose lasts up to 25 times longer than standard hose during hose-to-hose and hose-to-metal abrasion tests per ISO 6945.

Recommended For: High-pressure hydraulic oil lines. Exceeds SAE 100R17 and ISO11237 R17 working pressure, minimum bend radius requirements and performance requirements of EN 857 1SC. M3K hose has smaller exterior dimensions and significantly tighter bend radius than other SAE 100R1 and 100R2 hose.

Tube: Black, oil resistant, synthetic rubber (Nitrile - Type C). See Hose Stock Characteristics.





Reinforcement: Braided, high-tensile steel wire. -4, -5, -6 and -8 sizes are one braid; -10, -12 and -16 sizes are two braid.

Cover: Black, oil, abrasion and weather resistant, synthetic rubber (Modified Nitrile - Type C2), with color coded layline. Also available in Standard or MegaTuff® cover. See Hose Stock Characteristics.

Temperature Range: -40°F to +212°F (-40°C to +100°C). For water emulsions see Temperature Limits Table.

Coupling Recommendation (See Crimp Data Manual 428-7365 or E-Crimp):
GlobalSpiral™ Couplings (G20) Section E
MegaCrimp® Couplings (G25) Section G
Power Crimp® Couplings (-3 only) Section I
Stainless Steel Braid Couplings (G17) Section H



Part No.	Description	Product No.	Standard Pack					
70969	3M3K-XTFXREEL	4657-8069	440	3/16	.43	3250	13000	1.3
70569	4M3K-XTFXREEL	4657-1097	440	1/4	.48	3250	13000	1.5
70568	5M3K-XTFXREEL	4657-2300	385	5/16	.60	3250	13000	1.8
70570	6M3K-XTFXREEL	4657-1098	330	3/8	.63	3250	13000	2.0
70571	8M3K-XTFXREEL	4657-2248	220	1/2	.80	3250	13000	2.8
70572	10M3K-XTFXREEL	4657-2249	220	5/8	.99	3250	13000	3.0
70573	12M3K-XTFXREEL	4657-2250	220	3/4	1.15	3250	13000	3.8
70574	16M3K-XTFXREEL	4657-2307	165	1	1.48	3250	13000	4.5

M3KH Wire Braid Hose - High-Temp - SAE 100R17 High Pressure

(Meets Flame Resistance Acceptance Designation "MSHA 2G", and ISO11237 R17)

Recommended For: High-pressure hydraulic oil lines. Exceeds SAE 100R17 and ISO11237 R17 requirements and performance requirements of EN 857 1SC. M3KH hose has smaller exterior dimensions and significantly tighter bend radius than other SAE 100R1 and 100R2 hose.

Tube: Black, oil resistant, synthetic rubber (Nitrile - Type C). See Hose Stock Characteristics.

Reinforcement: Braided, high-tensile steel wire. -4, -5, -6 and -8 sizes are one braid; -10, -12 and -16 sizes are two braid.

Cover: Black, oil, abrasion and weather resistant, synthetic rubber (Neoprene CR), with color coded layline. See Hose Stock Characteristics.





Temperature Range: -40°F to +250°F (-40°C to +121°C). For water emulsions see Temperature Limits Table.

Coupling Recommendation (See Crimp Data Manual 428-7365 or E-Crimp):

GlobalSpiral™ Couplings (G20) Section E

MegaCrimp® Couplings (G25) Section G



Part No.	Description	Product No.	Standard Pack					
70898	4M3KHREEL	4657-2664	440	1/4	.48	3250	13000	2.0
70789	5M3KHREEL	4657-4055	330	5/16	.60	3250	13000	2.2
70899	6M3KHREEL	4657-2696	330	3/8	.65	3250	13000	2.5
70953	8M3KHREEL	4657-1360	220	1/2	.80	3250	13000	3.5
70954	10M3KHREEL	4657-1361	220	5/8	.99	3250	13000	4.0
70955	12M3KHREEL	4657-1362	220	3/4	1.15	3250	13000	4.8
70907	16M3KHREEL	4657-1363	165	1	1.48	3250	13000	6.0

M3KH Wire Braid Hose - High-Temp - SAE 100R17 - MegaTuff® Cover High Pressure

(Meets Flame Resistance Acceptance Designation "MSHA 2G", and ISO11237 R17)

MegaTuff® hose lasts up to 300 times longer than standard hose during hose-to-hose and hose-to-metal abrasion tests per ISO 6945.

Recommended For: High-pressure hydraulic oil lines. Exceeds SAE 100R17 and ISO11237 R17 working pressure, minimum bend radius requirements and performance requirements of EN 857 1SC. M3KH hose has smaller exterior dimensions and significantly tighter bend radius than other SAE 100R1 and 100R2 hose.

Tube: Black, oil resistant, synthetic rubber (Nitrile - Type C). See Hose Stock Characteristics.

Reinforcement: Braided, high-tensile steel wire. -4, -6 and -8 sizes are one braid; -10, -12 and -16 sizes are two braid.

Cover: Black, oil, abrasion and weather resistant MegaTuff® cover with synthetic rubber (Neoprene - Type A) base, with color coded layline. Also available in Standard cover. See Hose Stock Characteristics.





Temperature Range: -40°F to +250°F (-40°C to +121°C). For water emulsions see Temperature Limits Table.

Coupling Recommendation (See Crimp Data Manual 428-7365 or E-Crimp):

GlobalSpiral™ Couplings (G20) Section E

MegaCrimp® Couplings (G25) Section G



Part No.	Description	Product No.	Standard Pack					
71030	4M3KH-MTFXREEL	4657-2321	440	1/4	.48	3250	13000	2.0
71031	6M3KH-MTFXREEL	4657-2323	330	3/8	.63	3250	13000	2.5
71032	8M3KH-MTFXREEL	4657-2324	330	1/2	.80	3250	13000	3.5
71033	10M3KH-MTFXREEL	4657-2325	220	5/8	.99	3250	13000	4.0
71034	12M3KH-MTFXREEL	4657-2326	220	3/4	1.15	3250	13000	4.8
71035	16M3KH-MTFXREEL	4657-2327	165	1	1.48	3250	13000	6.0

M2T[®] MegaFlex[®] 2-Wire Braid Hose - SAE 100R16 High Pressure

(Meets Flame Resistance Acceptance Designation "MSHA 2G", and ISO11237 2SC R16)

Recommended For: High-pressure hydraulic oil lines. Exceeds SAE 100R16 and ISO11237 2SC R16 requirements and performance requirements of EN 857 2SC. M2T hose has smaller exterior dimensions and significantly tighter bend radius.

Tube: Black, oil resistant, synthetic rubber (Nitrile - Type C). See Hose Stock Characteristics.

Reinforcement: Two braids of high-tensile steel wire.

Cover: Black, oil, abrasion and weather resistant, synthetic rubber (Modified Nitrile - Type C2), with color coded layline. Also available with unique abrasion resistant MegaTuff[®] or XtraTuff[™] cover. See Hose Stock Characteristics.

Temperature Range: -40°F to +212°F (-40°C to +100°C). For water emulsions see Temperature Limits Table.

Coupling Recommendation (See Crimp Data Manual 428-7365 or E-Crimp):

GlobalSpiral[™] Couplings (G20) Section E

GlobalSpiral[™] Plus Couplings (-24 and -32) (G22) Section E

MegaCrimp[®] Couplings (G25) Section G

Stainless Steel Braid Couplings (G17) Section H



Part No.	Description	Product No.	Standard Pack	⌀	Ø	⌚	⌚	⌚
85600	4M2T X50FT	4657-1553	1	1/4	.56	6000	24000	1.5
71102	4M2TX150REEL	4657-4422	150	1/4	.56	6000	24000	1.5
70390	4M2TXREEL	4657-1552	550	1/4	.56	6000	24000	1.5
85601	6M2T X50FT	4657-1550	1	3/8	.70	5000	20000	2.0
70391	6M2TXREEL	4657-1555	385	3/8	.70	5000	20000	2.0
85602	8M2T X50FT	4657-1561	1	1/2	.82	4300	17200	2.8
70392	8M2TXREEL	4657-1559	330	1/2	.82	4300	17200	2.8
85603	10M2T X50FT	4657-1564	1	5/8	.95	3800	15200	3.0
70393	10M2TXREEL	4657-1563	220	5/8	.95	3800	15200	3.0
85604	12M2T X50FT	4657-1568	1	3/4	1.11	3500	14000	3.8
70394	12M2TXREEL	4657-1567	220	3/4	1.11	3500	14000	3.8
85605	16M2T X50FT	4657-1572	1	1	1.39	2500	10000	4.5
70395	16M2TXREEL	4657-1571	165	1	1.39	2500	10000	4.5
70025	20M2T X CTN	4657-4534	120	1 1/4	1.67	2300	9200	8.3
70145	24M2T X CTN	4657-4491	120	1 1/2	2.00	2000	8000	10.0
70146	32M2T X CTN	4657-4492	120	2	2.53	1500	6000	12.5

M2T[®] MegaFlex[®] 2-Wire Braid Hose - SAE 100R16 - MegaTuff[®] Cover High Pressure

(Meets Flame Resistance Acceptance Designation "MSHA 2G", and ISO11237 2SC R16)

MegaTuff[®] hose lasts up to 300 times longer than standard hose during hose-to-hose and hose-to-metal abrasion tests per ISO 6945.

Recommended For: High-pressure hydraulic oil lines. Exceeds SAE 100R16 and ISO11237 2SC R16 working pressure, minimum bend radius requirements and performance requirements of EN 857 2SC. M2T hose has smaller exterior dimensions and significantly tighter bend radius.

Tube: Black, oil resistant, synthetic rubber (Nitrile - Type C). See Hose Stock Characteristics.

Reinforcement: Two braids of high-tensile steel wire.

Cover: Black, oil, abrasion and weather resistant MegaTuff[®] cover with synthetic rubber (Neoprene - Type A) base, with color coded layline. Also available in Standard or XtraTuff[™] cover. See Hose Stock Characteristics.

Temperature Range: -40°F to +212°F (-40°C to +100°C). For water emulsions see Temperature Limits Table.

Coupling Recommendation (See Crimp Data Manual 428-7365 or E-Crimp):

GlobalSpiral[™] Couplings (G20) Section E

MegaCrimp[®] Couplings (G25) Section G





Stainless Steel Braid Couplings (G17) Section H



Part No.	Description	Product No.	Standard Pack	⌀	Ø	⌚	⌚	⌚
85534	4M2T-MTF X50FT	4657-4034	1	1/4	.56	6000	24000	1.5
70387	4M2T-MTFXREEL	4657-0222	350	1/4	.56	6000	24000	1.5
85535	6M2T-MTF X50FT	4657-4035	1	3/8	.70	5000	20000	2.0
70388	6M2T-MTFXREEL	4657-0223	330	3/8	.70	5000	20000	2.0

M2T® MegaFlex® 2-Wire Braid Hose - SAE 100R16 - MegaTuff® Cover High Pressure

Continued

Part No.	Description	Product No.	Standard Pack					
85536	8M2T-MTF X50FT	4657-4036	1	1/2	.82	4300	17200	2.8
70389	8M2T-MTFXREEL	4657-0224	330	1/2	.82	4300	17200	2.8
85537	10M2T-MTF X50FT	4657-4037	1	5/8	.95	3800	15200	3.0
70407	10M2T-MTFXREEL	4657-0225	220	5/8	.95	3800	15200	3.0
85538	12M2T-MTF X50FT	4657-4038	1	3/4	1.11	3500	14000	3.8
70408	12M2T-MTFXREEL	4657-0226	220	3/4	1.11	3500	14000	3.8
85539	16M2T-MTF X50FT	4657-4039	1	1	1.39	2500	10000	4.5
70409	16M2T-MTFXREEL	4657-0227	165	1	1.39	2500	10000	4.5

M2T® MegaFlex® 2-Wire Braid Hose - SAE 100R16 - XtraTuff™ Cover High Pressure

(Meets Flame Resistance Acceptance Designation "MSHA 2G", and ISO11237 2SC R16)
XtraTuff™ hose lasts up to 25 times longer than standard hose during hose-to-hose and hose-to-metal abrasion tests per ISO 6945.

Recommended For: High-pressure hydraulic oil lines. Exceeds SAE 100R16 and ISO11237 2SC R16 working pressure, minimum bend radius requirements and performance requirements of EN 857 2SC. M2T hose has smaller exterior dimensions and significantly tighter bend radius.

Tube: Black, oil resistant, synthetic rubber (Nitrile - Type C). See Hose Stock Characteristics.

Reinforcement: Two braids of high-tensile steel wire.

Cover: Black, oil, abrasion and weather resistant, synthetic rubber (Modified Nitrile - Type C2), with color coded layline. Also available in Standard or MegaTuff® cover. See Hose Stock Characteristics.

Temperature Range: -40°F to +212°F (-40°C to +100°C). For water emulsions see Temperature Limits Table.





Coupling Recommendation (See Crimp Data Manual 428-7365 or E-Crimp):

GlobalSpiral™ Couplings (G20) Section E

MegaCrimp® Couplings (G25) Section G

Stainless Steel Braid Couplings (G17) Section H



Part No.	Description	Product No.	Standard Pack					
71061	4M2T-XTFXREEL	4657-4138	350	1/4	.56	6000	24000	1.5
71038	6M2T-XTFXREEL	4657-4302	330	3/8	.70	5000	20000	2.0
71040	8M2T-XTFXREEL	4657-4304	330	1/2	.82	4300	17200	2.8
71043	10M2T-XTFXREEL	4657-4307	220	5/8	.95	3800	15200	3.0
71046	12M2T-XTFXREEL	4657-4310	220	3/4	1.11	3500	14000	3.8
71049	16M2T-XTFXREEL	4657-4313	165	1	1.39	2500	10000	4.5

CM2TDL MegaFlex® Connected Twin-Line 2-Wire Braid - SAE 100R16 - XtraTuff™ Cover High Pressure

(Meets Flame Resistance Acceptance Designation "MSHA 2G")

Recommended For: High-pressure hydraulic oil lines joined together for easier plumbing and routing. Meets SAE 100R16 requirements. CM2T hose has smaller exterior dimensions and significantly tighter bend radius. Exceeds performance standards of EN 857 2SC and ISO/DIS 1436.

Tube: Black, oil resistant, synthetic rubber (Nitrile - Type C). See Hose Stock Characteristics.

Reinforcement: Two braids of high-tensile steel wire.

Cover: Black, oil, abrasion and weather resistant, synthetic rubber (Modified Nitrile - Type C2), with color coded layline. See Hose Stock Characteristics.

Temperature Range: -40°F to +212°F (-40°C to +100°C). For water emulsions see Temperature Limits Table.

Coupling Recommendation (See Crimp Data Manual 428-7365 or E-Crimp):
GlobalSpiral™ Couplings (G20) Section E
MegaCrimp® Couplings (G25) Section G



Part No.	Description	Product No.	Standard Pack	⌀	Ø	⌚	⌚	⌚
85389	6CM2TDL-XTF X50FT	4657-4980	1	3/8	.70	4800	19200	3.5
71151	6CM2TDL-XTFXCTN	4657-4974	215	3/8	.70	4800	19200	3.5
85390	8CM2TDL-XTF X50FT	4657-4981	1	1/2	.82	4000	16000	5.0
71152	8CM2TDL-XTFXCTN	4657-4975	180	1/2	.82	4000	16000	5.0

Global G2 2-Wire Braid Hose - SAE 100R2 Type S High Pressure

(Meets Flame Resistance Acceptance Designation "MSHA 2G")

Recommended For: High-pressure hydraulic oil lines. Meets or exceeds the requirements of SAE 100R2, ISO1436 2SN R2 and EN 853 2SN.

Tube: Black, oil resistant, synthetic rubber (Nitrile - Type C). See Hose Stock Characteristics.

Reinforcement: Two braids of high-tensile steel wire.

Cover: Black, oil and abrasion resistant, thin synthetic rubber (Modified Nitrile - Type C2). See Hose Stock Characteristics.

Temperature Range: -40°F to +212°F (-40°C to +100°C). For water emulsions see Temperature Limits Table.





Coupling Recommendation (See Crimp Data Manual 428-7365 or E-Crimp):
Field Attachable Type T Couplings (-4 through -24) (G28) Section J
GlobalSpiral™ Couplings (G20) Section E
GlobalSpiral™ Plus Couplings (-24 and -32) (G22) Section E
MegaCrimp® Couplings (except -24 and -32) (G25) Section G
Power Crimp® Couplings (-3 only) Section I
Stainless Steel Braid Couplings (G17) Section H



Part No.	Description	Product No.	Standard Pack	⌀	Ø	⌚	⌚	⌚
86620	3G2 X50FT	4657-0029	1	3/16	.52	6025	24100	3.5
70233	3G2XREEL	4657-2182	440	3/16	.52	6025	24100	3.5
86621	4G2 X50FT	4657-4941	1	1/4	.59	5800	23200	4.0
71101	4G2X150REEL	4657-4421	150	1/4	.59	5800	23200	4.0
70605	4G2XREEL	4657-0125	550	1/4	.59	5800	23200	4.0
86622	6G2 X50FT	4657-4916	1	3/8	.74	4800	19200	5.0
86632	6G2 X100FT	4657-4906	1	3/8	.74	4800	19200	5.0
70606	6G2XREEL	4657-0126	400	3/8	.74	4800	19200	5.0
86623	8G2 X50FT	4657-4918	1	1/2	.86	4000	16000	7.0
86634	8G2 X100FT	4657-4908	1	1/2	.86	4000	16000	7.0
70607	8G2XREEL	4657-0127	330	1/2	.86	4000	16000	7.0
86626	10G2 X50FT	4657-1965	1	5/8	.99	3625	14500	8.0
70610	10G2XREEL	4657-0132	220	5/8	.99	3625	14500	8.0
86635	12G2 X50FT	4657-4909	1	3/4	1.15	3100	12400	9.5
86624	12G2 X50FT	4657-4943	1	3/4	1.15	3100	12400	9.5
70608	12G2XREEL	4657-0128	220	3/4	1.15	3100	12400	9.5
86625	16G2 X50FT	4657-4945	1	1	1.48	2400	9600	12.0
70609	16G2XREEL	4657-0129	165	1	1.48	2400	9600	12.0
86627	20G2 X25FT	4657-0689	1	1 1/4	1.86	1825	7300	16.5

Global G2 2-Wire Braid Hose - SAE 100R2 Type S High Pressure

Continued

Part No.	Description	Product No.	Standard Pack					
70240	20G2XCTN	4657-0644	120	1 1/4	1.86	1825	7300	16.5
86628	24G2 X25FT	4657-2507	1	1 1/2	2.11	1300	5200	20.0
86648	24G2 X50FT	4657-2516	1	1 1/2	2.11	1300	5200	20.0
70319	24G2XCTN	4657-2491	120	1 1/2	2.11	1300	5200	20.0
86629	32G2 X25FT	4657-2508	1	2	2.62	1175	4700	25.0
86649	32G2 X50FT	4657-2517	1	2	2.62	1175	4700	25.0
70320	32G2XCTN	4657-2492	120	2	2.62	1175	4700	25.0

Global G2H High-Temp 2-Wire Braid Hose Type AT High Pressure

(Meets Flame Resistance Acceptance Designation "MSHA 2G")

Recommended For: High-pressure hydraulic oil lines. Meets or exceeds the requirements of SAE 100R2, ISO1436 2SN R2 and EN 853 2SN.

Tube: Black, oil resistant, synthetic rubber (Nitrile - Type C). See Hose Stock Characteristics.

Reinforcement: Two braids of high-tensile steel wire.

Cover: Black, oil resistant, synthetic rubber (CSM - Type M). Also available with unique abrasion resistant MegaTuff® cover. See Hose Stock Characteristics.

Temperature Range: -40°F to +275°F (-40°C to +135°C) constant and +300°F (+149°C) intermittent (up to 10% of operating time). For water emulsions see Temperature Limits Table.

Coupling Recommendation (See Crimp Data Manual 428-7365 or E-Crimp):





Field Attachable Type T Couplings (-20 and -24) (G28) Section J

GlobalSpiral™ Couplings (G20) Section E

GlobalSpiral™ Plus Couplings (-24 and -32) (G22) Section E

MegaCrimp® Couplings (-20) (G25) Section G



Part No.	Description	Product No.	Standard Pack					
86520	20G2H X50FT	4657-0925	1	1 1/4	1.86	1650	6500	16.5
70230	20G2HXCTN	4657-0930	120	1 1/4	1.86	1650	6500	16.5
85427	24G2H X25FT	4657-4331	1	1 1/2	2.11	1300	5200	20.0
86518	24G2H X50FT	4657-0927	1	1 1/2	2.11	1300	5200	20.0
70241	24G2HXCTN	4657-0931	120	1 1/2	2.11	1300	5200	20.0
85428	32G2H X25FT	4657-4332	1	2	2.62	1175	4700	25.0
86519	32G2H X50FT	4657-0926	1	2	2.62	1175	4700	25.0
70242	32G2HXCTN	4657-0932	120	2	2.62	1175	4700	25.0

Global G2H High-Temp - MegaTuff® Cover Type AT High Pressure

(Meets Flame Resistance Acceptance Designation "MSHA 2G")

MegaTuff® hose lasts up to 300 times longer than standard hose during hose-to-hose and hose-to-metal abrasion tests per ISO 6945.

Recommended For: High-pressure hydraulic oil lines. Meets or exceeds the requirements of SAE 100R2, ISO1436 2SN R2 and EN 853 2SN.

Tube: Black, oil resistant, synthetic rubber (Nitrile - Type C). See Hose Stock Characteristics.

Reinforcement: Two braids of high-tensile steel wire.

Cover: Black, oil and abrasion resistant, synthetic rubber and MegaTuff® cover. Also available in Standard cover. See Hose Stock Characteristics.

Temperature Range: -40°F to +275°F (-40°C to +135°C) constant and +300°F (+149°C) intermittent (up to 10% of operating time). For water emulsions see Temperature Limits Table.

Coupling Recommendation (See Crimp Data Manual 428-7365 or E-Crimp):

Field Attachable Type T Couplings (-20 and -24) (G28) Section J

GlobalSpiral™ Couplings (G20) Section E

GlobalSpiral™ Plus Couplings (-24 and -32) (G22) Section E

MegaCrimp® Couplings (-20) (G25) Section G



Part No.	Description	Product No.	Standard Pack	⌀	Ø	⌚	⌚	⌚
70897	20G2H-MTFXCTN	4657-2573	100	1 1/4	1.87	1650	6500	16.5
70188	24G2H-MTFXCTN	4657-2151	100	1 1/2	2.15	1300	5200	20.0
70189	32G2H-MTFXCTN	4657-2152	100	2	2.65	1175	4700	25.0

G2XH 2-Wire Braid Xtreme® Heat Hose - SAE 100R2 Type S High Pressure

(Meets Flame Resistance Acceptance Designation "MSHA 2G")

Recommended For: High-pressure hydraulic applications where pressure or temperature requirements exceed SAE 100R2, ISO1436 2SN R2 and EN 853 2SN or where resistance to either petroleum-base or phosphate ester fluids is required. Meets SAE J1942 requirements.

Tube: Black, oil and chemical resistant, synthetic rubber (CPE).

Reinforcement: Two braids of high-tensile steel wire.

Cover: Blue, oil and abrasion resistant, thin synthetic rubber CSM. Flame resistance - U.S. MSHA 2G.

Temperature Range: Petroleum-base fluids: -40°F to +300°F (-40°C to +149°C). Phosphate esters fluids as recommended by the fluid manufacturer, but within a range of -40°F to +212°F. For water emulsions: Max. +225°F Pressure lines, Max +180°F Return lines.

Coupling Recommendation (See Crimp Data Manual 428-7365 or E-Crimp):

GlobalSpiral™ Couplings (-6 through -20) (G20) Section E

GlobalSpiral™ Plus Couplings (-24 and -32) (G22) Section E

MegaCrimp® Couplings (-4 through -20) (G25) Section G



Part No.	Description	Product No.	Standard Pack	⌀	Ø	⌚	⌚	⌚
85798	4G2XH X50FT	4657-4008	1	1/4	.59	6000	24000	4.0
70966	4G2XH XREEL	4657-2541	550	1/4	.59	6000	24000	4.0
85799	6G2XH X50FT	4657-4009	1	3/8	.74	5000	20000	5.0
70967	6G2XH XREEL	4657-2542	400	3/8	.74	5000	20000	5.0
85800	8G2XH X50FT	4657-4010	1	1/2	.86	4250	17000	7.0
70968	8G2XH XREEL	4657-2543	330	1/2	.86	4250	17000	7.0
85801	10G2XH X50FT	4657-4011	1	5/8	.99	3625	14500	8.0
70803	10G2XH XREEL	4657-2544	220	5/8	.99	3625	14500	8.0
85802	12G2XH X50FT	4657-4012	1	3/4	1.15	3100	12400	9.5
70909	12G2XH XREEL	4657-2545	220	3/4	1.15	3100	12400	9.5
85803	16G2XH X50FT	4657-4013	1	1	1.48	2500	10000	12.0
70878	16G2XH XREEL	4657-2546	165	1	1.48	2500	10000	12.0
70990	20G2XH XCTN	4657-4988	130	1 1/4	1.86	2250	9000	16.5
70988	24G2XH XCTN	4657-4989	130	1 1/2	2.15	1800	7200	20.0
70989	32G2XH XCTN	4657-4990	130	2	2.65	1500	6000	25.0

Global G2L PolarFlex® Hose - SAE 100R2 Type S High Pressure

(Meets Flame Resistance Acceptance Designation "MSHA 2G")

Recommended For: High-pressure hydraulic oil lines. Meets or exceeds the requirements of SAE 100R2, ISO1436 2SN R2 and EN 853 2SN. Qualified to Mil-DTL-13531 Type II Class B.

Tube: Black, oil resistant, synthetic rubber (Nitrile - Type C). See Hose Stock Characteristics.

Reinforcement: Two braids of high-tensile steel wire.

Cover: Black, oil and abrasion resistant, thin synthetic rubber (Neoprene - Type A). See Hose Stock Characteristics.

Temperature Range: -70°F to +212°F (-57°C to +100°C). For water emulsions see Temperature Limits Table.

Coupling Recommendation (See Crimp Data Manual 428-7365 or E-Crimp):

Field Attachable Type T Couplings (-4 through -24) (G28) Section J

GlobalSpiral™ Plus Couplings (-24 and -32) (G22) Section E

MegaCrimp® Couplings (except -24 and -32) (G25) Section G



Part No.	Description	Product No.	Standard Pack	⌀	Ø	⌀	⌀	⌀
85732	4G2L X50FT	4657-2475	1	1/4	.59	5800	23200	4.0
70286	4G2LXREEL	4657-2202	440	1/4	.59	5800	23200	4.0
85733	6G2L X50FT	4657-2476	1	3/8	.74	4800	19200	5.0
70287	6G2LXREEL	4657-2203	385	3/8	.74	4800	19200	5.0
85734	8G2L X50FT	4657-2477	1	1/2	.86	4000	16000	7.0
70290	8G2LXREEL	4657-2204	330	1/2	.86	4000	16000	7.0
85735	10G2L X50FT	4657-2478	1	5/8	.99	3625	14500	8.0
70291	10G2LXREEL	4657-2205	220	5/8	.99	3625	14500	8.0
85736	12G2L X50FT	4657-2479	1	3/4	1.15	3100	12400	9.5
70292	12G2LXREEL	4657-2206	220	3/4	1.15	3100	12400	9.5
85737	16G2L X50FT	4657-2480	1	1	1.48	2400	9600	12.0
70293	16G2LXREEL	4657-2207	165	1	1.48	2400	9600	12.0
85707	20G2L X50FT	4657-4102	1	1 1/4	1.84	1825	7300	16.5
70294	20G2LXCTN	4657-2208	120	1 1/4	1.84	1825	7300	16.5
85708	24G2L X50FT	4657-4103	1	1 1/2	2.12	1300	5200	20.0
70314	24G2LXCTN	4657-2315	120	1 1/2	2.12	1300	5200	20.0
85709	32G2L X50FT	4657-4104	1	2	2.62	1175	4700	25.0
70315	32G2LXCTN	4657-2316	120	2	2.62	1175	4700	25.0

Hot Oiler 2-Wire Braid Hose High Pressure

Recommended For: Static pressure, hot oiler applications. Designed specifically to handle the transfer of hot oil at 275°F continuous, 300°F intermittent to clear the paraffin around the casing to help start the flow of oil to the surface.

Tube: Black, oil resistant, synthetic rubber (Nitrile - Type C). See Hose Stock Characteristics.

Reinforcement: Two braids of high-tensile steel wire.

Cover: Black, oil and abrasion resistant, synthetic rubber (CSM - Type M).

Temperature Range: -40°F to +300°F (-40°C to +149°C).

Coupling Recommendation (See Crimp Data Manual 428-7365 or E-Crimp):

Field Attachable Type T Couplings (G28) Section J

GlobalSpiral™ Plus Couplings (G22) Section E



Part No.	Description	Product No.	Standard Pack	⌀	Ø	⌀	⌀	⌀
70860	24HOXCTN	4657-0063	120	1 1/2	2.15	2300	6900	20.0

Hot Oiler 2-Wire Braid Hose - MegaTuff® Cover High Pressure

Recommended For: Static pressure, hot oiler applications. Designed specifically to handle the transfer of hot oil at 275°F continuous, 300°F intermittent to clear the paraffin around the casing to help start the flow of oil to the surface.

Tube: Black, oil resistant, synthetic rubber (Nitrile – Type C). See Hose Stock Characteristics.

Reinforcement: Two braids of high-tensile steel wire.

Cover: Black, oil and abrasion resistant, synthetic rubber (CSM – Type M).





Temperature Range: -40°F to +300°F (-40°C to +149°C).

Coupling Recommendation (See Crimp Data Manual 428-7365 or E-Crimp):

Field Attachable Type T Couplings (G28) Section J

GlobalSpiral™ Plus Couplings (G22) Section E



Part No.	Description	Product No.	Standard Pack					
70015	24HO-MTF X CTN	4657-4463	120	1 1/2	2.15	2300	6900	20.0

M-XP™ Million Impulse Xtra Performance Wire Braid Hose High Pressure

(Meets Flame Resistance Acceptance Designation "MSHA 2G")

Recommended For: High-pressure, high impulse life hydraulic applications. Provides tighter than standard minimum bend radius and greater flexibility for easier plumbing.

Tube: Black, oil resistant, synthetic rubber (Nitrile – Type C). See Hose Stock Characteristics.

Reinforcement: Two braids of high-tensile steel wire.

Cover: Black, oil, abrasion and weather resistant, synthetic rubber (Modified Nitrile – Type C2), with color coded layline. See Hose Stock Characteristics.





Temperature Range: -40°F to +212°F (-40°C to +100°C). For water emulsions see Temperature Limits Table.

Coupling Recommendation (See Crimp Data Manual 428-7365 or E-Crimp):

GlobalSpiral™ Couplings (-6 through -12) (G20) Section E

MegaCrimp® Couplings (G25) Section G



Part No.	Description	Product No.	Standard Pack					
71105	4M-XPXREEL	4657-4216	440	1/4	.55	4000	16000	2.0
71106	6M-XPXREEL	4657-4217	330	3/8	.70	4000	16000	2.5
71107	8M-XPXREEL	4657-4218	220	1/2	.82	4000	16000	3.5
71108	10M-XPXREEL	4657-4219	220	5/8	.96	4000	16000	4.0
71109	12M-XPXREEL	4657-4220	220	3/4	1.17	4000	16000	4.7

J2AT 2-Wire Braid Jack Hose - 10,000 Static Pressure Only High Pressure

(Meets Flame Resistance Acceptance Designation "MSHA 2G")

Recommended For: Hydraulic jack applications. Meets Material Handling Institute specification IJ 100 for hydraulic hose and assemblies used with jacking systems. 10,000 Static Pressure Only

Tube: Black, oil resistant, synthetic rubber (Nitrile – Type C). See Hose Stock Characteristics.





Reinforcement: Two braids of high-tensile steel wire.

Cover: Black, oil and abrasion resistant, synthetic rubber (Modified Nitrile – Type C2). Also available with unique abrasion resistant MegaTuff® cover. See Hose Stock Characteristics.

Temperature Range: -40°F to +120°F (-40°C to +49°C).

Coupling Recommendation (See Crimp Data Manual 428-7365 or E-Crimp): Use MegaCrimp® Male Pipe Long Nose Couplings on jack end of assembly for engagement. Section G



Part No.	Description	Product No.	Standard Pack					
85650	4J2AT X50FT	4657-4880	1	1/4	.59	10000	20000	2.0
70800	4J2ATXREEL	4657-1400	350	1/4	.59	10000	20000	2.0
85651	6J2AT X50FT	4657-4881	1	3/8	.74	10000	20000	2.5
70801	6J2ATXREEL	4657-1404	330	3/8	.74	10000	20000	2.5

J2AT 2-Wire Braid Jack Hose - MegaTuff® Cover - 10,000 Static Pressure Only High Pressure

(Meets Flame Resistance Acceptance Designation "MSHA 2G")

MegaTuff® hose lasts up to 300 times longer than standard hose during hose-to-hose and hose-to-metal abrasion tests per ISO 6945.

Recommended For: Hydraulic jack applications. Meets Material Handling Institute specification IJ 100 for hydraulic hose and assemblies used with jacking systems. 10,000 Static Pressure Only

Tube: Black, oil resistant, synthetic rubber (Nitrile – Type C). See Hose Stock Characteristics.





Reinforcement: Two braids of high-tensile steel wire.

Cover: Black, oil and abrasion resistant, synthetic rubber and MegaTuff® cover. Also available in Standard cover. See Hose Stock Characteristics.

Temperature Range: -40°F to +120°F (-40°C to +49°C).

Coupling Recommendation (See Crimp Data Manual 428-7365 or E-Crimp): Use MegaCrimp® Male Pipe Long Nose Couplings on jack end of assembly for engagement. Section G



Part No.	Description	Product No.	Standard Pack					
70469	4J2AT-MTFXREEL	4657-1188	350	1/4	.59	10000	20000	2.0
70471	6J2AT-MTFXREEL	4657-1189	330	3/8	.74	10000	20000	2.5

G1 1-Wire Braid Hose - SAE 100R1 Type S Medium Pressure

(Meets Flame Resistance Acceptance Designation "MSHA 2G")

Recommended For: Medium pressure hydraulic lines. Meets or exceeds the requirements of SAE 100R1, ISO 1436 1SNR1 and EN 853 1SN.

Tube: Black, oil resistant, synthetic rubber (Nitrile - Type C). See Hose Stock Characteristics.

Reinforcement: One braid of high-tensile steel wire.

Cover: Black, oil and abrasion resistant, synthetic rubber (Modified Nitrile - Type C2). See Hose Stock Characteristics.

Temperature Range: -40°F to +212°F (-40°C to +100°C). For water emulsions see Temperature Limits Table.

Coupling Recommendation (See Crimp Data Manual 428-7365 or E-Crimp):

Field Attachable Type T Couplings (G27) Section J

GlobalSpiral™ Couplings (G20) Section E

GlobalSpiral™ Plus Couplings (G22) Section E

MegaCrimp® Couplings (except -3, -24 and -32) (G25) Section G

Power Crimp® Couplings (-3 only) Section I

Stainless Steel Braid Couplings (G17) Section H



Part No.	Description	Product No.	Standard Pack	⌀	Ø	⌚	⌚	⌚
70200	3G1XCTN	4657-0618	800	3/16	.47	3625	14500	3.0
70611	3G1XREEL	4657-0599	440	3/16	.47	3625	14500	3.0
86611	4G1 X50FT	4657-4940	1	1/4	.53	3275	13100	4.0
70600	4G1XREEL	4657-0120	440	1/4	.53	3275	13100	4.0
70199	5G1XCTN	4657-0031	550	5/16	.60	3125	12500	4.5
70970	5G1XREEL	4657-0116	350	5/16	.60	3125	12500	4.5
86612	6G1 X50FT	4657-4915	1	3/8	.68	2600	10400	5.0
86631	6G1 X100FT	4657-4905	1	3/8	.68	2600	10400	5.0
70601	6G1XREEL	4657-0121	385	3/8	.68	2600	10400	5.0
86613	8G1 X50FT	4657-4917	1	1/2	.80	2325	9300	7.0
86633	8G1 X100FT	4657-4907	1	1/2	.80	2325	9300	7.0
70602	8G1XREEL	4657-0122	330	1/2	.80	2325	9300	7.0
70612	10G1XREEL	4657-0115	220	5/8	.93	1900	7600	8.0
86614	12G1 X50FT	4657-4942	1	3/4	1.09	1525	6100	9.0
70603	12G1XREEL	4657-0123	220	3/4	1.09	1525	6100	9.0
86615	16G1 X50FT	4657-4944	1	1	1.40	1300	5200	12.0
70604	16G1XREEL	4657-0124	165	1	1.40	1300	5200	12.0
70271	20G1XCTN	4657-0646	120	1 1/4	1.71	925	3700	16.0
70278	24G1XCTN	4657-2489	120	1 1/2	1.96	725	2900	20.0
70279	32G1XCTN	4657-2490	120	2	2.51	600	2400	25.0

G1H 1-Wire Braid Hose - High-Temp - SAE 100R1 Type AT Medium Pressure

(Meets Flame Resistance Acceptance Designation "MSHA 2G")

Recommended For: Medium pressure hydraulic oil lines. Meets or exceeds requirements of SAE 100R1 Type AT.

Tube: Black, oil resistant, synthetic rubber (Nitrile - Type C). See Hose Stock Characteristics.

Reinforcement: One braid of high-tensile steel wire.

Cover: Black, oil and abrasion resistant, synthetic rubber (CSM - Type M).

Temperature Range: -40°F to +275°F (-40°C to +135°C) constant and +300°F (+149°C) intermittent (up to 10% of operating time). For water emulsions see Temperature Limits Table.

Coupling Recommendation (See Crimp Data Manual 428-7365 or E-Crimp):

GlobalSpiral™ Couplings (G20) Section E

GlobalSpiral™ Plus Couplings (-24 and -32) (G22) Section E

MegaCrimp® Couplings (except -24 and -32) (G25) Section G





Stainless Steel Braid Couplings (G17) Section H



Part No.	Description	Product No.	Standard Pack	⌀	Ø	⌚	⌚	⌚
85922	4G1H X50FT	4657-4105	1	1/4	.53	2750	11000	4.0
70755	4G1HXREEL	4657-2175	440	1/4	.53	2750	11000	4.0
85923	6G1H X50FT	4657-4106	1	3/8	.69	2250	9000	5.0

G1H 1-Wire Braid Hose - High-Temp - SAE 100R1 Type AT Medium Pressure

Continued

Part No.	Description	Product No.	Standard Pack					
70756	6G1HXREEL	4657-2176	385	3/8	.69	2250	9000	5.0
85924	8G1H X50FT	4657-4107	1	1/2	.80	2000	8000	7.0
70757	8G1HXREEL	4657-2177	330	1/2	.80	2000	8000	7.0
85925	10G1H X50FT	4657-4108	1	5/8	.94	1500	6000	8.0
70758	10G1HXREEL	4657-2178	220	5/8	.94	1500	6000	8.0
85938	12G1H X50FT	4657-2617	1	3/4	1.10	1250	5000	9.5
70759	12G1HXREEL	4657-2179	220	3/4	1.10	1250	5000	9.5
85934	16G1H X50FT	4657-4109	1	1	1.41	1000	4000	12.0
70760	16G1HXREEL	4657-2180	165	1	1.41	1000	4000	12.0
85935	20G1H X50FT	4657-4110	1	1 1/4	1.71	925	3700	16.0
70211	20G1HXCTN	4657-0940	120	1 1/4	1.71	925	3700	16.0
85936	24G1H X50FT	4657-4111	1	1 1/2	1.96	725	2900	20.0
70212	24G1HXCTN	4657-0934	120	1 1/2	1.96	725	2900	20.0
85937	32G1H X50FT	4657-4112	1	2	2.51	600	2400	25.0
70213	32G1HXCTN	4657-0935	120	2	2.51	600	2400	25.0

RFS Red Fire Suppressant Hose Medium Pressure

(Meets Flame Resistance Acceptance Designation "MSHA 2G")

Recommended For: Low-pressure powder fire suppressant applications in mining, forestry and fire fighting equipment. The red cover is for easy visual identification in these applications. Meets performance requirements of SAE 100R1.

Tube: Black, oil resistant, synthetic rubber (Nitrile - Type C). See Hose Stock Characteristics.





Reinforcement: One braid of high-tensile steel wire.

Cover: Red, oil and abrasion resistant (Modified Nitrile - Type C2).

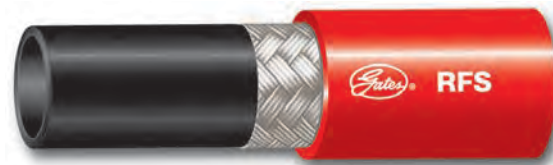
Temperature Range: -40°F to +212°F (-40°C to +100°C). For water emulsions see Temperature Limits Table.

Coupling Recommendation (See Crimp Data Manual 428-7365 or E-Crimp):
MegaCrimp® Couplings (G25) Section G
Power Crimp® Couplings (-3 only) Section I



Part No.	Description	Product No.	Standard Pack					
H24100-03F	3RFSXREEL	4657-2145	440	3/16	.45	3000	12000	3.0
H24100-04F	4RFSXREEL	4657-3314	440	1/4	.53	2750	11000	4.0
H24100-06F	6RFSXREEL	4657-3313	300	3/8	.68	2250	9000	5.0
H24100-08F	8RFSXREEL	4657-3315	330	1/2	.80	2000	8000	7.0
H24100-12F	12RFSXREEL	4657-3316	300	3/4	1.09	1250	5000	9.5
H24100-16F	16RFSXREEL	4657-2155	165	1	1.41	1000	4000	12.0

G3H High-Temp 2-Fiber Braid Hose - SAE 100R3 Medium Pressure

Recommended For: Hydraulic oil lines, anti-freeze solutions or water. Meets or exceeds requirements of SAE 100R3.

Tube: Black, synthetic rubber (Nitrile - Type C). See Hose Stock Characteristics.

Reinforcement: Two fiber braids.

Cover: Black, oil and abrasion resistant, synthetic rubber (Neoprene - Type A). See Hose Stock Characteristics.

Temperature Range: For hydraulic oil lines -40°F to +275°F (-40°C to +135°C) constant and +300°F (+149°C) intermittent (up to 10% of operating time). For water emulsions see Temperature Limits Table.

Coupling Recommendation (See Crimp Data Manual 428-7365 or E-Crimp):

GLX Couplings (-8, -12, -16, and -20) (G44) Section L

MegaCrimp® Couplings (-4, -6, -8, -10) (G25) Section G



Part No.	Description	Product No.	Standard Pack						
85951	4G3H X25FT	3319-4263	1	1/4	.56	1250	5000	3.0	28
70127	4G3HXCTN	3319-0088	455	1/4	.56	1250	5000	3.0	28
85950	5G3H X50FT	3319-4717	1	5/16	.66	1200	4800	3.5	28
70420	5G3HXCTN	3319-4287	330	5/16	.66	1200	4800	3.5	28
85952	6G3H X25FT	3319-4262	1	3/8	.75	1125	4500	4.0	28
70128	6G3HXCTN	3319-0087	350	3/8	.75	1125	4500	4.0	28
85953	8G3H X25FT	3319-4261	1	1/2	.94	1000	4000	5.0	28
70126	8G3HXCTN	3319-0090	225	1/2	.94	1000	4000	5.0	28
70421	10G3HXCTN	3319-4288	200	5/8	1.10	900	3600	5.5	28
85954	12G3H X25FT	3319-4265	1	3/4	1.25	750	3000	6.0	28
70119	12G3HXCTN	3319-0091	160	3/4	1.25	750	3000	6.0	28
85955	16G3H X25FT	3319-4264	1	1	1.50	565	2260	8.0	20
70120	16G3HXCTN	3319-0092	120	1	1.50	565	2260	8.0	20
85956	20G3H X50FT	3319-4718	1	1 1/4	1.75	375	1500	10.0	15
70121	20G3HXCTN	3319-0071	120	1 1/4	1.75	375	1500	10.0	15
85957	24G3H X50FT	3319-4719	1	1 1/2	1.94	300	1200	12.0	10
70422	24G3HXCTN	3319-4289	120	1 1/2	1.94	300	1200	12.0	10

GTH High-Temp 1-Fiber Braid Hose - SAE 100R6 Low Pressure

Recommended For: Hydraulic oil lines, heavy-duty transmission oil cooler lines and glycol anti-freeze solutions. Meets or exceeds requirements of SAE 100R6.

Tube: Black, specially compounded, synthetic rubber (Nitrile - Type C). See Hose Stock Characteristics.

Reinforcement: One fiber braid.

Cover: Black, oil and abrasion resistant, synthetic rubber (Neoprene - Type A). See Hose Stock Characteristics.

Temperature Range: For hydraulic oil lines -40°F to +275°F (-40°C to +135°C) constant and +300°F (+149°C) intermittent (up to 10% of operating time). For water emulsions see Temperature Limits Table.

Coupling Recommendation (See Crimp Data Manual 428-7365 or E-Crimp):

MegaCrimp® Couplings (except -3) (G25) Section G







Power Crimp® Couplings (-3 only) Section I



Part No.	Description	Product No.	Standard Pack						
70106	3GTHXCTN	3319-3301	715	3/16	.44	500	2000	2.0	28
70107	4GTHXCTN	3319-3305	775	1/4	.50	400	1600	2.5	28
86687	5GTH X50FT	3319-0305	1	5/16	.56	400	1600	3.0	28
70105	5GTH XBULK	3319-3309	250	5/16	.56	400	1600	3.0	28
70108	5GTHXCTN	3319-3310	650	5/16	.56	400	1600	3.0	28
86618	8GTH X50FT	3319-3317	1	1/2	.78	400	1600	4.0	18
70110	8GTHXCTN	3319-3320	400	1/2	.78	400	1600	4.0	18
70131	8GTHXREEL	3319-3323	200	1/2	.78	400	1600	4.0	18
86695	10GTH X25FT	3319-4268	1	5/8	.91	350	1400	5.0	15
70111	10GTHXCTN	3319-3325	250	5/8	.91	350	1400	5.0	15
70130	12GTHXCTN	3319-3335	225	3/4	1.06	300	1200	5.5	15

GTH High-Temp 1-Fiber Braid Hose - SAE 100R6
Low Pressure

Continued

Part No.	Description	Product No.	Standard Pack						
70746	16GTHXCTN	3319-3345	165	1	1.13	250	1000	8.0	10

GTHX High-Temp Fiber Spiral Hose - SAE 100R6
Low Pressure

Recommended For: Hydraulic oil lines, heavy-duty transmission oil cooler lines and glycol anti-freeze solutions. Meets or exceeds requirements of SAE 100R6.

Tube: Black, specially compounded, synthetic rubber (Nitrile - Type C). See Hose Stock Characteristics.







Reinforcement: Spiraled synthetic fiber.

Cover: Black, oil and abrasion resistant, synthetic rubber (Neoprene - Type A). See Hose Stock Characteristics.

Temperature Range: For hydraulic oil lines -40°F to +275°F (-40°C to +135°C) constant and +300°F (+149°C) intermittent (up to 10% of operating time). For water emulsions see Temperature Limits Table.

Coupling Recommendation (See Crimp Data Manual 428-7365 or E-Crimp): MegaCrimp® Couplings (G25) Section G



Part No.	Description	Product No.	Standard Pack						
86688	6GTHX X50FT	3289-0005	1	3/8	.63	400	1600	3.0	28
70109	6GTHX XREEL	3289-0002	300	3/8	.63	400	1600	3.0	28

M500 Wire Braid Hose
Low Pressure

(Meets Flame Resistance Acceptance Designation "MSHA 2G")

Recommended For: Pilot lines, grease lines and pressure return lines, 500 psi or less pressure applications.

Tube: Black, oil resistant, synthetic rubber (NBR).





Reinforcement: One braid of high-tensile steel wire.

Cover: Black, oil and abrasion resistant, synthetic rubber, flame resistance. Also available with unique abrasion resistant XtraTuff™ cover. See Hose Stock Characteristics.

Temperature Range: -40°F to +212°F (-40°C to +100°C).

Coupling Recommendation (See Crimp Data Manual 428-7365 or E-Crimp): GlobalSpiral™ Couplings (-6 through -16) (G20) Section E
MegaCrimp® Couplings (G25) Section G



Part No.	Description	Product No.	Standard Pack					
85442	4M500 X50FT	4657-4087	1	1/4	.48	500	2000	2.0
70747	4M500XREEL	4657-8027	440	1/4	.48	500	2000	2.0
85443	6M500 X50FT	4657-4088	1	3/8	.63	500	2000	2.5
70748	6M500XREEL	4657-8028	330	3/8	.63	500	2000	2.5
85444	8M500 X50FT	4657-4089	1	1/2	.76	500	2000	3.5
70749	8M500XREEL	4657-8029	220	1/2	.76	500	2000	3.5
85445	10M500 X50FT	4657-4090	1	5/8	.93	500	2000	4.0
70752	10M500XREEL	4657-8030	220	5/8	.93	500	2000	4.0
85446	12M500 X50FT	4657-4091	1	3/4	1.09	500	2000	4.7
70770	12M500XREEL	4657-8031	220	3/4	1.09	500	2000	4.7
85447	16M500 X50FT	4657-4092	1	1	1.40	500	2000	6.0
70974	16M500XREEL	4657-8032	165	1	1.40	500	2000	6.0

M500 Wire Braid Hose - XtraTuff™ Low Pressure

(Meets Flame Resistance Acceptance Designation "MSHA 2G")

Recommended For: Pilot lines, grease lines and pressure return lines, 500 psi or less pressure applications.

Tube: Black, oil resistant, synthetic rubber (NBR).





Reinforcement: One braid of high-tensile steel wire.

Cover: Black, oil and abrasion resistant, synthetic rubber, flame resistance. Also available in Standard cover. See Hose Stock Characteristics.

Temperature Range: -40°F to +212°F (-40°C to +100°C).

Coupling Recommendation (See Crimp Data Manual 428-7365 or E-Crimp):
GlobalSpiral™ Couplings (-6 through -16) (G20) Section E
MegaCrimp® Couplings (G25) Section G



Part No.	Description	Product No.	Standard Pack					
70979	4M500-XTFXREEL	4657-8033	440	1/4	.48	500	2000	2.0
70980	6M500-XTFXREEL	4657-8034	330	3/8	.63	500	2000	2.5
70981	8M500-XTFXREEL	4657-8035	220	1/2	.76	500	2000	3.5
70982	10M500-XTFXREEL	4657-8036	220	5/8	.93	500	2000	4.0
70983	12M500-XTFXREEL	4657-8037	220	3/4	1.09	500	2000	4.7
70984	16M500-XTFXREEL	4657-8038	165	1	1.40	500	2000	6.0

M500 Wire Braid Hose - MegaTuff® Low Pressure

(Meets Flame Resistance Acceptance Designation "MSHA 2G")

Recommended For: Pilot lines, grease lines and pressure return lines, 500 psi or less pressure applications.

Tube: Black, oil resistant, synthetic rubber (NBR).





Reinforcement: One braid of high-tensile steel wire.

Cover: Black, oil and abrasion resistant, synthetic rubber, flame resistance. Also available in Standard cover. See Hose Stock Characteristics.

Temperature Range: -40°F to +212°F (-40°C to +100°C).

Coupling Recommendation (See Crimp Data Manual 428-7365 or E-Crimp):
GlobalSpiral™ Couplings (-6 through -16) (G20) Section E
MegaCrimp® Couplings (G25) Section G



Part No.	Description	Product No.	Standard Pack					
70985	4M500-MTFXREEL	4657-8039	440	1/4	.48	500	2000	2.0
70986	6M500-MTFXREEL	4657-8040	330	3/8	.63	500	2000	2.5
70987	8M500-MTFXREEL	4657-8041	220	1/2	.76	500	2000	3.5

GMV Global MegaVac® Return Line and Suction Hose Low Pressure

(Meets Flame Resistance Acceptance Designation "MSHA 2G")

Recommended For: Petroleum and water-base hydraulic fluids in suction lines or in low pressure return lines. Meets or exceeds requirements of SAE 100R4. Uses half the bend radius of SAE 100R4. Meets marine ABS with use of HeatGuard® high temp sleeve.

Tube: Black, synthetic rubber is specifically designed for resistance to high temperatures (Nitrile - Type C). See Hose Stock Characteristics.

Reinforcement: Double spiral textile (braid for -12, -16 and -20) reinforced with a helical spiral-wire to prevent collapse.

Cover: Black synthetic rubber is oil and abrasion resistant (Neoprene - Type A). See Hose Stock Characteristics.

Temperature Range: -40°F to +275°F (-40°C to +135°C) constant and +300°F (+149°C) intermittent (up to 10% of operating time). For water emulsions see Temperature Limits Table.

Coupling Recommendation (See Crimp Data Manual 428-7365 or E-Crimp):

GL Couplings (-12 through -40) (G43) Section M
GlobalSpiral™ Plus Couplings (-24 and -32) (G22) Section E
MegaCrimp® Couplings (-12 through -20) (G25) Section G
Use clamp over beaded nipple.



Part No.	Description	Product No.	Standard Pack							
85577	12GMV X25FT	4504-0961	1	3/4	1.22	350	1400	2.5	25	
70184	12GMVXCTN	4504-0123	100	3/4	1.22	350	1400	2.5	25	
85578	16GMV X25FT	4504-0962	1	1	1.45	300	1200	3.0	25	
70185	16GMVXCTN	4504-0003	100	1	1.45	300	1200	3.0	25	
85579	20GMV X25FT	4504-0963	1	1 1/4	1.76	250	1000	4.0	25	
70186	20GMVXCTN	4504-0004	100	1 1/4	1.76	250	1000	4.0	25	
85583	24GMV X25FT	3105-0030	1	1 1/2	2.01	160	640	5.0	25	
70136	24GMV X100FT	3105-0004	100	1 1/2	2.01	160	640	5.0	25	
85584	32GMV X25FT	3105-0031	1	2	2.51	115	460	6.0	25	
70137	32GMV X100FT	3105-0006	100	2	2.51	115	460	6.0	25	
70147	36GMVXCTN*	3105-0008	100	2 1/4	2.76	90	360	7.0	25	
70138	40GMV X100FT	3105-0010	100	2 1/2	3.02	70	280	7.0	25	
70139	48GMV X100FT	3105-0014	100	3	3.51	60	240	9.0	25	
70140	56GMV X100FT	3105-0015	100	3 1/2	4.01	55	220	10.0	25	
70141	64GMV X100FT	3105-0018	100	4	4.51	55	220	12.0	25	

*Stem and clamp only, no Gates couplings available.

G4H MegaVac® Return Line and Suction Hose Low Pressure

(Meets Flame Resistance Acceptance Designation "MSHA 2G")

Recommended For: Petroleum and water-base hydraulic fluids in suction lines or in low pressure return lines. Meets or exceeds requirements of SAE 100R4 (except 1" I.D.). Uses half the bend radius of SAE 100R4.

Tube: Black, synthetic rubber is specifically designed for resistance to high temperatures (Nitrile - Type C). See Hose Stock Characteristics.

Reinforcement: Double spiral textile reinforced with a helical spiral-wire to prevent collapse.

Cover: Black synthetic rubber is oil and abrasion resistant (Neoprene - Type A). See Hose Stock Characteristics.

Temperature Range: -40°F to +275°F (-40°C to +135°C) constant and +300°F (+149°C) intermittent (up to 10% of operating time). For water emulsions see Temperature Limits Table.

Coupling Recommendation (See Crimp Data Manual 428-7365 or E-Crimp):







MegaCrimp® Couplings (-12 and -16) (G25) Section G
Use clamp over beaded nipple.



Part No.	Description	Product No.	Standard Pack							
85580	12G4H X25FT	3105-0027	1	3/4	1.17	300	1200	2.5	25	
70133	12G4HXCTN	3105-0022	100	3/4	1.17	300	1200	2.5	25	
85581	16G4H X25FT	3105-0028	1	1	1.43	250	1000	3.0	25	
70134	16G4HXCTN	3105-0001	100	1	1.43	250	1000	3.0	25	

G4H MegaVac[®] Return Line and Suction Hose Low Pressure

Continued

Part No.	Description	Product No.	Standard Pack						
85582	20G4H X25FT	3105-0029	1	1 1/4	1.68	200	800	4.0	25
70135	20G4HXCTN	3105-0036	100	1 1/4	1.68	200	800	4.0	25

RLA 1-Fiber Braid Return Line and Low Pressure Hose Low Pressure

(Meets Flame Resistance Acceptance Designation "MSHA 2G")

Recommended For: Low-pressure hydraulic oil return lines for general purpose water, glycol antifreeze solutions, conveying diesel fuel, gasoline or air. Meets SAE 30R2 performance requirements of both Type 1 and Type 2 for fuel and B20 constant contact up to 125°F biodiesel fuel transfer applications.

Tube: Black, oil resistant, synthetic rubber (Nitrile – Type C). See Hose Stock Characteristics.

Reinforcement: One fiber braid (–3 to –10). Spiral braid (–12 to –16).

Cover: Black, synthetic rubber. Oil and abrasion resistant (Modified Nitrile – Type C2). See Hose Stock Characteristics.

Temperature Range: –40°F to +212°F (–40°C to +100°C). Air to +160°F (+71°C) only. For water emulsions see Temperature Limits Table.







Coupling Recommendation (See Crimp Data Manual 428-7365 or E-Crimp):

GLX Couplings (–12 and –16) (G44) Section L

MegaCrimp[®] Couplings (except –3) (G25) Section G

Power Crimp[®] Couplings (–3 only) Section I



Part No.	Description	Product No.	Standard Pack						
85940	3RLA X25FT	3284-4028	1	3/16	.41	250	1000	3.0	28
70040	3RLAXREEL	3284-0110	550	3/16	.41	250	1000	3.0	28
85941	4RLA X25FT	3284-4029	1	1/4	.50	250	1000	3.0	28
70041	4RLAXREEL	3284-0120	550	1/4	.50	250	1000	3.0	28
85942	5RLA X25FT	3284-4030	1	5/16	.56	250	1000	4.0	28
70042	5RLAXREEL	3284-0130	550	5/16	.56	250	1000	4.0	28
85943	6RLA X25FT	3284-4031	1	3/8	.66	250	1000	4.0	28
70043	6RLAXREEL	3284-0140	550	3/8	.66	250	1000	4.0	28
85944	8RLA X25FT	3284-4032	1	1/2	.81	200	800	5.0	20
70044	8RLAXREEL	3284-0150	550	1/2	.81	200	800	5.0	20
85945	10RLA X25FT	3284-4033	1	5/8	.94	200	800	6.0	15
70045	10RLAXREEL	3284-0160	550	5/8	.94	200	800	6.0	15
85946	12RLA X25FT	3284-4088	1	3/4	1.09	200	800	6.0	10
70046	12RLAXREEL	3284-0170	650	3/4	1.09	200	800	6.0	10
85947	16RLA X25FT	3284-4181	1	1	1.34	160	640	8.0	10
70047	16RLAXREEL	3284-0180	400	1	1.34	160	640	8.0	10

RLC 3-Fiber Braid Return Line and Low Pressure Hose

Low Pressure

Recommended For: Petroleum-base hydraulic oils, glycol antifreeze, air or water in low pressure fluid transfer or hydraulic system return lines. Generally connected to 100R4 stems, beaded nipples, or tube type ports with worm gear clamps.

Tube: Black, oil resistant, synthetic rubber (Nitrile – Type C). See Hose Stock Characteristics.

Reinforcement: Three fiber braids.

Cover: Black, oil and abrasion resistant, synthetic rubber (Modified Nitrile – Type C2). See Hose Stock Characteristics.

Temperature Range: For hydraulic oil lines –40°F to +275°F (–40°C to +135°C) constant and +300°F (+149°C) intermittent (up to 10% of operating time); air to +160°F (+71°C) only. For water emulsions see Temperature Limits Table.

Coupling Recommendation (See Crimp Data Manual 428-7365 or E-Crimp): Use barbed stem or beaded-tube with clamps only.



Part No.	Description	Product No.	Standard Pack						
70142	16RLCXCTN	3319-0261	50	1	1.62	200	800	9.0	25
70074	20RLCXCTN	3319-0263	50	1 1/4	1.88	200	800	10.0	25
70075	24RLCXCTN	3319-0264	100	1 1/2	2.12	200	800	11.0	25
70143	28RLCXCTN	3319-0265	50	1 3/4	2.38	200	800	12.0	25
70076	32RLCXCTN	3319-0266	50	2	2.56	200	800	13.0	25
70070	36RLCXCTN	3319-0267	50	2 1/4	2.87	150	600	14.0	25
70077	40RLCXCTN	3319-0268	50	2 1/2	3.12	150	600	16.0	25
70078	48RLCXCTN	3319-0270	50	3	3.62	150	600	20.0	25
70081	56RLCXCTN	3319-0272	50	3 1/2	4.12	150	600	24.0	25
70144	72RLC X10FT	3319-0273	10	4 1/2	5.19	100	400	54.0	25

MegaTech® LOC 1-Fiber Braid High-Temp Lock-On Hose

Low Pressure

Recommended For: High-temperature (300°F) transmission oil cooler lines, pressurized hot oil return lines and turbocharger oil supply lines. Meets or exceeds SAE J1405 performance specifications for high-temperature transmission and lubricating oil systems using petroleum base oils. Not recommended for gasoline or diesel fuel applications.

Tube: True-bore GTS (Gates Technical Spec.) black tube specifically compounded for temperature and chemical resistance (CPE – Type J).

Reinforcement: One fiber braid.

Cover: Oil and mildew resistant, textile braid, impregnated with synthetic rubber.

Temperature Range: –40°F to +300°F (–40°C to +149°C).

Coupling Recommendation (See Crimp Data Manual 428-7365 or E-Crimp): Field Attachable LOC Couplings (G36) Section AA
MegaCrimp® Couplings (–16) (G25) Section G



Part No.	Description	Product No.	Standard Pack					
76993	4MEGATECHLOCXREEL	4319-0106	575	1/4	.50	300	1200	3.0
76994	6MEGATECHLOCXREEL	4319-0107	600	3/8	.64	300	1200	3.0
76995	8MEGATECHLOCXREEL	4319-0108	335	1/2	.78	300	1200	5.0
76996	10MEGATECHLOCXREEL	4319-0109	260	5/8	.91	300	1200	6.0
76997	12MEGATECHLOCXREEL	4319-0110	220	3/4	1.08	300	1200	7.0
76998	16MEGATECHLOCXREEL	4319-0111	200	1	1.33	300	1200	7.0

LOC 1-Fiber Braid Lock-On Hose Low Pressure

Recommended For: Petroleum-base hydraulic oils, glycol antifreeze compounds, water, engine lubricating oils and air. Lock-On hose and couplings are NOT recommended for vibration or pressure surge applications, such as permanent piping in residential or commercial buildings. Meets SAE 30R2, SAE 30R6 and SAE 30R7 performance requirements for fuel and B20 biodiesel fuel transfer applications up to +125°F.

Tube: Black, oil resistant, synthetic rubber (Nitrile – Type C). See Hose Stock Characteristics.

Reinforcement: One fiber braid.

Cover: Oil and mildew resistant, textile braid, impregnated with synthetic rubber.

Temperature Range: -40°F to +250°F (-40°C to +121°C). For air: -40°F to +160°F (-40°C to +71°C). For water emulsions see Temperature Limits Table.

Coupling Recommendation (See Crimp Data Manual 428-7365 or E-Crimp):
Field Attachable LOC Couplings (G36) Section AA
Use clamp over beaded nipple.



Part No.	Description	Product No.	Standard Pack					
86691	4LOC X50FT	4319-4935	1	1/4	.52	300	1200	3.0
70030	4LOCXREEL	4319-0112	300	1/4	.52	300	1200	3.0
86692	6LOC X50FT	4319-4936	1	3/8	.64	300	1200	3.0
70031	6LOCXREEL	4319-0113	300	3/8	.64	300	1200	3.0
86693	8LOC X50FT	4319-4937	1	1/2	.80	300	1200	5.0
70032	8LOCXREEL	4319-0114	300	1/2	.80	300	1200	5.0
70033	10LOCXREEL	4319-0115	250	5/8	.90	300	1200	6.0
70034	12LOCXREEL	4319-0116	225	3/4	1.00	300	1200	7.0

LOL Plus Lock-On Hose Low Pressure

(Black Cover Only Meets Flame Resistance Acceptance Designation "MSHA 2G")

Recommended For: Petroleum-base hydraulic oils, water, glycol antifreeze solutions, engine lubricating oils, and air. Lock-On hose and couplings are NOT recommended for pressure surge applications or critical applications, such as permanent piping in residential or commercial buildings. Do not use for gasoline or diesel fuels, unless approved by Gates H/C Product Application.

Tube: Black, oil resistant, synthetic rubber highly resistant to oil and heat (Nitrile – Type C). See Hose Stock Characteristics.

Reinforcement: One fiber braid.

Cover: Oil and abrasion resistant synthetic rubber (Modified Nitrile – Type C2). Available in black Neoprene (LOLA), blue (LOLB), green (LOLG), red (LOLR), yellow (LOLY) and gray (LOLC) colors.

Temperature Range: -40°F to +212°F (-40°C to +100°C). Air to +160°F (+71°C) only. For water emulsions see Temperature Limits Table.

Coupling Recommendation (See Crimp Data Manual 428-7365 or E-Crimp):
Field Attachable LOC Couplings (G36) Section AA
GLX Couplings (-4, -6, -8 and -12) (G44) Section L
Use clamp over beaded nipple.



Part No.	Description	Product No.	Standard Pack						
70650	3LOLAXREEL*	3284-2500	300	3/16	.41	300	1200	3.0	28
70651	3LOLBXREEL*	3284-2510	300	3/16	.41	300	1200	3.0	28
70655	3LOLCXREEL**	3284-2520	300	3/16	.41	300	1200	3.0	28
70652	3LOLGXREEL**	3284-2530	300	3/16	.41	300	1200	3.0	28
70653	3LOLRXREEL*	3284-2540	300	3/16	.41	300	1200	3.0	28
70654	3LOLYXREEL**	3284-2560	300	3/16	.41	300	1200	3.0	28
85961	4LOLA X50FT	3284-2266	1	1/4	.47	300	1200	3.0	28
70657	4LOLAXREEL	3284-2501	475	1/4	.47	300	1200	3.0	28
85967	4LOLB X25FT	3284-2272	1	1/4	.47	300	1200	3.0	28
70658	4LOLBXREEL	3284-2511	475	1/4	.47	300	1200	3.0	28
70662	4LOLCXREEL	3284-2521	475	1/4	.47	300	1200	3.0	28

*Couplings for this size are available on special order only.







**Special hose, subject to minimum order requirements if not in inventory.

NOTE: LOL Lock-On Hose is packaged in UPS shippable reels.

NOTE: The use of clamps with LOC Couplings is not recommended.

LOL Plus Lock-On Hose
Low Pressure

Continued

Part No.	Description	Product No.	Standard Pack						
85972	4LOLGX25FT	3284-2277	1	1/4	.47	300	1200	3.0	28
70659	4LOLGXREEL	3284-2531	475	1/4	.47	300	1200	3.0	28
85976	4LOLR X25FT	3284-2281	1	1/4	.47	300	1200	3.0	28
70660	4LOLRXREEL	3284-2541	475	1/4	.47	300	1200	3.0	28
70661	4LOLYXREEL	3284-2561	475	1/4	.47	300	1200	3.0	28
85960	5LOLA X25FT	3284-2297	1	5/16	.55	300	1200	3.0	28
85962	5LOLA X50FT	3284-2267	1	5/16	.55	300	1200	3.0	28
70664	5LOLAXREEL	3284-2502	300	5/16	.55	300	1200	3.0	28
85963	6LOLA X50FT	3284-2268	1	3/8	.63	300	1200	3.0	28
70665	6LOLAXREEL	3284-2503	300	3/8	.63	300	1200	3.0	28
85968	6LOLB X25FT	3284-2273	1	3/8	.63	300	1200	3.0	28
70666	6LOLBXREEL	3284-2513	300	3/8	.63	300	1200	3.0	28
70670	6LOLCXREEL	3284-2523	300	3/8	.63	300	1200	3.0	28
85973	6LOLG X25FT	3284-2278	1	3/8	.63	300	1200	3.0	28
70667	6LOLGXREEL	3284-2533	300	3/8	.63	300	1200	3.0	28
85977	6LOLR X25FT	3284-2282	1	3/8	.63	300	1200	3.0	28
70668	6LOLRXREEL	3284-2543	300	3/8	.63	300	1200	3.0	28
70669	6LOLYXREEL	3284-2563	300	3/8	.63	300	1200	3.0	28
85964	8LOLA X50FT	3284-2269	1	1/2	.77	300	1200	5.0	28
70672	8LOLAXREEL	3284-2504	300	1/2	.77	300	1200	5.0	28
85969	8LOLB X25FT	3284-2274	1	1/2	.77	300	1200	5.0	28
70673	8LOLBXREEL	3284-2515	300	1/2	.77	300	1200	5.0	28
70677	8LOLCXREEL	3284-2525	300	1/2	.77	300	1200	5.0	28
85974	8LOLG X25FT	3284-2279	1	1/2	.77	300	1200	5.0	28
70674	8LOLGXREEL	3284-2535	300	1/2	.77	300	1200	5.0	28
85978	8LOLR X25FT	3284-2283	1	1/2	.77	300	1200	5.0	28
70675	8LOLRXREEL	3284-2545	300	1/2	.77	300	1200	5.0	28
70676	8LOLYXREEL	3284-2565	300	1/2	.77	300	1200	5.0	28
85965	10LOLA X50FT	3284-2270	1	5/8	.94	300	1200	6.0	28
70679	10LOLAXREEL	3284-2505	250	5/8	.94	300	1200	6.0	28
85970	10LOLB X25FT	3284-2275	1	5/8	.94	300	1200	6.0	28
70680	10LOLBXREEL	3284-2517	250	5/8	.94	300	1200	6.0	28
70684	10LOLCXREEL	3284-2527	250	5/8	.94	300	1200	6.0	28
70681	10LOLGXREEL*	3284-2537	250	5/8	.94	300	1200	6.0	28
70682	10LOLRXREEL*	3284-2547	250	5/8	.94	300	1200	6.0	28
70683	10LOLYXREEL*	3284-2567	250	5/8	.94	300	1200	6.0	28
85966	12LOLA X50FT	3284-2271	1	3/4	1.06	300	1200	7.0	15
70686	12LOLAXREEL	3284-2506	225	3/4	1.06	300	1200	7.0	15
85971	12LOLB X25FT	3284-2276	1	3/4	1.06	300	1200	7.0	15
70687	12LOLBXREEL	3284-2519	225	3/4	1.06	300	1200	7.0	15
70691	12LOLCXREEL	3284-2529	225	3/4	1.06	300	1200	7.0	15
85975	12LOLG X25FT	3284-2280	1	3/4	1.06	300	1200	7.0	15
70688	12LOLGXREEL	3284-2536	225	3/4	1.06	300	1200	7.0	15
85979	12LOLR X25FT	3284-2284	1	3/4	1.06	300	1200	7.0	15
70689	12LOLRXREEL	3284-2549	225	3/4	1.06	300	1200	7.0	15
70690	12LOLYXREEL	3284-2569	225	3/4	1.06	300	1200	7.0	15

*Special hose, subject to minimum order requirements if not in inventory.

NOTE: LOL Lock-On Hose is packaged in UPS shippable reels.

NOTE: The use of clamps with LOC Couplings is not recommended.

PowerClean™ Hose

Recommended For: Hot and cold water high pressure cleaning equipment where heavy duty service is required. Specially compounded cover to handle pressure washer environment. (Blue, Gray, Red and Yellow covers are non-marking).

Tube: Synthetic rubber specially compounded to handle high-pressure water service.





Reinforcement: High tensile steel one or two-wire braid.

Cover: Specially compounded to handle pressure washer environment.

Temperature Range: -40°F to +250°F (-40°C to +121°C).
-40°F to +250°F (-40°C to +121°C). Laboratory tested for normal service. Increased operating temperatures will reduce hose assembly service life.

Coupling Recommendation (See Crimp Data Manual 428-7365 or E-Crimp):
MegaCrimp® Couplings (G25) Section G
Stainless Steel Braid Couplings (G17) Section H



Part No.	Description	Product No.	Standard Pack					
70840	4PC3500 BLK REEL	4657-2400	300	1/4	.53	3500	14000	4.0
85720	4PC3500 X50FT	4657-2467	1	1/4	.53	3500	14000	4.0
70841	4PC6000 BLK REEL	4657-2410	300	1/4	.59	6000	24000	4.0
85721	4PC6000 X50FT	4657-2468	1	1/4	.74	6000	24000	4.0
70842	6PC3000 BLK REEL	4657-2402	300	3/8	.68	3000	12000	5.0
70843	6PC3000 BLU REEL	4657-2404	300	3/8	.68	3000	12000	5.0
85723	6PC3000 BLU X50FT	4657-2470	1	3/8	.68	3000	12000	5.0
85722	6PC3000 X50FT	4657-2469	1	3/8	.68	3000	12000	5.0
70848	6PC3000 YLW REEL	4657-2417	300	3/8	.68	3000	12000	5.0
85698	6PC3000 YLW X50FT	4657-0064	1	3/8	.68	3000	12000	5.0
70844	6PC4000 BLK REEL	4657-2225	300	3/8	.68	4000	16000	5.0
85724	6PC4000 X50FT	4657-2471	1	3/8	.68	4000	16000	5.0
70845	6PC5000 BLK REEL	4657-2407	300	3/8	.74	5000	20000	5.0
76393	6PC5000 BLU REEL	4657-2429	300	3/8	.74	5000	20000	5.0
85725	6PC5000 X50FT	4657-2472	1	3/8	.74	5000	20000	5.0
70846	8PC2500 BLK REEL	4657-2408	300	1/2	.80	2500	10000	7.0
85726	8PC2500 X50FT	4657-2473	1	1/2	.80	2500	10000	7.0
70847	8PC4000 BLK REEL	4657-2426	300	1/2	.86	4000	16000	7.0
85727	8PC4000 X50FT	4657-2474	1	1/2	.86	4000	16000	7.0

NOTE: Not recommended for Steam Hose.

LP350 Hose

Application Note: No LP350 hose assemblies 60" or longer allowed per UL requirement.

Recommended For: Liquid or gaseous propane, butane or any combination of these two mixtures up to 350 psi rated working pressure. Can be used for natural gas under certain conditions such as: open/outside areas and well ventilated factory buildings (if local building codes permit). Not recommended for residential or office buildings. Contact Denver Product Application (303) 744-5070 for inspection and assembly testing information. Meets UL Standard #21, CAN/CGA-8.1-M86, NFPA 58, Section 8-3, 5.

Tube: Nitrile - Type C. See Hose Stock Characteristics.





Reinforcement: Braided, high tensile synthetic textile cord.

Cover: Black perforated Neoprene - Type A. See Hose Stock Characteristics.

Temperature Range: -40°F to +180°F (-40°C to +82°C). For water emulsions see Temperature Limits Table.

Coupling Recommendation (See Crimp Data Manual 428-7365 or E-Crimp):
GLX Couplings (G44) Section L



Part No.	Description	Product No.	Standard Pack					
85717	4LP350X X50FT	3220-1300	1	1/4	.58	350	1750	3.0
85718	6LP350X X50FT	3220-1123	1	3/8	.70	350	1750	3.0
85719	8LP350X X50FT	3220-1301	1	1/2	.91	350	1750	5.0
85738	12LP350X X50FT	3220-1302	1	3/4	1.24	350	1750	6.0

Nylon Air Brake Tubing

Recommended For: Truck, bus and mobile air brake, and service lines where heat and battery acids are not present. Conforms to SAE J844 specifications. Meets D.O.T. FMVSS 106-74.

Tube: Heat and light stabilized seamless extruded nylon.

Reinforcement: Type A: Non-reinforced in sizes 1/8", 5/32", 3/16" and 1/4". NOTE: 1/8" and 5/32" are NOT recognized by D.O.T. for air brake systems, these are for service lines only.

Type B: Reinforced with one open ply of fibrous nylon in sizes 5/16", 3/8", 1/2", 5/8" and 3/4".

Cover: Nylon. Available in black (NABTA), blue (NABTB), green (NABTG), red (NABTR), yellow (NABTY), orange (NABTO), purple (NABTP), brown (NABTN), silver (NABTS) and white (NABTW) colors. Other colors available upon request.



Temperature Range: -40°F to +200°F (-40°C to +93°C).

Coupling Recommendation (See Crimp Data Manual 428-7365 or E-Crimp):

Gates DOT Compression, Section Z

Gates DOT SureLok™ Couplings, Section Z



Part No.	Description	Product No.	Standard Pack	Tube O.D. (in)	Reinforcement Type			
H30002-25	2.5NABTA X100FT	4327-0050	1	5/32	A	150	800	.5
H30002-02	2NABTA X100FT	4327-0049	1	1/8	A	150	800	.37
H30000-02	2NABTAXLG REEL	4327-0117	1000	1/8	A	150	800	.37
H30002-03	3NABTA X100FT	4327-0051	1	3/16	A	150	800	.75
H30002-04	4NABTA X100FT	4327-0052	1	1/4	A	150	800	1.0
H30000-04	4NABTAXLG REEL	4327-0101	1000	1/4	A	150	800	1.0
H30062-04	4NABTB X100FT	4327-0068	1	1/4	A	150	800	1.0
H30061-04	4NABTBXLG REEL	4327-1001	5000	1/4	A	150	800	1.0
H30060-04	4NABTBXREEL	4327-0102	1000	1/4	A	150	800	1.0
H30042-04	4NABTG X100FT	4327-0058	1	1/4	A	150	800	1.0
H30040-04	4NABTGXREEL	4327-0104	1000	1/4	A	150	800	1.0
H30010-04	4NABTNXREEL	4327-0103	1000	1/4	A	150	800	1.0
H30082-04	4NABTO X100FT	4327-0078	1	1/4	A	150	960	1.0
H30030-04	4NABTPXLG REEL	4327-0125	1000	1/4	A	150	800	1.0
H30052-04	4NABTR X100FT	4327-0063	1	1/4	A	150	800	1.0
H30050-04	4NABTRXREEL	4327-0105	1000	1/4	A	150	800	1.0
H30090-04	4NABTSXREEL	4327-0106	1000	1/4	A	150	800	1.0
H30072-04	4NABTY X100FT	4327-0073	1	1/4	A	150	800	1.0
H30070-04	4NABTYXREEL	4327-0107	1000	1/4	A	150	800	1.0
H30002-05	5NABTA X100FT	4327-0053	1	5/16	B	150	800	1.25
H30000-05	5NABTAXREEL	4327-0120	500	5/16	B	150	800	1.25
H30002-06	6NABTA X100FT	4327-0054	1	3/8	B	150	800	1.5
H30000-06	6NABTAXLG REEL	4327-0201	1000	3/8	B	150	800	1.5
H30005-06	6NABTAXREEL	4327-0126	500	3/8	B	150	800	1.5
H30062-06	6NABTB X100FT	4327-0069	1	3/8	B	150	800	1.25
H30060-06	6NABTBXLG REEL	4327-1002	1000	3/8	B	150	800	1.25
H30065-06	6NABTBXREEL	4327-0128	500	3/8	B	150	800	1.25
H30042-06	6NABTG X100FT	4327-0059	1	3/8	B	150	800	1.25
H30040-06	6NABTGXLG REEL	4327-1003	1000	3/8	B	150	800	1.25
H30045-06	6NABTGXREEL	4327-0129	500	3/8	B	150	760	1.25
H30010-06	6NABTNXREEL	4327-0109	1000	3/8	B	150	800	1.25
H30082-06	6NABTO X100FT	4327-0079	1	3/8	B	150	1120	1.25
H30080-06	6NABTOXREEL	4327-1004	1000	3/8	B	150	1120	1.25
H30052-06	6NABTR X100FT	4327-0064	1	3/8	B	150	800	1.25
H30050-06	6NABTRXLG REEL	4327-1005	1000	3/8	B	150	800	1.25
H30055-06	6NABTRXREEL	4327-0127	500	3/8	B	150	800	1.25
H30020-06	6NABTWXREEL	4327-0110	1000	3/8	B	150	800	1.25
H30072-06	6NABTY X100FT	4327-0074	1	3/8	B	150	800	1.25
H30070-06	6NABTYXREEL	4327-0111	1000	3/8	B	150	800	1.25
H30002-08	8NABTA X100FT	4327-0055	1	1/2	B	150	760	2.0
H30000-08	8NABTAXREEL	4327-0112	500	1/2	B	150	760	2.0
H30062-08	8NABTB X100FT	4327-0070	1	1/2	B	150	760	2.0
H30065-08	8NABTBXREEL	4327-0133	500	1/2	B	150	760	2.0
H30042-08	8NABTG X100FT	4327-0060	1	1/2	B	150	760	2.0
H30045-08	8NABTGXREEL	4327-0132	500	1/2	B	150	720	2.0
H30082-08	8NABTO X100FT	4327-0080	1	1/2	B	150	760	2.0

Nylon Air Brake Tubing

Continued

Part No.	Description	Product No.	Standard Pack	Tube O.D. (in)	Reinforcement Type			
H30052-08	8NABTR X100FT	4327-0065	1	1/2	B	150	760	2.0
H30055-08	8NABTRXREEL	4327-0131	500	1/2	B	150	760	2.0
H30090-08	8NABTSXREEL	4327-0114	500	1/2	B	150	760	2.0
H30072-08	8NABTY X100FT	4327-0075	1	1/2	B	150	760	2.0
H30003-10	10NABTA X50FT	4327-0056	1	5/8	B	150	720	2.5
H30000-10	10NABTAXREEL	4327-0115	250	5/8	B	150	720	2.5
H30063-10	10NABTB X50FT	4327-0071	1	5/8	B	150	720	2.5
H30043-10	10NABTG X50FT	4327-0061	1	5/8	B	150	640	3.5
H30040-10	10NABTGXREEL	4327-1006	250	5/8	B	150	640	3.5
H30083-10	10NABTO X50FT	4327-0081	1	5/8	B	150	720	2.5
H30053-10	10NABTR X50FT	4327-0066	1	5/8	B	150	720	3.5
H30050-10	10NABTRXREEL	4327-1007	250	5/8	B	150	720	3.5
H30073-10	10NABTY X50FT	4327-0076	1	5/8	B	150	720	2.5
H30003-12	12NABTA X50FT	4327-0057	1	3/4	B	150	640	3.0
H30000-12	12NABTAXREEL	4327-0116	250	3/4	B	150	640	3.0
H30063-12	12NABTB X50FT	4327-0072	1	3/4	B	150	640	3.0
H30043-12	12NABTG X50FT	4327-0062	1	3/4	B	150	640	3.0
H30083-12	12NABTO X50FT	4327-0082	1	3/4	B	150	640	3.0
H30053-12	12NABTR X50FT	4327-0067	1	3/4	B	150	640	3.0
H30073-12	12NABTY X50FT	4327-0077	1	3/4	B	150	640	3.0

AB Series Air Brake Hose

Recommended For: Truck, bus and mobile air brake systems. Can be used as flexible connector between frame and axle. Meets SAE J1402 specification. Complies with D.O.T. FMVSS 106 requirements.

Temperature Range: -40°F to +212°F (-40°C to +100°C).

Coupling Recommendation (See Crimp Data Manual 428-7365 or E-Crimp): Gates G33 Series type air brake couplings. Section Z

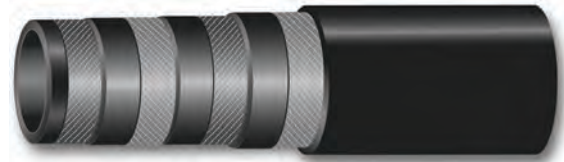

Part No.	Description	Product No.	Standard Pack				
27240	3/8 X 50FT Rubber Air Brake	3245-0601	1	3/8	3/4	225	1000
28760	3/8 X 250FT Reel Rubber Air Brake	3245-0602	1	3/8	3/4	225	1000
27241	1/2 X 50FT Rubber Air Brake	3245-0603	1	1/2	7/8	225	1000
28761	1/2 X 250FT Reel Rubber Air Brake	3245-0604	1	1/2	7/8	225	1000

NOTE: Federal law requires registration with the Department of Transportation for anyone producing air brake hose assemblies with swaged or crimped fittings. See Engineering and Technical Data Section for compliance.





Heavy-Duty Green Stripe® Air Brake Hose

Recommended For: Truck, bus and mobile air brake systems. Can be used as flexible connector between frame and axle. Exceeds SAE J1402 and Bendix specification. Complies with D.O.T. FMVSS 106 requirements.

Temperature Range: -40°F to +212°F (-40°C to +100°C).

Coupling Recommendation (See Crimp Data Manual 428-7365 or E-Crimp): Gates G33 Series type air brake couplings. Section Z



Part No.	Description	Product No.	Standard Pack				
28304	3/8 X250 REEL GS RBR AB	3245-4470	1	3/8	3/4	225	1000
27220	6ABGS X50FT	3245-4468	1	3/8	3/4	225	1000
27221	8ABGS X50FT	3245-4467	1	1/2	7/8	225	1000

NOTE: Federal law requires registration with the Department of Transportation for anyone producing air brake hose assemblies with swaged or crimped fittings. See Engineering and Technical Data Section for compliance.





Green Stripe® Vacuum Brake Hose

Recommended For: Extra heavy-duty hose designed to fit most air brake systems on trucks, trailers and other heavy equipment. Exceeds SAE J1403, Type H requirements. Complies with D.O.T. FMVSS 106VH requirements.

Temperature Range: -40°F to +257°F (-40°C to +125°C).

Coupling Recommendation (See Crimp Data Manual 428-7365 or E-Crimp): Gates G33 Series type air brake couplings. Section Z



Part No.	Description	Product No.	Standard Pack				
27210	3/8 X50FT VAC BRAKE	3276-4474	1	3/8	13/16	1200	30
27211	1/2 X50FT VAC BRAKE	3276-4475	1	1/2	15/16	1000	30
27212	5/8 X50FT VAC BRAKE	3245-4476	1	5/8	1 1/16	800	30
27213	3/4 X50FT VAC BRAKE	3145-4477	1	3/4	1 3/16	800	30

TR500 High-Temp/Air Brake/Engine Hose

Recommended For: Air brake hose, high temperature pressurized oil return lines and rotary oil/air compressor lines, engine and transmission coolant lines and lube oil lines. Meets or exceeds DOT FMVSS 106-74, SAE J1402 for air brake hose (4, 6, 8, 10). Not recommended for gasoline or diesel fuel applications.

Tube: Black (Nitrile - Type C). See Hose Stock Characteristics.







Reinforcement: One braid of high-tensile steel wire.

Cover: Oil and mildew resistant, textile braid, impregnated with synthetic rubber.

Temperature Range: -40°F to +250°F (-40°C to +121°C). For water emulsions see Temperature Limits Table.

Coupling Recommendation (See Crimp Data Manual 428-7365 or E-Crimp): MegaCrimp® Couplings (G25) Section G









Part No.	Description	Product No.	Standard Pack						
85745	4TR500 X50FT	4657-2600	1	1/4	.51	500	2000	1.0	30
70881	4TR500XREEL	4657-2228	250	1/4	.51	500	2000	1.0	30
85747	6TR500 X50FT	4657-2601	1	3/8	.66	500	2000	1.8	30
70883	6TR500XREEL	4657-2520	350	3/8	.66	500	2000	1.8	30
85748	8TR500 X50FT	4657-2602	1	1/2	.80	500	2000	2.3	30
70884	8TR500XREEL	4657-2521	350	1/2	.80	500	2000	2.3	30
85749	10TR500 X50FT	4657-2603	1	5/8	.93	500	2000	2.8	30

NOTE: Federal law requires registration with the Department of Transportation for anyone producing air brake hose assemblies with swaged or crimped fittings. See Engineering and Technical Data Section for compliance.

TR500 High-Temp/Air Brake/Engine Hose

Continued

Part No.	Description	Product No.	Standard Pack						
70885	10TR500XREEL	4657-2229	300	5/8	.93	500	2000	2.8	30
85750	12TR500 X50FT	4657-2604	1	3/4	1.04	500	2000	3.5	30
70886	12TR500XREEL	4657-2230	200	3/4	1.04	500	2000	3.5	30
85751	16TR500 X50FT	4657-2605	1	1	1.30	500	2000	4.5	30
70887	16TR500XREEL	4657-2231	150	1	1.30	500	2000	4.5	30

NOTE: Federal law requires registration with the Department of Transportation for anyone producing air brake hose assemblies with swaged or crimped fittings. See Engineering and Technical Data Section for compliance.

MegaTech® G5TB Xtreme® Heat Oil-Air Return

Recommended For: For pressurized hot oil return lines and rotary oil lines. Meets the requirements of SAE J1405 performance specifications for high-temperature transmission and lubricating oil systems using petroleum base oils.

Tube: True-bore GTS (Gates Technical Spec.) black tube specifically compounded for temperature and chemical resistance (CPE - Type J).

Reinforcement: Two braids of high-tensile steel wire.

Cover: Blue, oil and mildew resistant textile braid, impregnated with synthetic rubber.

Temperature Range: Petroleum-base fluids: -40°F to +300°F (-40°C to +149°C).

Phosphate esters fluids as recommended by the fluid manufacturer, but within a range of -40°F to +212°F (-40°C to +100°C). For water emulsions see Temperature Limits Table.





Coupling Recommendation (See Crimp Data Manual 428-7365 or E-Crimp):

GL Couplings (-24 and -32 only) (G43) Section M

GlobalSpiral™ Plus Couplings (-24 and -32) (G22) Section E

MegaCrimp® Couplings (G25) Section G



Part No.	Description	Product No.	Standard Pack					
85391	4MEGATECH G5TB X50FT	4657-4070	1	1/4	.59	3000	12000	2.0
71023	4MEGATECH G5TBXREEL	4657-2183	400	1/4	.59	3000	12000	2.0
85392	6MEGATECH G5TB X50FT	4657-4071	1	3/8	.74	3000	12000	2.5
71024	6MEGATECH G5TBXREEL	4657-2184	350	3/8	.74	3000	12000	2.5
85393	8MEGATECH G5TB X50FT	4657-4072	1	1/2	.86	3000	12000	3.5
71025	8MEGATECH G5TBXREEL	4657-2185	350	1/2	.86	3000	12000	3.5
71066	10MEGATECH G5TBXREEL	4657-2186	300	5/8	.95	2000	8000	4.0
71067	12MEGATECH G5TBXREEL	4657-2187	200	3/4	1.10	2000	8000	4.7
85396	16MEGATECH G5TB X50FT	4657-4075	1	1	1.37	1000	4000	6.0
71026	16MEGATECH G5TBXREEL	4657-2188	150	1	1.37	1000	4000	6.0
85398	20MEGATECH G5TB X25FT	4657-4079	1	1 1/4	1.67	1000	4000	8.5
85397	20MEGATECH G5TB X50FT	4657-4076	1	1 1/4	1.67	1000	4000	8.5
71027	20MEGATECH G5TBXCTN	4657-2189	100	1 1/4	1.67	1000	4000	8.5
85395	24MEGATECH G5TB X25FT	4657-4080	1	1 1/2	1.95	500	2000	9.5
85394	24MEGATECH G5TB X50FT	4657-4077	1	1 1/2	1.95	500	2000	9.5
71028	24MEGATECH G5TBXCTN	4657-2190	100	1 1/2	1.95	500	2000	9.5
85400	32MEGATECH G5TB X25FT	4657-4081	1	2	2.53	500	2000	10.5
85399	32MEGATECH G5TB X50FT	4657-4078	1	2	2.53	500	2000	10.5
71029	32MEGATECH G5TBXCTN	4657-2191	100	2	2.53	500	2000	10.5

MegaTech® II - SAE 100R2 Type AT - ACP Carton Pack High Pressure

Recommended For: Multi-purpose high-pressure, high-temperature, air compressor lines, petroleum-base or phosphate ester hydraulic fluid supply lines. Meets the requirements of SAE J1405 performance specifications for high-temperature transmission and lubricating oil systems using petroleum base oils. Meets or exceeds the requirements of SAE 100R2 and SAE 100R2 Type S.

Tube: Black, oil resistant, synthetic rubber (CPE - Type J). See Hose Stock Characteristics.

Reinforcement: Two braids of high-tensile steel wire.

Cover: Blue, oil and abrasion resistant, polyester braid.





Temperature Range: -40°F to +300°F (-40°C to +149°C).

Coupling Recommendation (See Crimp Data Manual 428-7365 or E-Crimp):

GlobalSpiral™ Plus Couplings (-24 and -32) (G22) Section E

MegaCrimp® Couplings (-20 only) (G25) Section G



Part No.	Description	Product No.	Standard Pack					
70975	20ACP MEGATECHIIIXCTN	4657-8018	100	1 1/4	1.89	2250	9000	15.0
70858	24ACP MEGATECHIIIXCTN	4657-2484	100	1 1/2	2.13	1500	6000	20.0
70802	32ACP MEGATECHII XCTN50	4657-4734	50	2	2.61	1300	5200	25.0
70859	32ACP MEGATECHIIIXCTN	4657-2485	100	2	2.61	1300	5200	25.0

MegaTech® 3000 High-Temp Oil-Air Return

Recommended For: For pressurized hot oil return lines and rotary oil lines. Meets the requirements of SAE J1405 performance specifications for high-temperature transmission and lubricating oil systems using petroleum base oils.

Tube: True-bore GTS (Gates Technical Spec.) black tube specifically compounded for temperature and chemical resistance (CPE - Type J).

Reinforcement: Two braids of high-tensile steel wire.

Cover: Oil and mildew resistant, textile braid, impregnated with synthetic rubber.







Temperature Range: Petroleum-base fluids: -40°F to +300°F (-40°C to +149°C).

Phosphate esters fluids as recommended by the fluid manufacturer, but within a range of -40°F to +212°F (-40°C to +100°C). For water emulsions see Temperature Limits Table.

Coupling Recommendation (See Crimp Data Manual 428-7365 or E-Crimp):

MegaCrimp® Couplings (G25) Section G



Part No.	Description	Product No.	Standard Pack						
70960	4MEGATECH 3000XREEL	4657-2373	400	1/4	.59	3000	12000	2.0	30
85987	4MEGATECH3000 X50FT	4657-4116	1	1/4	.59	3000	12000	2.0	30
70961	6MEGATECH 3000XREEL	4657-2374	350	3/8	.74	3000	12000	2.5	30
85988	6MEGATECH3000 X50FT	4657-4117	1	3/8	.74	3000	12000	2.5	30
70962	8MEGATECH 3000XREEL	4657-2319	350	1/2	.86	3000	12000	3.5	30
85989	8MEGATECH3000 X50FT	4657-4118	1	1/2	.86	3000	12000	3.5	30

MegaTech® 1000 High-Temp Oil-Air Return Fleet Application

Recommended For: Air brake, pressurized hot oil return lines and rotary oil/air compressor lines. Meets the requirements of DOT FMVSS 106-74, SAE J1402, for Air Brake Hose (-4, 6, 8, 10), and SAE J1405 performance specifications for high-temperature transmission and lubricating oil systems using petroleum base oils. Not recommended for gasoline or diesel fuel applications.

Tube: GTS (Gates Technical Spec.) black tube specifically compounded for temperature and chemical resistance (CPE - Type J). See Hose Stock Characteristics.

Reinforcement: One braid of high-tensile steel wire.

Cover: Oil and mildew resistant, textile braid, impregnated with synthetic rubber.

Temperature Range: Petroleum-base fluids: -40°F to +300°F (-40°C to +149°C). Phosphate esters fluids as recommended by the fluid manufacturer, but within a range of -40°F to +212°F (-40°C to +100°C). For water emulsions see Temperature Limits Table.

Coupling Recommendation (See Crimp Data Manual 428-7365 or E-Crimp): MegaCrimp® Couplings (G25) Section G



Part No.	Description	Product No.	Standard Pack	⊖	⊕	⊖	⊖	⊖	⊖
70850	4MEGATECH 1000XREEL	4657-2332	350	1/4	.52	1000	4000	2.0	30
85980	4MEGATECH1000 X50FT	4657-2503	1	1/4	.52	1000	4000	2.0	30
70851	6MEGATECH 1000XREEL	4657-2297	350	3/8	.66	1000	4000	2.5	30
85981	6MEGATECH1000 X50FT	4657-2504	1	3/8	.66	1000	4000	2.5	30
70852	8MEGATECH 1000XREEL	4657-2334	350	1/2	.80	1000	4000	3.5	30
85982	8MEGATECH1000 X50FT	4657-2505	1	1/2	.80	1000	4000	3.5	30
70853	10MEGATECH 1000XREEL	4657-2335	300	5/8	.93	1000	4000	4.0	30
85983	10MEGATECH1000 X50FT	4657-2506	1	5/8	.93	1000	4000	4.0	30
70888	12MEGATECH 1000XREEL	4657-2336	200	3/4	1.15	1000	4000	4.7	30
85984	12MEGATECH1000 X50FT	4657-4040	1	3/4	1.15	1000	4000	4.7	30
70889	16MEGATECH 1000XREEL	4657-2337	150	1	1.37	1000	4000	6.0	30
85985	16MEGATECH1000 X50FT	4657-4041	1	1	1.37	1000	4000	6.0	30
70890	20MEGATECH 1000XCTN	4657-2338	100	1 1/4	1.64	1000	4000	8.5	30
85986	20MEGATECH1000 X50FT	4657-4042	1	1 1/4	1.64	1000	4000	8.5	30

NOTE: Federal law requires registration with the Department of Transportation for anyone producing air brake hose assemblies with swaged or crimped fittings. See Engineering and Technical Data Section for compliance.

MegaTech® 500 High-Temp Oil-Air Return Fleet Application

Recommended For: For air brake hose, pressurized hot oil return lines and rotary oil/air compressor lines. Meets the requirements of SAE J1405 performance specifications for high-temperature transmission and lubricating oil systems using petroleum base oils. Not recommended for gasoline or diesel fuel applications.

Tube: GTS (Gates Technical Spec.) black tube specifically compounded for temperature and chemical resistance (CPE - Type J). See Hose Stock Characteristics.

Reinforcement: One braid of high-tensile steel wire.

Cover: Oil and mildew resistant, textile braid, impregnated with synthetic rubber.

Temperature Range: Petroleum-base fluids: -40°F to +300°F (-40°C to +149°C). Phosphate esters fluids as recommended by the fluid manufacturer, but within a range of -40°F to +212°F (-40°C to +100°C). For water emulsions see Temperature Limits Table.

Coupling Recommendation (See Crimp Data Manual 428-7365 or E-Crimp): GL Couplings (-24, -32 and -40) (G43) Section M
GlobalSpiral™ Plus Couplings (-24 and -32) (G22) Section E



Part No.	Description	Product No.	Standard Pack	⊖	⊕	⊖	⊖	⊖	⊖
70854	24MEGATECH 500XCTN	4657-0204	100	1 1/2	1.95	500	2000	15.0	30
85687	24MEGATECH500 X50FT	4657-0061	1	1 1/2	1.95	500	2000	15.0	30
70855	32MEGATECH 500XCTN	4657-0205	100	2	2.48	500	2000	18.0	30
85688	32MEGATECH500 X50FT	4657-0062	1	2	2.48	500	2000	18.0	30
70856	40MEGATECH 500XCTN	4657-0206	100	2 1/2	2.97	500	2000	22.0	30
70857	48MEGATECH 500XCTN	4657-0207	100	3	3.50	500	2000	24.0	30

MegaTech® 250 High-Temp Transmission Oil Cooler (TOC) Hose

Recommended For: High-temperature (300°F) transmission oil cooler lines, pressurized hot oil return lines and turbocharger oil supplies. Meets or exceeds SAE J1405 performance specifications for high-temperature transmission and lubricating oil systems using petroleum base oils. Not recommended for gasoline or diesel fuel applications.

Tube: GTS (Gates Technical Spec.) black tube specifically compounded for temperature and chemical resistance (CPE – Type J). See Hose Stock Characteristics.

Reinforcement: One braid of high-tensile steel wire.

Cover: Oil and mildew resistant, textile braid, impregnated with synthetic rubber.

Temperature Range: Petroleum-base fluids: -40°F to +300°F (-40°C to +149°C). Phosphate esters fluids as recommended by the fluid manufacturer, but within a range of -40°F to +212°F (-40°C to +100°C). For water emulsions see Temperature Limits Table.

Coupling Recommendation (See Crimp Data Manual 428-7365 or E-Crimp): MegaCrimp® Couplings (G25) Section G



Part No.	Description	Product No.	Standard Pack						
70891	4MEGATECH 250XREEL	4657-2339	250	1/4	.52	250	1000	1.0	30
85759	4MEGATECH250 X50FT	4657-0083	1	1/4	.52	250	1000	1.0	30
70892	6MEGATECH 250XREEL	4657-2340	350	3/8	.64	250	1000	1.8	30
85760	6MEGATECH250 X50FT	4657-0084	1	3/8	.64	250	1000	1.8	30
70893	8MEGATECH 250XREEL	4657-2341	350	1/2	.78	250	1000	2.5	30
85761	8MEGATECH250 X50FT	4657-0085	1	1/2	.78	250	1000	2.5	30
70894	10MEGATECH 250XREEL	4657-2342	300	5/8	.93	250	1000	3.0	30
85762	10MEGATECH250 X50FT	4657-0086	1	5/8	.93	250	1000	3.0	30
70895	12MEGATECH 250XREEL	4657-2343	200	3/4	1.06	250	1000	3.5	30
85763	12MEGATECH250 X50FT	4657-0087	1	3/4	1.06	250	1000	3.5	30
70896	16MEGATECH 250XREEL	4657-2344	150	1	1.36	250	1000	4.0	30
85764	16MEGATECH250 X50FT	4657-0088	1	1	1.36	250	1000	4.0	30
70900	20MEGATECH 250XCTN	4657-2345	120	1 1/4	1.65	250	1000	4.5	30
85765	20MEGATECH250 X50FT	4657-0089	1	1 1/4	1.65	250	1000	4.5	30

S/R-XH Suction/Return-Extreme Heat Hose

Recommended For: Hydraulic oil lines, heavy-duty transmission oil cooler lines and power steering circuit lines. Meets or exceeds requirements of SAE J1019.

Tube: Black, specially compounded, synthetic rubber (CPE – Type J).

Reinforcement: One or two fiber braids.

Cover: Black, oil and abrasion resistant, synthetic rubber (CSM – Type A).

Temperature Range: -40°F to +300°F (-40°C to +149°C).

Coupling Recommendation (See Crimp Data Manual 428-7365 or E-Crimp): MegaCrimp® Couplings (G25) Section G
Use clamp over beaded nipple.



Part No.	Description	Product No.	Standard Pack						
85439	8S/R XHX50FT	3319-4714	1	1/2	.78	250	1000	4.0	18
70963	8S/R XHXCTN	3319-4514	400	1/2	.78	250	1000	4.0	18
85440	10S/R XHX50FT	3319-4715	1	5/8	.83	250	1000	5.0	15
70964	10S/R XHXCTN	3319-4516	250	5/8	.83	250	1000	5.0	15
70965	12S/R XHXCTN	3319-4518	225	3/4	1.16	250	1000	6.0	15

C5C Hydraulic Hose - SAE 100R5

DOT FMVSS 106-74 Type All and SAE J1402 Type All for air brake applications (-4 to -12).

Recommended For: Medium pressure hydraulic petroleum-based oil lines in impulse applications, lube oil, air and water in applications such as air brakes, power steering (CAUTION: Intended for heavy-duty commercial vehicle use only), turbocharger oil supplies, tilt cab cylinders, transmission coolant and filtration lines. Meets or exceeds requirements of SAE 100R5 for traditional hydraulic applications, DOT FMVSS 106-74 Type All and SAE J1402 Type All for air brake applications (-4 to -12). Not recommended for gasoline or diesel fuel.

Tube: -4 and -5: black, oil and heat resistant synthetic rubber (Neoprene - Type A); -6 through -40: (Nitrile - Type C). See Hose Stock Characteristics.

Reinforcement: One braid of high-tensile carbon steel wire over one braid of polyester.

Cover: Black, oil and mildew resistant, polyester braid.

Temperature Range: Under SAE 100R5 (hydraulic) conditions -40°F to +212°F (-40°C to +100°C). All-purpose fleet application (hot lube oil lines) -40°F to +300°F (-40°C to +149°C). Air to +160°F (+71°C) only. Avoid continuous use at maximum temperature concurrent with maximum working pressures. For water emulsions see Temperature Limits Table.

Coupling Recommendation (See Crimp Data Manual 428-7365 or E-Crimp): C5 Field Attachable Couplings (G34) Section K



Part No.	Description	Product No.	Standard Pack	⊘	∅	⊘	⊘	⊘
86605	4C5C X50FT	3658-1762	1	3/16	.52	3000	12000	3.0
70589	4C5CXREEL	3658-1775	440	3/16	.52	3000	12000	3.0
86606	5C5C X50FT	3658-1763	1	1/4	.58	3000	12000	3.4
70590	5C5CXREEL	3658-1776	385	1/4	.58	3000	12000	3.4
86607	6C5C X50FT	3658-1764	1	5/16	.67	2250	9000	4.0
70591	6C5CXREEL	3658-1777	385	5/16	.67	2250	9000	4.0
86608	8C5C X50FT	3658-1765	1	13/32	.77	2000	8000	4.6
70592	8C5CXREEL	3658-1778	330	13/32	.77	2000	8000	4.6
86609	10C5C X50FT	3658-1766	1	1/2	.92	1750	7000	5.5
70593	10C5CXREEL	3658-1779	275	1/2	.92	1750	7000	5.5
86610	12C5C X50FT	3658-1767	1	5/8	1.08	1500	6000	6.5
70594	12C5CXREEL	3658-1780	220	5/8	1.08	1500	6000	6.5
86616	16C5C X50FT	3658-1768	1	7/8	1.23	800	3200	7.4
70595	16C5CXREEL	3658-1781	165	7/8	1.23	800	3200	7.4
86617	20C5C X25FT	3658-1772	1	1 1/8	1.50	625	2500	9.0
70096	20C5CXCTN	3658-1758	100	1 1/8	1.50	625	2500	9.0
70097	24C5CXCTN	3658-1759	100	1 3/8	1.75	500	2000	10.5
70098	32C5CXCTN	3658-1760	100	1 13/16	2.22	350	1400	13.3
70099	40C5CXCTN	3658-1761	100	2 3/8	2.88	350	1400	24.0

NOTE: Federal law requires registration with the Department of Transportation for anyone producing air brake hose assemblies with swaged or crimped fittings. See Engineering and Technical Data Section for compliance.

C5CXH Xtreme® Heat Hose - SAE 100R5

DOT FMVSS 106-74 Type All and SAE J1402 Type All for (-4 to -12).

Recommended For: Petroleum based or phosphate ester fluids, turbo charger oil supply and hot lube oil lines. Meets the requirements of SAE J1405 performance specifications for high temperature transmission and lubrication oil systems.

Tube: Black, oil and heat resistant synthetic polymer tube (CPE - Type J). See Hose Stock Characteristics.

Reinforcement: Braided high tensile wire and textile.

Cover: Blue, oil and mildew resistant polyester/textile braid.

Temperature Range: -40°F to +302°F (-40°C to +150°C).

Coupling Recommendation (See Crimp Data Manual 428-7365 or E-Crimp): C5 Field Attachable Couplings (-6, -10, -16 and -20) (G34) Section K
C5X Field Attachable Couplings (-5, -8, and -12 Only) (G34) Section K
Crimp options are MegaCrimp®, GlobalSpiral™ (depending on size)



Part No.	Description	Product No.	Standard Pack	⊘	∅	⊘	⊘	⊘
86992	5C5CXH X 50 FT	3658-4001	1	1/4	.58	3000	12000	3.4

C5CXH Xtreme® Heat Hose - SAE 100RS

Continued

Part No.	Description	Product No.	Standard Pack					
70992	5C5CXHXREEL	3658-0151	385	1/4	.58	3000	12000	3.4
86993	6C5CXH X 50 FT	3658-4002	1	1/3	.68	2250	9000	4.0
70993	6C5CXHXREEL	3658-0152	385	1/3	.68	2250	9000	4.0
86994	8C5CXH X 50 FT	3658-4003	1	3/7	.78	2000	8000	4.6
70994	8C5CXHXREEL	3658-0153	330	3/7	.77	2000	8000	4.6
86995	10C5CXH X 50 FT	3658-4004	1	1/2	.92	1750	7000	5.5
70995	10C5CXHXREEL	3658-0154	275	1/2	.92	1750	7000	5.5
86996	12C5CXH X 50 FT	3658-4005	1	2/3	1.08	1500	6000	6.5
70996	12C5CXHXREEL	3658-0155	220	2/3	1.08	1500	6000	6.5
86997	16C5CXH X 50 FT	3658-4006	1	8/9	1.23	800	3200	7.4
70997	16C5CXHXREEL	3658-0156	165	8/9	1.23	800	3200	7.4
86998	20C5CXH X 50 FT	3658-4007	1	1 1/7	1.50	625	2500	9.0
70998	20C5CXHXCTN	3658-0157	120	1 1/7	1.50	625	2500	9.0

C5D High-Temp Multi-Fluid Hose

DOT FMVSS 106-74 Type All, SAE J1402 Type All (-4 to -12).

Recommended For: Petroleum-base or phosphate ester fluids; diesel fuels and filtration lines, transmission coolant lines, hot lube oil lines, power steering (CAUTION: Intended for heavy-duty commercial vehicle use only), gasoline and turbocharger oil supplies. Tilt cab cylinder and air brakes. C5D (-4 to -12) meets or exceeds DOT FMVSS 106-74 Type All, SAE J1402 Type All and SAE J1405 and fuel resistance of SAE J30R2. Not approved for bio diesel.

Tube: Black, oil and heat resistant, synthetic rubber (CPE - Type J). See Hose Stock Characteristics.





Reinforcement: One braid of high-tensile steel wire over one braid of polyester.

Cover: Green for easy identification, oil and mildew resistant, polyester braid impregnated with synthetic rubber.

Temperature Range: -40°F to +300°F (-40°C to +149°C). Air to +250°F (+121°C) only, maximum phosphate esters to +212°F (+100°C). For water emulsions see Temperature Limits Table.

Coupling Recommendation (See Crimp Data Manual 428-7365 or E-Crimp): C5 Field Attachable Couplings (G34) Section K



Part No.	Description	Product No.	Standard Pack					
85680	4C5D X50FT	3658-0001	1	3/16	.52	1500	6000	1.0
70540	4C5DXREEL	3658-0020	440	3/16	.52	1500	6000	1.0
85681	5C5D X50FT	3658-0007	1	1/4	.58	1500	6000	1.5
70541	5C5DXREEL	3658-0027	385	1/4	.58	1500	6000	1.5
85682	6C5D X50FT	3658-0002	1	5/16	.67	1500	6000	1.8
70542	6C5DXREEL	3658-0021	385	5/16	.67	1500	6000	1.8
85683	8C5D X50FT	3658-0003	1	13/32	.77	1250	5000	2.0
70543	8C5DXREEL	3658-0022	330	13/32	.77	1250	5000	2.0
85684	10C5D X50FT	3658-0008	1	1/2	.92	1250	5000	2.0
70544	10C5DXREEL	3658-0028	275	1/2	.92	1250	5000	2.0
85685	12C5D X50FT	3658-0009	1	5/8	1.08	750	3000	2.3
70545	12C5DXREEL	3658-0029	220	5/8	1.08	750	3000	2.3
85686	16C5D X50FT	3658-0010	1	7/8	1.23	400	1600	3.5
70546	16C5DXREEL	3658-0030	165	7/8	1.23	400	1600	3.5

NOTE: Federal law requires registration with the Department of Transportation for anyone producing air brake hose assemblies with swaged or crimped fittings. See Engineering and Technical Data Section for compliance.

C5M Marine Fuel Line Hose

(Meets Flame Resistance Acceptance Designation "MSHA 2G")

Recommended For: All commercial and recreational vessel fuel line applications. Suitable for marine diesel, gasoline, B100 Bio diesel, gasohol fuels and hot oil applications. On-shore/off-shore and marine diesel fuel and gasoline applications and hot oil lines up to +212°F. Meets USCG marine fuel line specifications, SAE J1527 B100 to +125°F Type A Class 1 and SAE J1942 requirements. Exceeds performance requirements of SAE J30R2 for non-marine applications.

Tube: Nitrile – Type C. See Hose Stock Characteristics.





Reinforcement: One wire braid

Cover: Modified Nitrile – Type C2. Blue. See Hose Stock Characteristics.

Temperature Range: -4°F to +212°F (-20°C to +100°C) continuous service.

Coupling Recommendation (See Crimp Data Manual 428-7365 or E-Crimp): Brass or Carbon C5 Field Attachable Couplings (G34) Section K



Part No.	Description	Product No.	Standard Pack					
70614	5C5MXREEL	3658-1965	385	1/4	.58	500	2000	1.3
86596	6C5M X50FT	3658-4596	1	5/16	.67	500	2000	1.3
70615	6C5MXREEL	3658-1969	385	5/16	.67	500	2000	1.3
86597	8C5M X50FT	3658-4597	1	13/32	.77	500	2000	1.8
70616	8C5MXREEL	3658-1973	330	13/32	.77	500	2000	1.8
86598	10C5M X50FT	3658-4598	1	1/2	.92	500	2000	2.3
70617	10C5MXREEL	3658-1977	275	1/2	.92	500	2000	2.3
86599	12C5M X50FT	3658-4599	1	5/8	1.08	500	2000	2.8
70618	12C5MXREEL	3658-1981	220	5/8	1.08	500	2000	2.8
86600	16C5M X50FT	3658-4600	1	7/8	1.23	500	2000	3.5
70619	16C5MXREEL	3658-1985	165	7/8	1.23	500	2000	3.5

C5E High-Temp Flexline Hose

DOT FMVSS 106 Type A1, SAE J1405 and SAE J1402 Type A1 (-4 to -12).

Recommended For: Air brake hose, power steering (CAUTION: Intended for heavy-duty commercial vehicle use only), engine and transmission coolant lines, and hot (+300°F) lube oil lines. Not recommended for gasoline or diesel fuel.

Tube: Black, oil and heat resistant, synthetic rubber (Nitrile – Type C). See Hose Stock Characteristics.





Reinforcement: One braid of high-tensile steel wire over one braid of polyester.

Cover: Black, oil and heat resistant, textile braid impregnated with synthetic rubber. Green stripe for easy identification.

Temperature Range: -40°F to +300°F (-40°C to +149°C). Air +250°F (+121°C) maximum only. For water emulsions see Temperature Limits Table.

Coupling Recommendation (See Crimp Data Manual 428-7365 or E-Crimp): C5E Field Attachable Couplings (G35) Section K







Part No.	Description	Product No.	Standard Pack					
85690	4C5E X50FT	3658-4990	1	3/16	.49	1500	6000	.8
70530	4C5EXREEL	3658-0210	440	3/16	.49	1500	6000	.8
85691	5C5E X50FT	3658-4991	1	1/4	.55	1500	6000	1.0
70531	5C5EXREEL	3658-0211	385	1/4	.55	1500	6000	1.0
85692	6C5E X50FT	3658-4992	1	5/16	.61	1500	6000	1.3
70532	6C5EXREEL	3658-0212	385	5/16	.61	1500	6000	1.3
85693	8C5E X50FT	3658-4993	1	13/32	.73	1250	5000	1.8
70193	8C5EXCTN	3658-0203	475	13/32	.73	1250	5000	1.8
70533	8C5EXREEL	3658-0213	330	13/32	.73	1250	5000	1.8
85694	10C5E X50FT	3658-4994	1	1/2	.83	1250	5000	2.3
70194	10C5EXCTN	3658-0204	330	1/2	.83	1250	5000	2.3
70534	10C5EXREEL	3658-0214	275	1/2	.83	1250	5000	2.3
85695	12C5E X50FT	3658-4995	1	5/8	.95	750	3000	3.0
70195	12C5EXCTN	3658-0205	200	5/8	.95	750	3000	3.0

NOTE: Federal law requires registration with the Department of Transportation for anyone producing air brake hose assemblies with swaged or crimped fittings. See Engineering and Technical Data Section for compliance.

C5E High-Temp Flexline Hose

Continued

Part No.	Description	Product No.	Standard Pack					
70535	12C5EXREEL	3658-0215	220	5/8	.95	750	3000	3.0
85696	16C5E X50FT	3658-4996	1	7/8	1.20	400	1600	3.5
70536	16C5EXREEL	3658-0216	165	7/8	1.20	400	1600	3.5
85697	20C5E X25FT	3658-4989	1	1 1/8	1.49	300	1200	4.5
70197	20C5EXCTN	3658-0207	100	1 1/8	1.49	300	1200	4.5

NOTE: Federal law requires registration with the Department of Transportation for anyone producing air brake hose assemblies with swaged or crimped fittings. See Engineering and Technical Data Section for compliance.

C14 PTFE Hose - SAE 100R14 Type A - Nonconductive

Recommended For: Air compressor discharge, hot oil and fluids, hot and greasy environments.









Tube: Type A-Nonconductive white, smooth bore Polytetrafluoroethylene (PTFE). See Hose Stock Characteristics.

Cover/Reinforcement: One braid of 300 Series stainless steel wire.

Temperature Range: Dynamic: -65°F to +400°F (-54°C to +204°C). Static: -65°F to +450°F (-54°C to +232°C).

Coupling Recommendation (See Crimp Data Manual 428-7365 or E-Crimp): C14 Couplings (G40) Section N



Part No.	Description	Product No.	Standard Pack									
									72°F (22°C)	72°F (22°C)	450°F (232°C)	450°F (232°C)
85700	4C14 X25FT	7752-0425	1	3/16	.31	1500	6000	2.0	3000	12000	1500	6000
70804	4C14XCTN	7752-0400	400	3/16	.31	1500	6000	2.0	3000	12000	1500	6000
85701	5C14 X25FT	7752-0525	1	1/4	.38	1500	6000	3.0	3000	12000	1500	6000
70805	5C14XCTN	7752-0500	350	1/4	.38	1500	6000	3.0	3000	12000	1500	6000
85702	6C14 X25FT	7752-0625	1	5/16	.45	1500	6000	4.0	2500	10000	1500	6000
70806	6C14XCTN	7752-0600	300	5/16	.45	1500	6000	4.0	2500	10000	1500	6000
85703	8C14 X25FT	7752-0825	1	13/32	.55	1000	4000	5.3	2000	8000	1000	4000
70808	8C14XCTN	7752-0800	250	13/32	.55	1000	4000	5.3	2000	8000	1000	4000
85704	10C14 X25FT	7752-1025	1	1/2	.65	800	3200	6.5	1500	6000	800	3200
70810	10C14XCTN	7752-1000	200	1/2	.65	800	3200	6.5	1500	6000	800	3200
85705	12C14 X25FT	7752-1225	1	5/8	.79	800	3200	7.8	1200	4800	800	2600
70812	12C14XCTN	7752-1200	150	5/8	.79	800	3200	7.8	1200	4800	800	2600
85706	16C14 X25FT	7752-1625	1	7/8	1.03	800	3500	9.0	1000	4000	800	2200
70816	16C14XCTN	7752-1600	100	7/8	1.03	800	3500	9.0	1000	4000	800	2200

NOTE: Electrostatic Discharge: Many applications involving PTFE hose do not require a conductive tube. But you must review the potential for electrostatic discharge for every application and be aware that static electricity can be hazardous. In those cases where electrostatic discharge can occur, conductive PTFE hose with a conductive tube (Gates C14CT) is recommended. For more information on electrostatic discharge, refer to Technical Data Section.

C14CT PTFE Hose - SAE 100R14 Type B - Conductive

Recommended For: Air compressor discharge, hot oil and fluids, hot and greasy environments.

Tube: Type B-Conductive black/white smooth bore Polytetrafluoroethylene (PTFE). See Hose Stock Characteristics.

Cover/Reinforcement: One braid of 300 Series stainless steel wire.

Temperature Range: Dynamic: -65°F to +400°F (-54°C to +204°C). Static: -65°F to +450°F (-54°C to +232°C).

Coupling Recommendation (See Crimp Data Manual 428-7365 or E-Crimp): C14 Couplings (G40) Section N



Part No.	Description	Product No.	Standard Pack	⊖	⊕	⊖	⊕	R ₁₂	72°F (22°C)	72°F (22°C)	450°F (232°C)	450°F (232°C)
85730	6C14CT X25FT	7752-3625	1	5/16	.45	1500	6000	4.0	2500	10000	1500	6000
70906	6C14CTXCTN*	7752-3600	300	5/16	.45	1500	6000	4.0	2500	10000	1500	6000
85731	8C14CT X25FT	7752-3825	1	13/32	.55	1000	4000	5.3	2000	8000	1000	4000
70908	8C14CTXCTN*	7752-3800	250	13/32	.55	1000	4000	5.3	2000	8000	1000	4000

*Type B-Conductive Tube.

NOTE: Electrostatic Discharge: Many applications involving PTFE hose do not require a conductive tube. But you must review the potential for electrostatic discharge for every application and be aware that static electricity can be hazardous. In those cases where electrostatic discharge can occur, conductive PTFE hose with a conductive tube (Gates C14CT) is recommended. For more information on electrostatic discharge, refer to Technical Data Section.

PolarSeal® Hose Refrigerant

(SAE J51, Type A2 Dimensions; SAE J51, Type D Performance; SAE J2064, Type C, Class II Performance)

Recommended For: Liquid and gaseous R134a and R12 refrigerants in automotive air conditioning and industrial systems; i.e., tractors, construction trucks, mobile and stationary refrigeration units. Designed to minimize permeation of R134a refrigerant.

Tube: Black, synthetic rubber (Chloroprene - Type A). See Hose Stock Characteristics.

Reinforcement: Two layers of spiral polyester.

Cover: Black synthetic rubber (EPDM). See Hose Stock Characteristics.

Temperature Range: -22°F to +257°F (-30°C to +125°C).

Barrier: Nylon liner.

Coupling Recommendation (See Crimp Data Manual 428-7365 or E-Crimp): PolarSeal® Couplings (G45) Section P

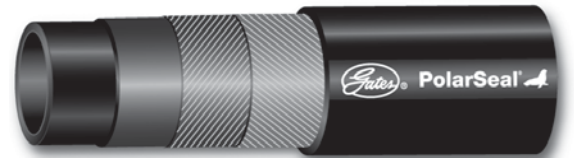

Part No.	Description	Product No.	Standard Pack	⊖	⊕	⊖	⊕	R ₁₂	⊖
85664	6AC134A X25FT	3353-0901	1	5/16	.75	500	2000	2.0	24
70624	6AC134AXREEL	3353-0903	340	5/16	.75	500	2000	2.0	24
85665	8AC134A X25FT	3353-0906	1	13/32	.91	500	2000	3.0	24
70625	8AC134AXREEL	3353-0908	235	13/32	.91	500	2000	3.0	24
85666	10AC134A X25FT	3353-0911	1	1/2	1.00	500	2000	4.0	24
70626	10AC134AXREEL	3353-0913	210	1/2	1.00	500	2000	4.0	24
85667	12AC134A X25FT	3353-0916	1	5/8	1.13	500	2000	5.0	24
70627	12AC134AXREEL	3353-0918	175	5/8	1.13	500	2000	5.0	24

PolarSeal® II Hose Refrigerant

Recommended For: AC systems on School/Transit Busses, RV's, Limos and other heavy equipment that has long run or hard to service AC lines. Liquid and gaseous R134a and R12 refrigerants in automotive air conditioning and industrial systems; i.e., tractors, construction trucks, mobile and stationary refrigeration units. Designed to minimize permeation of R134a refrigerant.

Tube: Black, synthetic Elastomeric rubber.

Reinforcement: Fabric Braid

Cover: Heat, Moisture and Ozone resistant black synthetic Elastomeric cover.

Temperature Range: -22°F to +257°F (-30°C to +125°C).

Barrier: Nylon liner.

Coupling Recommendation (See Crimp Data Manual 428-7365 or E-Crimp):
PolarSeal® II Couplings (Not In E-Crimp) (G46) Section Q

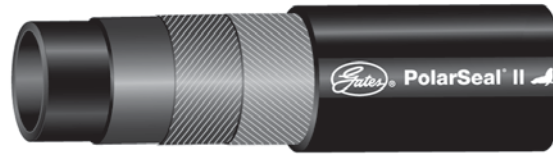

Part No.	Description	Product No.	Standard Pack					
85384	6ACC-PSII X50FT	3353-5007	1	5/16	.62	350	1400	1.5
71090	6ACC-PSIIXREEL	3353-5006	500	5/16	.62	350	1400	1.5
85385	8ACC-PSII X50FT	3353-5009	1	13/32	.74	350	1400	2.0
71091	8ACC-PSIIXREEL	3353-5008	500	13/32	.74	350	1400	2.0
85386	10ACC-PSII X50FT	3353-5011	1	1/2	.83	350	1400	2.5
71092	10ACC-PSIIXREEL	3353-5010	300	1/2	.83	350	1400	2.5
85387	12ACC-PSII X50FT	3353-5013	1	5/8	.96	350	1400	3.0
71093	12ACC-PSIIXREEL	3353-5012	250	5/8	.96	350	1400	3.0
85388	16ACC-PSII X50FT	3353-5017	1	7/8	1.23	350	1400	1.4
71094	16ACC-PSIIXREEL	3353-5016	100	7/8	1.23	350	1400	1.4

PS188 Power Steering Hose Power Steering

Designed to meet requirements of SAE J2050 specifications.

Recommended For: Power steering pressure lines. Designed to meet requirements of SAE J2050 specifications.

Tube: Synthetic rubber specially compounded to provide resistance to high temperatures and power steering fluid (CSM – Type M). See Hose Stock Characteristics.

Reinforcement: Two high strength nylon braids that resist high temperatures and allow for expansion for system noise dampening.

Cover: Black, synthetic rubber developed specifically to resist under hood environment (CSM).

Temperature Range: -40°F to +300°F (-40°C to +150°C).

Coupling Recommendation (See Crimp Data Manual 428-7365 or E-Crimp):
Permanent Power Steering Couplings (G50) Section R



Part No.	Description	Product No.	Standard Pack					
86049	6PS188 X25FT	3317-0107	1	3/8	.71	1500	6000	3.25
86050	6PS188 X50FT	3317-0108	1	3/8	.71	1500	6000	3.25

TH7 Hydraulic Hose - SAE 100R7 Thermoplastic

Recommended For: Petroleum, water base and synthetic hydraulic fluids. Applications include: power and telephone mobile equipment (cherry pickers), lubrication lines, blowout preventer control lines, hydraulic lifts and farm and construction machinery. TH7 hose meets or exceeds performance requirements of SAE 100R7 with a significantly tighter bend radius.

Tube: 100% seamless Nylon – Type Z that easily handles a broad range of hydraulic fluids, including phosphate esters and water glycol. See Hose Stock Characteristics.

Reinforcement: Synthetic fiber.

Cover: Black polyurethane that resists hydraulic fluids, high temperatures, aging and weathering. Black TH7 is perforated for use in general hydraulic and pneumatic service.

Temperature Range: -65°F to +200°F (-54°C to +93°C) continuous service for petroleum and synthetic oils. Maximum of +158°F (+70°C) for water, water/oil emulsions and water glycol.

Coupling Recommendation (See Crimp Data Manual 428-7365 or E-Crimp):
MegaCrimp® Couplings (G25) Section G
Swage PCTS Couplings (-2 and -3) (G51) Section O



Part No.	Description	Product No.	Standard Pack	⌀	⌀	⌚	⌚	R ²
71011	2TH7XCTN	4467-1154	250	1/8	.32	3000	12000	.5
85401	3TH7 X50FT	4467-1194	1	3/16	.41	3000	12000	.8
71012	3TH7XCTN	4467-1155	250	3/16	.41	3000	12000	.8
85402	4TH7 X50FT	4467-1195	1	1/4	.50	2750	11000	1.3
71013	4TH7XCTN	4467-1157	250	1/4	.50	2750	11000	1.3
85403	5TH7 X50FT	4467-1160	1	5/16	.56	2500	10000	1.8
71014	5TH7XCTN	4467-1159	250	5/16	.56	2500	10000	1.8
85404	6TH7 X50FT	4467-1162	1	3/8	.64	2250	9000	2.0
71015	6TH7XCTN	4467-1161	250	3/8	.64	2250	9000	2.0
85405	8TH7 X50FT	4467-1164	1	1/2	.80	2000	8000	3.0
71021	8TH7XCTN	4467-1207	250	1/2	.80	2000	8000	3.0
85406	12TH7 X50FT	4467-1193	1	3/4	1.05	1250	5000	5.0
71070	12TH7XCTN	4467-1165	200	3/4	1.05	1250	5000	5.0
85407	16TH7 X50FT	4467-1197	1	1	1.32	1000	4000	10.0
71071	16TH7XCTN	4467-1196	200	1	1.32	1000	4000	10.0

TH7NC Non Conductive Hydraulic Hose - SAE 100R7 Thermoplastic

Recommended For: Petroleum and synthetic hydraulic fluids. Applications include: power and telephone mobile equipment (cherry pickers), lubrication lines, blowout preventer control lines, hydraulic lifts and farm and construction machinery. Orange color TH7NC meets SAE 100R7 non-conductivity requirements and meets or exceeds performance requirements of SAE 100R7 with a significantly tighter bend radius. Meets ANSI A92.2 for vehicle mounted aerial devices (-4 to -8).

Tube: -2, -12, and -16: 100% seamless Nylon – Type Z that easily handles a broad range of hydraulic fluids, including phosphate esters and water glycol; -3 through -8 Polyester. See Hose Stock Characteristics.

Reinforcement: Synthetic fiber (except -2).

Cover: Orange urethane that resists hydraulic fluids, high temperatures, aging and weathering. Orange TH7NC is non-perforated for applications requiring electrical non-conductivity. Meets SAE 100R7 Electrical Conductivity Test. Maximum leakage shall not exceed 50 microamperes when subjected to 75 kV/Ft. for five minutes. (Orange is industry accepted color for non-conductive hose).

Temperature Range: -65°F to +200°F (-54°C to +93°C) continuous service for petroleum and synthetic oils. Maximum of +158°F (+70°C) for water, water/oil emulsions and water glycol.





Coupling Recommendation (See Crimp Data Manual 428-7365 or E-Crimp):
MegaCrimp® Couplings (G25) Section G
Swage PCTS Couplings (-2 and -3) (G51) Section O



Part No.	Description	Product No.	Standard Pack	⌀	⌀	⌚	⌚	R ²
71072	2TH7NCXCTN	4467-1166	250	1/8	.32	3000	12000	.5
85408	3TH7NC X50FT	4467-1205	1	3/16	.41	3000	12000	.8
71073	3TH7NCXCTN	4467-1167	250	3/16	.41	3000	12000	.8

TH7NC Non Conductive Hydraulic Hose - SAE 100R7 Thermoplastic

Continued

Part No.	Description	Product No.	Standard Pack					
85409	4TH7NC X50FT	4467-1170	1	1/4	.50	2750	11000	1.3
71016	4TH7NCXCTN	4467-1169	250	1/4	.50	2750	11000	1.3
85410	5TH7NC X50FT	4467-1172	1	5/16	.56	2500	10000	1.8
71074	5TH7NCXCTN	4467-1171	250	5/16	.56	2500	10000	1.8
85411	6TH7NC X50FT	4467-1174	1	3/8	.64	2250	9000	2.0
71017	6TH7NCXCTN	4467-1173	250	3/8	.64	2250	9000	2.0
85412	8TH7NC X50FT	4467-1206	1	1/2	.80	2000	8000	3.0
71018	8TH7NCXCTN	4467-1175	250	1/2	.80	2000	8000	3.0
85413	12TH7NC X50FT	4467-1200	1	3/4	1.05	1250	5000	5.0
71075	12TH7NCXCTN	4467-1177	200	3/4	1.05	1250	5000	5.0
85414	16TH7NC X50FT	4467-1199	1	1	1.32	1000	4000	10.0
71076	16TH7NCXCTN	4467-1198	200	1	1.32	1000	4000	10.0

TH7DL Dual Line Hydraulic Hose - SAE 100R7 Thermoplastic

Recommended For: Petroleum, water base and synthetic hydraulic fluids.
Applications include: power and telephone mobile equipment (cherry pickers), lubrication lines, blowout preventer control lines, hydraulic lifts and farm and construction machinery. TH7DL hose meets or exceeds performance requirements of SAE 100R7 with significantly tighter bend radius.

Tube: 100% seamless Nylon – Type Z that easily handles a broad range of hydraulic fluids, including phosphate esters and water glycol. See Hose Stock Characteristics.





Reinforcement: Synthetic fiber.

Cover: Black polyurethane that resists hydraulic fluids, high temperatures, aging and weathering. Black TH7DL is perforated for use in general hydraulic and pneumatic service.

Temperature Range: -65°F to +200°F (-54°C to +93°C) continuous service for petroleum and synthetic oils. Maximum of +158°F (+70°C) for water, water/oil emulsions and water glycol.

Coupling Recommendation (See Crimp Data Manual 428-7365 or E-Crimp): MegaCrimp® Couplings (G25) Section G



Part No.	Description	Product No.	Standard Pack					
71084	4TH7DLXCTN	4472-0220	250	1/4	.50	2750	11000	1.3
85422	5TH7DL X50FT	4472-0222	1	5/16	.56	2500	10000	1.8
71085	5TH7DLXCTN	4472-0221	250	5/16	.56	2500	10000	1.8
71022	6TH7DLXCTN	4472-0223	250	3/8	.64	2250	9000	2.0
71086	8TH7DLXCTN	4472-0224	250	1/2	.80	2000	8000	3.0

TH7NCDL Non Conductive Dual Line Hydraulic Hose - SAE 100R7 Thermoplastic

Recommended For: Petroleum, water base and synthetic hydraulic fluids.
Applications include: power and telephone mobile equipment (cherry pickers), lubrication lines, blowout preventer control lines, hydraulic lifts and farm and construction machinery. Orange color TH7NCDL meets SAE 100R7 non-conductivity requirements and meets or exceeds performance requirements of SAE 100R7 with significantly tighter bend radius. Meets ANSI A92.2 for vehicle mounted aerial devices (-3 and -8).

Tube: Polyester.

Reinforcement: Synthetic fiber.

Cover: Orange urethane that resists hydraulic fluids, high temperatures, aging and weathering. Orange TH7NCDL is non-perforated for applications requiring electrical non-conductivity. Meets SAE 100R7 Electrical Conductivity Test. Maximum leakage shall not exceed 50 microamperes when subjected to 75 kV/Ft. for five minutes. (Orange is industry accepted color for non-conductive hose.)

Temperature Range: -65°F to +200°F (-54°C to +93°C) continuous service for petroleum and synthetic oils. Maximum of +158°F (+70°C) for water, water/oil emulsions and water glycol.

Coupling Recommendation (See Crimp Data Manual 428-7365 or E-Crimp):
MegaCrimp® Couplings (G25) Section G



Part No.	Description	Product No.	Standard Pack	⌀	Ø	⌚	⌚	R ²
85786	4TH7NCDL X50FT	4472-0226	1	1/4	.50	2750	11000	1.3
71087	4TH7NCDLXCTN	4472-0225	250	1/4	.50	2750	11000	1.3
85424	6TH7NCDL X50FT	4472-0228	1	3/8	.64	2250	9000	2.0
71088	6TH7NCDLXCTN	4472-0227	250	3/8	.64	2250	9000	2.0
71089	8TH7NCDLXCTN	4472-0229	250	1/2	.80	2000	8000	3.0

TH8 Hydraulic Hose - SAE 100R8 Thermoplastic

Recommended For: Use with petroleum, water base and synthetic hydraulic fluids.
Applications include: power and telephone mobile equipment (cherry pickers), lubrication lines, blowout preventer control lines, hydraulic lifts and farm and construction machinery. TH8 hose meets or exceeds performance requirements of SAE 100R8 with a significantly tighter bend radius. Multiline available.

Tube: 100% seamless Nylon – Type Z that easily handles a broad range of hydraulic fluids, including phosphate esters and water glycol. See Hose Stock Characteristics.

Reinforcement: Polyester.

Cover: Black urethane resists hydraulic fluids, high temperatures, aging and weathering. Black TH8 cover is perforated for use in general hydraulic and pneumatic service.

Temperature Range: -65°F to +200°F (-54°C to +93°C) continuous service for petroleum and synthetic oils. Maximum of +158°F (+70°C) for water, water/oil emulsions and water glycol.

Coupling Recommendation (See Crimp Data Manual 428-7365 or E-Crimp):
MegaCrimp® Couplings (-4 through -16) (G25) Section G
Swage PCTS Couplings (-3 only) (G51) Section O



Part No.	Description	Product No.	Standard Pack	⌀	Ø	⌚	⌚	R ²
85415	3TH8 X50FT	4467-1201	1	3/16	.50	5000	20000	1.5
71077	3TH8XCTN	4467-1178	250	3/16	.50	5000	20000	1.5
85416	4TH8 X50FT	4467-1180	1	1/4	.61	5000	20000	2.0
71078	4TH8XCTN	4467-1179	250	1/4	.61	5000	20000	2.0
85417	6TH8 X50FT	4467-1182	1	3/8	.75	4000	16000	2.5
71079	6TH8XCTN	4467-1181	250	3/8	.75	4000	16000	2.5
85418	8TH8 X50FT	4467-1202	1	1/2	.87	3500	14000	4.0
71019	8TH8XCTN	4467-1183	250	1/2	.87	3500	14000	4.0
71080	12TH8XCTN	4467-1184	200	3/4	1.13	2250	9000	6.5
71081	16TH8XCTN	4467-1185	200	1	1.45	2000	8000	10.0

TH8NC Non Conductive Hydraulic Hose - SAE 100R8 Thermoplastic

Recommended For: Use with petroleum, water base and synthetic hydraulic fluids. Applications include: power and telephone mobile equipment (cherry pickers), lubrication lines, blowout preventer control lines, hydraulic lifts and farm and construction machinery. TH8NC hose (orange cover) meets SAE 100R8 non-conductivity requirements. TH8NC hose meets or exceeds performance requirements of SAE 100R8 with a significantly tighter bend radius. Multiline available.

Tube: 100% seamless Nylon – Type Z that easily handles a broad range of hydraulic fluids, including phosphate esters and water glycol. See Hose Stock Characteristics.





Reinforcement: Polyester.

Cover: Orange urethane resists hydraulic fluids, high temperatures, aging and weathering. TH8NC is non-perforated for applications requiring electrical non-conductivity. Meets SAE 100R8 Electrical Conductivity Test. Maximum leakage shall not exceed 50 microamperes when subjected to 75 kV/Ft. for five minutes. (Orange is industry accepted color for non-conductive hose).

Temperature Range: -65°F to +200°F (-54°C to +93°C) continuous service for petroleum and synthetic oils. Maximum of +158°F (+70°C) for water, water/oil emulsions and water glycol.

Coupling Recommendation (See Crimp Data Manual 428-7365 or E-Crimp): MegaCrimp® Couplings (G25) Section G



Part No.	Description	Product No.	Standard Pack					
85419	4TH8NC X50FT	4467-1187	1	1/4	.61	5000	20000	2.0
71020	4TH8NCXCTN	4467-1186	250	1/4	.61	5000	20000	2.0
85420	6TH8NC X50FT	4467-1203	1	3/8	.75	4000	16000	2.5
71082	6TH8NCXCTN	4467-1204	250	3/8	.75	4000	16000	2.5
85421	8TH8NC X50FT	4467-1190	1	1/2	.87	3500	14000	4.0
71083	8TH8NCXCTN	4467-1189	250	1/2	.87	3500	14000	4.0

TH18 Constant Pressure Hydraulic Hose - SAE 100R18 Thermoplastic

Recommended For: TH18 hose meets or exceeds performance requirements of SAE 100R18 with a significantly tighter bend radius. Suitable for petroleum or synthetic-based hydraulic fluids in hydraulic systems. TH18 is ideal for industrial and agricultural applications exposed to low temperatures or cyclic and quick temperature changes. Remains highly flexible in cold weather conditions and is resistant to hydraulic fluids, high temperatures, aging and weathering.

Tube: Polyester elastomer.





Reinforcement: Synthetic fiber.

Cover: Black, special polyester, perforated.

Temperature Range: -67°F to +212°F (-55°C to +100°C) continuous service for petroleum and synthetic oils. Maximum of +158°F (+70°C) for water-based fluids.

Coupling Recommendation (See Crimp Data Manual 428-7365 or E-Crimp): MegaCrimp® Couplings (with TuffCoat™ plating) (G25) Section G



Part No.	Description	Product No.	Standard Pack					
71001	4TH18XCTN	4467-0006	250	1/4	.48	3000	12000	1.4
71002	5TH18XCTN	4467-0007	250	5/16	.56	3000	12000	1.8
71003	6TH18XCTN	4467-0008	250	3/8	.65	3000	12000	1.8
71004	8TH18XCTN	4467-0009	250	1/2	.89	3000	12000	2.8
71005	10TH18XCTN	4467-0010	250	5/8	1.03	3000	12000	3.9

TH18NC Constant Pressure Non Conductive Hydraulic Hose - SAE 100R18 Thermoplastic

Recommended For: TH18NC hose meets or exceeds performance requirements of SAE 100R18 with a significantly tighter bend radius. Suitable for petroleum or synthetic-based hydraulic fluids in hydraulic systems. TH18NC non-conductive hose are suitable for use in high-voltage applications. Remains highly flexible in cold weather conditions and is resistant to hydraulic fluids, high temperatures, aging and weathering.

Tube: Polyester elastomer.





Reinforcement: Synthetic fiber.

Cover: Special polyester, orange (industry-accepted color for non-conductive hose), non-perforated for applications requiring electrical non-conductivity. Meets SAE 100R18 Electrical Conductivity Test. Maximum leakage shall not exceed 50 microamperes when subjected to 75kV/ft for five minutes.

Temperature Range: -67°F to +212°F (-55°C to +100°C) continuous service for petroleum and synthetic oils. Maximum of +158°F (+70°C) for water-based fluids.

Coupling Recommendation (See Crimp Data Manual 428-7365 or E-Crimp): MegaCrimp® Couplings (with TuffCoat™ plating) (G25) Section G



Part No.	Description	Product No.	Standard Pack					
71006	4TH18NCXCTN	4467-0011	250	1/4	.48	3000	12000	1.4
71007	5TH18NCXCTN	4467-0012	250	5/16	.56	3000	12000	1.8
71008	6TH18NCXCTN	4467-0013	250	3/8	.65	3000	12000	1.8
71009	8TH18NCXCTN	4467-0014	250	1/2	.89	3000	12000	2.8
71010	10TH18NCXCTN	4467-0015	250	5/8	1.03	3000	12000	3.9

NOTES

IN THE SHOP OR IN THE FIELD, GATES HAS A CRIMPER FOR EVERY JOB.

MOBILECRIMP® 4-20



- > The latest in high tech crimping.
- > Portable and lightweight – only 57 pounds.
- > Powerful enough to crimp up to 1-1/4" I.D. four spiral-wire hose.
- > Great for jobs in the field.

SC-32™ CRIMPER



- > Compact design to minimize space required.
- > High-ton ram force with an integrated pump.
- > Pump pre-wired for either 110 Volt or 220 Volt [1 phase] outlets.
- > Bottom-loading makes crimping easier.
- > Come with all the base plates and spacers required to crimp up to 2" hose.

POWER CRIMP® 707



- > The most precise, yet simplest crimper made.
- > The first crimper with electronic digital readout to indicate crimp diameter setting.
- > Crimps low pressure return lines to high pressure spiral hose, from 3/16" to 1-1/4" I.D. four-spiral wire.
- > Crimps straight and bent tube couplings plus 45° and 90° block types.
- > Swage capable.

GC32-XD® CRIMPER



- > Crimps every hose and coupling in the Gates hydraulic catalog, including 2-1/2" Global MegaVac® return lines.
- > Accepts electrical input from 208 volts to 260 volts, single phase.
- > Twice as fast as the Gates OmniCrimp 21 crimper, which the GC32-XD is replacing.
- > Patented quick change tool enables fast loading and unloading of color-coded, numbered dies.
- > 470 Radial Ton crimping force

GC96® CRIMPER



- > Electronic touch screen control panel for fast input of crimper settings.
- > Horizontal front-end feed makes crimping easier and convenient.
- > 340 ton force that allows crimping of a wide variety of couplings.
- > 2 speed die closure and rapid retract permit fast assembly fabrication.
- > Full range die sets that enable production of a wide range of hose assemblies.
- > 2" 6 wire and 6" industrial

For complete crimper specifications, see the following pages.

EQUIPMENT

HOSE/CPLG. SELECTION

G8K COUPLINGS

GLOBALSPIRAL COUPLINGS

STAINLESS STEEL SPIRAL

MEGACRIMP COUPLINGS

STAINLESS STEEL BRAID

POWER CRIMP COUPLINGS

FIELD ATTACHABLE G1 & G2 COUPLINGS

FIELD ATTACHABLE C5 COUPLINGS

GLX COUPLINGS

GL COUPLINGS

C14 COUPLINGS

PCTS THERMOPLASTIC COUPLINGS

POLARSEAL COUPLINGS

POLARSEAL II COUPLINGS

POWER STEERING

ADAPTERS

QUICK DISCONNECT COUPLERS

BALL VALVES

LIVE SWIVEL

ASSEMBLY FABRICATION

ACCESSORIES

EQUIPMENT AND PARTS

AIR BRAKE

BRASS

KITS

EQUIPMENT
HOSE/CPLG. SELECTION
G8K COUPLINGS
GLOBALSPIRAL COUPLINGS
STAINLESS STEEL SPIRAL
MEGACRIMP COUPLINGS
STAINLESS STEEL BRAID
POWER CRIMP COUPLINGS
FIELD ATTACHABLE G1 & G2 COUPLINGS
FIELD ATTACHABLE C5 COUPLINGS
GLX COUPLINGS
GL COUPLINGS
C14 COUPLINGS
PCTS THERMOPLASTIC COUPLINGS
POLARSEAL COUPLINGS
POLARSEAL II COUPLINGS
POWER STEERING
ADAPTERS
QUICK DISCONNECT COUPLERS
BALL VALVES
LIVE SWIVEL
ASSEMBLY FABRICATION
ACCESSORIES
EQUIPMENT AND PARTS
AIR BRAKE
BRASS
KITS

MOBILECRIMP® 4-20 CRIMPER

This lightweight, versatile crimper is powerful enough to crimp up to 1-1/4" four spiral-wire hose. Weighing approximately 57 pounds, this new field crimper combines the latest crimping technology with old-fashioned toughness and durability.

DIGITAL DIAL CONTROL

Just dial in appropriate crimp setting and hold the start button until light comes on and buzzer sounds, then release. Ability to lock-in setting for multiple assemblies. Light and buzzer operate on two "AAA" batteries.

Part Number: 77421
Product Number: 7480-0051

POSITIVE STOP CONTROL

No settings necessary since color-coded spacer rings control the crimp. Just hold the start button until the ram extends to a fixed "Stop" for each crimp, then release. Controlled crimp stroke for ease of repeatability.

Part Number: 77420
Product Number: 7480-0050



Accessories	Part Number	Product Number
Crimper-to-Pump Male Quick Disconnect	G95311-0606	7252-8831
Crimper-to-Pump Female Quick Disconnect	G95321-0606	7252-8830

MobileCrimp® 4-20 Die Selection Table

For MegaCrimp® (G25) Couplings

Hose Type	Hose Sizes						
	1/4"	3/8"	1/2"	5/8"	3/4"	1"	1-1/4"
M3K	MC21 or MC31	MC22 or MC32	MC33	MC34	MC35	MC37	—
M2T	MC21 or MC31	MC22 or MC32	MC33	MC34	MC35	MC37	—
G1	MC21 or MC31	MC22 or MC32	MC33	MC34	MC35	MC37	MC39
G2	MC21 or MC31	MC22 or MC32	MC33	MC34	MC35	MC37	MC39

For GlobalSpiral™ (G20) Couplings

Hose Type	Hose Sizes					
	3/8"	1/2"	5/8"	3/4"	1"	1-1/4"
EFG6K	MC33	MC33	MC35	MC35	MC37	—
EFG5K	MC33	MC33	MC35	MC35	MC37	—
EFG4K	MC33	MC33	MC35	MC35	MC37	MC39*

*MGS (G21 series) couplings only.

Die Sets (ordered separately)

Die Set	MC21/MC31	MC22/MC32	MC33	MC34	MC35	MC37	MC39
Part No.	78558/78468	78559/78469	78470	78471	78472	78474	78476
Product No.	7482-1220/1018	7482-1221/1019	7482-1133	7482-1134	7482-1135	7482-1137	7482-1139

MOBILECRIMP® 4-20 POWER SOURCES

Wide selection of pumps to match all your power needs.



HAND PUMP

No power source needed. Economical, convenient and portable for use anywhere. Make factory-quality assemblies in the field to minimize downtime.

Part Number: 77821
Product Number: 7481-0006
Pressure Rating: 10,000 psi
Weight: 25.6 lbs.

SHOP AIR PUMP

Works off standard shop air (90 psi). Economical, convenient and versatile for use wherever 90 psi compressed air is available.

Part Number: 77820
Product Number: 7481-0002
Pressure Rating: 10,000 psi
Weight: 10 lbs.

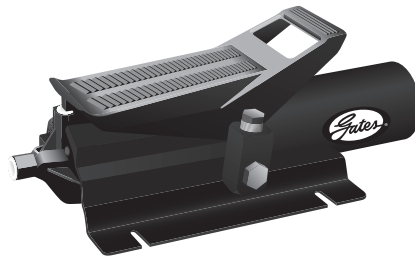

1/2 HP 115 VOLT AC PUMP

Medium speed. Economical. Recommended for a stationary or mobile application.

Part Number: 77441
Product Number: 7481-0034
Pressure Rating: 10,000 psi
Weight: 32 lbs.



1-1/2 HP 115 VOLT AC PUMP

High speed. Recommended for stationary applications only.

Part Number: 77442
Product Number: 7481-0035
Pressure Rating: 10,000 psi
Weight: 108 lbs.



1/4 HP 12 VOLT DC PUMP

Mobile operation, runs on standard 12 volt car/truck battery or a 12 volt portable battery pack. Ideal for tough jobs in the field.

Part Number: 77439
Product Number: 7481-0037
Pressure Rating: 10,000 psi
Weight: 20.5 lbs.



EQUIPMENT

HOSE/CPLG. SELECTION

G8K COUPLINGS

GLOBALSPIRAL COUPLINGS

STAINLESS STEEL SPIRAL

MEGACRIMP COUPLINGS

STAINLESS STEEL BRAID

POWER CRIMP COUPLINGS

FIELD ATTACHABLE G1 & G2 COUPLINGS

FIELD ATTACHABLE C5 COUPLINGS

GLX COUPLINGS

GL COUPLINGS

C14 COUPLINGS

PCTS THERMOPLASTIC COUPLINGS

POLARSEAL COUPLINGS

POLARSEAL II COUPLINGS

POWER STEERING

ADAPTERS

QUICK DISCONNECT COUPLERS

BALL VALVES

LIVE SWIVEL

ASSEMBLY FABRICATION

ACCESSORIES

EQUIPMENT AND PARTS

AIR BRAKE

BRASS

KITS

Equipment

EQUIPMENT

HOSE/CPLG. SELECTION

G8K COUPLINGS

GLOBALSPIRAL COUPLINGS

STAINLESS STEEL SPIRAL

MEGACRIMP COUPLINGS

STAINLESS STEEL BRAID

POWER CRIMP COUPLINGS

FIELD ATTACHABLE G1 & G2 COUPLINGS

FIELD ATTACHABLE C5 COUPLINGS

GLX COUPLINGS

GL COUPLINGS

C14 COUPLINGS

PCTS THERMOPLASTIC COUPLINGS

POLARSEAL COUPLINGS

POLARSEAL II COUPLINGS

POWER STEERING

ADAPTERS

QUICK DISCONNECT COUPLERS

BALL VALVES

LIVE SWIVEL

ASSEMBLY FABRICATION

ACCESSORIES

EQUIPMENT AND PARTS

AIR BRAKE

BRASS

KITS

POWER CRIMP® 707

Gates Power Crimp 707 is the most precise, yet simplest crimper made. It was the first crimper with electronic digital readout to indicate gauge setting. The toughest part about using the 707 is pushing a button. It takes just a few seconds to make factory-quality hose assemblies.

Crimps most hydraulic hose from low pressure return lines to extremely high pressure spirals, from 3/16" to 1-1/4" I.D. Crimps straight and bent tube couplings, plus 45° and 90° block types. Can also be adapted for use as a power swager.

SPECIFICATIONS

Part Number: 77700

Product Number: 7480-0043

Standard PC707 without die sets wired for 115 volts (includes die backup ring and a notched cone).

Production Rate: 100 assemblies per hour (using 1/2" I.D. two-wire straight thread assemblies).

Dimensions: 13" wide by 12" deep by 26-1/2" high.

Weight: 188 lbs.

PC707 230V Converter Kit

Converts crimper and pump

Part Number: 78760

Product Number: 7482-0499

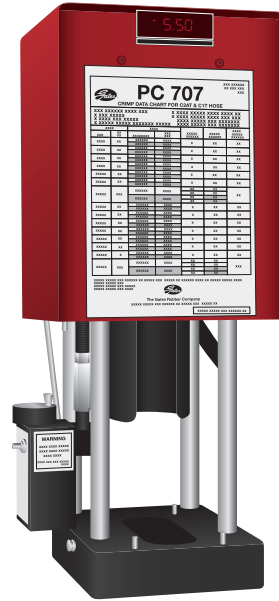

Power Crimp® 707 Die Selection Table

For MegaCrimp® (G25) Couplings

Hose Type	Hose Sizes						
	1/4"	3/8"	1/2"	5/8"	3/4"	1"	1-1/4"
M3K	721 or 731	722 or 732	733	734	735	737	—
M2T	721 or 731	722 or 732	733	734	735	737	—
G1	721 or 731	722 or 732	733	734	735	737	739
G2	721 or 731	722 or 732	733	734	735	737	739

For GlobalSpiral™ (G20) Couplings

Hose Type	Hose Sizes					
	3/8"	1/2"	5/8"	3/4"	1"	1-1/4"
EFG6K	733	733	735	735	737	—
EFG5K	733	733	735	735	737	—
EFG4K	733	733	735	735	737	739

Die Sets (ordered separately)

Die Set	721/731	722/732	733	734	735	737*	739*
Part No.	75943/78931	78844/78932	78933	78934	78935	78937	78939
Product No.	7482-1217/0931	7482-1218/0932	7482-0933	7482-0934	7482-0935	7482-0937	7482-0939

* Must Use No-Notch Die Cone.

Power Crimp® Power Source

The flows of two fixed displacement pumps are combined to deliver a high volume of oil at low pressure for fast transversion.

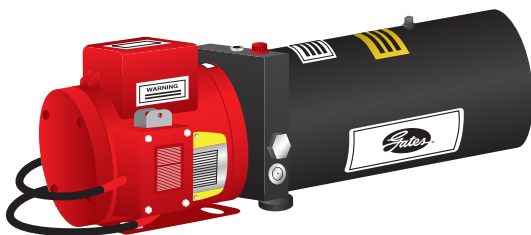

SPECIFICATIONS

Part Number: 77810

Product Number: 7481-0023

[115 volt, 30 amp, circuit, 1 h.p., 60 cycles]

Dimensions: 12" wide by 25" deep by 12" high.

Weight: 70 lbs.

Maximum Working Pressure: 4,900 psi.

SC32™ CRIMPER

The Gates SC32 crimper is a versatile, easy-to-use, economical machine suitable for a hard-working shop environment. It is offered in 110V and 220V single phase versions to match the shop power supply. This rugged crimper is designed for continued use to meet day-to-day shop and counter needs for crimps on hose up to 1-1/4" I.D. with occasional crimps for larger assemblies up to 2", 6-spiral hose.

Part Number: 77500

Product Number: 7480-0070

Wired for 220 Volts with 2 HP electric pump

Part Number: 77501

Product Number: 7480-0071

Wired for 110 Volts with 1 HP electric pump

SPECIFICATIONS

Dimensions: 16.5" W x 32" D x 29" H

Max. Rated Working Pressure: 10,000 psi

Max. Crimping Force: 80 tons

Weight: 275lbs



SC32™ Die Selection Table

For GlobalSpiral™ (G20) Couplings

Hose Type	Hose Sizes					
	3/8"	1/2"	5/8"	3/4"	1"	1-1/4"
EFG3K	733	733	735	735	737	—
EFG4K	733	733	735	735	737	—
EFG5K	733	733	735	735	737	739

For MegaCrimp® (G25) Couplings

Hose Type	Hose Sizes						
	1/4"	3/8"	1/2"	5/8"	3/4"	1"	1-1/4"
M3K	721 or 731	722 or 732	733	734	735	737	—
M2T	721 or 731	722 or 732	733	734	735	737	—
G1	721 or 731	722 or 732	733	734	735	737	739
G2	721 or 731	722 or 732	733	734	735	737	739

For GSP (G22) & GSM (G23, G24) Couplings

Hose Type	Hose Sizes	
	1-1/2"	2"
EFG6K	311	—
EFG5K	311	314
EFG3K	311	313
G1H	310(L)	313
G2H	310(L)	312

Die Sets (ordered separately)

Die Set	721/731	722/732	733	734	735	737*	739*
Part No.	78943/78931	78944/78932	78933	78934	78935	78937	78939
Product No.	7482-1217/0931	7482-1218/0932	7482-0933	7482-0934	7482-0935	7482-0937	7482-0939

Die Set	SC32-310L	SC32-311	SC32-312	SC32-313	SC32-314
Part No.	78977	78978	78979	78980	78981
Product No.	7482-1710	7482-1711	7482-1712	7482-1713	7482-1714

* Must Use No-Notch Die Cone.

EQUIPMENT

HOSE/CPLG. SELECTION

G8K COUPLINGS

GLOBALSPIRAL COUPLINGS

STAINLESS STEEL SPIRAL

MEGACRIMP COUPLINGS

STAINLESS STEEL BRAID

POWER CRIMP COUPLINGS

FIELD ATTACHABLE G1 & G2 COUPLINGS

FIELD ATTACHABLE C5 COUPLINGS

GLX COUPLINGS

GL COUPLINGS

C14 COUPLINGS

PCTS THERMOPLASTIC COUPLINGS

POLARSEAL COUPLINGS

POLARSEAL II COUPLINGS

POWER STEERING

ADAPTERS

QUICK DISCONNECT COUPLERS

BALL VALVES

LIVE SWIVEL

ASSEMBLY FABRICATION

ACCESSORIES

EQUIPMENT AND PARTS

AIR BRAKE

BRASS

KITS

Equipment

EQUIPMENT
HOSE/CPLG. SELECTION
G8K COUPLINGS
GLOBALSPIRAL COUPLINGS
STAINLESS STEEL SPIRAL
MEGACRIMP COUPLINGS
STAINLESS STEEL BRAID
POWER CRIMP COUPLINGS
FIELD ATTACHABLE G1 & G2 COUPLINGS
FIELD ATTACHABLE C5 COUPLINGS
GLX COUPLINGS
GL COUPLINGS
C14 COUPLINGS
PCTS THERMOPLASTIC COUPLINGS
POLARSEAL COUPLINGS
POLARSEAL II COUPLINGS
POWER STEERING
ADAPTERS
QUICK DISCONNECT COUPLERS
BALL VALVES
LIVE SWIVEL
ASSEMBLY FABRICATION
ACCESSORIES
EQUIPMENT AND PARTS
AIR BRAKE
BRASS
KITS

GC32-XD® CRIMPER

The new GC32-XD crimper from Gates crimps every hose and coupling in our hydraulics catalog—fast. The open crimper head accommodates any Gates hose construction or coupling configuration, including 2-1/2" Global MegaVac® return lines. And it makes them at a rate that's twice as fast as the Gates OmniCrimp 21 crimper, which the GC32-XD is replacing. Internally, the GC32-XD uses a unique cloverleaf* design that simply produces a better crimp. Unlike standard annular head configurations, Gates exclusive cloverleaf design reinforces the piston so the dies move smoother for more consistent crimps without any taper in the crimp O.D.



SPECIFICATIONS

Part Number: 78828
Product Number: 7480-7001
Dimensions: 37" high by 23" wide by 19-1/2" deep
Weight: 660 lbs.
Motor: 5 hp
Pump: 2-stage
Power Source: 208-260V, 45-65 Hz, 1 phase and 20 Amps
Maximum Operating Pressure: 470 tons

Rack and Stand sold Separately

Stand: Part Number: 78829

Product Number: 7482-7002

25-1/2" high by 31-3/4" wide by
 16-1/2" deep (height adjustable)

Die Rack: Part Number: 78830

Product Number: 7482-7003

*Patent pending

For GlobalSpiral™ (G20) Couplings

Hose Type	Hose Sizes					
	3/8"	1/2"	5/8"	3/4"	1"	1-1/4"
EFG6K	32-33	32-33	32-35	32-35	32-37	32-310L
EFG5K	32-33	32-33	32-35	32-35	32-37	32-310L
EFG4K	32-33	32-33	32-35	32-35	32-37	32-39

For GSP (G22) & GSM (G23, G24) Couplings

Hose Type	Hose Sizes	
	1-1/2"	2"
EFG6K	32-311	—
EFG5K	32-311	32-314
EFG3K	32-311	32-313
G1H	32-310(L)	32-313
G2H	32-310(L)	32-312

For MegaCrimp® (G25) Couplings

Hose Type	Hose Sizes						
	1/4"	3/8"	1/2"	5/8"	3/4"	1"	1-1/4"
M3K	32-21 or 32-31	32-22 or 32-32	32-33	32-34	32-35	32-37	—
M2T	32-21 or 32-31	32-22 or 32-32	32-33	32-34	32-35	32-37	—
G1	32-21 or 32-31	32-22 or 32-32	32-33	32-34	32-35	32-37	32-39
G2	32-21 or 32-31	32-22 or 32-32	32-33	32-34	32-35	32-37	32-39

For LifeGuard® Sleeving

1/4"	3/8"	1/2"
32-3234	32-3335	32-3436
5/8"	3/4"	1"
32-3537	32-3638	32-38311

Die Sets (ordered separately)

Die Set	32-21	32-22	32-31	32-33	32-34	32-35	32-36
Part No.	78860	78861	78862	78863	78864	78865	78866
Product No.	7482-7128	7482-7129	7482-7130	7482-7131	7482-7132	7482-7133	7482-7134
Die Set	32-37	32-38	32-39	32-310L	32-311	32-312	32-313
Part No.	78867	78868	78869	78870	78871	78872	78873
Product No.	7482-7135	7482-7136	7482-7137	7482-7138	7482-7139	7482-7140	7482-7141
Die Set	32-314	32-40	32-41	32-42	32-43	32-44	32-46
Part No.	78874	78875	78876	78877	78878	78879	78880
Product No.	7482-7142	7482-7143	7482-7144	7482-7145	7482-7146	7482-7147	7482-7148
Die Set	32-81	32-82	32-83	32-71	32-72	32-73	32-74
Part No.	78881	78882	78883	78671	78672	78673	78674
Product No.	7482-7149	7482-7150	7482-7151	7482-7200	7482-7201	7482-7202	7482-7203
Die Set	32-75	32-84	32-85	32-86	32-87	32-331	32-45
Part No.	78675	78884	78885	78886	78887	78888	78889
Product No.	7482-7204	7482-7152	7482-7153	7482-7154	7482-7155	7482-7156	7482-7157
Die Set	32-3234	32-3335	32-3436	32-33537	32-3638	32-38311	
Part No.	78792	78790	78791	78776	78777	78786	
Product No.	7482-1419	7482-1420	7482-1421	7482-1430	7482-1431	7482-1443	

GC96® CRIMPER

The GC96 crimper is capable of crimping 2" 6 wire and up to 6" I.D. industrial hose. This crimper allows distributors to make reliable and professional looking assemblies providing more value to the end user. The large crimper head allows industrial hose assemblies to be made with a variety of terminations using crimpable ferrules and sleeves. The GC96 crimper has additional versatility since in conjunction with optional spacer dies and GC32-XD® dies; it can make Gates hydraulic hose assemblies also.

SPECIFICATIONS

Product Number: 7480-9001

Dimensions: 31" high by 32" wide by 16" deep

Weight: 650 lbs.

Power Source: 208-264V, 45-65 Hz, single phase and 20 amps

Capability: 1/4"-2" Hydraulic hose 2-1/2"-4" Industrial hose

5"-6" Industrial hose up to and including 100 psi WP

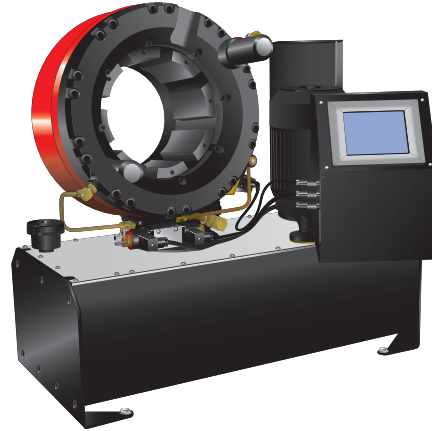

For GlobalSpiral™ (G20) Couplings

Hose Type	Hose Sizes					
	3/8"	1/2"	5/8"	3/4"	1"	1-1/4"
EFG6K	32-33	32-33	32-35	32-35	32-37	32-310L
EFG5K	32-33	32-33	32-35	32-35	32-37	32-310L
EFG4K	32-33	32-33	—	32-35	32-37	32-39

For MegaCrimp® (G25) Couplings

Hose Type	Hose Sizes						
	1/4"	3/8"	1/2"	5/8"	3/4"	1"	1-1/4"
M3K	32-21 or 32-31	32-22 or 32-32	32-33	32-34	32-35	32-37	—
M2T	32-21 or 32-31	32-22 or 32-32	32-33	32-34	32-35	32-37	—
G1	32-21 or 32-31	32-22 or 32-32	32-33	32-34	32-35	32-37	32-39
G2	32-21 or 32-31	32-22 or 32-32	32-33	32-34	32-35	32-37	32-39

For GSP (G22) & GSM (G23, G24) Couplings

Hose Type	Hose Sizes	
	1-1/2"	2"
EFG6K	32-311	—
EFG5K	32-311	32-314
EFG3K	32-311	32-313
G1H	32-310(L)	32-313
G2H	32-310(L)	32-312

For LifeGuard® Sleeving

	Hose Sizes		
	1/4"	3/8"	1/2"
	32-3234	32-3335	32-3436
	5/8"	3/4"	1"
	32-3537	32-3638	32-38311

Die Sets (ordered separately)

Die Set	32-21	32-22	32-31	32-33	32-34	32-35	32-36
Part No.	78860	78861	78862	78863	78864	78865	78866
Product No.	7482-7128	7482-7129	7482-7130	7482-7131	7482-7132	7482-7133	7482-7134
Die Set	32-37	32-38	32-39	32-310L	32-311	32-312	32-313
Part No.	78867	78868	78869	78870	78871	78872	78873
Product No.	7482-7135	7482-7136	7482-7137	7482-7138	7482-7139	7482-7140	7482-7141
Die Set	32-314	32-40	32-41	32-42	32-43	32-44	32-46
Part No.	78874	78875	78876	78877	78878	78879	78880
Product No.	7482-7142	7482-7143	7482-7144	7482-7145	7482-7146	7482-7147	7482-7148
Die Set	32-81	32-82	32-83	32-71	32-72	32-73	32-74
Part No.	78881	78882	78883	78671	78672	78673	78674
Product No.	7482-7149	7482-7150	7482-7151	7482-7200	7482-7201	7482-7202	7482-7203
Die Set	32-75	32-84	32-85	32-86	32-87	32-331	32-45
Part No.	78675	78884	78885	78886	78887	78888	78889
Product No.	7482-7204	7482-7152	7482-7153	7482-7154	7482-7155	7482-7156	7482-7157
Die Set	32-3234	32-3335	32-3436	32-33537	32-3638	32-38311	
Part No.	78792	78790	78791	78776	78777	78786	
Product No.	7482-1419	7482-1420	7482-1421	7482-1430	7482-1431	7482-1443	

EQUIPMENT

HOSE/CPLG. SELECTION

G8K COUPLINGS

GLOBALSPIRAL COUPLINGS

STAINLESS STEEL SPIRAL

MEGACRIMP COUPLINGS

STAINLESS STEEL BRAID

POWER CRIMP COUPLINGS

FIELD ATTACHABLE G1 & G2 COUPLINGS

FIELD ATTACHABLE C5 COUPLINGS

GLX COUPLINGS

GL COUPLINGS

C14 COUPLINGS

PCTS THERMOPLASTIC COUPLINGS

POLARSEAL COUPLINGS

POLARSEAL II COUPLINGS

POWER STEERING

ADAPTERS

QUICK DISCONNECT COUPLERS

BALL VALVES

LIVE SWIVEL

ASSEMBLY FABRICATION

ACCESSORIES

EQUIPMENT AND PARTS

AIR BRAKE

BRASS

KITS

EQUIPMENT
HOSE/CPLG. SELECTION
G8K COUPLINGS
GLOBALSPIRAL COUPLINGS
STAINLESS STEEL SPIRAL
MEGACRIMP COUPLINGS
STAINLESS STEEL BRAID
POWER CRIMP COUPLINGS
FIELD ATTACHABLE G1 & G2 COUPLINGS
FIELD ATTACHABLE C5 COUPLINGS
GLX COUPLINGS
GL COUPLINGS
C14 COUPLINGS
PCTS THERMOPLASTIC COUPLINGS
POLARSEAL COUPLINGS
POLARSEAL II COUPLINGS
POWER STEERING
ADAPTERS
QUICK DISCONNECT COUPLERS
BALL VALVES
LIVE SWIVEL
ASSEMBLY FABRICATION
ACCESSORIES
EQUIPMENT AND PARTS
AIR BRAKE
BRASS
KITS

POLARSEAL® HOSE PORTABLE CRIMPER II



Part Number: 77716
Product Number: 7480-6599

Gates portable PolarSeal Crimper II is a hand-operated hose crimping machine specifically designed for crimping Gates PolarSeal couplings and is intended for use with Gates PolarSeal refrigerant hose. Standard dies included will crimp 5/16" [-6 Black], 13/32" [-8 Blue], 1/2" [-10 Green] and 5/8" [-12 Clear] sizes.

Features:

- > Portable hand operation, easy to change over from size to size.
- > Heavy-duty construction for use with air impact wrenches.
- > Crimps two-braid dimension or nylon barrier hose.
- > OE-style bubble crimp.
- > Quick-change dies, no tools required to change sizes.
- > Lightweight for easy handling, less than six pounds.
- > Capable of crimping underhood air conditioning applications.
- > Includes four color-coded die sets for crimping two-braid barrier hose.
- > Removable die holder accommodates complicated shapes.
- > Color-coded, urethane encased dies.
- > Unit can be bench-mounted.
- > Shipped in a custom carrying case with instructions.
- > No electrical requirements.
- > Locator flag centers ferrule in dies.

POLARSEAL® II HOSE PLIERS



Ratcheting Pliers

Straight Jaw Pliers

Notched Jaw Pliers

The PolarSeal II pliers are used to crimp the clamps on PolarSeal II couplings. The ratcheting pliers will not release until the crimp is complete guaranteeing a proper seal. The straight jaw pliers are used when there are no obstructions to hinder crimping. The notched jaw pliers are for use in tight quarters. Use the side or the front of the pliers to complete the crimp.

Ratcheting Pliers

Part Number: 77953
Product Number: 7369-5503

Notched Jaw Pliers

Part Number: 77951
Product Number: 7369-5501

Straight Jaw Pliers

Part Number: 77952
Product Number: 7369-5502

HYDRAULIC HOSE REEL RACK



This sturdy and convenient rack stores three reels of hose.

Part Number: 78186
Product Number: 7484-0019
Dimensions: 30" deep by 28" wide by 72" high

HYDRAULIC COUPLING CABINET

Customized to fit all your needs!

Now even more versatile, these easy-to-assemble units are compactly designed to give you years of reliable service. Components are ordered individually by product number for easy customization.

1. MobileCrimp® 4-20

Pre-drilled holes in mounting shelf [item #2 below] allows easy mounting of either the Positive Stop or Digital Dial MobileCrimp 4-20 crimper.

Safety Hint:

If the MobileCrimp 4-20 is mounted on top of the cabinet, you **must**:

- > Use crimper mounting shelf [item #2 below]
- > Bolt shelf and cabinet to wall using pre-drilled holes
- > Not use the caster leg set

2. Mounting Shelf for MC 4-20 Crimper

Part Number: 78193
Product No. 7484-0013

3. Coupling Cabinet with Four Sliding Shelves [Two Shown]

Part Number: 78190
Product No. 7484-0010

Shelves slide out for easy access and can hold a combination of ten 3-1/2" wide bin boxes or five 7" wide bin boxes. Unit can be stacked and bolted together as shown in illustration. Each measures 41" wide by 21" high by 12" deep.

Safety Hint:

Slide open only one shelf at a time to avoid tipping.

4. Stationary Legs [Shown]

Part Number: 78191
Product No. 7484-0011

Allows for precise leveling.

Heavy-Duty Caster Leg Set [Not Shown]

Part Number: 78192
Product No. 7484-0012

Set consists of four heavy-duty casters, two of which can be locked.

5. Bin Boxes

Order separately in whatever combination best fits your needs. Dividers come with each bin box. Each bin box has slots to allow for maximum utilization.



When assembled, the typical combination of two four-shelf coupling cabinets and stationary leg set as shown measures 48" high by 41" wide by 12" deep.

Description	Part Number	Product Number
Ten 3.5" wide bins with 30 dividers	78194	7484-0014
Five 7" wide bins with 15 dividers	78195	7484-0015
Three dividers for 3.5" wide bin box	78196	7484-0016
Three dividers for 7" wide bin box	78197	7484-0017

EQUIPMENT

HOSE/CPLG. SELECTION

G&K COUPLINGS

GLOBALSPIRAL COUPLINGS

STAINLESS STEEL SPIRAL

MEGACRIMP COUPLINGS

STAINLESS STEEL BRAID

POWER CRIMP COUPLINGS

FIELD ATTACHABLE G1 & G2 COUPLINGS

FIELD ATTACHABLE C5 COUPLINGS

GLX COUPLINGS

GL COUPLINGS

C14 COUPLINGS

PCTS THERMOPLASTIC COUPLINGS

POLARSEAL COUPLINGS

POLARSEAL II COUPLINGS

POWER STEERING

ADAPTERS

QUICK DISCONNECT COUPLERS

BALL VALVES

LIVE SWIVEL

ASSEMBLY FABRICATION

ACCESSORIES

EQUIPMENT AND PARTS

AIR BRAKE

BRASS

KITS

EQUIPMENT
HOSE/CPLG. SELECTION
G8K COUPLINGS
GLOBAL SPIRAL COUPLINGS
STAINLESS STEEL SPIRAL
MEGACRIMP COUPLINGS
STAINLESS STEEL BRAID
POWER CRIMP COUPLINGS
FIELD ATTACHABLE G1 & G2 COUPLINGS
FIELD ATTACHABLE C5 COUPLINGS
GLX COUPLINGS
GL COUPLINGS
C14 COUPLINGS
PCTS THERMOPLASTIC COUPLINGS
POLARSEAL COUPLINGS
POLARSEAL II COUPLINGS
POWER STEERING
ADAPTERS
QUICK DISCONNECT COUPLERS
BALL VALVES
LIVE SWIVEL
ASSEMBLY FABRICATION
ACCESSORIES
EQUIPMENT AND PARTS
AIR BRAKE
BRASS
KITS

VERTICAL HYDRAULIC HOSE CABINET



Part Number: 78188

Product Number: 7484-0022

Rack up sales and get organized at the same time with a new 'vertical' hydraulic hose cabinet from Gates.

- > Six narrow and two wide slots to stock a variety of hydraulic hose.
- > Designed to support one hydraulic coupling cabinet on top for maximum efficiency.
- > Optional choice for use as cabinet base with maximum of one four-drawer cabinet.
- > Shown with four-drawer cabinet
[purchase separately as **Part Number:** 78190, **Product No.:** 7484-0010].

TWO-DRAWER COUPLING CABINET



Part Number: 78189

Product No. 7484-0021

This two-drawer cabinet is ideal to add nylon air brake tubing couplings to your hydraulic inventory. This cabinet can be stacked and bolted together with your existing hydraulic cabinet. Uses the same bin boxes as listed above. Measures 41" wide by 11" high by 12" deep.

WORK BENCH



Part Number: 78022

Product Number: 7484-0020

Dimensions: 36" wide by 24" deep by 36" tall

This new hydraulic work bench is ideal for holding either the Power Crimp® 707 or MobileCrimp® 4-20 crimpers as well as hydraulic saws. The lower shelf can be used for storage or as shown with the pump. It is made of an angle iron frame construction with a high-density fiberboard top and welded 13-gauge steel lower shelf. All hardware is included to allow for easy assembly in about 10 minutes.

HYDRAULIC COUPLING BIN

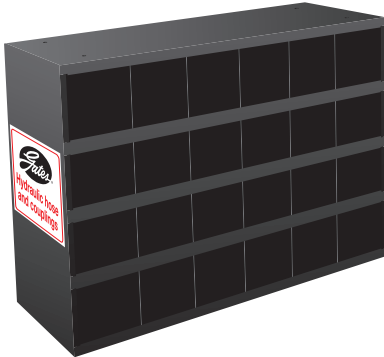

Part Number: 78207

Product Number: 7484-0007

The 24-bin cabinet is constructed of heavy gauge steel. Cabinet measures 34" wide by 24" high by 12" deep. Excellent for storing large 1-1/4" to 2" I.D. couplings.

COUPLING BIN BOXES



Part Number: 78208

Product Number: 7484-0008

Bin boxes for hydraulic couplings. Corrugated cardboard design gives extra strength. Includes four dividers per box.

Measures: 5" wide by 4-1/2" high by 11" deep.

Part Number: 78212

Product Number: 7484-0009

Measures: 7-1/2" wide by 4-1/2" high by 11" deep.

GATES HOSE CUTTER MODEL 2-24



Replacement Blade

Part Number: 78008

Product Number: 7793-0113

For two-wire braid hose through 1-1/2" I.D.

Part Number: 78023

Product Number: 7480-6600

Clean Easy Cuts – Safe Operation

FEATURES:

- > Cuts up to 1-1/2" I.D. two-wire braid hose and 1" four wire spiral hose.
- > Designed to operate on standard 20 amp service.
- > Reversible 8" scalloped-edge, high-speed steel blade with 5/8" bore can be sharpened.
- > Radius hose feed into blade for safety and reduced friction.
- > Inner blade guard for safe operation.

SPECIFICATIONS

Power Source: 1-1/2 HP [2.6 HP Peak], 115V, 60 Hz., 15 Amp motor with power cord and plug.

Dimensions: 13" wide by 24" length by 17" high.

Weight: 65 lbs.

EQUIPMENT

HOSE/CPLG. SELECTION

G&K COUPLINGS

GLOBALSPIRAL COUPLINGS

STAINLESS STEEL SPIRAL

MEGACRIMP COUPLINGS

STAINLESS STEEL BRAID

POWER CRIMP COUPLINGS

FIELD ATTACHABLE G1 & G2 COUPLINGS

FIELD ATTACHABLE C5 COUPLINGS

GLX COUPLINGS

GL COUPLINGS

C14 COUPLINGS

PCTS THERMOPLASTIC COUPLINGS

POLARSEAL COUPLINGS

POLARSEAL II COUPLINGS

POWER STEERING

ADAPTERS

QUICK DISCONNECT COUPLERS

BALL VALVES

LIVE SWIVEL

ASSEMBLY FABRICATION

ACCESSORIES

EQUIPMENT AND PARTS

AIR BRAKE

BRASS

KITS

Equipment

EQUIPMENT
HOSE/CPLG. SELECTION
G8K COUPLINGS
GLOBALSPIRAL COUPLINGS
STAINLESS STEEL SPIRAL
MEGACRIMP COUPLINGS
STAINLESS STEEL BRAID
POWER CRIMP COUPLINGS
FIELD ATTACHABLE G1 & G2 COUPLINGS
FIELD ATTACHABLE C5 COUPLINGS
GLX COUPLINGS
GL COUPLINGS
C14 COUPLINGS
PCTS THERMOPLASTIC COUPLINGS
POLARSEAL COUPLINGS
POLARSEAL II COUPLINGS
POWER STEERING
ADAPTERS
QUICK DISCONNECT COUPLERS
BALL VALVES
LIVE SWIVEL
ASSEMBLY FABRICATION
ACCESSORIES
EQUIPMENT AND PARTS
AIR BRAKE
BRASS
KITS

GATES POWER CUTTER 208

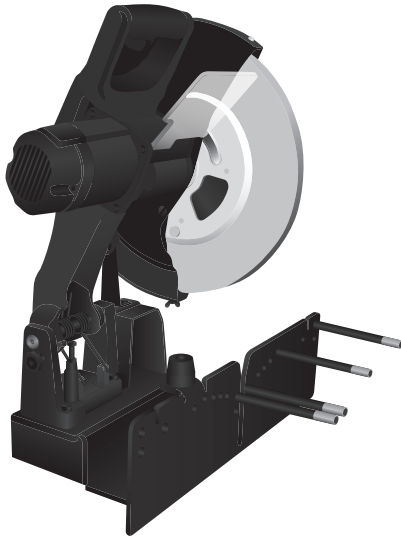

Caution: Keep blade sharp. Heat generated by a dull blade can damage steel and flare the hose.

BLADE SPECIFICATION

Blade Dimensions: 12" by 1/8"

Scalloped Replacement

Part Number: 78009

Product Number: 7482-0983

Optional Abrasive

Part Number: 78011

Product Number: 7482-0426

Part Number: 78028

Product Number: 7480-6609

Effortless Straight Cuts Every Time

- > Clear face shield for added safety.
 - > Powerful high torque, 4.5 horsepower peak motor that makes cutting faster and easier.
 - > Includes scalloped, 12" blade to dissipate heat, reducing friction for clean, faster cuts up to 1-1/4" I.D.
 - > Optional abrasive blade for continuous use with 1-1/4" I.D. and larger spiral-wire reinforced hose.
 - > Safely cuts two and four-wire hose through 2", six-wire hose through 1-1/4".
 - > Reversible blade can be sharpened; removal and installation is easy.
 - > Cuts small 3/16" I.D. hose and handles the tough job including 2" I.D. spiral wire hose.*
 - > Easy to use, front face plate with moveable pins holds hose securely for a clean straight cut.
 - > Sturdy blade guard shields blade for safety.
 - > Permanent mounting brackets [included] to attach saw to table.
- *Optional abrasive blade preferred for cutting spiral-wire hose, larger than 1-1/4" I.D.

CUTTER SPECIFICATIONS

Shaft/Arbor Hole Diameter: 1"

Power Source: 4.5 HP Peak, 115/50/60 Hz, 20 Amps.

No Load Speed: 3,500 rpm

Dimensions: 22-1/2" wide by 18-1/4" length by 23-1/2" high

Weight: 65 lbs.

GATES HOSE CUTTER MODEL 6-32

For six-wire spiral and two-wire braid hose through 2" I.D.



SPECIFICATIONS

Dimensions: 22" wide by 42" length by 24" high

Weight: 215 lbs.

Replacement Blade

Part Number: 78003

Product Number: 7482-1329

Part Number: 78018

Product Number: 7480-6597

Clean Easy Cuts – Safe Operation

FEATURES:

- > Cuts up to 2" I.D. two-wire braid through six-spiral reinforced hose.
 - > Reversible 10" scalloped-edge, high-speed steel blade with 3/4" bore, can be sharpened.
 - > Radius hose feed into blade for safety and reduced friction.
 - > Inner blade guard for safe operation.
 - > **Includes Coolant Spray System Kit** for reduced heat in high-capacity cutting applications [recommended for multi-braid and spiral reinforced hose]. Kit includes reservoir, spray nozzle and mounting hardware.
 - > Power cord not included.
- Power Source:** 3 HP [5.2 HP Peak], Single phase, 230V, 60 Hz., 20 Amp motor

4-16 PORTABLE HOSE SAW

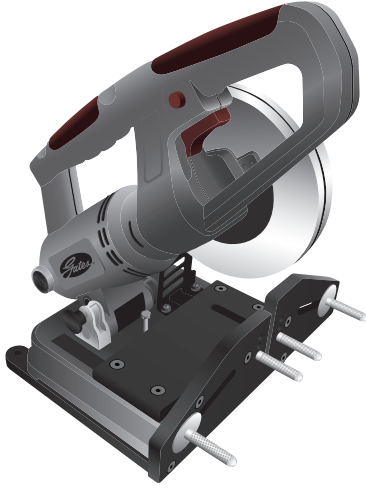

Part Number: 78069
Product Number: 7480-6605

SPECIFICATIONS

Voltage: 120 Volts
Cycle: 60 Hz / 1 phase
Power: 6.5 Amp
No-load speed: 7,400 rpm
Wheel size: 6"
Arbor Hole: 7/8"

FEATURES:

- > Cuts up to 1", four-wire braid
- > Abrasive cut-off wheel

Replacement Blade:
Part Number: 78066
Product Number: 7482-0012

GATES HS-1 HAND SWAGER

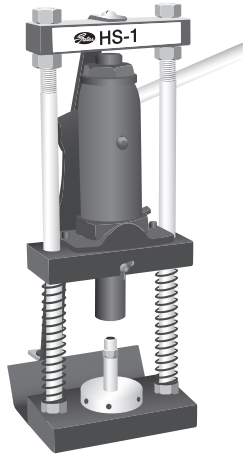

Part Number: 78080
Product Number: 7483-1000

Produces top quality assemblies using Gates 1/8" and 3/16" thermoplastic hydraulic hose with Gates PCTS couplings and Gates C14 PTFE hose and couplings.

Simply insert the assembly into the swager from the bottom, place dies around the coupling, and pump the handle.

A six-ton jack then goes to work and the swage is completed. Positive dies ensure a correct swage every time. The perfectly swaged assembly is removed and you are ready to repeat the process. Pushers and dies must be ordered separately.

SPECIFICATIONS

Dimensions: 15" wide by 7" deep by 19-1/2" high
Weight: 41 lbs.

HAND-HELD HOSE CUTTER

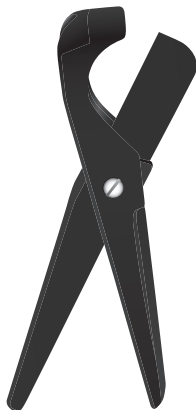

Part Number: 91153
Product Number: 7469-0153

Makes clean cuts—no ragged edges. Cuts most non-metal reinforced rubber hose. Excellent for cutting textile-reinforced hose.

FEATURES:

- > Lightweight with nylon handles.
- > Blade closes into handle for safety.
- > Cutter and blades packaged individually on shrink-wrapped cards.

Replacement Blade
Part Number: 91154
Product Number: 7469-0154

EQUIPMENT

HOSE/CPLG. SELECTION

G8K COUPLINGS

GLOBALSPIRAL COUPLINGS

STAINLESS STEEL SPIRAL

MEGACRIMP COUPLINGS

STAINLESS STEEL BRAID

POWER CRIMP COUPLINGS

FIELD ATTACHABLE G1 & G2 COUPLINGS

FIELD ATTACHABLE C5 COUPLINGS

GLX COUPLINGS

GL COUPLINGS

C14 COUPLINGS

PCTS THERMOPLASTIC COUPLINGS

POLARSEAL COUPLINGS

POLARSEAL II COUPLINGS

POWER STEERING

ADAPTERS

QUICK DISCONNECT COUPLERS

BALL VALVES

LIVE SWIVEL

ASSEMBLY FABRICATION

ACCESSORIES

EQUIPMENT AND PARTS

AIR BRAKE

BRASS

KITS

EQUIPMENT

HOSE/CPLG. SELECTION

G8K COUPLINGS

GLOBALSPIRAL COUPLINGS

STAINLESS STEEL SPIRAL

MEGACRIMP COUPLINGS

STAINLESS STEEL BRAID

POWER CRIMP COUPLINGS

FIELD ATTACHABLE G1 & G2 COUPLINGS

FIELD ATTACHABLE C5 COUPLINGS

GLX COUPLINGS

GL COUPLINGS

C14 COUPLINGS

PCTS THERMOPLASTIC COUPLINGS

POLARSEAL COUPLINGS

POLARSEAL II COUPLINGS

POWER STEERING

ADAPTERS

QUICK DISCONNECT COUPLERS

BALL VALVES

LIVE SWIVEL

ASSEMBLY FABRICATION

ACCESSORIES

EQUIPMENT AND PARTS

AIR BRAKE

BRASS

KITS

SMALL NYLON TUBING CUTTER AND REPLACEMENT BLADES

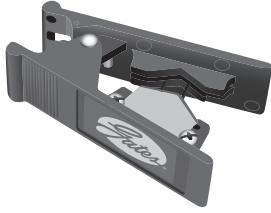

Part Number: 78015
Product Number: 7469-0147

Tubing cutter gives straight, clean, square cuts on J844 tubing.

FEATURES:

- > Lightweight and compact size – 3/4" by 3".
- > Designed to ensure user's safety.
- > "Blade guard" offers more protection against accidental blade contact.
- > Handle has ribs for improved grip.

Replacement Blade

Part Number: 78016
Product Number: 7208-40205

Gates also offers replacement blades in a five pack bag.

SWAGER CONVERSION KIT FOR THE POWER CRIMP® 707

Produces top quality assemblies using Gates 1/8" and 3/16" thermoplastic hydraulic hose with Gates PCTS couplings and Gates C14 PTFE hose and couplings. Easily converts the Power Crimp 707 to a power swager.

Description	Part Number	Product Number
Complete Kit	78081	7480-0040
Collar	78820	7482-0429
Die Cone	78821	7482-0430
Adapter	78824	7482-0433
Actuator Rod	78753	7482-0482
1/2" Spacer Ring	78184	7482-1253

Dies and pushers must be ordered separately. See Swage Data Chart in Gates Crimp Data Manual for details.

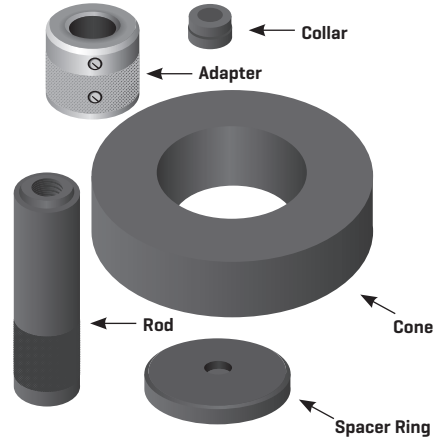

SURELOK™ QUICK-RELEASE PLIERS



Kit
Part Number: 91017
Product Number: 7468-0030

Single Units
SMALL
Straight - Part Number: 91023, **Product Number:** 7468-0036
Angle - Part Number: 91021, **Product Number:** 7468-0034
LARGE
Straight - Part Number: 91022, **Product Number:** 7468-0035
Angle - Part Number: 91020, **Product Number:** 7468-0033



SureLok™ couplings [Push-to-Connect] are the easiest and quickest coupling to install. Disconnecting them can be another thing. Placement near obstructions, as well as age and road debris, affect your ability to disconnect the SureLok coupling. Many times getting hands into an area to remove a coupling is almost impossible. SureLok pliers allow for the removal of a Push-to-Connect coupling from the tubing with just one hand in seconds. To help get into those tight spaces, SureLok pliers offer two different heads; one straight and one with a 90° offset. They also come in two sizes: Small, for tubing from 1/8" to 3/8"; and Large, for tubing 3/8" to 3/4". An instructional CD is included with each part number. Sold as single units, packs of two [Large or Small], as well as all four in a handy carrying case.

C14 HOSE INSERTION DIE HOLDER FOR USE WITH HOSE INSERTION DIES

Required for inserting hose into ferrule on all sizes. Use the fixture [see photo] to mount the Hose Insertion Die Holder onto a bench top to aid in the assembly of Gates C14 hose. Each item listed in the next page must be ordered separately.

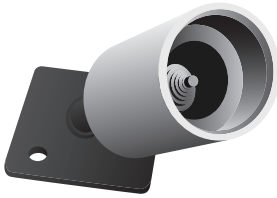

Hose Insertion Die Holder

Part Number: 78518

Product Number: 7483-0510

Hose Insertion Fixture

Part Number: 78517

Product Number: 7483-0511

C14 HOSE INSERTION DIES

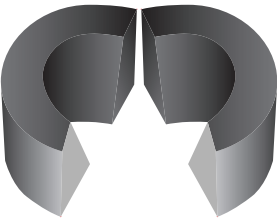

Used to guide the hose into the ferrule when used with the Hose Insertion Die Holder. One set required for each hose size. See product numbers listed in Gates Crimp Data and Dies Manual.

C14 HOSE EXPANDERS

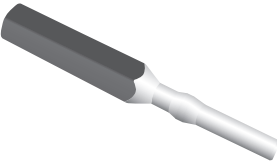

Used to expand the hose and round out the tube after cutting and to insert the stem into the hose. One expander required for each hose size. See product numbers listed in Gates Crimp Data and Dies Manual.

C14 SWAGE PUSHERS



Specially designed to accommodate Gates C14 couplings. They protect the threads and bottom out on the dies to complete the swage. Use the C14 Swage Data Chart in Gates Crimp Data and Dies Manual to determine the proper pushers.

C14 SWAGE DIES

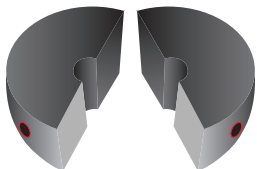

Specifically designed to swage Gates C14 hose assemblies. They provide the required swage dimensions to meet full performance. One die set is required for each hose size. See product numbers listed in Gates Crimp Data and Dies Manual.

EQUIPMENT

HOSE/CPLG. SELECTION

G8K COUPLINGS

GLOBAL SPIRAL COUPLINGS

STAINLESS STEEL SPIRAL

MEGACRIMP COUPLINGS

STAINLESS STEEL BRAID

POWER CRIMP COUPLINGS

FIELD ATTACHABLE G1 & G2 COUPLINGS

FIELD ATTACHABLE C5 COUPLINGS

GLX COUPLINGS

GL COUPLINGS

C14 COUPLINGS

PCTS THERMOPLASTIC COUPLINGS

POLARSEAL COUPLINGS

POLARSEAL II COUPLINGS

POWER STEERING

ADAPTERS

QUICK DISCONNECT COUPLERS

BALL VALVES

LIVE SWIVEL

ASSEMBLY FABRICATION

ACCESSORIES

EQUIPMENT AND PARTS

AIR BRAKE

BRASS

KITS

EQUIPMENT

HOSE/CPLG. SELECTION

G8K COUPLINGS

GLOBAL SPIRAL COUPLINGS

STAINLESS STEEL SPIRAL

MEGACRIMP COUPLINGS

STAINLESS STEEL BRAID

POWER CRIMP COUPLINGS

FIELD ATTACHABLE G1 & G2 COUPLINGS

FIELD ATTACHABLE C5 COUPLINGS

GLX COUPLINGS

GL COUPLINGS

C14 COUPLINGS

PCTS THERMOPLASTIC COUPLINGS

POLARSEAL COUPLINGS

POLARSEAL II COUPLINGS

POWER STEERING

ADAPTERS

QUICK DISCONNECT COUPLERS

BALL VALVES

LIVE SWIVEL

ASSEMBLY FABRICATION

ACCESSORIES

EQUIPMENT AND PARTS

AIR BRAKE

BRASS

KITS

PUSHERS AND DIES FOR C14 HOSE AND COUPLINGS

C14 Swage Pushers

Description	Part Number	Product Number
P-C14-4FJSX	78500	7483-0536
P-C14-5FJSX	78501	7483-0537
P-C14-6FJX	78502	7483-0538
P-C14-6FSX	78503	7483-0539
P-C14-8FJSX	78504	7483-0540
P-C14-10FJSX	78505	7483-0541
P-C14-12FJX	78506	7483-0542
P-C14-12FSX	78507	7483-0543
P-C14-16FJSX	78504	7483-0540
P-C14-2MP	78510	7483-0550
P-C14-4MP	78511	7483-0545
P-C14-6MP	78512	7483-0546
P-C14-8MP-8 810ABC	78513	7483-0547
P-C14-12MP-12ABC	78514	7483-0548
P-C14-16MP	78515	7483-0549
P-C14-4TUBE	78548	7483-0530
P-C14-5TUBE	78549	7483-0531
P-C14-6TUBE	78550	7483-0532
P-C14-8TUBE	78551	7483-0533
P-C14-10TUBE	78552	7483-0534
P-C14-12TUBE	78553	7483-0521
P-C14-12TUBE-JS	78554	7483-0522
P-C14-16TUBE-JS	78555	7483-0580
P-C14-6TBFLX	78565	7483-0552
P-C14-12TBFLX	78568	7483-0553

C14 Hose and Expanders

Description	Part Number	Product Number
HE-4C14	78530	7483-0555
HE-5C14	78531	7483-0556
HE-6C14	78532	7483-0557
HE-8C14	78533	7483-0558
HE-10C14	78534	7483-0559
HE-12C14	78535	7483-0560
HE-16C14	78536	7483-0561

C14 Hose Insertion Dies

Description	Part Number	Product Number
HD-4C14	78521	7483-0503
HD-5C14	78522	7483-0504
HD-6C14	78523	7483-0505
HD-8C14	78524	7483-0506
HD-10C14	78525	7483-0507
HD-12C14	78526	7483-0508
HD-16C14	78527	7483-0509

C14 Swage Dies

Description	Part Number	Product Number
SD-4C14	78539	7483-0513
SD-5C14	78540	7483-0514
SD-6C14	78541	7483-0515
SD-8C14	78542	7483-0516
SD-10C14	78543	7483-0517
SD-12C14	78544	7483-0518
SD-16C14	78545	7483-0519

C14 HOSE CUTTING SHEAR RECOMMENDED FOR C14 PTFE HOSE



Part Number: 78006

Product Number: 7480-6596

This cutting shear handles Gates C14 PTFE hose up through 1" without requiring pretaping of the hose. The shear is fast and easy to use and results in a very clean cut.

Weight: 18 lbs.

Dimensions: 9" wide by 15" high by 14" deep. 30" handle.

HOSE ASSEMBLY MACHINE POWER MATE 25



Portable hose assembly machine for field attachable couplings.

Machine Part Number: 78020

Product Number: 7480-0029
[115 volts, 30 amps, 1 phase, 60 cycles.]

Folding Stand Part Number: 78021

Product Number: 7480-0030

- > Produces complete, dependable hose assemblies.
- > Applies field attachable couplings in sizes from 3/16" through 2" I.D. on medium and high-pressure hose.
- > Accommodates male pipe, swivel, flange and elbow type field attachable couplings.
- > Easy and safe to operate.
- > Hand-skiving tool can be used with Power Mate 25.
- > Affords quick and simple operation reduces costly downtime and delays.
- > Heavy-duty provides years of trouble-free service.
- > Weighs 141 lbs. [without stand]. Takes up less than 4 by 5 ft. of floor space with stand.
- > Can be bench mounted or made portable with folding leg stand.

MEGACRIMP® COUPLING INSERTION TOOL



Part Number: 78017

Product Number: 7482-1342

Offers an easy way to confirm the right insertion depth for all Gates wire-braid hydraulic hose. To use, simply insert the hose into its proper slot indicated by dash size, push it all the way in, check for square cut [maximum allowable angle of cut is five degrees], then mark the insertion depth on the hose.

PUSH-ON TOOL



Part Number: 78050

Product Number: 7480-0100

This hand-operated coupling machine, made of rugged cast iron and steel construction, eliminates the hard work of manually pushing stems into hose. It comes complete with mandrels for 1/4", 3/8", 1/2", 5/8" and 3/4" I.D. sizes of lock-on couplings.

HAND-OPERATED HOSE PERFORATOR TOOL



These hose perforators have needle-studded wooden rollers which perforate the covers of non-skive wire braid hose used in high pressure inert gas applications. They are hand-operated so the operator can control the degree of perforation in the hose cover.

1-1/4" Hose Perforator for 3/16" to 3/4" I.D. Hose

Part Number: 78070

Product Number: 7482-6565

Dimensions: 2-1/2" O.D. roller by 1-1/4" wide by 8" OAL.

Weight: 3/4 lbs.

3" Hose Perforator for 1" to 2" I.D. Hose

Part Number: 78071

Product Number: 7482-6566

Dimensions: 3-3/4" O.D. roller by 3" wide by 9-1/2" OAL.

Weight: 1-1/4 lbs.

EQUIPMENT

HOSE/CPLG. SELECTION

G8K COUPLINGS

GLOBALSPIRAL COUPLINGS

STAINLESS STEEL SPIRAL

MEGACRIMP COUPLINGS

STAINLESS STEEL BRAID

POWER CRIMP COUPLINGS

FIELD ATTACHABLE G1 & G2 COUPLINGS

FIELD ATTACHABLE C5 COUPLINGS

GLX COUPLINGS

GL COUPLINGS

C14 COUPLINGS

PCTS THERMOPLASTIC COUPLINGS

POLARSEAL COUPLINGS

POLARSEAL II COUPLINGS

POWER STEERING

ADAPTERS

QUICK DISCONNECT COUPLERS

BALL VALVES

LIVE SWIVEL

ASSEMBLY FABRICATION

ACCESSORIES

EQUIPMENT AND PARTS

AIR BRAKE

BRASS

KITS

Equipment

EQUIPMENT
HOSE/CPLG. SELECTION
G8K COUPLINGS
GLOBALSPIRAL COUPLINGS
STAINLESS STEEL SPIRAL
MEGACRIMP COUPLINGS
STAINLESS STEEL BRAID
POWER CRIMP COUPLINGS
FIELD ATTACHABLE G1 & G2 COUPLINGS
FIELD ATTACHABLE C5 COUPLINGS
GLX COUPLINGS
GL COUPLINGS
C14 COUPLINGS
PCTS THERMOPLASTIC COUPLINGS
POLARSEAL COUPLINGS
POLARSEAL II COUPLINGS
POWER STEERING
ADAPTERS
QUICK DISCONNECT COUPLERS
BALL VALVES
LIVE SWIVEL
ASSEMBLY FABRICATION
ACCESSORIES
EQUIPMENT AND PARTS
AIR BRAKE
BRASS
KITS

MEGACLEAN™ SYSTEM

Used to remove dirt from the inside out with the help of pressurized launchers and compatible nozzles. Gates MegaClean foam projectiles sweep through the inside surface of the hose, taking fine particles of loose dirt and other contaminants with them. At 20–30 percent larger than the hose I.D., these projectiles leave nothing behind but a hose that truly is clean from the inside out.

MegaClean MC-K32 Kit

Part Number - MC-K32

Product Number - 7467-0001

- > MCL-32 Hand Launcher (Including "Rotary" Plug & Coupler)
- > MC-GAR-1 Adapter Ring [-4 thru -20]
- > LC32 Carrying & Storage Case
- > Hose Nozzles GH-04, GH-05, GH-06, GH-08, GH-10, GH-12, GH-16, GH-20, GH-24, GH-32
- > JIC Assembly Nozzles GA-04, GA-06, GA-08, GA-10, GA-12, GA-16, GA-20, GA-24, GA-32
- > GA-04-FFORX Nozzle
- > MC-32 Launcher Stand
- > 1 Projectile Catcher Bucket
- > 1 Roll MegaClean Assembly Tape
- > 1 Bag of Projectiles Listed in Chart Below



MegaClean MC-K20 Kit (Hose 1/4" – 1 1/4")

Part Number - MC-K20

Product Number - 7467-0002

- > MCL-20 Hand Launcher
- > Female Quick-Release Coupler
- > LC20 Carrying & Storage Case
- > GH-04, GH-05, GH-06, GH-08, GH-10, GH-12, GH-16, GH-20 Hose Nozzles
- > 1 Projectile Catcher Bucket
- > 1 Roll MegaClean Assembly Tape
- > 1 Bag of Projectiles Listed in Chart Below

MegaClean Projectiles Included in Kits

Part Number	Product Number	MC-K32	MC-K20	Bag Quantity
MC-HAP-04	7467-50005	X	X	100
MC-HP-04	7467-50025	X	X	100
MC-HAP-06	7467-50035	X	X	100
MC-HP-06	7467-50045	X	X	100
MC-HAP-08	7467-50055	X	X	100
MC-HP-08	7467-50065	X	X	100
MC-HP-08-1	7467-50075	X	X	50
MC-HP-10	7467-50085	X	X	50
MC-HP-12	7467-50105	X	X	50
MC-HP-16	7467-50135	X	X	40
MC-HP-20	7467-50155	X	X	30
MC-HP-24	7467-50175	X		20
MC-HP-32	7467-50195	X		15

How it works:



Step 1



Step 2

MegaClean™ System Replacement Projectiles

Description	Product Number	Part Number
MegaClean HAP-04-01 Assembly Projectile (100 ea)	7467-50005	MC-HAP-04-1
MegaClean HAP-04 Assembly Projectile (100 ea)	7467-50015	MC-HAP-04
MegaClean HP-04 Hose Projectile (100 ea)	7467-50025	MC-HP-04
MegaClean HAP-06 Assembly Projectile (100 ea)	7467-50035	MC-HAP-06
MegaClean HP-06 Hose Projectile (100 ea)	7467-50045	MC-HP-06
MegaClean HAP-08 Assembly Projectile (100 ea)	7467-50055	MC-HAP-08
MegaClean HP-08 Hose Projectile (100 ea)	7467-50065	MC-HP-08
MegaClean HP-08-1 Hose Projectile (50 ea)	7467-50075	MC-HP-08-1
MegaClean HP-10 Hose Projectile (50 ea)	7467-50085	MC-HP-10
MegaClean HP-10-1 Hose Projectile (50 ea)	7467-50095	MC-HP-10-1
MegaClean HP-12 Hose Projectile (50 ea)	7467-50105	MC-HP-12
MegaClean HP-12-1 Hose Projectile (40 ea)	7467-50115	MC-HP-12-1
MegaClean HP-14 Hose Projectile (40 ea)	7467-50125	MC-HP-14
MegaClean HP-16 Hose Projectile (40 ea)	7467-50135	MC-HP-16
MegaClean HP-16-1 Hose Projectile (30 ea)	7467-50145	MC-HP-16-1
MegaClean HP-20 Hose Projectile (30 ea)	7467-50155	MC-HP-20
MegaClean HP-20-1 Hose Projectile (20 ea)	7467-50165	MC-HP-20-1
MegaClean HP-24 Hose Projectile (20 ea)	7467-50175	MC-HP-24
MegaClean HP-24-1 Hose Projectile (15 ea)	7467-50185	MC-HP-24-1
MegaClean HP-32 Hose Projectile (15 ea)	7467-50195	MC-HP-32
MegaClean HP-32-1 Hose Projectile (10 ea)	7467-50205	MC-HP-32-1
MegaClean HP-40 Hose Projectile (10 ea)	7467-50215	MC-HP-40
MegaClean HP-48 Hose Projectile (10 ea)	7467-50225	MC-HP-48
MegaClean HP-56 Hose Projectile (10 ea)	7467-50235	MC-HP-56
MegaClean HP-64 Hose Projectile (10 ea)	7467-50245	MC-HP-64

Description - Bulk Pack	Product Number	Part Number
MegaClean HAPB-04-01 Assembly Projectile Bulk (10000 ea)	7467-5000	MC-HAPB-04-1
MegaClean HAPB-04 Assembly Projectile Bulk (10000 ea)	7467-5001	MC-HAPB-04
MegaClean HAPB-04 Assembly Projectile Bulk (10000 ea)	7467-5002	MC-HPB-04
MegaClean HAPB-06 Assembly Projectile Bulk (10000 ea)	7467-5003	MC-HAPB-06
MegaClean HPB-06 Hose Projectile Bulk (10000 ea)	7467-5004	MC-HPB-06
MegaClean HAPB-08 Assembly Projectile Bulk (10000 ea)	7467-5005	MC-HAPB-08
MegaClean HPB-08 Hose Projectile Bulk (10000 ea)	7467-5006	MC-HPB-08
MegaClean HPB-08-1 Hose Projectile Bulk (9000 ea)	7467-5007	MC-HPB-08-1
MegaClean HPB-10 Hose Projectile Bulk (7000 ea)	7467-5008	MC-HPB-10
MegaClean HPB-10-1 Hose Projectile Bulk (5500 ea)	7467-5009	MC-HPB-10-1
MegaClean HPB-12 Hose Projectile Bulk (4000 ea)	7467-5010	MC-HPB-12
MegaClean HPB-12-1 Hose Projectile Bulk (3800 ea)	7467-5011	MC-HPB-12-1
MegaClean HPB-14 Hose Projectile Bulk (3500 ea)	7467-5012	MC-HPB-14
MegaClean HPB-16 Hose Projectile Bulk (2000 ea)	7467-5013	MC-HPB-16
MegaClean HPB-16-1 Hose Projectile Bulk (1900 ea)	7467-5014	MC-HPB-16-1
MegaClean HPB-20 Hose Projectile Bulk (1500 ea)	7467-5015	MC-HPB-20
MegaClean HPB-20-1 Hose Projectile Bulk (1200 ea)	7467-5016	MC-HPB-20-1
MegaClean HPB-24 Hose Projectile Bulk (650 ea)	7467-5017	MC-HPB-24
MegaClean HPB-24-1 Hose Projectile Bulk (600 ea)	7467-5018	MC-HPB-24-1
MegaClean HPB-32 Hose Projectile Bulk (450 ea)	7467-5019	MC-HPB-32
MegaClean HPB-32-1 Hose Projectile Bulk (360 ea)	7467-5020	MC-HPB-32-1



Step 3



Step 4



Step 5



Step 6

EQUIPMENT

HOSE/CPLG. SELECTION

G&K COUPLINGS

GLOBALSPIRAL COUPLINGS

STAINLESS STEEL SPIRAL

MEGACRIMP COUPLINGS

STAINLESS STEEL BRAID

POWER CRIMP COUPLINGS

FIELD ATTACHABLE G1 & G2 COUPLINGS

FIELD ATTACHABLE C5 COUPLINGS

GLX COUPLINGS

GL COUPLINGS

C14 COUPLINGS

PCTS THERMOPLASTIC COUPLINGS

POLARSEAL COUPLINGS

POLARSEAL II COUPLINGS

POWER STEERING

ADAPTERS

QUICK DISCONNECT COUPLERS

BALL VALVES

LIVE SWIVEL

ASSEMBLY FABRICATION

ACCESSORIES

EQUIPMENT AND PARTS

AIR BRAKE

BRASS

KITS

EQUIPMENT
HOSE/CPLG. SELECTION
G8K COUPLINGS
GLOBAL SPIRAL COUPLINGS
STAINLESS STEEL SPIRAL
MEGACRIMP COUPLINGS
STAINLESS STEEL BRAID
POWER CRIMP COUPLINGS
FIELD ATTACHABLE G1 & G2 COUPLINGS
FIELD ATTACHABLE C5 COUPLINGS
GLX COUPLINGS
GL COUPLINGS
C14 COUPLINGS
PCTS THERMOPLASTIC COUPLINGS
POLARSEAL COUPLINGS
POLARSEAL II COUPLINGS
POWER STEERING
ADAPTERS
QUICK DISCONNECT COUPLERS
BALL VALVES
LIVE SWIVEL
ASSEMBLY FABRICATION
ACCESSORIES
EQUIPMENT AND PARTS
AIR BRAKE
BRASS
KITS

Gates Bend-N-Fit™ Tube Bender

Part Number: 91025

Product Number: 7468-1040



Simply and easily duplicates bent tubes:

- Power Steering
- Air Conditioning
- Transmission Oil Cooler Fuel
- Lines
- Plus many more applications

Bends SAE tubing as well as metric tubing – without changing any tooling - in the following sizes:

1/4" 5/16" 3/8" 1/2" 6mm -13mm

Easy! One-handed Operation

- > Load tubing by pushing in on Tubing Lock Release.
- > Pull down on Tubing Lock.
- > Load tubing into proper size bending slot.
- > Close Tubing Lock until it snaps into place. (Tubing Lock must snap for the tube to be firmly supported and for the tube to bend properly.)
- > Close the tube support slide onto the tube.



Tubing Lock **Tubing Lock Release**

Top of bender is segmented into 7 1/2° marks. This aids in precision bends. Original tube can be used as a pattern by measuring bends or by holding old tube above bender.

IMPORTANT: Be sure the mark on the tube support slide lines up with the zero on the top of the bender. Not lining up with zero will cause notching or creasing of the tube.

- > Push handle sliding Tube Support Slide across tube to make your bend.
- > Once you've made your first bend, rotate handle out of your way.
- > Push in on Tubing Lock Release.
- > Pull down on Tubing Lock.
- > Remove tubing and reorient for next bend.
- > Both the Tube Slide and Tube Lock move completely out of the way. This allows for bends in multiple planes.



Selecting the Proper Hose

SEVEN EASY STEPS FOR SELECTING THE PROPER HOSE

An effective way to remember hose selection criteria is to remember the word...

STAMPED

- S** = Size
- T** = Temperature
- A** = Application
- M** = Material to be conveyed
- P** = Pressure
- E** = Ends or couplings
- D** = Delivery [volume and velocity]

1. Hose Size [Dash Numbers]

The inside diameter of the hose must be adequate to keep pressure loss to a minimum and avoid damage to the hose due to heat generation or excessive turbulence. See hose sizing Nomographic Chart.

To determine the replacement hose size, read the layline printed on the side of the original hose. If the original hose layline is painted over or worn off, the original hose must be cut and the inside diameter measured for size.

NOTE: Before cutting an original hose assembly, measure the overall assembly length and fitting orientation. These measurements will be required to build the replacement assembly.

The hydraulics industry has adopted a measuring system called Dash Numbers to indicate hose and coupling size. The number which precedes the hose or coupling description is the dash size [see table]. This industry standard number denotes hose I.D. in sixteenths of an inch. [The exception to this is the SAE100R5 hose C5C, C5D, C5E, C5M as well as, C14 and AC134a, where dash sizes denote hose I.D. equal to equivalent tube O.D.] See chart to the right. Hose O.D. can be a critical factor when hose routing clamps are used or hose are routed through bulkheads. Check individual hose specification tables for O.D.'s.

Dash No.	Hose I.D.			
	All Except C5 Series, C14 and AC134a		C5 Series, C14 and AC134a	
	Inches	Millimeters	Inches	Millimeters
-2	1/8	3.2	--	--
-3	3/16	4.8	--	--
-4	1/4	6.4	3/16	4.8
-5	5/16	7.9	1/4	6.4
-6	3/8	9.5	5/16	7.9
-8	1/2	12.7	13/32	10.3
-10	5/8	15.9	1/2	12.7
-12	3/4	19.0	5/8	15.9
-14	7/8	22.2	--	--
-16	1	25.4	7/8	22.2
-20	1-1/4	31.8	1-1/8	28.6
-24	1-1/2	38.1	1-3/8	34.9
-32	2	50.8	1-13/16	46.0
-36	2-1/4	57.6	--	--
-40	2-1/2	63.5	2-3/8	60.3
-48	3	76.2	--	--
-56	3-1/2	88.9	--	--
-64	4	101.6	--	--
-72	4-1/2	115.2	--	--

EQUIPMENT
HOSE/CPLG. SELECTION
G&K COUPLINGS
GLOBALSPIRAL COUPLINGS
STAINLESS STEEL SPIRAL
MEGACRIMP COUPLINGS
STAINLESS STEEL BRAID
POWER CRIMP COUPLINGS
FIELD ATTACHABLE G1 & G2 COUPLINGS
FIELD ATTACHABLE C5 COUPLINGS
GLX COUPLINGS
GL COUPLINGS
C14 COUPLINGS
PCTS THERMOPLASTIC COUPLINGS
POLARSEAL COUPLINGS
POLARSEAL II COUPLINGS
POWER STEERING
ADAPTERS
QUICK DISCONNECT COUPLERS
BALL VALVES
LIVE SWIVEL
ASSEMBLY FABRICATION
ACCESSORIES
EQUIPMENT AND PARTS
AIR BRAKE
BRASS
KITS

Selecting the Proper Hose

EQUIPMENT
HOSE/CPLG. SELECTION
G8K COUPLINGS
GLOBAL SPIRAL COUPLINGS
STAINLESS STEEL SPIRAL
MEGACRIMP COUPLINGS
STAINLESS STEEL BRAID
POWER CRIMP COUPLINGS
FIELD ATTACHABLE G1 & G2 COUPLINGS
FIELD ATTACHABLE C5 COUPLINGS
GLX COUPLINGS
GL COUPLINGS
C14 COUPLINGS
PCTS THERMOPLASTIC COUPLINGS
POLARSEAL COUPLINGS
POLARSEAL II COUPLINGS
POWER STEERING
ADAPTERS
QUICK DISCONNECT COUPLERS
BALL VALVES
LIVE SWIVEL
ASSEMBLY FABRICATION
ACCESSORIES
EQUIPMENT AND PARTS
AIR BRAKE
BRASS
KITS

2. Temperature

When selecting a replacement assembly, two areas of temperature must be considered. These are fluid temperature and ambient temperature. The hose selected must be capable of withstanding the minimum and maximum temperature seen by the system. Care must be taken when routing near hot manifolds and in extreme cases a heat shield may be advisable.

See the Gates Hydraulic Hose Selection Guide; Hose Specification Pages; and/or the Additional Temperature Limits for Gates Hydraulic Hose Chart for temperature ranges and limits for water, water/oil emulsions and water/glycol solutions.

3. Application

Determine where or how the replacement hose or assembly is to be used. Most often only a duplicate of the original hose will have to be made. To fulfill the requirements of the application, additional questions may need to be answered, such as:

- > Where Will Hose be Used?
- > Fluid and/or Ambient Temperature?
- > Hose Construction?
- > Equipment Type?
- > Fluid Compatibility?
- > Thread End Connection Type?
- > Working and Surge Pressures?
- > Environmental Conditions?
- > Permanent or Field Attachable Couplings?
- > Suction Application?
- > Routing Requirements?
- > Thread Type?
- > Government and Industry Standards Being Met?
- > Unusual Mechanical Loads?
- > Minimum Bend Radius?
- > Non-Conductive Hose Required?
- > Excessive Abrasion?

4. Material to be Conveyed

Some applications require specialized oils or chemicals to be conveyed through the system. Hose selection must ensure compatibility of the hose tube, cover, couplings and O-rings with the fluid used. Additional caution must be exercised in hose selection for gaseous applications such as refrigerants and LPG.

NOTE: All block type couplings contain nitrile O-rings which must be compatible with the fluids being used.

5. Pressure

Most important in the hose selection process is knowing system pressure, including pressure spikes. Published working pressures must be equal to or greater than the system pressure. Pressure spikes greater than the published working pressure will shorten hose life and must be taken into consideration. Gates **DOES NOT** recommend using hose on applications having pressure spikes greater than published working pressures of the hose.

6. Ends of Couplings

Identify end connections using Gates coupling templates and measuring tools or Coupling Identification section. Once thread ends have been identified, consult the appropriate section of the catalog for specific part number selection.

7. Delivery (Volume and Velocity)

If the same I.D. of the original hose is used, assume the system is properly sized to efficiently transport fluid. If the system is new or altered, determine the hose I.D. needed to transport required fluid volume flow by using the Nomographic Chart.

Agency Specifications and Hose Selection Guide

INDUSTRY AGENCIES

- ABS** — American Bureau of Shipping
- AS** — Australia Standard
- DIN** — Deutsch Industry Norm, German
- DNV** — Det Norske Veritas for North Sea Floating Vessels
- EN** — European Norm/Standard
- GL** — Germanischer Lloyds
- IJS** — Industrial Jack Specifications

RCCC — Regular Commom Carrier Conference for Fleet Truck and Bus

SAE — Society of Automotive Engineers

GOVERNMENT AGENCIES

DOT/FMVSS — U.S. Department of Transportation/
Federal Motor Vehicle Safety Standard

MSHA — U.S. Mine Safety and Health Administration

USCG — U.S. Coast Guard

Meets These Agency Specifications

Hose Type	ABS	AS	DIN	DNV	EN	GL	IJS	RCCC	SAE	DOT/ FMVSS	MSHA	USCG J1942	
												Fuel Oil	Power
EFG6K, G6K	X	X	20023 4SH/4SP	X	EN 856 4SH/4SP	X			100R15		X		X
EFG5K, G5K	X	X	20023 4SH/4SP	X	EN 856 4SH/4SP	X			100R13		X		X
EFG4K, G4K	X	X	20023 4SP	X	EN 856 4SP	X			100R12		X		X
EFG3K, G3K	X		20023 4SP		EN 856 4SP	X			100R12		X		X
M5K		X		X		X							
M4K	X	X		X		X			100R19		X		X
M4KH	X					X			100R19		X		X
G2XH									100R2 Type AT		X		X
G2AT-HMP									100R2 Type AT		X		X*
M2T*	X	X		X	EN 853 2SN				100R16		X		X
CM2T				X	EN 857 2CS	X			100R16		X		
G2		X	20022 2SN	X	EN 853 2SN	X			100R2 Type AT		X		X
G2H		X		X	EN 853 2SN				100R2 Type AT		X	X	X
J2AT							X				X		
M3K	X	X		X	EN 857	X			100R17		X		X
M3K -12, -16	X	X		X	EN 857	X			100R17, 100R9		X	X	X
G1		X	20022 1SN	X	EN 853 1SN	X			100R1 Type AT		X		X
G1H				X	EN 853 1SN				100R1 Type AT		X	X	
MegaTech®									J1402, J1405	106-74 [-4 to -10]			
TR500									J1402	106-74			
NABT									J844				
C5C								RP305(B)	100R5	106-74 Type All [-4 to -10]			
C5E									J1405	106-74 Type All			
C5D									J1405	106-74 Type All			
C5M	X								J30R2, J1527		X	X	
G3H					EN 854 R3				100R3				
GTH, GTHX					EN 854 R6				100R6				
GMV	X®	X							100R4		X		X
LOL											X		
THERMOPLASTIC TH7, TH7NC*** TH8, TH8NC TH18, TH18NC									100R7 100R8 100R18				
C14									100R14				
REFRIGERANT PolarSeal® AC134a									J51 Type 2, J2064				
POWER STEERING PS188									2050				

* Except 1/4"

*** TH7NC meets ANSI A92.2 for vehicle mounted aerial devices [-3 to -8]

@ to be used with a fire sleeve

EQUIPMENT
HOSE/CPLG. SELECTION
G8K COUPLINGS
GLOBALSPIRAL COUPLINGS
STAINLESS STEEL SPIRAL
MEGACRIMP COUPLINGS
STAINLESS STEEL BRAID
POWER CRIMP COUPLINGS
FIELD ATTACHABLE G1 & G2 COUPLINGS
FIELD ATTACHABLE C5 COUPLINGS
GLX COUPLINGS
GL COUPLINGS
C14 COUPLINGS
PCTS THERMOPLASTIC COUPLINGS
POLARSEAL COUPLINGS
POLARSEAL II COUPLINGS
POWER STEERING
ADAPTERS
QUICK DISCONNECT COUPLERS
BALL VALVES
LIVE SWIVEL
ASSEMBLY FABRICATION
ACCESSORIES
EQUIPMENT AND PARTS
AIR BRAKE
BRASS
KITS

Characteristics of Hose Stock Types

EQUIPMENT

HOSE/CPLG. SELECTION

G8K COUPLINGS

GLOBAL SPIRAL COUPLINGS

STAINLESS STEEL SPIRAL

MEGACRIMP COUPLINGS

STAINLESS STEEL BRAID

POWER CRIMP COUPLINGS

FIELD ATTACHABLE G1 & G2 COUPLINGS

FIELD ATTACHABLE C5 COUPLINGS

GLX COUPLINGS

GL COUPLINGS

C14 COUPLINGS

PCTS THERMOPLASTIC COUPLINGS

POLARSEAL COUPLINGS

POLARSEAL II COUPLINGS

POWER STEERING

ADAPTERS

QUICK DISCONNECT COUPLERS

BALL VALVES

LIVE SWIVEL

ASSEMBLY FABRICATION

ACCESSORIES

EQUIPMENT AND PARTS

AIR BRAKE

BRASS

KITS

The characteristics shown below are for the normal or usual range of these specific stocks. Stocks can be changed somewhat through different compounding to meet the requirements of specialized applications.

Tube and cover stocks may occasionally be upgraded to take advantage of improved materials and technology.

For detailed information on a specific hose tube or cover stock, check the Chemical Resistance Table and also the specific hose page.

	Neoprene (Poly-Chloroprene) Type A	Nitrile (Acrylonitrile and Butadiene) Type C	Nylon Type Z	CSM (Chlorosulfonated Polyethylene) Type M	EPDM (Ethylene Propylene Diene) Type P	CPE (Chlorinated Polyethylene) Type J	PTFE (Polytetrafluoro- ethylene) Type T
Flame Resistance	Very Good	Poor	Good	Good	Poor	Good	Good
Petroleum Base Oils	Good	Excellent	Good to Excellent	Good	Poor	Very Good	Excellent
Diesel Fuel	Fair to Good	Good to Excellent	Good to Excellent	Good	Poor	Good	Excellent
Resistance to Gas Permeation	Good	Good	Good To Excellent	Good to Excellent	Fair to Good	Good	Good to Excellent
Weather	Good to Excellent	Poor	Excellent	Very Good	Excellent	Good	Excellent
Ozone	Good to Excellent	Poor for Tube; Good For Cover	Excellent	Very Good	Outstanding	Good	Excellent
Heat	Good	Good	Good	Very Good	Excellent	Excellent	Excellent
Low Temperature	Fair to Good	Poor to Fair	Excellent	Poor	Good to Excellent	Good	Excellent
Water-Oil Emulsions	Excellent	Excellent	Good to Excellent	Good	Poor	Excellent	Excellent
Water/Glycol Emulsions	Excellent	Excellent	Excellent	Excellent	Excellent	Excellent	Excellent
Diesters	Poor	Poor	Excellent	Fair	Excellent	Very Good	Excellent
Phosphate Esters	Fair (For Cover)	Poor	Excellent	Fair	Very Good	Very Good	Excellent
Phosphate Ester Base Emulsions	Fair (For Cover)	Poor	Excellent	Fair	Very Good	Very Good	Excellent

COVER ABRASION RESISTANCE

These comparisons are based on test results per ISO 6945 abrasion testing. The table shows the expected number of times of extended cover service life as compared to a standard cover.

	Modified Nitrile (Standard cover)	Nylon Sleeve	XtraTuff™	MegaTuff®
Relative Abrasion Resistance	1	15 X Standard Cover	25 X Standard Cover	300 X Standard Cover

Gates Hydraulic Hose Selection Guide

Standard Industry Specification	Gates Description	Construction (Reinforcement)	Use	Stock			
				Tube		Cover	
				Name	Type	Name	Type
Gates Proprietary Design	G8K	6-spiral, wire	Extremely High Pressure & Impulse Cycle Life, High Temperature, Petroleum Oils	Neoprene	A	Neoprene	A
ISO 3862 R15 SAE 100R15 EN 856 TYPE 4SP/4SH	EFG6K	4&6-spiral, wire	Extremely High Pressure & Impulse Cycle Life, High Temperature, Petroleum Oils, Environmental Fluids	Nitrile	C	Neoprene	A
	EFG6K-MTF	4&6-spiral, wire	Extremely High Abrasion Resistant, Pressure & Impulse Cycle Life, High Temperature, Petroleum Oils, Environmental Fluids	Nitrile	C	MegaTuff	-
ISO 3862 R13 SAE 100R13 EN 856 TYPE 4SP/4SH	EFG5K	4&6-spiral, wire	Extremely High Pressure & Impulse Cycle Life, High Temperature, Petroleum Oils, Environmental Fluids	Nitrile	C	Neoprene	A
	EFG5K-MTF	4&6-spiral, wire	Extremely High Abrasion Resistant, Pressure & Impulse Cycle Life, High Temperature, Petroleum Oils, Environmental Fluids	Nitrile	C	MegaTuff	-
ISO 3862 R12 SAE 100R12 EN 856 Type 4SP ++	EFG4K	4&6-spiral, wire	Extremely High Pressure & Impulse Cycle Life, High Temperature, Petroleum Oils, Environmental Fluids	Nitrile	C	Neoprene	A
	EFG4K-MTF	4&6-spiral, wire	Extremely High Abrasion Resistant, Pressure & Impulse Cycle Life, High Temperature, Petroleum Oils, Environmental Fluids	Nitrile	C	MegaTuff	-
ISO 3862 R12 SAE 100R12 EN 856 Type 4SP	EFG3K	4-spiral, wire	Extremely High Pressure & Impulse Cycle Life, High Temperature, Petroleum Oils, Environmental Fluids	Nitrile	C	Neoprene	A
	EFG3K-MTF	4-spiral, wire	Extremely High Abrasion Resistant, Pressure & Impulse Cycle Life, High Temperature, Petroleum Oils, Environmental Fluids	Nitrile	C	MegaTuff	-
Gates Proprietary Design	M-XP	2-braid, wire	Extremely High Pressure & Impulse Cycle Life, High Flexibility, Tight Bend Radius, Petroleum Oils, Environmental Fluids	Nitrile	C	Nitrile	C2
Gates Proprietary Design	M6K	2-braid, wire	High Pressure, Impulse Cycle Life & Flexibility, Tight Bend Radius, Petroleum Oils, Environmental Fluids	Nitrile	C	Nitrile	C2
Gates Proprietary Design	M5K	2-braid, wire	High Pressure, Impulse Cycle Life & Flexibility, Tight Bend Radius, Petroleum Oils, Environmental Fluids	Nitrile	C	Nitrile	C2
Gates Proprietary Design	M5K-XTF	2-braid, wire	High Abrasion Resistant, Pressure, Impulse Cycle Life & Flexibility, Tight Bend Radius, Petroleum Oils, Environmental Fluids	Nitrile	C	XtraTuff	Nitrile/PVC
Gates Proprietary Design	M5K-MTF	2-braid, wire	Extremely High Abrasion Resistant, High Pressure, Impulse Cycle Life & Flexibility, Tight Bend Radius, Petroleum Oils, Environmental Fluids	Nitrile	C	MegaTuff	-
ISO 11237 R19 SAE 100R19	M4K	2-braid, wire	High Pressure, Impulse Cycle Life & Flexibility, Tight Bend Radius, Petroleum Oils, Environmental Fluids	Nitrile	C	Nitrile	C2
	M4K-XTF	2-braid, wire	High Abrasion Resistant, Pressure, Impulse Cycle Life & Flexibility, Tight Bend Radius, Petroleum Oils, Environmental Fluids	Nitrile	C	XtraTuff	Nitrile/PVC
	M4K-MTF	2-braid, wire	Extremely High Abrasion Resistant, High Pressure, Impulse Cycle Life & Flexibility, Tight Bend Radius, Petroleum Oils, Environmental Fluids	Nitrile	C	MegaTuff	-
	M4KH	2-braid, wire	High Temperature, Pressure, Impulse Cycle Life & Flexibility, Tight Bend Radius, Petroleum Oils, Environmental Fluids	Nitrile	C	Chloroprene	CR
	M4KH-MTF	2-braid, wire	Extremely High Abrasion Resistant, High Temperature, Pressure, Impulse Cycle Life & Flexibility, Tight Bend Radius, Petroleum Oils, Environmental Fluids	Nitrile	C	MegaTuff	-
ISO 11237 R17 SAE 100R17	M3K	1 & 2-braid, wire	High Pressure, Impulse Cycle Life & Flexibility, Tight Bend Radius, Petroleum Oils, Environmental Fluids	Nitrile	C	Nitrile	C2
	M3K-XTF	1 & 2-braid, wire	High Abrasion Resistant, Pressure, Impulse Cycle Life & Flexibility, Tight Bend Radius, Petroleum Oils, Environmental Fluids	Nitrile	C	XtraTuff	Nitrile/PVC
	M3K-MTF	1 & 2-braid, wire	Extremely High Abrasion Resistant, High Pressure, Impulse Cycle Life & Flexibility, Tight Bend Radius, Petroleum Oils, Environmental Fluids	Nitrile	C	MegaTuff	-
	M3KH	1 & 2-braid, wire	High Temperature, Pressure, Impulse Cycle Life & Flexibility, Tight Bend Radius, Petroleum Oils, Environmental Fluids	Nitrile	C	Chloroprene	CR
	M3KH-MTF	1 & 2-braid, wire	Extremely High Abrasion Resistant, High Temperature, Pressure, Impulse Cycle Life & Flexibility, Tight Bend Radius, Petroleum Oils, Environmental Fluids	Nitrile	C	MegaTuff	-
ISO 11237 2SC R16 EN 857 2SC SAE 100R16	M2T®	2-braid, wire	High Pressure, Impulse Cycle Life & Flexibility, Tight Bend Radius, Petroleum Oils, Environmental Fluids	Nitrile	C	Nitrile	C2
	M2T®-XTF	2-braid, wire	High Abrasion Resistant, Pressure, Impulse Cycle Life & Flexibility, Tight Bend Radius, Petroleum Oils, Environmental Fluids	Nitrile	C	XtraTuff	Nitrile/PVC
	M2T®-MTF	2-braid, wire	Extremely High Abrasion Resistant, High Pressure, Impulse Cycle Life & Flexibility, Tight Bend Radius, Petroleum Oils, Environmental Fluids	Nitrile	C	MegaTuff	UHMWPE
Exceeds ISO 1436 2SC R16 SAE 100R16, EN 857 2SC	CM2TDL	2-braid, wire	High Pressure, Impulse Cycle Life & Flexibility, Tight Bend Radius, Petroleum Oils, Environmental Fluids	Nitrile	C	Nitrile	C2
ISO 1436 2SN R2 SAE 100R2 Type AT EN 853 Type 2SN	G2	2-braid, wire	High Pressure, Petroleum Oils & Environmental Fluids	Nitrile	C	NBR/PVC	C2
	G2L	2-braid, wire	High Pressure, Low Temperature, Petroleum Oils & Environmental Fluids	Nitrile	C	Neoprene	A
	G2H	2-braid, wire	High Pressure, Temperature, Petroleum Oils & Environmental Fluids	Nitrile	C	CSM	M
	G2XH	2-braid, wire	Extremely High Heat, High Pressure, Petroleum Oils & Environmental Fluids	CPE	J	CSM (BLUE)	(BLUE)
IJ100	J2AT	2-braid, wire	Industrial Jack Hose Applications	Nitrile	C	Nitrile	C2
IJ100	J2AT-MTF	2-braid, wire	Industrial Jack Hose Applications	Nitrile	C	MegaTuff	-
ISO 1436 1SN R1 SAE 100R1 Type AT EN 853 Type 1SN	G1	1-braid, wire	Medium Pressure, Petroleum Oils & Environmental Fluids	Nitrile	C	Nitrile	C2
SAE 100R1 Type AT EN 853 Type 1SN	G1H	1-braid, wire	High Temperature, Medium Pressure, Petroleum Oils & Environmental Fluids	Nitrile	C	CSM	M
Gates Proprietary Design	RFS	1-braid, wire	Low Pressure, Powder Fire Suppressant Applications	Nitrile	C	Nitrile (RED)	C2

EQUIPMENT
HOSE/CPLG. SELECTION
G8K COUPLINGS
GLOBALSPIRAL COUPLINGS
STAINLESS STEEL SPIRAL
MEGACRIMP COUPLINGS
STAINLESS STEEL BRAID
POWER CRIMP COUPLINGS
FIELD ATTACHABLE G1 & G2 COUPLINGS
FIELD ATTACHABLE C5 COUPLINGS
GLX COUPLINGS
GL COUPLINGS
C14 COUPLINGS
PCTS THERMOPLASTIC COUPLINGS
POLARSEAL COUPLINGS
POLARSEAL II COUPLINGS
POWER STEERING
ADAPTERS
QUICK DISCONNECT COUPLERS
BALL VALVES
LIVE SWIVEL
ASSEMBLY FABRICATION
ACCESSORIES
EQUIPMENT AND PARTS
AIR BRAKE
BRASS
KITS

Gates Hydraulic Hose Selection Guide - Continued

EQUIPMENT	HOSE/CPLG. SELECTION	Standard Industry Specification	Gates Description	Construction (Reinforcement)	Use	Stock			
						Tube		Cover	
						Name	Type	Name	Type
G8K COUPLINGS		SAE J1405 SAE J1402/DOT*** SAE100R2****	MegaTech® G5TB	1 & 2-braid, wire, textile	Extremely High Heat, Hot Oil Pressure & Return Lines, High Temperature Rotary Oil/Air, Air Compressor, Petroleum Oils	CPE	J	Textile	—
GLOBAL SPIRAL COUPLINGS			MegaTech® II	2-braid, wire, textile	Extremely High Heat, Hot Oil Pressure & Return Lines, High Temperature Rotary Oil/Air, Air Compressor, Petroleum Oils	CPE	J	Textile (Blue)	—
STAINLESS STEEL SPIRAL			MegaTech® 1000	1-braid, wire, textile	Extremely High Heat, Hot Oil Pressure & Return Lines, High Temperature Rotary Oil/Air, Air Compressor, Petroleum Oils, Air Brake	CPE	J	Textile	—
MEGACRIMP COUPLINGS			MegaTech® 500	1-braid, wire, textile	Extremely High Heat, Hot Oil Pressure & Return Lines, High Temperature Rotary Oil/Air, Air Compressor, Petroleum Oils	CPE	J	Textile	—
STAINLESS STEEL BRAID			MegaTech® 250	1-braid, wire, textile	Extremely High Heat, Hot Oil Pressure & Return Lines, High Temperature Rotary Oil/Air, Air Compressor, Petroleum Oils, Transmission Oil Cooler	CPE	J	Textile	—
			MegaTech® LOC	1-braid, textile	Extremely High Heat, Hot Oil Pressure & Return Lines, High Temperature Rotary Oil/Air, Air Compressor, Petroleum Oils, Transmission Oil Cooler	CPE	J	Textile	—
		SAE 100R3 EN 854 TYPE R3	G3H	2-braid, textile	Petrol. Oils, Antifreeze, Water, High Temperature	Nitrile	C	Neoprene	A
		SAE 100R6 EN 854 TYPE R6	GTH	1-braid, textile	Petrol. Oils, Antifreeze, Water, High Temperature	Nitrile	C	Neoprene	A
POWER CRIMP COUPLINGS		SAE 100R6 EN 854 TYPE R6	GTHX	1-spiral, textile	Petrol. Oils, Antifreeze, Water, High Temperature	Nitrile	C	Neoprene	A
FIELD ATTACHABLE G1 & G2 COUPLINGS		SAE 100R4	G4H	2-spiral, textile, helical wire	Return & Suction High Temperature	Nitrile	C	Neoprene	A
		SAE 100R4	GMV	2-spiral, textile, helical wire	Return & Suction High Temperature	Nitrile	C	Neoprene	A
FIELD ATTACHABLE C5 COUPLINGS		SAE 30R2 Type 1 & 2, B20 Biodiesel	RLA	1-braid, textile	Return & Suction Low Pressure, Biodiesel up to 125°F	Nitrile	C	Nitrile	C2
		Gates Proprietary Design	RLC	3-braid, textile	Return & Low Pressure	Nitrile	C	Nitrile	C2
GLX COUPLINGS		SAE 30R2, SAE 30R6, SAE 30R7 and B20 Biodiesel	LOC	1-braid, textile	Petrol, Oils, Antifreeze, Water, Air & Biodiesel up to 125°F	Nitrile	C	Textile	—
GL COUPLINGS		Gates Proprietary Design	LOL	1-braid, textile	Petrol, Oils, Antifreeze, Water & Air	Nitrile	C	***	A/C2
C14 COUPLINGS		SAE J1402, DOT FMVSS106-74	TR500	2-braid, wire, textile	Petrol & Syn. Fluids, Air Brakes	Nitrile	C	Textile	—
PCTS THERMOPLASTIC COUPLINGS		SAE 100R5, DOT FMVSS106-74, Type All	*C5C	3-braid, T-W-T	Petr. Oil, Air Brake, Power Steering	*Nitrile	C	Textile	—
POLARSEAL COUPLINGS		SAE J1402, DOT FMVSS106-74, Type All	C5D	3-braid, T-W-T	Petrol & Syn. Fluids, Air Brakes	CPE	J	Textile	—
		SAE J1527, SAE J1942, ISO 7840	C5M	1-braid, wire	Marine Fuel & Oil	Nitrile	C	NBR/PVC	C2
POLARSEAL II COUPLINGS		DOT FMVSS106-74, Type All	C5E	3-braid, T-W-T	Air Brake, Power Steering, Lube	Nitrile	C	Textile	—
PTFE									
POWER STEERING		SAE 100R14	C14	1-braid, stainless steel	High Temperature, Multi Fluid, Nonconductive	PTFE	—	Stainless Steel	—
		SAE 100R14	C14CT	1-braid, stainless steel	High Temperature, Multi Fluid, Conductive	PTFE	—	Stainless Steel	—
ADAPTERS									
Thermoplastic									
		SAE 100R7	TH7	1-braid, polyester	Petroleum & Synthetic Fluids	Nylon	Z	Urethane	U
		SAE 100R7	TH7NC/TH7NCDL	1-braid, polyester	Non-conductive	Nylon	Z	Urethane	U
		SAE 100R7	TH7DL	1-braid, polyester	Petroleum & Synthetic Fluids, Dual Line	Nylon	Z	Urethane	U
		SAE 100R7	TH7NCDL	1-braid, polyester	Non-conductive, Dual Line	Nylon	Z	Urethane	U
		SAE 100R8	TH8	2-braid, Polyester	Petroleum & Synthetic Fluids	Nylon	Z	Urethane	U
BALL VALVES		SAE 100R8	TH8NC	2-braid, Polyester	Non-conductive	Nylon	Z	Urethane	U
LIVE SWIVEL		SAE 100R18	TH18	1-braid, Synthetic Fiber	Petroleum & Synthetic Fluids	Nylon	Z	Polyester	U
		SAE 100R18	TH18NC	2-braid, Synthetic Fiber	Non-conductive	Nylon	Z	Polyester	U
ASSEMBLY FABRICATION									
Refrigerant									
ACCESSORIES		SAE J51 Type All Dimensions/ Type D Performance, J2064, Type C, Class II Performance	PolarSeal® AC134a	Nylon barrier, 2-spiral, Polyester	Air Conditioning (R12 and R134a)	Chloroprene	A	EPDM	P
EQUIPMENT AND PARTS		SAE J2064 Type C, Class I	PolarSeal® ACC-PSII		Reduced Barrier Construction, Air Conditioning (R12, R13A and R22)	Elastomeric/ Nylon	-	Elastomeric	-
AIR BRAKE		* -4 and -5 sizes have a Neoprene tube, ***MegaTech1000 sizes -4, -6, -8, -10, ****MegaTech II, +- -16 & -20 EFG4K							
BRASS									
KITS									

Gates Hydraulic Hose Selection Guide - Continued

Description	Temp. Range (°F)	Dash Size vs. Rated Working Pressure (psi)															
		-2	-3	-4	-5	-6	-8	-10	-12	-16	-20	-24	-32	-40	-48	-56	-64
G8K	-40 +250								8,000	8,000							
EFG6K	-40 +250					6,000	6,000	6,000	6,000	6,000	6,000	6,000					
EFG5K	-40 +250					5,000	5,000	5,000	5,000	5,000	5,000	5,000	5,000				
EFG4K	-40 +250					4,000	4,000	4,000	4,000	4,000	4,000	4,000					
EFG3K	-40 +250											3,000	3,000	3,000			
M-XP	-40 +212			4,000		4,000	4,000	4,000	4,000								
M2T®	-40 +212			6,000	5,500	5,000	4,300	3,800	3,500	2,500							
CM2TDL	-40 +212			4,800		4,000											
M6K	-40 +212			6,000													
M5K	-40 +212			5,000	5,000	5,000	5,000										
M4K	-40 +212			4,000	4,000	4,000	4,000	4,000	4,000	4,000							
M4KH	-40 +250			4,000	4,000	4,000	4,000	4,000	4,000								
M3K	-40 +212		3,250	3,250	3,250	3,250	3,250	3,250	3,250	3,250							
M3KH	-40 +250		3,000	3,000	3,000	3,000	3,000	3,000	3,000	3,000							
G2	-40 +212		6,000	5,800		4,800	4,000	3,625	3,100	2,400	1,825	1,300	1,175				
G2H	-40 +275										1,650	1,300	1,175				
G2XH	-40 +300			6,000		5,000	4,250	3,625	3,100	2,500	2,250						
G2L	-70 +212			5,800		4,800	4,000	3,625	3,100	2,400	1,825	1,300					
J2AT	-40 +120			10,000		10,000											
G1	-40 +212		3,625	3,275	3,125	2,600	2,325	1,900	1,525	1,275	925	725	600				
G1H	-40 +275			2,750		2,250	2,000	1,500	1,250	1,000	625	725	600				
G3H	-40 +275			1,250		1,125	1,000		750	565	375						
GTH	-40 +275		500	400	400	400	400	350	300								
GTHX	-40 +275					400											
G4H	-40 +275								300	250	200						
GMV	-40 +275								300	250	200	162	112	68	62	56	56
RLA	-40 +212		250	250	250	250	200	200	200	160							
RLC	-40 +275									200	200	200	200	150	150	150	
LOC	-40 +250			300		300	300	300	300								
LOL	-40 +212		300	300	300	300	300	300	300								
TR500	-40 +250			500		500	500	500	500	500	500						
MegaTech® II	-40 +300										2,250	1,500	1,300				
MegaTech® G5TB	-40 +300			3,000		3,000	3,000	1,000	1,000	1,000	1,000	500	500	500	500		
MegaTech® 3000	-40 +300			3,000		3,000	3,000										
MegaTech® 1000	-40 +300			1,000		1,000	1,000	1,000	1,000	1,000							
MegaTech® 500	-40 +300											500	500	500	500		
MegaTech® 250	-40 +300			250		250	250	250	250	250	250						
MegaTech® LOC	-40 +300			300		300	300	300	300	300							
C5C	-40 +212			3,000	3,000	2,250	2,000	1,750	1,500	800	625	500	350	350			
C5D	-40 +300•			1,500	1,500	1,500	1,500	1,250	1,250	750	400						
C5M	-40 +212				500	500	500	500	500	500							
C5E	-40 +300•			1,500	1,500	1,500	1,250	1,250	750	400	300						
C14	***			1,500	1,500	1,500	1,000	800	800	800							
C14 (Static)	-62 +72			3,000	3,000	2,500	2,000	1,500	1,200	1,000							
C14CT	***					1,500	1,000										
C14CT (Static)	72					2,500	2,000										
Thermoplastic																	
TH7	-65 +200	2,500	3,000	2,750	2,500	2,250	2,000		1,250	1,000							
TH7NC	-65 +200	2,500	3,000	2,750	2,500	2,250	2,000		1,250	1,000							
TH7DL	-65 +200			2,750	2,500	2,250	2,000										
TH7NCDL	-65 +200			2,750		2,250	2,000										
TH8	-65 +200		5,000			4,000	3,500		2,250	2,000							
TH8NC	-65 +200			5,000		4,000	3,500										
TH18	-67 +212			3,000	3,000	3,000	3,000	3,000									
TH18NC	-67 +212			3,000	3,000	3,000	3,000	3,000									
Refrigerant																	
PolarSeal® AC134a	-22 +257					500	500	500	500								
PolarSeal® ACC-PSII	-22 +257					350	350	350	350	350							

*** Dynamic temperatures -65 +400; Static temperatures +73 +450 • All purpose fleet application service — 40°F to +300°F (-40°C to +149°C), air to +250°F

EQUIPMENT
HOSE/CPLG. SELECTION
G8K COUPLINGS
GLOBAL SPIRAL COUPLINGS
STAINLESS STEEL SPIRAL
MEGACRIMP COUPLINGS
STAINLESS STEEL BRAID
POWER CRIMP COUPLINGS
FIELD ATTACHABLE G1 & G2 COUPLINGS
FIELD ATTACHABLE C5 COUPLINGS
GLX COUPLINGS
GL COUPLINGS
C14 COUPLINGS
PCTS THERMOPLASTIC COUPLINGS
POLARSEAL COUPLINGS
POLARSEAL II COUPLINGS
POWER STEERING
ADAPTERS
QUICK DISCONNECT COUPLERS
BALL VALVES
LIVE SWIVEL
ASSEMBLY FABRICATION
ACCESSORIES
EQUIPMENT AND PARTS
AIR BRAKE
BRASS
KITS

Additional Temperature Limits For Gates Hydraulic Hose

EQUIPMENT
HOSE/CPLG. SELECTION
G8K COUPLINGS
GLOBALSPIRAL COUPLINGS
STAINLESS STEEL SPIRAL
MEGACRIMP COUPLINGS
STAINLESS STEEL BRAID
POWER CRIMP COUPLINGS
FIELD ATTACHABLE G1 & G2 COUPLINGS
FIELD ATTACHABLE C5 COUPLINGS
GLX COUPLINGS
GL COUPLINGS
C14 COUPLINGS
PCTS THERMOPLASTIC COUPLINGS
POLARSEAL COUPLINGS
POLARSEAL II COUPLINGS
POWER STEERING
ADAPTERS
QUICK DISCONNECT COUPLERS
BALL VALVES
LIVE SWIVEL
ASSEMBLY FABRICATION
ACCESSORIES
EQUIPMENT AND PARTS
AIR BRAKE
BRASS
KITS

Caution: Water, water/oil emulsions and water/glycol solutions must be kept below the temperatures listed in the table below, relative to line pressures.

MAXIMUM TEMPERATURE LIMITS FOR WATER, WATER/OIL EMULSIONS AND WATER/GLYCOL SOLUTIONS

Hose	Pressure Lines	Return Lines
G8K, EFG6K, EFG5K, EFG4K, EFG3K, G2, G2L, M2T®, M6K, M5K, M4K, M3K, RFS, RLA, C5C, C5E, LOC, LOL	+200°F [+93°C]	+180°F [+82°C]
G2H, G1H, MegaTech® Line, G2XH, C5D, G3H, GTH, G4H, GMV, RLC, TR500, M3KH, M4KH	+225°F [+107°C]	+180°F [+82°C]

Caution: The fluid manufacturer’s recommended maximum operating temperature for any given fluid must not be exceeded. If different than the above listed hose temperatures, the lower limit must take precedence. Actual service life at temperatures approaching the recommended limit will depend on the particular application and the fluid being used in the hose. Intermittent (up to 10 percent of operating time) refers to momentary temperature surges. Detrimental effects increase with increased exposure to elevated temperatures.

Do NOT expose hose to maximum temperature and maximum rated working pressure at the same time.

SAE Recommended Practices for Hydraulic Hose Assemblies

A SUMMARY OF SAE J1273 FEB 2009

SCOPE

This summary provides guidelines for safety, selection, routing, fabrication, installation, replacement, maintenance, and storage of hose and hose assemblies. These are the recommended practices for hydraulic hose, but are also appropriate for many other hose and systems.

SAFETY

Safety should be a paramount concern whenever working with a hydraulic system. The fluids conveyed are often at high temperatures and extremely high pressures which present unique dangers.

Hydraulic fluid injuries are generally very severe and may come in several forms. Fluid injections wounds may occur any time there is a leak in a hydraulic system. Never check for leaks or damage to a hydraulic system by feel, the best case scenario with a fluid injection wound is months of painful treatment to recover, addition risks include amputation and death. Due to the high temperatures any time a user is exposed to hydraulic fluids severe burns may result, this exposure may be a result of an assembly failure or even oil released during maintenance. Additionally there is a danger of fire or explosion if a hose fails around a hot engine or exhaust manifold, or if a static discharge takes place in a fluid spray.

Unconstrained hose may whip on pressurization or in the event of failure and are extremely dangerous. Additionally during the release of pressure on the hydraulic system improperly secured booms or other cylinder supported components may drop suddenly.

A sometimes less recognized risk is that of electrical shock. Any equipment used to work around live electrical lines [such as lifts, etc]. Should be equipped with hydraulic hose rated as non-conductive. This is because most hydraulic hose have wire reinforcement and are inherently conductive. Also even when non-conductive hose are used it is important to recognize that hydraulic fluids may also act as conductors.

HOSE SELECTION

The Gates STAMPED process is the industry accepted standard for hose selection, this process involves determining the following properties:

SIZE

> Internal diameter requirements will affect fluid velocity and outside diameter may also sometime be concern for routing purposes. When in doubt match existing specifications.

TEMPERATURE

> The maximum recommended hose temperature should never be exceeded, either in the fluid conveyed or on the exterior of the hose. Similarly special hose are available which will maintain flexibility at very low temperatures, always follow manufacturer guidelines.

APPLICATION

> Environmental conditions such as ultraviolet light, salt water, air pollutants, temperature, ozone, chemicals, electricity, abrasion and paint application will all negatively impact hose assembly life.

> Static Discharge can become an issue when non-polar liquids or mixtures including non-polar liquids are conveyed in non-conductive hose. A static charge will build and on discharge perforate the hose tube, to avoid this use conductive tube products when conveying non-polar, or mixtures of non-polar, liquids.

> Electrical Conductivity of hydraulic hose or conveyed fluids is an issue with equipment used to work around electrical lines. If hydraulic equipment is to be used around electrical lines, always use hydraulic hose rated as non-conductive.

> The cleanliness requirements of a final hose assembly will be determined by the system it is to be applied too. Always follow the equipment manufacturer's recommended cleanliness standard.

> Be sure to select products which will meet any regulatory standards required in the application. Examples of these standards would include: SAE, USCG, EN/DIN, ABS, etc.

> Never place hose in a position where they are pulled on. Hose are designed to hold pressure and convey fluids, exposing them to axial loads will cause premature failure.

> Any special or unusual applications should always be approved by the hose manufacturer, otherwise additional independent testing may be required.

MATERIALS

> Permeation, or effusion, is the movement of a substance through the hose tube walls which may degrade the hose tube, cause cover blistering, or other undesired effects, and must be considered especially when conveying compressed gasses.

> Be sure to select a hose which is compatible and approved by the manufacturer for the fluid conveyed. Concentration, pressure, temperature and other factors may impact the compatibility of the hose and fluid.

EQUIPMENT

HOSE/CPLG. SELECTION

G8K COUPLINGS

GLOBAL SPIRAL COUPLINGS

STAINLESS STEEL SPIRAL

MEGACRIMP COUPLINGS

STAINLESS STEEL BRAID

POWER CRIMP COUPLINGS

FIELD ATTACHABLE G1 & G2 COUPLINGS

FIELD ATTACHABLE C5 COUPLINGS

GLX COUPLINGS

GL COUPLINGS

C14 COUPLINGS

PCTS THERMOPLASTIC COUPLINGS

POLARSEAL COUPLINGS

POLARSEAL II COUPLINGS

POWER STEERING

ADAPTERS

QUICK DISCONNECT COUPLERS

BALL VALVES

LIVE SWIVEL

ASSEMBLY FABRICATION

ACCESSORIES

EQUIPMENT AND PARTS

AIR BRAKE

BRASS

KITS

SAE Recommended Practices for Hydraulic Hose Assemblies – Continued

EQUIPMENT
HOSE/CPLG. SELECTION
G8K COUPLINGS
GLOBAL SPIRAL COUPLINGS
STAINLESS STEEL SPIRAL
MEGACRIMP COUPLINGS
STAINLESS STEEL BRAID
POWER CRIMP COUPLINGS
FIELD ATTACHABLE G1 & G2 COUPLINGS
FIELD ATTACHABLE C5 COUPLINGS
GLX COUPLINGS
GL COUPLINGS
C14 COUPLINGS
PCTS THERMOPLASTIC COUPLINGS
POLARSEAL COUPLINGS
POLARSEAL II COUPLINGS
POWER STEERING
ADAPTERS
QUICK DISCONNECT COUPLERS
BALL VALVES
LIVE SWIVEL
ASSEMBLY FABRICATION
ACCESSORIES
EQUIPMENT AND PARTS
AIR BRAKE
BRASS
KITS

PRESSURE

- > The maximum working pressure of a hose assembly is the lowest working pressure of any component of the assembly.
- > Hose should be sized with a working pressure equal to or above the maximum pressure encountered in a system. High frequency electronic transducers will be necessary to determine the maximum surge, or impulse, pressure in a system.
- > If a hose assembly will be exposed to suction, be sure it is rated to hold the maximum suction and pressure in that portion of the system.
- > Any time a hose assembly is to be exposed to external pressures, which may exceed the internal hose pressures, be sure to consult the hose manufacturer for recommendations.

ENDS

- > Always use manufacturer approved couplings for hose assemblies. Be sure to select the appropriate end termination for a system working pressure and other requirements such as vibration resistance.

DELIVERY

- > Always follow manufacturer recommendations for maximum fluid velocity within a hose. Excessive fluid velocity may cause excessive pressure loss, heat generation, hose movement or whipping, system noise, and hammer effects.

HOSE ROUTING

Proper attention to good hose routing and application practices will ensure reliable function of hose assemblies. The following is a short list of factors to consider when routing hose.

- > Vibration: Consider vibration requirements when selecting hose and predicting service life. Clamps, dampers, and other mechanisms may be necessary to reduce vibration.
- > Cover protection: Protect the hose cover from abrasion, erosion, snagging, and cutting. Special abrasion-resistant hose and hose guards are available for additional protection. Route the hose to reduce abrasion from hose rubbing other hose or objects that may abrade it.
- > External Physical Abuse: Route hose to avoid tensile [pulling] loads, side loads, flattening, thread damage, kinking, damage to sealing surfaces, abrasion and twisting.
- > Swivel Adapters: Swivel-type fittings or adapters do not transfer torque to hose while being tightened. Use these as needed to prevent twisting during installation.
- > Live Swivels: If two components in the system are rotating in relation to each other, live swivels may be necessary. These connectors reduce the torque transmitted to the hose.

- > Slings and Clamps: Use slings and clamps to support heavy or long hose and to keep it away from moving parts. Use clamps that prevent hose movement that will cause abrasion. Care shall be taken to prevent the sling clamp from abraiding the hose. Avoid over tightening of slings or clamps.
- > MBR: Routing during assembly and use at less than minimum bend radius may reduce hose life. Sharp bending at the hose/fitting juncture may result in leaking, hose rupturing, or the hose assembly blowing apart. A minimum straight length of 1.5 times the hose's outside diameter shall be allowed between the hose fitting and the point at which the bend starts.
- > Elbows and Adapters: Use elbows or adapters to relieve hose strain due to routing.
- > Lengths: Unnecessarily long hose can increase pressure drop and affect system performance. When pressurized, hose that is too short may pull loose from its fittings, or stress the hose fitting connections, causing premature metallic or seal failures.
- > Motion Absorbtion: Provide adequate hose length to distribute movement and prevent bends smaller than the minimum bend radius.
- > Hose Movement and Bending [multi plane bending]: Hose allows relative motion between system components. Analyze this motion when designing hose systems. The number of cycles per day may significantly affect hose life. Also avoid multiple planes of motion and twisting motion.
- > Hose and machine tolerances: Design hose to allow for changes in length due to machine motion and tolerances.
- > Hose length change due to pressure: Design hose to accommodate length changes from changing pressures. Do not cross or clamp together high- and low-pressure hose. The difference in length changes could wear the hose covers.

HOSE ASSEMBLY FABRICATION

- > Component inspection: Before creating an assembly be sure to inspect all components to be sure they are the correct product, cut correctly, and do not have any visually identifiable defects.
- > Couplings [compatibility]: Hose fitting components from one manufacturer are not usually compatible with fitting components supplied by another manufacturer. Never mix and match hose and couplings from different manufacturers, unless approved by both parties.
- > Hose assembly equipment [crimpers]: Hose and fittings from one manufacturer should not generally be assembled with the equipment of another manufacturer.

SAE Recommended Practices for Hydraulic Hose Assemblies – Continued

- > Safety Equipment: During fabrication, use proper safety equipment, including eye protection, respiratory protection, and adequate ventilation.
- > Reuse of Hose and Fittings: Damaged hose and fittings shall not be used.
 - Never reuse: Field-attachable fittings that have blown or pulled off hose
 - Never reuse: Any part of hose fittings that were permanently crimped or swaged to hose
 - Never reuse: Hose that has been in service
- > Cleanliness: Hose assemblies may be contaminated during fabrication. Clean hose to specified cleanliness levels.
- > Temperature: The fabrication of hose assemblies should be performed at an ambient temperature over 0°C.
- > Assembly inspection: After assembly, hose assemblies shall be inspected for visible defects and interior obstructions.
- > Marking: Hose assemblies shall be marked in accordance with any relevant standards.

HOSE ASSEMBLY INSTALLATION AND REPLACEMENT

- > Before installation inspect the hose assembly for:
 - Hose length and routing for compliance with original design
 - Correct style, size, length, and visible nonconformities
 - Coupling sealing surfaces for burrs, nicks, or other damage
- > Handling during installation: Handle hose with care during installation. Kinking hose, or bending at less than minimum bend radius may reduce hose life. Avoid sharp bending at the hose/fitting juncture. Before and during installation, hose assemblies should be at a temperature above 0°C.
- > Twist angle and orientation: To avoid twisting, which shortens hose life, the hose layline can be used as a reference. Twisting can also be avoided through the use of two wrenches during the installation of swivel connectors.

Securement and protection: Install necessary restraints and protective devices. Determine that such devices do not create additional stress or wear points.

Assembly Torque: Always follow the manufacturer recommended coupling installation practices, and torque or flats values. Improper installation may result in a leaking connection.

System Checkouts: In hydraulic or other liquid systems, eliminate all air entrapment after completing the installation. Follow manufacturers' instructions to test the system for possible malfunctions and leaks.

MAINTENANCE INSPECTION

As part of regular equipment maintenance, hose assemblies should always be checked for deterioration.

Frequency: Evaluate factors such as the nature and severity of the application, past history, and manufacturers' information to establish the frequency of inspections.

Visual Inspection: Only visually inspect for leaks. NEVER attempt to feel a leak, which could cause a fluid injection wound. Look for leaks, weeping, hose cracking, deformation, hardening or softening, rust, noise, smells, and any other defect which indicates a hose assembly may require replacement.

HOSE STORAGE

Age control: Store hose in a manner that facilitates age control and first-in, first-out usage based on manufacturing date on hose or hose assembly. Any hose or assembly in storage for more than two years should be visually inspected and proof pressure tested.

Storage Conditions will greatly affect hose shelf life, always store hose in the manufacturers' original packaging. Avoid high temperatures, ozone, solvents and their vapors, corrosive [acid or basic] liquids and fumes, rodents, extremes in humidity, ultraviolet light, insects, radiation, strong, electro-magnetic fields, molds, and fungi.

Basic Testing for Usability: Flex the hose to the minimum bend radius and compare it with new hose. After flexing, examine the cover and tube for cracks. If any appear, no matter how small, reject the hose.

If the hose is wire reinforced, and the hose is unusually stiff, or a cracking sound is heard during flexing, check for corrosion by cutting away a section of the cover from a sample. Corrosion would be another reason for rejection.

If doubt still persists, contact hose assembler to conduct proof-pressure tests or any other tests needed to verify hose quality.

REFERENCES

All of the material presented here may be explored in more detail by obtaining the original standards from the appropriate regulatory agency.

SOCIETY OF AUTOMOTIVE ENGINEERS (SAE)

- SAE J343 Test and Test Procedures for SAE 100R Series Hydraulic Hose and Hose Assemblies
- SAE J514 Hydraulic Tube Fittings
- SAE J517 Hydraulic Hose

INTERNATIONAL STANDARDS ORGANIZATION (ISO)

- ISO 3457 Earth moving machinery—Guards and shields—Definitions and specifications
- ISO 2230 Rubber products—Guidelines for storage
- ISO 8331 Rubber and plastics hose and hose assemblies—Guide to selection, storage, use and maintenance

EQUIPMENT
HOSE/CPLG. SELECTION
G8K COUPLINGS
GLOBAL SPIRAL COUPLINGS
STAINLESS STEEL SPIRAL
MEGACRIMP COUPLINGS
STAINLESS STEEL BRAID
POWER CRIMP COUPLINGS
FIELD ATTACHABLE G1 & G2 COUPLINGS
FIELD ATTACHABLE C5 COUPLINGS
GLX COUPLINGS
GL COUPLINGS
C14 COUPLINGS
PCTS THERMOPLASTIC COUPLINGS
POLARSEAL COUPLINGS
POLARSEAL II COUPLINGS
POWER STEERING
ADAPTERS
QUICK DISCONNECT COUPLERS
BALL VALVES
LIVE SWIVEL
ASSEMBLY FABRICATION
ACCESSORIES
EQUIPMENT AND PARTS
AIR BRAKE
BRASS
KITS

Motor Vehicle Safety Standard For Brake Hose

EQUIPMENT
HOSE/CPLG. SELECTION
G8K COUPLINGS
GLOBAL SPIRAL COUPLINGS
STAINLESS STEEL SPIRAL
MEGACRIMP COUPLINGS
STAINLESS STEEL BRAID
POWER CRIMP COUPLINGS
FIELD ATTACHABLE G1 & G2 COUPLINGS
FIELD ATTACHABLE C5 COUPLINGS
GLX COUPLINGS
GL COUPLINGS
C14 COUPLINGS
PCTS THERMOPLASTIC COUPLINGS
POLARSEAL COUPLINGS
POLARSEAL II COUPLINGS
POWER STEERING
ADAPTERS
QUICK DISCONNECT COUPLERS
BALL VALVES
LIVE SWIVEL
ASSEMBLY FABRICATION
ACCESSORIES
EQUIPMENT AND PARTS
AIR BRAKE
BRASS
KITS

DOT FMVSS 106-74

MOTOR VEHICLE SAFETY STANDARD FOR BRAKE HOSE

Gates has received an increasing number of inquiries about the Department of Transportation (DOT) regulation FMVSS-106 regarding air brake hose. The requirements of the standard were issued by the National Highway Traffic Safety Administration and are published in the Federal Register, 49 Code of Federal Regulations, Part 571 MVSS 106 Brake Hose.

NOTE: Anyone making brake assemblies must be registered with the Department of Transportation.

WHAT IS FMVSS-106?

The standard is written with specifics on labeling, performance tests, tests procedures, and registration. It is not a standard for design specifications for motor vehicle brake hose, brake hose assemblies, or brake hose end fittings. The Standard No. 106 will ensure that each user of brake hose will be supplied only the highest quality of hose. DOT will conduct random performance testing in accordance with the test procedures to ensure that the hose, couplings, and assemblies meet FMVSS 106.

“The purpose of the standard is to reduce deaths and injuries occurring as a result of brake system failure from pressure or vacuum loss due to hose or hose assembly rupture.” The regulations will apply to all over-the-road vehicles including trailers and motorcycles. Off-the-road vehicles will not be regulated if they are designed to operate on those other than public roads.

BASIC PROVISIONS OF FMVSS-106.

1. Three types of brake hose are covered [hydraulic, air, and vacuum brake] together with couplings and hose assemblies. At this point, we will only focus on air brake hose and assemblies.
2. Performance level for brake hose is established instead of design specifications.
3. Permanent as well as reusable fittings are permissible with air brake hose. Inside and outside diameters standards for air brake hose intended for use with field attachable couplings have been established. These hose are identified as Type I and Type II.

GATES CUSTOMER/ASSEMBLER WITH REGARD TO FMVSS-106.

1. Test [dimensional and pressure] each assembly or per customer’s requirements before it is packaged and delivered to the customer.
2. Two of every 100 air brake hose assemblies produced or per customer’s requirements are subjected to hydrostatic pressure testing and tensile strength [destructive] testing.

LABELING OF AIR BRAKE HOSE.

Any customer crimping air brake assemblies must be registered with the National Traffic Safety Administration [NHTSA].

THE NATIONAL HIGHWAY TRAFFIC SAFETY ADMINISTRATION (NHTSA) REQUIRES:

1. Product DOT CERTIFICATION. [Gates Corporation responsibility. The Gates logo is our DOT registration.]
2. Registration of the assembler. [Customer/Distributor responsibility.]*
3. Permanent assembly identification. [Customer/Distributor responsibility.] Refer to Gates frosted air brake hose labels below.

* To begin the registration process, please complete the BRAKE HOSE REGISTRATION application form on the following page. You can mail or fax the completed form to the address and number listed on the form.

FROSTED AIR BRAKE HOSE LABELS

Product Number: 7484-0023

To assist you in complying with the NHTSA requirement for identifying brake hose assemblies, Gates now offers mylar hose labels.

- > Self-adhesive
- > 1” wide by 3-3/4” long, with a 1-1/2” by 1” white area on one end for printed information
- > Format suitable for typewriters, computer printers or hand writing
- > Accepts 9-10 typed characters per row, 4 or 5 on a row
- > Wrap-around label resists damage from elements

LABEL APPLICATION PROCEDURE:

1. Print appropriate information on label.
2. Wrap tag around hose assembly, printed end first.
3. Cover printed end with clear mylar tail of label.

Comes in 500 labels per pack.



Brake Hose Registration Application

Brake Hose Assembler/Manufacturer's Plant Information

Plant Contact Name:	_____	_____	_____
	<i>Last</i>	<i>First</i>	<i>Position</i>
Plant Name:	_____		
Business Address:	_____		
	<i>Street, Suite No., P.O. Box No.</i>		
	_____	_____	_____
	<i>City</i>	<i>State/Province</i>	<i>Country</i> <i>Postal Code</i>
Plant Contact Info.:	_____	_____	_____
	<i>Telephone</i>	<i>Facsimile</i>	<i>E-mail</i>

Brake Hose Assembler/Manufacturer's Designation Symbol Information (The symbol you will use on your brake hose)

--

Brake Hose Assembler/Manufacturer's U.S. Resident as Agent as identified in the separate 49 CFR Part 551 submission (Complete agent information only if this application is for a foreign manufacturer)

Agent Name:	_____	_____	
	<i>Last</i>	<i>First</i>	
Business Address:	_____	_____	_____
	<i>Street, Suite No., P.O. Box No.</i>	<i>City</i>	<i>State</i> <i>Zip Code</i>
Agent Contact Info.:	_____	_____	_____
	<i>Telephone</i>	<i>Facsimile</i>	<i>E-mail</i>

Application Completed By

_____	_____	_____	_____
<i>Last</i>	<i>First</i>	<i>Date</i>	<i>E-mail</i>

Instructions For Application Submission

This suggested form will assist a manufacturer to comply with applying for Brake Hose Manufacturer's Identification. Please complete the form by typing or clearly printing. Each manufacturer who has submitted this information must keep its entry current, accurate, and complete by submitting revised information not later than 30 days after the relevant changes in its business occur.

EQUIPMENT
HOSE/CPLG. SELECTION
G&K COUPLINGS
GLOBAL SPIRAL COUPLINGS
STAINLESS STEEL SPIRAL
MEGACRIMP COUPLINGS
STAINLESS STEEL BRAID
POWER CRIMP COUPLINGS
FIELD ATTACHABLE G1 & G2 COUPLINGS
FIELD ATTACHABLE C5 COUPLINGS
GLX COUPLINGS
GL COUPLINGS
C14 COUPLINGS
PCTS THERMOPLASTIC COUPLINGS
POLARSEAL COUPLINGS
POLARSEAL II COUPLINGS
POWER STEERING
ADAPTERS
QUICK DISCONNECT COUPLERS
BALL VALVES
LIVE SWIVEL
ASSEMBLY FABRICATION
ACCESSORIES
EQUIPMENT AND PARTS
AIR BRAKE
BRASS
KITS

How to Make Hose Assemblies of Specific Lengths

EQUIPMENT
HOSE/CPLG. SELECTION
G8K COUPLINGS
GLOBAL SPIRAL COUPLINGS
STAINLESS STEEL SPIRAL
MEGACRIMP COUPLINGS
STAINLESS STEEL BRAID
POWER CRIMP COUPLINGS
FIELD ATTACHABLE G1 & G2 COUPLINGS
FIELD ATTACHABLE C5 COUPLINGS
GLX COUPLINGS
GL COUPLINGS
C14 COUPLINGS
PCTS THERMOPLASTIC COUPLINGS
POLARSEAL COUPLINGS
POLARSEAL II COUPLINGS
POWER STEERING
ADAPTERS
QUICK DISCONNECT COUPLERS
BALL VALVES
LIVE SWIVEL
ASSEMBLY FABRICATION
ACCESSORIES
EQUIPMENT AND PARTS
AIR BRAKE
BRASS
KITS

Overall Assembly Length – C1 – C2 = Hose Cut Length

The "C" length for each coupling is listed in the catalog, as shown below.

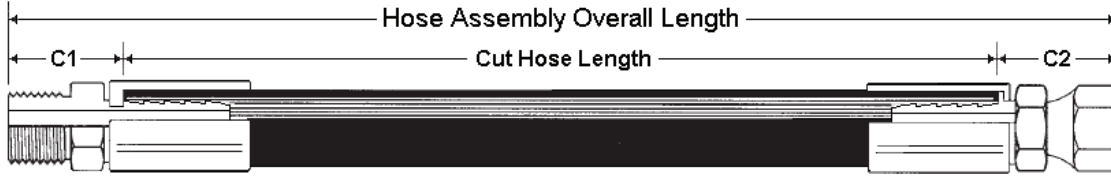

For the Gates Assembly 6M3K-8FJX-8MP-12.5

$$12.5'' - 1.38'' - 1.42'' = 9.7'' \text{ [Cut Hose Length]}$$

Descr.	Prod. No.	C		
		m	"	mm
6G-8MP	7100-10095	3	1.42	36.1

Descr.	Prod. No.	C		
		m	"	mm
6GE-8FJX	7100-10955	3	1.38	35.1

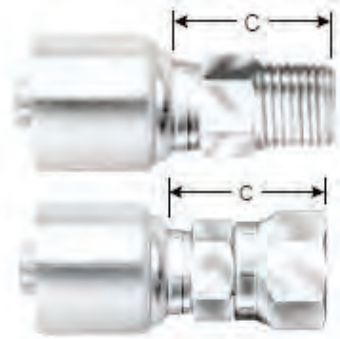

To meet SAE quality requirements: the final assembly must meet the dimensional requirements shown in the table on the right; the hose cut must be within 5° of perpendicular, on 1" hose this is less than 3/32"; and coupling orientation must be within 2° of specification, orientation which is off as little as one percent can half the life of a hose assembly.

Assembly OAL [in]	Tolerance [in]
≤ 12	±0.125
12 < L ≤ 18	±0.1875
18 < L ≤ 36	±0.25
> 36	+ 1%*

*to the nearest 0.125 inches

Best practice to achieve these requirements is to begin by dry fitting all components of the assembly, then measure from one end of a coupling to the opposite end of the cut hose, crimp the coupling and measure the change in length. This will give a good estimate of change in hose length due to the crimping process, and allow for compensation. The use of witness marks to verify orientation and coupling insertion depth is also encouraged.

When measuring a hose assembly, the point at which the ends of the assembly are measured will depend on the style and construction of the couplings. A summary of measurement points is shown below. More detailed information is available in the tech note "Overall Length of Hose Assemblies."

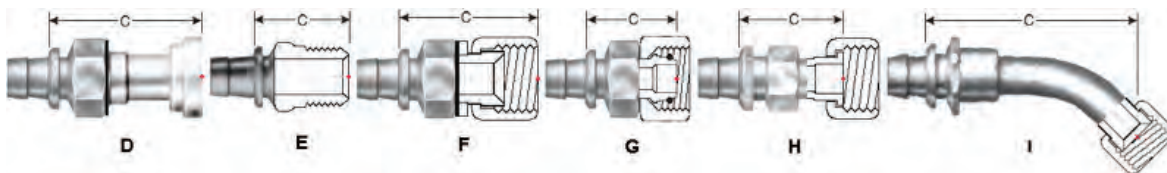

Coupling termination measurement points, from left to right: D) flange, E) straight male, F) US spec [SAE, JIC, NPSM], G) International spec [DIN, BSP, GAZ], H) FFOR and I) bent (elbow) couplings

How to Describe Gates Hydraulic Hose Assemblies

When you order hydraulic assemblies, be sure the following information is included as shown in the illustrations below:

1. Quantity of assemblies required.
2. Hose catalog description [dash size and type].
3. First coupling dash size and end style.
4. Second coupling dash size and end style.
5. Offset angle or orientation of couplings must be specified if both couplings contain bent tube ends.
6. Assembly overall length.

Example:

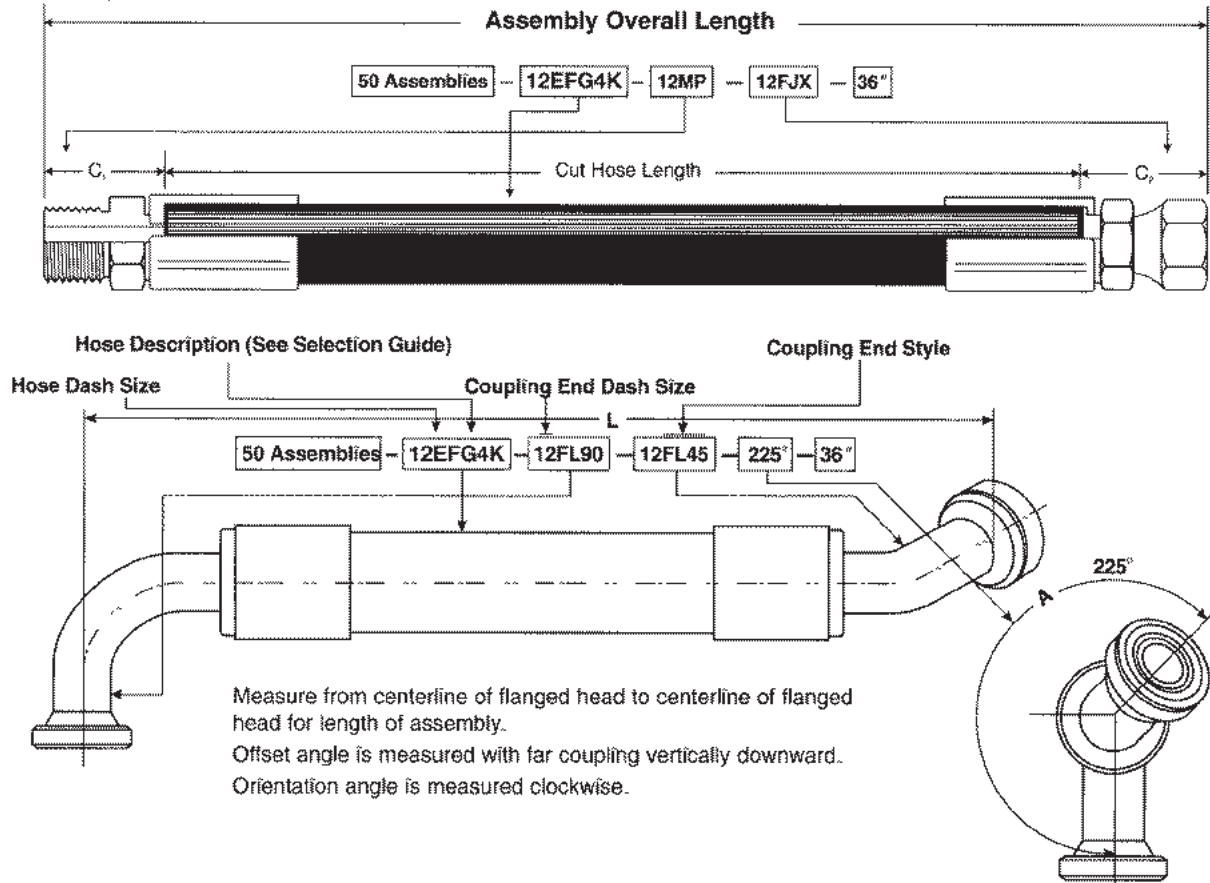

CAUTION:

Rated working pressure of the application should always determine selection of hose. Used up to the recommended **rated working pressure**, the hose will provide normal service life before replacement is required.

When new, the hose described in this catalog will meet or exceed the **minimum burst pressure** listed in the hose specification tables. However—as with any hose in the industry—after the hose has been impulsed for a length of time, **minimum burst pressure** will decrease from the figure shown in the specification tables.

Temperature ranges specified for specific hose refer to recommended temperature limits of fluids being conveyed or ambient temperatures. Exceeding these limits will cause degradation of material compounds and reduce hose service life.

EQUIPMENT
HOSE/CPLG. SELECTION
G8K COUPLINGS
GLOBALSPIRAL COUPLINGS
STAINLESS STEEL SPIRAL
MEGACRIMP COUPLINGS
STAINLESS STEEL BRAID
POWER CRIMP COUPLINGS
FIELD ATTACHABLE G1 & G2 COUPLINGS
FIELD ATTACHABLE C5 COUPLINGS
GLX COUPLINGS
GL COUPLINGS
C14 COUPLINGS
PCTS THERMOPLASTIC COUPLINGS
POLARSEAL COUPLINGS
POLARSEAL II COUPLINGS
POWER STEERING
ADAPTERS
QUICK DISCONNECT COUPLERS
BALL VALVES
LIVE SWIVEL
ASSEMBLY FABRICATION
ACCESSORIES
EQUIPMENT AND PARTS
AIR BRAKE
BRASS
KITS

How to Describe Gates Hydraulic Hose Assemblies

EQUIPMENT
HOSE/CPLG. SELECTION
G8K COUPLINGS
GLOBAL SPIRAL COUPLINGS
STAINLESS STEEL SPIRAL
MEGACRIMP COUPLINGS
STAINLESS STEEL BRAID
POWER CRIMP COUPLINGS
FIELD ATTACHABLE G1 & G2 COUPLINGS
FIELD ATTACHABLE C5 COUPLINGS
GLX COUPLINGS
GL COUPLINGS
C14 COUPLINGS
PCTS THERMOPLASTIC COUPLINGS
POLARSEAL COUPLINGS
POLARSEAL II COUPLINGS
POWER STEERING
ADAPTERS
QUICK DISCONNECT COUPLERS
BALL VALVES
LIVE SWIVEL
ASSEMBLY FABRICATION
ACCESSORIES
EQUIPMENT AND PARTS
AIR BRAKE
BRASS
KITS



Coupling A Information	Hose Type	Coupling B Information
<input type="checkbox"/> Male <input type="checkbox"/> Female Angle ___° Drop: <input type="checkbox"/> S <input type="checkbox"/> M <input type="checkbox"/> L <input type="checkbox"/> XL or Drop Length ____ [mm]	Gates _____ I.D. _____ or SAE 100R _____ Dash Size: <input type="checkbox"/> 2 <input type="checkbox"/> 3 <input type="checkbox"/> 4 <input type="checkbox"/> 5 <input type="checkbox"/> 6 <input type="checkbox"/> 8 <input type="checkbox"/> 10 <input type="checkbox"/> 12 <input type="checkbox"/> 16 <input type="checkbox"/> 20 <input type="checkbox"/> 24 <input type="checkbox"/> 32 <input type="checkbox"/> 40 <input type="checkbox"/> 48 <input type="checkbox"/> 56 <input type="checkbox"/> 64 Temperature _____° Working Pressure (psi): <input type="checkbox"/> 100 <input type="checkbox"/> 101-250 <input type="checkbox"/> 250-499 <input type="checkbox"/> 500-1000 <input type="checkbox"/> 1001-2999 <input type="checkbox"/> 3000-3999 <input type="checkbox"/> 4000-5999 <input type="checkbox"/> 6000 Application <input type="checkbox"/> Return Line <input type="checkbox"/> Pressure Line <input type="checkbox"/> Intake Line <input type="checkbox"/> High Pressure Line <input type="checkbox"/> Special Fluid _____	<input type="checkbox"/> Male <input type="checkbox"/> Female Angle ___° Drop: <input type="checkbox"/> S <input type="checkbox"/> M <input type="checkbox"/> L <input type="checkbox"/> XL or Drop Length ____ [mm]
Thread		Thread
<input type="checkbox"/> JIC [37° Flare] _____		<input type="checkbox"/> JIC [37° Flare] _____
<input type="checkbox"/> NPTF _____		<input type="checkbox"/> NPTF _____
<input type="checkbox"/> O-Ring Boss _____		<input type="checkbox"/> O-Ring Boss _____
<input type="checkbox"/> Flat-Face O-Ring _____		<input type="checkbox"/> Flat-Face O-Ring _____
[ORFS]		[ORFS]
<input type="checkbox"/> Code 61 _____		<input type="checkbox"/> Code 61 _____
<input type="checkbox"/> Code 62 _____		<input type="checkbox"/> Code 62 _____
<input type="checkbox"/> BSPP _____		<input type="checkbox"/> BSPP _____
<input type="checkbox"/> DIN [Light/Heavy] _____		<input type="checkbox"/> DIN [Light/Heavy] _____
<input type="checkbox"/> Other _____		<input type="checkbox"/> Other _____

Overall Length _____ In. mm

Coupling Orientation: _____°

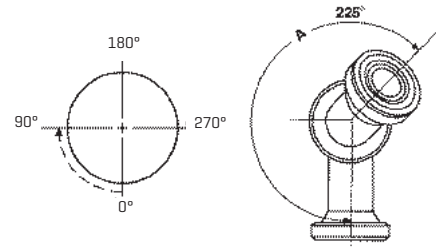

Measure from centerline of flanged head to centerline of flanged head for length of assembly.

Offset angle is measured with far coupling vertically downward.

Orientation angle is measured clockwise.

HOSE GUARDS

	Full Length	Partial Length	From End of Coupling
LifeGuard® Sleeve 	<input type="checkbox"/>	_____	_____
Wire Spring 	<input type="checkbox"/>	_____	_____
Flat Armor Spring 	<input type="checkbox"/>	_____	_____
Nylon Sleeve 	<input type="checkbox"/>	_____	_____
Plastic Coil Sleeve 	<input type="checkbox"/>	_____	_____

Hose Assembly Routing Tips

Proper hose installation is essential for satisfactory performance. If hose length is excessive, the appearance of the installation will be unsatisfactory and unnecessary cost of equipment will be involved. If hose assemblies are too short to permit adequate flexing and changes in length due to expansion or contraction, hose service life will be reduced.

The following diagrams show proper hose installations which provide maximum performance and cost savings. Consider these examples in determining length of a specific assembly.

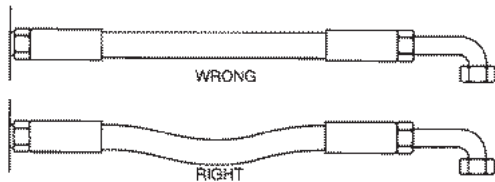

When hose installation is straight, allow enough slack in hose line to provide for length changes which will occur when pressure is applied.

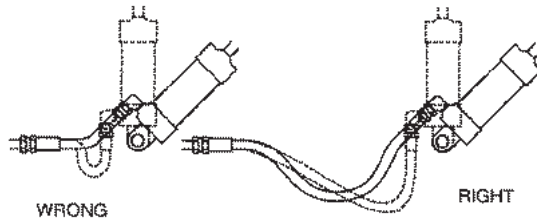

Adequate hose length is necessary to distribute movement on flexing applications and to avoid abrasion.

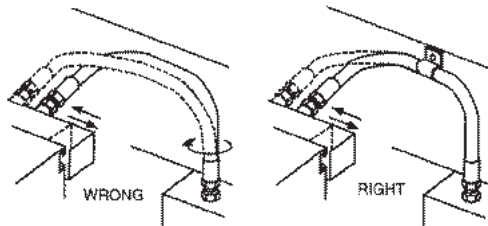

Avoid twisting of hose lines bent in two planes by clamping hose at change of plane.



Reduce number of pipe thread joints by using hydraulic adapters instead of pipe fittings.

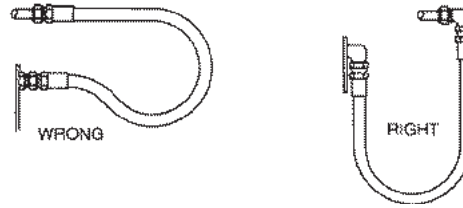

When radius is below the required minimum, use an angle adapter to avoid sharp bends.

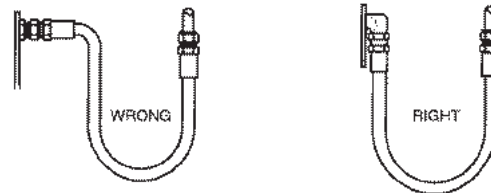

Use proper angle adapters to avoid tight bend in hose.

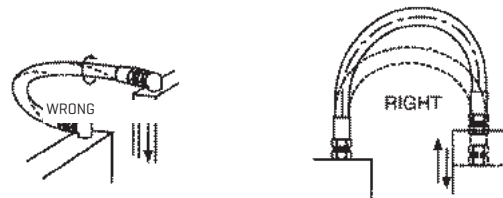

Prevent twisting and distortion by bending hose in same plane as the motion of the port to which hose is connected.

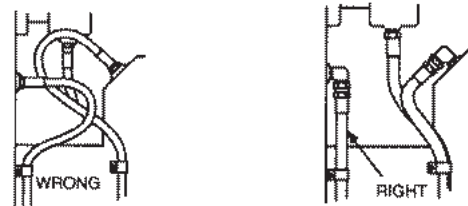

Route hose directly by using 45° and/or 90° adapter and fittings. Avoid excessive hose length to improve appearance.

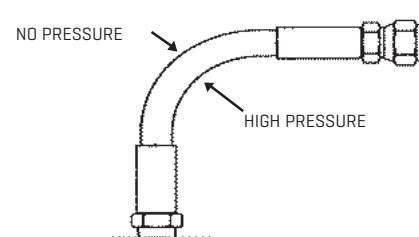

Note: To allow for length changes when hose is pressurized, do not clamp at bends so that curves will absorb changes. Do not clamp high and low pressure lines together.

EQUIPMENT
HOSE/CPLG. SELECTION
G8K COUPLINGS
GLOBAL SPIRAL COUPLINGS
STAINLESS STEEL SPIRAL
MEGACRIMP COUPLINGS
STAINLESS STEEL BRAID
POWER CRIMP COUPLINGS
FIELD ATTACHABLE G1 & G2 COUPLINGS
FIELD ATTACHABLE C5 COUPLINGS
GLX COUPLINGS
GL COUPLINGS
C14 COUPLINGS
PCTS THERMOPLASTIC COUPLINGS
POLARSEAL COUPLINGS
POLARSEAL II COUPLINGS
POWER STEERING
ADAPTERS
QUICK DISCONNECT COUPLERS
BALL VALVES
LIVE SWIVEL
ASSEMBLY FABRICATION
ACCESSORIES
EQUIPMENT AND PARTS
AIR BRAKE
BRASS
KITS

Hose Assembly Routing Tips – Continued

EQUIPMENT
HOSE/CPLG. SELECTION
G8K COUPLINGS
GLOBAL SPIRAL COUPLINGS
STAINLESS STEEL SPIRAL
MEGACRIMP COUPLINGS
STAINLESS STEEL BRAID
POWER CRIMP COUPLINGS
FIELD ATTACHABLE G1 & G2 COUPLINGS
FIELD ATTACHABLE C5 COUPLINGS
GLX COUPLINGS
GL COUPLINGS
C14 COUPLINGS
PCTS THERMOPLASTIC COUPLINGS
POLARSEAL COUPLINGS
POLARSEAL II COUPLINGS
POWER STEERING
ADAPTERS
QUICK DISCONNECT COUPLERS
BALL VALVES
LIVE SWIVEL
ASSEMBLY FABRICATION
ACCESSORIES
EQUIPMENT AND PARTS
AIR BRAKE
BRASS
KITS

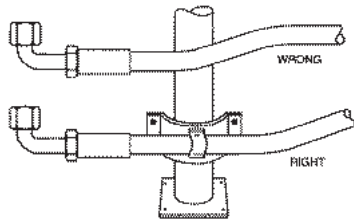

High ambient temperatures shorten hose life, so make sure hose is kept away from hot parts. If this is not possible, insulate hose.

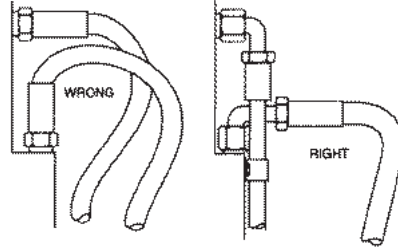

Elbows and adapters should be used to relieve strain on the assembly, and to provide neater installations which will be more accessible for inspection and maintenance.

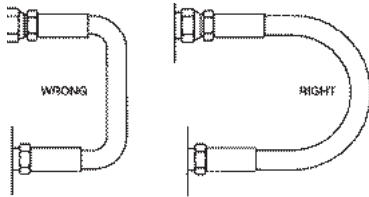

To avoid hose collapse and flow restriction, keep hose bend radius as large as possible. Refer to hose specification tables for minimum bend radius.

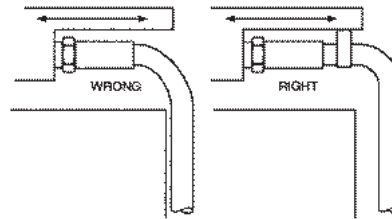

Run hose in the installation so that it avoids rubbing and abrasion. Often, clamps are required to support long hose runs or to keep hose away from moving parts. Use clamps of the correct size. A clamp too large allows hose to move inside the clamp and causes abrasion.

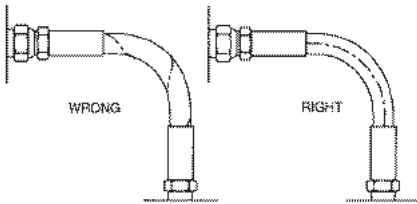

When installing hose, make sure it is not twisted. Pressure applied to a twisted hose can result in hose failure or loosening of connections.

Hydraulic Flareless Assembly Procedure (per SAE J514 6.1.3 and 6.1.4)

1. Bottom the tube in the coupling, and tighten the nut until the ferrule just grips the tube. With a little experience, the technician can determine this point by feel. If the couplings are bench assembled, the gripping action can be determined by rotating the tube by hand as the nut is drawn down. When the tube can no longer be turned by hand, the ferrule has started to grip the tube.
2. After the ferrule grips the tube, tighten the nut one full turn. This may vary slightly with different tubing materials, but for general practice, it is a good rule for the technician to follow.

GATES FIELD ATTACHABLE COUPLING INSTALLATION

1. Cut the hose end square with fine-tooth hacksaw or cut-off saw, the cut must be within 5° of perpendicular.

2. At a minimum be sure to blow out the hose to remove any rubber or metal dust, if higher levels of cleanliness are required utilize the MegaClean system or see the "Hose Assembly Cleanliness" tech note.

3. Be sure to thoroughly oil the stem and the inside of the hose. This is critical to ensure that



the ferrule and stem are easily placed onto the hose, without removing tube or cover material.

4. Secure the ferrule in a vise or adjustable wrench, then using a counter-clockwise motion, thread the hose into the socket until it bottoms out on the inside shoulder of the socket. Once fully inserted, using a counter-clockwise motion, turn the hose back one half turn.



5. With the hose and ferrule secured, thread the stem into the hose and socket in a clockwise motion until the stem hex contacts the ferrule. For production environments, a Gates field attachable coupling machine will speed up this installation.



6. Finally clean the assembly to ensure that the desired cleanliness levels are achieved. Follow the same procedure as in step 2.

Installation of LifeGuard® Line-of-Sight Sleeving

1. Determine LifeGuard sleeve length using the following guidelines:

Sleeve length should exceed the length of free hose (distance between clamps that hold sleeve on) by the following amount:

$$\text{LifeGuard Sleeve Length} = \text{Free Hose Length (in)} \times 1.05$$

All the decimals are rounded **up** to a full inch

For example: 11 3/4" free hose length x 1.05 = 12.34" ~ 13" LifeGuard sleeve length

Note: A minimum of 3/4" of sleeve must extend beyond the clamps to properly clamp the sleeve. Sleeve cannot extend over the hex part of the fitting.

2. A hot knife is recommended to cut the sleeve as it will seal the ends as it cuts and keep the sleeving from unraveling. Gates also sells a guide table which keeps the sleeving in the correct, slightly open position to help simplify this process. Failure to use the guide table with the hot knife could result in both edges of the sleeve being melted together, which in turn makes hose insertion impossible.

If a hot knife is not available, cut sleeve with sharp scissors, and seal the edges of the sleeve to prevent unraveling and to strengthen it. Use flame torch to seal the inside white lining to the black outer sheath. Make sure sleeve end is spread apart before sealing ends with flame.



3. Before inserting the stems and crimping, verify whether the LifeGuard sleeve and collars can be installed after the couplings are crimped or must be installed prior to crimping the couplings.

a. If the collars will fit over at least one of the couplings and also clear the backup hex nut, then the sleeve and collars can be assembled after the hose assembly is completely crimped.

b. If the collars will not freely clear the termination and backup hex of at least one of the stems, then the sleeve and collars must be slid over the hose before crimping. In certain cases it may be desirable to do this anyway, even if the collars will fit. [An example would be when an assembly that uses long drop 90° couplings at both ends.]

4. The LifeGuard line-of-sight sleeve consists of two sleeves woven one inside the other. When inserting the hose, it is critical that the hose is positioned inside the white inner sleeve. Be careful not to snag the inside lining of the sleeve while inserting hose. If hose does not glide in easily, use hose insertion tool.

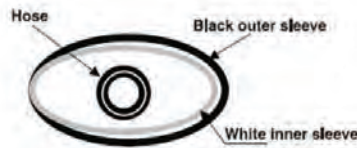

5. The aluminum collars must be free of burrs, sharp edges, gash marks and surface cracks/indentations. Embossing of these collars is permissible. The crimp O.D. for the aluminum collars depends on the hose type and ferrule used. Look up the proper crimp O.D. in eCrimp. The collars are listed numerically by product number. Match the collar product number to the hose type and ferrule product number being used. The collar crimp O.D. is listed in the table, directly to the right of the ferrule product number for each combination.

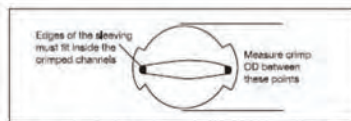

Note: Use PC707 LifeGuard die plate when making assemblies.

Note: The crimp O.D. tolerance for all aluminum collars used to hold LifeGuard line-of-sight nylon sleeving on hose assemblies is ±.005".

WARNING: Extra care must be taken when aligning the back-up hex of the coupling with the crimp dies during crimping of the LifeGuard assembly. Improperly positioned back-up hex can damage the die face.

6. Install proper die sets by first positioning the die plate in such manner as to let the notches rest against the back locator pins on the PC707 crimper. Then install the recommended die set taking extra care that the two die pins fit inside the two holes in the die plate.

7. Dial in crimp setting and crimp sleeve onto one end of the hose assembly.

8. To take the slack out of the sleeve, roll or twist the hose. This will take-up the excess in the sleeve, and help with crimping the other end of the assembly.

9. Pull back any remaining excess of the sleeve. Hold it in place and crimp the other end of the assembly.

10. LifeGuard crimp collars require specialized dies for their installation, since the final form of the collar is very different from a standard crimp. When crimping LifeGuard with the GC32-XD crimper, use eCrimp to determine the appropriate die and setting based on the hose and coupling to which it is to be attached. Once the die has been selected, care must be taken to ensure the die fingers are installed correctly. When using the LifeGuard die set, the fingers are properly aligned when the colored stripe forms a straight line across the die.



CG32-XD

11. Your LifeGuard assembly is now ready to go.



EQUIPMENT
HOSE/CPLG. SELECTION
G&K COUPLINGS
GLOBAL SPIRAL COUPLINGS
STAINLESS STEEL SPIRAL
MEGACRIMP COUPLINGS
STAINLESS STEEL BRAID
POWER CRIMP COUPLINGS
FIELD ATTACHABLE G1 & G2 COUPLINGS
FIELD ATTACHABLE C5 COUPLINGS
GLX COUPLINGS
GL COUPLINGS
C14 COUPLINGS
PCTS THERMOPLASTIC COUPLINGS
POLARSEAL COUPLINGS
POLARSEAL II COUPLINGS
POWER STEERING
ADAPTERS
QUICK DISCONNECT COUPLERS
BALL VALVES
LIVE SWIVEL
ASSEMBLY FABRICATION
ACCESSORIES
EQUIPMENT AND PARTS
AIR BRAKE
BRASS
KITS

Coupling Selection

EQUIPMENT
HOSE/CPLG. SELECTION
G8K COUPLINGS
GLOBAL SPIRAL COUPLINGS
STAINLESS STEEL SPIRAL
MEGACRIMP COUPLINGS
STAINLESS STEEL BRAID
POWER CRIMP COUPLINGS
FIELD ATTACHABLE G1 & G2 COUPLINGS
FIELD ATTACHABLE C5 COUPLINGS
GLX COUPLINGS
GL COUPLINGS
C14 COUPLINGS
PCTS THERMOPLASTIC COUPLINGS
POLARSEAL COUPLINGS
POLARSEAL II COUPLINGS
POWER STEERING
ADAPTERS
QUICK DISCONNECT COUPLERS
BALL VALVES
LIVE SWIVEL
ASSEMBLY FABRICATION
ACCESSORIES
EQUIPMENT AND PARTS
AIR BRAKE
BRASS
KITS

END CONFIGURATION SELECTION

It is important to keep in mind that the hose assembly [coupling and hose] is only one component of the system. In choosing the correct end terminations for the couplings attached to the hose, formal design standards and sound engineering judgement should be used.

In the absence of formal design standards, consider the following factors in choosing the proper end termination:

- > Pressure
- > Impulse frequency, amplitude and wave form
- > Vibration
- > Corrosion
- > Dissimilar metals [galvanic corrosion]
- > Maintenance procedures and frequency
- > Installation reliability
- > Connection's risk in the system
- > Exposure to the elements
- > Operator's and/or bystander's exposure to the connection
- > Installation, operation and service activities and practices that affect safety

If there are any questions as to what end fittings should be used, Gates recommends that you consult your field sales representative or the Gates Hose and Connector Product Application Group for assistance.

Stem and Ferrule Selection

Choosing the proper stem and ferrule termination to be used in the assembly. Check the Gates Crimp Data Manual to ensure proper hose assembly components and crimp specifications.

Gates also offers eCrimp™.

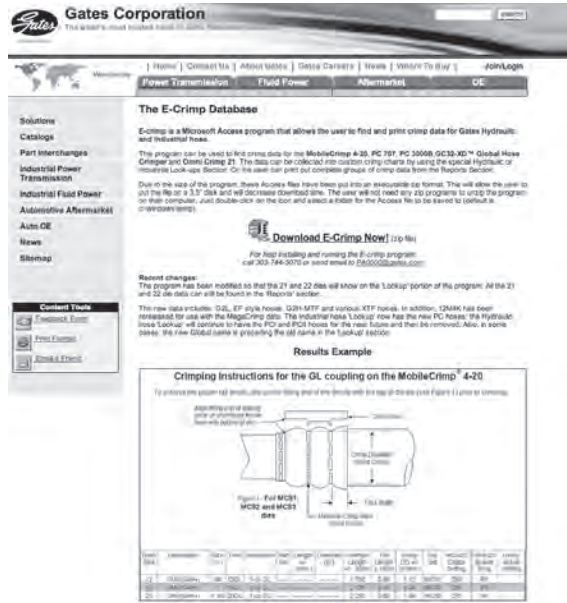

After determining the proper coupling components, refer to the Table of Contents in this catalog to find the proper coupling section. The ferrules are at the end of each coupling section.

Stem Selection

Different hose may require different coupling styles. To make your selection, determine the correct stem to be used. There are two functional ends of the stem to consider:

1. the hose end for hose attachment;
2. the thread end for port attachment.

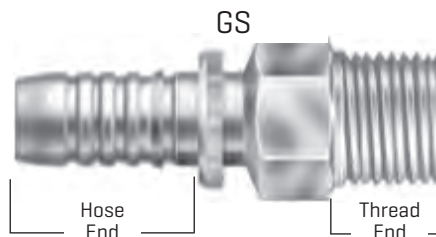

References to the coupling type(s) recommended for a specific hose are listed on the individual hose data pages; for example, EFG5K hose specifies GS couplings.

The thread end of a coupling [or adapter] can be identified by comparing the coupling being replaced or by measuring the port or thread end to which it is to be attached. See thread end identification nomenclature.

Coupling Selection – Continued

COUPLING AND ADAPTER END STYLE NOMENCLATURE

Gates couplings feature a meaningful description by combining end-style codes shown below that make thread end identification fast and easy. Always refer to Gates Crimp Data Manual when selecting hose and coupling combinations.

In the following example, the Gates description 12GS-12FJX90L identifies a GlobalSpiral™ Female JIC Swivel 90° Bend Long Drop coupling for -12 [3/4"] hose size and -12 [3/4"] stem size.

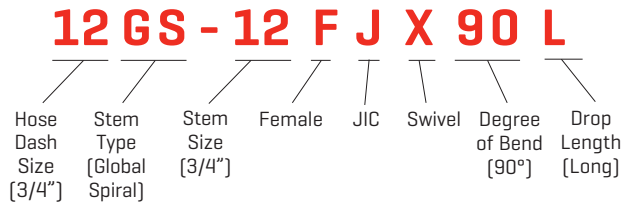

Code	Description
A	Adapterless
AB	Air Brake
API	API Unions
B	Brass
BBDS	British Bonded Seal
BJ	Banjo
BKHD	Bulkhead
BL	Block
BS	Bite Sleeve
BSPP	British Standard Pipe Parallel
BSPT	British Standard Pipe Tapered
C	Caterpillar Flang
CC	Clamping Collar
DH	DIN Heavy
DL	DIN Light
F	Female
FABX	Female Air Brake Swivel
FBFFOR	Female British Flat-Face O-Ring
FBO	Female Braze-on Stem
FF	Flat-Face
FFGX	Female French GAZ Swivel [Female Kobelco]
FFN	Female Flareless Nut
FOR	Flat-Face O-Ring
FFS	Female Flareless Sleeve
FG	Female Grease Thread
FKX	Female Komatsu Style Swivel
FL	Code 61 O-Ring Flange
FLC	Caterpillar Style O-Ring Flange
FLH	Code 62 O-Ring Flange Heavy
FLOS	Flange O-Ring Special
FT	Female SAE Tube
HLE	Hose Length Extender
HLEC	Hose Length Extender [Caterpillar]
HM	Hose Mender
HU	Hammer Union
I	Inverted Flare
J	JIC [37° Flare]
JIS	Japanese Industrial Standard
K	Komatsu Style [Japanese 30° Seat]

Code	Description
LH	Long Hex
LN	Lock Nut
M	Male
MB	Male Boss
MBAX	Male Boss Adapterless Swivel
MBDS	Metric Bonded Seal
MFA	Male Flareless Assembly [Ermeto]
MFG	Male French GAZ
MKB	Metric Kobelco
MM	Metric Male
MN	Metric Nut
MPG	Male Special Grease Fitting
MPLN	Male Pipe Long Nose
MLSP	Metric Light Stand Pipe
MSP	Metric Stand Pipe
NASP	North American Stand Pipe
OR	O-Ring
P	Pipe Thread [NPTF or NPSM]
PL	Press Lok*
PT	Port
PWX	Pressure Washer Swivel
QLD	Quick-Lok® Direct
QHD	Quick-Lok® High
R	Field Attachable
S	SAE [45° Flare]
SP	Special
SS	Stainless Steel
TS	Tube Sleeve
TSN	Tube Sleeve Nut
X	Swivel
Z	Parker Triple Thread
22	22-1/2° Bent Tube Angle
30	30° Bent Tube Angle
45	45° Bent Tube Angle
60	60° Bent Tube Angle
67	67-1/2° Bent Tube Angle
90	90° Bent Tube Angle
110	110° Bent Tube Angle
135	135° Bent Tube Angle

EQUIPMENT
HOSE/CPLG. SELECTION
G8K COUPLINGS
GLOBALSPIRAL COUPLINGS
STAINLESS STEEL SPIRAL
MEGACRIMP COUPLINGS
STAINLESS STEEL BRAID
POWER CRIMP COUPLINGS
FIELD ATTACHABLE G1 & G2 COUPLINGS
FIELD ATTACHABLE C5 COUPLINGS
GLX COUPLINGS
GL COUPLINGS
C14 COUPLINGS
PCTS THERMOPLASTIC COUPLINGS
POLARSEAL COUPLINGS
POLARSEAL II COUPLINGS
POWER STEERING
ADAPTERS
QUICK DISCONNECT COUPLERS
BALL VALVES
LIVE SWIVEL
ASSEMBLY FABRICATION
ACCESSORIES
EQUIPMENT AND PARTS
AIR BRAKE
BRASS
KITS

Coupling Selection – Continued

EQUIPMENT
HOSE/CPLG. SELECTION
G8K COUPLINGS
GLOBAL SPIRAL COUPLINGS
STAINLESS STEEL SPIRAL
MEGACRIMP COUPLINGS
STAINLESS STEEL BRAID
POWER CRIMP COUPLINGS
FIELD ATTACHABLE G1 & G2 COUPLINGS
FIELD ATTACHABLE C5 COUPLINGS
GLX COUPLINGS
GL COUPLINGS
C14 COUPLINGS
PCTS THERMOPLASTIC COUPLINGS
POLARSEAL COUPLINGS
POLARSEAL II COUPLINGS
POWER STEERING
ADAPTERS
QUICK DISCONNECT COUPLERS
BALL VALVES
LIVE SWIVEL
ASSEMBLY FABRICATION
ACCESSORIES
EQUIPMENT AND PARTS
AIR BRAKE
BRASS
KITS

THREAD END DASH SIZES, DESCRIPTIONS AND DIMENSIONS

Coupling Dash Size and End Style

Coupling dash size is a shorthand method of denoting the size of a particular end fitting [see Thread Chart].

EXAMPLE: 12MP denotes a 3/4" male pipe thread end fitting. The corresponding thread description for a 3/4" pipe thread is 3/4 -14 NPTF solid male.

EXAMPLE: 12FJX denotes a 3/4" female JIC swivel [37° seat] end fitting. The corresponding thread description for a 3/4" JIC thread is 1-1/16 - 12 JIC 37° flare swivel female.

EXAMPLE: 12FL denotes a 3/4" SAE standard pressure [Code 61] flange fitting. This is the standard fitting description for a 3/4" SAE standard pressure flange.

Termination Drop Lengths

Bent tube couplings carry a suffix designation that specifies the degree of bend and the length of the drop.

For example, a 12FJX90S is a female JIC swivel with a 90 degree bend. The "S" designates an SAE J516 short drop length. The short and long drops are specified in SAE J516. Flat-face and metric couplings meet ISO-12151-1 drop length specifications. Medium drops are not specified and can vary from manufacturer to manufacturer.

- S** – Short Drop
- M** – Medium Drop
- L** – Long Drop
- XL** – Extra Long Drop

Special, non-industry standard drop lengths are designated with a numerical suffix instead of the S, M, L code. For example, a **12FJX90-075** designates a 75mm drop.

SAE J516 Drop Length Specifications

JIC 37°, Code 61, Code 62

Hose Size	Short Drop [mm]	Long Drop [mm]
-4	17.3	45.7
-6	21.6	55.4
-8	27.7	61.7
-10	31.2	65.3
-12	46.2	94.7
-16	54.4	110.0

ISO Drop Length Specifications

ISO 12151-S JIC and ISO 12151-3 Code 61 & Code 62

Hose Size	Short Drop [mm]	Medium Drop [mm]	Long Drop [mm]
-4	21	32	46
-6	23	38	54
-8	29	41	64
-10	32	47	80
-12	48	58	86
-16	56	71	114
-20	64	78	129
-24	69	76	129

Thread End Catalog Descriptions

Gates coupling ends shown on the following pages are accepted as industry standards. See detailed catalog listings for availability of specific hose/coupling combinations, detailed descriptions, thread end configurations such as swivels, bent tubes and special ends.

Sealing Types for Hydraulic Couplings

When identifying hydraulic couplings, it is important to identify the type of seal made. There are three major types of coupling interfaces used in hydraulics today: Thread Interface, O-Rings and Mated Angle or Mechanical Joint. These three interfaces have developed differently in different parts of the world. In the following pages, country of origin and the coupling styles found in each country are identified. Brief descriptions and dimensional data help identify your particular coupling style.

Identifying couplings is as easy as 1-2-3!

1. Determine Seal Type.

- > Thread Interference
- > O-Ring
- > Mated Angle or Mechanical Joint
- > Mated Angle with O-Ring

Thread Interference. A characteristic of this thread is that the male is thinner at the front than it is at the back. As the male is threaded into the female, the edges of the thread distort by flattening out. This distortion creates the seal.

O-Ring. The O-ring on the male being compressed against the corresponding female makes this seal. This type of seal is excellent for high-pressure applications. The threads pull the fitting against the port, trap the O-ring and flatten it to form a tight seal.

Mated Angle or Mechanical Joint. Different angles are used to create the seal. The seal takes place where the two angles meet and are wedged into one another. These can be cut with the angle either being inverted or standard. Standard seat couplings have the nose angle of the male on the outer surface of the coupling. Inverted seat couplings contain the nose angle of the male on the inside bore of the coupling.

Mated Angle with O-Ring. These couplings are a hybrid, which use both the mated angle and the O-ring to make the seal.

2. Visual Identification.

Thread Interference. These are the easiest because the only factor here is whether the termination is male or female. Couplings that use this seal are:

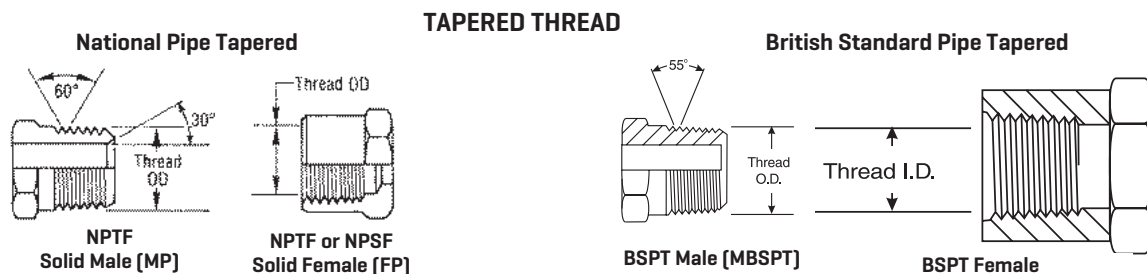

- O-Ring.** Two determinations are needed:
- A. O-Ring Location – Flange Groove, Outside, or on the Nose Seat
 - B. Coupling Termination – Male or Female

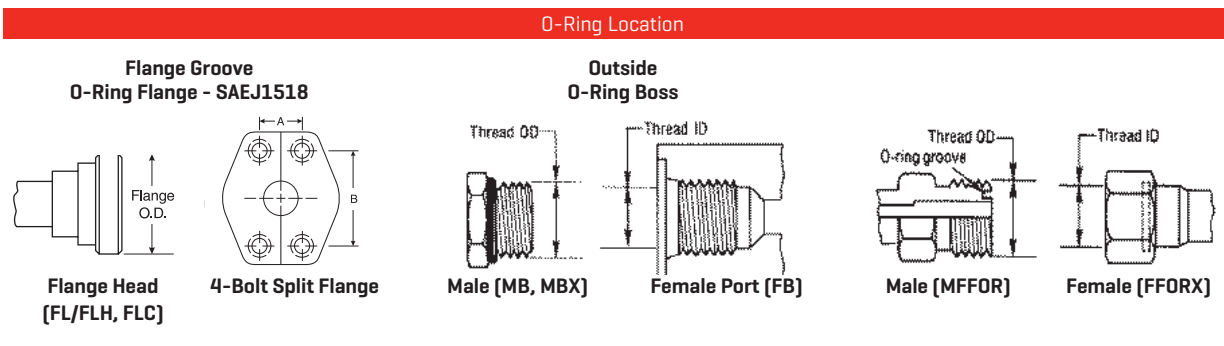

EQUIPMENT
HOSE/CPLG. SELECTION
G8K COUPLINGS
GLOBAL SPIRAL COUPLINGS
STAINLESS STEEL SPIRAL
MEGACRIMP COUPLINGS
STAINLESS STEEL BRAID
POWER CRIMP COUPLINGS
FIELD ATTACHABLE G1 & G2 COUPLINGS
FIELD ATTACHABLE C5 COUPLINGS
GLX COUPLINGS
GL COUPLINGS
C14 COUPLINGS
PCTS THERMOPLASTIC COUPLINGS
POLARSEAL COUPLINGS
POLARSEAL II COUPLINGS
POWER STEERING
ADAPTERS
QUICK DISCONNECT COUPLERS
BALL VALVES
LIVE SWIVEL
ASSEMBLY FABRICATION
ACCESSORIES
EQUIPMENT AND PARTS
AIR BRAKE
BRASS
KITS

Sealing Types for Hydraulic Couplings – Continued

EQUIPMENT
HOSE/CPLG. SELECTION
G8K COUPLINGS
GLOBAL SPIRAL COUPLINGS
STAINLESS STEEL SPIRAL
MEGACRIMP COUPLINGS
STAINLESS STEEL BRAID
POWER CRIMP COUPLINGS
FIELD ATTACHABLE G1 & G2 COUPLINGS
FIELD ATTACHABLE C5 COUPLINGS
GLX COUPLINGS
GL COUPLINGS
C14 COUPLINGS
PCTS THERMOPLASTIC COUPLINGS
POLARSEAL COUPLINGS
POLARSEAL II COUPLINGS
POWER STEERING
ADAPTERS
QUICK DISCONNECT COUPLERS
BALL VALVES
LIVE SWIVEL
ASSEMBLY FABRICATION
ACCESSORIES
EQUIPMENT AND PARTS
AIR BRAKE
BRASS
KITS

2. Visual Identification - Continued

- Mated Angle or Mechanical Joint.** Determine:
- Nose Seat – Standard or Inverted
 - Seat Angle [See Measuring Seat Angles]
 - Coupling Termination

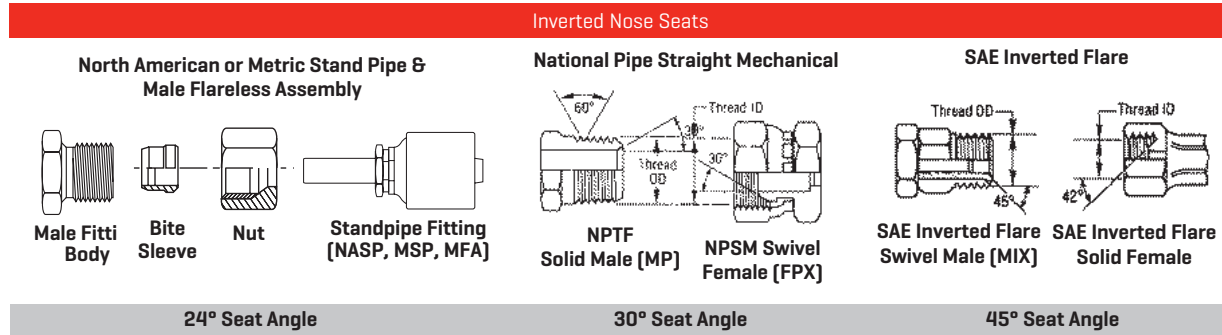
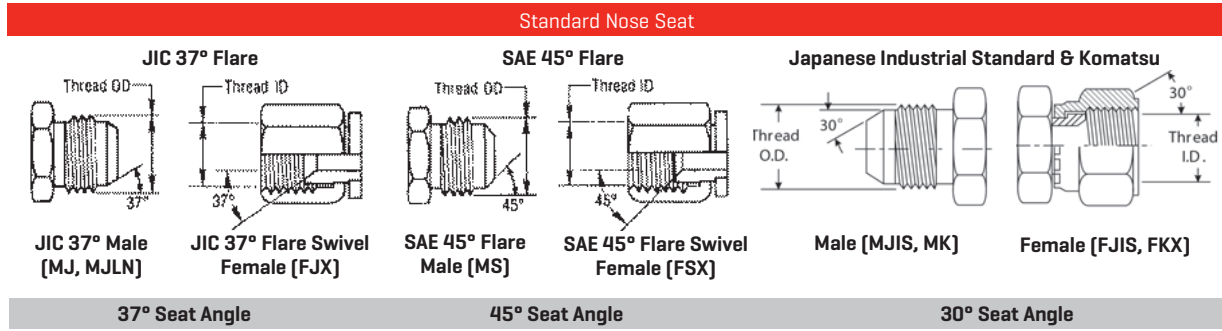

- Mated Angle with O-Ring.** Determine:
- O-Ring Location
 - Nose Seat
 - Seat Angle [See Measuring Seat Angles]
 - Coupling Termination

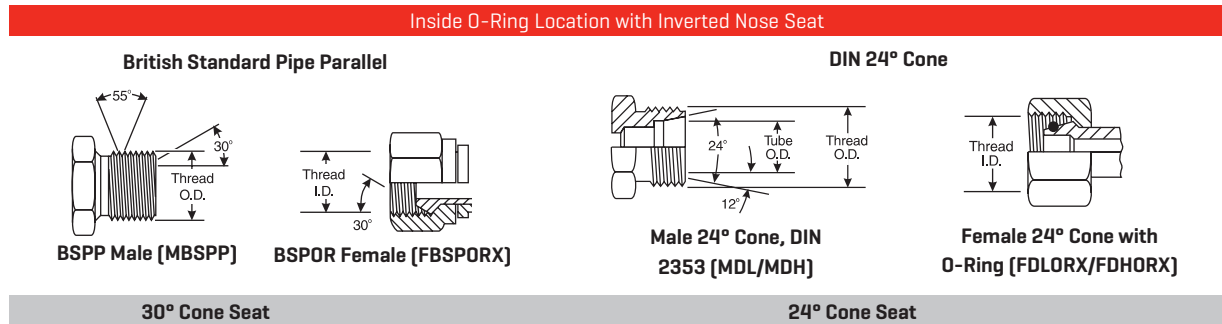

For a wall poster representation of this information, order literature form number 428-7125.

Sealing Types for Hydraulic Couplings – Continued

Measuring Seat Angles

Using the seat gauge, determine the angle of the seat, as illustrated. When the centerline of the seat gauge extends parallel with the projected longitudinal axis of the coupling, then the angles of the gauge and seat match.

NOTE: Thread binding will occur when different thread configurations are used. DO NOT mix thread configurations.

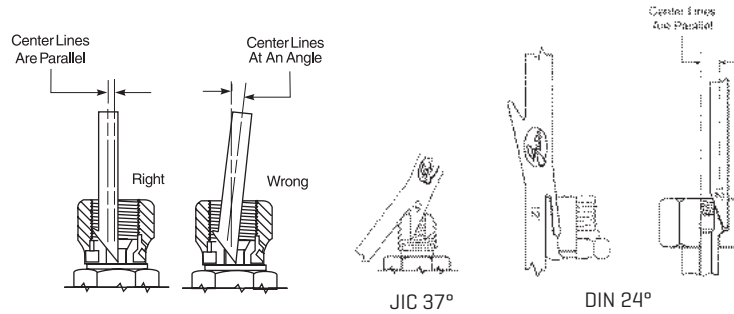

3. Measure Threads.

Because some couplings have very similar characteristics, the only way to determine the correct identification is by measuring the thread. Follow the procedure below when measuring coupling threads:

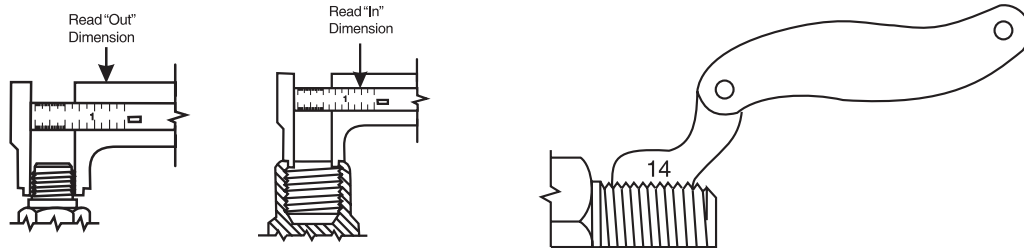

With the caliper measure the thread diameter of the largest point. [Outside Diameter (O.D.) of male threads—Inside Diameter (I.D.) of female threads.]

Using the thread gauge, determine the number of threads per inch. Comparison of gauge and coupling threads against a lighted background will ensure an accurate reading.

Match the measurements taken above against those in the following tables that appear to be similar to the coupling under consideration.

Gates provides many useful tools to assist you in identifying the right coupling!

EQUIPMENT
HOSE/CPLG. SELECTION
G8K COUPLINGS
GLOBAL SPIRAL COUPLINGS
STAINLESS STEEL SPIRAL
MEGACRIMP COUPLINGS
STAINLESS STEEL BRAID
POWER CRIMP COUPLINGS
FIELD ATTACHABLE G1 & G2 COUPLINGS
FIELD ATTACHABLE C5 COUPLINGS
GLX COUPLINGS
GL COUPLINGS
C14 COUPLINGS
PCTS THERMOPLASTIC COUPLINGS
POLARSEAL COUPLINGS
POLARSEAL II COUPLINGS
POWER STEERING
ADAPTERS
QUICK DISCONNECT COUPLERS
BALL VALVES
LIVE SWIVEL
ASSEMBLY FABRICATION
ACCESSORIES
EQUIPMENT AND PARTS
AIR BRAKE
BRASS
KITS

Coupling/Thread Identification Tools

EQUIPMENT

HOSE/CPLG.
SELECTION

G8K COUPLINGS

GLOBALSPIRAL
COUPLINGS

STAINLESS
STEEL SPIRAL

MEGACRIMP
COUPLINGS

STAINLESS
STEEL BRAID

POWER CRIMP
COUPLINGS

FIELD
ATTACHABLE G1
& G2 COUPLINGS

FIELD
ATTACHABLE C5
COUPLINGS

GLX COUPLINGS

GL COUPLINGS

C14 COUPLINGS

PCTS
THERMOPLASTIC
COUPLINGS

POLARSEAL
COUPLINGS

POLARSEAL II
COUPLINGS

POWER
STEERING

ADAPTERS

QUICK
DISCONNECT
COUPLERS

BALL VALVES

LIVE SWIVEL

ASSEMBLY
FABRICATION

ACCESSORIES

EQUIPMENT AND
PARTS

AIR BRAKE

BRASS

KITS

HYDRAULIC COUPLING TEMPLATES

Automotive Advertising Number: 428-7108



These templates provide a fast and easy way to measure North American threads, International threads, flange ends, seat angles [37° and 45°] and hose I.D.

STAINLESS STEEL DIGITAL CALIPER

Part Number: 78241



Caliper features an easy-to-read LCD screen clearly displaying the crimp diameter digitally. Capable of four-way measurement: inside, outside, depth and step. Constructed of hardened stainless steel and comes in a handy, protective carrying case.

INTERNATIONAL THREAD IDENTIFICATION KIT

Part Number: 86580



A sturdy, attractive carrying case suitable for counter display and field sales calls. Contains male metric and BSP plugs for identifying thread size, pocket thread I.D. kit, and flow chart with step-by-step instructions. For female thread identification, simply couple with the mating male.

POCKET THREAD IDENTIFICATION KIT

Part Number: 86583



To properly identify the correct replacement couplings, the measuring tools shown here should be used.

Contents:

- Calipers
- Seat Gauges [English]
- Seat Gauges [Metric]
- Thread Gauges
- Thread I.D. Guide

Thread Chart

THREAD CHART

For All Hose I.D.'s Except C5 Series, C14 and AC134a.

DASH SIZE	2	3	4	5	6	7	8	10	12	14	16	20	24	32	40	48
NPT Pipe Thread	1/8-27	1/4-18	3/8-18	1/2-14	5/8-14	3/4-14	7/8-14	1-11	1 1/16-11	1 1/8-11	1 1/4-11	1 1/2-11	1 3/4-11	2-11	2 1/2-11	3-11
NPSM Swivel Thread	1/8-27	1/4-18	3/8-18	1/2-14	5/8-14	3/4-14	7/8-14	1-11	1 1/16-11	1 1/8-11	1 1/4-11	1 1/2-11	1 3/4-11	2-11	2 1/2-11	3-11
JIC 37° Flare Thread	5/16-24	3/8-24	7/16-20	1/2-20	9/16-20	5/8-16	3/4-16	7/8-16	1 1/16-16	1 1/8-16	1 1/4-16	1 1/2-16	1 3/4-16	2-16	2 1/2-16	3-16
SAE 45° Flare Thread	5/16-24	3/8-24	7/16-20	1/2-20	9/16-20	5/8-16	3/4-16	7/8-16	1 1/16-16	1 1/8-16	1 1/4-16	1 1/2-16	1 3/4-16	2-16	2 1/2-16	3-16
SAE O-Ring Thread	5/16-24	3/8-24	7/16-20	1/2-20	9/16-20	5/8-16	3/4-16	7/8-16	1 1/16-16	1 1/8-16	1 1/4-16	1 1/2-16	1 3/4-16	2-16	2 1/2-16	3-16
Flat-Face Thread	9/16-18	5/8-18	3/4-18	7/8-18	1-18	1 1/16-18	1 1/8-18	1 1/4-18	1 1/2-18	1 3/4-18	2-18	2 1/2-18	3-18	3 1/2-18	4-18	4 1/2-18
Inverted Flare Thread	5/16-28	3/8-24	7/16-20	1/2-20	9/16-20	5/8-16	3/4-16	7/8-16	1 1/16-16	1 1/8-16	1 1/4-16	1 1/2-16	1 3/4-16	2-16	2 1/2-16	3-16
Compression Thread	5/16-24	3/8-24	7/16-20	1/2-20	9/16-20	5/8-16	3/4-16	7/8-16	1 1/16-16	1 1/8-16	1 1/4-16	1 1/2-16	1 3/4-16	2-16	2 1/2-16	3-16
Code 61 Flange Head O.D.	1.19	1.335	1.50	1.75	2.00	2.38	2.81	3.31	4.00							
Code 62 Flange Head O.D.	1.25	1.62	1.88	2.12	2.50	3.12										
BSPP Thread	1/8-28	1/4-19	3/8-19	1/2-14	5/8-14	3/4-14	7/8-14	1-11	1 1/16-11	1 1/8-11	1 1/4-11	1 1/2-11	1 3/4-11	2-11	2 1/2-11	3-11
BSPT Thread	1/8-28	1/4-19	3/8-19	1/2-14	5/8-14	3/4-14	7/8-14	1-11	1 1/16-11	1 1/8-11	1 1/4-11	1 1/2-11	1 3/4-11	2-11	2 1/2-11	3-11
Japanese Pipe Tapered Thread	1/8-28	1/4-19	3/8-19	1/2-14	5/8-14	3/4-14	7/8-14	1-11	1 1/16-11	1 1/8-11	1 1/4-11	1 1/2-11	1 3/4-11	2-11	2 1/2-11	3-11
Japanese Flare Thread	1/8-28	1/4-19	3/8-19	1/2-14	5/8-14	3/4-14	7/8-14	1-11	1 1/16-11	1 1/8-11	1 1/4-11	1 1/2-11	1 3/4-11	2-11	2 1/2-11	3-11
Copper/Nylon Air Brake Thread	7/16-24	1/2-20	9/16-18	1-18												
METRIC (mm)	8	10	12	14	16	18	20	22	24	26	30	33	36	42	45	52
MDL	M12X1.5	M14X1.5	M16X1.5	M18X1.5	M20X1.5	M22X1.5	M24X1.5	M26X1.5	M30X2.0	M36X2.0	M42X2.0	M45X2.0	M52X2.0			
MDH	M12X1.5	M14X1.5	M16X1.5	M18X1.5	M20X1.5	M22X1.5	M24X1.5	M26X1.5	M30X2.0	M36X2.0	M42X2.0	M45X2.0	M52X2.0			
Komatsu	M12X1.5	M14X1.5	M16X1.5	M18X1.5	M20X1.5	M22X1.5	M24X1.5	M26X1.5	M30X2.0	M36X2.0	M42X2.0	M45X2.0	M52X2.0			
GAZ*	M12X1.5	M14X1.5	M16X1.5	M18X1.5	M20X1.5	M22X1.5	M24X1.5	M26X1.5	M30X2.0	M36X2.0	M42X2.0	M45X2.0	M52X2.0			

*GAZ sizes are for catalog reference purposes. actual tube sizes are 13.25, 16.75, 21.25, 26.75, 33.5, 42.25

EQUIPMENT	
HOSE/CPLG. SELECTION	
G8K COUPLINGS	
GLOBAL SPIRAL COUPLINGS	
STAINLESS STEEL SPIRAL	
MEGACRIMP COUPLINGS	
STAINLESS STEEL BRAID	
POWER CRIMP COUPLINGS	
FIELD ATTACHABLE G1 & G2 COUPLINGS	
FIELD ATTACHABLE C5 COUPLINGS	
GLX COUPLINGS	
GL COUPLINGS	
C14 COUPLINGS	
PCTS THERMOPLASTIC COUPLINGS	
POLARSEAL COUPLINGS	
POLARSEAL II COUPLINGS	
POWER STEERING	
ADAPTERS	
QUICK DISCONNECT COUPLERS	
BALL VALVES	
LIVE SWIVEL	
ASSEMBLY FABRICATION	
ACCESSORIES	
EQUIPMENT AND PARTS	
AIR BRAKE	
BRASS	
KITS	

Coupling Identification

EQUIPMENT
HOSE/CPLG. SELECTION
G8K COUPLINGS
GLOBAL SPIRAL COUPLINGS
STAINLESS STEEL SPIRAL
MEGACRIMP COUPLINGS
STAINLESS STEEL BRAID
POWER CRIMP COUPLINGS
FIELD ATTACHABLE G1 & G2 COUPLINGS
FIELD ATTACHABLE C5 COUPLINGS
GLX COUPLINGS
GL COUPLINGS
C14 COUPLINGS
PCTS THERMOPLASTIC COUPLINGS
POLARSEAL COUPLINGS
POLARSEAL II COUPLINGS
POWER STEERING
ADAPTERS
QUICK DISCONNECT COUPLERS
BALL VALVES
LIVE SWIVEL
ASSEMBLY FABRICATION
ACCESSORIES
EQUIPMENT AND PARTS
AIR BRAKE
BRASS
KITS

This section lists the origin and coupling style found in each country. Brief descriptions and dimensional data follows each coupling style.

There are five coupling systems generally used for hydraulic connections today.

They are identified geographically or by country as:

- North American**
- British**
- French**
- German**
- Japanese**

NORTH AMERICAN THREAD TYPES

Iron Pipe Thread Abbreviations

- N** National
- S** Straight Thread
- F** Fuels
- P** Pipe
- T** Tapered Thread
- M** Mechanical Joint

NPTF

National Pipe Tapered thread for Fuel is a dryseal thread. It is used for both male and female ends.

The NPTF male will mate with the NPTF, NPSF, or NPSM female.

The NPTF male has tapered threads and a 30° inverted seat. The NPTF female has tapered threads and no seat. The seal takes place by deformation of the threads. The NPSM female has straight threads and a 30° inverted seat. The seal takes place on the 30° seat.

The NPTF connector is similar to, but not interchangeable with, the BSPT connector. The thread pitch is different in most sizes. Also, the thread angle is 60° instead of the 55° angle found on BSPT threads.

NPSF

National Pipe Straight thread for Fuels is sometimes used for female ends and properly mates with the NPTF male end. However, SAE recommends the NPTF thread in preference to the NPSF for female ends.

NPSM

National Pipe Straight thread for Mechanical Joint is used on the female swivel nut of iron pipe swivel adapters. The leak-resistant joint is not made by the sealing fit of threads, but by a tapered seat in the coupling end.

Dash Size	Nominal Size [In.]	No. Threads per Inch	Female Thread	Male Thread	Max. Torque Recommendation for Dry NPTF* [Ft. Lbs.]
			I.D. [In.]	O.D. [In.]	
-2	1/8	27	23/64	13/32	20
-4	1/4	18	15/32	35/64	25
-6	3/8	18	19/32	43/64	35
-8	1/2	14	3/4	27/32	45
-12	3/4	14	61/64	1-1/16	55
-16	1	11-1/2	1-13/64	1-5/16	65
-20	1-1/4	11-1/2	1-17/32	1-43/64	80
-24	1-1/2	11-1/2	1-25/32	1-29/32	95
-32	2	11-1/2	2-1/4	2-3/8	120

NPT Pipe Thread

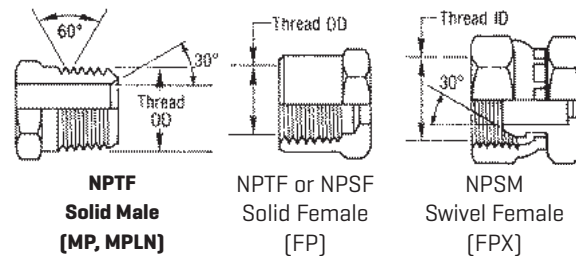

*NOTES:

- Torque values can vary considerably depending on thread condition. Use only enough torque to achieve adequate sealing.
- With female straight or parallel pipe threads [NPSM], maximum values are 50 percent of those listed in the table.
- If thread sealant is used, maximum values shown should be decreased by 25 percent.

NORTH AMERICAN THREAD TYPES – Continued

*JIC (37° Flare)

The Society of Automotive Engineers (SAE) specifies a 37° angle flare or seat be used with high pressure hydraulic tubing. These are commonly called JIC couplings.

The JIC 37° flare male will mate with a JIC female only.* The JIC male has straight threads and a 37° flare seat. The JIC female has straight threads and a 37° flare seat. The seal is made on the 37° flare seat.

Some sizes have the same threads as the SAE 45° flare. Carefully measure the seat angle to differentiate.

***Note:** Some C5, C5E and Lock-On couplings may have dual machined seats [both 37° and 45° seats].

JIC 37° Flare

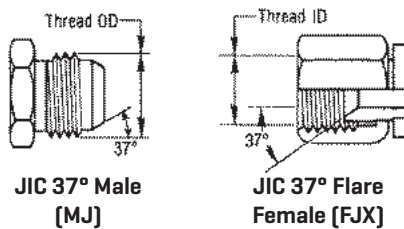

JIC 37° Male (MJ)

JIC 37° Flare Female (FJX)

*SAE (45° Flare)

A term usually applied to fittings having a 45° angle flare or seat. Soft copper tubing is generally used in such applications as it is easily flared to the 45° angle. These are for low-pressure applications—such as for fuel lines and refrigerant lines.

The SAE 45° flare male will mate with an SAE 45° flare female only or a dual seat JIC/SAE 45°.*

The SAE male has straight threads and a 45° flare seat. The SAE female has straight threads and a 45° flare seat. The seal is made on the 45° flare seat.

Some sizes have the same threads as the SAE 37° flare. Carefully measure the seat angle to differentiate.

***Note:** Some C5, C5E and Lock-On couplings may have dual machined seats [both 37° and 45° seats].

SAE 45° Flare

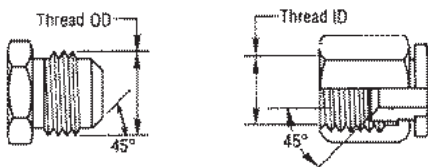

SAE 45° Flare Male (MS)

SAE 45° Flare Swivel Female (FSX)

Dash Size	Nominal Size [In.]	Thread Size	Female Thread	Male Thread	Steel Torque Recommendation [Ft. Lbs.]	
			I.D. [In.]	O.D. [In.]	Min.	Max.
-2	1/8	5/16 - 24	17/64	5/16	-	-
-3	3/16	3/8 - 24	21/64	3/8	-	-
-4	1/4	7/16 - 20	25/64	7/16	10	11
-5	5/16	1/2 - 20	29/64	1/2	13	15
-6	3/8	9/16 - 18	1/2	9/16	17	19
-8	1/2	3/4 - 16	11/16	3/4	34	38
-10	5/8	7/8 - 14	13/16	7/8	50	56
-12	3/4	1-1/1 - 12	31/32	1-1/16	70	78
-14	7/8	1-3/1 - 12	1-7/64	1-3/16	-	-
-16	1	1-5/16 - 12	1-15/64	1-5/16	94	104
-20	1-1/4	1-5/8 - 12	1-35/64	1-5/8	124	138
-24	1-1/2	1-7/8 - 12	1-51/64	1-7/8	156	173
-32	2	2-1/2 - 12	2-27/64	2-1/2	219	243

Dash Size	Nominal Size [In.]	Thread Size	Female Thread	Male Thread	Steel Torque Recommendation [Ft. Lbs.]	
			I.D. [In.]	O.D. [In.]	Min.	Max.
-2	1/8	5/16 - 24	17/64	5/16	-	-
-3	3/16	3/8 - 24	21/64	3/8	-	-
-4	1/4	7/16 - 20	25/64	7/16	10	11
-5	5/16	1/2 - 20	29/64	1/2	13	15
-6	3/8	5/8 - 18	9/16	5/8	17	19
-7	7/16	11/16 - 16	5/8	11/16	-	-
-8	1/2	3/4 - 16	11/16	3/4	34	38
-10	5/8	7/8 - 14	13/16	7/8	50	56
-12	3/4	1-1/16 - 14	63/64	1-1/16	70	78

Special Power Steering Thread End

Dash Size	Nominal Size [In.]	Thread Size	Female Thread	Male Thread
			I.D. [In.]	O.D. [In.]
-6	3/8	11/16 - 18	5/8	11/16

EQUIPMENT

HOSE/CPLG. SELECTION

G&K COUPLINGS

GLOBAL SPIRAL COUPLINGS

STAINLESS STEEL SPIRAL

MEGACRIMP COUPLINGS

STAINLESS STEEL BRAID

POWER CRIMP COUPLINGS

FIELD ATTACHABLE G1 & G2 COUPLINGS

FIELD ATTACHABLE C5 COUPLINGS

GLX COUPLINGS

GL COUPLINGS

C14 COUPLINGS

PCTS THERMOPLASTIC COUPLINGS

POLARSEAL COUPLINGS

POLARSEAL II COUPLINGS

POWER STEERING

ADAPTERS

QUICK DISCONNECT COUPLERS

BALL VALVES

LIVE SWIVEL

ASSEMBLY FABRICATION

ACCESSORIES

EQUIPMENT AND PARTS

AIR BRAKE

BRASS

KITS

Coupling Identification - Continued

NORTH AMERICAN THREAD TYPES - Continued

O-Ring Boss

The O-ring boss male will mate with an O-ring boss female only. The female is generally found on ports.

The male has straight threads, a sealing face and an O-ring. The female has straight threads and a sealing face.

The seal is made at the O-ring on the male and the sealing face on the female.

SAE Straight Thread O-Ring Boss

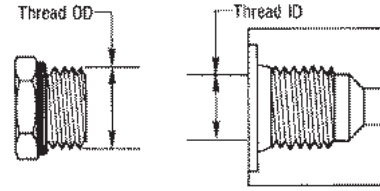

O-Ring Boss Male [MB, MBX]

O-Ring Boss Female Port [FB]

Dash Size	Nominal Size [In.]	Thread Size	Female Thread	Male Thread	O-Ring		Steel Torque Recommendations [Ft. Lbs]			
							Below 4,000 psi Working Pressure		Above 4,000 psi Working Pressure	
							Min.	Max.	Min.	Max.
-2	1/8	5/16 - 24	17/64	5/16	0.239	-	-	-	-	-
-3	3/16	3/8 - 24	21/64	3/8	0.301	30R	-	-	8	10
-4	1/4	7/16 - 20	25/64	7/16	0.351	40R	14	16	14	16
-5	5/16	1/2 - 20	29/64	1/2	0.414	50R	-	-	18	20
-6	3/8	9/16 - 18	1/2	9/16	0.468	60R	24	26	24	26
-8	1/2	3/4 - 16	11/16	3/4	0.644	80R	37	44	50	60
-10	5/8	7/8 - 14	13/16	7/8	0.755	100R	50	60	72	80
-12	3/4	1-1/16 - 12	31/32	1-1/16	0.924	120R	75	83	125	135
-14	7/8	1-3/16 - 12	1-7/64	1-3/16	1.048	140R	-	-	160	180
-16	1	1-5/16 - 12	1-15/64	1-5/16	1.171	160R	111	125	200	220
-20	1-1/4	1-5/8 - 12	1-35/64	1-5/8	1.475	200R	133	152	210	280
-24	1-1/2	1-7/8 - 12	1-51/64	1-7/8	1.720	-	156	184	270	360
-32	2	2-1/2 - 12	2-27/64	2-1/2	2.337	-	-	-	-	-

Gates Adapterless—MBAX

The Gates Adapterless coupling is designed for use in OEM assembly line applications. It eliminates the need for an adapter by directly connecting into the port, which reduces the number of possible leak points and reduces installation labor. It allows easy installation and eliminates the troubles of alignment on bent tube assemblies. It eliminates the performance limitations of the traditional male swivel. A jam nut locks the coupling into place.

Assemblies using the Gates Adapterless coupling can be serviced by replacing the assembly with an MB adapter in the port and a standard end termination [for example, an MB-MJ adapter and FJX couplings].

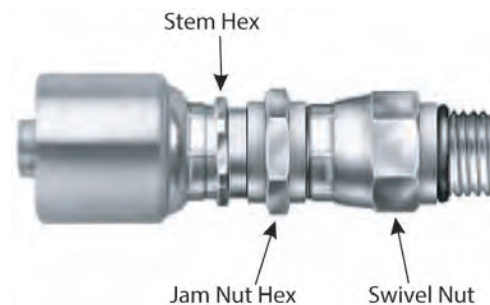

WARNING: The tightening of the jam nut is absolutely critical to performance so that the Adapterless coupling does not become a "live swivel". A live swiveling condition can cause wearing of the internal seals and result in leaks.

The Gates Adapterless coupling uses SAE O-Ring Boss threads. See the table above. The installation torque values are the same as SAE O-Ring Boss.

Coupling Identification – Continued

NORTH AMERICAN THREAD TYPES – Continued

O-Ring Flange—SAE J518

The SAE Code 61 and Code 62 4-bolt split flange is used worldwide, usually as a connection on pumps and motors. There are three exceptions.

1. The -10 size, which is common outside of North America, is not an SAE standard size (generally found on Komatsu equipment). All Komatsu flanges are the same as SAE code 61 except for the -10 size.
2. Caterpillar flanges, which are the same flange O.D. as SAE Code 62, have a thicker flange head ["C" dimension in Table].
3. Poclain flanges, which are completely different from SAE flanges.

SAE Code 61 and Code 62

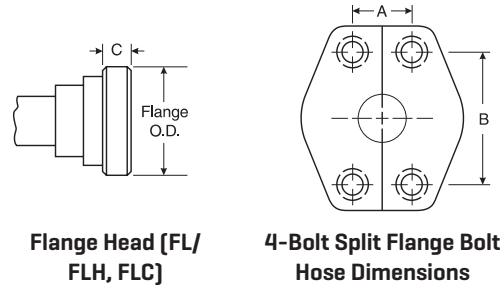

Flange Head [FL/ FLH, FLC]

4-Bolt Split Flange Bolt Hose Dimensions

Dash Size	Nominal Flange Size [In.]	Code 61 [FL]				Code 62 [FLH]				Caterpillar Code 62 [FLC]			
		Flange O.D. [In.]	A [In.]	B [In.]	C [In.]	Flange O.D. [In.]	A [In.]	B [In.]	C [In.]	Flange O.D. [In.]	A [In.]	B [In.]	C [In.]
-8	1/2	1.188	.688	1.500	.265	1.250	.718	1.594	.305	-	-	-	-
-10	5/8	1.345	-	-	.265	-	-	-	-	-	-	-	-
-12	3/4	1.500	.875	1.875	.265	1.625	.937	2.000	.345	1.625	.938	2.000	.560
-16	1	1.750	1.031	2.062	.315	1.875	1.093	2.250	.375	1.875	1.094	2.250	.560
-20	1-1/4	2.000	1.188	2.312	.315	2.125	1.250	2.625	.405	2.125	1.250	2.625	.560
-24	1-1/2	2.375	1.406	2.750	.315	2.500	1.437	3.125	.495	2.500	1.438	3.125	.560
-32	2	2.812	1.688	3.062	.375	3.125	1.750	3.812	.495	3.125	1.750	3.812	.560
-40	2-1/2	3.312	2.000	3.500	.375	-	-	-	-	-	-	-	-
-48	3	4.000	2.438	4.188	.375	-	-	-	-	-	-	-	-
-56	3-1/2	4.500	2.750	4.750	.422	-	-	-	-	-	-	-	-
-64	4	5.000	3.062	5.125	.442	-	-	-	-	-	-	-	-
-80	5	6.000	3.625	6.000	.442	-	-	-	-	-	-	-	-

O-Ring Face Seal (ORFS)—SAE J1453

A seal is made when the O-ring in the male contacts the flat face on the female. Couplings are intended for hydraulic systems where elastomeric seals are acceptable to overcome leakage and leak resistance is crucial.

The solid male O-ring face seal fitting will mate with a swivel female O-ring face seal SAE J1453 fitting only.

An O-ring rests in the O-ring groove in the male.

O-Ring Face Seal

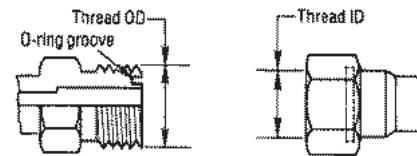

Male Flat-Face O-Ring [MFFOR]

Female Flat-Face O-Ring Swivel [FFORX]

Dash Size	Nominal Size [In.]	Thread Size	Female Thread	Male Thread	O-Ring Size
			I.D. [In.]	O.D. [In.]	
-4	1/4	9/16 - 18	1/2	9/16	-011
-6	3/8	11/16 - 16	5/8	11/16	-012
-8	1/2	13/16 - 16	3/4	13/16	-014
-10	5/8	1 - 14	15/16	1	-016
-12	3/4	1-3/16 - 12	1-1/8	1-3/16	-018
-16	1	1-7/16 - 12	1-11/32	1-7/16	-021
-20	1-1/4	1-11/16 - 12	1-19/32	1-11/16	-025
-24	1-1/2	2 - 12	1-29/32	2	-029

EQUIPMENT

HOSE/CPLG. SELECTION

G8K COUPLINGS

GLOBAL SPIRAL COUPLINGS

STAINLESS STEEL SPIRAL

MEGACRIMP COUPLINGS

STAINLESS STEEL BRAID

POWER CRIMP COUPLINGS

FIELD ATTACHABLE G1 & G2 COUPLINGS

FIELD ATTACHABLE C5 COUPLINGS

GLX COUPLINGS

GL COUPLINGS

C14 COUPLINGS

PCTS THERMOPLASTIC COUPLINGS

POLARSEAL COUPLINGS

POLARSEAL II COUPLINGS

POWER STEERING

ADAPTERS

QUICK DISCONNECT COUPLERS

BALL VALVES

LIVE SWIVEL

ASSEMBLY FABRICATION

ACCESSORIES

EQUIPMENT AND PARTS

AIR BRAKE

BRASS

KITS

Coupling Identification - Continued

NORTH AMERICAN THREAD TYPES - Continued

Flareless Tube

The flareless solid male will mate with a female flareless nut and compression sleeve only.

The male has straight threads and a 24° seat. The female has straight threads and has a compression sleeve for a sealing surface. The seal is made between the compression sleeve and the 24° seat on the male, and between the compression sleeve and the tubing on the female.

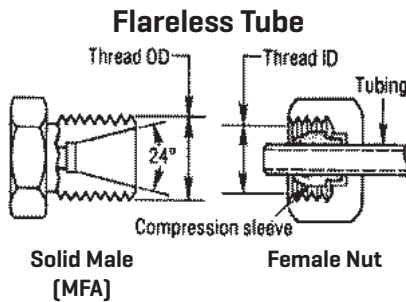

Dash Size	Tube Size [In.]	Nominal Size [In.]	Thread Size	Female Thread	Male Thread
				I.D. [In.]	O.D. [In.]
-2	1/8	5/16	5/16 - 24	17/64	5/16
-3	3/16	3/8	3/8 - 24	21/64	3/8
-4	1/4	7/16	7/16 - 20	25/64	7/16
-5	5/16	1/2	1/2 - 20	29/64	1/2
-6	3/8	9/16	9/16 - 18	1/2	9/16
-8	1/2	3/4	3/4 - 16	11/16	3/4
-10	5/8	7/8	7/8 - 14	13/16	7/8
-12	3/4	1-1/16	1-1/16 - 12	31/32	1-1/16
-14	7/8	1-3/16	1-3/16 - 12	1-7/64	1-3/16
-16	1	1-5/16	1-5/16 - 12	1-15/64	1-5/16
-20	1-1/4	1-5/8	1-5/8 - 12	1-35/64	1-5/8
-24	1-1/2	1-7/8	1-7/8 - 12	1-51/64	1-7/8
-32	2	2-1/2	2-1/2 - 12	2-27/64	2-1/2

North American Stand Pipe (NASP)

A stand pipe assembly is comprised of three components attached to a male fitting. The components are a Stand Pipe Tube, Bite Sleeve and Nut. The Nut is placed over the Stand Pipe, followed by the Bite Sleeve [see illustration below]. The Bite Sleeve and Stand Pipe are selected on the basis of tube O.D. required.

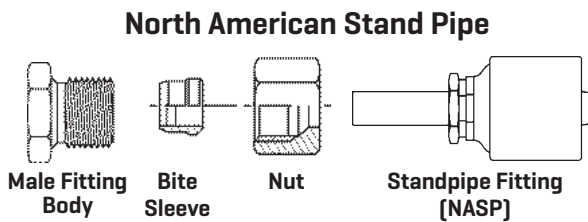

Dash Size	Tube O.D. [In.]	Tube Length [In.]
-4	0.25	0.88
-6	0.38	0.88
-8	0.50	1.00
-12	0.75	1.16
-16	1.00	1.12

SAE Inverted Flare

The SAE 45° inverted flare male will mate with an SAE 42° inverted flare female only.

The male has straight threads and a 45° inverted flare. The female has straight threads and a 42° inverted flare. The seal is made on the 45° flare seat on the male and the 42° flare seat on the female.

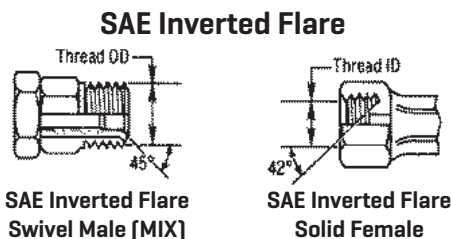

Dash Size	Nominal Size [In.]	Thread Size	Female Thread	Male Thread
			I.D. [In.]	O.D. [In.]
-2	1/8	5/16 - 28	9/32	5/16
-3	3/16	3/8 - 24	21/64	3/8
-4	1/4	7/16 - 24	25/64	7/16
-5	5/16	1/2 - 20	29/64	1/2
-6	3/8	5/8 - 18	37/64	5/8
-7	7/16	11/16 - 18	5/8	11/16
-8	1/2	3/4 - 18	45/64	3/4
-10	5/8	7/8 - 18	13/16	7/8
-12	3/4	1-1/16 - 16	1	1-1/16

NORTH AMERICAN THREAD TYPES – Continued

Air Brake Fittings

Female air brake swivels are designed to work exclusively with a male air brake adapter. Federal law requires only this combination to be used on air brake lines from the valve to the air brake diaphragm chamber.

The male has straight threads and an inverted seat. The female has straight threads and a corresponding inverted flare. The seal is made on the flare seats of both the male and female.

Dash Size	Thread Size	Female Thread I.D. [In.]	Male Thread O.D. [In.]
-6	3/4 - 20	23/32	3/4
-8	7/8 - 20	27/32	7/8

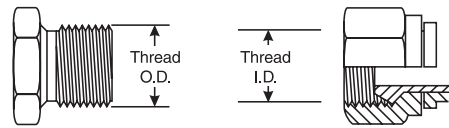

Male Air Brake

Female Air Brake Swivel

Grease Fittings

Special Male Grease Fitting

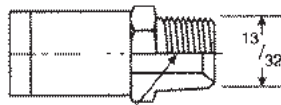

1/8-27 Pipe Thread

Special Female Grease Fitting



1/2-27 Tapered Thread

Parker Triple Thread Flare Fittings

Parker Triple Thread Flare Fittings

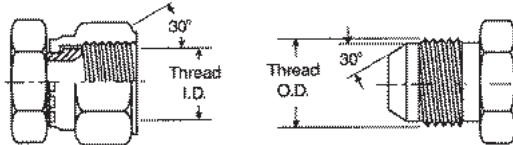

Swivel Female [FZX]

Solid Male [MZ]

Dash Size	Nominal Size [In.]	Thread Size	Female Thread	Male Thread
			I.D. [In.]	O.D. [In.]
-16	1-5/16	1-5/16 - 14	1-1/4	1-5/16

EQUIPMENT

HOSE/CPLG. SELECTION

G&K COUPLINGS

GLOBALSPIRAL COUPLINGS

STAINLESS STEEL SPIRAL

MEGACRIMP COUPLINGS

STAINLESS STEEL BRAID

POWER CRIMP COUPLINGS

FIELD ATTACHABLE G1 & G2 COUPLINGS

FIELD ATTACHABLE C5 COUPLINGS

GLX COUPLINGS

GL COUPLINGS

C14 COUPLINGS

PCTS THERMOPLASTIC COUPLINGS

POLARSEAL COUPLINGS

POLARSEAL II COUPLINGS

POWER STEERING

ADAPTERS

QUICK DISCONNECT COUPLERS

BALL VALVES

LIVE SWIVEL

ASSEMBLY FABRICATION

ACCESSORIES

EQUIPMENT AND PARTS

AIR BRAKE

BRASS

KITS

Coupling Identification - Continued

EQUIPMENT
HOSE/CPLG. SELECTION
G8K COUPLINGS
GLOBAL SPIRAL COUPLINGS
STAINLESS STEEL SPIRAL
MEGACRIMP COUPLINGS
STAINLESS STEEL BRAID
POWER CRIMP COUPLINGS
FIELD ATTACHABLE G1 & G2 COUPLINGS
FIELD ATTACHABLE C5 COUPLINGS
GLX COUPLINGS
GL COUPLINGS
C14 COUPLINGS
PCTS THERMOPLASTIC COUPLINGS
POLARSEAL COUPLINGS
POLARSEAL II COUPLINGS
POWER STEERING
ADAPTERS
QUICK DISCONNECT COUPLERS
BALL VALVES
LIVE SWIVEL
ASSEMBLY FABRICATION
ACCESSORIES
EQUIPMENT AND PARTS
AIR BRAKE
BRASS
KITS

Foreign Thread Types

Identifying Foreign Couplings

If you can identify the country of origin of the equipment you are working with, it is easy to identify the coupling style. Simply find the appropriate country in the following pages and locate the particular coupling in the table that follows.

Foreign Thread Types - British

It is a common misconception that all foreign threads are metric. This is not always the case. There are two common thread forms: Metric and Whitworth (BSP). The country of origin and the proper nomenclature for each is listed below.

British Standard Pipe Parallel

Popular couplings have British Standard Pipe (BSP) threads, also known as Whitworth threads. These can be parallel threads (BSPP) with a 30° inverted flare or tapered threads (BSPT), with a 30° inverted flare. Port connections are usually made with BSPP threads and a soft metal cutting ring for sealing.

The BSPP (parallel) male will mate with a BSPOR (parallel) female or a female port.

The BSPP male has straight threads and a 30° seat. The BSPOR female has straight threads, a 30° seat, and O-ring. The female port has straight threads and a spotface. The seal on the port is made with an O-ring or soft metal washer on the male.

The BSPP (parallel) connector is similar to, but not interchangeable with, the NPSM connector. The thread pitch is different in most sizes, and the thread angle is 55° instead of the 60° angle found on NPSM threads.

Dash Size	Nominal Size [In.]	Thread Size	Female Parallel Thread	Male Parallel Thread	Torque Recommendation [Ft. Lbs.]	
			I.D. [In.]	O.D. [In.]	Min.	Max.
-2	1/8	1/8 - 28	11/32	3/8	7	9
-4	1/4	1/4 - 19	15/32	17/32	11	18
-6	3/8	3/8 - 19	19/32	21/32	19	28
-8	1/2	1/2 - 14	3/4	13/16	30	36
-10	5/8	5/8 - 14	13/16	29/32	37	44
-12	3/4	3/4 - 14	31/32	1-1/32	50	60
-16	1	1 - 11	1-7/32	1-11/32	79	95
-20	1-1/4	1-1/4 - 11	1-17/32	1-21/32	127	152
-24	1-1/2	1-1/2 - 11	1-25/32	1-7/8	167	190
-32	2	2 - 11	2-7/32	2-11/32	262	314

British Standard Pipe Parallel (BSPOR)

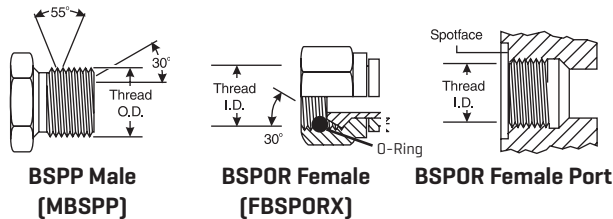

British Flat-Face Seal

A seal is made when the O-ring in the male contacts the flat face on the female. These couplings are intended for hydraulic systems where elastomeric seals are acceptable to overcome leakage and leak resistance is crucial.

The solid male British O-ring face seal fitting will mate with a swivel female British O-ring face seal fitting only. An O-ring rests in the O-ring groove in the male.

Dash Size	Nominal Size [In.]	Thread Size	Female Parallel Thread	Male Parallel Thread	Torque Recommendation [Ft. Lbs.]	
			I.D. [In.]	O.D. [In.]	Min.	Max.
-6	3/8	3/8-19	19/32	21/32	18	20
-8	1/2	1/2-14	3/4	13/16	32	40
-12	3/4	3/4-14	31/32	1 1/32	65	80

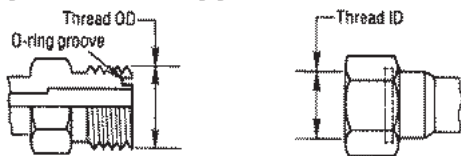

Male British Flat-Face (MBFF) Female British Flat-Face (FBFF)

Foreign Thread Types – British – Continued

British Standard Pipe Tapered

The BSPT [tapered] male will mate with a BSPT [tapered] female, or a BSPOR [parallel] female.

The BSPT male has tapered threads. When mating with either the BSPT [tapered] female or the BSPOR [parallel] female port, the seal is made on the threads.

The BSPT connector is similar to, but not interchangeable with, the NPTF connector. The thread pitch is different in most cases, and the thread angle is 55° instead of the 60° angle found on NPTF threads.

British Standard Pipe Tapered (BSPT)

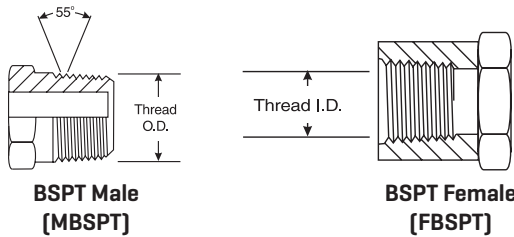

Dash Size	Nominal Size [In.]	Thread Size	Female Parallel Thread	Male Parallel Thread	Torque Recommendation [Ft. Lbs.]	
			I.D. [In.]	O.D. [In.]	Min.	Max.
-2	1/8	1/8 - 28	11/32	3/8	7	9
-4	1/4	1/4 - 19	15/32	17/32	11	18
-6	3/8	3/8 - 19	19/32	21/32	19	28
-8	1/2	1/2 - 14	3/4	13/16	30	36
-10	5/8	5/8 - 14	13/16	29/32	37	44
-12	3/4	3/4 - 14	31/32	1-1/32	50	60
-16	1	1 - 11	1-7/32	1-11/32	79	95
-20	1-1/4	1-1/4 - 11	1-17/32	1-21/32	127	152
-24	1-1/2	1-1/2 - 11	1-25/32	1-7/8	167	190
-32	2	2 - 11	2-7/32	2-11/32	262	314

Foreign Thread Types – French

Popular couplings are French GAZ. These have a 24° seat and metric threads. These are similar to German DIN couplings, but the threads are different in some sizes. Although both are metric threads, the French use fine threads in all sizes and German DIN couplings use coarse threads in larger sizes. Most port connections are flange connections. French flanges are different than SAE—they have a lip that protrudes from the flange face. These are called Poclairn-style flanges.

GAZ 24°

The French Metric [GAZ] male will mate with the female 24° cone or the female tube fitting.

The male has a 24° seat and straight metric threads. The female has a 24° seat or a tubing sleeve and straight metric threads and is interchangeable with female Kobelco.

When measuring the flare angle with the seat angle gauge, use the 12° gauge. The seat angle gauge measures the angle from the connector centerline.

Metric Thread Size	Female Thread I.D. [mm]	Male Thread O.D. [mm]	Tube O.D. [mm]
M20x1.5	18.5	20.0	13.25
M24x1.5	22.5	24.0	16.75
M30x1.5	28.5	30.0	21.25
M36x1.5	34.5	36.0	26.75
M45x1.5	43.5	45.0	33.50
M52x1.5	50.5	52.0	42.25

French Metric (GAZ)

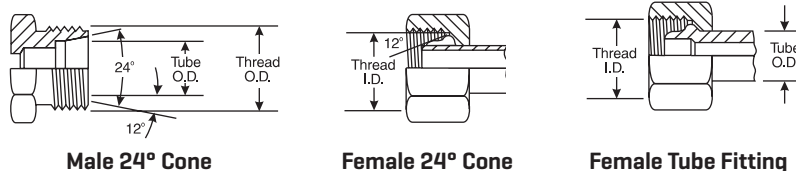

EQUIPMENT

HOSE/CPLG. SELECTION

G8K COUPLINGS

GLOBALSPIRAL COUPLINGS

STAINLESS STEEL SPIRAL

MEGACRIMP COUPLINGS

STAINLESS STEEL BRAID

POWER CRIMP COUPLINGS

FIELD ATTACHABLE G1 & G2 COUPLINGS

FIELD ATTACHABLE C5 COUPLINGS

GLX COUPLINGS

GL COUPLINGS

C14 COUPLINGS

PCTS THERMOPLASTIC COUPLINGS

POLARSEAL COUPLINGS

POLARSEAL II COUPLINGS

POWER STEERING

ADAPTERS

QUICK DISCONNECT COUPLERS

BALL VALVES

LIVE SWIVEL

ASSEMBLY FABRICATION

ACCESSORIES

EQUIPMENT AND PARTS

AIR BRAKE

BRASS

KITS

Coupling Identification - Continued

Foreign Thread Types - French - Continued

GAZ Poclairn 24° Flange

The Poclairn (French GAZ) 24° high pressure flange is usually found on Poclairn equipment.

The male flange will mate with a female flange or port. The seal is made on the 24° seat.

Nominal Size [In.]	A [In.]	B [In.]	C [In.]	D [In.]	E [In.]	F [In.]
1/2	1.57	.72	2.20	1.89	.55	.35
5/8	1.57	.72	2.20	1.89	.55	.35
3/4	2.00	.94	2.75	2.38	.71	.43

Poclairn (French GAZ)

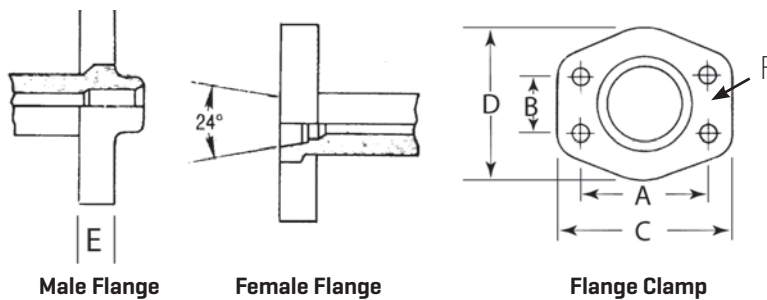

Foreign Thread Types - German DIN (Deutsche Industrial Norme)

Popular couplings are German DIN (Deutsche Industrial Norme). A coupling referred to as "metric" usually means a DIN coupling.

DIN 24° Cone

The DIN 24° cone male will mate with any of the females shown.

The male has a 24° seat, straight metric threads, and a recessed counterbore which matches the tube O.D. of the coupling used with it. The mating female is a 24° cone with O-ring, a metric tube fitting or a universal 24° and 60° cone.

There is a light and heavy series DIN coupling. Proper identification is made by measuring both the thread size and the tube O.D. [The heavy series has a smaller tube O.D. but a thicker wall section than the light.]

When measuring the flare angle with the seat angle gauge, use the 12° gauge. The seat angle gauge measures the angle from the connector centerline.

Metric Thread Size	Female Thread I.D. [mm]	Male Thread O.D. [mm]	Tube O.D.		Torque Recommendation [Ft. Lbs.]	
			Light Series [mm]	Heavy Series [mm]	Min.	Max.
M12x1.5	10.5	12.0	6	—	7	15
M14x1.5	12.5	14.0	8	—	15	26
M16x1.5	14.5	16.0	10	8	18	30
M18x1.5	16.5	18.0	12	10	22	33
M20x1.5	18.5	20.0	14	12	26	37
M22x1.5	20.5	22.0	15	14	30	52
M24x1.5	22.5	24.0	—	16	30	52
M26x1.5	24.5	26.0	18	—	44	74
M30x2.0	28.0	30.0	22	20	59	89
M36x2.0	34.0	36.0	28	25	74	111
M42x2.0	40.0	42.0	—	30	74	162
M45x2.0	43.0	45.0	35	—	133	184
M52x2.0	50.0	52.0	42	38	148	221

DIN 24° Male and Mating Females

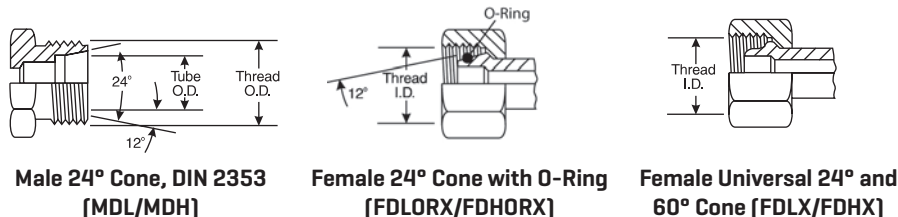

Male 24° Cone, DIN 2353 (MDL/MDH)

Female 24° Cone with O-Ring (FDLORX/FDHORX)

Female Universal 24° and 60° Cone (FDLX/FDHX)

Coupling Identification – Continued

Foreign Thread Types – German DIN – Continued

DIN 60° Cone

The DIN 60° cone male will mate with the female universal 24° or 60° cone connector only.

The male has a 60° seat and straight metric threads. The female has a 24° and 60° universal seat and straight metric threads.

When measuring the flare angle with the seat angle gauge, use the 30° gauge. The seat angle gauge measures the angle from the connector centerline.

Metric Thread Size	Female Thread	Male Thread	Tube O.D. [mm]	Torque Recommendation [Ft. Lbs.]	
	I.D. [mm]	O.D. [mm]		Min.	Max.
M14x1.5	12.5	14.0	8	15	26
M16x1.5	14.5	16.0	10	18	30
M18x1.5	16.5	18.0	12	22	33
M22x1.5	20.5	22.0	15	30	52
M26x1.5	24.5	26.0	18	44	74
M30x1.5	28.5	30.0	22	59	59
M38x1.5	36.5	38.0	28	74	111
M45x1.5	43.5	45.0	35	133	184
M52x2.0	50.5	52.0	42	148	221

DIN 60° Male and Mating Female

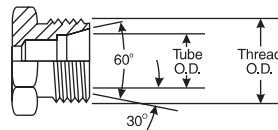

Male 60° Cone, DIN 6711

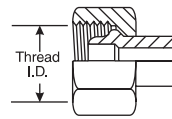

Female Universal 24° and 60° Cone

EQUIPMENT
HOSE/CPLG. SELECTION
G&K COUPLINGS
GLOBALSPIRAL COUPLINGS
STAINLESS STEEL SPIRAL
MEGACRIMP COUPLINGS
STAINLESS STEEL BRAID
POWER CRIMP COUPLINGS
FIELD ATTACHABLE G1 & G2 COUPLINGS
FIELD ATTACHABLE C5 COUPLINGS
GLX COUPLINGS
GL COUPLINGS
C14 COUPLINGS
PCTS THERMOPLASTIC COUPLINGS
POLARSEAL COUPLINGS
POLARSEAL II COUPLINGS
POWER STEERING
ADAPTERS
QUICK DISCONNECT COUPLERS
BALL VALVES
LIVE SWIVEL
ASSEMBLY FABRICATION
ACCESSORIES
EQUIPMENT AND PARTS
AIR BRAKE
BRASS
KITS

Coupling Identification - Continued

Foreign Thread Types - German DIN - Continued

DIN 3852 Couplings Type A & B (Parallel Threads)

The male DIN 3852 Type A & B couplings will mate with the female DIN coupling shown below. Gates offers this thread as an adapter.

The male and female type A & B couplings have straight threads. The seal occurs when the ring seal (Type A) or the face seal (Type B) mates with the face of the female port.

There are two series of DIN 3852 Type A & B couplings, the light [L] and the heavy [S] series.

Note: Commonly used threads on male metric adapters.

DIN 3852 Couplings Type A & B (Parallel Threads)

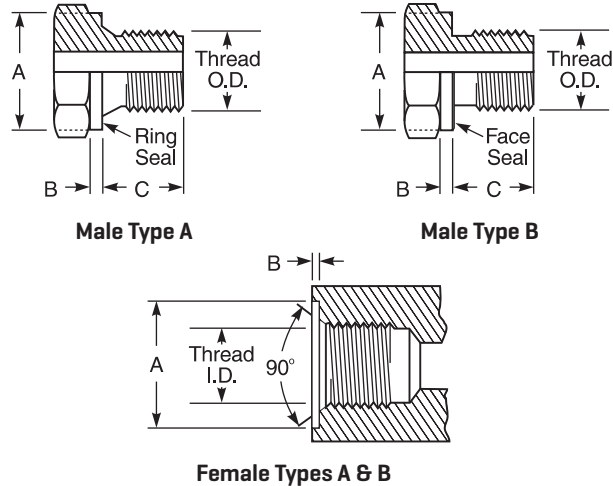

Series	Tube O.D. [mm]	Thread Size	Metric Thread Parallel						Whitworth Thread Parallel								
			Female			Male			Female [BSPOR]			Male [BSPP]					
			Thread I.D. [mm]	A [mm]	B [mm]	Thread O.D. [mm]	A [mm]	B [mm]	C [mm]	Thread I.D. [In.]	A [mm]	B [mm]	Thread O.D. [In.]	A [mm]	B [mm]	C [mm]	
L Light	6	10x1.0	8.5	15	1.0	10	14	1.5	8	1/8-28	11/32	15	1.0	3/8	14	1.5	8
	8	12x1.5	10.5	18	1.5	12	17	2.0	12	1/4-19	15/32	19	1.5	1/2	17	2.0	12
	10	14x1.5	12.5	20	1.5	14	19	2.0	12	1/4-19	15/32	19	1.5	1/2	19	2.0	12
	12	16x1.5	14.5	22	1.5	16	21	2.5	12	3/8-19	19/32	23	2.0	21/32	21	2.5	12
	15	18x1.5	16.5	24	2.0	18	23	2.5	12	1/2-14	3/4	27	2.5	13/16	23	2.5	12
	18	22x1.5	20.5	28	2.5	22	27	3.0	14	1/2-14	3/4	27	2.5	13/16	27	3.0	14
	22	26x1.5	24.5	32	2.5	26	31	3.0	16	3/4-14	31/32	33	2.5	1-1/32	31	3.0	16
	28	33x2.0	31.5	40	2.5	33	39	3.0	18	1-11	1-7/32	40	2.5	1-5/16	39	3.0	18
	35	42x2.0	40.5	50	2.5	42	49	3.0	20	1-1/4-11	1-17/32	50	2.5	1-21/32	49	3.0	20
	42	48x2.0	46.5	56	2.5	48	55	3.0	22	1-1/2-11	1-25/32	56	2.5	1-7/8	55	3.0	22
S Heavy	6	12x1.5	10.5	18	1.5	12	17	2.0	12	1/4-19	15/32	19	1.5	1/2	17	2.0	12
	8	14x1.5	12.5	20	1.5	14	19	2.0	12	1/4-19	15/32	19	1.5	1/2	19	2.0	12
	10	16x1.5	14.5	22	1.5	16	21	2.5	12	3/8-19	19/32	23	2.0	21/32	21	2.5	12
	12	18x1.5	16.5	24	2.0	18	23	2.5	12	3/8-19	19/32	23	2.0	21/32	23	2.5	12
	14	20x1.5	18.5	26	2.0	20	25	3.0	14	1/2-14	3/4	27	2.5	13/16	25	3.0	14
	16	22x1.5	20.5	28	2.5	22	27	3.0	14	1/2-14	3/4	27	2.5	13/16	27	3.0	14
	20	27x2.0	25.5	33	2.5	27	32	3.0	16	3/4-14	31/32	33	2.5	1-1/32	32	3.0	16
	25	33x2.0	31.5	40	2.5	33	39	3.0	18	1-11	1-7/32	40	2.5	1-5/16	39	3.0	18
	30	42x2.0	40.5	50	2.5	42	49	3.0	20	1-1/4-11	1-17/32	50	2.5	1-21/32	49	3.0	20
	38	48x2.0	46.5	56	2.5	48	55	3.0	22	1-1/2-11	1-25/32	56	2.5	1-7/8	55	3.0	22

Foreign Thread Types – German DIN – Continued

DIN 3852 Type C Metric and Whitworth Tapered (BSPT) Thread Connectors

The DIN 3852 Type C couplings are available with either metric or Whitworth British thread. The male will mate only with the female as shown.

The male and female couplings have tapered threads. The seal takes place on the threads. There are three series of DIN 3852 Type C Couplings: extra light [LL], light [L] and heavy [S].

DIN 3852 Type C Metric and Whitworth Tapered Thread Connectors

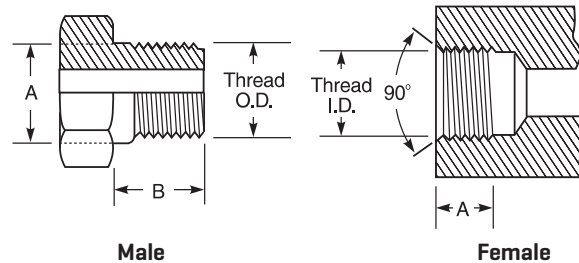

Series	Tube O.D. (mm)	Metric Tapered Threads						Whitworth Tapered Threads					
		Thread Size	Female		Male		Thread Size	Female		Male			
			Thread I.D. (mm)	A (mm)	Thread O.D. (mm)	A (mm)		B (mm)	Thread I.D. (In.)	A (mm)	Thread O.D. (In.)	A (mm)	B (mm)
LL Extra Light	4	8x1.0	6.5	5.5	8	8.40	8	1/8-28	11/32	5.5	1/8	.392	8
	5	8x1.0	6.5	5.5	8	8.40	8	1/8-28	11/32	5.5	1/8	.392	8
	6	10x1.0	8.5	5.5	10	10.40	8	1/8-28	11/32	5.5	1/8	.392	8
	8	10x1.0	8.5	5.5	10	10.40	8	1/8-28	11/32	5.5	1/8	.392	8
L Light	6	10x1.0	8.5	5.5	10	10.40	8	1/8-28	11/32	5.5	1/8	.392	8
	8	12x1.5	10.5	8.5	12	12.53	12	1/4-19	15/32	8.5	1/4	.532	12
	10	14x1.5	12.5	8.5	14	14.53	12	1/4-19	15/32	8.5	1/4	.532	12
	12	16x1.5	14.5	8.5	16	16.53	12	3/8-19	19/32	8.5	3/8	.670	12
	15	18x1.5	16.5	8.5	18	18.53	12	1/2-14	3/4	8.5	1/2	.839	14
S Heavy	18	22x1.5	20.5	10.5	22	22.65	14	1/2-14	3/4	10.5	1/2	.839	14
	6	12x1.5	10.5	8.5	12	12.53	12	1/4-19	15/32	8.5	1/4	.532	12
	8	14x1.5	12.5	8.5	14	14.53	12	1/4-19	15/32	8.5	1/4	.532	12
	10	16x1.5	14.5	8.5	16	16.53	12	3/8-19	19/32	8.5	3/8	.670	12
	12	18x1.5	16.5	8.5	18	18.53	12	3/8-19	19/32	8.5	3/8	.670	12
	14	20x1.5	18.5	10.5	20	20.65	14	1/2-14	3/4	10.5	1/2	.839	14
	16	22x1.5	20.5	10.5	22	22.65	14	1/2-14	3/4	10.5	1/2	.839	14

Metric Stand Pipe Assembly

A metric stand pipe assembly is comprised of three components attached to a male fitting. The components are: a Stand Pipe Tube, Bite Sleeve and Metric Nut. The nut is placed over the Stand Pipe, followed by the Bite Sleeve (see illustration below). For DIN light assemblies, a DIN light metric nut is used. For DIN heavy assemblies, a DIN heavy metric nut is used. The Bite Sleeve and Stand Pipe are selected on the basis of tube O.D.

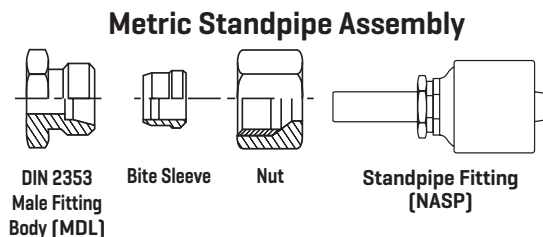

Metric Stand Pipe DIN Tube O.D. (mm)	Bite Sleeve DIN Tube O.D. (mm)	Metric Nut Thread	
		Light	Heavy
6	6	M12x1.5	—
8	8	M14x1.5	M16x1.5
10	10	M16x1.5	M18x1.5
12	12	M18x1.5	M20x1.5
15	15	M22x1.5	—
16	16	—	M24x1.5
18	18	M26x1.5	—
20	20	—	M30x2.0
22	22	M30x2.0	—
25	25	—	M36x2.0
28	28	M36x2.0	—
30	30	—	M42x2.0
35	35	M45x2.0	—
38	38	—	M52x2.0
42	42	M52x2.0	—

EQUIPMENT
HOSE/CPLG. SELECTION
G8K COUPLINGS
GLOBAL SPIRAL COUPLINGS
STAINLESS STEEL SPIRAL
MEGACRIMP COUPLINGS
STAINLESS STEEL BRAID
POWER CRIMP COUPLINGS
FIELD ATTACHABLE G1 & G2 COUPLINGS
FIELD ATTACHABLE C5 COUPLINGS
GLX COUPLINGS
GL COUPLINGS
C14 COUPLINGS
PCTS THERMOPLASTIC COUPLINGS
POLARSEAL COUPLINGS
POLARSEAL II COUPLINGS
POWER STEERING
ADAPTERS
QUICK DISCONNECT COUPLERS
BALL VALVES
LIVE SWIVEL
ASSEMBLY FABRICATION
ACCESSORIES
EQUIPMENT AND PARTS
AIR BRAKE
BRASS
KITS

Coupling Identification - Continued

Foreign Thread Types - Japanese

There are two popular types of coupling styles in Japan, Japanese Industrial Standard and Komatsu. These couplings look similar to Male JIC and Female JIC Swivel couplings. However there are two major differences: The threads are BSP and the seat angle is only 30° instead of 37° for JIC.

- 1. Japanese Industrial Standard.** Most Japanese equipment uses this type of coupling with a 30° seat and British Standard Pipe Parallel threads. They are not interchangeable with British couplings, since the flare is not inverted.
- 2. Komatsu.** All Komatsu equipment uses couplings with a 30° seat and metric fine threads. All flanges are Code 61 or Code 62, except -10 which utilizes a special Komatsu-style flange that does not conform to SAE standard sizing.

Japanese 30° Flare Parallel Threads

The Japanese 30° flare male connector will mate with a Japanese 30° flare female only.

The male and female have straight threads and a 30° seat. The seal is made on the 30° seat.

The threads on the Japanese 30° flare connector conform to JIS B 0202, which are the same as the BSPOR threads. Both the British and Japanese connectors have a 30° seat, but they are not interchangeable because the British seat is inverted.

Dash Size	Nominal Size [In.]	Thread Size	Female Thread I.D. [In.]	Male Thread O.D. [In.]
-2	1/8	1/8 - 28	11/32	3/8
-4	1/4	1/4 - 19	7/16	17/32
-6	3/8	3/8 - 19	19/32	21/32
-8	1/2	1/2 - 14	3/4	13/16
-10	5/8	5/8 - 14	13/16	29/32
-12	3/4	3/4 - 14	15/16	1-1/32
-16	1	1 - 11	1-13/16	1-15/16
-20	1-1/4	1-1/4 - 11	1-17/32	1-21/32
-24	1-1/2	1-1/2 - 11	1-25/32	1-7/8
-32	2	2 - 11	2-7/32	2-11/32

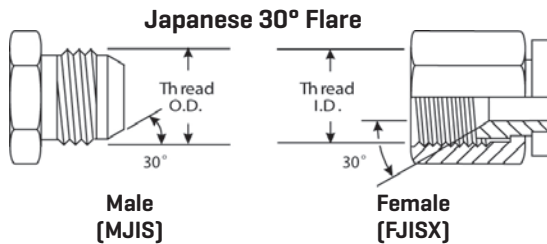

Japanese Tapered Pipe Thread

The Japanese tapered pipe thread connector is identical to and fully interchangeable with the BSPT (tapered) connector. The Japanese connector does not have a 30° flare and will not mate with the BSPOR female.

The threads conform to JIS B 0203, which are the same as BSPT threads.

The seal on the Japanese tapered pipe thread connector is made on the threads.

Dash Size	Nominal Size [In.]	Thread Size	Female Parallel Thread I.D. [In.]	Male Parallel Thread O.D. [In.]
-2	1/8	1/8 - 28	11/32	3/8
-4	1/4	1/4 - 19	7/16	17/32
-6	3/8	3/8 - 19	19/32	21/32
-8	1/2	1/2 - 14	3/4	13/16
-12	3/4	3/4 - 14	15/16	1-1/32
-16	1	1 - 11	1-13/16	1-15/16
-20	1-1/4	1-1/4 - 11	1-17/32	1-21/32
-24	1-1/2	1-1/2 - 11	1-25/32	1-7/8
-32	2	2 - 11	2-7/32	1-11/32
-32	2	2 - 11	2-7/32	2-11/32

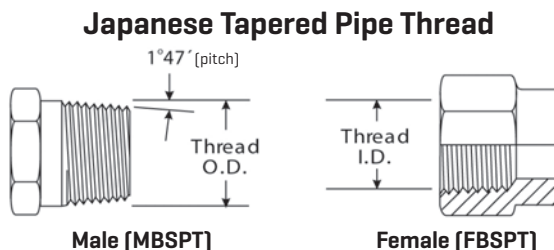

Foreign Thread Types – Japanese – Continued

Komatsu Style 30° Flare Parallel Threads

The Komatsu style 30° flare parallel thread connector is identical to the Japanese 30° flare parallel thread connector except for the threads. The Komatsu style connector uses metric fine threads which conform to JIS B 0207. Gates identifies these as Komatsu-style by marking the hex nuts with two small notches.

The Komatsu style connector seals on the 30° flare.

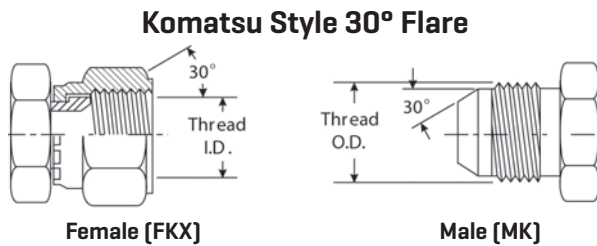

Dash Size	Nominal Size		Thread Size	Female Thread I.D. [mm]	Male Thread [O.D.] [mm]
	[In.]	[mm]			
-4	1/4	6.5	M14x1.5	12.5	14
-6	3/8	9.5	M18x1.5	16.5	18
-8	1/2	13	M22x1.5	20.5	22
-10	5/8	16	M24x1.5	22.5	24
-12	3/4	19	M30x1.5	28.5	30
-16	1	25	M33x1.5	31.5	33
-20	1-1/4	32	M36x1.5	34.5	36
-24	1-1/2	38	M42x1.5	40.5	42

Komatsu Style Flange Fitting

The Komatsu style flange fitting is nearly identical to and fully interchangeable with the SAE Code 61 flange fitting. In all sizes the O-ring dimensions are different. When replacing a Komatsu style flange with an SAE style flange, an SAE style O-ring must always be used.

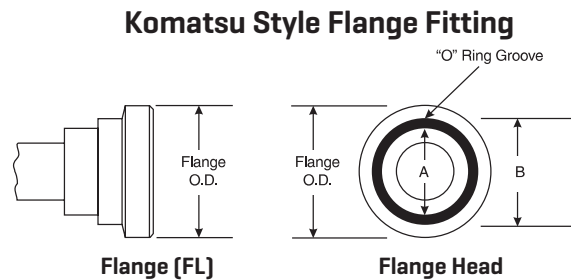

Dash Size	Nominal Size		Flange O.D. [In.]	A [In.]	B [In.]
	[In.]	[mm]			
-8	1/2	12.7	1.188	.728	.984
-10*	5/8	15.9	1.345	.728	1.102
-12	3/4	19.1	1.500	.846	1.220
-16	1	25.4	1.750	1.122	1.496
-20	1-1/4	31.8	2.000	1.358	1.732
-24	1-1/2	38.1	2.375	1.750	2.125
-32	2	50.8	2.812	2.225	2.559

*[-10 is a non-SAE size flange]

Metric Kobelco Metric Bite Sleeve

These are similar to the German DIN 24° cone, but the DIN style uses coarser threads. Therefore, the Kobelco and German DIN are not interchangeable for female Kobelco [see French GAZ 24° swivel].

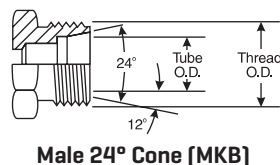

Dash Size	Metric Thread Size	Female Thread I.D. [mm]	Male Thread O.D. [mm]
-22	M30X1.5	28	30
-28	M36X1.5	34	36
-35	M45X1.5	43	45

EQUIPMENT

HOSE/CPLG. SELECTION

G&K COUPLINGS

GLOBAL SPIRAL COUPLINGS

STAINLESS STEEL SPIRAL

MEGACRIMP COUPLINGS

STAINLESS STEEL BRAID

POWER CRIMP COUPLINGS

FIELD ATTACHABLE G1 & G2 COUPLINGS

FIELD ATTACHABLE C5 COUPLINGS

GLX COUPLINGS

GL COUPLINGS

C14 COUPLINGS

PCTS THERMOPLASTIC COUPLINGS

POLARSEAL COUPLINGS

POLARSEAL II COUPLINGS

POWER STEERING

ADAPTERS

QUICK DISCONNECT COUPLERS

BALL VALVES

LIVE SWIVEL

ASSEMBLY FABRICATION

ACCESSORIES

EQUIPMENT AND PARTS

AIR BRAKE

BRASS

KITS

Gates Global Part Numbering System

EQUIPMENT
HOSE/CPLG. SELECTION
G8K COUPLINGS
GLOBALSPIRAL COUPLINGS
STAINLESS STEEL SPIRAL
MEGACRIMP COUPLINGS
STAINLESS STEEL BRAID
POWER CRIMP COUPLINGS
FIELD ATTACHABLE G1 & G2 COUPLINGS
FIELD ATTACHABLE C5 COUPLINGS
GLX COUPLINGS
GL COUPLINGS
C14 COUPLINGS
PCTS THERMOPLASTIC COUPLINGS
POLARSEAL COUPLINGS
POLARSEAL II COUPLINGS
POWER STEERING
ADAPTERS
QUICK DISCONNECT COUPLERS
BALL VALVES
LIVE SWIVEL
ASSEMBLY FABRICATION
ACCESSORIES
EQUIPMENT AND PARTS
AIR BRAKE
BRASS
KITS

Gates couplings feature a meaningful part number that makes coupling identification fast and easy. Always refer to Gates Crimp Data Manual when selecting hose and coupling combinations.

In the following example, the Global Part Number G25100-0808 identifies a MegaCrimp® Male Pipe [MP] coupling with -8 [1/2"] stem size and -8 [1/2"] thread size.

G25100-0808

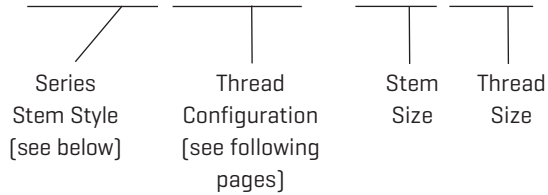

Series Stem Styles:

- G17** - Stainless Steel Braid Couplings
- G18** - Stainless Steel Spiral Couplings
- G19** - G8K Couplings
- G20** - GlobalSpiral™
- G21** - GlobalSpiral™ One Piece Couplings For MC4-20 Crimper
- G22** - GlobalSpiral™ Plus [GSP]
- G23** - GlobalSpiral™ Max [-32] [GSM] Pressure Couplings
- G24** - GlobalSpiral™ Max [GSM] Pressure Couplings
- G25** - MegaCrimp® Couplings
- G27** - Field Attachable Type T for G1 Hose [1 Wire]
- G28** - Field Attachable Type T for G2 Hose [2 Wire]
- G34** - Field Attachable for C5CXH, C5C, C5D & C5M Hose
- G35** - Field Attachable for C5E Hose
- G36** - Brass Lock-On Field Attachable Couplings
- G40** - C14 Couplings
- G43** - GL Couplings
- G44** - GLX® Couplings
- G45** - PolarSeal® Couplings
- G46** - PolarSeal® II Couplings
- G50** - Power Steering Couplings
- G51** - PCTS Thermoplastic Couplings

Other Non-Stem Series Styles:

- G30** - Air Brake Copper Tubing
- G31** - SureLok™ Air Brake Couplings
- G32** - Compression Air Brake
- G33** - Air Brake Couplings For Rubber Hose
- G37** - Single Bead
- G38** - Barbed Stem
- G49** - Automotive Adapters
- G52** - Gates OE-Style Clamp Collars
- G55** - Copper Tubing Industrial
- G56** - Industrial SureLok™
- G57** - Mini-Barbed Tube
- G58** - Compression PVC
- G60** - SAE to SAE Adapters
- G62** - British to SAE Adapters
- G63** - Metric Conversion Adapters
- G64** - International to International Adapters
- G65** - Japanese Conversion Adapters
- G80** - Hose Bend Restrictors
- G81** - Hose Guards
- G82** - G82 & G83 Spring Guards
- G83** - G82 & G83 Spring Guards
- G89** - C14 Assembly
- G93** - Live Swivel
- G94** - Quick Disconnect Couplers
- G95** - Quick Disconnect Couplers
- G96** - Ball Valves

Gates Global Part Numbering System - Continued

Thread Configurations for Stem Styles

These three-digit numbers identify the various coupling thread configurations

100 - MP	Male Pipe [NPTF - 30° Cone Seat]	306 - FL45S	Code 61 O-Ring Flange - 45° Bent Tube - Short
101 - MPLN	Male Pipe Long Nose	307 - FL45	Code 61 O-Ring Flange - 45° Bent Tube
102 - MPAPI	API Line Pipe Connection	308 - FL60S	Code 61 O-Ring Flange - 60° Bent Tube - Short
103 - MPLH	Male Pipe [NPTF - 30° Cone Seat] - Long Hex	309 - FL60M	Code 61 O-Ring Flange - 60° Bent Tube - Medium
105 - MPX	Male Pipe Swivel [NPTF - Without 30° Cone Seat]	311 - FL67	Code 61 O-Ring Flange - 67 1/2° Bent Tube
106 - MPX90	Male Pipe Swivel - 90° Block [NPTF - Without 30° Cone Seat]	313 - FL90XS	Code 61 O-Ring Flange - 90° Bent Tube - Extra Short
107 - MPX90L	Male Pipe Swivel - 90° Long Block [NPTF - Without 30° Cone Seat]	314 - FL90S	Code 61 O-Ring Flange - 90° Bent Tube - Short
110 - FP	Female Pipe [NPTF - Without 30° Cone Seat]	315 - FL90M	Code 61 O-Ring Flange - 90° Bent Tube - Medium
111 - FPX	Female Pipe Swivel [NPSM - 30° Cone Seat]	316 - FL90L	Code 61 O-Ring Flange - 90° Bent Tube - Long
120 - MB	Male O-Ring Boss	317 - FL90XL	Code 61 O-Ring Flange - 90° Bent Tube - Extra Long
121 - MBX	Male O-Ring Boss Swivel	318 - FL90XXL	Code 61 O-Ring Flange - 90° Bent Tube - Extra Extra Long
122 - MBX45BL	Male O-Ring Boss Swivel - 45° Block	319 - FL90Non-ISO	Code 61 O-Ring Flange - 90° Bent Tube - Non-ISO
123 - MBX90BL	Male O-Ring Boss Swivel - 90° Block	323 - FL100	Code 61 O-Ring Flange - 100° Bent Tube
124 - MBX90BL	Male O-Ring Boss Swivel - 90° Block Long	325 - FL110	Code 61 O-Ring Flange - 110° Bent Tube
126 - MBX45	Male O-Ring Boss Swivel - 45° Bent Tube	327 - FL120	Code 61 O-Ring Flange - 120° Bent Tube
128 - MBX90	Male O-Ring Boss Swivel - 90° Bent Tube	329 - FL125	Code 61 O-Ring Flange - 125° Bent Tube
134 - MBAX90M	Male O-Ring Boss Adapterless Swivel - 90° Bent Tube - Medium	331 - FL135	Code 61 O-Ring Flange - 135° Bent Tube
140 - FMX	Female MegaSeal Swivel	342 - RFL90S	Special Flange - 90°
145 - FMX45	Female MegaSeal Swivel - 45° Bent Tube	345 - BSPP-LX	Male BSPP to Male BSPP
149 - FMX90S	Female MegaSeal Swivel - 90° Bent Tube - Short	350 - FLH	Code 62 O-Ring Flange Heavy
150 - FMX90	Female MegaSeal Swivel - 90° Bent Tube	352 - FLH22	Code 62 O-Ring Flange Heavy - 22 1/2° Bent Tube
151 - FMX90L	Female MegaSeal Swivel - 90° Bent Tube - Long	353 - FLH20	Code 62 O-Ring Flange Heavy - 22° Bent Tube
165 - MJ	Male JIC 37° Flare	354 - FLH30	Code 62 O-Ring Flange Heavy - 30° Bent Tube
170 - FJX	Female JIC 37° Flare Swivel	357 - FLH45	Code 62 O-Ring Flange Heavy - 45° Bent Tube
171 - FJXL	Female JIC 37° Flare Swivel - Long	359 - FLH60	Code 62 O-Ring Flange Heavy - 60° Bent Tube
172 - FJX30	Female JIC 37° Flare Swivel - 30° Bent Tube	360 - FLH67	Code 62 O-Ring Flange Heavy - 67 1/2° Bent Tube
174 - FJX45S	Female JIC 37° Flare Swivel - 45° Bent Tube - Short	364 - FLH90S	Code 62 O-Ring Flange Heavy - 90° Bent Tube - Short
175 - FJX45	Female JIC 37° Flare Swivel - 45° Bent Tube	365 - FLH90M	Code 62 O-Ring Flange Heavy - 90° Bent Tube - Medium
176 - FJX45L	Female JIC 37° Flare Swivel - 45° Bent Tube - Long	366 - FLH90L	Code 62 O-Ring Flange Heavy - 90° Bent Tube - Long
177 - FJX60	Female JIC 37° Flare Swivel - 60° Bent Tube	367 - FLH90XL	Code 62 O-Ring Flange Heavy - 90° Bent Tube - Extra Long - Non ISO
179 - FJX90S	Female JIC 37° Flare Swivel - 90° Bent Tube - Short	369 - GS-FLH110	Code 62 O-Ring Flange Heavy - 110° Bent Tube
180 - FJX90M	Female JIC 37° Flare Swivel - 90° Bent Tube - Medium	370 - FLFF	Code 61 Flange Without O-Ring Groove
181 - FJX90L	Female JIC 37° Flare Swivel - 90° Bent Tube - Long	400 - FLC	Caterpillar Style O-Ring Flange
182 - FJX90XL	Female JIC 37° Flare Swivel - 90° Bent Tube - Extra Long	401 - FLCL	Caterpillar Style O-Ring Flange - Long
183 - FJX90	Female JIC 37° Flare Swivel - 90° Bent Tube	402 - FLC22	Caterpillar Style O-Ring Flange - 22 1/2° Bent Tube
187 - FJX90BLK	Female JIC 37° Flare Swivel - 90° Block	404 - FLC30	Caterpillar Style O-Ring Flange - 30° Bent Tube
195 - MS	Male SAE 45° Flare	407 - FLC45	Caterpillar Style O-Ring Flange - 45° Bent Tube
196 - MS45	Male SAE 45° Flare - 45° Bent Tube	408 - FLC45	Caterpillar Style O-Ring Flange - 45° Bent Tube
197 - MS90	Male SAE 45° Flare - 90° Bent Tube	409 - FLC60	Caterpillar Style O-Ring Flange - 60° Bent Tube
200 - FSX	Female SAE 45° Flare Swivel	410 - FLC67	Caterpillar Style O-Ring Flange - 67 1/2° Bent Tube
202 - FSX45	Female SAE 45° Flare Swivel - 45° Bent Tube	415 - FLC90	Caterpillar Style O-Ring Flange - 90° Bent Tube
204 - FSX90S	Female SAE 45° Flare Swivel - 90° Bent Tube - Short	416 - FLC90L	Caterpillar Style O-Ring Flange - 90° Bent Tube - Long
205 - FSX90	Female SAE 45° Flare Swivel - 90° Bent Tube	420 - FPFL	Female French GAZ [Poclairn] 24° High Pressure Flange
206 - FSX90L	Female SAE 45° Flare Swivel - 90° Bent Tube - Long	450 - FJ/FB-LX	Male JIC to Female Boss
210 - FJSX	Dual Seat Female JIC 37°/SAE 45° Flare Swivel	460 - ABC	Air Brake Compression
211 - FJSX45	Dual Seat Female JIC 37°/SAE 45° Flare Swivel - 45° Bent Tube	461 - STA	Straight Tube Assembly
212 - FJSX90	Dual Seat Female JIC 37°/SAE 45° Flare Swivel - 90° Bent Tube	462 - STA-ABC	Straight Tube Assembly [STA] and One Air Brake Compression [ABC]
213 - RFJSX90L	Dual Seat Female JIC 37°/SAE 45° Flare Swivel - 90° Bent Tube - Long	480 - MPFL	Male French GAZ [Poclairn] 24° High Pressure Flange
225 - MFFOR	Male Flat-Face O-Ring	482 - MPFL90	Male French GAZ [Poclairn] 24° High Pressure Flange - 90° Bent Tube
226 - MFFORBKHDLN	Male Flat-Face O-Ring Bulk Head Long Nose	500 - MIX	SAE Male Inverted Swivel
230 - FFORX	Female Flat-Face O-Ring Swivel	502 - MIX45	SAE Male Inverted Swivel - 45° Bent Tube
232 - FFORX22	Female Flat-Face O-Ring Swivel - 22 1/2° Bent Tube	504 - MIX90	SAE Male Inverted Swivel - 90° Bent Tube
233 - FFORX30	Female Flat-Face O-Ring Swivel - 30° Bent Tube	510 - MFA	SAE Male Flareless Assembly
234 - FFORX45S	Female Flat-Face O-Ring Swivel - 45° Bent Tube - Short	511 - MFA90	Male SAE Flareless Assembly - 90° Block
235 - FFORX45	Female Flat-Face O-Ring Swivel - 45° Bent Tube	520 - SP	North American Stand Pipe
238 - FFORX67	Female Flat-Face O-Ring Swivel - 67 1/2° Bent Tube	527 - FBO	Female Braze-On Stems
239 - FFORX90S	Female Flat-Face O-Ring Swivel - 90° Bent Tube - Short	534 - HLEC	Hose Length Extender - Caterpillar
240 - FFORX90M	Female Flat-Face O-Ring Swivel - 90° Bent Tube - Medium	535 - HLE	Hose Length Extender
241 - FFORX90L	Female Flat-Face O-Ring Swivel - 90° Bent Tube - Long	536 - HLE45	Hose Length Extender - 45° Bent Tube
248 - FFORX135	Female Flat-Face O-Ring Swivel - 135° Bent Tube	537 - HLE90	Hose Length Extender - 90° Bent Tube
300 - FL	Code 61 O-Ring Flange	538 - HLESG	Hose Length Extender with Sight Glass
301 - FLL	Code 61 O-Ring Flange Long Neck	539 - HLET	Hose Length Extender - Tee
302 - FL22M	Code 61 O-Ring Flange - 22 1/2° Bent Tube - Medium	540 - FABX	Female Air Brake Swivel
304 - FL30	Code 61 O-Ring Flange - 30° Bent Tube	541 - HLE180	Hose Length Extender - 180° Bent Tube
		542 - HLEY	Y Splicer
		543 - TBFLX	Two-Bolt Flange Swivel

EQUIPMENT
HOSE/CPLG. SELECTION
G8K COUPLINGS
GLOBAL SPIRAL COUPLINGS
STAINLESS STEEL SPIRAL
MEGACRIMP COUPLINGS
STAINLESS STEEL BRAID
POWER CRIMP COUPLINGS
FIELD ATTACHABLE G1 & G2 COUPLINGS
FIELD ATTACHABLE C5 COUPLINGS
GLX COUPLINGS
GL COUPLINGS
C14 COUPLINGS
PCTS THERMOPLASTIC COUPLINGS
POLARSEAL COUPLINGS
POLARSEAL II COUPLINGS
POWER STEERING
ADAPTERS
QUICK DISCONNECT COUPLERS
BALL VALVES
LIVE SWIVEL
ASSEMBLY FABRICATION
ACCESSORIES
EQUIPMENT AND PARTS
AIR BRAKE
BRASS
KITS

Gates Global Part Numbering System - Continued

Thread Configurations for Stem Styles - Continued

EQUIPMENT				
HOSE/CPLG. SELECTION				
G8K COUPLINGS				
GLOBAL SPIRAL COUPLINGS	561 - FG 562 - FZX 563 - PWX 564 - BJ 578 - MTON180 580 - MTON134SP 582 - MTON134SP90	Female Grease Female Parker Triple Thread Flare Pressure Wash Swivel US Banjo Male O-Ring [MOR] - 180° Bent Tube Male SAE Tube O-Ring Nut Swivel with R134a Service Port Male SAE Tube O-Ring Nut Swivel with R134a Service Port - 90° Bent Tube Male SAE Tube O-Ring Nut Swivel Male SAE Tube O-Ring Nut - 45° Bent Tube Male SAE Tube O-Ring Nut - 90° Bent Tube Female SAE Tube O-Ring Nut Swivel with R12 Service Port Female SAE Tube O-Ring Nut Swivel with R12 Service - 90° Bent Tube Female SAE Tube O-Ring Nut Swivel with R134a Service Port Female SAE Tube O-Ring Nut Swivel with R134a Service Port - 90° Bent Tube Female SAE Tube O-Ring Nut Swivel Female SAE Tube O-Ring Nut Swivel - 45° Bent Tube Female SAE Tube O-Ring Nut Swivel - 90° Bent Tube Female SAE Tube O-Ring Metric Nut Swivel Female SAE Tube O-Ring Metric Nut Swivel - 45° Bent Tube Female SAE Tube O-Ring Metric Nut Swivel - 90° Bent Tube Female SAE Tube O-Ring Nut Swivel - 90° Block Male Inverted O-Ring Male Inverted O-Ring - 45° Bent Tube Male Inverted O-Ring - 90° Bent Tube Male Inverted O-Ring Bulkhead Male Inverted O-Ring Bulkhead - 90° Bent Tube Female SAE Tube Dual O-Ring Nut Female SAE Tube Dual O-Ring Nut - 45° Bent Tube Female SAE Tube Dual O-Ring Nut - 90° Bent Tube Female SAE Tube Dual O-Ring Metric Nut Female SAE Tube Dual O-Ring Metric Nut - 45° Bent Tube Female SAE Tube Dual O-Ring Metric Nut - 90° Bent Tube Female SAE Tube O-Ring Nut - 180° Bent Tube Male Inverted O-Ring with R134a Service Port Male Inverted O-Ring with R134a Service Port - 90° Bent Tube Universal Tee O-Ring Splicer English Threads Male DIN 24° Cone - Light Series Female DIN 24° Cone Swivel - Light Series with O-Ring Female DIN 24° Cone Swivel - Light Series with O-Ring - 45° Bent Tube Female DIN 24° Cone Swivel - Light Series with O-Ring - 90° Bent Tube Male French GAZ Female French GAZ Swivel Female SAE Tube O-Ring Nut Swivel with R134a High Pressure Service Port Female French GAZ Swivel - 90° Bent Tube Female French GAZ Swivel - 90° Bent Tube - Short Male DIN 24° Cone - Heavy Series Female DIN 24° Cone Swivel - Heavy Series with O-Ring Female DIN 24° Cone Swivel - Heavy Series with O-Ring - 45° Bent Tube Female DIN 24° Cone Swivel - Heavy Series with O-Ring - 90° Bent Tube Male Kobelco Style Metric Light Stand Pipe International Thread Metric 7642 DIN Banjo Male British Standard Pipe Tapered/Japanese Tapered Thread Male British Standard Pipe Parallel Female British Standard Parallel Pipe O-Ring Swivel Female British Standard Parallel Pipe O-Ring Swivel Female British Standard Parallel Pipe O-Ring Swivel - 45° Bent Tube Female British Standard Parallel Pipe O-Ring Swivel - 90° Bent Tube	845 - FBSPORX90BL 850 - BSPBJ 855 - FBFFX 910 - FKX 911 - FKX45 913 - FKX90 930 - FJISX 935 - MMFA 947 - FSLTORSP 948 - FSLSP 949 - MSL45 950 - MSL 951 - MSL90 952 - FSL 953 - FSL90 954 - R12SP 955 - FSL45 956 - R134SP 957 - R134SP-RL 958 - CFON90 959 - CFON90BL 960 - CFON134SP90BL 961 - CBSR12SP90 962 - CBSRR12SP90 963 - FTONM90134SPH 964 - FTONM90SPL 965 - MIOM 970 - MQLH 971 - MQLH45S 972 - MQLH90S 973 - MQLH90L 974 - MB 995 - G8K1F 995 - GS1F 995 - GSP1F 995 - B1F 995 - CLAMP 995 - S1F 995 - S2F	Female British Standard Parallel Pipe O-Ring Swivel - 90° Block International Thread British Std Pipe Banjo Female British Flat-Face Swivel Female Komatsu Style Japanese Metric Swivel Female Komatsu Style Japanese Metric Swivel - 45° Bent Tube Female Komatsu Style Japanese Metric Swivel - 90° Bent Tube Female Japanese Industrial Standard Swivel Male Metric Flareless Assembly Female [Ford] Spring Lock Tee O-Ring Splicer Female [Ford] Spring Lock Liquid Line Splicer Male [Ford] Spring Lock - 45° Bent Tube Male [Ford] Spring Lock Male [Ford] Spring Lock - 90° Bent Tube Female [Ford] Spring Lock Female [Ford] Spring Lock - 90° Bent Tube Hose Splicer with R12 Thread Service Port Female [Ford] Spring Lock - 45° Bent Tube Hose Splicer with R134a Service Port Female Rotalok with R134a Service Port - 90° Block Compressor Female SAE Tube O-Ring Nut Swivel - 90° Bent Tube Compressor Female SAE Tube O-Ring Nut Swivel - 90° Block Compressor Female Tube O-Ring Nut with 134a Service Port - 90° Block Compressor Block - Single w/Switch or Service Port - 90° Bent Tube Compressor Block - Single Reverse w/Switch or Service Port - 90° Bent Tube Metric Female O-Ring [FOR] with Switch or Service Port - 90° Bent Tube Metric Female O-Ring [FOR] with Switch or Service Port - 90° Bent Tube Metric Male Insert O-Ring [MIO] Male Quick-Lok High Male Quick-Lok High - 45° Bent Tube - Short Male Quick-Lok High - 90° Bent Tube - Short Male Quick-Lok High - 90° Bent Tube - Long Female Quick-Lok High to Male O-Ring Boss Adapter G8K Ferrule for G8K Spiral Hose GS Ferrule for 4-Spiral Hose GSP Ferrule for 4-Spiral EF Hose Non-Skive Ferrule Clamp Assemblies Stainless Steel Spiral Couplings-Non-Skive Ferrules Stainless Steel Spiral Couplings-Skive Ferrules
STAINLESS STEEL SPIRAL				
MEGACRIMP COUPLINGS	583 - MTON 584 - MTON45 585 - MTON90 586 - FTONR12SP 587 - FTONR12SP90			
STAINLESS STEEL BRAID	588 - FTON134SP 589 - FTON134SP90			
POWER CRIMP COUPLINGS	590 - FTON 591 - FTON45 592 - FTON90 593 - FTONM 594 - FTONM45			
FIELD ATTACHABLE G1 & G2 COUPLINGS	595 - FTONM90 596 - FTON90BL 597 - MIO 598 - MIO45 599 - MIO90 600 - MIOBKHD 602 - MIOBKHD90 604 - FTDON 605 - FTDON45 606 - FTDON90 607 - FTDOMN 608 - FTDOMN45 609 - FTDOMN90 610 - FTON180 611 - MIO134SP 613 - MIO134SP90			
FIELD ATTACHABLE C5 COUPLINGS	614 - TORSP 615 - MDL 645 - FDLORX 650 - FDLORX45			
GLX COUPLINGS	655 - FDLORX90			
GL COUPLINGS	675 - MFG 680 - FFGX 688 - FTON134SPH			
C14 COUPLINGS	690 - FFGX90 691 - FFGX90S 715 - MDH 720 - FDHORX 725 - FDHORX45			
PCTS THERMOPLASTIC COUPLINGS	730 - FDHORX90			
POLARSEAL COUPLINGS	735 - MKB 750 - MSP 770 - DBJ 795 - MBSPT			
POLARSEAL II COUPLINGS	810 - MBSPP 830 - FBSPX 830 - FBSPORX 831 - FBSPORX45 832 - FBSPORX90			
POWER STEERING				
ADAPTERS				
QUICK DISCONNECT COUPLERS				
BALL VALVES				
LIVE SWIVEL				
ASSEMBLY FABRICATION				
ACCESSORIES				
EQUIPMENT AND PARTS				
AIR BRAKE				
BRASS				
KITS				

Gates Global Part Numbering System - Continued

Air Brake

In the following example, the Global Part Number G31100-0808 identifies a SureLok™ Male Pipe [MP] coupling with -8 [1/2"] tube size and -8 [1/2"] thread size.

G 31



Series Stem Style
[see below]

1 00 - 0 8



Thread Configuration
[see below]



Stem Size
[1/2"]

0 8

Thread Size
[1/2"]

Series Stem Styles:

- G31—SureLok™ Fittings [Description = AB]
- G32—Compression Fittings [Description = ABC]
- G33—Air Brake Fittings for Rubber Hose [Description = ABR]

THREAD CONFIGURATIONS

These three-digit numbers identify the various coupling thread configurations

021 - MP-ATDV	Air Tank Drain Valve	138 - AB-AB-MP90	Air Brake to Male Pipe - Tee - 90°
022 - MP-AV	Air Vent	140 - MPX-AB-AB	Male Pipe Swivel to Air Brake to Air Brake - Tee
027 - MP-CV	One Way Check Valve	142 - AB-AB-MPX	Air Brake on Run to Male Pipe Swivel - Tee
028 - CTI-MP-CV	Copper Tubing Industrial to Male Pipe - Check Valve	150 - AB-FP	Air Brake to Female Pipe
030 - MAB-MP	Air Brake Adapter	151 - ABR-FABX-MPA	Air Brake to Female Air Brake Swivel with Adapter
031 - GH	Gladhand	154 - AB-FP90	Air Brake to Female Pipe - 90°
032 - GH-SEAL	Gladhand Seal	160 - AB-AB-FP	Air Brake on Run to Female Pipe - Tee
040 - TSI-AB	Tube Sleeve Insert	161 - MP-FP-CTI	Male Pipe to Female Pipe to Copper Tubing Industrial - Tee
050 - TS-AB	Tube Sleeve	168 - AB-MP-FP	Air Brake to Male Pipe to Female Pipe
060 - TSN-AB	Tube Sleeve Nut	190 - MBT-MFA	Mini-Barb to Male Flareless Assembly
061 - SGN-ABR	Spring Guard Nut	300 - AB-AB-BKHD	Air Brake Bulkhead
080 - CARTRIDGE-AB	Air Brake Cartridge	301 - FP-FPBKHD	Air Brake Bulkhead
099 - CARTRIDGE-SLI	Cartridge	302 - MP-FPBKHD	Air Brake Bulkhead
100 - AB-MP	Air Brake to Male Pipe	303 - MP-FPBKHD	Air Brake Bulkhead
102 - AB-MP45	Air Brake to Male Pipe - 45°	350 - AB-MFA-BKHD	Air Brake to Male Flareless Assembly Bulkhead
104 - AB-MP90	Air Brake to Male Pipe - 90°	360 - AB-FP-BKHD	Air Brake to Female Pipe Bulkhead
105 - AB-MP-PT90	Air Brake to Male Pipe - 90° with port	400 - AB-AB	Air Brake Union
106 - ABC-MP90L	Air Brake to Male Pipe - 90° - Long	401 - MBT-MBTL	Mini-Barb Union - Long
110 - ABRSG-MP	Air Brake to Male Pipe with Spring Guard	402 - SLI-SLI-D	Double Union
111 - ABRI-MP	Air Brake to Male Pipe without Nut	404 - AB-AB90	Air Brake Union - 90°
112 - SGABR	Air Brake Spring Guard	450 - AB-AB-AB	Air Brake Union - Tee
122 - AB-MPX45	Air Brake to Male Pipe Swivel - 45°	452 - ABC-ABC-ABC	Air Brake Union - Tee
124 - AB-MPX90	Air Brake to Male Pipe Swivel - 90°	453 - AB-AB-ABMH	Air Brake Union - Tee with Mounting Hole
130 - MP-AB-AB	Male Pipe to Air Brake to Air Brake - Tee	601 - ABC-MP90TV	Air Brake to Male Pipe Truck Valve - 90°
131 - MP-AB-ABC	Male Pipe to Air Brake to Air Brake - Tee	602 - MP-ABC90TV	Male Pipe to Air Brake Truck Valve - 90°
134 - AB-AB-MP	Air Brake on Run to Male Pipe - Tee	610 - MP-MS90-TV	Male Pipe to Male SAE 45 Flare Truck Valve - 90°
135 - AB-AB-MP	Air Brake on Run to Male Pipe - Tee	612 - MS-MP90-TV	Male SAE 45 Flare to Male Pipe Truck Valve - 90°
136 - AB-AB-MP	Air Brake on Run to Male Pipe - Tee	620 - SB-MP90-TV	Single Bead Male Pipe Truck Valve - 90°

EQUIPMENT

HOSE/CPLG.
SELECTION

G&K COUPLINGS

GLOBAL SPIRAL
COUPLINGS

STAINLESS
STEEL SPIRAL

MEGACRIMP
COUPLINGS

STAINLESS
STEEL BRAID

POWER CRIMP
COUPLINGS

FIELD
ATTACHABLE G1
& G2 COUPLINGS

FIELD
ATTACHABLE C5
COUPLINGS

GLX COUPLINGS

GL COUPLINGS

C14 COUPLINGS

PCTS
THERMOPLASTIC
COUPLINGS

POLARSEAL
COUPLINGS

POLARSEAL II
COUPLINGS

POWER
STEERING

ADAPTERS

QUICK
DISCONNECT
COUPLERS

BALL VALVES

LIVE SWIVEL

ASSEMBLY
FABRICATION

ACCESSORIES

EQUIPMENT AND
PARTS

AIR BRAKE

BRASS

KITS

Gates Global Part Numbering System - Continued

Air Brake - Continued

EQUIPMENT	HOSE/CPLG. SELECTION	
G8K COUPLINGS		622 - SB-MP90-TVP Single Bead to Male Pipe Truck Valve with Pin Handle - 90°
GLOBAL SPIRAL COUPLINGS		630 - FP-MP90-TV Female Pipe to Male Pipe Truck Valve - 90°
		650 - FP-FP-FP3WTV 3-Way Truck Valve
STAINLESS STEEL SPIRAL		655 - FP-FP-FP4WTV 4-Way Truck Valve
		656 - FP-FP-FP4WTV-L 4-Way Truck Valve - Long
MEGACRIMP COUPLINGS		701 - MFA-MFASC Male Flareless Assembly to Male Flareless Assembly Shut-Off Cock
		705 - MFA-MPSC Male Flareless Assembly to Male Pipe Shut-Off Cock
STAINLESS STEEL BRAID		710 - MP-FPSC Male Pipe to Female Pipe Shut-Off Cock
		715 - FP-FPSC Female Pipe to Female Pipe Shut-Off Cock
POWER CRIMP COUPLINGS		720 - MS-MPSC Male SAE 45° Flare to Male Pipe Shut-Off Cock
		730 - MS-MSSC Male SAE 45° Flare to Male SAE 45° Flare Shut-Off Cock
FIELD ATTACHABLE G1 & G2 COUPLINGS		801 - MP-ADC Male Pipe Air Drain Cock
		805 - FP-MPADC Female Pipe to Male Pipe Air Drain Cock
FIELD ATTACHABLE C5 COUPLINGS		823 - BN-MPDC90 Male Pipe Drain Cock - Bibb Nose
		830 - MP-ISDC Male Pipe Drain Cock - Internal Seat
		831 - MP-ESDC Male Pipe Drain Cock - External Seat
		832 - MP-ADCBN Male Pipe Air Drain Cock - Bibb Nose
GLX COUPLINGS		850 - ATNKV Air Tank Valve
		901 - MFA-MFANV Male Flareless Assembly to Male Flareless Assembly - Needle Valve
GL COUPLINGS		905 - MFA-MP90NV Male Flareless Assembly to Male Flareless Assembly - Needle Valve - 90°
C14 COUPLINGS		910 - MFA-MPNV Male Flareless Assembly to Male Pipe - Needle Valve
		915 - MP-MPNV Male Pipe to Male Pipe - Needle Valve
PCTS THERMOPLASTIC COUPLINGS		920 - MP-FPNV Male Pipe to Female Pipe - Needle Valve
		930 - FP-FPNV Female Pipe to Female Pipe - Needle Valve
		940 - MS-MPNV Male SAE 45° Flare to Male Pipe - Needle Valve
POLARSEAL COUPLINGS		945 - MS-MP90NV Male SAE 45° Flare to Male Pipe - Needle Valve - 90°
		950 - MS-MSNV Male SAE 45° Flare to Male SAE 45° Flare - Needle Valve
POLARSEAL II COUPLINGS		970 - AB-MANIFOLD 6-Port Manifold
		975 - SLI-SLI-SLI-Y Union - "Y"
POWER STEERING		978 - MPX-SLI-SLI-Y Male Pipe Swivel to Industrial SureLok Union - "Y"
ADAPTERS		
QUICK DISCONNECT COUPLERS		
BALL VALVES		
LIVE SWIVEL		
ASSEMBLY FABRICATION		
ACCESSORIES		
EQUIPMENT AND PARTS		
AIR BRAKE		
BRASS		
KITS		

Gates Global Part Numbering System - Continued

Adapters

In the following example, the Global Part Number G60110-0808 identifies a Male Pipe NPTF [MP] to Male Pipe NPTF [MP] adapter with -8 [1/2"] pipe thread and -8 [1/2"] pipe thread size. Meets SAE100R2 working pressures except where noted.

SERIES STEM STYLES:

G60 - SAE to SAE **G62** - British to SAE **G63** - Metric to SAE **G64** - International to International **G65** - Japanese Conversion

G 60



Adapter Style

1 1 0



Thread Configuration
[see below]

0 8



Stem Size

[Measured in 1/16" - 8/16 = 1/2"]

0 8

Thread Size

[Measured in 1/16" - 8/16 = 1/2"]

THREAD CONFIGURATIONS

These three-digit numbers identify the various coupling thread configurations

SAE to SAE

60050 - FFN	Female Flareless Nut
60051 - FFS	Female Flareless Sleeve
60102 - MP-PLUG	Male Pipe NPTF Plug
60110 - MP-MP	Male Pipe NPTF to Male Pipe NPTF
60115 - MP-MP90	Male Pipe NPTF to Male Pipe NPTF - 90°
60130 - MP-FPS	Male Pipe NPTF to Female Pipe NPTF Reducer Bushing - Short
60132 - MP-FPL	Male Pipe NPTF to Female Pipe NPTF Increasing Bushing - Long
60136 - MP-FP90	Male Pipe NPTF to Female Pipe NPTF - 90°
60140 - MP-FPX	Male Pipe NPTF to Female Pipe Swivel NPSM
60142 - MP-FPX45	Male Pipe NPTF to Female Pipe Swivel NPSM - 45°
60144 - MP-FPX90	Male Pipe NPTF to Female Pipe Swivel NPSM - 90°
60152 - FP-FP	Female Pipe NPTF to Female Pipe NPTF
60156 - FP-FP90	Female Pipe NPTF to Female Pipe NPTF - 90°
60160 - FP-FPX	Female Pipe NPTF to Female Pipe Swivel NPSM
60162 - FP-FPX45	Female Pipe NPTF to Female Pipe Swivel NPSM - 45°
60164 - FP-FPX90	Female Pipe NPTF to Female Pipe Swivel NPSM - 90°
60181 - FP-FP-FP	Female Pipe NPTF - Tee
60183 - FP-FP-MP	Female Pipe NPTF on Run to Male Pipe NPTF - Tee
60184 - FPX-FPX-FPX	Female Pipe Swivel NPSM - Tee
60186 - FPX-FPX-MP	Female Pipe Swivel NPSM on Run to Male Pipe NPTF - Tee
60248 - O-RING	O-Rings for Straight Thread Boss Fittings
60250 - MB-PLUG	Male O-Ring Boss Plug
60275 - MB-FP	Male O-Ring Boss to Female Pipe NPTF
60285 - MB-FPX	Male O-Ring Boss to Female Pipe Swivel NPSM
60287 - MB-FPX45	Male O-Ring Boss to Female Pipe Swivel NPSM - 45°
60289 - MB-FPX90	Male O-Ring Boss to Female Pipe Swivel NPSM - 90°
60291 - FB-MP	Female O-Ring Boss to Male Pipe NPTF
60301 - MB-MJ	Male O-Ring Boss to Male JIC 37° Flare
60308 - MB-MJ45	Male O-Ring Boss to Male JIC 37° Flare - 45°
60312 - MB-MJ90	Male O-Ring Boss to Male JIC 37° Flare - 90°
60320 - MB-FJX	Male O-Ring Boss to Female JIC 37° Flare Swivel
60350 - MJ-MJ-MB	Male JIC 37° Flare on Run to Male O-Ring Boss - Tee
60352 - MB-MJ-MJ	Male O-Ring Boss to Male JIC 37° Flare to Male JIC 37° Flare - Tee

60352 - 5MB-5MJ-5MJ	Male O-Ring Boss to Male JIC 37° Flare to Male JIC 37° Flare - Tee
60352 - 6MB-6MJ-6MJ	Male O-Ring Boss to Male JIC 37° Flare to Male JIC 37° Flare - Tee
60394 - TS	Tube Sleeve
60395 - TSN	Tube Sleeve Nut
60399 - LN	Locknuts for Bulkhead Fittings
60401 - FJ-CAP	Female JIC 37° Flare Cap
60402 - MJ-PLUG	Male JIC 37° Flare Plug
60405 - MJ-FBO	Male JIC 37° Flare to Female Braze - On
60410 - MJ-MJ	Male JIC 37° Flare to Male JIC 37° Flare
60417 - MJ-MJ90	Male JIC 37° Flare to Male JIC 37° Flare - 90°
60420 - MJ-FJ	Male JIC 37° Flare to Female JIC 37° Flare
60422 - MJ-FJX90	Male JIC 37° Flare to Female JIC 37° Flare Swivel - 90°
60424 - MJ-FJX45	Male JIC 37° Flare to Female JIC 37° Flare Swivel - 45°
60445 - MJ-BKHD	Male JIC 37° Flare to Female JIC 37° Flare Bulkhead
60446 - MJ-BKHD45	Male JIC 37° Flare to Male JIC 37° Flare Bulkhead - 45°
60447 - MJ-BKHD90	Male JIC 37° Flare to Male JIC 37° Flare Bulkhead - 90°
60469 - MJ-MJ-MJ	Male JIC 37° Flare Tee
60470 - MJ-MJ-FJX	Male JIC 37° Flare on Run to Female JIC 37° Flare Swivel - Tee
60471 - MJ-MJ-BKHD	Male JIC 37° Flare on Run to Male JIC 37° Flare Bulkhead - Tee
60472 - MJ-BKHD-MJ	Male JIC 37° Flare to Male JIC 37° Flare Bulkhead to Male JIC 37° Flare - Tee
60473 - MJ-FJX-MJ	Male JIC 37° Flare to Female JIC 37° Flare Swivel to Male JIC 37° Flare - Tee
60490 - MJ-MP	Male JIC 37° Flare to Male Pipe NPTF
60497 - MJ-MP45	Male JIC 37° Flare to Male Pipe NPTF - 45°
60499 - MJ-MP90	Male JIC 37° Flare to Male Pipe NPTF - 90°
60510 - MJ-FP	Male JIC 37° Flare to Female Pipe NPTF
60514 - MJ-FP90	Male JIC 37° Flare to Female Pipe NPTF - 90°
60520 - FJX-MP	Female JIC 37° Flare Swivel to Male Pipe NPTF
60524 - FJX-MP90	Female JIC 37° Flare Swivel to Male Pipe NPTF - 90°
60530 - FJX-FP	Female JIC 37° Flare Swivel to Female Pipe NPTF
60541 - MJBKHD-MP	Male JIC 37° Flare Bulkhead to Male Pipe NPTF
60551 - MJ-MJ-MP	Male JIC 37° Flare on Run to Male Pipe NPTF - Tee

EQUIPMENT
HOSE/CPLG. SELECTION
G8K COUPLINGS
GLOBAL SPIRAL COUPLINGS
STAINLESS STEEL SPIRAL
MEGACRIMP COUPLINGS
STAINLESS STEEL BRAID
POWER CRIMP COUPLINGS
FIELD ATTACHABLE G1 & G2 COUPLINGS
FIELD ATTACHABLE C5 COUPLINGS
GLX COUPLINGS
GL COUPLINGS
C14 COUPLINGS
PCTS THERMOPLASTIC COUPLINGS
POLARSEAL COUPLINGS
POLARSEAL II COUPLINGS
POWER STEERING
ADAPTERS
QUICK DISCONNECT COUPLERS
BALL VALVES
LIVE SWIVEL
ASSEMBLY FABRICATION
ACCESSORIES
EQUIPMENT AND PARTS
AIR BRAKE
BRASS
KITS

Gates Global Part Numbering System - Continued

Adapters - Continued

EQUIPMENT	HOSE/CPLG. SELECTION		
G8K COUPLINGS			
GLOBAL SPIRAL COUPLINGS		60593 - DCN Brass Adapters-Double Compression 60594 - DCN-MP Brass Adapters-Double Compression to Male Pipe 60595 - DCN-MP90 Brass Adapters-Double Compression to Male Pipe - 90°	60920 - FL4K-MFFOR45/ FL5K-MFFOR45 Code 61 O-Ring Flange to Male Flat-Face O-Ring 45° - High Pressure 60925 - FL4K-MFFOR90/ FL5K-MFFOR90 Code 61 O-Ring Flange to Male Flat-Face O-Ring 90° - High Pressure
STAINLESS STEEL SPIRAL		60596 - T-MIXN-S Brass Adapters-Steel Tubing Male Inverted Swivel Nut - Steel 60597 - T-MIXN-SL Brass Adapters-Steel Tubing Male Inverted Swivel Nut - Steel - Long	60927 - FLH-CAP Code 62 O-Ring Flange Cap 60929 - FHHS Flange Half Sets [Code 62 - SAE J518] 60930 - FLH6K-MJ Code 62 O-Ring Flange Heavy to Male JIC 37° Flare - [6,000 psi]
MEGACRIMP COUPLINGS		60599 - T-MIXN-B Brass Adapters-Brass Tubing Male Inverted Swivel Nut 60600 - MS-MP Brass Adapters-Male SAE 45° Flare to Male Pipe - Brass	60935 - FLH6K-MJ45 Code 62 O-Ring Flange Heavy to Male JIC 37° Flare 45° - [6,000 psi] 60940 - FLH6K-MJ90 Code 62 O-Ring Flange Heavy to Male JIC 37° Flare 90° - [6,000 psi]
STAINLESS STEEL BRAID		60654 - MS-MP90 Brass Adapters-Male SAE 45° Flare to Male Pipe - 90° - Brass 60660 - MS-FP Brass Adapters-Male SAE 45° Flare to Female Pipe - Brass	60945 - FLH6K-MFFOR Code 62 O-Ring Flange Heavy to Male Flat-Face O Ring - [6,000 psi] 60950 - FLH6K-MFFOR45 Code 62 O-Ring Flange Heavy to Male Flat-Face O-Ring 45° - [6,000 psi]
POWER CRIMP COUPLINGS		60664 - MS-FP90 Brass Adapters-Male SAE 45° Flare to Female Pipe - 90° Brass 60698 - O-RING FF O-Rings for Flat-Face Fittings 60701 - FFOR-CAP Female Flat-Face O-Ring Cap 60702 - MFFOR-PLUG Male Flat-Face O-Ring Plug 60705 - MFFOR-MFFOR Male Flat-Face O-Ring to Male Flat-Face O-Ring 60712 - MFFOR-MFFOR90 Male Flat-Face O-Ring to Male Flat-Face O-Ring - 90° 60724 - MFFOR-FFORX90 Male Flat-Face O-Ring to Female Flat-Face Swivel - 90°	60955 - FLH6K-MFFOR90 Code 62 O-Ring Flange Heavy to Male Flat-Face O-Ring 90° - [6,000 psi] 60959 - CATFHS Caterpillar-Style Flange Half Sets 62150 - MBSPT-MJ British Male Standard Pipe Tapered Thread to Male JIC 37° Flare 62153 - MBSPT-MJ45 British Male Standard Pipe Tapered Thread to Male JIC 37° Flare - 45° 62155 - MBSPT-MJ90 British Male Standard Pipe Tapered Thread to Male JIC 37° Flare - 90°
FIELD ATTACHABLE G1 & G2 COUPLINGS			
FIELD ATTACHABLE C5 COUPLINGS			
GLX COUPLINGS		60740 - MFFOR-MFFOR-MFFOR Male Flat-Face O-Ring Tee 60742 - MFFOR-MFFOR-FFORX Male Flat-Face O-Ring on Run to Female Flat-Face Swivel- Tee 60744 - MFFOR-FFORX-MFFOR Male Flat-Face O-Ring to Female Flat-Face O-Ring to Male Flat-Face O-Ring - Tee 60748 - MFFOR-BKHDT Male Flat-Face O-Ring to Male Flat-Face "O" Bulkhead - Tee 60770 - MFFOR-MP Male Flat-Face O-Ring to Male Pipe NPTF 60785 - MFFOR-FJX Male Flat-Face O-Ring to Female JIC 37° Flare Swivel 60800 - MFFOR-MB Male Flat-Face O-Ring to Male O-Ring Boss 60801 - MFFOR-MBL Male Flat-Face O-Ring to Male O-Ring Boss 60805 - MFFOR-MB45 Male Flat-Face O-Ring to Male O-Ring Boss - 45° 60810 - MFFOR-MB90 Male Flat-Face O-Ring to Male O-Ring Boss - 90° 60811 - MFFOR-MB90L Male Flat-Face O-Ring to Male O-Ring Boss - 90° Long Drop 60820 - MFFOR-MFFOR-MB Male Flat-Face O-Ring on Run to Male O-Ring Boss - Tee 60821 - MFFOR-MB-MFFOR Male Flat-Face O-Ring to Male O-Ring Boss to Male Flat-Face O-Ring - Tee 60880 - FFORX-MJ Female Flat-Face Swivel to Male JIC 37° Flare 60897 - FL-CAP Code 61 O-Ring Flange Cap 60898 - FLANGE O-RING O-Rings for Code 61, Code 62, and Caterpillar-Style Flange Fittings 60899 - CFHS Flange Half Sets [Code 61 - SAE J518] 60900 - FL-MJ Code 61 O-Ring Flange to Male JIC 37° Flare 60901 - FL4K-MJ / FL5K-MJ Code 61 O-Ring Flange to Male JIC 37° Flare - High Pressure 60905 - FL-MJ45 Code 61 O-Ring Flange to Male JIC 37° Flare - 45° 60906 - FL4K-MJ45 / FL5K-MJ45 Code 61 O-Ring Flange to Male JIC 37° Flare - 45° - High Pressure 60910 - FL-MJ90 Code 61 O-Ring Flange to Male JIC 37° Flare - 90° 60911 - FL4K-MJ90 / FL5K-MJ90 Code 61 O-Ring Flange to Male JIC 37° Flare - 90° - High Pressure 60915 - FL4K-MFFOR / FL5K-MFFOR Code 61 O-Ring Flange to Male Flat-Face O-Ring - High Pressure	62200 - MBSPP-MP British Male Standard Pipe Parallel to Male Pipe NPTF 62220 - MBSPP-FP British Male Standard Pipe Parallel to Female Pipe NPTF 62300 - MBSPP-MJ British Male Standard Pipe Parallel to Male JIC 37° Flare 62305 - MBSPP-MJ45 British Male Standard Pipe Parallel to Male JIC 37° Flare - 45° 62310 - MBSPP-MJ90 British Male Standard Pipe Parallel to Male JIC 37° Flare - 90° 62320 - MBSPP-FJX British Male Standard Pipe Parallel to Female JIC 37° Flare Swivel 62450 - MBSPPOR-MJ British Male Standard Pipe Parallel with O-Ring to Male JIC 37° Flare 62460 - MBSPPOR-MJ90 British Male Standard Pipe Parallel with O-Ring to Male JIC 37° Flare - 90° 62470 - MBSPPOR-MFFOR British Male Standard Pipe Parallel with O-Ring to Male Flat-Face O-Ring 62471 - MBSPPOR-MFFORL British Male Standard Pipe Parallel with O-Ring to Male Flat-Face O-Ring - Long 62473 - MBSPPOR-MFFOR45 British Male Standard Pipe Parallel with O-Ring to Male Flat-Face O-Ring - 45° 62475 - MBSPPOR-MFFOR90 British Male Standard Pipe Parallel with O-Ring to Male Flat-Face O-Ring - 90° 62500 - FBSPP-MP Female British Standard Pipe Parallel to Male Pipe NPTF 62520 - FBSPP-FP Female British Standard Pipe Parallel to Female Pipe NPTF 62550 - FBSPP-MJ Female British Standard Pipe Parallel to Male JIC 37° Flare 62605 - FBSPPX-MP90 Female British Standard Pipe Parallel Swivel to Male Pipe NPTF - 90° 62650 - FBSPPX-MJ Female British Standard Pipe Parallel Swivel to Male JIC 37° Flare 62660 - FBSPPX-FJX Female British Standard Pipe Parallel Swivel to Female JIC 37° Flare Swivel 62801 - FBFFOR-MJ Female British Flat-Face O-Ring to Male JIC 37° Flare
C14 COUPLINGS			
PCTS THERMOPLASTIC COUPLINGS			
POLARSEAL COUPLINGS			
POLARSEAL II COUPLINGS			
POWER STEERING			
ADAPTERS			
QUICK DISCONNECT COUPLERS			
BALL VALVES			
LIVE SWIVEL			
ASSEMBLY FABRICATION			
ACCESSORIES			
EQUIPMENT AND PARTS			
AIR BRAKE			
BRASS			
KITS			

Gates Global Part Numbering System - Continued

Adapters - Continued

63099	- MMOR-PLUG	Male Metric O-Ring Plug
63120	- MM-FP	Male Metric with O-Ring to Female Pipe NPTF
63150	- MM-MJ	Male Metric with O-Ring to Male JIC 37° Flare
63160	- MM-MJ90	Male Metric with O-Ring to Male JIC 37° Flare - 90°
63350	- MDL-MJ	Male DIN 24 Cone - Light Series to Male JIC 37° Flare
63450	- FDLX-MJ	Female DIN 24 Cone Swivel - Light Series to Male JIC 37° Flare
63650	- MDH-MJ	Male DIN 24 Cone - Heavy Series to Male JIC 37° Flare
63750	- FDHX-MJ	Female DIN 24 Cone Swivel - Heavy Series to Male JIC 37° Flare
63980	- MKB-PLUG	Male Kobelco Plug
63990	- MKB-MJ	Male Kobelco to Male JIC 37° Flare
64075	- BBDS	British Bonded Seal
64094	- MBSPQR-PLUG	Male British Standard Pipe Parallel with O-Ring Plug
64095	- O-RING FBSP	O-Rings for British Standard Parallel Pipe [BSPP Couplings]
64097	- FBSP-CAP	Female British Standard Pipe Parallel Cap
64098	- MBSP-PLUG	Male British Standard Pipe Tapered Thread Plug
64099	- MBSP-PLUG	Male British Standard Pipe Parallel Plug
64350	- MBSP-FBSPX	Male British Standard Pipe Parallel to Female British Standard Pipe Parallel Swivel
64775	- MBDS	Metric Bonded Seal
64780	- O-RING DIN L	O-Rings for DIN Light Series [MegaCrimp and GlobalSpiral Couplings]
64781	- O-RING DIN H	O-Rings for DIN Heavy Series [MegaCrimp and GlobalSpiral Couplings]
64790	- MM-PLUG	Male Metric Plug
64792	- MDL-PLUG	Male DIN 24 Cone - Light Series Plug
64793	- FDL-CAP	Female DIN 24 Cone - Light Series Cap
64794	- MDH-PLUG	Male DIN 24 Cone - Heavy Series Plug
64795	- FDH-CAP	Female DIN 24 Cone - Heavy Series Cap
65097	- FJIS-CAP	Female Japanese Industrial Standard Cap
65099	- MJIS-PLUG	Male Japanese Industrial Standard Plug
65100	- FJIS-MJ	Female Japanese Industrial Standard to Male JIC 37° Flare
65597	- FK-CAP	Female Komatsu Cap
65599	- MK-PLUG	Male Komatsu Plug
65600	- FK-MJ	Female Komatsu to Male JIC 37° Flare
65700	- MK-MK	Male Komatsu to Male Komatsu
65750	- MK-MJ	Male Komatsu to Male JIC 37° Flare
65800	- MK-FK90	Male Komatsu to Female Komatsu - 90°
65950	- MK-FK-MK	Male Komatsu to Female Komatsu to Male Komatsu - Tee

EQUIPMENT
HOSE/CPLG. SELECTION
G&K COUPLINGS
GLOBALSPIRAL COUPLINGS
STAINLESS STEEL SPIRAL
MEGACRIMP COUPLINGS
STAINLESS STEEL BRAID
POWER CRIMP COUPLINGS
FIELD ATTACHABLE G1 & G2 COUPLINGS
FIELD ATTACHABLE C5 COUPLINGS
GLX COUPLINGS
GL COUPLINGS
C14 COUPLINGS
PCTS THERMOPLASTIC COUPLINGS
POLARSEAL COUPLINGS
POLARSEAL II COUPLINGS
POWER STEERING
ADAPTERS
QUICK DISCONNECT COUPLERS
BALL VALVES
LIVE SWIVEL
ASSEMBLY FABRICATION
ACCESSORIES
EQUIPMENT AND PARTS
AIR BRAKE
BRASS
KITS

Gates Global Part Numbering System - Continued

Quick Disconnect Couplers

Gates Quick Disconnect couplers feature a meaningful part number that makes coupling identification fast and easy. Always refer to Gates Cross Reference Charts when selecting a quick disconnect coupler for a competitive interchange.

G94021-0808 D

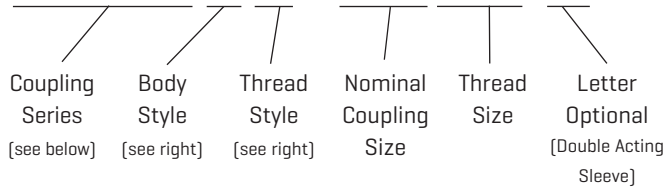

BODY STYLE IDENTIFICATION

- 0 Assembly
- 1 Male Tip (Nipple)
- 2 Female Coupler
- 3 Repair Kit
- 5 O-Ring
- 6 Backup Ring
- 8 Dust Plug
- 9 Dust Cap

THREAD STYLE

- 0 Not Applicable
- 1 Female Pipe
- 2 Female O-Ring Boss
- 3 Bulkhead Mounts
- 4 Female British Parallel Pipe

MISCELLANEOUS

- D Double-Acting Sleeve
- P Connect-Under-Pressure Option

COUPLING SERIES IDENTIFICATION

G940 Series (Agriculture Standard-Ball Valve)

- G94** - 011 MQBA-FP Male Ball Valve to Female Pipe
- G94** - 012 MQBA-FB Male Ball Valve to Female O-Ring Boss
- G94** - 021 FQBA-FP Female Ball Valve To Female Pipe
- G94** - 021 FQBADA-FP Female Ball Valve To Female Pipe
- G94** - 022 FQBA-FB Female Ball Valve To Female O-Ring Boss
- G94** - 025 QDAOR O-Ring

G940 and G941 Series (Agricultural)

- G94** - 081 QDADP/C QD Plug - Cap Combination

G941 Series (Agriculture Standard-Poppet Valve)

- G94** - 111 MQPA-FP Male Poppet Valve to Female Pipe
- G94** - 121 FQPA-FP Female Poppet Valve to Female Pipe

G942 Series (John Deere Old Style)

- G94** - 211 MQBAJD-FP Male Ball Valve to Female Pipe
- G94** - 212 MQBAJD-FB Male Ball Valve to Female O-Ring Boss
- G94** - 221 FQBAJD-FP Female Ball Valve to Female Pipe

G943 Series (International Harvester Old Style)

- G94** - 311 MQBAIHC-FP Male Tip - Ball Valve to Female Pipe

G944 Series (J.I. Case Old Style)

- G94** - 411 MQBAJIC-FP Male Tip - Ball Valve to Female Pipe

G945 Series (Industrial ISO 7241-1 - Series B)

- G94** - 511 MQPI-FP Male Poppet Valve to Female Pipe
- G94** - 521 FQPI-FP Female Poppet Valve to Female Pipe
- G94** - 525 QDIOR O-Ring
- G94** - 526 QDIBR Backup Ring
- G94** - 581 QDIDP/C QD Plug - Cap Combination

G949 Series (Flush Face - HTMA)

- G94** - 911 MQFF-FP Male Flush Face Valve to Female Pipe
- G94** - 912 MQFF-FB Male Flush Face Valve to Female O-Ring Boss
- G94** - 913 MQFF-BKHD Male Flush Face Valve to JIC 37 Flare Bulkhead
- G94** - 915 MQFF-FBPP Male Flush Face Valve to Female British Pipe Parallel
- G94** - 921 FQFF-FP Female Flush Face Valve to Female Pipe
- G94** - 922 FQFF-FB Female Flush Face Valve to Female O-Ring Boss

- G94** - 923 FQFF-BKHD Female Flush Face to JIC 37 Flare Bulkhead
- G94** - 925 FQFF-FBPP Female Flush Face Valve to Female British Pipe Parallel
- G94** - 981 QDFFDP/C Dust Plug/Cap Combination

G950 Series (Flush Face - High Pressure)

- G95** - 021 FQFFH-FP Female Flush Face Valve
- G95** - 011 MQFFH-FP Male Flush Face Valve
- G95** - 081 QDFFHDP/C QD Plug - Cap Combination

G951 Series (Wing Nut)

- G95** - 111 MQW-FP Male (Brass) - Less Flange
- G95** - 121 FQW-FP Female (Brass) - Wing Nut (Cast Iron)
- G95** - 180 QWDP Dust Plug
- G95** - 190 QWDC Dust Cap

G952 Series (High Pressure Wing Nut)

- G95** - 211 MQWH-FP Male Acme Flat Threads to Female Pipe
- G95** - 221 FQWH-FP Female Wing Nut to Female Pipe
- G95** - 280 QWHDP Dust Plug
- G95** - 290 QWHDC Dust Cap

G953 Series (Very High Pressure)

- G95** - 311 MQFFVH-FP Male Poppet Valve to Female Pipe
- G95** - 321 FQFFVH-FP Female Screw to Connect to Female Pipe

G956 Series (Industrial ISO 7241 - Series A)

- G95** - 611 MQP-FP Male Poppet Valve to Female Pipe
- G95** - 621 FQP-FP Female Poppet Valve to Female Pipe
- G95** - 625 QDOR O-Ring
- G95** - 626 QDBR Backup Ring
- G95** - 681 QDDP/C QD Plug - Cap Combination

G959 Series (Agriculture QD Adapters)

- G95** - 961 MJD-FISO John Deere Old Style to ISO Style
- G95** - 962 MISO-FJD ISO Style to John Deere Old Style
- G95** - 963 MIHC-FJD Int'l Harvester to John Deere Old Style
- G95** - 964 MIHC-FISO Int'l Harvester Old Style to ISO Style
- G95** - 965 MISO-FIHC ISO Style to Int'l Harvester Old Style
- G95** - 966 MISO-FJDDSO ISO Style to John Deere Old Style - (Double Shutoff)
- G95** - 967 MISO-FIHCDSO ISO Style to Int'l Harvester Old Style - (Double Shutoff)

Gates Global Part Numbering System - Continued

High Pressure Ball Valves

Gates Ball Valves feature a meaningful part number that makes coupling identification fast and easy.

G96210-0808

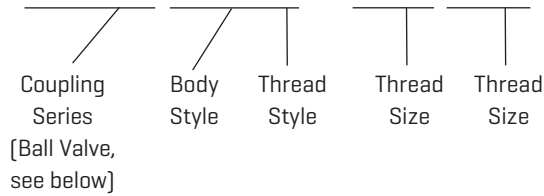

BODY AND THREAD IDENTIFICATION

110	FP-FPBV	Female Pipe NPTF
115	FB-FBBV	Female O-Ring Boss
120	FP-FPBV	Female Pipe NPTF
210	FP-FP-FPBV	Female Pipe NPTF
211	FP-FP-FPBV	Female Pipe NPTF
300	FL-FLBV	Code 61 O-Ring Flange
310	FL-FLBV	Code 61 O-Ring Flange
350	FLH-FLHBV	Code 62 O-Ring Flange
355	FLH-FLHBV	Code 62 O-Ring Flange

High Pressure Live Swivels

Gates Live Swivels feature a meaningful part number that makes coupling identification fast and easy.

G93510-0808

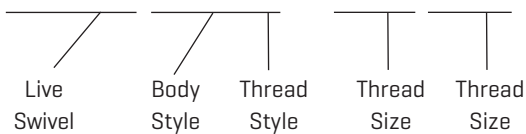

BODY AND THREAD IDENTIFICATION

345	BSPP-BSPP-LX	Male BSPP to Male BSPP
410	MJ-MJ-LX	Male JIC to Male JIC
450	MJ-FJ/FB-LX	Male JIC to Female Boss
500	JIC SWIVEL SEAL KIT	JIC Seal Kit
510	MJ-FP-LX	Male JIC to Female Pipe
600	ORS LIVE SWIVEL SEAL KIT	ORS Seal Kit
700	ORS/BSPP LIVE SWVL SEAL KIT	ORS/BSPP Seal Kit
724	MFFOR-FFORX-LX	Male ORFS to Female ORFS
742	MFFOR-MFFOR-LX	Male ORFS to Male ORFS

EQUIPMENT

HOSE/CPLG.
SELECTION

G8K COUPLINGS

GLOBAL SPIRAL
COUPLINGS

STAINLESS
STEEL SPIRAL

MEGACRIMP
COUPLINGS

STAINLESS
STEEL BRAID

POWER CRIMP
COUPLINGS

FIELD
ATTACHABLE G1
& G2 COUPLINGS

FIELD
ATTACHABLE C5
COUPLINGS

GLX COUPLINGS

GL COUPLINGS

C14 COUPLINGS

PCTS
THERMOPLASTIC
COUPLINGS

POLARSEAL
COUPLINGS

POLARSEAL II
COUPLINGS

POWER
STEERING

ADAPTERS

QUICK
DISCONNECT
COUPLERS

BALL VALVES

LIVE SWIVEL

ASSEMBLY
FABRICATION

ACCESSORIES

EQUIPMENT AND
PARTS

AIR BRAKE

BRASS

KITS

Coupling/Thread Configurations

GlobalSpiral™ (GS) Couplings

For EFG6K, EFG5K, EFG4K, EFG3K, and more Hose

EQUIPMENT
HOSE/CPLG. SELECTION
G8K COUPLINGS
GLOBALSPIRAL COUPLINGS
STAINLESS STEEL SPIRAL
MEGACRIMP COUPLINGS
STAINLESS STEEL BRAID
POWER CRIMP COUPLINGS
FIELD ATTACHABLE G1 & G2 COUPLINGS
FIELD ATTACHABLE C5 COUPLINGS
GLX COUPLINGS
GL COUPLINGS
C14 COUPLINGS
PCTS THERMOPLASTIC COUPLINGS
POLARSEAL COUPLINGS
POLARSEAL II COUPLINGS
POWER STEERING
ADAPTERS
QUICK DISCONNECT COUPLERS
BALL VALVES
LIVE SWIVEL
ASSEMBLY FABRICATION
ACCESSORIES
EQUIPMENT AND PARTS
AIR BRAKE
BRASS
KITS

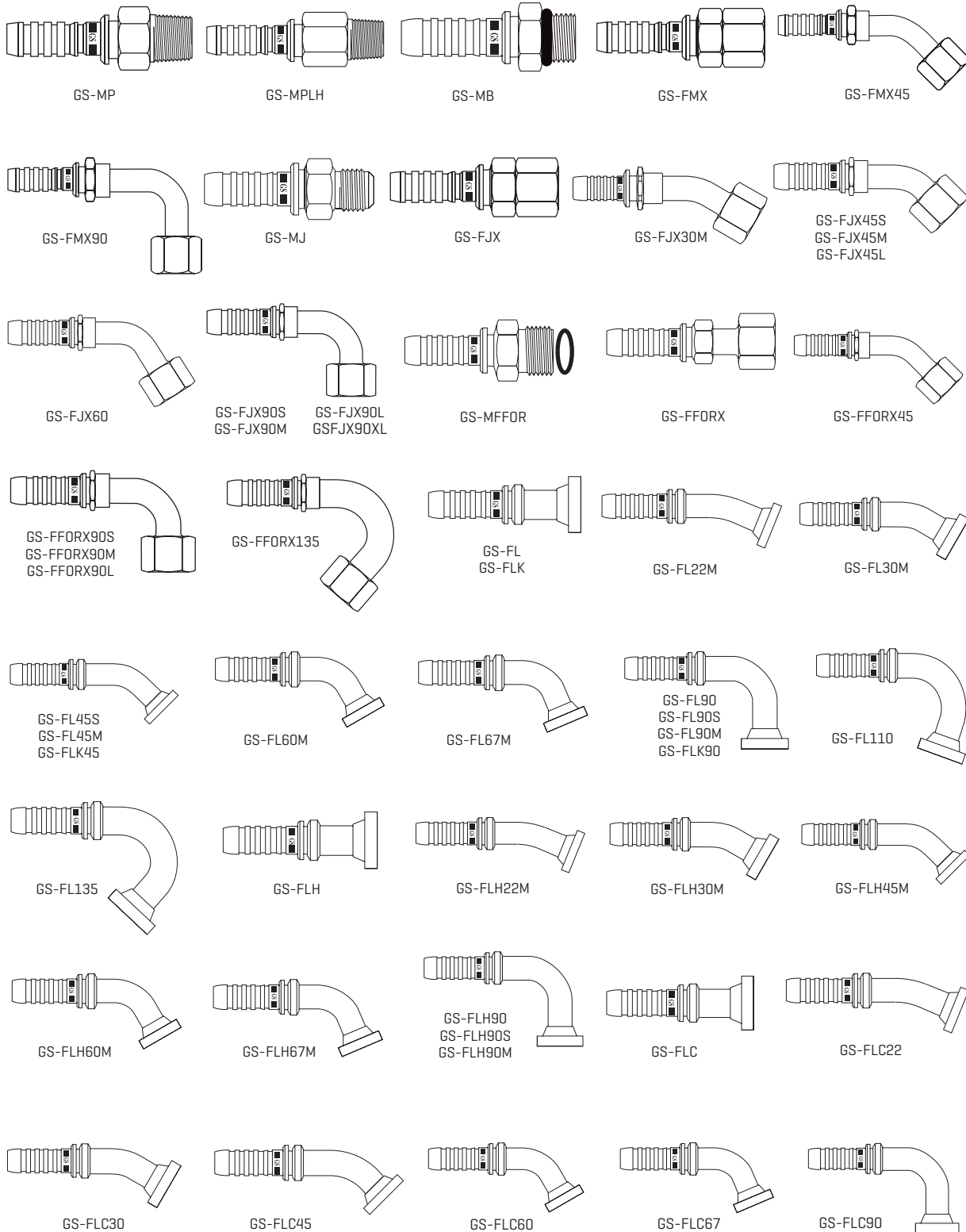

GlobalSpiral™ (GS) Couplings

For EFG6K, EFG5K, EFG4K, EFG3K and more Hose-Continued

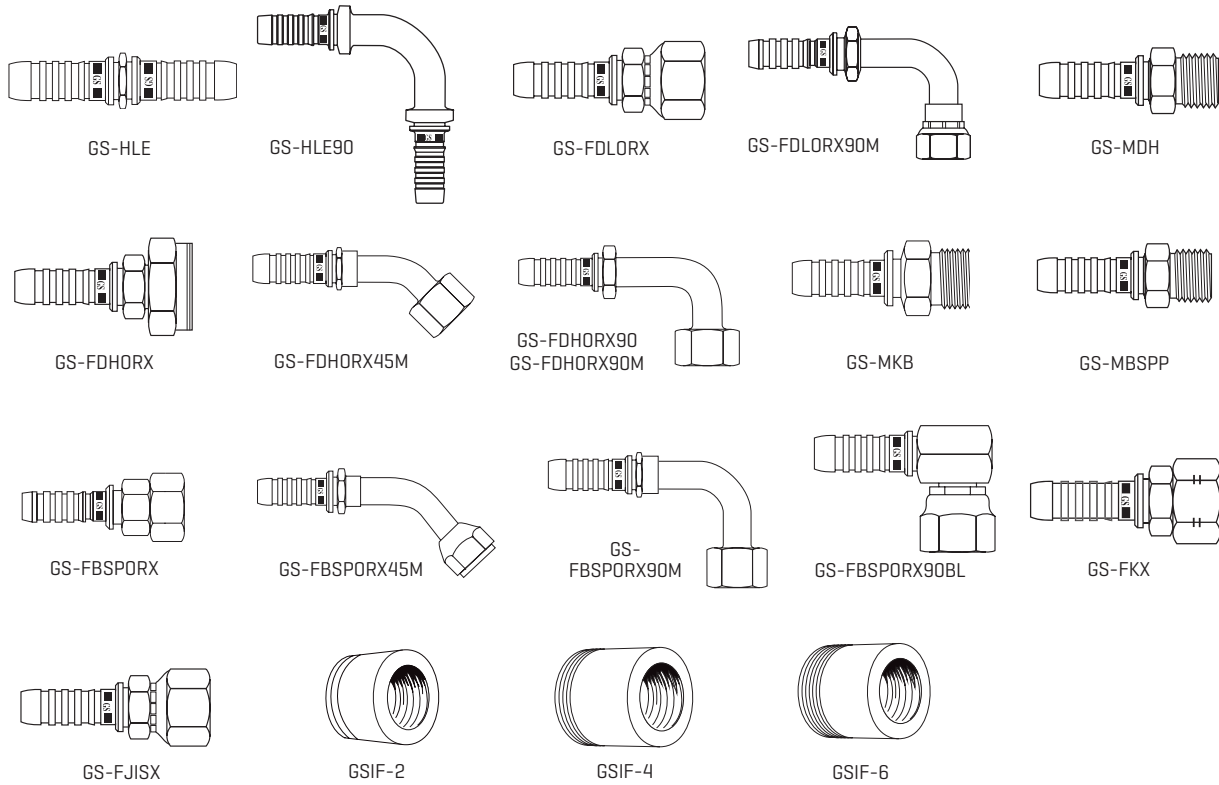

GlobalSpiral™ (GS) Couplings

One-Piece Couplings for Use with MobileCrimp® Crimpers for EFG6K, EFG5K, EFG4K, EFG3K and more Hose

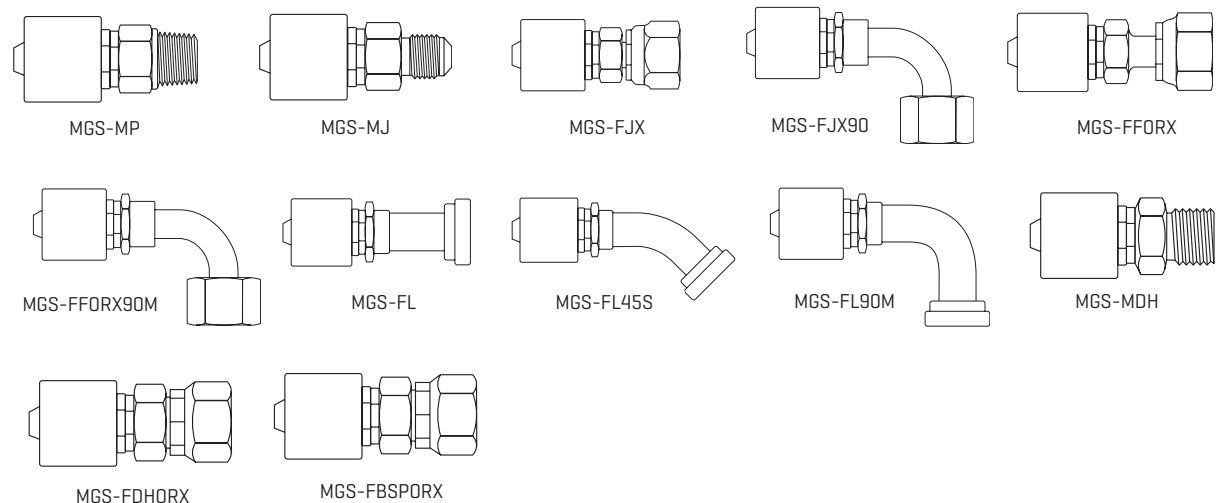

EQUIPMENT
HOSE/CPLG. SELECTION
G8K COUPLINGS
GLOBALSPIRAL COUPLINGS
STAINLESS STEEL SPIRAL
MEGACRIMP COUPLINGS
STAINLESS STEEL BRAID
POWER CRIMP COUPLINGS
FIELD ATTACHABLE G1 & G2 COUPLINGS
FIELD ATTACHABLE C5 COUPLINGS
GLX COUPLINGS
GL COUPLINGS
C14 COUPLINGS
PCTS THERMOPLASTIC COUPLINGS
POLARSEAL COUPLINGS
POLARSEAL II COUPLINGS
POWER STEERING
ADAPTERS
QUICK DISCONNECT COUPLERS
BALL VALVES
LIVE SWIVEL
ASSEMBLY FABRICATION
ACCESSORIES
EQUIPMENT AND PARTS
AIR BRAKE
BRASS
KITS

Coupling/Thread Configurations - Continued

MegaCrimp® Couplings

For High and Medium Pressure Hose

EQUIPMENT
HOSE/CPLG. SELECTION
G8K COUPLINGS
GLOBALSPIRAL COUPLINGS
STAINLESS STEEL SPIRAL
MEGACRIMP COUPLINGS
STAINLESS STEEL BRAID
POWER CRIMP COUPLINGS
FIELD ATTACHABLE G1 & G2 COUPLINGS
FIELD ATTACHABLE C5 COUPLINGS
GLX COUPLINGS
GL COUPLINGS
C14 COUPLINGS
PCTS THERMOPLASTIC COUPLINGS
POLARSEAL COUPLINGS
POLARSEAL II COUPLINGS
POWER STEERING
ADAPTERS
QUICK DISCONNECT COUPLERS
BALL VALVES
LIVE SWIVEL
ASSEMBLY FABRICATION
ACCESSORIES
EQUIPMENT AND PARTS
AIR BRAKE
BRASS
KITS

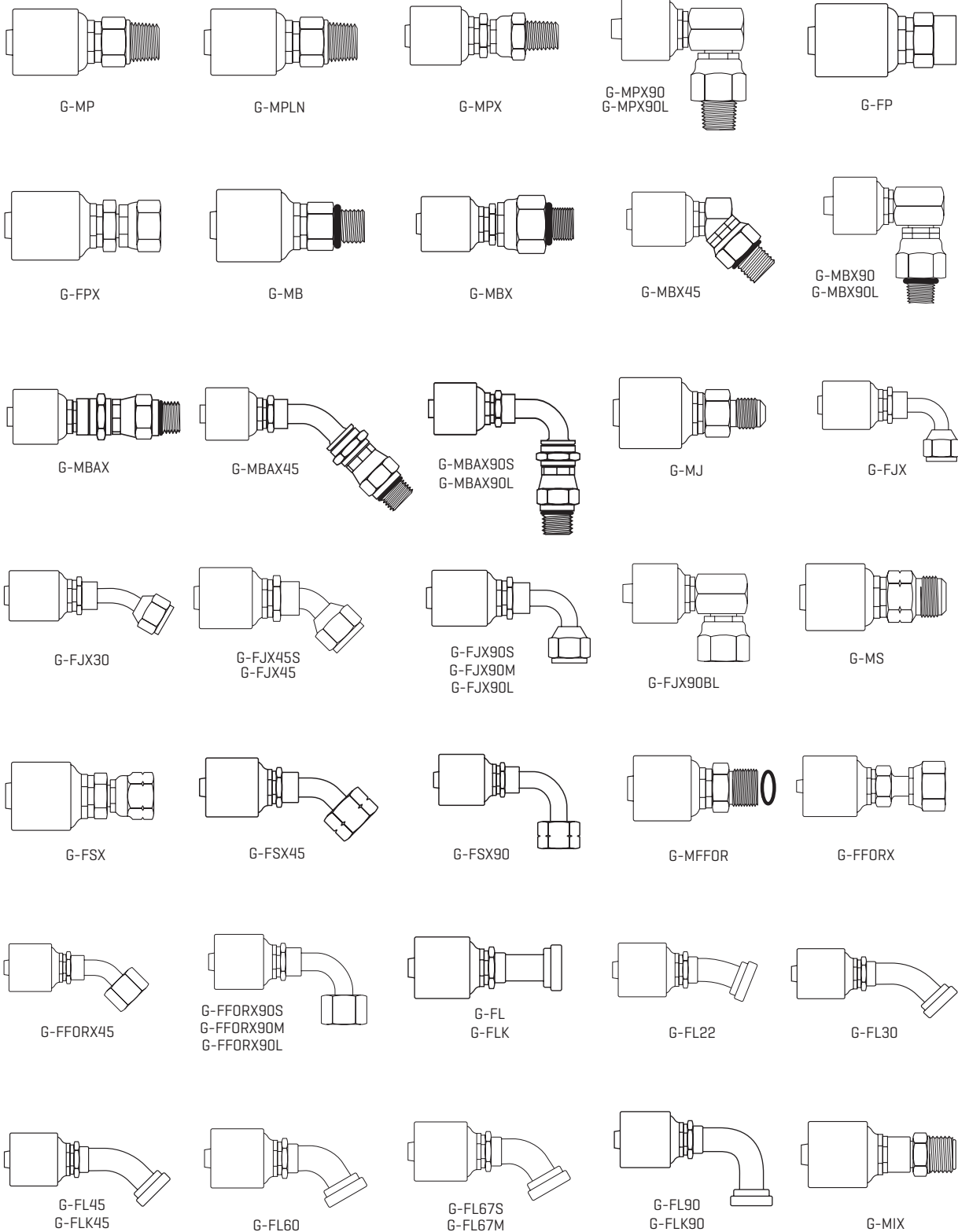

MegaCrimp® Couplings - Continued

For High And Medium Pressure Hose-Continued

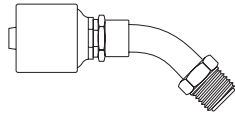

G-MIX45

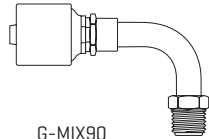

G-MIX90

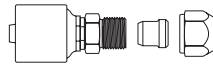

G-MFA

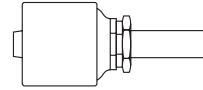

G-NASP

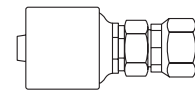

G-FABX

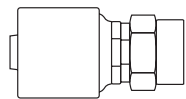

G-FG

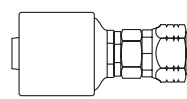

G-FZX

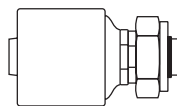

G-PWX

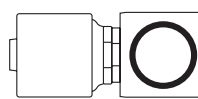

G-BJ

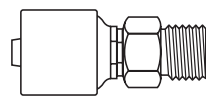

G-MDL

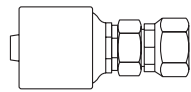

G-FDLORX

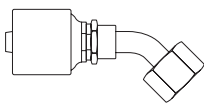

G-FDLORX45

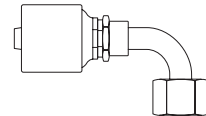

G-FDLORX90

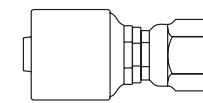

G-FFGX

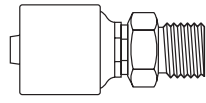

G-MDH

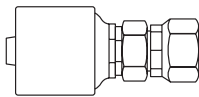

G-FDHORX

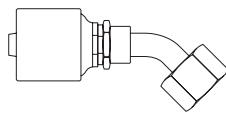

G-FDHORX45

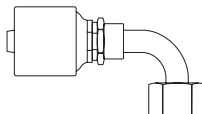

G-FDHORX90

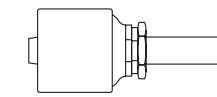

G-MLSP

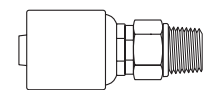

G-MBSPT

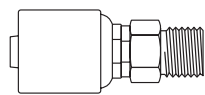

G-MBSPP

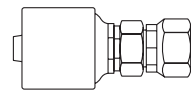

G-FBSPORX

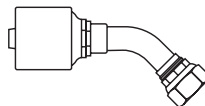

G-FBSPORX45

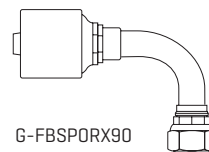

G-FBSPORX90

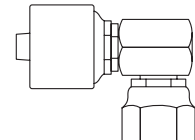

G-FBSPORX90BL

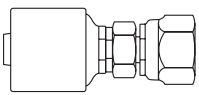

G-FBFFX

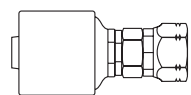

G-FKX

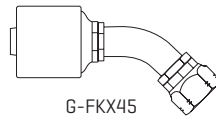

G-FKX45
G-FKX45M

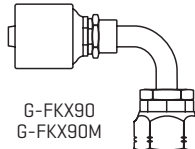

G-FKX90
G-FKX90M

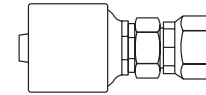

G-FJISX

EQUIPMENT

HOSE/CPLG.
SELECTION

G8K COUPLINGS

GLOBALSPIRAL
COUPLINGS

STAINLESS
STEEL SPIRAL

MEGACRIMP
COUPLINGS

STAINLESS
STEEL BRAID

POWER CRIMP
COUPLINGS

FIELD
ATTACHABLE G1
& G2 COUPLINGS

FIELD
ATTACHABLE C5
COUPLINGS

GLX COUPLINGS

GL COUPLINGS

C14 COUPLINGS

PCTS
THERMOPLASTIC
COUPLINGS

POLARSEAL
COUPLINGS

POLARSEAL II
COUPLINGS

POWER
STEERING

ADAPTERS

QUICK
DISCONNECT
COUPLERS

BALL VALVES

LIVE SWIVEL

ASSEMBLY
FABRICATION

ACCESSORIES

EQUIPMENT AND
PARTS

AIR BRAKE

BRASS

KITS

Chemical Resistance Ratings

EQUIPMENT
HOSE/CPLG. SELECTION
G8K COUPLINGS
GLOBALSPIRAL COUPLINGS
STAINLESS STEEL SPIRAL
MEGACRIMP COUPLINGS
STAINLESS STEEL BRAID
POWER CRIMP COUPLINGS
FIELD ATTACHABLE G1 & G2 COUPLINGS
FIELD ATTACHABLE C5 COUPLINGS
GLX COUPLINGS
GL COUPLINGS
C14 COUPLINGS
PCTS THERMOPLASTIC COUPLINGS
POLARSEAL COUPLINGS
POLARSEAL II COUPLINGS
POWER STEERING
ADAPTERS
QUICK DISCONNECT COUPLERS
BALL VALVES
LIVE SWIVEL
ASSEMBLY FABRICATION
ACCESSORIES
EQUIPMENT AND PARTS
AIR BRAKE
BRASS
KITS

CHEMICAL RESISTANCE RATINGS FOR GATES HOSE POLYMERS, COUPLINGS AND ADAPTER MATERIALS

The Chemical Resistance Table lists the relative resistance of hose and coupling materials to more common chemicals. These ratings do not cover all possible variations of all factors, such as temperature, concentration, degradation or fluid contamination, etc. Testing under actual conditions is the best way to ensure chemical compatibility for critical applications.

For specific information, contact Gates Hose/Connector Product Application, Denver, Colorado 303-744-5070.

Rating Scale

“1” Excellent resistance

“2” Good resistance

“X” Not recommended

“—” Testing recommended

HOW TO USE THE CHEMICAL RESISTANCE TABLE

1. Chemicals are listed alphabetically.
2. Find the hose, coupling and adapter material type that has a resistance rating of “1” or “2” [See Rating Scale].
3. Find hose with compatible polymer[s] in the Gates Hydraulic Hose Selection Guide.
4. Look for compatible couplings for the selected hose by following the hose page references in the Selection Guide.

NOTE: O-rings used with couplings also must be considered for chemical compatibility with the fluid to be conveyed. This includes couplings containing internal O-rings; for example, MPX [Male Pipe Swivel]. Gates standard O-ring is made of Nitrile. If O-rings other than Nitrile are required, contact Gates Hose/Connector Product Application.

Chemical Resistance Table

Rating Scale: 1 Excellent 2 Good resistance X Not recommended - Testing recommended	Gates Hose Polymers							Couplings & Adapters					
	Trade Names							Carbon Steel	Stainless Steel 304	Stainless Steel 316	Aluminum	Brass	
	A	C	C _e	J	M	T	Z						
	Neoprene	Nitrile	Nitrile/PVC	CPE	CSM	Urethane <small>(lower rating only)</small>	PTFE	Nylon					
	Chemical Name												
A													
Absorption Oil	2	1	2	1	2	-	1	1	-	-	-	-	1
Acetaldehyde	X	X	X	-	X	1	1	2	1	1	1	1	1
Acetamide	1	2	-	-	X	1	-	-	-	-	-	-	-
Acetic Acid, 5-20%	2	X	2	1	2	X	1	1	X	2	2	2	X
Acetic Acid, 25%	2	X	2	1	2	-	1	X	X	2	2	2	X
Acetic Acid, 30%	2	X	-	1	-	-	1	2	X	2	1	2	X
Acetic Acid, 50%	2	X	2	1	-	-	1	2	X	2	2	2	X
Acetic Acid, 50% Boiling	X	X	-	-	-	-	1	X	X	X	2	-	-
Acetic Acid, 80%	X	X	-	-	-	-	1	X	X	2	2	2	X
Acetic Acid, 80% Boiling	X	X	-	-	-	-	1	X	X	X	2	X	X
Acetic Acid, 100%	X	X	-	-	-	-	1	X	X	X	2	2	X
Acetic Acid, 100% Boiling	X	X	-	-	-	X	1	X	X	X	2	-	X
Acetic Acid, 100% [Hot] Vapors	2	2	-	-	-	-	-	X	X	X	2	X	X
Acetic Acid, Air Free	-	-	-	-	-	-	1	-	X	X	X	-	X
Acetic Acid, Anhydride	X	X	X	1	2	-	1	X	X	2	2	2	X
Acetic Acid, Areated	-	-	-	-	-	-	1	-	X	X	X	-	X
Acetic Acid, Crude	X	X	-	-	-	-	1	X	X	2	1	2	X
Acetic Acid, Glacial	X	X	X	1	X	X	1	X	X	2	2	2	-
Acetone [Dimethylketone]	X	X	X	1	X	X	1	1	1	1	1	1	1
Acetonitrile [Methyl Cyanide]	2	X	2	1	2	-	-	-	-	-	-	-	-
Acetylene	2	2	1	1	-	-	1	1	1	1	1	1	2
Acrylonitrile [Vinyl Cyanide]	X	X	X	1	X	-	-	-	1	1	1	2	1
Aero Lubriplate	1	1	-	-	-	-	-	-	1	1	1	1	-
Aero-Safe 2300	X	X	-	-	X	-	-	-	1	1	1	1	1
Aeroshell Type 1A, 1AC, 4	2	1	-	-	1	-	-	-	-	-	-	-	-
Aeroshell 7AGrease	2	1	-	-	X	-	-	-	1	1	1	1	-
Aeroshell 17 Grease	2	1	-	-	X	-	-	-	1	1	1	1	-
Aeroshell 750	X	2	-	-	X	-	-	-	1	1	1	1	-
Air, Ambient	1	1	1	1	1	1	1	1	1	1	1	1	1
Air, 150°F	1	1	1	1	1	1	1	1	1	1	1	1	1
Air, 180°F	2	2	2	1	2	2	1	1	1	1	1	1	1
Air, 200°F	X	X	X	1	X	2	1	2	1	1	1	1	1
Aircraft Hyd. Oil AA	-	1	-	-	-	-	-	-	1	1	1	1	1
Alcohol	1	1	-	-	-	-	1	-	1	1	1	1	1
Alcohol, Amyl	2	2	-	-	-	-	1	1	-	2	1	2	-
Alcohol, Benzyl	X	X	-	1	2	2	1	-	1	1	1	-	-
Alcohol, Butyl	2	X	2	-	2	1	1	-	1	1	1	1	1
Alcohol, Denatured	1	1	-	-	1	-	1	-	1	1	1	1	1
Alcohol, Diacetone	-	X	-	-	2	-	1	-	1	1	1	1	1
Alcohol, Ethyl [Ethanol]	1	1	1	1	1	2	1	1	1	1	1	1	2
Alcohol, Furfural	2	X	X	1	2	-	1	-	2	1	1	1	1
Alcohol, Hexyl [Hexanol]	2	1	-	-	X	-	1	-	1	1	1	1	2
Alcohol, Isobutyl	2	2	-	-	1	-	1	-	1	1	1	1	2
Alcohol, Isopropyl [Isopropanol]	2	2	2	-	2	2	1	-	1	1	1	1	2
Alcohol, Methyl [100%] [Methanol]	1	1	1	1	1	-	1	-	1	1	1	1	2
Alcohol, Methyl [6%]	1	1	1	-	1	-	1	-	1	1	1	1	2
Alcohol, Octyl	2	2	-	-	-	-	1	-	1	1	1	1	-
Alcohol, Propyl	1	1	-	-	-	-	1	X	2	1	1	1	1
Alkazene	X	X	X	-	X	X	-	-	1	1	-	-	-
Aluminum Chloride	1	1	1	1	1	2	1	X	X	2	2	X	X
Aluminum Fluoride	1	1	1	1	1	2	1	X	X	2	2	X	X
Aluminum Hydroxide	1	1	1	1	1	-	1	-	-	1	1	-	1
Aluminum Hydroxide, Saturated	1	1	-	-	-	-	1	-	1	1	-	-	-
Aluminum Nitrate	1	1	1	1	1	2	1	-	X	1	1	2	-
Aluminum Sulfate	1	1	1	1	1	X	1	1	X	X	2	X	X
Alums [Ammonium or Potassium]	1	1	1	1	1	-	1	-	X	2	2	X	X
Ammonia, Aqueous	1	2	1	-	1	-	1	1	-	1	1	-	X
Ammonium Carbonate	2	X	-	-	-	-	-	-	1	1	1	-	-
Ammonium Chloride, 1%	X	2	1	1	1	1	1	X	X	2	2	X	X
Ammonium Chloride, 10% Boiling	X	X	-	-	-	-	1	X	X	2	2	X	X
Ammonium Chloride, 28% Boiling	X	X	-	-	-	-	1	X	X	2	2	X	X
Ammonium Chloride, 50% Boiling	X	X	-	-	-	-	1	X	X	2	2	X	X
Ammonium Hydroxide	2	2	2	1	1	X	1	1	2	1	1	-	X

Rating Scale: 1 Excellent 2 Good resistance X Not recommended - Testing recommended	Gates Hose Polymers							Couplings & Adapters						
	Trade Names							Carbon Steel	Stainless Steel 304	Stainless Steel 316	Aluminum	Brass		
	A	C	C _e	J	M	T	Z							
	Neoprene	Nitrile	Nitrile/PVC	CPE	CSM	Urethane <small>(lower rating only)</small>	PTFE	Nylon						
	Chemical Name													
A														
Ammonium Hydroxide, 3 Molar	1	X	-	-	-	-	2	1	-	X	2	2	X	X
Ammonium Hydroxide, Concentrated	1	X	-	1	-	X	1	1	1	X	2	2	X	X
Ammonium Metaphosphate	2	2	2	-	2	-	1	-	-	1	1	1	X	-
Ammonium Nitrate, Fertilizer	1	2	1	1	1	1	1	X	1	1	1	2	X	-
Ammonium Nitrite	1	1	-	-	-	-	-	1	-	2	1	1	X	-
Ammonium Persulfate	X	X	X	1	-	X	-	X	X	2	2	X	X	X
Ammonium Persulfate, 5%	1	X	-	-	-	-	-	X	X	2	2	X	X	X
Ammonium Persulfate, 10%	1	X	-	-	-	X	-	X	X	2	2	X	X	X
Ammonium Phosphate [Mono, Di, Tri, Basic]	1	1	1	1	1	1	1	2	X	2	2	X	-	-
Ammonium Sulfate	1	2	1	1	1	1	1	X	X	X	2	X	X	X
Ammonium Thiocyanate	1	1	-	1	1	-	1	-	1	1	1	-	-	-
Amyl Acetate	X	X	X	2	X	2	1	X	1	1	X	2	-	-
Amyl Alcohol	2	2	2	1	-	-	1	1	1	1	1	1	1	1
Amyl Borate	2	2	2	-	-	-	-	-	-	-	-	-	-	-
Amyl Chloride	X	-	X	2	X	-	1	2	-	1	1	-	-	-
Amyl Chloronaphthalene	X	X	X	-	X	-	1	-	-	1	1	-	-	-
Amyl Naphthalene	X	X	X	-	X	-	1	-	-	1	1	-	-	-
Amyl Phenol	-	-	-	-	-	-	1	-	-	1	1	-	-	-
AN-0-3 Grade M	1	1	-	-	-	-	-	-	-	-	-	-	-	-
AN-0-6	1	1	-	-	-	-	-	-	-	-	-	-	-	-
AN-0-366	1	1	-	-	-	-	-	-	-	-	-	-	-	-
Anderol, L-774 [Diester]	X	2	-	-	-	-	1	X	-	-	-	-	-	-
Anderol, L-826 [Diester]	X	2	-	-	-	-	1	X	-	-	-	-	-	-
Anderol, L-829 [Diester]	X	2	-	-	-	-	1	X	-	-	-	-	-	-
ANG-25 [Glycerol Ester]	2	2	-	-	-	-	1	2	-	-	-	-	-	-
ANG-25 [Diester Base, TG749]	X	2	-	-	-	-	1	X	1	1	1	1	-	-
Aniline	X	X	X	2	X	X	1	2	2	1	1	X	X	X
Aniline Dyes	X	X	-	2	-	-	1	X	2	1	1	2	X	X
Aniline Hydrochloride	X	X	-	2	-	-	1	-	X	1	1	-	-	-
Animal Gelatin	1	1	-	1	-	-	1	-	-	1	1	-	-	-
Animal Fats	2	1	-	1	-	-	1	1	1	1	1	1	X	-
Animal Oil [Lard Oil]	2	1	-	1	-	-	1	-	1	1	1	1	-	-
Antifreeze, Alcohol Base	2	2	2	2	2	-	1	-	1	1	1	1	-	-
Antifreeze, Glycol Base	2	1	1	1	1	-	1	1	1	1	1	1	1	1
Antimony Chloride, 50%	-	1	-	-	-	-	1	X	X	X	X	-	-	-
AN-VV-0-366B Hydraulic Fluid	1	-	-	-	-	-	2	-	-	-	-	-	-	-
Aqua Regia [Concentrated]	X	X	X	2	X	X	1	X	X	X	X	X	-	-
Arco A.T.F. Dexron	-	1	-	-	-	-	-	-	-	-	-	-	-	-
Arco C2, 100	-	1	-	-	-	-	-	-	-	-	-	-	-	-
Aromatic Fuel 30%, Mil.	-	-	-	-	-	-	1	-	-	-	-	-	-	-
Aromatic Fuel 50%	X	2	-	-	-	-	1	-	-	-	-	-	-	-
Aromatic Hydrocarbons	X	X	-	-	X	2	1	-	2	1	2	2	2	2
Arsenic Acid	-	-	-	1	-	-	1	-	2	-	1	2	-	-
Askarel, Transformer Oil	X	X	X	-	X	-	1	-	-	1	1	1	-	1
Asphalt, Under 180°F	2	2	2	X	X	1	1	-	1	1	1	-	2	-
Asphalt, Cut Back	X	2	2	-	X	1	1	1	1	1	1	2	2	-
Asphalt, Topping	1	X	-	-	-	-	1	-	-	1	1	-	-	-
ASTM Oil No.	1	1	1	1	1	2	1	1	1	1	1	1	1	1
ASTM Oil No.	2	2	1	-	2	-	1	1	1	1	1	1	1	1
ASTM Oil No. 3	X	1	X	X	X	-	1	1	1	1	1	1	1	1
ASTM Oil No. 4	X	2	-	-	-	-	1	-	-	1	1	1	-	-
ASTM Reference Fuel A	2	1	1	1	1	-	1	1	1	1	1	1	1	1
ASTM Reference Fuel B	2	1	2	2	X	-	1	-	1	1	1	1	1	1
ASTM Reference Fuel C	X	2	X	2	X	-	1	-	1	1	1	1	-	-
ATL-857	X	2	-	-	-	-	-	-	-	-	-	-	-	-
Atlantic Dominion F	2	1	-	-	-	-	-	-	-	-	-	-	-	-
Automatic Transmission Fluid - ATF	2	1	-	1	-	-	1	-	1	1	1	1	-	-
Aviation Gasoline, Mil.	-	2	-	-	-	-	-	-	1	1	1	1	-	-
B														
Baltic Types 100, 150, 200, 300, 500	-	1	-	-	-	-	1	-	-	-	-	-	-	-
Banvel, Concentrated [Ag Spray]	-	-	-	-	-	-	1	1	-	-	1	-	-	-
Bardol B	X	X	X	-	X	-	1	-	-	1	1	1	-	-
Barium Carbonate	1	1	1	1	1	1	-	1	1	2	1	1	X	1

Chemical Resistance Table – Continued

EQUIPMENT	HOSE/CPLG. SELECTION											HOSE/CPLG. SELECTION																								
	Rating Scale:		Gates Hose Polymers								Couplings & Adapters					Rating Scale:		Gates Hose Polymers								Couplings & Adapters										
	1 Excellent		Trade Names													2 Good resistance		Trade Names																		
	2 Good resistance															Rating Scale:															2 Good resistance		Rating Scale:			
	X Not recommended		A C C ₂ J M T Z		X Not recommended		A C C ₂ J M T Z		X Not recommended		A C C ₂ J M T Z		X Not recommended		A C C ₂ J M T Z		X Not recommended		A C C ₂ J M T Z		X Not recommended		A C C ₂ J M T Z													
- Testing recommended		Neoprene		Nitrile		Nitrile/PVC		CPE		CSM		Urethane <small>(lower rating only)</small>		PTFE		Nylon		Carbon Steel		Stainless Steel 304		Stainless Steel 316			Aluminum		Brass									
		Chemical Name		Neoprene		Nitrile		Nitrile/PVC		CPE		CSM		Urethane <small>(lower rating only)</small>		PTFE		Nylon		Carbon Steel		Stainless Steel 304		Stainless Steel 316			Aluminum		Brass							
			Barium Chloride	X	1	1	1	1	1	1	1	1	1	1	1	1	1	X	2	2	X	2		2												
			Barium Chloride, 5%	X	1	-	-	-	-	-	-	-	-	-	-	-	-	2	1	1	X	-														
			Barium Chloride, Aqueous Solution (Hot)	X	1	-	-	-	-	-	-	-	-	1	X			2	2	2	X	-														
			Barium Hydroxide	1	1	1	1	1	1	X	1	1	1	1	1	1	1	X	1	1	X	X														
			Barium Sulfate	1	1	-	1	2	-	1	1	1	1	1	1	1	1	2	1	1	2	2														
			Barium Sulfate, Aqueous Solution (Hot)	X	-	-	-	-	-	-	-	-	-	1	X			2	1	1	2	-														
			Barium Sulfide	2	1	1	1	1	1	-	1	2	1	2	1	2	1	X	1	1	X	X														
			Bayol D	-	1	-	-	-	-	-	-	-	-	-	-	-	-	-	-	-	-	-														
			Bayol 35	-	1	-	-	-	-	-	-	-	-	-	-	-	-	-	-	-	-	-														
			Beet Sugar Liquors	X	1	1	1	1	X	1	-	-	-	2	2	2	2	X	-																	
			Bellows 80-20 Hydraulic Oil	-	1	-	-	-	2	1	-	-	-	-	-	-	-	-	-	-	-	-														
			Benzaldehyde	X	X	X	2	X	1	1	1	1	1	1	1	1	1	1	1	1	1	1														
			Benzene, Benzol	X	X	X	X	X	2	1	1	1	1	1	1	1	1	1	1	1	1	1														
			Benzene Sulfonic Acid	X	-	-	-	-	1	-	-	-	-	X	-	2	X	-																		
			Benzine, Petroleum Ether	X	2	X	1	-	2	1	-	-	-	1	1	1	1	1	1	1	1	1														
			Benzoic Acid 21°C [70°F]	X	X	X	1	-	1	-	-	-	-	1	1	1	1	1	1	1	1	1														
			Benzol	X	X	X	X	-	-	1	1	1	1	1	1	1	1	1	1	1	1	1														
			Benzyl Alcohol	X	X	-	1	-	1	X	1	1	1	1	1	1	1	1	1	1	1	1														
			Benzyl Benzoate	-	-	-	-	-	1	-	-	-	-	1	1	1	1	-	-	-	-	-														
			Benzyl Chloride	X	X	X	X	-	-	1	2	1	-	-	-	-	-	1	-	-	-															
			Biodiesel**	-	-	-	-	-	1	1	-	-	-	1	1	1	-	-	-	-	-															
			Bismuth Carbonate	X	-	-	-	-	1	-	-	-	-	1	1	1	-	1	1	1	-															
			Black Point 77	-	1	-	-	-	-	-	-	-	-	-	-	-	-	-	-	-	-															
			Black Sulfate Liquor	2	2	2	2	2	-	1	1	1	1	1	1	1	1	1	1	1	1															
			Blast Furnace Gas	X	X	X	-	X	X	1	-	-	-	1	1	1	2	1	1	1	2	1														
			Borax, Sodium Borate	X	2	1	1	1	1	1	X	2	1	1	1	X	2	1	1	1	1	1														
			Bordeaux Mixture	2	2	2	-	-	1	1	1	1	1	1	1	1	1	X	-	1	1	X														
			Boric Acid	1	1	1	-	1	1	1	X	X	2	2	1	X	1	2	2	1	X	1														
			Boron Fuels, HEF	X	X	-	-	-	-	-	-	-	-	-	-	-	-	-	-	-	-	-														
			Brake Fluid, Petroleum Base	2	1	2	1	X	-	1	-	-	-	1	1	1	-	1	1	1	-															
			Brake Fluid, Synthetic Base	X	X	X	1	X	-	1	1	1	1	1	1	1	1	1	1	1	1	1														
			Bray GG - 130	X	2	-	-	-	-	-	-	-	-	-	-	-	-	-	-	-	-															
			Brayco 719-r [VV-H-910]	2	X	-	-	-	-	-	-	-	-	-	-	-	-	-	-	-	-	-														
			Brayco 885 [MIL-L-6085A]	X	2	-	-	-	-	-	-	-	-	-	-	-	-	-	-	-	-	-														
			Brayco 910	2	2	-	-	-	-	-	-	-	-	-	-	-	-	-	-	-	-	-														
			Brine	1	1	1	1	-	1	1	1	2	1	1	1	2	1	2	1	1	2	2														
			Brom-113	X	2	-	-	-	-	-	-	-	-	-	-	-	-	-	-	-	-															
			Brom-114	2	2	-	-	-	-	-	-	-	-	-	-	-	-	-	-	-	-															
			Bromine, Dry	X	X	X	-	-	X	-	-	-	-	X	X	X	-	X	X	X	-															
			Bunker Oil	X	2	2	-	X	2	1	1	1	1	1	1	1	1	1	1	1	1															
			Butadiene	X	2	-	-	-	1	1	-	-	-	-	1	1	-	1	1	-	1															
			Butane	X	X	X	-	X	X	1	X	1	1	1	1	1	1	1	1	1	1															
			Butter Oil	2	-	-	-	-	1	-	-	-	-	-	1	1	1	1	1	1	1															
			Butyric Acid	X	-	-	1	-	-	1	X	X	1	1	-	2	1	1	-	2																
			Butyl Acetate	X	X	X	2	X	-	1	-	-	-	2	1	1	1	1	1	1	1															
			Butyl Alcohol	1	1	1	1	-	-	1	1	1	1	1	1	1	1	1	1	1	1															
			Butyl Amine	-	-	-	-	-	-	1	1	1	1	1	1	1	1	1	1	1	1															
			Butyl Carbitol	2	2	-	1	-	-	1	-	-	-	1	1	1	1	1	1	1	1															
			Butyl Mercaptan	-	-	-	-	-	1	-	-	-	-	-	1	1	1	-	-	-	-															
			Butyl Stearate	X	2	2	2	-	-	1	-	-	-	1	1	1	1	1	1	1	1															
			Butyraldehyde	X	X	-	2	-	-	1	-	-	-	-	-	-	-	-	-	-	-															
			C																																	
			Calcium																																	

Chemical Resistance Table - Continued

Rating Scale: 1 Excellent 2 Good resistance X Not recommended - Testing recommended	Gates Hose Polymers							Couplings & Adapters					
	Trade Names												
	A	C	C _o	J	M	T	Z	Carbon Steel	Stainless Steel 304	Stainless Steel 316	Aluminum	Brass	
	Neoprene	Nitrile	Nitrile/PVC	CPE	CSM	Urethane <small>(cover rating only)</small>	PTFE	Nylon	Carbon Steel	Stainless Steel 304	Stainless Steel 316	Aluminum	Brass
	Chemical Name	Neoprene	Nitrile	Nitrile/PVC	CPE	CSM	Urethane <small>(cover rating only)</small>	PTFE	Nylon	Carbon Steel	Stainless Steel 304	Stainless Steel 316	Aluminum
Citric Acid, 15% Boiling	1	2	-	-	-	1	X	X	2	1	X	X	
Citric Acid, Concentrated Boiling	1	X	1	-	1	2	1	X	X	X	1	X	X
Coal Gas	1	X	-	1	1	1	-	-	-	-	-	-	-
Coal Tars	X	2	X	2	2	-	1	X	1	1	1	1	1
Cod Liver Oil	1	1	1	-	-	1	-	-	1	1	1	1	1
Coke Oven Gas (Under 100°F)	X	2	X	-	2	-	1	-	1	1	1	1	1
Condor 1000,1002,1004,1006,1008	-	2	-	-	-	-	-	-	-	-	-	-	-
Condor 1008,1010,1012,1014,1016	-	2	-	-	-	-	-	-	-	-	-	-	-
Convelex 10	X	X	-	-	-	-	-	-	-	-	-	-	-
Copper Arsenate, Cupric Arsenate	-	-	-	2	-	1	-	1	1	1	-	-	-
Copper Chloride, 1%	1	1	-	-	-	1	X	X	X	1	-	X	
Copper Chloride, 5%	1	1	-	-	-	1	X	X	X	1	-	-	-
Copper Chloride, Cupric Chloride	2	2	2	2	2	1	1	2	X	X	1	-	X
Copper Cyanide, Cupric Cyanide	2	2	2	-	2	-	1	X	1	1	1	-	X
Copper Nitrate, 1% & 5%	1	1	-	-	-	-	1	1	X	1	X	X	
Copper Nitrate, Cupric Nitrate	1	1	1	1	1	-	1	-	1	1	1	-	-
Copper Sulfate, Cupric Sulfate	1	1	1	1	1	1	1	1	X	1	1	X	X
Copper Sulfate, 10%	1	1	-	-	-	1	-	X	2	2	X	-	-
Copper Sulfate, 50%	1	1	-	-	-	1	-	-	2	2	-	-	-
Corn Oil	X	2	2	2	X	X	1	-	1	1	1	-	1
Corn Syrup	2	2	-	2	-	-	1	-	1	1	1	1	-
Cottonseed Oil	2	2	1	2	2	X	1	2	1	1	1	1	1
Creosote, Wood Or Coal Tar (Under 100°F)	X	2	X	-	X	X	1	X	2	1	1	1	X
Cresol, Cresylic Acid (Under 100°F)	X	X	X	1	X	-	1	X	2	1	1	2	-
Cresylic Acid	X	X	-	-	-	1	X	1	1	1	1	-	-
Crude Petroleum Oil (Under 100°F)	X	X	2	2	2	2	1	-	X	X	2	1	-
Cutting Oil, Water Soluble	X	1	-	-	-	1	-	1	1	1	1	1	-
Cutting Oil, Sulfur Base	X	1	-	-	-	1	-	1	1	1	1	1	-
Cutting Oil	2	1	2	1	X	-	1	-	1	1	1	1	1
Cyclohexane	X	2	-	1	X	1	1	1	1	1	1	1	1
Cyclohexanone	X	X	X	2	X	1	1	1	-	1	1	2	-
Cymene	X	X	X	X	X	-	1	-	1	1	1	1	1
D													
Dasco FR150, FR200, FR200B, FR310	-	1	-	-	-	-	1	1	1	1	1	1	1
Dasco IFR	-	1	-	-	-	-	1	1	1	1	1	1	1
DC200, DC510, DC550, DC560	-	1	-	-	-	-	1	-	1	1	1	1	1
Decalin	X	2	-	2	X	-	1	1	-	-	-	-	1
Dectol R60 Oils	X	1	-	-	-	2	-	-	-	-	-	-	-
Denatured Alcohol	1	1	1	1	-	-	1	1	1	1	1	1	1
Developing Fluids, Photo	1	1	-	1	-	-	-	X	X	2	-	-	-
Developing Solutions, Hypos	2	-	-	1	2	-	1	-	1	1	-	-	-
Diacetone	X	X	X	1	X	-	1	1	1	1	1	1	1
Diacetone Alcohol	-	X	-	1	-	-	1	1	1	1	1	1	1
Dibenzel Ether	X	X	-	2	-	-	1	-	1	1	1	1	1
Dibutyl Ether	X	X	-	1	-	-	1	-	1	1	1	1	1
Dibutyl Phthalate (Under 120°F)	X	X	X	2	X	2	1	-	1	1	1	1	1
Dibutyl Sebacate	X	X	X	2	-	-	1	-	-	-	-	-	1
Dichlorobenzene	X	X	X	X	X	X	1	1	-	1	1	-	1
Dichloroethane	X	X	X	X	-	-	1	X	-	X	X	X	X
Diesel, Biodiesel**	-	-	-	-	-	-	1	1	-	1	-	-	-
Diesel Oil, Fuel ASTM #2	2	1	2	2	X	1	1	1	1	1	1	1	1
Diester Lubricant MIL-I-780B	X	2	-	-	-	-	1	-	1	1	1	1	-
Diester Synthetic Lubricants	X	2	-	-	-	-	1	-	1	1	1	1	-
Diethylamine (Under 120°F)	2	2	-	2	X	-	1	1	1	1	1	1	1
Diethylene Glycol	1	1	1	1	1	1	1	1	1	1	1	1	1
Diethyl Ether	X	X	-	1	-	-	1	-	1	1	1	1	1
Diethyl Phthalate	-	X	-	2	-	-	1	-	-	1	1	-	1
Diethyl Sebacate	X	X	X	2	-	-	1	-	-	1	1	-	1

**Nitrile 150°F or less, no constant contact.

Rating Scale: 1 Excellent 2 Good resistance X Not recommended - Testing recommended	Gates Hose Polymers							Couplings & Adapters					
	Trade Names												
	A	C	C _o	J	M	T	Z	Carbon Steel	Stainless Steel 304	Stainless Steel 316	Aluminum	Brass	
	Neoprene	Nitrile	Nitrile/PVC	CPE	CSM	Urethane <small>(cover rating only)</small>	PTFE	Nylon	Carbon Steel	Stainless Steel 304	Stainless Steel 316	Aluminum	Brass
	Chemical Name	Neoprene	Nitrile	Nitrile/PVC	CPE	CSM	Urethane <small>(cover rating only)</small>	PTFE	Nylon	Carbon Steel	Stainless Steel 304	Stainless Steel 316	Aluminum
Diisobutylene	X	2	-	1	X	-	1	-	2	1	1	2	1
Diisobutyl Ketone	X	X	X	2	X	-	1	1	1	1	1	1	1
Diisopropyl Ketone	X	X	X	2	X	-	1	1	-	1	1	1	-
Dimethyl Aniline	X	X	X	2	X	-	1	-	-	-	-	-	1
Dimethyl Formamide (Under 120°F)	X	X	X	-	-	-	1	-	1	1	1	1	-
Dimethyl Phthalate	X	X	X	1	X	-	1	-	-	-	-	-	1
Diethyl Phthalate	X	X	X	2	X	-	1	-	1	1	1	1	1
Diethyl Sebacate	X	X	X	X	X	-	1	-	1	1	1	1	-
Dioxane	X	X	X	2	-	-	1	1	1	1	1	1	1
Dipentene	X	X	X	2	-	-	1	-	1	1	1	1	1
Dirco Oils	-	1	-	-	-	-	-	1	1	1	1	1	1
Dispersing Oil #10	X	X	-	-	-	-	1	-	1	1	1	1	-
Dowtherm A	X	X	X	2	X	X	1	-	1	1	1	1	1
Dowtherm E	X	X	X	2	-	-	1	-	1	1	1	1	1
DP47, 200 Flow - DOW	-	1	-	-	-	-	1	1	1	1	1	1	1
Duro FR-HD	-	1	-	-	-	X	1	1	1	1	1	1	1
Duro Oils	-	1	-	-	-	-	1	1	1	1	1	1	1
E													
Elco 28-EPLubricant	X	1	-	-	-	-	-	-	1	1	1	1	-
Enamels	-	-	-	-	-	-	1	1	-	-	-	-	1
Energol HL68	-	1	-	-	-	-	-	-	1	1	1	1	1
Energol HLPC 68	-	1	-	-	-	-	-	-	1	1	1	1	1
EPHydraulic Oils, Chevron	-	1	-	-	-	-	-	-	1	1	1	1	1
Epichlorohydrin (Under 120°F)	X	X	-	-	-	-	1	-	1	2	1	1	-
Esam-6 Fluid	2	-	-	-	-	-	-	-	-	-	-	-	-
Ethanol	1	1	-	1	-	X	1	1	X	1	1	-	1
Ethanolamine, Aminoethanol	2	2	-	1	X	X	1	1	1	1	1	1	1
Ethers (Under 120°F)	X	X	2	1	2	2	1	1	1	1	1	1	1
Ethyl Acetate	X	X	X	2	X	2	1	1	1	1	1	2	2
Ethyl Acetoacetate	X	X	X	1	X	X	1	-	1	1	1	1	1
Ethyl Acrylate	X	X	X	2	X	X	1	-	1	1	1	1	-
Ethyl Alcohol	1	1	1	1	-	-	1	1	1	1	1	1	2
Ethyl Amine, Monoethylamine	X	X	X	1	X	X	1	-	2	1	1	2	1
Ethyl Benzene	X	X	X	2	X	1	1	-	1	1	1	1	1
Ethyl Bromide, Di	X	X	X	2	X	-	1	-	1	1	1	1	1
Ethyl Butyrate	X	X	X	-	-	-	1	-	-	1	1	1	-
Ethyl Cellulose	-	-	-	1	-	-	1	-	1	1	1	-	1
Ethyl Chloride	X	X	X	-	X	1	-	-	2	1	1	1	2
Ethyl Ether	X	X	X	-	-	-	1	-	2	1	1	1	1
Ethyl Mercaptan	X	X	X	-	X	X	1	-	2	-	-	-	-
Ethyl Oxalate	X	X	-	1	X	X	1	-	-	-	-	-	-
Ethyl Pentachlorobenzene	-	X	-	X	-	1	1	-	2	1	1	-	1
Ethyl Silicate	1	1	1	1	-	-	1	1	1	1	1	1	1
Ethylene Chloride	X	X	X	X	-	1	1	X	2	1	1	-	2
Ethylene Chlorohydrin, Under 100°F	X	X	X	-	-	X	1	X	1	1	2	X	-
Ethylene Diamine (Under 100°F)	2	2	2	1	X	X	1	-	-	-	-	-	1
Ethylene Dichloride	X	X	-	2	-	-	1	1	1	-	1	X	-
Ethylene Glycol	1	1	1	1	1	1	1	1	2	1	1	1	1
F													
Factovis 52	-	1	-	-	-	-	-	-	1	1	1	1	1
Fatty Acids	2	2	2	2	X	1	1	1	2	1	1	1	2
Ferric Chloride	-	-	-	1	2	-	-	1	1	X	X	X	X
Ferric Chloride, 1%	1	1	-	-	-	-	1	1	X	2	2	X	X
Ferric Chloride, 1% Boiling	-	2	-	-	-	-	1	1	X	X	X	X	X
Ferric Chloride, 5% Still	2	1	-	-	-	-	1	1	X	X	X	X	X
Ferric Chloride, 5% Agitated or Aerated	2	2	-	-	-	-	1	1	X	X	X	X	X
Ferric Chloride, 10%	2	1	-	-	-	-	1	1	X	X	X	X	X
Ferric Sulfate	2	2	2	1	2	-	-	1	1	X	1	X	X
Ferrous Chloride	1	1	-	1	2	-	1	-	X	1	2	-	2
Ferrous Nitrate	2	2	2	-	2	-	1	-	-	1	1	-	-
Ferrous Sulfate, Copper Gas	2	2	2	1	2	-	1	-	X	1	1	1	2

EQUIPMENT
HOSE/CPLG. SELECTION
G&K COUPLINGS
GLOBALSPIRAL COUPLINGS
STAINLESS STEEL SPIRAL
MEGACRIMP COUPLINGS
STAINLESS STEEL BRAID
POWER CRIMP COUPLINGS
FIELD ATTACHABLE G1 & G2 COUPLINGS
FIELD ATTACHABLE C5 COUPLINGS
GLX COUPLINGS
GL COUPLINGS
C14 COUPLINGS
PCTS THERMOPLASTIC COUPLINGS
POLARSEAL COUPLINGS
POLARSEAL II COUPLINGS
POWER STEERING
ADAPTERS
QUICK DISCONNECT COUPLERS
BALL VALVES
LIVE SWIVEL
ASSEMBLY FABRICATION
ACCESSORIES
EQUIPMENT AND PARTS
AIR BRAKE
BRASS
KITS

Chemical Resistance Table - Continued

EQUIPMENT	Rating Scale: 1 Excellent 2 Good resistance X Not recommended - Testing recommended	Gates Hose Polymers	Couplings & Adapters
HOSE/CPLG. SELECTION		Trade Names	
G8K COUPLINGS		A C C _e J M T Z	
GLOBASPIRAL COUPLINGS		Neoprene	Carbon Steel
STAINLESS STEEL SPIRAL		Nitrile	Stainless Steel 304
STAINLESS STEEL BRAID		Nitrile/PVC	Aluminum
POWER CRIMP COUPLINGS		CPE	CSM
FIELD ATTACHABLE G1 & G2 COUPLINGS		Urethane (lower rating only)	
FIELD ATTACHABLE C5 COUPLINGS		PTFE	
GLX COUPLINGS	Chemical Name	Neoprene	Carbon Steel
GL COUPLINGS	Nitrile	Nitrile/PVC	Stainless Steel 304
C14 COUPLINGS	CPE	CPE	Stainless Steel 316
PCTS THERMOPLASTIC COUPLINGS	CSM	CSM	Aluminum
POLARSEAL COUPLINGS	Urethane (lower rating only)	Urethane (lower rating only)	Brass
POLARSEAL II COUPLINGS	PTFE	PTFE	Carbon Steel
POWER STEERING ADAPTERS	Nylon	Nylon	Stainless Steel 304
QUICK DISCONNECT COUPLERS	Nylon	Nylon	Stainless Steel 316
BALL VALVES	Nylon	Nylon	Aluminum
LIVE SWIVEL	Nylon	Nylon	Brass
ASSEMBLY FABRICATION	Nylon	Nylon	Carbon Steel
ACCESSORIES	Nylon	Nylon	Stainless Steel 304
EQUIPMENT AND PARTS	Nylon	Nylon	Stainless Steel 316
AIR BRAKE	Nylon	Nylon	Aluminum
BRASS	Nylon	Nylon	Brass
KITS	Nylon	Nylon	Carbon Steel

*Use Gates fuel hose or contact Denver Product Applications Department.

EQUIPMENT	Rating Scale: 1 Excellent 2 Good resistance X Not recommended - Testing recommended	Gates Hose Polymers	Couplings & Adapters
HOSE/CPLG. SELECTION		Trade Names	
G8K COUPLINGS		A C C _e J M T Z	
GLOBASPIRAL COUPLINGS		Neoprene	Carbon Steel
STAINLESS STEEL SPIRAL		Nitrile	Stainless Steel 304
STAINLESS STEEL BRAID		Nitrile/PVC	Aluminum
POWER CRIMP COUPLINGS		CPE	CSM
FIELD ATTACHABLE G1 & G2 COUPLINGS		Urethane (lower rating only)	
FIELD ATTACHABLE C5 COUPLINGS		PTFE	
GLX COUPLINGS	Chemical Name	Neoprene	Carbon Steel
GL COUPLINGS	Nitrile	Nitrile/PVC	Stainless Steel 304
C14 COUPLINGS	CPE	CPE	Stainless Steel 316
PCTS THERMOPLASTIC COUPLINGS	CSM	CSM	Aluminum
POLARSEAL COUPLINGS	Urethane (lower rating only)	Urethane (lower rating only)	Brass
POLARSEAL II COUPLINGS	PTFE	PTFE	Carbon Steel
POWER STEERING ADAPTERS	Nylon	Nylon	Stainless Steel 304
QUICK DISCONNECT COUPLERS	Nylon	Nylon	Stainless Steel 316
BALL VALVES	Nylon	Nylon	Aluminum
LIVE SWIVEL	Nylon	Nylon	Brass
ASSEMBLY FABRICATION	Nylon	Nylon	Carbon Steel
ACCESSORIES	Nylon	Nylon	Stainless Steel 304
EQUIPMENT AND PARTS	Nylon	Nylon	Stainless Steel 316
AIR BRAKE	Nylon	Nylon	Aluminum
BRASS	Nylon	Nylon	Brass
KITS	Nylon	Nylon	Carbon Steel

Chemical Resistance Table – Continued

Rating Scale: 1 Excellent 2 Good resistance X Not recommended - Testing recommended	Gates Hose Polymers							Couplings & Adapters																		
	Trade Names																									
	A	C	C _e	J	M	T	Z	Stainless Steel 304		Stainless Steel 316																
	Neoprene	Nitrile	Nitrile/PVC	CPE	CSM	Urethane (Cover rating only)	PTFE	Nylon	Carbon Steel	Aluminum	Brass															
Chemical Name																										
I																										
Imol, Imol S150, S220, S300, S500	-	1	-	-	-	2	1	1	1	1	1	1	-													
Industron 53	-	1	-	-	-	-	1	-	-	-	-	-	-													
Ink (Printers)	1	1	-	-	-	-	1	1	2	2	1	-	2													
Ink Oil	-	2	-	-	-	-	1	-	1	1	1	-	1													
Insulating Oil (Transformer)	2	1	2	-	X	-	1	-	1	1	1	-	1													
Isobutyl Alcohol	2	2	2	1	-	-	1	1	1	1	1	2														
Iodine (Under 100°F)	X	X	-	1	2	X	1	1	2	2	2	X	-													
Iodine, In Alcohol	2	-	-	-	X	1	-	-	-	-	-	X	-													
Iodine Pentafluoride	X	X	-	-	-	1	-	X	2	2	X	-														
Isooctane	1	1	2	2	1	2	1	1	1	1	1	2	1													
Isooctyl Thioglucolate	-	-	-	-	-	-	1	1	-	-	-	1	-													
Isobutane - WET	X	X	-	-	-	X	1	X	X	1	1	2	1													
Isopropyl Acetate	X	X	X	-	X	2	1	1	2	2	1	X	1													
Isopropyl Alcohol [Isopropanol]	2	2	2	1	2	2	1	1	1	1	1	1	2													
Isopropyl Ether	X	X	X	-	-	-	1	1	1	1	1	1	1													
J																										
Fuel JP-3 (Under 100°F)	2	1	2	-	X	2	1	1	1	1	1	2	1													
Jet Fuel JP-4 (Under 100°F)	X	1	2	-	X	-	1	1	1	1	1	2	1													
Jet Fuel JP-5	X	1	X	-	X	-	1	1	2	1	1	2	1													
Jet Fuel JP-6	X	1	X	-	X	-	1	1	2	1	1	2	1													
Jet Fuel JP-x	2	1	X	-	X	-	1	1	2	1	1	2	1													
K																										
Kerosene	X	1	2	1	X	-	1	1	1	1	1	1	1													
Ketchup	1	1	-	-	-	-	1	1	-	1	1	-	-													
Ketones	X	X	X	-	X	X	1	1	1	1	1	2	1													
L																										
Lacquer Solvents	X	X	X	-	X	2	1	1	X	2	1	1	1													
Lacquers	X	X	X	-	X	-	1	1	X	X	1	1	1													
Lactic Acid	1	X	X	-	1	X	1	-	X	2	1	X	2													
Lactic Acid [5%]	2	1	-	-	-	-	1	1	X	2	1	1	X													
Lactic Acid [5% Boiling]	X	X	-	-	-	-	1	-	X	2	1	2	X													
Lactic Acid [10% Boiling]	X	X	-	-	-	-	1	-	X	2	1	X	X													
Lactol	2	2	2	-	-	-	1	-	1	1	1	1	1													
Lard	2	1	-	1	-	-	1	1	1	1	1	1	X													
Lasso (Ag Spray)	-	-	-	-	-	-	1	1	-	1	1	-	-													
Latex	1	1	-	-	X	-	1	1	1	1	1	1	1													
Lead Acetate	X	X	-	1	2	1	1	-	2	2	2	X	1													
Lead Arsenate	2	2	-	-	-	-	1	-	1	1	1	-	-													
Lead Nitrate	2	2	-	-	1	1	1	-	1	2	2	-	-													
Lead Sulfate	1	1	-	1	2	-	1	-	1	1	1	-	-													
Lead, Tetraethyl (Under 100°F)	X	2	X	-	X	-	1	2	-	-	-	-	-													
Lead, Tetramethyl	X	2	X	-	X	1	1	-	-	-	-	-	-													
Lecithin	2	X	-	-	-	-	1	-	-	1	1	-	-													
Ligroin (Petroleum Ether, Under 120°F)	X	1	-	-	X	-	1	-	2	1	1	X	-													
Lime [Chlorinated, Free Chlorine 20%]	-	1	-	1	-	1	-	-	-	-	2	-	-													
Lime Bleach (Under 100°F)	X	2	X	-	X	-	-	-	X	2	1	-	-													
Lime Sulphur	1	X	-	-	-	-	2	1	2	1	1	X	X													
Lime Sulfur (Under 135°F)	1	X	X	-	2	-	2	1	2	1	1	X	X													
Lindane (Ag Spray)	-	-	-	-	-	-	1	1	-	1	1	-	-													
Linoleic Acid	X	2	X	-	-	-	1	-	X	2	1	1	-													
Linseed Oil	X	1	-	-	-	-	1	1	1	1	1	2	2													
Linseed Oil (Boiled)	2	2	1	1	1	1	1	1	2	1	1	1	2													
Lubricating Oil [SAE 10, 20, 30, 40, 50]	2	2	-	-	-	-	1	1	1	1	1	1	1													
Lubricating Oils [Diester, Under 135°F]	X	2	X	-	-	X	1	1	1	1	1	1	1													

| Cover stock rating only; Rating for tube stock "X"

Rating Scale: 1 Excellent 2 Good resistance X Not recommended - Testing recommended	Gates Hose Polymers							Couplings & Adapters																		
	Trade Names																									
	A	C	C _e	J	M	T	Z	Stainless Steel 304		Stainless Steel 316																
	Neoprene	Nitrile	Nitrile/PVC	CPE	CSM	Urethane (Cover rating only)	PTFE	Nylon	Carbon Steel	Aluminum	Brass															
Chemical Name																										
M																										
Machine Oil (Under 135°F)	1	1	2	-	2	-	1	1	1	1	1	1	1													
Magnesium Carbonate	1	1	1	-	1	1	1	-	2	2	2	1	-													
Magnesium Chloride	1	1	1	1	1	1	1	1	X	2	1	X	2													
Magnesium Hydroxide	2	2	2	1	1	X	1	-	1	1	1	X	X													
Magnesium Nitrate	2	2	2	-	1	-	1	-	2	2	2	X	1													
Magnesium Sulfate	2	2	2	1	1	1	1	1	2	2	2	2	2													
Malathion (Ag Spray Dilute)	-	2	-	-	-	-	1	1	1	1	1	-	1													
Maleic Acid	2	X	-	-	-	-	1	-	2	2	1	-	-													
Malic Acid	-	-	-	-	-	-	1	-	2	2	1	-	-													
Manganese Salts	-	1	1	-	1	-	1	-	-	-	-	-	-													
Maxmul (Penzoil Hydraulic Fluid)	2	1	2	-	-	-	1	-	1	-	1	-	-													
Mercuric Chloride	1	2	2	1	1	2	1	X	X	1	1	X	X													
Mercuric Cyanide	1	2	2	-	1	-	-	-	2	2	2	X	-													
Mercurous Nitrate (Under 120°F)	1	2	2	-	1	-	1	-	1	1	1	X	-													
Mercury	1	2	2	1	1	2	1	1	1	1	1	X	X													
Mesityl Oxide	X	X	X	2	X	X	1	-	1	1	1	1	1													
Methane	2	1	-	-	-	-	1	-	-	1	1	-	-													
Methoxychlor (Insecticide)	-	-	-	-	-	-	1	X	1	1	1	-	-													
Methyl Acetate	X	X	X	1	X	-	1	-	1	1	1	1	1													
Methyl Acrylate	X	X	X	-	X	-	1	-	1	1	1	1	1													
Methyl Alcohol	1	1	1	1	-	-	1	1	1	1	1	1	2													
Methyl Amine (25% Aqueous Solution)	2	X	-	-	-	-	1	-	1	1	1	1	-													
Methyl Amine (60%)	2	2	-	-	-	-	1	2	1	1	1	1	2													
Methyl Amine (99%)	X	X	-	-	-	-	1	-	1	1	1	1	X													
Methyl Bromide	X	X	X	-	X	X	1	1	1	1	1	1	1													
Methyl Butyl Ketone (MBK)	X	X	X	2	X	-	1	-	1	1	1	1	1													
Methyl Cellosolve (Under 100°F)	2	X	-	1	X	-	1	-	2	2	2	2	1													

Chemical Resistance Table – Continued

Rating Scale: 1 Excellent 2 Good resistance X Not recommended - Testing recommended	Gates Hose Polymers							Couplings & Adapters				
	Trade Names							Carbon Steel	Stainless Steel 304	Stainless Steel 316	Aluminum	Brass
	A	C	C _e	J	M	T	Z					
	Neoprene	Nitrile	Nitrile/PVC	CPE	CSM	Urethane (cover rating only)	PTFE	Nylon				
Chemical Name												
Potassium Hydroxide (70% Hot)	-	-	-	-	-	1	-	X	-	-	X	X
Potassium Iodide	1	1	-	-	1	-	1	1	2	2	-	-
Potassium Nitrate	1	1	-	1	-	1	1	1	1	2	2	2
Potassium Nitrate [1% To 5%]	1	1	-	-	-	-	1	-	1	1	1	2
Potassium Permanganate	1	2	-	-	-	-	1	2	1	2	2	2
Potassium Permanganate [5%]	1	1	-	-	-	-	1	1	1	1	1	-
Potassium Persulfate	-	-	-	-	-	-	1	-	-	-	-	-
Potassium Phosphate	1	-	-	-	1	-	1	X	2	2	X	-
Potassium Sulfate	1	1	-	1	-	1	1	1	2	2	1	-
Potassium Sulfate - 1% & 5%	1	1	-	-	-	-	1	1	1	1	1	X
Potassium Sulfide	1	1	-	-	-	-	1	2	2	2	-	-
Potassium Sulfite	1	1	-	1	-	-	1	1	1	1	1	-
Potassium Thiosulfate	1	-	-	-	1	-	1	-	-	-	-	-
Primatol A, S, P (Ag Spray)	-	-	-	-	-	-	1	-	-	-	-	-
Propane Gas	X	X	-	-	-	X	1	-	1	1	-	1
Propionic Acid	X	X	-	-	-	-	1	-	2	2	-	-
Propyl Acetate	X	X	-	2	-	-	1	-	-	-	-	-
Propyl Alcohol	1	1	2	1	-	X	1	1	1	1	-	2
Propylene [Liquid Or Gas, Ambient]	X	X	-	1	-	-	1	2	1	1	1	-
Propylene Dichloride	-	-	-	-	-	-	1	-	2	1	X	-
Propylene Glycol	1	1	-	1	1	1	1	2	1	1	-	-
Propylene Oxide	X	X	-	-	-	-	-	2	1	1	2	-
Purina Insecticide	X	X	-	-	-	-	1	2	1	1	1	2
Puropale RX Oils	-	1	-	-	-	2	1	1	1	1	1	1
Pyranol, Transformer Oil	2	1	-	-	-	-	1	-	1	1	1	-
Pydraul	X	X	-	-	-	-	1	-	-	-	-	-
Pydraul 10E, 29E-LT, 30E, 60, 65E, 115E	X	X	-	2	-	-	1	-	1	1	1	1
Pydraul 135	-	X	-	2	-	-	1	2	1	1	-	-
Pydraul 150	X	X	X	2	X	2	1	2	1	1	1	1
Pydraul 280	X	X	X	2	X	2	1	2	1	1	-	-
Pydraul 312	X	X	X	2	-	2	1	1	1	1	-	-
Pydraul 50E	-	-	-	2	-	2	1	1	1	1	-	-
Pydraul 540	X	X	X	2	X	X	1	X	1	1	-	-
Pydraul 625	X	X	X	2	X	2	1	2	1	1	-	-
Pydraul A-200	X	X	X	2	X	X	1	2	1	1	-	-
Pydraul F-9	X	X	X	2	X	2	1	1	1	1	-	-
Pyridine (50%)	X	X	-	-	X	1	1	-	1	1	1	1
Pyrogard 160, 230, 630	-	-	-	-	-	-	1	-	1	1	-	-
Pyrogard 51, 53, 55	-	X	-	-	-	-	1	-	1	1	-	-
Pyrogard C, D	-	1	-	-	-	2	1	1	1	1	1	1
Q												
Quench Oil	2	2	-	-	-	-	1	-	-	1	1	-
Quintolubric 822	2	1	-	-	-	-	1	-	1	1	1	1
R												
Ramrod (Ag Spray)	-	-	-	-	-	-	1	1	1	1	1	1
Rando Oils	-	1	-	-	-	-	2	1	1	1	1	1
Rape Seed Oil	2	X	-	-	X	-	1	2	1	1	1	1
Red Oil [Comm. Oleic Acid, MIL-H-5606]	2	2	2	1	2	-	1	1	2	2	1	2
Refined Wax (Petroleum)	2	1	2	-	-	-	2	1	1	1	-	1
Regal Oils R&O	-	1	-	-	-	-	2	1	1	1	1	1
Richfield Weed Killer	X	2	-	-	X	-	1	-	-	-	-	-
Round Up	2	2	-	-	-	-	1	-	2	1	1	1
Rubilene Oils	-	1	-	-	-	-	2	1	1	-	-	-
S												
Salicylic Acid	1	X	-	-	-	-	1	1	1	1	2	-

Rating Scale: 1 Excellent 2 Good resistance X Not recommended - Testing recommended	Gates Hose Polymers							Couplings & Adapters								
	Trade Names							Carbon Steel	Stainless Steel 304	Stainless Steel 316	Aluminum	Brass				
	A	C	C _e	J	M	T	Z									
	Neoprene	Nitrile	Nitrile/PVC	CPE	CSM	Urethane (cover rating only)	PTFE	Nylon								
Chemical Name																
Salt Water (Sea Water)	2	2	2	-	2	1	1	1	2	1	1	X	2			
Santosafe W-G15, W-G20, W-G30	-	1	-	-	-	-	2	1	1	1	1	1	1			
Santo Safe 300	X	X	-	-	-	-	-	1	-	1	1	1	-			
Sevin	-	-	-	-	-	-	-	1	1	1	-	-	-			
Sewage	2	2	2	1	2	-	-	1	1	X	1	1	2			
SFR Fluid B (Shell)	-	X	-	-	-	-	-	-	1	-	-	-	-			
SFR Fluid C (Shell)	-	X	-	-	-	-	-	-	1	-	-	-	-			
Shellac	2	1	-	-	-	-	-	-	1	1	1	1	-			
Shellac (Bleached)	2	1	-	-	-	-	-	-	1	1	1	1	2			
Shellac (Orange)	2	1	-	-	-	-	-	-	1	1	1	1	2			
Silicone Greases	2	2	2	-	2	-	-	1	1	1	1	1	1			
Silicone Oils	2	2	2	-	2	-	-	1	1	1	1	1	1			
Silver Cyanide	1	-	-	-	-	-	-	-	-	-	1	1	X			
Silver Nitrate	1	1	1	1	1	-	1	1	2	1	1	1	2			
Skydrol 500A&B 7000	X	X	X	2	X	-	-	1	1	1	1	1	-			
Soap Oil	X	X	-	-	X	-	-	-	1	-	1	1	-			
Soap Solutions	2	1	2	1	1	1	1	1	1	1	1	1	1			
Soda Ash (Sodium Carbonate)	1	1	1	1	1	1	1	1	1	1	1	1	X	2		
Soda Water	-	-	-	-	-	-	-	1	1	1	-	-	-			
Sodium Acetate	X	X	X	1	X	2	1	1	1	1	1	1	1			
Sodium Benzoate	-	-	-	-	-	-	-	-	1	1	-	-	-			
Sodium Bicarbonate	1	1	1	1	1	1	1	1	1	2	1	1	2	2		
Sodium Bisulfate (Niter Cake)	1	1	1	1	1	1	1	1	1	X	2	1	X	X		
Sodium Bisulfite	1	1	1	1	1	1	1	1	1	2	1	1	2	-		
Sodium Borate	1	1	1	1	1	1	1	1	1	1	1	1	1	-		
Sodium Carbonate	1	1	1	1	1	1	1	1	1	2	2	2	X	2		
Sodium Chlorate	2	1	-	-	-	-	1	1	1	1	2	2	2	X	-	
Sodium Chloride	1	1	1	1	1	1	1	1	1	2	2	1	X	X		
Sodium Chloride - 2%	1	1	-	-	-	-	-	1	1	2	2	1	X	X		
Sodium Chloride - 5%	1	1	-	-	-	-	-	1	1	-	2	1	X	X		
Sodium Chloride - 5% @ 150°F	1	1	-	-	-	-	-	1	1	-	2	1	-	X		
Sodium Chloride Saturated	1	1	-	-	-	-	-	1	1	-	1	1	X	-		
Sodium Chloride Saturated (Boiling)	-	-	-	-	-	-	-	-	1	-	-	2	1	X	-	
Sodium Chloride Slurry	-	-	-	-	-	-	-	-	1	-	-	-	-	-	-	
Sodium Cyanide	1	1	1	1	1	1	1	1	1	2	1	1	X	X		
Sodium Dichromate	2	1	-	-	2	1	1	1	1	-	-	-	-	-	-	
Sodium Ferricyanide	-	-	-	-	-	-	-	-	1	-	2	2	2	-	-	
Sodium Ferrocyanide	-	-	-	-	-	-	-	-	1	-	-	-	-	-	-	
Sodium Fluoride	-	1	-	-	-	-	-	-	1	-	2	2	2	-	-	
Sodium Fluoride [5%]	-	1	-	-	-	-	-	-	1	1	2	2	2	-	-	
Sodium Fluoride [70%]	-	-	-	-	-	-	-	-	1	-	-	2	-	-	-	
Sodium Hydrosulfide	1	X	-	-	-	-	-	-	1	-	-	-	-	-	-	
Sodium Hydrosulfite	-	-	-	-	-	-	-	-	1	-	-	-	-	-	-	
Sodium Hydroxide	2	2	-	-	-	-	-	-	1	-	2	-	-	-	X	
Sodium Hydroxide [3 Molar]	2	2	-	-	-	-	-	-	1	-	-	-	-	-	X	
Sodium Hydroxide [10%]	-	-	-	1	-	-	-	-	1	-	-	-	-	-	-	
Sodium Hydroxide [20% Cold]	1	2	-	-	-	-	-	-	1	1	1	1	X	X	-	
Sodium Hydroxide [20% Hot]	1	X	-	-	-	-	-	-	1	-	2	1	1	X	X	
Sodium Hydroxide [40%]	1	2	2	1	1	-	-	-	1	2	2	1	1	X	X	
Sodium Hydroxide [50% Cold]	2	X	X	1	1	-	-	-	1	2	2	2	2	X	X	
Sodium Hydroxide [50% Hot]	-	-	-	1	2	-	-	-	1	X	X	2	2	X	X	
Sodium Hydroxide [60%]	2	X	X	1	2	-	-	-	1	X	X	2	2	X	X	
Sodium Hydroxide [70% Cold]	1	2	-	-	-	-	-	-	-	1	-	-	-	2	X	X
Sodium Hydroxide [70% Hot]	-	-	-	-	-	-	-	-	-	1	-	-	-	-	-	-
Sodium Hydroxide [80% Hot]	1	X	-	-	-	-	-	-	1	-	X	X	X	X	X	
Sodium Hypochlorite	1	X	-	-	-	-	-	-	1	-	X	X	X	X	-	

EQUIPMENT
HOSE/CPLG. SELECTION
G&K COUPLINGS
GLOBAL SPIRAL COUPLINGS
STAINLESS STEEL SPIRAL
MEGACRIMP COUPLINGS
STAINLESS STEEL BRAID
POWER CRIMP COUPLINGS
FIELD ATTACHABLE G1 & G2 COUPLINGS
FIELD ATTACHABLE C5 COUPLINGS
GLX COUPLINGS
GL COUPLINGS
C14 COUPLINGS
PCTS THERMOPLASTIC COUPLINGS
POLARSEAL COUPLINGS
POLARSEAL II COUPLINGS
POWER STEERING
ADAPTERS
QUICK DISCONNECT COUPLERS
BALL VALVES
LIVE SWIVEL
ASSEMBLY FABRICATION
ACCESSORIES
EQUIPMENT AND PARTS
AIR BRAKE
BRASS
KITS

Chemical Resistance Table – Continued

EQUIPMENT	Rating Scale:												Rating Scale:															
HOSE/CPLG. SELECTION	1 Excellent			Gates Hose Polymers						Couplings & Adapters			2 Good resistance			Gates Hose Polymers						Couplings & Adapters						
	8BK COUPLINGS	2 Good resistance		Trade Names												Trade Names												
GLOBAL SPIRAL COUPLINGS	X Not recommended			A	C	C ₂	J	M	T	Z	Carbon Steel			Stainless Steel 304			Stainless Steel 316			Aluminum			Brass					
STAINLESS STEEL SPIRAL	- Testing recommended			Neoprene	Nitrile	Nitrile/PVC	CPE	CSM	Urethane (cover rating only)	PTFE	Nylon	Carbon Steel	Stainless Steel 304	Stainless Steel 316	Aluminum	Brass	Chemical Name											
MEGACRIMP COUPLINGS	Sodium Hypochlorite, 5%	-	X	X	1	1	X	1	1	1	X	X	2	X	X	Sulfuric Acid, Aerated, No Velocity	-	-	-	-	-	1	-	2	2	2	X	-
STAINLESS STEEL BRAID	Sodium Hypochlorite, 20%	X	X	X	1	1	X	1	2	X	X	2	X	X	Sulfuric Acid, Air Free No Velocity	-	-	-	-	-	-	1	-	X	X	2	X	-
POWER CRIMP COUPLINGS	Sodium Hyposulfate	X	-	-	-	-	-	-	-	X	1	1	X	-	Sulfuric Acid, Concentrated	X	X	-	-	-	-	1	-	-	1	1	-	-
	Sodium Metaphosphate	2	2	2	1	2	-	1	1	X	1	1	1	X	Sulfuric Acid, Fuming, Oleum	X	-	-	-	-	-	1	-	2	1	1	2	-
FIELD ATTACHABLE G1 & G2 COUPLINGS	Sodium Nitrate	X	X	-	1	2	1	1	1	1	2	2	2	2	Sulfuric Acid [10%]	1	2	2	1	1	-	1	X	-	X	2	2	X
	Sodium Perborate	X	X	-	-	X	-	1	2	X	1	1	1	X	Sulfuric Acid [30%]	1	-	-	1	1	-	1	X	X	X	2	X	X
FIELD ATTACHABLE C5 COUPLINGS	Sodium Peroxide [Sodium Dioxide]	1	2	1	2	1	-	1	X	X	1	1	1	X	Sulfuric Acid [50%]	2	X	X	1	1	-	1	X	X	X	2	X	X
	Sodium Phosphate	X	1	-	1	-	1	1	1	1	2	1	1	X	Sulfuric Acid [75%]	X	X	X	-	2	-	1	X	X	X	2	X	X
GLX COUPLINGS	Sodium Phosphate [Mono]	1	1	-	-	-	-	1	-	-	-	-	-	Sulfuric Acid [93%]	X	X	X	-	X	-	1	X	2	X	2	X	X	
	Sodium Phosphate [Dibasic]	2	1	-	-	-	-	1	-	-	-	-	-	Sulfuric Acid [98%]	X	X	X	X	X	-	1	X	2	X	2	X	X	
GL COUPLINGS	Sodium Phosphate [Tribasic]	2	1	-	-	-	-	1	-	2	2	2	-	Sulfurous Acid	2	2	-	-	-	-	1	X	X	2	2	-	-	
	Sodium Silicate	1	1	-	1	2	1	1	1	1	1	1	-	Sulfurous Acid [10%]	-	X	-	1	1	-	1	-	-	X	2	1	X	
C14 COUPLINGS	Sodium Silicate [Hot]	1	1	-	-	-	-	1	-	2	2	2	X	X	Sulfurous Acid [75%]	X	X	X	1	1	-	1	X	X	X	2	X	X
	Sodium Sulfate	1	1	-	1	1	1	1	1	2	1	1	-	2	Sun R&O Oils	-	1	-	-	-	2	1	1	1	1	1	1	
PCT5 THERMOPLASTIC COUPLINGS	Sodium Sulfide	1	1	-	1	1	1	1	1	X	X	2	X	X	Sunsafe [Fire Resist. Hydr. Fluid]	2	1	-	-	-	2	1	1	1	1	1	1	-
	Sodium Sulfite	2	2	2	1	2	1	1	2	1	1	1	-	X	Suntac HPOils	-	1	-	-	-	2	1	1	1	-	1	1	
POLARSEAL COUPLINGS	Sodium Sulfite, 5%	1	1	-	-	-	-	1	-	1	1	1	-	1	Suntac WR Oils	-	1	-	-	-	2	1	1	1	-	1	1	
	Sodium Sulfite, 10% @ 150°F	1	1	-	-	-	-	1	-	2	2	2	2	-	Sunvis Oils 700, 800, 900	-	1	-	-	-	2	1	1	1	1	1	-	
POLARSEAL II COUPLINGS	Sodium Thiosulfate [HPD, Antichlor]	1	1	1	1	1	1	1	1	X	1	1	2	X	Super Hydraulic Oils [Conoco]	-	1	-	-	-	2	1	1	1	1	1	1	
	Sodium Tripolyphosphate [STPP]	-	-	-	-	-	-	1	-	-	1	1	X	X	Sutan Plus, Herbicide	X	X	X	1	-	-	1	1	1	1	1	-	
POWER STEERING ADAPTERS	Solnurs Oils	-	1	-	-	-	2	1	1	1	1	1	1	1	Sutazine Plus, Herbicide	X	X	-	1	-	-	-	1	X	1	1	1	
	Sour Crude Oil	-	-	-	-	-	-	1	-	-	-	-	-	Synthetic Oil [Citgo]	-	-	-	-	-	-	2	-	1	1	1	-		
QUICK DISCONNECT COUPLERS	Soybean Oil	2	2	2	-	2	-	1	1	1	1	1	1	-	Syrup	2	1	2	-	-	-	1	1	-	1	1	1	
	Spent Acid	-	-	-	-	2	-	1	-	-	1	1	-	-	T	-	-	-	-	-	-	-	-	-	-	-		
BALL VALVES	Stannic Chloride	X	2	2	1	X	-	1	X	X	X	X	X	X	Tall Oil [Under 150°F]	2	2	2	-	X	-	1	-	2	X	2	X	
	Stannic Chloride, 50%	X	1	-	-	-	-	1	-	X	X	X	X	-	Tallow	2	2	2	-	-	-	1	1	2	2	2	1	
LIVE SWIVEL	Stannous Chloride [Under 150°F]	1	1	-	1	1	-	1	X	-	X	2	X	-	Tannic Acid [10%]	2	X	-	1	2	-	1	X	2	1	1	2	
	Stannous Chloride, 15%	1	1	-	-	-	-	1	-	X	X	-	X	-	Tar And Tar Oil	2	-	-	-	-	2	1	1	1	1	1	2	
ASSEMBLY FABRICATION	Starch	2	2	-	-	1	1	1	1	X	1	1	1	-	Tar [Bituminous, Under 100°F]	2	2	2	X	-	-	1	-	X	1	1	2	
	Steam	USE STEAM HOSE			-	2	1	-	1	1	-	1	1	-	2	Tartaric Acid	2	2	2	1	1	-	1	1	X	2	2	
EQUIPMENT AND PARTS	Stearic Acid	2	2	2	1	2	1	1	1	X	2	1	X	X	Tellus Oils	-	1	-	-	-	2	1	1	1	1	1	1	
	Stearin	-	-	-	-	-	-	1	2	-	-	-	-	-	Tenol Oils	-	1	-	-	-	2	1	1	-	-	-		
AIR BRAKE	Stoddard Solvent	2	2	X	1	-	X	1	1	2	1	1	1	1	Tergitol	-	-	-	-	-	1	-	2	1	1	-		
	Styrene [Vinyl Benzene]	X	X	-	-	-	-	1	1	1	1	1	1	1	Terpineol	X	2	-	1	2	-	1	2	-	-	-		
BRASS	Styrene [Monomer]	-	X	-	2	-	-	1	2	2	X	2	X	2	Terresstic	-	1	-	-	-	-	1	1	1	1	-		
	Sucrose Solutions	1	1	1	-	1	-	1	-	1	1	1	-	-	Tetraethyl Lead	2	2	-	-	-	-	1	2	-	-	-		
KITS	Sulfamic Acid [10%, Under 170°F]	-	-	-	1	2	-	1	-	-	-	-	-	-	Tetraethyl Lead Blend	X	2	-	-	-	-	1	-	-	-			
	Sulfate Black Liquor	1	1	-	-	-	-	1	1	2	2	2	X	-	Tetrahydrofuran [THF]	X	X	-	-	X	2	1	1	2	-	-		
ACCESSORIES	Sulfate Green Liquor	1	1	-	-	-	-	1	1	2	2	2	X	-	Tetralin	X	X	-	-	X	-	1	2	1	1	1		
	Sulfur	-	-	-	-	-	-	-	-	-	-	-	-	-	Thiopen	X	X	-	-	-	-	1	-	-	-			
EQUIPMENT AND PARTS	Sulfur [Molten]	X	X	-	-	-	-	-	-	-	-	-	-	-	Titanium Tetrachloride	X	X	X	-	-	-	1	-	1	2	2		
	Sulfur Chloride	X	X	X	-	2	-	1	2	X	X	2	X	X	Toluene [Toluol]	X	X	X	X	X	-	1	1	1	1	1		
AIR BRAKE	Sulfur Dioxide [Moist]	2	X	-	-	2	-	1	1	-	2	1	1	X	Toluene Diisocyanate [Under 150°F]	X	-	-	-	-	-	1	-	1	1	1		
	Sulfur Dioxide [Dry]	X	X	X	-	2	-	1	X	2	1	1	1	1	Transformer Oil [Askarel Types]	X	X	X	1	X	-	1	-	1	1	1		
BRASS	Sulfur Dioxide [Liquid]	2	X	-	-	2	-	1	-	-	-	-	-	-	Transformer Oil [Petroleum Type]	2	1	2	1	X	2	1	1	1	1	1		
	Sulfur Hexafluoride [Gas]	1	2	-	2	-	1	X	-	-	-	-	-	-	Transmission Fluid, Type A	2	1	2	1	2	-	1	2	-	1	1		
KITS	Sulfur Trioxide [Dry]	X	X	X	X	X	-	1	1	2	2	2	X	-	Tributoxyethyl Phosphate	X	X	X	X	X	-	1	2	1	-	X		
	Sulfuric Acid, 85%	X	X	-	-	-	-	1	-	X	2	1	X	-	Tributyl Phosphate	X	X	X	2	X	-	1	2	X	2	1		
KITS	Sulfuric Acid, 3 Molar	X	X	-	-	-	-	1	-	-	-	-	-	-	Trichloroethylene	X	X	X	2	X	-	1	2	X	2	1		
															Trichloromonofluoroethane													

Chemical Resistance Table – Continued

Rating Scale: 1 Excellent 2 Good resistance X Not recommended - Testing recommended	Gates Hose Polymers							Couplings & Adapters					
	Trade Names												
	A	C	C ₂	J	M	T	Z	Carbon Steel		Stainless Steel 304	Stainless Steel 316	Aluminum	Brass
	Neoprene	Nitrile	Nitrile/PVC	CPE	CSM	Urethane <small>(lower rating only)</small>	PTFE	Nylon	Carbon Steel	Stainless Steel 304	Stainless Steel 316	Aluminum	Brass
Chemical Name													
[Freon 17]	Use Freon Hose							1	1	1	X	-	
Trichlorotrifluoroethane [Freon 113]	Use Freon Hose							1	1	1	X	-	
Tricresyl Phosphate	X	X	X	1	X	-	1	1	2	2	X	-	
Triethanolamine [TEA]	2	2	-	1	2	-	1	1	1	1	1	1	
Tripolyphosphate [STPP]	X	1	-	-	-	-	1	-	2	1	X	-	
Tung Oil	2	2	-	-	2	-	1	1	1	1	1	1	
Turpentine	X	2	-	2	X	1	1	1	X	1	1	2	
Type I Fuel [MIL-S-3136] ASTM Fuel A	2	1	-	-	-	-	1	-	1	1	1	1	
Type II Fuel [MIL-S-3136]	X	2	-	-	-	-	1	-	1	1	1	1	
Type III Fuel [MIL-3136] ASTM Fuel B	X	1	-	-	-	-	1	-	1	1	1	1	
U													
Ucon Hydrolube Types 150CP, 200CP	-	1	-	-	-	2	1	1	1	1	1	1	
Ucon Hydrolube Types 275CP, 300CP, 550CP	-	-	-	-	-	-	1	-	-	-	-	-	
Ucon M1	-	1	-	-	-	2	1	1	1	1	1	1	
Union ATF Dexron	-	1	-	-	-	2	1	1	1	1	1	-	
Union ATF Type F	-	1	-	-	-	2	1	1	1	1	1	1	
Union C-2 Fluid	-	1	-	-	-	2	1	1	1	1	1	-	
Union C-POil	-	1	-	-	-	2	1	1	1	1	1	1	
Union Hydraulic Oil AW	-	1	-	-	-	2	1	1	1	1	1	1	
Union Hydraulic Tractor Fluid	-	1	-	-	-	2	1	1	1	1	1	1	
Urea Solution	1	2	-	1	1	2	1	1	1	1	2	-	
V													
Varnish	X	X	X	-	X	-	1	1	2	1	1	2	
Vegetable Oils	2	1	2	1	-	2	1	1	1	1	1	2	
Vegetable Oil (Hot)	-	-	-	-	-	-	1	1	2	2	2	1	
Versilube	1	1	-	-	-	-	1	-	1	1	1	-	
Versilube F-50, F-44	2	2	2	-	2	2	1	1	1	1	1	1	
Vinegar	2	X	X	2	X	-	1	1	X	2	1	X	
Vinyl Acetate	X	X	X	1	X	-	1	-	2	1	2	1	
Vinyl Chloride [Chloroethylene, Monomer]	X	X	X	X	X	-	1	-	2	1	1	2	
Vitrea Oils	X	X	X	-	-	2	1	1	1	1	1	-	
W													
Water	1	1	1	1	1	1	1	1	2	1	1	1	
Water, Acid Mine	2	X	-	-	-	-	1	1	X	2	2	X	
Water, Brine	2	2	-	-	1	1	1	1	X	2	2	-	
Water Deionized, [Demineralized]	-	-	-	-	-	-	1	-	-	-	-	-	
Water, Distilled	2	1	-	-	1	1	1	1	X	1	1	1	
Water, Fresh	1	1	-	-	-	-	1	1	X	1	1	1	
Water In Oil Emulsions	-	-	-	-	-	2	1	1	-	-	-	-	
Water, Potable [FDA Tube Only]	Use FDA Hose Only							-	-	-	-	-	
Water, Salt	2	1	-	-	-	-	1	1	X	2	2	X	
White & Bagley No. 2190 Cutting Oil	2	1	-	-	-	-	1	-	-	-	-	-	
Wines	2	1	1	1	1	-	1	1	2	2	2	1	
Wood Oil	2	1	-	1	2	1	1	1	1	1	1	1	
X													
Xylene	X	X	-	X	-	2	1	X	2	2	2	-	

Rating Scale: 1 Excellent 2 Good resistance X Not recommended - Testing recommended	Gates Hose Polymers							Couplings & Adapters					
	Trade Names												
	A	C	C ₂	J	M	T	Z	Carbon Steel		Stainless Steel 304	Stainless Steel 316	Aluminum	Brass
	Neoprene	Nitrile	Nitrile/PVC	CPE	CSM	Urethane <small>(lower rating only)</small>	PTFE	Nylon	Carbon Steel	Stainless Steel 304	Stainless Steel 316	Aluminum	Brass
Chemical Name													
Z													
Zeric	-	1	-	-	-	2	1	2	-	-	-	-	
Zinc Acetate	2	X	-	-	X	-	1	2	1	1	1	1	
Zinc Chloride Solutions	1	1	1	1	1	-	1	1	X	2	1	X	
Zinc Chromate	-	-	-	1	1	-	1	-	-	1	1	-	
Zinc Hydrate	-	-	-	-	-	2	1	-	-	-	-	-	
Zinc Sulfate Solutions	2	2	2	1	2	-	1	2	X	2	1	X	

EQUIPMENT
HOSE/CPLG. SELECTION
G8K COUPLINGS
GLOBAL SPIRAL COUPLINGS
STAINLESS STEEL SPIRAL
MEGACRIMP COUPLINGS
STAINLESS STEEL BRAID
POWER CRIMP COUPLINGS
FIELD ATTACHABLE G1 & G2 COUPLINGS
FIELD ATTACHABLE C5 COUPLINGS
GLX COUPLINGS
GL COUPLINGS
C14 COUPLINGS
PCTS THERMOPLASTIC COUPLINGS
POLARSEAL COUPLINGS
POLARSEAL II COUPLINGS
POWER STEERING
ADAPTERS
QUICK DISCONNECT COUPLERS
BALL VALVES
LIVE SWIVEL
ASSEMBLY FABRICATION
ACCESSORIES
EQUIPMENT AND PARTS
AIR BRAKE
BRASS
KITS

Nomographic Chart

FLOW CAPACITY OF HOSE ASSEMBLIES AT RECOMMENDED FLOW VELOCITIES

EQUIPMENT
HOSE/CPLG. SELECTION
G8K COUPLINGS
GLOBALSPIRAL COUPLINGS
STAINLESS STEEL SPIRAL
MEGACRIMP COUPLINGS
STAINLESS STEEL BRAID
POWER CRIMP COUPLINGS
FIELD ATTACHABLE G1 & G2 COUPLINGS
FIELD ATTACHABLE C5 COUPLINGS
GLX COUPLINGS
GL COUPLINGS
C14 COUPLINGS
PCTS THERMOPLASTIC COUPLINGS
POLARSEAL COUPLINGS
POLARSEAL II COUPLINGS
POWER STEERING
ADAPTERS
QUICK DISCONNECT COUPLERS
BALL VALVES
LIVE SWIVEL
ASSEMBLY FABRICATION
ACCESSORIES
EQUIPMENT AND PARTS
AIR BRAKE
BRASS
KITS

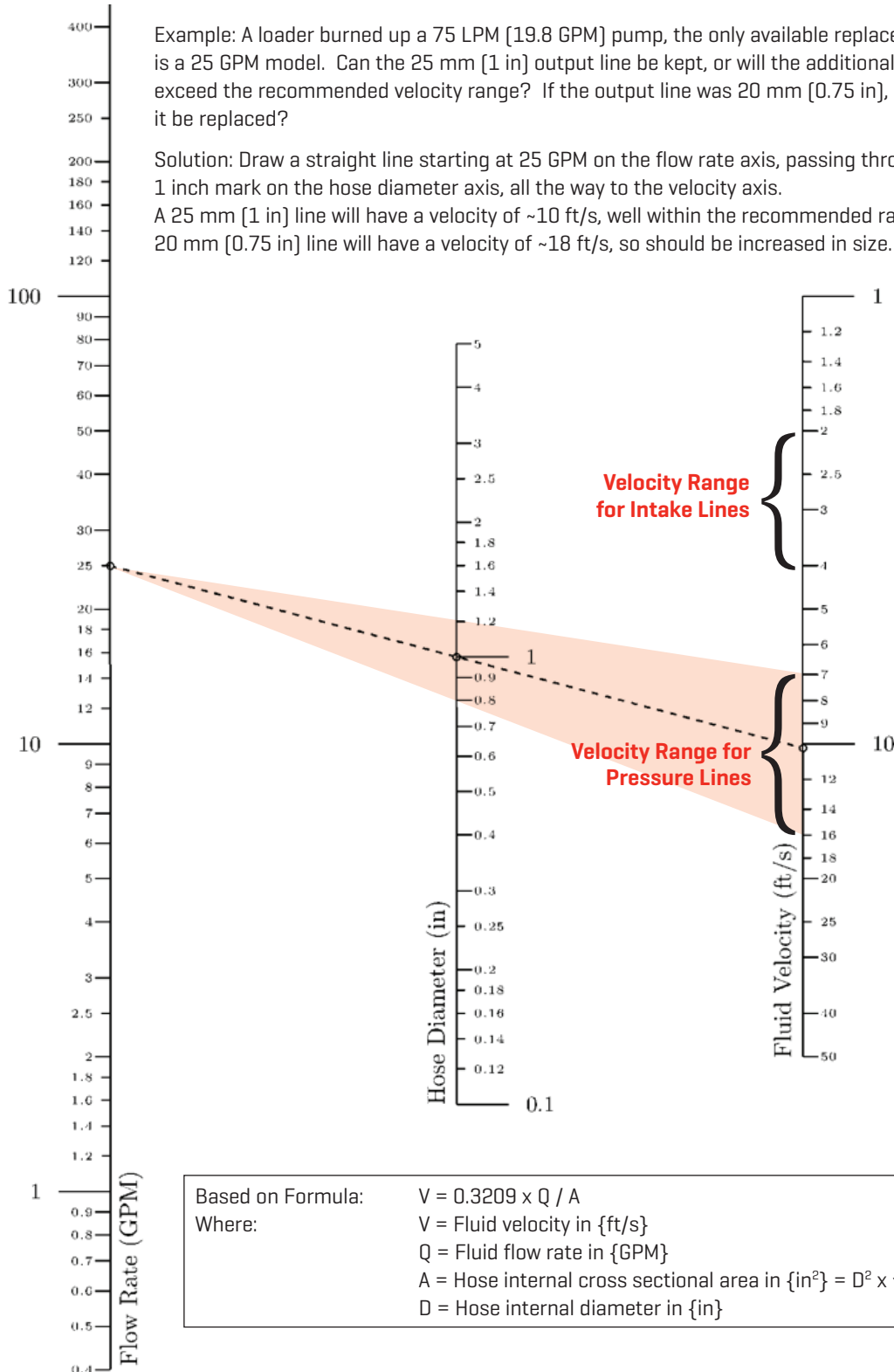

Properties of C14 PTFE Tube

Tensile Strength, 73°F [23°C]	1500-3000 Lb./Sq. In.
Elongation, 73°F [23°C]	100-200%
Stiffness, 73°F [23°C]	60,000 Lb/Sq. In.
Impact Strength	
@70°F [21°C]	2.0 Ft.-Lb./In.
@73°F [23°C]	3.5 Ft.-Lb./In.
@170°F [77°C]	6.0 Ft.-Lb./In.
Hardness, Durometer	D55-D70 Shore D
Compressive Stress at	
1% Deformation @73°F [23°C]	600 Lb./Sq. In.
1% Offset @73°F [23°C]	1000 Lb./Sq. In.
Deformation Under Load, 24 Hrs. @ 122°F [50°C]	
1200 Lb./Sq. In.	4-8%
2000 Lb./Sq. In.	25%
Heat-Distortion Temperature @66 Lb./Sq. In.	250°F [121°C]
Coefficient of Linear Thermal Expansion per °F; 77-140°F [25-60°C]	5.5 x 10 ⁻⁵
Thermal Conductivity 0.18 In.	1.7 B.T.U./Hr./Sq.Ft./°F/In.
Specific Heat	0.25 B.T.U./Lb./°F
Water Absorption	0.0%
Flammability	Nonflammable
Specific Gravity	2.1-2.3

EQUIPMENT

HOSE/CPLG.
SELECTION

G8K COUPLINGS

GLOBAL SPIRAL
COUPLINGS

STAINLESS
STEEL SPIRAL

MEGACRIMP
COUPLINGS

STAINLESS
STEEL BRAID

POWER CRIMP
COUPLINGS

FIELD
ATTACHABLE G1
& G2 COUPLINGS

FIELD
ATTACHABLE C5
COUPLINGS

GLX COUPLINGS

GL COUPLINGS

C14 COUPLINGS

PCTS
THERMOPLASTIC
COUPLINGS

POLARSEAL
COUPLINGS

POLARSEAL II
COUPLINGS

POWER
STEERING

ADAPTERS

QUICK
DISCONNECT
COUPLERS

BALL VALVES

LIVE SWIVEL

ASSEMBLY
FABRICATION

ACCESSORIES

EQUIPMENT AND
PARTS

AIR BRAKE

BRASS

KITS

Electrostatic Discharge

EQUIPMENT
HOSE/CPLG. SELECTION
G8K COUPLINGS
GLOBAL SPIRAL COUPLINGS
STAINLESS STEEL SPIRAL
MEGACRIMP COUPLINGS
STAINLESS STEEL BRAID
POWER CRIMP COUPLINGS
FIELD ATTACHABLE G1 & G2 COUPLINGS
FIELD ATTACHABLE C5 COUPLINGS
GLX COUPLINGS
GL COUPLINGS
C14 COUPLINGS
PCTS THERMOPLASTIC COUPLINGS
POLARSEAL COUPLINGS
POLARSEAL II COUPLINGS
POWER STEERING
ADAPTERS
QUICK DISCONNECT COUPLERS
BALL VALVES
LIVE SWIVEL
ASSEMBLY FABRICATION
ACCESSORIES
EQUIPMENT AND PARTS
AIR BRAKE
BRASS
KITS

Most applications of PTFE hose do not require the use of a conductive inner tube. Under certain applications, the potential for Static Discharge must be considered. Be aware that static electricity can be a hazard. Under those conditions where static discharge can occur, the use of conductive Gates C14CT hose is recommended. The following should serve to increase your knowledge and understanding of this phenomenon and how to avoid its occurrence:

When two different materials contact each other, electrons from one material can move across its boundary and associate with the other. These electrons align themselves with the material contacted. If the two materials are good conductors of electricity, the positive and negative electrons flow back and forth between them, keeping them in balance. If one or both are insulators, the flow will not occur. A charge will then build up on the surface of one of the materials. When the charge exceeds the electric strength of the material, electric breakdown results.

In applying this to PTFE hose, we have to consider fluids and gases that are poor conductors of electricity and the flow rates of those fluids and gases. In order for a liquid or gas to be a poor electrical conductor, it will generally satisfy one or both of the following conditions:

1. Be nonpolar; that is, an imbalance between protons and electrons, and/or
2. Contain a nonmixable component or a suspended solid; such as water in kerosene.

So when a liquid contacts a PTFE tube that isn't a good conductor [white PTFE innercore], the result is phase separation and the electric charge starts to build. The rate at which static electricity builds up now becomes a function of the fluid flow rate. When the electric strength of the PTFE tube is exceeded, the electric charge will puncture the tube wall and ground itself on the stainless steel braid of the hose.

In hydraulics, high pressures generally mean high velocities. Historically, fluids were filtered upstream of the hose using metallic filter elements. The metallic element helped to ground the charge. But, today, most filtration is done with paper-type and glass-fiber filter elements that have a tendency to inject an electrostatic charge into the fluid they are filtering.

Steam and fuels are two specific areas of concern. No hose in this catalog can or should be used in steam applications. Contact Gates Product Application for proper hose recommendation.

Fuels [i.e. gasoline and white spirits, hydrazine, benzene, diesel oils, etc.] are, for the most part, "nonconductive" liquids. These fluids usually are transferred at fairly low velocities, but there still is a potential for an electrostatic discharge due to external factors, such as humidity and, to some extent, temperature. You should take all of these factors into account even at fluid velocities at or below 1 meter per second.

When using PTFE hose, you can offset the potential hazard of electrostatic discharge by using a conductive Gates C14CT hose. Carbon is added to the PTFE inner tube wall during manufacture. The carbon layer directs the electrostatic charge down the inner diameter of the hose to the metal end fittings. This prevents the charge from building up on the inner tube wall.

So, it's important to examine any application where nonconductive fluids are used and any of the above conditions exist. This section is not meant to cover all conditions or situations when they involve fuels, steam or other media which may cause electrostatic buildup or potential discharge. If you need help on any individual application, contact Hose/Connector Product Application, Denver.

Following is a list of some of the chemicals that meet at least one of the criteria necessary to create electrostatic discharge:

- > Cyclohexane
- > Decalin
- > Diacetone
- > Dibutyl Ether
- > Dibutyl Phthalate
- > Dibutyl Sebacate
- > Dimethyl Phthalate
- > Dioctyl Phthalate
- > Dipentene
- > Fuel Oil
- > Gasoline
- > Hexane
- > Hexene
- > Hydrazine
- > Kerosene
- > Lacquers
- > Lacquer Solvents
- > Naphtha
- > Naphthalene
- > Octane
- > Paint
- > Petroleum
- > Pinene
- > Silicone Oils
- > Skydrol 500 & 700
- > Steam
- > Toluene
- > Transformer Oil
- > Turpentine
- > Varnish
- > Versilube

General Industry Practice has identified the above fluids as requiring a conductive hose—Gates C14CT.

Effusion/Corrosion for PTFE Hose and Hose Assemblies

WHAT IS EFFUSION?

It is the process where chemical molecules move through the PTFE wall and escape from a hose or hose assembly. It is sometimes called permeation. The rate at which effusion occurs depends upon temperature, pressure, wall thickness and the hose material.

The fact that effusion occurs isn't the problem. This process will happen with most all media in most hose material.

The basic issues are:

1. At what rate will effusion occur?
2. How hazardous are the media?
3. In what kind of environment does effusion take place; closed room, outside, etc.?

GENERAL MEDIA CONCERNS REGARDING THE POTENTIAL EFFECTS OF EFFUSION:

- > Media where corrosion is not of concern, but effusion may displace the air we breathe, thus becoming a hazard to personnel.

Some of the chemicals in this category are:

- > Carbon Dioxide
- > Neon
- > Nitrogen
- > Argon
- > Steam
- > Xenon
- > Oxygen
- > Krypton
- > Helium

- > Media that can effuse in their "vapor phase"; i.e., their boiling point is below approximately +125°F [+52°C] at atmospheric pressure. These media can form chemicals that can corrode the braid and/or cause injury to personnel.

Some of these include:

- > Acetaldehyde [Flammable, Toxic]
- > Benzene [Flammable, Toxic]
- > Liquid Butane [Flammable]
- > Carbon Disulfide [Flammable, Toxic]
- > Diethyl Ether [Flammable, Narcotic]
- > Ethyl Mercaptan [Flammable, Toxic]
- > Hydrochloric Acid [Corrosive, Toxic]
- > Lacquer Solvents [Flammable]
- > Methyl Bromide [Flammable, Toxic, Corrosive]

- > Methylene Chloride [Toxic]
- > Methyl Formate [Flammable, toxic]
- > Liquid Propane [Flammable]
- > Sulphur Trioxide [Corrosive, toxic]
- > Liquid Chlorine [Corrosive, toxic]

- > Media with the potential to effuse and cause corrosion of the braid reinforcement and fitting materials. These chemicals are all gases while at atmospheric pressure and a temperature of +56°F [+13°C] or lower.

Some of these chemicals are:

- > Acetylene [Flammable]
- > Butadiene [Flammable]
- > Butane Gas [Flammable]
- > Carbon Monoxide [Toxic, Flammable]
- > Chlorine [Toxic, Corrosive]
- > Chlorine Trifluoride [Toxic, Corrosive]
- > Ethyl Chloride [Toxic, Corrosive]
- > Hydrogen [Flammable]
- > Hydrogen Chloride [Corrosive, Toxic]
- > Hydrogen Sulfide [Flammable, Toxic]
- > Hydrocyanic Acid [Flammable, Toxic]
- > Hydrogen Cyanide [Flammable, Toxic]
- > Coke Oven Gas [Flammable, Toxic]
- > Natural Gas [Flammable, Toxic]
- > Propane Gas [Flammable]
- > Sulfur Dioxide [Corrosive]
- > Vinyl Chloride Monomer [Toxic, Corrosive]

It is important that hose assemblies used in these applications are installed in well-vented areas to avoid potential problems for personnel and/or equipment.

EQUIPMENT
HOSE/CPLG. SELECTION
G8K COUPLINGS
GLOBAL SPIRAL COUPLINGS
STAINLESS STEEL SPIRAL
MEGACRIMP COUPLINGS
STAINLESS STEEL BRAID
POWER CRIMP COUPLINGS
FIELD ATTACHABLE G1 & G2 COUPLINGS
FIELD ATTACHABLE C5 COUPLINGS
GLX COUPLINGS
GL COUPLINGS
C14 COUPLINGS
PCTS THERMOPLASTIC COUPLINGS
POLARSEAL COUPLINGS
POLARSEAL II COUPLINGS
POWER STEERING
ADAPTERS
QUICK DISCONNECT COUPLERS
BALL VALVES
LIVE SWIVEL
ASSEMBLY FABRICATION
ACCESSORIES
EQUIPMENT AND PARTS
AIR BRAKE
BRASS
KITS

Hydraulic System Pressure Drop

EQUIPMENT
HOSE/CPLG. SELECTION
G8K COUPLINGS
GLOBAL SPIRAL COUPLINGS
STAINLESS STEEL SPIRAL
MEGACRIMP COUPLINGS
STAINLESS STEEL BRAID
POWER CRIMP COUPLINGS
FIELD ATTACHABLE G1 & G2 COUPLINGS
FIELD ATTACHABLE C5 COUPLINGS
GLX COUPLINGS
GL COUPLINGS
C14 COUPLINGS
PCTS THERMOPLASTIC COUPLINGS
POLARSEAL COUPLINGS
POLARSEAL II COUPLINGS
POWER STEERING
ADAPTERS
QUICK DISCONNECT COUPLERS
BALL VALVES
LIVE SWIVEL
ASSEMBLY FABRICATION
ACCESSORIES
EQUIPMENT AND PARTS
AIR BRAKE
BRASS
KITS

WHAT IS PRESSURE DROP?

Friction is defined as the resistance an object encounters in moving over another. Solids, liquids, and gasses all exhibit friction in their motion. In hose and piping systems the result of this friction is pressure drop and heat generation that may be accurately estimated with engineering models.

WHY DOES PRESSURE DROP MATTER?

If there is excessive pressure drop in a system pumps, will have to work harder, use more energy, and the working fluid will increase in temperature. Depending on the source of the additional pressure loss it could: raise the whole system pressure, increasing wear and introducing potentially dangers over pressure conditions; render some tools or equipment functions inoperable, because of inadequate operation pressure; or create damaging cavitation and loss of net positive suction head [NPSH].

WHAT AFFECTS PRESSURE DROP?

The factors which contribute pressure loss may be broken down into two general categories: mechanical components and fluid properties. Mechanical components such as valves, flow meters, quick disconnects, adapters, couplings, tubing, hose, etc., all contribute to pressure loss. The amount of pressure loss in mechanical components is impacted by criteria such as cross sectional area, internal surface roughness, length, bends, and geometric complexity. Fluid properties such as density, viscosity, heat capacity and bulk modulus will also contribute to pressure loss. Fluid properties are impacted by temperature, pressure, contamination, air entrainment, and time.

While all of these components contribute to pressure loss, fluid velocity has the most impact. Fluid velocity is a direct product of flow rate and cross sectional area.

WHAT CAN BE DONE TO REDUCE PRESSURE DROP?

- > Check system pressure drop when non-identical replacement parts are required or there is ongoing system problems.
- > Use straight adapters and bent couplings whenever possible.
- > Replace worn parts and old fluids.
- > Lower the fluid velocity.

HOW CAN I CALCULATE PRESSURE DROP FOR A HOSE ASSEMBLY?

With some basic system information reliable pressure drop approximations may be readily calculated. First determine the applicable mechanical components and fluid for the analysis (doing 1 hose assembly at a time is recommended), then enter those values into the Gates online pressure drop calculator. Hose assembly information: Inside Diameter, Length, Couplings, Adapters

Fluid information: Density, Viscosity, and Heat Capacity [these may be estimated with fluid type and temperature]

Fahrenheit-Celsius Conversion

Look up a temperature reading in the middle column [shaded]. If it's in degrees Centigrade, read the Fahrenheit equivalent in the right-hand column. If it's in degrees Fahrenheit, read the Centigrade equivalent in the left-hand column.

C	FC	F
-68	-90	-130
-62	-80	-112
-57	-70	-94
-51	-60	-76
-46	-50	-58
-40	-40	-40
-34	-30	-22
-29	-20	-4
-23	-10	14
-17.8	0	32
-17.2	1	33.8
-16.7	2	35.6
-16.1	3	37.4
-15.6	4	39.2
-15.0	5	41.0
-14.4	6	42.8
-13.9	7	44.6
-13.3	8	46.4
-12.8	9	48.2
-12.2	10	50.0
-11.7	11	51.8
-11.1	12	53.6
-10.6	13	55.4
-10.0	14	57.2
-9.4	15	59.0
-8.9	16	60.8
-8.3	17	62.6
-7.8	18	64.4
-7.2	19	66.2
-6.7	20	68.0
-6.1	21	69.8
-5.6	22	71.6
-5.0	23	73.4
-4.4	24	75.2
-3.9	25	77.0
-3.3	26	78.8
-2.8	27	80.6
-2.2	28	82.4
-1.7	29	84.2
-1.1	30	86.0
-6	31	87.8
0	32	89.6
.6	33	91.4
1.1	34	93.2
1.7	35	95.0
2.2	36	96.8
2.8	37	98.6
3.3	38	100.4
3.9	39	102.2
4.4	40	104.0

C	FC	F
5.0	41	105.8
5.6	42	107.6
6.1	43	109.4
6.7	44	111.2
7.2	45	113.0
7.8	46	114.8
8.3	47	116.6
8.9	48	118.4
9.4	49	120.2
10.0	50	122.0
10.6	51	123.8
11.1	52	125.6
11.7	53	127.4
12.2	54	129.2
12.8	55	131.0
13.3	56	132.8
13.9	57	134.6
14.4	58	136.4
15.0	59	138.2
15.6	60	140.0
16.1	61	141.8
16.7	62	143.6
17.2	63	145.4
17.8	64	147.2
18.3	65	149.0
18.9	66	150.8
19.4	67	152.6
20.0	68	154.4
20.6	69	156.2
21.1	70	158.0
21.7	71	159.8
22.2	72	161.6
22.8	73	163.4
23.3	74	165.2
23.9	75	167.0
24.4	76	168.8
25.0	77	170.6
25.6	78	172.4
26.1	79	174.2
26.7	80	176.0
27.2	81	177.8
27.8	82	179.6
28.3	83	181.6
28.9	84	183.2
29.4	85	185.0
30.0	86	186.8
30.6	87	188.6
31.1	88	190.4
31.7	89	192.2
32.2	90	194.0
32.8	91	195.8

C	FC	F
33.3	92	197.6
33.9	93	199.4
34.4	94	201.2
35.0	95	203.0
35.6	96	204.8
36.1	97	206.6
36.7	98	208.4
37.2	99	210.2
37.8	100	212.0
43	110	230
49	120	248
54	130	266
60	140	284
66	150	302
71	160	320
77	170	338
82	180	356
88	190	374
93	200	392
99	210	410
100	212	413.6
104	220	428
110	230	446
116	240	464
121	250	482
127	260	500
132	270	518
138	280	536
143	290	554
149	300	572
154	310	590
160	320	608
166	330	626
170	338	640
171	340	644
177	350	662
182	360	680
186	366	691
188	370	698
193	380	716
198	388	730
199	390	734
204	400	752
208	406	763
210	410	770
216	420	788
221	430	806
227	440	824
232	450	842

EQUIPMENT
HOSE/CPLG. SELECTION
G&K COUPLINGS
GLOBAL SPIRAL COUPLINGS
STAINLESS STEEL SPIRAL
MEGACRIMP COUPLINGS
STAINLESS STEEL BRAID
POWER CRIMP COUPLINGS
FIELD ATTACHABLE G1 & G2 COUPLINGS
FIELD ATTACHABLE C5 COUPLINGS
GLX COUPLINGS
GL COUPLINGS
C14 COUPLINGS
PCTS THERMOPLASTIC COUPLINGS
POLARSEAL COUPLINGS
POLARSEAL II COUPLINGS
POWER STEERING
ADAPTERS
QUICK DISCONNECT COUPLERS
BALL VALVES
LIVE SWIVEL
ASSEMBLY FABRICATION
ACCESSORIES
EQUIPMENT AND PARTS
AIR BRAKE
BRASS
KITS

Conversions

PRESSURE CONVERSIONS

Metric to PSI [1 kPa = .145 psi]

PSI to Metric [1 psi = 6.89 kPa]

	Kilo Pascals [kPa]	Mega Pascals [MPa]	Bar [Bar]	Pounds per Square Inch [psi]	Pounds per Square Inch [psi]	Kilo Pascals [kPa]	Mega Pascals [MPa]	Bar [Bar]
STAINLESS STEEL SPIRAL	100	0.1	1	14.5	10	68.9	0.07	0.7
	200	0.2	2	29.0	20	137.9	0.14	1.4
MEGACRIMP COUPLINGS	300	0.3	3	43.5	30	206.8	0.21	2.1
	400	0.4	4	58.0	40	275.8	0.28	2.8
	500	0.5	5	72.5	50	344.7	0.34	3.4
STAINLESS STEEL BRAID	600	0.6	6	87.0	60	413.7	0.41	4.1
	700	0.7	7	101.5	70	482.6	0.48	4.8
	800	0.8	8	116.0	80	551.6	0.55	5.5
POWER CRIMP COUPLINGS	900	0.9	9	130.5	90	620.5	0.62	6.2
	1,000	1.0	10	145.0	100	689	0.7	6.9
	2,000	2.0	20	290.1	200	1,379	1.4	13.8
FIELD ATTACHABLE G1 & G2 COUPLINGS	3,000	3.0	30	435.1	300	2,068	2.1	20.7
	4,000	4.0	40	580.2	400	2,758	2.8	27.6
	5,000	5.0	50	725.2	500	3,447	3.4	34.5
FIELD ATTACHABLE C5 COUPLINGS	6,000	6.0	60	870.2	600	4,137	4.1	41.4
	7,000	7.0	70	1,015.3	700	4,826	4.8	48.3
	8,000	8.0	80	1,160.3	800	5,516	5.5	55.2
	9,000	9.0	90	1,305.3	900	6,205	6.2	62.1
GLX COUPLINGS	10,000	10	100	1,450	1,000	6,895	6.9	68.9
	20,000	20	200	2,901	2,000	13,790	13.8	137.9
GL COUPLINGS	30,000	30	300	4,351	3,000	20,684	20.7	206.8
	40,000	40	400	5,802	4,000	27,579	27.6	275.8
C14 COUPLINGS	50,000	50	500	7,252	5,000	34,474	34.5	344.7
	60,000	60	600	8,702	6,000	41,369	41.4	413.7
PCTS THERMOPLASTIC COUPLINGS	70,000	70	700	10,153	7,000	48,263	48.3	482.6
	80,000	80	800	11,603	8,000	55,158	55.2	551.6
	90,000	90	900	13,053	9,000	62,053	62.1	620.5
	100,000	100	1000	14,504	10,000	68,948	68.9	689
POLARSEAL COUPLINGS	200,000	200	2000	29,008	20,000	137,895	137.9	1,379
	300,000	300	3000	43,511	30,000	206,843	206.8	2,068
					40,000	275,790	275.8	2,758

EXAMPLES

(A) Convert 3,429 psi to the equivalent pressure in Bar.

(B) Convert 3,429 psi to the equivalent pressure in MPa.

	3,000 psi	=	206.8 Bar
+	400 psi	=	27.6 Bar
+	20 psi	=	1.4 Bar
+	9 psi	=	.62 Bar
<hr/>			
	3429 psi	=	236.42 Bar

	3,000 psi	=	20.680 MPa
+	400 psi	=	2.760 MPa
+	20 psi	=	.140 MPa
+	9 psi	=	.062 MPa
<hr/>			
	3,429 psi	=	23.642 MPa

FAHRENHEIT-CELSIUS CONVERSION

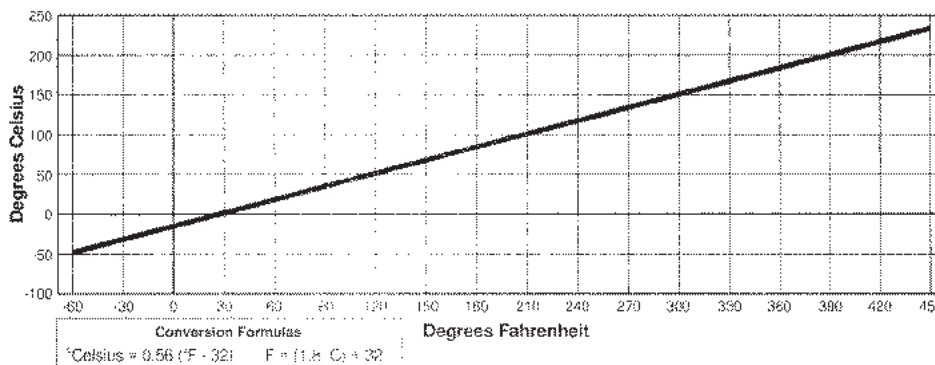

DECIMAL AND MILLIMETER FRACTION EQUIVALENTS

Inches			Inches			Inches		
Fractions	Decimals	Millimeters	Fractions	Decimals	Millimeters	Fractions	Decimals	Millimeters
1/64	.015625	.397	23/64	.359375	9.128	11/16	.6875	17.463
1/32	.03125	.794	3/8	.375	9.525	45/64	.703125	17.859
3/64	.046875	1.191	25/64	.390625	9.922	23/32	.71875	18.256
1/16	.0625	1.588	13/32	.40625	10.319	47/64	.734375	18.653
5/64	.078125	1.984	27/64	.421875	10.716	3/4	.750	19.050
3/32	.09375	2.381	7/16	.4375	11.113	49/64	.765625	19.447
7/64	.109375	2.778	29/64	.453125	11.509	25/32	.78125	19.844
1/8	.125	3.175	15/32	.46875	11.906	51/64	.796875	20.241
9/64	.140625	3.572	31/64	.484375	12.303	13/16	.8125	20.638
5/32	.15625	3.969	1/2	.500	12.700	53/64	.828125	21.034
11/64	.171875	4.366	33/64	.515625	13.097	27/32	.84375	21.431
3/16	.1875	4.763	17/32	.53125	13.494	55/64	.859375	21.828
13/64	.203125	5.159	35/64	.546875	13.891	7/8	.875	22.225
7/32	.21875	5.556	9/16	.5625	14.288	57/64	.890625	22.622
15/64	.234375	5.953	37/64	.578125	14.684	29/32	.90625	23.019
1/4	.250	6.350	19/32	.59375	15.081	59/64	.921875	23.416
17/64	.265625	6.747	39/64	.609375	15.478	15/16	.9375	23.813
9/32	.28125	7.144	5/8	.625	15.875	61/64	.953125	24.209
19/64	.296875	7.541	41/64	.640625	16.272	31/32	.96875	24.606
5/16	.3125	7.938	21/32	.65625	16.669	63/64	.984375	25.003
						1	1.000	25.400

METRIC (SI) — U.S. UNITS FOR FLUID POWER USE

[The following conversions are based on information taken from ASTM, American Society for Testing and Materials, Handbook E380-72.]

Quantity	Customary U.S. Unit	SI Unit	Conversion from U.S. to SI Units	Conversion from SI to U.S. Units
Area	Square Inch [in ²]	Square Metre [m ²]	[in ²] x [6.4516 x 10 ⁻⁴] = [m ²]	[m ²] x 1550.003 = [in ²]
Force	Pound [lb _f]	Newton [N]	[lb _f] x 4.4482 = [N]	[N] x [2.2481 x 10 ⁻¹] = [lb _f]
Frequency	Cycles/Second [cps]	Hertz [H _z]	1 [cps] = 1[H _z]	1[Hz] = 1[cps]
Length	Inch [in]	Metre [m]	[in] x [2.540 x 10 ⁻²] = [m]	[m] x 39.370 = [in]
Mass	Pound [lb _m]	Kilogram [kg]	[lb _m] x .4536 = [kg]	[kg] x 2.2046 = [lb _m]
Power	Electric Horsepower [HP]	Watt [W]	[HP] x [7.460 x 10 ²] = [W]	[W] x [1.3405 x 10 ⁻³] = [HP]
	Pounds/Sq In [psi]	Newtons/Sq Metre [N/m ²]	[psi] x [6.8948 x 10 ³] = [N/m ²]	[N/m ²] x [1.4504 x 10 ⁻⁴] = [psi]
Pressure	[Non-Preferred Conversions]			
	[psi]	Mega Pascal [MPa]	[psi]/145 = MPa	[MPa] x 145 = [psi]
	[psi]	Bar [Bar]	psi/14.5 = Bar	[Bar] x [1.4504 x 10 ¹] = [psi]
	[Bar]	[N/m ²]	[Bar] x 100,000 = [N/m ²]	[N/m ²] x [1.00 x 10 ⁻⁵] = [Bar]
Temperature	Degrees Fahrenheit [°F]	Degrees Celsius [°C]	[°Celsius] = 0.556[°F-32]	[1.8°C] + 32 = °F
Torque	Pound-Inch [lb _f -in]	Newton-Metres [N-m]	[lb _f -in] x [1.1298 x 10 ⁻¹] = [N-m]	[N-m] x 8.8507 = [lb _f -in]
	US Gallon [Gal]	Cubic Metre [m ³]	[Gal] x [3.7854 x 10 ⁻³] = [m ³]	[m ³] x [2.6417 x 10 ²] = [Gal]
Volume	[Non-Preferred Conversions]			
		Litre [l]	[Gal] x 3.7854 = [l]	[l] x [2.6417 x 10 ⁻¹] = [Gal]
Work	Foot-Pound [ft-lb _f]	Joule [J]	[ft-lb _f] x 1.3558 = [J]	[J] x [7.3756 x 10 ⁻¹] = [ft-lb _f]

EQUIPMENT

HOSE/CPLG.
SELECTION

G&K COUPLINGS

GLOBAL SPIRAL
COUPLINGSSTAINLESS
STEEL SPIRALMEGACRIMP
COUPLINGSSTAINLESS
STEEL BRAIDPOWER CRIMP
COUPLINGSFIELD
ATTACHABLE G1
& G2 COUPLINGSFIELD
ATTACHABLE C5
COUPLINGS

GLX COUPLINGS

GL COUPLINGS

C14 COUPLINGS

PCTS
THERMOPLASTIC
COUPLINGSPOLAR SEAL
COUPLINGSPOLAR SEAL II
COUPLINGSPOWER
STEERING

ADAPTERS

QUICK
DISCONNECT
COUPLERS

BALL VALVES

LIVE SWIVEL

ASSEMBLY
FABRICATION

ACCESSORIES

EQUIPMENT AND
PARTS

AIR BRAKE

BRASS

KITS

Tightening and Torque Recommendations for Hydraulic Couplings

EQUIPMENT
HOSE/CPLG. SELECTION
G8K COUPLINGS
GLOBAL SPIRAL COUPLINGS
STAINLESS STEEL SPIRAL
MEGACRIMP COUPLINGS
STAINLESS STEEL BRAID
POWER CRIMP COUPLINGS
FIELD ATTACHABLE G1 & G2 COUPLINGS
FIELD ATTACHABLE C5 COUPLINGS
GLX COUPLINGS
GL COUPLINGS
C14 COUPLINGS
PCTS THERMOPLASTIC COUPLINGS
POLARSEAL COUPLINGS
POLARSEAL II COUPLINGS
POWER STEERING
ADAPTERS
QUICK DISCONNECT COUPLERS
BALL VALVES
LIVE SWIVEL
ASSEMBLY FABRICATION
ACCESSORIES
EQUIPMENT AND PARTS
AIR BRAKE
BRASS
KITS

1. Determine the correct torque value for your coupling using the manufacturers' recommendations. The minimum torque values are adequate for sealing in most applications; never exceed the maximum torque recommendations. Only use manufacturer specified torque values; do not use SAE recommendations.
2. Calculate the correct torque wrench setting. Wrench Setting = Desired Torque * L / LA [see Figure 1]
3. Ensure that the seal face and threads are clean and in good condition. O-rings should be lubricated with light oil, but threads should be completely dry unless making a tapered pipe thread connection [interference seal].
4. If the assembly has a male connector on one end, install the male connector first.
5. Hand tighten the connection by bringing seal face in contact and rotating the nut by hand until it stops, approximately 0.3-1 ft-lb.
6. Mark the coupling nut and backup hex with a line for flats method of torque verification.
7. Apply a wrench to the backup hex to prevent the coupling and hose from moving while tightening the nut with a torque wrench. Failure to retain the backup hex during installation can cause hose twisting and will result in additional clamp load force that can cause seal face damage.
8. While keeping the backup hex secure apply the torque wrench to the fitting nut and pull until the proper torque is achieved. The coupling nut must be in motion when the final torque is achieved, otherwise the nut must be loosened and retightened until the torque is attained while the nut is in motion.
9. If a torque wrench cannot fit into the coupling area or if it is unavailable, flats method may be used to ensure that JIC couplings are properly tightened, as shown in figure 2. Checking flats is also a good method of ensuring that critical connections have been properly tightened.

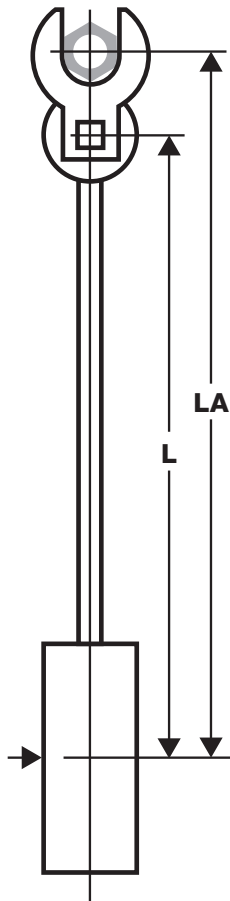

Figure 1 - Torque wrench adjustment when using a crowfoot wrench. Torque Wrench Setting = Desired Torque * L / LA

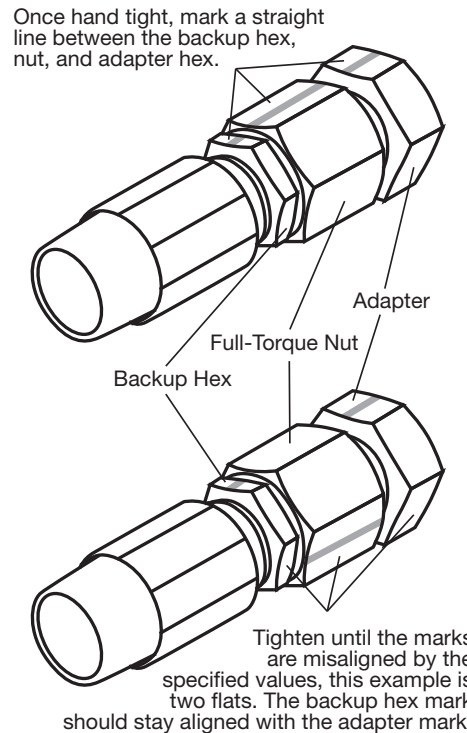

Figure 2 - Flats method of verifying coupling torque.

Coupling and Adapter Installation Torque Recommendations

JIC, SAE 45°, ORFS, O-RING BOSS, GATES ADAPTERLESS, & MEGASEAL®

Dash Size 1/16 inch	JIC 37°, SAE 45° & MegaSeal (Steel)		JIC 37°, SAE 45° & MegaSeal (Brass)		Flat Face O-Ring Seal (Steel)		SAE O-Ring Boss (Steel) & Gates Adapterless ≤ 4000 PSI		SAE O-Ring Boss (Steel) & Gates Adapterless > 4000 PSI	
	ft-lb		ft-lb		ft-lb		ft-lb		ft-lb	
	Min	Max	Min	Max	Min	Max	Min	Max	Min	Max
-3								8	10	
-4	10	11	5	6	10	12	14	16	14	16
-5	13	15	7	9					18	20
-6	17	19	12	15	18	20	24	26	24	26
-8	34	38	20	24	32	40	37	44	50	60
-10	50	56	34	40	46	56	50	60	72	80
-12	70	78	53	60	65	80	75	83	125	135
-14					65	80			160	180
-16	94	104	74	82	92	105	111	125	200	220
-20	124	138	75	83	125	140	133	152	210	280
-24	156	173	79	87	150	180	156	184	270	360
-32	219	243	158	175						

DIN 24/60 & INVERTED CONE

Size mm		Torque ft-lb	
Light Tube O.D.	Heavy Tube O.D.	Min	Max
6		7	15
8		15	26
10	8	18	30
12	10	22	33
14	12	26	37
15	14	30	52
	16	30	52
18	20	44	74
22	25	59	89
28	30	74	111
	38	74	162
35		133	184
42		148	221

BSP 30° & JIS

Dash Size 1/16 inch	Torque ft-lb	
	Min	Max
-2	7	9
-4	11	18
-6	19	28
-8	30	36
-10	37	44
-12	50	60
-16	79	95
-20	127	152
-24	167	190
-32	262	314

4-BOLT FLANGES

Dash Size 1/16 inch	Bolt Size inch	Torque ft-lb
-8	0.31	17
-12	0.38	26
-16	0.44	43
-20	0.5	65
-24	0.63	130
-32	0.75	220

Note:
1. Align faces and finger tighten bolts before applying final torque in a pattern. The seal faces must be parallel with even bolt tension to seal properly.
2. Torque values apply to bolts which are plated or coated in light engine oil.
3. Before assembly lubricate O-ring with light oil [SAE 10W or 20W].

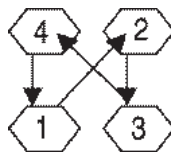

SAE MALE FLARELESS ASSEMBLY (MFA)

After hand tight (when the sleeve bites the tube) rotate nut one full turn (eight flats).

NPTF

Dash Size 1/16 inch	Max Torque ft-lb
-2	20
-4	25
-6	35
-8	45
-12	55
-16	65
-20	80
-24	95
-32	120

Note:
1. The torque values obtained from tightening pipe threads can vary considerably depending on thread condition. Adequate sealing can occur at values much lower than the maximum values listed above. Only enough torque to achieve adequate sealing should be used.
2. When using a male tapered pipe thread with a female straight or parallel pipe thread, maximum values are 50% of those listed in the table.
3. If thread sealant is used, maximum values shown should be decreased by 25%.

FLATS METHOD VALUES

Termination Type	Dash Size 1/16 in	Flats
JIS	4	0.5 - 1.5
JIC	4	1.5 - 1.75
JIC	6	1.0 - 1.5
JIC	8	1.5 - 1.75
JIC	10	1.0 - 1.5
JIC	12	1.0 - 1.5
JIC	16	.75 - 1.0
JIC	20	.75 - 1.0
JIC	24	.75 - 1.0
JIC	32	.75 - 1.0

Note:
1. Seal faces must be in contact and the fitting fully hand tightened before marking flats.
2. Flats method is most accurate for the first assembly cycle, for multiple disassembly/assembly cycles torque values are more reliable.
3. Tightening two flats or more is analogous to severe over torque and may damage seal faces.

Conversion	Formula
ft-lb to N-m	[ft-lb]*1.3558 = [N-m]
ft-lb to in-lb	[ft-lb]*12 = [in-lb]
N-m to in-lb	[N-m]*8.8508 = [in-lb]

EQUIPMENT

HOSE/CPLG. SELECTION

G&K COUPLINGS

GLOBAL SPIRAL COUPLINGS

STAINLESS STEEL SPIRAL

MEGACRIMP COUPLINGS

STAINLESS STEEL BRAID

POWER CRIMP COUPLINGS

FIELD ATTACHABLE G1 & G2 COUPLINGS

FIELD ATTACHABLE C5 COUPLINGS

GLX COUPLINGS

GL COUPLINGS

C14 COUPLINGS

PCTS THERMOPLASTIC COUPLINGS

POLARSEAL COUPLINGS

POLARSEAL II COUPLINGS

POWER STEERING

ADAPTERS

QUICK DISCONNECT COUPLERS

BALL VALVES

LIVE SWIVEL

ASSEMBLY FABRICATION

ACCESSORIES

EQUIPMENT AND PARTS

AIR BRAKE

BRASS

KITS

NOTES

EQUIPMENT
HOSE/CPLG. SELECTION
G8K COUPLINGS
GLOBALSPIRAL COUPLINGS
STAINLESS STEEL SPIRAL
MEGACRIMP COUPLINGS
STAINLESS STEEL BRAID
POWER CRIMP COUPLINGS
FIELD ATTACHABLE G1 & G2 COUPLINGS
FIELD ATTACHABLE C5 COUPLINGS
GLX COUPLINGS
GL COUPLINGS
C14 COUPLINGS
PCTS THERMOPLASTIC COUPLINGS
POLARSEAL COUPLINGS
POLARSEAL II COUPLINGS
POWER STEERING
ADAPTERS
QUICK DISCONNECT COUPLERS
BALL VALVES
LIVE SWIVEL
ASSEMBLY FABRICATION
ACCESSORIES
EQUIPMENT AND PARTS
AIR BRAKE
BRASS
KITS

Hydraulic Hose For G8K Couplings



The Gates eCrimp program is a web based utility which allows users and distributors of Gates hydraulic and industrial hose products to find and print the most up to date crimp specifications with nothing more than an internet browser.

This program can be used to find crimp data for the MobileCrimp 4-20, PC 707, SC32, PC 3000B, GC32-XD™ Global Hose Crimper, GC96 and Omni Crimp 21. Custom result may be printed by selecting the crimper, hose and coupling. Optionally results may also be limited by die set and working pressure.



The eCrimp mobile app gives you all the same features of the online version in the palm of your hands. Use the app to find the most up-to-date crimp specifications quickly and easily. It is available for download for the iPhone and iPad from the App Store.

EQUIPMENT
HOSE/CPLG. SELECTION
G8K COUPLINGS
GLOBAL SPIRAL COUPLINGS
STAINLESS STEEL SPIRAL
MEGACRIMP COUPLINGS
STAINLESS STEEL BRAID
POWER CRIMP COUPLINGS
FIELD ATTACHABLE G1 & G2 COUPLINGS
FIELD ATTACHABLE C5 COUPLINGS
GLX COUPLINGS
GL COUPLINGS
C14 COUPLINGS
PCTS THERMOPLASTIC COUPLINGS
POLARSEAL COUPLINGS
POLARSEAL II COUPLINGS
POWER STEERING
ADAPTERS
QUICK DISCONNECT COUPLERS
BALL VALVES
LIVE SWIVEL
ASSEMBLY FABRICATION
ACCESSORIES
EQUIPMENT AND PARTS
AIR BRAKE
BRASS
KITS

EQUIPMENT
HOSE/CPLG. SELECTION
G8K COUPLINGS
GLOBALSPIRAL COUPLINGS
STAINLESS STEEL SPIRAL
MEGACRIMP COUPLINGS
STAINLESS STEEL BRAID
POWER CRIMP COUPLINGS
FIELD ATTACHABLE G1 & G2 COUPLINGS
FIELD ATTACHABLE C5 COUPLINGS
GLX COUPLINGS
GL COUPLINGS
C14 COUPLINGS
PCTS THERMOPLASTIC COUPLINGS
POLARSEAL COUPLINGS
POLARSEAL II COUPLINGS
POWER STEERING
ADAPTERS
QUICK DISCONNECT COUPLERS
BALL VALVES
LIVE SWIVEL
ASSEMBLY FABRICATION
ACCESSORIES
EQUIPMENT AND PARTS
AIR BRAKE
BRASS
KITS

Caterpillar Style O-Ring Flange

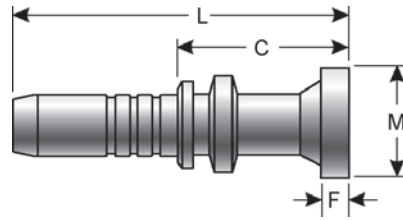

Part No.	Descr.	Prod. No.	⊖		M		L		C		F	
			"	mm	"	mm	"	mm	"	mm	"	mm
G19400-1212	12G8K-12FLC	7347-80215	3/4	19.1	1.62	41.2	5.93	150.6	2.95	75.0	.56	14.2
G19400-1616	16G8K-16FLC	7347-80015	1	25.4	1.87	47.5	5.64	143.3	2.96	75.2	.56	14.2

Caterpillar Style O-Ring Flange - 45° Bent Tube

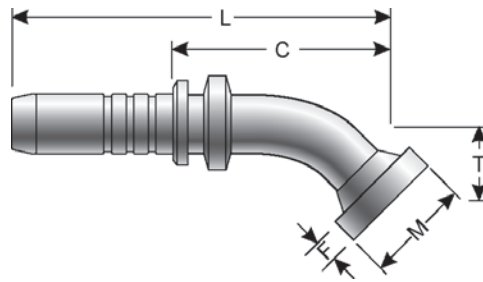

Part No.	Descr.	Prod. No.	⊖		M		T		L		C		F	
			"	mm	"	mm	"	mm	"	mm	"	mm	"	mm
G19407-1212	12G8K-12FLC45-034	7347-80225	3/4	19.1	1.62	41.2	1.35	34.3	6.65	168.9	3.68	93.5	.56	14.2
G19407-1616	16G8K-16FLC45-050	7347-80025	1	25.4	1.87	47.5	1.97	50.0	7.76	197.1	5.08	129.0	.56	14.2

Caterpillar Style O-Ring Flange - 90° Bent Tube

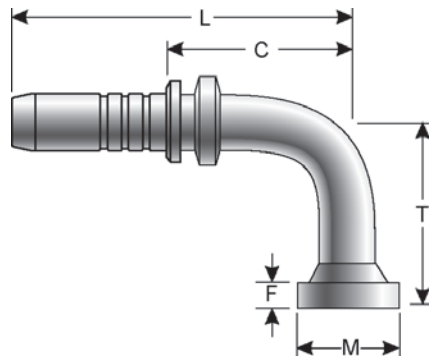

Part No.	Descr.	Prod. No.	⊖		M		T		L		C		F	
			"	mm	"	mm	"	mm	"	mm	"	mm	"	mm
G19415-1212	12G8K-12FLC90-070	7347-80235	3/4	19.1	1.62	41.2	2.76	70.1	6.18	157.0	3.22	81.8	.56	14.2
G19415-1616	16G8K-16FLC90-093	7347-80055	1	25.4	1.87	47.5	3.66	93.0	6.46	164.1	3.79	96.3	.56	14.2

G8K Couplings

Caterpillar Style O-Ring Flange - 90° Bent Tube - Continued

Part No.	Descr.	Prod. No.	⊖		M		T		L		C		F	
			"	mm	"	mm	"	mm	"	mm	"	mm	"	mm
G19416-1616	16G8K-16FLC90-117	7347-80045	1	25.4	1.87	47.5	4.61	117.1	6.46	164.1	3.79	96.3	.56	14.2

G8K Ferrule for G8K Spiral Hose

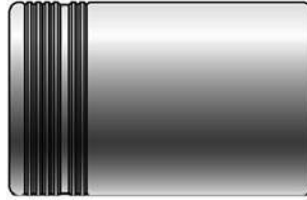

Part No.	Descr.	Prod. No.	⊖		L	
			"	mm	"	mm
G19995-0012	12G8K1F	7347-80205	3/4	19.1	2.56	65.0
G19995-0016	16G8K1F	7347-80065	1	25.4	2.60	66.0

EQUIPMENT

HOSE/CPLG.
SELECTION

G8K COUPLINGS

GLOBALSPIRAL
COUPLINGS

STAINLESS
STEEL SPIRAL

MEGACRIMP
COUPLINGS

STAINLESS
STEEL BRAID

POWER CRIMP
COUPLINGS

FIELD
ATTACHABLE G1
& G2 COUPLINGS

FIELD
ATTACHABLE C5
COUPLINGS

GLX COUPLINGS

GL COUPLINGS

C14 COUPLINGS

PCTS
THERMOPLASTIC
COUPLINGS

POLARSEAL
COUPLINGS

POLARSEAL II
COUPLINGS

POWER
STEERING

ADAPTERS

QUICK
DISCONNECT
COUPLERS

BALL VALVES

LIVE SWIVEL

ASSEMBLY
FABRICATION

ACCESSORIES

EQUIPMENT AND
PARTS

AIR BRAKE

BRASS

KITS

NOTES

EQUIPMENT
HOSE/CPLG. SELECTION
G8K COUPLINGS
GLOBALSPIRAL COUPLINGS
STAINLESS STEEL SPIRAL
MEGACRIMP COUPLINGS
STAINLESS STEEL BRAID
POWER CRIMP COUPLINGS
FIELD ATTACHABLE G1 & G2 COUPLINGS
FIELD ATTACHABLE C5 COUPLINGS
GLX COUPLINGS
GL COUPLINGS
C14 COUPLINGS
PCTS THERMOPLASTIC COUPLINGS
POLARSEAL COUPLINGS
POLARSEAL II COUPLINGS
POWER STEERING
ADAPTERS
QUICK DISCONNECT COUPLERS
BALL VALVES
LIVE SWIVEL
ASSEMBLY FABRICATION
ACCESSORIES
EQUIPMENT AND PARTS
AIR BRAKE
BRASS
KITS

Hydraulic Hose For GlobalSpiral™ Couplings



Also available with MegaTuff® cover

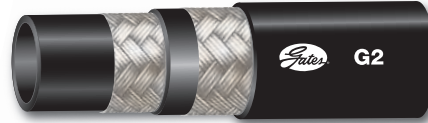

Also available with MegaTuff® cover



Also available with MegaTuff® cover



Also available with MegaTuff® cover

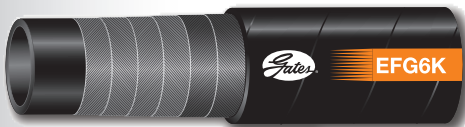
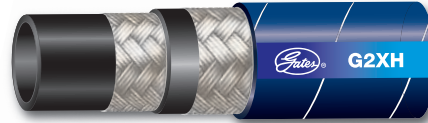

Also available with MegaTuff® cover



Also available with MegaTuff® cover

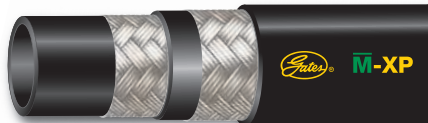
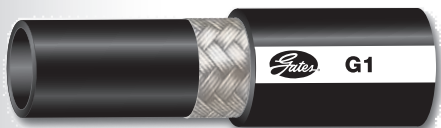

Also available with MegaTuff® and XraTuff™ cover

EQUIPMENT
HOSE/CPLG. SELECTION
G&K COUPLINGS
GLOBAL SPIRAL COUPLINGS
STAINLESS STEEL SPIRAL
MEGACRIMP COUPLINGS
STAINLESS STEEL BRAID
POWER CRIMP COUPLINGS
FIELD ATTACHABLE G1 & G2 COUPLINGS
FIELD ATTACHABLE C5 COUPLINGS
GLX COUPLINGS
GL COUPLINGS
C14 COUPLINGS
PCTS THERMOPLASTIC COUPLINGS
POLARSEAL COUPLINGS
POLARSEAL II COUPLINGS
POWER STEERING
ADAPTERS
QUICK DISCONNECT COUPLERS
BALL VALVES
LIVE SWIVEL
ASSEMBLY FABRICATION
ACCESSORIES
EQUIPMENT AND PARTS
AIR BRAKE
BRASS
KITS

Hydraulic Hose For GlobalSpiral™ Couplings - Continued

EQUIPMENT
HOSE/CPLG. SELECTION
G8K COUPLINGS
GLOBAL SPIRAL COUPLINGS
STAINLESS STEEL SPIRAL
MEGACRIMP COUPLINGS
STAINLESS STEEL BRAID
POWER CRIMP COUPLINGS
FIELD ATTACHABLE G1 & G2 COUPLINGS
FIELD ATTACHABLE C5 COUPLINGS
GLX COUPLINGS
GL COUPLINGS
C14 COUPLINGS
PCTS THERMOPLASTIC COUPLINGS
POLARSEAL COUPLINGS
POLARSEAL II COUPLINGS
POWER STEERING
ADAPTERS
QUICK DISCONNECT COUPLERS
BALL VALVES
LIVE SWIVEL
ASSEMBLY FABRICATION
ACCESSORIES
EQUIPMENT AND PARTS
AIR BRAKE
BRASS
KITS



Also available with MegaTuff® and XraTuff™ cover



Also available with MegaTuff® cover



Also available with MegaTuff® cover



Also available with MegaTuff® and XraTuff™ cover

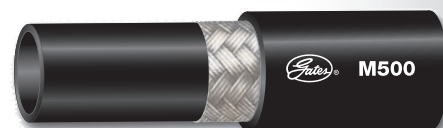

Also available with MegaTuff® and XraTuff™ cover



Also available with MegaTuff® and XraTuff™ cover

The Gates eCrimp program is a web based utility which allows users and distributors of Gates hydraulic and industrial hose products to find and print the most up to date crimp specifications with nothing more than an internet browser.

This program can be used to find crimp data for the MobileCrimp 4-20, PC 707, SC32, PC 3000B, GC32-XD™ Global Hose Crimper, GC96 and Omni Crimp 21. Custom result may be printed by selecting the crimper, hose and coupling. Optionally results may also be limited by die set and working pressure.



The eCrimp mobile app gives you all the same features of the online version in the palm of your hands. Use the app to find the most up-to-date crimp specifications quickly and easily. It is available for download for the iPhone and iPad from the App Store.

Male Pipe (NPTF - 30° Cone Seat)

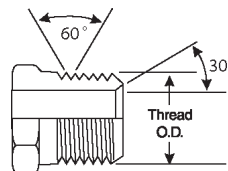
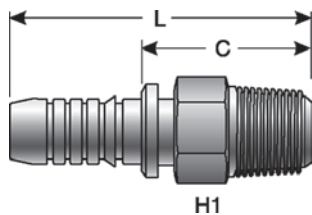

Part No.	Descr.	Prod. No.	⌀		H1	L		C		
			"	mm		"	mm	"	mm	
G20100-0606	6GS-6MP	7347-20145	3/8	9.5	3/8-18	11/16	2.72	69.1	1.31	33.3
G20100-0608	6GS-8MP	7347-20155	3/8	9.5	1/2-14	7/8	2.87	72.9	1.46	37.1
G20100-0808	8GS-8MP	7347-20245	1/2	12.7	1/2-14	7/8	2.91	73.9	1.43	36.3
G20100-0812	8GS-12MP	7347-20265	1/2	12.7	3/4-14	1 1/16	3.03	77.0	1.56	39.6
G20100-1008	10GS-8MP	7347-20335	5/8	15.9	1/2-14	15/16	3.35	85.1	1.34	34.0
G20100-1012	10GS-12MP	7347-20355	5/8	15.9	3/4-14	1 1/8	3.58	90.9	1.60	40.6
G20100-1208	12GS-8MP	7347-20425	3/4	19.1	1/2-14	1 1/16	3.54	89.9	1.54	39.1
G20100-1212	12GS-12MP	7347-20445	3/4	19.1	3/4-14	1 1/16	3.54	89.9	1.54	39.1
G20100-1216	12GS-16MP	7347-20465	3/4	19.1	1-11 1/2	1 3/8	3.82	97.0	1.81	46.0
G20100-1612	16GS-12MP	7347-20535	1	25.4	3/4-14	1 3/8	3.98	101.1	1.74	44.2
G20100-1616	16GS-16MP	7347-20555	1	25.4	1-11 1/2	1 3/8	4.17	105.9	1.94	49.3
G20100-1620	16GS-20MP	7347-20565	1	25.4	1 1/4-11 1/2	1 3/4	4.29	109.0	2.06	52.3
G20100-2020	20GS-20MP	7347-20645	1 1/4	31.8	1 1/4-11 1/2	1 3/4	5.00	127.0	2.20	55.9

API Line Pipe Connection

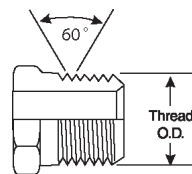
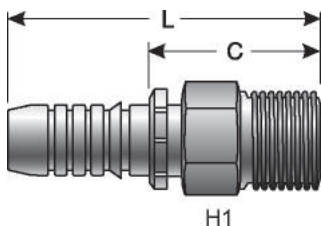

Part No.	Descr.	Prod. No.	⌀		H1	L		C		
			"	mm		"	mm	"	mm	
G20102-2020	20GS-20MPAPI	7347-76955	1 1/4	31.8	1 1/4-11 1/2	1 3/4	5.51	140.0	2.70	68.6

- EQUIPMENT
- HOSE/CPLG. SELECTION
- G&K COUPLINGS
- GLOBAL SPIRAL COUPLINGS**
- STAINLESS STEEL SPIRAL
- MEGACRIMP COUPLINGS
- STAINLESS STEEL BRAID
- POWER CRIMP COUPLINGS
- FIELD ATTACHABLE G1 & G2 COUPLINGS
- FIELD ATTACHABLE C5 COUPLINGS
- GLX COUPLINGS
- GL COUPLINGS
- C14 COUPLINGS
- PCTS THERMOPLASTIC COUPLINGS
- POLARSEAL COUPLINGS
- POLARSEAL II COUPLINGS
- POWER STEERING
- ADAPTERS
- QUICK DISCONNECT COUPLERS
- BALL VALVES
- LIVE SWIVEL
- ASSEMBLY FABRICATION
- ACCESSORIES
- EQUIPMENT AND PARTS
- AIR BRAKE
- BRASS
- KITS

Male Pipe (NPTF - 30° Cone Seat) - Long Hex

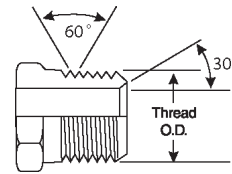
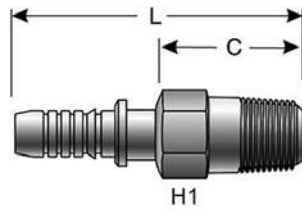

Part No.	Descr.	Prod. No.	⊖		H1	L		C		
			"	mm		"	"	mm	"	mm
G20103-1616	16GS-16MPLH	7347-76545	1	25.4	1-11 1/2	1 3/8	5.16	131.1	2.92	74.2

Male O-Ring Boss

SAE J1926/2 ISO 11926-2 Heavy Duty (S Series) Stud End.

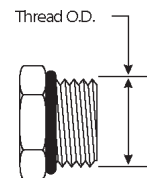
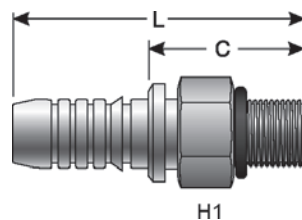

Part No.	Descr.	Prod. No.	⊖		H1	L		C			
			"	mm		"	"	mm	"	mm	
G20120-0606	6GS-6MB	7347-21145	3/8	9.5	9/16-18	11/16	2.56	65.0	1.15	29.2	
G20120-0808	8GS-8MB	7347-21245	1/2	12.7	3/4-16	7/8	2.76	70.1	1.26	32.0	
POLARSEAL II COUPLINGS	G20120-0810	8GS-10MB	1/2	12.7	7/8-14	1	2.83	71.9	1.34	34.0	
	G20120-1010	10GS-10MB	5/8	15.9	7/8-14	1	3.46	87.9	1.48	37.6	
	G20120-1012	10GS-12MB	7347-21355	5/8	15.9	1 1/16-12	1 1/4	3.46	87.9	1.48	37.6
POWER STEERING	G20120-1212	12GS-12MB	3/4	19.1	1 1/16-12	1 1/4	3.66	93.0	1.65	41.9	
	G20120-1216	12GS-16MB	7347-21465	3/4	19.1	1 5/16-12	1 1/2	3.54	89.9	1.54	39.1
ADAPTERS	G20120-1612	16GS-12MB	1	25.4	1 1/16-12	1 3/8	3.98	101.1	1.74	44.2	
	G20120-1616	16GS-16MB	7347-21555	1	25.4	1 5/16-12	1 1/2	3.86	98.1	1.62	41.2
QUICK DISCONNECT COUPLERS	G20120-1620	16GS-20MB	7347-21565	1	25.4	1 5/8-12	1 7/8	4.53	115.1	1.62	41.2
	G20120-2020	20GS-20MB	7347-21645	1 1/4	31.8	1 5/8-12	1 7/8	4.53	115.1	1.73	43.9

Female MegaSeal® Swivel

Gates High Performance Replacement for Female JIC Fittings – Connects to Standard Male JIC Termination.

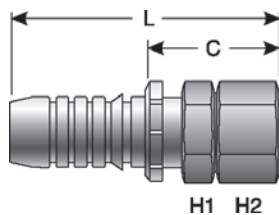

Part No.	Descr.	Prod. No.	⊖		🌀	H1	H2	L		C	
			"	mm				"	mm	"	mm
G20140-1212	12GS-12FMX	7347-69445	3/4	19.1	1 1/16-12	1 1/8	1 1/4	4.02	102.1	2.02	51.3
G20140-1216	12GS-16FMX	7347-69465	3/4	19.1	1 5/16-12	1 1/8	1 1/2	4.06	103.1	2.06	52.3
G20140-1616	16GS-16FMX	7347-69555	1	25.4	1 5/16-12	1 1/2	1 1/2	4.37	111.0	2.15	54.6
G20140-2020	20GS-20FMX	7347-69645	1 1/4	31.8	1 5/8-12	1 7/8	2	5.36	136.1	2.56	65.0

Female MegaSeal® Swivel - 45° Bent Tube

Gates High Performance Replacement for Female JIC Fittings – Connects to Standard Male JIC Termination.

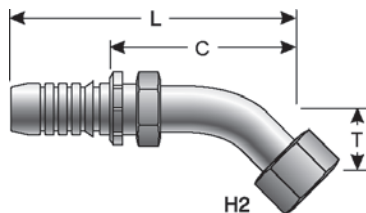

Part No.	Descr.	Prod. No.	⊖		🌀	H2	T		L		C	
			"	mm			"	mm	"	mm	"	mm
G20145-1212	12GS-12FMX45-032	7347-73275	3/4	19.1	1 1/16-12	1 1/4	1.26	32.0	5.08	129.0	3.07	78.0
G20145-1616	16GS-16FMX45-038	7347-70555	1	25.4	1 5/16-12	1 1/2	1.50	38.1	6.26	159.0	4.04	102.6
G20145-2020	20GS-20FMX45-041	7347-70645	1 1/4	31.8	1 5/8-12	2	1.61	40.9	7.47	189.7	4.67	118.6

Female MegaSeal® Swivel - 90° Bent Tube

Gates High Performance Replacement for Female JIC Fittings – Connects to Standard Male JIC Termination.

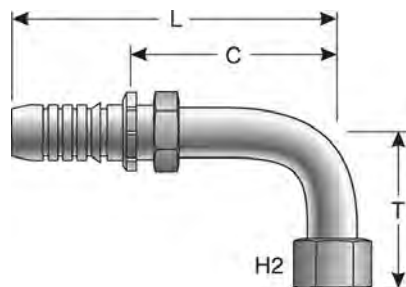

Part No.	Descr.	Prod. No.	⊖		🌀	H2	T		L		C	
			"	mm			"	mm	"	mm	"	mm
G20149-1212	12GS-12FMX90-048	7347-71445	3/4	19.1	1 1/16-12	1 1/4	1.89	48.0	4.72	119.9	2.72	69.1

EQUIPMENT
HOSE/CPLG. SELECTION
G8K COUPLINGS
GLOBAL SPIRAL COUPLINGS
STAINLESS STEEL SPIRAL
MEGACRIMP COUPLINGS
STAINLESS STEEL BRAID
POWER CRIMP COUPLINGS
FIELD ATTACHABLE G1 & G2 COUPLINGS
FIELD ATTACHABLE C5 COUPLINGS
GLX COUPLINGS
GL COUPLINGS
C14 COUPLINGS
PCTS THERMOPLASTIC COUPLINGS
POLARSEAL COUPLINGS
POLARSEAL II COUPLINGS
POWER STEERING
ADAPTERS
QUICK DISCONNECT COUPLERS
BALL VALVES
LIVE SWIVEL
ASSEMBLY FABRICATION
ACCESSORIES
EQUIPMENT AND PARTS
AIR BRAKE
BRASS
KITS

Female MegaSeal® Swivel - 90° Bent Tube - Continued

Part No.	Descr.	Prod. No.	⊖		H2	T		L		C		
			"	mm		"	"	"	mm	"	mm	
G20150-1212	12GS-12FMX90-058	7347-71395	3/4	19.1	1 1/16-12	1 1/4	2.28	57.9	4.72	119.9	2.72	69.1
G20151-1212	12GS-12FMX90-096	7347-71405	3/4	19.1	1 1/16-12	1 1/4	3.78	96.0	4.72	119.9	2.72	69.1
G20150-1216	12GS-16FMX90-056	7347-71465	3/4	19.1	1 5/16-12	1 1/2	2.20	55.9	5.39	136.9	3.39	86.1
G20149-1616	16GS-16FMX90-056	7347-71555	1	25.4	1 5/16-12	1 1/2	2.20	55.9	5.67	144.0	3.45	87.6
G20150-1616	16GS-16FMX90-071	7347-71505	1	25.4	1 5/16-12	1 1/2	2.80	71.1	5.67	144.0	3.45	87.6

Male JIC 37° Flare

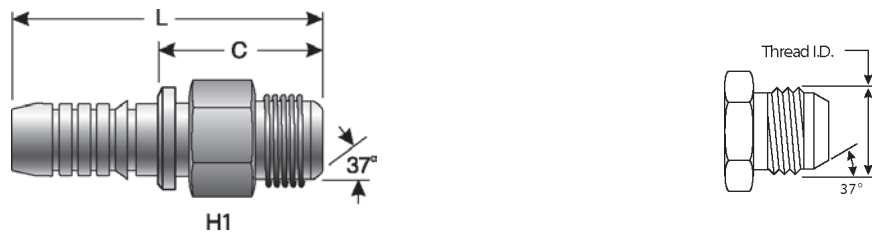

Part No.	Descr.	Prod. No.	⊖		H1	L		C		
			"	mm		"	"	mm	"	mm
G20165-0606	6GS-6MJ	7347-22145	3/8	9.5	9/16-18	11/16	2.60	66.0	1.19	30.2
G20165-0608	6GS-8MJ	7347-22155	3/8	9.5	3/4-16	13/16	2.76	70.1	1.35	34.3
G20165-0610	6GS-10MJ	7347-22165	3/8	9.5	7/8-14	15/16	3.03	77.0	1.62	41.2
G20165-0808	8GS-8MJ	7347-22245	1/2	12.7	3/4-16	13/16	2.83	71.9	1.36	34.5
G20165-0810	8GS-10MJ	7347-22255	1/2	12.7	7/8-14	7/8	2.95	74.9	1.48	37.6
G20165-1010	10GS-10MJ	7347-22345	5/8	15.9	7/8-14	15/16	3.62	92.0	1.64	41.7
G20165-1012	10GS-12MJ	7347-22355	5/8	15.9	1 1/16-12	1 1/16	3.70	94.0	1.72	43.7
G20165-1212	12GS-12MJ	7347-22445	3/4	19.1	1 1/16-12	1 1/8	3.66	93.0	1.65	41.9
G20165-1214	12GS-14MJ	7347-22455	3/4	19.1	1 3/16-12	1 1/4	3.70	94.0	1.69	42.9
G20165-1216	12GS-16MJ	7347-22465	3/4	19.1	1 5/16-12	1 5/16	3.78	96.0	1.77	45.0
G20165-1616	16GS-16MJ	7347-22555	1	25.4	1 5/16-12	1 3/8	4.09	103.9	1.86	47.2
G20165-1620	16GS-20MJ	7347-22585	1	25.4	1 5/8-12	1 3/4	4.27	108.5	2.04	51.8
G20165-2020	20GS-20MJ	7347-22645	1 1/4	31.8	1 5/8-12	1 3/4	4.92	125.0	2.12	53.9

Female JIC 37° Flare Swivel



Part No.	Descr.	Prod. No.	⊖		H1	H2	L		C		
			"	mm			"	"	mm	"	mm
G20170-0606	6GS-6FJX	7347-24145	3/8	9.5	9/16-18	3/4	3/4	2.72	69.1	1.31	33.3
G20170-0608	6GS-8FJX	7347-24155	3/8	9.5	3/4-16	3/4	7/8	2.80	71.1	1.39	35.3
G20170-0808	8GS-8FJX	7347-24245	1/2	12.7	3/4-16	7/8	7/8	2.83	71.9	1.36	34.5

Female JIC 37° Flare Swivel - Continued

Part No.	Descr.	Prod. No.	⊖		🌀	H1	H2	L		C	
			"	mm				"	mm	"	mm
G20170-0810	8GS-10FJX	7347-24255	1/2	12.7	7/8-14	7/8	1 1/16	2.99	76.0	1.51	38.4
G20170-0812	8GS-12FJX	7347-24265	1/2	12.7	1 1/16-12	7/8	1 1/4	3.03	77.0	1.56	39.6
G20170-1010	10GS-10FJXMM	7347-82175	5/8	15.9	7/8-14	1	1 1/16	3.68	93.5	1.70	43.2
G20170-1012	10GS-12FJX	7347-24355	5/8	15.9	1 1/16-12	1	1 1/4	3.74	95.0	1.76	44.7
G20170-1210	12GS-10FJX	7347-24435	3/4	19.1	7/8-14	1 1/16	1 1/8	3.87	98.3	1.87	47.5
G20170-1212	12GS-12FJX	7347-24445	3/4	19.1	1 1/16-12	1	1 1/4	3.87	98.3	1.86	47.2
G20170-1214	12GS-14FJX	7347-24455	3/4	19.1	1 3/16-12	1 1/8	1 3/8	4.06	103.1	2.06	52.3
G20170-1216	12GS-16FJX	7347-24465	3/4	19.1	1 5/16-12	1 1/4	1 1/2	4.02	102.1	2.01	51.1
G20170-1612	16GS-12FJX	7347-24535	1	25.4	1 1/16-12	1 3/8	1 3/8	4.25	108.0	2.00	50.8
G20170-1614	16GS-14FJX	7347-24545	1	25.4	1 3/16-12	1 3/8	1 1/2	4.25	108.0	2.01	51.1
G20170-1616	16GS-16FJX	7347-24555	1	25.4	1 5/16-12	1 1/2	1 1/2	4.30	109.2	2.07	52.6
G20170-1620	16GS-20FJX	7347-24565	1	25.4	1 5/8-12	1 1/2	2	4.53	115.1	2.31	58.7
G20170-2016	20GS-16FJX	7347-24635	1 1/4	31.8	1 5/16-12	1 3/4	1 5/8	5.08	129.0	2.28	57.9
G20170-2020	20GS-20FJX	7347-24645	1 1/4	31.8	1 5/8-12	1 7/8	2	5.29	134.4	2.56	65.0
G20170-2024	20GS-24FJX	7347-24655	1 1/4	31.8	1 7/8-12	1 7/8	2 3/8	5.39	136.9	2.59	65.8

Female JIC 37° Flare Swivel - 30° Bent Tube

S, M and L Drops per ISO Final Draft International Standard 12151-S.

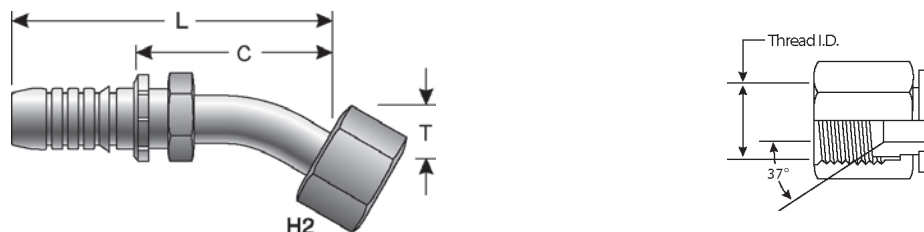

Part No.	Descr.	Prod. No.	⊖		🌀	H2	T		L		C	
			"	mm			"	mm	"	mm	"	mm
G20172-1616	16GS-16FJX30M	7347-73055	1	25.4	1 5/16-12	1 1/2	1.06	26.9	6.02	152.9	3.80	96.5

Female JIC 37° Flare Swivel - 45° Bent Tube

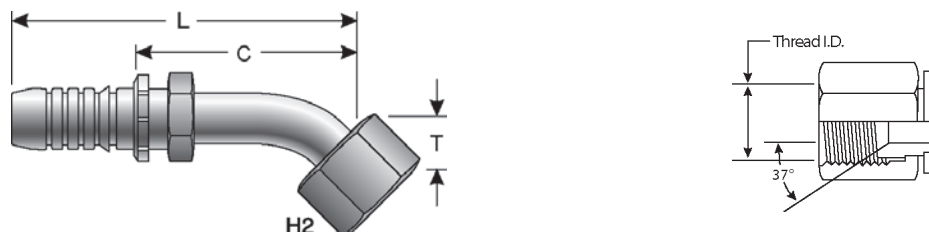

Part No.	Descr.	Prod. No.	⊖		🌀	H2	T		L		C	
			"	mm			"	mm	"	mm	"	mm
G20174-0606	6GS-6FJX45S	7347-25145	3/8	9.5	9/16-18	3/4	.43	10.9	3.23	82.0	1.82	46.2
G20174-0608	6GS-8FJX45S	7347-25155	3/8	9.5	3/4-16	7/8	.59	15.0	3.66	93.0	2.25	57.2
G20174-0808	8GS-8FJX45S	7347-25245	1/2	12.7	3/4-16	7/8	.59	15.0	3.70	94.0	2.22	56.4
G20174-0810	8GS-10FJX45S	7347-25255	1/2	12.7	7/8-14	1 1/16	.63	16.0	3.58	90.9	2.11	53.6

- EQUIPMENT
- HOSE/CPLG. SELECTION
- G8K COUPLINGS
- GLOBAL SPIRAL COUPLINGS
- STAINLESS STEEL SPIRAL
- MEGACRIMP COUPLINGS
- STAINLESS STEEL BRAID
- POWER CRIMP COUPLINGS
- FIELD ATTACHABLE G1 & G2 COUPLINGS
- FIELD ATTACHABLE C5 COUPLINGS
- GLX COUPLINGS
- GL COUPLINGS
- C14 COUPLINGS
- PCTS THERMOPLASTIC COUPLINGS
- POLARSEAL COUPLINGS
- POLARSEAL II COUPLINGS
- POWER STEERING
- ADAPTERS
- QUICK DISCONNECT COUPLERS
- BALL VALVES
- LIVE SWIVEL
- ASSEMBLY FABRICATION
- ACCESSORIES
- EQUIPMENT AND PARTS
- AIR BRAKE
- BRASS
- KITS

Female JIC 37° Flare Swivel - 45° Bent Tube - Continued

Part No.	Descr.	Prod. No.	⊖		H2	T		L		C		
			"	mm		"	mm	"	mm	"	mm	
G20175-1010	10GS-10FJXMM45-018	7347-83275	5/8	15.9	7/8-14	1 1/16	.71	18.0	4.45	113.0	2.48	63.0
G20174-1012	10GS-12FJX45S	7347-25355	5/8	15.9	1 1/16-12	1 1/4	.83	21.1	4.80	121.9	2.82	71.6
G20174-1212	12GS-12FJX45S	7347-25445	3/4	19.1	1 1/16-12	1 1/4	.83	21.1	5.12	130.1	3.11	79.0
G20174-1216	12GS-16FJX45S	7347-25465	3/4	19.1	1 5/16-12	1 1/2	.94	23.9	5.39	136.9	3.39	86.1
G20174-1616	16GS-16FJX45S	7347-25555	1	25.4	1 5/16-12	1 1/2	.94	23.9	5.98	151.9	3.77	95.8
G20175-1616	16GS-16FJX45M	7347-26555	1	25.4	1 5/16-12	1 1/2	1.50	38.1	6.30	160.0	4.07	103.4
G20174-1620	16GS-20FJX45S	7347-25565	1	25.4	1 5/8-12	2	.98	24.9	6.46	164.1	4.23	107.4
G20175-2020	20GS-20FJX45-038	7347-76175	1 1/4	31.8	1 5/8-12	2	1.50	38.1	7.09	180.1	4.29	109.0

Female JIC 37° Flare Swivel - 60° Bent Tube

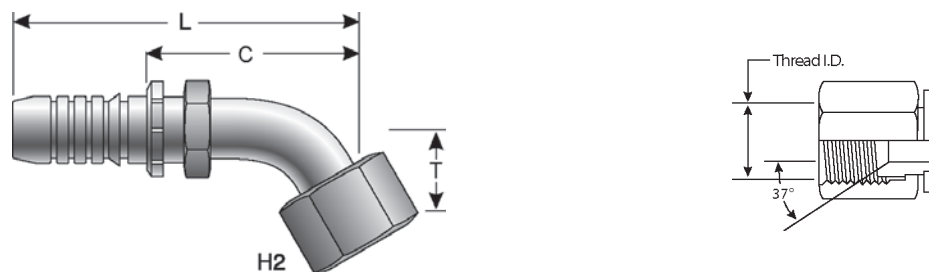

Part No.	Descr.	Prod. No.	⊖		H2	T		L		C		
			"	mm		"	mm	"	mm	"	mm	
G20177-1212	12GS-12FJX60-043	7347-76795	3/4	19.1	1 1/16-12	1 1/4	1.69	42.9	5.59	142.0	3.58	90.9

Female JIC 37° Flare Swivel - 90° Bent Tube

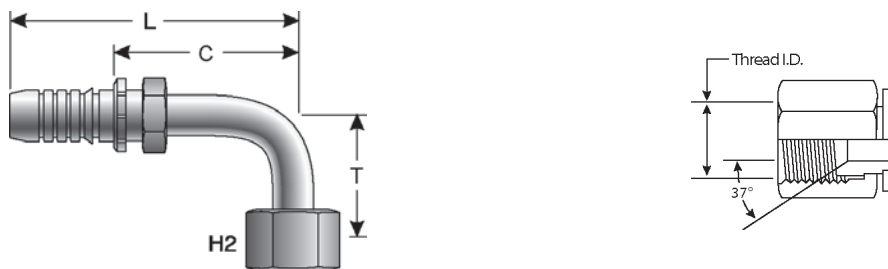

Part No.	Descr.	Prod. No.	⊖		H2	T		L		C		
			"	mm		"	mm	"	mm	"	mm	
G20179-0606	6GS-6FJX90S	7347-27145	3/8	9.5	9/16-18	3/4	.91	23.1	3.11	79.0	1.70	43.2
G20180-0606	6GS-6FJXMM90M	7347-84045	3/8	9.5	9/16-18	3/4	1.50	38.1	3.11	79.0	1.70	43.2
G20181-0606	6GS-6FJX90L	7347-29145	3/8	9.5	9/16-18	3/4	2.13	54.1	3.39	86.1	1.98	50.3
G20180-0608	6GS-8FJX90M	7347-28155	3/8	9.5	3/4-16	7/8	1.61	40.9	3.58	90.9	2.17	55.1
G20182-0608	6GS-8FJX90-083	7347-76785	3/8	9.5	3/4-16	7/8	3.27	83.1	3.58	90.9	2.17	55.1
G20179-0808	8GS-8FJX90S	7347-27245	1/2	12.7	3/4-16	7/8	1.14	29.0	3.39	86.1	1.91	48.5
G20180-0808	8GS-8FJX90M	7347-28245	1/2	12.7	3/4-16	7/8	1.61	40.9	3.62	92.0	2.15	54.6
G20181-0808	8GS-8FJX90L	7347-29245	1/2	12.7	3/4-16	7/8	2.52	64.0	3.62	92.0	2.15	54.6
G20182-0808	8GS-8FJX90XL	7347-73065	1/2	12.7	3/4-16	7/8	4.06	103.1	3.62	92.0	2.15	54.6

Female JIC 37° Flare Swivel - 90° Bent Tube - Continued

Part No.	Descr.	Prod. No.	⊖		H2	T		L		C		
			"	mm		"	"	"	mm	"	mm	
G20179-0810	8GS-10FJX90S	7347-27255	1/2	12.7	7/8-14	1 1/16	1.26	32.0	3.62	92.0	2.15	54.6
G20180-0810	8GS-10FJX90M	7347-28165	1/2	12.7	7/8-14	1 1/16	1.85	47.0	3.50	88.9	2.01	51.1
G20181-0810	8GS-10FJX90L	7347-29255	1/2	12.7	7/8-14	1 1/16	3.27	83.1	3.74	95.0	2.26	57.4
G20179-0812	8GS-12FJX90S	7347-27265	1/2	12.7	1 1/16-12	1 1/4	1.89	48.0	4.37	111.0	2.89	73.4
G20179-1010	10GS-10FJXMM90-036	7347-84275	5/8	15.9	7/8-14	1 1/16	1.42	36.1	4.37	111.0	1.70	43.2
G20180-1010	10GS-10FJXMM90M	7347-84285	5/8	15.9	7/8-14	1 1/16	1.85	47.0	4.21	106.9	2.23	56.6
G20180-1012	10GS-12FJX90M	7347-28355	5/8	15.9	1 1/16-12	1 1/4	2.28	57.9	4.76	120.9	2.78	70.6
G20179-1212	12GS-12FJX90S	7347-27445	3/4	19.1	1 1/16-12	1 1/4	1.89	48.0	4.45	113.0	2.44	62.0
G20180-1212	12GS-12FJX90M	7347-28445	3/4	19.1	1 1/16-12	1 1/4	2.28	57.9	4.45	113.0	2.44	62.0
G20181-1212	12GS-12FJX90L	7347-29445	3/4	19.1	1 1/16-12	1 1/4	3.78	96.0	4.45	113.0	2.44	62.0
G20180-1214	12GS-14FJX90-060	7347-28455	3/4	19.1	1 3/16-12	1 3/8	2.36	59.9	5.55	141.0	3.54	89.9
G20179-1216	12GS-16FJX90S	7347-27465	3/4	19.1	1 5/16-12	1 1/2	2.20	55.9	5.31	134.9	3.31	84.1
G20180-1216	12GS-16FJX90M	7347-28465	3/4	19.1	1 5/16-12	1 1/2	2.80	71.1	5.31	134.9	3.31	84.1
G20181-1216	12GS-16FJX90L	7347-29465	3/4	19.1	1 5/16-12	1 1/2	4.49	114.1	5.32	135.1	3.31	84.1
G20179-1616	16GS-16FJX90S	7347-27555	1	25.4	1 5/16-12	1 1/2	2.20	55.9	5.67	144.0	3.45	87.6
G20180-1616	16GS-16FJX90M	7347-28555	1	25.4	1 5/16-12	1 1/2	2.80	71.1	5.67	144.0	3.45	87.6
G20181-1616	16GS-16FJX90L	7347-29555	1	25.4	1 5/16-12	1 1/2	4.33	110.0	5.67	144.0	3.45	87.6
G20181-1620	16GS-20FJX90L	7347-29565	1	25.4	1 5/8-12	2	5.08	129.0	6.06	153.9	3.84	97.5
G20179-2020	20GS-20FJX90S	7347-27645	1 1/4	31.8	1 5/8-12	2	2.52	64.0	6.85	174.0	4.05	102.9
G20180-2020	20GS-20FJX90M	7347-28645	1 1/4	31.8	1 5/8-12	2	3.07	78.0	6.85	174.0	4.05	102.9
G20181-2020	20GS-20FJX90L	7347-29645	1 1/4	31.8	1 5/8-12	2	5.08	129.0	6.85	174.0	4.05	102.9
G20180-2024	20GS-24FJX90M	7347-28655	1 1/4	31.8	1 7/8-12	2 3/8	3.39	86.1	7.32	185.9	4.52	114.8

Male Flat-Face O-Ring

Includes Peroxide-cured O-Ring
Metric Hex per ISO Draft International Standard 12151-1.
Utilizes SAE J1453 Captive O-Ring Groove for Improved O-Ring Retention.

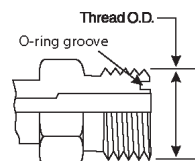
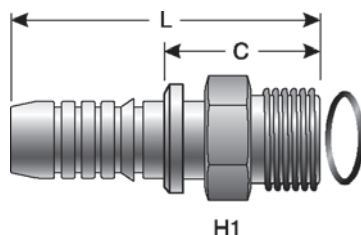

Part No.	Descr.	Prod. No.	⊖		H1	L		C		
			"	mm		"	mm	"	mm	
G20225-0606	6GS-6MFFOR	7347-23865	3/8	9.5	11/16-16	19	2.52	64.0	1.11	28.2
G20225-0808	8GS-8MFFOR	7347-23825	1/2	12.7	13/16-16	22	2.68	68.1	1.20	30.5
G20225-0810	8GS-10MFFOR	7347-23895	1/2	12.7	1-14	27	2.91	73.9	1.44	36.6
G20225-1010	10GS-10MFFOR	7347-23875	5/8	15.9	1-14	27	3.42	86.9	1.44	36.6
G20225-1012	10GS-12MFFOR	7347-23885	5/8	15.9	1 3/16-12	32	3.50	88.9	1.52	38.6
G20225-1212	12GS-12MFFOR	7347-23835	3/4	19.1	1 3/16-12	32	3.50	88.9	1.50	38.1
G20225-1216	12GS-16MFFOR	7347-23845	3/4	19.1	1 7/16-12	41	3.74	95.0	1.73	43.9
G20225-1616	16GS-16MFFOR	7347-23815	1	25.4	1 7/16-12	41	4.02	102.1	1.78	45.2
G20225-1620	16GS-20MFFOR	7347-23925	1	25.4	1 11/16-12	50	4.17	106.0	1.78	45.2
G20225-2020	20GS-20MFFOR	7347-23855	1 1/4	31.8	1 11/16-12	50	4.72	119.9	1.93	49.0

- EQUIPMENT
- HOSE/CPLG. SELECTION
- G8K COUPLINGS
- GLOBAL SPIRAL COUPLINGS
- STAINLESS STEEL SPIRAL
- MEGACRIMP COUPLINGS
- STAINLESS STEEL BRAID
- POWER CRIMP COUPLINGS
- FIELD ATTACHABLE G1 & G2 COUPLINGS
- FIELD ATTACHABLE C5 COUPLINGS
- GLX COUPLINGS
- GL COUPLINGS
- C14 COUPLINGS
- PCTS THERMOPLASTIC COUPLINGS
- POLARSEAL COUPLINGS
- POLARSEAL II COUPLINGS
- POWER STEERING
- ADAPTERS
- QUICK DISCONNECT COUPLERS
- BALL VALVES
- LIVE SWIVEL
- ASSEMBLY FABRICATION
- ACCESSORIES
- EQUIPMENT AND PARTS
- AIR BRAKE
- BRASS
- KITS

Female Flat-Face O-Ring Swivel

Metric Hex per ISO Draft International Standard 12151-1.
SAE J1453 O-Ring Face Seal.

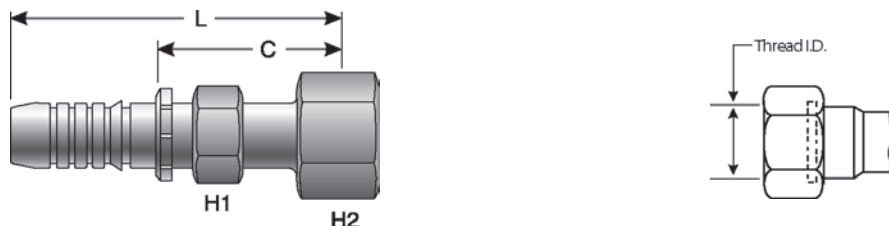

Part No.	Descr.	Prod. No.	⊖		🌀	H1	H2	L		C	
			"	mm				"	mm	"	mm
G20230-0606	6GS-6FFORX	7347-30145	3/8	9.5	11/16-16	22	22	2.72	69.1	1.31	33.3
G20230-0608	6GS-8FFORX	7347-30155	3/8	9.5	13/16-16	22	24	2.83	71.9	1.43	36.3
G20230-0808	8GS-8FFORX	7347-30245	1/2	12.7	13/16-16	27	24	2.87	72.9	1.40	35.6
G20230-0810	8GS-10FFORX	7347-30255	1/2	12.7	1-14	27	30	3.07	78.0	1.59	40.4
G20230-0812	8GS-12FFORX	7347-30265	1/2	12.7	1 3/16-12	27	36	3.11	79.0	1.63	41.4
G20230-1010	10GS-10FFORX	7347-30345	5/8	15.9	1-14	30	30	3.70	94.0	1.72	43.7
G20230-1012	10GS-12FFORX	7347-30355	5/8	15.9	1 3/16-12	30	36	3.74	95.0	1.76	44.7
G20230-1210	12GS-10FFORX	7347-30435	3/4	19.1	1-14	32	30	3.82	97.0	1.81	46.0
G20230-1212	12GS-12FFORX	7347-30445	3/4	19.1	1 3/16-12	32	36	1.95	49.5	1.89	48.1
G20230-1216	12GS-16FFORX	7347-30465	3/4	19.1	1 7/16-12	32	41	4.06	103.1	2.05	52.1
G20230-1220	12GS-20FFORX	7347-30475	3/4	19.1	1 11/16-12	32	50	3.91	99.3	1.90	48.3
G20230-1612	16GS-12FFORX	7347-30535	1	25.4	1 3/16-12	36	36	5.15	130.8	2.92	74.2
G20230-1616	16GS-16FFORX	7347-30555	1	25.4	1 7/16-12	41	41	4.36	110.7	2.14	54.4
G20230-1620	16GS-20FFORX	7347-30565	1	25.4	1 11/16-12	41	50	4.36	110.7	2.14	54.4
G20230-2020	20GS-20FFORX	7347-30645	1 1/4	31.8	1 11/16-12	50	50	5.04	128.0	2.24	56.9
G20230-2024	20GS-24FFORX	7347-30655	1 1/4	31.8	2-12	50	60	5.12	130.1	2.32	58.9

Female Flat-Face O-Ring Swivel - 22 1/2° Bent Tube

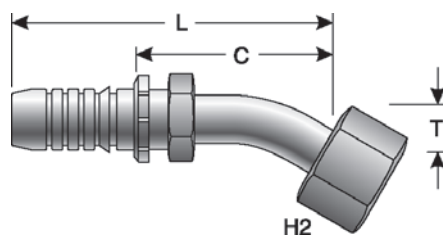

Part No.	Descr.	Prod. No.	⊖		🌀	H2	T		L		C	
			"	mm			"	mm	"	mm	"	mm
G20232-1616	16GS-16FFORX22-011	7347-78615	1	25.4	1 7/16-12	41	.43	10.9	5.87	149.1	3.68	93.5

Female Flat-Face O-Ring Swivel - 30° Bent Tube

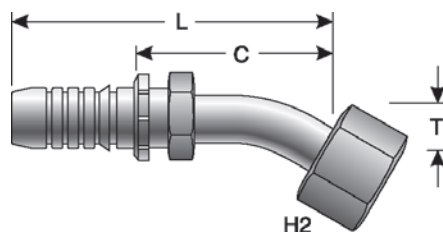

Part No.	Descr.	Prod. No.	⊖		🌀		H2	T		L		C	
			"	mm	"	mm		"	mm	"	mm	"	mm
G20233-1616	16GS-16FFORX30-14	7347-76345	1	25.4	1 7/16-12	41	.55	14.0	5.87	149.1	3.64	92.5	

Female Flat-Face O-Ring Swivel - 45° Bent Tube

Metric Hex per ISO Draft International Standard 12151-1.
SAE J1453 O-Ring Face Seal.

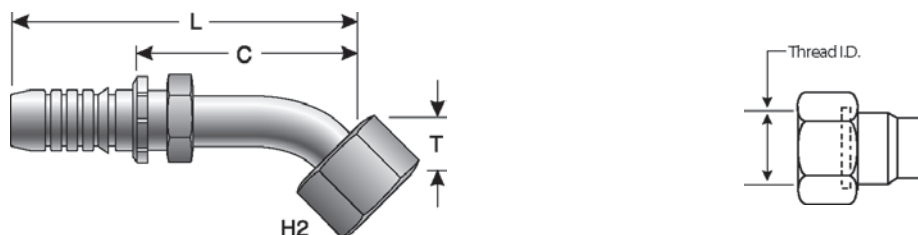

Part No.	Descr.	Prod. No.	⊖		🌀		H2	T		L		C	
			"	mm	"	mm		"	mm	"	mm	"	mm
G20234-0606	6GS-6FFORX45S	7347-31145	3/8	9.5	11/16-16	22	.43	10.9	3.23	82.0	1.82	46.2	
G20234-0608	6GS-8FFORX45S	7347-31155	3/8	9.5	13/16-16	24	.59	15.0	3.66	93.0	2.25	57.2	
G20234-0808	8GS-8FFORX45S	7347-31245	1/2	12.7	13/16-16	24	.59	15.0	3.70	94.0	2.22	56.4	
G20234-0810	8GS-10FFORX45S	7347-31255	1/2	12.7	1-14	30	.63	16.0	3.90	99.1	2.42	61.5	
G20234-0812	8GS-12FFORX45S	7347-31265	1/2	12.7	1 3/16-12	36	.83	21.1	4.53	115.1	3.05	77.5	
G20234-1010	10GS-10FFORX45S	7347-31345	5/8	15.9	1-14	30	.63	16.0	4.37	111.0	2.39	60.7	
G20234-1212	12GS-12FFORX45S	7347-31445	3/4	19.1	1 3/16-12	36	.83	21.1	4.92	125.0	2.91	73.9	
G20234-1216	12GS-16FFORX45S	7347-31465	3/4	19.1	1 7/16-12	24	.94	23.9	5.39	136.9	3.39	86.1	
G20234-1616	16GS-16FFORX45S	7347-31555	1	25.4	1 7/16-12	24	.94	23.9	5.67	144.0	3.46	87.9	
G20234-1620	16GS-20FFORX45S	7347-31565	1	25.4	1 11/16-12	50	.98	24.9	6.46	164.1	4.24	107.7	
G20234-2020	20GS-20FFORX45-032	7347-76045	1 1/4	31.8	1 11/16-12	50	1.26	32.0	7.09	180.1	4.29	109.0	

EQUIPMENT
HOSE/CPLG. SELECTION
G8K COUPLINGS
GLOBAL SPIRAL COUPLINGS
STAINLESS STEEL SPIRAL
MEGACRIMP COUPLINGS
STAINLESS STEEL BRAID
POWER CRIMP COUPLINGS
FIELD ATTACHABLE G1 & G2 COUPLINGS
FIELD ATTACHABLE C5 COUPLINGS
GLX COUPLINGS
GL COUPLINGS
C14 COUPLINGS
PCTS THERMOPLASTIC COUPLINGS
POLARSEAL COUPLINGS
POLARSEAL II COUPLINGS
POWER STEERING
ADAPTERS
QUICK DISCONNECT COUPLERS
BALL VALVES
LIVE SWIVEL
ASSEMBLY FABRICATION
ACCESSORIES
EQUIPMENT AND PARTS
AIR BRAKE
BRASS
KITS

Female Flat-Face O-Ring Swivel - 90° Bent Tube

Metric Hex per ISO Draft International Standard 12151-1.
SAE J1453 O-Ring Face Seal.

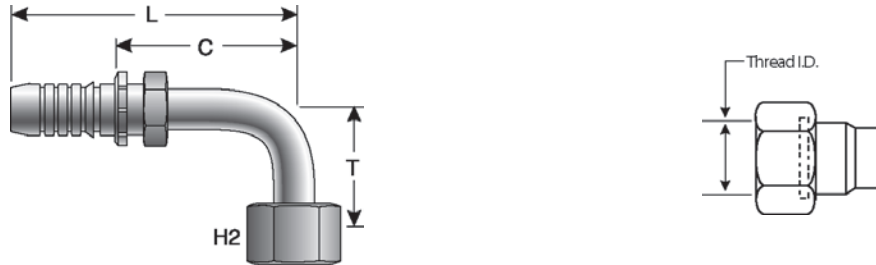

Part No.	Descr.	Prod. No.	⌀		H2		T		L		C	
			"	mm	"	mm	"	mm	"	mm	"	mm
G20239-0606	6GS-6FFORX90S	7347-32145	3/8	9.5	11/16-16	22	.91	23.1	3.07	78.0	1.66	42.2
G20241-0606	6GS-6FFORX90L	7347-34145	3/8	9.5	11/16-16	22	2.13	54.1	3.35	85.1	1.94	49.3
G20240-0608	6GS-8FFORX90M	7347-33155	3/8	9.5	13/16-16	24	1.61	40.9	3.35	85.1	1.94	49.3
G20239-0808	8GS-8FFORX90S	7347-32245	1/2	12.7	13/16-16	24	1.14	29.0	3.39	86.1	1.91	48.5
G20240-0808	8GS-8FFORX90M	7347-33245	1/2	12.7	13/16-16	24	1.61	40.9	3.39	86.1	1.91	48.5
G20241-0808	8GS-8FFORX90-083	7347-73845	1/2	12.7	13/16-16	24	3.27	83.1	3.39	86.1	1.91	48.5
G20239-0810	8GS-10FFORX90S	7347-32255	1/2	12.7	1-14	30	1.26	32.0	3.98	101.1	2.50	63.5
G20240-0810	8GS-10FFORX90M	7347-33255	1/2	12.7	1-14	30	1.85	47.0	3.98	101.1	2.50	63.5
G20241-0810	8GS-10FFORX90L	7347-34255	1/2	12.7	1-14	30	2.76	70.1	3.98	101.1	2.50	63.5
G20239-0812	8GS-12FFORX90S	7347-32265	1/2	12.7	1 3/16-12	36	1.89	48.0	4.21	106.9	2.74	69.6
G20239-1010	10GS-10FFORX90S	7347-32345	5/8	15.9	1-14	30	1.26	32.0	4.20	106.7	2.22	56.4
G20240-1010	10GS-10FFORX90M	7347-33345	5/8	15.9	1-14	30	1.85	47.0	4.21	106.9	2.20	55.9
G20241-1010	10GS-10FFORX90L	7347-34345	5/8	15.9	1-14	30	2.76	70.1	4.45	113.0	2.44	62.0
G20239-1012	10GS-12FFORX90S	7347-32355	5/8	15.9	1 3/16-12	36	1.26	32.0	4.21	106.9	2.74	69.6
G20239-1210	12GS-10FFORX90S	7347-32435	3/4	19.1	1-14	30	1.26	32.0	4.37	111.0	2.36	59.9
G20239-1212	12GS-12FFORX90S	7347-32445	3/4	19.1	1 3/16-12	36	1.89	48.0	5.04	128.0	3.03	77.0
G20240-1212	12GS-12FFORX90M	7347-33445	3/4	19.1	1 3/16-12	36	2.28	57.9	5.04	128.0	3.03	77.0
G20241-1212	12GS-12FFORX90L	7347-34445	3/4	19.1	1 3/16-12	36	3.78	96.0	5.04	128.0	3.03	77.0
G20239-1216	12GS-16FFORX90S	7347-32465	3/4	19.1	1 7/16-12	41	2.20	55.9	5.39	136.9	3.39	86.1
G20240-1216	12GS-16FFORX90M	7347-33465	3/4	19.1	1 7/16-12	41	2.80	71.1	5.39	136.9	3.39	86.1
G20241-1216	12GS-16FFORX90L	7347-34465	3/4	19.1	1 7/16-12	41	4.49	114.1	5.39	136.9	3.39	86.1
G20239-1616	16GS-16FFORX90S	7347-32555	1	25.4	1 7/16-12	41	2.20	55.9	5.67	144.0	3.45	87.6
G20240-1616	16GS-16FFORX90M	7347-33555	1	25.4	1 7/16-12	41	2.80	71.1	5.67	144.0	3.45	87.6
G20241-1616	16GS-16FFORX90L	7347-34555	1	25.4	1 7/16-12	41	4.49	114.1	5.67	144.0	3.45	87.6
G20239-1620	16GS-20FFORX90S	7347-32565	1	25.4	1 11/16-12	50	2.52	64.0	6.06	153.9	3.84	97.5
G20240-1620	16GS-20FFORX90M	7347-33565	1	25.4	1 11/16-12	50	3.07	78.0	6.05	153.7	3.83	97.3
G20241-1620	16GS-20FFORX90L	7347-34565	1	25.4	1 11/16-12	50	5.08	129.0	6.05	153.7	3.83	97.3
G20239-2020	20GS-20FFORX90S	7347-32645	1 1/4	31.8	1 11/16-12	50	2.52	64.0	6.77	172.0	3.97	100.8
G20240-2020	20GS-20FFORX90M	7347-33645	1 1/4	31.8	1 11/16-12	50	3.07	78.0	6.77	172.0	3.97	100.8
G20241-2020	20GS-20FFORX90L	7347-34645	1 1/4	31.8	1 11/16-12	50	5.08	129.0	6.77	172.0	3.97	100.8
G20239-2024	20GS-24FFORX90-064	7347-76985	1 1/4	31.8	2-12	60	2.52	64.0	6.77	172.0	3.97	100.8

Female Flat-Face O-Ring Swivel - 135° Bent Tube

Metric Hex per ISO Draft International Standard 12151-1.
SAE J1453 O-Ring Face Seal.

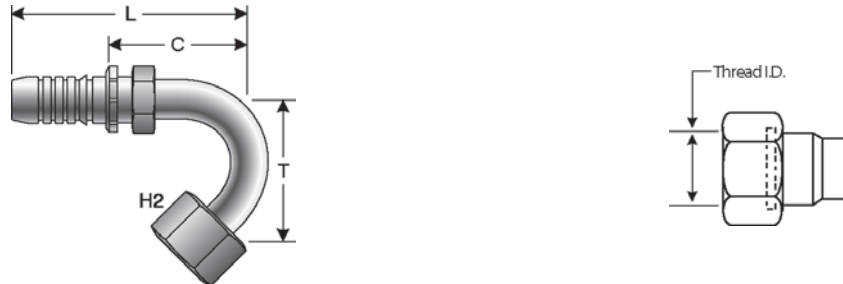

Part No.	Descr.	Prod. No.	⌀		H2	T		L		C		
			"	mm		"	mm	"	mm	"	mm	
G20248-1216	12GS-16FFORX135	7347-73795	3/4	19.1	1 7/16-12	24	2.99	76.0	3.39	86.1	1.48	37.6

Code 61 O-Ring Flange

-8FL, -12FL, -16FL Max. W.P. 5,000 psi; -20FL Max. W.P. 4,000 psi.
See Accessories for O-Rings.

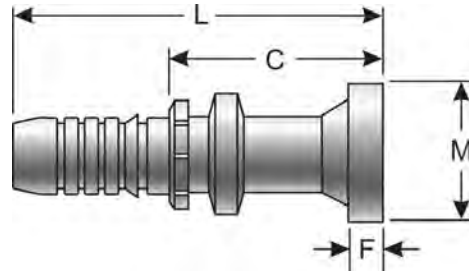

Part No.	Descr.	Prod. No.	⌀		M		L		C		F	
			"	mm	"	mm	"	mm	"	mm	"	mm
G20300-0608	6GS-8FL	7347-41155	3/8	9.5	1.19	30.2	3.54	89.9	2.13	54.1	.27	6.9
G20300-0808	8GS-8FL	7347-41245	1/2	12.7	1.19	30.2	3.66	93.0	2.19	55.6	.27	6.9
G20300-0810	8GS-10FLK	7347-55255	1/2	12.7	1.35	34.3	3.21	81.5	1.74	44.2	.27	6.9
G20300-0812	8GS-12FL	7347-41265	1/2	12.7	1.50	38.1	3.86	98.1	2.38	60.5	.27	6.9
G20300-0816	8GS-16FL	7347-41285	1/2	12.7	1.75	44.5	2.84	72.1	1.37	34.8	.32	8.1
G20300-1010	10GS-10FLK	7347-73335	5/8	15.9	1.35	34.3	4.49	114.1	2.51	63.8	.27	6.9
G20300-1012	10GS-12FL	7347-41355	5/8	15.9	1.50	38.1	4.29	109.0	2.31	58.7	.27	6.9
G20300-1208	12GS-8FL	7347-41425	3/4	19.1	1.19	30.2	4.41	112.0	2.40	61.0	.27	6.9
G20300-1210	12GS-10FLK	7347-73375	3/4	19.1	1.35	34.3	4.33	110.0	2.32	58.9	.27	6.9
G20300-1212	12GS-12FL	7347-41445	3/4	19.1	1.50	38.1	4.37	111.0	2.36	59.9	.27	6.9
G20300-1216	12GS-16FL	7347-41465	3/4	19.1	1.75	44.5	4.37	111.0	2.36	59.9	.32	8.1
G20300-1220	12GS-20FL	7347-41475	3/4	19.1	2.00	50.8	4.37	111.0	2.36	59.9	.32	8.1
G20300-1612	16GS-12FL	7347-41535	1	25.4	1.50	38.1	4.65	118.1	2.40	61.0	.27	6.9
G20300-1616	16GS-16FL	7347-41555	1	25.4	1.75	44.5	4.92	125.0	2.70	68.6	.32	8.1
G20300-1620	16GS-20FL	7347-41565	1	25.4	2.00	50.8	4.92	125.0	2.69	68.3	.32	8.1
G20300-1624	16GS-24FL	7347-41575	1	25.4	2.38	60.5	4.92	125.0	1.90	48.3	.32	8.1
G20300-2016	20GS-16FL	7347-41635	1 1/4	31.8	1.75	44.5	5.35	135.9	2.55	64.8	.32	8.1
G20300-2020	20GS-20FL	7347-41645	1 1/4	31.8	2.00	50.8	5.75	146.1	2.95	74.9	.32	8.1
G20300-2024	20GS-24FL	7347-41655	1 1/4	31.8	2.38	60.5	6.30	160.0	3.50	88.9	.32	8.1
G20300-2032	20GS-32FL	7347-41665	1 1/4	31.8	2.81	71.4	5.71	145.0	2.91	73.9	.38	9.7

EQUIPMENT
HOSE/CPLG. SELECTION
G8K COUPLINGS
GLOBAL SPIRAL COUPLINGS
STAINLESS STEEL SPIRAL
MEGACRIMP COUPLINGS
STAINLESS STEEL BRAID
POWER CRIMP COUPLINGS
FIELD ATTACHABLE G1 & G2 COUPLINGS
FIELD ATTACHABLE C5 COUPLINGS
GLX COUPLINGS
GL COUPLINGS
C14 COUPLINGS
PCTS THERMOPLASTIC COUPLINGS
POLARSEAL COUPLINGS
POLARSEAL II COUPLINGS
POWER STEERING
ADAPTERS
QUICK DISCONNECT COUPLERS
BALL VALVES
LIVE SWIVEL
ASSEMBLY FABRICATION
ACCESSORIES
EQUIPMENT AND PARTS
AIR BRAKE
BRASS
KITS

EQUIPMENT
HOSE/CPLG. SELECTION
G8K COUPLINGS
GLOBAL SPIRAL COUPLINGS
STAINLESS STEEL SPIRAL
MEGACRIMP COUPLINGS
STAINLESS STEEL BRAID
POWER CRIMP COUPLINGS
FIELD ATTACHABLE G1 & G2 COUPLINGS
FIELD ATTACHABLE C5 COUPLINGS
GLX COUPLINGS
GL COUPLINGS
C14 COUPLINGS
PCTS THERMOPLASTIC COUPLINGS
POLARSEAL COUPLINGS
POLARSEAL II COUPLINGS
POWER STEERING ADAPTERS
QUICK DISCONNECT COUPLERS
BALL VALVES
LIVE SWIVEL
ASSEMBLY FABRICATION
ACCESSORIES
EQUIPMENT AND PARTS
AIR BRAKE
BRASS
KITS

Code 61 O-Ring Flange Long Neck

-8FL, -12FL, -16FL Max. W.P. 5,000 psi; -20FL Max. W.P. 4,000 psi.
S, M and L Drops per ISO Final Draft International Standard 12151-3.
See Accessories for O-Rings.

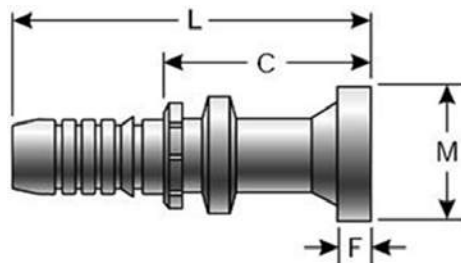

Part No.	Descr.	Prod. No.	⌀		M		L		C		F	
			"	mm	"	mm	"	mm	"	mm	"	mm
G20301-1212	12GS-12FLL	7347-41455	3/4	19.1	1.50	38.1	5.20	132.1	3.19	81.0	.27	6.9
G20301-1616	16GS-16FLL	7347-41545	1	25.4	1.75	44.5	5.63	143.0	3.41	86.6	.32	8.1
G20301-2020	20GS-20FLL	7347-41675	1 1/4	31.8	2.00	50.8	6.26	159.0	3.46	87.9	.32	8.1

Code 61 O-Ring Flange - 22 1/2° Bent Tube

-8FL, -12FL, -16FL Max. W.P. 5,000 psi; -20FL Max. W.P. 4,000 psi.
S, M and L Drops per ISO Final Draft International Standard 12151-3.
See Accessories for O-Rings.

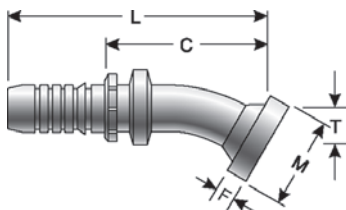

Part No.	Descr.	Prod. No.	⌀		M		T		L		C		F	
			"	mm	"	mm	"	mm	"	mm	"	mm	"	mm
G20302-0808	8GS-8FL22M	7347-42245	1/2	12.7	1.19	30.2	.35	8.9	3.78	96.0	2.30	58.4	.27	6.9
G20302-1212	12GS-12FL22M	7347-42445	3/4	19.1	1.50	38.1	.43	10.9	5.16	131.1	3.15	80.0	.27	6.9
G20302-1216	12GS-16FL22M	7347-42465	3/4	19.1	1.75	44.5	.55	14.0	5.24	133.1	3.23	82.0	.32	8.1
G20302-1616	16GS-16FL22M	7347-42555	1	25.4	1.75	44.5	.55	14.0	6.10	154.9	3.87	98.3	.32	8.1
G20302-1620	16GS-20FL22M	7347-42565	1	25.4	2.00	50.8	.59	15.0	6.61	167.9	4.37	111.0	.32	8.1
G20302-2020	20GS-20FL22M	7347-42645	1 1/4	31.8	2.00	50.8	.59	15.0	7.01	178.1	4.21	106.9	.32	8.1
G20302-2024	20GS-24FL22M	7347-42655	1 1/4	31.8	2.38	60.5	.71	18.0	7.32	185.9	4.52	114.8	.32	8.1

Code 61 O-Ring Flange - 30° Bent Tube

-8FL, -12FL, -16FL Max. W.P. 5,000 psi; -20FL Max. W.P. 4,000 psi.
S, M and L Drops per ISO Final Draft International Standard 12151-3.
See Accessories for O-Rings.

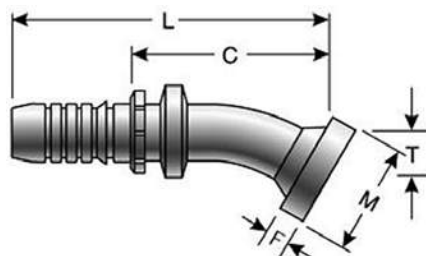

Part No.	Descr.	Prod. No.	⊖		M		T		L		C		F	
			"	mm	"	mm	"	mm	"	mm	"	mm	"	mm
G20304-0812	8GS-12FL30M	7347-43265	1/2	12.7	1.50	38.1	.63	16.0	3.94	100.1	2.46	62.5	.27	6.9
G20304-1212	12GS-12FL30M	7347-43445	3/4	19.1	1.50	38.1	.63	16.0	5.08	129.0	3.07	78.0	.27	6.9
G20304-1216	12GS-16FL30M	7347-43465	3/4	19.1	1.75	44.5	.75	19.1	4.76	120.9	2.76	70.1	.32	8.1
G20304-1616	16GS-16FL30M	7347-43555	1	25.4	1.75	44.5	.75	19.1	6.02	152.9	3.80	96.5	.32	8.1
G20304-1620	16GS-20FL30M	7347-43565	1	25.4	2.00	50.8	.87	22.1	6.54	166.1	4.29	109.0	.32	8.1
G20304-2020	20GS-20FL30M	7347-43645	1 1/4	31.8	2.00	50.8	.87	22.1	6.93	176.0	4.13	104.9	.32	8.1
G20304-2024	20GS-24FL30M	7347-43655	1 1/4	31.8	2.38	60.5	1.18	30.0	7.17	182.1	4.37	111.0	.32	8.1

Code 61 O-Ring Flange - 45° Bent Tube

-8FL, -12FL, -16FL Max. W.P. 5,000 psi; -20FL Max. W.P. 4,000 psi.
S, M and L Drops per ISO Final Draft International Standard 12151-3.
See Accessories for O-Rings.

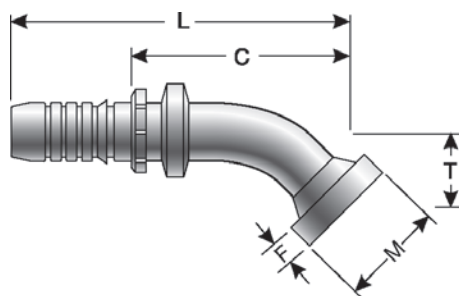

Part No.	Descr.	Prod. No.	⊖		M		T		L		C		F	
			"	mm	"	mm	"	mm	"	mm	"	mm	"	mm
G20307-0608	6GS-8FL45M	7347-44155	3/8	9.5	1.19	30.2	.75	19.1	3.66	93.0	2.25	57.2	.27	6.9
G20307-0808	8GS-8FL45M	7347-44245	1/2	12.7	1.19	30.2	.75	19.1	3.70	94.0	2.22	56.4	.27	6.9
G20307-0812	8GS-12FL45M	7347-44265	1/2	12.7	1.50	38.1	1.02	25.9	3.98	101.1	2.50	63.5	.27	6.9
G20307-1010	10GS-10FLK45-026	7347-73365	5/8	15.9	1.35	34.3	1.02	25.9	4.76	120.9	2.78	70.6	.27	6.9
G20307-1012	10GS-12FL45M	7347-44355	5/8	15.9	1.50	38.1	1.02	25.9	5.00	127.0	3.02	76.7	.27	6.9
G20307-1212	12GS-12FL45M	7347-44445	3/4	19.1	1.50	38.1	1.02	25.9	4.88	124.0	2.87	72.9	.27	6.9
G20306-1216	12GS-16FL45S	7347-73135	3/4	19.1	1.75	44.5	1.10	27.9	4.96	126.0	2.95	74.9	.32	8.1
G20307-1616	16GS-16FL45M	7347-44555	1	25.4	1.75	44.5	1.26	32.0	5.79	147.1	3.57	90.7	.32	8.1
G20307-1620	16GS-20FL45M	7347-44565	1	25.4	2.00	50.8	1.50	38.1	6.22	158.0	3.97	100.8	.32	8.1
G20307-2016	20GS-16FL45M	7347-44635	1 1/4	31.8	1.75	44.5	1.26	32.0	6.42	163.1	3.62	92.0	.32	8.1
G20306-2020	20GS-20FL45S	7347-73565	1 1/4	31.8	2.00	50.8	1.26	32.0	6.69	169.9	3.89	98.8	.32	8.1
G20306-2024	20GS-24FL45S	7347-73575	1 1/4	31.8	2.38	60.5	1.50	38.1	6.93	176.0	4.13	104.9	.32	8.1

- EQUIPMENT
- HOSE/CPLG. SELECTION
- G8K COUPLINGS
- GLOBAL SPIRAL COUPLINGS
- STAINLESS STEEL SPIRAL
- MEGACRIMP COUPLINGS
- STAINLESS STEEL BRAID
- POWER CRIMP COUPLINGS
- FIELD ATTACHABLE G1 & G2 COUPLINGS
- FIELD ATTACHABLE C5 COUPLINGS
- GLX COUPLINGS
- GL COUPLINGS
- C14 COUPLINGS
- PCTS THERMOPLASTIC COUPLINGS
- POLARSEAL COUPLINGS
- POLARSEAL II COUPLINGS
- POWER STEERING
- ADAPTERS
- QUICK DISCONNECT COUPLERS
- BALL VALVES
- LIVE SWIVEL
- ASSEMBLY FABRICATION
- ACCESSORIES
- EQUIPMENT AND PARTS
- AIR BRAKE
- BRASS
- KITS

EQUIPMENT
HOSE/CPLG. SELECTION
G8K COUPLINGS
GLOBAL SPIRAL COUPLINGS
STAINLESS STEEL SPIRAL
MEGACRIMP COUPLINGS
STAINLESS STEEL BRAID
POWER CRIMP COUPLINGS
FIELD ATTACHABLE G1 & G2 COUPLINGS
FIELD ATTACHABLE C5 COUPLINGS
GLX COUPLINGS
GL COUPLINGS
C14 COUPLINGS
PCTS THERMOPLASTIC COUPLINGS
POLARSEAL COUPLINGS
POLARSEAL II COUPLINGS
POWER STEERING
ADAPTERS
QUICK DISCONNECT COUPLERS
BALL VALVES
LIVE SWIVEL
ASSEMBLY FABRICATION
ACCESSORIES
EQUIPMENT AND PARTS
AIR BRAKE
BRASS
KITS

Code 61 O-Ring Flange - 60° Bent Tube

-8FL, -12FL, -16FL Max. W.P. 5,000 psi; -20FL Max. W.P. 4,000 psi.
S, M and L Drops per ISO Final Draft International Standard 12151-3.
See Accessories for O-Rings.

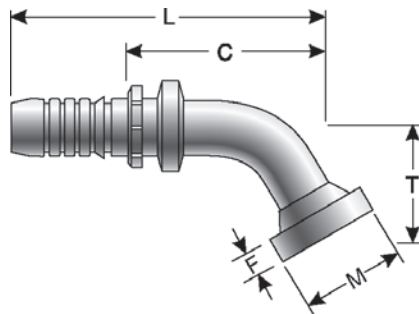

Part No.	Descr.	Prod. No.	⊖		M		T		L		C		F	
			"	mm	"	mm	"	mm	"	mm	"	mm	"	mm
G20309-0808	8GS-8FL60M	7347-45245	1/2	12.7	1.19	30.2	1.06	26.9	4.09	103.9	2.62	66.6	.27	6.9
G20309-1212	12GS-12FL60M	7347-45445	3/4	19.1	1.50	38.1	1.46	37.1	5.39	136.9	3.39	86.1	.27	6.9
G20309-1216	12GS-16FL60M	7347-45465	3/4	19.1	1.75	44.5	1.73	43.9	5.35	135.9	3.35	85.1	.32	8.1
G20309-1616	16GS-16FL60M	7347-45555	1	25.4	1.75	44.5	1.73	43.9	6.18	157.0	3.97	100.8	.32	8.1
G20309-1620	16GS-20FL60M	7347-45565	1	25.4	2.00	50.8	2.17	55.1	6.18	157.0	3.94	100.1	.32	8.1
G20309-2020	20GS-20FL60M	7347-45645	1 1/4	31.8	2.00	50.8	2.17	55.1	7.36	186.9	4.56	115.8	.32	8.1
G20309-2024	20GS-24FL60M	7347-45655	1 1/4	31.8	2.38	60.5	2.52	64.0	7.68	195.1	4.88	124.0	.32	8.1

Code 61 O-Ring Flange - 67 1/2° Bent Tube

-8FL, -12FL, -16FL Max. W.P. 5,000 psi; -20FL Max. W.P. 4,000 psi.
S, M and L Drops per ISO Final Draft International Standard 12151-3.
See Accessories for O-Rings.

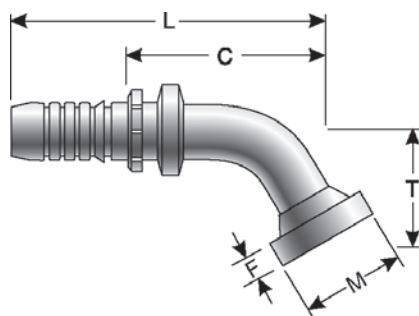

Part No.	Descr.	Prod. No.	⊖		M		T		L		C		F	
			"	mm	"	mm	"	mm	"	mm	"	mm	"	mm
G20311-0812	8GS-12FL67-032	7347-78025	1/2	12.7	1.50	38.1	1.26	32.0	3.70	94.0	2.21	56.1	.27	6.9
G20311-1212	12GS-12FL67M	7347-46445	3/4	19.1	1.50	38.1	1.65	41.9	5.20	132.1	3.19	81.0	.27	6.9
G20311-1216	12GS-16FL67M	7347-46465	3/4	19.1	1.75	44.5	2.01	51.1	5.08	129.0	3.07	78.0	.32	8.1
G20311-1616	16GS-16FL67M	7347-46555	1	25.4	1.75	44.5	2.01	51.1	5.94	150.9	3.71	94.2	.32	8.1
G20311-1620	16GS-20FL67M	7347-46565	1	25.4	2.00	50.8	2.52	64.0	5.83	148.1	3.59	91.2	.32	8.1
G20311-2020	20GS-20FL67M	7347-46645	1 1/4	31.8	2.00	50.8	2.52	64.0	7.01	178.1	4.21	106.9	.32	8.1
G20311-2024	20GS-24FL67S	7347-76605	1 1/4	31.8	2.38	60.5	2.01	51.1	6.46	164.1	3.66	93.0	.32	8.1

Code 61 O-Ring Flange - 90° Bent Tube

-8FL, -12FL, -16FL Max. W.P. 5,000 psi; -20FL Max. W.P. 4,000 psi.
S, M and L Drops per ISO Final Draft International Standard 12151-3.
See Accessories for O-Rings.

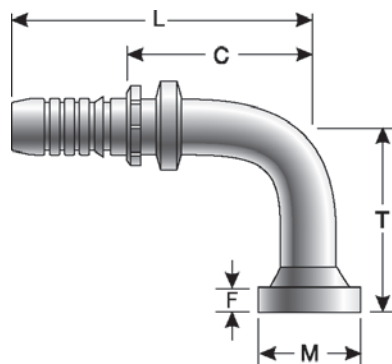

Part No.	Descr.	Prod. No.	⌀		M		T		L		C		F	
			"	mm	"	mm	"	mm	"	mm	"	mm	"	mm
	16GS-12FL90	7347-73255	1	25.4	1.50	38.1	3.15	80.0	5.31	134.9	3.10	78.7	.27	6.9
G20315-0608	6GS-8FL90M	7347-74155	3/8	9.5	1.19	30.2	1.57	39.9	3.43	87.1	2.02	51.3	.27	6.9
G20315-0808	8GS-8FL90M	7347-74245	1/2	12.7	1.19	30.2	1.57	39.9	3.46	87.9	1.99	50.6	.27	6.9
G20316-0808	8GS-8FL90L	7347-73815	1/2	12.7	1.19	30.2	3.27	83.1	3.46	87.9	1.99	50.6	.27	6.9
G20315-0812	8GS-12FL90M	7347-74265	1/2	12.7	1.50	38.1	2.28	57.9	3.46	87.9	1.98	50.3	.27	6.9
G20315-1010	10GS-10FLK90-055	7347-73355	5/8	15.9	1.35	34.3	2.17	55.1	4.33	110.0	2.35	59.7	.27	6.9
G20315-1012	10GS-12FL90M	7347-74355	5/8	15.9	1.50	38.1	2.28	57.9	4.33	110.0	2.35	59.7	.27	6.9
G20314-1208	12GS-8FL90-050	7347-76035	3/4	19.1	1.19	30.2	1.97	50.0	4.80	121.9	2.80	71.1	.27	6.9
G20315-1210	12GS-10FLK90-055	7347-73695	3/4	19.1	1.35	34.3	2.17	55.1	4.65	118.1	2.64	67.1	.27	6.9
G20315-1212	12GS-12FL90M	7347-74445	3/4	19.1	1.50	38.1	2.28	57.9	4.41	112.0	2.40	61.0	.27	6.9
G20317-1212	12GS-12FL90-100	7347-73905	3/4	19.1	1.50	38.1	3.94	100.1	4.41	112.0	2.40	61.0	.27	6.9
G20318-1212	12GS-12FL90-125	7347-73985	3/4	19.1	1.50	38.1	4.92	125.0	4.80	121.9	2.80	71.1	.27	6.9
G20314-1216	12GS-16FL90S	7347-73915	3/4	19.1	1.75	44.5	2.40	61.0	4.41	112.0	2.40	61.0	.32	8.1
G20315-1216	12GS-16FL90M	7347-73925	3/4	19.1	1.75	44.5	2.76	70.1	4.41	112.0	2.40	61.0	.32	8.1
G20316-1216	12GS-16FL90-080	7347-76805	3/4	19.1	1.75	44.5	3.15	80.0	5.04	128.0	3.03	77.0	.32	8.1
G20319-1216	12GS-16FL90-178	7347-79025	3/4	19.1	1.75	44.5	7.01	178.1	4.41	112.0	2.38	60.5	.32	8.1
G20314-1220	12GS-20FL90-054	7347-73995	3/4	19.1	2.00	50.8	2.13	54.1	5.16	131.1	3.15	80.0	.32	8.1
G20317-1220	12GS-20FL90-125	7347-78375	3/4	19.1	2.00	50.8	4.92	125.0	4.76	120.9	2.76	70.1	.32	8.1
G20315-1612	16GS-12FL90M	7347-74535	1	25.4	1.50	38.1	2.28	57.9	5.31	134.9	5.08	129.0	.27	6.9
G20314-1616	16GS-16FL90S	7347-47555	1	25.4	1.75	44.5	2.40	61.0	5.31	134.9	3.09	78.5	.32	8.1
G20315-1616	16GS-16FL90M	7347-74555	1	25.4	1.75	44.5	2.76	70.1	5.31	134.9	3.09	78.5	.32	8.1
G20317-1616	16GS-16FL90-120	7347-73165	1	25.4	1.75	44.5	4.72	119.9	5.28	134.1	3.04	77.2	.32	8.1
G20319-1616	16GS-16FL90-210	7347-78875	1	25.4	1.75	44.5	8.27	210.1	5.28	134.1	3.02	76.7	.32	8.1
G20314-1620	16GS-20FL90S	7347-47565	1	25.4	2.00	50.8	2.68	68.1	5.28	134.1	3.02	76.7	.32	8.1
G20315-1620	16GS-20FL90M	7347-74565	1	25.4	2.00	50.8	3.54	89.9	5.28	134.1	2.99	76.0	.32	8.1
G20317-1620	16GS-20FL90-120	7347-76495	1	25.4	2.00	50.8	4.72	119.9	5.28	134.1	3.04	77.2	.32	8.1
G20313-1624	16GS-24FL90-060	7347-73975	1	25.4	2.38	60.5	2.36	59.9	5.71	145.0	3.47	88.1	.32	8.1
G20314-1624	16GS-24FL90S	7347-47575	1	25.4	2.38	60.5	3.19	81.0	5.28	134.1	3.04	77.2	.32	8.1
G20315-2016	20GS-16FL90M	7347-74635	1 1/4	31.8	1.75	44.5	2.76	70.1	6.30	160.0	3.50	88.9	.32	8.1
G20316-2016	20GS-16FL90-215	7347-78885	1 1/4	31.8	1.75	44.5	8.46	214.9	6.30	160.0	3.50	88.9	.32	8.1
G20314-2020	20GS-20FL90S	7347-47645	1 1/4	31.8	2.00	50.8	2.68	68.1	6.50	165.1	3.70	94.0	.32	8.1
G20315-2020	20GS-20FL90M	7347-74645	1 1/4	31.8	2.00	50.8	3.54	89.9	6.50	165.1	3.70	94.0	.32	8.1
G20317-2020	20GS-20FL90-168	7347-76105	1 1/4	31.8	2.00	50.8	6.61	167.9	6.54	166.1	3.74	95.0	.32	8.1
G20314-2024	20GS-24FL90S	7347-47655	1 1/4	31.8	2.38	60.5	3.19	81.0	6.50	165.1	3.70	94.0	.32	8.1
G20315-2024	20GS-24FL90-118	7347-76085	1 1/4	31.8	2.38	60.5	4.65	118.1	6.50	165.1	3.70	94.0	.32	8.1

- EQUIPMENT
- HOSE/CPLG. SELECTION
- G8K COUPLINGS
- GLOBAL SPIRAL COUPLINGS
- STAINLESS STEEL SPIRAL
- MEGACRIMP COUPLINGS
- STAINLESS STEEL BRAID
- POWER CRIMP COUPLINGS
- FIELD ATTACHABLE G1 & G2 COUPLINGS
- FIELD ATTACHABLE C5 COUPLINGS
- GLX COUPLINGS
- GL COUPLINGS
- C14 COUPLINGS
- PCTS THERMOPLASTIC COUPLINGS
- POLARSEAL COUPLINGS
- POLARSEAL II COUPLINGS
- POWER STEERING
- ADAPTERS
- QUICK DISCONNECT COUPLERS
- BALL VALVES
- LIVE SWIVEL
- ASSEMBLY FABRICATION
- ACCESSORIES
- EQUIPMENT AND PARTS
- AIR BRAKE
- BRASS
- KITS

EQUIPMENT
HOSE/CPLG. SELECTION
G8K COUPLINGS
GLOBAL SPIRAL COUPLINGS
STAINLESS STEEL SPIRAL
MEGACRIMP COUPLINGS
STAINLESS STEEL BRAID
POWER CRIMP COUPLINGS
FIELD ATTACHABLE G1 & G2 COUPLINGS
FIELD ATTACHABLE C5 COUPLINGS
GLX COUPLINGS
GL COUPLINGS
C14 COUPLINGS
PCTS THERMOPLASTIC COUPLINGS
POLARSEAL COUPLINGS
POLARSEAL II COUPLINGS
POWER STEERING
ADAPTERS
QUICK DISCONNECT COUPLERS
BALL VALVES
LIVE SWIVEL
ASSEMBLY FABRICATION
ACCESSORIES
EQUIPMENT AND PARTS
AIR BRAKE
BRASS
KITS

Code 61 O-Ring Flange - 100° Bent Tube

-8FL, -12FL, -16FL Max. W.P. 5,000 psi; -20FL Max. W.P. 4,000 psi.
See Accessories for O-Rings.

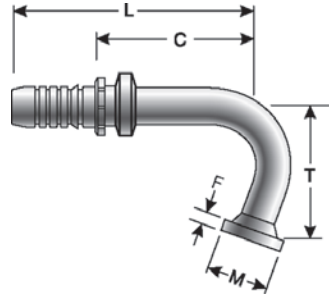

Part No.	Descr.	Prod. No.	⊕		M		T		L		C		F	
			"	mm	"	mm	"	mm	"	mm	"	mm	"	mm
G20323-1216	12GS-16FL100-059	7347-78055	3/4	19.1	1.75	44.5	2.32	58.9	4.93	125.2	2.92	74.2	.32	8.1

Code 61 O-Ring Flange - 110° Bent Tube

-8FL, -12FL, -16FL Max. W.P. 5,000 psi; -20FL Max. W.P. 4,000 psi.
See Accessories for O-Rings.

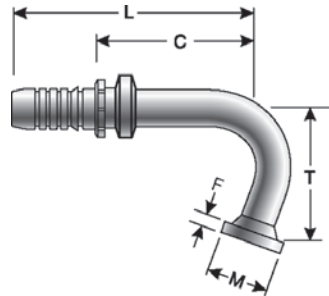

Part No.	Descr.	Prod. No.	⊕		M		T		L		C		F	
			"	mm	"	mm	"	mm	"	mm	"	mm	"	mm
G20325-1212	12GS-12FL110-064	7347-76025	3/4	19.1	1.50	38.1	2.52	64.0	5.16	131.1	3.15	80.0	.27	6.9
G20325-1616	16GS-16FL110-073	7347-73005	1	25.4	1.75	44.5	2.87	72.9	5.83	148.1	3.61	91.7	.32	8.1
G20325-1620	16GS-20FL110-073	7347-76455	1	25.4	2.00	50.8	2.87	72.9	4.65	118.1	2.41	61.2	.32	8.1
G20325-2020	20GS-20FL110-080	7347-76115	1 1/4	31.8	2.00	50.8	3.15	80.0	7.13	181.1	4.33	110.0	.32	8.1
G20325-2024	20GS-24FL110-080	7347-76125	1 1/4	31.8	2.38	60.5	3.15	80.0	7.13	181.1	4.33	110.0	.32	8.1

Code 61 O-Ring Flange - 135° Bent Tube

-8FL, -12FL, -16FL Max. W.P. 5,000 psi; -20FL Max. W.P. 4,000 psi.
See Accessories for O-Rings.

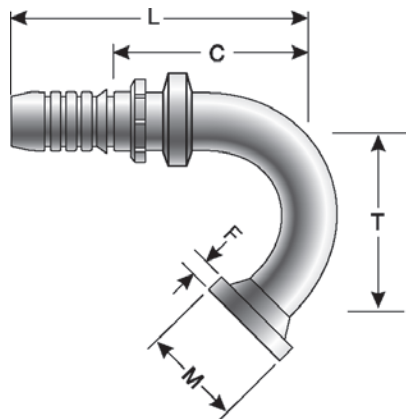

Part No.	Descr.	Prod. No.	⊘		M		T		L		C		F	
			"	mm	"	mm	"	mm	"	mm	"	mm	"	mm
G20331-1212	12GS-12FL135-070	7347-76825	3/4	19.1	1.50	38.1	2.76	70.1	3.82	97.0	1.81	46.0	.27	6.9

Code 62 O-Ring Flange Heavy

All FLH sizes Maximum Working Pressure 6,000 PSI.
See Accessories for O-Rings.

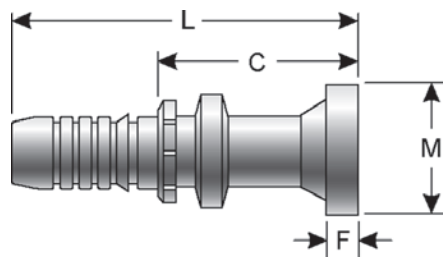

Part No.	Descr.	Prod. No.	⊘		M		L		C		F	
			"	mm	"	mm	"	mm	"	mm	"	mm
G20350-0808	8GS-8FLH	7347-48245	1/2	12.7	1.25	31.8	3.66	93.0	2.19	55.6	.31	7.9
G20350-0812	8GS-12FLH	7347-48265	1/2	12.7	1.63	41.4	3.66	93.0	2.19	55.6	.35	8.9
G20350-1008	10GS-8FLH	7347-48335	5/8	15.9	1.25	31.8	4.29	109.0	2.31	58.7	.31	7.9
G20350-1012	10GS-12FLH	7347-48355	5/8	15.9	1.63	41.4	4.29	109.0	2.31	58.7	.35	8.9
G20350-1212	12GS-12FLH	7347-48445	3/4	19.1	1.63	41.4	4.49	114.1	2.48	63.0	.35	8.9
G20350-1216	12GS-16FLH	7347-48465	3/4	19.1	1.88	47.8	4.49	114.1	2.48	63.0	.38	9.7
G20350-1612	16GS-12FLH	7347-48535	1	25.4	1.63	41.4	5.08	129.0	2.86	72.6	.35	8.9
G20350-1616	16GS-16FLH	7347-48555	1	25.4	1.88	47.8	4.92	125.0	2.70	68.6	.38	9.7
G20350-1620	16GS-20FLH	7347-48565	1	25.4	2.13	54.1	4.92	125.0	2.69	68.3	.41	10.4
G20350-2016	20GS-16FLH	7347-48635	1 1/4	31.8	1.88	47.8	6.42	163.1	3.62	92.0	.38	9.7
G20350-2020	20GS-20FLH	7347-48645	1 1/4	31.8	2.13	54.1	5.75	146.1	2.95	74.9	.41	10.4
G20350-2024	20GS-24FLH	7347-48655	1 1/4	31.8	2.50	63.5	6.30	160.0	3.50	88.9	.50	12.7

- EQUIPMENT
- HOSE/CPLG. SELECTION
- G8K COUPLINGS
- GLOBAL SPIRAL COUPLINGS
- STAINLESS STEEL SPIRAL
- MEGACRIMP COUPLINGS
- STAINLESS STEEL BRAID
- POWER CRIMP COUPLINGS
- FIELD ATTACHABLE G1 & G2 COUPLINGS
- FIELD ATTACHABLE C5 COUPLINGS
- GLX COUPLINGS
- GL COUPLINGS
- C14 COUPLINGS
- PCTS THERMOPLASTIC COUPLINGS
- POLARSEAL COUPLINGS
- POLARSEAL II COUPLINGS
- POWER STEERING
- ADAPTERS
- QUICK DISCONNECT COUPLERS
- BALL VALVES
- LIVE SWIVEL
- ASSEMBLY FABRICATION
- ACCESSORIES
- EQUIPMENT AND PARTS
- AIR BRAKE
- BRASS
- KITS

Code 62 O-Ring Flange Heavy - 22 1/2° Bent Tube

All FLH sizes Maximum Working Pressure 6,000 PSI.
S, M and L Drops per ISO Final Draft International Standard 12151-3.
See Accessories for O-Rings.

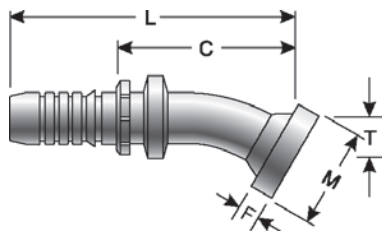

Part No.	Descr.	Prod. No.	⊖		M		T		L		C		F	
			"	mm	"	mm	"	mm	"	mm	"	mm	"	mm
G20352-1216	12GS-16FLH22M	7347-49465	3/4	19.1	1.88	47.8	.55	14.0	5.43	137.9	3.43	87.1	.38	9.7
G20352-1616	16GS-16FLH22M	7347-49555	1	25.4	1.88	47.8	.55	14.0	6.10	154.9	3.88	98.6	.38	9.7
G20352-1620	16GS-20FLH22M	7347-49565	1	25.4	2.13	54.1	.59	15.0	6.61	167.9	4.52	114.8	.41	10.4
G20352-2020	20GS-20FLH22M	7347-49645	1 1/4	31.8	2.13	54.1	.59	15.0	7.32	185.9	4.52	114.8	.41	10.4
G20352-2024	20GS-24FLH22M	7347-49655	1 1/4	31.8	2.50	63.5	.71	18.0	7.40	188.0	4.60	116.8	.50	12.7

Code 62 O-Ring Flange Heavy - 30° Bent Tube

All FLH sizes Maximum Working Pressure 6,000 PSI.
S, M and L Drops per ISO Final Draft International Standard 12151-3.
See Accessories for O-Rings.

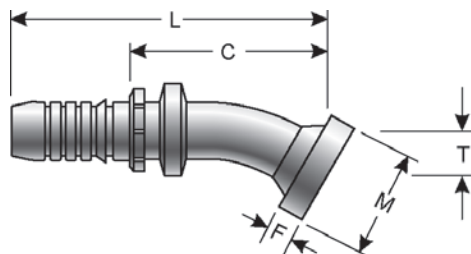

Part No.	Descr.	Prod. No.	⊖		M		T		L		C		F	
			"	mm	"	mm	"	mm	"	mm	"	mm	"	mm
G20354-1212	12GS-12FLH30M	7347-50445	3/4	19.1	1.63	41.4	.63	16.0	5.08	129.0	3.07	78.0	.35	8.9
G20354-1216	12GS-16FLH30M	7347-50465	3/4	19.1	1.88	47.8	.75	19.1	5.08	129.0	3.07	78.0	.38	9.7
G20354-1616	16GS-16FLH30M	7347-50555	1	25.4	1.88	47.8	.75	19.1	6.02	152.9	3.80	96.5	.38	9.7
G20354-1620	16GS-20FLH30M	7347-50565	1	25.4	2.13	54.1	1.50	38.1	6.22	158.0	3.98	101.1	.41	10.4
G20354-2020	20GS-20FLH30M	7347-50645	1 1/4	31.8	2.13	54.1	.87	22.1	7.24	183.9	4.44	112.8	.41	10.4
G20354-2024	20GS-24FLH30M	7347-50655	1 1/4	31.8	2.50	63.5	1.18	30.0	7.24	183.9	4.44	112.8	.50	12.7

EQUIPMENT
HOSE/CPLG. SELECTION
G8K COUPLINGS
GLOBAL SPIRAL COUPLINGS
STAINLESS STEEL SPIRAL
MEGACRIMP COUPLINGS
STAINLESS STEEL BRAID
POWER CRIMP COUPLINGS
FIELD ATTACHABLE G1 & G2 COUPLINGS
FIELD ATTACHABLE C5 COUPLINGS
GLX COUPLINGS
GL COUPLINGS
C14 COUPLINGS
PCTS THERMOPLASTIC COUPLINGS
POLARSEAL COUPLINGS
POLARSEAL II COUPLINGS
POWER STEERING
ADAPTERS
QUICK DISCONNECT COUPLERS
BALL VALVES
LIVE SWIVEL
ASSEMBLY FABRICATION
ACCESSORIES
EQUIPMENT AND PARTS
AIR BRAKE
BRASS
KITS

Code 62 O-Ring Flange Heavy - 45° Bent Tube

All FLH sizes Maximum Working Pressure 6,000 PSI.
S, M and L Drops per ISO Final Draft International Standard 12151-3.
See Accessories for O-Rings.

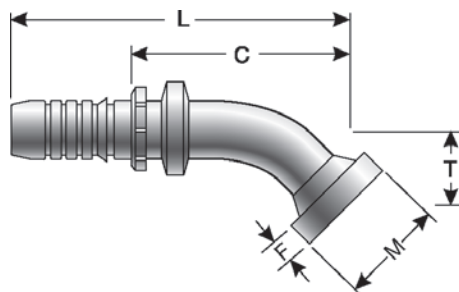

Part No.	Descr.	Prod. No.	⊖		M		T		L		C		F	
			"	mm	"	mm	"	mm	"	mm	"	mm	"	mm
G20357-0808	8GS-8FLH45M	7347-51245	1/2	12.7	1.25	31.8	.75	19.1	3.70	94.0	2.22	56.4	.31	7.9
G20357-0812	8GS-12FLH45M	7347-51265	1/2	12.7	1.63	41.4	1.02	25.9	3.98	101.1	2.50	63.5	.35	8.9
G20357-1012	10GS-12FLH45M	7347-51355	5/8	15.9	1.63	41.4	1.02	25.9	5.00	127.0	3.02	76.7	.35	8.9
G20357-1208	12GS-8FLH45M	7347-51425	3/4	19.1	1.25	31.8	.75	19.1	4.56	115.8	2.55	64.8	.31	7.9
G20357-1212	12GS-12FLH45M	7347-51445	3/4	19.1	1.63	41.4	1.02	25.9	4.88	124.0	2.87	72.9	.35	8.9
G20357-1216	12GS-16FLH45M	7347-51465	3/4	19.1	1.88	47.8	1.26	32.0	5.12	130.1	3.11	79.0	.38	9.7
G20357-1612	16GS-12FLH45M	7347-51535	1	25.4	1.63	41.4	1.02	25.9	5.55	141.0	3.33	84.6	.35	8.9
G20357-1616	16GS-16FLH45M	7347-51555	1	25.4	1.88	47.8	1.26	32.0	5.79	147.1	3.57	90.7	.38	9.7
G20357-1620	16GS-20FLH45M	7347-51565	1	25.4	2.13	54.1	1.50	38.1	6.22	158.0	3.98	101.1	.41	10.4
G20357-2016	20GS-16FLH45M	7347-51635	1 1/4	31.8	1.88	47.8	1.26	32.0	6.73	170.9	3.93	99.8	.38	9.7
G20357-2020	20GS-20FLH45M	7347-51645	1 1/4	31.8	2.13	54.1	1.50	38.1	6.93	176.0	4.13	104.9	.41	10.4
G20357-2024	20GS-24FLH45M	7347-51655	1 1/4	31.8	2.50	63.5	1.73	43.9	6.93	176.0	4.13	104.9	.50	12.7

Code 62 O-Ring Flange Heavy - 60° Bent Tube

All FLH sizes Maximum Working Pressure 6,000 PSI.
S, M and L Drops per ISO Final Draft International Standard 12151-3.
See Accessories for O-Rings.

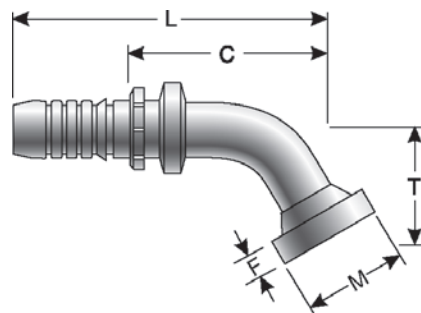

Part No.	Descr.	Prod. No.	⊖		M		T		L		C		F	
			"	mm	"	mm	"	mm	"	mm	"	mm	"	mm
G20359-1212	12GS-12FLH60M	7347-52445	3/4	19.1	1.63	41.4	1.46	37.1	5.39	136.9	3.39	86.1	.35	8.9
G20359-1216	12GS-16FLH60M	7347-52465	3/4	19.1	1.88	47.8	1.73	43.9	5.35	135.9	3.35	85.1	.38	9.7
G20359-1616	16GS-16FLH60M	7347-52555	1	25.4	1.88	47.8	1.73	43.9	6.18	157.0	3.96	100.6	.38	9.7
G20359-2020	20GS-20FLH60M	7347-52645	1 1/4	31.8	2.13	54.1	2.17	55.1	7.32	185.9	4.52	114.8	.41	10.4
G20359-2024	20GS-24FLH60M	7347-52655	1 1/4	31.8	2.50	63.5	2.52	64.0	7.64	194.1	4.84	122.9	.50	12.7

EQUIPMENT
HOSE/CPLG. SELECTION
G8K COUPLINGS
GLOBAL SPIRAL COUPLINGS
STAINLESS STEEL SPIRAL
MEGACRIMP COUPLINGS
STAINLESS STEEL BRAID
POWER CRIMP COUPLINGS
FIELD ATTACHABLE G1 & G2 COUPLINGS
FIELD ATTACHABLE C5 COUPLINGS
GLX COUPLINGS
GL COUPLINGS
C14 COUPLINGS
PCTS THERMOPLASTIC COUPLINGS
POLARSEAL COUPLINGS
POLARSEAL II COUPLINGS
POWER STEERING
ADAPTERS
QUICK DISCONNECT COUPLERS
BALL VALVES
LIVE SWIVEL
ASSEMBLY FABRICATION
ACCESSORIES
EQUIPMENT AND PARTS
AIR BRAKE
BRASS
KITS

EQUIPMENT
HOSE/CPLG. SELECTION
G8K COUPLINGS
GLOBAL SPIRAL COUPLINGS
STAINLESS STEEL SPIRAL
MEGACRIMP COUPLINGS
STAINLESS STEEL BRAID
POWER CRIMP COUPLINGS
FIELD ATTACHABLE G1 & G2 COUPLINGS
FIELD ATTACHABLE C5 COUPLINGS
GLX COUPLINGS
GL COUPLINGS
C14 COUPLINGS
PCTS THERMOPLASTIC COUPLINGS
POLARSEAL COUPLINGS
POLARSEAL II COUPLINGS
POWER STEERING
ADAPTERS
QUICK DISCONNECT COUPLERS
BALL VALVES
LIVE SWIVEL
ASSEMBLY FABRICATION
ACCESSORIES
EQUIPMENT AND PARTS
AIR BRAKE
BRASS
KITS

Code 62 O-Ring Flange Heavy - 67 1/2° Bent Tube

All FLH sizes Maximum Working Pressure 6,000 PSI.
S, M and L Drops per ISO Final Draft International Standard 12151-3.
See Accessories for O-Rings.

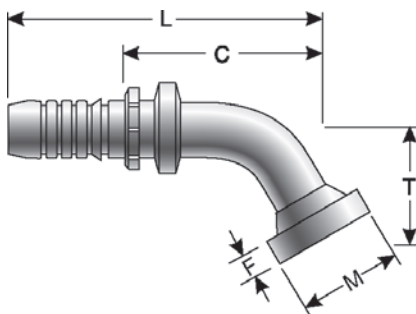

Part No.	Descr.	Prod. No.	⊖		M		T		L		C		F	
			"	mm	"	mm	"	mm	"	mm	"	mm	"	mm
G20360-1616	16GS-16FLH67M	7347-53555	1	25.4	1.88	47.8	2.01	51.1	5.94	150.9	3.72	94.5	.38	9.7

Code 62 O-Ring Flange Heavy - 90° Bent Tube

All FLH sizes Maximum Working Pressure 6,000 PSI.
S, M and L Drops per ISO Final Draft International Standard 12151-3.
See Accessories for O-Rings.

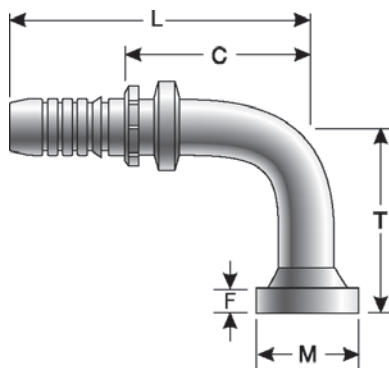

Part No.	Descr.	Prod. No.	⊖		M		T		L		C		F	
			"	mm	"	mm	"	mm	"	mm	"	mm	"	mm
G20365-0808	8GS-8FLH90M	7347-75245	1/2	12.7	1.25	31.8	1.57	39.9	3.46	87.9	1.99	50.6	.31	7.9
G20366-0808	8GS-8FLH90-080	7347-73825	1/2	12.7	1.25	31.8	3.15	80.0	3.46	87.9	1.99	50.6	.31	7.9
G20365-0812	8GS-12FLH90M	7347-75265	1/2	12.7	1.63	41.4	2.28	57.9	3.46	87.9	1.99	50.6	.35	8.9
G20365-1008	10GS-8FLH90M	7347-75335	5/8	15.9	1.25	31.8	1.57	39.9	4.45	113.0	2.47	62.7	.31	7.9
G20365-1012	10GS-12FLH90M	7347-75355	5/8	15.9	1.63	41.4	2.28	57.9	4.33	110.0	2.35	59.7	.35	8.9
G20365-1212	12GS-12FLH90M	7347-75445	3/4	19.1	1.63	41.4	2.28	57.9	4.41	112.0	2.40	61.0	.35	8.9
G20366-1212	12GS-20FLH90-100	7347-76415	3/4	19.1	1.63	41.4	3.94	100.1	4.41	112.0	2.40	61.0	.35	8.9
G20367-1212	12GS-12FLH90-122	7347-76415	3/4	19.1	1.63	41.4	4.80	121.9	4.80	121.9	2.80	71.1	.35	8.9
G20364-1216	12GS-16FLH90S	7347-54465	3/4	19.1	1.88	47.8	2.40	61.0	4.41	112.0	2.40	61.0	.38	9.7
G20365-1216	12GS-16FLH90M	7347-73935	3/4	19.1	1.88	47.8	2.76	70.1	4.41	112.0	2.40	61.0	.38	9.7
G20367-1216	12GS-16FLH90-140	7347-76715	3/4	19.1	1.88	47.8	5.51	140.0	4.57	116.1	2.56	65.0	.38	9.7
G20365-1220	12GS-20FLH90M	7347-75475	3/4	19.1	2.13	54.1	3.54	89.9	4.80	121.9	2.80	71.1	.41	10.4
G20365-1612	16GS-12FLH90M	7347-54535	1	25.4	1.63	41.4	2.28	57.9	5.31	134.9	3.09	78.5	.35	8.9
G20364-1616	16GS-16FLH90S	7347-54555	1	25.4	1.88	47.8	2.40	61.0	5.31	134.9	3.09	78.5	.38	9.7
G20365-1616	16GS-16FLH90M	7347-75555	1	25.4	1.88	47.8	2.76	70.1	5.31	134.9	3.09	78.5	.38	9.7

Code 62 O-Ring Flange Heavy - 90° Bent Tube - Continued

Part No.	Descr.	Prod. No.	⊖		M		T		L		C		F	
			"	mm	"	mm	"	mm	"	mm	"	mm	"	mm
G20366-1616	16GS-16FLH90-120	7347-73015	1	25.4	1.88	47.8	4.72	119.9	5.28	134.1	3.04	77.2	.38	9.7
G20367-1616	16GS-16FLH90-090	7347-78105	1	25.4	1.88	47.8	3.54	89.9	5.52	140.2	3.28	83.3	.38	9.7
G20364-1620	16GS-20FLH90S	7347-54565	1	25.4	2.13	54.1	2.68	68.1	5.28	134.1	3.02	76.7	.41	10.4
G20365-1620	16GS-20FLH90M	7347-75565	1	25.4	2.13	54.1	3.54	89.9	5.28	134.1	3.02	76.7	.41	10.4
G20364-1624	16GS-24FLH90S	7347-54575	1	25.4	2.50	63.5	3.19	81.0	5.28	134.1	3.04	77.2	.50	12.7
G20364-2016	20GS-16FLH90S	7347-54635	1 1/4	31.8	1.88	47.8	2.40	61.0	6.30	160.0	3.50	88.9	.38	9.7
G20365-2016	20GS-16FLH90M	7347-75635	1 1/4	31.8	1.88	47.8	2.76	70.1	6.30	160.0	3.50	88.9	.38	9.7
G20366-2016	20GS-16FLH90-100	7347-76185	1 1/4	31.8	1.88	47.8	3.94	100.1	6.30	160.0	3.50	88.9	.38	9.7
G20364-2020	20GS-20FLH90-076	7347-73635	1 1/4	31.8	2.13	54.1	2.99	76.0	6.50	165.1	3.70	94.0	.41	10.4
G20365-2020	20GS-20FLH90M	7347-75645	1 1/4	31.8	2.13	54.1	3.54	89.9	6.50	165.1	3.70	94.0	.41	10.4
G20366-2020	20GS-20FLH90-120	7347-76135	1 1/4	31.8	2.13	54.1	4.72	119.9	6.50	165.1	3.70	94.0	.41	10.4
G20367-2020	20GS-20FLH90-152	7347-76485	1 1/4	31.8	2.13	54.1	5.98	151.9	6.50	165.1	3.70	94.0	.41	10.4
G20364-2024	20GS-24FLH90S	7347-54655	1 1/4	31.8	2.50	63.5	3.19	81.0	6.50	165.1	3.70	94.0	.50	12.7

Code 62 O-Ring Flange Heavy - 110° Bent Tube

All FLH sizes Maximum Working Pressure 6,000 PSI.

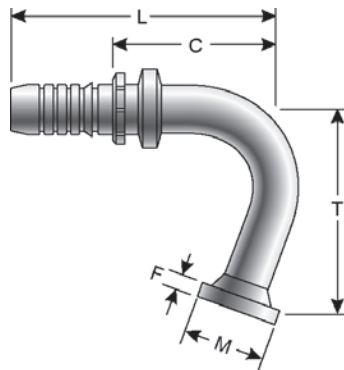

Part No.	Descr.	Prod. No.	⊖		M		T		L		C		F	
			"	mm	"	mm	"	mm	"	mm	"	mm	"	mm
G20369-1212	12GS-12FLH110-064	7347-78525	3/4	19.1	1.50	38.1	2.76	70.1	3.82	97.0	1.81	46.0	.27	6.9

- EQUIPMENT
- HOSE/CPLG. SELECTION
- G8K COUPLINGS
- GLOBAL SPIRAL COUPLINGS
- STAINLESS STEEL SPIRAL
- MEGACRIMP COUPLINGS
- STAINLESS STEEL BRAID
- POWER CRIMP COUPLINGS
- FIELD ATTACHABLE G1 & G2 COUPLINGS
- FIELD ATTACHABLE C5 COUPLINGS
- GLX COUPLINGS
- GL COUPLINGS
- C14 COUPLINGS
- PCTS THERMOPLASTIC COUPLINGS
- POLARSEAL COUPLINGS
- POLARSEAL II COUPLINGS
- POWER STEERING
- ADAPTERS
- QUICK DISCONNECT COUPLERS
- BALL VALVES
- LIVE SWIVEL
- ASSEMBLY FABRICATION
- ACCESSORIES
- EQUIPMENT AND PARTS
- AIR BRAKE
- BRASS
- KITS

EQUIPMENT
HOSE/CPLG. SELECTION
G8K COUPLINGS
GLOBAL SPIRAL COUPLINGS
STAINLESS STEEL SPIRAL
MEGACRIMP COUPLINGS
STAINLESS STEEL BRAID
POWER CRIMP COUPLINGS
FIELD ATTACHABLE G1 & G2 COUPLINGS
FIELD ATTACHABLE C5 COUPLINGS
GLX COUPLINGS
GL COUPLINGS
C14 COUPLINGS
PCTS THERMOPLASTIC COUPLINGS
POLARSEAL COUPLINGS
POLARSEAL II COUPLINGS
POWER STEERING
ADAPTERS
QUICK DISCONNECT COUPLERS
BALL VALVES
LIVE SWIVEL
ASSEMBLY FABRICATION
ACCESSORIES
EQUIPMENT AND PARTS
AIR BRAKE
BRASS
KITS

Caterpillar Style O-Ring Flange

NOTE: These FLC flanges are designed with a thicker flange head. The 0.56" flange dimension is frequently found on Caterpillar equipment. These flanges let the user utilize the existing Caterpillar flange halves or new Gates Caterpillar flange halves. At the user's option, standard Code 62 flanges and halves can be used in place of Caterpillar flanges and halves. The standard Code 62 flange head thickness ranges between .305" and .495". See Accessories for O-Rings.

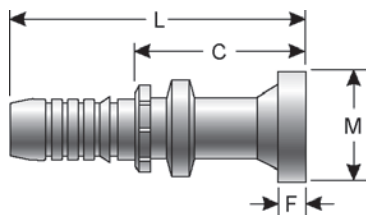

Part No.	Descr.	Prod. No.	⊖		M		L		C		F	
			"	mm	"	mm	"	mm	"	mm	"	mm
G20400-1212	12GS-12FLC	7347-62445	3/4	19.1	1.63	41.4	5.71	145.0	3.70	94.0	.56	14.2
G20400-1216	12GS-16FLC	7347-62465	3/4	19.1	1.88	47.8	5.71	145.0	3.70	94.0	.56	14.2
G20400-1616	16GS-16FLC	7347-62555	1	25.4	1.88	47.8	6.10	154.9	3.87	98.3	.56	14.2
G20400-1620	16GS-20FLC	7347-62565	1	25.4	2.13	54.1	6.10	154.9	3.87	98.3	.56	14.2
G20400-2020	20GS-20FLC	7347-62645	1 1/4	31.8	2.13	54.1	7.36	186.9	4.56	115.8	.56	14.2
G20400-2024	20GS-24FLC	7347-62655	1 1/4	31.8	2.50	63.5	7.36	186.9	4.56	115.8	.56	14.2

Caterpillar Style O-Ring Flange - 22 1/2° Bent Tube

NOTE: These FLC flanges are designed with a thicker flange head. The 0.56" flange dimension is frequently found on Caterpillar equipment. These flanges let the user utilize the existing Caterpillar flange halves or new Gates Caterpillar flange halves. At the user's option, standard Code 62 flanges and halves can be used in place of Caterpillar flanges and halves. The standard Code 62 flange head thickness ranges between .305" and .495". See Accessories for O-Rings.

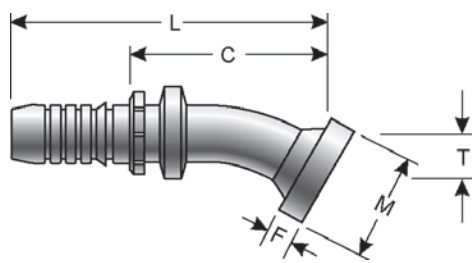

Part No.	Descr.	Prod. No.	⊖		M		T		L		C		F	
			"	mm	"	mm	"	mm	"	mm	"	mm	"	mm
G20402-1212	12GS-12FLC22-016	7347-63445	3/4	19.1	1.63	41.4	.63	16.0	5.63	143.0	3.62	92.0	.56	14.2
G20402-1616	16GS-16FLC22-017	7347-63555	1	25.4	1.88	47.8	.67	17.0	6.02	152.9	3.78	96.0	.56	14.2
G20402-1620	16GS-20FLC22-017	7347-63565	1	25.4	2.13	54.1	.67	17.0	6.02	152.9	3.78	96.0	.56	14.2
G20402-2020	20GS-20FLC22-017	7347-63645	1 1/4	31.8	2.13	54.1	.67	17.0	7.28	184.9	4.48	113.8	.56	14.2
G20402-2024	20GS-24FLC22-017	7347-63655	1 1/4	31.8	2.50	63.5	.67	17.0	7.28	184.9	4.48	113.8	.56	14.2

Caterpillar Style O-Ring Flange - 30° Bent Tube

NOTE: These FLC flanges are designed with a thicker flange head. The 0.56" flange dimension is frequently found on Caterpillar equipment. These flanges let the user utilize the existing Caterpillar flange halves or new Gates Caterpillar flange halves. At the user's option, standard Code 62 flanges and halves can be used in place of Caterpillar flanges and halves. The standard Code 62 flange head thickness ranges between .305" and .495".

See Accessories for O-Rings.

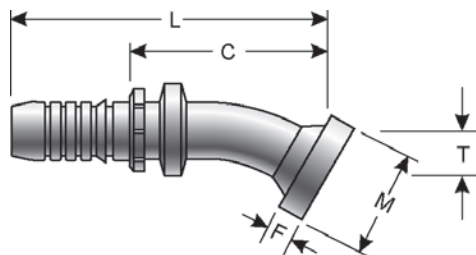

Part No.	Descr.	Prod. No.	⊖		M		T		L		C		F	
			"	mm	"	mm	"	mm	"	mm	"	mm	"	mm
G20404-1212	12GS-12FLC30-022	7347-64445	3/4	19.1	1.63	41.4	.87	22.1	5.51	140.0	3.50	88.9	.56	14.2
G20404-1216	12GS-16FLC30-022	7347-64465	3/4	19.1	1.88	47.8	.87	22.1	5.55	141.0	3.54	89.9	.56	14.2
G20404-1616	16GS-16FLC30-023	7347-64555	1	25.4	1.88	47.8	.91	23.1	5.94	150.9	3.69	93.7	.56	14.2
G20404-1620	16GS-20FLC30-023	7347-64565	1	25.4	2.13	54.1	.91	23.1	5.94	150.9	3.69	93.7	.56	14.2
G20404-2020	20GS-20FLC30-024	7347-64645	1 1/4	31.8	2.13	54.1	.94	23.9	7.20	182.9	4.41	112.0	.56	14.2
G20404-2024	20GS-24FLC30-024	7347-64655	1 1/4	31.8	2.50	63.5	.94	23.9	7.20	182.9	4.41	112.0	.56	14.2

Caterpillar Style O-Ring Flange - 45° Bent Tube

NOTE: These FLC flanges are designed with a thicker flange head. The 0.56" flange dimension is frequently found on Caterpillar equipment. These flanges let the user utilize the existing Caterpillar flange halves or new Gates Caterpillar flange halves. At the user's option, standard Code 62 flanges and halves can be used in place of Caterpillar flanges and halves. The standard Code 62 flange head thickness ranges between .305" and .495".

See Accessories for O-Rings.

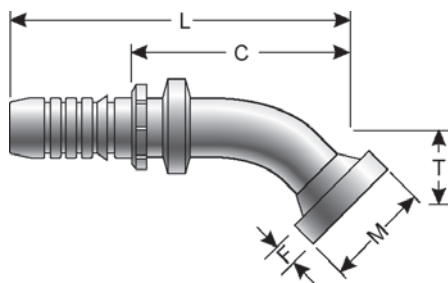

Part No.	Descr.	Prod. No.	⊖		M		T		L		C		F	
			"	mm	"	mm	"	mm	"	mm	"	mm	"	mm
G20407-1212	12GS-12FLC45-035	7347-65445	3/4	19.1	1.63	41.4	1.38	35.1	5.24	133.1	3.23	82.0	.56	14.2
G20408-1212	12GS-12FLC45-066	7347-76425	3/4	19.1	1.63	41.4	2.60	66.0	6.50	165.1	4.49	114.1	.56	14.2
G20407-1216	12GS-16FLC45-035	7347-65465	3/4	19.1	1.88	47.8	1.38	35.1	5.24	133.1	3.23	82.0	.56	14.2
G20407-1616	16GS-16FLC45-037	7347-65555	1	25.4	1.88	47.8	1.46	37.1	5.63	143.0	3.40	86.4	.56	14.2
G20407-1620	16GS-20FLC45-037	7347-65565	1	25.4	2.13	54.1	1.46	37.1	5.63	143.0	3.40	86.4	.56	14.2
G20407-2020	20GS-20FLC45-037	7347-65645	1 1/4	31.8	2.13	54.1	1.46	37.1	6.93	176.0	4.13	104.9	.56	14.2
G20407-2024	20GS-24FLC45-037	7347-65655	1 1/4	31.8	2.50	63.5	1.46	37.1	6.93	176.0	4.13	104.9	.56	14.2

EQUIPMENT
HOSE/CPLG. SELECTION
G8K COUPLINGS
GLOBAL SPIRAL COUPLINGS
STAINLESS STEEL SPIRAL
MEGACRIMP COUPLINGS
STAINLESS STEEL BRAID
POWER CRIMP COUPLINGS
FIELD ATTACHABLE G1 & G2 COUPLINGS
FIELD ATTACHABLE C5 COUPLINGS
GLX COUPLINGS
GL COUPLINGS
C14 COUPLINGS
PCTS THERMOPLASTIC COUPLINGS
POLARSEAL COUPLINGS
POLARSEAL II COUPLINGS
POWER STEERING
ADAPTERS
QUICK DISCONNECT COUPLERS
BALL VALVES
LIVE SWIVEL
ASSEMBLY FABRICATION
ACCESSORIES
EQUIPMENT AND PARTS
AIR BRAKE
BRASS
KITS

EQUIPMENT
HOSE/CPLG. SELECTION
G8K COUPLINGS
GLOBAL SPIRAL COUPLINGS
STAINLESS STEEL SPIRAL
MEGACRIMP COUPLINGS
STAINLESS STEEL BRAID
POWER CRIMP COUPLINGS
FIELD ATTACHABLE G1 & G2 COUPLINGS
FIELD ATTACHABLE C5 COUPLINGS
GLX COUPLINGS
GL COUPLINGS
C14 COUPLINGS
PCTS THERMOPLASTIC COUPLINGS
POLARSEAL COUPLINGS
POLARSEAL II COUPLINGS
POWER STEERING
ADAPTERS
QUICK DISCONNECT COUPLERS
BALL VALVES
LIVE SWIVEL
ASSEMBLY FABRICATION
ACCESSORIES
EQUIPMENT AND PARTS
AIR BRAKE
BRASS
KITS

Caterpillar Style O-Ring Flange - 60° Bent Tube

NOTE: These FLC flanges are designed with a thicker flange head. The 0.56" flange dimension is frequently found on Caterpillar equipment. These flanges let the user utilize the existing Caterpillar flange halves or new Gates Caterpillar flange halves. At the user's option, standard Code 62 flanges and halves can be used in place of Caterpillar flanges and halves. The standard Code 62 flange head thickness ranges between .305" and .495". See Accessories for O-Rings.

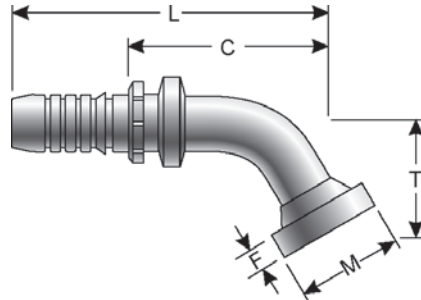

Part No.	Descr.	Prod. No.	⊖		M		T		L		C		F	
			"	mm	"	mm	"	mm	"	mm	"	mm	"	mm
G20409-1216	12GS-16FLC60-048	7347-66465	3/4	19.1	1.88	47.8	1.89	48.0	5.75	146.1	3.74	95.0	.56	14.2
G20409-1616	16GS-16FLC60-050	7347-66555	1	25.4	1.88	47.8	1.97	50.0	6.42	163.1	4.17	105.9	.56	14.2
G20409-1620	16GS-20FLC60-050	7347-66565	1	25.4	2.13	54.1	1.97	50.0	6.42	163.1	4.17	105.9	.56	14.2
G20409-2020	20GS-20FLC60-052	7347-66645	1 1/4	31.8	2.13	54.1	2.05	52.1	7.80	198.1	5.00	127.0	.56	14.2
G20409-2024	20GS-24FLC60-052	7347-66655	1 1/4	31.8	2.50	63.5	2.05	52.1	7.80	198.1	5.00	127.0	.56	14.2

Caterpillar Style O-Ring Flange - 67 1/2° Bent Tube

NOTE: These FLC flanges are designed with a thicker flange head. The 0.56" flange dimension is frequently found on Caterpillar equipment. These flanges let the user utilize the existing Caterpillar flange halves or new Gates Caterpillar flange halves. At the user's option, standard Code 62 flanges and halves can be used in place of Caterpillar flanges and halves. The standard Code 62 flange head thickness ranges between .305" and .495". See Accessories for O-Rings.

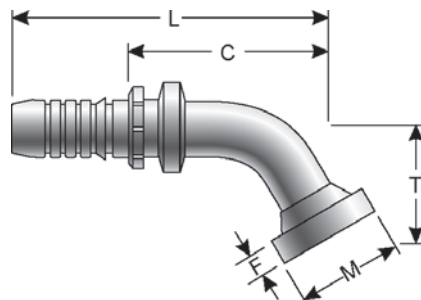

Part No.	Descr.	Prod. No.	⊖		M		T		L		C		F	
			"	mm	"	mm	"	mm	"	mm	"	mm	"	mm
G20410-1616	16GS-16FLC67-057	7347-67555	1	25.4	1.88	47.8	2.24	56.9	6.14	156.0	3.90	99.1	.56	14.2
G20410-1620	16GS-20FLC67-057	7347-67565	1	25.4	2.13	54.1	2.24	56.9	6.14	156.0	3.90	99.1	.56	14.2
G20410-2020	20GS-20FLC67-059	7347-67645	1 1/4	31.8	2.13	54.1	2.32	58.9	7.52	191.0	4.72	119.9	.56	14.2
G20410-2024	20GS-24FLC67-059	7347-67655	1 1/4	31.8	2.50	63.5	2.32	58.9	7.52	191.0	4.72	119.9	.56	14.2

Caterpillar Style O-Ring Flange - 90° Bent Tube

NOTE: These FLC flanges are designed with a thicker flange head. The 0.56" flange dimension is frequently found on Caterpillar equipment. These flanges let the user utilize the existing Caterpillar flange halves or new Gates Caterpillar flange halves. At the user's option, standard Code 62 flanges and halves can be used in place of Caterpillar flanges and halves. The standard Code 62 flange head thickness ranges between .305" and .495".

See Accessories for O-Rings.

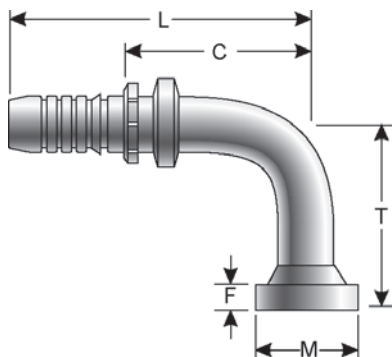

Part No.	Descr.	Prod. No.	⊖		M		T		L		C		F	
			"	mm	"	mm	"	mm	"	mm	"	mm	"	mm
G20415-1212	12GS-12FLC90-068	7347-73945	3/4	19.1	1.63	41.4	2.68	68.1	4.92	125.0	2.91	73.9	.56	14.2
G20416-1212	12GS-12FLC90-128	7347-76015	3/4	19.1	1.63	41.4	5.04	128.0	4.61	117.1	2.60	66.0	.56	14.2
G20415-1216	12GS-16FLC90-068	7347-73955	3/4	19.1	1.88	47.8	2.68	68.1	4.61	117.1	2.60	66.0	.56	14.2
G20415-1616	16GS-16FLC90-074	7347-68555	1	25.4	1.88	47.8	2.91	73.9	5.16	131.1	2.92	74.2	.56	14.2
G20416-1616	16GS-16FLC90-132	7347-73035	1	25.4	1.88	47.8	5.20	132.1	5.16	131.1	2.92	74.2	.56	14.2
G20415-1620	16GS-20FLC90-074	7347-68565	1	25.4	2.13	54.1	2.91	73.9	5.16	131.1	2.92	74.2	.56	14.2
G20416-1620	16GS-20FLC90-132	7347-68585	1	25.4	2.13	54.1	5.19	131.8	5.15	130.8	2.92	74.2	.56	14.2
G20415-2020	20GS-20FLC90-077	7347-68645	1 1/4	31.8	2.13	54.1	3.03	77.0	6.54	166.1	3.74	95.0	.56	14.2
G20416-2020	20GS-20FLC90-150	7347-68685	1 1/4	31.8	2.13	54.1	5.90	149.9	9.48	240.8	6.70	170.2	.56	14.2
G20415-2024	20GS-24FLC90-077	7347-68655	1 1/4	31.8	2.50	63.5	3.03	77.0	6.54	166.1	3.74	95.0	.56	14.2

Female French GAZ (Poclair) 24° High Pressure Flange

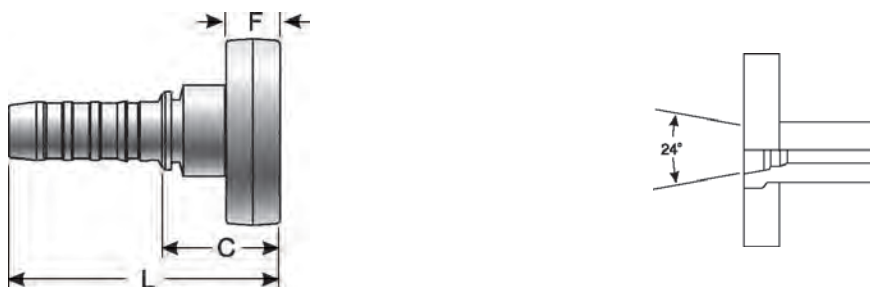

Part No.	Descr.	Prod. No.	⊖		L		C		F	
			"	mm	"	mm	"	mm	"	mm
G20420-0817	8GS-17FPFL	7347-93215	1/2	12.7	2.72	69.1	1.24	31.5	.56	14.2
G20420-1021	10GS-21FPFL	7347-92995	5/8	15.9	3.35	85.1	1.37	34.8	.56	14.2
G20420-1227	12GS-27FPFL	7347-93065	3/4	19.1	3.58	90.9	1.57	39.9	.56	14.2
G20420-1634	16GS-34FPFL	7347-93165	1	25.4	4.02	102.1	1.78	45.2	.56	14.2
G20420-2042	20GS-42FPFL	7347-93465	1 1/4	31.8	5.24	133.1	2.44	62.0	.56	14.2

EQUIPMENT
HOSE/CPLG. SELECTION
G8K COUPLINGS
GLOBAL SPIRAL COUPLINGS
STAINLESS STEEL SPIRAL
MEGACRIMP COUPLINGS
STAINLESS STEEL BRAID
POWER CRIMP COUPLINGS
FIELD ATTACHABLE G1 & G2 COUPLINGS
FIELD ATTACHABLE C5 COUPLINGS
GLX COUPLINGS
GL COUPLINGS
C14 COUPLINGS
PCTS THERMOPLASTIC COUPLINGS
POLARSEAL COUPLINGS
POLARSEAL II COUPLINGS
POWER STEERING
ADAPTERS
QUICK DISCONNECT COUPLERS
BALL VALVES
LIVE SWIVEL
ASSEMBLY FABRICATION
ACCESSORIES
EQUIPMENT AND PARTS
AIR BRAKE
BRASS
KITS

Male French GAZ (Poclairn) 24° High Pressure Flange

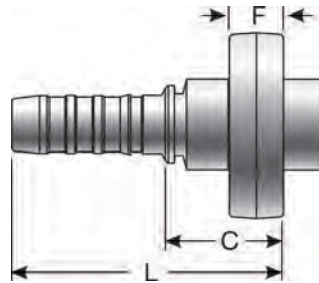

Part No.	Descr.	Prod. No.	⊖		L		C		F	
			"	mm	"	mm	"	mm	"	mm
G20480-0817	8GS-17MPFL	7347-93225	1/2	12.7	3.11	79.0	1.63	41.4	.56	14.2
G20480-1021	10GS-21MPFL	7347-93005	5/8	15.9	3.27	83.1	1.29	32.8	.56	14.2
G20480-1227	12GS-27MPFL	7347-93085	3/4	19.1	4.02	102.1	2.01	51.1	.56	14.2
G20480-1634	16GS-34MPFL	7347-93185	1	25.4	4.51	114.6	2.27	57.7	.56	14.2
G20480-2042	20GS-42MPFL	7347-93475	1 1/4	31.8	6.77	172.0	3.96	100.6	.56	14.2

Male French GAZ (Poclairn) 24° High Pressure Flange - 90° Bent Tube

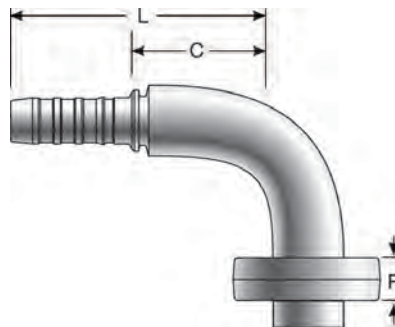

Part No.	Descr.	Prod. No.	⊖		T		L		C		F	
			"	mm	"	mm	"	mm	"	mm	"	mm
G20482-1021	10GS-21MPFL90	7347-93045	5/8	15.9	2.27	57.7	3.62	92.0	1.64	41.7	.56	14.2
G20482-2042	20GS-42MPFL90	7347-93485	1 1/4	31.8	3.51	89.2	5.90	149.9	3.09	78.5	.56	14.2

Hose Length Extender Caterpillar

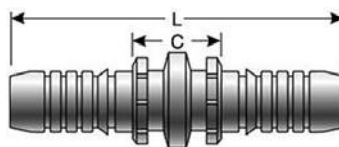

Part No.	Descr.	Prod. No.	⊖		L		C	
			"	mm	"	mm	"	mm
G20534-1212	12GS-12HLEC	7347-76405	3/4	19.1	6.42	163.1	2.40	61.0
G20534-1616	16GS-16HLEC	7347-76395	1	25.4	7.09	180.1	2.61	66.3

Hose Length Extender

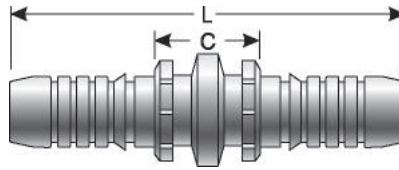

Part No.	Descr.	Prod. No.	⊖		L		C	
			"	mm	"	mm	"	mm
G20535-0808	8GS-8HLE	7347-73265	1/2	12.7	3.70	94.0	.75	19.1
G20535-1212	12GS-12HLE	7347-76815	3/4	19.1	4.80	121.9	.78	19.8
G20535-1616	16GS-16HLE	7347-76625	1	25.4	5.43	137.9	.98	24.9
G20535-2020	20GS-20HLE	7347-78585	1 1/4	31.8	6.77	172.0	1.17	29.7

Hose Length Extender - 45° Bent Tube

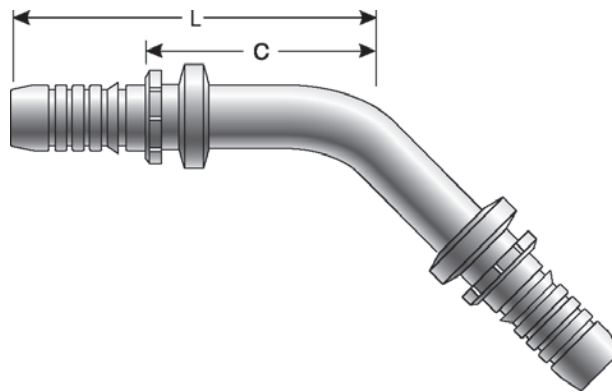

Part No.	Descr.	Prod. No.	⊖		L		C	
			"	mm	"	mm	"	mm
G20536-2020	20GS-20HLE45-103	7347-78895	1 1/4	31.8	9.80	248.9	6.19	157.2

- EQUIPMENT
- HOSE/CPLG. SELECTION
- G8K COUPLINGS
- GLOBAL SPIRAL COUPLINGS**
- STAINLESS STEEL SPIRAL
- MEGACRIMP COUPLINGS
- STAINLESS STEEL BRAID
- POWER CRIMP COUPLINGS
- FIELD ATTACHABLE G1 & G2 COUPLINGS
- FIELD ATTACHABLE C5 COUPLINGS
- GLX COUPLINGS
- GL COUPLINGS
- C14 COUPLINGS
- PCTS THERMOPLASTIC COUPLINGS
- POLARSEAL COUPLINGS
- POLARSEAL II COUPLINGS
- POWER STEERING
- ADAPTERS
- QUICK DISCONNECT COUPLERS
- BALL VALVES
- LIVE SWIVEL
- ASSEMBLY FABRICATION
- ACCESSORIES
- EQUIPMENT AND PARTS
- AIR BRAKE
- BRASS
- KITS

Hose Length Extender - 90° Bent Tube

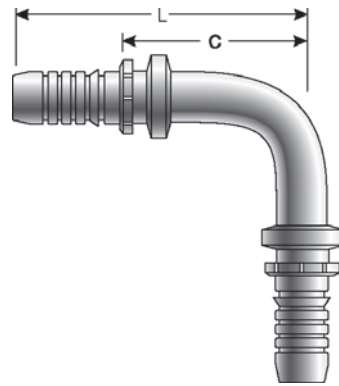

Part No.	Descr.	Prod. No.	⊖		L		C	
			"	mm	"	mm	"	mm
G20537-0808	8GS-8HLE90-086	7347-73195	1/2	12.7	3.39	86.1	1.91	48.5
G20537-1212	12GS-12HLE90-112	7347-73965	3/4	19.1	4.39	111.5	2.38	60.5
G20537-1616	16GS-16HLE90-127	7347-73705	1	25.4	5.00	127.0	2.76	70.1
G20537-2020	20GS-20HLE90-155	7347-76705	1 1/4	31.8	6.10	154.9	3.30	83.8

Male DIN 24° Cone - Light Series

Do not use at a pressure above DIN Light ratings.
Nut Hex per ISO Draft International Standards 12151-2.

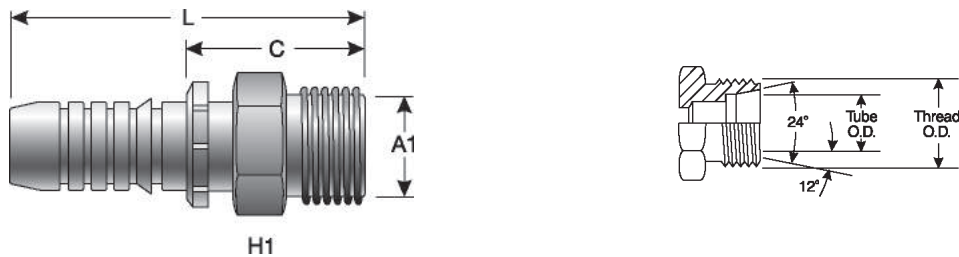

Part No.	Descr.	Prod. No.	⊖		H1	L		C		A1	
			"	mm		"	mm	"	mm		
G20615-0612	6GS-12MDL	7347-93445	3/8	9.5	M18X1.5	22	2.51	63.8	1.10	27.9	12.0
G20615-0815	8GS-15MDL	7347-90625	1/2	12.7	M22X1.5	24	2.48	63.0	1.00	25.4	15.0
G20615-1222	12GS-22MDL	7347-93565	3/4	19.1	M30X2.0	32	3.13	79.5	1.12	28.5	22.0
G20615-1628	16GS-28MDL	7347-91495	1	25.4	M36X2.0	41	3.54	89.9	1.31	33.3	28.0

Female DIN 24° Cone Swivel - Light Series with O-Ring

Do not use at a pressure above DIN Light ratings.
Nut Hex per ISO Draft International Standards 12151-2.

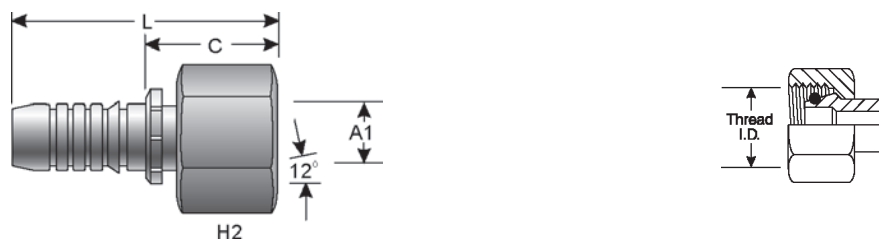

Part No.	Descr.	Prod. No.	⊖		H2	L		C		A1	
			"	mm		"	mm	"	mm		
G20645-0612	6GS-12FDLORX	7347-92815	3/8	9.5	M18X1.5	22	2.87	72.9	1.46	37.1	12.0
G20645-0815	8GS-15FDLORX	7347-90595	1/2	12.7	M22X1.5	22	2.87	72.9	1.40	35.6	15.0
G20645-1018	10GS-18FDLORX	7347-92105	5/8	15.9	M26X1.5	32	3.61	91.7	1.63	41.4	18.0
G20645-1222	12GS-22FDLORX	7347-92125	3/4	19.1	M30X2.0	36	3.82	97.0	1.81	46.0	22.0
G20645-1228	12GS-28FDLORX	7347-92165	3/4	19.1	M36X2.0	41	3.90	99.1	1.89	48.1	28.0
G20645-1628	16GS-28FDLORX	7347-90795	1	25.4	M36X2.0	41	4.13	104.9	1.91	48.5	28.0
G20645-2035	20GS-35FDLORX	7347-94135	1 1/4	31.8	M45X2.0	50	5.21	132.3	2.41	61.2	35.0

Female DIN 24° Cone Swivel - Light Series with O-Ring - 45° Bent Tube

Do not use at a pressure above DIN Light ratings.
Nut Hex per ISO Draft International Standards 12151-2.

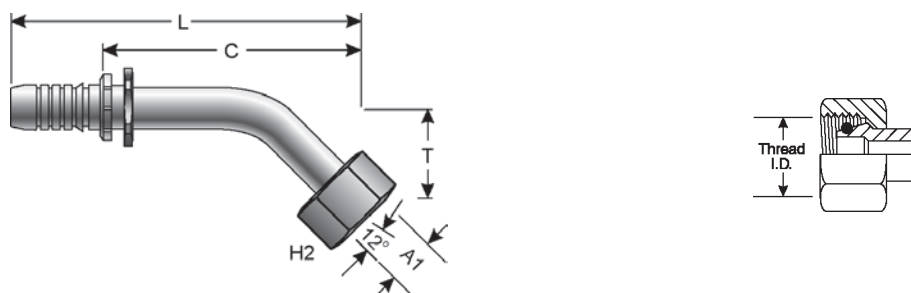

Part No.	Descr.	Prod. No.	⊖		H2	T		L		C		A1	
			"	mm		"	mm	"	mm	"	mm		
G20650-0815	8GS-15FDLORX45	7347-90605	1/2	12.7	M22X1.5	27	.79	20.1	3.72	94.5	2.25	57.2	15.0
G20650-1222	12GS-22FDLORX45	7347-92525	3/4	19.1	M30X2.0	36	1.17	29.7	5.35	135.9	3.34	84.8	22.0
G20650-1628	16GS-28FDLORX45	7347-91525	1	25.4	M36X2.0	41	1.21	30.7	6.12	155.5	3.90	99.1	28.0

EQUIPMENT
HOSE/CPLG. SELECTION
G8K COUPLINGS
GLOBAL SPIRAL COUPLINGS
STAINLESS STEEL SPIRAL
MEGACRIMP COUPLINGS
STAINLESS STEEL BRAID
POWER CRIMP COUPLINGS
FIELD ATTACHABLE G1 & G2 COUPLINGS
FIELD ATTACHABLE C5 COUPLINGS
GLX COUPLINGS
GL COUPLINGS
C14 COUPLINGS
PCTS THERMOPLASTIC COUPLINGS
POLARSEAL COUPLINGS
POLARSEAL II COUPLINGS
POWER STEERING
ADAPTERS
QUICK DISCONNECT COUPLERS
BALL VALVES
LIVE SWIVEL
ASSEMBLY FABRICATION
ACCESSORIES
EQUIPMENT AND PARTS
AIR BRAKE
BRASS
KITS

Female DIN 24° Cone Swivel - Light Series with O-Ring - 90° Bent Tube

Do not use at a pressure above DIN Light ratings.
Nut Hex per ISO Draft International Standards 12151-2.

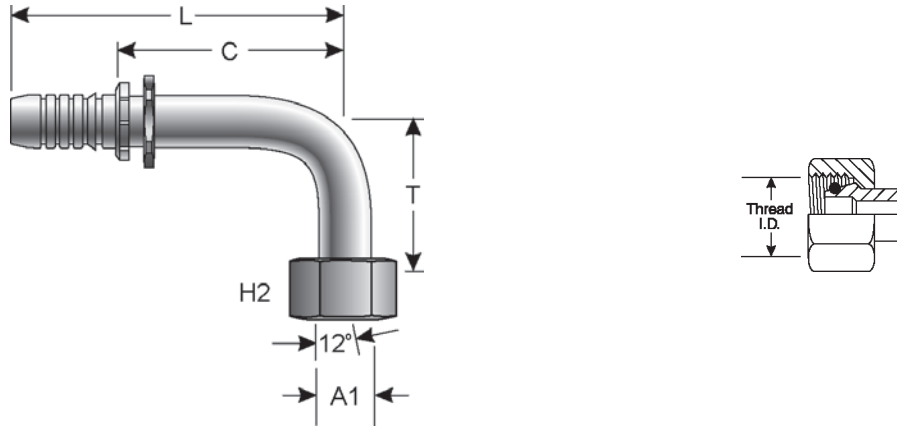

Part No.	Descr.	Prod. No.	⊖		H2	T		L		C		A1	
			"	mm		"	mm	"	mm	"	mm		
G20655-0612	6GS-12FDLORX90	7347-92455	3/8	9.5	M19X1.5	22	1.45	36.8	3.07	78.0	1.66	42.2	12.0
G20655-0815	8GS-15FDLORX90	7347-90615	1/2	12.7	M22X1.5	27	1.65	41.9	3.46	87.9	1.98	50.3	15.0
G20655-1018	10GS-18FDLORX90	7347-92515	5/8	15.9	M26X1.5	32	2.03	51.6	4.47	113.5	2.49	63.3	18.0
G20655-1222	12GS-22FDLORX90M	7347-92135	3/4	19.1	M30X2.0	36	2.44	62.0	4.86	123.4	2.86	72.6	22.0
G20655-1628	16GS-28FDLORX90M	7347-90765	1	25.4	M36X2.0	41	2.76	70.1	5.82	147.8	2.71	68.8	28.0

Male French GAZ

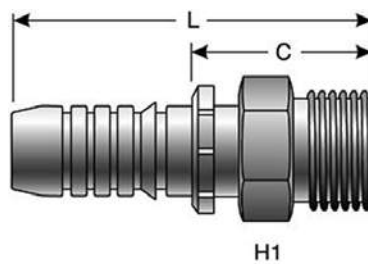

Part No.	Descr.	Prod. No.	⊖		H1	L		C		
			"	mm		"	mm	"	mm	
G20675-0817	8GS-17MFG	7347-90655	1/2	12.7	M24X1.5	26	2.61	66.3	1.14	29.0
G20675-1221	12GS-21MFG	7347-94075	3/4	19.1	M30X1.5	32	3.23	82.0	1.22	31.0
G20675-1227	12GS-27MFG	7347-93055	3/4	19.1	M36X1.5	42	3.33	84.6	1.32	33.5
G20675-1634	16GS-34MFG	7347-93155	1	25.4	M45X1.5	50	3.70	94.0	1.46	37.1

Female French GAZ Swivel (Female Kobelco)

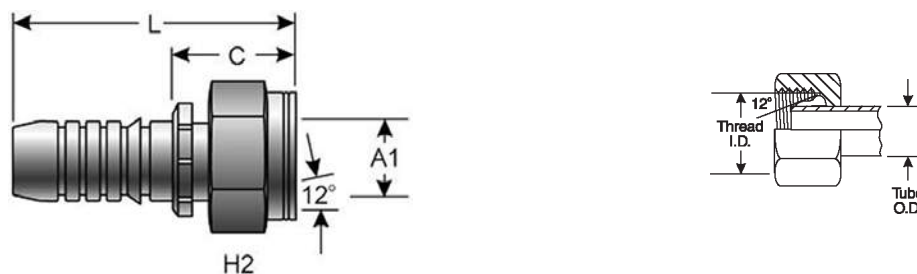

Part No.	Descr.	Prod. No.	⊖		H2	L		C		A1	
			"	mm		"	mm	"	mm		mm
G20680-0817	8GS-17FFGX	7347-90665	1/2	12.7	M24X1.5	30	2.68	68.1	1.20	30.5	16.8
G20680-1021	10GS-21FFGX	7347-93025	5/8	15.9	M30X1.5	36	3.44	87.4	1.44	36.6	21.3
G20680-1221	12GS-21FFGX	7347-94715	3/4	19.1	M30X1.5	36	3.27	83.1	1.29	32.8	21.3
G20680-1227	12GS-27FFGX	7347-93075	3/4	19.1	M36X1.5	41	3.41	86.6	1.40	35.6	26.6
G20680-1627	16GS-27FFGX	7347-94725	1	25.4	M36X1.5	41	3.41	86.6	1.40	35.6	26.6
G20680-1634	16GS-34FFGX	7347-93175	1	25.4	M45X1.5	55	3.76	95.5	1.54	39.1	33.5

Female French GAZ Swivel - 90° Bent Tube

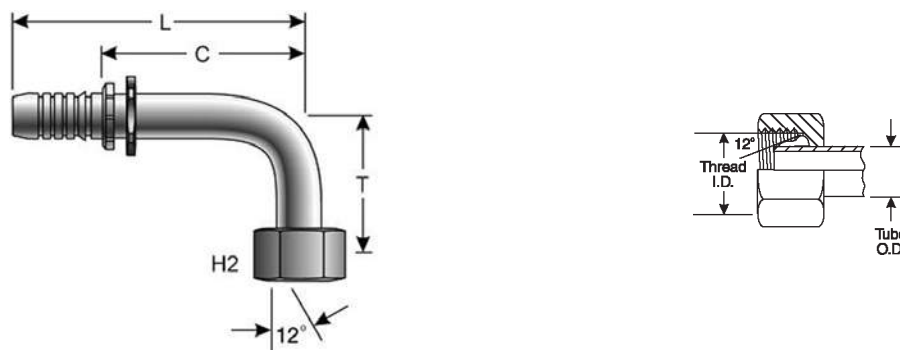

Part No.	Descr.	Prod. No.	⊖		H2	T		L		C		
			"	mm		"	mm	"	mm	"	mm	mm
G20690-1021	10GS-21FFGX90	7347-93035	5/8	15.9	M30X1.5	36	1.77	45.0	3.62	92.0	1.64	41.7
G20690-1221	12GS-21FFGX90	7347-94735	3/4	19.1	M30X1.5	36	2.00	50.8	4.91	124.7	2.90	73.7
G20691-1227	12GS5K-27FFGX90-060	7347-78645	3/4	19.1	M36X1.5	41	2.36	59.9	4.91	124.7	2.90	73.7
G20690-1627	16GS-27FFGX90	7347-94745	1	25.4	M30X1.5	41	2.64	67.1	5.94	150.9	3.72	94.5
G20691-1634	16GS5K-34FFGX90-065	7347-78655	1	25.4	M45X1.5	55	2.56	65.0	5.67	144.0	3.45	87.6

- EQUIPMENT
- HOSE/CPLG. SELECTION
- G8K COUPLINGS
- GLOBAL SPIRAL COUPLINGS
- STAINLESS STEEL SPIRAL
- MEGACRIMP COUPLINGS
- STAINLESS STEEL BRAID
- POWER CRIMP COUPLINGS
- FIELD ATTACHABLE G1 & G2 COUPLINGS
- FIELD ATTACHABLE C5 COUPLINGS
- GLX COUPLINGS
- GL COUPLINGS
- C14 COUPLINGS
- PCTS THERMOPLASTIC COUPLINGS
- POLARSEAL COUPLINGS
- POLARSEAL II COUPLINGS
- POWER STEERING
- ADAPTERS
- QUICK DISCONNECT COUPLERS
- BALL VALVES
- LIVE SWIVEL
- ASSEMBLY FABRICATION
- ACCESSORIES
- EQUIPMENT AND PARTS
- AIR BRAKE
- BRASS
- KITS

Male DIN 24° Cone - Heavy Series

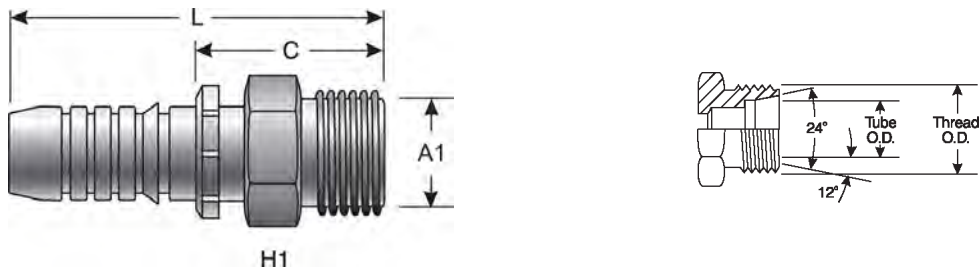

Part No.	Descr.	Prod. No.	⊖		H1	L		C		A1	
			"	mm		"	mm	"	mm		
G20715-0612	6GS-12MDH	7347-01785	3/8	9.5	M20X1.5	22	2.51	63.8	1.10	27.9	12.0
G20715-0614	6GS-14MDH	7347-92675	3/8	9.5	M22X1.5	24	2.59	65.8	1.18	30.0	14.0
G20715-0816	8GS-16MDH	7347-91325	1/2	12.7	M24X1.5	27	1.17	29.7	1.18	30.0	16.0
G20715-1020	10GS-20MDH	7347-92695	5/8	15.9	M30X2.0	32	3.35	85.1	1.37	34.8	20.0
G20715-1220	12GS-20MDH	7347-92255	3/4	19.1	M30X2.0	32	3.35	85.1	1.34	34.0	20.0
G20715-1225	12GS-25MDH	7347-92265	3/4	19.1	M36X2.0	41	3.50	88.9	1.50	38.1	25.0
G20715-1230	12GS-30MDH	7347-93765	3/4	19.1	M42X2.0	46	3.90	99.1	1.06	26.9	30.0
G20715-1625	16GS-25MDH	7347-91505	1	25.4	M36X2.0	41	3.82	97.0	1.58	40.1	25.0
G20715-1630	16GS-30MDH	7347-91515	1	25.4	M42X2.0	46	3.90	99.1	1.66	42.2	30.0
G20715-2038	20GS-38MDH	7347-93295	1 1/4	31.8	M52X2.0	55	4.84	122.9	2.04	51.8	38.0

Female DIN 24° Cone Swivel - Heavy Series with O-Ring

Nut Hex per ISO Draft International Standards 12151-2.

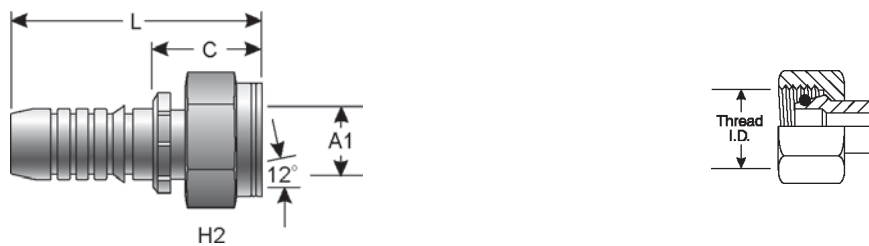

Part No.	Descr.	Prod. No.	⊖		H2	L		C		A1	
			"	mm		"	mm	"	mm		
G20720-0610	6GS-10FDHORX	7347-92635	3/8	9.5	M18X1.5	22	3.24	82.3	1.41	35.8	10.0
G20720-0612	6GS-12FDHORX	7347-92645	3/8	9.5	M20X1.5	24	2.87	72.9	1.46	37.1	12.0
G20720-0614	6GS-14FDHORX	7347-92085	3/8	9.5	M22X1.5	27	2.97	75.4	1.56	39.6	14.0
G20720-0812	8GS-12FDHORX	7347-95195	1/2	12.7	M20X1.5	24	2.87	72.9	1.53	38.9	12.0
G20720-0814	8GS-14FDHORX	7347-92095	1/2	12.7	M22X1.5	27	3.01	76.5	1.53	38.9	14.0
G20720-0816	8GS-16FDHORX	7347-91335	1/2	12.7	M24X1.5	30	3.11	79.0	1.63	41.4	16.0
G20720-0820	8GS-20FDHORX	7347-92715	1/2	12.7	M30X2.0	36	3.11	79.0	1.96	49.9	20.0
G20720-1020	10GS-20FDHORX	7347-92115	5/8	15.9	M30X2.0	36	3.94	100.1	1.96	49.9	20.0
G20720-1025	10GS-25FDHORX	7347-93425	5/8	15.9	M36X2.0	46	4.09	103.9	2.11	53.6	25.0
G20720-1220	12GS-20FDHORX	7347-92145	3/4	19.1	M30X2.0	36	4.06	103.1	2.05	52.1	20.0
G20720-1225	12GS-25FDHORX	7347-92155	3/4	19.1	M36X2.0	46	4.23	107.4	2.22	56.4	25.0
G20720-1625	16GS-25FDHORX	7347-91535	1	25.4	M36X2.0	46	4.57	116.1	2.35	59.7	25.0
G20720-1630	16GS-30FDHORX	7347-90805	1	25.4	M42X2.0	50	4.65	118.1	2.43	61.7	30.0
G20720-1638	16GS-38FDHORX	7347-94225	1	25.4	M52X2.0	60	4.40	111.8	2.17	55.1	38.0
G20720-2038	20GS-38FDHORX	7347-93305	1 1/4	31.8	M52X2.0	60	5.71	145.0	2.91	73.9	38.0

Female DIN 24° Cone Swivel - Heavy Series with O-Ring - 45° Bent Tube

Nut Hex per ISO Draft International Standards 12151-2.

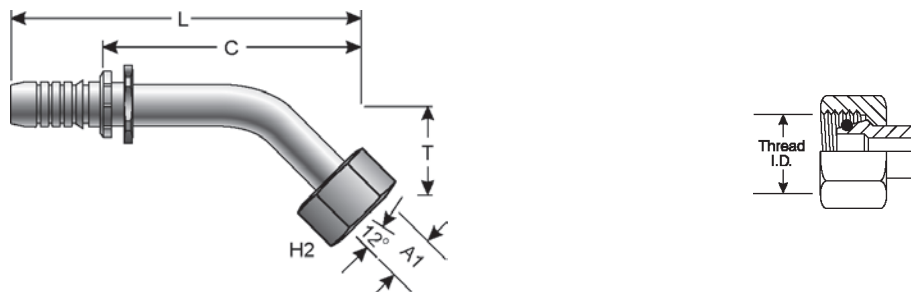

Part No.	Descr.	Prod. No.	⊖		H2	T		L		C		A1	
			"	mm		"	mm	"	mm	"	mm		
G20725-0612	6GS-12FDHORX45	7347-92425	3/8	9.5	M20X1.5	24	2.87	72.9	2.97	75.4	1.41	35.8	12.0
G20725-0614	6GS-14FDHORX45	7347-92465	3/8	9.5	M22X1.5	27	2.97	75.4	3.31	84.1	1.46	37.1	14.0
G20725-0816	8GS-16FDHORX45M	7347-91345	1/2	12.7	M24X1.5	30	.85	21.6	3.70	94.0	2.23	56.6	16.0
G20725-1020	10GS-20FDHORX45	7347-92325	5/8	15.9	M30X2.0	36	.98	24.9	4.79	121.7	2.81	71.4	20.0
G20725-1220	12GS-20FDHORX45	7347-93285	3/4	19.1	M30X2.0	36	1.17	29.7	6.33	160.8	4.33	110.0	20.0
G20725-1225	12GS-25FDHORX45M	7347-92175	3/4	19.1	M36X2.0	46	1.23	31.2	5.31	134.9	3.40	86.4	25.0
G20725-1625	16GS-25FDHORX45M	7347-91545	1	25.4	M36X2.0	46	1.38	35.1	3.90	99.1	1.66	42.2	25.0
G20725-1630	16GS-30FDHORX45	7347-91565	1	25.4	M42X2.0	50	1.38	35.1	6.29	159.8	4.07	103.4	30.0
G20725-2038	20GS-38FDHORX45M	7347-93415	1 1/4	31.8	M52X2.0	60	1.67	42.4	7.72	196.1	4.92	125.0	38.0

Female DIN 24° Cone Swivel - Heavy Series with O-Ring - 90° Bent Tube

Nut Hex per ISO Draft International Standards 12151-2.

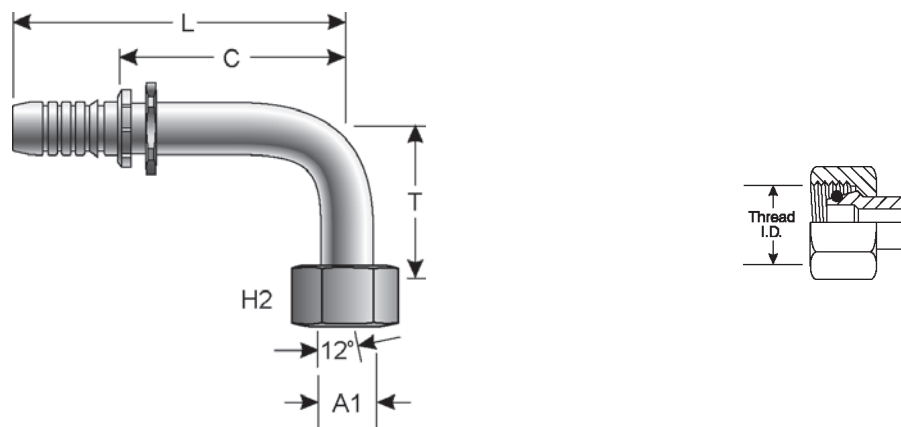

Part No.	Descr.	Prod. No.	⊖		H2	T		L		C		A1	
			"	mm		"	mm	"	mm	"	mm		
G20730-0612	6GS-12FDHORX90	7347-92435	3/8	9.5	M20X1.5	24	1.45	36.8	3.07	78.0	1.46	37.1	12.0
G20730-0614	6GS-14FDHORX90	7347-92475	3/8	9.5	M22X1.5	27	1.57	39.9	3.07	78.0	1.66	42.2	14.0
G20730-0816	8GS-16FDHORX90M	7347-91485	1/2	12.7	M24X1.5	30	1.73	43.9	3.39	86.1	1.91	48.5	16.0
G20730-1020	10GS-20FDHORX90M	7347-92335	5/8	15.9	M30X2.0	36	2.01	51.1	4.43	112.5	2.45	62.2	20.0
G20730-1220	12GS-20FDHORX90M	7347-92185	3/4	19.1	M30X2.0	36	2.44	62.0	4.86	123.4	2.85	72.4	20.0
G20730-1225	12GS-25FDHORX90M	7347-92195	3/4	19.1	M36X2.0	46	2.52	64.0	4.86	123.4	2.85	72.4	25.0
G20730-1625	16GS-25FDHORX90	7347-91555	1	25.4	M36X2.0	46	2.99	76.0	5.94	150.9	3.72	94.5	25.0
G20730-1630	16GS-30FDHORX90M	7347-90775	1	25.4	M42X2.0	50	2.99	76.0	5.81	147.6	3.59	91.2	30.0
G20730-2038	20GS-38FDHORX90M	7347-93315	1 1/4	31.8	M52X2.0	60	3.43	87.1	7.11	180.6	4.31	109.5	38.0

- EQUIPMENT
- HOSE/CPLG. SELECTION
- G8K COUPLINGS
- GLOBAL SPIRAL COUPLINGS
- STAINLESS STEEL SPIRAL
- MEGACRIMP COUPLINGS
- STAINLESS STEEL BRAID
- POWER CRIMP COUPLINGS
- FIELD ATTACHABLE G1 & G2 COUPLINGS
- FIELD ATTACHABLE C5 COUPLINGS
- GLX COUPLINGS
- GL COUPLINGS
- C14 COUPLINGS
- PCTS THERMOPLASTIC COUPLINGS
- POLARSEAL COUPLINGS
- POLARSEAL II COUPLINGS
- POWER STEERING
- ADAPTERS
- QUICK DISCONNECT COUPLERS
- BALL VALVES
- LIVE SWIVEL
- ASSEMBLY FABRICATION
- ACCESSORIES
- EQUIPMENT AND PARTS
- AIR BRAKE
- BRASS
- KITS

EQUIPMENT
HOSE/CPLG. SELECTION
G8K COUPLINGS
GLOBAL SPIRAL COUPLINGS
STAINLESS STEEL SPIRAL
MEGACRIMP COUPLINGS
STAINLESS STEEL BRAID
POWER CRIMP COUPLINGS
FIELD ATTACHABLE G1 & G2 COUPLINGS
FIELD ATTACHABLE C5 COUPLINGS
GLX COUPLINGS
GL COUPLINGS
C14 COUPLINGS
PCTS THERMOPLASTIC COUPLINGS
POLARSEAL COUPLINGS
POLARSEAL II COUPLINGS
POWER STEERING
ADAPTERS
QUICK DISCONNECT COUPLERS
BALL VALVES
LIVE SWIVEL
ASSEMBLY FABRICATION
ACCESSORIES
EQUIPMENT AND PARTS
AIR BRAKE
BRASS
KITS

Male Kobelco Style

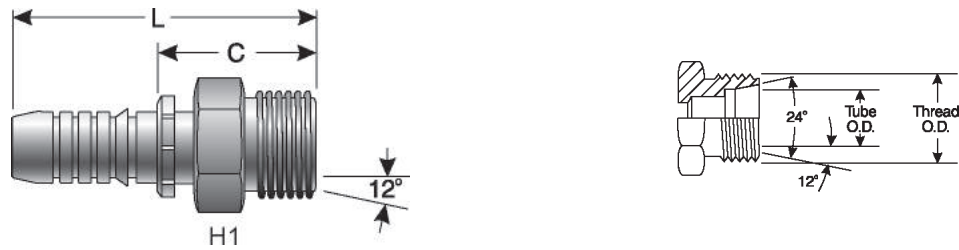

Part No.	Descr.	Prod. No.	⌀		H1	L		C		
			"	mm		"	mm	"	mm	
G20735-1222	12GS-22MKB	7347-73665	3/4	19.1	M30X2.0	36	3.35	85.1	1.34	34.0
G20735-1228	12GS-28MKB	7347-73675	3/4	19.1	M36X1.5	41	3.62	92.0	1.61	40.9
G20735-1628	16GS-28MKB	7347-73095	1	25.4	M36X1.5	50	3.98	101.1	1.74	44.2
G20735-1635	16GS-35MKB	7347-73025	1	25.4	M45X1.5	50	3.74	95.0	1.50	38.1

Male British Standard Pipe Parallel

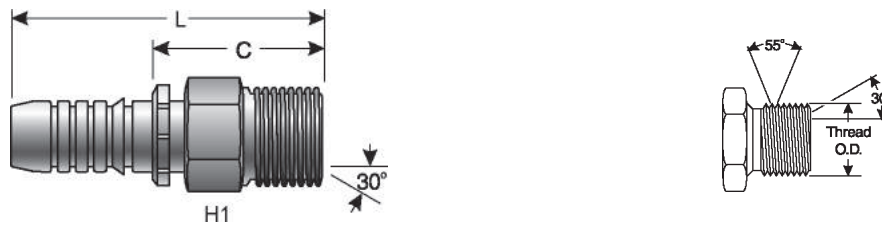

Part No.	Descr.	Prod. No.	⌀		H1	L		C		
			"	mm		"	mm	"	mm	
G20810-0606	6GS-6MBSPP	7347-01775	3/8	9.5	3/8-19	22	2.48	63.0	1.07	27.2
G20810-0808	8GS-8MBSPP	7347-91365	1/2	12.7	1/2-14	27	2.66	67.6	1.81	46.0
G20810-1010	10GS-10MBSPP	7347-92615	5/8	15.9	5/8-14	30	2.66	67.6	1.18	30.0
G20810-1012	10GS-12MBSPP	7347-92625	5/8	15.9	3/4-14	32	3.35	85.1	1.37	34.8
G20810-1212	12GS-12MBSPP	7347-92205	3/4	19.1	3/4-14	32	3.35	85.1	1.37	34.8
G20810-1616	16GS-16MBSPP	7347-90825	1	25.4	1-11	41	3.86	98.1	1.62	41.2
G20810-2020	20GS-20MBSPP	7347-93365	1 1/4	31.8	1 1/4-11	50	4.65	118.1	1.85	47.0

Female British Standard Parallel Pipe O-Ring Swivel

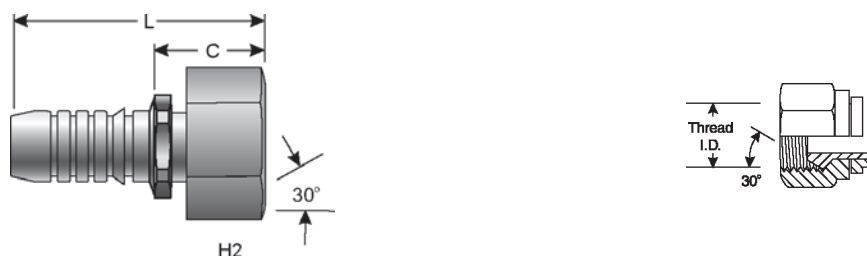

Part No.	Descr.	Prod. No.	⊖		H2	L		C		
			"	mm		"	mm	"	mm	
G20830-0606	6GS-6FBSPORX	7347-92235	3/8	9.5	3/8-19	22	2.34	59.4	.93	23.6
G20830-0608	6GS-8FBSPORX	7347-92705	3/8	9.5	1/2-14	27	2.40	61.0	.93	23.6
G20830-0808	8GS-8FBSPORX	7347-91405	1/2	12.7	1/2-14	27	2.40	61.0	.93	23.6
G20830-1010	10GS-10FBSPORX	7347-92405	5/8	15.9	5/8-14	30	3.35	85.1	1.18	30.0
G20830-1012	10GS-12FBSPORX	7347-93965	5/8	15.9	3/4-14	30	3.35	85.1	1.37	34.8
G20830-1212	12GS-12FBSPORX	7347-93995	3/4	19.1	3/4-14	32	3.41	86.6	1.40	35.6
G20830-1216	12GS-16FBSPORX	7347-92585	3/4	19.1	1-11	41	3.74	95.0	1.40	35.6
G20830-1616	16GS-16FBSPORX	7347-90815	1	25.4	1-11	41	3.74	95.0	1.52	38.6
G20830-1620	16GS-20FBSPORX	7347-94195	1	25.4	1 1/2	50	3.27	83.1	1.03	26.2
G20830-2020	20GS-20FBSPORX	7347-93375	1 1/4	31.8	1 1/4-11	50	4.59	116.6	1.79	45.5

Female British Standard Parallel Pipe O-Ring Swivel - 45° Bent Tube

S, M and L Drops and Hex per ISO Working Draft 12151-6.

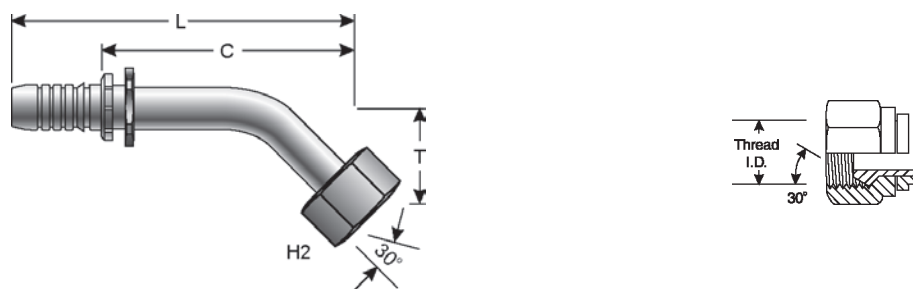

Part No.	Descr.	Prod. No.	⊖		H2	T		L		C		
			"	mm		"	mm	"	mm	"	mm	
G20831-0606	6GS-6FBSPORX45M	7347-92345	3/8	9.5	3/8-19	22	.61	15.5	3.27	83.1	1.86	47.2
G20831-0808	8GS-8FBSPORX45M	7347-91415	1/2	12.7	1/2-14	27	.67	17.0	3.60	91.4	2.13	54.1
G20831-1010	10GS-10FBSPORX45	7347-92285	5/8	15.9	5/8-14	30	1.04	26.4	4.20	106.7	2.25	57.2
G20831-1212	12GS-12FBSPORX45M	7347-92245	3/4	19.1	3/4-14	32	1.11	28.2	5.29	134.4	3.28	83.3
G20831-1616	16GS-16FBSPORX45M	7347-92275	1	25.4	1-11	41	1.22	31.0	6.12	155.5	3.90	99.1
G20831-2020	20GS-20FBSPORX45M	7347-93395	1 1/4	31.8	1 1/4-11	50	1.48	37.6	7.52	191.0	4.72	119.9

- EQUIPMENT
- HOSE/CPLG. SELECTION
- G8K COUPLINGS
- GLOBAL SPIRAL COUPLINGS
- STAINLESS STEEL SPIRAL
- MEGACRIMP COUPLINGS
- STAINLESS STEEL BRAID
- POWER CRIMP COUPLINGS
- FIELD ATTACHABLE G1 & G2 COUPLINGS
- FIELD ATTACHABLE C5 COUPLINGS
- GLX COUPLINGS
- GL COUPLINGS
- C14 COUPLINGS
- PCTS THERMOPLASTIC COUPLINGS
- POLARSEAL COUPLINGS
- POLARSEAL II COUPLINGS
- POWER STEERING
- ADAPTERS
- QUICK DISCONNECT COUPLERS
- BALL VALVES
- LIVE SWIVEL
- ASSEMBLY FABRICATION
- ACCESSORIES
- EQUIPMENT AND PARTS
- AIR BRAKE
- BRASS
- KITS

Female British Standard Parallel Pipe O-Ring Swivel - 90° Bent Tube

S, M and L Drops and Hex per ISO Working Draft 12151-6.

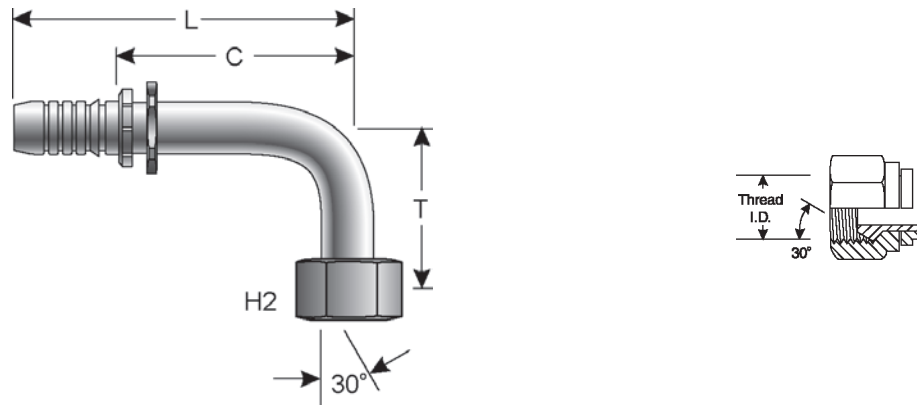

Part No.	Descr.	Prod. No.	⊖		H2	T		L		C		
			"	mm		"	mm	"	mm	"	mm	
G20832-0606	6GS-6FBSPORX90M	7347-92355	3/8	9.5	3/8-19	22	1.26	32.0	3.07	78.0	1.66	42.2
G20832-0808	8GS-8FBSPORX90M	7347-91425	1/2	12.7	1/2-14	27	1.48	37.6	3.46	87.9	1.99	50.6
G20832-1010	10GS-10FBSPORX90	7347-92295	5/8	15.9	5/8-14	30	1.90	48.3	4.70	119.4	2.45	62.2
G20832-1212	12GS-12FBSPORX90M	7347-92225	3/4	19.1	3/4-14	32	2.36	59.9	4.86	123.4	2.85	72.4
G20832-1616	16GS-16FBSPORX90M	7347-90785	1	25.4	1-11	41	2.76	70.1	5.81	147.6	3.59	91.2
G20832-2020	20GS-20FBSPORX90M	7347-93405	1 1/4	31.8	1 1/4-11	50	3.15	80.0	7.11	180.6	4.31	109.5

Female British Standard Parallel Pipe O-Ring Swivel - 90° Block



Part No.	Descr.	Prod. No.	⊖		H2	T		L		C		
			"	mm		"	mm	"	mm	"	mm	
G20845-1212	12GS-12FBSPORX90BL	7347-93955	3/4	19.1	3/4-14	32	1.53	38.9	3.07	78.0	1.06	26.9

Female British Flat Face Swivel

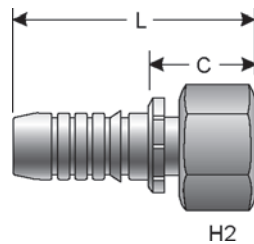

Part No.	Descr.	Prod. No.	⊖		H2	L		C		
			"	mm		"	mm	"	mm	
G20855-1616	16GS-16FBFFX	7347-78915	1	25.4	1-11	41	3.78	96.0	1.56	39.6

Female Komatsu Style Japanese Metric Swivel

These female swivels have been marked with two small notches on the hex to identify them as the Komatsu style.

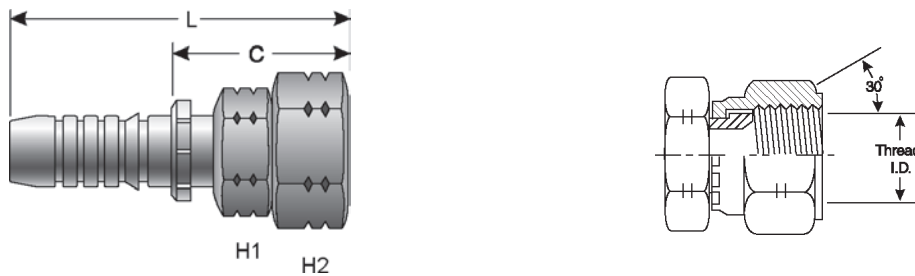

Part No.	Descr.	Prod. No.	⊖		H1	H2	L		C		
			"	mm			"	mm	"	mm	
G20910-0808	8GS-8FKX	7347-35245	1/2	12.7	M22X1.5	27	27	2.93	74.4	1.46	37.1
G20910-1010	10GS-10FKX	7347-35345	5/8	15.9	M24X1.5	30	32	3.74	95.0	1.76	44.7
G20910-1212	12GS-12FKX	7347-35445	3/4	19.1	M30X1.5	32	36	4.00	101.6	2.00	50.8
G20910-1616	16GS-16FKX	7347-35555	1	25.4	M33X1.5	41	41	4.51	114.6	2.29	58.2

Female Japanese Industrial Standard 30° Flare Swivel



Part No.	Descr.	Prod. No.	⊖		H1	H2	L		C		
			"	mm			"	mm	"	mm	
G20930-1212	12GS-12FJISX	7347-76195	3/4	19.1	3/4-14	32	36	3.87	98.3	1.86	47.2
G20930-1616	16GS-16FJISX	7347-76005	1	25.4	1-11	41	41	4.25	108.0	2.03	51.6
G20930-2020	20GS-20FJISX	7347-76235	1 1/4	31.8	1 1/4-11	27	50	5.35	135.9	2.56	65.0

EQUIPMENT
HOSE/CPLG. SELECTION
G&K COUPLINGS
GLOBAL SPIRAL COUPLINGS
STAINLESS STEEL SPIRAL
MEGACRIMP COUPLINGS
STAINLESS STEEL BRAID
POWER CRIMP COUPLINGS
FIELD ATTACHABLE G1 & G2 COUPLINGS
FIELD ATTACHABLE C5 COUPLINGS
GLX COUPLINGS
GL COUPLINGS
C14 COUPLINGS
PCTS THERMOPLASTIC COUPLINGS
POLARSEAL COUPLINGS
POLARSEAL II COUPLINGS
POWER STEERING
ADAPTERS
QUICK DISCONNECT COUPLERS
BALL VALVES
LIVE SWIVEL
ASSEMBLY FABRICATION
ACCESSORIES
EQUIPMENT AND PARTS
AIR BRAKE
BRASS
KITS

EQUIPMENT
HOSE/CPLG. SELECTION
G8K COUPLINGS
GLOBAL SPIRAL COUPLINGS
STAINLESS STEEL SPIRAL
MEGACRIMP COUPLINGS
STAINLESS STEEL BRAID
POWER CRIMP COUPLINGS
FIELD ATTACHABLE G1 & G2 COUPLINGS
FIELD ATTACHABLE C5 COUPLINGS
GLX COUPLINGS
GL COUPLINGS
C14 COUPLINGS
PCTS THERMOPLASTIC COUPLINGS
POLARSEAL COUPLINGS
POLARSEAL II COUPLINGS
POWER STEERING
ADAPTERS
QUICK DISCONNECT COUPLERS
BALL VALVES
LIVE SWIVEL
ASSEMBLY FABRICATION
ACCESSORIES
EQUIPMENT AND PARTS
AIR BRAKE
BRASS
KITS

GS Ferrule for Wire Braid Hose

Consult eCrimp for wire braid types and sizes.

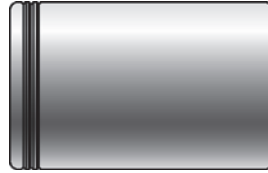

Part No.	Descr.	Prod. No.	⊖		L		⊖	
			"	mm	"	mm	"	mm
G20995-0106	6GS1F-1	7347-02875	3/8	9.5	1.20	30.5	.96	24.4
G20995-0206	6GS1F-2	7347-02945	3/8	9.5	1.20	30.5	1.06	26.9
G20995-0208	8GS1F-2	7347-02955	1/2	12.7	1.47	37.3	1.15	29.2
G20995-0210	10GS1F-2	7347-02965	5/8	15.9	1.40	35.56	1.33	33.8
G20995-0212	12GS1F-2	7347-02975	3/4	19.1	1.73	44.0	1.57	39.9
G20995-0216	16GS1F-2	7347-02985	1	25.4	2.06	52.3	1.94	49.3
G20995-0220	20GS1F-2	7347-02995	1 1/4	31.8	2.41	61.2	2.37	60.2

GS Ferrule for 4-Spiral Hose



Part No.	Descr.	Prod. No.	⊖		L		⊖	
			"	mm	"	mm	"	mm
G20995-0406	6GS1F-4	7347-03105	3/8	9.5	1.43	36.3	1.25	31.8
G20995-0408	8GS1F-4	7347-03115	1/2	12.7	1.44	36.9	1.35	34.3
G20995-0410	10GS1F-4	7347-03125	5/8	15.9	1.88	47.8	1.64	41.7
G20995-0412	12GS1F-4	7347-03135	3/4	19.1	2.00	50.8	1.80	45.7
G20995-0416	16GS1F-4	7347-03145	1	25.4	2.22	56.4	2.07	52.6
G20995-0420	20GS1F-4	7347-03155	1 1/4	31.8	2.67	67.8	2.42	61.5

GS Ferrule for 6-Spiral Hose



Part No.	Descr.	Prod. No.	⊖		L		⊖	
			"	mm	"	mm	"	mm
G20995-0620	20GS1F-6	7347-02905	1 1/4	31.8	2.87	72.9	2.67	67.8

1 1/4" Special One-Piece Couplings - Male Pipe (NPTF - 30° Cone Seat)

MGS Couplings for use with MC4-20 Crimper Only.



Part No.	Descr.	Prod. No.	⊕		H1	L		C		
			"	mm		"	mm	"	mm	
G21100-2020	20MGS-20MP	7347-86005	1 1/4	31.8	1 1/4-1 1/2	1 3/4	5.00	127.0	2.20	55.9

1 1/4" Special One-Piece Couplings - Male JIC 37° Flare

MGS Couplings for use with MC4-20 Crimper Only.

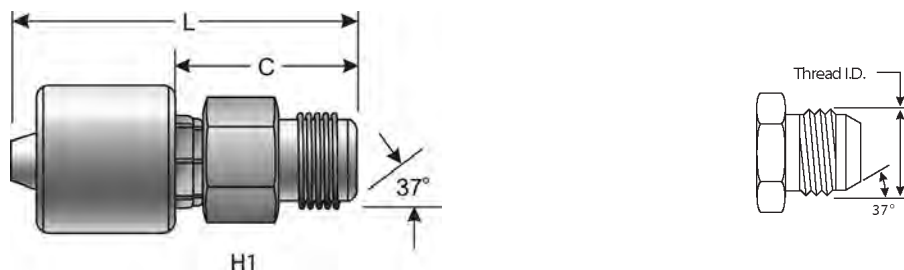

Part No.	Descr.	Prod. No.	⊕		H1	L		C		
			"	mm		"	mm	"	mm	
G21165-2020	20MGS-20MJ	7347-86015	1 1/4	31.8	1 5/8-12	1 3/4	4.92	125.0	2.12	53.9

1 1/4" Special One-Piece Couplings - Female JIC 37° Flare Swivel

MGS Couplings for use with MC4-20 Crimper Only.



Part No.	Descr.	Prod. No.	⊕		H1	H2	L		C		
			"	mm			"	mm	"	mm	
G21170-2020	20MGS-20FJX	7347-86025	1 1/4	31.8	1 5/8-12	1 7/8	2	5.35	135.9	2.56	65.0

- EQUIPMENT
- HOSE/CPLG. SELECTION
- G&K COUPLINGS
- GLOBAL SPIRAL COUPLINGS
- STAINLESS STEEL SPIRAL
- MEGACRIMP COUPLINGS
- STAINLESS STEEL BRAID
- POWER CRIMP COUPLINGS
- FIELD ATTACHABLE G1 & G2 COUPLINGS
- FIELD ATTACHABLE C5 COUPLINGS
- GLX COUPLINGS
- GL COUPLINGS
- C14 COUPLINGS
- PCTS THERMOPLASTIC COUPLINGS
- POLARSEAL COUPLINGS
- POLARSEAL II COUPLINGS
- POWER STEERING
- ADAPTERS
- QUICK DISCONNECT COUPLERS
- BALL VALVES
- LIVE SWIVEL
- ASSEMBLY FABRICATION
- ACCESSORIES
- EQUIPMENT AND PARTS
- AIR BRAKE
- BRASS
- KITS

EQUIPMENT
HOSE/CPLG. SELECTION
G8K COUPLINGS
GLOBAL SPIRAL COUPLINGS
STAINLESS STEEL SPIRAL
MEGACRIMP COUPLINGS
STAINLESS STEEL BRAID
POWER CRIMP COUPLINGS
FIELD ATTACHABLE G1 & G2 COUPLINGS
FIELD ATTACHABLE C5 COUPLINGS
GLX COUPLINGS
GL COUPLINGS
C14 COUPLINGS
PCTS THERMOPLASTIC COUPLINGS
POLARSEAL COUPLINGS
POLARSEAL II COUPLINGS
POWER STEERING
ADAPTERS
QUICK DISCONNECT COUPLERS
BALL VALVES
LIVE SWIVEL
ASSEMBLY FABRICATION
ACCESSORIES
EQUIPMENT AND PARTS
AIR BRAKE
BRASS
KITS

1 1/4" Special One-Piece Couplings - Female JIC 37° Flare Swivel - 90° Bent Tube

MGS Couplings for use with MC4-20 Crimper Only.

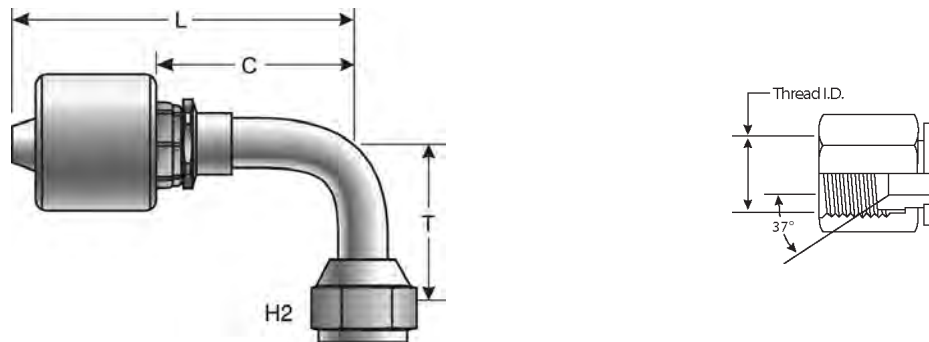

Part No.	Descr.	Prod. No.	⊖		H2	T		L		C		
			"	mm		"	mm	"	mm	"	mm	
G21180-2020	20MGS-20FJX90M-078	7347-86035	1 1/4	31.8	1 5/8-12	2	3.07	78.0	6.85	174.0	4.05	102.9

1 1/4" Special One-Piece Couplings - Female Flat-Face O-Ring Swivel

MGS Couplings for use with MC4-20 Crimper Only.

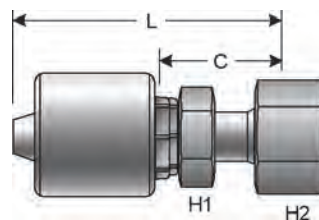

Part No.	Descr.	Prod. No.	⊖		H1	H2	L		C		
			"	mm			"	mm	"	mm	
G21230-2020	20MGS-20FFORX	7347-86045	1 1/4	31.8	1 11/16-12	50	50	5.04	128.0	2.24	56.9

1 1/4" Special One-Piece Couplings - Female Flat-Face O-Ring Swivel - 90° Bent Tube

MGS Couplings for use with MC4-20 Crimper Only.

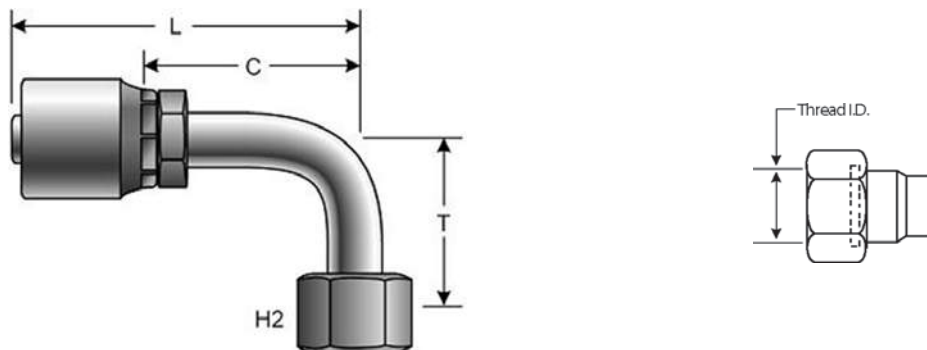

Part No.	Descr.	Prod. No.	⊖		H2	T		L		C		
			"	mm		"	mm	"	mm	"	mm	
G21240-2020	20MGS-20FFORX90M	7347-86055	1 1/4	31.8	1 11/16-12	50	3.07	78.0	6.77	172.0	3.97	100.8

1 1/4" Special One-Piece Couplings - Code 61 O-Ring Flange

MGS Couplings for use with MC4-20 Crimper Only.

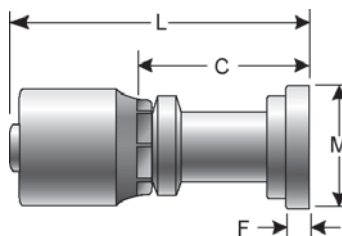

Part No.	Descr.	Prod. No.	⊖		M		L		C		F	
			"	mm	"	mm	"	mm	"	mm	"	mm
G21300-2020	20MGS-20FL	7347-86065	1 1/4	31.8	2.00	50.8	5.75	146.1	2.95	74.9	.32	8.1

EQUIPMENT
HOSE/CPLG. SELECTION
G8K COUPLINGS
GLOBAL SPIRAL COUPLINGS
STAINLESS STEEL SPIRAL
MEGACRIMP COUPLINGS
STAINLESS STEEL BRAID
POWER CRIMP COUPLINGS
FIELD ATTACHABLE G1 & G2 COUPLINGS
FIELD ATTACHABLE C5 COUPLINGS
GLX COUPLINGS
GL COUPLINGS
C14 COUPLINGS
PCTS THERMOPLASTIC COUPLINGS
POLARSEAL COUPLINGS
POLARSEAL II COUPLINGS
POWER STEERING
ADAPTERS
QUICK DISCONNECT COUPLERS
BALL VALVES
LIVE SWIVEL
ASSEMBLY FABRICATION
ACCESSORIES
EQUIPMENT AND PARTS
AIR BRAKE
BRASS
KITS

EQUIPMENT
HOSE/CPLG. SELECTION
G8K COUPLINGS
GLOBAL SPIRAL COUPLINGS
STAINLESS STEEL SPIRAL
MEGACRIMP COUPLINGS
STAINLESS STEEL BRAID
POWER CRIMP COUPLINGS
FIELD ATTACHABLE G1 & G2 COUPLINGS
FIELD ATTACHABLE C5 COUPLINGS
GLX COUPLINGS
GL COUPLINGS
C14 COUPLINGS
PCTS THERMOPLASTIC COUPLINGS
POLARSEAL COUPLINGS
POLARSEAL II COUPLINGS
POWER STEERING
ADAPTERS
QUICK DISCONNECT COUPLERS
BALL VALVES
LIVE SWIVEL
ASSEMBLY FABRICATION
ACCESSORIES
EQUIPMENT AND PARTS
AIR BRAKE
BRASS
KITS

1 1/4" Special One-Piece Couplings - Code 61 O-Ring Flange - 45° Bent Tube

MGS Couplings for use with MC4-20 Crimper Only.

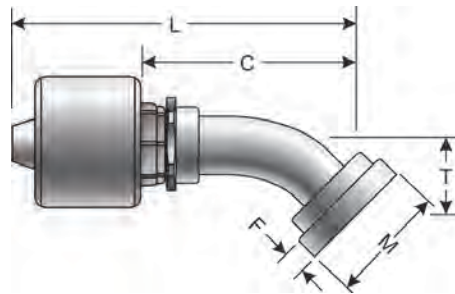

Part No.	Descr.	Prod. No.	⊕		M		T		L		C		F	
			"	mm	"	mm	"	mm	"	mm	"	mm	"	mm
G21307-2020	20MGS-20FL45S-032	7347-86075	1 1/4	31.8	2.00	50.8	1.26	32.0	6.69	169.9	3.89	98.8	.32	8.1

1 1/4" Special One-Piece Couplings - Code 61 O-Ring Flange - 90° Bent Tube

MGS Couplings for use with MC4-20 Crimper Only.

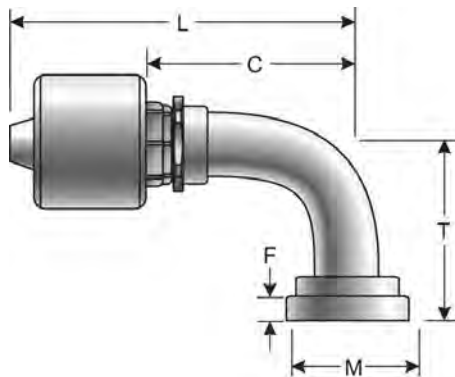

Part No.	Descr.	Prod. No.	⊕		M		T		L		C		F	
			"	mm	"	mm	"	mm	"	mm	"	mm	"	mm
G21315-2020	20MGS-20FL90M-090	7347-86085	1 1/4	31.8	2.00	50.8	3.54	89.9	6.54	166.1	3.74	95.0	.32	8.1

1 1/4" Special One-Piece Couplings - Code 62 O-Ring Flange

MGS Couplings for use with MC4-20 Crimper Only.

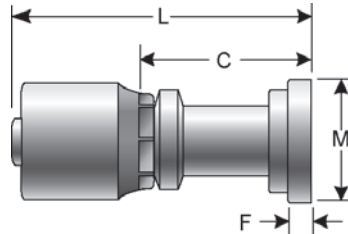

Part No.	Descr.	Prod. No.	⊖		M		L		C		F	
			"	mm	"	mm	"	mm	"	mm	"	mm
G21350-2020	20MGS-20FLH	7347-86135	1 1/4	31.8	2.13	54.1	5.75	146.1	2.95	74.9	.41	10.4

1 1/4" Special One-Piece Couplings - Male DIN 24° Cone - Heavy Series

MGS Couplings for use with MC4-20 Crimper Only.

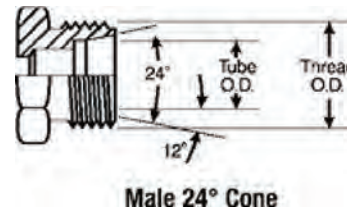
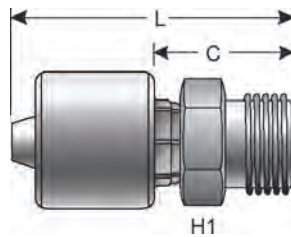



Male 24° Cone

Part No.	Descr.	Prod. No.	⊖			H1	L		C	
			"	mm	"	mm	"	mm	"	mm
G21715-2038	20MGS-38MDH	7347-86115	1 1/4	31.8	M52X2.0	55	4.84	122.9	2.04	51.8

1 1/4" Special One-Piece Couplings - Female DIN 24° Cone Swivel - Heavy Series with O-Ring

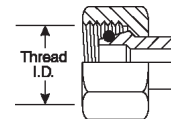
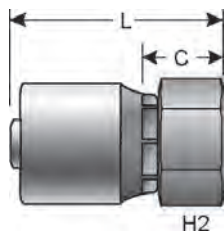
MGS Couplings for use with MC4-20 Crimper Only.



Part No.	Descr.	Prod. No.	⊖			H2	L		C	
			"	mm	"	mm	"	mm	"	mm
G21720-2038	20MGS-38FDHORX	7347-86095	1 1/4	31.8	M52X2.0	60	5.71	145.0	2.91	73.9

EQUIPMENT
HOSE/CPLG. SELECTION
G8K COUPLINGS
GLOBAL SPIRAL COUPLINGS
STAINLESS STEEL SPIRAL
MEGACRIMP COUPLINGS
STAINLESS STEEL BRAID
POWER CRIMP COUPLINGS
FIELD ATTACHABLE G1 & G2 COUPLINGS
FIELD ATTACHABLE C5 COUPLINGS
GLX COUPLINGS
GL COUPLINGS
C14 COUPLINGS
PCTS THERMOPLASTIC COUPLINGS
POLARSEAL COUPLINGS
POLARSEAL II COUPLINGS
POWER STEERING
ADAPTERS
QUICK DISCONNECT COUPLERS
BALL VALVES
LIVE SWIVEL
ASSEMBLY FABRICATION
ACCESSORIES
EQUIPMENT AND PARTS
AIR BRAKE
BRASS
KITS

1 1/4" Special One-Piece Couplings - Female British Standard Pipe Parallel O-Ring Swivel

MGS Couplings for use with MC4-20 Crimper Only.

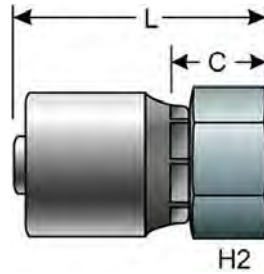

Part No.	Descr.	Prod. No.	⊖		🌀		H2	L		C	
			"	mm	"	mm	"	mm	"	mm	
G21830-2020	20MGS-20FBSPORX	7347-86105	1 1/4	31.8	1 1/4-11	60	4.59	116.6	1.79	45.5	

- EQUIPMENT
- HOSE/CPLG. SELECTION
- G8K COUPLINGS
- GLOBAL SPIRAL COUPLINGS
- STAINLESS STEEL SPIRAL
- MEGACRIMP COUPLINGS
- STAINLESS STEEL BRAID
- POWER CRIMP COUPLINGS
- FIELD ATTACHABLE G1 & G2 COUPLINGS
- FIELD ATTACHABLE C5 COUPLINGS
- GLX COUPLINGS
- GL COUPLINGS
- C14 COUPLINGS
- PCTS THERMOPLASTIC COUPLINGS
- POLARSEAL COUPLINGS
- POLARSEAL II COUPLINGS
- POWER STEERING
- ADAPTERS
- QUICK DISCONNECT COUPLERS
- BALL VALVES
- LIVE SWIVEL
- ASSEMBLY FABRICATION
- ACCESSORIES
- EQUIPMENT AND PARTS
- AIR BRAKE
- BRASS
- KITS

Male Pipe (NPTF - 30° Cone Seat)

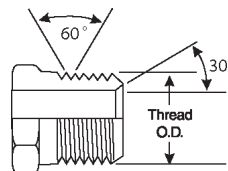
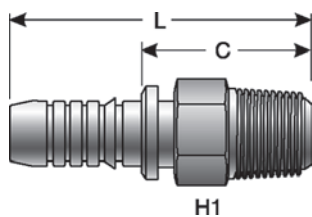

Part No.	Descr.	Prod. No.	⊖		H1	L		C		
			"	mm		"	mm	"	mm	
G22100-2424	24GSP-24MP	7347-20725	1 1/2	38.1	1 1/2-11 1/2	2	5.24	133.1	2.34	59.4
G22100-3232	32GSP-32MP	7347-20795	2	50.8	2-11 1/2	2.50	6.05	153.7	2.43	61.7

API Line Pipe Connection

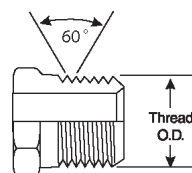
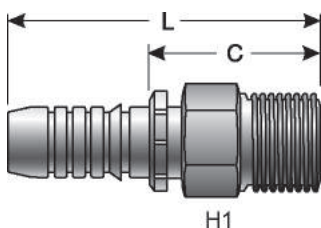

Part No.	Descr.	Prod. No.	⊖		H1	L		C		
			"	mm		"	mm	"	mm	
G22102-2424	24GSP-24MPAPI	7347-85665	1 1/2	38.1	1 1/2-11 1/2	2	5.45	138.4	2.65	67.3
G22102-3232	32GSP-32MPAPI	7347-85415	2	50.8	2-11 1/2	2.50	7.90	200.7	4.28	108.7

Male Pipe (NPTF - 30° Cone Seat) - Long Hex

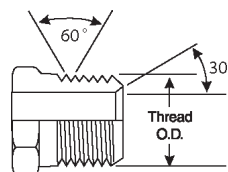
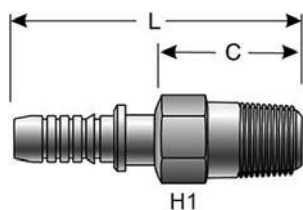

Part No.	Descr.	Prod. No.	⊖		H1	L		C		
			"	mm		"	mm	"	mm	
G22103-2424	24GSP-24MPLH	7347-20745	1 1/2	38.1	1 1/2-11 1/2	2	6.29	159.8	3.40	86.4

- EQUIPMENT
- HOSE/CPLG. SELECTION
- G8K COUPLINGS
- GLOBAL SPIRAL COUPLINGS
- STAINLESS STEEL SPIRAL
- MEGACRIMP COUPLINGS
- STAINLESS STEEL BRAID
- POWER CRIMP COUPLINGS
- FIELD ATTACHABLE G1 & G2 COUPLINGS
- FIELD ATTACHABLE C5 COUPLINGS
- GLX COUPLINGS
- GL COUPLINGS
- C14 COUPLINGS
- PCTS THERMOPLASTIC COUPLINGS
- POLARSEAL COUPLINGS
- POLARSEAL II COUPLINGS
- POWER STEERING
- ADAPTERS
- QUICK DISCONNECT COUPLERS
- BALL VALVES
- LIVE SWIVEL
- ASSEMBLY FABRICATION
- ACCESSORIES
- EQUIPMENT AND PARTS
- AIR BRAKE
- BRASS
- KITS

EQUIPMENT
HOSE/CPLG. SELECTION
G8K COUPLINGS
GLOBAL SPIRAL COUPLINGS
STAINLESS STEEL SPIRAL
MEGACRIMP COUPLINGS
STAINLESS STEEL BRAID
POWER CRIMP COUPLINGS
FIELD ATTACHABLE G1 & G2 COUPLINGS
FIELD ATTACHABLE C5 COUPLINGS
GLX COUPLINGS
GL COUPLINGS
C14 COUPLINGS
PCTS THERMOPLASTIC COUPLINGS
POLARSEAL COUPLINGS
POLARSEAL II COUPLINGS
POWER STEERING
ADAPTERS
QUICK DISCONNECT COUPLERS
BALL VALVES
LIVE SWIVEL
ASSEMBLY FABRICATION
ACCESSORIES
EQUIPMENT AND PARTS
AIR BRAKE
BRASS
KITS

Male JIC 37° Flare

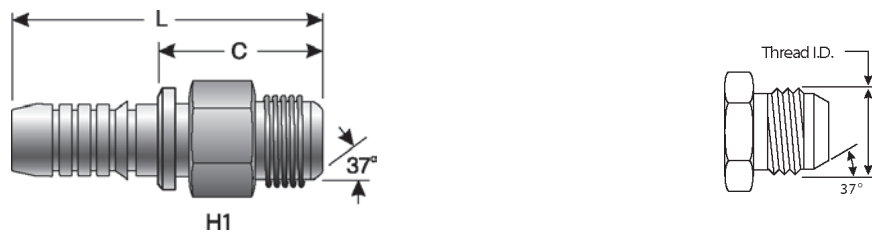

Part No.	Descr.	Prod. No.	⊖		"	H1	L		C	
			"	mm			"	"	mm	"
G22165-2420	24GSP-20MJ	7347-81455	1 1/2	38.1	1 5/8-12	1.97	5.00	127.0	2.10	53.3
G22165-2424	24GSP-24MJ	7347-81465	1 1/2	38.1	1 7/8-12	1.97	5.12	130.1	2.22	56.4
G22165-3232	32GSP-32MJ	7347-81535	2	50.8	2 1/2-12	2.56	6.34	161.0	2.72	69.1

Female JIC 37° Flare Swivel



Part No.	Descr.	Prod. No.	⊖		"	H1	H2	L		C	
			"	mm				"	"	mm	"
G22170-2424	24GSP-24FJX	7347-82455	1 1/2	38.1	1 7/8-12	1.97	2.36	5.64	143.3	2.74	69.6
G22170-2432	24GSP-32FJX	7347-82465	1 1/2	38.1	2 1/2-12	2.56	2.98	6.88	174.8	3.17	80.5
G22170-3232	32GSP-32FJX	7347-82525	2	50.8	2 1/2-12	2.56	2.95	6.80	172.7	3.17	80.5

Female JIC 37° Flare Swivel - 45° Bent Tube

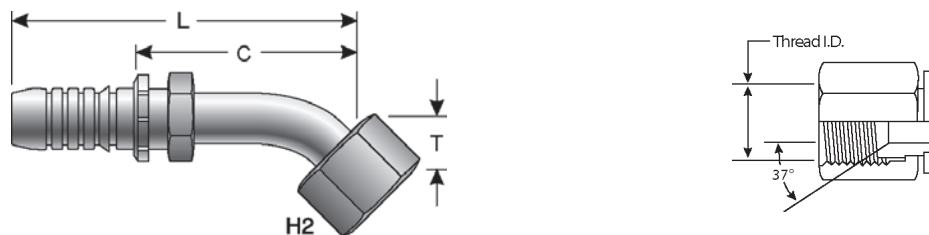

Part No.	Descr.	Prod. No.	⊖		"	H2	T	L		C		
			"	mm				"	mm	"	mm	
G22175-2424	24GSP-24FJX45-050	7347-83735	1 1/2	38.1	1 7/8-12	2 1/3	1.97	50.0	9.17	232.9	6.28	159.5

Female JIC 37° Flare Swivel - 90° Bent Tube

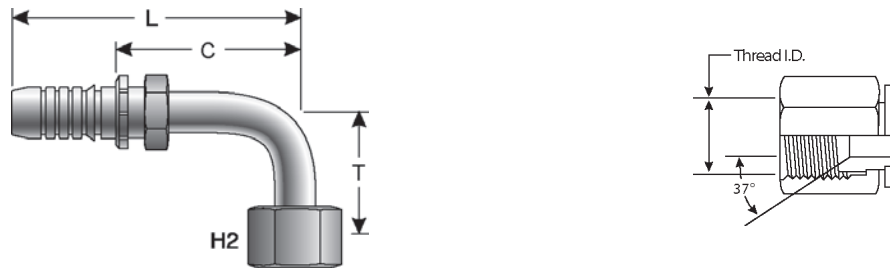

Part No.	Descr.	Prod. No.	⌀		H2	T		L		C		
			"	mm		"	mm	"	mm	"	mm	
G22179-2424	24GSP-24FJX90-089	7347-84745	1 1/2	38.1	1 7/8-12	2 1/3	3.50	88.9	8.35	212.1	5.45	138.4
G22180-2424	24GSP-24FJX90-118	7347-84755	1 1/2	38.1	1 7/8-12	2 1/3	4.65	118.1	7.46	189.5	4.56	115.8
G22180-3232	32GSP-32FJX90M	7347-84785	2	50.8	2 1/2-12	3	5.51	140.0	10.71	272.0	7.07	179.6

Male Flat-Face O-Ring

Includes Peroxide-cured O-Ring
Metric Hex per ISO Draft International Standard 12151-1.
Utilizes SAE J1453 Captive O-Ring Groove for Improved O-Ring Retention.



Part No.	Descr.	Prod. No.	⌀		H1	L		C		
			"	mm		"	mm	"	mm	
G22225-2424	24GSP-24MFFOR	7347-23905	1 1/2	38.1	2-12	55	5.12	130.1	2.22	56.4

Female Flat-Face O-Ring Swivel

Metric Hex per ISO Draft International Standard 12151-1.
SAE J1453 O-Ring Face Seal.

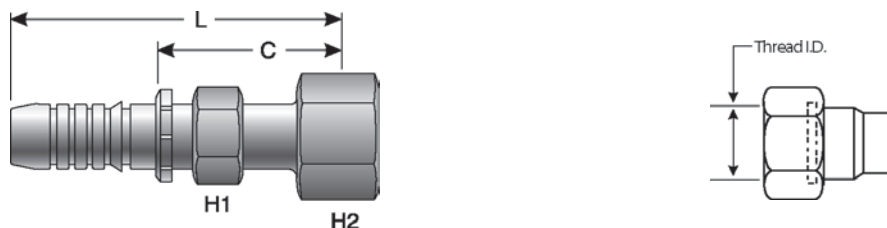

Part No.	Descr.	Prod. No.	⌀		H1	H2	L		C		
			"	mm			"	mm	"	mm	
G22230-2424	24GSP-24FFORX	7347-30725	1 1/2	38.1	2-12	55	2 1/4	5.17	131.3	2.37	60.2

EQUIPMENT
HOSE/CPLG. SELECTION
G8K COUPLINGS
GLOBAL SPIRAL COUPLINGS
STAINLESS STEEL SPIRAL
MEGACRIMP COUPLINGS
STAINLESS STEEL BRAID
POWER CRIMP COUPLINGS
FIELD ATTACHABLE G1 & G2 COUPLINGS
FIELD ATTACHABLE C5 COUPLINGS
GLX COUPLINGS
GL COUPLINGS
C14 COUPLINGS
PCTS THERMOPLASTIC COUPLINGS
POLARSEAL COUPLINGS
POLARSEAL II COUPLINGS
POWER STEERING
ADAPTERS
QUICK DISCONNECT COUPLERS
BALL VALVES
LIVE SWIVEL
ASSEMBLY FABRICATION
ACCESSORIES
EQUIPMENT AND PARTS
AIR BRAKE
BRASS
KITS

EQUIPMENT
HOSE/CPLG. SELECTION
G8K COUPLINGS
GLOBAL SPIRAL COUPLINGS
STAINLESS STEEL SPIRAL
MEGACRIMP COUPLINGS
STAINLESS STEEL BRAID
POWER CRIMP COUPLINGS
FIELD ATTACHABLE G1 & G2 COUPLINGS
FIELD ATTACHABLE C5 COUPLINGS
GLX COUPLINGS
GL COUPLINGS
C14 COUPLINGS
PCTS THERMOPLASTIC COUPLINGS
POLARSEAL COUPLINGS
POLARSEAL II COUPLINGS
POWER STEERING
ADAPTERS
QUICK DISCONNECT COUPLERS
BALL VALVES
LIVE SWIVEL
ASSEMBLY FABRICATION
ACCESSORIES
EQUIPMENT AND PARTS
AIR BRAKE
BRASS
KITS

Female Flat-Face O-Ring Swivel - 45° Bent Tube

Metric Hex per ISO Draft International Standard 12151-1.
SAE J1453 O-Ring Face Seal.

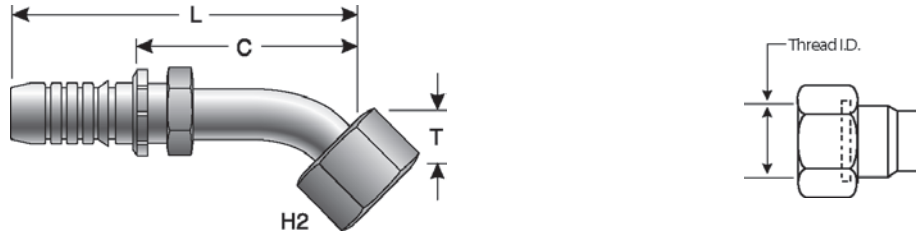

Part No.	Descr.	Prod. No.	⌀		🌀		H2		T		L		C	
			"	mm	"	mm	"	mm	"	mm	"	mm	"	mm
G22235-2424	24GSP-24FFORX45-036	7347-31725	1 1/2	38.1	2-12	2 1/4	2.70	68.6	7.61	193.3	4.81	122.2		

Female Flat-Face O-Ring Swivel - 90° Bent Tube

Metric Hex per ISO Draft International Standard 12151-1.
SAE J1453 O-Ring Face Seal.

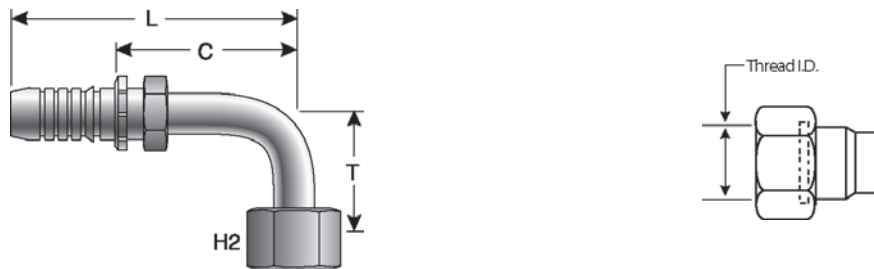

Part No.	Descr.	Prod. No.	⌀		🌀		H2		T		L		C	
			"	mm	"	mm	"	mm	"	mm	"	mm	"	mm
G22240-2424	24GSP-24FFORX90M	7347-33725	1 1/2	38.1	2-12	2 1/4	3.41	86.6	7.61	193.3	4.81	122.2		
G22241-2424	24GSP-24FFORX90L	7347-34725	1 1/2	38.1	2-12	2 1/4	5.54	140.7	7.61	193.3	4.81	122.2		

Code 61 O-Ring Flange

-24FL Max. W.P. 3,000 psi; -32FL Max. W.P. 3,000 psi
See Accessories for O-Rings.

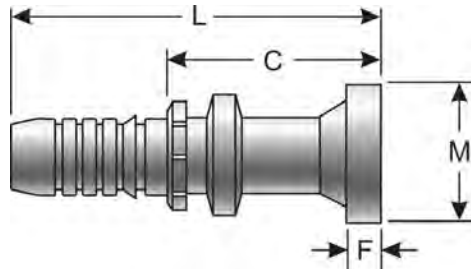

Part No.	Descr.	Prod. No.	⌀		M		L		C		F	
			"	mm	"	mm	"	mm	"	mm	"	mm
G22300-2420	24GSP-20FL	7347-41715	1 1/2	38.1	2.00	50.8	5.74	145.8	2.85	72.4	.31	7.9
G22300-2424	24GSP-24FL	7347-41725	1 1/2	38.1	2.38	60.5	6.02	152.9	3.12	79.3	.32	8.1
G22300-2432	24GSP-32FL	7347-41735	1 1/2	38.1	2.81	71.4	5.79	147.1	2.99	76.0	.38	9.7
G22300-3224	32GSP-24FL	7347-41785	2	50.8	2.38	60.5	6.53	165.9	2.49	63.3	.32	8.1
G22300-3232	32GSP-32FL	7347-41795	2	50.8	2.81	71.4	6.27	159.3	2.65	67.3	.38	9.7
G22300-3240	32GSP-40FL	7347-41805	2	50.8	3.31	84.1	8.52	216.4	2.99	76.0	.38	9.7

Code 61 O-Ring Flange - 22 1/2° Bent Tube

-24FL Max. W.P. 3,000 psi; -32FL Max. W.P. 3,000 psi
S, M and L Drops per ISO Final Draft International Standard 12151-3.
See Accessories for O-Rings.

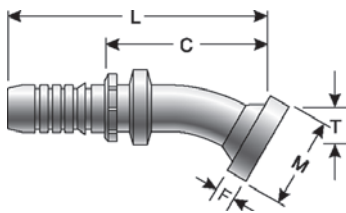

Part No.	Descr.	Prod. No.	⌀		M		T		L		C		F	
			"	mm	"	mm	"	mm	"	mm	"	mm	"	mm
G22302-2424	24GSP-24FL22M	7347-42725	1 1/2	38.1	2.38	60.5	.71	18.0	8.31	211.0	5.41	137.4	.32	8.1
G22302-2432	24GSP-32FL22M	7347-42735	1 1/2	38.1	2.81	71.4	.87	22.1	8.43	214.1	8.43	214.1	.38	9.7
G22302-3232	32GSP-32FL22M	7347-42795	2	50.8	2.81	71.4	.97	24.6	10.83	275.1	8.43	214.1	.38	9.7

- EQUIPMENT
- HOSE/CPLG. SELECTION
- G8K COUPLINGS
- GLOBAL SPIRAL COUPLINGS
- STAINLESS STEEL SPIRAL
- MEGACRIMP COUPLINGS
- STAINLESS STEEL BRAID
- POWER CRIMP COUPLINGS
- FIELD ATTACHABLE G1 & G2 COUPLINGS
- FIELD ATTACHABLE C5 COUPLINGS
- GLX COUPLINGS
- GL COUPLINGS
- C14 COUPLINGS
- PCTS THERMOPLASTIC COUPLINGS
- POLARSEAL COUPLINGS
- POLARSEAL II COUPLINGS
- POWER STEERING
- ADAPTERS
- QUICK DISCONNECT COUPLERS
- BALL VALVES
- LIVE SWIVEL
- ASSEMBLY FABRICATION
- ACCESSORIES
- EQUIPMENT AND PARTS
- AIR BRAKE
- BRASS
- KITS

EQUIPMENT
HOSE/CPLG. SELECTION
G8K COUPLINGS
GLOBAL SPIRAL COUPLINGS
STAINLESS STEEL SPIRAL
MEGACRIMP COUPLINGS
STAINLESS STEEL BRAID
POWER CRIMP COUPLINGS
FIELD ATTACHABLE G1 & G2 COUPLINGS
FIELD ATTACHABLE C5 COUPLINGS
GLX COUPLINGS
GL COUPLINGS
C14 COUPLINGS
PCTS THERMOPLASTIC COUPLINGS
POLARSEAL COUPLINGS
POLARSEAL II COUPLINGS
POWER STEERING
ADAPTERS
QUICK DISCONNECT COUPLERS
BALL VALVES
LIVE SWIVEL
ASSEMBLY FABRICATION
ACCESSORIES
EQUIPMENT AND PARTS
AIR BRAKE
BRASS
KITS

Code 61 O-Ring Flange - 30° Bent Tube

-24FL Max. W.P. 3,000 psi; -32FL Max. W.P. 3,000 psi
 S, M and L Drops per ISO Final Draft International Standard 12151-3.
 See Accessories for O-Rings.

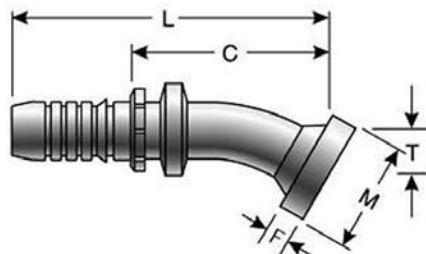

Part No.	Descr.	Prod. No.	⊖		M		T		L		C		F	
			"	mm	"	mm	"	mm	"	mm	"	mm	"	mm
G22304-2424	24GSP-24FL30S	7347-43725	1 1/2	38.1	2.38	60.5	.98	24.9	8.23	209.0	5.31	134.9	.32	8.1
G22304-2432	24GSP-32FL30M	7347-43735	1 1/2	38.1	2.81	71.4	1.26	32.0	8.27	210.1	5.39	136.9	.38	9.7
G22304-3232	32GSP-32FL30M	7347-43795	2	50.8	2.81	71.4	1.25	31.8	10.70	271.8	7.10	180.3	.38	9.7

Code 61 O-Ring Flange - 45° Bent Tube

-24FL Max. W.P. 3,000 psi; -32FL Max. W.P. 3,000 psi
 S, M and L Drops per ISO Final Draft International Standard 12151-3.
 See Accessories for O-Rings.

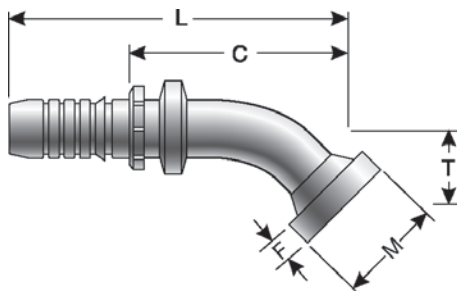

Part No.	Descr.	Prod. No.	⊖		M		T		L		C		F	
			"	mm	"	mm	"	mm	"	mm	"	mm	"	mm
G22306-2420	24GSP-20FL45S	7347-44715	1 1/2	38.1	2.00	50.8	1.26	32.0	7.09	180.1	4.49	114.1	.32	8.1
G22306-2424	24GSP-24FL45S	7347-44725	1 1/2	38.1	2.38	60.5	1.50	38.1	7.95	201.9	5.05	128.3	.32	8.1
G22306-2432	24GSP-32FL45S	7347-44735	1 1/2	38.1	2.81	71.4	2.05	52.1	7.87	199.9	4.97	126.2	.38	9.7
G22306-3224	32GSP-24FL45S	7347-44785	2	50.8	2.38	60.5	1.50	38.1	8.10	205.8	4.48	113.8	.32	8.1
G22307-3232	32GSP-32FL45-066	7347-44805	2	50.8	2.81	71.4	2.60	66.0	10.12	257.1	6.50	165.1	.38	9.7

Code 61 O-Ring Flange - 60° Bent Tube

-24FL Max. W.P. 3,000 psi; -32FL Max. W.P. 3,000 psi
 S, M and L Drops per ISO Final Draft International Standard 12151-3.
 See Accessories for O-Rings.

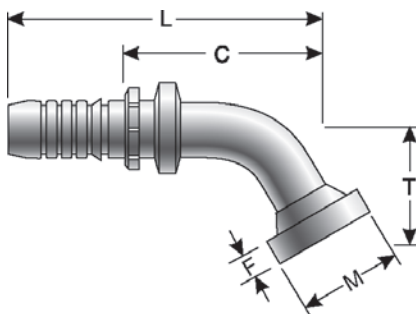

Part No.	Descr.	Prod. No.	⊖		M		T		L		C		F	
			"	mm	"	mm	"	mm	"	mm	"	mm	"	mm
G22308-2424	24GSP-24FL60S	7347-45725	1 1/2	38.1	2.38	60.5	2.08	52.8	9.09	230.9	6.20	157.5	.32	8.1
G22309-2432	24GSP-32FL60S	7347-45735	1 1/2	38.1	2.81	71.4	2.95	74.9	9.21	233.9	6.30	160.0	.38	9.7
G22309-3232	32GSP-32FL60S	7347-45805	2	50.8	2.81	71.4	2.95	74.9	10.20	259.1	6.56	166.6	.38	9.7

Code 61 O-Ring Flange - 67 1/2° Bent Tube

-24FL Max. W.P. 3,000 psi; -32FL Max. W.P. 3,000 psi
 S, M and L Drops per ISO Final Draft International Standard 12151-3.
 See Accessories for O-Rings.

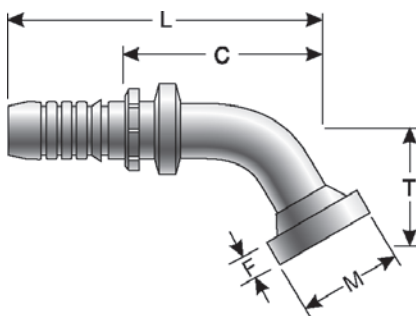

Part No.	Descr.	Prod. No.	⊖		M		T		L		C		F	
			"	mm	"	mm	"	mm	"	mm	"	mm	"	mm
G22311-2424	24GSP-24FL67S	7347-46725	1 1/2	38.1	2.38	60.5	2.40	61.0	8.90	226.1	5.90	149.9	.32	8.1
G22311-2432	24GSP-32FL67S	7347-46735	1 1/2	38.1	2.81	71.4	3.33	84.6	10.20	259.1	5.90	149.9	.38	9.7
G22311-3232	32GSP-32FL67S	7347-46795	2	50.8	2.81	71.4	3.84	97.5	10.20	259.1	6.56	166.6	.38	9.7

- EQUIPMENT
- HOSE/CPLG. SELECTION
- G8K COUPLINGS
- GLOBAL SPIRAL COUPLINGS
- STAINLESS STEEL SPIRAL
- MEGACRIMP COUPLINGS
- STAINLESS STEEL BRAID
- POWER CRIMP COUPLINGS
- FIELD ATTACHABLE G1 & G2 COUPLINGS
- FIELD ATTACHABLE C5 COUPLINGS
- GLX COUPLINGS
- GL COUPLINGS
- C14 COUPLINGS
- PCTS THERMOPLASTIC COUPLINGS
- POLARSEAL COUPLINGS
- POLARSEAL II COUPLINGS
- POWER STEERING
- ADAPTERS
- QUICK DISCONNECT COUPLERS
- BALL VALVES
- LIVE SWIVEL
- ASSEMBLY FABRICATION
- ACCESSORIES
- EQUIPMENT AND PARTS
- AIR BRAKE
- BRASS
- KITS

EQUIPMENT
HOSE/CPLG. SELECTION
G8K COUPLINGS
GLOBAL SPIRAL COUPLINGS
STAINLESS STEEL SPIRAL
MEGACRIMP COUPLINGS
STAINLESS STEEL BRAID
POWER CRIMP COUPLINGS
FIELD ATTACHABLE G1 & G2 COUPLINGS
FIELD ATTACHABLE C5 COUPLINGS
GLX COUPLINGS
GL COUPLINGS
C14 COUPLINGS
PCTS THERMOPLASTIC COUPLINGS
POLARSEAL COUPLINGS
POLARSEAL II COUPLINGS
POWER STEERING
ADAPTERS
QUICK DISCONNECT COUPLERS
BALL VALVES
LIVE SWIVEL
ASSEMBLY FABRICATION
ACCESSORIES
EQUIPMENT AND PARTS
AIR BRAKE
BRASS
KITS

Code 61 O-Ring Flange - 90° Bent Tube

-24FL Max. W.P. 3,000 psi; -32FL Max. W.P. 3,000 psi
S, M and L Drops per ISO Final Draft International Standard 12151-3.
See Accessories for O-Rings.

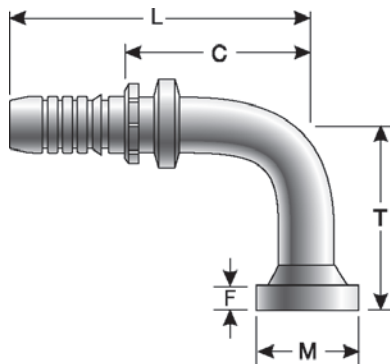

Part No.	Descr.	Prod. No.	⌀		M		T		L		C		F	
			"	mm	"	mm	"	mm	"	mm	"	mm	"	mm
G22314-2420	24GSP-20FL90S	7347-47715	1 1/2	38.1	2.00	50.8	2.68	68.1	6.81	173.0	3.92	99.6	.32	8.1
G22314-2424	24GSP-24FL90S	7347-47725	1 1/2	38.1	2.38	60.5	3.19	81.0	7.24	183.9	4.33	110.0	.32	8.1
G22315-2424	24GSP-24FL90M	7347-74725	1 1/2	38.1	2.36	59.9	4.09	103.9	6.89	175.0	4.01	101.9	.32	8.1
G22316-2424	24GSP-24FL90-148	7347-85625	1 1/2	38.1	2.36	59.9	5.83	148.1	6.89	175.0	4.01	101.9	.32	8.1
G22314-2432	24GSP-32FL90S	7347-47735	1 1/2	38.1	2.81	71.4	4.72	119.9	6.90	175.3	4.01	101.9	.38	9.7
G22315-2432	24GSP-32FL90-080	7347-47745	1 1/2	38.1	2.81	71.4	3.15	80.0	6.99	177.6	4.01	101.9	.38	9.7
G22316-2432	24GSP-32FL90-170	7347-85435	1 1/2	38.1	2.81	71.4	6.69	169.9	6.88	174.8	3.99	101.4	.38	9.7
G22314-3224	32GSP-24FL90S	7347-47785	2	50.8	2.36	59.9	3.19	81.0	7.76	197.1	4.13	104.9	.31	7.9
G22314-3232	32GSP-32FL90-114	7347-47805	2	50.8	2.81	71.4	4.49	114.1	8.74	222.0	5.12	130.1	.38	9.7
G22315-3232	32GSP-32FL90-165	7347-85425	2	50.8	2.81	71.4	6.50	165.1	9.69	246.1	6.06	153.9	.38	9.7
G22316-3232	32GSP-32FL90-200	7347-85455	2	50.8	2.81	71.4	7.97	202.4	8.74	222.0	5.13	130.3	.38	9.7
G22315-3240	32GSP-40FL90-110	7347-74805	2	50.8	3.31	84.1	4.38	111.3	8.52	216.4	4.98	126.5	.38	9.7

Code 61 O-Ring Flange - 110° Bent Tube

-24FL Max. W.P. 3,000 psi; -32FL Max. W.P. 3,000 psi
See Accessories for O-Rings.

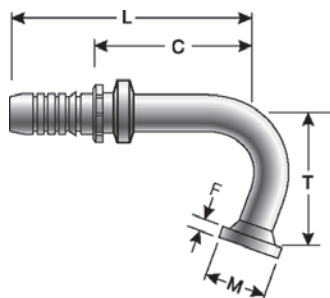

Part No.	Descr.	Prod. No.	⌀		M		T		L		C		F	
			"	mm	"	mm	"	mm	"	mm	"	mm	"	mm
G22325-2424	24GSP-24FL110-094	7347-85635	1 1/2	38.1	2.36	59.9	3.70	94.0	7.95	201.9	5.07	128.8	.31	7.9
G22325-3232	32GSP-32FL110-140	7347-85465	2	50.8	2.81	71.4	3.51	89.2	9.80	248.9	6.40	162.6	.38	9.7

Code 61 O-Ring Flange - 120° Bent Tube

-24FL Max. W.P. 3,000 psi; -32FL Max. W.P. 3,000 psi
See Accessories for O-Rings.

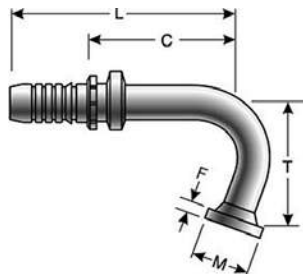

Part No.	Descr.	Prod. No.	⊖		M		T		L		C		F	
			"	mm	"	mm	"	mm	"	mm	"	mm	"	mm
G22327-2424	24GSP-24FL120-119	7347-85645	1 1/2	38.1	2.36	59.9	4.69	119.1	7.20	182.9	4.31	109.5	.31	7.9

Code 61 O-Ring Flange - 125° Bent Tube

-24FL Max. W.P. 3,000 psi; -32FL Max. W.P. 3,000 psi
See Accessories for O-Rings.

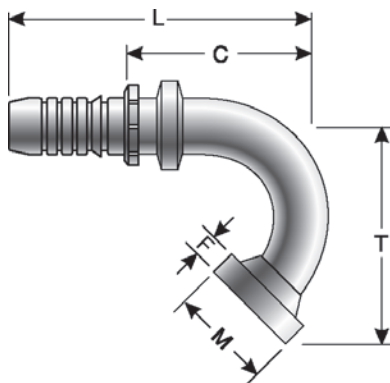

Part No.	Descr.	Prod. No.	⊖		M		T		L		C		F	
			"	mm	"	mm	"	mm	"	mm	"	mm	"	mm
G22329-3232	32GSP-32FL125-150	7347-85475	2	50.8	2.81	71.4	3.90	99.1	8.30	210.8	4.70	119.4	.38	9.7

- EQUIPMENT
- HOSE/CPLG. SELECTION
- G&K COUPLINGS
- GLOBAL SPIRAL COUPLINGS
- STAINLESS STEEL SPIRAL
- MEGACRIMP COUPLINGS
- STAINLESS STEEL BRAID
- POWER CRIMP COUPLINGS
- FIELD ATTACHABLE G1 & G2 COUPLINGS
- FIELD ATTACHABLE C5 COUPLINGS
- GLX COUPLINGS
- GL COUPLINGS
- C14 COUPLINGS
- PCTS THERMOPLASTIC COUPLINGS
- POLARSEAL COUPLINGS
- POLARSEAL II COUPLINGS
- POWER STEERING
- ADAPTERS
- QUICK DISCONNECT COUPLERS
- BALL VALVES
- LIVE SWIVEL
- ASSEMBLY FABRICATION
- ACCESSORIES
- EQUIPMENT AND PARTS
- AIR BRAKE
- BRASS
- KITS

EQUIPMENT
HOSE/CPLG. SELECTION
G8K COUPLINGS
GLOBAL SPIRAL COUPLINGS
STAINLESS STEEL SPIRAL
MEGACRIMP COUPLINGS
STAINLESS STEEL BRAID
POWER CRIMP COUPLINGS
FIELD ATTACHABLE G1 & G2 COUPLINGS
FIELD ATTACHABLE C5 COUPLINGS
GLX COUPLINGS
GL COUPLINGS
C14 COUPLINGS
PCTS THERMOPLASTIC COUPLINGS
POLARSEAL COUPLINGS
POLARSEAL II COUPLINGS
POWER STEERING
ADAPTERS
QUICK DISCONNECT COUPLERS
BALL VALVES
LIVE SWIVEL
ASSEMBLY FABRICATION
ACCESSORIES
EQUIPMENT AND PARTS
AIR BRAKE
BRASS
KITS

Code 61 Flange Without O-Ring Groove

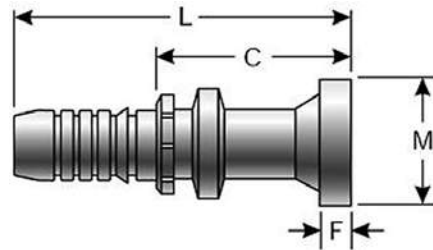

Part No.	Descr.	Prod. No.	⊖		M		L		C		F	
			"	mm	"	mm	"	mm	"	mm	"	mm
G22370-2424	24GSP-24FLFF	7347-85655	1 1/2	38.1	2.38	60.5	6.02	152.9	3.12	79.3	.32	8.1

Code 62 O-Ring Flange Heavy

See Accessories for O-Rings.

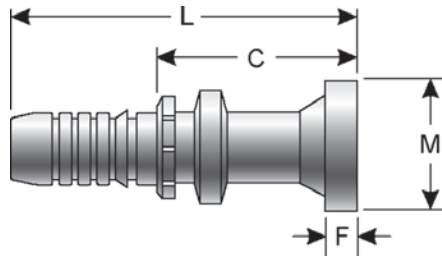

Part No.	Descr.	Prod. No.	⊖		M		L		C		F	
			"	mm	"	mm	"	mm	"	mm	"	mm
G22350-2424	24GSP-24FLH	7347-48725	1 1/2	38.1	2.50	63.5	6.57	166.9	3.68	93.5	.50	12.7
G22350-2432	24GSP-32FLH	7347-48735	1 1/2	38.1	3.13	79.5	6.57	166.9	3.68	93.5	.50	12.7
G22350-3232	32GSP-32FLH	7347-48795	2	50.8	3.13	79.5	7.09	180.1	3.46	87.9	.50	12.7

Code 62 O-Ring Flange Heavy - 45° Bent Tube

S, M and L Drops per ISO Final Draft International Standard 12151-3.
See Accessories for O-Rings.

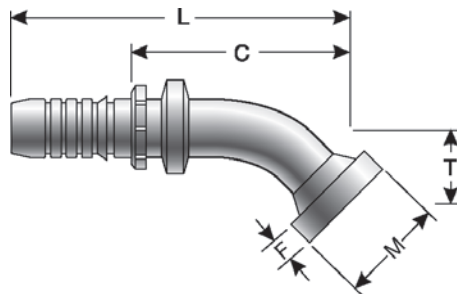

Part No.	Descr.	Prod. No.	⊖		M		T		L		C		F	
			"	mm	"	mm	"	mm	"	mm	"	mm	"	mm
G22357-2424	24GSP-24FLH45M	7347-51725	1 1/2	38.1	2.50	63.5	1.73	43.9	7.56	192.0	4.65	118.1	.50	12.7

Code 62 O-Ring Flange Heavy - 45° Bent Tube - Continued

Part No.	Descr.	Prod. No.	⊖		M		T		L		C		F	
			"	mm	"	mm	"	mm	"	mm	"	mm	"	mm
G22357-2432	24GSP-32FLH45S	7347-51735	1 1/2	38.1	3.13	79.5	2.05	52.1	7.87	199.9	4.98	126.5	.50	12.7
G22357-3232	32GSP-32FLH45-066	7347-51805	2	50.8	3.13	79.5	2.60	66.0	10.67	271.0	7.06	179.3	.50	12.7

Code 62 O-Ring Flange Heavy - 90° Bent Tube

S, M and L Drops per ISO Final Draft International Standard 12151-3.
See Accessories for O-Rings.

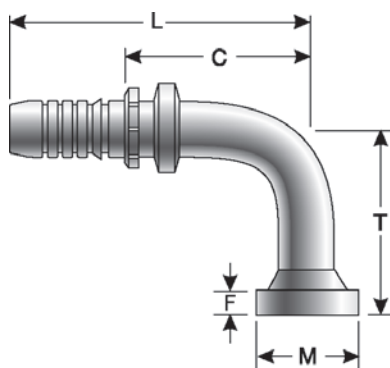

Part No.	Descr.	Prod. No.	⊖		M		T		L		C		F	
			"	mm	"	mm	"	mm	"	mm	"	mm	"	mm
G22365-2424	24GSP-24FLH90-094	7347-79105	1 1/2	38.1	2.50	63.5	3.70	94.0	6.91	175.5	4.01	101.9	.50	12.7
G22364-2432	24GSP-32FLH90S	7347-54735	1 1/2	38.1	3.13	79.5	4.72	119.9	6.96	176.8	4.06	103.1	.49	12.5
G22365-3232	32GSP-32FLH90M	7347-75795	2	50.8	3.13	79.5	5.40	137.2	8.72	221.5	5.09	129.3	.50	12.7

Hose Length Extender

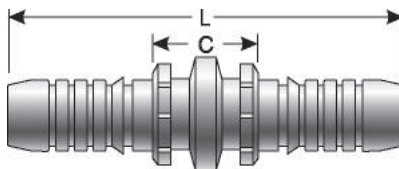

Part No.	Descr.	Prod. No.	⊖		L		C	
			"	mm	"	mm	"	mm
G22535-2424	24GSP-24HLE	7347-85445	1 1/2	38.1	7.33	186.2	1.53	38.9
G22535-3232	32GSP-32HLE	7347-79335	2	50.8	8.76	222.5	1.52	38.6

- EQUIPMENT
- HOSE/CPLG. SELECTION
- G8K COUPLINGS
- GLOBAL SPIRAL COUPLINGS
- STAINLESS STEEL SPIRAL
- MEGACRIMP COUPLINGS
- STAINLESS STEEL BRAID
- POWER CRIMP COUPLINGS
- FIELD ATTACHABLE G1 & G2 COUPLINGS
- FIELD ATTACHABLE C5 COUPLINGS
- GLX COUPLINGS
- GL COUPLINGS
- C14 COUPLINGS
- PCTS THERMOPLASTIC COUPLINGS
- POLARSEAL COUPLINGS
- POLARSEAL II COUPLINGS
- POWER STEERING
- ADAPTERS
- QUICK DISCONNECT COUPLERS
- BALL VALVES
- LIVE SWIVEL
- ASSEMBLY FABRICATION
- ACCESSORIES
- EQUIPMENT AND PARTS
- AIR BRAKE
- BRASS
- KITS

Hose Length Extender - 90° Bent Tube

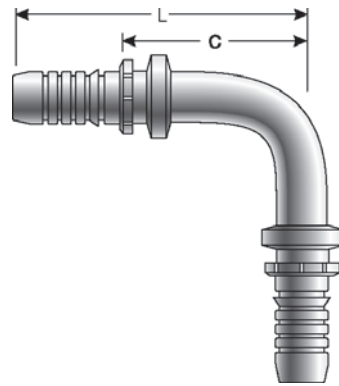

Part No.	Descr.	Prod. No.	⊖		L		C	
			"	mm	"	mm	"	mm
G22537-2424	24GSP-24HLE90-182	7347-85525	1 1/2	38.1	7.17	182.0	4.27	108.4

Male British Standard Pipe Tapered

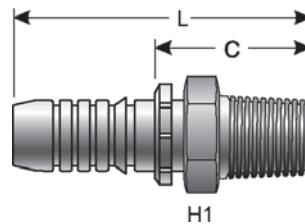

Part No.	Descr.	Prod. No.	⊖			H1	L		C	
			"	mm	"	mm	"	mm	"	mm
G22795-2424	24GSP-24MBSPT	7347-95235	1 1/2	38.1	1 1/2-11	55	5.12	130.1	2.22	56.4

Female British Standard Parallel Pipe O-Ring Swivel

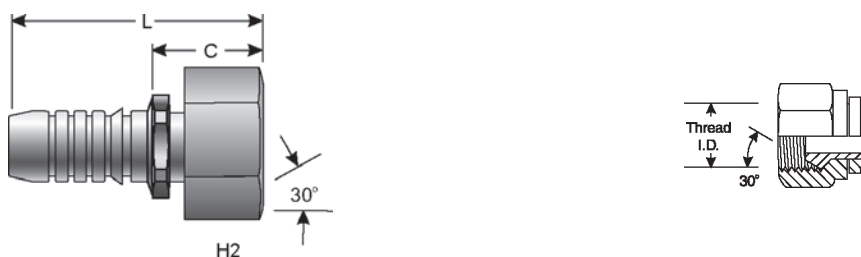

Part No.	Descr.	Prod. No.	⊖			H2	L		C	
			"	mm	"	mm	"	mm	"	mm
G22830-2424	24GSP-24FBSPORX	7347-95025	1 1/2	38.1	1 1/2-11	55	4.92	125.0	2.01	51.1
G22830-3232	32GSP-32FBSPORX	7347-95105	2	50.8	2-11	70	5.98	151.9	2.36	59.9

Female British Standard Parallel Pipe O-Ring Swivel - 45° Bent Tube

S, M and L Drops and Hex per ISO Working Draft 12151-6.

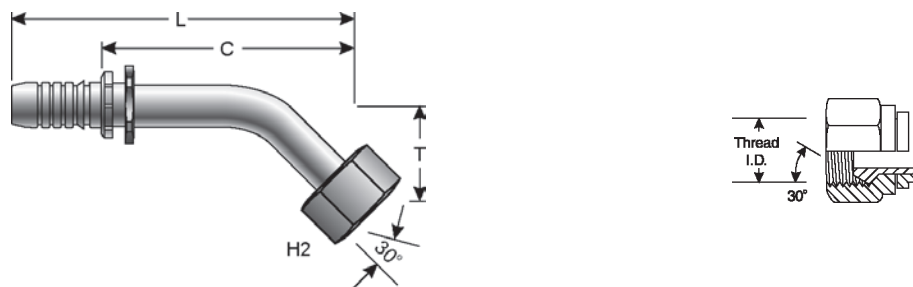

Part No.	Descr.	Prod. No.	⊖		🌀		H2	T		L		C	
			"	mm	"	mm		"	mm	"	mm	"	mm
G22831-2424	24GSP-24FBSPORX45	7347-95035	1 1/2	38.1	1 1/2-11	55	1.96	49.8	8.44	214.4	5.54	140.7	
G22831-3232	32GSP-32FBSPORX45	7347-95115	2	50.8	2-11	70	2.45	62.2	10.87	276.1	7.24	183.9	

Female British Standard Parallel Pipe O-Ring Swivel - 90° Bent Tube

S, M and L Drops and Hex per ISO Working Draft 12151-6.

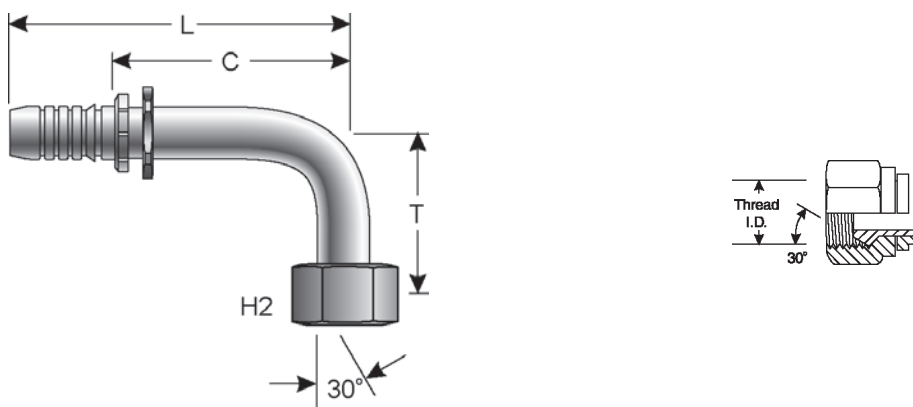

Part No.	Descr.	Prod. No.	⊖		🌀		H2	T		L		C	
			"	mm	"	mm		"	mm	"	mm	"	mm
G22832-2424	24GSP-24FBSPORX90	7347-95045	1 1/2	38.1	1 1/2-11	55	3.93	99.8	7.66	194.6	4.75	120.7	
G22832-3232	32GSP-32FBSPORX90	7347-95125	2	50.8	2-11	70	5.08	129.0	10.02	254.5	6.40	162.6	

- EQUIPMENT
- HOSE/CPLG. SELECTION
- G8K COUPLINGS
- GLOBAL SPIRAL COUPLINGS
- STAINLESS STEEL SPIRAL
- MEGACRIMP COUPLINGS
- STAINLESS STEEL BRAID
- POWER CRIMP COUPLINGS
- FIELD ATTACHABLE G1 & G2 COUPLINGS
- FIELD ATTACHABLE C5 COUPLINGS
- GLX COUPLINGS
- GL COUPLINGS
- C14 COUPLINGS
- PCTS THERMOPLASTIC COUPLINGS
- POLARSEAL COUPLINGS
- POLARSEAL II COUPLINGS
- POWER STEERING
- ADAPTERS
- QUICK DISCONNECT COUPLERS
- BALL VALVES
- LIVE SWIVEL
- ASSEMBLY FABRICATION
- ACCESSORIES
- EQUIPMENT AND PARTS
- AIR BRAKE
- BRASS
- KITS

EQUIPMENT
HOSE/CPLG. SELECTION
G8K COUPLINGS
GLOBAL SPIRAL COUPLINGS
STAINLESS STEEL SPIRAL
MEGACRIMP COUPLINGS
STAINLESS STEEL BRAID
POWER CRIMP COUPLINGS
FIELD ATTACHABLE G1 & G2 COUPLINGS
FIELD ATTACHABLE C5 COUPLINGS
GLX COUPLINGS
GL COUPLINGS
C14 COUPLINGS
PCTS THERMOPLASTIC COUPLINGS
POLARSEAL COUPLINGS
POLARSEAL II COUPLINGS
POWER STEERING
ADAPTERS
QUICK DISCONNECT COUPLERS
BALL VALVES
LIVE SWIVEL
ASSEMBLY FABRICATION
ACCESSORIES
EQUIPMENT AND PARTS
AIR BRAKE
BRASS
KITS

Female Komatsu Style Japanese Metric Swivel

These couplings have a longer reach (L dimension) to accommodate the OmniCrimp 21 crimper. These female swivels have been marked with two small notches on the hex to identify them as the Komatsu style.

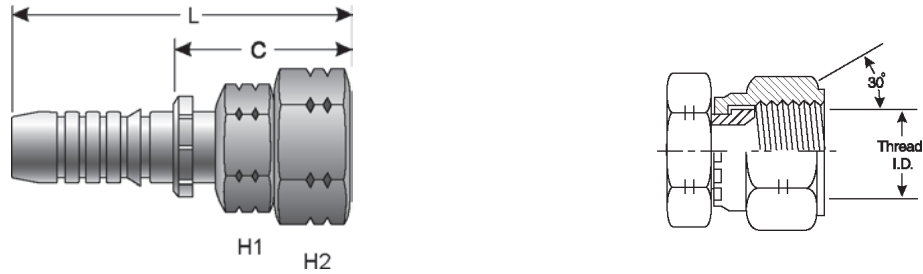

Part No.	Descr.	Prod. No.	⊖		🌀	H1	H2	L		C	
			"	mm				"	mm	"	mm
G22910-2424	24GSP-24FKX	7347-35725	1 1/2	38.1	M42X1.5	49	59	5.81	147.6	2.92	74.2

Female Japanese Industrial Standard 30° Flare Swivel



Part No.	Descr.	Prod. No.	⊖		🌀	H1	H2	L		C	
			"	mm				"	mm	"	mm
G22930-2424	24GSP-24FJISX	7347-79345	1 1/2	38.1	1 1/2-11	54	54	5.61	142.5	2.72	69.1

GSP Ferrule for Wire Braid Hose

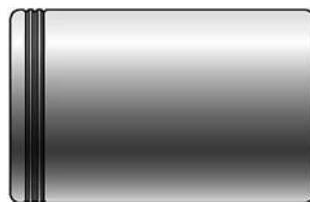

Part No.	Descr.	Prod. No.	⊖		L		⊖	
			"	mm	"	mm	"	mm
G22995-0224	24GSP1F-2	7347-03165	1 1/2	38.1	2.98	75.7	2.76	70.1
G22995-0232	32GSP1F-2	7347-03185	2	50.8	3.54	89.9	3.29	83.6

GSP Ferrule for 4-Spiral Hose

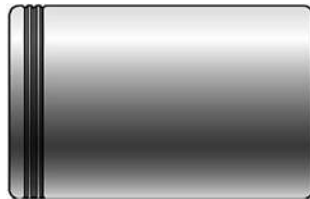

Part No.	Descr.	Prod. No.	⊖		L		∅	
			"	mm	"	mm	"	mm
G22995-0424	24GSP1F-4	7347-03175	1 1/2	38.1	3.01	76.5	2.83	71.9
G22995-0432	32GSP1F-4	7347-03195	2	50.8	3.58	90.9	3.35	85.1

EQUIPMENT
HOSE/CPLG. SELECTION
G&K COUPLINGS
GLOBAL SPIRAL COUPLINGS
STAINLESS STEEL SPIRAL
MEGACRIMP COUPLINGS
STAINLESS STEEL BRAID
POWER CRIMP COUPLINGS
FIELD ATTACHABLE G1 & G2 COUPLINGS
FIELD ATTACHABLE C5 COUPLINGS
GLX COUPLINGS
GL COUPLINGS
C14 COUPLINGS
PCTS THERMOPLASTIC COUPLINGS
POLARSEAL COUPLINGS
POLARSEAL II COUPLINGS
POWER STEERING
ADAPTERS
QUICK DISCONNECT COUPLERS
BALL VALVES
LIVE SWIVEL
ASSEMBLY FABRICATION
ACCESSORIES
EQUIPMENT AND PARTS
AIR BRAKE
BRASS
KITS

EQUIPMENT
HOSE/CPLG. SELECTION
G8K COUPLINGS
GLOBAL SPIRAL COUPLINGS
STAINLESS STEEL SPIRAL
MEGACRIMP COUPLINGS
STAINLESS STEEL BRAID
POWER CRIMP COUPLINGS
FIELD ATTACHABLE G1 & G2 COUPLINGS
FIELD ATTACHABLE C5 COUPLINGS
GLX COUPLINGS
GL COUPLINGS
C14 COUPLINGS
PCTS THERMOPLASTIC COUPLINGS
POLARSEAL COUPLINGS
POLARSEAL II COUPLINGS
POWER STEERING
ADAPTERS
QUICK DISCONNECT COUPLERS
BALL VALVES
LIVE SWIVEL
ASSEMBLY FABRICATION
ACCESSORIES
EQUIPMENT AND PARTS
AIR BRAKE
BRASS
KITS

Male Pipe (NPTF - 30° Cone Seat)



Do Not Use in Oil Field (API) Connections

Part No.	Descr.	Prod. No.	⊖		H1	L		C		
			"	mm		"	mm	"	mm	
G24100-2424	24GSM-24MP	7341-02585	1 1/2	38.1	1 1/2-11	2	6.51	165.4	2.77	70.4
G24100-3232	32GSH-32MP	7341-06455	2	50.8	2-11 1/2	2.75	7.54	191.5	3.05	77.5

API Line Pipe Connection

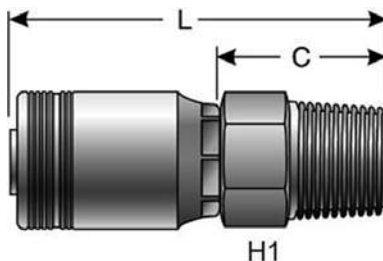

Part No.	Descr.	Prod. No.	⊖		H1	L		C		
			"	mm		"	mm	"	mm	
G24102-2424	24GSM-24APILP	7341-02735	1 1/2	38.1	1 1/2-11	2	5.76	146.3	2.23	56.6

Male JIC 37° Flare

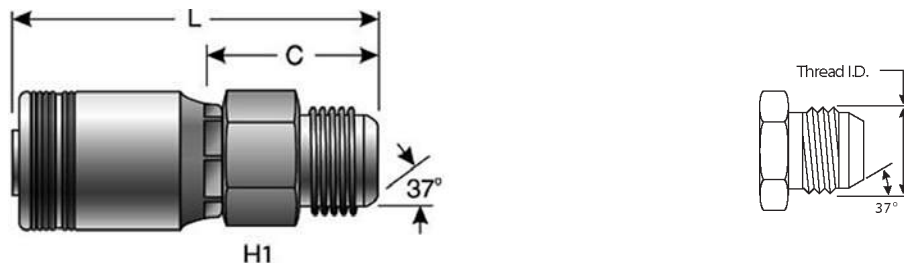

Part No.	Descr.	Prod. No.	⊖		H1	L		C		
			"	mm		"	mm	"	mm	
G24165-2424	24GSM-24MJ	7341-02555	1 1/2	38.1	1 7/8-12	1.97	6.39	162.3	2.65	67.3
G23165-3232	32GSM-32MJ	7341-20465	2	50.8	2 1/2-12	2.56	7.72	196.1	3.23	82.1

Female JIC 37° Flare Swivel

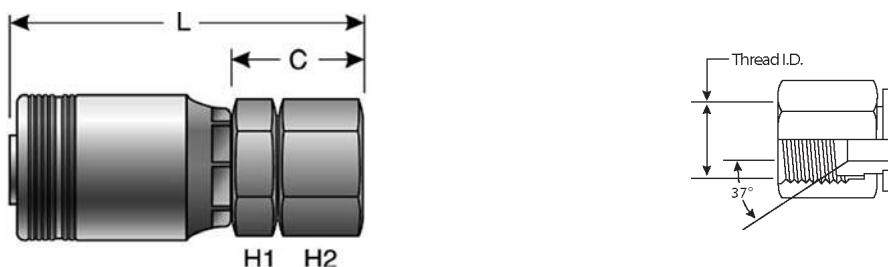

Part No.	Descr.	Prod. No.	⊖		🌀	H1	H2	L		C	
			"	mm				"	mm	"	mm
G24170-2424	24GSM-24FJX	7341-02525	1 1/2	38.1	1 7/8-12	2.17	2.36	6.78	172.2	3.04	77.2
G23170-3232	32GSM-32FJX	7341-20455	2	50.8	2 1/2-12	2.76	2.95	8.07	205.1	3.59	91.1

Female JIC 37° Flare Swivel - 45° Bent Tube

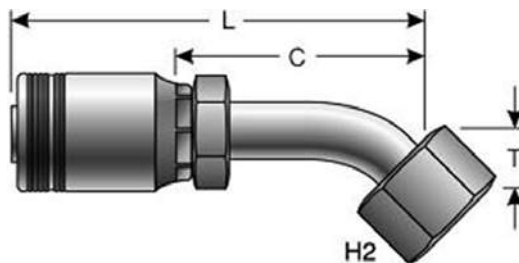

Part No.	Descr.	Prod. No.	⊖		🌀	H2	T		L		C	
			"	mm			"	mm	"	mm	"	mm
G24174-2424	24GSM-24FJX45-034	7341-02535	1 1/2	38.1	1 7/8-12	60	1.34	34.0	8.90	226.1	5.15	130.8

Female JIC 37° Flare Swivel - 90° Bent Tube

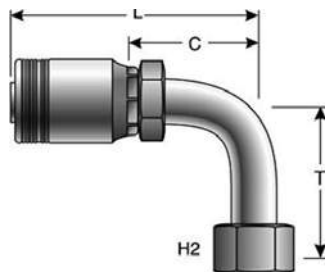

Part No.	Descr.	Prod. No.	⊖		🌀	H2	T		L		C	
			"	mm			"	mm	"	mm	"	mm
G24180-2424	24GSM-24FJX90M	7341-02545	1 1/2	38.1	1 7/8-12	60	3.39	86.1	8.96	227.6	7.18	182.4

- EQUIPMENT
- HOSE/CPLG. SELECTION
- G8K COUPLINGS
- GLOBAL SPIRAL COUPLINGS
- STAINLESS STEEL SPIRAL
- MEGACRIMP COUPLINGS
- STAINLESS STEEL BRAID
- POWER CRIMP COUPLINGS
- FIELD ATTACHABLE G1 & G2 COUPLINGS
- FIELD ATTACHABLE C5 COUPLINGS
- GLX COUPLINGS
- GL COUPLINGS
- C14 COUPLINGS
- PCTS THERMOPLASTIC COUPLINGS
- POLARSEAL COUPLINGS
- POLARSEAL II COUPLINGS
- POWER STEERING
- ADAPTERS
- QUICK DISCONNECT COUPLERS
- BALL VALVES
- LIVE SWIVEL
- ASSEMBLY FABRICATION
- ACCESSORIES
- EQUIPMENT AND PARTS
- AIR BRAKE
- BRASS
- KITS

EQUIPMENT
HOSE/CPLG. SELECTION
G8K COUPLINGS
GLOBAL SPIRAL COUPLINGS
STAINLESS STEEL SPIRAL
MEGACRIMP COUPLINGS
STAINLESS STEEL BRAID
POWER CRIMP COUPLINGS
FIELD ATTACHABLE G1 & G2 COUPLINGS
FIELD ATTACHABLE C5 COUPLINGS
GLX COUPLINGS
GL COUPLINGS
C14 COUPLINGS
PCTS THERMOPLASTIC COUPLINGS
POLARSEAL COUPLINGS
POLARSEAL II COUPLINGS
POWER STEERING
ADAPTERS
QUICK DISCONNECT COUPLERS
BALL VALVES
LIVE SWIVEL
ASSEMBLY FABRICATION
ACCESSORIES
EQUIPMENT AND PARTS
AIR BRAKE
BRASS
KITS

Female Flat-Face Swivel

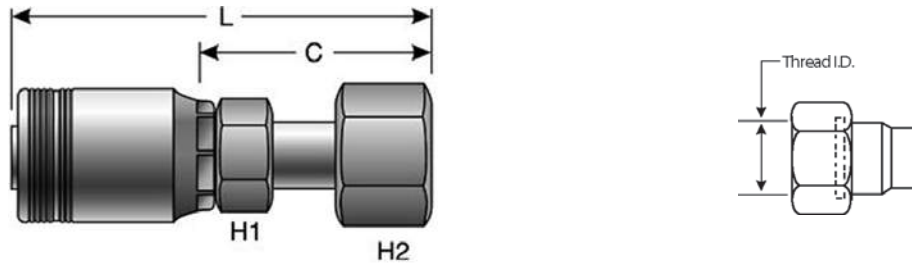

Part No.	Descr.	Prod. No.	⊖		🌀	H1	H2	L		C	
			"	mm				"	mm	"	mm
G24230-2424	24GSM-24FFORX	7341-02445	1 1/2	38.1	2-12	2.17	2.36	6.47	164.3	2.73	69.3
G23230-3232	32GSM-32FFORX	7341-20485	2	50.8	2 1/2-12	2.76	2.95	7.60	193.0	3.07	79.0

Female Flat-Face Swivel - 45° Bent Tube

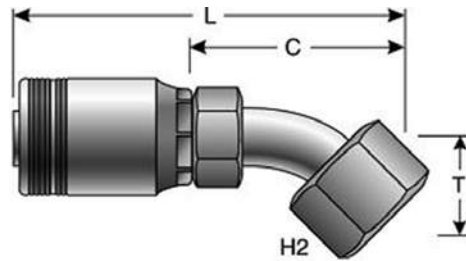

Part No.	Descr.	Prod. No.	⊖		🌀	H2	T		L		C	
			"	mm			"	mm	"	mm	"	mm
G24234-2424	24GSM4K-24FFORX45-038	7341-02455	1 1/2	38.1	2-12	60	1.50	38.1	9.31	236.6	5.56	141.1

Female Flat-Face Swivel - 90° Bent Tube

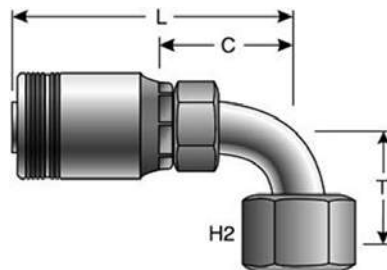

Part No.	Descr.	Prod. No.	⊖		🌀	H2	T		L		C	
			"	mm			"	mm	"	mm	"	mm
G24240-2424	24GSM4K-24FFORX90M	7341-02475	1 1/2	38.1	2-12	2.50	3.41	86.6	8.48	215.4	3.69	93.7

Code 61 O-Ring Flange

Maximum working pressure 3,000 PSI.

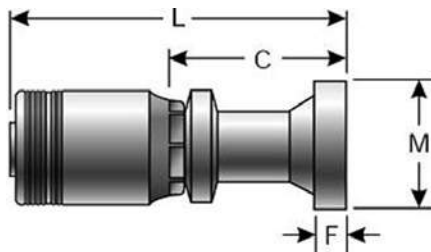

Part No.	Descr.	Prod. No.	⌀		M		L		C		F	
			"	mm	"	mm	"	mm	"	mm	"	mm
G24300-2424	24GSM-24FL	7341-01905	1 1/2	38.1	2.38	60.5	7.09	180.1	3.35	85.1	.31	7.9
G24300-2432	24GSM-32FL	7341-01915	1 1/2	38.1	2.81	71.4	7.40	188.0	3.66	93.0	.38	9.7
G23300-3232	32GSM-32FL	7341-20255	2	50.8	2.81	71.4	9.90	251.4	5.41	137.4	.38	9.7

Code 61 O-Ring Flange - 30° Bent Tube

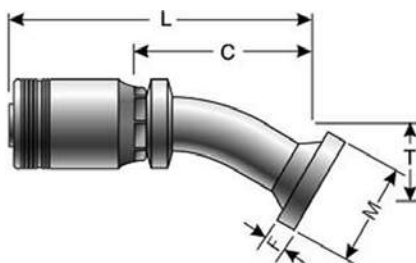

Part No.	Descr.	Prod. No.	⌀		M		T		L		C		F	
			"	mm	"	mm	"	mm	"	mm	"	mm	"	mm
G24304-2424	24GSM-24FL30M	7341-01925	1 1/2	38.1	2.38	60.5	1.77	45.0	8.52	216.4	5.00	127.0	.32	8.1

Code 61 O-Ring Flange - 45° Bent Tube

Maximum working pressure 3,000 PSI.

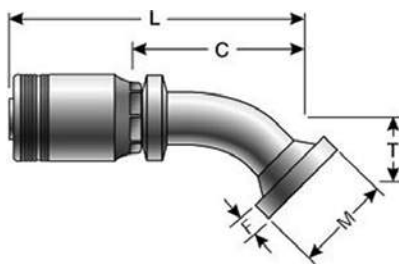

Part No.	Descr.	Prod. No.	⌀		M		T		L		C		F	
			"	mm	"	mm	"	mm	"	mm	"	mm	"	mm
G24307-2424	24GSM-24FL45M	7341-01945	1 1/2	38.1	2.38	60.5	1.73	43.9	9.05	229.9	5.31	134.9	.31	7.9
G24306-2432	24GSM-32FL45S	7341-01955	1 1/2	38.1	2.81	71.4	2.05	52.1	9.13	231.9	5.34	136.6	.38	9.7

- EQUIPMENT
- HOSE/CPLG. SELECTION
- G8K COUPLINGS
- GLOBAL SPIRAL COUPLINGS
- STAINLESS STEEL SPIRAL
- MEGACRIMP COUPLINGS
- STAINLESS STEEL BRAID
- POWER CRIMP COUPLINGS
- FIELD ATTACHABLE G1 & G2 COUPLINGS
- FIELD ATTACHABLE C5 COUPLINGS
- GLX COUPLINGS
- GL COUPLINGS
- C14 COUPLINGS
- PCTS THERMOPLASTIC COUPLINGS
- POLARSEAL COUPLINGS
- POLARSEAL II COUPLINGS
- POWER STEERING
- ADAPTERS
- QUICK DISCONNECT COUPLERS
- BALL VALVES
- LIVE SWIVEL
- ASSEMBLY FABRICATION
- ACCESSORIES
- EQUIPMENT AND PARTS
- AIR BRAKE
- BRASS
- KITS

Code 61 O-Ring Flange - 45° Bent Tube - Continued

Part No.	Descr.	Prod. No.	⊖		M		T		L		C		F	
			"	mm	"	mm	"	mm	"	mm	"	mm	"	mm
G23307-3232	32GSM-32FL45M	7341-20265	2	50.8	3.13	79.5	2.20	56.0	11.30	288.0	6.83	173.6	.50	12.7

Code 61 O-Ring Flange - 60° Bent Tube

Maximum working pressure 3,000 PSI.

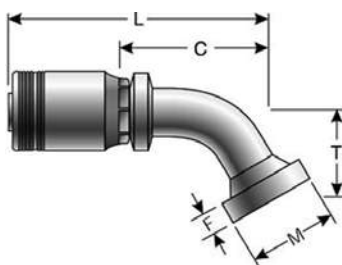

Part No.	Descr.	Prod. No.	⊖		M		T		L		C		F	
			"	mm	"	mm	"	mm	"	mm	"	mm	"	mm
G24309-2424	24GSM-24FL60M	7341-01965	1 1/2	38.1	2.38	60.5	2.52	64.0	9.50	241.3	5.75	146.1	.31	7.9

Code 61 O-Ring Flange - 90° Bent Tube

Maximum working pressure 3,000 PSI.

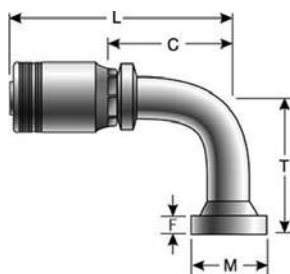

Part No.	Descr.	Prod. No.	⊖		M		T		L		C		F	
			"	mm	"	mm	"	mm	"	mm	"	mm	"	mm
G24314-2424	24GSM-24FL90S	7341-01985	1 1/2	38.1	2.38	60.5	3.19	81.0	8.46	214.9	4.72	119.9	.31	7.9
G23314-3232	32GSM-32FL90-130	7341-20275	2	50.8	3.13	79.5	5.12	130.0	10.43	265.0	5.93	150.5	.50	12.7

EQUIPMENT
HOSE/CPLG. SELECTION
G8K COUPLINGS
GLOBAL SPIRAL COUPLINGS
STAINLESS STEEL SPIRAL
MEGACRIMP COUPLINGS
STAINLESS STEEL BRAID
POWER CRIMP COUPLINGS
FIELD ATTACHABLE G1 & G2 COUPLINGS
FIELD ATTACHABLE C5 COUPLINGS
GLX COUPLINGS
GL COUPLINGS
C14 COUPLINGS
PCTS THERMOPLASTIC COUPLINGS
POLARSEAL COUPLINGS
POLARSEAL II COUPLINGS
POWER STEERING
ADAPTERS
QUICK DISCONNECT COUPLERS
BALL VALVES
LIVE SWIVEL
ASSEMBLY FABRICATION
ACCESSORIES
EQUIPMENT AND PARTS
AIR BRAKE
BRASS
KITS

Code 62 O-Ring Flange Heavy

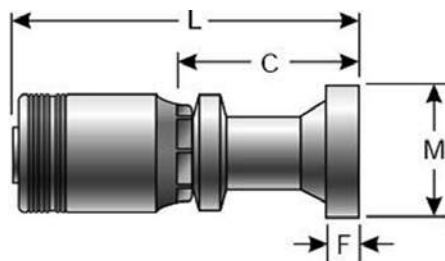

Part No.	Descr.	Prod. No.	⊖		M		L		C		F	
			"	mm	"	mm	"	mm	"	mm	"	mm
G24350-2420	24GSM-20FLH	7341-02245	1 1/2	38.1	2.13	54.1	7.87	199.9	4.13	104.9	.41	10.4
G24350-2424	24GSM-24FLH	7341-02255	1 1/2	38.1	2.50	63.5	7.87	199.9	4.13	104.9	.50	12.7
G24350-2432	24GSM-32FLH	7341-02265	1 1/2	38.1	3.13	79.5	7.87	199.9	4.13	104.9	.50	12.7
G23350-3224	32GSM-24FLH	7341-20095	2	50.8	2.50	63.5	9.06	230.0	4.57	116.0	.50	12.7
G23350-3232	32GSM-32FLH	7341-20005	2	50.8	3.13	79.5	9.90	251.4	5.41	137.4	.50	12.7

Code 62 O-Ring Flange Heavy - 22° Bent Tube

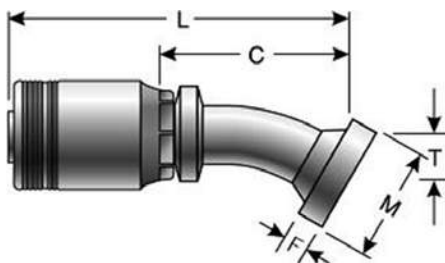

Part No.	Descr.	Prod. No.	⊖		M		T		L		C		F	
			"	mm	"	mm	"	mm	"	mm	"	mm	"	mm
G24352-2424	24GSM-24FLH22M	7341-02275	1 1/2	38.1	2.50	63.5	.70	17.8	9.56	242.8	5.84	148.4	.50	12.7
G24353-2424	24GSM-24FLH20-024	7341-02395	1 1/2	38.1	2.50	63.5	.94	23.9	9.56	242.8	5.81	147.6	.50	12.7

Code 62 O-Ring Flange Heavy - 30° Bent Tube

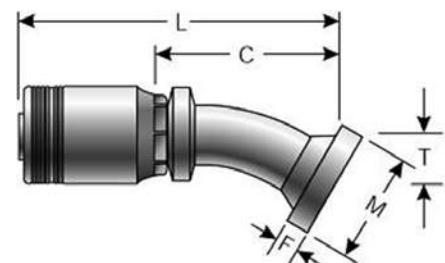

Part No.	Descr.	Prod. No.	⊖		M		T		L		C		F	
			"	mm	"	mm	"	mm	"	mm	"	mm	"	mm
G24354-2424	24GSM-24FLH30M	7341-02295	1 1/2	38.1	2.50	63.5	3.54	89.9	9.45	240.0	5.70	144.8	.50	12.7

EQUIPMENT
HOSE/CPLG. SELECTION
G&K COUPLINGS
GLOBAL SPIRAL COUPLINGS
STAINLESS STEEL SPIRAL
MEGACRIMP COUPLINGS
STAINLESS STEEL BRAID
POWER CRIMP COUPLINGS
FIELD ATTACHABLE G1 & G2 COUPLINGS
FIELD ATTACHABLE C5 COUPLINGS
GLX COUPLINGS
GL COUPLINGS
C14 COUPLINGS
PCTS THERMOPLASTIC COUPLINGS
POLARSEAL COUPLINGS
POLARSEAL II COUPLINGS
POWER STEERING
ADAPTERS
QUICK DISCONNECT COUPLERS
BALL VALVES
LIVE SWIVEL
ASSEMBLY FABRICATION
ACCESSORIES
EQUIPMENT AND PARTS
AIR BRAKE
BRASS
KITS

Code 62 O-Ring Flange Heavy - 30° Bent Tube - Continued

Part No.	Descr.	Prod. No.	⊖		M		T		L		C		F	
			"	mm	"	mm	"	mm	"	mm	"	mm	"	mm
G23354-3232	32GSM-32FLH30-040	7341-20065	2	50.8	3.13	79.5	1.57	40.0	12.17	309.0	7.66	194.6	.50	12.7

Code 62 O-Ring Flange Heavy - 45° Bent Tube

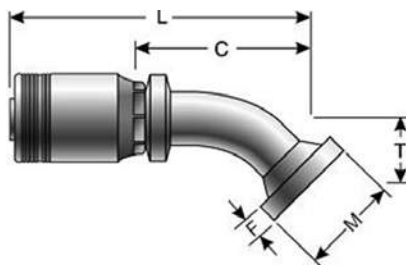

Part No.	Descr.	Prod. No.	⊖		M		T		L		C		F	
			"	mm	"	mm	"	mm	"	mm	"	mm	"	mm
G24357-2424	24GSM-24FLH45M	7341-02315	1 1/2	38.1	2.50	63.5	1.73	43.9	9.13	231.9	5.39	136.9	.50	12.7
G24357-2432	24GSM-32FLH45M	7341-02325	1 1/2	38.1	3.13	79.5	2.20	55.9	9.48	240.8	5.74	146.0	.50	12.7
G23357-3232	32GSM-32FLH45-063	7341-20055	2	50.8	3.13	79.5	2.48	63.0	11.69	297.0	6.00	152.5	.50	12.7

Code 62 O-Ring Flange Heavy - 60° Bent Tube

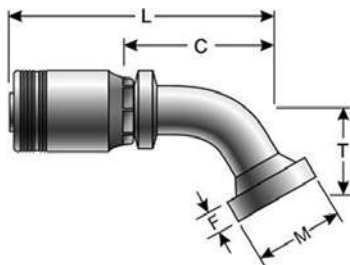

Part No.	Descr.	Prod. No.	⊖		M		T		L		C		F	
			"	mm	"	mm	"	mm	"	mm	"	mm	"	mm
G24359-2424	24GSM-24FLH60M	7341-02335	1 1/2	38.1	2.50	63.5	2.50	63.5	9.25	235.0	6.23	158.2	.50	12.7
G23359-3232	32GSM-32FLH60M	7341-20075	2	50.8	3.13	79.5	3.27	83.1	12.28	311.9	7.77	197.4	.50	12.7

Code 62 O-Ring Flange Heavy - 90° Bent Tube

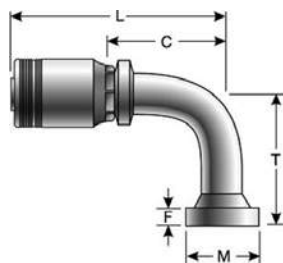

Part No.	Descr.	Prod. No.	⊖		M		T		L		C		F	
			"	mm	"	mm	"	mm	"	mm	"	mm	"	mm
G24365-2424	24GSM-24FLH90-094	7341-02355	1 1/2	38.1	2.50	63.5	3.70	94.0	8.73	221.7	4.68	118.9	.50	12.7
G24366-2424	24GSM-24FLH90-150	7341-02375	1 1/2	38.1	2.50	63.5	5.90	149.9	8.42	213.9	4.68	118.9	.50	12.7
G24365-2432	24GSM-32FLH90S	7341-02365	1 1/2	38.1	2.81	71.4	4.72	119.9	8.42	213.9	4.68	118.9	.50	12.7
G23364-3232	32GSM-32FLH90S	7341-20085	2	50.8	3.13	79.5	4.72	120.0	10.41	264.0	5.91	150.0	.50	12.7
G23365-3232	32GSM-32FLH90M	7341-20045	2	50.8	3.13	79.5	5.43	138.0	10.41	264.0	5.91	150.0	.50	12.7
G23366-3232	32GSM-32FLH90-159	7341-20035	2	50.8	3.13	79.5	6.26	159.0	10.41	264.0	5.92	150.4	.50	12.7

Caterpillar Style O-Ring Flange

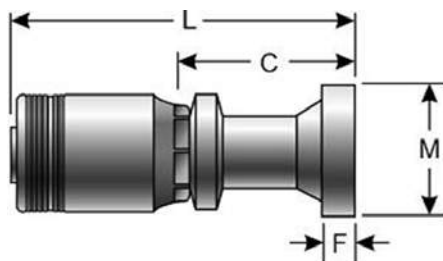

Part No.	Descr.	Prod. No.	⊖		M		L		C		F	
			"	mm	"	mm	"	mm	"	mm	"	mm
G24400-2424	24GSM-24FLC	7341-02055	1 1/2	38.1	2.50	63.5	7.44	189.0	3.71	94.2	.56	14.2
G24401-2424	24GSM-24FLCL	7341-02175	1 1/2	38.1	2.50	63.5	9.37	238.0	5.64	143.3	.56	14.2
G24400-2432	24GSM-32FLC	7341-02065	1 1/2	38.1	3.13	79.5	7.87	199.9	4.13	104.9	.56	14.2
G23400-3232	32GSM-32FLC	7341-20205	2	50.8	2.81	71.4	8.97	227.7	4.48	113.8	.38	9.7

EQUIPMENT
HOSE/CPLG. SELECTION
G8K COUPLINGS
GLOBAL SPIRAL COUPLINGS
STAINLESS STEEL SPIRAL
MEGACRIMP COUPLINGS
STAINLESS STEEL BRAID
POWER CRIMP COUPLINGS
FIELD ATTACHABLE G1 & G2 COUPLINGS
FIELD ATTACHABLE C5 COUPLINGS
GLX COUPLINGS
GL COUPLINGS
C14 COUPLINGS
PCTS THERMOPLASTIC COUPLINGS
POLARSEAL COUPLINGS
POLARSEAL II COUPLINGS
POWER STEERING
ADAPTERS
QUICK DISCONNECT COUPLERS
BALL VALVES
LIVE SWIVEL
ASSEMBLY FABRICATION
ACCESSORIES
EQUIPMENT AND PARTS
AIR BRAKE
BRASS
KITS

EQUIPMENT
HOSE/CPLG. SELECTION
G8K COUPLINGS
GLOBAL SPIRAL COUPLINGS
STAINLESS STEEL SPIRAL
MEGACRIMP COUPLINGS
STAINLESS STEEL BRAID
POWER CRIMP COUPLINGS
FIELD ATTACHABLE G1 & G2 COUPLINGS
FIELD ATTACHABLE C5 COUPLINGS
GLX COUPLINGS
GL COUPLINGS
C14 COUPLINGS
PCTS THERMOPLASTIC COUPLINGS
POLARSEAL COUPLINGS
POLARSEAL II COUPLINGS
POWER STEERING
ADAPTERS
QUICK DISCONNECT COUPLERS
BALL VALVES
LIVE SWIVEL
ASSEMBLY FABRICATION
ACCESSORIES
EQUIPMENT AND PARTS
AIR BRAKE
BRASS
KITS

Caterpillar Style O-Ring Flange - 22° Bent Tube

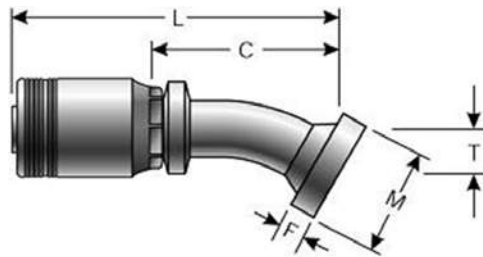

Part No.	Descr.	Prod. No.	⊖		M		T		L		C		F	
			"	mm	"	mm	"	mm	"	mm	"	mm	"	mm
G24402-2424	24GSM-24FLC22-017	7341-02075	1 1/2	38.1	2.50	63.5	.66	16.8	9.29	236.0	5.57	141.5	.56	14.2
G24402-2432	24GSM-32FLC22-022	7341-02085	1 1/2	38.1	3.13	79.5	.87	22.1	7.87	261.0	4.13	104.9	.56	14.2

Caterpillar Style O-Ring Flange - 30° Bent Tube

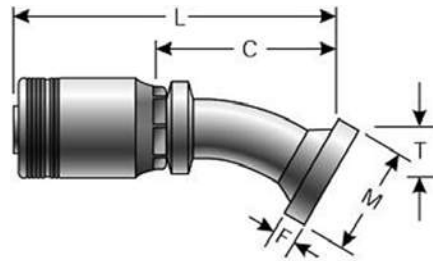

Part No.	Descr.	Prod. No.	⊖		M		T		L		C		F	
			"	mm	"	mm	"	mm	"	mm	"	mm	"	mm
G24404-2424	24GSM-24FLC30-023	7341-02095	1 1/2	38.1	2.50	63.5	.90	22.9	9.25	235.0	5.49	139.5	.56	14.2
G24404-2432	24GSM-32FLC30-035	7341-02105	1 1/2	38.1	3.13	79.5	1.37	34.8	10.11	257.0	6.36	161.6	.56	14.2
G23404-3232	32GSM-32FLC30-035	7341-20245	2	50.8	3.13	79.5	1.38	35.0	11.85	301.2	7.37	187.2	.56	14.2

Caterpillar Style O-Ring Flange - 45° Bent Tube

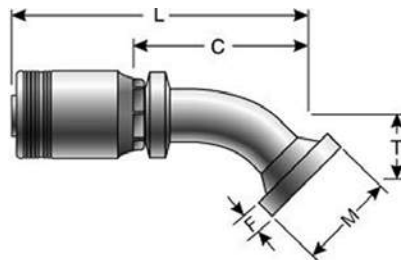

Part No.	Descr.	Prod. No.	⊖		M		T		L		C		F	
			"	mm	"	mm	"	mm	"	mm	"	mm	"	mm
G24407-2424	24GSM-24FLC45-039	7341-02115	1 1/2	38.1	2.50	63.5	1.54	39.1	8.94	227.1	5.20	132.1	.56	14.2
G24407-2432	24GSM-32FLC45-059	7341-02125	1 1/2	38.1	3.13	79.5	2.32	58.9	9.60	244.0	5.86	149.0	.56	14.2
G23407-3232	32GSM-32FLC45-064	7341-20215	2	50.8	3.13	79.5	2.52	64.0	11.32	287.5	6.83	173.5	.56	14.2

Caterpillar Style O-Ring Flange - 60° Bent Tube

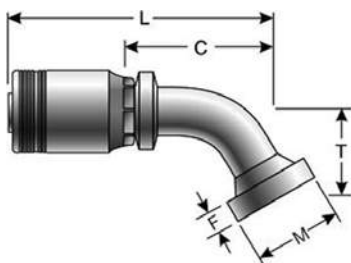

Part No.	Descr.	Prod. No.	⊘		M		T		L		C		F	
			"	mm	"	mm	"	mm	"	mm	"	mm	"	mm
G24409-2424	24GSM-24FLC60-055	7341-02135	1 1/2	38.1	2.50	63.5	2.17	55.1	9.91	251.7	6.17	156.7	.56	14.2
G24409-2432	24GSM-32FLC60-087	7341-02145	1 1/2	38.1	3.13	79.5	3.42	86.9	11.69	297.0	7.94	201.9	.56	14.2
G23409-3232	32GSM-32FLC60-083	7341-20225	2	50.8	3.13	79.5	3.27	83.1	12.69	322.3	8.17	207.5	.56	14.2

Caterpillar Style O-Ring Flange - 90° Bent Tube

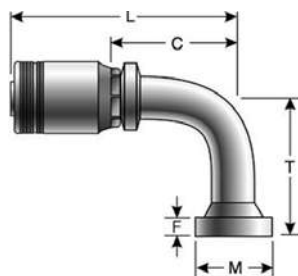

Part No.	Descr.	Prod. No.	⊘		M		T		L		C		F	
			"	mm	"	mm	"	mm	"	mm	"	mm	"	mm
G24415-2424	24GSM-24FLC90-087	7341-02155	1 1/2	38.1	2.50	63.5	3.43	87.1	8.43	214.1	4.70	119.4	.56	14.2
G24415-2432	24GSM-32FLC90-140	7341-02165	1 1/2	38.1	3.13	79.5	5.51	140.0	8.85	225.0	5.11	129.9	.56	14.2
G23415-3232	32GSM-32FLC90-130	7341-20235	2	50.8	3.13	79.5	5.12	130.0	10.41	264.5	5.93	150.5	.50	12.7

Hose Length Extender

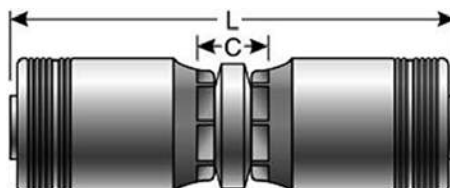

Part No.	Descr.	Prod. No.	⊘		L		C	
			"	mm	"	mm	"	mm
G23534-3232	32GSM-32HLE	7341-20475	2	50.8	11.11	282.0	2.14	54.4

- EQUIPMENT
- HOSE/CPLG. SELECTION
- G8K COUPLINGS
- GLOBAL SPIRAL COUPLINGS
- STAINLESS STEEL SPIRAL
- MEGACRIMP COUPLINGS
- STAINLESS STEEL BRAID
- POWER CRIMP COUPLINGS
- FIELD ATTACHABLE G1 & G2 COUPLINGS
- FIELD ATTACHABLE C5 COUPLINGS
- GLX COUPLINGS
- GL COUPLINGS
- C14 COUPLINGS
- PCTS THERMOPLASTIC COUPLINGS
- POLARSEAL COUPLINGS
- POLARSEAL II COUPLINGS
- POWER STEERING
- ADAPTERS
- QUICK DISCONNECT COUPLERS
- BALL VALVES
- LIVE SWIVEL
- ASSEMBLY FABRICATION
- ACCESSORIES
- EQUIPMENT AND PARTS
- AIR BRAKE
- BRASS
- KITS

Hose Length Extender for Caterpillar with Clamping Area

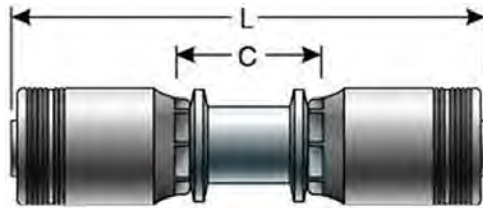

Part No.	Descr.	Prod. No.	⊖		🌀	L	C
			"	mm			
G24534-2424	24GSM-24HLEC	7341-02645	1 1/2	38.1	1 1/2	10.66	3.18

Female DIN 24° Cone Swivel - Heavy Series with O-Ring

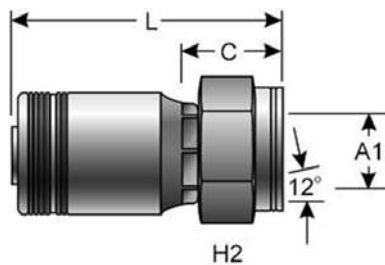

Part No.	Descr.	Prod. No.	⊖		🌀	H2	L		C		A1
			"	mm			"	mm	"	mm	
G24720-2438	24GSM-38FDHORX	7341-07055	1 1/2	38.1	M52X2.0	60	7.09	180.1	3.35	85.1	38.0

Female DIN 24° Cone Swivel - Heavy Series with O-Ring - 45° Bent Tube

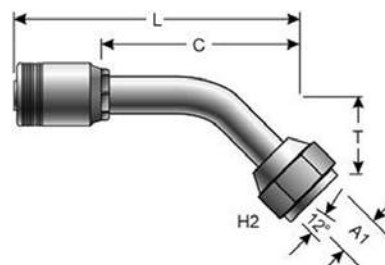

Part No.	Descr.	Prod. No.	⊖		🌀	H2	T		L		C		A1
			"	mm			"	mm	"	mm	"	mm	
G24725-2438	24GSM-38FDHORX45	7341-07065	1 1/2	38.1	M52X2.0	60	1.74	44.2	9.33	237.0	5.59	142.0	38.0

Female DIN 24° Cone Swivel - Heavy Series with O-Ring - 90° Bent Tube

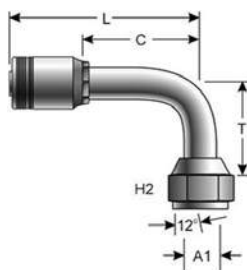

Part No.	Descr.	Prod. No.	⊖		M52X2.0	H2	T		L		C		A1
			"	mm			"	mm	"	mm	"	mm	
G24730-2438	24GSM-38FDHORX90	7341-07075	1 1/2	38.1	M52X2.0	60	3.62	92.0	8.76	222.5	5.02	127.5	38.0

Male British Standard Pipe Parallel

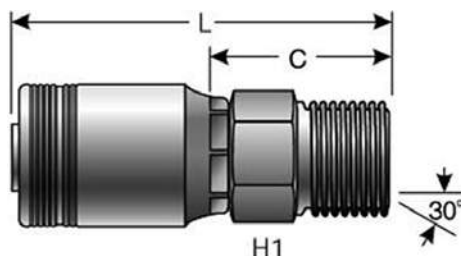

Part No.	Descr.	Prod. No.	⊖		1 1/2-11	H1	L		C	
			"	mm			"	mm	"	mm
G24810-2424	24GSM-24MBSPP	7341-07025	1 1/2	38.1	1 1/2-11	2 1/4	6.41	162.8	2.67	67.8
G23810-3232	32GSM-32MBSPP	7341-20585	2	50.8	6.2-11	70	7.40	188.0	2.91	74.0

Female British Standard Parallel Pipe O-Ring Swivel

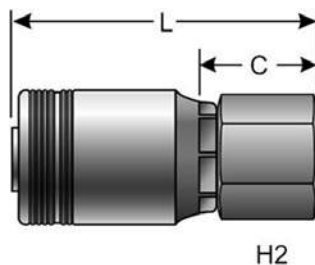

Part No.	Descr.	Prod. No.	⊖		H2	L		C	
			"	mm		"	mm	"	mm
G24830-2424	24GSM-24FBSPORX	7341-07015	1 1/2	38.1	1 1/2	6.06	153.9	2.32	58.9
G23830-3232	32GSM-32FBSPORX	7341-20555	2	50.8	2-11	7.24	183.9	2.76	70.0

EQUIPMENT
HOSE/CPLG. SELECTION
G8K COUPLINGS
GLOBAL SPIRAL COUPLINGS
STAINLESS STEEL SPIRAL
MEGACRIMP COUPLINGS
STAINLESS STEEL BRAID
POWER CRIMP COUPLINGS
FIELD ATTACHABLE G1 & G2 COUPLINGS
FIELD ATTACHABLE C5 COUPLINGS
GLX COUPLINGS
GL COUPLINGS
C14 COUPLINGS
PCTS THERMOPLASTIC COUPLINGS
POLARSEAL COUPLINGS
POLARSEAL II COUPLINGS
POWER STEERING
ADAPTERS
QUICK DISCONNECT COUPLERS
BALL VALVES
LIVE SWIVEL
ASSEMBLY FABRICATION
ACCESSORIES
EQUIPMENT AND PARTS
AIR BRAKE
BRASS
KITS

Female British Standard Parallel Pipe O-Ring Swivel - 45° Bent Tube

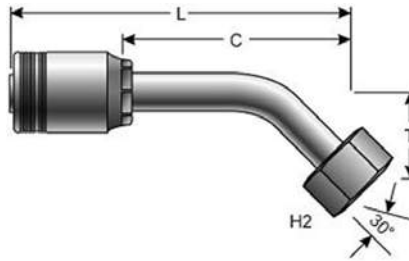

Part No.	Descr.	Prod. No.	⊖		H2	T		L		C		
			"	mm		"	mm	"	mm	"	mm	
G24831-2424	24GSM-24FBSPORX45	7341-07035	1 1/2	38.1	1 1/2	55	1.96	49.8	9.56	242.8	5.81	147.6
G23831-3232	32GSM-32FBSPORX45	7341-20565	2	50.8	2-11	70	2.95	75.0	12.11	307.6	7.62	193.6

Female British Standard Parallel Pipe O-Ring Swivel - 90° Bent Tube

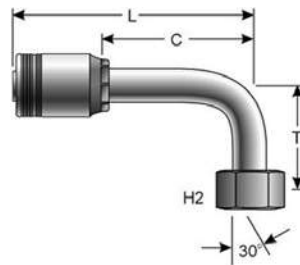

Part No.	Descr.	Prod. No.	⊖		H2	T		L		C		
			"	mm		"	mm	"	mm	"	mm	
G24832-2424	24GSM-24FBSPORX90	7341-07045	1 1/2	38.1	1 1/2	55	3.94	100.1	8.76	222.5	5.02	127.5
G23832-3232	32GSM-32FBSPORX90	7341-20575	2	50.8	2-11	70	5.91	150.0	10.89	276.5	6.40	162.5

EQUIPMENT
HOSE/CPLG. SELECTION
G8K COUPLINGS
GLOBAL SPIRAL COUPLINGS
STAINLESS STEEL SPIRAL
MEGACRIMP COUPLINGS
STAINLESS STEEL BRAID
POWER CRIMP COUPLINGS
FIELD ATTACHABLE G1 & G2 COUPLINGS
FIELD ATTACHABLE C5 COUPLINGS
GLX COUPLINGS
GL COUPLINGS
C14 COUPLINGS
PCTS THERMOPLASTIC COUPLINGS
POLARSEAL COUPLINGS
POLARSEAL II COUPLINGS
POWER STEERING
ADAPTERS
QUICK DISCONNECT COUPLERS
BALL VALVES
LIVE SWIVEL
ASSEMBLY FABRICATION
ACCESSORIES
EQUIPMENT AND PARTS
AIR BRAKE
BRASS
KITS

Hydraulic Hose For Stainless Steel Spiral Couplings



Also available with MegaTuff® and XraTuff™ cover



The Gates eCrimp program is a web based utility which allows users and distributors of Gates hydraulic and industrial hose products to find and print the most up to date crimp specifications with nothing more than an internet browser.

This program can be used to find crimp data for the MobileCrimp 4-20, PC 707, SC32, PC 3000B, GC32-XD™ Global Hose Crimper, GC96 and Omni Crimp 21. Custom result may be printed by selecting the crimper, hose and coupling. Optionally results may also be limited by die set and working pressure.



The eCrimp mobile app gives you all the same features of the online version in the palm of your hands. Use the app to find the most up-to-date crimp specifications quickly and easily. It is available for download for the iPhone and iPad from the App Store.

EQUIPMENT
HOSE/CPLG. SELECTION
G8K COUPLINGS
GLOBAL SPIRAL COUPLINGS
STAINLESS STEEL SPIRAL
MEGACRIMP COUPLINGS
STAINLESS STEEL BRAID
POWER CRIMP COUPLINGS
FIELD ATTACHABLE G1 & G2 COUPLINGS
FIELD ATTACHABLE C5 COUPLINGS
GLX COUPLINGS
GL COUPLINGS
C14 COUPLINGS
PCTS THERMOPLASTIC COUPLINGS
POLARSEAL COUPLINGS
POLARSEAL II COUPLINGS
POWER STEERING
ADAPTERS
QUICK DISCONNECT COUPLERS
BALL VALVES
LIVE SWIVEL
ASSEMBLY FABRICATION
ACCESSORIES
EQUIPMENT AND PARTS
AIR BRAKE
BRASS
KITS

Stainless Steel Spiral Couplings

Male Pipe (NPTF - 30° Cone Seat)

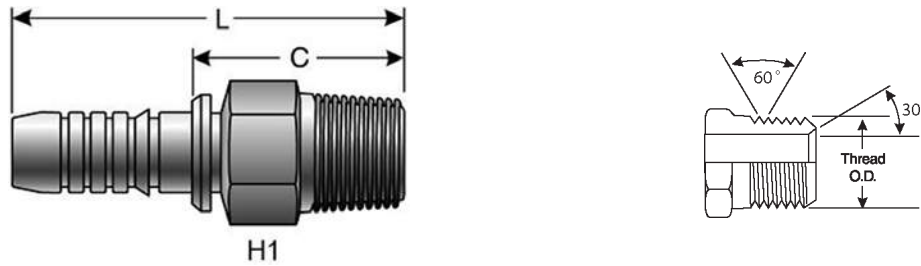

Part No.	Descr.	Prod. No.	⊖		🌀	H1		L		C	
			"	mm		"	mm	"	mm	"	mm
G18100-0606	6S-6MP-SS	7362-00285	3/8	9.5	3/8-18	.68	17.3	2.24	56.9	1.22	31.0
G18100-0808	8S-8MP-SS	7362-00305	1/2	12.7	1/2-14	.87	22.2	1.22	31.0	1.43	36.3
G18100-1212	12S-12MP-SS	7362-00335	3/4	19.1	3/4-14	1.06	27	3.54	90.0	1.54	39.0
G18100-1616	16S-16MP-SS	7362-00365	1	25.4	1-11 1/2	1.37	34.8	4.17	106.0	1.94	49.2
G18100-2020	20S-20MP-SS	7362-00395	1 1/4	31.8	1 1/4-11 1/2	1.81	46	4.94	125.5	2.19	55.6

Female JIC 37° Flare Swivel

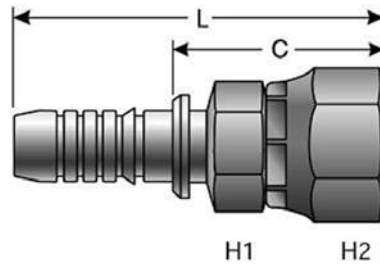

Part No.	Descr.	Prod. No.	⊖		🌀	H1		H2		L		C	
			"	mm		"	mm	"	mm	"	mm	"	mm
G18170-0606	6S-6FJX-SS	7362-01245	3/8	9.5	9/16-18	.69	17.5	.75	19.1	2.23	56.6	1.21	30.8
G18170-0808	8S-8FJSX-SS	7362-01275	1/2	12.7	3/4-16	.88	22.4	.88	22.4	2.84	72.1	1.36	34.5
G18170-1010	10S-10FJX-SS	7362-01295	5/8	15.9	7/8-14	.94	23.9	1.06	26.9	3.61	91.6	1.63	41.3
G18170-1212	12S-12FJX-SS	7362-01325	3/4	19.1	1 1/16-12	1.06	26.9	1.25	31.8	3.91	99.3	1.99	50.6
G18170-1616	16S-16FJX-SS	7362-01385	1	25.4	1 3/16-12	1.38	35.1	1.50	38.1	4.35	110.4	2.11	53.6
G18170-2020	20S-20FJX-SS	7362-01415	1 1/4	31.8	1 5/8-12	1.88	47.6	2	50.8	5.11	129.9	2.36	66.0
G18170-2424	24S-24FJX-SS	7362-01445	1 1/2	38.1	1 7/8-12	2	50.8	2.25	57.2	6.00	152.5	2.48	63.0

Female Flat-Face O-Ring Swivel Metric Hex

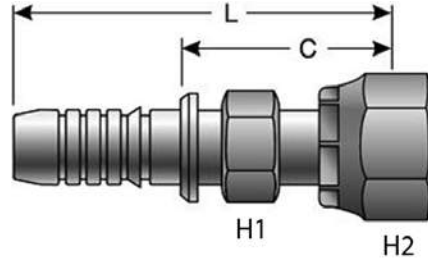

Part No.	Descr.	Prod. No.	⊖		🌀	H1		H2		L		C	
			"	mm		"	mm	"	mm	"	mm	"	mm
G18230-0606	6S-6FFORX-SS	7362-03265	3/8	9.5	11/16-16	.75	19	.87	22	2.65	67.5	1.26	32.0
G18230-0808	8S-8FFORX-SS	7362-03275	1/2	12.7	13/16-16	.91	23	.94	24	2.91	74.0	1.43	36.4
G18230-1010	10S-10FFORX-SS	7362-03295	5/8	15.9	1-14	1.06	27	1.18	30	3.68	93.5	1.70	43.2
G18230-1212	12S-12FFORX-SS	7362-03315	3/4	19.1	1 3/16-12	1.18	30	1.41	36	3.70	94.0	1.69	43.0
G18230-1616	16S-16FFORX-SS	7362-03335	1	25.4	1 7/16-12	1.42	36	1.61	41	4.47	113.5	2.23	113.5
G18230-2020	20S-20FFORX-SS	7362-03355	1 1/4	31.8	1 11/16-12	1.81	46	1.96	50	5.27	134.0	2.53	64.2
G18230-2424	24S-24FFORX-SS	7362-03375	1 1/2	38.1	2-12	1.97	50	2.36	60	6.06	154.0	2.54	64.5

Code 61 O-Ring Flange

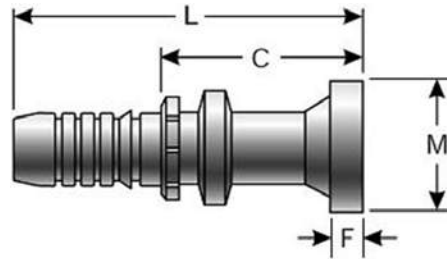

Part No.	Descr.	Prod. No.	⊖		M		L		C		F	
			"	mm	"	mm	"	mm	"	mm	"	mm
G18300-1212	12S-12FL-SS	7362-04375	3/4	19.1	1.50	38.1	4.33	110.0	2.32	59.0	.26	6.6
G18300-1616	16S-16FL-SS	7362-04405	1	25.4	1.75	44.5	4.80	122.0	2.57	65.2	.31	7.9
G18300-2020	20S-20FL-SS	7362-04435	1 1/4	31.8	2.00	50.8	5.43	138.0	2.69	68.2	.31	7.9

- EQUIPMENT
- HOSE/CPLG. SELECTION
- G&K COUPLINGS
- GLOBALSPIRAL COUPLINGS
- STAINLESS STEEL SPIRAL**
- MEGACRIMP COUPLINGS
- STAINLESS STEEL BRAID
- POWER CRIMP COUPLINGS
- FIELD ATTACHABLE G1 & G2 COUPLINGS
- FIELD ATTACHABLE C5 COUPLINGS
- GLX COUPLINGS
- GL COUPLINGS
- C14 COUPLINGS
- PCTS THERMOPLASTIC COUPLINGS
- POLARSEAL COUPLINGS
- POLARSEAL II COUPLINGS
- POWER STEERING
- ADAPTERS
- QUICK DISCONNECT COUPLERS
- BALL VALVES
- LIVE SWIVEL
- ASSEMBLY FABRICATION
- ACCESSORIES
- EQUIPMENT AND PARTS
- AIR BRAKE
- BRASS
- KITS

Stainless Steel Spiral Couplings

Code 62 O-Ring Flange Heavy

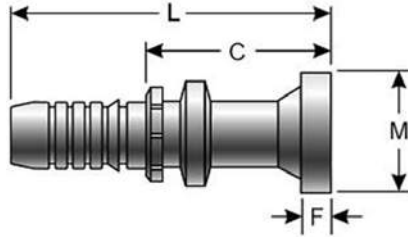

Part No.	Descr.	Prod. No.	⊖		M		L		C		F	
			"	mm	"	mm	"	mm	"	mm	"	mm
G18350-1212	12S-12FLH-SS	7362-04105	3/4	19.1	1.62	41.2	4.48	113.8	2.48	63.0	.35	8.9
G18350-1616	16S-16FLH-SS	7362-04135	1	25.4	1.88	47.8	4.92	125.0	2.68	68.1	.38	9.7
G18350-2020	20S-20FLH-SS	7362-04155	1 1/4	31.8	2.12	53.9	5.75	146.1	3.00	76.2	.41	10.4
G18350-2424	24S-24FLH-SS	7362-04165	1 1/2	38.1	2.12	53.9	7.14	181.6	3.62	92.1	.41	10.4
G18350-3232	32S-32FLH-SS	7362-04195	2	50.8	3.12	79.3	7.24	183.9	3.42	86.9	.50	12.7

Non-Skive Ferrules

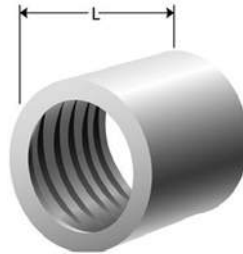

Part No.	Descr.	Prod. No.	⊖		L	
			"	mm	"	mm
G18995-0210	10S1F-2SS	7362-51755	5/8	15.9	1.40	35.6
G18995-0212	12S1F-2SS	7362-51585	3/4	19.1	1.73	44.0
G18995-0216	16S1F-2SS	7362-51595	1	25.4	2.06	52.2
G18995-0406	6S1F-4SS	7362-51445	3/8	9.5	1.10	28.0
G18995-0408	8S1F-4SS	7362-51345	1/2	12.7	1.50	38.1
G18995-0410	10S1F-4SS	7362-51485	5/8	15.9	1.88	47.8
G18995-0412	12S1F-4SS	7362-51495	3/4	19.1	2.00	50.8
G18995-0416	16S1F-4SS	7362-51525	1	25.4	2.22	56.4
G18995-0420	20S1F-4SS	7362-51535	1 1/4	31.8	2.67	67.8
G18995-0620	20S1F-6SS	7362-51625	1 1/4	31.8	2.87	72.9

Skive Ferrules

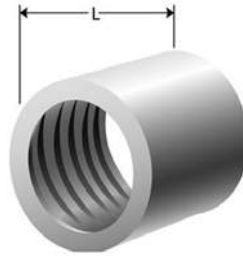

Part No.	Descr.	Prod. No.	⊖		L	
			"	mm	"	mm
G18995-0624	24S2F-6SS	7362-51655	1 1/2	38.1	3.53	89.7
G18995-0632	32S2F-6SS	7362-51685	2	50.8	3.68	93.5

EQUIPMENT
HOSE/CPLG. SELECTION
G&K COUPLINGS
GLOBAL SPIRAL COUPLINGS
STAINLESS STEEL SPIRAL
MEGACRIMP COUPLINGS
STAINLESS STEEL BRAID
POWER CRIMP COUPLINGS
FIELD ATTACHABLE G1 & G2 COUPLINGS
FIELD ATTACHABLE C5 COUPLINGS
GLX COUPLINGS
GL COUPLINGS
C14 COUPLINGS
PCTS THERMOPLASTIC COUPLINGS
POLARSEAL COUPLINGS
POLARSEAL II COUPLINGS
POWER STEERING
ADAPTERS
QUICK DISCONNECT COUPLERS
BALL VALVES
LIVE SWIVEL
ASSEMBLY FABRICATION
ACCESSORIES
EQUIPMENT AND PARTS
AIR BRAKE
BRASS
KITS

NOTES

EQUIPMENT
HOSE/CPLG. SELECTION
G8K COUPLINGS
GLOBALSPIRAL COUPLINGS
STAINLESS STEEL SPIRAL
MEGACRIMP COUPLINGS
STAINLESS STEEL BRAID
POWER CRIMP COUPLINGS
FIELD ATTACHABLE G1 & G2 COUPLINGS
FIELD ATTACHABLE C5 COUPLINGS
GLX COUPLINGS
GL COUPLINGS
C14 COUPLINGS
PCTS THERMOPLASTIC COUPLINGS
POLARSEAL COUPLINGS
POLARSEAL II COUPLINGS
POWER STEERING
ADAPTERS
QUICK DISCONNECT COUPLERS
BALL VALVES
LIVE SWIVEL
ASSEMBLY FABRICATION
ACCESSORIES
EQUIPMENT AND PARTS
AIR BRAKE
BRASS
KITS

Hydraulic Hose For MegaCrimp Couplings

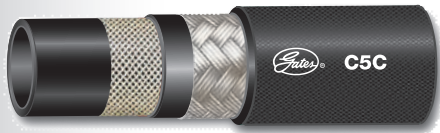

Also available with MegaTuff® cover

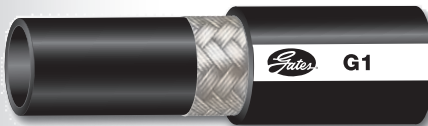
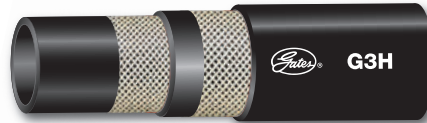

EQUIPMENT
HOSE/CPLG. SELECTION
G&K COUPLINGS
GLOBAL SPIRAL COUPLINGS
STAINLESS STEEL SPIRAL
MEGACRIMP COUPLINGS
STAINLESS STEEL BRAID
POWER CRIMP COUPLINGS
FIELD ATTACHABLE G1 & G2 COUPLINGS
FIELD ATTACHABLE C5 COUPLINGS
GLX COUPLINGS
GL COUPLINGS
C14 COUPLINGS
PCTS THERMOPLASTIC COUPLINGS
POLARSEAL COUPLINGS
POLARSEAL II COUPLINGS
POWER STEERING
ADAPTERS
QUICK DISCONNECT COUPLERS
BALL VALVES
LIVE SWIVEL
ASSEMBLY FABRICATION
ACCESSORIES
EQUIPMENT AND PARTS
AIR BRAKE
BRASS
KITS

Hydraulic Hose For MegaCrimp Couplings - Continued

EQUIPMENT
HOSE/CPLG. SELECTION
G8K COUPLINGS
GLOBALSPIRAL COUPLINGS
STAINLESS STEEL SPIRAL
MEGACRIMP COUPLINGS
STAINLESS STEEL BRAID
POWER CRIMP COUPLINGS
FIELD ATTACHABLE G1 & G2 COUPLINGS
FIELD ATTACHABLE C5 COUPLINGS
GLX COUPLINGS
GL COUPLINGS
C14 COUPLINGS
PCTS THERMOPLASTIC COUPLINGS
POLARSEAL COUPLINGS
POLARSEAL II COUPLINGS
POWER STEERING
ADAPTERS
QUICK DISCONNECT COUPLERS
BALL VALVES
LIVE SWIVEL
ASSEMBLY FABRICATION
ACCESSORIES
EQUIPMENT AND PARTS
AIR BRAKE
BRASS
KITS



Also available with MegaTuff® cover



Also available with MegaTuff® cover

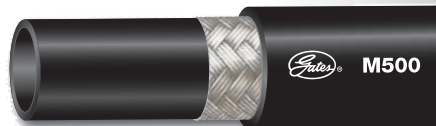

Also available with MegaTuff® and XraTuff™ cover



Also available with MegaTuff® and XraTuff™ cover

Also available with MegaTuff® and XraTuff™ cover



Also available with MegaTuff® and XraTuff™ cover



Also available with MegaTuff® cover



Also available with MegaTuff® and XraTuff™ cover

Hydraulic Hose For MegaCrimp Couplings - Continued

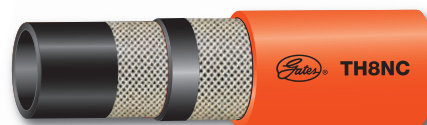
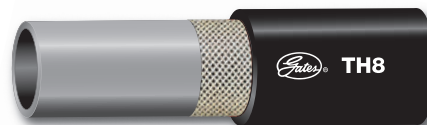
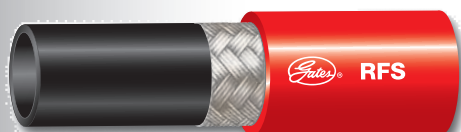
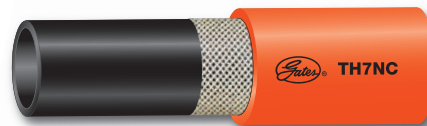
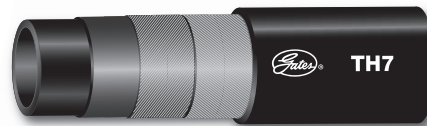
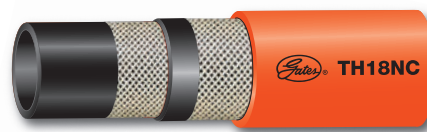
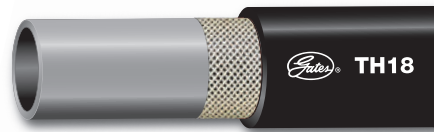
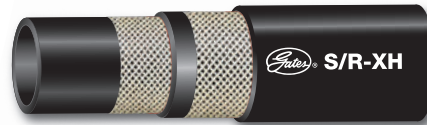

EQUIPMENT
HOSE/CPLG. SELECTION
G&K COUPLINGS
GLOBAL SPIRAL COUPLINGS
STAINLESS STEEL SPIRAL
MEGACRIMP COUPLINGS
STAINLESS STEEL BRAID
POWER CRIMP COUPLINGS
FIELD ATTACHABLE G1 & G2 COUPLINGS
FIELD ATTACHABLE C5 COUPLINGS
GLX COUPLINGS
GL COUPLINGS
C14 COUPLINGS
PCTS THERMOPLASTIC COUPLINGS
POLARSEAL COUPLINGS
POLARSEAL II COUPLINGS
POWER STEERING
ADAPTERS
QUICK DISCONNECT COUPLERS
BALL VALVES
LIVE SWIVEL
ASSEMBLY FABRICATION
ACCESSORIES
EQUIPMENT AND PARTS
AIR BRAKE
BRASS
KITS

Male Pipe (NPTF - 30° Cone Seat)



Part No.	Descr.	Prod. No.	⌀		H1	L		C		
			"	mm		"	mm	"	mm	
G25100-0402	4G-2MP	7100-10025	1/4	6.4	1/8-27	1/2	1.96	49.8	.94	23.9
G25100-0404	4G-4MP	7100-10035	1/4	6.4	1/4-18	9/16	2.17	55.0	1.14	29.0
G25100-0406	4G-6MP	7100-10045	1/4	6.4	3/8-18	11/16	2.17	55.0	1.14	29.0
G25100-0408	4G-8MP	7100-10055	1/4	6.4	1/2-14	7/8	2.44	62.0	1.41	35.8
G25100-0504	5G-4MP	7100-00065	5/16	7.9	1/4-18	5/8	2.28	58.0	1.18	30.0
G25100-0506	5G-6MP	7100-10065	5/16	7.9	3/8-18	11/16	2.32	59.0	1.22	31.0
G25100-0604	6G-4MP	7100-10075	3/8	9.5	1/4-18	5/8	2.32	58.9	1.22	31.0
G25100-0606	6G-6MP	7100-10085	3/8	9.5	3/8-18	11/16	2.32	58.9	1.22	31.0
G25100-0608	6G-8MP	7100-10095	3/8	9.5	1/2-14	7/8	2.51	63.8	1.42	36.1
G25100-0804	8G-4MP	7100-10105	1/2	12.7	1/4-18	13/16	2.72	69.0	1.24	31.5
G25100-0806	8G-6MP	7100-00105	1/2	12.7	3/8-18	13/16	2.72	69.0	1.24	31.5
G25100-0808	8G-8MP	7100-00115	1/2	12.7	1/2-14	7/8	2.87	73.0	1.40	35.5
G25100-0812	8G-12MP	7100-00125	1/2	12.7	3/4-14	1 1/16	2.95	74.9	1.47	37.3
G25100-1008	10G-8MP	7100-00225	5/8	15.9	1/2-14	15/16	2.95	75.0	1.48	37.5
G25100-1012	10G-12MP	7100-00235	5/8	15.9	3/4-14	1 1/16	2.95	75.0	1.48	37.5
G25100-1208	12G-8MP	7100-00155	3/4	19.1	1/2-14	1 1/16	3.46	87.9	1.45	36.8
G25100-1212	12G-12MP	7100-00165	3/4	19.1	3/4-14	1 1/16	3.46	87.9	1.45	36.8
G25100-1216	12G-16MP	7100-00175	3/4	19.1	1-11 1/2	1 3/8	3.77	95.8	1.77	45.0
G25100-1612	16G-12MP	7100-00195	1	25.4	3/4-14	1 3/8	3.93	99.8	1.70	43.2
G25100-1616	16G-16MP	7100-00205	1	25.4	1-11 1/2	1 3/8	4.11	104.4	1.87	47.5
G25100-2020	20G-20MP	7100-00215	1 1/4	31.8	1 1/4-11 1/2	1 3/4	4.44	112.8	2.12	53.8

Male Pipe Long Nose

For use with J2AT Jack Hose and special high-pressure applications.

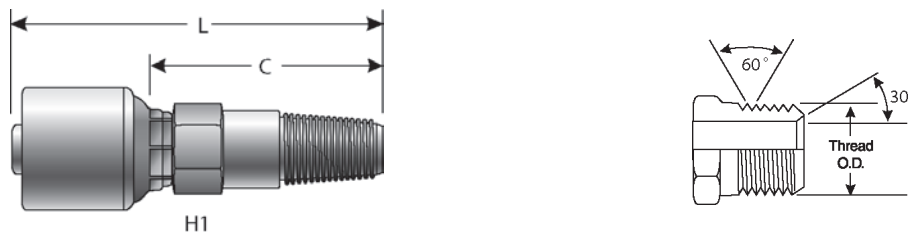

Part No.	Descr.	Prod. No.	⌀		H1	L		C		
			"	mm		"	mm	"	mm	
G25101-0404	4G-4MPLN	7100-16615	1/4	6.4	1/4-18	9/16	2.56	65.0	1.54	39.0
G25101-0406	4G-6MPLN	7100-16625	1/4	6.4	3/8-18	11/16	2.56	65.0	1.54	39.0
G25101-0604	6G-4MPLN	7100-16645	3/8	9.5	1/4-18	5/8	2.72	69.0	1.62	41.1
G25101-0606	6G-6MPLN	7100-16635	3/8	9.5	3/8-18	11/16	2.72	69.0	1.62	41.1

Male Pipe Swivel (NPTF - Without 30° Cone Seat)

NOT TO BE USED AS A LIVE SWIVEL.

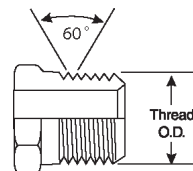
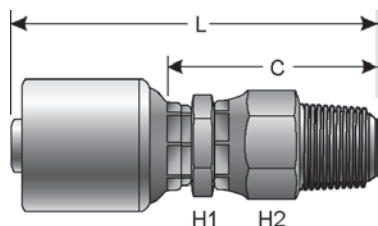

Part No.	Descr.	Prod. No.	⊖		🌀	H1	H2	L		C	
			"	mm				"	"	"	mm
G25105-0402	4G-2MPX	7100-10245	1/4	6.4	1/8-27	1/2	1/2	2.39	60.7	1.37	34.8
G25105-0404	4G-4MPX	7100-10255	1/4	6.4	1/4-18	1/2	11/16	2.61	66.3	1.58	40.1
G25105-0406	4G-6MPX	7100-10265	1/4	6.4	3/8-18	5/8	7/8	2.73	69.3	1.71	43.4
G25105-0408	4G-8MPX	7100-10275	1/4	6.4	1/2-14	3/4	1	2.97	75.4	1.94	49.4
G25105-0604	6G-4MPX	7100-10285	3/8	9.5	1/4-18	5/8	7/8	2.87	72.8	1.77	44.9
G25105-0606	6G-6MPX	7100-10295	3/8	9.5	3/8-18	5/8	7/8	2.81	71.4	1.71	43.4
G25105-0608	6G-8MPX	7100-10305	3/8	9.5	1/2-14	3/4	1	3.04	77.2	1.94	49.3
G25105-0806	8G-6MPX	7100-00315	1/2	12.7	3/8-18	13/16	7/8	3.22	81.8	1.75	44.5
G25105-0808	8G-8MPX	7100-00325	1/2	12.7	1/2-14	13/16	1	3.42	86.9	1.94	49.3
G25105-1012	10G-12MPX	7100-00335	5/8	15.9	3/4-14	1 1/16	1 5/16	3.48	88.4	2.01	51.1
G25105-1208	12G-8MPX	7100-00345	3/4	19.1	1/2-14	1 1/16	1	3.97	100.8	1.96	49.8
G25105-1212	12G-12MPX	7100-00355	3/4	19.1	3/4-14	1 1/16	1 5/16	4.01	101.9	2.00	50.8
G25105-1616	16G-16MPX	7100-00365	1	25.4	1-11 1/2	1 3/8	1 5/8	4.73	120.1	2.49	63.2

Male Pipe Swivel - 90° Block (NPTF - Without 30° Cone Seat)

NOT TO BE USED AS A LIVE SWIVEL.

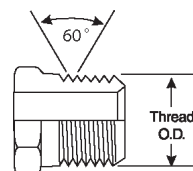
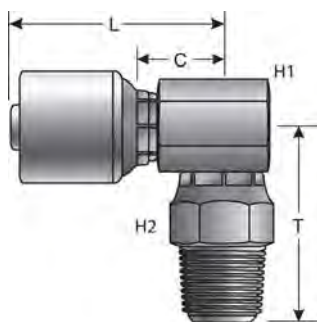

Part No.	Descr.	Prod. No.	⊖		🌀	H1	H2	T		L		C	
			"	mm				"	"	"	mm	"	mm
G25106-0402	4G-2MPX90	7100-10365	1/4	6.4	1/8-27	11/16	1/2	1.20	30.5	1.75	44.4	.72	18.3
G25106-0404	4G-4MPX90	7100-10375	1/4	6.4	1/4-18	11/16	11/16	1.62	41.1	1.75	44.5	.72	18.3
G25106-0406	4G-6MPX90	7100-10385	1/4	6.4	3/8-18	11/16	7/8	1.73	43.9	1.82	46.2	.79	20.1
G25106-0604	6G-4MPX90	7100-10395	3/8	9.5	1/4-18	3/4	11/16	1.65	41.9	1.96	49.7	.85	21.6
G25106-0606	6G-6MPX90	7100-10405	3/8	9.5	3/8-18	3/4	7/8	1.76	44.7	1.96	49.7	.85	21.6
G25106-0608	6G-8MPX90	7100-10415	3/8	9.5	1/2-14	3/4	1	1.93	49.1	1.96	49.7	.85	21.6
G25106-0806	8G-6MPX90	7100-07135	1/2	12.7	3/8-18	—	7/8	1.88	47.8	2.55	64.7	1.07	27.2
G25106-0808	8G-8MPX90	7100-00425	1/2	12.7	1/2-14	—	1	2.05	52.1	2.55	64.7	1.07	27.2
G25106-1212	12G-12MPX90	7100-00435	3/4	19.1	3/4-14	—	1 5/16	2.30	58.4	3.17	80.5	1.16	29.5

- EQUIPMENT
- HOSE/CPLG. SELECTION
- G&K COUPLINGS
- GLOBALSPIRAL COUPLINGS
- STAINLESS STEEL SPIRAL
- MEGACRIMP COUPLINGS
- STAINLESS STEEL BRAID
- POWER CRIMP COUPLINGS
- FIELD ATTACHABLE G1 & G2 COUPLINGS
- FIELD ATTACHABLE C5 COUPLINGS
- GLX COUPLINGS
- GL COUPLINGS
- C14 COUPLINGS
- PCTS THERMOPLASTIC COUPLINGS
- POLARSEAL COUPLINGS
- POLARSEAL II COUPLINGS
- POWER STEERING
- ADAPTERS
- QUICK DISCONNECT COUPLERS
- BALL VALVES
- LIVE SWIVEL
- ASSEMBLY FABRICATION
- ACCESSORIES
- EQUIPMENT AND PARTS
- AIR BRAKE
- BRASS
- KITS

Male Pipe Swivel - 90° Long Block (NPTF - Without 30° Cone Seat)

NOT TO BE USED AS A LIVE SWIVEL.

These couplings have a longer reach (L dimension) to accommodate the OmniCrimp 21 crimper.

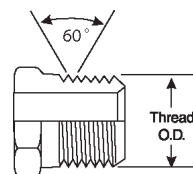
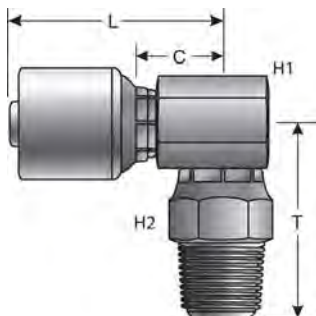

Part No.	Descr.	Prod. No.	⊖		H1	H2	T	L		C			
			"	mm				"	mm	"	mm		
G25107-0608	6G-8MPX90L	7100-00445	3/8	9.5	1/2-14	3/4	1	1.93	49.0	3.40	86.4	1.94	49.3
G25107-0808	8G-8MPX90L	7100-00455	1/2	12.7	1/2-14	1	1	2.06	52.3	3.27	83.1	1.80	45.7
G25107-1212	12G-12MPX90L	7100-00475	3/4	19.1	3/4-14	1 3/8	1 5/16	2.30	58.4	3.93	99.7	1.92	48.7

Female Pipe (NPTF - Without 30° Cone Seat)

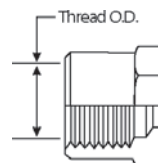
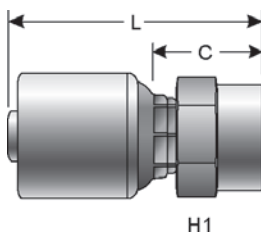

Part No.	Descr.	Prod. No.	⊖		H1	L		C		
			"	mm		"	mm	"	mm	
G25110-0402	4G-2FP	7100-10485	1/4	6.4	1/8-27	9/16	1.74	44.2	.72	18.3
G25110-0404	4G-4FP	7100-10495	1/4	6.4	1/4-18	11/16	1.98	50.3	.96	24.4
G25110-0406	4G-6FP	7100-10505	1/4	6.4	3/8-18	13/16	1.98	50.3	.96	24.4
G25110-0604	6G-4FP	7100-10515	3/8	9.5	1/4-18	11/16	2.00	50.8	.90	22.9
G25110-0606	6G-6FP	7100-10525	3/8	9.5	3/8-18	13/16	2.06	52.3	.96	24.4
G25110-0608	6G-8FP	7100-10535	3/8	9.5	1/2-14	1	2.24	56.9	1.14	29.0
G25110-0806	8G-6FP	7100-00545	1/2	12.7	3/8-18	13/16	2.46	62.5	.98	24.9
G25110-0808	8G-8FP	7100-00555	1/2	12.7	1/2-14	1	2.63	66.8	1.16	29.5
G25110-1212	12G-12FP	7100-00565	3/4	19.1	3/4-14	1 1/4	3.22	81.8	1.22	31.0

Female Pipe Swivel (NPSM - 30° Cone Seat)

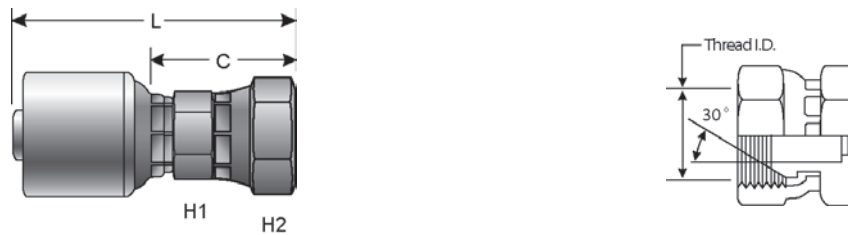

Part No.	Descr.	Prod. No.	⊖		🌀	H1		H2		L		C	
			"	mm		"	mm	"	mm	"	mm	"	mm
G25111-0404	4G-4FPX	7100-10575	1/4	6.4	1/4-18	1/2	—	11/16	2.24	56.9	1.21	30.7	
G25111-0606	6G-6FPX	7100-10585	3/8	9.5	3/8-18	5/8	—	7/8	2.48	63.0	1.38	35.1	
G25111-0608	6G-8FPX	7100-10595	3/8	9.5	1/2-14	13/16	—	1	2.55	64.8	1.45	36.8	
G25111-0808	8G-8FPX	7100-00595	1/2	12.7	1/2-14	13/16	—	1	2.88	73.2	1.41	35.8	
G25111-1212	12G-12FPX	7100-00605	3/4	19.1	3/4-14	—	27	1 1/4	3.71	94.2	1.70	43.2	
G25111-1616	16G-16FPX	7100-00615	1	25.4	1-11 1/2	1 3/8	—	1 1/2	4.10	104.1	1.87	47.5	
G25111-2020	20G-20FPX	7100-00625	1 1/4	31.8	1 1/4-11 1/2	1 3/4	—	1 7/8	4.67	118.6	2.26	57.4	

Male O-Ring Boss

SAE J1926/3 ISO 11926-3 Light-Duty (L Series) Stud End.



Part No.	Descr.	Prod. No.	⊖		🌀	H1		L		C	
			"	mm		"	mm	"	mm	"	mm
G25120-0404	4G-4MB	7100-12205	1/4	6.4	7/16-20	9/16	1.99	50.5	.96	24.5	
G25120-0405	4G-5MB	7100-12215	1/4	6.4	1/2-20	5/8	1.99	50.5	.96	24.5	
G25120-0406	4G-6MB	7100-12225	1/4	6.4	9/16-18	11/16	2.05	52.0	1.02	26.0	
G25120-0605	6G-5MB	7100-12285	3/8	9.5	1/2-20	5/8	2.05	52.0	.95	24.1	
G25120-0606	6G-6MB	7100-13235	3/8	9.5	9/16-18	11/16	2.20	56.0	1.11	28.1	
G25120-0608	6G-8MB	7100-13245	3/8	9.5	3/4-16	7/8	2.28	58.0	1.19	30.1	
G25120-0610	6G-10MB	7100-12255	3/8	9.5	7/8-14	1	2.22	56.5	1.13	28.6	
G25120-0612	6G-12MB	7100-12265	3/8	9.5	1 1/16-12	1 1/4	2.42	61.5	1.32	33.6	
G25120-0808	8G-8MB	7100-13275	1/2	12.7	3/4-16	7/8	2.64	67.0	1.16	29.5	
G25120-0810	8G-10MB	7100-13285	1/2	12.7	7/8-14	1	2.68	68.0	1.20	30.5	
G25120-0812	8G-12MB	7100-13295	1/2	12.7	1 1/16-12	1 1/4	2.91	74.0	1.44	36.5	
G25120-1008	10G-8MB	7100-02305	5/8	15.9	3/4-16	15/16	2.83	72.0	1.36	34.5	
G25120-1010	10G-10MB	7100-13315	5/8	15.9	7/8-14	1	2.83	72.0	1.36	34.5	
G25120-1012	10G-12MB	7100-13325	5/8	15.9	1 1/16-12	1 1/4	2.99	76.0	1.52	38.5	
G25120-1210	12G-10MB	7100-02265	3/4	19.1	7/8-14	1	3.23	82.1	1.22	31.1	
G25120-1212	12G-12MB	7100-02335	3/4	19.1	1 1/16-12	1 1/4	3.33	84.5	1.32	33.5	
G25120-1214	12G-14MB	7100-02345	3/4	19.1	1 3/16-12	1 3/8	3.31	84.0	1.30	33.0	
G25120-1216	12G-16MB	7100-02355	3/4	19.1	1 5/16-12	1 1/2	3.44	87.5	1.44	36.5	
G25120-1614	16G-14MB	7100-02365	1	25.4	1 3/16-12	1 3/8	3.78	96.0	1.54	39.2	
G25120-1616	16G-16MB	7100-02375	1	25.4	1 5/16-12	1 1/2	3.84	97.5	1.60	40.7	
G25120-1620	16G-20MB	7100-02255	1	25.4	1 5/8-12	1 7/8	3.74	95.0	1.50	38.2	
G25120-2020	20G-20MB	7100-02385	1 1/4	31.8	1 5/8-12	1 7/8	3.90	99.0	1.57	40.0	

- EQUIPMENT
- HOSE/CPLG. SELECTION
- G8K COUPLINGS
- GLOBALSPIRAL COUPLINGS
- STAINLESS STEEL SPIRAL
- MEGACRIMP COUPLINGS**
- STAINLESS STEEL BRAID
- POWER CRIMP COUPLINGS
- FIELD ATTACHABLE G1 & G2 COUPLINGS
- FIELD ATTACHABLE C5 COUPLINGS
- GLX COUPLINGS
- GL COUPLINGS
- C14 COUPLINGS
- PCTS THERMOPLASTIC COUPLINGS
- POLARSEAL COUPLINGS
- POLARSEAL II COUPLINGS
- POWER STEERING
- ADAPTERS
- QUICK DISCONNECT COUPLERS
- BALL VALVES
- LIVE SWIVEL
- ASSEMBLY FABRICATION
- ACCESSORIES
- EQUIPMENT AND PARTS
- AIR BRAKE
- BRASS
- KITS

Male O-Ring Boss Swivel

NOT TO BE USED AS A LIVE SWIVEL.
 NOTE: Internal O-Rings rated at 250°F (121°C).
 SAE J1926/3 ISO 11926-3 Light-Duty (L Series) Stud End.

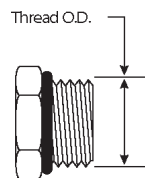
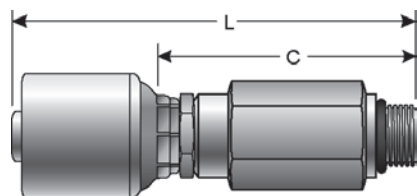

Part No.	Descr.	Prod. No.	⊖		H2	L		C		
			"	mm		"	mm	"	mm	
G25121-0404	4G-4MBX	7209-40015	1/4	6.4	7/16-20	19	3.21	81.5	2.19	55.5
G25121-0406	4G-6MBX	7209-40025	1/4	6.4	9/16-18	19	3.21	81.5	2.19	55.5
G25121-0606	6G-6MBX	7209-40045	3/8	9.5	9/16-18	22	3.33	84.5	2.23	56.6
G25121-0608	6G-8MBX	7209-40055	3/8	9.5	3/4-16	23	3.33	84.5	2.23	56.6
G25121-0610	6G-10MBX	7209-40065	3/8	9.5	7/8-14	27	3.21	81.5	2.11	53.6
G25121-0808	8G-8MBX	7209-40085	1/2	12.7	3/4-16	23	3.78	96.0	2.30	58.5
G25121-0810	8G-10MBX	7209-40095	1/2	12.7	7/8-14	27	3.84	97.5	2.36	60.0
G25121-1010	10G-10MBX	7209-40115	5/8	15.9	7/8-14	32	3.88	98.5	2.40	61.0
G25121-1212	12G-12MBX	7209-40145	3/4	19.1	1 1/16-12	32	4.55	115.5	2.54	64.5

Male O-Ring Boss Swivel - 45° Block

NOT TO BE USED AS A LIVE SWIVEL.
 NOTE: Internal O-Rings rated at 250°F (121°C).
 SAE J1926/3 ISO 11926-3 Light-Duty (L Series) Stud End.

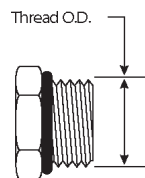
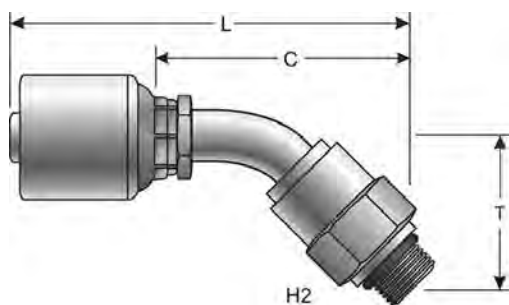

Part No.	Descr.	Prod. No.	⊖		H2	T		L		C		
			"	mm		"	mm	"	mm	"	mm	
G25122-0606	6G-6MBX45BL	7100-12475	3/8	9.5	9/16-18	7/8	1.09	27.8	3.11	79.0	2.01	51.0
G25122-0608	6G-8MBX45BL	7100-12485	3/8	9.5	3/4-16	1	1.06	26.9	3.07	78.1	1.98	50.2
G25122-0808	8G-8MBX45BL	7100-02495	1/2	12.7	3/4-16	1	1.12	28.4	3.04	77.2	1.56	39.7
G25122-0810	8G-10MBX45BL	7100-02505	1/2	12.7	7/8-14	1	1.16	29.5	3.08	78.3	1.61	40.8

Male O-Ring Boss Swivel - 90° Block

NOT TO BE USED AS A LIVE SWIVEL.
 NOTE: Internal O-Rings rated at 250°F (121°C).
 SAE J1926/3 ISO 11926-3 Light-Duty (L Series) Stud End.

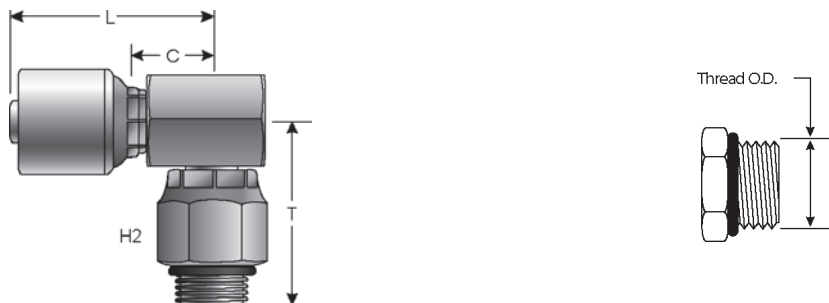

Part No.	Descr.	Prod. No.	⌀		H2	T		L		C		
			"	mm		"	mm	"	mm	"	mm	
G25123-0405	4G-5MBX90BL	7100-12555	1/4	6.4	1/2-20	11/16	1.57	40.0	1.75	44.4	.80	20.2
G25123-0406	4G-6MBX90BL	7100-12515	1/4	6.4	9/16-18	7/8	1.65	41.8	1.82	46.3	.80	20.2
G25123-0606	6G-6MBX90BL	7100-12525	3/8	9.5	9/16-18	7/8	1.67	42.5	2.41	61.2	.86	21.8
G25123-0608	6G-8MBX90BL	7100-12535	3/8	9.5	3/4-16	1	1.63	41.3	2.41	61.2	.86	21.8
G25123-0610	6G-10MBX90BL	7100-12545	3/8	9.5	7/8-14	1	1.69	42.8	1.95	49.6	.85	21.7
G25123-0808	8G-8MBX90BL	7100-02555	1/2	12.7	3/4-16	1	1.75	44.5	2.55	64.8	1.07	27.2
G25124-0808	8G-8MBX90BLL	7100-02705	1/2	12.7	3/4-16	1	1.75	44.4	3.27	83.1	1.80	45.6
G25123-0810	8G-10MBX90BL	7100-02565	1/2	12.7	7/8-14	1	1.81	46.0	2.55	64.7	1.07	27.2
G25124-0810	8G-10MBX90BLL	7100-02715	1/2	12.7	7/8-14	1	1.81	46.0	3.27	83.1	1.80	45.6
G25123-0812	8G-12MBX90BL	7100-02575	1/2	12.7	1 1/16-12	1 5/16	2.09	53.1	2.52	64.1	1.07	27.2
G25124-0812	8G-12MBX90BLL	7100-02725	1/2	12.7	1 1/16-12	1 5/16	2.09	53.1	3.76	95.5	2.28	58.0
G25123-1010	10G-10MBX90BL	7100-02585	5/8	15.9	7/8-14	1	1.81	46.0	2.40	61.0	.93	23.6
G25124-1010	10G-10MBX90BLL	7100-02735	5/8	15.9	7/8-14	1	1.81	46.0	3.15	79.9	1.67	42.4
G25123-1212	12G-12MBX90BL	7100-02595	3/4	19.1	1 1/16-12	1 5/16	2.39	60.7	3.18	80.8	1.17	29.7
G25124-1212	12G-12MBX90BLL	7100-02755	3/4	19.1	1 1/16-12	1 5/16	2.28	57.9	3.94	100.0	1.93	49.0

Male O-Ring Boss Swivel - 45° Bent Tube

NOT TO BE USED AS A LIVE SWIVEL.
 NOTE: Internal O-Rings rated at 250°F (121°C).
 SAE J1926/3 ISO 11926-3 Light-Duty (L Series) Stud End.

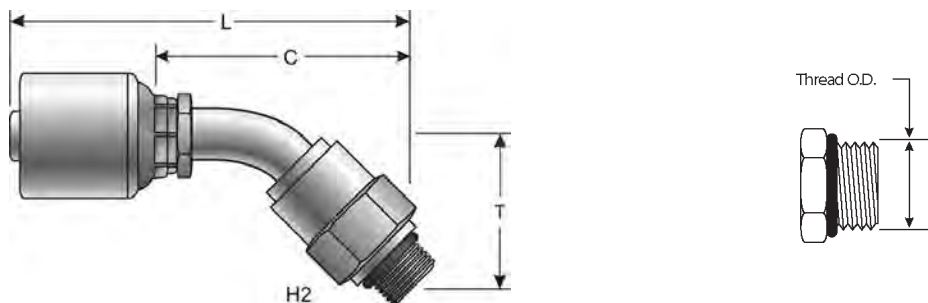

Part No.	Descr.	Prod. No.	⌀		H2	T		L		C		
			"	mm		"	mm	"	mm	"	mm	
G25126-0606	6G-6MBX45	7209-40225	3/8	9.5	9/16-18	22	1.52	38.7	3.65	92.6	2.54	64.6
G25126-0608	6G-8MBX45	7209-40235	3/8	9.5	3/4-16	24	1.52	38.7	3.65	92.6	2.54	64.6
G25126-0808	8G-8MBX45	7209-40255	1/2	12.7	3/4-16	24	1.64	41.7	4.24	107.7	2.77	70.3
G25126-0810	8G-10MBX45	7209-40265	1/2	12.7	7/8-14	27	1.69	42.8	4.28	108.8	2.81	71.3

- EQUIPMENT
- HOSE/CPLG. SELECTION
- G8K COUPLINGS
- GLOBAL SPIRAL COUPLINGS
- STAINLESS STEEL SPIRAL
- MEGACRIMP COUPLINGS**
- STAINLESS STEEL BRAID
- POWER CRIMP COUPLINGS
- FIELD ATTACHABLE G1 & G2 COUPLINGS
- FIELD ATTACHABLE C5 COUPLINGS
- GLX COUPLINGS
- GL COUPLINGS
- C14 COUPLINGS
- PCTS THERMOPLASTIC COUPLINGS
- POLARSEAL COUPLINGS
- POLARSEAL II COUPLINGS
- POWER STEERING
- ADAPTERS
- QUICK DISCONNECT COUPLERS
- BALL VALVES
- LIVE SWIVEL
- ASSEMBLY FABRICATION
- ACCESSORIES
- EQUIPMENT AND PARTS
- AIR BRAKE
- BRASS
- KITS

Male O-Ring Boss Swivel - 90° Bent Tube

NOT TO BE USED AS A LIVE SWIVEL.
 NOTE: Internal O-Rings rated at 250°F (121°C).
 SAE J1926/3 ISO 11926-3 Light-Duty (L Series) Stud End.

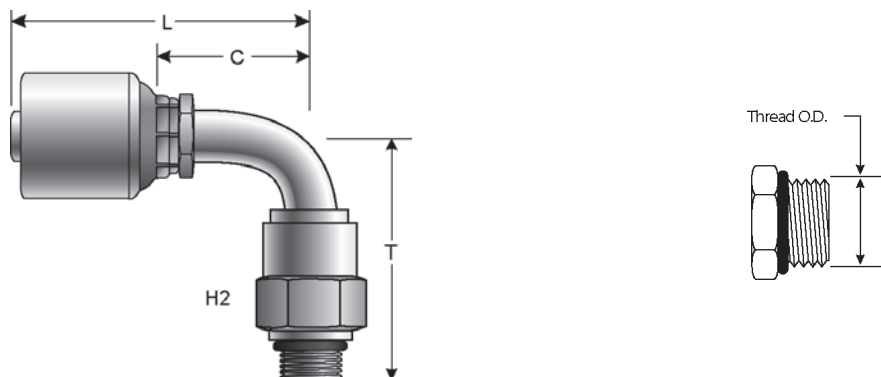

Part No.	Descr.	Prod. No.	⊖		H2	T		L		C		
			"	mm		"	"	"	mm	"	mm	
G25128-0406	4G-6MBX90	7209-40425	1/4	6.4	9/16-18	7/8	2.36	60.0	2.19	55.6	1.17	29.6
G25128-0606	6G-6MBX90	7209-40455	3/8	9.5	9/16-18	7/8	2.48	63.1	2.47	62.8	1.37	34.8
G25128-0608	6G-8MBX90	7209-40475	3/8	9.5	3/4-16	1	2.48	63.1	2.47	62.8	1.37	34.8
G25128-0610	6G-10MBX90	7209-40485	3/8	9.5	7/8-14	1	2.37	60.1	2.47	62.8	1.37	34.8
G25128-0808	8G-8MBX90	7209-40505	1/2	12.7	3/4-16	1	2.76	70.1	3.16	80.3	1.69	42.9
G25128-0810	8G-10MBX90	7209-40525	1/2	12.7	7/8-14	1	2.82	71.6	3.16	80.3	1.69	42.9
G25128-0812	8G-12MBX90	7209-40545	1/2	12.7	1 1/16-12	1 1/4	2.90	73.6	3.16	80.3	1.69	42.9
G25128-1010	10G-10MBX90	7209-40585	5/8	15.9	7/8-14	1 5/16	3.14	79.8	3.55	90.1	2.07	52.6
G25128-1012	10G-12MBX90	7209-40605	5/8	15.9	1 1/16-12	1	3.18	80.8	3.55	90.1	2.07	52.6
G25128-1212	12G-12MBX90	7209-40645	3/4	19.1	1 1/16-12	1 5/16	3.42	86.8	4.33	110.1	2.33	59.1

Male O-Ring Boss Adapterless Swivel - 90° Bent Tube

NOTE: Internal O-Rings rated at 250°F (121°C).

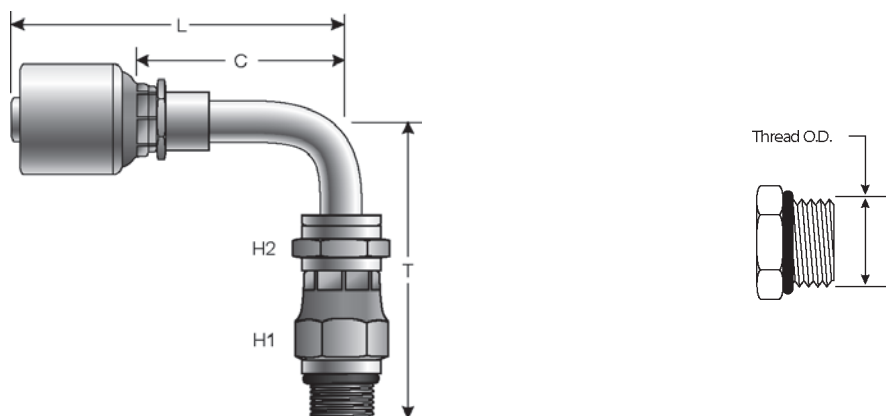

Part No.	Descr.	Prod. No.	⊖		H1	H2	T		L		C		
			"	mm			"	"	"	mm	"	mm	
G25134-0404	4G-4MBAX90M	7100-18615	1/4	6.4	7/16-20	17	17	2.95	74.9	2.42	61.5	1.38	35.1
G25134-0606	6G-6MBAX90M	7100-18715	3/8	9.5	9/16-18	22	22	3.27	83.1	2.76	70.1	1.66	42.2
G25134-0808	8G-8MBAX90M	7100-18765	1/2	12.7	3/4-16	24	24	3.82	97.0	3.44	87.4	1.97	50.0
G25134-1010	10G-10MBAX90M	7100-18815	5/8	15.9	7/8-14	30	30	4.33	110.0	3.76	95.5	2.28	57.9

Male O-Ring Boss Adapterless Swivel - 90° Bent Tube - Continued

Part No.	Descr.	Prod. No.	⊖		🌀		H1	H2	T		L		C	
			"	mm	"	mm			"	mm	"	mm	"	mm
G25134-1212	12G-12MBAX90M	7100-18865	3/4	19.1	1 1/16-12	36	36	4.80	122.0	4.49	114.1	2.48	63.0	

Male JIC 37° Flare

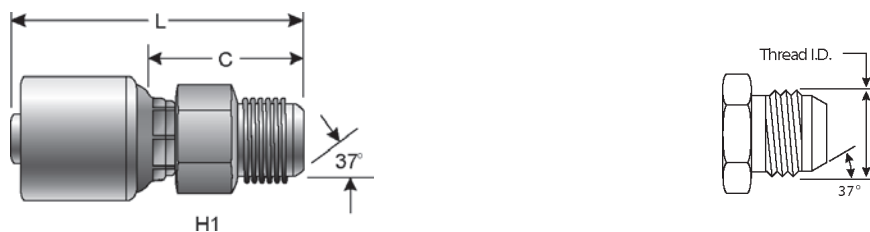

Part No.	Descr.	Prod. No.	⊖		🌀		H1	L		C	
			"	mm	"	mm		"	mm	"	mm
G25165-0404	4G-4MJ	7103-36045	1/4	6.4	7/16-20	14	2.19	55.5	1.16	29.5	
G25165-0405	4G-5MJ	7103-36055	1/4	6.4	1/2-20	14	2.19	55.5	1.16	29.5	
G25165-0406	4G-6MJ	7103-36065	1/4	6.4	9/16-18	17	2.22	56.5	1.20	30.5	
G25165-0505	5G-5MJ	7103-36105	5/16	7.9	1/2-20	17	2.26	57.5	1.16	29.5	
G25165-0506	5G-6MJ	7103-36115	5/16	7.9	9/16-18	17	2.26	57.5	1.16	29.5	
G25165-0606	6G-6MJ	7103-36155	3/8	9.5	9/16-18	17	2.30	58.5	1.20	30.6	
G25165-0608	6G-8MJ	7103-36165	3/8	9.5	3/4-16	19	2.48	63.0	1.38	35.1	
G25165-0610	6G-10MJ	7103-36175	3/8	9.5	7/8-14	24	2.64	67.0	1.54	39.1	
G25165-0808	8G-8MJ	7103-36215	1/2	12.7	3/4-16	22	2.81	71.5	1.34	34.0	
G25165-0810	8G-10MJ	7103-36225	1/2	12.7	7/8-14	24	2.91	74.0	1.44	36.5	
G25165-0812	8G-12MJ	7103-36235	1/2	12.7	1 1/16-12	27	3.19	81.0	1.71	43.5	
G25165-1008	10G-8MJ	7103-36265	5/8	15.9	3/4-16	27	2.93	74.5	1.46	37.0	
G25165-1010	10G-10MJ	7103-36275	5/8	15.9	7/8-14	27	3.03	77.0	1.56	39.5	
G25165-1012	10G-12MJ	7103-36285	5/8	15.9	1 1/16-12	27	3.19	81.0	1.71	43.5	
G25165-1210	12G-10MJ	7103-36315	3/4	19.1	7/8-14	27	3.68	93.5	1.67	42.5	
G25165-1212	12G-12MJ	7103-36325	3/4	19.1	1 1/16-12	27	3.72	94.5	1.71	43.5	
G25165-1214	12G-14MJ	7103-36335	3/4	19.1	1 3/16-12	32	3.76	95.5	1.75	44.5	
G25165-1216	12G-16MJ	7103-36345	3/4	19.1	1 5/16-12	36	3.78	96.0	1.77	45.0	
G25165-1614	16G-14MJ	7103-36375	1	25.4	1 3/16-12	36	4.09	104.0	1.86	47.2	
G25165-1616	16G-16MJ	7103-36385	1	25.4	1 5/16-12	36	4.11	104.5	1.88	47.7	
G25165-1620	16G-20MJ	7103-36395	1	25.4	1 5/8-12	46	4.29	109.0	2.06	52.2	
G25165-2020	20G-20MJ	7103-36435	1 1/4	31.8	1 5/8-12	46	4.43	112.5	2.11	53.5	
G25165-2024	20G-24MJ	7103-36445	1 1/4	31.8	1 7/8-12	50	4.43	112.5	2.11	53.5	

- EQUIPMENT
- HOSE/CPLG. SELECTION
- G8K COUPLINGS
- GLOBAL SPIRAL COUPLINGS
- STAINLESS STEEL SPIRAL
- MEGACRIMP COUPLINGS
- STAINLESS STEEL BRAID
- POWER CRIMP COUPLINGS
- FIELD ATTACHABLE G1 & G2 COUPLINGS
- FIELD ATTACHABLE C5 COUPLINGS
- GLX COUPLINGS
- GL COUPLINGS
- C14 COUPLINGS
- PCTS THERMOPLASTIC COUPLINGS
- POLARSEAL COUPLINGS
- POLARSEAL II COUPLINGS
- POWER STEERING
- ADAPTERS
- QUICK DISCONNECT COUPLERS
- BALL VALVES
- LIVE SWIVEL
- ASSEMBLY FABRICATION
- ACCESSORIES
- EQUIPMENT AND PARTS
- AIR BRAKE
- BRASS
- KITS

Female JIC 37° Flare Swivel



	Part No.	Descr.	Prod. No.	⌀		H1	H2	L		C		
				"	mm			"	"	mm	"	mm
POWER CRIMP COUPLINGS	G25170-0404	4G-4FJX	7103-08045	1/4	6.4	7/16-20	15	14	2.20	55.9	1.18	29.9
	G25170-0405	4G-5FJX	7103-08055	1/4	6.4	1/2-20	15	17	2.30	58.3	1.27	32.3
FIELD ATTACHABLE G1 & G2 COUPLINGS	G25170-0406	4G-6FJX	7103-08065	1/4	6.4	9/16-18	15	19	2.35	59.6	1.32	33.6
	G25170-0505	5G-5FJX	7103-09095	5/16	7.9	1/2-20	17	17	2.44	62.1	1.34	34.1
	G25170-0506	5G-6FJX	7103-09105	5/16	7.9	9/16-18	17	19	2.50	63.6	1.40	35.6
FIELD ATTACHABLE C5 COUPLINGS	G25170-0604	6G-4FJXSP	7103-10125	3/8	9.5	7/16-20	17	14	2.30	58.4	1.20	30.5
	G25171-0604	6G-4FJX	7103-09135	3/8	9.5	7/16-20	15.9	14	2.94	74.7	1.84	46.8
	G25170-0605	6G-5FJXSP	7103-10135	3/8	9.5	1/2-20	17	17	2.27	57.7	1.17	29.8
GLX COUPLINGS	G25171-0605	6G-5FJX	7103-09125	3/8	9.5	1/2-20	17	17	2.96	75.2	1.86	47.3
	G25170-0606	6G-6FJX	7103-08145	3/8	9.5	9/16-18	18	19	2.42	61.5	1.29	32.7
GL COUPLINGS	G25170-0608	6G-8FJX	7103-08155	3/8	9.5	3/4-16	18	24	2.63	66.7	1.49	37.9
	G25170-0610	6G-10FJX	7103-08165	3/8	9.5	7/8-14	18	27	2.76	70.0	1.62	41.2
C14 COUPLINGS	G25170-0612	6G-12FJX	7103-09175	3/8	9.5	1 1/16-12	17	32	2.91	74.0	1.81	46.0
	G25170-0806	8G-6FJXSP	7103-10195	1/2	12.7	9/16-18	22	19	2.67	67.8	1.19	30.3
PCTS THERMOPLASTIC COUPLINGS	G25171-0806	8G-6FJX	7103-09195	1/2	12.7	9/16-18	22	19	3.81	96.7	2.33	59.2
	G25170-0808	8G-8FJX	7103-08205	1/2	12.7	3/4-16	22	24	2.88	73.2	1.50	38.0
	G25170-0810	8G-10FJX	7103-08215	1/2	12.7	7/8-14	22	27	3.01	76.5	1.63	41.3
	G25170-0812	8G-12FJX	7103-08225	1/2	12.7	1 1/8-12	22	32	3.06	77.7	1.67	42.5
POLARSEAL COUPLINGS	G25170-0816	8G-16FJX	7103-09235	1/2	12.7	1 5/16-12	22	41	3.52	89.3	2.04	51.8
	G25170-1008	10G-8FJXSP	7103-10255	5/8	15.9	3/4-16	24	24	2.90	73.6	1.42	36.1
POLARSEAL II COUPLINGS	G25171-1008	10G-8FJX	7103-09255	5/8	15.9	3/4-16	24	24	4.06	103.0	2.58	65.5
	G25170-1010	10G-10FJX	7103-08265	5/8	15.9	7/8-14	24	27	3.14	79.7	1.66	42.2
	G25170-1012	10G-12FJX	7103-08275	5/8	15.9	1 1/16-12	24	32	3.20	81.4	1.73	43.9
POWER STEERING	G25170-1014	10G-14FJX	7103-08285	5/8	15.9	1 3/16-12	24	36	3.39	86.1	1.91	48.6
	G25170-1208	12G-8FJX	7103-10305	3/4	19.1	3/4-16	27	24	3.51	89.1	1.50	38.1
ADAPTERS	G25170-1210	12G-10FJXSP	7103-10315	3/4	19.1	7/8-14	27	27	3.51	89.2	1.50	38.2
	G25171-1210	12G-10FJX	7103-09315	3/4	19.1	7/8-14	27	27	4.80	122.0	2.80	71.0
	G25170-1212	12G-12FJX	7103-08325	3/4	19.1	1 1/16-12	30	32	3.74	95.0	1.73	44.0
QUICK DISCONNECT COUPLERS	G25170-1214	12G-14FJX	7103-08335	3/4	19.1	1 3/16-12	30	36	3.81	96.9	1.81	45.9
	G25170-1216	12G-16FJX	7103-08345	3/4	19.1	1 5/16-12	30	41	3.85	97.9	1.85	46.9
	G25170-1612	16G-12FJXSP	7103-10375	1	25.4	1 1/16-12	36	32	4.02	102.0	1.78	45.2
BALL VALVES	G25171-1612	16G-12FJX	7103-09375	1	25.4	1 1/16-12	36	32	5.87	149.1	3.64	92.4
	G25170-1614	16G-14FJXSP	7103-10385	1	25.4	1 3/16-12	36	36	4.02	102.1	1.78	45.3
LIVE SWIVEL	G25171-1614	16G-14FJX	7103-09385	1	25.4	1 3/16-12	36	36	6.31	160.4	4.08	103.6
	G25170-1616	16G-16FJX	7103-08395	1	25.4	1 5/16-12	36	41	4.24	107.8	2.01	51.0
	G25170-1620	16G-20FJX	7103-08405	1	25.4	1 5/8-12	36	50	4.54	115.3	2.30	58.5
ASSEMBLY FABRICATION	G25170-2020	20G-20FJX	7103-08435	1 1/4	31.8	1 5/8-12	41	50	4.42	112.3	2.10	53.3
	G25170-2024	20G-24FJX	7103-08445	1 1/4	31.8	1 7/8-12	41	60	4.86	123.4	2.14	64.4

Female JIC 37° Flare Swivel - 30° Bent Tube

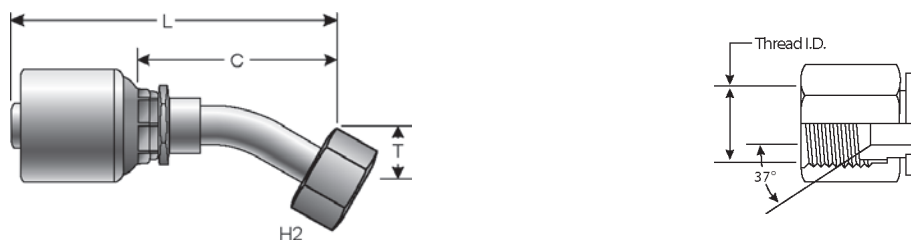

Part No.	Descr.	Prod. No.	⊖		H2	T		L		C		
			"	mm		"	mm	"	mm	"	mm	
G25172-1012	10G-12FJX30-018	7103-57005	5/8	15.9	1 1/16-12	32	.71	18.0	4.43	112.4	2.95	74.9
G25172-1210	12G-10FJX30-018	7103-59005	3/4	19.1	7/8-14	27	.71	18.0	4.45	113.0	2.44	62.0

Female JIC 37° Flare Swivel - 45° Bent Tube

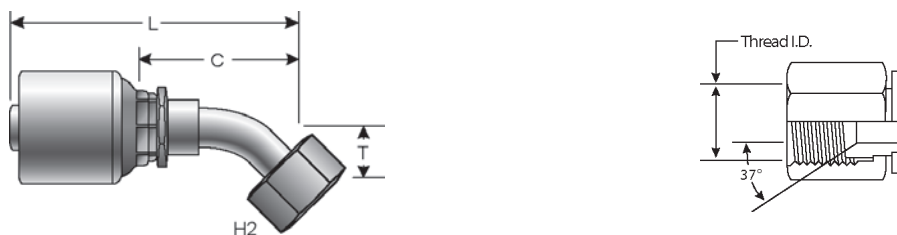

Part No.	Descr.	Prod. No.	⊖		H2	T		L		C		
			"	mm		"	mm	"	mm	"	mm	
G25175-0404	4G-4FJX45S	7103-46055	1/4	6.4	7/16-20	14	.39	10.0	2.74	69.7	1.72	43.7
G25175-0405	4G-5FJX45-011	7103-46075	1/4	6.4	1/2-20	17	.43	11.0	2.59	65.8	1.56	39.7
G25175-0406	4G-6FJX45S	7103-46135	1/4	6.4	9/16-18	19	.43	11.0	2.69	68.3	1.67	42.3
G25175-0505	5G-5FJX45-011	7103-46175	5/16	7.9	1/2-20	17	.43	11.0	2.69	68.3	1.59	40.3
G25175-0506	5G-6FJX45S	7103-46195	5/16	7.9	9/16-18	19	.43	11.0	2.85	72.4	1.75	44.4
G25175-0604	6G-4FJX45S	7103-46215	3/8	9.5	7/16-20	14	.39	10.0	2.86	72.7	1.76	44.8
G25175-0606	6G-6FJX45S	7103-46235	3/8	9.5	9/16-18	19	.43	11.0	3.05	77.5	1.95	49.6
G25175-0608	6G-8FJX45S	7103-46255	3/8	9.5	3/4-16	24	.59	15.0	3.51	89.1	2.41	61.2
G25174-0808	8G-8FJX45S	7103-46295	1/2	12.7	3/4-16	24	.59	15.0	3.42	86.9	1.95	49.5
G25175-0810	8G-10FJX45S	7103-46315	1/2	12.7	7/8-14	27	.63	16.0	3.81	96.8	2.34	59.4
G25175-1010	10G-10FJX45S	7103-46355	5/8	15.9	7/8-14	27	.63	16.0	3.80	96.4	2.32	59.0
G25175-1012	10G-12FJX45S	7103-46375	5/8	15.9	1 1/16-12	32	.83	21.0	4.57	116.0	3.09	78.5
G25175-1210	12G-10FJX45S	7103-46415	3/4	19.1	7/8-14	27	.75	19.0	4.58	116.3	2.57	65.3
G25175-1212	12G-12FJX45S	7103-46425	3/4	19.1	1 1/16-12	32	.83	21.0	5.09	129.2	3.08	78.2
G25175-1216	12G-16FJX45S	7103-46455	3/4	19.1	1 5/16-12	41	.94	24.0	5.24	133.1	3.23	82.1
G25174-1612	16G-12FJX45S	7103-46495	1	25.4	1 1/16-12	32	.83	21.0	5.48	139.2	3.24	82.4
G25175-1616	16G-16FJX45S	7103-46505	1	25.4	1 5/16-12	41	.94	24.0	5.68	144.3	3.44	87.5
G25175-2020	20G-20FJX45-035	7103-46605	1 1/4	31.8	1 5/8-12	50	1.38	35.0	6.65	169.0	4.33	110.0

- EQUIPMENT
- HOSE/CPLG. SELECTION
- G8K COUPLINGS
- GLOBALSPIRAL COUPLINGS
- STAINLESS STEEL SPIRAL
- MEGACRIMP COUPLINGS**
- STAINLESS STEEL BRAID
- POWER CRIMP COUPLINGS
- FIELD ATTACHABLE G1 & G2 COUPLINGS
- FIELD ATTACHABLE C5 COUPLINGS
- GLX COUPLINGS
- GL COUPLINGS
- C14 COUPLINGS
- PCTS THERMOPLASTIC COUPLINGS
- POLARSEAL COUPLINGS
- POLARSEAL II COUPLINGS
- POWER STEERING
- ADAPTERS
- QUICK DISCONNECT COUPLERS
- BALL VALVES
- LIVE SWIVEL
- ASSEMBLY FABRICATION
- ACCESSORIES
- EQUIPMENT AND PARTS
- AIR BRAKE
- BRASS
- KITS

Female JIC 37° Flare Swivel - 90° Bent Tube

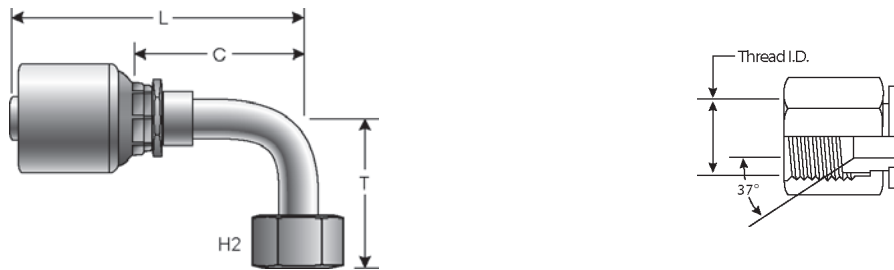

Part No.	Descr.	Prod. No.	⊖		H2	T		L		C		
			"	mm		"	mm	"	mm	"	mm	
G25179-0404	4G-4FJX90S	7103-47045	1/4	6.4	7/16-20	14	.83	21.0	2.48	63.1	1.46	37.1
G25180-0404	4G-4FJX90M	7103-47055	1/4	6.4	7/16-20	14	1.26	32.0	2.48	63.1	1.46	37.1
G25181-0404	4G-4FJX90L	7103-47065	1/4	6.4	7/16-20	14	1.81	46.0	2.48	63.1	1.46	37.1
G25179-0405	4G-5FJX90-023	7103-47075	1/4	6.4	1/2-20	17	.91	23.0	2.45	62.2	1.43	36.2
G25180-0405	4G-5FJX90M	7103-47095	1/4	6.4	1/2-20	17	1.26	32.0	2.25	57.2	1.23	31.2
G25181-0405	4G-5FJX90L	7103-47105	1/4	6.4	1/2-20	17	1.81	46.0	2.25	57.2	1.23	31.2
G25179-0406	4G-6FJX90S	7103-47125	1/4	6.4	9/16-18	19	.91	23.0	2.80	71.2	1.78	45.1
G25180-0406	4G-6FJX90M	7103-47135	1/4	6.4	9/16-18	19	1.50	38.0	2.56	64.9	1.53	38.9
G25181-0406	4G-6FJX90L	7103-47145	1/4	6.4	9/16-18	19	2.13	54.0	2.73	69.3	1.70	43.2
G25179-0506	5G-6FJX90S	7103-47165	5/16	7.9	9/16-18	19	.91	23.0	2.96	75.2	1.86	47.2
G25180-0506	5G-6FJX90M	7103-47175	5/16	7.9	9/16-18	19	1.50	38.0	2.99	76.0	1.89	48.0
G25179-0604	6G-4FJX90S	7103-47195	3/8	9.5	7/16-20	14	.83	21.0	2.60	66.1	1.50	38.2
G25181-0604	6G-4FJX90L	7103-47635	3/8	9.5	7/16-20	14	1.81	46.0	2.37	60.2	1.27	32.3
G25179-0606	6G-6FJX90S	7103-47205	3/8	9.5	9/16-18	19	.91	23.0	3.09	78.6	1.99	50.7
G25180-0606	6G-6FJX90M	7103-47215	3/8	9.5	9/16-18	19	1.50	38.0	3.01	76.5	1.91	48.5
G25181-0606	6G-6FJX90L	7103-47225	3/8	9.5	9/16-18	19	2.13	54.0	2.78	70.6	1.68	42.7
G25179-0608	6G-8FJX90S	7103-47245	3/8	9.5	3/4-16	24	1.14	29.0	3.18	80.7	2.08	52.8
G25180-0608	6G-8FJX90M	7103-47255	3/8	9.5	3/4-16	24	1.61	41.0	3.31	84.1	2.21	56.2
G25181-0608	6G-8FJX90L	7103-47265	3/8	9.5	3/4-16	24	2.52	64.0	3.33	84.5	2.23	56.6
G25180-0610	6G-10FJX90M	7103-47235	3/8	9.5	7/8-14	27	1.85	47.0	3.25	82.5	2.15	54.6
G25179-0808	8G-8FJX90S	7103-47285	1/2	12.7	3/4-16	24	1.14	29.0	3.19	81.0	1.71	43.6
G25180-0808	8G-8FJX90M	7103-47295	1/2	12.7	3/4-16	24	1.61	41.0	3.04	77.3	1.30	32.9
G25181-0808	8G-8FJX90L	7103-47305	1/2	12.7	3/4-16	24	2.52	64.0	3.04	77.3	1.57	39.9
G25179-0810	8G-10FJX90S	7103-47325	1/2	12.7	7/8-14	27	1.26	32.0	3.67	93.3	2.20	55.8
G25180-0810	8G-10FJX90M	7103-47335	1/2	12.7	7/8-14	27	1.85	47.0	3.67	93.3	2.20	55.8
G25181-0810	8G-10FJX90L	7103-47345	1/2	12.7	7/8-14	27	2.76	70.0	3.67	93.3	2.20	55.8
G25179-0812	8G-12FJX90S	7103-47355	1/2	12.7	1 1/16-12	32	1.22	48.0	2.73	69.3	1.78	70.0
G25179-1010	10G-10FJX90-036	7103-47675	5/8	15.9	7/8-14	27	1.42	36.0	3.50	89.0	2.03	51.5
G25180-1010	10G-10FJX90M	7103-47375	5/8	15.9	7/8-14	27	1.85	47.0	3.68	93.4	2.20	55.9
G25181-1010	10G-10FJX90L	7103-47385	5/8	15.9	7/8-14	27	2.76	70.0	3.38	85.9	1.91	48.4
G25179-1012	10G-12FJX90S	7103-47405	5/8	15.9	1 1/16-12	32	1.89	48.0	4.22	107.3	2.75	69.8
G25180-1012	10G-12FJX90M	7103-47415	5/8	15.9	1 1/16-12	32	2.28	58.0	4.03	102.3	1.80	45.8
G25181-1012	10G-12FJX90L	7103-47425	5/8	15.9	1 1/16-12	32	3.78	96.0	4.56	115.7	3.08	78.2
G25180-1210	12G-10FJX90M	7103-47435	3/4	19.1	7/8-14	27	1.85	47.0	4.49	114.1	2.48	63.1
G25179-1212	12G-12FJX90S	7103-47445	3/4	19.1	1 1/16-12	32	1.89	48.0	4.82	122.4	2.81	71.4
G25180-1212	12G-12FJX90M	7103-47455	3/4	19.1	1 1/16-12	32	2.28	58.0	4.82	122.4	2.81	71.4
G25181-1212	12G-12FJX90L	7103-47465	3/4	19.1	1 1/16-12	32	3.78	96.0	4.82	122.4	2.81	71.4
G25179-1214	12G-14FJX90-054	7103-47615	3/4	19.1	1 3/16-12	36	2.13	54.0	4.88	124.0	2.87	73.0
G25181-1214	12G-14FJX90-100	7103-47625	3/4	19.1	1 3/16-12	36	3.94	100.0	4.23	107.4	2.22	56.4
G25179-1216	12G-16FJX90S	7103-47475	3/4	19.1	1 5/16-12	41	2.20	56.0	5.22	132.7	3.22	81.7
G25180-1216	12G-16FJX90M	7103-47515	3/4	19.1	1 5/16-12	41	2.80	71.0	4.78	121.3	2.77	70.3
G25179-1616	16G-16FJX90S	7103-47485	1	25.4	1 5/16-12	41	2.20	56.0	5.73	145.6	3.50	88.8
G25180-1616	16G-16FJX90M	7103-47495	1	25.4	1 5/16-12	41	2.80	71.0	4.73	120.2	2.50	63.4
G25181-1616	16G-16FJX90L	7103-47505	1	25.4	1 5/16-12	41	4.49	114.0	4.74	120.3	2.50	63.5
G25179-1620	16G-20FJX90S	7103-47535	1	25.4	1 5/8-12	50	2.52	64.0	6.18	157.0	3.94	100.2

Female JIC 37° Flare Swivel - 90° Bent Tube - Continued

Part No.	Descr.	Prod. No.	⊖		H2	T		L		C		
			"	mm		"	mm	"	mm	"	mm	
G25181-2020	20G-20FJX90L	7103-47585	1 1/4	31.8	1 5/8-12	50	5.08	129.0	6.22	158.0	3.90	99.0
G25183-2020	20G-20FJX90-089	7103-47595	1 1/4	31.8	1 5/8-12	50	3.50	89.0	6.22	157.8	3.89	98.8

Female JIC 37° Flare Swivel - 90° Block

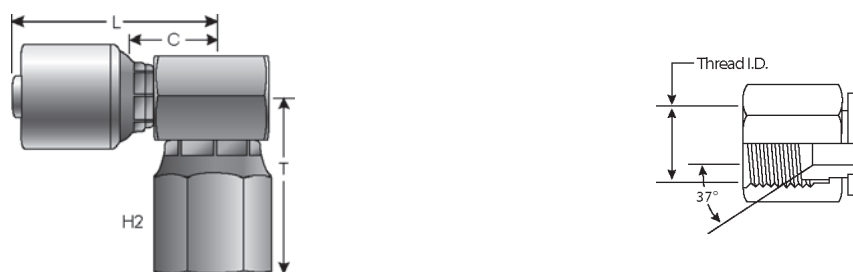

Part No.	Descr.	Prod. No.	⊖		H2	T		L		C		
			"	mm		"	mm	"	mm	"	mm	
G25187-1216	12G-16FJX90BLK	7103-59015	3/4	19.1	1 5/16-12	1.38	2.09	53.2	4.53	115.0	1.73	44.0

Male SAE 45° Flare

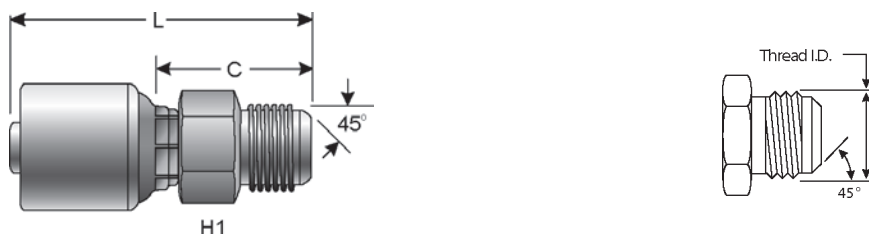

Part No.	Descr.	Prod. No.	⊖		H1	L		C		
			"	mm		"	mm	"	mm	
G25195-0404	4G-4MS	7100-11815	1/4	6.4	7/16-20	1/2	2.50	63.5	1.08	27.5
G25195-0405	4G-5MS	7100-11825	1/4	6.4	1/2-20	1/2	2.16	54.8	1.13	28.8
G25195-0606	6G-6MS	7100-11835	3/8	9.5	5/8-18	5/8	2.38	60.5	1.28	32.6
G25195-0608	6G-8MS	7100-11845	3/8	9.5	3/4-16	13/16	2.42	61.4	1.31	33.4
G25195-0808	8G-8MS	7100-01855	1/2	12.7	3/4-16	13/16	2.89	73.5	1.42	36.0
G25195-0810	8G-10MS	7100-01865	1/2	12.7	7/8-14	7/8	3.03	77.0	1.56	39.5
G25195-1212	12G-12MS	7100-01875	3/4	19.1	1 1/16-14	1 1/16	3.78	96.0	1.77	45.0

- EQUIPMENT
- HOSE/CPLG. SELECTION
- G8K COUPLINGS
- GLOBALSPIRAL COUPLINGS
- STAINLESS STEEL SPIRAL
- MEGACRIMP COUPLINGS**
- STAINLESS STEEL BRAID
- POWER CRIMP COUPLINGS
- FIELD ATTACHABLE G1 & G2 COUPLINGS
- FIELD ATTACHABLE C5 COUPLINGS
- GLX COUPLINGS
- GL COUPLINGS
- C14 COUPLINGS
- PCTS THERMOPLASTIC COUPLINGS
- POLARSEAL COUPLINGS
- POLARSEAL II COUPLINGS
- POWER STEERING
- ADAPTERS
- QUICK DISCONNECT COUPLERS
- BALL VALVES
- LIVE SWIVEL
- ASSEMBLY FABRICATION
- ACCESSORIES
- EQUIPMENT AND PARTS
- AIR BRAKE
- BRASS
- KITS

Female SAE 45° Flare Swivel



	Part No.	Descr.	Prod. No.	⊖		🌀	H1	H2	L		C	
				"	mm				"	"	"	mm
POWER CRIMP COUPLINGS	G25200-0404	4G-4FSX	7100-11885	1/4	6.4	7/16-20	1/2	9/16	2.24	57.0	1.22	31.0
	G25200-0405	4G-5FSX	7100-11895	1/4	6.4	1/2-20	1/2	11/16	2.21	56.2	1.19	30.2
	G25200-0406	4G-6FSX	7100-11905	1/4	6.4	5/8-18	5/8	3/4	2.31	58.7	1.28	32.6
FIELD ATTACHABLE G1 & G2 COUPLINGS	G25200-0506	5G-6FSX	7100-11935	5/16	7.9	5/8-18	5/8	3/4	2.44	62.1	1.34	34.1
	G25200-0606	6G-6FSX	7100-11915	3/8	9.5	5/8-18	5/8	3/4	2.44	62.1	1.35	34.2
	G25200-0608	6G-8FSX	7100-11925	3/8	9.5	3/4-16	11/16	7/8	2.48	63.1	1.38	35.1
FIELD ATTACHABLE C5 COUPLINGS	G25200-0808	8G-8FSX	7100-01935	1/2	12.7	3/4-16	13/16	7/8	2.82	71.6	1.34	34.1
	G25200-0810	8G-10FSX	7100-01945	1/2	12.7	7/8-14	13/16	1 1/16	2.99	75.9	1.51	38.4
	G25200-1212	12G-12FSX	7100-01955	3/4	19.1	1 1/16-14	1 1/16	1 1/4	3.68	93.5	1.67	42.5

Female SAE 45° Flare Swivel - 45° Bent Tube

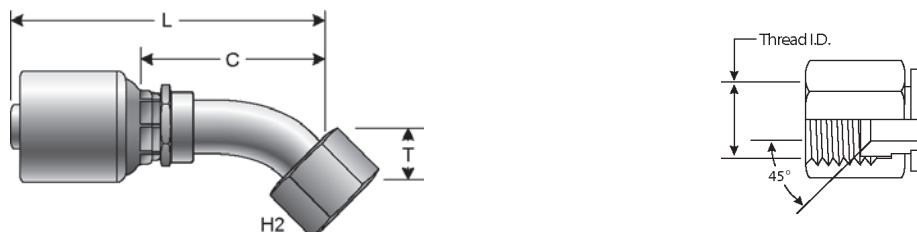

	Part No.	Descr.	Prod. No.	⊖		🌀	H2	T		L		C	
				"	mm			"	mm	"	mm	"	mm
POWER STEERING ADAPTERS	G25202-0404	4G-4FSX45	7100-11965	1/4	6.4	7/16-20	1 9/16	.33	8.4	2.34	59.5	1.32	33.5
	G25202-0405	4G-5FSX45-009	7100-01965	1/4	6.4	1/2-20	5/8	.36	9.1	2.63	66.9	1.61	40.9
QUICK DISCONNECT COUPLERS	G25202-0606	6G-6FSX45	7100-11995	3/8	9.5	5/8-18	3/4	.39	9.9	2.74	69.5	1.64	41.6
	G25202-0608	6G-8FSX45-014	7100-02035	3/8	9.5	3/4-16	7/8	.55	14.0	3.46	87.8	2.36	59.9
BALL VALVES	G25202-0808	8G-8FSX45	7100-02015	1/2	12.7	3/4-16	7/8	.55	14.0	3.31	84.0	1.83	46.5
	G25202-0810	8G-10FSX45-016	7100-02055	1/2	12.7	7/8-14	1	.63	16.0	3.67	93.1	2.19	55.6
LIVE SWIVEL	G25202-1212	12G-12FSX45	7100-02045	3/4	19.1	1 1/16-14	1 1/4	.78	19.8	4.37	111.0	2.36	60.0

Female SAE 45° Flare Swivel - 90° Bent Tube

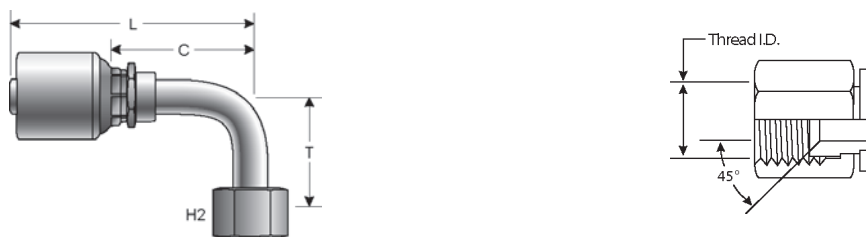

Part No.	Descr.	Prod. No.	⊖		H2	T	L		C			
			"	mm			"	mm	"	mm		
G25205-0404	4G-4FSX90	7100-12055	1/4	6.4	7/16-20	9/16	1.24	31.5	2.05	52.0	1.02	26.0
G25205-0405	4G-5FSX90-046	7100-01985	1/4	6.4	1/2-20	5/8	1.80	45.7	2.47	62.8	1.45	36.8
G25204-0506	5G-6FSX90-022	7100-02005	5/16	7.9	5/8-18	3/4	.85	21.6	2.77	70.4	1.67	42.4
G25205-0606	6G-6FSX90	7100-12105	3/8	9.5	5/8-18	3/4	1.52	38.5	2.36	60.0	1.26	32.1
G25206-0606	6G-6FSX90-055	7100-01995	3/8	9.5	5/8-18	3/4	2.18	55.4	2.83	71.8	1.73	43.9
G25205-0608	6G-8FSX90	7100-02125	3/8	9.5	3/4-16	7/8	1.75	44.5	2.50	63.5	1.40	35.6
G25205-0808	8G-8FSX90	7100-02135	1/2	12.7	3/4-16	7/8	1.75	44.5	2.93	74.5	1.46	37.0
G25204-0810	8G-10FSX90-031	7100-02065	1/2	12.7	7/8-14	1	1.23	31.2	3.29	83.5	1.81	46.0
G25205-1212	12G-12FSX90	7100-02185	3/4	19.1	1 1/16-14	1 1/4	2.78	70.6	3.94	100.0	1.93	49.0

Male Flat-Face O-Ring

SAE J1453 Captive O-Ring Groove for Improved O-Ring Retention.



Part No.	Descr.	Prod. No.	⊖		H1	L		C		
			"	mm		"	mm	"	mm	
G25225-0404	4G-4MFFOR	7104-16045	1/4	6.4	9/16-18	17	2.07	52.5	1.04	26.5
G25225-0406	4G-6MFFOR	7104-16055	1/4	6.4	11/16-16	19	2.13	54.0	1.10	28.0
G25225-0506	5G-6MFFOR	7104-16065	5/16	7.9	11/16-16	19	2.20	56.0	1.10	28.0
G25225-0606	6G-6MFFOR	7104-16075	3/8	9.5	11/16-16	19	2.20	56.0	1.11	28.1
G25225-0608	6G-8MFFOR	7104-16085	3/8	9.5	13/16-16	22	2.32	59.0	1.22	31.1
G25225-0610	6G-10MFFOR	7104-16095	3/8	9.5	1-14	27	2.52	64.0	1.42	36.1
G25225-0808	8G-8MFFOR	7104-16115	1/2	12.7	13/16-16	22	2.69	68.2	1.21	30.7
G25225-0810	8G-10MFFOR	7104-16125	1/2	12.7	1-14	27	2.87	73.0	1.40	35.5
G25225-0812	8G-12MFFOR	7104-16135	1/2	12.7	1 3/16-12	32	3.01	76.5	1.54	39.0
G25225-1010	10G-10MFFOR	7104-16155	5/8	15.9	1-14	27	2.87	73.0	1.40	35.5
G25225-1012	10G-12MFFOR	7104-16165	5/8	15.9	1 3/16-12	32	3.03	77.0	1.56	39.5
G25225-1212	12G-12MFFOR	7104-16185	3/4	19.1	1 3/16-12	32	3.54	90.0	1.54	39.0
G25225-1216	12G-16MFFOR	7104-16195	3/4	19.1	1 7/16-12	41	3.74	95.0	1.73	44.0
G25225-1616	16G-16MFFOR	7104-16215	1	25.4	1 7/16-12	41	4.02	102.0	1.78	45.2
G25225-1620	16G-20MFFOR	7104-16225	1	25.4	1 11/16-12	46	4.13	105.0	1.90	48.2
G25225-2020	20G-20MFFOR	7104-16245	1 1/4	31.8	1 11/16-12	46	4.29	109.0	1.97	50.0

- EQUIPMENT
- HOSE/CPLG. SELECTION
- G8K COUPLINGS
- GLOBALSPIRAL COUPLINGS
- STAINLESS STEEL SPIRAL
- MEGACRIMP COUPLINGS
- STAINLESS STEEL BRAID
- POWER CRIMP COUPLINGS
- FIELD ATTACHABLE G1 & G2 COUPLINGS
- FIELD ATTACHABLE C5 COUPLINGS
- GLX COUPLINGS
- GL COUPLINGS
- C14 COUPLINGS
- PCTS THERMOPLASTIC COUPLINGS
- POLARSEAL COUPLINGS
- POLARSEAL II COUPLINGS
- POWER STEERING
- ADAPTERS
- QUICK DISCONNECT COUPLERS
- BALL VALVES
- LIVE SWIVEL
- ASSEMBLY FABRICATION
- ACCESSORIES
- EQUIPMENT AND PARTS
- AIR BRAKE
- BRASS
- KITS

Male Flat-Face O-Ring Bulk Head Long Nose

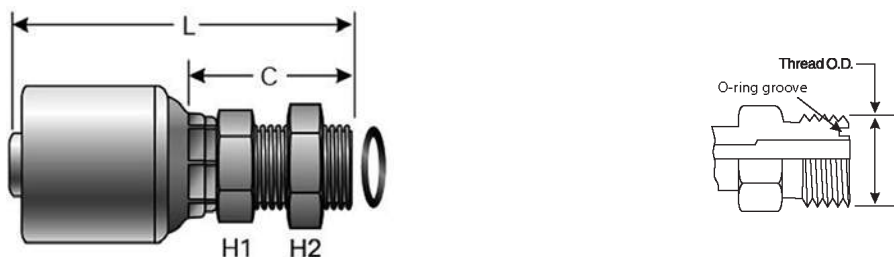

Part No.	Descr.	Prod. No.	⌀		H1	H2	L		C		
			"	mm			"	mm	"	mm	"
G25226-0606	6G-6MFFORBKHDLN	7104-17075	3/8	9.5	11/16-16	27	27	3.07	78.1	1.98	50.2
G25226-0808	8G-8MFFORBKHDLN	7104-17115	1/2	12.7	13/16-16	30	30	3.55	90.2	2.07	52.7

Female Flat-Face O-Ring Swivel

SAE J1453 O-Ring Face Seal.

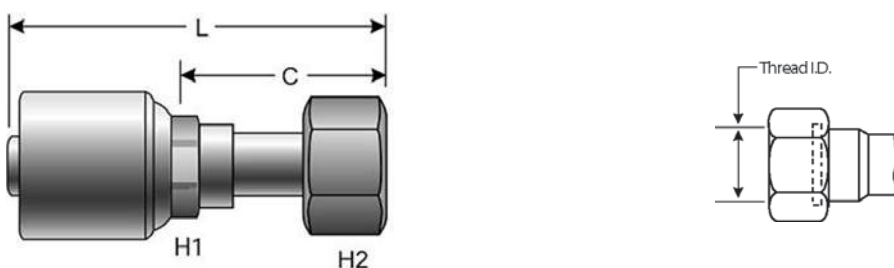

Part No.	Descr.	Prod. No.	⌀		H1	H2	L		C		
			"	mm			"	mm	"	mm	"
G25230-0404	4G-4FFORX	7104-18045	1/4	6.4	9/16-18	15	17	2.07	52.7	1.05	26.7
G25230-0406	4G-6FFORX	7104-18055	1/4	6.4	11/16-16	15	22	2.01	51.1	.99	25.1
G25230-0408	4G-8FFORX	7104-18075	1/4	6.4	13/16-16	15	24	1.99	50.5	.96	24.5
G25230-0506	5G-6FFORX	7104-19505	5/16	7.9	11/16-16	17	22	2.42	61.5	1.32	33.5
G25230-0604	6G-4FFORX	7104-19085	3/8	9.5	9/16-18	17	17	3.08	78.3	1.98	50.3
G25230-0606	6G-6FFORX	7104-18095	3/8	9.5	11/16-16	18	22	2.27	57.7	1.14	28.9
G25230-0608	6G-8FFORX	7104-18105	3/8	9.5	13/16-16	18	24	2.26	57.4	1.13	28.6
G25230-0610	6G-10FFORX	7104-18115	3/8	9.5	1-14	18	30	2.15	54.7	1.02	25.9
G25230-0806	8G-6FFORX	7104-19145	1/2	12.7	11/16-16	22	22	3.78	95.9	2.30	58.4
G25230-0808	8G-8FFORX	7104-18155	1/2	12.7	13/16-16	22	24	2.62	66.5	1.23	31.3
G25230-0810	8G-10FFORX	7104-18165	1/2	12.7	1-14	22	30	2.76	70.0	1.37	34.8
G25230-0812	8G-12FFORX	7104-18175	1/2	12.7	1 3/16-12	22	36	2.81	71.5	1.43	36.3
G25230-1008	10G-8FFORX	7104-19195	5/8	15.9	13/16-16	24	24	3.83	97.2	2.35	59.7
G25230-1010	10G-10FFORX	7104-18205	5/8	15.9	1-14	24	30	2.99	76.0	1.52	38.5
G25230-1012	10G-12FFORX	7104-18215	5/8	15.9	1 3/16-12	24	36	3.03	77.0	1.56	39.5
G25230-1210	12G-10FFORX	7104-19245	3/4	19.1	1-14	30	30	3.74	95.1	1.74	44.1
G25230-1212	12G-12FFORX	7104-18255	3/4	19.1	1 3/16-12	30	36	3.65	92.8	1.65	41.8
G25230-1216	12G-16FFORX	7104-18265	3/4	19.1	1 7/16-12	30	41	3.48	88.3	1.47	37.3
G25230-1612	16G-12FFORX	7104-19295	1	25.4	1 3/16-12	36	36	5.58	141.8	3.35	85.0
G25230-1616	16G-16FFORX	7104-18305	1	25.4	1 7/16-12	36	41	4.09	104.0	1.86	47.2
G25230-1620	16G-20FFORX	7104-18315	1	25.4	1 11/16-12	36	50	4.06	103.0	1.82	46.2
G25230-2020	20G-20FFORX	7104-18355	1 1/4	31.8	1 5/8-12	41	50	4.29	109.0	1.97	50.0
G25230-2024	20G-24FFORX	7104-18385	1 1/4	31.8	2-12	41	60	4.09	104.0	1.77	45.0

Female Flat-Face O-Ring Swivel - 30° Bent Tube

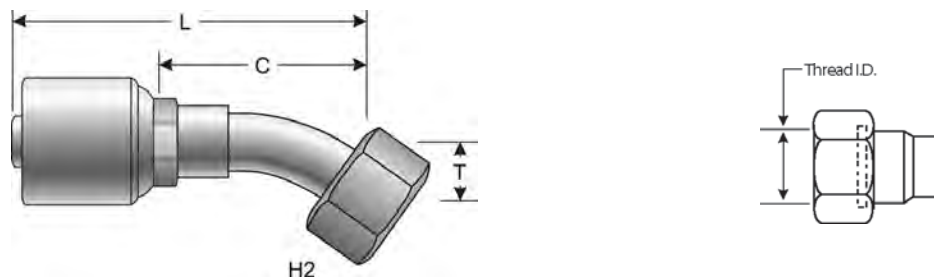

Part No.	Descr.	Prod. No.	⊖		H2	T		L		C		
			"	mm		"	mm	"	mm	"	mm	
G25233-0810	8G-10FFORX30-010	7104-07025	1/2	12.7	1-14	30	.38	9.7	3.65	92.7	2.18	55.3

Female Flat-Face O-Ring Swivel - 45° Bent Tube

SAE J1453 O-Ring Face Seal.

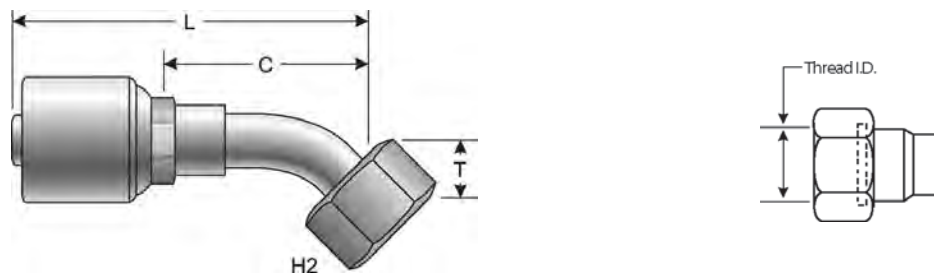

Part No.	Descr.	Prod. No.	⊖		H2	T		L		C		
			"	mm		"	mm	"	mm	"	mm	
G25235-0404	4G-4FFORX45S	7104-22045	1/4	6.4	9/16-18	17	.39	10.0	2.57	65.2	1.54	39.2
G25235-0406	4G-6FFORX45S	7104-22055	1/4	6.4	11/16-16	22	.43	11.0	2.70	68.5	1.67	42.5
G25235-0506	5G-6FFORX45S	7104-22335	5/16	7.9	11/16-16	22	.43	11.0	2.73	69.4	1.63	41.4
G25235-0604	6G-4FFORX45S	7104-22075	3/8	9.5	9/16-18	17	.39	10.0	2.60	66.1	1.50	38.1
G25235-0606	6G-6FFORX45S	7104-22085	3/8	9.5	11/16-16	22	.43	11.0	2.75	69.8	1.65	41.9
G25235-0608	6G-8FFORX45S	7104-22095	3/8	9.5	13/16-16	24	.59	15.0	3.35	85.2	2.26	57.3
G25234-0806	8G-6FFORX45S	7104-22125	1/2	12.7	11/16-16	22	.43	11.0	3.57	90.7	2.09	53.2
G25235-0808	8G-8FFORX45S	7104-22135	1/2	12.7	13/16-16	24	.59	15.0	3.50	89.0	2.03	51.6
G25235-0810	8G-10FFORX45S	7104-22145	1/2	12.7	1-14	30	.63	16.0	3.98	101.0	2.50	63.5
G25235-0812	8G-12FFORX45S	7104-22155	1/2	12.7	1 3/16-12	36	.83	21.0	4.34	110.3	2.87	72.8
G25235-1008	10G-8FFORX45S	7104-22165	5/8	15.9	13/16-16	24	.59	15.0	3.81	96.8	2.33	59.3
G25235-1010	10G-10FFORX45S	7104-22175	5/8	15.9	1-14	30	.63	16.0	3.96	100.5	2.48	63.0
G25235-1012	10G-12FFORX45S	7104-22185	5/8	15.9	1 3/16-12	36	.83	21.0	4.17	105.9	2.69	68.4
G25235-1210	12G-10FFORX45S	7104-22215	3/4	19.1	1-14	30	.63	16.0	4.45	113.0	2.44	62.0
G25235-1212	12G-12FFORX45S	7104-22225	3/4	19.1	1 3/16-12	36	.83	21.0	4.66	118.4	2.65	67.4
G25235-1216	12G-16FFORX45S	7104-22235	3/4	19.1	1 7/16-12	41	.94	24.0	4.80	122.0	2.80	71.0
G25235-1612	16G-12FFORX45S	7104-22255	1	25.4	1 3/16-12	36	.83	21.0	5.33	135.5	2.98	75.7
G25235-1616	16G-16FFORX45S	7104-22265	1	25.4	1 7/16-12	41	.94	24.0	5.78	146.9	3.55	90.1
G25235-2020	20G-20FFORX45S	7104-22295	1 1/4	31.8	1 11/16-12	50	.98	25.0	6.22	158.0	3.90	99.0

- EQUIPMENT
- HOSE/CPLG. SELECTION
- G8K COUPLINGS
- GLOBALSPIRAL COUPLINGS
- STAINLESS STEEL SPIRAL
- MEGACRIMP COUPLINGS**
- STAINLESS STEEL BRAID
- POWER CRIMP COUPLINGS
- FIELD ATTACHABLE G1 & G2 COUPLINGS
- FIELD ATTACHABLE C5 COUPLINGS
- GLX COUPLINGS
- GL COUPLINGS
- C14 COUPLINGS
- PCTS THERMOPLASTIC COUPLINGS
- POLARSEAL COUPLINGS
- POLARSEAL II COUPLINGS
- POWER STEERING
- ADAPTERS
- QUICK DISCONNECT COUPLERS
- BALL VALVES
- LIVE SWIVEL
- ASSEMBLY FABRICATION
- ACCESSORIES
- EQUIPMENT AND PARTS
- AIR BRAKE
- BRASS
- KITS

Female Flat-Face O-Ring Swivel - 67 1/2° Bent Tube

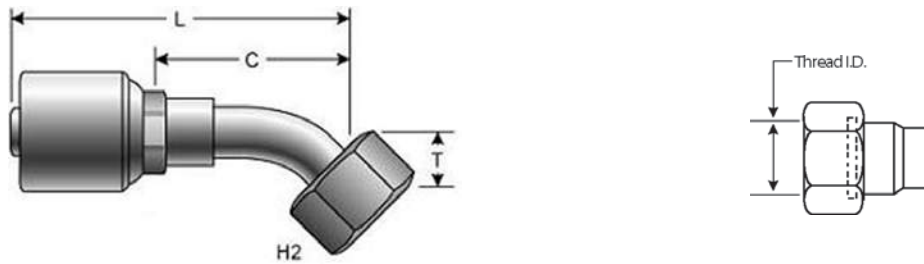

Part No.	Descr.	Prod. No.	⌀		H2	T		L		C		
			"	mm		"	mm	"	mm	"	mm	
G25238-0808	8G-8FFORX67-022	7104-07015	1/2	12.7	13/16-16	.94	.87	22.0	3.25	82.5	1.77	45.0

Female Flat-Face O-Ring Swivel - 90° Bent Tube

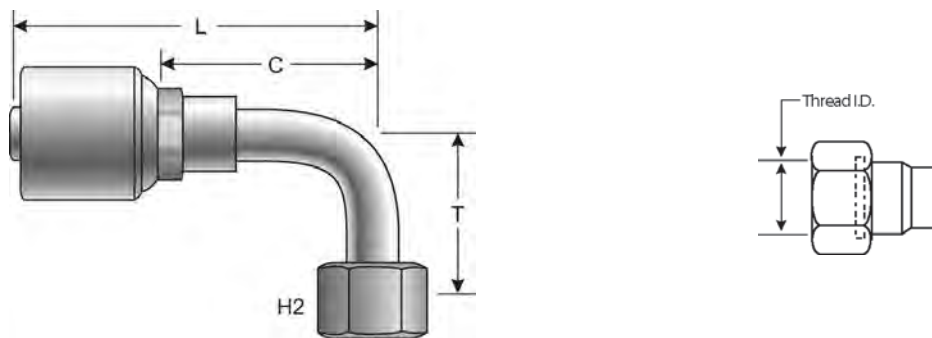

Part No.	Descr.	Prod. No.	⌀		H2	T		L		C		
			"	mm		"	mm	"	mm	"	mm	
G25239-0404	4G-4FFORX90S	7104-24045	1/4	6.4	9/16-18	17	.83	21.0	2.37	60.2	1.35	34.2
G25240-0404	4G-4FFORX90M	7104-24055	1/4	6.4	9/16-18	17	1.26	32.0	2.21	56.2	1.19	30.2
G25241-0404	4G-4FFORX90L	7104-24065	1/4	6.4	9/16-18	17	1.81	46.0	2.21	56.2	1.19	30.2
G25239-0406	4G-6FFORX90S	7104-24095	1/4	6.4	11/16-16	22	.91	23.0	2.50	63.4	1.47	37.4
G25240-0406	4G-6FFORX90M	7104-24105	1/4	6.4	11/16-16	22	1.50	38.0	2.50	63.4	1.47	37.4
G25241-0406	4G-6FFORX90L	7104-24115	1/4	6.4	11/16-16	22	2.13	54.0	2.43	61.6	1.40	35.6
G25239-0408	4G-8FFORX90S	7104-24145	1/4	6.4	13/16-16	24	1.14	29.0	2.83	72.0	1.81	46.0
G25241-0408	4G-8FFORX90L	7104-24165	1/4	6.4	13/16-16	24	2.52	64.0	2.64	67.1	1.62	41.1
G25239-0506	5G-6FFORX90S	7104-24955	5/16	7.9	11/16-16	22	.91	23.0	2.83	72.0	1.73	44.0
G25239-0604	6G-4FFORX90S	7104-24195	3/8	9.5	9/16-18	17	.83	21.0	2.42	61.4	1.32	33.6
G25239-0606	6G-6FFORX90S	7104-24245	3/8	9.5	11/16-16	22	.91	23.0	2.85	72.5	1.76	44.6
G25240-0606	6G-6FFORX90M	7104-24255	3/8	9.5	11/16-16	22	1.50	38.0	2.50	63.6	1.41	35.7
G25241-0606	6G-6FFORX90L	7104-24265	3/8	9.5	11/16-16	22	2.13	54.0	2.73	69.3	1.63	41.4
G25239-0608	6G-8FFORX90S	7104-24295	3/8	9.5	13/16-16	24	1.14	29.0	2.87	73.0	1.78	45.1
G25240-0608	6G-8FFORX90M	7104-24305	3/8	9.5	13/16-16	24	1.61	41.0	2.70	68.5	1.60	40.6
G25241-0608	6G-8FFORX90L	7104-24315	3/8	9.5	13/16-16	24	2.52	64.0	2.72	69.0	1.62	41.1
G25239-0806	8G-6FFORX90S	7104-24345	1/2	12.7	11/16-16	22	.91	23.0	3.29	83.5	1.81	46.0
G25241-0806	8G-6FFORX90L	7104-24365	1/2	12.7	11/16-16	22	2.13	54.0	3.16	80.3	1.69	42.8
G25239-0808	8G-8FFORX90S	7104-24395	1/2	12.7	13/16-16	24	1.14	29.0	3.30	83.9	1.83	46.5
G25240-0808	8G-8FFORX90M	7104-24405	1/2	12.7	13/16-16	24	1.61	41.0	3.30	83.9	1.83	46.5
G25241-0808	8G-8FFORX90L	7104-24415	1/2	12.7	13/16-16	24	2.52	64.0	3.30	83.9	1.83	46.5
G25239-0810	8G-10FFORX90S	7104-24445	1/2	12.7	1-14	30	1.26	32.0	3.66	92.9	2.18	55.4
G25240-0810	8G-10FFORX90M	7104-24455	1/2	12.7	1-14	30	1.85	47.0	3.67	93.2	2.19	55.7

Female Flat-Face O-Ring Swivel - 90° Bent Tube - Continued

Part No.	Descr.	Prod. No.	⊖		H2	T		L		C		
			"	mm		"	mm	"	mm	"	mm	
G25241-0810	8G-10FFORX90L	7104-24465	1/2	12.7	1-14	30	2.76	70.0	3.57	90.6	2.09	53.1
G25239-1008	10G-8FFORX90S	7104-24495	5/8	15.9	13/16-16	24	1.14	29.0	3.64	92.4	2.16	54.9
G25241-1008	10G-8FFORX90L	7104-24515	5/8	15.9	13/16-16	24	2.52	64.0	3.64	92.4	2.16	54.9
G25239-1010	10G-10FFORX90S	7104-24545	5/8	15.9	1-14	30	1.26	32.0	3.64	92.5	2.17	55.0
G25240-1010	10G-10FFORX90M	7104-24555	5/8	15.9	1-14	30	1.85	47.0	3.65	92.8	2.18	55.3
G25241-1010	10G-10FFORX90L	7104-24565	5/8	15.9	1-14	30	2.76	70.0	3.55	90.2	2.07	52.7
G25239-1012	10G-12FFORX90S	7104-24595	5/8	15.9	1 3/16-12	36	1.89	48.0	3.79	96.3	2.31	58.8
G25239-1210	12G-10FFORX90S	7104-24635	3/4	19.1	1-14	30	1.26	32.0	4.09	104.0	2.09	53.0
G25239-1212	12G-12FFORX90S	7104-24645	3/4	19.1	1 3/16-12	36	1.89	48.0	4.28	108.8	2.28	57.8
G25240-1212	12G-12FFORX90M	7104-24655	3/4	19.1	1 3/16-12	36	2.28	58.0	4.29	109.0	2.28	58.0
G25241-1212	12G-12FFORX90L	7104-24665	3/4	19.1	1 3/16-12	36	3.78	96.0	4.65	118.2	2.65	67.2
G25239-1216	12G-16FFORX90S	7104-24695	3/4	19.1	1 7/16-12	41	2.20	56.0	5.06	128.5	3.05	77.5
G25239-1612	16G-12FFORX90S	7104-24735	1	25.4	1 3/16-12	36	1.89	48.0	5.09	129.4	2.86	72.6
G25239-1616	16G-16FFORX90S	7104-24745	1	25.4	1 7/16-12	41	2.20	56.0	5.11	129.9	2.88	73.1
G25240-1616	16G-16FFORX90M	7104-24755	1	25.4	1 7/16-12	41	2.80	71.0	5.11	129.9	2.88	73.1
G25241-1616	16G-16FFORX90L	7104-24765	1	25.4	1 7/16-12	41	4.49	114.0	5.11	129.9	2.88	73.1
G25239-1620	16G-20FFORX90S	7104-24905	1	25.4	1 11/16-12	50	2.52	64.0	5.11	129.9	2.88	73.1
G25240-1620	16G-20FFORX90M	7104-24915	1	25.4	1 11/16-12	50	3.07	78.0	6.14	156.0	3.91	99.2
G25239-2020	20G-20FFORX90S	7104-24795	1 1/4	31.8	1 11/16-12	50	2.52	64.0	5.91	150.0	3.58	91.0
G25240-2020	20G-20FFORX90M	7104-24805	1 1/4	31.8	1 11/16-12	50	3.07	78.0	5.51	140.0	3.19	81.0
G25241-2020	20G-20FFORX90L	7104-24815	1 1/4	31.8	1 11/16-12	50	5.08	129.0	5.51	140.0	3.19	81.0

Code 61 O-Ring Flange

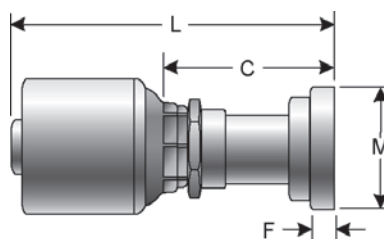

Part No.	Descr.	Prod. No.	⊖		M		L		C		F	
			"	mm	"	mm	"	mm	"	mm	"	mm
G25300-0808	8G-8FL	7103-25055	1/2	12.7	1.19	30.2	3.15	80.0	1.67	42.5	.27	6.9
G25300-0810	8G-10FLK	7100-03805	1/2	12.7	1.35	34.3	3.15	80.0	1.67	42.5	.27	6.9
G25300-0812	8G-12FL	7103-25105	1/2	12.7	1.50	38.1	3.15	80.0	1.67	42.5	.27	6.9
G25300-1010	10G-10FLK	7100-03825	5/8	15.9	1.35	34.3	4.69	119.0	3.21	81.5	.27	6.9
G25300-1212	12G-12FL	7103-25205	3/4	19.1	1.50	38.1	3.86	98.0	1.85	47.0	.27	6.9
G25300-1216	12G-16FL	7103-25255	3/4	19.1	1.75	44.5	3.50	88.8	1.49	37.8	.32	8.1
G25300-1612	16G-12FL	7103-25295	1	25.4	1.50	38.1	5.04	128.0	2.80	71.2	.27	6.9
G25300-1616	16G-16FL	7103-25305	1	25.4	1.75	44.5	4.13	105.0	1.90	48.2	.32	8.1
G25300-1620	16G-20FL	7103-25355	1	25.4	2.00	50.8	4.13	105.0	1.90	48.2	.32	8.1
G25300-1624	16G-24FL	7100-03875	1	25.4	2.38	60.5	3.78	96.0	1.54	39.2	.32	8.1
G25300-2020	20G-20FL	7103-25405	1 1/4	31.8	2.00	50.8	4.43	112.5	2.11	53.5	.32	8.1
G25300-2024	20G-24FL	7103-25455	1 1/4	31.8	2.38	60.5	4.63	117.5	2.30	58.5	.32	8.1

- EQUIPMENT
- HOSE/CPLG. SELECTION
- G8K COUPLINGS
- GLOBAL SPIRAL COUPLINGS
- STAINLESS STEEL SPIRAL
- MEGACRIMP COUPLINGS**
- STAINLESS STEEL BRAID
- POWER CRIMP COUPLINGS
- FIELD ATTACHABLE G1 & G2 COUPLINGS
- FIELD ATTACHABLE C5 COUPLINGS
- GLX COUPLINGS
- GL COUPLINGS
- C14 COUPLINGS
- PCTS THERMOPLASTIC COUPLINGS
- POLARSEAL COUPLINGS
- POLARSEAL II COUPLINGS
- POWER STEERING
- ADAPTERS
- QUICK DISCONNECT COUPLERS
- BALL VALVES
- LIVE SWIVEL
- ASSEMBLY FABRICATION
- ACCESSORIES
- EQUIPMENT AND PARTS
- AIR BRAKE
- BRASS
- KITS

Code 61 O-Ring Flange - 22 1/2° Bent Tube

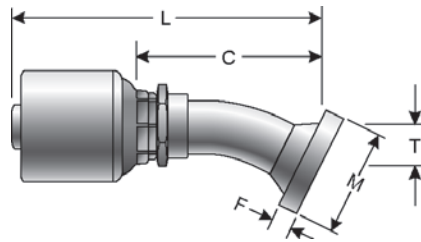

Part No.	Descr.	Prod. No.	⊖		M		T		L		C		F	
			"	mm	"	mm	"	mm	"	mm	"	mm	"	mm
G25302-1212	12G-12FL22M	7103-26155	3/4	19.1	1.50	38.1	.43	11.0	4.76	121.0	2.76	70.0	.27	6.9
G25302-1216	12G-16FL22M-014	7100-03955	3/4	19.1	1.75	44.5	.55	14.0	4.76	121.0	2.76	70.0	.32	8.1
G25302-1616	16G-16FL22M	7103-26255	1	25.4	1.75	44.5	.55	14.0	5.61	142.5	3.37	85.7	.32	8.1
G25302-2020	20G-20FL22M	7103-26355	1 1/4	31.8	2.00	50.8	.59	15.0	6.00	152.5	3.68	93.5	.32	8.1

Code 61 O-Ring Flange - 30° Bent Tube

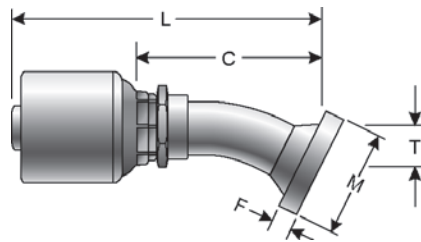

Part No.	Descr.	Prod. No.	⊖		M		T		L		C		F	
			"	mm	"	mm	"	mm	"	mm	"	mm	"	mm
G25304-1212	12G-12FL30M	7103-26655	3/4	19.1	1.50	38.1	.63	16.0	4.70	119.5	2.70	68.5	.32	8.1
G25304-1216	12G-16FL30M	7100-04045	3/4	19.1	1.75	44.5	.75	19.0	4.88	124.0	2.87	73.0	.32	8.1
G25304-1616	16G-16FL30M	7103-26755	1	25.4	1.75	44.5	.75	19.0	5.69	144.5	3.45	87.7	.32	8.1
G25304-1620	16G-20FL30M	7103-26805	1	25.4	2.00	50.8	.87	22.0	5.89	149.5	3.65	92.7	.32	8.1
G25304-2020	20G-20FL30S	7103-26845	1 1/4	31.8	2.00	50.8	.79	20.0	6.04	153.4	3.72	94.4	.32	8.1

Code 61 O-Ring Flange - 45° Bent Tube

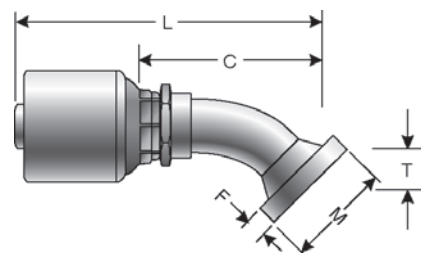

Part No.	Descr.	Prod. No.	⊖		M		T		L		C		F	
			"	mm	"	mm	"	mm	"	mm	"	mm	"	mm
G25307-0808	8G-8FL45M	7103-27085	1/2	12.7	1.19	30.2	.75	19.0	3.85	97.8	2.37	60.3	.26	6.6

Code 61 O-Ring Flange - 45° Bent Tube - Continued

Part No.	Descr.	Prod. No.	⊖		M		T		L		C		F	
			"	mm	"	mm	"	mm	"	mm	"	mm	"	mm
G25307-0812	8G-12FL45M	7103-27165	1/2	12.7	1.50	38.1	1.02	26.0	4.13	104.8	2.65	67.3	.27	6.9
G25307-1010	10G-10FLK45	7100-04155	5/8	15.9	1.35	34.3	1.02	26.0	4.19	106.5	2.72	69.0	.27	6.9
G25307-1012	10G-12FL45M	7103-27205	5/8	15.9	1.50	38.1	1.02	26.0	4.43	112.6	2.96	75.1	.26	6.6
G25307-1212	12G-12FL45M	7103-27245	3/4	19.1	1.50	38.1	1.02	26.0	4.82	122.5	2.81	71.5	.27	6.9
G25306-1216	12G-16FL45S	7103-27315	3/4	19.1	1.75	44.5	1.10	28.0	4.90	124.5	2.89	73.5	.32	8.1
G25306-1616	16G-16FL45S	7103-27395	1	25.4	1.75	44.5	1.10	28.0	5.61	142.5	3.37	85.7	.32	8.1
G25306-1620	16G-20FL45S	7103-27475	1	25.4	2.00	50.8	1.26	32.0	5.87	149.0	3.63	92.2	.32	8.1
G25307-1624	16G-24FL45	7100-07185	1	25.4	2.38	60.5	1.06	26.9	5.30	134.5	3.06	77.7	.32	8.1
G25306-2020	20G-20FL45S	7103-27555	1 1/4	31.8	2.00	50.8	1.26	32.0	6.18	157.0	3.86	98.0	.32	8.1

Code 61 O-Ring Flange - 60° Bent Tube

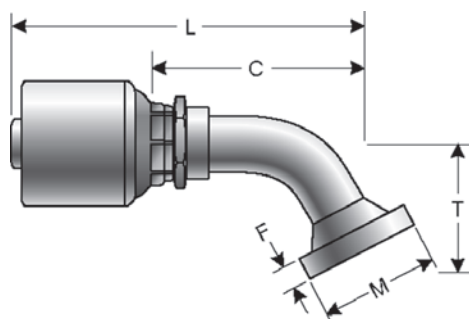

Part No.	Descr.	Prod. No.	⊖		M		T		L		C		F	
			"	mm	"	mm	"	mm	"	mm	"	mm	"	mm
G25309-1212	12G-12FL60M	7103-28155	3/4	19.1	1.50	38.1	1.46	37.0	5.04	128.0	3.03	77.0	.27	6.9
G25309-1216	12G-16FL60M	7103-28205	3/4	19.1	1.75	44.5	1.73	44.0	5.20	132.0	3.19	81.0	.32	8.1
G25309-1616	16G-16FL60M	7103-28255	1	25.4	1.75	44.5	1.73	44.0	5.85	148.5	3.61	91.7	.32	8.1
G25308-2020	20G-20FL60S	7103-28345	1 1/4	31.8	2.00	50.8	1.77	45.0	6.22	158.0	3.90	99.0	.32	8.1

Code 61 O-Ring Flange - 67 1/2° Bent Tube

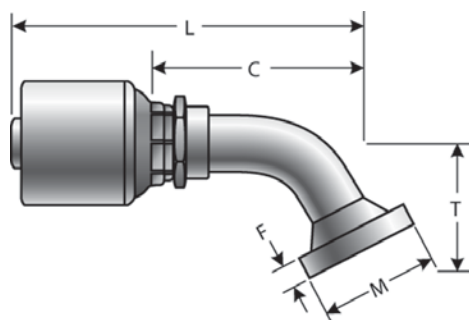

Part No.	Descr.	Prod. No.	⊖		M		T		L		C		F	
			"	mm	"	mm	"	mm	"	mm	"	mm	"	mm
G25311-1212	12G-12FL67M	7100-04355	3/4	19.1	1.50	38.1	1.65	42.0	4.65	118.0	2.64	67.0	.27	6.9
G25311-2020	20G-20FL67S	7100-04335	1 1/4	31.8	2.00	50.8	2.01	51.0	5.92	150.4	3.60	91.4	.32	8.1

- EQUIPMENT
- HOSE/CPLG. SELECTION
- G8K COUPLINGS
- GLOBAL SPIRAL COUPLINGS
- STAINLESS STEEL SPIRAL
- MEGACRIMP COUPLINGS
- STAINLESS STEEL BRAID
- POWER CRIMP COUPLINGS
- FIELD ATTACHABLE G1 & G2 COUPLINGS
- FIELD ATTACHABLE C5 COUPLINGS
- GLX COUPLINGS
- GL COUPLINGS
- C14 COUPLINGS
- PCTS THERMOPLASTIC COUPLINGS
- POLARSEAL COUPLINGS
- POLARSEAL II COUPLINGS
- POWER STEERING
- ADAPTERS
- QUICK DISCONNECT COUPLERS
- BALL VALVES
- LIVE SWIVEL
- ASSEMBLY FABRICATION
- ACCESSORIES
- EQUIPMENT AND PARTS
- AIR BRAKE
- BRASS
- KITS

Code 61 O-Ring Flange - 90° Bent Tube

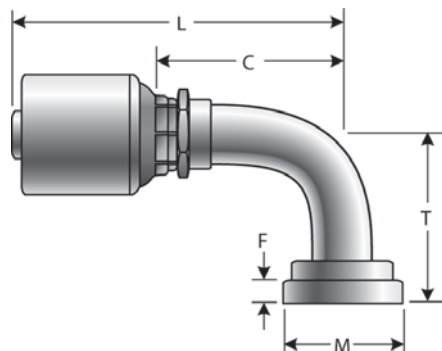

Part No.	Descr.	Prod. No.	⊖		M		T		L		C		F	
			"	mm	"	mm	"	mm	"	mm	"	mm	"	mm
	10G-12FL90M	7100-04485	5/8	15.9	1.50	38.1	2.28	58.0	3.94	100.0	2.46	62.5	.27	6.9
G25315-0808	8G-8FL90M	7103-29115	1/2	12.7	1.19	30.2	1.57	40.0	3.59	91.2	2.11	53.7	.27	6.9
G25315-0812	8G-12FL90M	7103-29235	1/2	12.7	1.50	38.1	2.28	58.0	3.60	91.5	2.13	54.0	.27	6.9
G25315-1010	10G-10FLK90	7100-04475	5/8	15.9	1.35	34.3	2.17	55.0	3.90	99.0	2.42	61.5	.27	6.9
G25315-1212	12G-12FL90M	7103-29535	3/4	19.1	1.50	38.1	2.28	58.0	4.54	115.3	2.53	64.3	.27	6.9
G25314-1216	12G-16FL90S	7103-29585	3/4	19.1	1.75	44.5	2.40	61.0	4.72	119.8	2.71	68.8	.32	8.1
G25315-1612	16G-12FL90M	7103-29655	1	25.4	1.50	38.1	2.28	58.0	5.09	129.3	2.85	72.5	.27	6.9
G25314-1616	16G-16FL90S	7103-29705	1	25.4	1.75	44.5	2.40	61.0	5.48	139.3	3.25	82.5	.32	8.1
G25314-1620	16G-20FL90S	7103-29765	1	25.4	2.00	50.8	2.68	68.0	5.48	139.3	3.25	82.5	.32	8.1
G25314-1624	16G-24FL90S-081	7100-04555	1	25.4	2.38	60.5	3.19	81.0	5.57	141.6	3.34	84.8	.32	8.1
G25314-2020	20G-20FL90S	7103-29885	1 1/4	31.8	2.00	50.8	2.68	68.0	6.22	158.1	3.90	99.1	.32	8.1
G25315-2020	20G-20FL90M	7103-29895	1 1/4	31.8	2.00	50.8	3.54	90.0	5.31	135.0	2.99	76.0	.32	8.1
G25316-2020	20G-20FL90-102	7100-04565	1 1/4	31.8	2.00	50.8	4.00	101.6	5.43	138.0	3.11	79.0	.32	8.1
G25314-2024	20G-24FL90S	7103-29945	1 1/4	31.8	2.38	60.5	3.19	81.0	6.22	158.1	3.90	99.1	.32	8.1

SAE Male Inverted Swivel



Part No.	Descr.	Prod. No.	⊖		H1	H2	L		C		
			"	mm			"	mm	"	mm	
G25500-0403	4G-3MIX	7100-16205	1/4	6.4	3/8-24	1/2	3/8	2.52	64.0	1.50	38.0
G25500-0404	4G-4MIX	7100-16225	1/4	6.4	7/16-24	1/2	7/16	2.52	63.9	1.49	37.9
G25500-0405	4G-5MIX	7100-16235	1/4	6.4	1/2-20	1/2	1/2	2.52	63.9	1.49	37.9
G25500-0604	6G-4MIX	7100-16185	3/8	9.5	7/16-24	5/8	7/16	2.63	66.9	1.54	39.0
G25500-0605	6G-5MIX	7100-16245	3/8	9.5	1/2-20	5/8	1/2	2.56	64.9	1.46	37.0
G25500-0606	6G-6MIX	7100-16255	3/8	9.5	5/8-18	5/8	5/8	2.75	69.9	1.65	42.0
G25500-0607	6G-7MIX	7100-16265	3/8	9.5	11/16-18	5/8	11/16	2.76	70.0	1.66	42.1
G25500-0806	8G-6MIX	7100-06275	1/2	12.7	5/8-18	13/16	5/8	3.13	79.5	1.65	42.0
G25500-0808	8G-8MIX	7100-06285	1/2	12.7	3/4-18	13/16	3/4	3.30	83.8	1.82	46.3
G25500-1010	10G-10MIX	7100-06295	5/8	15.9	7/8-18	15/16	7/8	3.92	99.5	2.44	62.0

SAE Male Inverted Swivel - 45° Bent Tube

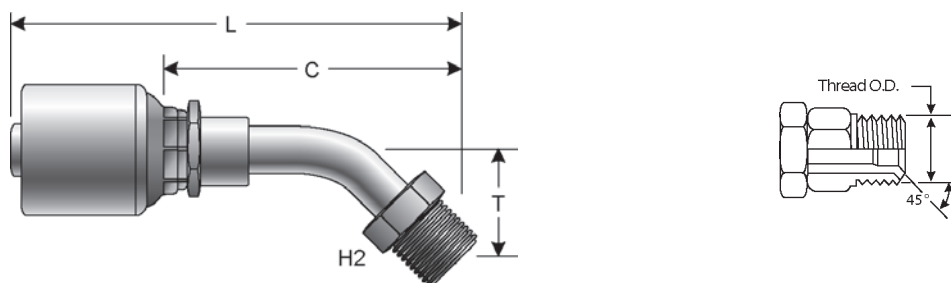

Part No.	Descr.	Prod. No.	⌀		H2	T		L		C		
			"	mm		"	mm	"	mm	"	mm	
G25502-0403	4G-3MIX45-018	7100-16275	1/4	6.4	3/8-24	3/8	.69	17.5	2.67	67.9	1.65	41.9
G25502-0404	4G-4MIX45-024	7100-16285	1/4	6.4	7/16-24	4/9	.93	23.5	3.04	77.3	2.02	51.2
G25502-0604	6G-4MIX45	7100-16305	3/8	9.5	7/16-24	7/16	1.00	25.4	3.17	80.5	2.07	52.6
G25502-0605	6G-5MIX45	7100-16315	3/8	9.5	1/2-20	1/2	1.00	25.4	3.13	79.5	2.03	51.6
G25502-0606	6G-6MIX45	7100-16325	3/8	9.5	5/8-18	5/8	1.00	25.4	3.32	84.3	2.22	56.4
G25502-0607	6G-7MIX45	7100-16335	3/8	9.5	11/16-18	11/16	1.00	25.4	3.39	86.0	2.29	58.1
G25502-0808	8G-8MIX45	7100-16345	1/2	12.7	3/4-18	3/4	1.14	29.0	4.17	106.0	2.70	68.5
G25502-1010	10G-10MIX45	7100-16435	5/8	15.9	7/8-18	7/8	1.38	35.1	2.33	59.2	1.31	33.2

SAE Male Inverted Swivel - 90° Bent Tube

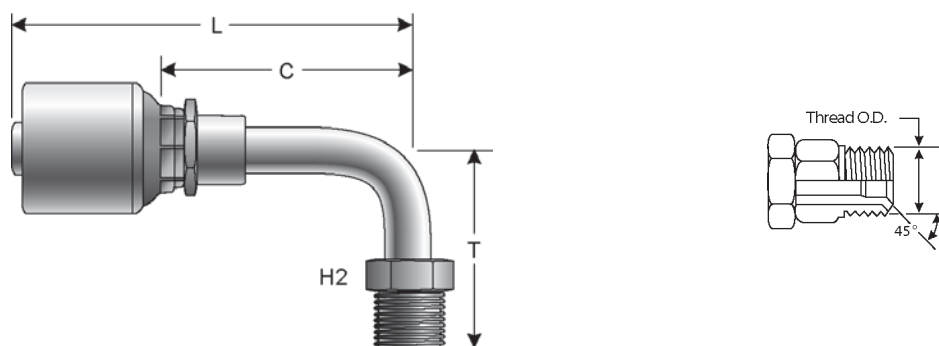

Part No.	Descr.	Prod. No.	⌀		H2	T		L		C		
			"	mm		"	mm	"	mm	"	mm	
G25504-0404	4G-4MIX90	7100-16355	1/4	6.4	7/16-24	7/16	1.38	35.1	2.33	59.2	1.31	33.2
G25504-0405	4G-5MIX90	7100-16365	1/4	6.4	1/2-20	1/2	1.38	35.1	2.46	62.5	1.44	36.5
G25504-0506	5G-6MIX90-035	7100-16385	5/16	7.9	5/8-18	5/8	1.38	35.1	2.78	70.5	1.67	42.5
G25504-0604	6G-4MIX90	7100-16395	3/8	9.5	7/16-24	7/16	1.38	35.1	2.44	62.0	1.34	34.1
G25504-0605	6G-5MIX90	7100-16405	3/8	9.5	1/2-20	1/2	1.38	35.1	2.50	63.5	1.40	35.6
G25504-0606	6G-6MIX90	7100-16415	3/8	9.5	5/8-18	5/8	1.38	35.1	2.80	71.0	1.70	43.1
G25504-0607	6G-7MIX90	7100-16425	3/8	9.5	11/16-18	11/16	1.38	35.1	2.80	71.0	1.70	43.1
G25504-0808	8G-8MIX90	7100-06435	1/2	12.7	3/4-18	3/4	1.64	41.7	3.29	83.5	1.81	46.0
G25504-1010	10G-10MIX90	7100-06335	5/8	15.9	7/8-18	7/8	1.81	46.0	3.89	98.7	2.41	61.3

- EQUIPMENT
- HOSE/CPLG. SELECTION
- G8K COUPLINGS
- GLOBALSPIRAL COUPLINGS
- STAINLESS STEEL SPIRAL
- MEGACRIMP COUPLINGS**
- STAINLESS STEEL BRAID
- POWER CRIMP COUPLINGS
- FIELD ATTACHABLE G1 & G2 COUPLINGS
- FIELD ATTACHABLE C5 COUPLINGS
- GLX COUPLINGS
- GL COUPLINGS
- C14 COUPLINGS
- PCTS THERMOPLASTIC COUPLINGS
- POLARSEAL COUPLINGS
- POLARSEAL II COUPLINGS
- POWER STEERING
- ADAPTERS
- QUICK DISCONNECT COUPLERS
- BALL VALVES
- LIVE SWIVEL
- ASSEMBLY FABRICATION
- ACCESSORIES
- EQUIPMENT AND PARTS
- AIR BRAKE
- BRASS
- KITS

SAE Male Flareless Assembly

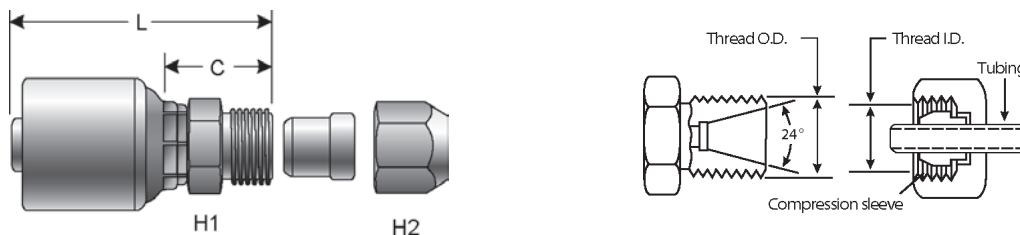

Part No.	Descr.	Prod. No.	⌀		H1	H2	L		C		
			"	mm			"	mm	"	mm	
G25510-0404	4G-4MFA	7100-16445	1/4	6.4	7/16-20	1/2	9/16	2.09	53.0	1.06	27.0
G25510-0405	4G-5MFA	7100-16455	1/4	6.4	1/2-20	1/2	5/8	1.97	50.0	.94	24.0
G25510-0505	5G-5MFA	7100-16515	5/16	7.9	1/2-20	5/8	5/8	2.13	54.0	1.02	26.0
G25510-0506	5G-6MFA	7100-16505	5/16	7.9	9/16-18	5/8	11/16	2.21	56.1	1.11	28.1
G25510-0604	6G-4MFA	7100-16465	3/8	9.5	7/16-20	5/8	9/16	2.17	55.0	1.07	27.1
G25510-0605	6G-5MFA	7100-16475	3/8	9.5	1/2-20	5/8	5/8	2.17	55.0	1.07	27.1
G25510-0606	6G-6MFA	7100-16485	3/8	9.5	9/16-18	5/8	11/16	2.20	56.0	1.11	28.1
G25510-0608	6G-8MFA	7100-16495	3/8	9.5	3/4-16	3/4	7/8	2.40	61.0	1.30	33.1
G25510-0808	8G-8MFA	7100-06505	1/2	12.7	3/4-16	13/16	7/8	2.78	70.5	1.30	33.0
G25510-0810	8G-10MFA	7100-06515	1/2	12.7	7/8-14	7/8	1	2.83	72.0	1.36	34.5
G25510-1212	12G-12MFA	7100-06525	3/4	19.1	1 1/16-12	1 1/16	1 1/4	3.54	90.0	1.54	39.0
G25510-1616	16G-16MFA	7100-06535	1	25.4	1 5/16-12	1 3/8	1 1/2	3.94	100.0	1.70	43.2

North American Stand Pipe

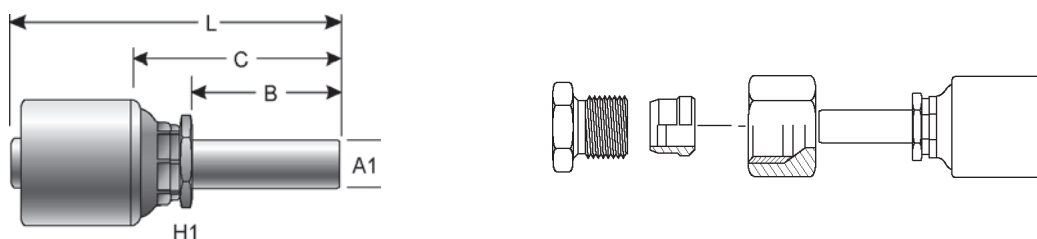

Part No.	Descr.	Prod. No.	⌀		H1	L		C		B		A1
			"	mm		"	mm	"	mm	"	mm	
G25520-0404	4G-4NASP	7100-08305	1/4	6.4	1/2	2.26	57.5	1.24	31.5	.88	22.4	1/4
G25520-0606	6G-6NASP	7100-08335	3/8	9.5	5/8	2.34	59.5	1.24	31.6	.88	22.4	3/8
G25520-0808	8G-8NASP	7100-08365	1/2	12.7	13/16	2.87	73.0	1.40	35.5	1.00	25.4	1/2
G25520-1212	12G-12NASP	7100-08435	3/4	19.1	1 1/16	3.58	91.0	1.57	40.0	1.16	29.5	3/4
G25520-1616	16G-16NASP	7100-08465	1	25.4	1 7/16	3.86	98.0	1.62	41.2	1.12	28.4	1

Hose Length Extender

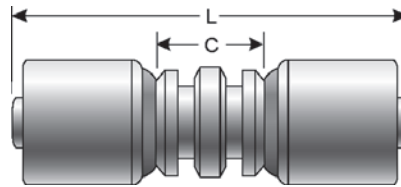

Part No.	Descr.	Prod. No.	⊖		L		C	
			"	mm	"	mm	"	mm
G25535-2020	20G-20HLE	7101-50705	1 1/4	31.8	5.96	151.5	1.32	33.5

Female Air Brake Swivel

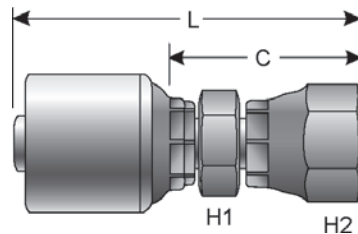

Part No.	Descr.	Prod. No.	⊖		🌀	H1	H2	L		C	
			"	mm				"	mm	"	mm
G25540-0606	6G-6FABX	7100-13095	3/8	9.5	3/4-20	3/4	7/8	2.41	61.2	1.31	33.3
G25540-0806	8G-6FABX	7100-13105	1/2	12.7	3/4-20	13/16	7/8	2.74	69.7	1.27	32.2
G25540-0808	8G-8FABX	7100-13125	1/2	12.7	7/8-20	13/16	1 1/16	3.02	76.7	1.54	39.2

Female Grease

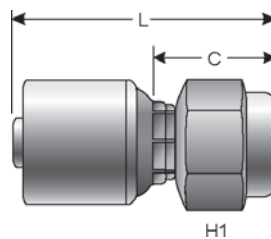

Part No.	Descr.	Prod. No.	⊖		🌀	H1	L		C	
			"	mm			"	mm	"	mm
G25561-0408	4G-8FG	7100-09605	1/4	6.4	1/2-27	11/16	1.87	47.5	.85	21.5
G25561-0608	6G-8FG	7100-09615	3/8	9.5	1/2-27	11/16	1.93	49.1	.83	21.2

- EQUIPMENT
- HOSE/CPLG. SELECTION
- G8K COUPLINGS
- GLOBALSPIRAL COUPLINGS
- STAINLESS STEEL SPIRAL
- MEGACRIMP COUPLINGS**
- STAINLESS STEEL BRAID
- POWER CRIMP COUPLINGS
- FIELD ATTACHABLE G1 & G2 COUPLINGS
- FIELD ATTACHABLE C5 COUPLINGS
- GLX COUPLINGS
- GL COUPLINGS
- C14 COUPLINGS
- PCTS THERMOPLASTIC COUPLINGS
- POLARSEAL COUPLINGS
- POLARSEAL II COUPLINGS
- POWER STEERING
- ADAPTERS
- QUICK DISCONNECT COUPLERS
- BALL VALVES
- LIVE SWIVEL
- ASSEMBLY FABRICATION
- ACCESSORIES
- EQUIPMENT AND PARTS
- AIR BRAKE
- BRASS
- KITS

EQUIPMENT
HOSE/CPLG. SELECTION
G8K COUPLINGS
GLOBALSPIRAL COUPLINGS
STAINLESS STEEL SPIRAL
MEGACRIMP COUPLINGS
STAINLESS STEEL BRAID
POWER CRIMP COUPLINGS
FIELD ATTACHABLE G1 & G2 COUPLINGS
FIELD ATTACHABLE C5 COUPLINGS
GLX COUPLINGS
GL COUPLINGS
C14 COUPLINGS
PCTS THERMOPLASTIC COUPLINGS
POLARSEAL COUPLINGS
POLARSEAL II COUPLINGS
POWER STEERING
ADAPTERS
QUICK DISCONNECT COUPLERS
BALL VALVES
LIVE SWIVEL
ASSEMBLY FABRICATION
ACCESSORIES
EQUIPMENT AND PARTS
AIR BRAKE
BRASS
KITS

Female Parker Triple Thread Flare

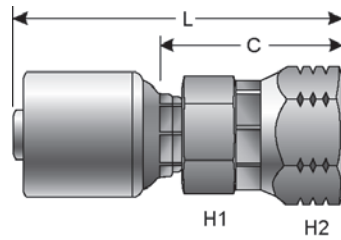

Part No.	Descr.	Prod. No.	⊖		🌀	H1	H2	L		C	
			"	mm				"	mm	"	mm
G25562-1616	16G-16FZX	7100-00015	1	25.4	1 5/16-14	1 3/8	1 1/2	3.98	101.0	1.74	44.3

Pressure Wash Swivel

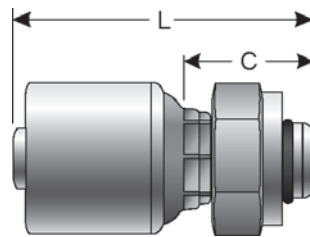

Part No.	Descr.	Prod. No.	⊖		🌀	L		C	
			"	mm		"	mm	"	mm
G25563-0406	4G-6PWX	7100-02905	1/4	6.4	M22X1.5	2.52	64.0	1.50	38.0
G25563-0606	6G-6PWX	7100-02915	3/8	9.5	M22X1.5	2.60	66.0	1.50	38.1

US Banjo

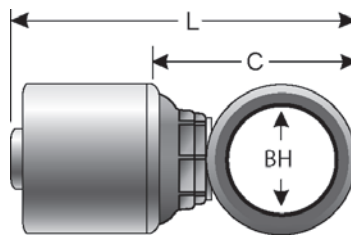

Part No.	Descr.	Prod. No.	⊖		L		C		BH
			"	mm	"	mm	"	mm	
G25564-0606	6G-6BJ	7100-02945	3/4	19.1	2.28	57.9	.74	18.8	3/8

Male DIN 24° Cone - Light Series



Part No.	Descr.	Prod. No.	⊖		🌀	H1	L		C		A1
			"	mm			"	mm	"	mm	
G25615-0406	4G-6MDL	7100-92685	1/4	6.4	M12X1.5	14	1.69	42.9	.78	19.8	6.0
G25615-0408	4G-8MDL	7100-14835	1/4	6.4	M14X1.5	17	1.97	50.0	.94	24.0	8.0
G25615-0410	4G-10MDL	7100-14845	1/4	6.4	M16X1.5	17	2.01	51.0	.98	25.0	10.0
G25615-0610	6G-10MDL	7100-14865	3/8	9.5	M16X1.5	17	2.07	52.5	.97	24.6	10.0
G25615-0612	6G-12MDL	7100-14875	3/8	9.5	M18X1.5	19	2.07	52.5	.97	24.6	12.0
G25615-0615	6G-15MDL	7100-92695	3/8	9.5	M22X1.5	24	1.86	47.3	.94	23.9	15.0
G25615-0815	8G-15MDL	7100-04885	1/2	12.7	M22X1.5	24	2.56	65.0	1.08	27.5	15.0
G25615-1018	10G-18MDL	7100-04895	5/8	15.9	M26X1.5	27	2.56	65.0	1.08	27.5	18.0
G25615-1022	10G-22MDL	7100-04935	5/8	15.9	M30X2.0	32	2.75	69.8	1.27	32.3	22.0
G25615-1222	12G-22MDL	7100-04905	3/4	19.1	M30X2.0	32	3.27	83.0	1.26	32.0	22.0
G25615-1628	16G-28MDL	7100-04915	1	25.4	M36X2.0	41	3.70	94.0	1.46	37.2	28.0
G25615-2035	20G-35MDL	7100-04925	1 1/4	31.8	M45X2.0	46	3.92	99.5	1.59	40.5	35.0

Female DIN 24° Cone Swivel - Light Series with O-Ring

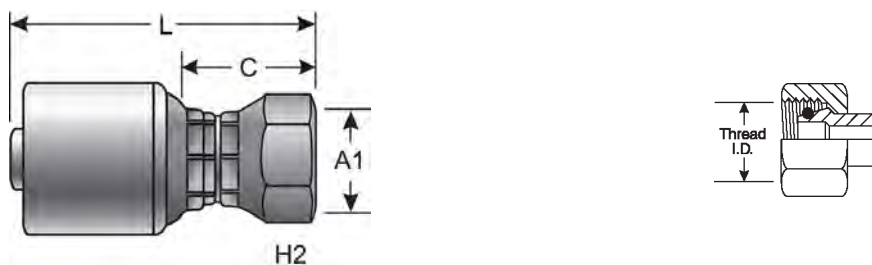

Part No.	Descr.	Prod. No.	⊖		🌀	H2	L		C		A1
			"	mm			"	mm	"	mm	
	6G-12FDLORX	7100-92055	3/8	9.5	M18X1.5	22	2.09	53.0	1.18	29.9	12.0
G25645-0406	4G-6FDLORX	7100-92135	1/4	6.4	M12X1.5	14	1.92	48.7	1.01	25.8	6.0
G25645-0408	4G-8FDLORX	7100-91995	1/4	6.4	M14X1.5	17	2.02	51.3	1.12	28.4	8.0
G25645-0410	4G-10FDLORX	7100-92145	1/4	6.4	M16X1.5	19	2.06	52.2	1.15	29.3	10.0
G25645-0412	4G-12FDLORX	7100-92865	1/4	6.4	M18X1.5	22	2.07	52.6	1.17	29.7	12.0
G25645-0510	5G-10FDLORX	7100-92015	5/16	7.9	M16X1.5	19	2.12	53.9	1.17	29.7	10.0
G25645-0512	5G-12FDLORX	7100-92035	5/16	7.9	M18X1.5	22	2.30	58.5	1.18	30.0	12.0
G25645-0610	6G-10FDLORX	7100-92175	3/8	9.5	M16X1.5	19	2.06	52.3	1.15	29.2	10.0
G25645-0815	8G-15FDLORX	7100-92075	1/2	12.7	M22X1.5	27	2.43	61.8	1.16	29.3	15.0
G25645-1018	10G-18FDLORX	7100-92095	5/8	15.9	M26X1.5	32	2.36	60.0	1.19	30.3	18.0
G25645-1218	12G-18FDLORX	7100-92825	3/4	19.1	M26X1.5	32	2.70	68.5	1.18	30.0	18.0
G25645-1222	12G-22FDLORX	7100-92115	3/4	19.1	M30X2.0	36	2.79	70.8	1.27	32.3	22.0
G25645-1628	16G-28FDLORX	7100-92205	1	25.4	M36X2.0	41	3.21	81.6	1.45	36.7	28.0
G25645-2035	20G-35FDLORX	7100-92215	1 1/4	31.8	M45X2.0	50	3.56	90.4	1.74	44.1	35.0
G25645-2042	20G-42FDLORX	7100-95305	1 1/4	31.8	M52X2.0	60	4.25	108.0	1.93	49.0	42.0

- EQUIPMENT
- HOSE/CPLG. SELECTION
- G&K COUPLINGS
- GLOBALSPIRAL COUPLINGS
- STAINLESS STEEL SPIRAL
- MEGACRIMP COUPLINGS
- STAINLESS STEEL BRAID
- POWER CRIMP COUPLINGS
- FIELD ATTACHABLE G1 & G2 COUPLINGS
- FIELD ATTACHABLE C5 COUPLINGS
- GLX COUPLINGS
- GL COUPLINGS
- C14 COUPLINGS
- PCTS THERMOPLASTIC COUPLINGS
- POLARSEAL COUPLINGS
- POLARSEAL II COUPLINGS
- POWER STEERING
- ADAPTERS
- QUICK DISCONNECT COUPLERS
- BALL VALVES
- LIVE SWIVEL
- ASSEMBLY FABRICATION
- ACCESSORIES
- EQUIPMENT AND PARTS
- AIR BRAKE
- BRASS
- KITS

Female DIN 24° Cone Swivel - Light Series with O-Ring - 45° Bent Tube

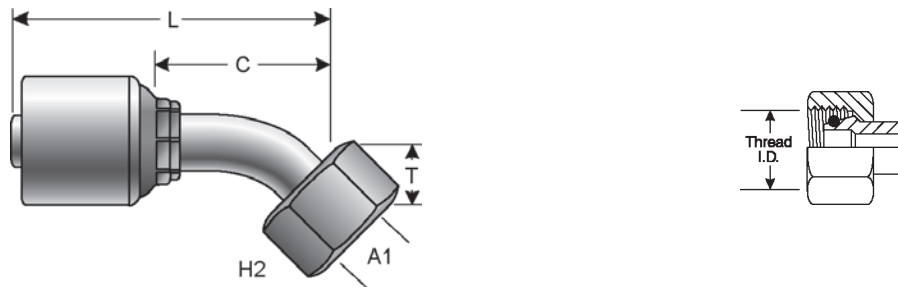

Part No.	Descr.	Prod. No.	⊖		H2	T		L		C		A1	
			"	mm		"	mm	"	mm	"	mm		
G25650-0408	4G-8FDLORX45	7100-91855	1/4	6.4	M14X1.5	17	.64	16.2	2.34	59.5	1.44	36.5	8.0
G25650-0410	4G-10FDLORX45	7100-92265	1/4	6.4	M16X1.5	19	.70	17.9	2.41	61.3	1.51	38.3	10.0
G25650-0510	5G-10FDLORX45	7100-91895	5/16	7.9	M16X1.5	19	.67	17.1	2.50	63.4	1.55	39.3	10.0
G25650-0610	6G-10FDLORX45	7100-92295	3/8	9.5	M16X1.5	19	.73	18.6	2.50	63.6	1.59	40.5	10.0
G25650-0612	6G-12FDLORX45	7100-91875	3/8	9.5	M18X1.5	22	.74	18.9	2.52	64.0	1.61	40.9	12.0
G25650-0615	6G-15FDLORX45	7100-92315	3/8	9.5	M22X1.5	27	.89	22.5	2.66	67.5	1.75	44.4	15.0
G25650-0815	8G-15FDLORX45	7100-91935	1/2	12.7	M22X1.5	27	.79	20.2	3.13	79.6	1.85	47.1	15.0
G25650-1018	10G-18FDLORX45	7100-91955	5/8	15.9	M26X1.5	32	.98	24.8	3.37	85.7	2.21	56.0	18.0
G25650-1222	12G-22FDLORX45	7100-91975	3/4	19.1	M30X2.0	36	1.17	29.8	4.12	104.6	2.60	66.1	22.0
G25650-1628	16G-28FDLORX45	7100-92325	1	25.4	M36X2.0	41	1.21	30.9	4.87	123.7	3.10	78.8	28.0
G25650-2035	20G-35FDLORX45	7100-92335	1 1/4	31.8	M45X2.0	50	1.48	37.5	5.48	139.3	3.68	93.4	35.0

Female DIN 24° Cone Swivel - Light Series with O-Ring - 90° Bent Tube

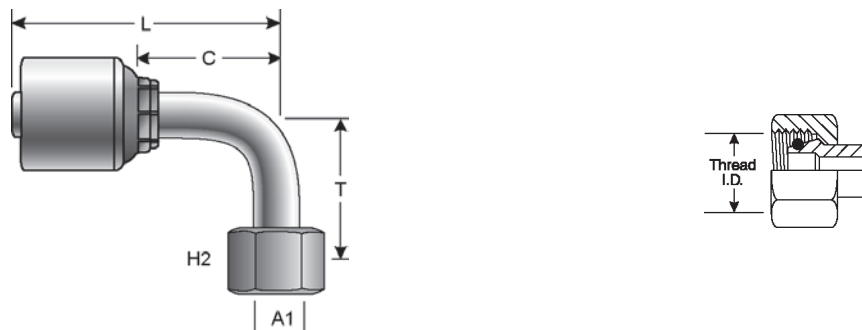

Part No.	Descr.	Prod. No.	⊖		H2	T		L		C		A1	
			"	mm		"	mm	"	mm	"	mm		
G25655-0406	4G-6FDLORX90	7100-92375	1/4	6.4	M12X1.5	14	1.38	35.0	2.15	54.5	1.24	31.5	6.0
G25655-0408	4G-8FDLORX90	7100-95845	1/4	6.4	M14X1.5	17	1.38	35.0	2.36	60.0	1.34	34.0	8.0
G25655-0410	4G-10FDLORX90	7100-92385	1/4	6.4	M16X1.5	19	1.44	36.5	2.15	54.5	1.24	31.5	10.0
G25655-0510	5G-10FDLORX90	7100-91725	5/16	7.9	M16X1.5	19	1.44	36.5	2.31	58.6	1.35	34.4	10.0
G25655-0610	6G-10FDLORX90	7100-92415	3/8	9.5	M16X1.5	19	1.44	36.5	2.18	55.3	1.27	32.2	10.0
G25655-0612	6G-12FDLORX90	7100-91705	3/8	9.5	M18X1.5	22	1.46	37.0	2.18	55.3	1.27	32.2	12.0
G25655-0815	8G-15FDLORX90	7100-91765	1/2	12.7	M22X1.5	27	1.65	42.0	2.87	72.9	1.59	40.4	15.0
G25655-1018	10G-18FDLORX90	7100-91785	5/8	15.9	M26X1.5	32	2.03	51.5	3.04	77.3	1.87	47.6	18.0
G25655-1222	12G-22FDLORX90	7100-91805	3/4	19.1	M30X2.0	36	2.44	62.0	3.73	94.8	2.22	56.3	22.0
G25655-1628	16G-28FDLORX90	7100-92445	1	25.4	M36X2.0	41	2.76	70.0	4.69	119.2	2.93	74.3	28.0
G25655-2035	20G-35FDLORX90	7100-92455	1 1/4	31.8	M45X2.0	50	3.15	80.0	5.07	128.8	3.26	82.8	35.0

Female French GAZ Swivel

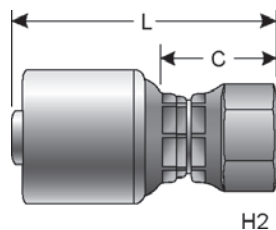

Part No.	Descr.	Prod. No.	⊖		H2	L		C		
			"	mm		"	mm	"	mm	
G25680-0817	8G-17FFGX	7100-93555	1/2	12.7	M24X1.5	30	2.50	63.4	1.02	25.9

Male DIN 24° Cone - Heavy Series

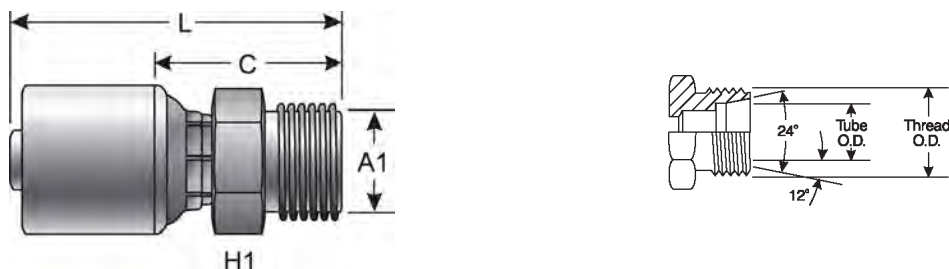

Part No.	Descr.	Prod. No.	⊖		H1	L		C		A1	
			"	mm		"	mm	"	mm		
G25715-0408	4G-8MDH	7100-15315	1/4	6.4	M16X1.5	17	2.09	53.0	1.06	27.0	8.0
G25715-0410	4G-10MDH	7100-15325	1/4	6.4	M18X1.5	19	2.07	52.5	1.04	26.5	10.0
G25715-0512	5G-12MDH	7100-93015	5/16	7.9	M20X1.5	22	2.04	51.9	1.09	27.8	12.0
G25715-0610	6G-10MDH	7100-15345	3/8	9.5	M18X1.5	19	2.17	55.0	1.07	27.1	10.0
G25715-0612	6G-12MDH	7100-15355	3/8	9.5	M20X1.5	24	2.26	57.5	1.17	29.6	12.0
G25715-0614	6G-14MDH	7100-15365	3/8	9.5	M22X1.5	24	2.34	59.5	1.24	31.6	14.0
G25715-0812	8G-12MDH	7100-94815	1/2	12.7	M20X1.5	24	2.42	61.5	1.14	29.0	12.0
G25715-0816	8G-16MDH	7100-05375	1/2	12.7	M24X1.5	27	2.72	69.0	1.24	31.5	16.0
G25715-1020	10G-20MDH	7100-05385	5/8	15.9	M30X2.0	32	2.89	73.5	1.42	36.0	20.0
G25715-1220	12G-20MDH	7100-92755	3/4	19.1	M30X2.0	32	2.85	72.3	1.33	33.9	20.0
G25715-1225	12G-25MDH	7100-05395	3/4	19.1	M36X2.0	41	3.62	92.0	1.61	41.0	25.0
G25715-1630	16G-30MDH	7100-92535	1	25.4	M42X2.0	46	3.48	88.3	1.67	42.4	30.0
G25715-2038	20G-38MDH	7100-92545	1 1/4	31.8	M52X2.0	55	3.72	94.4	1.93	49.1	38.0

- EQUIPMENT
- HOSE/CPLG. SELECTION
- G8K COUPLINGS
- GLOBALSPIRAL COUPLINGS
- STAINLESS STEEL SPIRAL
- MEGACRIMP COUPLINGS**
- STAINLESS STEEL BRAID
- POWER CRIMP COUPLINGS
- FIELD ATTACHABLE G1 & G2 COUPLINGS
- FIELD ATTACHABLE C5 COUPLINGS
- GLX COUPLINGS
- GL COUPLINGS
- C14 COUPLINGS
- PCTS THERMOPLASTIC COUPLINGS
- POLARSEAL COUPLINGS
- POLARSEAL II COUPLINGS
- POWER STEERING
- ADAPTERS
- QUICK DISCONNECT COUPLERS
- BALL VALVES
- LIVE SWIVEL
- ASSEMBLY FABRICATION
- ACCESSORIES
- EQUIPMENT AND PARTS
- AIR BRAKE
- BRASS
- KITS

Female DIN 24° Cone Swivel - Heavy Series with O-Ring



	Part No.	Descr.	Prod. No.	⊖		H2	L		C		A1	
				"	mm		"	mm	"	mm		
STAINLESS STEEL BRAID												
POWER CRIMP COUPLINGS	G25720-0408	4G-8FDHORX	7100-92005	1/4	6.4	M16X1.5	19	2.02	51.3	1.12	28.4	8.0
	G25720-0410	4G-10FDHORX	7100-92155	1/4	6.4	M18X1.5	22	2.06	52.2	1.15	29.3	10.0
	G25720-0412	4G-12FDHORX	7100-92875	1/4	6.4	M20X1.5	24	2.19	55.7	1.17	29.7	12.0
FIELD ATTACHABLE G1 & G2 COUPLINGS	G25720-0512	5G-12FDHORX	7100-92045	5/16	7.9	M20X1.5	24	2.28	58.0	1.18	30.0	12.0
	G25720-0514	5G-14FDHORX	7100-94835	5/16	7.9	M22X1.5	27	2.11	53.6	1.18	30.0	14.0
	G25720-0610	6G-10FDHORX	7100-92185	3/8	9.5	M18X1.5	22	2.06	52.3	1.15	29.2	10.0
FIELD ATTACHABLE C5 COUPLINGS	G25720-0612	6G-12FDHORX	7100-92065	3/8	9.5	M20X1.5	24	2.09	53.0	1.18	29.9	12.0
	G25720-0614	6G-14FDHORX	7100-93305	3/8	9.5	M22X1.5	27	2.19	55.6	1.28	32.5	14.0
	G25720-0812	8G-12FDHORX	7100-93335	1/2	12.7	M20X1.5	24	2.76	70.2	1.29	32.7	12.0
GLX COUPLINGS	G25720-0814	8G-14FDHORX	7100-94795	1/2	12.7	M22X1.5	27	2.56	65.0	1.28	32.5	14.0
	G25720-0816	8G-16FDHORX	7100-96435	1/2	12.7	M24X1.5	30	2.61	66.4	1.32	33.5	15.4
GL COUPLINGS	G25720-1020	10G-20FDHORX	7100-92105	5/8	15.9	M30X2.0	36	2.67	67.9	1.51	38.2	20.0
	G25720-1220	12G-20FDHORX	7100-96675	3/4	19.1	M30X2.0	36	3.61	91.7	1.60	40.7	20.0
C14 COUPLINGS	G25720-1225	12G-25FDHORX	7100-92125	3/4	19.1	M36X2.0	46	3.19	81.1	1.68	42.6	25.0
	G25720-1625	16G-25FDHORX	7100-93215	1	25.4	M36X2.0	46	4.04	102.5	1.80	45.7	25.0
	G25720-1630	16G-30FDHORX	7100-92235	1	25.4	M42X2.0	50	3.70	94.1	1.94	49.2	30.0
PCTS THERMOPLASTIC COUPLINGS	G25720-2038	20G-38FDHORX	7100-92245	1 1/4	31.8	M52X2.0	60	4.10	104.1	2.28	57.8	38.0

Female DIN 24° Cone Swivel - Heavy Series with O-Ring - 45° Bent Tube

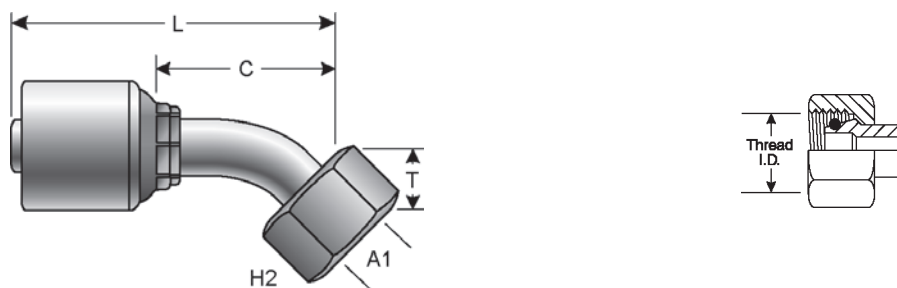

	Part No.	Descr.	Prod. No.	⊖		H2	T	L		C		A1		
				"	mm			"	mm	"	mm			
POLARSEAL COUPLINGS														
POLARSEAL II COUPLINGS														
POWER STEERING														
ADAPTERS														
QUICK DISCONNECT COUPLERS														
BALL VALVES														
LIVE SWIVEL														
ASSEMBLY FABRICATION														
ACCESSORIES	G25725-0408	4G-8FDHORX45	7100-91865	1/4	6.4	M16X1.5	19	.64	16.2	2.34	59.5	1.44	36.5	8.0
	G25725-0410	4G-10FDHORX45	7100-95765	1/4	6.4	M18X1.5	22	.70	17.9	2.54	64.4	1.51	38.3	7.9
	G25725-0610	6G-10FDHORX45	7100-96125	3/8	9.5	M18X1.5	22	.73	18.6	2.70	68.5	1.59	40.5	10.9
EQUIPMENT AND PARTS	G25725-0612	6G-12FDHORX45	7100-91885	3/8	9.5	M20X1.5	24	.74	18.9	2.52	64.0	1.61	40.9	12.0
	G25725-0814	8G-14FDHORX45	7100-94855	1/2	12.7	M22X1.5	27	1.11	28.3	3.40	86.4	2.13	54.0	14.0
	G25725-0816	8G-16FDHORX45	7100-91945	1/2	12.7	M24X1.5	30	.85	21.6	3.19	81.0	1.91	48.5	16.0
AIR BRAKE	G25725-1020	10G-20FDHORX45	7100-91965	5/8	15.9	M30X2.0	36	.98	24.9	3.36	85.4	2.19	55.7	20.0
	G25725-1225	12G-25FDHORX45	7100-91985	3/4	19.1	M36X2.0	46	1.23	31.2	4.17	106.0	2.66	67.6	25.0
BRASS														
KITS														

Female DIN 24° Cone Swivel - Heavy Series with O-Ring - 90° Bent Tube

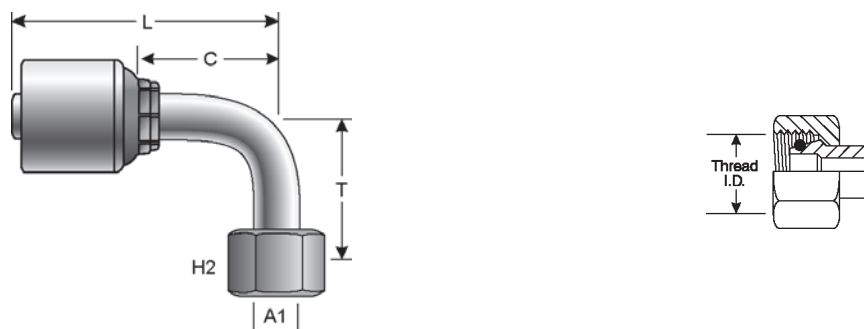

Part No.	Descr.	Prod. No.	⌀		H2	T		L		C		A1	
			"	mm		"	mm	"	mm	"	mm		
G25730-0408	4G-8FDHORX90	7100-95835	1/4	6.4	M16X1.5	19	1.38	35.0	2.36	60.0	1.34	34.0	8.0
G25730-0410	4G-10FDHORX90	7100-92395	1/4	6.4	M18X1.5	22	1.44	36.5	2.15	54.5	1.24	31.5	10.0
G25730-0512	5G-12FDHORX90	7100-91755	5/16	7.9	M20X1.5	24	1.46	37.0	2.32	59.0	1.22	31.0	12.0
G25730-0514	5G-14FDHORX90	7100-94845	5/16	7.9	M22X1.5	27	1.57	40.0	2.15	54.6	1.22	31.0	14.0
G25730-0610	6G-10FDHORX90	7100-92425	3/8	9.5	M18X1.5	22	1.44	36.5	2.18	55.3	1.27	32.2	10.0
G25730-0612	6G-12FDHORX90	7100-91715	3/8	9.5	M20X1.5	24	1.46	37.0	2.18	55.3	1.27	32.2	12.0
G25730-0614	6G-14FDHORX90	7100-92465	3/8	9.5	M22X1.5	27	1.57	40.0	2.18	55.3	1.27	32.2	14.0
G25730-0814	8G-14FDHORX90	7100-13005	1/2	12.7	M22X1.5	27	2.01	51.0	3.11	79.0	1.64	41.6	14.0
G25730-0816	8G-16FDHORX90	7100-91775	1/2	12.7	M24X1.5	30	1.73	44.0	2.87	72.9	1.59	40.4	16.0
G25730-1020	10G-20FDHORX90	7100-91795	5/8	15.9	M30X2.0	36	2.01	51.0	3.00	76.3	1.83	46.6	20.0
G25730-1025	10G-25FDHORX90	7100-94825	5/8	15.9	M36X2.0	46	2.52	64.0	3.31	84.1	1.83	46.6	25.0
G25730-1220	12G-20FDHORX90	7100-93035	3/4	19.1	M30X2.0	36	2.01	51.0	3.46	87.8	1.94	49.3	20.0
G25730-1225	12G-25FDHORX90	7100-91815	3/4	19.1	M36X2.0	46	2.52	64.0	3.73	94.8	2.22	56.3	25.0
G25730-1625	16G-25FDHORX90	7100-94925	1	25.4	M36X2.0	46	2.99	76.0	5.43	137.8	3.19	81.0	25.0

Metric Light Stand Pipe

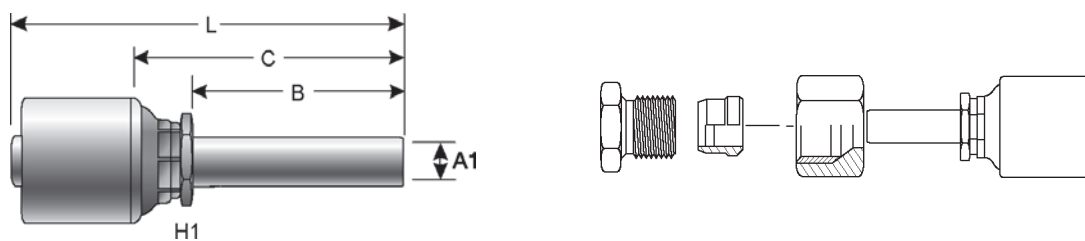

Part No.	Descr.	Prod. No.	⌀		H1	L		C		B		A1
			"	mm		"	mm	"	mm	"	mm	
G25750-0406	4G-6MSP	7100-93355	1/4	6.4	1/2	2.46	62.5	1.44	36.5	.87	22.0	6.0
G25750-0408	4G-8MSP	7100-93365	1/4	6.4	1/2	2.46	62.5	1.44	36.5	.87	22.0	8.0
G25750-0410	4G-10MSP	7100-93375	1/4	6.4	1/2	2.54	64.5	1.52	38.5	.87	22.0	10.0
G25750-0610	6G-10MSP	7100-90325	3/8	9.5	5/8	2.62	66.5	1.52	38.6	.91	23.0	10.0
G25750-0612	6G-12MSP	7100-90005	3/8	9.5	5/8	2.62	66.5	1.52	38.6	.91	23.0	12.0
G25750-0815	8G-15MSP	7100-90045	1/2	12.7	13/16	3.00	76.3	1.53	38.8	.98	25.0	15.0
G25750-1018	10G-18MSP	7100-93405	5/8	15.9	15/16	3.04	77.2	1.56	39.7	.98	25.0	18.0
G25750-1022	10G-22MSP	7100-95335	5/8	15.9	15/16	3.11	79.0	1.63	41.5	.98	25.0	22.0
G25750-1218	12G-18MSP	7100-95345	3/4	19.1	1 1/16	3.54	90.0	1.54	39.0	1.02	26.0	18.0
G25750-1222	12G-22MSP	7100-93465	3/4	19.1	1 1/16	3.67	93.2	1.66	42.2	1.10	28.0	22.0
G25750-1628	16G-28MSP	7100-95355	1	25.4	1 7/16	4.09	104.0	1.86	47.2	1.18	30.0	28.0

- EQUIPMENT
- HOSE/CPLG. SELECTION
- G8K COUPLINGS
- GLOBALSPIRAL COUPLINGS
- STAINLESS STEEL SPIRAL
- MEGACRIMP COUPLINGS
- STAINLESS STEEL BRAID
- POWER CRIMP COUPLINGS
- FIELD ATTACHABLE G1 & G2 COUPLINGS
- FIELD ATTACHABLE C5 COUPLINGS
- GLX COUPLINGS
- GL COUPLINGS
- C14 COUPLINGS
- PCTS THERMOPLASTIC COUPLINGS
- POLARSEAL COUPLINGS
- POLARSEAL II COUPLINGS
- POWER STEERING
- ADAPTERS
- QUICK DISCONNECT COUPLERS
- BALL VALVES
- LIVE SWIVEL
- ASSEMBLY FABRICATION
- ACCESSORIES
- EQUIPMENT AND PARTS
- AIR BRAKE
- BRASS
- KITS

International Thread Metric 7642 DIN Banjo

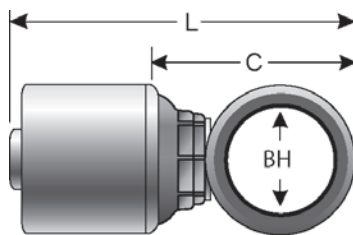

Part No.	Descr.	Prod. No.	⌀		L		C		BH
			"	mm	"	mm	"	mm	
G25770-0412	4G-12DBJ	7100-91195	1/4	6.4	2.03	51.4	1.11	28.3	12.1
G25770-0612	6G-12DBJ	7100-98125	3/8	9.5	2.20	56.0	1.11	28.1	12.1
G25770-0614	6G-14DBJ	7100-91275	3/8	9.5	2.30	58.3	1.20	30.4	14.1
G25770-0616	6G-16DBJ	7100-91285	3/8	9.5	2.20	55.8	1.27	32.4	16.1
G25770-0618	6G-18DBJ	7100-91295	3/8	9.5	2.28	57.8	1.35	34.4	18.1
G25770-0818	8G-18DBJ	7100-91305	1/2	12.7	2.64	67.2	1.37	34.7	18.1
G25770-1226	12G-26DBJ	7100-93895	3/4	19.1	3.73	94.7	1.72	43.7	26.1
G25770-1630	16G-30DBJ	7100-94995	1	25.4	4.30	109.2	2.06	52.4	30.1

Male British Standard Pipe Tapered/Japanese Tapered Thread



Part No.	Descr.	Prod. No.	⌀		H1	L		C		
			"	mm		"	mm	"	mm	
G25795-0404	4G-4MBSPT	7100-91075	1/4	6.4	1/4-19	14	1.89	47.9	.97	24.8
G25795-0606	6G-6MBSPT	7100-91105	3/8	9.5	3/8-19	19	1.95	49.5	1.03	26.1
G25795-0808	8G-8MBSPT	7100-91125	1/2	12.7	1/2-14	22	2.49	63.4	1.22	30.9
G25795-1212	12G-12MBSPT	7100-91145	3/4	19.1	3/4-14	32	2.92	74.1	1.41	35.7
G25795-1616	16G-16MBSPT	7100-91155	1	25.4	1-11	36	3.44	87.5	1.64	41.6

EQUIPMENT
HOSE/CPLG. SELECTION
G8K COUPLINGS
GLOBALSPIRAL COUPLINGS
STAINLESS STEEL SPIRAL
MEGACRIMP COUPLINGS
STAINLESS STEEL BRAID
POWER CRIMP COUPLINGS
FIELD ATTACHABLE G1 & G2 COUPLINGS
FIELD ATTACHABLE C5 COUPLINGS
GLX COUPLINGS
GL COUPLINGS
C14 COUPLINGS
PCTS THERMOPLASTIC COUPLINGS
POLARSEAL COUPLINGS
POLARSEAL II COUPLINGS
POWER STEERING
ADAPTERS
QUICK DISCONNECT COUPLERS
BALL VALVES
LIVE SWIVEL
ASSEMBLY FABRICATION
ACCESSORIES
EQUIPMENT AND PARTS
AIR BRAKE
BRASS
KITS

Male British Standard Parallel Pipe

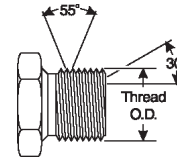
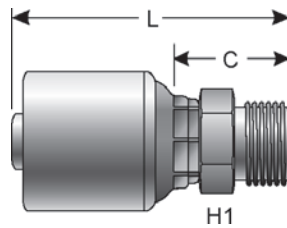

Part No.	Descr.	Prod. No.	⊖		🌀	H1	L		C	
			"	mm			"	mm	"	mm
G25810-0404	4G-4MBSPP	7100-15515	1/4	6.4	1/4-19	19	2.03	51.5	1.00	25.5
G25810-0604	6G-4MBSPP	7100-98255	3/8	9.5	1/4-19	19	2.05	52.0	.95	24.1
G25810-0606	6G-6MBSPP	7100-15525	3/8	9.5	3/8-19	22	2.17	55.0	1.07	27.1
G25810-0608	6G-8MBSPP	7100-15535	3/8	9.5	1/2-14	27	2.36	60.0	1.26	32.1
G25810-0806	8G-6MBSPP	7100-93245	1/2	12.7	3/8-19	22	2.30	58.5	1.02	26.0
G25810-0808	8G-8MBSPP	7100-05545	1/2	12.7	1/2-14	27	2.72	69.0	1.24	31.5
G25810-1010	10G-10MBSPP	7100-05555	5/8	15.9	5/8-14	30	2.89	73.5	1.42	36.0
G25810-1212	12G-12MBSPP	7100-05565	3/4	19.1	3/4-14	32	3.35	85.0	1.34	34.0
G25810-1616	16G-16MBSPP	7100-05575	1	25.4	1-11	41	3.98	101.0	1.74	44.2
G25810-2020	20G-20MBSPP	7100-05585	1 1/4	31.8	1 1/4-11	50	4.33	110.0	2.01	51.0

Female British Standard Parallel Pipe O-Ring Swivel

Includes O-Ring sealing in flare.

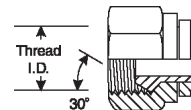
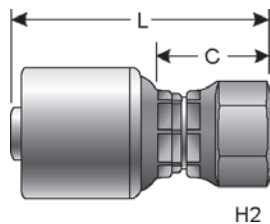

Part No.	Descr.	Prod. No.	⊖		🌀	H2	L		C	
			"	mm			"	mm	"	mm
G25830-0402	4G-2FBSPX	7100-93285	1/4	6.4	1/8-28	14	1.62	41.1	.71	18.0
G25830-0404	4G-4FBSPORX	7100-95915	1/4	6.4	1/4-19	19	1.57	39.9	.67	17.0
G25830-0406	4G-6FBSPORX	7100-95015	1/4	6.4	3/8-19	22	2.05	52.0	1.02	26.0
G25830-0506	5G-6FBSPORX	7100-94195	5/16	7.9	3/8-19	22	2.13	54.0	1.02	26.0
G25830-0508	5G-8FBSPORX	7100-94205	5/16	7.9	1/2-14	27	2.16	54.8	1.06	26.8
G25830-0606	6G-6FBSPORX	7100-95045	3/8	9.5	3/8-19	22	1.61	40.9	.70	17.8
G25830-0608	6G-8FBSPORX	7100-94225	3/8	9.5	1/2-14	27	2.15	54.7	1.06	26.8
G25830-0806	8G-6FBSPORX	7100-94235	1/2	12.7	3/8-19	22	2.62	66.5	1.14	29.0
G25830-0808	8G-8FBSPORX	7100-94245	1/2	12.7	1/2-14	27	2.53	64.2	1.05	26.7
G25830-0810	8G-10FBSPORX	7100-94255	1/2	12.7	5/8-14	30	2.68	68.0	1.20	30.5
G25830-1010	10G-10FBSPORX	7100-94265	5/8	15.9	5/8-14	30	2.70	68.5	1.22	31.0
G25830-1012	10G-12FBSPORX	7100-94275	5/8	15.9	3/4-14	32	2.74	69.5	1.26	32.0
G25830-1212	12G-12FBSPORX	7100-94285	3/4	19.1	3/4-14	32	3.27	83.0	1.26	32.0
G25830-1216	12G-16FBSPORX	7100-94295	3/4	19.1	1-11	41	3.43	87.0	1.42	36.0
G25830-1616	16G-16FBSPORX	7100-94305	1	25.4	1-11	41	3.78	96.0	1.54	39.2
G25830-2020	20G-20FBSPORX	7100-95235	1 1/4	31.8	1 1/4-11	50	3.48	88.5	1.16	29.5

EQUIPMENT

HOSE/CPLG. SELECTION

G8K COUPLINGS

GLOBALSPIRAL COUPLINGS

STAINLESS STEEL SPIRAL

MEGACRIMP COUPLINGS

STAINLESS STEEL BRAID

POWER CRIMP COUPLINGS

FIELD ATTACHABLE G1 & G2 COUPLINGS

FIELD ATTACHABLE C5 COUPLINGS

GLX COUPLINGS

GL COUPLINGS

C14 COUPLINGS

PCTS THERMOPLASTIC COUPLINGS

POLARSEAL COUPLINGS

POLARSEAL II COUPLINGS

POWER STEERING

ADAPTERS

QUICK DISCONNECT COUPLERS

BALL VALVES

LIVE SWIVEL

ASSEMBLY FABRICATION

ACCESSORIES

EQUIPMENT AND PARTS

AIR BRAKE

BRASS

KITS

Female British Standard Parallel Pipe O-Ring Swivel - 45° Bent Tube

Includes O-Ring sealing in flare.

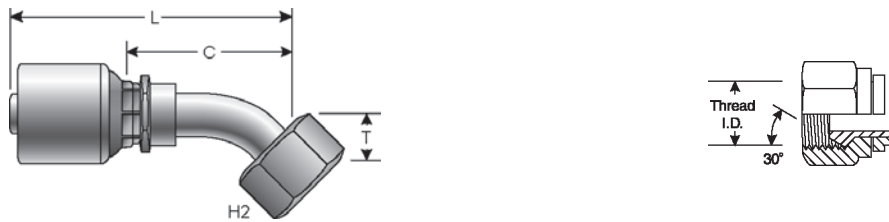

Part No.	Descr.	Prod. No.	⌀		H2	T		L		C		
			"	mm		"	mm	"	mm	"	mm	
G25831-0404	4G-4FBSPORX45	7100-91445	1/4	6.4	1/4-19	19	.46	11.6	2.13	54.0	1.22	31.1
G25831-0606	6G-6FBSPORX45	7100-96315	3/8	9.5	3/8-19	22	.60	15.2	2.63	66.9	1.54	39.0
G25831-0608	6G-8FBSPORX45	7100-91485	3/8	9.5	1/2-14	27	.76	19.3	2.60	66.1	1.69	43.0
G25831-0808	8G-8FBSPORX45	7100-91495	1/2	12.7	1/2-14	27	.67	17.0	3.01	76.5	1.73	44.0
G25831-1010	10G-10FBSPORX45	7100-91505	5/8	15.9	5/8-14	30	.84	21.3	3.22	81.8	2.05	52.1
G25831-1212	12G-12FBSPORX45	7100-91525	3/4	19.1	3/4-14	32	1.11	28.3	4.05	102.9	2.54	64.4
G25831-1616	16G-16FBSPORX45	7100-91535	1	25.4	1-11	41	1.22	30.9	4.87	123.6	3.10	78.8
G25831-2020	20G-20FBSPORX45	7100-92715	1 1/4	31.8	1 1/4-11	50	1.48	37.5	5.50	139.6	3.68	93.4

Female British Standard Parallel Pipe O-Ring Swivel - 90° Bent Tube

Includes O-Ring sealing in flare.

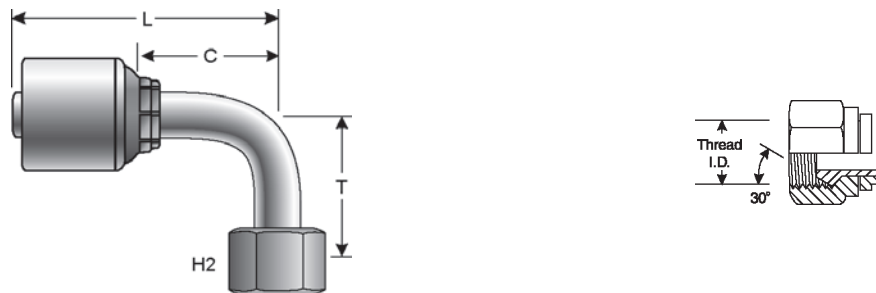

Part No.	Descr.	Prod. No.	⌀		H2	T		L		C		
			"	mm		"	mm	"	mm	"	mm	
G25832-0404	4G-4FBSPORX90	7100-91545	1/4	6.4	1/4-19	19	.93	23.5	1.94	49.4	1.04	26.5
G25832-0606	6G-6FBSPORX90	7100-91575	3/8	9.5	3/8-19	22	1.26	32.0	2.44	61.9	1.34	34.0
G25832-0608	6G-8FBSPORX90	7100-91585	3/8	9.5	1/2-14	27	1.48	37.5	2.18	55.3	1.27	32.2
G25832-0808	8G-8FBSPORX90	7100-96585	1/2	12.7	1/2-14	27	1.47	37.3	3.07	78.0	1.59	40.5
G25832-0810	8G-10FBSPORX90	7100-93145	1/2	12.7	5/8-14	30	1.81	46.0	3.21	81.5	1.73	44.0
G25832-1010	10G-10FBSPORX90	7100-91605	5/8	15.9	5/8-14	30	1.81	46.0	3.00	76.3	1.83	46.6
G25832-1212	12G-12FBSPORX90	7100-91625	3/4	19.1	3/4-14	32	2.36	60.0	3.72	94.5	2.20	56.0
G25832-1616	16G-16FBSPORX90	7100-91635	1	25.4	1-11	41	2.76	70.0	4.69	119.2	2.93	74.3
G25832-2020	20G-20FBSPORX90	7100-91645	1 1/4	31.8	1 1/4-11	50	3.15	80.0	5.07	128.8	3.26	82.8

Female British Standard Parallel Pipe O-Ring Swivel - 90° Block

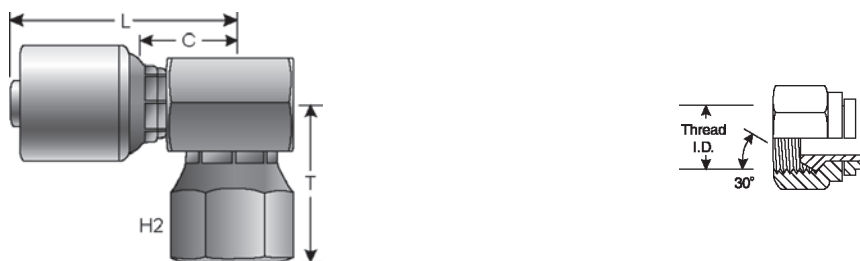

Part No.	Descr.	Prod. No.	⊖		H2	T		L		C		
			"	mm		"	mm	"	mm	"	mm	
G25845-0404	4G-4FBSPORX90BL	7100-91825	1/4	6.4	1/4-19	19	.71	18.0	1.74	44.2	.72	18.2
G25845-0606	6G-6FBSPORX90BL	7100-91835	3/8	9.5	3/8-19	22	.83	21.0	1.71	43.5	.79	20.0
G25845-0808	8G-8FBSPORX90BL	7100-91845	1/2	12.7	1/2-14	27	.94	24.0	2.20	55.9	.93	23.5
G25845-1616	16G-16FBSPORX90BL	7100-92585	1	25.4	1-11	41	1.42	36.1	3.17	80.5	1.36	34.6

International Thread British Std Pipe Banjo

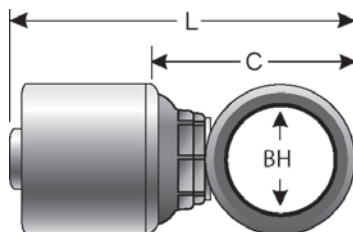

Part No.	Descr.	Prod. No.	⊖		L		C		BH
			"	mm	"	mm	"	mm	
G25850-0404	4G-4BSPBJ	7100-92565	1/4	6.4	2.10	53.4	1.19	30.3	13.2
G25850-0606	6G-6BSPBJ	7100-92575	3/8	9.5	2.20	55.8	1.30	32.4	16.8
G25850-0808	8G-8BSPBJ	7100-92925	1/2	12.7	2.80	70.7	1.50	38.2	21.0

Female British Flat-Face Swivel

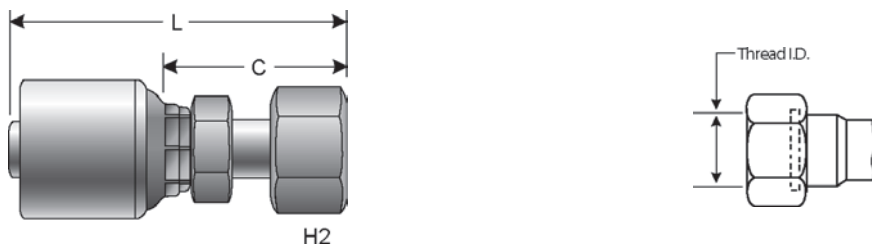

Part No.	Descr.	Prod. No.	⊖		H2	L		C		
			"	mm		"	mm	"	mm	
G25855-0606	6G-6FBFFX	7100-93715	3/8	9.5	3/8-19	22	1.81	46.0	.71	18.1
G25855-0608	6G-8FBFFX	7100-93725	3/8	9.5	1/2-14	27	1.79	45.5	.69	17.6
G25855-0808	8G-8FBFFX	7100-93735	1/2	12.7	1/2-14	27	2.19	55.5	.71	18.0

- EQUIPMENT
- HOSE/CPLG. SELECTION
- G8K COUPLINGS
- GLOBALSPIRAL COUPLINGS
- STAINLESS STEEL SPIRAL
- MEGACRIMP COUPLINGS**
- STAINLESS STEEL BRAID
- POWER CRIMP COUPLINGS
- FIELD ATTACHABLE G1 & G2 COUPLINGS
- FIELD ATTACHABLE C5 COUPLINGS
- GLX COUPLINGS
- GL COUPLINGS
- C14 COUPLINGS
- PCTS THERMOPLASTIC COUPLINGS
- POLARSEAL COUPLINGS
- POLARSEAL II COUPLINGS
- POWER STEERING
- ADAPTERS
- QUICK DISCONNECT COUPLERS
- BALL VALVES
- LIVE SWIVEL
- ASSEMBLY FABRICATION
- ACCESSORIES
- EQUIPMENT AND PARTS
- AIR BRAKE
- BRASS
- KITS

Female British Flat-Face Swivel - Continued

Part No.	Descr.	Prod. No.	⊖		H2	L		C		
			"	mm		"	mm	"	mm	
G25855-0812	8G-12FBFFX	7100-93745	1/2	12.7	3/4-14	32	2.07	52.5	.59	15.0
G25855-1212	12G-12FBFFX	7100-93325	3/4	19.1	3/4-14	32	2.07	52.6	1.04	26.4

Female Komatsu Style Japanese Metric Swivel

These female swivels have been marked with two small notches on the hex to identify them as the Komatsu style.



Part No.	Descr.	Prod. No.	⊖		H1	H2	L		C		
			"	mm			"	mm	"	mm	
G25910-0404	4G-4FKX	7100-03625	1/4	6.4	M14X1.5	14	19	2.35	59.7	1.33	33.7
G25910-0406	4G-6FKX	7100-03635	1/4	6.4	M18X1.5	14	24	2.44	62.0	1.42	36.0
G25910-0606	6G-6FKX	7100-03645	3/8	9.5	M18X1.5	17	24	2.52	64.0	1.42	36.1
G25910-0808	8G-8FKX	7100-03655	1/2	12.7	M22X1.5	22	27	3.07	78.1	1.60	40.6
G25910-1010	10G-10FKX	7100-03665	5/8	15.9	M24X1.5	24	32	3.21	81.5	1.73	44.0
G25910-1212	12G-12FKX	7100-03675	3/4	19.1	M30X1.5	30	36	3.95	100.3	1.94	49.3
G25910-1616	16G-16FKX	7100-03685	1	25.4	M33X1.5	41	41	4.57	116.0	2.33	59.2
G25910-2020	20G-20FKX	7100-03775	1 1/4	31.8	M36X1.5	44.5	50.8	4.82	122.4	2.44	62.0

Female Komatsu Style Japanese Metric Swivel - 45° Bent Tube

These female swivels have been marked with two small notches on the hex to identify them as the Komatsu style.

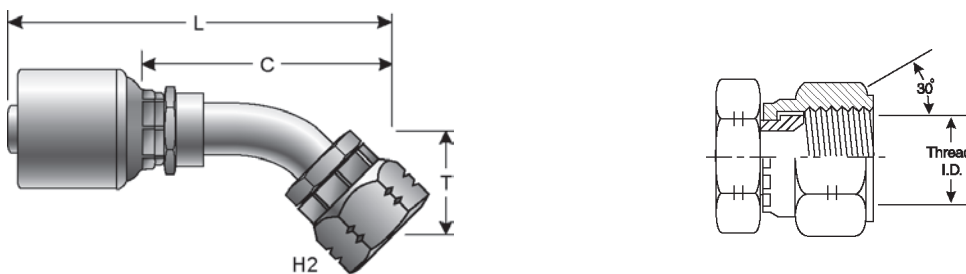

Part No.	Descr.	Prod. No.	⊖		H2	T		L		C		
			"	mm		"	mm	"	mm	"	mm	
G25911-0404	4G-4FKX45	7100-03035	1/4	6.4	M14X1.5	19	.75	19.0	2.93	74.3	1.90	48.3
G25911-0606	6G-6FKX45	7100-03045	3/8	9.5	M18X1.5	24	1.10	28.0	3.64	92.4	2.54	64.4
G25911-0808	8G-8FKX45	7100-03055	1/2	12.7	M22X1.5	27	.71	18.0	3.85	97.7	2.37	60.3
G25911-1010	10G-10FKX45	7100-03065	5/8	15.9	M24X1.5	32	1.10	28.0	4.70	119.3	3.22	81.8
G25911-1212	12G-12FKX45	7100-03075	3/4	19.1	M30X1.5	36	1.18	30.0	5.64	143.2	3.63	92.2

Female Komatsu Style Japanese Metric Swivel - 90° Bent Tube

These female swivels have been marked with two small notches on the hex to identify them as the Komatsu style.

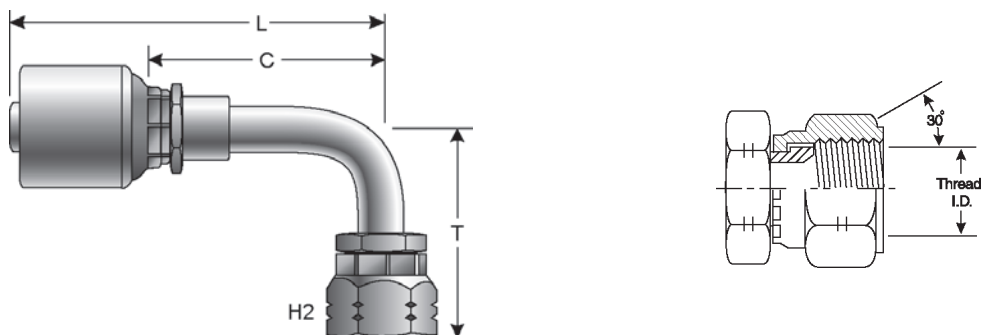

Part No.	Descr.	Prod. No.	⌀		H1	H2	T		L		C			
			"	mm			"	mm	"	mm	"	mm	"	mm
G25913-0404	4G-4FKX90	7100-03125	1/4	6.4	M14X1.5	—	—	19	1.50	38.0	2.47	62.7	1.44	36.7
G25913-0606	6G-6FKX90	7100-03135	3/8	9.5	M18X1.5	—	—	24	1.10	28.0	2.72	69.1	1.62	41.2
G25913-0808	8G-8FKX90	7100-03145	1/2	12.7	M22X1.5	—	—	27	1.38	35.0	3.63	92.2	2.15	54.7
G25913-1010	10G-10FKX90	7100-06795	5/8	15.9	M24X1.5	15/16	1 1/4	—	2.57	65.3	3.43	87.0	1.95	49.5
G25913-1212	12G-12FKX90	7100-03165	3/4	19.1	M30X1.5	—	—	36	2.48	63.0	5.33	135.5	3.33	84.5

Female Japanese Industrial Standard Swivel



Part No.	Descr.	Prod. No.	⌀		H1	H2	L		C		
			"	mm			"	mm	"	mm	"
G25930-0404	4G-4FJISX	7100-03305	1/4	6.4	1/4-19	14	19	2.32	59.0	1.30	33.0
G25930-0606	6G-6FJISX	7100-03325	3/8	9.5	3/8-19	17	22	2.46	62.5	1.36	34.6
G25930-0808	8G-8FJISX	7100-03345	1/2	12.7	1/2-14	22	27	3.15	79.9	1.67	42.4
G25930-1212	12G-12FJISX	7100-03365	3/4	19.1	3/4-14	30	36	3.79	96.3	1.78	45.3
G25930-1616	16G-16FJISX	7100-03385	1	25.4	1-11	41	41	4.28	108.6	2.04	51.8
G25930-2020	20G-20FJISX	7100-03405	1 1/4	31.8	1 1/4-11	50	50	4.89	124.1	2.56	65.1

- EQUIPMENT
- HOSE/CPLG. SELECTION
- G8K COUPLINGS
- GLOBALSPIRAL COUPLINGS
- STAINLESS STEEL SPIRAL
- MEGACRIMP COUPLINGS**
- STAINLESS STEEL BRAID
- POWER CRIMP COUPLINGS
- FIELD ATTACHABLE G1 & G2 COUPLINGS
- FIELD ATTACHABLE C5 COUPLINGS
- GLX COUPLINGS
- GL COUPLINGS
- C14 COUPLINGS
- PCTS THERMOPLASTIC COUPLINGS
- POLARSEAL COUPLINGS
- POLARSEAL II COUPLINGS
- POWER STEERING
- ADAPTERS
- QUICK DISCONNECT COUPLERS
- BALL VALVES
- LIVE SWIVEL
- ASSEMBLY FABRICATION
- ACCESSORIES
- EQUIPMENT AND PARTS
- AIR BRAKE
- BRASS
- KITS

EQUIPMENT
HOSE/CPLG. SELECTION
G8K COUPLINGS
GLOBALSPIRAL COUPLINGS
STAINLESS STEEL SPIRAL
MEGACRIMP COUPLINGS
STAINLESS STEEL BRAID
POWER CRIMP COUPLINGS
FIELD ATTACHABLE G1 & G2 COUPLINGS
FIELD ATTACHABLE C5 COUPLINGS
GLX COUPLINGS
GL COUPLINGS
C14 COUPLINGS
PCTS THERMOPLASTIC COUPLINGS
POLARSEAL COUPLINGS
POLARSEAL II COUPLINGS
POWER STEERING
ADAPTERS
QUICK DISCONNECT COUPLERS
BALL VALVES
LIVE SWIVEL
ASSEMBLY FABRICATION
ACCESSORIES
EQUIPMENT AND PARTS
AIR BRAKE
BRASS
KITS

Male Quick-Lok® High

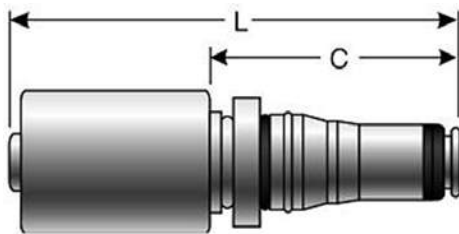

Part No.	Descr.	Prod. No.	⌀		L		C	
			"	mm	"	mm	"	mm
G25970-0404	4G-4MQLH	7209-32005	1/4	6.4	2.64	67.0	1.61	41.0
G25970-0606	6G-6MQLH	7209-32025	3/8	9.5	2.72	69.0	1.62	41.1
G25970-0808	8G-8MQLH	7209-32055	1/2	12.7	3.11	79.0	1.63	41.5
G25970-1010	10G-10MQLH	7209-32085	5/8	15.9	3.11	79.0	1.63	41.5
G25970-1212	12G-12MQLH	7209-32105	3/4	19.1	3.66	93.0	1.65	42.0
G25970-1616	16G-16MQLH	7209-32125	1	25.4	3.98	101.0	1.74	44.2

Male Quick-Lok® High - 45° Bent Tube

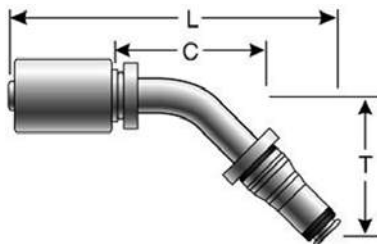

Part No.	Descr.	Prod. No.	⌀		T		L		C	
			"	mm	"	mm	"	mm	"	mm
G25971-0404	4G-4MQLH45S-008	7209-33005	1/4	6.4	.30	7.5	2.96	75.1	1.93	49.1
G25971-0606	6G-6MQLH45S-008	7209-33015	3/8	9.5	.33	8.4	3.21	81.6	2.11	53.7
G25971-0808	8G-8MQLH45S-010	7209-33025	1/2	12.7	.41	10.3	3.77	95.7	2.29	58.2
G25971-1010	10G-10MQLH45S-013	7209-33045	5/8	15.9	.50	12.7	4.12	104.6	2.64	67.1
G25971-1212	12G-12MQLH45S-014	7209-33055	3/4	19.1	.56	14.2	4.88	124.0	2.87	73.0
G25971-1616	16G-16MQLH45S-017	7209-33065	1	25.4	.66	16.7	5.49	139.5	3.26	82.7

Male Quick-Lok® High - 90° Bent Tube

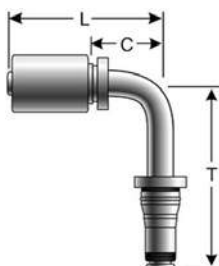

Part No.	Descr.	Prod. No.	⊖		T		L		C	
			"	mm	"	mm	"	mm	"	mm
G25972-0404	4G-4MQLH90S-018	7209-34005	1/4	6.4	.71	18.0	2.19	55.6	1.17	29.6
G25973-0404	4G-4MQLH90L-039	7209-34015	1/4	6.4	1.54	39.0	2.19	55.6	1.17	29.6
G25972-0606	6G-6MQLH90S-020	7209-34045	3/8	9.5	.79	20.1	2.47	62.8	1.37	34.8
G25973-0606	6G-6MQLH90L-046	7209-34055	3/8	9.5	1.79	45.5	2.40	60.9	1.30	32.9
G25972-0808	8G-8MQLH90S-026	7209-34085	1/2	12.7	1.01	25.6	3.16	80.3	1.69	42.9
G25973-0808	8G-8MQLH90L-057	7209-34095	1/2	12.7	2.22	56.5	3.04	77.1	1.56	39.7
G25972-1010	10G-10MQLH90S-033	7209-34115	5/8	15.9	1.29	32.8	3.55	90.1	2.07	52.6
G25973-1010	10G-10MQLH90L-065	7209-34125	5/8	15.9	2.56	65.0	3.72	94.4	2.24	57.0
G25972-1212	12G-12MQLH90S-037	7209-34155	3/4	19.1	1.45	36.8	4.33	110.1	2.33	59.1
G25973-1212	12G-12MQLH90L-075	7209-34165	3/4	19.1	2.93	74.5	4.20	106.7	2.19	55.7
G25972-1616	16G-16MQLH90S-044	7209-34195	1	25.4	1.72	43.8	5.48	139.1	3.24	82.3
G25973-1616	16G-16MQLH90L-103	7209-34215	1	25.4	4.06	103.0	4.87	123.7	2.63	66.9

Female Quick-Lok® High to Male O-Ring Boss Adapter

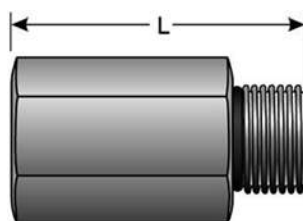



H1

Part No.	Descr.	Prod. No.	⊖			H1	L	
			"	mm	"	mm	"	mm
G25974-0404	4FQLH-4MB	7209-05025	1/4	6.4	7/16-20	19	1.65	42.0
G25974-0406	4FQLH-6MB	7209-05035	1/4	6.4	9/16-18	19	1.65	42.0
G25974-0604	6FQLH-4MB	7209-05075	3/8	9.5	7/16-20	22	1.65	42.0
G25974-0606	6FQLH-6MB	7209-05085	3/8	9.5	9/16-18	22	1.69	43.0
G25974-0608	6FQLH-8MB	7209-05095	3/8	9.5	3/4-16	24	1.69	43.0
G25974-0806	8FQLH-6MB	7209-05135	1/2	12.7	9/16-18	24	1.71	43.5
G25974-0808	8FQLH-8MB	7209-05145	1/2	12.7	3/4-16	24	1.75	44.5
G25974-0810	8FQLH-10MB	7209-05155	1/2	12.7	7/8-14	27	1.81	46.0
G25974-1008	10FQLH-8MB	7209-05195	5/8	15.9	3/4-16	27	1.85	47.0
G25974-1010	10FQLH-10MB	7209-05205	5/8	15.9	7/8-14	27	1.85	47.0
G25974-1012	10FQLH-12MB	7209-05215	5/8	15.9	1 1/16-12	32	1.89	48.0
G25974-1210	12FQLH-10MB	7209-05255	3/4	19.1	7/8-14	32	1.89	48.0
G25974-1212	12FQLH-12MB	7209-05265	3/4	19.1	1 1/16-12	32	1.97	50.0
G25974-1216	12FQLH-16MB	7209-05275	3/4	19.1	1 5/16-12	41	1.97	50.0

- EQUIPMENT
- HOSE/CPLG. SELECTION
- G&K COUPLINGS
- GLOBALSPIRAL COUPLINGS
- STAINLESS STEEL SPIRAL
- MEGACRIMP COUPLINGS**
- STAINLESS STEEL BRAID
- POWER CRIMP COUPLINGS
- FIELD ATTACHABLE G1 & G2 COUPLINGS
- FIELD ATTACHABLE C5 COUPLINGS
- GLX COUPLINGS
- GL COUPLINGS
- C14 COUPLINGS
- PCTS THERMOPLASTIC COUPLINGS
- POLARSEAL COUPLINGS
- POLARSEAL II COUPLINGS
- POWER STEERING
- ADAPTERS
- QUICK DISCONNECT COUPLERS
- BALL VALVES
- LIVE SWIVEL
- ASSEMBLY FABRICATION
- ACCESSORIES
- EQUIPMENT AND PARTS
- AIR BRAKE
- BRASS
- KITS

Female Quick-Lok® High to Male O-Ring Boss Adapter - Continued

Part No.	Descr.	Prod. No.				H1	L	
			"	mm	"	mm	"	mm
G25974-1612	16FQLH-12MB	7209-05315	1	25.4	1 1/16-12	41	2.09	53.0
G25974-1616	16FQLH-16MB	7209-05325	1	25.4	1 5/16-12	41	1.97	50.0

EQUIPMENT
HOSE/CPLG. SELECTION
G8K COUPLINGS
GLOBALSPIRAL COUPLINGS
STAINLESS STEEL SPIRAL
MEGACRIMP COUPLINGS
STAINLESS STEEL BRAID
POWER CRIMP COUPLINGS
FIELD ATTACHABLE G1 & G2 COUPLINGS
FIELD ATTACHABLE C5 COUPLINGS
GLX COUPLINGS
GL COUPLINGS
C14 COUPLINGS
PCTS THERMOPLASTIC COUPLINGS
POLARSEAL COUPLINGS
POLARSEAL II COUPLINGS
POWER STEERING
ADAPTERS
QUICK DISCONNECT COUPLERS
BALL VALVES
LIVE SWIVEL
ASSEMBLY FABRICATION
ACCESSORIES
EQUIPMENT AND PARTS
AIR BRAKE
BRASS
KITS

Hydraulic Hose For Stainless Steel Braid Couplings



Also available with MegaTuff® and XraTuff™ cover

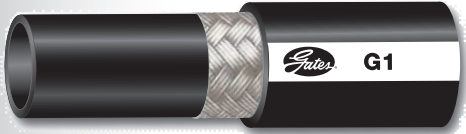

Also available with MegaTuff® and XraTuff™ cover



Also available with MegaTuff® cover



Also available with MegaTuff® and XraTuff™ cover



EQUIPMENT
HOSE/CPLG. SELECTION
G&K COUPLINGS
GLOBAL SPIRAL COUPLINGS
STAINLESS STEEL SPIRAL
MEGACRIMP COUPLINGS
STAINLESS STEEL BRAID
POWER CRIMP COUPLINGS
FIELD ATTACHABLE G1 & G2 COUPLINGS
FIELD ATTACHABLE C5 COUPLINGS
GLX COUPLINGS
GL COUPLINGS
C14 COUPLINGS
PCTS THERMOPLASTIC COUPLINGS
POLARSEAL COUPLINGS
POLARSEAL II COUPLINGS
POWER STEERING
ADAPTERS
QUICK DISCONNECT COUPLERS
BALL VALVES
LIVE SWIVEL
ASSEMBLY FABRICATION
ACCESSORIES
EQUIPMENT AND PARTS
AIR BRAKE
BRASS
KITS

Stainless Steel Braid Couplings

Male Pipe (NPTF - 30° Cone Seat)

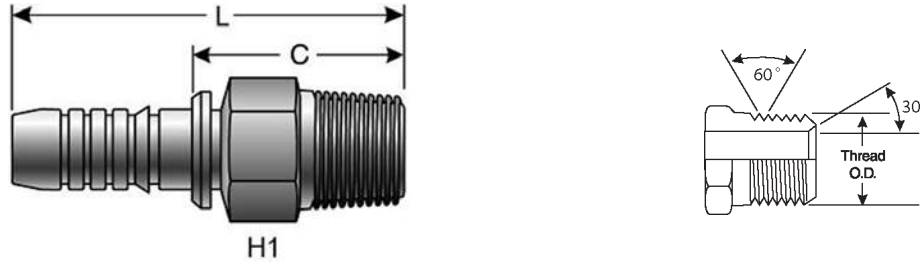

Part No.	Descr.	Prod. No.	⌀		Threads	H1		L		C	
			"	mm		"	mm	"	mm	"	mm
G17100-0404	4B-4MP-SS	7362-00245	1/4	6.4	1/4-18	.56	14.3	2.16	54.9	1.14	29.0
G17100-0606	6B-6MP-SS	7362-00275	3/8	9.5	3/8-18	.68	17.5	2.32	58.9	1.22	31.0
G17100-0808	8B-8MP-SS	7362-00295	1/2	12.7	1/2-14	.88	22.4	2.89	73.4	1.46	37.1
G17100-1212	12B-12MP-SS	7362-00325	3/4	19.1	3/4-14	1.06	27	3.21	81.5	1.51	38.4
G17100-1616	16B-16MP-SS	7362-00355	1	25.4	1-11 1/2	1.38	35	3.62	91.9	1.91	48.6
G17100-2020	20B-20MP-SS	7362-00385	1 1/4	31.8	1 1/4-11 1/2	1.75	44.5	4.44	113.0	2.14	54.6
G17100-2424	24B-24MP-SS	7362-00405	1 1/2	38.1	1 1/2-11 1/2	2	50.8	5.24	133.1	2.34	59.4
G17100-3232	32B-32MP-SS	7362-00425	2	50.8	2-11 1/2	2.50	63.5	6.05	153.7	2.43	61.7

Female JIC 37° Flare Swivel

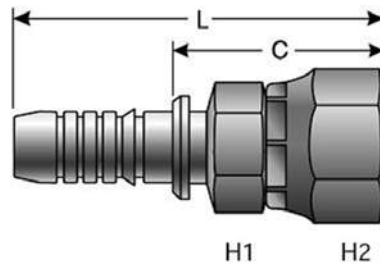

Part No.	Descr.	Prod. No.	⌀		Threads	H1		H2		L		C	
			"	mm		"	mm	"	mm	"	mm	"	mm
G17170-0606	6B-6FJX-SS	7362-01225	3/8	9.5	9/16-18	.62	15.8	.75	19.1	2.35	59.7	1.26	31.8
G17170-1212	12B-12FJX-SS	7362-01315	3/4	19.1	1 1/16-12	1.06	26.9	1.25	31.8	3.41	86.6	1.71	43.4
G17170-1616	16B-16FJX-SS	7362-01375	1	25.4	1 5/16-12	1.37	34.8	1.50	38.1	3.66	92.9	1.95	49.5
G17170-2020	20B-20FJX-SS	7362-01405	1 1/4	31.8	1 5/8-12	1.88	47.6	2	50.8	4.72	119.9	2.42	61.5
G17170-2424	24B-24FJX-SS	7362-01435	1 1/2	38.1	1 7/8-12	2	50.8	2.25	57.2	5.39	136.9	2.50	63.5
G17170-3232	32B-32FJX-SS	7362-01465	2	50.8	2 1/2-12	2.75	69.9	3	76.2	6.48	164.6	2.86	72.6

Stainless Steel Braid Couplings

Female JIC 37° Flare Swivel - 45° Bent Tube

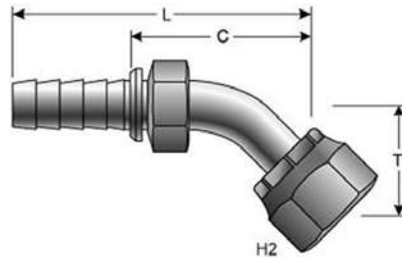

Part No.	Descr.	Prod. No.	⊖		🌀	H2		T		L		C	
			"	mm		"	mm	"	mm	"	mm	"	mm
G17174-0606	6B-6FJX45S-SS	7362-11235	3/8	9.5	9/16-18	.75	19.1	.43	11.0	2.94	74.6	1.84	46.7
G17174-1212	12B-12FJX45S-SS	7362-11345	3/4	19.1	1 1/16-12	1.25	31.8	.83	21.0	5.27	133.8	3.56	90.4

Female JIC 37° Flare Swivel - 90° Bent Tube

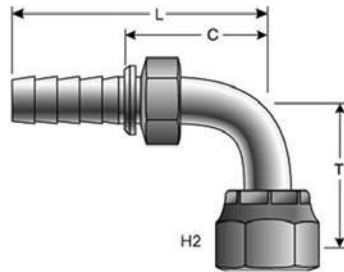

Part No.	Descr.	Prod. No.	⊖		🌀	H2		T		L		C	
			"	mm		"	mm	"	mm	"	mm	"	mm
G17180-0606	6B-6FJX90M-SS	7362-21265	3/8	9.5	9/16-18	.75	19.1	1.50	38.0	2.13	54.1	1.03	26.2
G17180-1212	12B-12FJX90M-SS	7362-21455	3/4	19.1	1 1/16-12	1.25	31.8	2.28	57.9	3.81	96.8	2.11	53.5
G17180-1616	16B-16FJX90M-SS	7362-21555	1	25.4	1 5/16-12	1.50	38.1	2.80	71.0	4.37	110.9	2.66	67.6

Female SAE 45° Flare Swivel

Part No.	Descr.	Prod. No.	⊖		🌀	H1		H2		L		C	
			"	mm		"	mm	"	mm	"	mm	"	mm
G17200-1212	12B-12FSX-SS	7362-01335	3/4	19.1	1 1/16-14	1.06	26.9	1.25	31.8	3.41	86.6	1.71	43.4

EQUIPMENT

HOSE/CPLG. SELECTION

G8K COUPLINGS

GLOBALSPIRAL COUPLINGS

STAINLESS STEEL SPIRAL

MEGACRIMP COUPLINGS

STAINLESS STEEL BRAID

POWER CRIMP COUPLINGS

FIELD ATTACHABLE G1 & G2 COUPLINGS

FIELD ATTACHABLE C5 COUPLINGS

GLX COUPLINGS

GL COUPLINGS

C14 COUPLINGS

PCTS THERMOPLASTIC COUPLINGS

POLARSEAL COUPLINGS

POLARSEAL II COUPLINGS

POWER STEERING

ADAPTERS

QUICK DISCONNECT COUPLERS

BALL VALVES

LIVE SWIVEL

ASSEMBLY FABRICATION

ACCESSORIES

EQUIPMENT AND PARTS

AIR BRAKE

BRASS

KITS

Stainless Steel Braid Couplings

Dual Seat Female JIC 37°/SAE 45° Flare Swivel

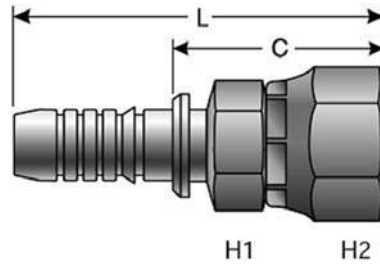

Part No.	Descr.	Prod. No.	⊖		🌀	H1		H2		L		C	
			"	mm		"	mm	"	mm	"	mm	"	mm
G17210-0404	4B-4FJSX-SS	7362-01205	1/4	6.4	7/16-20	.50	12.7	.56	14.2	2.24	57.0	1.21	30.9
G17210-0808	8B-8FJSX-SS	7362-01265	1/2	12.7	3/4-16	.81	20.6	.87	22.1	2.82	71.6	1.38	35.1
G17210-1010	10B-10FJSX-SS	7362-01285	5/8	15.9	7/8-14	.93	23.6	1.06	26.9	3.06	77.7	1.61	41.4

Dual Seat Female JIC 37°/SAE 45° Flare Swivel - 45° Bent Tube

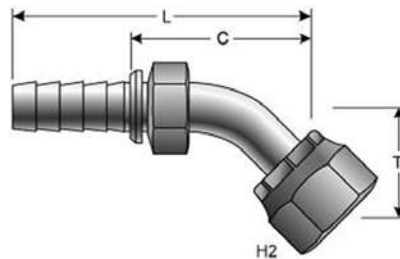

Part No.	Descr.	Prod. No.	⊖		🌀	H2		T		L		C	
			"	mm		"	mm	"	mm	"	mm	"	mm
G17211-0404	4B-4FJSX45S-SS	7362-11205	1/4	6.4	7/16-20	.56	14.2	.39	10.0	2.59	65.7	1.56	39.6
G17211-0808	8B-8FJSX45S-SS	7362-11285	1/2	12.7	3/4-16	.88	22.4	.59	15.0	3.65	92.7	2.22	56.4
G17211-1010	10B-10FJSX45S-SS	7362-11305	5/8	15.9	7/8-14	1.06	26.9	.63	16.0	4.04	102.6	2.60	66.1

Dual Seat Female JIC 37°/SAE 45° Flare Swivel - 90° Bent Tube

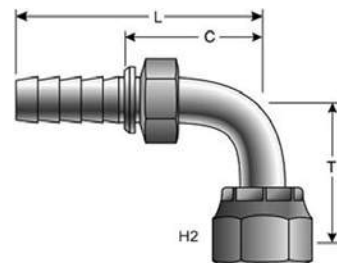

Part No.	Descr.	Prod. No.	⊖		🌀	H2		T		L		C	
			"	mm		"	mm	"	mm	"	mm	"	mm
G17213-0404	4B-4FJSX90M-SS	7362-21215	1/4	6.4	7/16-20	.56	14.2	1.26	32.0	1.92	48.9	.90	22.9
G17213-0808	8B-8FJSX90M-SS	7362-21355	1/2	12.7	3/4-16	.87	22.1	1.61	41.0	2.83	72.0	1.40	35.6

Dual Seat Female JIC 37°/SAE 45° Flare Swivel - 90° Bent Tube - Continued

Part No.	Descr.	Prod. No.	⊖		🌀		H2		T		L		C	
			"	mm	"	mm	"	mm	"	mm	"	mm	"	mm
G17212-1010	10B-10FJSX90S-SS	7362-21395	5/8	15.9	7/8-14	1.06	26.9	1.26	32.0	3.37	85.7	1.93	49.1	
G17213-1010	10B-10FJSX90M-SS	7362-21405	5/8	15.9	7/8-14	1.06	26.9	1.85	47.0	3.06	77.7	1.62	41.2	

Female Flat-Face O-Ring Swivel Metric Hex

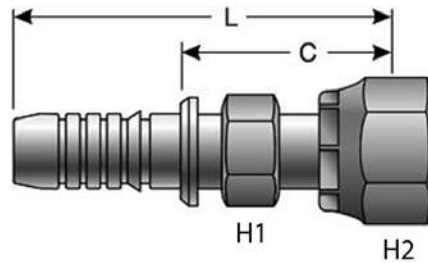

Part No.	Descr.	Prod. No.	⊖		🌀		H1		H2		L		C	
			"	mm	"	mm	"	mm	"	mm	"	mm	"	mm
G17230-0404	4B-4FFORX-SS	7362-03045	1/4	6.4	9/16-18	.55	14	.67	17	2.14	54.5	1.11	28.4	
G17230-0808	8B-8FFORX-SS	7362-03085	1/2	12.7	13/16-16	.87	22.2	.87	24	2.89	73.4	1.46	37.1	
G17230-1010	10B-10FFORX-SS	7362-03105	5/8	15.9	1-14	.94	24	1.18	30	3.09	78.5	1.66	42.1	
G17230-1212	12B-12FFORX-SS	7362-03125	3/4	19.1	1 3/16-12	1.18	30	1.42	36	3.42	87.0	1.72	43.7	
G17230-1616	16B-16FFORX-SS	7362-03145	1	25.4	1 7/16-12	1.42	36	1.61	40.9	3.97	101.0	2.27	57.7	
G17230-2020	20B-20FFORX-SS	7362-03165	1 1/4	31.8	1 11/16-12	1.81	46	1.97	41	4.88	124.0	2.58	65.6	
G17230-2424	24B-24FFORX-SS	7362-03185	1 1/2	38.1	2-12	1.97	50	2.36	60	5.51	140.0	2.61	66.4	

Code 61 O-Ring Flange

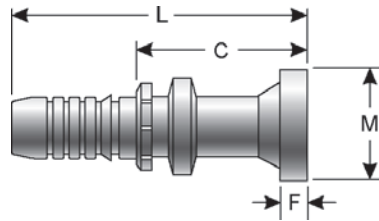

Part No.	Descr.	Prod. No.	⊖		M		L		C		F	
			"	mm	"	mm	"	mm	"	mm	"	mm
G17300-2424	24B-24FL-SS	7362-04475	1 1/2	38.1	2.36	59.9	5.89	149.6	2.99	75.9	.31	7.9
G17300-3232	32B-32FL-SS	7362-04205	2	50.8	2.81	71.4	6.27	159.3	2.65	67.3	.36	9.1

- EQUIPMENT
- HOSE/CPLG. SELECTION
- G8K COUPLINGS
- GLOBALSPIRAL COUPLINGS
- STAINLESS STEEL SPIRAL
- MEGACRIMP COUPLINGS
- STAINLESS STEEL BRAID
- POWER CRIMP COUPLINGS
- FIELD ATTACHABLE G1 & G2 COUPLINGS
- FIELD ATTACHABLE C5 COUPLINGS
- GLX COUPLINGS
- GL COUPLINGS
- C14 COUPLINGS
- PCTS THERMOPLASTIC COUPLINGS
- POLARSEAL COUPLINGS
- POLARSEAL II COUPLINGS
- POWER STEERING
- ADAPTERS
- QUICK DISCONNECT COUPLERS
- BALL VALVES
- LIVE SWIVEL
- ASSEMBLY FABRICATION
- ACCESSORIES
- EQUIPMENT AND PARTS
- AIR BRAKE
- BRASS
- KITS

Stainless Steel Braid Couplings

Non-Skive Ferrule

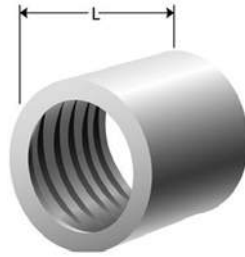

Part No.	Descr.	Prod. No.	⊕		L	
			"	mm	"	mm
G17995-0104	4B1F-1SS	7362-51305	1/4	6.4	1.25	31.8
G17995-0106	6B1F-1SS	7362-51425	3/8	9.5	1.20	30.5
G17995-0204	4B1F-2SS	7362-51415	1/4	6.4	1.04	26.3
G17995-0206	6B1F-2SS	7362-51435	3/8	9.5	1.20	30.5
G17995-0208	8B1F-1SS	7362-51465	1/2	12.7	1.47	37.3
G17995-0210	10B1F-1SS	7362-51475	5/8	15.9	1.47	37.3
G17995-0212D	12B1F-2SS	7362-51565	3/4	19.1	1.65	42.0
G17995-0212	12B1F-1SS	7362-51505	3/4	19.1	1.69	42.9
G17995-0216D	16B1F-2SS	7362-51885	1	25.4	1.97	50.0
G17995-0216	16B1F-3SS	7362-51865	1	25.4	1.69	43.0
G17995-0220	20B1F-1SS	7362-51545	1 1/4	31.8	2.41	61.2
G17995-0224	24B1F-2SS	7362-51665	1 1/2	38.1	2.98	75.8
G17995-0232	32B1F-2SS	7362-51705	2	50.8	3.54	90.0
G17995-0424	24B1F-4SS	7362-51675	1 1/2	38.1	3.01	76.5
G17995-0432	32B1F-4SS	7362-51725	2	50.8	3.58	91.0

EQUIPMENT
HOSE/CPLG. SELECTION
G8K COUPLINGS
GLOBALSPIRAL COUPLINGS
STAINLESS STEEL SPIRAL
MEGACRIMP COUPLINGS
STAINLESS STEEL BRAID
POWER CRIMP COUPLINGS
FIELD ATTACHABLE G1 & G2 COUPLINGS
FIELD ATTACHABLE C5 COUPLINGS
GLX COUPLINGS
GL COUPLINGS
C14 COUPLINGS
PCTS THERMOPLASTIC COUPLINGS
POLARSEAL COUPLINGS
POLARSEAL II COUPLINGS
POWER STEERING
ADAPTERS
QUICK DISCONNECT COUPLERS
BALL VALVES
LIVE SWIVEL
ASSEMBLY FABRICATION
ACCESSORIES
EQUIPMENT AND PARTS
AIR BRAKE
BRASS
KITS

Hydraulic Hose For Power Crimp® Couplings

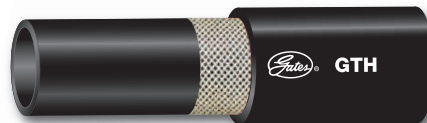
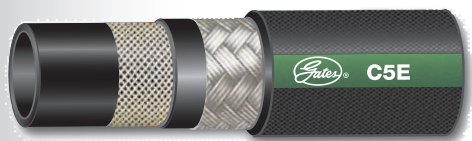

Also available with MegaTuff® cover

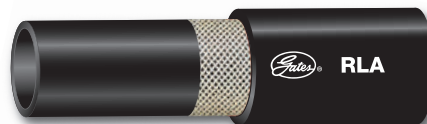

The Gates eCrimp program is a web based utility which allows users and distributors of Gates hydraulic and industrial hose products to find and print the most up to date crimp specifications with nothing more than an internet browser.

This program can be used to find crimp data for the MobileCrimp 4-20, PC 707, SC32, PC 3000B, GC32-XD™ Global Hose Crimper, GC96 and Omni Crimp 21. Custom result may be printed by selecting the crimper, hose and coupling. Optionally results may also be limited by die set and working pressure.



The eCrimp mobile app gives you all the same features of the online version in the palm of your hands. Use the app to find the most up-to-date crimp specifications quickly and easily. It is available for download for the iPhone and iPad from the App Store.

EQUIPMENT
HOSE/CPLG. SELECTION
G8K COUPLINGS
GLOBALSPIRAL COUPLINGS
STAINLESS STEEL SPIRAL
MEGACRIMP COUPLINGS
STAINLESS STEEL BRAID
POWER CRIMP COUPLINGS
FIELD ATTACHABLE G1 & G2 COUPLINGS
FIELD ATTACHABLE C5 COUPLINGS
GLX COUPLINGS
GL COUPLINGS
C14 COUPLINGS
PCTS THERMOPLASTIC COUPLINGS
POLARSEAL COUPLINGS
POLARSEAL II COUPLINGS
POWER STEERING
ADAPTERS
QUICK DISCONNECT COUPLERS
BALL VALVES
LIVE SWIVEL
ASSEMBLY FABRICATION
ACCESSORIES
EQUIPMENT AND PARTS
AIR BRAKE
BRASS
KITS

EQUIPMENT
HOSE/CPLG. SELECTION
G8K COUPLINGS
GLOBALSPIRAL COUPLINGS
STAINLESS STEEL SPIRAL
MEGACRIMP COUPLINGS
STAINLESS STEEL BRAID
POWER CRIMP COUPLINGS
FIELD ATTACHABLE G1 & G2 COUPLINGS
FIELD ATTACHABLE C5 COUPLINGS
GLX COUPLINGS
GL COUPLINGS
C14 COUPLINGS
PCTS THERMOPLASTIC COUPLINGS
POLARSEAL COUPLINGS
POLARSEAL II COUPLINGS
POWER STEERING
ADAPTERS
QUICK DISCONNECT COUPLERS
BALL VALVES
LIVE SWIVEL
ASSEMBLY FABRICATION
ACCESSORIES
EQUIPMENT AND PARTS
AIR BRAKE
BRASS
KITS

Male Pipe (NPTF - 30° Cone Seat)



Part No.	Descr.	Prod. No.	⊖		H1	L		C		
			"	mm		"	mm	"	mm	
80001	3-2MP	7334-36215	3/16	4.8	1/8-27	1/2	2.03	51.6	.94	23.9
80002	3-4MP	7334-36245	3/16	4.8	1/4-18	9/16	2.22	56.4	1.13	28.7

Male Special Grease Fitting

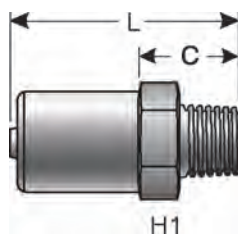

Part No.	Descr.	Prod. No.	⊖		H1	L		C		
			"	mm		"	mm	"	mm	
80120	3-2MPG	7334-32445	3/16	4.8	1/8-27	9/16	1.34	34.0	.56	14.2
80140	3-2MPGB	7334-37925	3/16	4.8	1/8-27	9/16	1.34	34.0	.78	19.8

Male Pipe Swivel (NPTF - Without 30° Cone Seat)

NOT TO BE USED AS A LIVE SWIVEL.

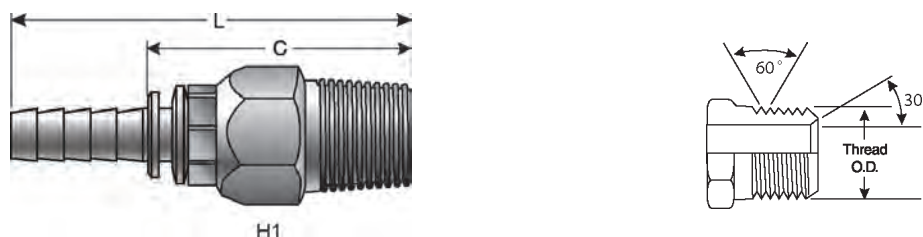

Part No.	Descr.	Prod. No.	⊖		H1	L		C		
			"	mm		"	mm	"	mm	
80031	3-2MPX	7334-36335	3/16	4.8	1/8-27	1/2	2.40	61.0	1.31	33.3

Female Pipe (NPTF - Without 30° Cone Seat)



Part No.	Descr.	Prod. No.	⊖		H1	L		C		
			"	mm		"	mm	"	mm	
80061	3-2FP	7334-36225	3/16	4.8	1/8-27	9/16	1.85	47.0	.76	19.3

Male JIC 37° Flare

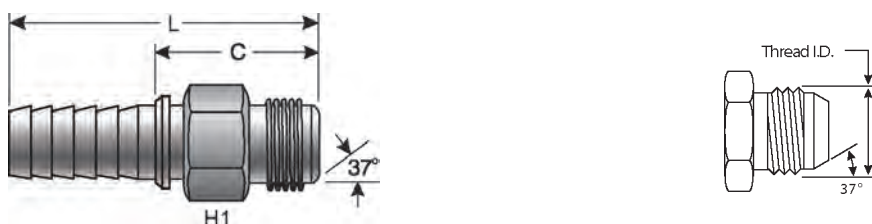

Part No.	Descr.	Prod. No.	⊖		H1	L		C		
			"	mm		"	mm	"	mm	
80181	3-4MJ	7334-36235	3/16	4.8	7/16-20	1/2	2.09	53.1	1.00	25.4

Female JIC 37° Flare Swivel

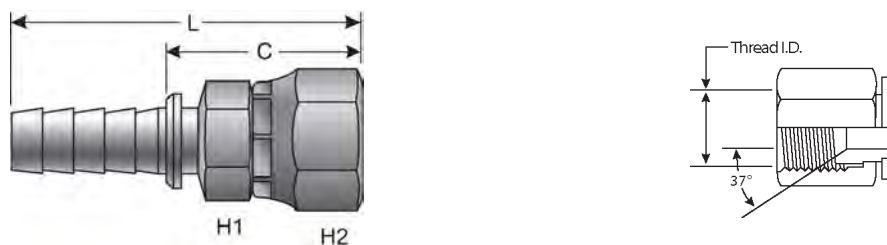

Part No.	Descr.	Prod. No.	⊖		H1	H2	L		C	
			"	mm			"	mm	"	mm
80131	3-3FJX	7334-36315	3/16	4.8	1/2	9/16	2.20	55.9	1.11	28.2
80132	3-4FJX	7334-36325	3/16	4.8	1/2	9/16	2.21	56.1	1.12	28.5

- EQUIPMENT
- HOSE/CPLG. SELECTION
- G8K COUPLINGS
- GLOBALSPIRAL COUPLINGS
- STAINLESS STEEL SPIRAL
- MEGACRIMP COUPLINGS
- STAINLESS STEEL BRAID
- POWER CRIMP COUPLINGS**
- FIELD ATTACHABLE G1 & G2 COUPLINGS
- FIELD ATTACHABLE C5 COUPLINGS
- GLX COUPLINGS
- GL COUPLINGS
- C14 COUPLINGS
- PCTS THERMOPLASTIC COUPLINGS
- POLARSEAL COUPLINGS
- POLARSEAL II COUPLINGS
- POWER STEERING
- ADAPTERS
- QUICK DISCONNECT COUPLERS
- BALL VALVES
- LIVE SWIVEL
- ASSEMBLY FABRICATION
- ACCESSORIES
- EQUIPMENT AND PARTS
- AIR BRAKE
- BRASS
- KITS

EQUIPMENT
HOSE/CPLG. SELECTION
G8K COUPLINGS
GLOBALSPIRAL COUPLINGS
STAINLESS STEEL SPIRAL
MEGACRIMP COUPLINGS
STAINLESS STEEL BRAID
POWER CRIMP COUPLINGS
FIELD ATTACHABLE G1 & G2 COUPLINGS
FIELD ATTACHABLE C5 COUPLINGS
GLX COUPLINGS
GL COUPLINGS
C14 COUPLINGS
PCTS THERMOPLASTIC COUPLINGS
POLARSEAL COUPLINGS
POLARSEAL II COUPLINGS
POWER STEERING
ADAPTERS
QUICK DISCONNECT COUPLERS
BALL VALVES
LIVE SWIVEL
ASSEMBLY FABRICATION
ACCESSORIES
EQUIPMENT AND PARTS
AIR BRAKE
BRASS
KITS

Female JIC 37° Flare Swivel - 45° Bent Tube

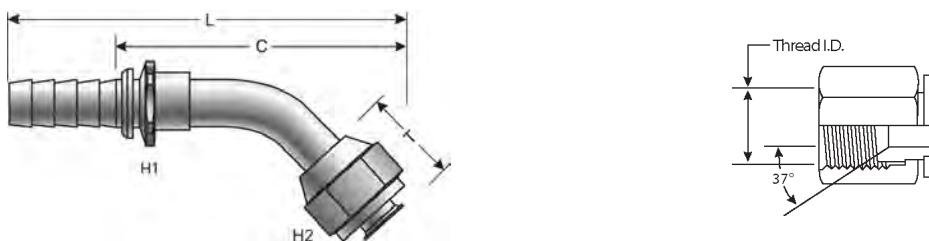

Part No.	Descr.	Prod. No.	⊖		7/16-20	H1	H2	T		L		C	
			"	mm				"	mm	"	mm	"	mm
83105	3C2-4FJX45S	7303-01005	3/16	4.8	7/16-20	1/2	9/16	.33	8.4	2.80	71.1	1.71	43.4

Female JIC 37° Flare Swivel - 90° Bent Tube

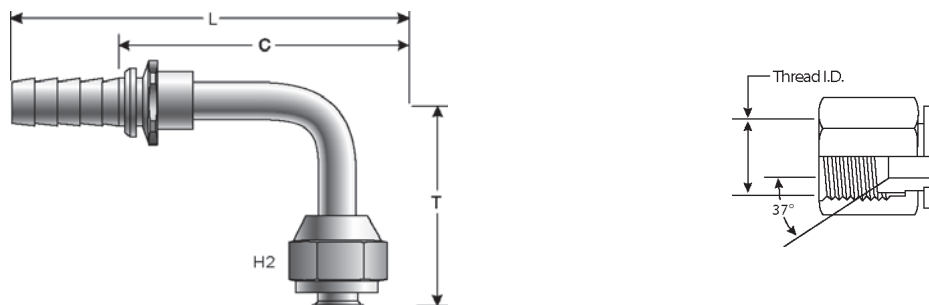

Part No.	Descr.	Prod. No.	⊖		7/16-20	H2	T		L		C	
			"	mm			"	mm	"	mm	"	mm
83125	3C2-4FJX90S	7303-01505	3/16	4.8	7/16-20	9/16	.68	17.3	2.54	64.5	1.45	36.8

Female Flat-Face O-Ring Swivel

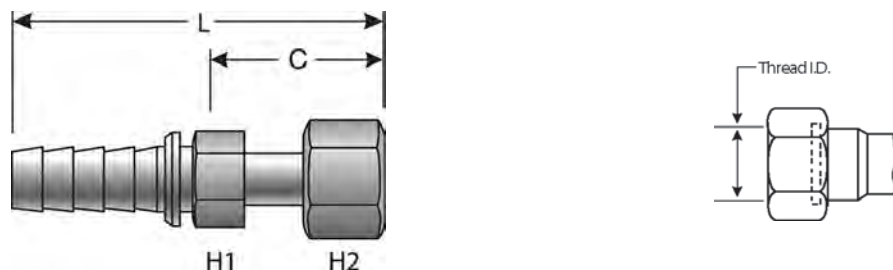

Part No.	Descr.	Prod. No.	⊖		11/16-16	H1	H2	L		C	
			"	mm				"	mm	"	mm
83603	3C2-6FFORX	7303-05945	3/16	4.8	11/16-16	5/8	13/16	2.63	66.8	1.54	39.1

SAE Male Inverted Swivel

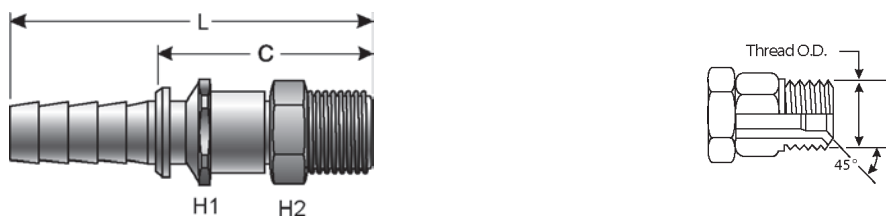

Part No.	Descr.	Prod. No.	⊖		🌀	H1	H2	L		C	
			"	mm				"	mm	"	mm
83301	3C2-3MIX	7303-02995	3/16	4.8	3/8-24	1/2	3/8	2.67	67.8	1.58	40.1

SAE Male Inverted Swivel - 45° Bent Tube

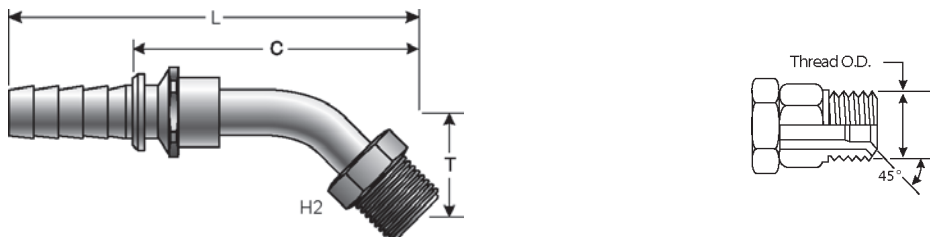

Part No.	Descr.	Prod. No.	⊖		🌀	H2	T	L		C		
			"	mm				"	mm	"	mm	
83302	3C2-3MIX45S	7303-03205	3/16	4.8	3/8-24	3/8	.58	14.7	2.78	70.6	1.69	42.9

SAE Male Inverted Swivel - 90° Bent Tube

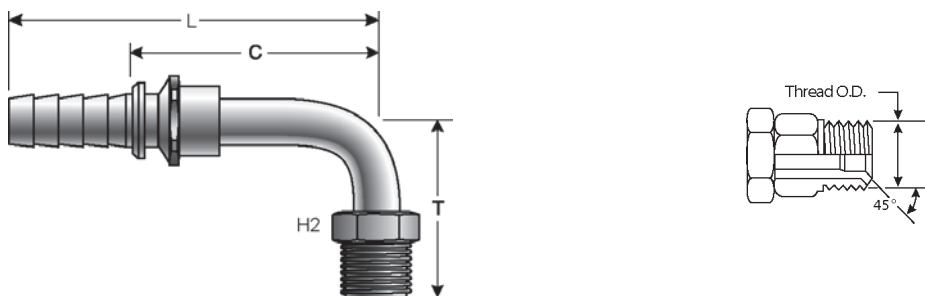

Part No.	Descr.	Prod. No.	⊖		🌀	H2	T	L		C		
			"	mm				"	mm	"	mm	
83303	3C2-3MIX90S	7303-03495	3/16	4.8	3/8-24	3/8	1.05	26.7	2.42	61.5	1.33	33.8

- EQUIPMENT
- HOSE/CPLG. SELECTION
- G8K COUPLINGS
- GLOBALSPIRAL COUPLINGS
- STAINLESS STEEL SPIRAL
- MEGACRIMP COUPLINGS
- STAINLESS STEEL BRAID
- POWER CRIMP COUPLINGS**
- FIELD ATTACHABLE G1 & G2 COUPLINGS
- FIELD ATTACHABLE C5 COUPLINGS
- GLX COUPLINGS
- GL COUPLINGS
- C14 COUPLINGS
- PCTS THERMOPLASTIC COUPLINGS
- POLARSEAL COUPLINGS
- POLARSEAL II COUPLINGS
- POWER STEERING
- ADAPTERS
- QUICK DISCONNECT COUPLERS
- BALL VALVES
- LIVE SWIVEL
- ASSEMBLY FABRICATION
- ACCESSORIES
- EQUIPMENT AND PARTS
- AIR BRAKE
- BRASS
- KITS

Female Braze-On Stems

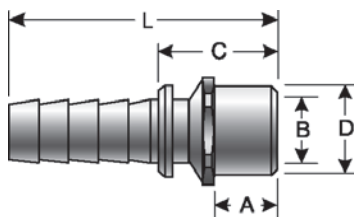

Part No.	Descr.	Prod. No.	⌀		B	A	D		L		C	
			"	mm			"	mm	"	mm	"	mm
80410	3-4FBO	7305-09135	3/16	4.8	.25	1/4	.56	14.22	1.76	44.7	.68	17.3
80401	4-4FBO	7305-09145	1/4	6.4	.25	1/4	.56	14.22	1.67	42.4	.58	14.7
80402	4-5FBO	7305-09165	1/4	6.4	.32	3/8	.56	14.22	1.67	42.4	.58	14.7
80403	6-6FBO	7334-36755	3/8	9.5	.38	3/8	.75	19.05	1.72	43.7	.70	17.8
80400	6-8FBO	7305-29165	3/8	9.5	.50	3/8	.88	22.35	1.72	43.7	.70	17.8
80404	8-8FBO	7305-39145	1/2	12.7	.50	3/8	.88	22.35	2.20	55.9	.76	19.3
80405	8-10FBO	7305-39165	1/2	12.7	.63	3/8	.88	22.35	2.20	55.9	.76	19.3
80406	12-12FBO	7305-59145	3/4	19.1	.75	3/8	1.12	28.45	2.47	62.7	.76	19.3
80407	12-16FBO	7305-59165	3/4	19.1	1.01	15/32	1.38	35.05	2.75	69.9	1.04	26.4
80408	16-16FBO	7305-69145	1	25.4	1.01	15/32	1.38	35.05	2.75	69.9	1.04	26.4
80409	20-20FBO	7305-79145	1 1/4	31.8	1.26	3/8	1.81	45.97	3.29	83.6	1.11	28.2
80411	24-24FBO	7305-89145	1 1/2	38.1	1.51	3/8	2.00	50.80	3.75	95.3	1.11	28.2

Female DIN 24° Cone Swivel - Light Series

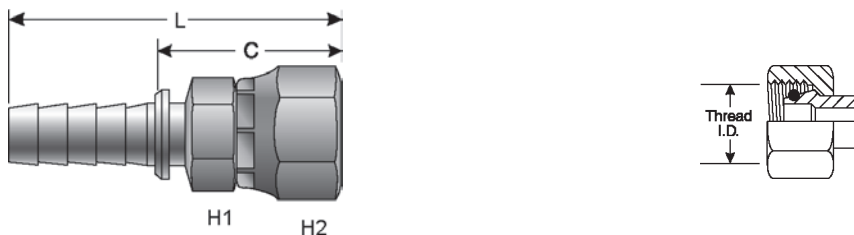

Part No.	Descr.	Prod. No.	⌀		M	H1	H2	L		C		I/O
			"	mm				"	mm	"	mm	
83709	3C2-6FDLX	7303-08195	3/16	4.8	M12X1.5	14	14	2.20	55.9	1.11	28.2	6.0

Female DIN 24° Cone Swivel - Light Series - 90° Bent Tube

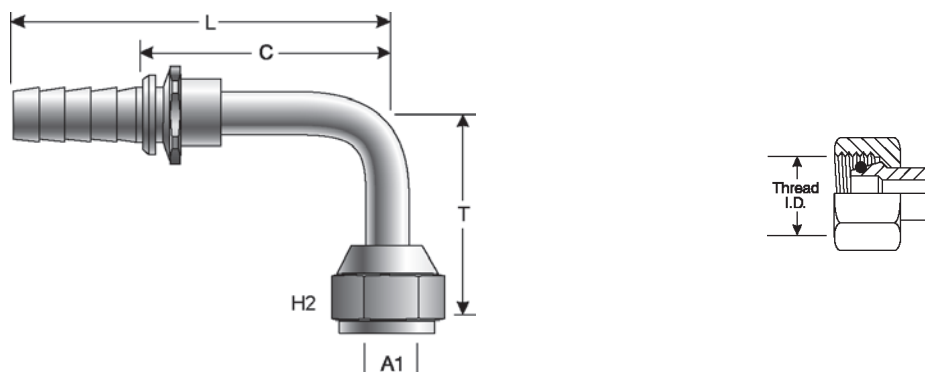

Part No.	Descr.	Prod. No.	⊖		M12X1.5	H2	T		L		C		A1
			"	mm			"	mm	"	mm	"	mm	
83740	3C2-6FDLX90	7303-08205	3/16	4.8	M12X1.5	14	1.26	32.0	2.52	64.0	1.43	36.3	6.0

Power Crimp® Two Ferrules (Steel) - PC2F Series

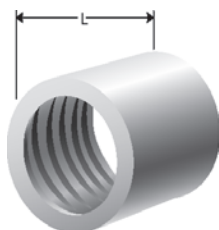

Part No.	Descr.	Prod. No.	L		⊖	
			"	mm	"	mm
80415	3PC2F-2	7266-00075	1.00	25.4	.76	19.3
80416	4PC2F-2	7266-00345	1.00	25.4	.84	21.3
80461	4PC2F-4	7266-00395	1.20	30.5	.89	22.6
80417	5PC2F-2	7266-00385	1.00	25.4	.87	22.1
80418	6PC2F-2	7266-00335	1.00	25.4	.94	23.9
80462	6PC2F-4	7266-00405	1.20	30.5	1.06	26.9
80419	8PC2F-2	7266-00025	1.25	31.8	1.13	28.7
80463	8PC2F-4	7266-00415	1.47	37.3	1.28	32.5
80476	10PC2F-2B	7266-00465	1.47	37.3	1.32	33.5
80447	10PC2F-2C	7266-08105	1.25	31.8	1.23	31.2
80423	12PC2F-2	7266-00185	1.47	37.3	1.50	38.1
80422	12PC2F-4	7266-00145	1.97	50.0	1.38	35.1
80424	16PC2F-2	7266-00135	1.97	50.0	1.75	44.5
80425	16PC2F-4	7266-00175	2.07	52.6	1.87	47.5
80427	20PC2F-2	7266-00225	2.35	59.7	2.25	57.2
80426	20PC2F-4	7266-00215	2.77	70.4	2.19	55.6
80428	24PC2F-4	7266-00355	2.88	73.2	2.55	64.8
80429	32PC2F-4	7266-00375	3.43	87.1	3.16	80.3

- EQUIPMENT
- HOSE/CPLG. SELECTION
- G8K COUPLINGS
- GLOBALSPIRAL COUPLINGS
- STAINLESS STEEL SPIRAL
- MEGACRIMP COUPLINGS
- STAINLESS STEEL BRAID
- POWER CRIMP COUPLINGS**
- FIELD ATTACHABLE G1 & G2 COUPLINGS
- FIELD ATTACHABLE C5 COUPLINGS
- GLX COUPLINGS
- GL COUPLINGS
- C14 COUPLINGS
- PCTS THERMOPLASTIC COUPLINGS
- POLARSEAL COUPLINGS
- POLARSEAL II COUPLINGS
- POWER STEERING
- ADAPTERS
- QUICK DISCONNECT COUPLERS
- BALL VALVES
- LIVE SWIVEL
- ASSEMBLY FABRICATION
- ACCESSORIES
- EQUIPMENT AND PARTS
- AIR BRAKE
- BRASS
- KITS

Power Crimp® One Non-Skive Ferrules (Steel) - PC1FS Series

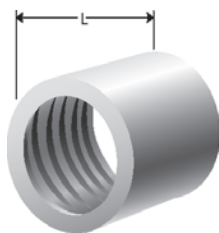

Part No.	Descr.	Prod. No.	L		Ø	
			"	mm	"	mm
80481	3PC1FS	7266-07035	1.20	30.5	.83	21.1
80584	4M3KPC	7266-07805	1.20	30.5	.89	22.6
80468	4PC1F-M2S	7266-07635	1.20	30.5	.83	21.1
80482	4PC1FS	7266-07045	1.28	32.5	.87	22.1
80483	5PC1FS	7266-07055	1.20	30.5	.97	24.6
80585	6M3KPC	7266-07815	1.20	30.5	.97	24.6
81512	6PC1F-M2S	7266-07375	1.20	30.5	1.06	26.9
80484	6PC1FS	7266-07065	1.20	30.5	.96	24.4
80586	8M3KPC	7266-07825	1.50	38.1	1.15	29.2
80474	8PC1F-M2S	7266-07395	1.47	37.3	1.20	30.5
80485	8PC1FS	7266-07085	1.47	37.3	1.15	29.2
80477	10PC1F-M2S	7266-07415	1.47	37.3	1.31	33.3
80486	10PC1FS-M3K	7266-07105	1.49	37.9	1.21	30.7
80475	12PC1F-M2S	7266-07435	1.69	42.9	1.57	39.9
80487	12PC1FS-M3K	7266-07125	1.69	42.9	1.53	38.9
80480	16PC1F-M2S	7266-07475	1.69	42.9	1.94	49.3
80488	16PC1FS	7266-07165	1.69	42.9	1.32	33.5
80489	20PC1FS	7266-07205	2.41	61.2	2.38	60.5
80489X	20PC1FSX BULK	7266-0720	2.41	61.2	2.38	60.5
80491	24PC1FS	7266-07245	2.69	68.3	2.69	68.3
80492	32PC1FS	7266-07325	3.56	90.4	3.25	82.6

EQUIPMENT
HOSE/CPLG. SELECTION
G8K COUPLINGS
GLOBALSPIRAL COUPLINGS
STAINLESS STEEL SPIRAL
MEGACRIMP COUPLINGS
STAINLESS STEEL BRAID
POWER CRIMP COUPLINGS
FIELD ATTACHABLE G1 & G2 COUPLINGS
FIELD ATTACHABLE C5 COUPLINGS
GLX COUPLINGS
GL COUPLINGS
C14 COUPLINGS
PCTS THERMOPLASTIC COUPLINGS
POLARSEAL COUPLINGS
POLARSEAL II COUPLINGS
POWER STEERING
ADAPTERS
QUICK DISCONNECT COUPLERS
BALL VALVES
LIVE SWIVEL
ASSEMBLY FABRICATION
ACCESSORIES
EQUIPMENT AND PARTS
AIR BRAKE
BRASS
KITS

Field Attachable Type T for G1 Hose [1 Wire]

Male Pipe (NPTF - 30° Cone Seat)



Part No.	Descr.	Prod. No.	⊖		🌀	H1	L		C	
			"	mm			"	mm	"	mm
G27100-0402	4C1T-2RMP	7231-81241	1/4	6.4	1/8-27	1/2	2.30	58.4	1.29	32.8
G27100-0404	4C1T-4RMP	7231-81210	1/4	6.4	1/4-18	9/16	2.52	64.0	1.51	38.4
G27100-0604	6C1T-4RMP	7231-81242	3/8	9.5	1/4-18	9/16	2.68	68.1	1.54	39.1
G27100-0606	6C1T-6RMP	7231-81211	3/8	9.5	3/8-18	11/16	2.53	64.3	1.39	35.3
G27100-0806	8C1T-6RMP	7231-81243	1/2	12.7	3/8-18	11/16	3.05	77.5	1.70	43.2
G27100-0808	8C1T-8RMP	7231-81212	1/2	12.7	1/2-14	7/8	3.06	77.7	1.71	43.4
G27100-0812	8C1T-12RMP	7231-81244	1/2	12.7	3/4-14	1 1/16	3.13	79.5	1.87	47.5
G27100-1212	12C1T-12RMP	7231-81213	3/4	19.1	3/4-14	1 1/16	3.19	81.0	1.73	43.9
G27100-1616	16C1T-16RMP	7231-81214	1	25.4	1-11 1/2	1 3/8	3.78	96.0	2.10	53.3

Male Pipe Swivel (NPTF - Without 30° Cone Seat)

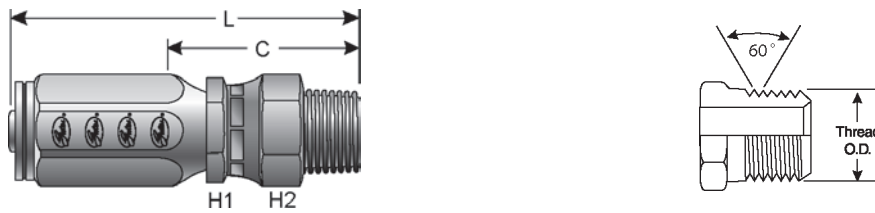

Part No.	Descr.	Prod. No.	⊖		🌀	H1	H2	L		C	
			"	mm				"	mm	"	mm
G27105-0404	4C1T-4RMPX	7231-22445	1/4	6.4	1/4-18	7/16	7/8	3.18	80.8	2.17	55.1
G27105-0606	6C1T-6RMPX	7231-22455	3/8	9.5	3/8-18	5/8	7/8	3.51	89.2	2.23	56.6
G27105-0808	8C1T-8RMPX	7231-22465	1/2	12.7	1/2-14	3/4	1	3.99	101.4	2.63	66.8
G27105-1212	12C1T-12RMPX	7231-22475	3/4	19.1	3/4-14	1 1/16	1 5/16	4.27	108.5	2.73	69.3

Male O-Ring Boss



Part No.	Descr.	Prod. No.	⊖		🌀	H1	L		C	
			"	mm			"	mm	"	mm
G27120-0606	6C1T-6RMB	7231-22255	3/8	9.5	9/16-18	11/16	2.52	64.0	1.24	31.5

EQUIPMENT
HOSE/CPLG. SELECTION
G8K COUPLINGS
GLOBALSPIRAL COUPLINGS
STAINLESS STEEL SPIRAL
MEGACRIMP COUPLINGS
STAINLESS STEEL BRAID
POWER CRIMP COUPLINGS
FIELD ATTACHABLE G1 & G2 COUPLINGS
FIELD ATTACHABLE C5 COUPLINGS
GLX COUPLINGS
GL COUPLINGS
C14 COUPLINGS
PCTS THERMOPLASTIC COUPLINGS
POLARSEAL COUPLINGS
POLARSEAL II COUPLINGS
POWER STEERING
ADAPTERS
QUICK DISCONNECT COUPLERS
BALL VALVES
LIVE SWIVEL
ASSEMBLY FABRICATION
ACCESSORIES
EQUIPMENT AND PARTS
AIR BRAKE
BRASS
KITS

Field Attachable Type T for G1 Hose [1 Wire]

Male O-Ring Boss - Continued

Part No.	Descr.	Prod. No.	⊖		H1	L		C		
			"	mm		"	mm	"	mm	
G27120-0608	6C1T-8RMB	7231-22265	3/8	9.5	3/4-16	7/8	2.59	65.8	1.32	33.5
G27120-0808	8C1T-8RMB	7231-22275	1/2	12.7	3/4-16	7/8	2.87	72.9	1.52	38.6
G27120-0810	8C1T-10RMB	7231-22285	1/2	12.7	7/8-14	1	3.11	79.0	1.76	44.7

Male JIC 37° Flare



Part No.	Descr.	Prod. No.	⊖		H1	L		C		
			"	mm		"	mm	"	mm	
G27165-0606	6C1T-6RMJ	7231-22185	3/8	9.5	9/16-18	9/16	2.68	68.1	1.40	35.6
G27165-0808	8C1T-8RMJ	7231-22195	1/2	12.7	3/4-16	3/4	3.05	77.5	1.70	43.2
G27165-0810	8C1T-10RMJ	7231-22205	1/2	12.7	7/8-14	7/8	3.31	84.1	1.96	49.9
G27165-1212	12C1T-12RMJ	7231-22215	3/4	19.1	1 1/16-12	1 1/16	3.52	89.4	1.98	50.3

Female JIC 37° Flare Swivel



Part No.	Descr.	Prod. No.	⊖		H1	H2	L		C		
			"	mm			"	mm	"	mm	
G27170-0404	4C1T-4RFJX	7231-81215	1/4	6.4	7/16-20	9/16	9/16	2.47	62.7	1.46	37.1
G27170-0405	4C1T-5RFJX	7231-81216	1/4	6.4	1/2-20	11/16	11/16	2.58	65.5	1.57	39.9
G27170-0606	6C1T-6RFJX	7231-81217	3/8	9.5	9/16-18	3/4	3/4	2.80	71.1	1.65	41.9
G27170-0608	6C1T-8RFJX	7231-81218	3/8	9.5	3/4-16	3/4	7/8	2.91	73.9	1.76	44.7
G27170-0808	8C1T-8RFJX	7231-81219	1/2	12.7	3/4-16	13/16	7/8	3.24	82.3	1.89	48.1
G27170-0810	8C1T-10RFJX	7231-81220	1/2	12.7	7/8-14	13/16	1 1/16	3.34	84.8	1.99	50.6
G27170-1212	12C1T-12RFJX	7231-81221	3/4	19.1	1 1/16-12	1 1/8	1 1/4	3.45	87.6	1.91	48.5
G27170-1616	16C1T-16RFJX	7231-81222	1	25.4	1 5/16-12	1 3/8	1 1/2	3.90	99.1	2.22	56.4

Field Attachable Type T for G1 Hose [1 Wire]

Female JIC 37° Flare Swivel - 45° Bent Tube

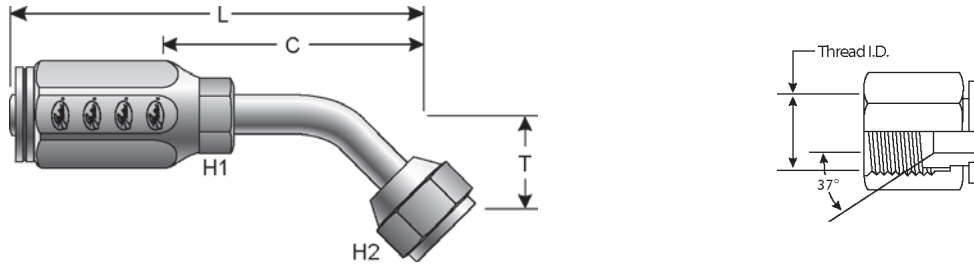

Part No.	Descr.	Prod. No.	⊖		🌀	H1	H2	T		L		C	
			"	mm				"	mm	"	mm	"	mm
G27175-0404	4C1T-4RFJX45	7231-22545	1/4	6.4	7/16-20	3/8	9/16	.33	8.4	2.80	71.1	1.79	45.5
G27175-0606	6C1T-6RFJX45	7231-22555	3/8	9.5	9/16-18	1/2	11/16	.39	9.9	3.37	85.6	1.79	45.5
G27175-0808	8C1T-8RFJX45	7231-22565	1/2	12.7	3/4-16	5/8	7/8	.55	14.0	4.11	104.4	2.10	53.3
G27175-1212	12C1T-12RFJX45	7231-22575	3/4	19.1	1 1/16-12	1 1/4	1 1/4	.78	19.8	4.70	119.4	3.16	80.3

Female JIC 37° Flare Swivel - 90° Bent Tube

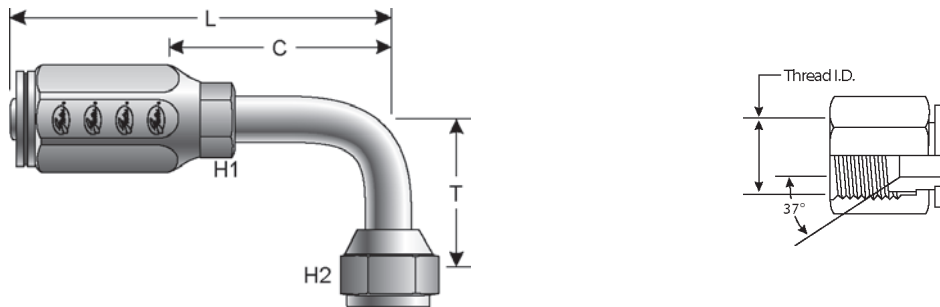

Part No.	Descr.	Prod. No.	⊖		🌀	H1	H2	T		L		C	
			"	mm				"	mm	"	mm	"	mm
G27180-0404	4C1T-4RFJX90	7231-22655	1/4	6.4	7/16-20	3/8	9/16	.68	17.3	2.69	68.3	1.68	42.7
G27180-0606	6C1T-6RFJX90	7231-22665	3/8	9.5	9/16-18	1/2	11/16	.85	21.6	3.28	83.3	2.00	50.8
G27180-0608	6C1T-6RFJX90	7231-22675	3/8	9.5	3/4-16	5/8	7/8	1.09	27.7	3.58	90.9	2.31	58.7
G27180-0808	8C1T-8RFJX90	7231-22685	1/2	12.7	3/4-16	5/8	7/8	1.09	27.7	3.86	98.1	2.51	63.8
G27180-0810	8C1T-10RFJX90	7231-22695	1/2	12.7	7/8-14	3/4	1	1.23	31.2	3.92	99.6	2.59	65.8
G27180-1212	12C1T-12RFJX90	7231-22705	3/4	19.1	1 1/16-12	1 1/4	1 1/4	1.82	46.2	4.59	116.6	3.05	77.5

- EQUIPMENT
- HOSE/CPLG. SELECTION
- G8K COUPLINGS
- GLOBALSPIRAL COUPLINGS
- STAINLESS STEEL SPIRAL
- MEGACRIMP COUPLINGS
- STAINLESS STEEL BRAID
- POWER CRIMP COUPLINGS
- FIELD ATTACHABLE G1 & G2 COUPLINGS**
- FIELD ATTACHABLE C5 COUPLINGS
- GLX COUPLINGS
- GL COUPLINGS
- C14 COUPLINGS
- PCTS THERMOPLASTIC COUPLINGS
- POLARSEAL COUPLINGS
- POLARSEAL II COUPLINGS
- POWER STEERING
- ADAPTERS
- QUICK DISCONNECT COUPLERS
- BALL VALVES
- LIVE SWIVEL
- ASSEMBLY FABRICATION
- ACCESSORIES
- EQUIPMENT AND PARTS
- AIR BRAKE
- BRASS
- KITS

Field Attachable Type T for G2 Hose [2 Wire]

Male Pipe (NPTF - 30° Cone Seat)



Part No.	Descr.	Prod. No.	⊖		H1	L		C		
			"	mm		"	mm	"	mm	
G28100-0402	4C2AT-2RMP	7231-81247	1/4	6.4	1/8-27	1/2	2.30	58.4	1.23	31.2
G28100-0404	4C2AT-4RMP	7231-81223	1/4	6.4	1/4-18	9/16	2.52	64.0	1.45	36.8
G28100-0604	6C2AT-4RMP	7231-81248	3/8	9.5	1/4-18	9/16	2.68	68.1	1.45	36.8
G28100-0606	6C2AT-6RMP	7231-81224	3/8	9.5	3/8-18	11/16	2.53	64.3	1.30	33.0
G28100-0806	8C2AT-6RMP	7231-81249	1/2	12.7	3/8-18	11/16	3.05	77.5	1.63	41.4
G28100-0808	8C2AT-8RMP	7231-81225	1/2	12.7	1/2-14	7/8	3.06	77.7	1.64	41.7
G28100-0812	8C2AT-12RMP	7231-81251	1/2	12.7	3/4-14	1 1/16	3.13	79.5	1.71	43.4
G28100-1212	12C2AT-12RMP	7231-81226	3/4	19.1	3/4-14	1 1/16	3.19	81.0	1.65	41.9
G28100-1616	16C2AT-16RMP	7231-81227	1	25.4	1-11 1/2	1 3/8	3.78	96.0	2.04	51.8
G28100-2020	20C2AT-20RMP	7231-81228	1 1/4	31.8	1 1/4-11 1/2	1 3/4	4.59	116.6	2.49	63.3
G28100-2424	24C2AT-24RMP	7231-81252	1 1/2	38.1	1 1/2-11 1/2	2	5.18	131.6	2.68	68.1

Male Pipe Swivel (NPTF - Without 30° Cone Seat)

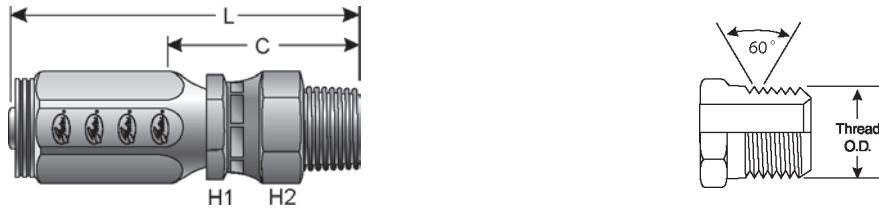

Part No.	Descr.	Prod. No.	⊖		H1	H2	L		C		
			"	mm			"	mm	"	mm	
G28105-0404	4C2AT-4RMPX	7231-22495	1/4	6.4	1/4-18	7/16	11/16	3.18	80.8	2.11	53.6
G28105-0606	6C2AT-6RMPX	7231-22505	3/8	9.5	3/8-18	5/8	7/8	3.51	89.2	2.27	57.7
G28105-0808	8C2AT-8RMPX	7231-22515	1/2	12.7	1/2-14	3/4	1	3.99	101.4	2.56	65.0
G28105-1212	12C2AT-12RMPX	7231-22525	3/4	19.1	3/4-14	1 1/16	1 5/16	4.27	108.5	2.73	69.3

Field Attachable Type T for G2 Hose [2 Wire]

Male O-Ring Boss

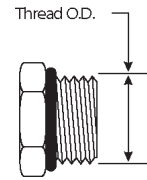
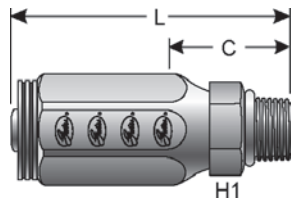

Part No.	Descr.	Prod. No.	⌀		H1	L		C		
			"	mm		"	"	"	mm	"
G28120-0606	6C2AT-6RMB	7231-22355	3/8	9.5	9/16-18	11/16	2.52	64.0	1.28	32.5
G28120-0608	6C2AT-8RMB	7231-22365	3/8	9.5	3/4-16	7/8	2.59	65.8	1.36	34.5
G28120-0808	8C2AT-8RMB	7231-22375	1/2	12.7	3/4-16	7/8	2.87	72.9	1.45	36.8
G28120-0810	8C2AT-10RMB	7231-22385	1/2	12.7	7/8-14	1	3.11	79.0	1.59	40.4

Male JIC 37° Flare

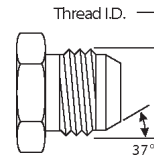
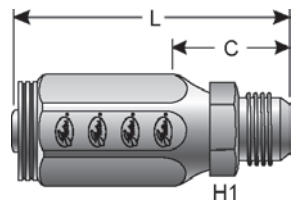

Part No.	Descr.	Prod. No.	⌀		H1	L		C		
			"	mm		"	"	"	mm	"
G28165-0606	6C2AT-6RMJ	7231-22025	3/8	9.5	9/16-18	9/16	2.68	68.1	1.45	36.8
G28165-0808	8C2AT-8RMJ	7231-22045	1/2	12.7	3/4-16	3/4	3.05	77.5	1.63	41.4
G28165-0810	8C2AT-10RMJ	7231-22055	1/2	12.7	7/8-14	7/8	3.31	84.1	1.89	48.1
G28165-1212	12C2AT-12RMJ	7231-22065	3/4	19.1	1 1/16-12	1 1/16	3.52	89.4	1.98	50.3

Female JIC 37° Flare Swivel

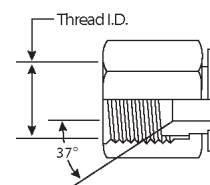
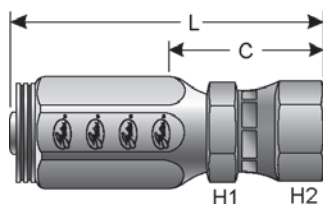

Part No.	Descr.	Prod. No.	⌀		H1	H2	L		C		
			"	mm			"	"	"	mm	"
G28170-0404	4C2AT-4RFJX	7231-81229	1/4	6.4	7/16-20	9/16	9/16	2.47	62.7	1.40	35.6
G28170-0405	4C2AT-5RFJX	7231-81230	1/4	6.4	1/2-20	11/16	11/16	2.58	65.5	1.57	39.9
G28170-0606	6C2AT-6RFJX	7231-81231	3/8	9.5	9/16-18	3/4	3/4	2.80	71.1	1.56	39.6
G28170-0608	6C2AT-8RFJX	7231-81232	3/8	9.5	3/4-16	3/4	3/4	2.91	73.9	1.67	42.4
G28170-0808	8C2AT-8RFJX	7231-81233	1/2	12.7	3/4-16	13/16	7/8	3.24	82.3	1.82	46.2
G28170-0810	8C2AT-10RFJX	7231-81234	1/2	12.7	7/8-14	13/16	1 1/16	3.34	84.8	1.92	48.8
G28170-1212	12C2AT-12RFJX	7231-81235	3/4	19.1	1 1/16-12	1 1/8	1 1/2	3.45	87.6	1.91	48.5

EQUIPMENT
HOSE/CPLG. SELECTION
G8K COUPLINGS
GLOBALSPIRAL COUPLINGS
STAINLESS STEEL SPIRAL
MEGACRIMP COUPLINGS
STAINLESS STEEL BRAID
POWER CRIMP COUPLINGS
FIELD ATTACHABLE G1 & G2 COUPLINGS
FIELD ATTACHABLE C5 COUPLINGS
GLX COUPLINGS
GL COUPLINGS
C14 COUPLINGS
PCTS THERMOPLASTIC COUPLINGS
POLARSEAL COUPLINGS
POLARSEAL II COUPLINGS
POWER STEERING
ADAPTERS
QUICK DISCONNECT COUPLERS
BALL VALVES
LIVE SWIVEL
ASSEMBLY FABRICATION
ACCESSORIES
EQUIPMENT AND PARTS
AIR BRAKE
BRASS
KITS

Field Attachable Type T for G2 Hose [2 Wire]

Female JIC 37° Flare Swivel - Continued

Part No.	Descr.	Prod. No.	⊖		H1	H2	L		C		
			"	mm			"	mm	"	mm	
G28170-1616	16C2AT-16RFJX	7231-81236	1	25.4	1 5/16-12	1 3/8	1 1/2	3.90	99.1	2.16	54.9
G28170-2020	20C2AT-20RFJX	7231-81237	1 1/4	31.8	1 5/12-12	1 7/8	2	4.85	123.2	2.74	69.6
G28170-2424	24C2AT-24RFJX	7231-81254	1 1/2	38.1	1 7/8-12	2 1/8	2 1/4	5.26	133.6	2.76	70.1

Female JIC 37° Flare Swivel - 45° Bent Tube

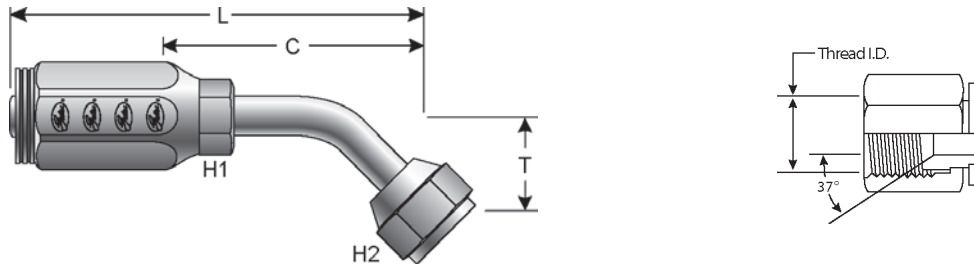

Part No.	Descr.	Prod. No.	⊖		H1	H2	T		L		C		
			"	mm			"	mm	"	mm	"	mm	
G28175-0404	4C2AT-4RFJX45	7231-22595	1/4	6.4	7/16-20	3/8	9/16	.33	8.4	2.80	71.1	1.73	43.9
G28175-0606	6C2AT-6RFJX45	7231-22605	3/8	9.5	9/16-18	1/2	11/16	.39	9.9	3.37	85.6	2.14	54.4
G28175-0808	8C2AT-8RFJX45	7231-22615	1/2	12.7	3/4-16	5/8	7/8	.55	14.0	4.11	104.4	2.68	68.1
G28175-1212	12C2AT-12RFJX45	7231-22625	3/4	19.1	1 1/16-12	7/8	1 1/4	.78	19.8	4.70	119.4	3.16	80.3

Female JIC 37° Flare Swivel - 90° Bent Tube

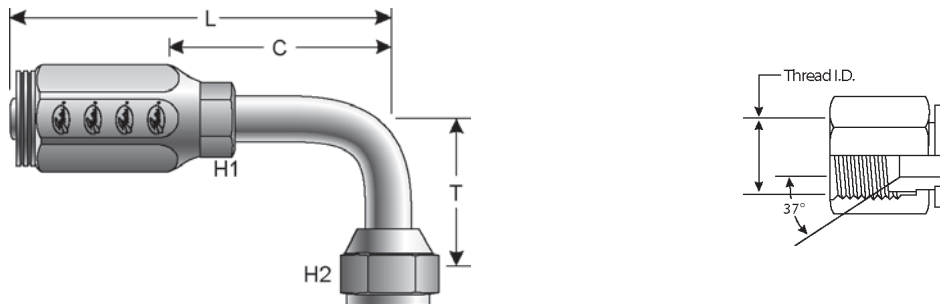

Part No.	Descr.	Prod. No.	⊖		H1	H2	T		L		C		
			"	mm			"	mm	"	mm	"	mm	
G28180-0404	4C2AT-4RFJX90	7231-22755	1/4	6.4	7/16-20	3/8	9/16	.68	17.3	2.69	68.3	1.62	41.2
G28180-0606	6C2AT-6RFJX90	7231-22765	3/8	9.5	9/16-18	1/2	11/16	.85	21.6	3.28	83.3	2.04	51.8
G28180-0608	6C2AT-8RFJX90	7231-22775	3/8	9.5	3/4-16	5/8	7/8	1.09	27.7	3.58	90.9	2.35	59.7
G28180-0808	8C2AT-8RFJX90	7231-22785	1/2	12.7	3/4-16	5/8	7/8	1.09	27.7	3.86	98.1	2.42	61.5
G28180-0810	8C2AT-10RFJX90	7231-22795	1/2	12.7	7/8-14	3/4	1	1.23	31.2	3.92	99.6	2.50	63.5
G28180-1212	12C2AT-12RFJX90	7231-22805	3/4	19.1	1 1/16-12	7/8	1 1/4	1.82	46.2	4.59	116.6	3.05	77.5

Female Flat-Face O-Ring Swivel

SAE J1453 O-Ring Face Seal.

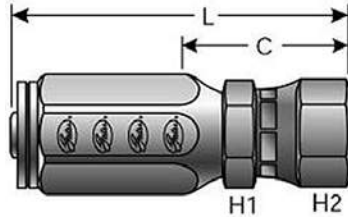

Part No.	Descr.	Prod. No.	⊖		🌀	H1	H2	L		C	
			"	mm				"	mm	"	mm
G28230-0404	4C2AT-4RFFORX	7231-14105	1/4	6.4	9/16-18	43/64	43/64	2.50	63.5	1.43	36.3
G28230-0606	6C2AT-6RFFORX	7231-14125	3/8	9.5	11/16-16	7/8	7/8	2.88	73.2	1.64	41.7
G28230-0808	8C2AT-8RFFORX	7231-14145	1/2	12.7	13/16-16	61/64	61/64	3.37	85.6	1.94	49.3
G28230-1212	12C2AT-12RFFORX	7231-14165	3/4	19.1	1 13/16-16	1 1/8	1 13/32	2.03	51.6	3.57	90.7

Female Flat-Face O-Ring Swivel - 45° Bent Tube

SAE J1453 O-Ring Face Seal.

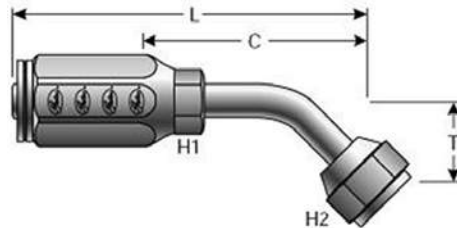

Part No.	Descr.	Prod. No.	⊖		🌀	H1	H2	T		L		C	
			"	mm				"	mm	"	mm	"	mm
G28234-0404	4C2AT-4RFFORX45S	7231-14305	1/4	6.4	9/16-18	3/8	9/16	.68	17.3	2.69	68.3	1.62	41.2
G28234-0606	6C2AT-6RFFORX45S	7231-14325	3/8	9.5	11/16-16	1/2	11/16	.85	21.6	3.28	83.3	2.04	51.8
G28234-0808	8C2AT-8RFFORX45S	7231-14345	1/2	12.7	13/16-16	5/8	7/8	1.09	27.7	3.86	98.1	2.42	61.5
G28234-1212	12C2AT-12RFFORX45S	7231-14365	3/4	19.1	1 13/16-12	7/8	1 1/4	1.82	46.2	4.59	116.6	3.05	77.5

EQUIPMENT
HOSE/CPLG. SELECTION
G8K COUPLINGS
GLOBALSPIRAL COUPLINGS
STAINLESS STEEL SPIRAL
MEGACRIMP COUPLINGS
STAINLESS STEEL BRAID
POWER CRIMP COUPLINGS
FIELD ATTACHABLE G1 & G2 COUPLINGS
FIELD ATTACHABLE C5 COUPLINGS
GLX COUPLINGS
GL COUPLINGS
C14 COUPLINGS
PCTS THERMOPLASTIC COUPLINGS
POLARSEAL COUPLINGS
POLARSEAL II COUPLINGS
POWER STEERING
ADAPTERS
QUICK DISCONNECT COUPLERS
BALL VALVES
LIVE SWIVEL
ASSEMBLY FABRICATION
ACCESSORIES
EQUIPMENT AND PARTS
AIR BRAKE
BRASS
KITS

Field Attachable Type T for G2 Hose [2 Wire]

Female Flat-Face O-Ring Swivel - 90° Bent Tube

SAE J1453 O-Ring Face Seal.

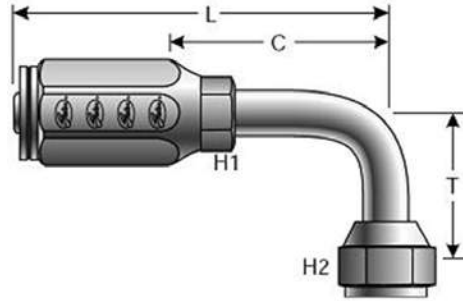

Part No.	Descr.	Prod. No.	⌀		H1		H2		T		L		C	
			"	mm	"	"	"	mm	"	mm	"	mm	"	mm
G28239-0404	4C2AT-4RFFORX90S	7231-14505	1/4	6.4	9/16-18	3/8	9/16	.68	17.3	2.69	68.3	1.62	41.2	
G28239-0606	6C2AT-6RFFORX90S	7231-14525	3/8	9.5	11/16-16	1/2	11/16	.85	21.6	3.28	83.3	2.04	51.8	
G28239-0808	8C2AT-8RFFORX90S	7231-14545	1/2	12.7	13/16-16	5/8	7/8	1.09	27.7	3.86	98.1	2.42	61.5	
G28239-1212	12C2AT-12RFFORX90S	7231-14565	3/4	19.1	1 13/16-12	—	7/8	1.88	40.8	4.54	115.3	3.00	76.2	

EQUIPMENT
HOSE/CPLG. SELECTION
G8K COUPLINGS
GLOBALSPIRAL COUPLINGS
STAINLESS STEEL SPIRAL
MEGACRIMP COUPLINGS
STAINLESS STEEL BRAID
POWER CRIMP COUPLINGS
FIELD ATTACHABLE G1 & G2 COUPLINGS
FIELD ATTACHABLE C5 COUPLINGS
GLX COUPLINGS
GL COUPLINGS
C14 COUPLINGS
PCTS THERMOPLASTIC COUPLINGS
POLARSEAL COUPLINGS
POLARSEAL II COUPLINGS
POWER STEERING
ADAPTERS
QUICK DISCONNECT COUPLERS
BALL VALVES
LIVE SWIVEL
ASSEMBLY FABRICATION
ACCESSORIES
EQUIPMENT AND PARTS
AIR BRAKE
BRASS
KITS

Field Attachable for C5CXH, C5C, C5D & C5M Hose

Hydraulic Hose For C5C, C5CXH, C5D & C5M Couplings

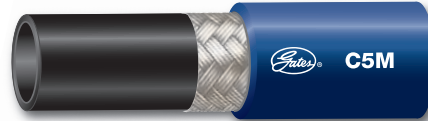
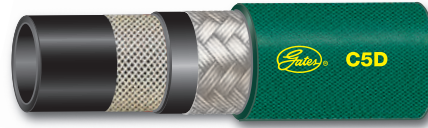
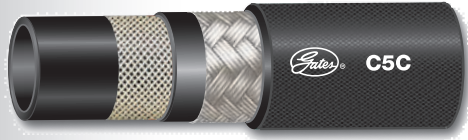

Hydraulic Hose For C5CXH Couplings

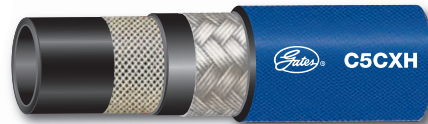

The Gates eCrimp program is a web based utility which allows users and distributors of Gates hydraulic and industrial hose products to find and print the most up to date crimp specifications with nothing more than an internet browser.

This program can be used to find crimp data for the MobileCrimp 4-20, PC 707, SC32, PC 3000B, GC32-XD™ Global Hose Crimper, GC96 and Omni Crimp 21. Custom result may be printed by selecting the crimper, hose and coupling. Optionally results may also be limited by die set and working pressure.



eCrimp

The eCrimp mobile app gives you all the same features of the online version in the palm of your hands. Use the app to find the most up-to-date crimp specifications quickly and easily. It is available for download for the iPhone and iPad from the App Store.

EQUIPMENT
HOSE/CPLG. SELECTION
G8K COUPLINGS
GLOBALSPIRAL COUPLINGS
STAINLESS STEEL SPIRAL
MEGACRIMP COUPLINGS
STAINLESS STEEL BRAID
POWER CRIMP COUPLINGS
FIELD ATTACHABLE G1 & G2 COUPLINGS
FIELD ATTACHABLE C5 COUPLINGS
GLX COUPLINGS
GL COUPLINGS
C14 COUPLINGS
PCTS THERMOPLASTIC COUPLINGS
POLARSEAL COUPLINGS
POLARSEAL II COUPLINGS
POWER STEERING
ADAPTERS
QUICK DISCONNECT COUPLERS
BALL VALVES
LIVE SWIVEL
ASSEMBLY FABRICATION
ACCESSORIES
EQUIPMENT AND PARTS
AIR BRAKE
BRASS
KITS

Field Attachable for C5CXH, C5C, C5D & C5M Hose

Male Pipe (NPTF - 30° Cone Seat) - Steel

DOT FMVSS 106-74 Type All.

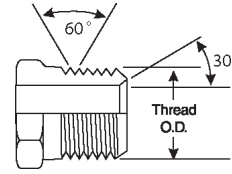
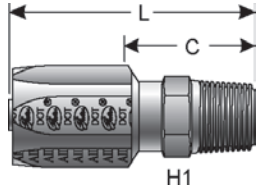

Part No.	Descr.	Prod. No.	⊖		H1	L		C		
			"	mm		"	mm	"	mm	
G34100-0402	4C5-2RMP	7236-04015	3/16	4.8	1/8-27	1/2	1.64	41.7	.94	23.9
G34100-0404	4C5-4RMP	7236-04025	3/16	4.8	1/4-18	9/16	1.83	46.5	1.13	28.7
G34100-0502	5C5X-2RMP	7237-00145	1/4	6.4	1/8-27	1/2	1.77	45.0	1.00	25.4
G34100-0504	5C5X-4RMP	7237-00155	1/4	6.4	1/4-18	9/16	1.96	49.8	1.19	30.2
G34100-0604	6C5-4RMP	7236-04055	5/16	7.9	1/4-18	9/16	2.17	55.1	1.22	31.0
G34100-0606	6C5-6RMP	7236-04275	5/16	7.9	3/8-18	11/16	2.17	55.1	1.22	31.0
G34100-0806	8C5X-6RMP	7237-00195	13/32	10.3	3/8-18	11/16	2.46	62.5	1.34	34.0
G34100-0808	8C5X-8RMP	7237-00205	13/32	10.3	1/2-14	7/8	2.71	68.8	1.59	40.4
G34100-1008	10C5-8RMP	7236-04085	1/2	12.7	1/2-14	1 1/16	2.88	73.2	1.59	40.4
G34100-1012	10C5-12RMP	7236-04095	1/2	12.7	3/4-14	1	2.95	74.9	1.66	42.2
G34100-1208	12C5X-8RMP	7237-00235	5/8	15.9	1/2-14	7/8	3.15	80.0	1.59	40.4
G34100-1212	12C5X-12RMP	7237-00245	5/8	15.9	3/4-14	1 1/16	3.25	82.6	1.69	42.9
G34100-1612	16C5-12RMP	7236-86412	7/8	22.2	3/4-14	1 1/8	2.71	68.8	1.53	38.9
G34100-1616	16C5-16RMP	7236-86413	7/8	22.2	1-11 1/2	1 3/8	2.90	73.7	1.72	43.7
G34100-2020	20C5-20RMP	7236-86428	1 1/8	28.6	1 1/4-11 1/2	1 11/16	3.25	82.6	1.88	47.8
G34100-2424	24C5-24RMP	7236-86388	1 3/8	34.9	1 1/2-11 1/2	2	3.45	87.6	2.03	51.6
G34100-3232	32C5-32RMP	7236-86389	1 13/16	46.0	2-11 1/2	2 1/2	4.07	103.4	2.22	56.4

Male Pipe (NPTF - 30° Cone Seat) - Brass

DOT FMVSS 106-74 Type All.

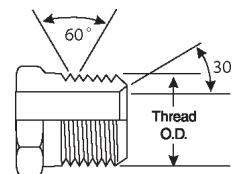
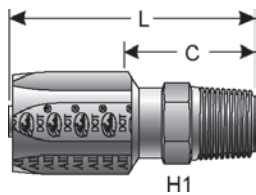

Part No.	Descr.	Prod. No.	⊖		H1	L		C		
			"	mm		"	mm	"	mm	
G34100-0504B	5C5-4RMPB	7236-03005	1/4	6.4	1/4-18	9/16	1.96	49.8	1.19	30.2
G34100-0606B	6C5-6RMPB	7236-03015	5/16	7.9	3/8-18	11/16	2.17	55.1	1.22	31.0
G34100-0808B	8C5-8RMPB	7236-03085	13/32	10.3	1/2-14	7/8	2.71	68.8	1.59	40.4
G34100-1008B	10C5-8RMPB	7236-03035	1/2	12.7	1/2-14	7/8	2.88	73.2	1.59	40.4
G34100-1212B	12C5-12RMPB	7236-03045	5/8	15.9	3/4-14	1 1/16	3.26	82.8	1.69	42.9
G34100-1616B	16C5-16RMPB	7236-03065	7/8	22.2	1-11 1/2	1 3/8	2.91	73.9	1.72	43.7

Male O-Ring Boss - Steel

DOT FMVSS 106-74 Type All.

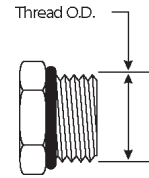
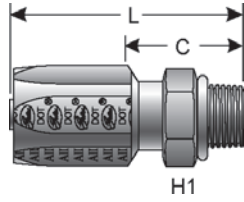

Part No.	Descr.	Prod. No.	⊖		🌀	H1	L		C	
			"	mm			"	mm	"	mm
G34120-0404	4C5-4RMB	7236-86451	3/16	4.8	7/16-20	5/8	1.66	42.2	.94	23.9
G34120-0606	6C5-6RMB	7236-86453	5/16	7.9	9/16-18	11/16	2.00	50.8	1.05	26.7
G34120-0808	8C5X-8RMB	7237-00635	13/32	10.3	3/4-16	15/16	2.35	59.7	1.19	30.2

Male JIC 37° Flare - Steel

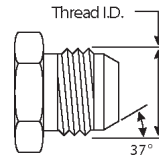
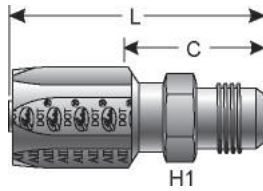

Part No.	Descr.	Prod. No.	⊖		🌀	H1	L		C	
			"	mm			"	mm	"	mm
G34165-0404	4C5-4RMJ	7236-86431	3/16	4.8	7/16-20	1/2	1.79	45.5	1.09	27.7
G34165-0505	5C5X-5FMJ	7237-00655	1/4	6.4	1/2-20	1/2	1.96	49.8	1.19	30.2
G34165-0606	6C5-6RMJ	7236-86433	5/16	7.9	9/16-18	9/16	2.17	55.1	1.22	31.0
G34165-0808	8C5X-8RMJ	7237-00675	13/32	10.3	3/4-16	3/4	2.56	65.0	1.44	36.6
G34165-1010	10C5-10RMJ	7236-86435	1/2	12.7	7/8-14	7/8	2.88	73.2	1.59	40.4
G34165-1212	12C5X-12RMJ	7237-00695	5/8	15.9	1 1/16-12	1 1/16	3.34	84.8	1.78	45.2
G34165-1616	16C5-16RMJ	7236-86437	7/8	22.2	1 5/16-12	1 5/16	2.87	72.9	1.69	42.9

Female JIC 37° Flare Swivel - Steel

DOT FMVSS 106-74 Type All.

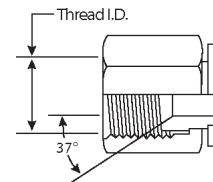
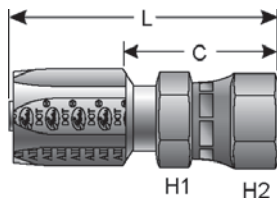

Part No.	Descr.	Prod. No.	⊖		🌀	H1	H2	L		C	
			"	mm				"	mm	"	mm
G34170-0606	6C5-6RFJX	7238-86443	5/16	7.9	9/16-18	3/4	3/4	2.39	60.7	1.44	36.6
G34170-0806	8C5X-6RFJX	7237-00415	13/32	10.3	9/16-18	3/4	3/4	2.66	67.6	1.54	39.1
G34170-1012	10C5-12RFJX	7238-04325	1/2	12.7	1 1/16-12	1 1/4	1 1/4	3.22	81.8	1.93	49.0
G34170-1212	12C5X-12RFJX	7237-00455	5/8	15.9	1 1/8-12	1 1/4	1 1/4	3.50	88.9	1.94	49.3

- EQUIPMENT
- HOSE/CPLG. SELECTION
- G8K COUPLINGS
- GLOBALSPIRAL COUPLINGS
- STAINLESS STEEL SPIRAL
- MEGACRIMP COUPLINGS
- STAINLESS STEEL BRAID
- POWER CRIMP COUPLINGS
- FIELD ATTACHABLE G1 & G2 COUPLINGS
- FIELD ATTACHABLE C5 COUPLINGS
- GLX COUPLINGS
- GL COUPLINGS
- C14 COUPLINGS
- PCTS THERMOPLASTIC COUPLINGS
- POLARSEAL COUPLINGS
- POLARSEAL II COUPLINGS
- POWER STEERING
- ADAPTERS
- QUICK DISCONNECT COUPLERS
- BALL VALVES
- LIVE SWIVEL
- ASSEMBLY FABRICATION
- ACCESSORIES
- EQUIPMENT AND PARTS
- AIR BRAKE
- BRASS
- KITS

Field Attachable for C5CXH, C5C, C5D & C5M Hose

Female JIC 37° Flare Swivel - Steel - Continued

Part No.	Descr.	Prod. No.	⊖		H1	H2	L		C		
			"	mm			"	mm	"	mm	
G34170-1616	16C5-16RFJX	7238-86447	7/8	22.2	1 5/16-12	1 1/2	1 1/2	3.12	79.3	1.94	49.3
G34170-2020	20C5-20RFJX	7238-86394	1 1/8	28.6	1 5/8-12	2	2	3.56	90.4	2.19	55.6
G34170-2424	24C5-24RFJX	7238-86395	1 3/8	34.9	1 7/8-12	2 1/4	2 1/4	3.79	96.3	2.37	60.2
G34170-3232	32C5-32RFJX	7238-86396	1 13/16	46.0	2 1/2-12	2 1/2	2 7/8	4.99	126.8	2.72	69.1

Female JIC 37° Flare Swivel - Brass

DOT FMVSS 106-74 Type All.



Part No.	Descr.	Prod. No.	⊖		H1	H2	L		C		
			"	mm			"	mm	"	mm	
G34170-0606B	6C5-6RFJXB	7238-04075	5/16	7.9	9/16-18	3/4	3/4	2.39	60.7	1.44	36.6
G34170-1212B	12C5-12RFJXB	7238-04085	5/8	15.9	1 1/16-12	1 1/4	1 1/4	3.50	88.9	1.94	49.3
G34170-1616B	16C5-16RFJXB	7238-04095	7/8	22.2	1 5/16-12	1 1/2	1 1/2	3.12	79.3	1.94	49.3

Female JIC 37° Flare Swivel - 45° Bent Tube - Steel

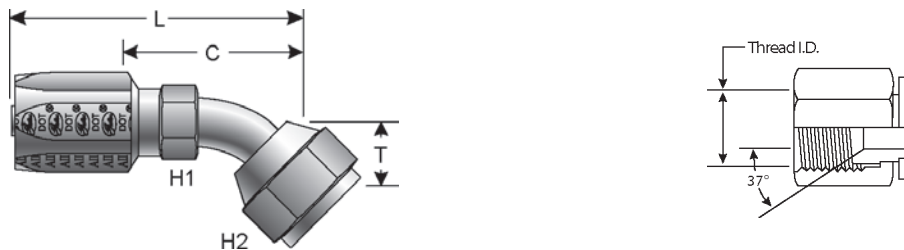

Part No.	Descr.	Prod. No.	⊖		H1	H2	T	L		C			
			"	mm				"	mm	"	mm		
G34175-0606	6C5-6RFJX45	7235-86464	5/16	7.9	9/16-18	1/2	11/16	.41	10.4	2.40	61.0	1.45	36.8
G34175-1212	12C5X-12RFJX45S	7237-00535	5/8	15.9	1 1/16-12	7/8	1 1/4	.78	19.8	4.27	108.5	2.71	68.8
G34175-1616	16C5-16RFJX45	7235-86468	7/8	22.2	1 5/16-12	—	1 1/2	.88	22.4	4.03	102.4	2.84	72.1

Female JIC 37° Flare Swivel - 90° Bent Tube - Steel

DOT FMVSS 106-74 Type All.

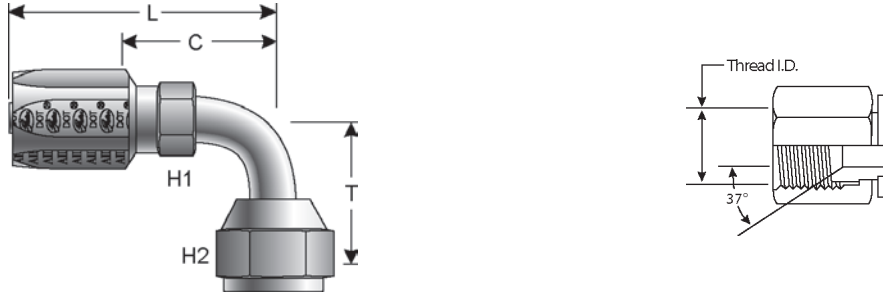

Part No.	Descr.	Prod. No.	⌀		H1	H2	T		L		C		
			"	mm			"	"	"	mm	"	mm	"
G34180-0606	6C5-6RFJX90	7235-86471	5/16	7.9	9/16-18	1/2	11/16	.84	21.3	2.28	57.9	1.33	33.8
G34181-0606	6C5-6RFJX90L	7235-04205	5/16	7.9	9/16-18	1/2	11/16	2.19	55.6	2.28	57.9	1.33	33.8
G34180-1212	12C5X-12RFJX90S	7237-00545	5/8	15.9	1 1/16-12	7/8	1 1/4	1.81	46.0	4.22	107.2	2.66	67.6
G34181-1212	12C5X-12RFJX90L	7237-00555	5/8	15.9	1 1/16-12	7/8	1 1/4	3.75	95.3	4.22	107.2	2.66	67.6
G34180-1616	16C5-16RFJX90	7235-86475	7/8	22.2	1 5/16-12	—	1 1/2	2.16	54.9	3.95	100.3	2.76	70.1
G34181-1616	16C5-16RFJX90L	7235-86482	7/8	22.2	1 5/16-12	—	1 1/2	4.34	110.2	3.95	100.3	2.76	70.1
G34179-2020	20C5-20RFJX90S	7235-20265	1 1/8	28.6	1 5/8-12	—	2	2.75	69.9	5.07	128.8	3.70	94.0
G34181-2020	20C5-20RFJX90L	7235-20255	1 1/8	28.6	1 5/8-12	—	2	5.50	139.7	5.26	133.6	3.89	98.8

Male SAE 45° Flare - Steel



Part No.	Descr.	Prod. No.	⌀		H1	L		C		
			"	mm		"	mm	"	mm	
G34195-0404	4C5-4RMS	7236-86414	3/16	4.8	1/2-20	1/2	1.76	44.7	1.06	26.9
G34195-0505	5C5X-5RMS	7237-00725	1/4	6.4	1/2-20	1/2	1.96	49.8	1.19	30.2
G34195-0606	6C5-6RMS	7236-86416	5/16	7.9	5/8-18	5/8	2.23	56.6	1.28	32.5
G34195-0808	8C5X-8RMS	7237-00745	13/32	10.3	3/4-16	3/4	2.65	67.3	1.53	38.9
G34195-1010	10C5-10RMS	7236-86418	1/2	12.7	7/8-14	7/8	3.01	76.5	1.72	43.7
G34195-1212	12C5X-12RMS	7237-00765	5/8	15.9	1 1/16-14	1 1/16	3.50	88.9	1.94	49.3

- EQUIPMENT
- HOSE/CPLG. SELECTION
- G8K COUPLINGS
- GLOBALSPIRAL COUPLINGS
- STAINLESS STEEL SPIRAL
- MEGACRIMP COUPLINGS
- STAINLESS STEEL BRAID
- POWER CRIMP COUPLINGS
- FIELD ATTACHABLE G1 & G2 COUPLINGS
- FIELD ATTACHABLE C5 COUPLINGS
- GLX COUPLINGS
- GL COUPLINGS
- C14 COUPLINGS
- PCTS THERMOPLASTIC COUPLINGS
- POLARSEAL COUPLINGS
- POLARSEAL II COUPLINGS
- POWER STEERING
- ADAPTERS
- QUICK DISCONNECT COUPLERS
- BALL VALVES
- LIVE SWIVEL
- ASSEMBLY FABRICATION
- ACCESSORIES
- EQUIPMENT AND PARTS
- AIR BRAKE
- BRASS
- KITS

Field Attachable for C5CXH, C5C, C5D & C5M Hose

EQUIPMENT
HOSE/CPLG. SELECTION
G8K COUPLINGS
GLOBALSPIRAL COUPLINGS
STAINLESS STEEL SPIRAL
MEGACRIMP COUPLINGS
STAINLESS STEEL BRAID
POWER CRIMP COUPLINGS
FIELD ATTACHABLE G1 & G2 COUPLINGS

Female SAE 45° Flare Swivel - Steel

DOT FMVSS 106-74 Type All.



Part No.	Descr.	Prod. No.	⌀		H1	H2	L		C		
			"	mm			"	"	"	mm	"
G34200-0606	6C5-6RFSX	7238-04235	5/16	7.9	5/8-18	3/4	3/4	2.42	61.5	1.47	37.3
G34200-1012	10C5-12RFSX	7238-04335	1/2	12.7	1 1/16-14	1 1/4	1 1/4	3.22	81.8	1.93	49.0
G34200-1212	12C5X-12RFSX	7237-00795	5/8	15.9	1 1/16-14	1 1/4	1 1/4	3.50	88.9	1.94	49.3

FIELD ATTACHABLE C5 COUPLINGS

Female SAE 45° Flare Swivel - Brass

DOT FMVSS 106-74 Type All.



Part No.	Descr.	Prod. No.	⌀		H1	H2	L		C		
			"	mm			"	"	"	mm	"
G34200-0606B	6C5-6RFSXB	7238-04045	5/16	7.9	5/8-18	3/4	3/4	2.42	61.5	1.47	37.3
G34200-1212B	12C5-12RFSXB	7238-04055	5/8	15.9	1 1/16-14	1 1/4	1 1/4	3.50	88.9	1.94	49.3

GLX COUPLINGS
GL COUPLINGS
C14 COUPLINGS
PCTS THERMOPLASTIC COUPLINGS

Female SAE 45° Flare Swivel - 45° Bent Tube - Steel

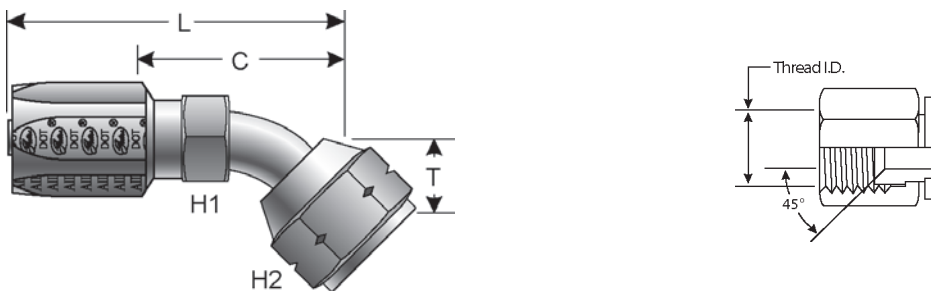

Part No.	Descr.	Prod. No.	⌀		H1	H2	T	L		C			
			"	mm				"	"	"	mm	"	mm
G34202-0606	6C5-6RFSX45	7235-04855	5/16	7.9	5/8-18	1/2	3/4	.41	10.4	2.42	61.5	1.47	37.3
G34202-1212	12C5X-12RFSX45S	7237-00835	5/8	15.9	1 1/16-14	7/8	1 1/4	.74	18.8	4.27	108.5	2.71	68.8

POLARSEAL COUPLINGS
POLARSEAL II COUPLINGS
POWER STEERING
ADAPTERS
QUICK DISCONNECT COUPLERS
BALL VALVES
LIVE SWIVEL
ASSEMBLY FABRICATION
ACCESSORIES
EQUIPMENT AND PARTS
AIR BRAKE
BRASS
KITS

Female SAE 45° Flare Swivel - 90° Bent Tube - Steel

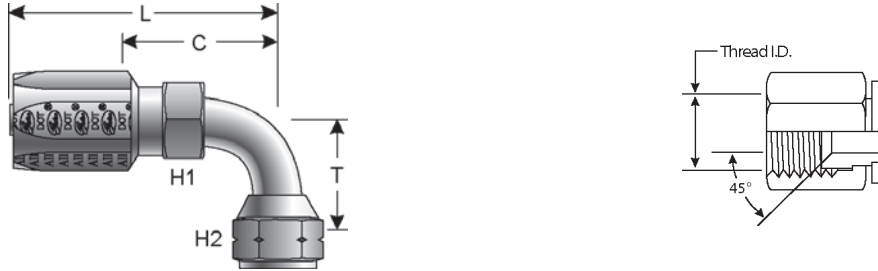

Part No.	Descr.	Prod. No.	⌀		H1	H2	T		L		C		
			"	mm			"	mm	"	mm	"	mm	
G34205-0606	6C5-6RFSX90	7235-04915	5/16	7.9	5/8-18	1/2	3/4	.84	21.3	2.28	57.9	1.33	33.8
G34206-0606	6C5-6RFSX90L	7235-86497	5/16	7.9	5/8-18	1/2	3/4	2.19	55.6	2.28	57.9	1.22	31.0
G34205-1212	12C5X-12RFSX90S	7237-00845	5/8	15.9	1 1/16-14	7/8	1 1/4	1.81	46.0	4.72	119.9	2.66	67.6
G34206-1212	12C5X-12RFSX90L	7237-00855	5/8	15.9	1 1/16-14	7/8	1 1/4	3.75	95.3	4.22	107.2	2.16	54.9

Dual Seat Female JIC 37°/SAE 45° Flare Swivel - Steel

DOT FMVSS 106-74 Type All.

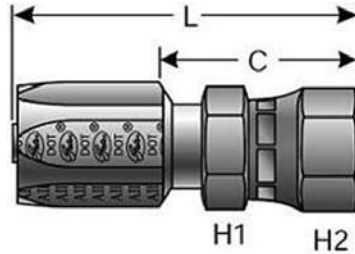

Part No.	Descr.	Prod. No.	⌀		H1	H2	L		C		
			"	mm			"	mm	"	mm	
G34210-0404	4C5-4RFJSX	7238-04215	3/16	4.8	7/16-20	9/16	9/16	1.92	48.8	1.22	31.0
G34210-0504	5C5X-4RFJSX	7237-00875	1/4	6.4	7/16-20	9/16	9/16	2.05	52.1	1.28	32.5
G34210-0505	5C5X-5RFJSX	7237-00885	1/4	6.4	1/2-20	11/16	11/16	2.11	53.6	1.34	34.0
G34210-0608	6C5-8RFJSX	7238-04295	5/16	7.9	3/4-16	7/8	7/8	2.48	63.0	1.53	38.9
G34210-0808	8C5X-8RFJSX	7237-00905	13/32	10.3	3/4-16	7/8	7/8	2.75	69.9	1.63	41.4
G34210-1008	10C5-8RFJSX	7238-04315	1/2	12.7	3/4-16	7/8	7/8	2.93	74.4	1.64	41.7
G34210-1010	10C5-10RFJSX	7238-04255	1/2	12.7	7/8-14	1 1/16	1 1/16	3.10	78.7	1.81	46.0

EQUIPMENT
HOSE/CPLG. SELECTION
G8K COUPLINGS
GLOBALSPIRAL COUPLINGS
STAINLESS STEEL SPIRAL
MEGACRIMP COUPLINGS
STAINLESS STEEL BRAID
POWER CRIMP COUPLINGS
FIELD ATTACHABLE G1 & G2 COUPLINGS
FIELD ATTACHABLE C5 COUPLINGS
GLX COUPLINGS
GL COUPLINGS
C14 COUPLINGS
PCTS THERMOPLASTIC COUPLINGS
POLARSEAL COUPLINGS
POLARSEAL II COUPLINGS
POWER STEERING
ADAPTERS
QUICK DISCONNECT COUPLERS
BALL VALVES
LIVE SWIVEL
ASSEMBLY FABRICATION
ACCESSORIES
EQUIPMENT AND PARTS
AIR BRAKE
BRASS
KITS

Dual Seat Female JIC 37°/SAE 45° Flare Swivel - Brass

DOT FMVSS 106-74 Type All.

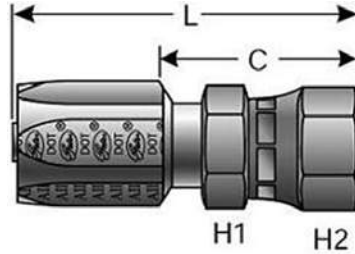

Part No.	Descr.	Prod. No.	⊖		🌀	H1	H2	L		C	
			"	mm				"	mm	"	mm
G34210-0505B	5C5-5RFJSXB	7238-04005	1/4	6.4	1/2-20	11/16	11/16	2.11	53.6	1.34	34.0
G34210-0808B	8C5-8RFJSXB	7238-04015	13/32	10.3	3/4-16	7/8	7/8	2.75	69.9	1.63	41.4
G34210-1010B	10C5-10RFJSXB	7238-04025	1/2	12.7	7/8-14	1 1/16	1 1/16	3.10	78.7	1.81	46.0

Dual Seat Female JIC 37°/SAE 45° Flare Swivel - 45° Bent Tube - Steel

DOT FMVSS 106-74 Type All.

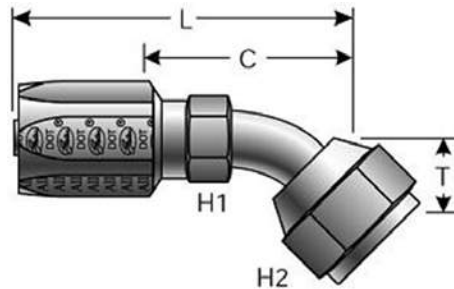

Part No.	Descr.	Prod. No.	⊖		🌀	H1	H2	T		L		C	
			"	mm				"	mm	"	mm	"	mm
G34211-0404	4C5-4RFJSX45	7235-20005	3/16	4.8	7/16-20	7/16	9/16	.34	8.6	1.90	48.3	1.21	30.7
G34211-0505	5C5X-5RFJSX45S	7237-00945	1/4	6.4	1/2-20	7/16	5/8	.38	9.7	2.11	53.6	1.34	34.0
G34211-0608	6C5-8RFJSX45	7235-20045	5/16	7.9	3/4-16	5/8	7/8	.56	14.2	2.71	68.8	1.76	44.7
G34211-0808	8C5X-8RFJSX45S	7237-00965	13/32	10.3	3/4-16	5/8	7/8	.56	14.2	2.98	75.7	1.86	47.2
G34211-1010	10C5-10RFJSX45	7235-20035	1/2	12.7	7/8-14	3/4	1	.63	16.0	3.60	91.4	2.31	58.7

Dual Seat Female JIC 37°/SAE 45° Flare Swivel - 90° Bent Tube - Steel

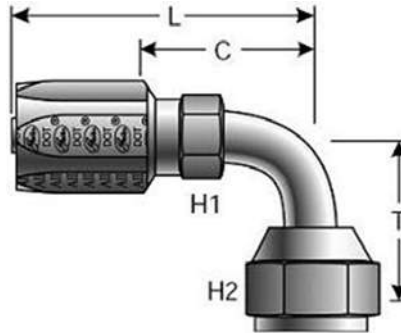

Part No.	Descr.	Prod. No.	⊖		🌀	H1	H2	T		L		C	
			"	mm				"	mm	"	mm	"	mm
G34212-0404	4C5-4RFJSX90	7235-20105	3/16	4.8	7/16-20	7/16	9/16	.69	17.5	1.78	45.2	1.08	27.4
G34213-0404	4C5-4RFJSX90L	7235-20205	3/16	4.8	7/16-20	7/16	9/16	1.81	46.0	1.78	45.2	1.08	27.4
G34212-0505	5C5X-5RFJSX90S	7237-01005	1/4	6.4	1/2-20	7/16	5/8	.78	19.8	2.02	51.3	1.25	31.8
G34213-0505	5C5X-5RFJSX90L	7237-01015	1/4	6.4	1/2-20	7/16	5/8	1.78	45.2	2.02	51.3	1.25	31.8
G34212-0808	8C5X-8RFJSX90S	7237-01025	13/32	10.3	3/4-16	5/8	7/8	1.09	27.7	2.79	70.9	1.67	42.4
G34213-0808	8C5X-8RFJSX90L	7237-01035	13/32	10.3	3/4-16	5/8	7/8	2.44	62.0	2.79	70.9	1.67	42.4
G34212-1010	10C5-10RFJSX90	7235-20135	1/2	12.7	7/8-14	3/4	1	1.25	31.8	3.41	86.6	2.12	53.9
G34213-1010	10C5-10RFJSX90L	7235-20235	1/2	12.7	7/8-14	3/4	1	2.56	65.0	3.41	86.6	2.12	53.9

Female Flat-Face Swivel - Steel

DOT FMVSS 106-74 Type All.
SAE J1453 O-Ring Face Seal.

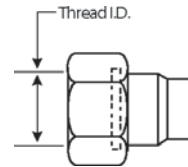
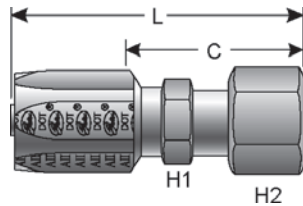

Part No.	Descr.	Prod. No.	⊖		🌀	H1	H2	L		C	
			"	mm				"	mm	"	mm
G34230-0404	4C5-4RFFORX	7238-01505	3/16	4.8	9/16-18	9/16	11/16	2.07	52.6	1.32	33.5
G34230-0606	6C5-6RFFORX	7238-01265	5/16	7.9	11/16-16	1/2	13/16	2.53	64.3	1.58	40.1
G34230-0808	8C5X-8RFFORX	7237-01085	13/32	10.3	13/16-16	13/16	15/16	2.92	74.2	1.77	45.0
G34230-1010	10C5-10RFFORX	7238-01545	1/2	12.7	1-14	15/16	1 1/8	3.23	82.0	1.94	49.3
G34230-1212	12C5X-12RFFORX	7237-01105	5/8	15.9	1 3/16-12	7/8	1 3/8	3.70	94.0	2.12	53.9

- EQUIPMENT
- HOSE/CPLG. SELECTION
- G8K COUPLINGS
- GLOBALSPIRAL COUPLINGS
- STAINLESS STEEL SPIRAL
- MEGACRIMP COUPLINGS
- STAINLESS STEEL BRAID
- POWER CRIMP COUPLINGS
- FIELD ATTACHABLE G1 & G2 COUPLINGS
- FIELD ATTACHABLE C5 COUPLINGS
- GLX COUPLINGS
- GL COUPLINGS
- C14 COUPLINGS
- PCTS THERMOPLASTIC COUPLINGS
- POLARSEAL COUPLINGS
- POLARSEAL II COUPLINGS
- POWER STEERING
- ADAPTERS
- QUICK DISCONNECT COUPLERS
- BALL VALVES
- LIVE SWIVEL
- ASSEMBLY FABRICATION
- ACCESSORIES
- EQUIPMENT AND PARTS
- AIR BRAKE
- BRASS
- KITS

Field Attachable for C5CXH, C5C, C5D & C5M Hose

EQUIPMENT
HOSE/CPLG. SELECTION
G8K COUPLINGS
GLOBALSPIRAL COUPLINGS
STAINLESS STEEL SPIRAL
MEGACRIMP COUPLINGS
STAINLESS STEEL BRAID
POWER CRIMP COUPLINGS
FIELD ATTACHABLE G1 & G2 COUPLINGS
FIELD ATTACHABLE C5 COUPLINGS
GLX COUPLINGS
GL COUPLINGS
C14 COUPLINGS
PCTS THERMOPLASTIC COUPLINGS
POLARSEAL COUPLINGS
POLARSEAL II COUPLINGS
POWER STEERING
ADAPTERS
QUICK DISCONNECT COUPLERS
BALL VALVES
LIVE SWIVEL
ASSEMBLY FABRICATION
ACCESSORIES
EQUIPMENT AND PARTS
AIR BRAKE
BRASS
KITS

Female Flat-Face Swivel - 45° Bent Tube - Steel

SAE J1453 O-Ring Face Seal.

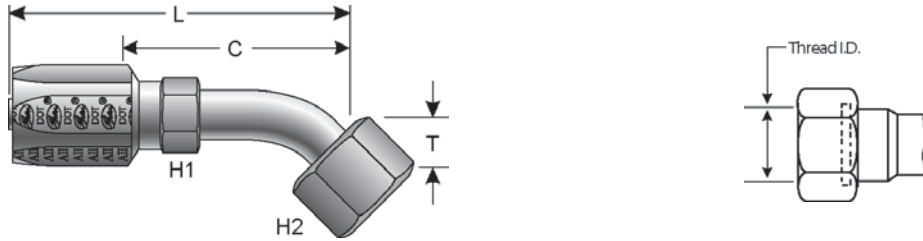

Part No.	Descr.	Prod. No.	⌀		H1	H2	T		L		C		
			"	mm			"	mm	"	mm	"	mm	
G34235-0404	4C5-4RFFORX45	7235-05275	3/16	4.8	9/16-18	1/2	11/16	.41	10.4	2.42	61.5	1.67	42.4

Female Flat-Face Swivel - 90° Bent Tube - Steel

SAE J1453 O-Ring Face Seal.

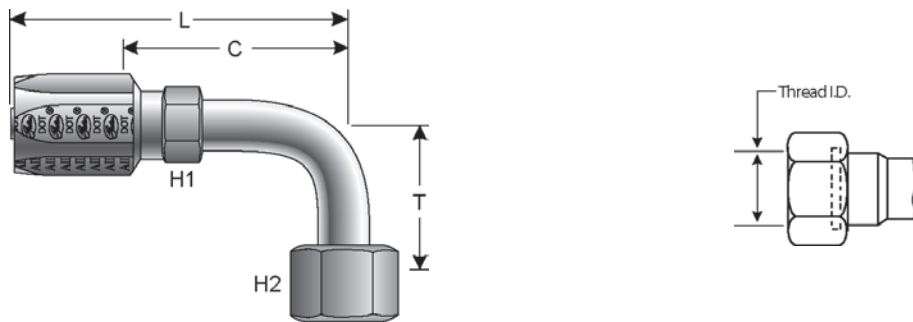

Part No.	Descr.	Prod. No.	⌀		H1	H2	T		L		C		
			"	mm			"	mm	"	mm	"	mm	
G34240-0404	4C5-4RFFORX90	7235-05285	3/16	4.8	1/2-20	1/2	11/16	.82	20.8	2.17	55.1	1.42	36.1
G34239-0606	6C5-6RFFORX90S	7235-05305	5/16	7.9	5/8-18	1/2	13/16	.90	22.9	2.77	70.4	1.82	46.2

Special Flange - 90° - Engine Oil Connection (Code 61-2 bolt)

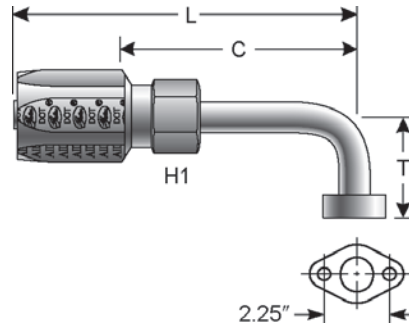

Part No.	Descr.	Prod. No.	⊖		H1	T		L		C	
			"	mm		"	mm	"	mm	"	mm
G34342-2020	20C5-20RFL90S	7235-20275	1 1/8	28.6	1 9/16	2.50	63.5	4.95	125.7	3.95	100.3

Male SAE 45° Flare Inverted Swivel - Steel

DOT FMVSS 106-74 Type All.



Part No.	Descr.	Prod. No.	⊖		H1	H2	L		C		
			"	mm			"	mm	"	mm	
G34500-0404	4C5-4RMIX	7235-86372	3/16	4.8	7/16-24	7/16	7/16	2.41	61.2	1.72	43.7
G34500-0505	5C5X-5RMIX	7237-01155	1/4	6.4	1/2-20	7/16	1/2	2.63	66.8	1.84	46.7
G34500-0506	5C5X-6RMIX	7237-01165	1/4	6.4	5/8-18	1/2	5/8	2.59	65.8	1.82	46.2
G34500-0605	6C5-5RMIX	7235-01035	5/16	7.9	1/2-20	1/2	1/2	2.60	66.0	1.65	41.9
G34500-0606	6C5-6RMIX	7235-86382	5/16	7.9	5/8-18	1/2	5/8	2.86	72.6	1.91	48.5
G34500-0608	6C5-8RMIX	7235-01055	5/16	7.9	3/4-16	5/8	3/4	3.23	82.0	2.28	57.9
G34500-0806	8C5X-6RMIX	7237-01205	13/32	10.3	5/8-18	5/8	5/8	3.13	79.5	2.01	51.1
G34500-0808	8C5X-8RMIX	7237-01215	13/32	10.3	3/4-16	5/8	3/4	3.49	88.7	2.37	60.2

- EQUIPMENT
- HOSE/CPLG. SELECTION
- G8K COUPLINGS
- GLOBALSPIRAL COUPLINGS
- STAINLESS STEEL SPIRAL
- MEGACRIMP COUPLINGS
- STAINLESS STEEL BRAID
- POWER CRIMP COUPLINGS
- FIELD ATTACHABLE G1 & G2 COUPLINGS
- FIELD ATTACHABLE C5 COUPLINGS
- GLX COUPLINGS
- GL COUPLINGS
- C14 COUPLINGS
- PCTS THERMOPLASTIC COUPLINGS
- POLARSEAL COUPLINGS
- POLARSEAL II COUPLINGS
- POWER STEERING
- ADAPTERS
- QUICK DISCONNECT COUPLERS
- BALL VALVES
- LIVE SWIVEL
- ASSEMBLY FABRICATION
- ACCESSORIES
- EQUIPMENT AND PARTS
- AIR BRAKE
- BRASS
- KITS

Field Attachable for C5CXH, C5C, C5D & C5M Hose

Male SAE 45° Flare Inverted Swivel - 45° Bent Tube - Steel

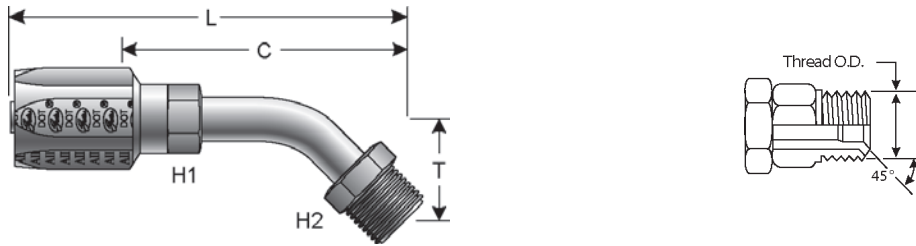

Part No.	Descr.	Prod. No.	⊖		7/16-24	H1	H2	T		L		C	
			"	mm				"	mm	"	mm	"	mm
G34502-0404	4C5-4RMIX45	7235-05005	3/16	4.8	7/16-24	7/16	7/16	.62	15.8	2.18	55.4	1.48	37.6
G34502-0606	6C5-6RMIX45	7235-05015	5/16	7.9	5/8-18	1/2	5/8	.94	23.9	3.03	77.0	2.09	53.1
G34502-0808	8C5X-8RMIX45-028	7237-01245	13/32	10.3	3/4-16	5/8	3/4	1.09	27.7	3.44	87.4	2.32	58.9

Male SAE 45° Flare Inverted Swivel - 90° Bent Tube - Steel

DOT FMVSS 106-74 Type All.

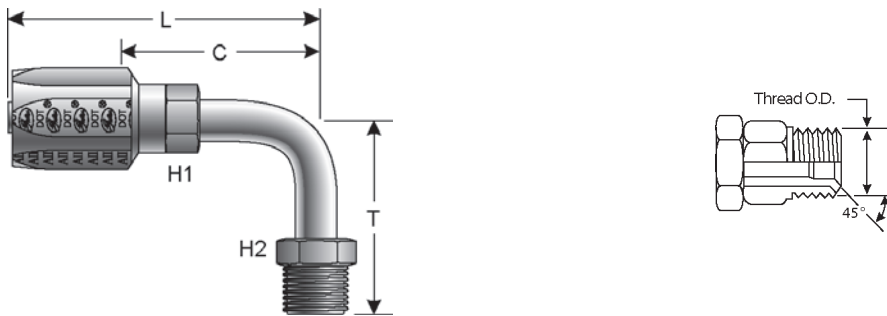

Part No.	Descr.	Prod. No.	⊖		7/16-24	H1	H2	T		L		C	
			"	mm				"	mm	"	mm	"	mm
G34504-0404	4C5-4RMIX90	7235-05105	3/16	4.8	7/16-24	7/16	7/16	1.56	39.6	2.17	55.1	1.47	37.3
G34504-0505	5C5X-5RMIX90-042	7237-01265	1/4	6.4	1/2-20	7/16	1/2	1.66	42.2	2.43	61.7	1.66	42.2
G34504-0606	6C5-6RMIX90	7235-86387	5/16	7.9	5/8-18	1/2	5/8	1.69	42.9	2.64	67.1	1.69	42.9
G34504-0608	6C5-8RMIX90	7235-05135	5/16	7.9	3/4-16	5/8	3/4	1.78	45.2	2.73	69.3	1.78	45.2
G34504-0806	8C5X-6RMIX90-043	7237-01295	13/32	10.3	5/8-18	5/8	5/8	1.69	42.9	2.81	71.4	1.69	42.9
G34504-0808	8C5X-8RMIX90-045	7237-01305	13/32	10.3	3/4-16	5/8	3/4	1.78	45.2	2.90	73.7	1.78	45.2

SAE Male Flareless Assembly - Steel

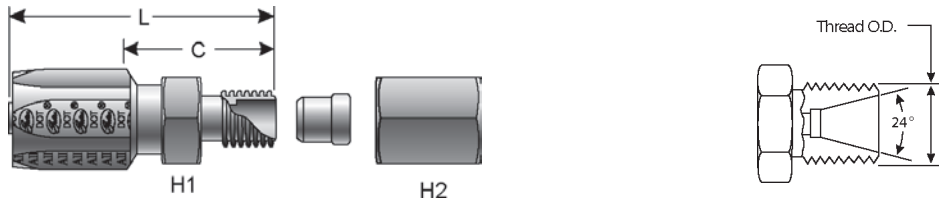

Part No.	Descr.	Prod. No.	⌀		Thread	H1	H2	L		C	
			"	mm				"	mm	"	mm
G34510-0404	4C5-4RMFA	7236-04855	3/16	4.8	7/16-20	1/2	9/16	1.81	46.0	1.06	26.9
G34510-0505	5C5X-5RMFA	7237-01325	1/4	6.4	1/2-20	9/16	5/8	1.91	48.5	1.12	28.5
G34510-0604	6C5-4RMFA	7236-04875	5/16	7.9	7/16-20	9/16	9/16	2.03	51.6	1.13	28.7
G34510-0606	6C5-6RMFA	7236-04885	5/16	7.9	5/8-18	5/8	11/16	2.05	52.1	1.15	29.2
G34510-0808	8C5X-8RMFA	7237-01355	13/32	10.3	3/4-16	13/16	7/8	2.52	64.0	1.37	34.8
G34510-1010	10C5-10RMFA	7236-04905	1/2	12.7	7/8-14	15/16	1	2.77	70.4	1.48	37.6

Female Air Brake Swivel - Steel

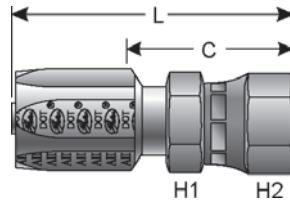

Part No.	Descr.	Prod. No.	⌀		Thread	H1	H2	L		C	
			"	mm				"	mm	"	mm
G34540-0606	6C5-6RFABX	7238-04425	5/16	7.9	3/4-20	7/8	7/8	2.29	58.2	1.34	34.0
G34540-0806	8C5X-6RFABX	7237-01395	13/32	10.3	3/4-20	7/8	7/8	2.60	66.0	1.48	37.6

Parker Triple Thread Female Swivel - Steel



Part No.	Descr.	Prod. No.	⌀		Thread	H1	H2	L		C	
			"	mm				"	mm	"	mm
G34562-1616	16C5-16RFZX	7238-86461	7/8	22.2	1 5/16-14	1 1/2	1 1/2	2.90	73.7	1.72	43.7

- EQUIPMENT
- HOSE/CPLG. SELECTION
- G8K COUPLINGS
- GLOBALSPIRAL COUPLINGS
- STAINLESS STEEL SPIRAL
- MEGACRIMP COUPLINGS
- STAINLESS STEEL BRAID
- POWER CRIMP COUPLINGS
- FIELD ATTACHABLE G1 & G2 COUPLINGS
- FIELD ATTACHABLE C5 COUPLINGS
- GLX COUPLINGS
- GL COUPLINGS
- C14 COUPLINGS
- PCTS THERMOPLASTIC COUPLINGS
- POLARSEAL COUPLINGS
- POLARSEAL II COUPLINGS
- POWER STEERING
- ADAPTERS
- QUICK DISCONNECT COUPLERS
- BALL VALVES
- LIVE SWIVEL
- ASSEMBLY FABRICATION
- ACCESSORIES
- EQUIPMENT AND PARTS
- AIR BRAKE
- BRASS
- KITS

Field Attachable for C5E Hose

Male Pipe (NPTF - 30° Cone Seat - Steel)

DOT FMVSS Type A1 (No mandrel required).

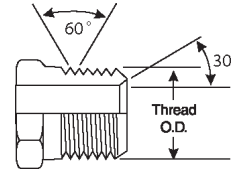
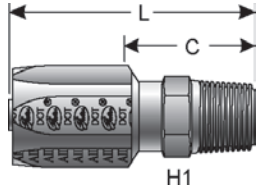

Part No.	Descr.	Prod. No.	⊖		H1	L		C		
			"	mm		"	mm	"	mm	
G35100-0402	4C5E-2RMP	7236-00755	3/16	4.8	1/8-27	1/2	1.53	38.9	.81	20.6
G35100-0404	4C5E-4RMP	7236-00765	3/16	4.8	1/4-18	9/16	1.75	44.5	1.03	26.2
G35100-0504	5C5E-4RMP	7236-00775	1/4	6.4	1/4-18	9/16	1.76	44.7	.96	24.4
G35100-0604	6C5E-4RMP	7236-00785	5/16	7.9	1/4-18	9/16	1.85	47.0	1.00	25.4
G35100-0606	6C5E-6RMP	7236-00795	5/16	7.9	3/8-18	11/16	1.89	48.0	1.04	26.4
G35100-0806	8C5E-6RMP	7236-00805	13/32	10.3	3/8-18	11/16	2.19	55.6	1.19	30.2
G35100-0808	8C5E-8RMP	7236-00815	13/32	10.3	1/2-14	7/8	2.29	58.2	1.29	32.8
G35100-1008	10C5E-8RMP	7236-00825	1/2	12.7	1/2-14	7/8	2.38	60.5	1.31	33.3
G35100-1212	12C5E-12RMP	7236-00835	5/8	15.9	3/4-14	1 1/16	2.59	65.8	1.44	36.6
G35100-1216	12C5E-16RMP	7236-00845	5/8	15.9	1-11 1/2	1 3/8	2.87	72.9	1.72	43.7
G35100-1612	16C5E-12RMP	7236-00865	7/8	22.2	3/4-14	1 1/16	2.49	63.3	1.43	36.3
G35100-1616	16C5E-16RMP	7236-00855	7/8	22.2	1-11 1/2	1 3/8	2.80	71.1	1.74	44.2
G35100-2020	20C5E-20RMP	7236-00885	1 1/8	28.6	1 1/4-11	1 3/4	2.92	74.2	1.80	45.7

Female JIC 37° Flare Swivel - Steel

DOT FMVSS Type A1 (No mandrel required).

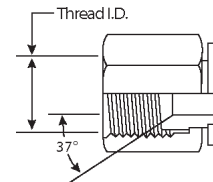
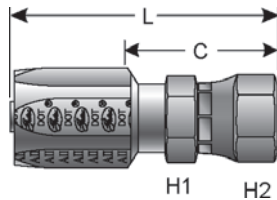

Part No.	Descr.	Prod. No.	⊖		H1	H2	L		C		
			"	mm			"	mm	"	mm	
G35170-0606	6C5E-6RFJX	7238-01025	5/16	7.9	9/16-18	3/4	3/4	2.04	51.8	1.19	30.2
G35170-1212	12C5E-12RFJX	7238-01055	5/8	15.9	1 1/16-12	1 1/4	1 1/4	2.92	74.2	1.78	45.2
G35170-1616	16C5E-16RFJX	7238-01065	7/8	22.2	1 5/16-12	1 1/2	1 1/2	2.90	73.7	1.84	46.7
G35170-2020	20C5E-20RFJX	7238-01215	1 1/8	28.6	1 5/8-12	1 9/16	2	3.34	84.8	2.20	55.9

Female JIC 37° Flare Swivel - 45° Bent Tube - Steel

DOT FMVSS Type A1 (No mandrel required).

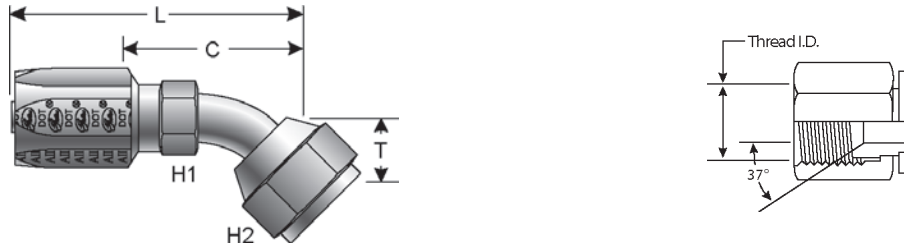

Part No.	Descr.	Prod. No.	⊖		H1	H2	T		L		C		
			"	mm			"	mm	"	mm	"	mm	"
G35175-0606	6C5E-6RFJX45	7235-20415	5/16	7.9	9/16-18	1/2	11/16	.41	10.4	2.33	59.2	1.48	37.6
G35175-1212	12C5E-12RFJX45	7235-20455	5/8	15.9	1 1/16-12	7/8	1 1/4	.78	19.8	3.63	92.2	2.49	63.3

Female JIC 37° Flare Swivel - 90° Bent Tube - Steel

DOT FMVSS Type A1 (No mandrel required).

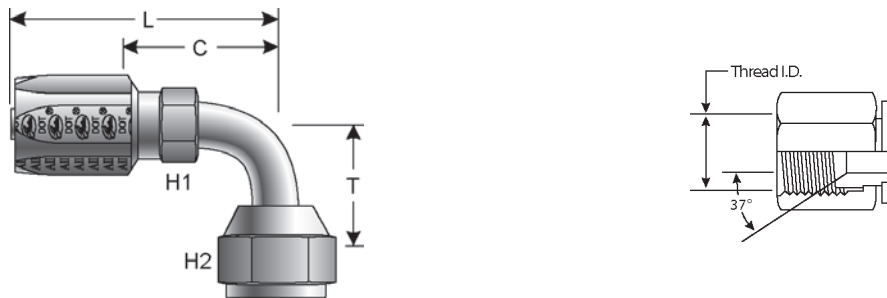

Part No.	Descr.	Prod. No.	⊖		H1	H2	T		L		C		
			"	mm			"	mm	"	mm	"	mm	"
G35180-0606	6C5E-6RFJX90	7235-00305	5/16	7.9	9/16-18	1/2	11/16	.91	23.4	2.21	56.1	1.78	45.2
G35180-1212	12C5E-12RFJX90	7235-00265	5/8	15.9	1 1/16-12	7/8	1 1/4	1.81	46.0	3.58	90.9	2.44	62.0
G35180-1616	16C5E-16RFJX90	7235-00285	7/8	22.2	1 5/16-13	—	1 1/2	2.16	54.9	3.72	94.5	2.66	67.6
G35180-2020	20C5E-20RFJX90	7235-20345	1 1/8	28.6	1 5/8-12	2	1 9/16	2.65	67.3	5.58	141.7	4.45	113.0

EQUIPMENT

HOSE/CPLG. SELECTION

G8K COUPLINGS

GLOBALSPIRAL COUPLINGS

STAINLESS STEEL SPIRAL

MEGACRIMP COUPLINGS

STAINLESS STEEL BRAID

POWER CRIMP COUPLINGS

FIELD ATTACHABLE G1 & G2 COUPLINGS

FIELD ATTACHABLE C5 COUPLINGS

GLX COUPLINGS

GL COUPLINGS

C14 COUPLINGS

PCTS THERMOPLASTIC COUPLINGS

POLARSEAL COUPLINGS

POLARSEAL II COUPLINGS

POWER STEERING

ADAPTERS

QUICK DISCONNECT COUPLERS

BALL VALVES

LIVE SWIVEL

ASSEMBLY FABRICATION

ACCESSORIES

EQUIPMENT AND PARTS

AIR BRAKE

BRASS

KITS

Female SAE 45° Flare Swivel - Steel

DOT FMVSS Type A1 (No mandrel required).

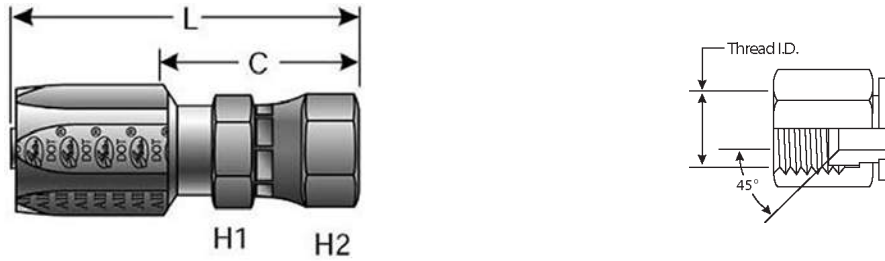

Part No.	Descr.	Prod. No.	⊖		🌀	H1	H2	L		C	
			"	mm				"	"	"	mm
G35200-0606	6C5E-6RFSX	7238-00955	5/16	7.9	5/8-18	3/4	3/4	2.13	54.1	1.28	32.5
G35200-1212	12C5E-12RFSX	7238-00985	5/8	15.9	1 1/16-14	1 1/4	1 1/4	2.94	74.7	1.80	45.7

Female SAE 45° Flare Swivel - 45° Bent Tube - Steel

DOT FMVSS Type A1 (No mandrel required).

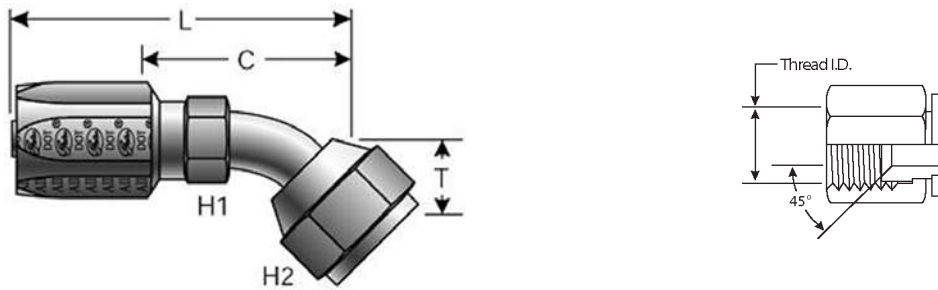

Part No.	Descr.	Prod. No.	⊖		🌀	H1	H2	T		L		C	
			"	mm				"	"	"	mm	"	mm
G35202-0606	6C5E-6RFSX45	7235-20425	5/16	7.9	5/8-18	1/2	3/4	.41	10.4	2.33	59.2	1.48	37.6
G35202-1212	12C5E-12RFSX45	7235-20465	5/8	15.9	1 1/16-14	7/8	1 1/4	.78	19.8	3.63	92.2	2.49	63.3

- EQUIPMENT
- HOSE/CPLG. SELECTION
- G8K COUPLINGS
- GLOBALSPIRAL COUPLINGS
- STAINLESS STEEL SPIRAL
- MEGACRIMP COUPLINGS
- STAINLESS STEEL BRAID
- POWER CRIMP COUPLINGS
- FIELD ATTACHABLE G1 & G2 COUPLINGS
- FIELD ATTACHABLE C5 COUPLINGS
- GLX COUPLINGS
- GL COUPLINGS
- C14 COUPLINGS
- PCTS THERMOPLASTIC COUPLINGS
- POLARSEAL COUPLINGS
- POLARSEAL II COUPLINGS
- POWER STEERING
- ADAPTERS
- QUICK DISCONNECT COUPLERS
- BALL VALVES
- LIVE SWIVEL
- ASSEMBLY FABRICATION
- ACCESSORIES
- EQUIPMENT AND PARTS
- AIR BRAKE
- BRASS
- KITS

Female SAE 45° Flare Swivel - 90° Bent Tube - Steel

DOT FMVSS Type A1 (No mandrel required).

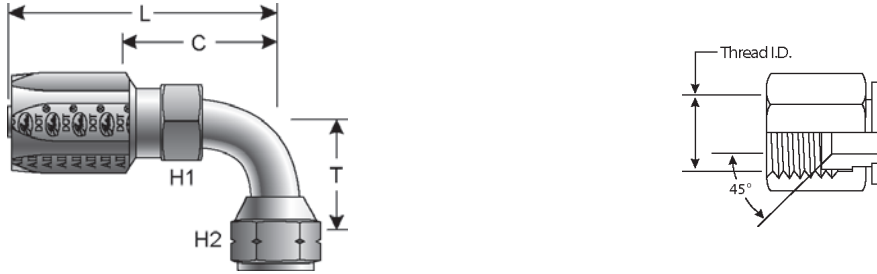

Part No.	Descr.	Prod. No.	⌀		H1	H2	T	L		C			
			"	mm				"	mm	"	mm		
G35205-0606	6C5E-6RFSX90	7235-00315	5/16	7.9	5/8-18	1/2	3/4	.84	21.3	2.21	56.1	1.36	34.5
G35205-1212	12C5E-12RFSX90	7235-00275	5/8	15.9	1 1/16-14	7/8	1 1/4	1.81	46.0	3.58	90.9	2.44	62.0

Dual Seat Female JIC 37°/SAE 45° Flare Swivel - Steel

DOT FMVSS Type A1 (No mandrel required).

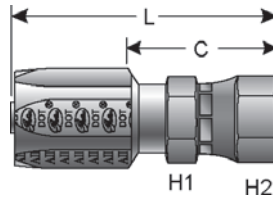

Part No.	Descr.	Prod. No.	⌀		H1	H2	L	C			
			"	mm				"	mm		
G35210-0404	4C5E-4RFJSX	7238-01005	3/16	4.8	7/16-20	1/2	9/16	1.82	46.2	1.10	27.9
G35210-0505	5C5E-5RFJSX	7238-01015	1/4	6.4	1/2-20	1/2	11/16	2.00	50.8	1.21	30.7
G35210-0808	8C5E-8RFJSX	7238-01035	13/32	10.3	3/4-16	7/8	7/8	2.45	62.2	1.45	36.8
G35210-1010	10C5E-10RFJSX	7238-01045	1/2	12.7	7/8-14	1 1/16	1 1/16	2.72	69.1	1.65	41.9

Dual Seat Female JIC 37°/SAE 45° Flare Swivel - 45° Bent Tube - Steel

DOT FMVSS Type A1 (No mandrel required).

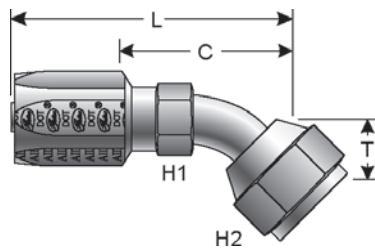

Part No.	Descr.	Prod. No.	⌀		H1	H2	T	L		C			
			"	mm				"	mm	"	mm		
G35211-0404	4C5E-4RFJSX45	7235-20405	3/16	4.8	7/16-20	1/2	9/16	.34	8.6	1.92	48.8	1.20	30.5
G35211-0808	8C5E-8RFJSX45	7235-20435	13/32	10.3	3/4-16	11/16	7/8	.56	14.2	2.73	69.3	1.73	43.9

EQUIPMENT
HOSE/CPLG. SELECTION
G&K COUPLINGS
GLOBALSPIRAL COUPLINGS
STAINLESS STEEL SPIRAL
MEGACRIMP COUPLINGS
STAINLESS STEEL BRAID
POWER CRIMP COUPLINGS
FIELD ATTACHABLE G1 & G2 COUPLINGS
FIELD ATTACHABLE C5 COUPLINGS
GLX COUPLINGS
GL COUPLINGS
C14 COUPLINGS
PCTS THERMOPLASTIC COUPLINGS
POLARSEAL COUPLINGS
POLARSEAL II COUPLINGS
POWER STEERING
ADAPTERS
QUICK DISCONNECT COUPLERS
BALL VALVES
LIVE SWIVEL
ASSEMBLY FABRICATION
ACCESSORIES
EQUIPMENT AND PARTS
AIR BRAKE
BRASS
KITS

Field Attachable for C5E Hose

EQUIPMENT
HOSE/CPLG. SELECTION
G8K COUPLINGS
GLOBAL SPIRAL COUPLINGS
STAINLESS STEEL SPIRAL
MEGACRIMP COUPLINGS
STAINLESS STEEL BRAID
POWER CRIMP COUPLINGS
FIELD ATTACHABLE G1 & G2 COUPLINGS
FIELD ATTACHABLE C5 COUPLINGS
GLX COUPLINGS
GL COUPLINGS
C14 COUPLINGS
PCTS THERMOPLASTIC COUPLINGS
POLARSEAL COUPLINGS
POLARSEAL II COUPLINGS
POWER STEERING
ADAPTERS
QUICK DISCONNECT COUPLERS
BALL VALVES
LIVE SWIVEL
ASSEMBLY FABRICATION
ACCESSORIES
EQUIPMENT AND PARTS
AIR BRAKE
BRASS
KITS

Dual Seat Female JIC 37°/SAE 45° Flare Swivel - 45° Bent Tube - Steel - Continued

Part No.	Descr.	Prod. No.	⊖		H1	H2	T		L		C		
			"	mm			"	mm	"	mm	"	mm	
G35211-1010	10C5E-10RFJSX45	7235-20445	1/2	12.7	7/8-14	3/4	1	.63	16.0	3.17	80.5	2.11	53.6

Dual Seat Female JIC 37°/SAE 45° Flare Swivel - 90° Bent Tube - Steel

DOT FMVSS Type A1 (No mandrel required).

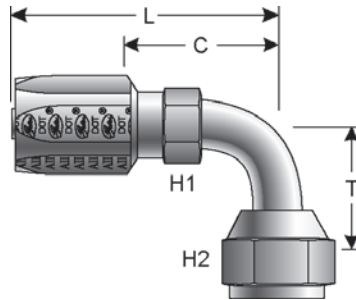

Part No.	Descr.	Prod. No.	⊖		H1	H2	T		L		C		
			"	mm			"	mm	"	mm	"	mm	
G35212-0404	4C5E-4RFJSX90	7235-20305	3/16	4.8	7/16-20	1/2	9/16	.69	17.5	1.72	43.7	1.00	25.4
G35212-0808	8C5E-8RFJSX90	7235-20315	13/32	10.3	3/4-16	11/16	7/8	1.09	27.7	2.54	64.5	1.54	39.1
G35212-1010	10C5E-10RFJSX90	7235-20325	1/2	12.7	7/8-14	3/4	1	1.25	31.8	2.97	75.4	1.91	48.5

Special Flange - 90° - Engine Oil Connection (Code 61-2 bolt) - Steel

DOT FMVSS Type A1 (No mandrel required).

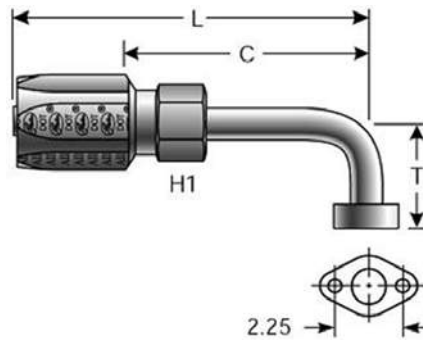

Part No.	Descr.	Prod. No.	⊖		H1	T	L		C		
			"	mm			"	mm	"	mm	
G35342-2020	20C5E-20RFL90S	7235-20355	1 1/8	28.6	1 9/16	2.50	63.5	4.95	125.7	3.82	97.0

Male SAE 45° Flare Inverted Swivel - Steel

DOT FMVSS Type A1 (No mandrel required).

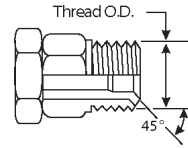
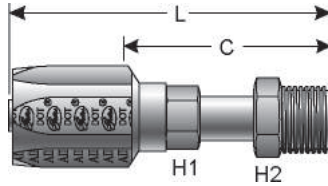

Part No.	Descr.	Prod. No.	⊖		🌀	H1	H2	L		C	
			"	mm				"	"	"	mm
G35500-0404	4C5E-4RMIX	7235-02855	3/16	4.8	7/16-24	1/2	7/16	2.05	52.1	1.33	33.8
G35500-0505	5C5E-5RMIX	7235-02865	1/4	6.4	1/2-20	1/2	1/2	2.26	57.4	1.45	36.8
G35500-0605	6C5E-5RMIX	7235-02875	5/16	7.9	1/2-20	1/2	1/2	2.39	60.7	1.54	39.1
G35500-0606	6C5E-6RMIX	7235-02885	5/16	7.9	5/8-18	1/2	5/8	2.71	68.8	1.86	47.2
G35500-0808	8C5E-8RMIX	7235-02895	13/32	10.3	3/4-18	11/16	3/4	3.24	82.3	2.24	56.9

Male SAE 45° Flare Inverted Swivel - 45° Bent Tube - Steel

DOT FMVSS Type A1 (No mandrel required).

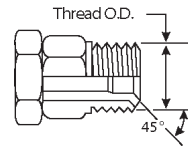
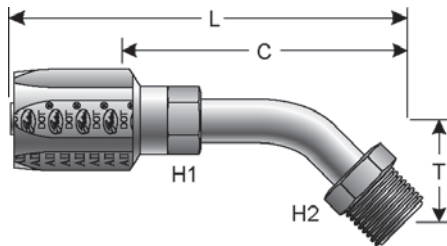

Part No.	Descr.	Prod. No.	⊖		🌀	H1	H2	T		L		C	
			"	mm				"	mm	"	mm	"	mm
G35502-0606	6C5E-6RMIX45	7235-02795	5/16	7.9	5/8-18	1/2	5/8	.84	21.3	3.79	96.3	2.94	74.7
G35502-0808	8C5E-8RMIX45	7235-02905	13/32	10.3	3/4-18	11/16	3/4	1.09	27.7	4.24	107.7	3.24	82.3

EQUIPMENT

HOSE/CPLG. SELECTION

G8K COUPLINGS

GLOBALSPIRAL COUPLINGS

STAINLESS STEEL SPIRAL

MEGACRIMP COUPLINGS

STAINLESS STEEL BRAID

POWER CRIMP COUPLINGS

FIELD ATTACHABLE G1 & G2 COUPLINGS

FIELD ATTACHABLE C5 COUPLINGS

GLX COUPLINGS

GL COUPLINGS

C14 COUPLINGS

PCTS THERMOPLASTIC COUPLINGS

POLARSEAL COUPLINGS

POLARSEAL II COUPLINGS

POWER STEERING

ADAPTERS

QUICK DISCONNECT COUPLERS

BALL VALVES

LIVE SWIVEL

ASSEMBLY FABRICATION

ACCESSORIES

EQUIPMENT AND PARTS

AIR BRAKE

BRASS

KITS

Field Attachable for C5E Hose

Male SAE 45° Flare Inverted Swivel - 90° Bent Tube - Steel

DOT FMVSS Type A1 (No mandrel required).

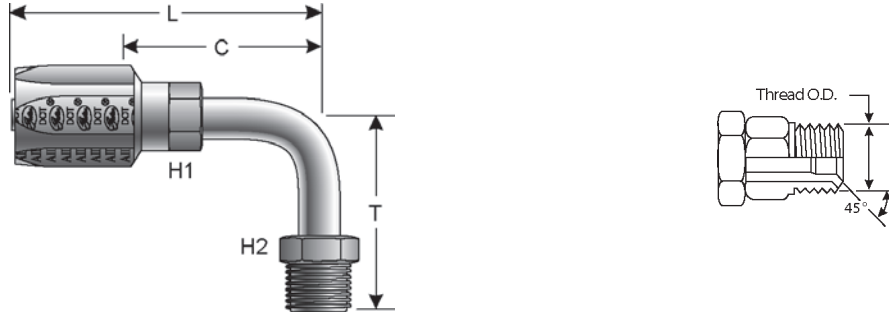

Part No.	Descr.	Prod. No.	⊖		🌀	H1	H2	T		L		C	
			"	mm				"	mm	"	mm	"	mm
G35504-0404	4C5E-4RMIX90	7235-02805	3/16	4.8	7/16-24	1/2	7/16	1.25	31.8	2.05	52.1	1.33	33.8
G35504-0505	5C5E-5RMIX90	7235-02815	1/4	6.4	1/2-20	1/2	1/2	1.50	38.1	2.25	57.2	1.46	37.1
G35504-0605	6C5E-5RMIX90	7235-02825	5/16	7.9	1/2-20	1/2	1/2	1.50	38.1	2.39	60.7	1.54	39.1
G35504-0606	6C5E-6RMIX90	7235-02835	5/16	7.9	5/8-18	1/2	5/8	1.63	41.4	2.71	68.8	1.86	47.2
G35504-0808	8C5E-8RMIX90	7235-02845	13/32	10.3	3/4-18	11/16	3/4	2.00	50.8	3.24	82.3	2.24	56.9

SAE Male Flareless Assembly - Steel

DOT FMVSS Type A1 (No mandrel required).

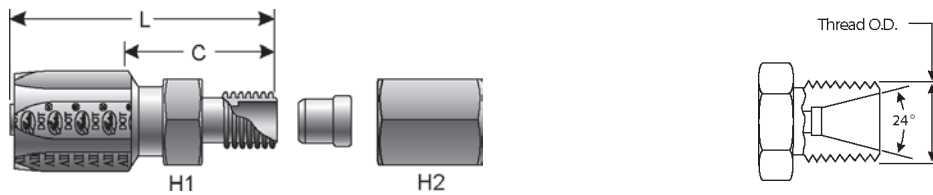

Part No.	Descr.	Prod. No.	⊖		🌀	H1	H2	L		C	
			"	mm				"	mm	"	mm
G35510-0404	4C5E-4RMFA	7236-04955	3/16	4.8	7/16-20	1/2	9/16	1.68	42.7	.96	24.4
G35510-0505	5C5E-5RMFA	7236-04965	1/4	6.4	1/2-20	9/16	5/8	1.72	43.7	.92	23.4
G35510-0604	6C5E-4RMFA	7236-04975	5/16	7.9	7/16-20	9/16	9/16	2.12	53.9	1.01	25.7
G35510-0606	6C5E-6RMFA	7236-04985	5/16	7.9	9/16-18	5/8	11/16	1.87	47.5	1.03	26.2
G35510-0808	8C5E-8RMFA	7236-04995	13/32	10.3	3/4-16	13/16	7/8	2.15	54.6	1.15	29.2
G35510-1010	10C5E-10RMFA	7236-05005	1/2	12.7	7/8-14	15/16	1	2.34	59.4	1.27	32.3

Parker Triple Thread Female Swivel - Steel

DOT FMVSS Type A1 (No mandrel required).

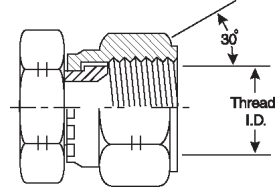
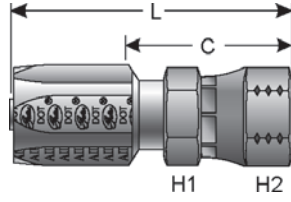

Part No.	Descr.	Prod. No.	⌀		H1	H2	L		C		
			"	mm			"	mm	"	mm	"
G35562-1616	16C5E-16RFZX	7238-01075	7/8	22.2	1 5/16-14	1 1/2	1 1/2	2.74	69.6	1.68	42.7

EQUIPMENT
HOSE/CPLG. SELECTION
G8K COUPLINGS
GLOBALSPIRAL COUPLINGS
STAINLESS STEEL SPIRAL
MEGACRIMP COUPLINGS
STAINLESS STEEL BRAID
POWER CRIMP COUPLINGS
FIELD ATTACHABLE G1 & G2 COUPLINGS
FIELD ATTACHABLE C5 COUPLINGS
GLX COUPLINGS
GL COUPLINGS
C14 COUPLINGS
PCTS THERMOPLASTIC COUPLINGS
POLARSEAL COUPLINGS
POLARSEAL II COUPLINGS
POWER STEERING
ADAPTERS
QUICK DISCONNECT COUPLERS
BALL VALVES
LIVE SWIVEL
ASSEMBLY FABRICATION
ACCESSORIES
EQUIPMENT AND PARTS
AIR BRAKE
BRASS
KITS

NOTES

EQUIPMENT
HOSE/CPLG. SELECTION
G8K COUPLINGS
GLOBALSPIRAL COUPLINGS
STAINLESS STEEL SPIRAL
MEGACRIMP COUPLINGS
STAINLESS STEEL BRAID
POWER CRIMP COUPLINGS
FIELD ATTACHABLE G1 & G2 COUPLINGS
FIELD ATTACHABLE C5 COUPLINGS
GLX COUPLINGS
GL COUPLINGS
C14 COUPLINGS
PCTS THERMOPLASTIC COUPLINGS
POLARSEAL COUPLINGS
POLARSEAL II COUPLINGS
POWER STEERING
ADAPTERS
QUICK DISCONNECT COUPLERS
BALL VALVES
LIVE SWIVEL
ASSEMBLY FABRICATION
ACCESSORIES
EQUIPMENT AND PARTS
AIR BRAKE
BRASS
KITS

Hydraulic Hose For GLX Couplings

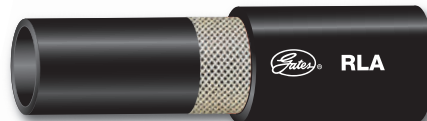
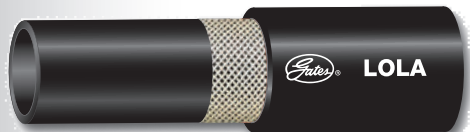
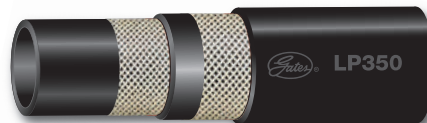
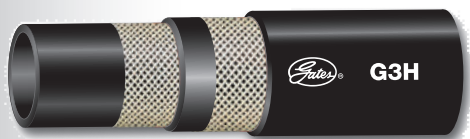

The Gates eCrimp program is a web based utility which allows users and distributors of Gates hydraulic and industrial hose products to find and print the most up to date crimp specifications with nothing more than an internet browser.

This program can be used to find crimp data for the MobileCrimp 4-20, PC 707, SC32, PC 3000B, GC32-XD™ Global Hose Crimper, GC96 and Omni Crimp 21. Custom result may be printed by selecting the crimper, hose and coupling. Optionally results may also be limited by die set and working pressure.



The eCrimp mobile app gives you all the same features of the online version in the palm of your hands. Use the app to find the most up-to-date crimp specifications quickly and easily. It is available for download for the iPhone and iPad from the App Store.



EQUIPMENT
HOSE/CPLG. SELECTION
G&K COUPLINGS
GLOBAL SPIRAL COUPLINGS
STAINLESS STEEL SPIRAL
MEGACRIMP COUPLINGS
STAINLESS STEEL BRAID
POWER CRIMP COUPLINGS
FIELD ATTACHABLE G1 & G2 COUPLINGS
FIELD ATTACHABLE C5 COUPLINGS
GLX COUPLINGS
GL COUPLINGS
C14 COUPLINGS
PCTS THERMOPLASTIC COUPLINGS
POLARSEAL COUPLINGS
POLARSEAL II COUPLINGS
POWER STEERING
ADAPTERS
QUICK DISCONNECT COUPLERS
BALL VALVES
LIVE SWIVEL
ASSEMBLY FABRICATION
ACCESSORIES
EQUIPMENT AND PARTS
AIR BRAKE
BRASS
KITS

EQUIPMENT
HOSE/CPLG. SELECTION
G8K COUPLINGS
GLOBALSPIRAL COUPLINGS
STAINLESS STEEL SPIRAL
MEGACRIMP COUPLINGS
STAINLESS STEEL BRAID
POWER CRIMP COUPLINGS
FIELD ATTACHABLE G1 & G2 COUPLINGS
FIELD ATTACHABLE C5 COUPLINGS
GLX COUPLINGS
GL COUPLINGS
C14 COUPLINGS
PCTS THERMOPLASTIC COUPLINGS
POLARSEAL COUPLINGS
POLARSEAL II COUPLINGS
POWER STEERING
ADAPTERS
QUICK DISCONNECT COUPLERS
BALL VALVES
LIVE SWIVEL
ASSEMBLY FABRICATION
ACCESSORIES
EQUIPMENT AND PARTS
AIR BRAKE
BRASS
KITS

Male Pipe (NPTF 30° Cone Seat)

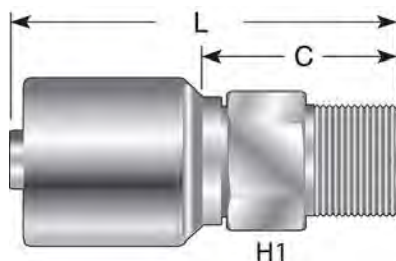

Part No.	Descr.	Prod. No.	⊖	🌀	H1	L		C	
			"	"	"	"	mm	"	mm
G44100-0402	4GLX-2MP	7107-00105	1/4	1/8-27	1/2	2.01	51.1	.98	24.9
G44100-0404	4GLX-4MP	7107-00115	1/4	1/4-18	9/16	2.17	55.1	1.14	29.0
G44100-0604	6GLX-4MP	7107-00135	3/8	1/4-18	11/16	2.32	58.9	1.22	31.0
G44100-0606	6GLX-6MP	7107-00145	3/8	3/8-18	11/16	2.32	58.9	1.22	31.0
G44100-0806	8GLX-6MP	7107-00165	1/2	3/8-18	13/16	2.72	69.1	1.24	31.5
G44100-0808	8GLX-8MP	7107-00175	1/2	1/2-14	7/8	2.78	70.6	1.40	35.6
G44100-0812	8GLX-12MP	7107-00785	1/2	3/4-14	13/16	3.46	87.9	1.45	36.8
G44100-1008	10GLX-8MP	7107-00195	5/8	1/2-14	15/16	2.40	61.0	1.55	39.4
G44100-1208	12GLX-8MP	7107-00215	3/4	1/2-14	1 1/16	3.46	87.9	1.46	37.1
G44100-1212	12GLX-12MP	7107-00225	3/4	3/4-14	1 1/16	3.46	87.9	1.46	37.1
G44100-1616	16GLX-16MP	7107-00255	1	1-11 1/2	1 3/8	4.11	104.4	1.88	47.8
G44100-2020	20GLX-20MP	7107-00265	1 1/4	1 1/4-11 1/2	1 3/4	4.41	112.0	2.09	53.1

MPX Male NPTF Swivel



Part No.	Descr.	Prod. No.	⊖	🌀	H1	H2	L		C	
			"	"	"	"	"	mm	"	mm
G44105-0404	4GLX-4MPX	7107-00565	1/4	1/4-18	1/2	11/16	2.61	66.3	1.58	40.1
G44105-0606	6GLX-6MPX	7107-00575	3/8	3/8-18	5/8	7/8	2.81	71.4	1.72	43.7
G44105-0808	8GLX-8MPX	7107-00585	1/2	1/2-14	13/16	1	3.42	86.9	1.95	49.5
G44105-1212	12GLX-12MPX	7107-00595	3/4	3/4-14	1 1/16	1 5/16	4.02	102.1	2.01	51.1
G44105-1616	16GLX-16MPX	7107-00605	1	1-11 1/2	1 3/8	1 5/8	4.73	120.1	2.50	63.5
G44105-2020	20GLX-20MPX	7107-00615	1 1/4	1 1/4-11 1/2	1 7/8	2	5.30	134.6	2.98	75.7

FP Female NPTF



Part No.	Descr.	Prod. No.	⊖	🌀	H1	L		C	
			"	"		"	mm	"	mm
G44110-0404	4GLX-4FP	7107-00415	1/4	1/4-18	11/16	1.99	50.6	.96	24.4
G44110-0604	6GLX-4FP	7107-00425	3/8	1/4-18	11/16	2.07	52.6	.97	24.6
G44110-0606	6GLX-6FP	7107-00435	3/8	3/8-18	13/16	2.07	52.6	.97	24.6
G44110-0806	8GLX-6FP	7107-00445	1/2	3/8-18	13/16	2.48	63.0	1.00	25.4
G44110-0808	8GLX-8FP	7107-00455	1/2	1/2-14	1	2.64	67.1	1.16	29.5
G44110-1212	12GLX-12FP	7107-00465	3/4	3/4-14	1 1/4	3.23	82.0	1.22	31.0
G44110-1616	16GLX-16FP	7107-00475	1	1-11 1/2	1 1/2	3.86	98.1	1.62	41.2

FPX Female NPSM Swivel



Part No.	Descr.	Prod. No.	⊖	🌀	H1	H2	L		C	
			"	"			"	mm	"	mm
G44111-0404	4GLX-4FPX	7107-00345	1/4	1/4-18	1/2	11/16	2.24	56.9	1.22	31.0
G44111-0604	6GLX-4FPX	7107-00355	3/8	1/4-18	5/8	11/16	2.40	61.0	1.30	33.0
G44111-0606	6GLX-6FPX	7107-00365	3/8	3/8-18	5/8	7/8	2.49	63.3	1.39	35.3
G44111-0806	8GLX-6FPX	7107-00375	1/2	3/8-18	13/16	7/8	2.85	72.4	1.38	35.1
G44111-0808	8GLX-8FPX	7107-00385	1/2	1/2-14	13/16	1	2.89	73.4	1.41	35.8
G44111-1212	12GLX-12FPX	7107-00395	3/4	3/4-14	1 1/16	1 1/4	3.72	94.5	1.71	43.4
G44111-1616	16GLX-16FPX	7107-00405	1	1-11 1/2	1 3/8	1 1/2	4.11	104.4	1.87	47.5

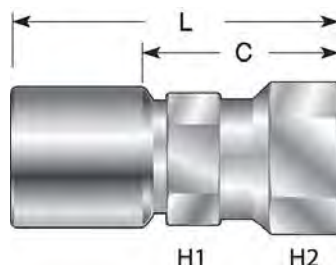

Female JIC 37° Flare Swivel



Part No.	Descr.	Prod. No.	⊖	🌀	H1	H2	L		C	
			"	"			"	mm	"	mm
G44170-0404	4GLX-4FJX	7107-00275	1/4	7/16-20	1/2	9/16	2.10	53.3	1.08	27.4
G44170-0606	6GLX-6FJX	7107-00285	3/8	9/16-18	5/8	3/4	2.31	58.7	1.19	30.2



- EQUIPMENT
- HOSE/CPLG. SELECTION
- G8K COUPLINGS
- GLOBALSPIRAL COUPLINGS
- STAINLESS STEEL SPIRAL
- MEGACRIMP COUPLINGS
- STAINLESS STEEL BRAID
- POWER CRIMP COUPLINGS
- FIELD ATTACHABLE G1 & G2 COUPLINGS
- FIELD ATTACHABLE C5 COUPLINGS
- GLX COUPLINGS
- GL COUPLINGS
- C14 COUPLINGS
- PCTS THERMOPLASTIC COUPLINGS
- POLARSEAL COUPLINGS
- POLARSEAL II COUPLINGS
- POWER STEERING
- ADAPTERS
- QUICK DISCONNECT COUPLERS
- BALL VALVES
- LIVE SWIVEL
- ASSEMBLY FABRICATION
- ACCESSORIES
- EQUIPMENT AND PARTS
- AIR BRAKE
- BRASS
- KITS

Female JIC 37° Flare Swivel - Continued

Part No.	Descr.	Prod. No.			H1	H2	L		C	
			"	"			"	mm	"	mm
G44170-0808	8GLX-8FJX	7107-00295	1/2	3/4-16	13/16	7/8	2.82	71.6	1.34	34.0
G44170-1010	10GLX-10FJX	7107-00305	5/8	7/8-14	—	1 1/16	2.27	57.7	1.42	36.1
STAINLESS STEEL SPIRAL	G44170-1212	7107-00315	3/4	1 1/16-12	1 1/16	1 1/4	3.68	93.5	1.67	42.4
	G44170-1616	7107-00325	1	1 5/16-12	1 3/8	1 1/2	4.17	105.9	1.94	49.3
G44170-2020	20GLX-20FJX	7107-00335	1 1/4	1 5/8-12	1 3/4	2	4.58	116.3	2.26	57.4



MS 45° SAE Male Solid



Part No.	Descr.	Prod. No.			H1	L		C	
			"	"		"	mm	"	mm
G44195-0404	4GLX-4MS	7107-00525	1/4	7/16-20	1/2	2.11	53.6	1.08	27.4
G44195-0606	6GLX-6MS	7107-00535	3/8	5/8-18	5/8	2.38	60.5	1.28	32.5
G44195-0808	8GLX-8MS	7107-00545	1/2	3/4-16	13/16	2.89	73.4	1.42	36.1
G44195-1212	12GLX-12MS	7107-00555	3/4	1 1/16-14	1 1/16	3.78	96.0	1.77	45.0

FSX 45° SAE Female Swivel



Part No.	Descr.	Prod. No.			H1	L		C	
			"	"		"	mm	"	mm
G44200-0404	4GLX-4FSX	7107-00485	1/4	7/16-20	1/2	2.24	56.9	1.22	31.0
G44200-0606	6GLX-6FSX	7107-00495	3/8	5/8-18	5/8	2.44	62.0	1.35	34.3
G44200-0808	8GLX-8FSX	7107-00505	1/2	3/4-16	13/16	2.82	71.6	1.34	34.0
G44200-1212	12GLX-12FSX	7107-00515	3/4	1 1/16-14	1 1/16	3.68	93.5	1.67	42.4

EQUIPMENT
HOSE/CPLG. SELECTION
G8K COUPLINGS
GLOBALSPIRAL COUPLINGS
STAINLESS STEEL SPIRAL
MEGACRIMP COUPLINGS
STAINLESS STEEL BRAID
POWER CRIMP COUPLINGS
FIELD ATTACHABLE G1 & G2 COUPLINGS
FIELD ATTACHABLE C5 COUPLINGS
GLX COUPLINGS
GL COUPLINGS
C14 COUPLINGS
PCTS THERMOPLASTIC COUPLINGS
POLARSEAL COUPLINGS
POLARSEAL II COUPLINGS
POWER STEERING
ADAPTERS
QUICK DISCONNECT COUPLERS
BALL VALVES
LIVE SWIVEL
ASSEMBLY FABRICATION
ACCESSORIES
EQUIPMENT AND PARTS
AIR BRAKE
BRASS
KITS

Hydraulic Hose For GL Couplings



The Gates eCrimp program is a web based utility which allows users and distributors of Gates hydraulic and industrial hose products to find and print the most up to date crimp specifications with nothing more than an internet browser.

This program can be used to find crimp data for the MobileCrimp 4-20, PC 707, SC32, PC 3000B, GC32-XD™ Global Hose Crimper, GC96 and Omni Crimp 21. Custom result may be printed by selecting the crimper, hose and coupling. Optionally results may also be limited by die set and working pressure.



The eCrimp mobile app gives you all the same features of the online version in the palm of your hands. Use the app to find the most up-to-date crimp specifications quickly and easily. It is available for download for the iPhone and iPad from the App Store.

EQUIPMENT
HOSE/CPLG. SELECTION
G&K COUPLINGS
GLOBALSPIRAL COUPLINGS
STAINLESS STEEL SPIRAL
MEGACRIMP COUPLINGS
STAINLESS STEEL BRAID
POWER CRIMP COUPLINGS
FIELD ATTACHABLE G1 & G2 COUPLINGS
FIELD ATTACHABLE C5 COUPLINGS
GLX COUPLINGS
GL COUPLINGS
C14 COUPLINGS
PCTS THERMOPLASTIC COUPLINGS
POLARSEAL COUPLINGS
POLARSEAL II COUPLINGS
POWER STEERING
ADAPTERS
QUICK DISCONNECT COUPLERS
BALL VALVES
LIVE SWIVEL
ASSEMBLY FABRICATION
ACCESSORIES
EQUIPMENT AND PARTS
AIR BRAKE
BRASS
KITS

GL Couplings

Male Pipe (NPTF - 30° Cone Seat)

Special GL Dies Required.

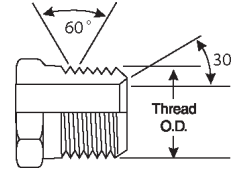
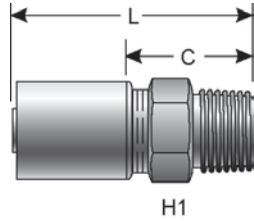

Part No.	Descr.	Prod. No.	⌀		Threads	H1	L		C	
			"	mm			"	mm	"	mm
G43100-1212	12GL-12MP	7348-00015	3/4	19.1	3/4-14	1 3/4	3.46	87.9	1.46	37.1
G43100-1216	12GL-16MP	7348-00025	3/4	19.1	1-11 1/2	1 3/8	1.77	45.0	1.64	41.7
G43100-1616	16GL-16MP	7348-00035	1	25.4	1-11 1/2	1 3/8	4.11	104.4	1.88	47.8
G43100-2020	20GL-20MP	7348-00045	1 1/4	31.8	1 1/4-11 1/2	1 3/4	2.13	54.1	2.09	53.1
G43100-2424	24GL-24MP	7348-00055	1 1/2	38.1	1 1/2-11 1/2	2	4.83	122.7	2.19	55.6
G43100-3232	32GL-32MP	7348-00065	2	50.8	2-11 1/2	2 1/2	5.39	136.9	2.33	59.2

Male Pipe Swivel (NPTF - Without 30° Cone Seat)

NOT TO BE USED AS A LIVE SWIVEL.
Special GL Dies Required.

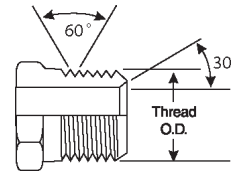
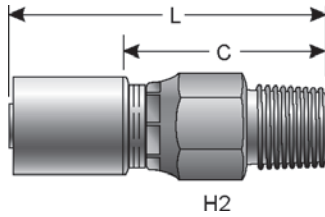

Part No.	Descr.	Prod. No.	⌀		Threads	H2	L		C	
			"	mm			"	mm	"	mm
G43105-1212	12GL-12MPX	7348-00105	3/4	19.1	3/4-14	1 5/16	4.02	102.1	2.01	51.1
G43105-1616	16GL-16MPX	7348-00115	1	25.4	1-11 1/2	1 5/8	4.73	120.1	2.50	63.5

Female JIC 37° Flare Swivel

Special GL Dies Required.

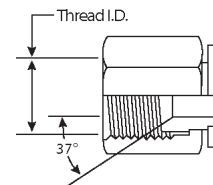
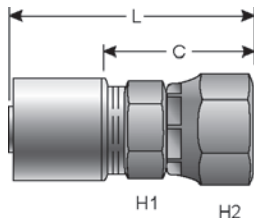

Part No.	Descr.	Prod. No.	⌀		Threads	H1	H2	L		C	
			"	mm				"	mm	"	mm
G43170-1212	12GL-12FJX	7348-00205	3/4	19.1	1 1/16-12	1 1/16	1 1/4	3.68	93.5	1.67	42.4

Female JIC 37° Flare Swivel - Continued

Part No.	Descr.	Prod. No.	⊖		🌀	H1	H2	L		C	
			"	mm				"	mm	"	mm
G43170-1214	12GL-14FJX	7348-00215	3/4	19.1	1 3/16-12	1 1/8	1 3/8	3.65	92.7	1.64	41.7
G43170-1216	12GL-16FJX	7348-00225	3/4	19.1	1 5/16-12	1 1/4	1 1/2	3.78	96.0	1.77	45.0
G43170-1616	16GL-16FJX	7348-00235	1	25.4	1 5/16-12	1 3/8	1 1/2	4.17	105.9	1.94	49.3
G43170-2020	20GL-20FJX	7348-00245	1 1/4	31.8	1 5/8-12	1 3/4	2	4.58	116.3	2.26	57.4
G43170-2420	24GL-20FJX	7348-00195	1 1/2	38.1	1 5/8-12	1 3/4	2	4.84	122.9	2.20	55.9
G43170-2424	24GL-24FJX	7348-00255	1 1/2	38.1	1 7/8-12	2	2 1/4	5.19	131.8	2.55	64.8
G43170-3232	32GL-32FJX	7348-00265	2	50.8	3-12	2 1/2	3 1/2	5.98	151.9	2.92	74.2
G43170-4040	40GL-40FJX	7305-05475	2 1/2	63.5	2 1/2	3	3 1/2	5.36	136.1	2.91	73.9

Female JIC 37° Flare Swivel - 90° Bent Tube

Special GL Dies Required.

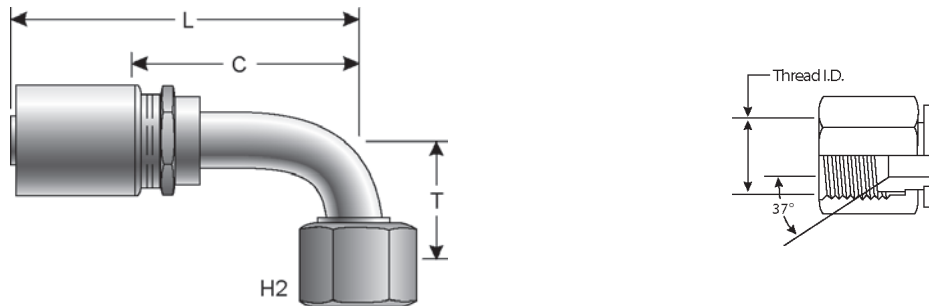

Part No.	Descr.	Prod. No.	⊖		🌀	H2	T		L		C	
			"	mm			"	mm	"	mm	"	mm
G43179-1212	12GL-12FJX90S	7348-01385	3/4	19.1	1 1/16-12	1 1/4	1.89	48.0	4.61	117.1	2.60	66.0
G43179-1616	16GL-16FJX90S	7348-01485	1	25.4	1 5/16-12	1 1/2	2.20	55.9	5.12	130.1	2.88	73.2
G43180-2020	20GL-20FJX90M	7348-01525	1 1/4	31.8	1 5/8-12	2	3.07	78.0	6.24	158.5	3.91	99.3
G43180-2420	24GL-20FJX90M	7348-01585	1 1/2	38.1	1 5/8-12	2	3.07	78.0	6.24	158.5	3.91	99.3
G43181-2420	24GL-20FJX90L	7348-01595	1 1/2	38.1	1 5/8-12	2	5.08	129.0	5.59	142.0	2.96	75.2
G43183-2424	24GL-24FJX90-092	7348-01545	1 1/2	38.1	1 7/8-12	2 1/4	4.05	102.9	7.10	180.3	4.85	123.2

Female Flat-Face Swivel

SAE J1453 O-Ring Face Seal.
Special GL Dies Required.

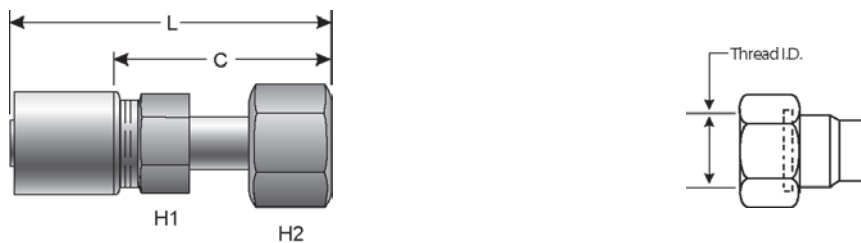

Part No.	Descr.	Prod. No.	⊖		🌀	H1	H2	L		C	
			"	mm				"	mm	"	mm
G43230-1212	12GL-12FFORX	7348-00305	3/4	19.1	1 3/16-12	1 1/16	1 3/8	3.78	96.0	1.77	45.0

- EQUIPMENT
- HOSE/CPLG. SELECTION
- G8K COUPLINGS
- GLOBALSPIRAL COUPLINGS
- STAINLESS STEEL SPIRAL
- MEGACRIMP COUPLINGS
- STAINLESS STEEL BRAID
- POWER CRIMP COUPLINGS
- FIELD ATTACHABLE G1 & G2 COUPLINGS
- FIELD ATTACHABLE C5 COUPLINGS
- GLX COUPLINGS
- GL COUPLINGS**
- C14 COUPLINGS
- PCTS THERMOPLASTIC COUPLINGS
- POLARSEAL COUPLINGS
- POLARSEAL II COUPLINGS
- POWER STEERING
- ADAPTERS
- QUICK DISCONNECT COUPLERS
- BALL VALVES
- LIVE SWIVEL
- ASSEMBLY FABRICATION
- ACCESSORIES
- EQUIPMENT AND PARTS
- AIR BRAKE
- BRASS
- KITS

GL Couplings

Female Flat-Face Swivel - Continued

Part No.	Descr.	Prod. No.	⊖		🌀	H1	H2	L		C	
			"	mm				"	mm	"	mm
G43230-1616	16GL-16FFORX	7348-00355	1	25.4	1 7/16-12	1 3/8	1 5/8	4.46	113.3	2.22	56.4
G43230-2020	20GL-20FFORX	7348-00365	1 1/4	31.8	1 11/16-12	1 3/4	1 7/8	4.50	114.3	2.18	55.4
G43230-2424	24GL-24FFORX	7348-00375	1 1/2	38.1	2-12	1 3/8	2 1/4	3.98	101.1	1.74	44.2

Female Flat-Face Swivel - 45° Bent Tube

SAE J1453 O-Ring Face Seal.
Special GL Dies Required.

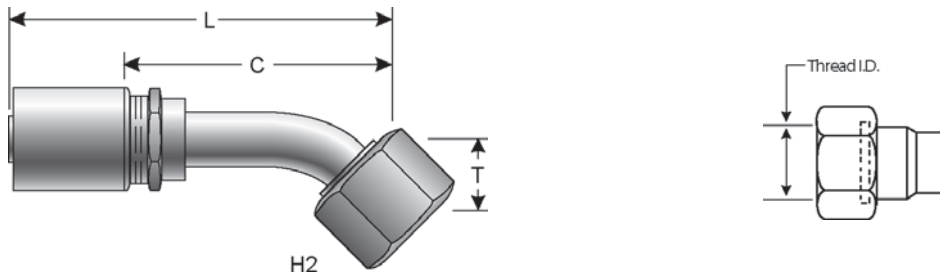

Part No.	Descr.	Prod. No.	⊖		🌀	H2	T		L		C	
			"	mm			"	mm	"	mm	"	mm
G43234-1212	12GL-12FFORX45S	7348-00405	3/4	19.1	1 7/16-12	1 3/8	.83	21.1	4.67	118.6	2.66	67.6
G43234-1616	16GL-16FFORX45S	7348-00415	1	25.4	1 7/16-12	1 5/8	.94	23.9	5.08	129.0	2.85	72.4
G43234-2020	20GL-20FFORX45S	7348-00425	1 1/4	31.8	1 11/16-12	1 7/8	.98	24.9	5.81	147.6	3.49	88.7

Female Flat-Face Swivel - 90° Bent Tube

SAE J1453 O-Ring Face Seal.
Special GL Dies Required.

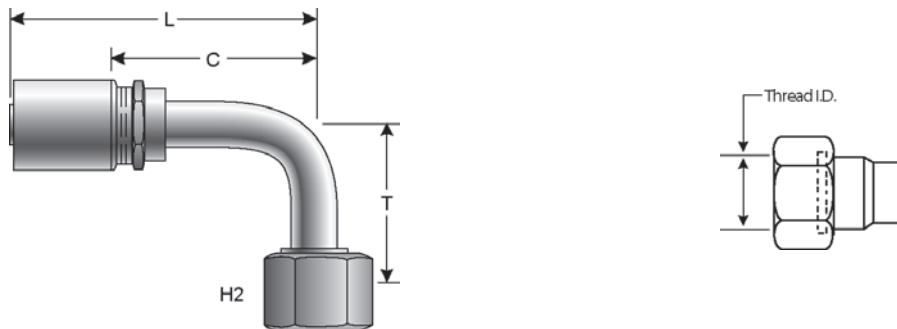

Part No.	Descr.	Prod. No.	⊖		🌀	H2	T		L		C	
			"	mm			"	mm	"	mm	"	mm
G43239-1212	12GL-12FFORX90S	7348-00455	3/4	19.1	1 3/16-12	1 3/8	1.89	48.0	4.28	108.7	2.28	57.9
G43240-1212	12GL-12FFORX90M	7348-02155	3/4	19.1	1 3/16-12	1 1/4	1.89	48.0	4.61	117.1	2.60	66.0
G43239-1616	16GL-16FFORX90S	7348-00465	1	25.4	1 7/16-12	1 5/8	2.20	55.9	5.11	129.8	2.88	73.2
G43239-2020	20GL-20FFORX90S	7348-00475	1 1/4	31.8	1 11/16-12	1 7/8	2.52	64.0	5.51	140.0	3.19	81.0
G43240-2424	24GL-24FFORX90M	7350-24985	1 1/2	38.1	2-12	2 1/3	3.39	86.1	7.26	184.4	4.62	117.4

Code 61 O-Ring Flange

Special GL Dies Required.

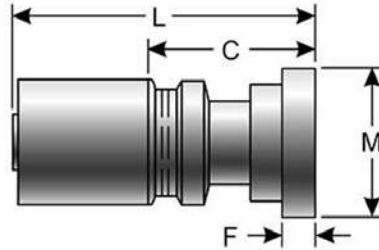

Part No.	Descr.	Prod. No.	⊖		M		L		C		F	
			"	mm	"	mm	"	mm	"	mm	"	mm
G43300-1212	12GL-12FL	7348-00505	3/4	19.1	1.50	38.1	3.86	98.1	1.85	47.0	.27	6.9
G43300-1616	16GL-16FL	7348-00555	1	25.4	1.75	44.5	3.78	96.0	1.54	39.1	.32	8.1
G43300-2020	20GL-20FL	7348-00525	1 1/4	31.8	2.00	50.8	4.43	112.5	2.11	53.6	.32	8.1
G43300-2340	32GL-40FL	7350-25575	2	50.8	3.31	84.1	5.61	142.5	2.55	64.7	.38	9.7
G43300-2424	24GL-24FL	7348-00535	1 1/2	38.1	2.38	60.5	4.94	125.5	2.30	58.4	.32	8.1
G43300-3232	32GL-32FL	7348-00545	2	50.8	2.81	71.4	5.61	142.5	2.54	64.5	.38	9.7
G43300-4040	40GL-40FL	7305-05505	2 1/2	63.5	3.31	84.1	5.66	143.8	3.15	80.0	.38	9.7
G43300-4048	40GL-48FL	7305-05605	2 1/2	63.5	4.00	101.6	5.66	143.8	3.21	81.5	.38	9.7
G43300-4056	40GL-56FL	7305-05705	2 1/2	63.5	4.50	114.3	5.33	135.4	2.77	70.4	.44	11.2
G43300-4064	40GL-64FL	7305-05795	2 1/2	63.5	5.00	127.0	5.33	135.4	2.88	73.2	.44	11.2
G43300-4848	48GL-48FL	7305-05805	3	76.2	4.00	101.6	6.54	166.1	3.46	87.9	.32	8.1
G43300-5656	56GL-56FL	7305-06305	3 1/2	88.9	4.50	114.3	6.70	170.2	3.06	77.7	.32	8.1
G43300-6464	64GL-64FL	7305-06695	4	101.6	5.00	127.0	7.74	196.6	3.70	94.0	.44	11.2

Code 61 O-Ring Flange - 22° Bent Tube

Special GL Dies Required.

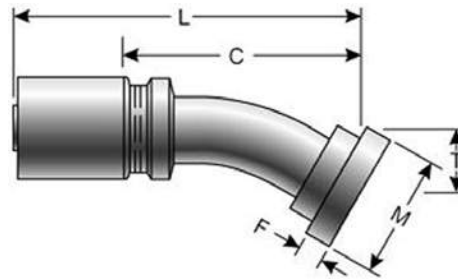

Part No.	Descr.	Prod. No.	⊖		M		T		L		C		F	
			"	mm	"	mm	"	mm	"	mm	"	mm	"	mm
G43302-2424	24GL-24FL22M-018	7348-00575	1 1/2	38.1	2.38	60.5	.71	18.0	6.39	162.3	3.76	95.5	.32	8.1
G43302-4040	40GL-40FL22	7305-05515	2 1/2	63.5	3.31	84.1	.63	16.0	6.81	173.0	4.36	110.7	.38	9.7
G43302-4048	40GL-48FL22	7305-05615	2 1/2	63.5	4.00	101.6	.67	17.0	6.86	174.2	4.41	112.0	.38	9.7

- EQUIPMENT
- HOSE/CPLG. SELECTION
- G8K COUPLINGS
- GLOBALSPIRAL COUPLINGS
- STAINLESS STEEL SPIRAL
- MEGACRIMP COUPLINGS
- STAINLESS STEEL BRAID
- POWER CRIMP COUPLINGS
- FIELD ATTACHABLE G1 & G2 COUPLINGS
- FIELD ATTACHABLE C5 COUPLINGS
- GLX COUPLINGS
- GL COUPLINGS**
- C14 COUPLINGS
- PCTS THERMOPLASTIC COUPLINGS
- POLARSEAL COUPLINGS
- POLARSEAL II COUPLINGS
- POWER STEERING
- ADAPTERS
- QUICK DISCONNECT COUPLERS
- BALL VALVES
- LIVE SWIVEL
- ASSEMBLY FABRICATION
- ACCESSORIES
- EQUIPMENT AND PARTS
- AIR BRAKE
- BRASS
- KITS

GL Couplings

Code 61 O-Ring Flange - 30° Bent Tube

Special GL Dies Required.

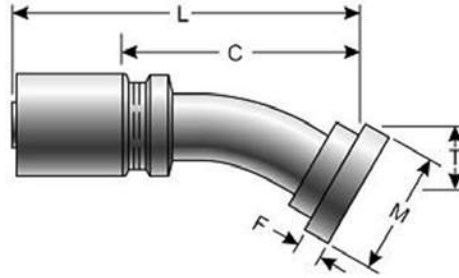

Part No.	Descr.	Prod. No.	⊖		M		T		L		C		F	
			"	mm	"	mm	"	mm	"	mm	"	mm	"	mm
G43304-1212	12GL-12FL30M	7348-00605	3/4	19.1	1.50	38.1	.63	16.0	4.51	114.6	2.50	63.5	.27	6.9
G43304-1616	16GL-16FL30M	7348-00615	1	25.4	1.75	44.5	.75	19.1	4.92	125.0	2.69	68.3	.32	8.1
G43304-2020	20GL-20FL30M	7348-00625	1 1/4	31.8	2.00	50.8	.87	22.1	5.37	136.4	3.05	77.5	.32	8.1
G43304-2424	24GL-24FL30M	7348-00635	1 1/2	38.1	2.38	60.5	1.18	30.0	6.86	174.2	4.22	107.2	.32	8.1
G43304-3232	32GL-32FL30M	7348-00645	2	50.8	2.81	71.4	1.26	32.0	7.78	197.6	4.72	119.9	.38	9.7
G43304-4040	40GL-40FL30	7305-05525	2 1/2	63.5	3.31	84.1	1.08	27.4	7.30	185.4	4.85	123.2	.38	9.7
G43304-4048	40GL-48FL30	7305-05625	2 1/2	63.5	4.00	101.6	1.08	27.4	7.36	186.9	4.91	124.7	.38	9.7
G43304-4848	48GL-48FL30	7305-05825	3	76.2	4.00	101.6	1.12	28.5	8.23	209.0	5.15	130.8	.38	9.7

Code 61 O-Ring Flange - 45° Bent Tube

Special GL Dies Required.

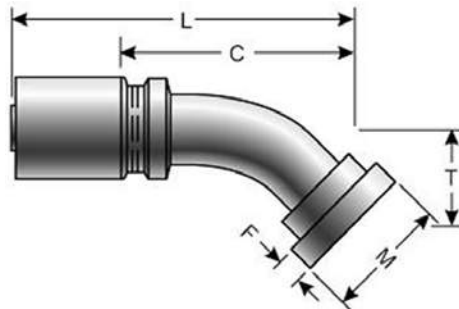

Part No.	Descr.	Prod. No.	⊖		M		T		L		C		F	
			"	mm	"	mm	"	mm	"	mm	"	mm	"	mm
G43307-1212	12GL-12FL45M	7348-00705	3/4	19.1	1.50	38.1	1.02	25.9	4.67	118.6	2.66	67.6	.27	6.9
G43306-1616	16GL-16FL45S	7348-00715	1	25.4	1.75	44.5	1.10	27.9	5.11	129.8	2.87	72.9	.32	8.1
G43306-2020	20GL-20FL45S	7348-00725	1 1/4	31.8	2.00	50.8	1.26	32.0	5.59	142.0	3.29	83.6	.32	8.1
G43306-2424	24GL-24FL45S	7348-00735	1 1/2	38.1	2.38	60.5	1.50	38.1	6.62	168.2	3.99	101.4	.32	8.1
G43306-3232	32GL-32FL45S	7348-00745	2	50.8	2.81	71.4	2.05	52.1	8.07	205.0	5.00	127.0	.38	9.7
G43307-4040	40GL-40FL45	7305-05535	2 1/2	63.5	3.31	84.1	1.72	43.7	7.72	196.1	5.27	133.9	.38	9.7
G43307-4048	40GL-48FL45	7305-05635	2 1/2	63.5	4.00	101.6	1.76	44.7	7.76	197.1	5.31	134.9	.38	9.7
G43307-4848	48GL-48FL45	7305-05835	3	76.2	4.00	101.6	2.03	51.6	9.18	233.2	6.10	154.9	.38	9.7
G43307-4856	48GL-56FL45	7305-05895	3	76.2	4.50	114.3	2.03	51.6	12.38	314.5	9.30	236.2	.44	11.2
G43307-5656	56GL-56FL45	7305-06335	3 1/2	88.9	4.50	114.3	2.13	54.1	9.66	245.4	6.02	152.9	.44	11.2
G43307-5664	56GL-64FL45	7305-06385	3 1/2	88.9	5.00	127.0	2.13	54.1	9.66	245.4	6.02	152.9	.44	11.2
G43307-6565	64GL-64FL45	7305-06725	4	101.6	5.00	127.0	3.61	91.7	12.70	322.6	8.66	220.0	.44	11.2

Code 61 O-Ring Flange - 60° Bent Tube

Special GL Dies Required.

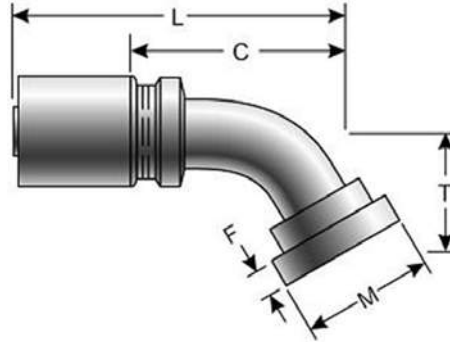

Part No.	Descr.	Prod. No.	⊖		M		T		L		C		F	
			"	mm	"	mm	"	mm	"	mm	"	mm	"	mm
G43309-1212	12GL-12FL60M	7348-00805	3/4	19.1	1.50	38.1	1.46	37.1	4.61	117.1	2.60	66.0	.27	6.9
G43309-1616	16GL-16FL60M	7348-00815	1	25.4	1.75	44.5	1.73	43.9	5.14	130.7	2.90	73.7	.32	8.1
G43308-2020	20GL-20FL60S	7348-00825	1 1/4	31.8	2.00	50.8	1.77	45.0	5.67	144.0	3.35	85.1	.32	8.1
G43308-2424	24GL-24FL60S	7348-00835	1 1/2	38.1	2.38	60.5	2.09	53.1	6.63	168.4	3.99	101.4	.32	8.1
G43308-3232	32GL-32FL60S	7348-00845	2	50.8	2.81	71.4	2.95	74.9	8.59	218.2	5.52	140.2	.38	9.7
G43309-4040	40GL-40FL60	7305-05545	2 1/2	63.5	3.31	84.1	2.63	66.8	8.13	206.5	5.68	144.3	.38	9.7
G43309-4848	48GL-48FL60	7305-05845	3	76.2	4.00	101.6	3.11	79.0	9.66	245.4	6.58	167.1	.38	9.7

Code 61 O-Ring Flange - 67 1/2° Bent Tube

Special GL Dies Required.

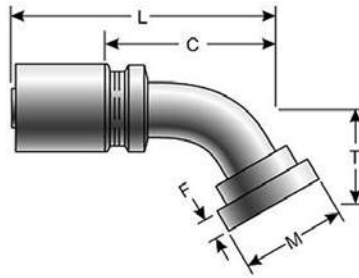

Part No.	Descr.	Prod. No.	⊖		M		T		L		C		F	
			"	mm	"	mm	"	mm	"	mm	"	mm	"	mm
G43311-3232	32GL-32FL67S	7348-00875	2	50.8	2.81	71.4	3.35	85.1	8.56	217.4	5.49	139.5	.38	9.7
G43311-4040	40GL-40FL67	7305-05555	2 1/2	63.5	3.31	84.1	3.13	79.5	8.22	208.8	5.77	146.6	.38	9.7
G43311-4848	48GL-48FL67	7305-05905	3	76.2	4.00	101.6	3.87	98.3	9.50	241.3	6.42	163.1	.38	9.7
G43311-6464	64GL-64FL67	7305-06635	4	101.6	5.00	127.0	6.90	175.3	14.20	360.7	10.17	258.3	.44	11.2

- EQUIPMENT
- HOSE/CPLG. SELECTION
- G&K COUPLINGS
- GLOBALSPIRAL COUPLINGS
- STAINLESS STEEL SPIRAL
- MEGACRIMP COUPLINGS
- STAINLESS STEEL BRAID
- POWER CRIMP COUPLINGS
- FIELD ATTACHABLE G1 & G2 COUPLINGS
- FIELD ATTACHABLE C5 COUPLINGS
- GLX COUPLINGS
- GL COUPLINGS**
- C14 COUPLINGS
- PCTS THERMOPLASTIC COUPLINGS
- POLARSEAL COUPLINGS
- POLARSEAL II COUPLINGS
- POWER STEERING
- ADAPTERS
- QUICK DISCONNECT COUPLERS
- BALL VALVES
- LIVE SWIVEL
- ASSEMBLY FABRICATION
- ACCESSORIES
- EQUIPMENT AND PARTS
- AIR BRAKE
- BRASS
- KITS

GL Couplings

Code 61 O-Ring Flange - 90° Bent Tube

Special GL Dies Required.

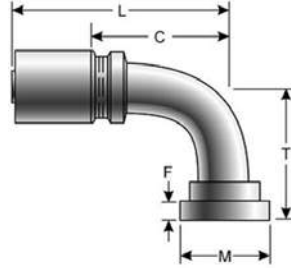

Part No.	Descr.	Prod. No.	⊘		M		T		L		C		F	
			"	mm	"	mm	"	mm	"	mm	"	mm	"	mm
G43315-1212	12GL-12FL90M	7348-00905	3/4	19.1	1.50	38.1	2.28	57.9	4.40	111.8	2.39	60.7	.27	6.9
G43314-1216	12GL-16FL90S	7348-00915	3/4	19.1	1.75	44.5	2.40	61.0	4.40	111.8	2.39	60.7	.32	8.1
G43314-1616	16GL-16FL90S	7348-00925	1	25.4	1.75	44.5	2.40	61.0	5.04	128.0	2.81	71.4	.32	8.1
G43314-1620	16GL-20FL90S	7348-00935	1	25.4	2.00	50.8	2.68	68.1	5.04	128.0	2.81	71.4	.32	8.1
G43314-2020	20GL-20FL90S	7348-00945	1 1/4	31.8	2.00	50.8	2.68	68.1	5.41	137.4	3.09	78.5	.32	8.1
G43314-2024	20GL-24FL90-068	7348-00955	1 1/4	31.8	2.38	60.5	2.68	68.1	5.41	137.4	3.09	78.5	.32	8.1
G43314-2424	24GL-24FL90S	7348-00965	1 1/2	38.1	2.38	60.5	3.12	79.3	6.26	159.0	3.62	92.0	.32	8.1
G43314-3232	32GL-32FL90S	7348-00975	2	50.8	2.81	71.4	4.50	114.3	8.73	221.7	5.20	132.1	.38	9.7
G43314-3240	32GL-40FL90-114	7348-00775	2	50.8	3.32	84.3	4.50	114.3	8.77	222.8	5.71	145.0	.38	9.7
G43315-4040	40GL-40FL90	7305-05565	2 1/2	63.5	3.31	84.1	4.62	117.4	8.06	204.7	5.61	142.5	.38	9.7
G43315-4048	40GL-48FL90	7305-05665	2 1/2	63.5	4.00	101.6	4.62	117.4	8.12	206.3	5.67	144.0	.38	9.7
G43315-4848	48GL-48FL90	7305-05855	3	76.2	4.00	101.6	5.50	139.7	9.70	246.4	6.62	168.2	.38	9.7
G43315-5656	56GL-56FL90	7305-06365	3 1/2	88.9	4.50	114.3	5.63	143.0	10.17	258.3	6.53	165.9	.38	9.7
G43315-5664	56GL-64FL90	7305-06395	3 1/2	88.9	5.00	127.0	6.90	175.3	10.09	256.3	6.45	163.8	.38	9.7
G43315-6464	64GL-64FL90	7305-06645	4	101.6	5.00	127.0	7.38	187.5	12.61	320.3	8.58	217.9	.38	9.7

Hydraulic Hose For C14 Couplings



EQUIPMENT
HOSE/CPLG. SELECTION
G&K COUPLINGS
GLOBALSPIRAL COUPLINGS
STAINLESS STEEL SPIRAL
MEGACRIMP COUPLINGS
STAINLESS STEEL BRAID
POWER CRIMP COUPLINGS
FIELD ATTACHABLE G1 & G2 COUPLINGS
FIELD ATTACHABLE C5 COUPLINGS
GLX COUPLINGS
GL COUPLINGS
C14 COUPLINGS
PCTS THERMOPLASTIC COUPLINGS
POLARSEAL COUPLINGS
POLARSEAL II COUPLINGS
POWER STEERING
ADAPTERS
QUICK DISCONNECT COUPLERS
BALL VALVES
LIVE SWIVEL
ASSEMBLY FABRICATION
ACCESSORIES
EQUIPMENT AND PARTS
AIR BRAKE
BRASS
KITS

The Gates eCrimp program is a web based utility which allows users and distributors of Gates hydraulic and industrial hose products to find and print the most up to date crimp specifications with nothing more than an internet browser.

This program can be used to find crimp data for the MobileCrimp 4-20, PC 707, SC32, PC 3000B, GC32-XD™ Global Hose Crimper, GC96 and Omni Crimp 21. Custom result may be printed by selecting the crimper, hose and coupling. Optionally results may also be limited by die set and working pressure.



The eCrimp mobile app gives you all the same features of the online version in the palm of your hands. Use the app to find the most up-to-date crimp specifications quickly and easily. It is available for download for the iPhone and iPad from the App Store.

C14 Couplings

Male Pipe (NPTF - 30° Cone Seat) - Stainless Steel

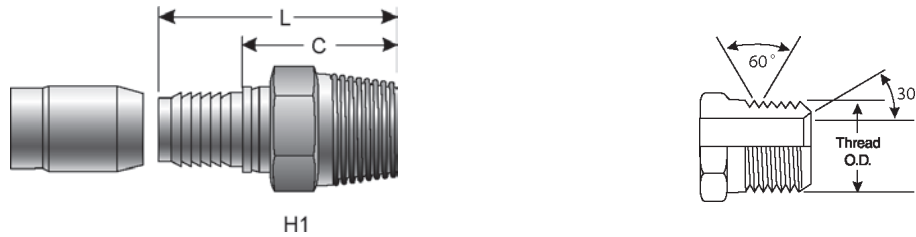

Part No.	Descr.	Prod. No.	⊖		🌀	H1	L		C	
			"	mm			"	mm	"	mm
G40100-0402S	4C14-2MP-SS	7753-00085	3/16	4.8	1/8-27	7/16	1.26	32.0	.81	20.6
G40100-0404S	4C14-4MP-SS	7753-00015	3/16	4.8	1/4-18	9/16	1.47	37.3	1.02	25.9
G40100-0504S	5C14-4MP-SS	7753-00025	1/4	6.4	1/4-18	9/16	1.47	37.3	1.02	25.9
G40100-0604S	6C14-4MP-SS	7753-00095	5/16	7.9	1/4-18	9/16	1.60	40.7	1.05	26.7
G40100-0606S	6C14-6MP-SS	7753-00035	5/16	7.9	3/8-18	11/16	1.63	41.4	1.08	27.4
G40100-0806S	8C14-6MP-SS	7753-00105	13/32	10.3	3/8-18	11/16	1.68	42.7	1.07	27.2
G40100-0808S	8C14-8MP-SS	7753-00045	13/32	10.3	1/2-14	7/8	1.93	49.0	1.32	33.5
G40100-1008S	10C14-8MP-SS	7753-00055	1/2	12.7	1/2-14	7/8	2.05	52.1	1.35	34.3
G40100-1212S	12C14-12MP-SS	7753-00065	5/8	15.9	3/4-14	1 1/16	2.21	56.1	1.44	36.6
G40100-1616S	16C14-16MP-SS	7753-00075	7/8	22.2	1-11 1/2	1 3/8	2.56	65.0	1.65	41.9

Male Pipe (NPTF - 30° Cone Seat) - Brass

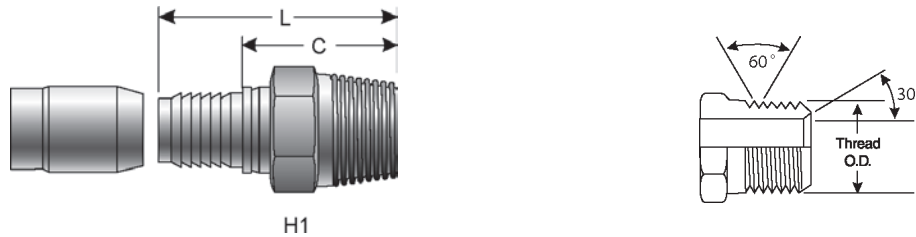

Part No.	Descr.	Prod. No.	⊖		🌀	H1	L		C	
			"	mm			"	mm	"	mm
G40100-0402B	4C14-2MP-B	7753-10085	3/16	4.8	1/8-27	7/16	1.26	32.0	.81	20.6
G40100-0404B	4C14-4MP-B	7753-10015	3/16	4.8	1/4-18	9/16	1.47	37.3	1.02	25.9
G40100-0504B	5C14-4MP-B	7753-10025	1/4	6.4	1/4-18	9/16	1.47	37.3	1.02	25.9
G40100-0604B	6C14-4MP-B	7753-10095	5/16	7.9	1/4-18	9/16	1.60	40.7	1.05	26.7
G40100-0606B	6C14-6MP-B	7753-10035	5/16	7.9	3/8-18	11/16	1.63	41.4	1.08	27.4
G40100-0806B	8C14-6MP-B	7753-10105	13/32	10.3	3/8-18	11/16	1.68	42.7	1.07	27.2
G40100-0808B	8C14-8MP-B	7753-10045	13/32	10.3	1/2-14	7/8	1.93	49.0	1.32	33.5
G40100-1008B	10C14-8MP-B	7753-10055	1/2	12.7	1/2-14	7/8	2.05	52.1	1.35	34.3
G40100-1212B	12C14-12MP-B	7753-10065	5/8	15.9	3/4-14	1 1/16	2.21	56.1	1.44	36.6
G40100-1616B	16C14-16MP-B	7753-10075	7/8	22.2	1-11 1/2	1 3/8	2.56	65.0	1.65	41.9

C14 Couplings

Dual Seat Female JIC 37°/SAE 45° Flare Swivel - Stainless Steel

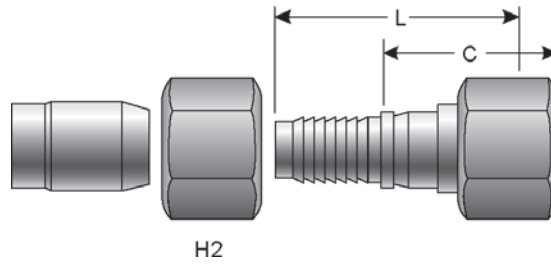

Part No.	Descr.	Prod. No.	⊖		🌀	H2	L		C	
			"	mm			"	mm	"	mm
G40170-0404S	4C14-4FJSX-SS	7753-00125	3/16	4.8	7/16-20	9/16	.95	24.1	.87	22.1
G40170-0505S	5C14-5FJSX-SS	7753-00135	1/4	6.4	1/2-20	11/16	1.01	25.7	.94	23.9
G40170-0808S	8C14-8FJSX-SS	7753-00155	13/32	10.3	3/4-16	7/8	1.30	33.0	1.13	28.7
G40170-1010S	10C14-10FJSX-SS	7753-00165	1/2	12.7	7/8-14	1 1/16	1.47	37.3	1.29	32.8
G40170-1616S	16C14-16FJSX-SS	7753-00185	7/8	22.2	1 5/16-12	1 1/2	1.75	44.5	1.46	37.1

Dual Seat Female JIC 37°/SAE 45° Flare Swivel - Brass

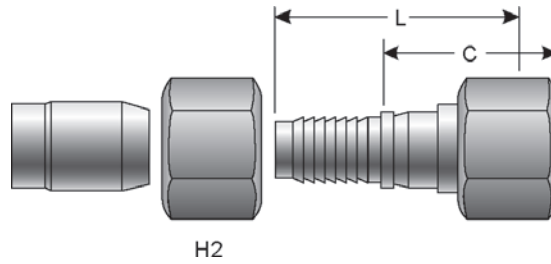

Part No.	Descr.	Prod. No.	⊖		🌀	H2	L		C	
			"	mm			"	mm	"	mm
G40170-0404B	4C14-4FJSX-B	7753-10125	3/16	4.8	7/16-20	9/16	.95	24.1	.79	20.1
G40170-0505B	5C14-5FJSX-B	7753-10135	1/4	6.4	1/2-20	11/16	1.01	25.7	.94	23.9
G40170-0808B	8C14-8FJSX-B	7753-10155	13/32	10.3	3/4-16	7/8	1.30	33.0	1.13	28.7
G40170-1010B	10C14-10FJSX-B	7753-10165	1/2	12.7	7/8-14	1 1/16	1.47	37.3	1.29	32.8
G40170-1616B	16C14-16FJSX-B	7753-10185	7/8	22.2	1 5/16-12	1 1/2	1.75	44.5	1.46	37.1

EQUIPMENT
HOSE/CPLG. SELECTION
G8K COUPLINGS
GLOBALSPIRAL COUPLINGS
STAINLESS STEEL SPIRAL
MEGACRIMP COUPLINGS
STAINLESS STEEL BRAID
POWER CRIMP COUPLINGS
FIELD ATTACHABLE G1 & G2 COUPLINGS
FIELD ATTACHABLE C5 COUPLINGS
GLX COUPLINGS
GL COUPLINGS
C14 COUPLINGS
PCTS THERMOPLASTIC COUPLINGS
POLARSEAL COUPLINGS
POLARSEAL II COUPLINGS
POWER STEERING
ADAPTERS
QUICK DISCONNECT COUPLERS
BALL VALVES
LIVE SWIVEL
ASSEMBLY FABRICATION
ACCESSORIES
EQUIPMENT AND PARTS
AIR BRAKE
BRASS
KITS

C14 Couplings

Female JIC 37° Flare Swivel - Stainless Steel

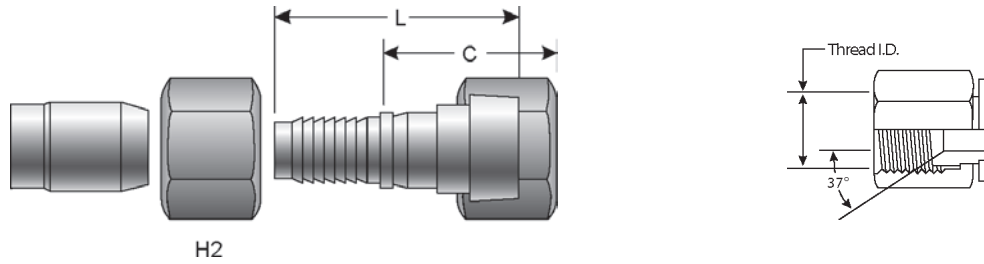

Part No.	Descr.	Prod. No.	⊖		H2	L		C		
			"	mm		"	mm	"	mm	
G40170-0606S	6C14-6FJX-SS	7753-00145	5/16	7.9	9/16-18	3/4	1.19	30.2	1.01	25.7
G40170-1212S	12C14-12FJX-SS	7753-00175	5/8	15.9	1 1/16-12	1 1/4	1.56	39.6	1.36	34.5

Female JIC 37° Flare Swivel - Brass

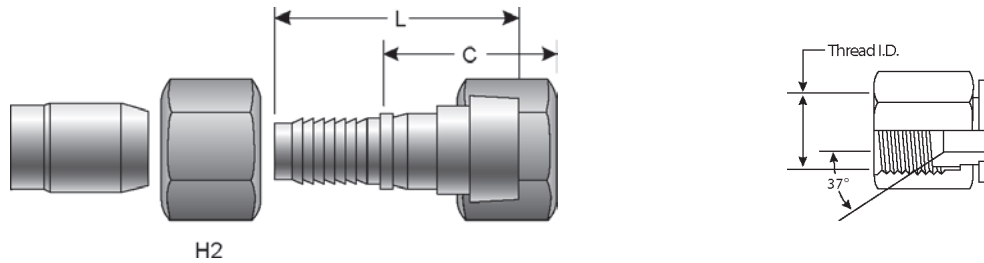

Part No.	Descr.	Prod. No.	⊖		H2	L		C		
			"	mm		"	mm	"	mm	
G40170-0606B	6C14-6FJX-B	7753-10145	5/16	7.9	9/16-18	3/4	1.19	30.2	1.01	25.7
G40170-1212B	12C14-12FJX-B	7753-10175	5/8	15.9	1 1/16-12	1 1/4	1.56	39.6	1.36	34.5

Female JIC 37° Flare Swivel - 45° Bent Tube - Steel

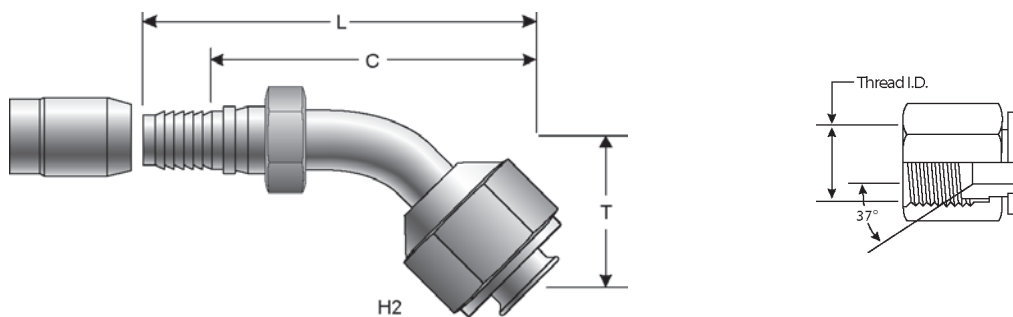

Part No.	Descr.	Prod. No.	⊖		H2	T		L		C		
			"	mm		"	mm	"	mm	"	mm	
G40175-0404	4C14-4FJX45	7753-20495	3/16	4.8	7/16-20	9/16	.41	10.4	1.69	42.9	1.25	31.8
G40175-0505	5C14-5FJX45	7753-20505	1/4	6.4	1/2-20	5/8	.49	12.5	1.85	47.0	1.44	36.6

C14 Couplings

Female JIC 37° Flare Swivel - 45° Bent Tube - Steel - Continued

Part No.	Descr.	Prod. No.	⊖		🌀	H2	T		L		C	
			"	mm			"	mm	"	mm	"	mm
G40175-0606	6C14-6FJX45	7753-20515	5/16	7.9	9/16-18	11/16	.55	14.0	2.13	54.1	1.62	41.2
G40175-0808	8C14-8FJX45	7753-20525	13/32	10.3	3/4-16	7/8	.63	16.0	2.44	62.0	1.88	47.8
G40175-1010	10C14-10FJX45	7753-20535	1/2	12.7	7/8-14	1	.75	19.1	2.78	70.6	2.08	52.8
G40175-1212	12C14-12FJX45	7753-20545	5/8	15.9	1 1/16-12	1 1/4	.90	22.9	3.92	99.6	3.15	80.0
G40175-1616	16C14-16FJX45	7753-20555	7/8	22.2	1 5/16-12	1 1/2	1.13	28.7	4.77	121.2	3.86	98.0

Female JIC 37° Flare Swivel - 90° Bent Tube - Steel

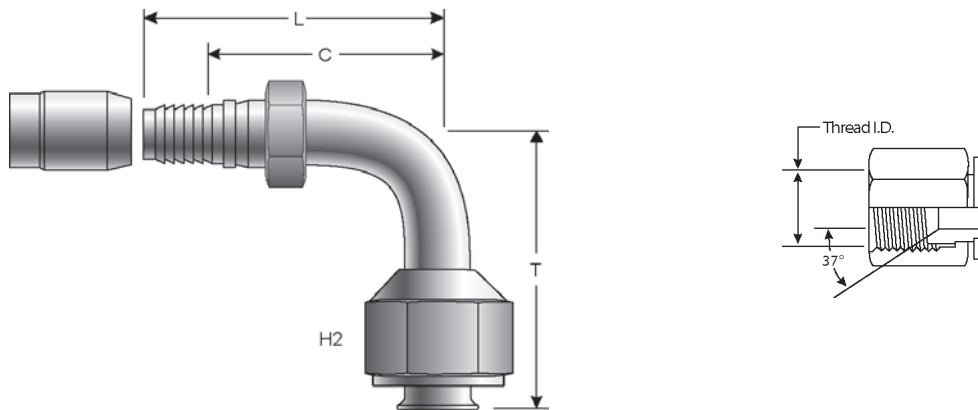

Part No.	Descr.	Prod. No.	⊖		🌀	H2	T		L		C	
			"	mm			"	mm	"	mm	"	mm
G40179-0404	4C14-4FJX90	7753-20565	3/16	4.8	7/16-20	9/16	.71	18.0	1.42	36.1	1.00	25.4
G40179-0505	5C14-5FJX90	7753-20575	1/4	6.4	1/2-20	5/8	.88	22.4	1.55	39.4	1.06	26.9
G40179-0606	6C14-6FJX90	7753-20585	5/16	7.9	9/16-18	11/16	1.00	25.4	1.80	45.7	1.25	31.8
G40179-0808	8C14-8FJX90	7753-20595	13/32	10.3	3/4-16	7/8	1.18	30.0	2.10	53.3	1.50	38.1
G40179-1010	10C14-10FJX90	7753-20605	1/2	12.7	7/8-14	1	1.50	38.1	2.47	62.7	1.81	46.0
G40179-1212	12C14-12FJX90	7753-20615	5/8	15.9	1 1/16-12	1 1/4	2.00	50.8	3.88	98.6	3.11	79.0
G40179-1616	16C14-16FJX90	7753-20625	7/8	22.2	1 5/16-12	1 1/2	2.48	63.0	4.64	117.9	3.73	94.7

Female SAE 45° Flare Swivel - Brass

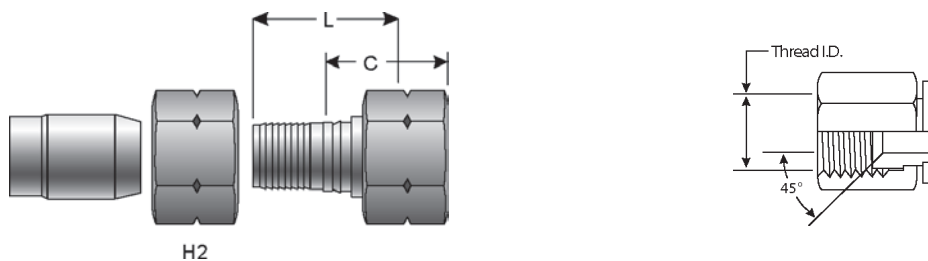

Part No.	Descr.	Prod. No.	⊖		🌀	H2	L		C	
			"	mm			"	mm	"	mm
G40200-0606B	6C14-6FSX-B	7753-10195	5/16	7.9	5/8-18	3/4	1.19	30.2	1.01	25.7
G40200-1212B	12C14-12FSX-B	7753-10205	5/8	15.9	1 1/16-14	1 1/4	1.56	39.6	1.36	34.5

- EQUIPMENT
- HOSE/CPLG. SELECTION
- G8K COUPLINGS
- GLOBALSPIRAL COUPLINGS
- STAINLESS STEEL SPIRAL
- MEGACRIMP COUPLINGS
- STAINLESS STEEL BRAID
- POWER CRIMP COUPLINGS
- FIELD ATTACHABLE G1 & G2 COUPLINGS
- FIELD ATTACHABLE C5 COUPLINGS
- GLX COUPLINGS
- GL COUPLINGS
- C14 COUPLINGS**
- PCTS THERMOPLASTIC COUPLINGS
- POLARSEAL COUPLINGS
- POLARSEAL II COUPLINGS
- POWER STEERING
- ADAPTERS
- QUICK DISCONNECT COUPLERS
- BALL VALVES
- LIVE SWIVEL
- ASSEMBLY FABRICATION
- ACCESSORIES
- EQUIPMENT AND PARTS
- AIR BRAKE
- BRASS
- KITS

C14 Couplings

Female SAE 45° Flare Swivel - 45° Bent Tube - Steel

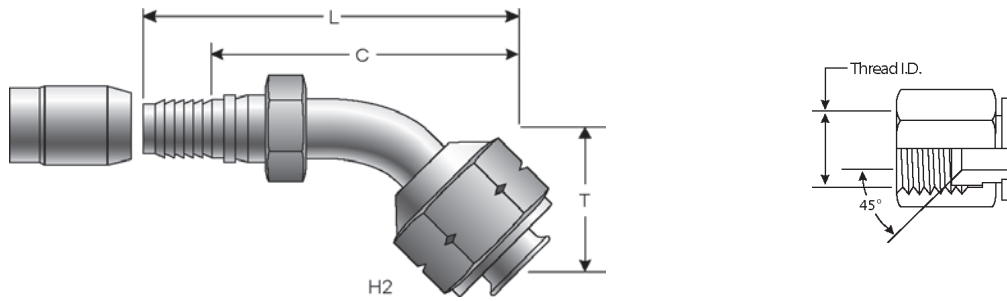

Part No.	Descr.	Prod. No.	⊖		H2	T		L		C		
			"	mm		"	mm	"	mm	"	mm	
G40202-0404	4C14-4FSX45	7753-20215	3/16	4.8	7/16-20	9/16	.41	10.4	1.69	42.9	1.25	31.8
G40202-0505	5C14-5FSX45	7753-20225	1/4	6.4	1/2-20	5/8	.49	12.5	1.85	47.0	1.44	36.6
G40202-0606	6C14-6FSX45	7753-20235	5/16	7.9	5/8-18	3/4	.55	14.0	2.13	54.1	1.62	41.2
G40202-0808	8C14-8FSX45	7753-20245	13/32	10.3	3/4-16	7/8	.63	16.0	2.44	62.0	1.88	47.8
G40202-1010	10C14-10FSX45	7753-20635	1/2	12.7	7/8-14	1	.75	19.1	2.78	70.6	2.12	53.9
G40202-1212	12C14-12FSX45	7753-20645	5/8	15.9	1 1/16-14	1 1/4	.90	22.9	3.92	99.6	3.15	80.0

Female SAE 45° Flare Swivel - 90° Bent Tube - Steel

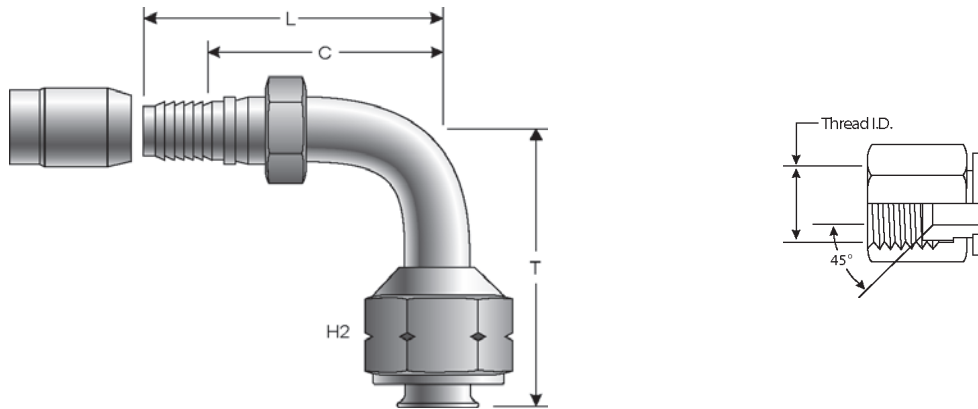

Part No.	Descr.	Prod. No.	⊖		H2	T		L		C		
			"	mm		"	mm	"	mm	"	mm	
G40205-0404	4C14-4FSX90	7753-20255	3/16	4.8	7/16-20	9/16	.71	18.0	1.42	36.1	1.00	25.4
G40205-0505	5C14-5FSX90	7753-20265	1/4	6.4	1/2-20	5/8	.88	22.4	1.55	39.4	1.06	26.9
G40205-0606	6C14-6FSX90	7753-20275	5/16	7.9	5/8-18	3/4	1.00	25.4	1.80	45.7	1.25	31.8
G40205-0808	8C14-8FSX90	7753-20285	13/32	10.3	3/4-16	7/8	1.18	30.0	2.10	53.3	1.50	38.1
G40205-1010	10C14-10FSX90	7753-20295	1/2	12.7	7/8-14	1 1/16	1.50	38.1	2.47	62.7	1.81	46.0
G40205-1212	12C14-12FSX90	7753-20665	5/8	15.9	1 1/16-14	1 1/4	2.00	50.8	3.88	98.6	3.11	79.0

C14 Couplings

Air Brake Compression - Brass

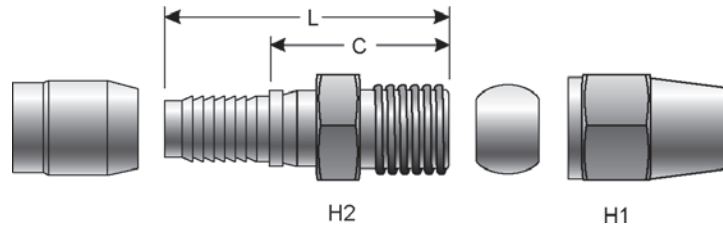

Part No.	Descr.	Prod. No.	⌀		🌀	H1	H2	L		C		⌀
			"	mm				"	mm	"	mm	
G40460-0808B	8C14-8ABC-B	7753-10365	13/32	10.3	11/16-20	7/8	13/16	1.71	43.4	1.10	27.9	.50
G40460-1010B	10C14-10ABC-B	7753-10385	1/2	12.7	13/16-18	7/8	15/16	1.89	48.0	1.19	30.2	.63
G40460-1212B	12C14-12ABC-B	7753-10395	5/8	15.9	1-18	1 1/16	1 1/8	2.13	54.1	1.36	34.5	.75

Straight Tube Assembly - Brass

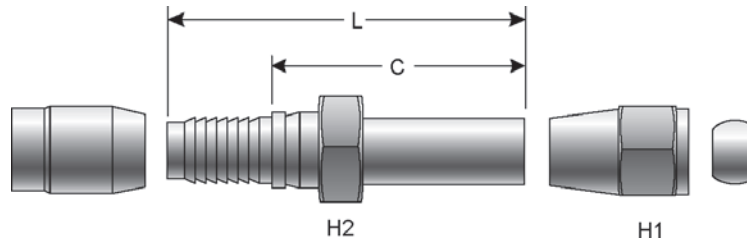

Part No.	Descr.	Prod. No.	⌀		🌀	H1	H2	L		C		⌀
			"	mm				"	mm	"	mm	
G40461-1008B	10C14-8STA-B	7753-10415	1/2	12.7	11/16-20	3/4	13/16	3.18	80.8	2.21	56.1	.50
G40461-1010B	10C14-10STA-B	7753-10425	1/2	12.7	13/16-18	3/4	15/16	3.50	88.9	2.53	64.3	.63
G40461-1212B	12C14-12STA-B	7753-10435	5/8	15.9	1-18	7/8	1 1/8	3.67	93.2	2.61	66.3	.75

SAE Male Inverted Swivel - Steel

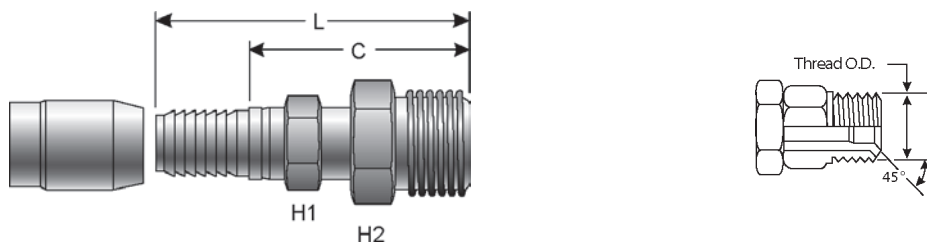

Part No.	Descr.	Prod. No.	⌀		🌀	H1	H2	L		C	
			"	mm				"	mm	"	mm
G40500-0404	4C14-4MIX	7753-20305	3/16	4.8	7/16-24	7/16	7/16	1.84	46.7	1.39	35.3
G40500-0505	5C14-5MIX	7753-20315	1/4	6.4	1/2-20	1/2	1/2	1.90	48.3	1.45	36.8
G40500-0606	6C14-6MIX	7753-20325	5/16	7.9	5/8-18	9/16	5/8	2.07	52.6	1.52	38.6
G40500-0808	8C14-8MIX	7753-20335	13/32	10.3	3/4-18	5/8	3/4	2.21	56.1	1.60	40.6
G40500-1010	10C14-10MIX	7753-20345	1/2	12.7	7/8-16	3/4	7/8	2.47	62.7	1.77	45.0

EQUIPMENT
HOSE/CPLG. SELECTION
G8K COUPLINGS
GLOBALSPIRAL COUPLINGS
STAINLESS STEEL SPIRAL
MEGACRIMP COUPLINGS
STAINLESS STEEL BRAID
POWER CRIMP COUPLINGS
FIELD ATTACHABLE G1 & G2 COUPLINGS
FIELD ATTACHABLE C5 COUPLINGS
GLX COUPLINGS
GL COUPLINGS
C14 COUPLINGS
PCTS THERMOPLASTIC COUPLINGS
POLARSEAL COUPLINGS
POLARSEAL II COUPLINGS
POWER STEERING
ADAPTERS
QUICK DISCONNECT COUPLERS
BALL VALVES
LIVE SWIVEL
ASSEMBLY FABRICATION
ACCESSORIES
EQUIPMENT AND PARTS
AIR BRAKE
BRASS
KITS

C14 Couplings

SAE Male Inverted Swivel - 45° Bent Tube - Steel

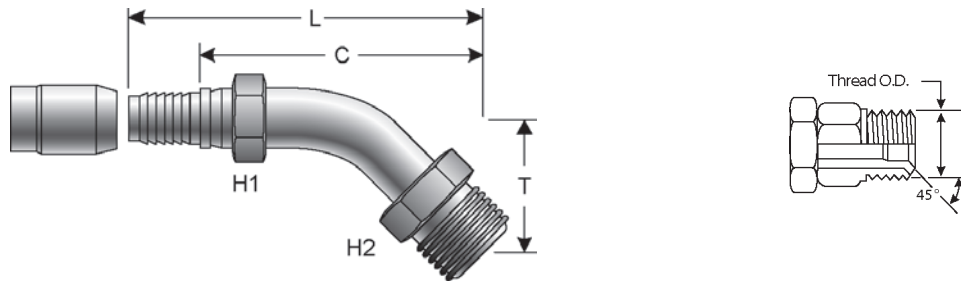

Part No.	Descr.	Prod. No.	⌀		H1	H2	T		L		C		
			"	mm			"	mm	"	mm	"	mm	
G40502-0404	4C14-4MIX45	7753-20355	3/16	4.8	7/16-24	7/16	7/16	.73	18.5	1.99	50.6	1.53	38.9
G40502-0606	6C14-6MIX45	7753-20365	5/16	7.9	5/8-18	9/16	5/8	.94	23.9	2.48	63.0	1.93	49.0
G40502-0808	8C14-8MIX45	7753-20375	13/32	10.3	3/4-18	5/8	3/4	1.14	29.0	2.95	74.9	2.10	53.3
G40502-1010	10C14-10MIX45	7753-20695	1/2	12.7	7/8-18	3/4	7/8	1.34	34.0	3.37	85.6	2.67	67.8
G40502-1212	12C14-12MIX45	7753-20705	5/8	15.9	1 3/16-16	7/8	1 1/16	1.54	39.1	4.56	115.8	3.79	96.3

SAE Male Inverted Swivel - 90° Bent Tube - Steel

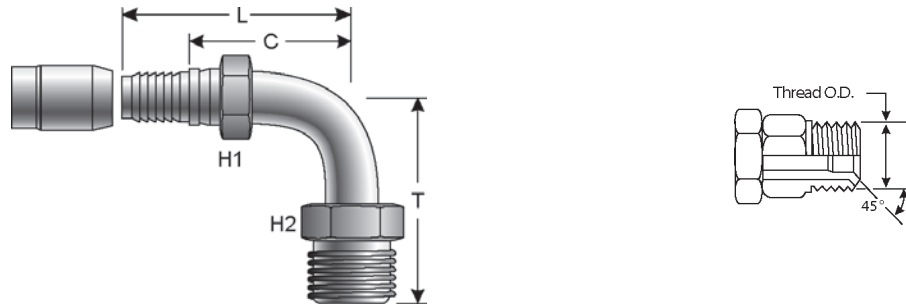

Part No.	Descr.	Prod. No.	⌀		H1	H2	T		L		C		
			"	mm			"	mm	"	mm	"	mm	
G40504-0404	4C14-4MIX90	7753-20385	3/16	4.8	7/16-24	7/16	7/16	1.30	33.0	1.42	36.1	.97	24.6
G40504-0505	5C14-5MIX90	7753-20395	1/4	6.4	1/2-20	1/2	1/2	1.48	37.6	1.54	39.1	1.09	27.7
G40504-0606	6C14-6MIX90	7753-20405	5/16	7.9	5/8-18	9/16	5/8	1.63	41.4	1.80	45.7	1.25	31.8
G40504-0808	8C14-8MIX90	7753-20415	13/32	10.3	3/4-18	5/8	3/4	1.91	48.5	2.10	53.3	1.77	45.0
G40504-1010	10C14-10MIX90	7753-20425	1/2	12.7	7/8-18	3/4	7/8	2.16	54.9	2.47	62.7	1.77	45.0
G40504-1212	12C14-12MIX90	7753-20715	5/8	15.9	1 3/16-16	7/8	1 1/16	2.66	67.6	3.60	91.4	2.83	71.9

C14 Couplings

Two-Bolt Flange Swivel - Brass (Steel Flange) - Laundry Flange

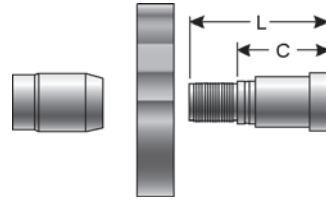

Part No.	Descr.	Prod. No.	⊕		A	L		C	
			"	mm		"	mm	"	mm
G40543-1212	12C14-12TBFLX	7753-10265	5/8	15.9	2.00	2.27	57.7	.59	15.0
G40543-1616	16C14-16TBFLX	7753-10275	7/8	22.2	2.00	2.45	62.2	.81	20.6

C14 Assembly with Two Female Dual Seat JIC 37°/SAE 45° Flare Swivel (FJSX) Couplings-Steel



Part No.	Descr.	Prod. No.	⊕		L	
			"	mm	"	mm
G89170-1018	10C14-10FJSX-10FJSX-18	4479-0002	1/2	12.7	18.00	457.2
G89170-1024	10C14-10FJSX-10FJSX-24	4479-0003	1/2	12.7	24.00	609.6
G89170-1030	10C14-10FJSX-10FJSX-30	4479-0004	1/2	12.7	30.00	762.0
G89170-1036	10C14-10FJSX-10FJSX-36	4479-0005	1/2	12.7	36.00	914.4
G89170-1042	10C14-10FJSX-10FJSX-42	4479-0006	1/2	12.7	42.00	1066.8
G89170-1048	10C14-10FJSX-10FJSX-48	4479-0007	1/2	12.7	48.00	1219.2
G89170-1054	10C14-10FJSX-10FJSX-54	4479-0008	1/2	12.7	54.00	1371.6
G89170-1072	10C14-10FJSX-10FJSX-72	4479-0009	1/2	12.7	72.00	1828.8
G89170-1084	10C14-10FJSX-10FJSX-84	4479-0010	1/2	12.7	84.00	2133.6

C14 Assembly with Two Air Brake Compression (ABC) Couplings - Steel



Part No.	Descr.	Prod. No.	⊕		L	
			"	mm	"	mm
G89460-1018	10C14-10ABC-10ABC-18	4479-0011	1/2	12.7	18.00	457.2
G89460-1024	10C14-10ABC-10ABC-24	4479-0012	1/2	12.7	24.00	609.6

EQUIPMENT
HOSE/CPLG. SELECTION
G8K COUPLINGS
GLOBALSPIRAL COUPLINGS
STAINLESS STEEL SPIRAL
MEGACRIMP COUPLINGS
STAINLESS STEEL BRAID
POWER CRIMP COUPLINGS
FIELD ATTACHABLE G1 & G2 COUPLINGS
FIELD ATTACHABLE C5 COUPLINGS
GLX COUPLINGS
GL COUPLINGS
C14 COUPLINGS
PCTS THERMOPLASTIC COUPLINGS
POLARSEAL COUPLINGS
POLARSEAL II COUPLINGS
POWER STEERING
ADAPTERS
QUICK DISCONNECT COUPLERS
BALL VALVES
LIVE SWIVEL
ASSEMBLY FABRICATION
ACCESSORIES
EQUIPMENT AND PARTS
AIR BRAKE
BRASS
KITS

C14 Couplings

C14 Assembly with Two Straight Tube Assembly (STA) Couplings - Steel

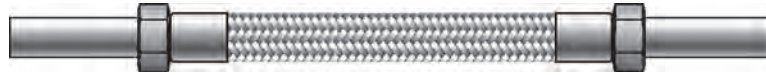

Part No.	Descr.	Prod. No.	⊖		L	
			"	mm	"	mm
G89461-1018	10C14-10STA-10STA-18	4479-0013	1/2	12.7	18.00	457.2
G89461-1024	10C14-10STA-10STA-24	4479-0014	1/2	12.7	24.00	609.6
G89461-1036	10C14-10STA-10STA-36	4479-0015	1/2	12.7	36.00	914.4
G89461-1224	12C14-12STA-12STA-24	4479-0020	5/8	15.9	24.00	609.6
G89461-1236	12C14-12STA-12STA-36	4479-0021	5/8	15.9	36.00	914.4

C14 One Straight Tube Assembly (STA) and One Air Brake Compression (ABC) Couplings - Steel



Part No.	Descr.	Prod. No.	⊖		L	
			"	mm	"	mm
G89462-1018	10C14-10STA-10ABC-18	4479-0016	1/2	12.7	18.00	457.2
G89462-1024	10C14-10STA-10ABC-24	4479-0017	1/2	12.7	24.00	609.6
G89462-1036	10C14-10STA-10ABC-36	4479-0018	1/2	12.7	36.00	914.4
G89462-1048	10C14-10STA-10ABC-48	4479-0019	1/2	12.7	48.00	1219.2
G89462-1224	12C14-12STA-12ABC-24	4479-0022	5/8	15.9	24.00	609.6
G89462-1236	12C14-12STA-12ABC-36	4479-0023	5/8	15.9	36.00	914.4
G89462-1248	12C14-12STA-12ABC-48	4479-0024	5/8	15.9	48.00	1219.2

Power Trim Assemblies - Steel

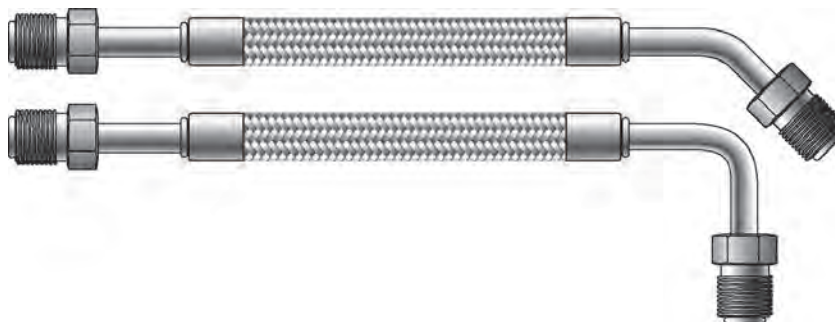

Part No.	Descr.	Prod. No.	⊖		🌀	L		🔦	🔦
			"	mm		"	mm		
G89502-0414	PTA-45	7752-00455	3/16	4.8	3/8-24	14.50	368.3	10000	2500
G89504-0414	PTA-90	7752-00905	3/16	4.8	3/8-24	14.50	368.3	10000	2500

Hydraulic Hose For PCTS Thermoplastic Couplings

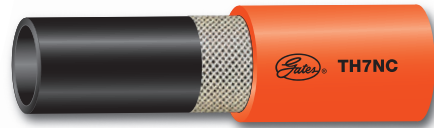

The Gates eCrimp program is a web based utility which allows users and distributors of Gates hydraulic and industrial hose products to find and print the most up to date crimp specifications with nothing more than an internet browser.

This program can be used to find crimp data for the MobileCrimp 4-20, PC 707, SC32, PC 3000B, GC32-XD™ Global Hose Crimper, GC96 and Omni Crimp 21. Custom result may be printed by selecting the crimper, hose and coupling. Optionally results may also be limited by die set and working pressure.



The eCrimp mobile app gives you all the same features of the online version in the palm of your hands. Use the app to find the most up-to-date crimp specifications quickly and easily. It is available for download for the iPhone and iPad from the App Store.

EQUIPMENT
HOSE/CPLG. SELECTION
G&K COUPLINGS
GLOBALSPIRAL COUPLINGS
STAINLESS STEEL SPIRAL
MEGACRIMP COUPLINGS
STAINLESS STEEL BRAID
POWER CRIMP COUPLINGS
FIELD ATTACHABLE G1 & G2 COUPLINGS
FIELD ATTACHABLE C5 COUPLINGS
GLX COUPLINGS
GL COUPLINGS
C14 COUPLINGS
PCTS THERMOPLASTIC COUPLINGS
POLARSEAL COUPLINGS
POLARSEAL II COUPLINGS
POWER STEERING
ADAPTERS
QUICK DISCONNECT COUPLERS
BALL VALVES
LIVE SWIVEL
ASSEMBLY FABRICATION
ACCESSORIES
EQUIPMENT AND PARTS
AIR BRAKE
BRASS
KITS

PCTS Thermoplastic Couplings (One-Piece)

EQUIPMENT
HOSE/CPLG. SELECTION
G8K COUPLINGS
GLOBALSPIRAL COUPLINGS
STAINLESS STEEL SPIRAL
MEGACRIMP COUPLINGS
STAINLESS STEEL BRAID
POWER CRIMP COUPLINGS
FIELD ATTACHABLE G1 & G2 COUPLINGS
FIELD ATTACHABLE C5 COUPLINGS
GLX COUPLINGS
GL COUPLINGS
C14 COUPLINGS
PCTS THERMOPLASTIC COUPLINGS
POLARSEAL COUPLINGS
POLARSEAL II COUPLINGS
POWER STEERING
ADAPTERS
QUICK DISCONNECT COUPLERS
BALL VALVES
LIVE SWIVEL
ASSEMBLY FABRICATION
ACCESSORIES
EQUIPMENT AND PARTS
AIR BRAKE
BRASS
KITS

Male Pipe (NPTF - 30° Cone Seat)

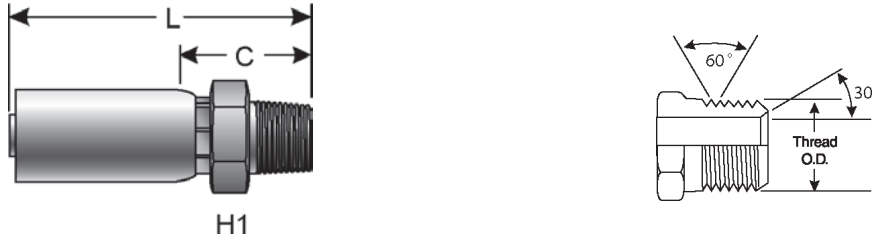

Part No.	Descr.	Prod. No.	⊖		🌀	H1	L		C	
			"	mm			"	mm	"	mm
G51100-0202	2PCTS-2MP	7336-11985	1/8	3.2	1/8-27	1/2	1.34	34.0	.74	18.8
G51100-0204	2PCTS-4MP	7336-11995	1/8	3.2	1/4-18	1/2	1.53	38.9	.93	23.6
G51100-0302	3PCTS-2MP	7336-12005	3/16	4.8	1/8-27	9/16	1.94	49.3	1.08	27.4
G51100-0304	3PCTS-4MP	7336-12015	3/16	4.8	1/4-18	11/16	2.13	54.1	1.27	32.3

Male Pipe Swivel (NPTF - Without 30° Cone Seat)

NOT TO BE USED AS A LIVE SWIVEL.



Part No.	Descr.	Prod. No.	⊖		🌀	H1	H2	L		C	
			"	mm				"	mm	"	mm
G51105-0202	2PCTS-2MPX	7337-11985	1/8	3.2	1/8-27	1/2	23/32	1.93	49.0	1.33	33.8
G51105-0302	3PCTS-2MPX	7337-12005	3/16	4.8	1/8-27	23/32	23/32	2.50	63.5	1.50	38.1
G51105-0304	3PCTS-4MPX	7337-12015	3/16	4.8	1/4-18	23/32	23/32	2.72	69.1	1.86	47.2

Female JIC 37° Flare Swivel

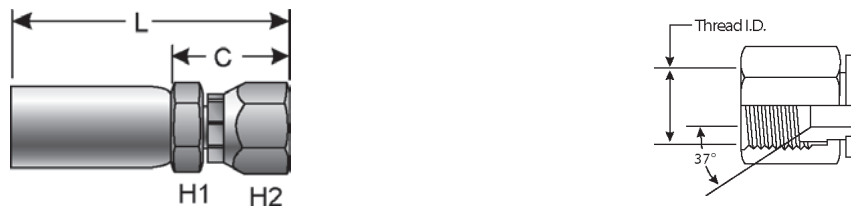

Part No.	Descr.	Prod. No.	⊖		🌀	H1	H2	L		C	
			"	mm				"	mm	"	mm
G51170-0203	2PCTS-3FJX	7338-11985	1/8	3.2	3/8-24	1/2	9/16	1.65	41.9	1.05	26.7

Female JIC 37° Flare Swivel - 90° Bent Tube

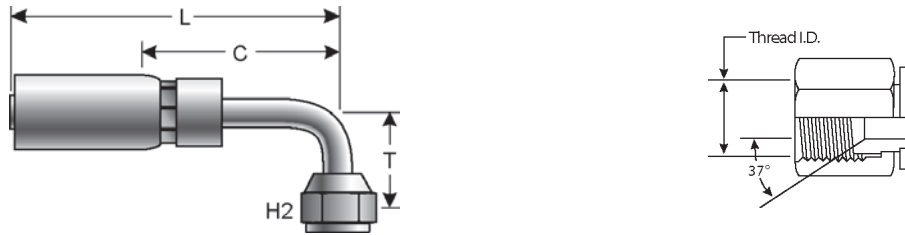

Part No.	Descr.	Prod. No.	⊖		7/16-20	H2	T		L		C	
			"	mm			"	mm	"	mm	"	mm
G51179-0304	3PCTS-4FJX90S	7338-12695	3/16	4.8	7/16-20	9/16	.78	19.8	2.45	62.2	1.58	40.1

Dual Seat Female JIC 37°/SAE 45° Flare Swivel - 45° Bent Tube

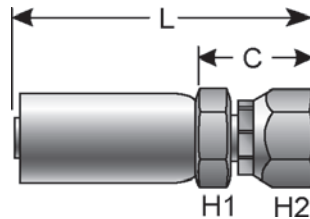

Part No.	Descr.	Prod. No.	⊖		7/16-20	H1	H2	L		C	
			"	mm				"	mm	"	mm
G51210-0204	2PCTS-4FJSX	7338-11995	1/8	3.2	7/16-20	1/2	5/8	1.73	44.0	1.12	28.5
G51210-0304	3PCTS-4FJSX	7338-12005	3/16	4.8	7/16-20	9/16	5/8	2.23	56.6	1.16	29.5

- EQUIPMENT
- HOSE/CPLG. SELECTION
- G8K COUPLINGS
- GLOBALSPIRAL COUPLINGS
- STAINLESS STEEL SPIRAL
- MEGACRIMP COUPLINGS
- STAINLESS STEEL BRAID
- POWER CRIMP COUPLINGS
- FIELD ATTACHABLE G1 & G2 COUPLINGS
- FIELD ATTACHABLE C5 COUPLINGS
- GLX COUPLINGS
- GL COUPLINGS
- C14 COUPLINGS
- PCTS THERMOPLASTIC COUPLINGS**
- POLARSEAL COUPLINGS
- POLARSEAL II COUPLINGS
- POWER STEERING
- ADAPTERS
- QUICK DISCONNECT COUPLERS
- BALL VALVES
- LIVE SWIVEL
- ASSEMBLY FABRICATION
- ACCESSORIES
- EQUIPMENT AND PARTS
- AIR BRAKE
- BRASS
- KITS

NOTES

EQUIPMENT
HOSE/CPLG. SELECTION
G8K COUPLINGS
GLOBALSPIRAL COUPLINGS
STAINLESS STEEL SPIRAL
MEGACRIMP COUPLINGS
STAINLESS STEEL BRAID
POWER CRIMP COUPLINGS
FIELD ATTACHABLE G1 & G2 COUPLINGS
FIELD ATTACHABLE C5 COUPLINGS
GLX COUPLINGS
GL COUPLINGS
C14 COUPLINGS
PCTS THERMOPLASTIC COUPLINGS
POLARSEAL COUPLINGS
POLARSEAL II COUPLINGS
POWER STEERING
ADAPTERS
QUICK DISCONNECT COUPLERS
BALL VALVES
LIVE SWIVEL
ASSEMBLY FABRICATION
ACCESSORIES
EQUIPMENT AND PARTS
AIR BRAKE
BRASS
KITS

Hydraulic Hose For PolarSeal® Couplings



The Gates eCrimp program is a web based utility which allows users and distributors of Gates hydraulic and industrial hose products to find and print the most up to date crimp specifications with nothing more than an internet browser.

This program can be used to find crimp data for the MobileCrimp 4-20, PC 707, SC32, PC 3000B, GC32-XD™ Global Hose Crimper, GC96 and Omni Crimp 21. Custom result may be printed by selecting the crimper, hose and coupling. Optionally results may also be limited by die set and working pressure.



The eCrimp mobile app gives you all the same features of the online version in the palm of your hands. Use the app to find the most up-to-date crimp specifications quickly and easily. It is available for download for the iPhone and iPad from the App Store.



EQUIPMENT
HOSE/CPLG. SELECTION
G&K COUPLINGS
GLOBALSPIRAL COUPLINGS
STAINLESS STEEL SPIRAL
MEGACRIMP COUPLINGS
STAINLESS STEEL BRAID
POWER CRIMP COUPLINGS
FIELD ATTACHABLE G1 & G2 COUPLINGS
FIELD ATTACHABLE C5 COUPLINGS
GLX COUPLINGS
GL COUPLINGS
C14 COUPLINGS
PCTS THERMOPLASTIC COUPLINGS
POLARSEAL COUPLINGS
POLARSEAL II COUPLINGS
POWER STEERING
ADAPTERS
QUICK DISCONNECT COUPLERS
BALL VALVES
LIVE SWIVEL
ASSEMBLY FABRICATION
ACCESSORIES
EQUIPMENT AND PARTS
AIR BRAKE
BRASS
KITS

EQUIPMENT
HOSE/CPLG. SELECTION
G8K COUPLINGS
GLOBALSPIRAL COUPLINGS
STAINLESS STEEL SPIRAL
MEGACRIMP COUPLINGS
STAINLESS STEEL BRAID
POWER CRIMP COUPLINGS
FIELD ATTACHABLE G1 & G2 COUPLINGS
FIELD ATTACHABLE C5 COUPLINGS
GLX COUPLINGS
GL COUPLINGS
C14 COUPLINGS
PCTS THERMOPLASTIC COUPLINGS
POLARSEAL COUPLINGS
POLARSEAL II COUPLINGS
POWER STEERING
ADAPTERS
QUICK DISCONNECT COUPLERS
BALL VALVES
LIVE SWIVEL
ASSEMBLY FABRICATION
ACCESSORIES
EQUIPMENT AND PARTS
AIR BRAKE
BRASS
KITS

Male SAE 45° Flare - Aluminum

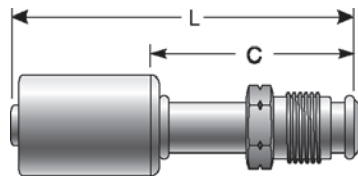

Part No.	Descr.	Prod. No.	⊖	🌀	L	C
			"	"		
G45195-0606	6ACA-6MS	7332-00015	5/16	5/8-18	3.38	2.13
G45195-0808	8ACA-8MS	7332-00025	13/32	3/4-16	3.50	2.25
G45195-1010	10ACA-10MS	7332-00035	1/2	7/8-14	3.81	2.56
G45195-1212	12ACA-12MS	7332-00045	5/8	1 1/16-14	4.00	2.75

Male SAE 45° Flare - 45° Bent Tube - Aluminum

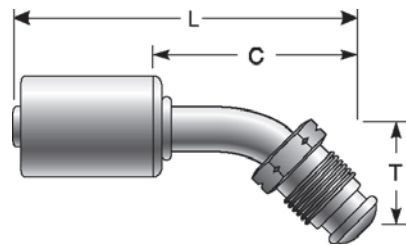

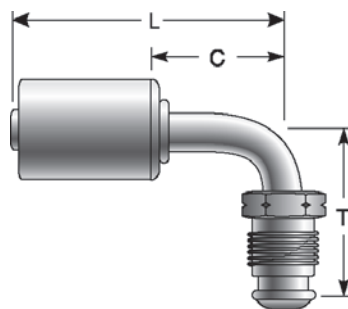

Part No.	Descr.	Prod. No.	⊖	🌀	T	L	C
			"	"			
G45196-0606	6ACA-6MS45	7332-00055	5/16	5/8-18	.94	3.25	2.00
G45196-0808	8ACA-8MS45	7332-00065	13/32	3/4-16	1.06	3.50	2.25
G45196-1010	10ACA-10MS45	7332-00075	1/2	7/8-14	1.12	3.87	2.62
G45196-1212	12ACA-12MS45	7332-00085	5/8	1 1/16-14	1.25	4.25	3.00

Male SAE 45° Flare - 90° Bent Tube - Aluminum





Part No.	Descr.	Prod. No.	⊖	🌀	T	L	C
			"	"			
G45197-0606	6ACA-6MS90	7332-00095	5/16	5/8-18	1.75	2.56	1.31
G45197-0808	8ACA-8MS90	7332-00105	13/32	3/4-16	1.81	2.75	1.50

Male SAE 45° Flare - 90° Bent Tube - Aluminum - Continued

Part No.	Descr.	Prod. No.			T	L	C
			"	"			
G45197-1010	10ACA-10MS90	7332-00115	1/2	7/8-14	2.19	3.00	1.75
G45197-1212	12ACA-12MS90	7332-00125	5/8	1 1/16-14	2.45	3.25	2.00

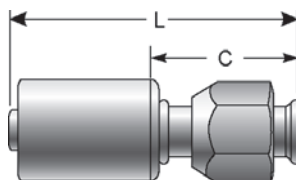

Female SAE 45° Flare Swivel - Aluminum

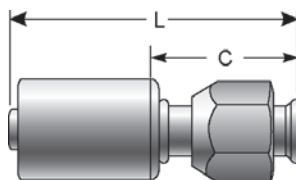

Part No.	Descr.	Prod. No.			L	C
			"	"		
G45200-0606	6ACA-6FSX	7332-00135	5/16	5/8-18	2.88	1.63
G45200-0608	6ACA-8FSX	7332-00145	5/16	3/4-16	2.69	1.44
G45200-0806	8ACA-6FSX	7332-02825	13/32	5/8-18	2.69	1.44
G45200-0808	8ACA-8FSX	7332-00155	13/32	3/4-16	2.69	1.44
G45200-1008	10ACA-8FSX	7332-02835	1/2	3/4-16	3.00	1.75
G45200-1010	10ACA-10FSX	7332-00165	1/2	7/8-14	3.00	1.75
G45200-1210	12ACA-10FSX	7332-00175	5/8	7/8-14	3.25	2.00
G45200-1212	12ACA-12FSX	7332-00185	5/8	1 1/16-14	3.25	2.00

Female SAE 45° Flare Swivel - Steel



Part No.	Descr.	Prod. No.			L	C
			"	"		
G45200-0606S	6ACA-6FSX-S	7332-01755	5/16	5/8-18	2.88	1.60
G45200-0808S	8ACA-8FSX-S	7332-01765	13/32	3/4-16	2.69	1.44
G45200-1010S	10ACA-10FSX-S	7332-01775	1/2	7/8-14	3.00	1.75

- EQUIPMENT
- HOSE/CPLG. SELECTION
- G8K COUPLINGS
- GLOBAL SPIRAL COUPLINGS
- STAINLESS STEEL SPIRAL
- MEGACRIMP COUPLINGS
- STAINLESS STEEL BRAID
- POWER CRIMP COUPLINGS
- FIELD ATTACHABLE G1 & G2 COUPLINGS
- FIELD ATTACHABLE C5 COUPLINGS
- GLX COUPLINGS
- GL COUPLINGS
- C14 COUPLINGS
- PCTS THERMOPLASTIC COUPLINGS
- POLARSEAL COUPLINGS**
- POLARSEAL II COUPLINGS
- POWER STEERING
- ADAPTERS
- QUICK DISCONNECT COUPLERS
- BALL VALVES
- LIVE SWIVEL
- ASSEMBLY FABRICATION
- ACCESSORIES
- EQUIPMENT AND PARTS
- AIR BRAKE
- BRASS
- KITS

Female SAE 45° Flare Swivel - 45° Bent Tube - Aluminum

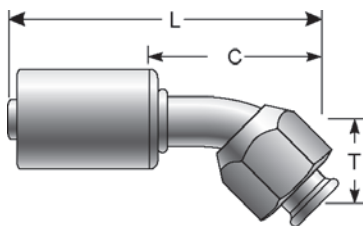

Part No.	Descr.	Prod. No.	⊖	🌀	T	L	C
			"	"			
G45202-0606	6ACA-6FSX45	7332-00195	5/16	5/8-18	.56	2.87	1.62
G45202-0806	8ACA-6FSX45	7332-02855	13/32	5/8-18	.63	3.04	1.79
G45202-0808	8ACA-8FSX45	7332-00205	13/32	3/4-16	.63	3.07	1.82
G45202-1010	10ACA-10FSX45	7332-00215	1/2	7/8-14	.88	3.63	2.38
G45202-1210	12ACA-10FSX45	7332-02875	5/8	7/8-14	1.00	3.97	2.72
G45202-1212	12ACA-12FSX45	7332-00225	5/8	1 1/16-14	1.00	4.00	2.75

Female SAE 45° Flare Swivel - 90° Bent Tube - Aluminum

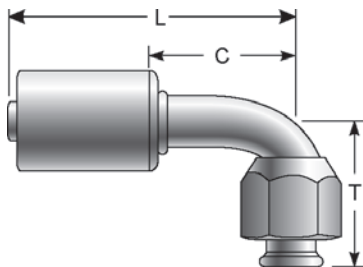

Part No.	Descr.	Prod. No.	⊖	🌀	T	L	C
			"	"			
G45205-0606	6ACA-6FSX90	7332-00235	5/16	5/8-18	1.06	2.56	1.31
G45205-0608	6ACA-8FSX90	7332-00245	5/16	3/4-16	1.25	2.75	1.50
G45205-0806	8ACA-6FSX90	7332-02885	13/32	5/8-18	1.25	2.75	1.50
G45205-0808	8ACA-8FSX90	7332-00255	13/32	3/4-16	1.25	2.75	1.50
G45205-1008	10ACA-8FSX90	7332-02895	1/2	3/4-16	1.50	3.00	1.75
G45205-1010	10ACA-10FSX90	7332-00265	1/2	7/8-14	1.50	3.00	1.75
G45205-1210	12ACA-10FSX90	7332-00275	5/8	7/8-14	1.50	3.25	2.00
G45205-1212	12ACA-12FSX90	7332-00285	5/8	1 1/16-14	1.50	3.85	2.00

Female SAE 45° Flare Swivel - 90° Bent Tube - Steel

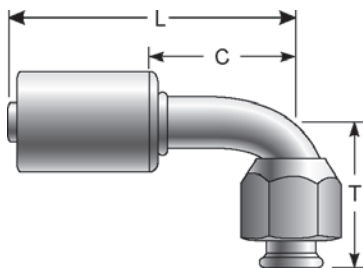

Part No.	Descr.	Prod. No.	⊖	🌀	T	L	C
			"	"	"	"	"
G45205-0606S	6ACA-6FSX90-S	7332-01785	5/16	5/8-18	1.06	2.56	1.31
G45205-0808S	8ACA-8FSX90-S	7332-01795	13/32	3/4-16	1.25	2.75	1.50
G45205-1010S	10ACA-10FSX90-S	7332-01805	1/2	7/8-14	1.50	3.00	1.75

Male SAE Flareless Assembly - Aluminum

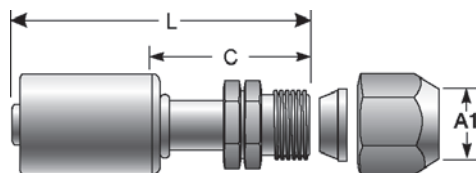

Part No.	Descr.	Prod. No.	⊖	🌀	A1	L	C
			"	"	"	"	"
G45510-0606	6ACA-6MFA	7332-00295	5/16	5/8-18	3/8	2.69	1.44
G45510-0608	6ACA-8MFA	7332-02905	5/16	3/4-16	1/2	2.81	1.56
G45510-0806	8ACA-6MFA	7332-02915	13/32	5/8-18	3/8	2.75	1.50
G45510-0808	8ACA-8MFA	7332-00305	13/32	3/4-16	1/2	2.88	1.63
G45510-0810	8ACA-10MFA	7332-00315	13/32	7/8-14	5/8	3.00	1.75
G45510-1008	10ACA-8MFA	7332-00325	1/2	3/4-16	1/2	2.94	1.69
G45510-1010	10ACA-10MFA	7332-00335	1/2	7/8-14	5/8	3.00	1.75
G45510-1210	12ACA-10MFA	7332-00345	5/8	7/8-14	5/8	3.13	1.88
G45510-1212	12ACA-12MFA	7332-00355	5/8	1 1/16-12	3/4	3.25	2.00

EQUIPMENT
HOSE/CPLG. SELECTION
G&K COUPLINGS
GLOBALSPIRAL COUPLINGS
STAINLESS STEEL SPIRAL
MEGACRIMP COUPLINGS
STAINLESS STEEL BRAID
POWER CRIMP COUPLINGS
FIELD ATTACHABLE G1 & G2 COUPLINGS
FIELD ATTACHABLE C5 COUPLINGS
GLX COUPLINGS
GL COUPLINGS
C14 COUPLINGS
PCTS THERMOPLASTIC COUPLINGS
POLARSEAL COUPLINGS
POLARSEAL II COUPLINGS
POWER STEERING
ADAPTERS
QUICK DISCONNECT COUPLERS
BALL VALVES
LIVE SWIVEL
ASSEMBLY FABRICATION
ACCESSORIES
EQUIPMENT AND PARTS
AIR BRAKE
BRASS
KITS

Male SAE Flareless Assembly - 90° Block - Aluminum

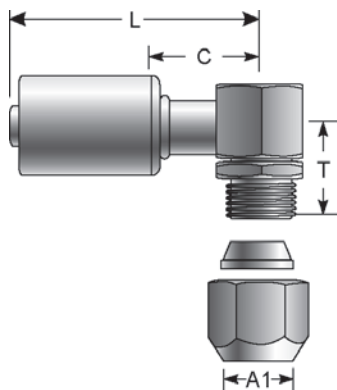

Part No.	Descr.	Prod. No.			A1	T	L	C
			"	"	"	"	"	"
G45511-0606	6ACA-6MFA90	7332-00365	5/16	5/8-18	3/8	.78	2.24	.99
G45511-0608	6ACA-8MFA90	7332-02925	5/16	3/4-16	1/2	.96	2.31	1.06
G45511-0806	8ACA-6MFA90	7332-02935	13/32	5/8-18	3/8	.78	2.28	1.03
G45511-0808	8ACA-8MFA90	7332-00375	13/32	3/4-16	1/2	.96	2.37	1.12
G45511-0810	8ACA-10MFA90	7332-00385	13/32	7/8-14	5/8	1.08	2.43	1.18
G45511-1008	10ACA-8MFA90	7332-00395	1/2	3/4-16	1/2	.96	2.38	1.13
G45511-1010	10ACA-10MFA90	7332-00405	1/2	7/8-14	5/8	1.08	2.44	1.19
G45511-1210	12ACA-10MFA90	7332-00415	5/8	7/8-14	5/8	1.08	2.56	1.31
G45511-1212	12ACA-12MFA90	7332-00425	5/8	1 1/16-12	3/4	1.19	2.66	1.41

Female Braze-On Stems - Aluminum

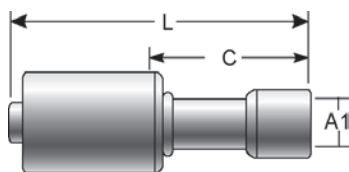

Part No.	Descr.	Prod. No.		A1	L	C
			"	"	"	"
G45527-0606	6ACA-6FBO	7332-02945	5/16	3/8	2.10	.85
G45527-0808	8ACA-8FBO	7332-02955	13/32	1/2	2.10	.85
G45527-1010	10ACA-10FBO	7332-02965	1/2	5/8	2.10	.85
G45527-1210	12ACA-10FBO	7332-02975	5/8	5/8	2.10	.85
G45527-1212	12ACA-12FBO	7332-02985	5/8	3/4	2.10	.85

Female Braze-On Stems - Steel

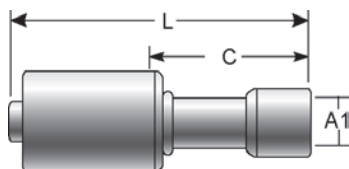

Part No.	Descr.	Prod. No.	⊖	A1	L	C
			"			
G45527-0606S	6ACA-6FBO-S	7332-01905	5/16	3/8	2.10	.85
G45527-0808S	8ACA-8FBO-S	7332-01915	13/32	1/2	2.10	.85
G45527-1010S	10ACA-10FBO-S	7332-01925	1/2	5/8	2.10	.85
G45527-1210S	12ACA-10FBO-S	7332-01945	5/8	5/8	2.10	.85
G45527-1212S	12ACA-12FBO-S	7332-01935	5/8	3/4	2.10	.85

Hose Length Extender - Aluminum

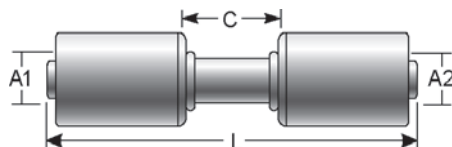

Part No.	Descr.	Prod. No.	⊖	A1	A2	L	C
			"				
G45535-0606	6ACA-6HLE	7332-01385	5/16	5/16	5/16	4.00	1.50
G45535-0608	6ACA-8HLE	7332-01395	5/16	5/16	13/32	4.00	1.50
G45535-0808	8ACA-8HLE	7332-01405	13/32	13/32	13/32	4.00	1.50
G45535-0810	8ACA-10HLE	7332-01415	13/32	13/32	1/2	4.13	1.63
G45535-1010	10ACA-10HLE	7332-01425	1/2	1/2	1/2	4.13	1.63
G45535-1210	12ACA-10HLE	7332-02995	5/8	5/8	1/2	4.25	1.75
G45535-1212	12ACA-12HLE	7332-01435	5/8	5/8	5/8	4.25	1.75

EQUIPMENT
HOSE/CPLG. SELECTION
G&K COUPLINGS
GLOBALSPIRAL COUPLINGS
STAINLESS STEEL SPIRAL
MEGACRIMP COUPLINGS
STAINLESS STEEL BRAID
POWER CRIMP COUPLINGS
FIELD ATTACHABLE G1 & G2 COUPLINGS
FIELD ATTACHABLE C5 COUPLINGS
GLX COUPLINGS
GL COUPLINGS
C14 COUPLINGS
PCTS THERMOPLASTIC COUPLINGS
POLARSEAL COUPLINGS
POLARSEAL II COUPLINGS
POWER STEERING
ADAPTERS
QUICK DISCONNECT COUPLERS
BALL VALVES
LIVE SWIVEL
ASSEMBLY FABRICATION
ACCESSORIES
EQUIPMENT AND PARTS
AIR BRAKE
BRASS
KITS

Hose Length Extender - 90° Bent Tube - Aluminum

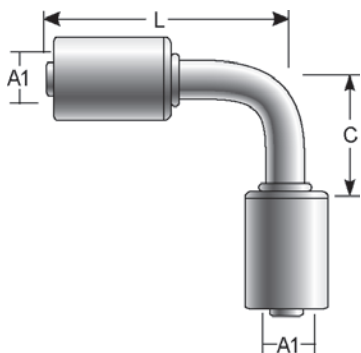

Part No.	Descr.	Prod. No.	⊖	A1	L	C
			"	"	"	"
G45537-0606	6ACA-6HLE90	7332-01445	5/16	5/16	2.50	1.25
G45537-0808	8ACA-8HLE90	7332-01455	13/32	13/32	2.62	1.37
G45537-1010	10ACA-10HLE90	7332-01465	1/2	1/2	2.88	1.63
G45537-1212	12ACA-12HLE90	7332-01475	5/8	5/8	3.25	2.00

Hose Length Extender with Sight Glass - Aluminum

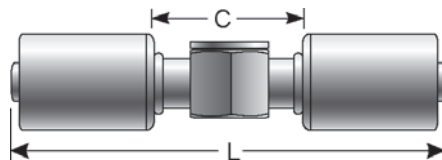

Part No.	Descr.	Prod. No.	⊖	L	C
			"	"	"
G45538-0606	6ACA-6HLESG	7332-01485	5/16	4.12	1.62

EQUIPMENT
HOSE/CPLG. SELECTION
G8K COUPLINGS
GLOBALSPIRAL COUPLINGS
STAINLESS STEEL SPIRAL
MEGACRIMP COUPLINGS
STAINLESS STEEL BRAID
POWER CRIMP COUPLINGS
FIELD ATTACHABLE G1 & G2 COUPLINGS
FIELD ATTACHABLE C5 COUPLINGS
GLX COUPLINGS
GL COUPLINGS
C14 COUPLINGS
PCTS THERMOPLASTIC COUPLINGS
POLARSEAL COUPLINGS
POLARSEAL II COUPLINGS
POWER STEERING
ADAPTERS
QUICK DISCONNECT COUPLERS
BALL VALVES
LIVE SWIVEL
ASSEMBLY FABRICATION
ACCESSORIES
EQUIPMENT AND PARTS
AIR BRAKE
BRASS
KITS

Hose Length Extender - Tee - Aluminum

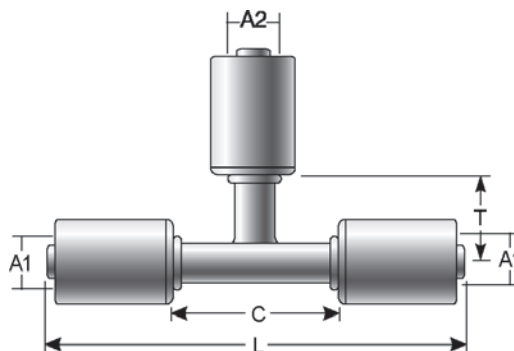

Part No.	Descr.	Prod. No.	⊖	A1	A2	T	L	C
			"					
G45539-0606	6ACA-6HLET	7332-02295	5/16	5/16	5/16	1.13	4.75	2.25
G45539-0808	8ACA-8HLET	7332-02305	13/32	13/32	13/32	1.19	4.88	2.38
G45539-1010	10ACA-10HLET	7332-02315	1/2	1/2	1/2	1.25	5.00	2.50
G45539-1210	12ACA-10HLET	7332-03015	5/8	5/8	1/2	1.34	5.25	2.75
G45539-1212	12ACA-12HLET	7332-02325	5/8	5/8	5/8	1.37	5.25	2.75

Hose Length Extender - 180° Bent Tube - Aluminum

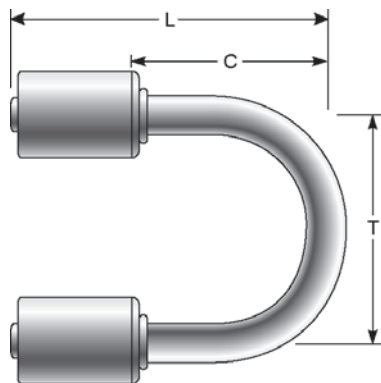

Part No.	Descr.	Prod. No.	⊖	T	L	C
			"			
G45541-0606	6ACA-6HLE180	7332-02255	5/16	3.00	3.88	2.63
G45541-0808	8ACA-8HLE180	7332-02265	13/32	3.00	4.00	2.75
G45541-1010	10ACA-10HLE180	7332-02275	1/2	3.00	4.13	2.88
G45541-1212	12ACA-12HLE180	7332-02285	5/8	3.00	4.50	3.25

- EQUIPMENT
- HOSE/CPLG. SELECTION
- G8K COUPLINGS
- GLOBALSPIRAL COUPLINGS
- STAINLESS STEEL SPIRAL
- MEGACRIMP COUPLINGS
- STAINLESS STEEL BRAID
- POWER CRIMP COUPLINGS
- FIELD ATTACHABLE G1 & G2 COUPLINGS
- FIELD ATTACHABLE C5 COUPLINGS
- GLX COUPLINGS
- GL COUPLINGS
- C14 COUPLINGS
- PCTS THERMOPLASTIC COUPLINGS
- POLARSEAL COUPLINGS**
- POLARSEAL II COUPLINGS
- POWER STEERING
- ADAPTERS
- QUICK DISCONNECT COUPLERS
- BALL VALVES
- LIVE SWIVEL
- ASSEMBLY FABRICATION
- ACCESSORIES
- EQUIPMENT AND PARTS
- AIR BRAKE
- BRASS
- KITS

EQUIPMENT
HOSE/CPLG. SELECTION
G8K COUPLINGS
GLOBALSPIRAL COUPLINGS
STAINLESS STEEL SPIRAL
MEGACRIMP COUPLINGS
STAINLESS STEEL BRAID
POWER CRIMP COUPLINGS
FIELD ATTACHABLE G1 & G2 COUPLINGS
FIELD ATTACHABLE C5 COUPLINGS
GLX COUPLINGS
GL COUPLINGS
C14 COUPLINGS
PCTS THERMOPLASTIC COUPLINGS
POLARSEAL COUPLINGS
POLARSEAL II COUPLINGS
POWER STEERING
ADAPTERS
QUICK DISCONNECT COUPLERS
BALL VALVES
LIVE SWIVEL
ASSEMBLY FABRICATION
ACCESSORIES
EQUIPMENT AND PARTS
AIR BRAKE
BRASS
KITS

Male SAE Tube O-Ring Nut Swivel with R134a Service Port - Aluminum

O-Ring not included. Must be ordered separately.

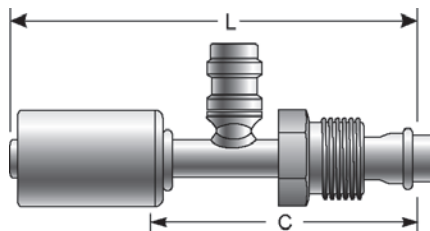

Part No.	Descr.	Prod. No.	⊖		L	C
			"	"	"	"
G45580-0606	6ACA-6MTON134SP	7332-03025	5/16	5/8-18	3.35	2.10
G45580-0808	8ACA-8MTON134SP	7332-03035	13/32	3/4-18	3.35	2.10
G45580-1010	10ACA-10MTON134SP	7332-03045	1/2	7/8-18	3.59	2.34
G45580-1212	12ACA-12MTON134SP	7332-03055	5/8	1 1/16-12	3.72	2.47

Male SAE Tube O-Ring Nut Swivel with R134a Service Port - 90° Bent Tube - Aluminum

O-Ring not included. Must be ordered separately.

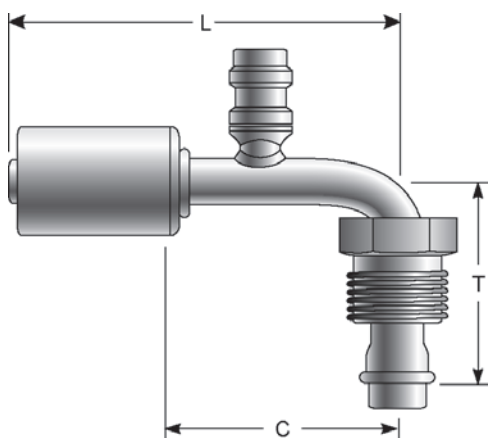

Part No.	Descr.	Prod. No.	⊖		T	L	C
			"	"	"	"	"
G45582-1010	10ACA-10MTON134SP90	7332-02585	1/2	7/8-18	1.50	3.85	2.60

Male SAE Tube O-Ring Nut Swivel - Aluminum

O-Ring not included. Must be ordered separately.

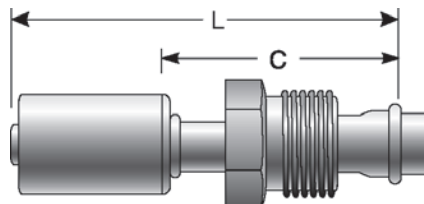

Part No.	Descr.	Prod. No.			L	C
			"	"		
G45583-0606	6ACA-6MTON	7332-00435	5/16	5/8-18	3.19	1.94
G45583-0607	6ACA-7MTON	7332-02115	5/16	11/16-16	3.00	1.75
G45583-0608	6ACA-8MTON	7332-03065	5/16	3/4-18	3.25	2.00
G45583-0806	8ACA-6MTON	7332-03075	13/32	5/8-18	3.25	2.00
G45583-0808	8ACA-8MTON	7332-00445	13/32	3/4-18	3.25	2.00
G45583-1010	10ACA-10MTON	7332-00455	1/2	7/8-18	3.38	2.13
G45583-1210	12ACA-10MTON	7332-03085	5/8	7/8-18	3.88	2.63
G45583-1212	12ACA-12MTON	7332-00465	5/8	1 1/16-12	3.88	2.63

Male SAE Tube O-Ring Nut Swivel - Steel

O-Ring not included. Must be ordered separately.

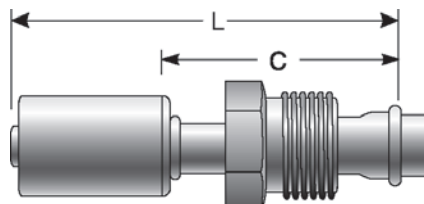

Part No.	Descr.	Prod. No.			L	C
			"	"		
G45583-0606S	6ACA-6MTON-S	7332-01285	5/16	5/8-18	3.19	1.94
G45583-0607S	6ACA-7MTON-S	7332-02125	5/16	11/16-16	3.00	1.75
G45583-1010S	10ACA-10MTON-S	7332-01865	1/2	7/8-18	3.38	2.13

EQUIPMENT
HOSE/CPLG. SELECTION
G&K COUPLINGS
GLOBALSPIRAL COUPLINGS
STAINLESS STEEL SPIRAL
MEGACRIMP COUPLINGS
STAINLESS STEEL BRAID
POWER CRIMP COUPLINGS
FIELD ATTACHABLE G1 & G2 COUPLINGS
FIELD ATTACHABLE C5 COUPLINGS
GLX COUPLINGS
GL COUPLINGS
C14 COUPLINGS
PCTS THERMOPLASTIC COUPLINGS
POLARSEAL COUPLINGS
POLARSEAL II COUPLINGS
POWER STEERING
ADAPTERS
QUICK DISCONNECT COUPLERS
BALL VALVES
LIVE SWIVEL
ASSEMBLY FABRICATION
ACCESSORIES
EQUIPMENT AND PARTS
AIR BRAKE
BRASS
KITS

EQUIPMENT
HOSE/CPLG. SELECTION
G8K COUPLINGS
GLOBALSPIRAL COUPLINGS
STAINLESS STEEL SPIRAL
MEGACRIMP COUPLINGS
STAINLESS STEEL BRAID
POWER CRIMP COUPLINGS
FIELD ATTACHABLE G1 & G2 COUPLINGS
FIELD ATTACHABLE C5 COUPLINGS
GLX COUPLINGS
GL COUPLINGS
C14 COUPLINGS
PCTS THERMOPLASTIC COUPLINGS
POLARSEAL COUPLINGS
POLARSEAL II COUPLINGS
POWER STEERING
ADAPTERS
QUICK DISCONNECT COUPLERS
BALL VALVES
LIVE SWIVEL
ASSEMBLY FABRICATION
ACCESSORIES
EQUIPMENT AND PARTS
AIR BRAKE
BRASS
KITS

Male SAE Tube O-Ring Nut - 45° Bent Tube - Aluminum

O-Ring not included. Must be ordered separately.

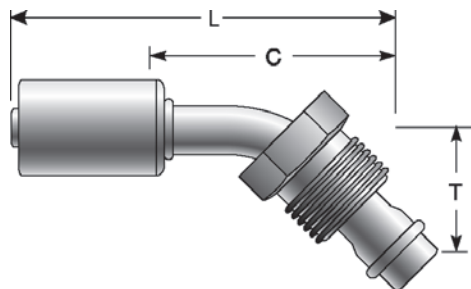

Part No.	Descr.	Prod. No.	⊖	🌀	T	L	C
			"	"			
G45584-0606	6ACA-6MTON45	7332-00475	5/16	5/8-18	.88	3.19	1.94
G45584-0608	6ACA-8MTON45	7332-03095	5/16	3/4-18	1.00	3.47	2.22
G45584-0806	8ACA-6MTON45	7332-03105	13/32	5/8-18	1.00	3.47	2.22
G45584-0808	8ACA-8MTON45	7332-00485	13/32	3/4-18	1.00	3.44	2.19
G45584-1010	10ACA-10MTON45	7332-00495	1/2	7/8-18	1.06	3.81	2.56
G45584-1212	12ACA-12MTON45	7332-00505	5/8	1 1/16-12	1.19	4.19	2.94

Male SAE Tube O-Ring Nut - 90° Bent Tube - Aluminum

O-Ring not included. Must be ordered separately.

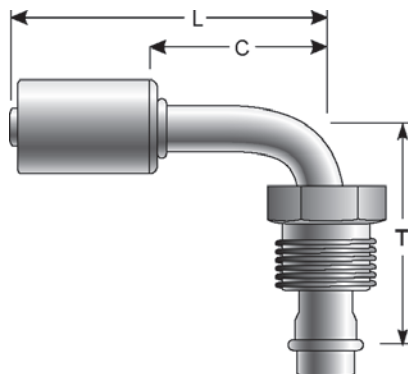

Part No.	Descr.	Prod. No.	⊖	🌀	T	L	C
			"	"			
G45585-0606	6ACA-6MTON90	7332-00515	5/16	5/8-18	1.63	2.56	1.31
G45585-0607	6ACA-7MTON90	7332-03115	5/16	11/16-16	1.56	2.56	1.31
G45585-0608	6ACA-8MTON90	7332-03125	5/16	3/4-18	1.88	2.75	1.50
G45585-0806	8ACA-6MTON90	7332-03135	13/32	5/8-18	1.88	2.75	1.50
G45585-0808	8ACA-8MTON90	7332-00525	13/32	3/4-18	1.88	2.75	1.50
G45585-1010	10ACA-10MTON90	7332-00535	1/2	7/8-18	2.12	3.00	1.75
G45585-1210	12ACA-10MTON90	7332-03145	5/8	7/8-18	2.25	3.25	2.00
G45585-1212	12ACA-12MTON90	7332-00545	5/8	1 1/16-12	2.25	3.25	2.00

Male SAE Tube O-Ring Nut - 90° Bent Tube - Steel

O-Ring not included. Must be ordered separately.

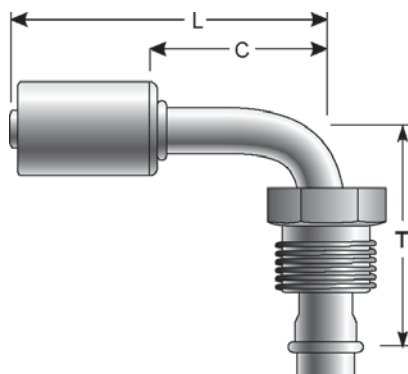

Part No.	Descr.	Prod. No.	⊖	🌀	T	L	C
			"	"	"	"	"
G45585-0606S	6 MOR/LP-6 SB-90-STL	7332-01295	5/16	5/8-18	1.63	2.56	1.31
G45585-1010S	10ACA-10MTON90-S	7332-01875	1/2	7/8-18	2.12	3.00	1.75

Female SAE Tube O-Ring Nut Swivel with R12 Service Port - Aluminum

O-Ring not included. Must be ordered separately.
 Service Ports: High Side: 6-8 Hose; 3/8" Schrader Valve
 Service Ports: Low Side: 10-12 Hose; 1/4" Schrader Valve

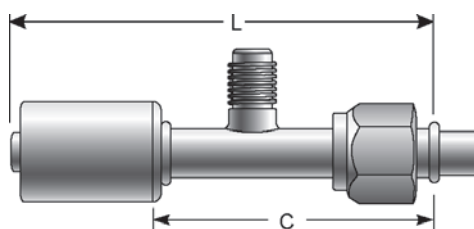

Part No.	Descr.	Prod. No.	⊖	🌀	L	C
			"	"	"	"
G45586-0606	6ACA-6FTONR12SP	7332-01985	5/16	5/8-18	3.38	2.13
G45586-0808	8ACA-8FTONR12SP	7332-01995	13/32	3/4-16	3.38	2.13
G45586-1010	10ACA-10FTONR12SP	7332-02005	1/2	7/8-14	3.62	2.37

- EQUIPMENT
- HOSE/CPLG. SELECTION
- G8K COUPLINGS
- GLOBALSPIRAL COUPLINGS
- STAINLESS STEEL SPIRAL
- MEGACRIMP COUPLINGS
- STAINLESS STEEL BRAID
- POWER CRIMP COUPLINGS
- FIELD ATTACHABLE G1 & G2 COUPLINGS
- FIELD ATTACHABLE C5 COUPLINGS
- GLX COUPLINGS
- GL COUPLINGS
- C14 COUPLINGS
- PCTS THERMOPLASTIC COUPLINGS
- POLARSEAL COUPLINGS**
- POLARSEAL II COUPLINGS
- POWER STEERING
- ADAPTERS
- QUICK DISCONNECT COUPLERS
- BALL VALVES
- LIVE SWIVEL
- ASSEMBLY FABRICATION
- ACCESSORIES
- EQUIPMENT AND PARTS
- AIR BRAKE
- BRASS
- KITS

Female SAE Tube O-Ring Nut Swivel with R12 Service Port - 90° Bent Tube - Aluminum

O-Ring not included. Must be ordered separately.

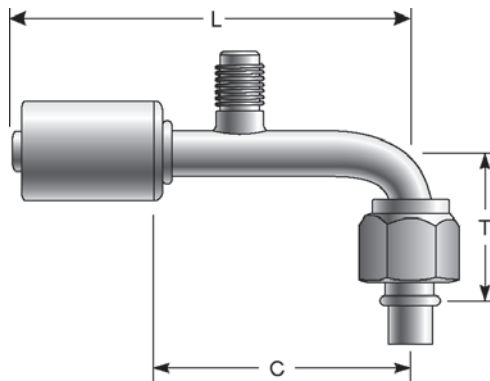

Part No.	Descr.	Prod. No.	⊖	🌀	T	L	C
			"	"			
G45587-0606	6ACA-6FTONR12SP90	7332-02015	5/16	5/8-18	1.12	3.62	2.37
G45587-0808	8ACA-8FTONR12SP90	7332-02025	13/32	3/4-16	1.31	3.62	2.37
G45587-1010	10ACA-10FTONR12SP90	7332-02035	1/2	7/8-14	1.50	3.88	2.63
G45587-1210	12ACA-10FTONR12SP90	7332-02045	5/8	7/8-14	1.75	4.19	2.94

Female SAE Tube O-Ring Nut Swivel with R134a Service Port - Aluminum

O-Ring not included. Must be ordered separately.

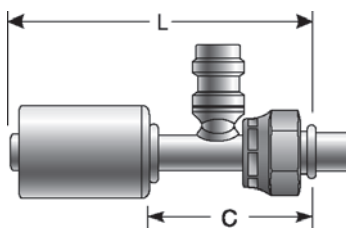

Part No.	Descr.	Prod. No.	⊖	🌀	L	C
			"	"		
G45588-0606	6ACA-6FTON134SP	7332-00555	5/16	5/8-18	3.30	2.05
G45588-0808	8ACA-8FTON134SP	7332-00565	13/32	3/4-16	3.38	2.13
G45588-1010	10ACA-10FTON134SP	7332-00575	1/2	7/8-14	3.62	2.37
G45588-1210	12ACA-10FTON134SP	7332-00585	5/8	7/8-14	3.75	2.50

Female SAE Tube O-Ring Nut Swivel with R134a Service Port - Steel

O-Ring not included. Must be ordered separately.

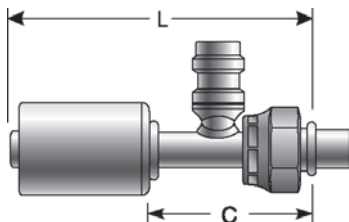

Part No.	Descr.	Prod. No.			L	C
			"	"		
G45588-0808S	8ACA-8FTON134SP-S	7332-02685	13/32	3/4-16	3.38	2.13
G45588-1010S	10ACA-10FTON134SP-S	7332-02695	1/2	7/8-14	3.62	2.37

Female SAE Tube O-Ring Nut Swivel with R134a Service Port - 90° Bent Tube - Aluminum

O-Ring not included. Must be ordered separately.

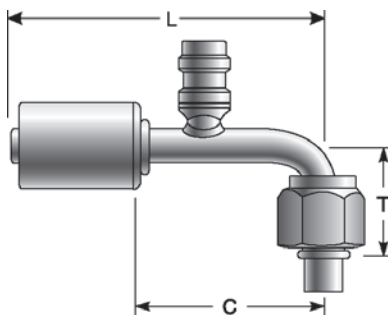

Part No.	Descr.	Prod. No.			T	L	C
			"	"			
G45589-0606	6ACA-6FTON134SP90	7332-00595	5/16	5/8-18	1.12	3.62	2.37
G45589-0808	8ACA-8FTON134SP90	7332-00605	13/32	3/4-16	1.31	3.62	2.37
G45589-1010	10ACA-10FTON134SP90	7332-00615	1/2	7/8-14	1.50	3.88	2.63
G45589-1210	12ACA-10FTON134SP90	7332-00625	5/8	7/8-14	1.75	4.19	2.94

- EQUIPMENT
- HOSE/CPLG. SELECTION
- G8K COUPLINGS
- GLOBALSPIRAL COUPLINGS
- STAINLESS STEEL SPIRAL
- MEGACRIMP COUPLINGS
- STAINLESS STEEL BRAID
- POWER CRIMP COUPLINGS
- FIELD ATTACHABLE G1 & G2 COUPLINGS
- FIELD ATTACHABLE C5 COUPLINGS
- GLX COUPLINGS
- GL COUPLINGS
- C14 COUPLINGS
- PCTS THERMOPLASTIC COUPLINGS
- POLARSEAL COUPLINGS**
- POLARSEAL II COUPLINGS
- POWER STEERING
- ADAPTERS
- QUICK DISCONNECT COUPLERS
- BALL VALVES
- LIVE SWIVEL
- ASSEMBLY FABRICATION
- ACCESSORIES
- EQUIPMENT AND PARTS
- AIR BRAKE
- BRASS
- KITS

Female SAE Tube O-Ring Nut Swivel with R134a Service Port - 90° Bent Tube - Steel

O-Ring not included. Must be ordered separately.

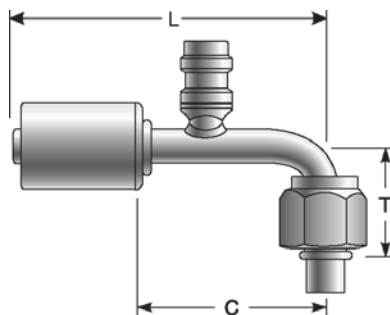

Part No.	Descr.	Prod. No.	⊖		T	L	C
			"	"	"	"	"
G45589-0606S	6ACA-6FTON134SP90-S	7332-02075	5/16	5/8-18	1.12	3.62	2.37
G45589-0808S	8ACA-8FTON134SP90-S	7332-01705	13/32	3/4-16	1.50	3.62	2.37
G45589-1010S	10ACA-10FTON134SP90-S	7332-01715	1/2	7/8-14	1.75	3.88	2.63
G45589-1210S	12ACA-10FTON134SP90-S	7332-02085	5/8	7/8-14	1.75	4.19	2.94

Female SAE Tube O-Ring Nut Swivel - Aluminum

O-Ring not included. Must be ordered separately.

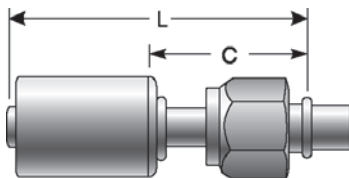

Part No.	Descr.	Prod. No.	⊖		L	C
			"	"	"	"
G45590-0605	6ACA-5FTON**	7332-00635	5/16	9/16-18	2.81	1.56
G45590-0606	6ACA-6FTON	7332-00645	5/16	5/8-18	2.88	1.63
G45590-0608	6ACA-8FTON	7332-00655	5/16	3/4-16	3.00	1.75
G45590-0806	8ACA-6FTON	7332-03165	13/32	5/8-18	3.00	1.75
G45590-0808	8ACA-8FTON	7332-00665	13/32	3/4-16	3.00	1.75
G45590-1008	10ACA-8FTON	7332-01505	1/2	3/4-16	3.19	1.94
G45590-1010	10ACA-10FTON	7332-00675	1/2	7/8-14	3.19	1.94
G45590-1012	10ACA-12FTON	7332-01515	1/2	1 1/16-14	3.31	2.06
G45590-1210	12ACA-10FTON	7332-00685	5/8	7/8-14	3.31	2.06
G45590-1212	12ACA-12FTON	7332-00695	5/8	1 1/16-14	3.31	2.06

*Standard and Metric Threads are equivalent for 6ACA-5FTON.

**Used on Toyota Receivers and Dryers.

Female SAE Tube O-Ring Nut Swivel - Steel

O-Ring not included. Must be ordered separately.

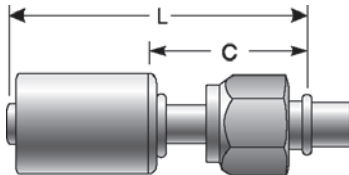

Part No.	Descr.	Prod. No.	⊖		L	C
			"	"		
G45590-0606S	6ACA-6FTON-S	7332-01275	5/16	5/8-18	2.88	1.63
G45590-0808S	8ACA-8FTON-S	7332-01645	13/32	3/4-16	3.00	1.75
G45590-1010S	10ACA-10FTON-S	7332-01655	1/2	7/8-14	3.19	1.94
G45590-1210S	12ACA-10FTON-S	7332-01815	5/8	7/8-14	3.31	2.06
G45590-1212S	12ACA-12FTON-S	7332-03175	5/8	1 1/16-14	3.31	2.06

Female SAE Tube O-Ring Nut Swivel - 45° Bent Tube - Aluminum

O-Ring not included. Must be ordered separately.

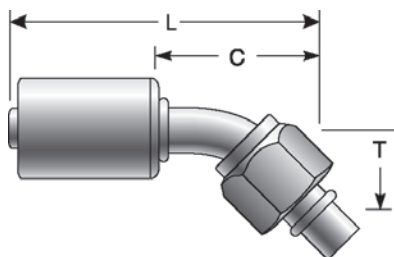

Part No.	Descr.	Prod. No.	⊖		T	L	C
			"	"			
G45591-0606	6ACA-6FTON45	7332-00705	5/16	5/8-18	.56	2.87	1.52
G45591-0806	8ACA-6FTON45	7332-03185	13/32	5/8-18	.63	3.04	1.79
G45591-0808	8ACA-8FTON45	7332-00715	13/32	3/4-16	.63	3.07	1.82
G45591-1008	10ACA-8FTON45	7332-03195	1/2	3/4-16	.88	3.60	2.35
G45591-1010	10ACA-10FTON45	7332-00725	1/2	7/8-14	.88	3.63	2.38
G45591-1210	12ACA-10FTON45	7332-03205	5/8	7/8-14	.94	3.91	2.66
G45591-1212	12ACA-12FTON45	7332-00735	5/8	1 1/16-14	.94	3.94	2.69

EQUIPMENT
HOSE/CPLG. SELECTION
G&K COUPLINGS
GLOBALSPIRAL COUPLINGS
STAINLESS STEEL SPIRAL
MEGACRIMP COUPLINGS
STAINLESS STEEL BRAID
POWER CRIMP COUPLINGS
FIELD ATTACHABLE G1 & G2 COUPLINGS
FIELD ATTACHABLE C5 COUPLINGS
GLX COUPLINGS
GL COUPLINGS
C14 COUPLINGS
PCTS THERMOPLASTIC COUPLINGS
POLARSEAL COUPLINGS
POLARSEAL II COUPLINGS
POWER STEERING
ADAPTERS
QUICK DISCONNECT COUPLERS
BALL VALVES
LIVE SWIVEL
ASSEMBLY FABRICATION
ACCESSORIES
EQUIPMENT AND PARTS
AIR BRAKE
BRASS
KITS

Female SAE Tube O-Ring Nut Swivel - 45° Bent Tube - Steel

O-Ring not included. Must be ordered separately.

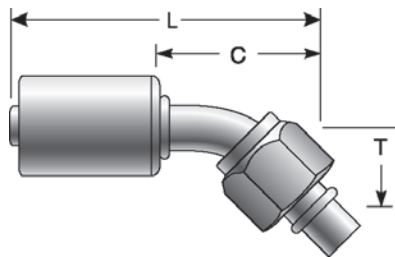

Part No.	Descr.	Prod. No.	⊖		T	L	C
			"	"	"	"	"
G45591-0606S	6ACA-6FTON45-S	7332-01665	5/16	5/8-18	.56	2.87	1.52
G45591-0808S	8ACA-8FTON45-S	7332-02055	13/32	3/4-16	.63	3.07	1.82
G45591-1010S	10ACA-10FTON45-S	7332-01675	1/2	7/8-14	.88	3.63	2.38

Female SAE Tube O-Ring Nut Swivel - 90° Bent Tube - Aluminum

O-Ring not included. Must be ordered separately.

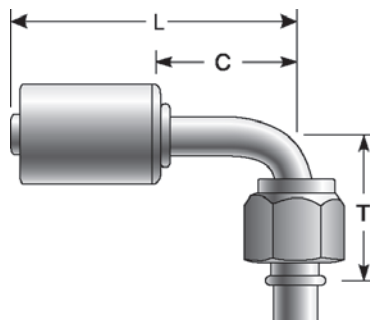

Part No.	Descr.	Prod. No.	⊖		T	L	C
			"	"	"	"	"
G45592-0605	6ACA-5FTON90*	7332-00745	5/16	9/16-18	1.12	2.75	1.63
G45592-0606	6ACA-6FTON90	7332-00755	5/16	5/8-18	1.12	2.56	1.31
G45592-0608	6ACA-8FTON90	7332-00765	5/16	3/4-16	1.31	2.75	1.50
G45592-0806	8ACA-6FTON90	7332-03155	13/32	5/8-18	1.31	2.75	1.50
G45592-0808	8ACA-8FTON90	7332-00775	13/32	3/4-16	1.31	2.75	1.50
G45592-1008	10ACA-8FTON90	7332-01545	1/2	3/4-16	1.50	3.00	1.75
G45592-1010	10ACA-10FTON90	7332-00785	1/2	7/8-14	1.50	3.00	1.75
G45592-1012	10ACA-12FTON90	7332-01555	1/2	1 1/16-14	1.75	3.25	2.00
G45592-1210	12ACA-10FTON90	7332-00795	5/8	7/8-14	1.75	3.25	2.00
G45592-1212	12ACA-12FTON90	7332-00805	5/8	1 1/16-14	1.75	3.25	2.00

*Used on Toyota Receivers and Dryers.

EQUIPMENT
HOSE/CPLG. SELECTION
G8K COUPLINGS
GLOBALSPIRAL COUPLINGS
STAINLESS STEEL SPIRAL
MEGACRIMP COUPLINGS
STAINLESS STEEL BRAID
POWER CRIMP COUPLINGS
FIELD ATTACHABLE G1 & G2 COUPLINGS
FIELD ATTACHABLE C5 COUPLINGS
GLX COUPLINGS
GL COUPLINGS
C14 COUPLINGS
PCTS THERMOPLASTIC COUPLINGS
POLARSEAL COUPLINGS
POLARSEAL II COUPLINGS
POWER STEERING
ADAPTERS
QUICK DISCONNECT COUPLERS
BALL VALVES
LIVE SWIVEL
ASSEMBLY FABRICATION
ACCESSORIES
EQUIPMENT AND PARTS
AIR BRAKE
BRASS
KITS

Female SAE Tube O-Ring Nut Swivel - 90° Bent Tube - Steel

O-Ring not included. Must be ordered separately.

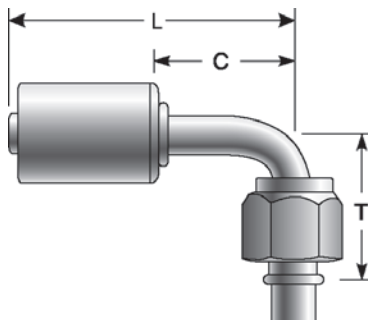

Part No.	Descr.	Prod. No.	⊖		T	L	C
			"	"			
G45592-0606S	6ACA-6FTON90-S	7332-01305	5/16	5/8-18	1.12	2.56	1.31
G45592-0808S	8ACA-8FTON90-S	7332-01685	13/32	3/4-16	1.31	2.75	1.50
G45592-1010S	10ACA-10FTON90-S	7332-01695	1/2	7/8-14	1.50	3.00	1.75
G45592-1210S	12ACA-10FTON90-S	7332-01825	5/8	7/8-14	1.50	3.25	2.00

Female SAE Tube O-Ring Metric Nut Swivel - Aluminum

O-Ring not included. Must be ordered separately.

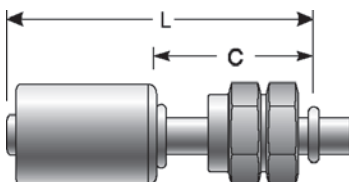

Part No.	Descr.	Prod. No.	⊖		L	C
			"	"		
G45593-0616	6ACA-16FTOMN	7332-00815	5/16	M16X1.5	2.81	1.56
G45593-0618	6ACA-18FTOMN	7332-03215	5/16	M18X1.5	2.87	1.62
G45593-0620	6ACA-20FTOMN	7332-03225	5/16	M20X1.5	2.94	1.69
G45593-0820	8ACA-20FTOMN	7332-03235	13/32	M20X1.5	2.94	1.69
G45593-1022	10ACA-22FTOMN	7332-00825	1/2	M22X1.5	3.19	1.94
G45593-1024	10ACA-24FTOMN	7332-00835	1/2	M24X2.0	3.19	1.94
G45593-1227	12ACA-27FTOMN	7332-00845	5/8	M27X2.0	3.31	2.06

EQUIPMENT
HOSE/CPLG. SELECTION
G&K COUPLINGS
GLOBALSPIRAL COUPLINGS
STAINLESS STEEL SPIRAL
MEGACRIMP COUPLINGS
STAINLESS STEEL BRAID
POWER CRIMP COUPLINGS
FIELD ATTACHABLE G1 & G2 COUPLINGS
FIELD ATTACHABLE C5 COUPLINGS
GLX COUPLINGS
GL COUPLINGS
C14 COUPLINGS
PCTS THERMOPLASTIC COUPLINGS
POLARSEAL COUPLINGS
POLARSEAL II COUPLINGS
POWER STEERING
ADAPTERS
QUICK DISCONNECT COUPLERS
BALL VALVES
LIVE SWIVEL
ASSEMBLY FABRICATION
ACCESSORIES
EQUIPMENT AND PARTS
AIR BRAKE
BRASS
KITS

EQUIPMENT
HOSE/CPLG. SELECTION
G8K COUPLINGS
GLOBALSPIRAL COUPLINGS
STAINLESS STEEL SPIRAL
MEGACRIMP COUPLINGS
STAINLESS STEEL BRAID
POWER CRIMP COUPLINGS
FIELD ATTACHABLE G1 & G2 COUPLINGS
FIELD ATTACHABLE C5 COUPLINGS
GLX COUPLINGS
GL COUPLINGS
C14 COUPLINGS
PCTS THERMOPLASTIC COUPLINGS
POLARSEAL COUPLINGS
POLARSEAL II COUPLINGS
POWER STEERING
ADAPTERS
QUICK DISCONNECT COUPLERS
BALL VALVES
LIVE SWIVEL
ASSEMBLY FABRICATION
ACCESSORIES
EQUIPMENT AND PARTS
AIR BRAKE
BRASS
KITS

Female SAE Tube O-Ring Metric Nut Swivel - 45° Bent Tube - Aluminum

O-Ring not included. Must be ordered separately.

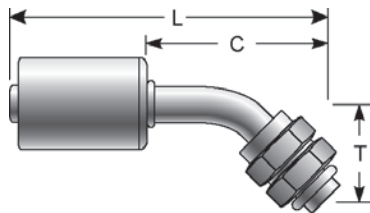

Part No.	Descr.	Prod. No.	⊖		T	L	C
			"	"	"	"	"
G45594-0614	6ACA-14FTOMN45	7332-03245	5/16	M14X1.5	.63	3.47	2.22
G45594-0616	6ACA-16FTOMN45	7332-03255	5/16	M16X1.5	.63	3.47	2.22
G45594-0618	6ACA-18FTOMN45	7332-03265	5/16	M18X1.5	.69	3.53	2.28
G45594-0620	6ACA-20FTOMN45	7332-03275	5/16	M20X1.5	.75	3.72	2.47
G45594-0820	8ACA-20FTOMN45	7332-03285	13/32	M20X1.5	.75	3.72	2.47
G45594-1022	10ACA-22FTOMN45	7332-03295	1/2	M22X1.5	.88	3.60	2.35
G45594-1024	10ACA-24FTOMN45	7332-03305	1/2	M24X2.0	.88	3.60	2.35
G45594-1227	12ACA-27FTOMN45	7332-03315	5/8	M27X2.0	1.00	4.59	3.34

Female SAE Tube O-Ring Metric Nut Swivel - 90° Bent Tube - Aluminum

O-Ring not included. Must be ordered separately.

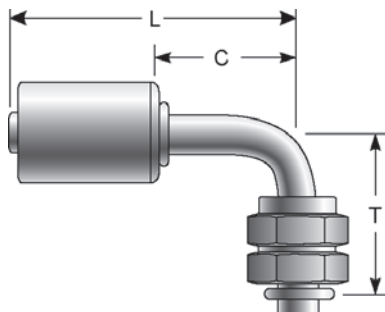

Part No.	Descr.	Prod. No.	⊖		T	L	C
			"	"	"	"	"
G45595-0616	6ACA-16FTOMN90	7332-00855	5/16	M16X1.5	1.12	2.75	1.50
G45595-0618	6ACA-18FTOMN90	7332-03325	5/16	M18X1.5	1.12	2.75	1.50
G45595-0620	6ACA-20FTOMN90	7332-03335	5/16	M20X1.5	1.25	2.75	1.50
G45595-0820	8ACA-20FTOMN90	7332-03345	13/32	M20X1.5	1.37	2.94	1.69
G45595-1022	10ACA-22FTOMN90	7332-00865	1/2	M22X1.5	1.63	3.13	1.88
G45595-1024	10ACA-24FTOMN90	7332-00875	1/2	M24X2.0	1.50	3.13	1.88
G45595-1227	12ACA-27FTOMN90	7332-00885	5/8	M27X2.0	1.75	3.38	2.13

Female SAE Tube O-Ring Nut Swivel - 90° Block - Steel

O-Ring not included. Must be ordered separately.

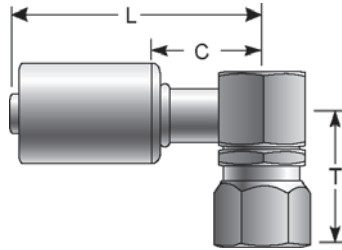

Part No.	Descr.	Prod. No.	⊖	🌀	T	L	C
			"	"	"	"	"
G45596-0808S	8ACA-8FTON90BL-S	7332-01835	13/32	3/4-16	.71	2.44	1.19
G45596-1010S	10ACA-10FTON90BL-S	7332-01845	1/2	7/8-14	.71	2.50	1.25
G45596-1210S	12ACA-10FTON90BL-S	7332-01855	5/8	7/8-14	.71	2.62	1.37

Male Inverted O-Ring - Aluminum

O-Ring not included. Must be ordered separately.

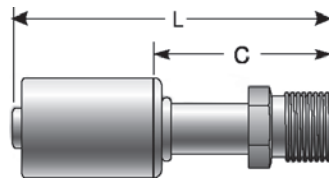

Part No.	Descr.	Prod. No.	⊖	🌀	L	C
			"	"	"	"
G45597-0606	6ACA-6MIO	7332-00895	5/16	5/8-18	2.94	1.69
G45597-0808	8ACA-8MIO	7332-00905	13/32	3/4-18	3.13	1.88
G45597-1010	10ACA-10MIO	7332-00915	1/2	7/8-14	3.62	2.37
G45597-1212	12ACA-12MIO	7332-00925	5/8	1 1/16-14	3.88	2.63

Male Inverted O-Ring - Steel

O-Ring not included. Must be ordered separately.

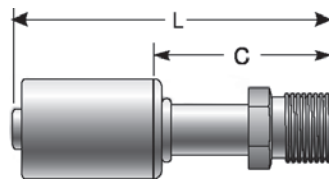

Part No.	Descr.	Prod. No.	⊖	🌀	L	C
			"	"	"	"
G45597-0606S	6ACA-6MIO-S	7332-01885	5/16	5/8-18	2.94	1.69
G45597-0808S	8ACA-8MIO-S	7332-01895	13/32	3/4-18	3.13	1.88
G45597-1010S	10ACA-10MIO-S	7332-03355	1/2	7/8-14	3.62	2.37

EQUIPMENT
HOSE/CPLG. SELECTION
G8K COUPLINGS
GLOBALSPIRAL COUPLINGS
STAINLESS STEEL SPIRAL
MEGACRIMP COUPLINGS
STAINLESS STEEL BRAID
POWER CRIMP COUPLINGS
FIELD ATTACHABLE G1 & G2 COUPLINGS
FIELD ATTACHABLE C5 COUPLINGS
GLX COUPLINGS
GL COUPLINGS
C14 COUPLINGS
PCTS THERMOPLASTIC COUPLINGS
POLARSEAL COUPLINGS
POLARSEAL II COUPLINGS
POWER STEERING
ADAPTERS
QUICK DISCONNECT COUPLERS
BALL VALVES
LIVE SWIVEL
ASSEMBLY FABRICATION
ACCESSORIES
EQUIPMENT AND PARTS
AIR BRAKE
BRASS
KITS

EQUIPMENT
HOSE/CPLG. SELECTION
G8K COUPLINGS
GLOBALSPIRAL COUPLINGS
STAINLESS STEEL SPIRAL
MEGACRIMP COUPLINGS
STAINLESS STEEL BRAID
POWER CRIMP COUPLINGS
FIELD ATTACHABLE G1 & G2 COUPLINGS
FIELD ATTACHABLE C5 COUPLINGS
GLX COUPLINGS
GL COUPLINGS
C14 COUPLINGS
PCTS THERMOPLASTIC COUPLINGS
POLARSEAL COUPLINGS
POLARSEAL II COUPLINGS
POWER STEERING
ADAPTERS
QUICK DISCONNECT COUPLERS
BALL VALVES
LIVE SWIVEL
ASSEMBLY FABRICATION
ACCESSORIES
EQUIPMENT AND PARTS
AIR BRAKE
BRASS
KITS

Male Inverted O-Ring - 45° Bent Tube - Aluminum

O-Ring not included. Must be ordered separately.

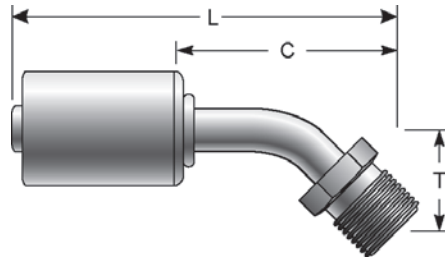

Part No.	Descr.	Prod. No.	⊖	🌀	T	L	C
			"	"	"	"	"
G45598-0606	6ACA-6MIO45	7332-03365	5/16	5/8-18	.75	3.03	1.78
G45598-0808	8ACA-8MIO45	7332-03375	13/32	3/4-18	1.00	3.41	2.16
G45598-1010	10ACA-10MIO45	7332-03385	1/2	7/8-14	1.25	3.97	2.72

Male Inverted O-Ring - 90° Bent Tube - Aluminum

O-Ring not included. Must be ordered separately.

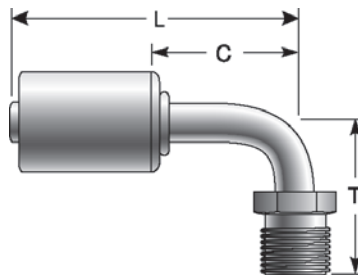

Part No.	Descr.	Prod. No.	⊖	🌀	T	L	C
			"	"	"	"	"
G45599-0606	6ACA-6MIO90	7332-00935	5/16	5/8-18	1.50	2.56	1.31
G45599-0808	8ACA-8MIO90	7332-00945	13/32	3/4-18	1.75	2.75	1.50
G45599-1010	10ACA-10MIO90	7332-00955	1/2	7/8-14	2.00	3.00	1.75

Male Inverted O-Ring Bulkhead - Aluminum

O-Ring not included. Must be ordered separately.

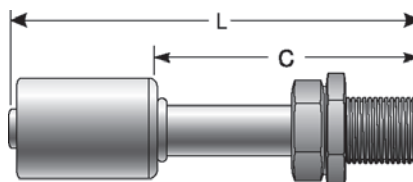

Part No.	Descr.	Prod. No.	⊖	🌀	L	C
			"	"	"	"
G45600-0606	6ACA-6MIOBKHD	7332-00965	5/16	5/8-18	4.00	2.75
G45600-0808	8ACA-8MIOBKHD	7332-00975	13/32	3/4-18	4.25	3.00

Male Inverted O-Ring Bulkhead - Aluminum - Continued

Part No.	Descr.	Prod. No.	⊖	🌀	L	C
			"	"	"	"
G45600-1010	10ACA-10MIOBKHD	7332-00985	1/2	7/8-14	4.44	3.19

Male Inverted O-Ring Bulkhead - 90° Bent Tube - Aluminum

O-Ring not included. Must be ordered separately.

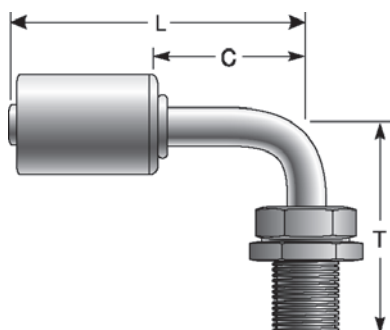

Part No.	Descr.	Prod. No.	⊖	🌀	T	L	C
			"	"	"	"	"
G45602-0606	6ACA-6MIOBKHD90	7332-00995	5/16	5/8-18	2.12	3.13	1.88
G45602-0808	8ACA-8MIOBKHD90	7332-01005	13/32	3/4-18	2.44	3.25	2.00
G45602-1010	10ACA-10MIOBKHD90	7332-01015	1/2	7/8-14	2.50	3.50	2.25

Female SAE Tube Dual O-Ring Nut - Aluminum

O-Ring not included. Must be ordered separately.

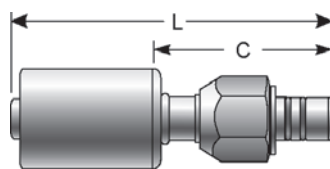

Part No.	Descr.	Prod. No.	⊖	🌀	L	C
			"	"	"	"
G45604-0808	8ACA-8FTDON	7332-03395	13/32	13/16-16	3.55	2.30
G45604-1010	10ACA-10FTDON	7332-03405	1/2	15/16-16	3.79	2.54
G45604-1212	12ACA-12FTDON	7332-03415	5/8	1 1/16-14	3.96	2.71

- EQUIPMENT
- HOSE/CPLG. SELECTION
- G8K COUPLINGS
- GLOBALSPIRAL COUPLINGS
- STAINLESS STEEL SPIRAL
- MEGACRIMP COUPLINGS
- STAINLESS STEEL BRAID
- POWER CRIMP COUPLINGS
- FIELD ATTACHABLE G1 & G2 COUPLINGS
- FIELD ATTACHABLE C5 COUPLINGS
- GLX COUPLINGS
- GL COUPLINGS
- C14 COUPLINGS
- PCTS THERMOPLASTIC COUPLINGS
- POLARSEAL COUPLINGS**
- POLARSEAL II COUPLINGS
- POWER STEERING
- ADAPTERS
- QUICK DISCONNECT COUPLERS
- BALL VALVES
- LIVE SWIVEL
- ASSEMBLY FABRICATION
- ACCESSORIES
- EQUIPMENT AND PARTS
- AIR BRAKE
- BRASS
- KITS

EQUIPMENT
HOSE/CPLG. SELECTION
G8K COUPLINGS
GLOBALSPIRAL COUPLINGS
STAINLESS STEEL SPIRAL
MEGACRIMP COUPLINGS
STAINLESS STEEL BRAID
POWER CRIMP COUPLINGS
FIELD ATTACHABLE G1 & G2 COUPLINGS
FIELD ATTACHABLE C5 COUPLINGS
GLX COUPLINGS
GL COUPLINGS
C14 COUPLINGS
PCTS THERMOPLASTIC COUPLINGS
POLARSEAL COUPLINGS
POLARSEAL II COUPLINGS
POWER STEERING
ADAPTERS
QUICK DISCONNECT COUPLERS
BALL VALVES
LIVE SWIVEL
ASSEMBLY FABRICATION
ACCESSORIES
EQUIPMENT AND PARTS
AIR BRAKE
BRASS
KITS

Female SAE Tube Dual O-Ring Nut - 45° Bent Tube - Aluminum

O-Ring not included. Must be ordered separately.

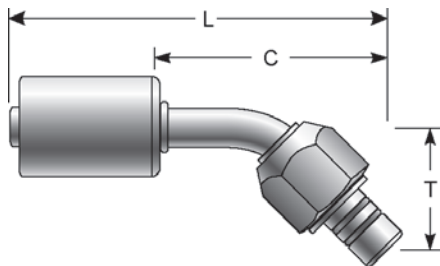

Part No.	Descr.	Prod. No.	⊖	🌀	T	L	C
			"	"	"	"	"
G45605-0808	8ACA-8FTDON45	7332-03425	13/32	13/16-16	1.02	3.43	2.18
G45605-1212	12ACA-12FTDON45	7332-03445	5/8	1 1/16-14	1.40	4.37	3.12

Female SAE Tube Dual O-Ring Nut - 90° Bent Tube - Aluminum

O-Ring not included. Must be ordered separately.

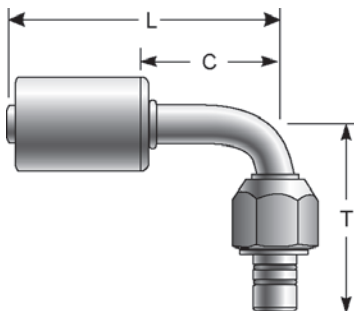

Part No.	Descr.	Prod. No.	⊖	🌀	T	L	C
			"	"	"	"	"
G45606-0808	8ACA-8FTDON90	7332-03455	13/32	13/16-16	1.86	2.75	1.50
G45606-1010	10ACA-10FTDON90	7332-03465	1/2	15/16-16	1.91	3.00	1.75
G45606-1212	12ACA-12FTDON90	7332-03475	5/8	1 1/16-14	2.40	3.25	2.00

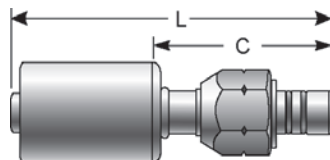

Female SAE Tube Dual O-Ring Metric Nut - Aluminum

O-Ring not included. Must be ordered separately.



Part No.	Descr.	Prod. No.	⊖	🌀	L	C
			"	"	"	"
G45607-0824	8ACA-24FTDOMN	7332-03485	13/32	M24X2.0	3.55	2.30
G45607-1024	10ACA-24FTDOMN	7332-03495	1/2	M24X2.0	3.79	2.54



Female SAE Tube Dual O-Ring Metric Nut - Aluminum - Continued

Part No.	Descr.	Prod. No.			L	C
			"	"		
G45607-1227	12ACA-27FTDOMN	7332-03505	5/8	M27X2.0	3.96	2.71

Female SAE Tube Dual O-Ring Metric Nut - 45° Bent Tube - Aluminum

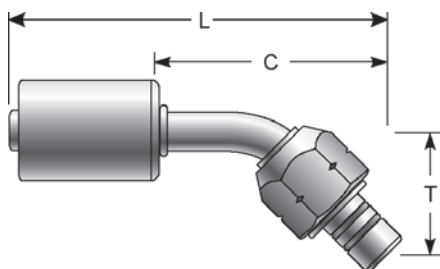
O-Ring not included. Must be ordered separately.





Part No.	Descr.	Prod. No.			T	L	C
			"	"			
G45608-0824	8ACA-24FTDOMN45	7332-03515	13/32	M24X2.0	1.02	3.43	2.18
G45608-1024	10ACA-24FTDOMN45	7332-03525	1/2	M24X2.0	1.30	4.02	2.77
G45608-1227	12ACA-27FTDOMN45	7332-03535	5/8	M27X2.0	1.40	4.37	3.12

Female SAE Tube Dual O-Ring Metric Nut - 90° Bent Tube - Aluminum

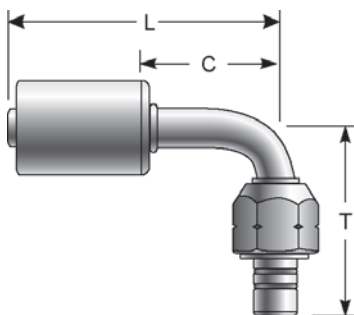
O-Ring not included. Must be ordered separately.



Part No.	Descr.	Prod. No.			T	L	C
			"	"			
G45609-0824	8ACA-24FTDOMN90	7332-03545	13/32	M24X2.0	1.86	2.75	1.50
G45609-1024	10ACA-24FTDOMN90	7332-03555	1/2	M24X2.0	1.91	3.00	1.75
G45609-1227	12ACA-27FTDOMN90	7332-03565	5/8	M27X2.0	2.40	3.25	2.00

- EQUIPMENT
- HOSE/CPLG. SELECTION
- G8K COUPLINGS
- GLOBALSPIRAL COUPLINGS
- STAINLESS STEEL SPIRAL
- MEGACRIMP COUPLINGS
- STAINLESS STEEL BRAID
- POWER CRIMP COUPLINGS
- FIELD ATTACHABLE G1 & G2 COUPLINGS
- FIELD ATTACHABLE C5 COUPLINGS
- GLX COUPLINGS
- GL COUPLINGS
- C14 COUPLINGS
- PCTS THERMOPLASTIC COUPLINGS
- POLARSEAL COUPLINGS**
- POLARSEAL II COUPLINGS
- POWER STEERING
- ADAPTERS
- QUICK DISCONNECT COUPLERS
- BALL VALVES
- LIVE SWIVEL
- ASSEMBLY FABRICATION
- ACCESSORIES
- EQUIPMENT AND PARTS
- AIR BRAKE
- BRASS
- KITS

EQUIPMENT
HOSE/CPLG. SELECTION
G8K COUPLINGS
GLOBALSPIRAL COUPLINGS
STAINLESS STEEL SPIRAL
MEGACRIMP COUPLINGS
STAINLESS STEEL BRAID
POWER CRIMP COUPLINGS
FIELD ATTACHABLE G1 & G2 COUPLINGS
FIELD ATTACHABLE C5 COUPLINGS
GLX COUPLINGS
GL COUPLINGS
C14 COUPLINGS
PCTS THERMOPLASTIC COUPLINGS
POLARSEAL COUPLINGS
POLARSEAL II COUPLINGS
POWER STEERING
ADAPTERS
QUICK DISCONNECT COUPLERS
BALL VALVES
LIVE SWIVEL
ASSEMBLY FABRICATION
ACCESSORIES
EQUIPMENT AND PARTS
AIR BRAKE
BRASS
KITS

Female SAE Tube O-Ring Nut - 180° Bent Tube - Aluminum

O-Ring not included. Must be ordered separately.

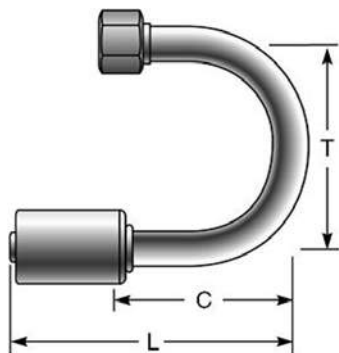

Part No.	Descr.	Prod. No.			T	L	C
			"	"			
G45610-0606	6ACA-6FTON180	7332-03575	5/16	5/8-18	1.63	3.50	2.25
G45610-0808	8ACA-8FTON180	7332-03585	13/32	3/4-18	1.75	3.50	2.25
G45610-1212	12ACA-12FTON180	7332-03595	5/8	1 1/16-14	2.12	4.50	3.25

Male Inverted O-Ring with R134a Service Port - Aluminum

O-Ring not included. Must be ordered separately.

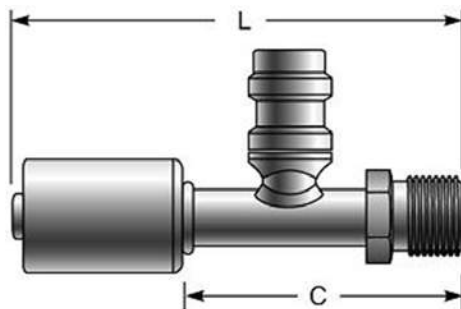

Part No.	Descr.	Prod. No.			L	C
			"	"		
G45611-0606	6ACA-6MIO134SP	7332-03605	5/16	5/8-18	3.47	2.22
G45611-0808	8ACA-8MIO134SP	7332-03615	13/32	3/4-18	4.22	2.97
G45611-1010	10ACA-10MIO134SP	7332-03625	1/2	7/8-14	4.22	2.97
G45611-1212	12ACA-12MIO134SP	7332-03635	5/8	1 1/16-14	4.47	3.22

Male Inverted O-Ring with R134a Service Port - 90° Bent Tube - Aluminum

O-Ring not included. Must be ordered separately.

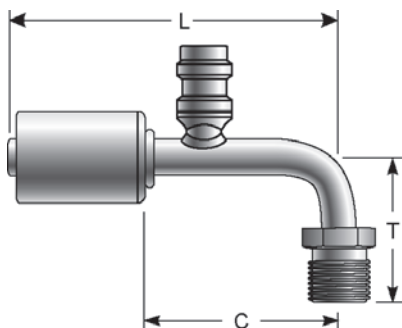

Part No.	Descr.	Prod. No.	⊖	🌀	T	L	C
			"	"	"	"	"
G45613-0606	6ACA-6MIO134SP90	7332-03645	5/16	5/8-18	1.50	3.59	2.34
G45613-0808	8ACA-8MIO134SP90	7332-03655	13/32	3/4-18	1.80	3.59	2.34
G45613-1010	10ACA-10MIO134SP90	7332-03665	1/2	7/8-14	2.00	3.85	2.60

Universal Tee O-Ring Splicer English Threads - Aluminum

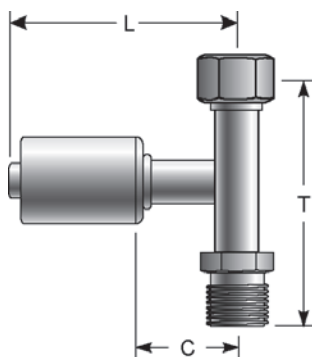

Part No.	Descr.	Prod. No.	⊖	🌀	T	L	C
			"	"	"	"	"
G45614-0606	6ACA-6TORSP	7332-03675	5/16	5/8-18	2.47	2.50	1.25
G45614-0608	6ACA-8TORSP	7332-03685	5/16	3/4-16	2.97	2.62	1.37
G45614-1010	10ACA-10TORSP	7332-03695	1/2	7/8-14	3.53	2.75	1.50
G45614-1012	10ACA-12TORSP	7332-03705	1/2	1 1/16-14	4.10	2.94	1.69

- EQUIPMENT
- HOSE/CPLG. SELECTION
- G8K COUPLINGS
- GLOBALSPIRAL COUPLINGS
- STAINLESS STEEL SPIRAL
- MEGACRIMP COUPLINGS
- STAINLESS STEEL BRAID
- POWER CRIMP COUPLINGS
- FIELD ATTACHABLE G1 & G2 COUPLINGS
- FIELD ATTACHABLE C5 COUPLINGS
- GLX COUPLINGS
- GL COUPLINGS
- C14 COUPLINGS
- PCTS THERMOPLASTIC COUPLINGS
- POLARSEAL COUPLINGS**
- POLARSEAL II COUPLINGS
- POWER STEERING
- ADAPTERS
- QUICK DISCONNECT COUPLERS
- BALL VALVES
- LIVE SWIVEL
- ASSEMBLY FABRICATION
- ACCESSORIES
- EQUIPMENT AND PARTS
- AIR BRAKE
- BRASS
- KITS

EQUIPMENT
HOSE/CPLG. SELECTION
G8K COUPLINGS
GLOBALSPIRAL COUPLINGS
STAINLESS STEEL SPIRAL
MEGACRIMP COUPLINGS
STAINLESS STEEL BRAID
POWER CRIMP COUPLINGS
FIELD ATTACHABLE G1 & G2 COUPLINGS
FIELD ATTACHABLE C5 COUPLINGS
GLX COUPLINGS
GL COUPLINGS
C14 COUPLINGS
PCTS THERMOPLASTIC COUPLINGS
POLARSEAL COUPLINGS
POLARSEAL II COUPLINGS
POWER STEERING
ADAPTERS
QUICK DISCONNECT COUPLERS
BALL VALVES
LIVE SWIVEL
ASSEMBLY FABRICATION
ACCESSORIES
EQUIPMENT AND PARTS
AIR BRAKE
BRASS
KITS

Female SAE Tube O-Ring Nut Swivel with R134a High Pressure Service Port - Aluminum

O-Ring not included. Must be ordered separately.

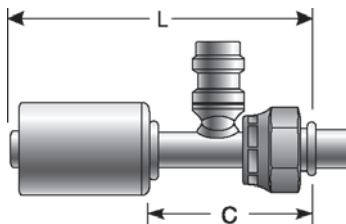

Part No.	Descr.	Prod. No.	⊖	🌀	L	C
			"	"	"	"
G45688-1010	10ACA-10FTON134SPH	7332-04245	1/2	7/8-14	3.62	2.37

Male Metric Flareless Assembly - Aluminum

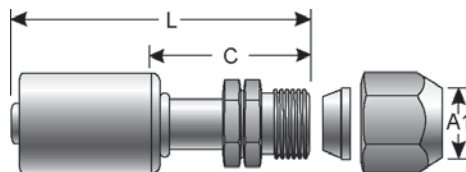

Part No.	Descr.	Prod. No.	⊖	🌀	A1	L	C
			"	"	mm	"	"
G45935-0608	6ACA-8MMFA	7332-01025	5/16	5/8-18	8.0	2.77	1.52
G45935-0812	8ACA-12MMFA	7332-01035	13/32	3/4-16	12.0	3.00	1.75
G45935-1015	10ACA-14.5MMFA	7332-01045	1/2	7/8-14	14.5	3.12	1.87

Female (Ford) Spring Lock Tee O-Ring Splicer - Aluminum

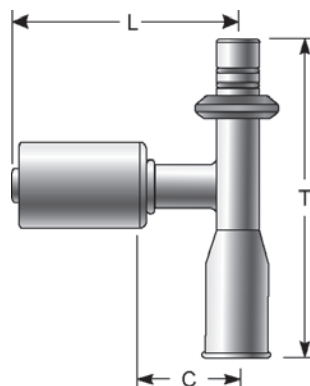

Part No.	Descr.	Prod. No.	⊖	T	L	C
			"	"	"	"
G45947-0608	6ACA-8FSLTORSP	7332-03735	5/16	1.72	5.13	3.88
G45947-1012	10ACA-12FSLTORSP	7332-03775	1/2	1.97	5.62	4.37

Female (Ford) Spring Lock Liquid Line Splicer - Aluminum

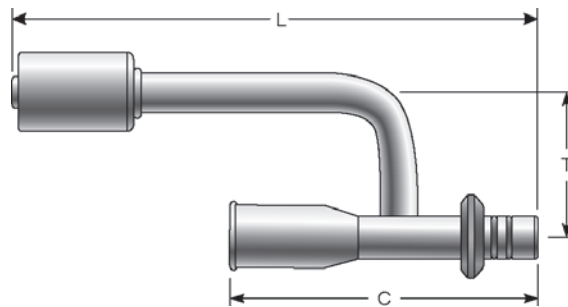

Part No.	Descr.	Prod. No.	⊖	T	L	C
			"	"	"	"
G45948-0608	6ACA-8FSLSP	7332-03715	5/16	1.75	5.13	3.88

Male (Ford) Spring Lock - 45° Bent Tube - Aluminum

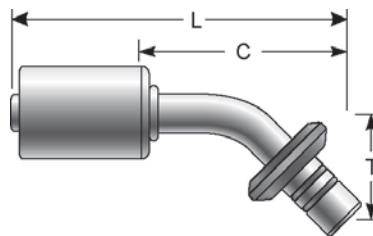

Part No.	Descr.	Prod. No.	⊖	T	L	C
			"	"	"	"
G45949-0606	6ACA-6MSL45	7332-03725	5/16	1.25	3.97	2.72
G45949-0608	6ACA-8MSL45	7332-03745	5/16	1.31	4.09	2.84
G45949-0808	8ACA-8MSL45	7332-03755	13/32	1.31	4.09	2.84
G45949-1010	10ACA-10MSL45	7332-03765	1/2	1.63	4.48	3.23
G45949-1210	12ACA-10MSL45	7332-03785	5/8	1.63	4.48	3.23
G45949-1212	12ACA-12MSL45	7332-03795	5/8	1.75	4.72	3.47

Male (Ford) Spring Lock - Aluminum

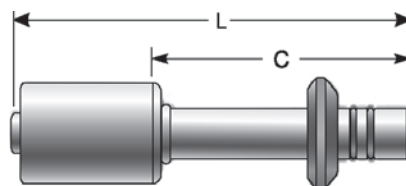

Part No.	Descr.	Prod. No.	⊖	L	C
			"	"	"
G45950-0606	6ACA-6MSL	7332-01055	5/16	3.81	2.56
G45950-0608	6ACA-8MSL	7332-01575	5/16	3.88	2.63
G45950-0808	8ACA-8MSL	7332-01065	13/32	3.88	2.63

- EQUIPMENT
- HOSE/CPLG. SELECTION
- G8K COUPLINGS
- GLOBALSPIRAL COUPLINGS
- STAINLESS STEEL SPIRAL
- MEGACRIMP COUPLINGS
- STAINLESS STEEL BRAID
- POWER CRIMP COUPLINGS
- FIELD ATTACHABLE G1 & G2 COUPLINGS
- FIELD ATTACHABLE C5 COUPLINGS
- GLX COUPLINGS
- GL COUPLINGS
- C14 COUPLINGS
- PCTS THERMOPLASTIC COUPLINGS
- POLARSEAL COUPLINGS**
- POLARSEAL II COUPLINGS
- POWER STEERING
- ADAPTERS
- QUICK DISCONNECT COUPLERS
- BALL VALVES
- LIVE SWIVEL
- ASSEMBLY FABRICATION
- ACCESSORIES
- EQUIPMENT AND PARTS
- AIR BRAKE
- BRASS
- KITS

EQUIPMENT
HOSE/CPLG. SELECTION
G8K COUPLINGS
GLOBALSPIRAL COUPLINGS
STAINLESS STEEL SPIRAL
MEGACRIMP COUPLINGS
STAINLESS STEEL BRAID
POWER CRIMP COUPLINGS
FIELD ATTACHABLE G1 & G2 COUPLINGS
FIELD ATTACHABLE C5 COUPLINGS
GLX COUPLINGS
GL COUPLINGS
C14 COUPLINGS
PCTS THERMOPLASTIC COUPLINGS
POLARSEAL COUPLINGS
POLARSEAL II COUPLINGS
POWER STEERING
ADAPTERS
QUICK DISCONNECT COUPLERS
BALL VALVES
LIVE SWIVEL
ASSEMBLY FABRICATION
ACCESSORIES
EQUIPMENT AND PARTS
AIR BRAKE
BRASS
KITS

Male (Ford) Spring Lock - Aluminum - Continued

Part No.	Descr.	Prod. No.	⊖	L	C
			"	"	"
G45950-1010	10ACA-10MSL	7332-01075	1/2	4.00	2.75
G45950-1210	12ACA-10MSL	7332-01585	5/8	4.00	2.75
G45950-1212	12ACA-12MSL	7332-01085	5/8	4.25	3.00

Male (Ford) Spring Lock - 90° Bent Tube - Aluminum

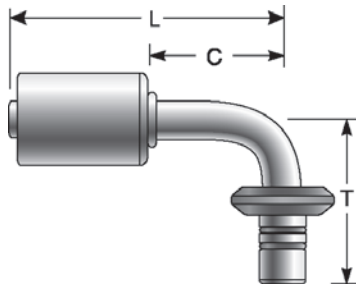

Part No.	Descr.	Prod. No.	⊖	T	L	C
			"	"	"	"
G45951-0606	6ACA-6MSL90	7332-02135	5/16	2.19	2.88	1.63
G45951-0608	6ACA-8MSL90	7332-02185	5/16	2.38	3.12	1.88
G45951-0808	8ACA-8MSL90	7332-02145	13/32	2.38	2.94	1.69
G45951-1010	10ACA-10MSL90	7332-02155	1/2	2.50	1.95	1.89
G45951-1210	12ACA-10MSL90	7332-02175	5/8	2.50	3.13	1.89
G45951-1212	12ACA-12MSL90	7332-02165	5/8	2.38	3.69	2.44

Female (Ford) Spring Lock - Aluminum

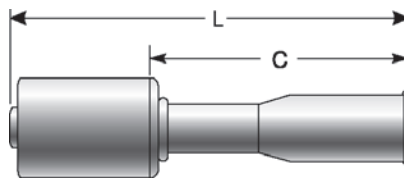

Part No.	Descr.	Prod. No.	⊖	L	C
			"	"	"
G45952-0606	6ACA-6FSL	7332-01095	5/16	3.81	2.56
G45952-0608	6ACA-8FSL	7332-01595	5/16	3.85	2.59
G45952-0808	8ACA-8FSL	7332-01105	13/32	3.88	2.63
G45952-1010	10ACA-10FSL	7332-01115	1/2	4.13	2.88
G45952-1210	12ACA-10FSL	7332-01605	5/8	4.28	3.10
G45952-1212	12ACA-12FSL	7332-01125	5/8	4.25	3.00

Female (Ford) Spring Lock - 90° Bent Tube - Aluminum

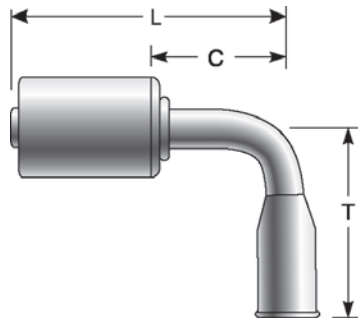

Part No.	Descr.	Prod. No.	⊖	T	L	C
			"			
G45953-0606	6ACA-6FSL90	7332-02195	5/16	2.19	2.88	1.63
G45953-0608	6ACA-8FSL90	7332-02245	5/16	2.38	3.12	1.88
G45953-0808	8ACA-8FSL90	7332-02205	13/32	2.38	2.94	1.69
G45953-1010	10ACA-10FSL90	7332-02215	1/2	2.50	3.13	1.89
G45953-1210	12ACA-10FSL90	7332-02235	5/8	2.50	3.13	1.89
G45953-1212	12ACA-12FSL90	7332-02225	5/8	3.20	3.69	2.44

Hose Splicer with R12 Thread Service Port - Aluminum

Service Ports: High Side; 6-8 Hose; 3/8" Schrader Valve
 Service Ports: Low Side; 10-12 Hose; 1/4" Schrader Valve

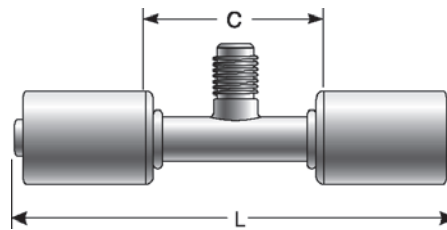

Part No.	Descr.	Prod. No.	⊖	L	C
			"		
G45954-0606	6ACA-R12SP	7332-01135	5/16	4.50	2.00
G45954-0808	8ACA-R12SP	7332-01145	13/32	4.50	2.00
G45954-1010	10ACA-R12SP	7332-01155	1/2	4.63	2.13
G45954-1212	12ACA-R12SP	7332-01165	5/8	4.75	2.25

EQUIPMENT
HOSE/CPLG. SELECTION
G8K COUPLINGS
GLOBALSPIRAL COUPLINGS
STAINLESS STEEL SPIRAL
MEGACRIMP COUPLINGS
STAINLESS STEEL BRAID
POWER CRIMP COUPLINGS
FIELD ATTACHABLE G1 & G2 COUPLINGS
FIELD ATTACHABLE C5 COUPLINGS
GLX COUPLINGS
GL COUPLINGS
C14 COUPLINGS
PCTS THERMOPLASTIC COUPLINGS
POLARSEAL COUPLINGS
POLARSEAL II COUPLINGS
POWER STEERING
ADAPTERS
QUICK DISCONNECT COUPLERS
BALL VALVES
LIVE SWIVEL
ASSEMBLY FABRICATION
ACCESSORIES
EQUIPMENT AND PARTS
AIR BRAKE
BRASS
KITS

Female (Ford) Spring Lock - 45° Bent Tube - Aluminum

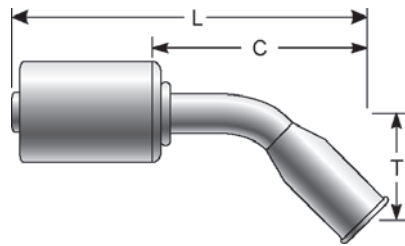

Part No.	Descr.	Prod. No.	⊘	T	L	C
			"			
G45955-0606	6ACA-6FSL45	7332-03805	5/16	1.31	4.03	2.78
G45955-0608	6ACA-8FSL45	7332-03815	5/16	1.37	4.15	2.90
G45955-0808	8ACA-8FSL45	7332-03825	13/32	1.37	4.15	2.90
G45955-1010	10ACA-10FSL45	7332-03835	1/2	1.69	4.54	3.29
G45955-1210	12ACA-10FSL45	7332-03845	5/8	1.75	4.60	3.35
G45955-1212	12ACA-12FSL45	7332-03855	5/8	1.75	4.72	3.47

Hose Splicer with R134a Service Port - Aluminum

Service Ports: High Side; 6–8 Hose; 3/8" Schrader Valve
 Service Ports: Low Side; 10–12 Hose; 1/4" Schrader Valve

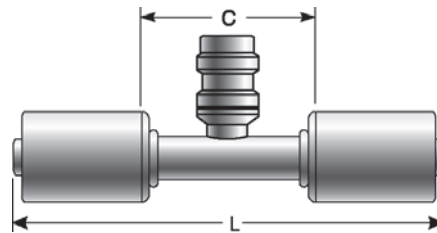

Part No.	Descr.	Prod. No.	⊘	L	C
			"		
G45956-0606	6ACA-R134SP	7332-01175	5/16	4.50	2.00
G45956-0808	8ACA-R134SP	7332-01185	13/32	4.50	2.00
G45956-1010	10ACA-R134SP	7332-01195	1/2	4.63	2.13
G45956-1212	12ACA-R134SP	7332-01205	5/8	4.75	2.25

Hose Splicer with R134a Service Port - Steel

Pressure Ports: High Side; 6-8 Hose
 Pressure Ports: Low Side; 10-12 Hose

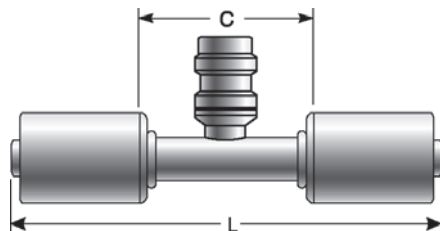

Part No.	Descr.	Prod. No.		L	C
			"		
G45956-0606S	6ACA-R134SP-S	7332-01955	5/16	4.50	2.00
G45956-0808S	8ACA-R134SP-S	7332-01965	13/32	4.50	2.00
G45956-1010S	10ACA-R134SP-S	7332-01975	1/2	4.63	2.13
G45956-1212S	12ACA-R134SP-S	7332-03005	5/8	4.75	2.25

Female Rotalok (Compressor Connection) with R134a Service Port - 90° Block - Aluminum

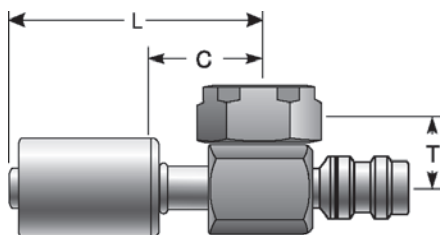

Part No.	Descr.	Prod. No.			T	L	C
			"	"			
G45957-0816	8ACA-R134SP-RL	7332-01215	13/32	1-14	.78	2.45	1.20
G45957-1016	10ACA-R134SP-RL	7332-01225	1/2	1-14	.78	2.51	1.26

- EQUIPMENT
- HOSE/CPLG. SELECTION
- G8K COUPLINGS
- GLOBALSPIRAL COUPLINGS
- STAINLESS STEEL SPIRAL
- MEGACRIMP COUPLINGS
- STAINLESS STEEL BRAID
- POWER CRIMP COUPLINGS
- FIELD ATTACHABLE G1 & G2 COUPLINGS
- FIELD ATTACHABLE C5 COUPLINGS
- GLX COUPLINGS
- GL COUPLINGS
- C14 COUPLINGS
- PCTS THERMOPLASTIC COUPLINGS
- POLARSEAL COUPLINGS**
- POLARSEAL II COUPLINGS
- POWER STEERING
- ADAPTERS
- QUICK DISCONNECT COUPLERS
- BALL VALVES
- LIVE SWIVEL
- ASSEMBLY FABRICATION
- ACCESSORIES
- EQUIPMENT AND PARTS
- AIR BRAKE
- BRASS
- KITS

EQUIPMENT
HOSE/CPLG. SELECTION
G8K COUPLINGS
GLOBALSPIRAL COUPLINGS
STAINLESS STEEL SPIRAL
MEGACRIMP COUPLINGS
STAINLESS STEEL BRAID
POWER CRIMP COUPLINGS
FIELD ATTACHABLE G1 & G2 COUPLINGS
FIELD ATTACHABLE C5 COUPLINGS
GLX COUPLINGS
GL COUPLINGS
C14 COUPLINGS
PCTS THERMOPLASTIC COUPLINGS
POLARSEAL COUPLINGS
POLARSEAL II COUPLINGS
POWER STEERING
ADAPTERS
QUICK DISCONNECT COUPLERS
BALL VALVES
LIVE SWIVEL
ASSEMBLY FABRICATION
ACCESSORIES
EQUIPMENT AND PARTS
AIR BRAKE
BRASS
KITS

Compressor Female SAE Tube O-Ring Nut Swivel - 90° Bent Tube - Steel

O-Ring not included. Must be ordered separately.

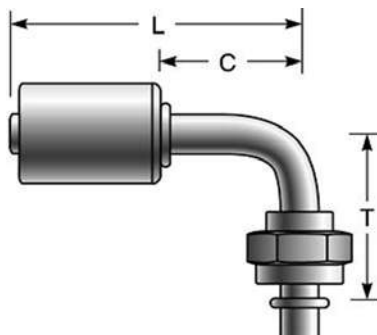

Part No.	Descr.	Prod. No.	⊘	🌀	T	L	C
			"	"	"	"	"
G45958-0810S	8ACA-10CFTON90-S	7332-02335	13/32	1-14	1.50	3.01	1.42
G45958-1210S	12ACA-10CFTON90-S	7332-02065	5/8	1-14	1.63	3.18	1.60

Compressor Female SAE Tube O-Ring Nut Swivel - 90° Block - Steel

O-Ring not included. Must be ordered separately.

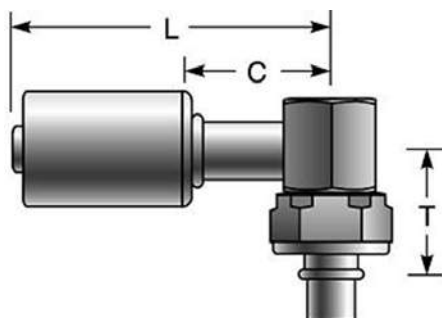

Part No.	Descr.	Prod. No.	⊘	🌀	T	L	C
			"	"	"	"	"
G45959-0810S	8ACA-10CFTON90BL-S	7332-02095	13/32	1-14	.80	3.02	1.43
G45959-1210S	12ACA-10CFTON90BL-S	7332-02105	5/8	1-14	.80	3.14	1.55

Compressor Female Tube O-Ring Nut with 134a Service Port - 90° Block - Steel

O-Ring not included. Must be ordered separately.

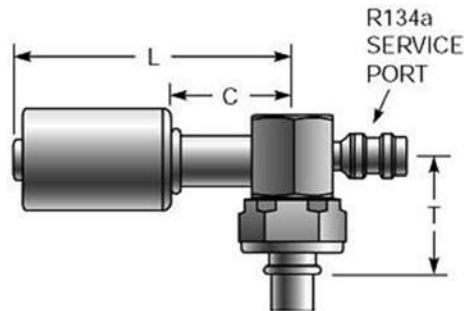

Part No.	Descr.	Prod. No.	⊖	🌀	T	L	C
			"	"	"	"	"
G45960-0810S	8ACA-10CFTON134SP90BL-S	7332-03865	13/32	1-14	.78	2.45	1.20
G45960-1010S	10ACA-10CFTON134SP90BL-S	7332-03875	1/2	1-14	.78	2.51	1.26
G45960-1210S	12ACA-10CFTON134SP90BL-S	7332-02755	5/8	1-14	.78	2.67	1.42

Compressor Block - Single w/Switch or Service Port - 90° Bent Tube - Aluminum

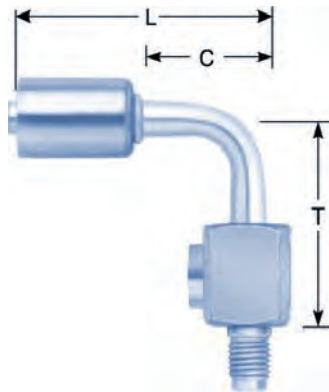

Part No.	Descr.	Prod. No.	⊖	🌀	T	L	C
			"	"	"	"	"
G45961-0808	8ACA-8CBSR12SP90	7332-03935	13/32	3/4-16	1.31	3.62	2.37
G45961-1008	10ACA-8CBSR12SP90	7332-03945	1/2	3/4-16	1.31	3.88	2.63
G45961-1208	12ACA-8CBSR12SP90	7332-03955	5/8	3/4-16	1.31	4.17	2.94

EQUIPMENT
HOSE/CPLG. SELECTION
G8K COUPLINGS
GLOBALSPIRAL COUPLINGS
STAINLESS STEEL SPIRAL
MEGACRIMP COUPLINGS
STAINLESS STEEL BRAID
POWER CRIMP COUPLINGS
FIELD ATTACHABLE G1 & G2 COUPLINGS
FIELD ATTACHABLE C5 COUPLINGS
GLX COUPLINGS
GL COUPLINGS
C14 COUPLINGS
PCTS THERMOPLASTIC COUPLINGS
POLARSEAL COUPLINGS
POLARSEAL II COUPLINGS
POWER STEERING
ADAPTERS
QUICK DISCONNECT COUPLERS
BALL VALVES
LIVE SWIVEL
ASSEMBLY FABRICATION
ACCESSORIES
EQUIPMENT AND PARTS
AIR BRAKE
BRASS
KITS

Compressor Block - Single Reverse w/Switch or Service Port - 90° Bent Tube - Aluminum

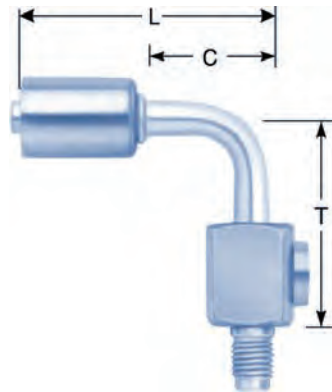

Part No.	Descr.	Prod. No.			T	L	C
			"	"	"	"	"
G45962-0808	8ACA-8CBSRR12SP90	7332-03965	13/32	3/4-16	1.31	3.62	2.37
G45962-1008	10ACA-8CBSRR12SP90	7332-03975	1/2	3/4-16	1.31	3.88	2.63
G45962-1208	12ACA-8CBSRR12SP90	7332-03985	5/8	3/4-16	1.31	4.17	2.94

R12 Ferrules



Part No.	Descr.	Prod. No.
83930	6PCACF	7334-71305
83931	8PCACF	7334-71315
83932	10PCACF	7334-71325
83933	12PCACF	7334-71335

Inline Orifice Tube

Description: The orifice tube is found on an accumulator air conditioning system. It is the dividing point between high and low pressure sides of the refrigeration system. The orifice tube filters and restricts high-pressure refrigerant in the liquid line and meters refrigerant flow as a low-pressure liquid. It is located in the refrigerant line between the condenser outlet and the evaporator inlet. The tube should be replaced any time the air conditioning system is opened for service.





Part No.	Descr.	Prod. No.		L	
			"	"	mm
G46011-0057	IOT-ORANGE	7332-02795	.057	3.50	88.9
G46011-0062	IOT-RED	7332-02805	.062	3.50	88.9

Inline Orifice Tube - Continued

Part No.	Descr.	Prod. No.		L	
			"	"	mm
G46010-0072	IOT-WHITE	7332-02775	.072	3.50	88.9
G46011-0072	IOT-BLUE	7332-02785	.072	3.50	88.9
G46010-1072	IOT-BLACK	7332-02815	.072	3.50	88.9

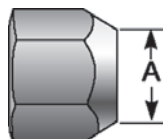
Female Flareless Nut - Aluminum



Part No.	Descr.	Prod. No.		A1
			"	"
G46050-0006	6ACFFN	7332-04135	5/8-18	3/8
G46050-0008	8ACFFN	7332-04145	3/4-16	1/2
G46050-0010	10ACFFN	7332-04155	7/8-14	5/8
G46050-0012	12ACFFN	7332-04165	1 1/16-14	3/4

Female Flareless Sleeve

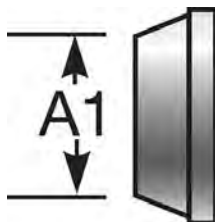

Part No.	Descr.	Prod. No.	A1
			"
G46051-0006	6ACFFS	7332-04175	3/8
G46051-0008	8ACFFS	7332-04185	1/2
G46051-0010	10ACFFS	7332-04195	5/8
G46051-0012	12ACFFS	7332-04205	3/4

- EQUIPMENT
- HOSE/CPLG. SELECTION
- G8K COUPLINGS
- GLOBAL SPIRAL COUPLINGS
- STAINLESS STEEL SPIRAL
- MEGACRIMP COUPLINGS
- STAINLESS STEEL BRAID
- POWER CRIMP COUPLINGS
- FIELD ATTACHABLE G1 & G2 COUPLINGS
- FIELD ATTACHABLE C5 COUPLINGS
- GLX COUPLINGS
- GL COUPLINGS
- C14 COUPLINGS
- PCTS THERMOPLASTIC COUPLINGS
- POLARSEAL COUPLINGS**
- POLARSEAL II COUPLINGS
- POWER STEERING
- ADAPTERS
- QUICK DISCONNECT COUPLERS
- BALL VALVES
- LIVE SWIVEL
- ASSEMBLY FABRICATION
- ACCESSORIES
- EQUIPMENT AND PARTS
- AIR BRAKE
- BRASS
- KITS

EQUIPMENT
HOSE/CPLG. SELECTION
G8K COUPLINGS
GLOBALSPIRAL COUPLINGS
STAINLESS STEEL SPIRAL
MEGACRIMP COUPLINGS
STAINLESS STEEL BRAID
POWER CRIMP COUPLINGS
FIELD ATTACHABLE G1 & G2 COUPLINGS
FIELD ATTACHABLE C5 COUPLINGS
GLX COUPLINGS
GL COUPLINGS
C14 COUPLINGS
PCTS THERMOPLASTIC COUPLINGS
POLARSEAL COUPLINGS
POLARSEAL II COUPLINGS
POWER STEERING
ADAPTERS
QUICK DISCONNECT COUPLERS
BALL VALVES
LIVE SWIVEL
ASSEMBLY FABRICATION
ACCESSORIES
EQUIPMENT AND PARTS
AIR BRAKE
BRASS
KITS

Metric Female Flareless Sleeve



Part No.	Descr.	Prod. No.	
			mm
G46052-0008	8ACMFFS	7332-04215	8
G46052-0012	12ACMFFS	7332-04225	12
G46052-0014	14.5ACMFFS	7332-04235	14.5

Accumulator/Compressor Sealing Washer



Part No.	Descr.	Prod. No.	
			"
G46091-0010	10CPWTN	7332-04015	5/8
G46092-0010	10CPWTK	7332-04035	5/8
G46090-0012	12ACMW	7332-04005	3/4
G46091-0012	12CPWTN	7332-04025	3/4

Valve Core

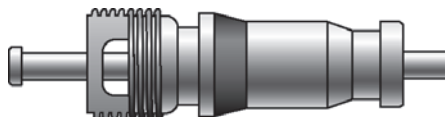

Part No.	Descr.	Prod. No.	
			"
G46093-0000	.210VC	7332-04045	.210x36

Valve Cap for R12 Service Port

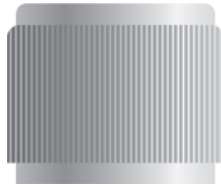

Part No.	Descr.	Prod. No.	
			"
G46094-0004	4R12CAP	7332-04055	7/16-20

Red High Side Cap R134a Port

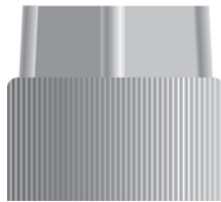

Part No.	Descr.	Prod. No.	
			"
G46095-0008	8HS134CAP	7332-04115	8

Blue Low Side Cap R134a Port

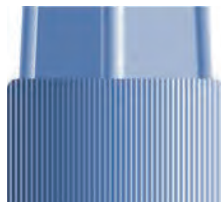

Part No.	Descr.	Prod. No.	
			"
G46096-0008	8LS134CAP	7332-04125	8

EQUIPMENT
HOSE/CPLG. SELECTION
G&K COUPLINGS
GLOBALSPIRAL COUPLINGS
STAINLESS STEEL SPIRAL
MEGACRIMP COUPLINGS
STAINLESS STEEL BRAID
POWER CRIMP COUPLINGS
FIELD ATTACHABLE G1 & G2 COUPLINGS
FIELD ATTACHABLE C5 COUPLINGS
GLX COUPLINGS
GL COUPLINGS
C14 COUPLINGS
PCTS THERMOPLASTIC COUPLINGS
POLARSEAL COUPLINGS
POLARSEAL II COUPLINGS
POWER STEERING
ADAPTERS
QUICK DISCONNECT COUPLERS
BALL VALVES
LIVE SWIVEL
ASSEMBLY FABRICATION
ACCESSORIES
EQUIPMENT AND PARTS
AIR BRAKE
BRASS
KITS

EQUIPMENT
HOSE/CPLG. SELECTION
G8K COUPLINGS
GLOBALSPIRAL COUPLINGS
STAINLESS STEEL SPIRAL
MEGACRIMP COUPLINGS
STAINLESS STEEL BRAID
POWER CRIMP COUPLINGS
FIELD ATTACHABLE G1 & G2 COUPLINGS
FIELD ATTACHABLE C5 COUPLINGS
GLX COUPLINGS
GL COUPLINGS
C14 COUPLINGS
PCTS THERMOPLASTIC COUPLINGS
POLARSEAL COUPLINGS
POLARSEAL II COUPLINGS
POWER STEERING
ADAPTERS
QUICK DISCONNECT COUPLERS
BALL VALVES
LIVE SWIVEL
ASSEMBLY FABRICATION
ACCESSORIES
EQUIPMENT AND PARTS
AIR BRAKE
BRASS
KITS

O-Ring for Switch



Part No.	Descr.	Prod. No.	
G46097-0006	6SWOR	7332-04065	3/8

O-Rings for PolarSeal® Couplings



Part No.	Descr.	Prod. No.	Inside Diameter	W Wall Thickness
			"	"
G46098-0006	6ACOR	7332-01235	.30	.07
G46098-0008	8ACOR	7332-01245	.43	.07
G46098-0010	10ACOR	7332-01255	.55	.07
G46098-0012	12ACOR	7332-01265	.68	.07

O-Ring for Ford Spring Lock



Part No.	Descr.	Prod. No.	
G46099-0006	6FSLOR	7332-04075	3/8
G46099-0008	8FSLOR	7332-04085	1/2
G46099-0010	10FSLOR	7332-04095	5/8

O-Ring for Ford Spring Lock - Continued

Part No.	Descr.	Prod. No.	
			"
G46099-0012	12FSLOR	7332-04105	3/4

EQUIPMENT
HOSE/CPLG. SELECTION
G&K COUPLINGS
GLOBAL SPIRAL COUPLINGS
STAINLESS STEEL SPIRAL
MEGACRIMP COUPLINGS
STAINLESS STEEL BRAID
POWER CRIMP COUPLINGS
FIELD ATTACHABLE G1 & G2 COUPLINGS
FIELD ATTACHABLE C5 COUPLINGS
GLX COUPLINGS
GL COUPLINGS
C14 COUPLINGS
PCTS THERMOPLASTIC COUPLINGS
POLARSEAL COUPLINGS
POLARSEAL II COUPLINGS
POWER STEERING
ADAPTERS
QUICK DISCONNECT COUPLERS
BALL VALVES
LIVE SWIVEL
ASSEMBLY FABRICATION
ACCESSORIES
EQUIPMENT AND PARTS
AIR BRAKE
BRASS
KITS

NOTES

EQUIPMENT
HOSE/CPLG. SELECTION
G8K COUPLINGS
GLOBALSPIRAL COUPLINGS
STAINLESS STEEL SPIRAL
MEGACRIMP COUPLINGS
STAINLESS STEEL BRAID
POWER CRIMP COUPLINGS
FIELD ATTACHABLE G1 & G2 COUPLINGS
FIELD ATTACHABLE C5 COUPLINGS
GLX COUPLINGS
GL COUPLINGS
C14 COUPLINGS
PCTS THERMOPLASTIC COUPLINGS
POLARSEAL COUPLINGS
POLARSEAL II COUPLINGS
POWER STEERING
ADAPTERS
QUICK DISCONNECT COUPLERS
BALL VALVES
LIVE SWIVEL
ASSEMBLY FABRICATION
ACCESSORIES
EQUIPMENT AND PARTS
AIR BRAKE
BRASS
KITS

Hydraulic Hose For PolarSeal® II Couplings

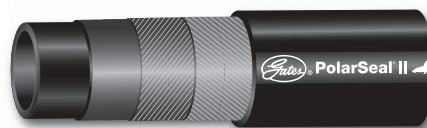

The Gates eCrimp program is a web based utility which allows users and distributors of Gates hydraulic and industrial hose products to find and print the most up to date crimp specifications with nothing more than an internet browser.

This program can be used to find crimp data for the MobileCrimp 4-20, PC 707, SC32, PC 3000B, GC32-XD™ Global Hose Crimper, GC96 and Omni Crimp 21. Custom result may be printed by selecting the crimper, hose and coupling. Optionally results may also be limited by die set and working pressure.



The eCrimp mobile app gives you all the same features of the online version in the palm of your hands. Use the app to find the most up-to-date crimp specifications quickly and easily. It is available for download for the iPhone and iPad from the App Store.

EQUIPMENT
HOSE/CPLG. SELECTION
G&K COUPLINGS
GLOBAL SPIRAL COUPLINGS
STAINLESS STEEL SPIRAL
MEGACRIMP COUPLINGS
STAINLESS STEEL BRAID
POWER CRIMP COUPLINGS
FIELD ATTACHABLE G1 & G2 COUPLINGS
FIELD ATTACHABLE C5 COUPLINGS
GLX COUPLINGS
GL COUPLINGS
C14 COUPLINGS
PCTS THERMOPLASTIC COUPLINGS
POLARSEAL COUPLINGS
POLARSEAL II COUPLINGS
POWER STEERING
ADAPTERS
QUICK DISCONNECT COUPLERS
BALL VALVES
LIVE SWIVEL
ASSEMBLY FABRICATION
ACCESSORIES
EQUIPMENT AND PARTS
AIR BRAKE
BRASS
KITS

EQUIPMENT
HOSE/CPLG. SELECTION
G8K COUPLINGS
GLOBAL SPIRAL COUPLINGS
STAINLESS STEEL SPIRAL
MEGACRIMP COUPLINGS
STAINLESS STEEL BRAID
POWER CRIMP COUPLINGS
FIELD ATTACHABLE G1 & G2 COUPLINGS
FIELD ATTACHABLE C5 COUPLINGS
GLX COUPLINGS
GL COUPLINGS
C14 COUPLINGS
PCTS THERMOPLASTIC COUPLINGS
POLARSEAL COUPLINGS
POLARSEAL II COUPLINGS
POWER STEERING
ADAPTERS
QUICK DISCONNECT COUPLERS
BALL VALVES
LIVE SWIVEL
ASSEMBLY FABRICATION
ACCESSORIES
EQUIPMENT AND PARTS
AIR BRAKE
BRASS
KITS

Male Flareless Assembly

Part No.	Descr.	Prod. No.	Standard Pack
G46510-0606	6ACC-6MFA	7332-51355	1
G46510-0808	8ACC-8MFA	7332-51365	1
G46510-1010	10ACC-10MFA	7332-51375	1
G46510-1212	12ACC-12MFA	7332-51385	1

Male Flareless Assembly - 90° Bent Tube

Part No.	Descr.	Prod. No.	Standard Pack
G46511-0606	6ACC-6MFA90	7332-51395	1
G46511-0808	8ACC-8MFA90	7332-51405	1
G46511-1010	10ACC-10MFA90	7332-51415	1
G46511-1212	12ACC-12MFA90	7332-51425	1

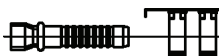

Weld On Hose End

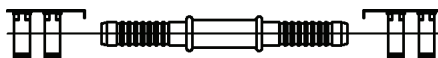

Part No.	Descr.	Prod. No.	
G46527-0606	6ACC-6FBO	7332-51165	5/16
G46527-0808	8ACC-8FBO	7332-51175	13/32
G46527-1010	10ACC-10FBO	7332-51185	1/2
G46527-1210	12ACC-10FBO	7332-51345	5/8
G46527-1212	12ACC-12FBO	7332-51195	5/8
G46527-1216	12ACC-16FBO	7332-51205	5/8

Splicer



Part No.	Descr.	Prod. No.		
G46535-0606	6ACC-6HLE	7332-50915	5/16	6
G46535-0808	8ACC-8HLE	7332-50925	13/32	8
G46535-1010	10ACC-10HLE	7332-50935	1/2	10
G46535-1212	12ACC-12HLE	7332-50945	5/8	12

T Splicer

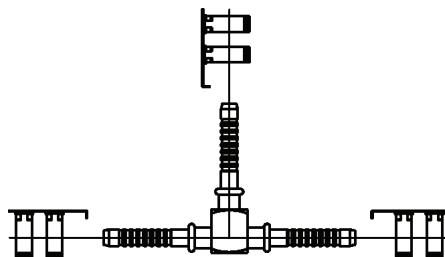

Part No.	Descr.	Prod. No.		
			"	"
G46539-0606	6ACC-6HLET	7332-51085	5/16	6
G46539-0808	8ACC-8HLET	7332-51095	13/32	8
G46539-1010	10ACC-10HLET	7332-51105	1/2	10
G46539-1212	12ACC-12HLET	7332-51115	5/8	12
G46539-1616	16ACC-16HLET	7332-51125	7/8	16

Y Splicer

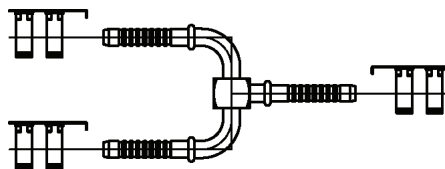

Part No.	Descr.	Prod. No.		
			"	"
G46542-0808	8ACC-8HLEY	7332-51135	13/32	8
G46542-1010	10ACC-10HLEY	7332-51145	1/2	10
G46542-1212	12ACC-12HLEY	7332-51155	5/8	12

Male O-Ring (MOR) - 180° Bent Tube

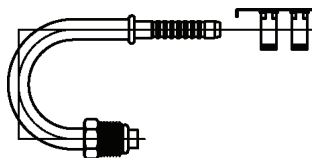

Part No.	Descr.	Prod. No.		
			"	"
G46578-0606	6ACC-6MTON180	7332-50895	5/16	5/8-18
G46578-1010	10ACC-10MTON180	7332-50905	5/8	7/8-14

EQUIPMENT
HOSE/CPLG. SELECTION
G8K COUPLINGS
GLOBALSPIRAL COUPLINGS
STAINLESS STEEL SPIRAL
MEGACRIMP COUPLINGS
STAINLESS STEEL BRAID
POWER CRIMP COUPLINGS
FIELD ATTACHABLE G1 & G2 COUPLINGS
FIELD ATTACHABLE C5 COUPLINGS
GLX COUPLINGS
GL COUPLINGS
C14 COUPLINGS
PCTS THERMOPLASTIC COUPLINGS
POLARSEAL COUPLINGS
POLARSEAL II COUPLINGS
POWER STEERING
ADAPTERS
QUICK DISCONNECT COUPLERS
BALL VALVES
LIVE SWIVEL
ASSEMBLY FABRICATION
ACCESSORIES
EQUIPMENT AND PARTS
AIR BRAKE
BRASS
KITS

Male O-Ring (MOR) with Switch or Service Port - 90° Bent Tube

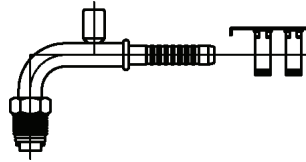

Part No.	Descr.	Prod. No.		
			"	"
G46582-0808H	8ACC-8MTON90134SWPH	7332-50695	13/32	3/4-16

Male O-Ring (MOR)



Part No.	Descr.	Prod. No.		
			"	"
G46583-0606	6ACC-6MTON	7332-50525	5/16	5/8-18
G46583-0806	8ACC-6MTON	7332-50585	13/32	5/8-18
G46583-0808	8ACC-8MTON	7332-50535	13/32	3/4-16
G46583-1010	10ACC-10MTON	7332-50545	1/2	7/8-14
G46583-1210	12ACC-10MTON	7332-50595	5/8	7/8-14
G46583-1212	12ACC-12MTON	7332-50565	5/8	1 1/16-14
G46583-1610	16ACC-10MTON	7332-50555	7/8	7/8-14
G46583-1612	16ACC-12MTON	7332-50575	7/8	1 1/16-14

Male O-Ring (MOR) - 45° Bent Tube

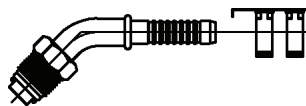

Part No.	Descr.	Prod. No.		
			"	"
G46584-0606	6ACC-6MTON45	7332-50605	5/16	5/8-18
G46584-1210	12ACC-10MTON45	7332-50615	5/8	7/8-14

Male O-Ring (MOR) - 90° Bent Tube

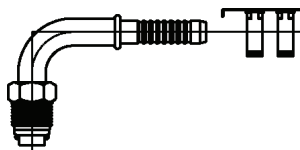

Part No.	Descr.	Prod. No.		
			"	"
G46585-0606	6ACC-6MTON90	7332-50625	5/16	5/8-18
G46585-0806	8ACC-6MTON90	7332-50665	13/32	5/8-18
G46585-0808	8ACC-8MTON90	7332-50635	13/32	3/4-16
G46585-1008	10ACC-8MTON90	7332-50675	1/2	3/4-16
G46585-1010	10ACC-10MTON90	7332-50645	1/2	7/8-14
G46585-1210	12ACC-10MTON90	7332-50685	5/8	7/8-14
G46585-1212	12ACC-12MTON90	7332-50655	5/8	1 1/16-14

Straight Female O-Ring (FOR) with Switch or Service Port

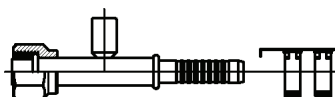

Part No.	Descr.	Prod. No.		
			"	"
G46588-0808H	8ACC-8FTON134SPH	7332-50135	13/32	3/4-16
G46588-0808P	8ACC-8FTONSWP	7332-50125	13/32	3/4-16
G46588-1008H	10ACC-8FTON134SPH	7332-50195	1/2	3/4-16
G46588-1010L	10ACC-10FTON134SPL	7332-50145	1/2	7/8-14
G46588-1210L	12ACC-10FTON134SPL	7332-50205	5/8	7/8-14
G46588-1210M	12ACC-10FTONMSWP	7332-50215	5/8	7/8-14
G46588-1212L	12ACC-12FTON134SPL	7332-50175	5/8	1 1/16-14
G46588-1212M	12ACC-12FTONMSWP	7332-50185	5/8	1 1/16-14
G46588-1212P	12ACC-12FTONSWP	7332-50165	5/8	1 1/16-14
G46588-1610L	16ACC-10FTON134SPL	7332-50155	7/8	7/8-14

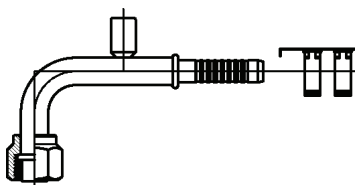

Female O-Ring (FOR) with Switch or Service Port - 90° Bent Tube



Part No.	Descr.	Prod. No.		
			"	"
G46589-0608H	6ACC-8FTON134SPH90	7332-50505	5/16	3/4-16
G46589-0808H	8ACC-8FTON134SPH90	7332-50415	13/32	3/4-16
G46589-0808P	8ACC-8FTONSWP90	7332-50405	13/32	3/4-16



- EQUIPMENT
- HOSE/CPLG. SELECTION
- G8K COUPLINGS
- GLOBALSPIRAL COUPLINGS
- STAINLESS STEEL SPIRAL
- MEGACRIMP COUPLINGS
- STAINLESS STEEL BRAID
- POWER CRIMP COUPLINGS
- FIELD ATTACHABLE G1 & G2 COUPLINGS
- FIELD ATTACHABLE C5 COUPLINGS
- GLX COUPLINGS
- GL COUPLINGS
- C14 COUPLINGS
- PCTS THERMOPLASTIC COUPLINGS
- POLARSEAL COUPLINGS
- POLARSEAL II COUPLINGS**
- POWER STEERING
- ADAPTERS
- QUICK DISCONNECT COUPLERS
- BALL VALVES
- LIVE SWIVEL
- ASSEMBLY FABRICATION
- ACCESSORIES
- EQUIPMENT AND PARTS
- AIR BRAKE
- BRASS
- KITS

Female O-Ring (FOR) with Switch or Service Port - 90° Bent Tube - Continued

Part No.	Descr.	Prod. No.		
			"	"
G46589-1008H	10ACC-8FTON134SPH90	7332-50485	1/2	3/4-16
G46589-1008P	10ACC-8FTONSWP90	7332-50475	1/2	3/4-16
G46589-1010H	10ACC-10FTON134SPH90	7332-50445	1/2	7/8-14
G46589-1010L	10ACC-10FTON134SPL90	7332-50425	1/2	7/8-14
G46589-1010M	10ACC-10FTONMSWP90	7332-50435	1/2	7/8-14
G46589-1210L	12ACC-10FTON134SPL90	7332-50515	5/8	7/8-14
G46589-1210P	12ACC-10FTONMSWP90	7332-50495	5/8	7/8-14
G46589-1212M	12ACC-12FTONMSWP90	7332-50465	5/8	1 1/16-14
G46589-1212P	12ACC-12FTONSWP90	7332-50455	5/8	1 1/16-14

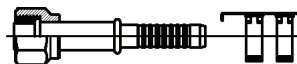

Straight Female O-Ring

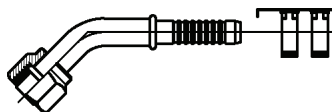

Part No.	Descr.	Prod. No.		
			"	"
G46590-0606	6ACC-6FTON	7332-50015	5/16	5/8-18
G46590-0608	6ACC-8FTON	7332-50105	5/16	3/4-16
G46590-0806	8ACC-6FTON	7332-50075	13/32	5/8-18
G46590-0808	8ACC-8FTON	7332-50025	13/32	3/4-16
G46590-0810	8ACC-10FTON	7332-50115	13/32	7/8-14
G46590-1008	10ACC-8FTON	7332-50085	1/2	3/4-16
G46590-1010	10ACC-10FTON	7332-50035	1/2	7/8-14
G46590-1210	12ACC-10FTON	7332-50095	5/8	7/8-14
G46590-1212	12ACC-12FTON	7332-50055	5/8	1 1/16-14
G46590-1610	16ACC-10FTON	7332-50045	7/8	7/8-14
G46590-1612	16ACC-12FTON	7332-50065	7/8	1 1/16-14

Female O-Ring (FOR) - 45° Bent Tube



Part No.	Descr.	Prod. No.		
			"	"
G46591-0606	6ACC-6FTON45	7332-50225	5/16	5/8-18
G46591-0808	8ACC-8FTON45	7332-50235	13/32	3/4-16
G46591-1008	10ACC-8FTON45	7332-50275	1/2	3/4-16
G46591-1010	10ACC-10FTON45	7332-50245	1/2	7/8-14
G46591-1210	12ACC-10FTON45	7332-50285	5/8	7/8-14
G46591-1212	12ACC-12FTON45	7332-50255	5/8	1 1/16-14
G46591-1612	16ACC-12FTON45	7332-50265	7/8	1 1/16-14

Female O-Ring (FOR) - 90° Bent Tube

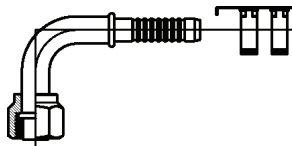

Part No.	Descr.	Prod. No.		
			"	"
G46592-0606	6ACC-6FTON90	7332-50295	5/16	5/8-18
G46592-0608	6ACC-8FTON90	7332-50385	5/16	3/4-16
G46592-0806	8ACC-6FTON90	7332-50355	13/32	5/8-18
G46592-0808	8ACC-8FTON90	7332-50305	13/32	3/4-16
G46592-0810	8ACC-10FTON90	7332-50395	13/32	7/8-14
G46592-1008	10ACC-8FTON90	7332-50365	1/2	3/4-16
G46592-1010	10ACC-10FTON90	7332-50315	1/2	7/8-14
G46592-1210	12ACC-10FTON90	7332-50375	5/8	7/8-14
G46592-1212	12ACC-12FTON90	7332-50335	5/8	1 1/16-14
G46592-1610	16ACC-10FTON90	7332-50325	7/8	7/8-14
G46592-1612	16ACC-12FTON90	7332-50345	7/8	1 1/16-14

Metric Female O-Ring (FOR)

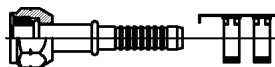

Part No.	Descr.	Prod. No.		
			"	"
G46593-0820	8ACC-20FTOMN	7332-51215	13/32	M20X1.5
G46593-1027	10ACC-27FTOMN	7332-51225	1/2	M27X2.0

Metric Female O-Ring (FOR) - 90° Bent Tube

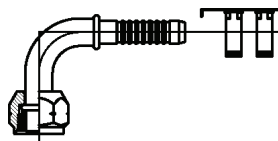

Part No.	Descr.	Prod. No.		
			"	"
G46595-0618	6ACC-18FTOMN90	7332-51235	5/16	M18X1.5
G46595-0820	8ACC-20FTOMN90	7332-51245	13/32	M20X1.5
G46595-1227	12ACC-27FTOMN90	7332-51255	5/8	M27X2.0

- EQUIPMENT
- HOSE/CPLG. SELECTION
- G8K COUPLINGS
- GLOBALSPIRAL COUPLINGS
- STAINLESS STEEL SPIRAL
- MEGACRIMP COUPLINGS
- STAINLESS STEEL BRAID
- POWER CRIMP COUPLINGS
- FIELD ATTACHABLE G1 & G2 COUPLINGS
- FIELD ATTACHABLE C5 COUPLINGS
- GLX COUPLINGS
- GL COUPLINGS
- C14 COUPLINGS
- PCTS THERMOPLASTIC COUPLINGS
- POLARSEAL COUPLINGS
- POLARSEAL II COUPLINGS**
- POWER STEERING
- ADAPTERS
- QUICK DISCONNECT COUPLERS
- BALL VALVES
- LIVE SWIVEL
- ASSEMBLY FABRICATION
- ACCESSORIES
- EQUIPMENT AND PARTS
- AIR BRAKE
- BRASS
- KITS

EQUIPMENT
HOSE/CPLG. SELECTION
G8K COUPLINGS
GLOBALSPIRAL COUPLINGS
STAINLESS STEEL SPIRAL
MEGACRIMP COUPLINGS
STAINLESS STEEL BRAID
POWER CRIMP COUPLINGS
FIELD ATTACHABLE G1 & G2 COUPLINGS
FIELD ATTACHABLE C5 COUPLINGS
GLX COUPLINGS
GL COUPLINGS
C14 COUPLINGS
PCTS THERMOPLASTIC COUPLINGS
POLARSEAL COUPLINGS
POLARSEAL II COUPLINGS
POWER STEERING
ADAPTERS
QUICK DISCONNECT COUPLERS
BALL VALVES
LIVE SWIVEL
ASSEMBLY FABRICATION
ACCESSORIES
EQUIPMENT AND PARTS
AIR BRAKE
BRASS
KITS

Male Insert O-Ring (MIO)

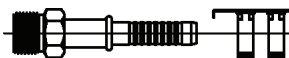

Part No.	Descr.	Prod. No.		
			"	"
G46597-0606	6ACC-6MIO	7332-50795	5/16	5/8-18
G46597-0806	8ACC-6MIO	7332-50815	13/32	5/8-18
G46597-0808	8ACC-8MIO	7332-50805	13/32	3/4-16
G46597-1210	12ACC-10MIO	7332-50825	5/8	7/8-14

Male Insert O-Ring (MIO) - 90° Bent Tube

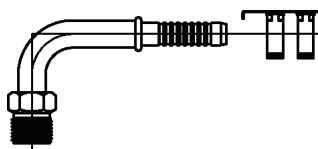

Part No.	Descr.	Prod. No.		
			"	"
G46599-0606	6ACC-6MIO90	7332-50835	5/16	5/8-18
G46599-0806	8ACC-6MIO90	7332-50865	13/32	5/8-18
G46599-0808	8ACC-8MIO90	7332-50845	13/32	3/4-16
G46599-1008	10ACC-8MIO90	7332-50875	1/2	3/4-16
G46599-1010	10ACC-10MIO90	7332-50855	1/2	7/8-14
G46599-1210	12ACC-10MIO90	7332-50885	5/8	7/8-14

Male Insert O-Ring (MIO) Bulkhead

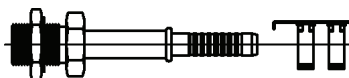

Part No.	Descr.	Prod. No.		
			"	"
G46600-0606	6ACC-6MIOBKHD	7332-50705	5/16	5/8-18
G46600-0808	8ACC-8MIOBKHD	7332-50715	13/32	3/4-16
G46600-1010	10ACC-10MIOBKHD	7332-50725	1/2	7/8-14
G46600-1210	12ACC-10MIOBKHD	7332-50745	5/8	7/8-14
G46600-1612	16ACC-12MIOBKHD	7332-50735	7/8	1 1/16-14

Male Insert O-Ring (MIO) Bulkhead - 90° Bent Tube

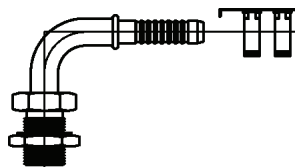

Part No.	Descr.	Prod. No.		
			"	"
G46602-0606	6ACC-6MIOBKHD90	7332-50755	5/16	5/8-18
G46602-0808	8ACC-8MIOBKHD90	7332-50765	13/32	3/4-16
G46602-1010	10ACC-10MIOBKHD90	7332-50775	1/2	7/8-14
G46602-1210	12ACC-10MIOBKHD90	7332-50785	5/8	7/8-14

Splicer with Switch or Service Port

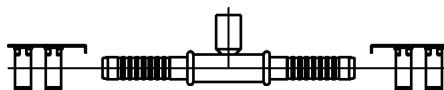

Part No.	Descr.	Prod. No.		
			"	"
G46956-0606H	6ACC-6HLE134SPH	7332-50965	5/16	6
G46956-0606P	6ACC-6HLESWP	7332-50955	5/16	6
G46956-0808H	8ACC-8HLE134SPH	7332-50985	13/32	8
G46956-0808M	8ACC-8HLEMSWP	7332-50995	13/32	8
G46956-0808P	8ACC-8HLESWP	7332-50975	13/32	8
G46956-1010H	10ACC-10HLE134SPH	7332-51035	1/2	10
G46956-1010L	10ACC-10HLE134SPL	7332-51015	1/2	10
G46956-1010M	10ACC-10HLEMSWP	7332-51025	1/2	10
G46956-1010P	10ACC-10HLESWP	7332-51005	1/2	10
G46956-1212L	12ACC-12HLE134SPL	7332-51055	5/8	12
G46956-1212M	12ACC-12HLEMSWP	7332-51065	5/8	12
G46956-1212P	12ACC-12HLESWP	7332-51045	5/8	12
G46956-1616L	16ACC-16HLE134SPL	7332-51075	7/8	16

Metric Female O-Ring (FOR) with Switch or Service Port - 90° Bent Tube

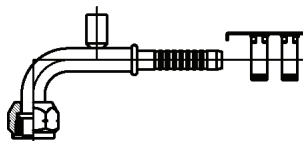

Part No.	Descr.	Prod. No.		
			"	"
G46963-0610	6ACC-10FTOMN90134SPH	7332-51265	5/16	M10X1.5
G46964-1024	10ACC-24FTOMN90SPL	7332-51275	1/2	M24X2.0

EQUIPMENT
HOSE/CPLG. SELECTION
G&K COUPLINGS
GLOBALSPIRAL COUPLINGS
STAINLESS STEEL SPIRAL
MEGACRIMP COUPLINGS
STAINLESS STEEL BRAID
POWER CRIMP COUPLINGS
FIELD ATTACHABLE G1 & G2 COUPLINGS
FIELD ATTACHABLE C5 COUPLINGS
GLX COUPLINGS
GL COUPLINGS
C14 COUPLINGS
PCTS THERMOPLASTIC COUPLINGS
POLARSEAL COUPLINGS
POLARSEAL II COUPLINGS
POWER STEERING
ADAPTERS
QUICK DISCONNECT COUPLERS
BALL VALVES
LIVE SWIVEL
ASSEMBLY FABRICATION
ACCESSORIES
EQUIPMENT AND PARTS
AIR BRAKE
BRASS
KITS

EQUIPMENT
HOSE/CPLG. SELECTION
G8K COUPLINGS
GLOBALSPIRAL COUPLINGS
STAINLESS STEEL SPIRAL
MEGACRIMP COUPLINGS
STAINLESS STEEL BRAID
POWER CRIMP COUPLINGS
FIELD ATTACHABLE G1 & G2 COUPLINGS
FIELD ATTACHABLE C5 COUPLINGS
GLX COUPLINGS
GL COUPLINGS
C14 COUPLINGS
PCTS THERMOPLASTIC COUPLINGS
POLARSEAL COUPLINGS
POLARSEAL II COUPLINGS
POWER STEERING
ADAPTERS
QUICK DISCONNECT COUPLERS
BALL VALVES
LIVE SWIVEL
ASSEMBLY FABRICATION
ACCESSORIES
EQUIPMENT AND PARTS
AIR BRAKE
BRASS
KITS

Metric Male Insert O-Ring (MIO)

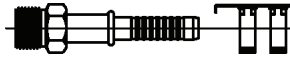

Part No.	Descr.	Prod. No.		
			"	"
G46965-1020	10ACC-20MIOM	7332-51285	1/2	M20X1.5

Clamp Assemblies

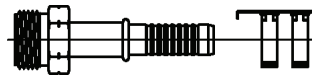

Part No.	Descr.	Prod. No.	
			"
G46995-0006	6CLAMP	7332-51295	5/16
G46995-0008	8CLAMP	7332-51305	13/32
G46995-0010	10CLAMP	7332-51315	1/2
G46995-0012	12CLAMP	7332-51325	5/8
G46995-0016	16CLAMP	7332-51335	7/8

SAE Male Flareless (includes Sleeve and Nut)

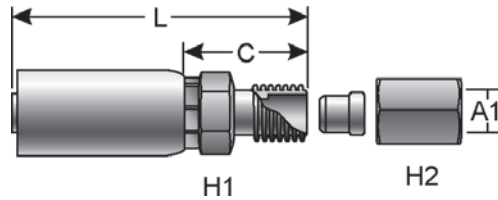

Part No.	Descr.	Prod. No.	⊖		🌀	H1	H2	L		C		A1
			"	mm				"	mm	"	mm	
G50510-0604	6PS-4MFA	7334-28615	3/8	9.7	7/16-20	11/16	9/16	2.37	60.2	1.00	25.4	1/4
G50510-0605	6PS-5MFA	7334-28625	3/8	9.7	1/2-20	11/16	5/8	2.37	60.2	1.00	25.4	5/16
G50510-0606	6PS-6MFA	7334-28635	3/8	9.7	5/8-18	11/16	11/16	2.39	60.7	1.01	25.7	3/8

SAE Metric Male Flareless (includes Sleeve and Nut)

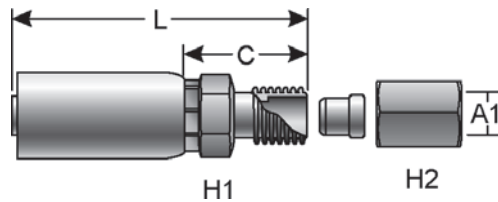

Part No.	Descr.	Prod. No.	⊖		🌀	H1	H2	L		C		A1
			"	mm				"	mm	"	mm	
G50510-0608	6PS-M8MFA	7334-28935	3/8	9.7	3/4-16	11/16	11/16	2.31	58.7	.93	23.6	8.0
G50510-0610	6PS-M10MFA	7334-28945	3/8	9.7	7/8-14	11/16	3/4	2.35	59.7	.97	24.6	10.0
G50510-0612	6PS-M12MFA	7334-28955	3/8	9.7	1 1/16-12	3/4	7/8	2.35	59.7	.97	24.6	12.0

- EQUIPMENT
- HOSE/CPLG. SELECTION
- G&K COUPLINGS
- GLOBALSPIRAL COUPLINGS
- STAINLESS STEEL SPIRAL
- MEGACRIMP COUPLINGS
- STAINLESS STEEL BRAID
- POWER CRIMP COUPLINGS
- FIELD ATTACHABLE G1 & G2 COUPLINGS
- FIELD ATTACHABLE C5 COUPLINGS
- GLX COUPLINGS
- GL COUPLINGS
- C14 COUPLINGS
- PCTS THERMOPLASTIC COUPLINGS
- POLARSEAL COUPLINGS
- POLARSEAL II COUPLINGS
- POWER STEERING**
- ADAPTERS
- QUICK DISCONNECT COUPLERS
- BALL VALVES
- LIVE SWIVEL
- ASSEMBLY FABRICATION
- ACCESSORIES
- EQUIPMENT AND PARTS
- AIR BRAKE
- BRASS
- KITS

NOTES

EQUIPMENT
HOSE/CPLG. SELECTION
G8K COUPLINGS
GLOBALSPIRAL COUPLINGS
STAINLESS STEEL SPIRAL
MEGACRIMP COUPLINGS
STAINLESS STEEL BRAID
POWER CRIMP COUPLINGS
FIELD ATTACHABLE G1 & G2 COUPLINGS
FIELD ATTACHABLE C5 COUPLINGS
GLX COUPLINGS
GL COUPLINGS
C14 COUPLINGS
PCTS THERMOPLASTIC COUPLINGS
POLARSEAL COUPLINGS
POLARSEAL II COUPLINGS
POWER STEERING
ADAPTERS
QUICK DISCONNECT COUPLERS
BALL VALVES
LIVE SWIVEL
ASSEMBLY FABRICATION
ACCESSORIES
EQUIPMENT AND PARTS
AIR BRAKE
BRASS
KITS

Male Pipe NPTF Plug

For use up to SAE 100R2 maximum working pressure.

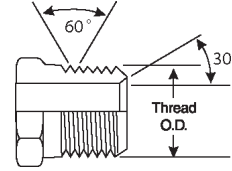
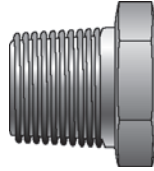

Part No.	Descr.	Prod. No.		
			"	"
G60102-0002	2MP-PLUG	7259-22815	1/8-27	
G60102-0004	4MP-PLUG	7259-22825	1/4-18	
G60102-0006	6MP-PLUG	7259-22835	3/8-18	
G60102-0008	8MP-PLUG	7259-22845	1/2-14	
G60102-0012	12MP-PLUG	7259-22855	3/4-14	
G60102-0016	16MP-PLUG	7259-22865	1-11 1/2	
G60102-0020	20MP-PLUG	7259-22875	1 1/4-11 1/2	
G60102-0024	24MP-PLUG	7259-24395	1 1/2-11 1/2	
G60102-0032	32MP-PLUG	7259-32765	2-11 1/2	

Male Pipe NPTF to Male Pipe NPTF

For use up to SAE 100R2 maximum working pressure.

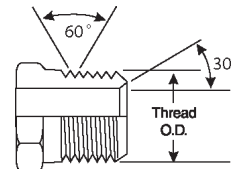
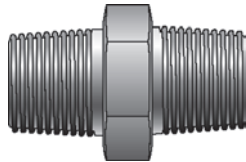

Part No.	Descr.	Prod. No.		
			"	"
G60110-0202	2MP-2MP	7259-23695	1/8-27	1/8-27
G60110-0402	4MP-2MP	7259-23705	1/4-18	1/8-27
G60110-0404	4MP-4MP	7259-23715	1/4-18	1/4-18
G60110-0602	6MP-2MP	7259-06455	3/8-18	1/8-27
G60110-0604	6MP-4MP	7259-23725	3/8-18	1/4-18
G60110-0606	6MP-6MP	7259-23735	3/8-18	3/8-18
G60110-0804	8MP-4MP	7259-23745	1/2-14	1/4-18
G60110-0806	8MP-6MP	7259-23755	1/2-14	3/8-18
G60110-0808	8MP-8MP	7259-23765	1/2-14	1/2-14
G60110-1204	12MP-4MP	7259-07405	3/4-14	1/4-18
G60110-1206	12MP-6MP	7259-06395	3/4-14	3/8-18
G60110-1208	12MP-8MP	7259-23775	3/4-14	1/2-14
G60110-1212	12MP-12MP	7259-23785	3/4-14	3/4-14
G60110-1606	16MP-6MP	7259-07325	1-11 1/2	3/8-18
G60110-1608	16MP-8MP	7259-06235	1-11 1/2	1/2-14
G60110-1612	16MP-12MP	7259-23795	1-11 1/2	3/4-14
G60110-1616	16MP-16MP	7259-23805	1-11 1/2	1-11 1/2
G60110-2012	20MP-12MP	7259-08015	1 1/4-11 1/2	3/4-14
G60110-2016	20MP-16MP	7259-05875	1 1/4-11 1/2	1-11 1/2
G60110-2020	20MP-20MP	7259-23815	1 1/4-11 1/2	1 1/4-11 1/2
G60110-2412	24MP-12MP	7259-08545	1 1/2-11 1/2	3/4-14
G60110-2416	24MP-16MP	7259-08025	1 1/2-11 1/2	1-11 1/2
G60110-2420	24MP-20MP	7259-08125	1 1/2-11 1/2	1 1/4-11 1/2

- EQUIPMENT
- HOSE/CPLG. SELECTION
- G&K COUPLINGS
- GLOBALSPIRAL COUPLINGS
- STAINLESS STEEL SPIRAL
- MEGACRIMP COUPLINGS
- STAINLESS STEEL BRAID
- POWER CRIMP COUPLINGS
- FIELD ATTACHABLE G1 & G2 COUPLINGS
- FIELD ATTACHABLE C5 COUPLINGS
- GLX COUPLINGS
- GL COUPLINGS
- C14 COUPLINGS
- PCTS THERMOPLASTIC COUPLINGS
- POLARSEAL COUPLINGS
- POLARSEAL II COUPLINGS
- POWER STEERING
- ADAPTERS
- QUICK DISCONNECT COUPLERS
- BALL VALVES
- LIVE SWIVEL
- ASSEMBLY FABRICATION
- ACCESSORIES
- EQUIPMENT AND PARTS
- AIR BRAKE
- BRASS
- KITS

Male Pipe NPTF to Male Pipe NPTF - Continued

Part No.	Descr.	Prod. No.		
			"	"
G60110-2424	24MP-24MP	7259-23825	1 1/2-11 1/2	1 1/2-11 1/2
G60110-3224	32MP-24MP	7259-08555	2-11 1/2	1 1/2-11 1/2
G60110-3232	32MP-32MP	7259-23835	2-11 1/2	2-11 1/2

Male Pipe NPTF to Male Pipe NPTF - 90°

For use up to SAE 100R2 maximum working pressure.

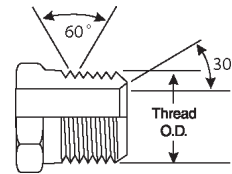
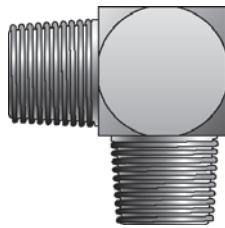

Part No.	Descr.	Prod. No.		
			"	"
G60115-0202	2MP-2MP90	7259-25205	1/8-27	1/8-27
G60115-0404	4MP-4MP90	7259-25215	1/4-18	1/4-18
G60115-0604	6MP-4MP90	7259-70755	3/8-18	1/4-18
G60115-0606	6MP-6MP90	7259-25225	3/8-18	3/8-18
G60115-0804	8MP-4MP90	7259-08565	1/2-14	1/4-18
G60115-0806	8MP-6MP90	7259-70855	1/2-14	3/8-18
G60115-0808	8MP-8MP90	7259-25235	1/2-14	1/2-14
G60115-1208	12MP-8MP90	7259-05725	3/4-14	1/2-14
G60115-1212	12MP-12MP90	7259-25245	3/4-14	3/4-14
G60115-1612	16MP-12MP90	7259-09835	1-11 1/2	3/4-14
G60115-1616	16MP-16MP90	7259-25255	1-11 1/2	1-11 1/2
G60115-2020	20MP-20MP90	7259-08575	1 1/4-11 1/2	1 1/4-11 1/2
G60115-2424	24MP-24MP90	7259-07155	1 1/2-11 1/2	1 1/2-11 1/2

Male Pipe NPTF to Female Pipe NPTF Reducer Bushing - Short

For use up to SAE 100R2 maximum working pressure.

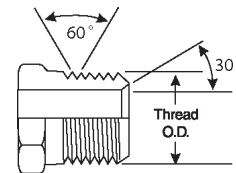
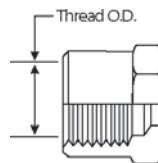
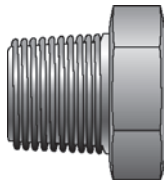

Part No.	Descr.	Prod. No.		
			"	"
G60130-0402	4MP-2FPS	7259-22595	1/4-18	1/8-27
G60130-0602	6MP-2FPS	7259-22605	3/8-18	1/8-27
G60130-0604	6MP-4FPS	7259-22615	3/8-18	1/4-18
G60130-0802	8MP-2FPS	7259-05815	1/2-14	1/8-27
G60130-0804	8MP-4FPS	7259-22635	1/2-14	1/4-18
G60130-0806	8MP-6FPS	7259-22645	1/2-14	3/8-18

Male Pipe NPTF to Female Pipe NPTF Reducer Bushing - Short - Continued

Part No.	Descr.	Prod. No.		
			"	"
G60130-1202	12MP-2FPS	7259-07335	3/4-14	1/8-27
G60130-1204	12MP-4FPS	7259-22665	3/4-14	1/4-18
G60130-1206	12MP-6FPS	7259-22675	3/4-14	3/8-18
G60130-1208	12MP-8FPS	7259-22685	3/4-14	1/2-14
G60130-1602	16MP-2FPS	7259-08585	1-11 1/2	1/8-27
G60130-1604	16MP-4FPS	7259-05355	1-11 1/2	1/4-18
G60130-1606	16MP-6FPS	7259-06665	1-11 1/2	3/8-18
G60130-1608	16MP-8FPS	7259-22725	1-11 1/2	1/2-14
G60130-1612	16MP-12FPS	7259-22735	1-11 1/2	3/4-14
G60130-2004	20MP-4FPS	7259-07475	1 1/4-11 1/2	1/4-18
G60130-2008	20MP-8FPS	7259-05525	1 1/4-11 1/2	1/2-14
G60130-2012	20MP-12FPS	7259-22755	1 1/4-11 1/2	3/4-14
G60130-2016	20MP-16FPS	7259-22765	1 1/4-11 1/2	1-11 1/2
G60130-2412	24MP-12FPS	7259-22785	1 1/2-11 1/2	3/4-14
G60130-2416	24MP-16FPS	7259-22795	1 1/2-11 1/2	1-11 1/2
G60130-2420	24MP-20FPS	7259-22805	1 1/2-11 1/2	1 1/4-11 1/2
G60130-3220	32MP-20FPS	7259-05425	2-11 1/2	1 1/4-11 1/2
G60130-3224	32MP-24FPS	7259-32825	2-11 1/2	1 1/2-11 1/2

Male Pipe NPTF to Female Pipe NPTF Increasing Bushing - Long

For use up to SAE 100R2 maximum working pressure.

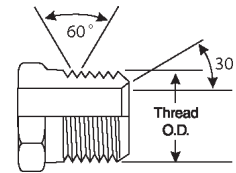
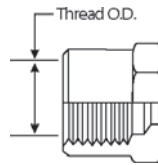
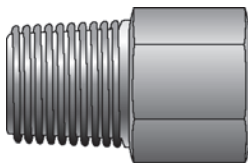



Part No.	Descr.	Prod. No.		
			"	"
G60132-0204	2MP-4FPL	7259-25365	1/8-27	1/4-18
G60132-0206	2MP-6FPL	7259-08365	1/8-27	3/8-18
G60132-0402	4MP-2FPL	7259-08615	1/4-18	1/8-27
G60132-0404	4MP-4FPL	7259-00475	1/4-18	1/4-18
G60132-0406	4MP-6FPL	7259-25385	1/4-18	3/8-18
G60132-0408	4MP-8FPL	7259-05515	1/4-18	1/2-14
G60132-0604	6MP-4FPL	7259-05025	3/8-18	1/4-18
G60132-0606	6MP-6FPL	7259-00535	3/8-18	3/8-18
G60132-0608	6MP-8FPL	7259-25415	3/8-18	1/2-14
G60132-0808	8MP-8FPL	7259-05175	1/2-14	1/2-14
G60132-0812	8MP-12FPL	7259-25435	1/2-14	3/4-14
G60132-0816	8MP-16FPL	7259-07755	1/2-14	1-11 1/2
G60132-1208	12MP-8FPL	7259-00315	3/4-14	1/2-14
G60132-1212	12MP-12FPL	7259-06545	3/4-14	3/4-14
G60132-1216	12MP-16FPL	7259-25455	3/4-14	1-11 1/2
G60132-1612	16MP-12FPL	7259-05735	1-11 1/2	3/4-14
G60132-1616	16MP-16FPL	7259-08635	1-11 1/2	1-11 1/2
G60132-1620	16MP-20FPL	7259-25475	1-11 1/2	1 1/4-11 1/2
G60132-1624	16MP-24FPL	7259-08645	1-11 1/2	1 1/2-11 1/2
G60132-2020	20MP-20FPL	7259-07345	1 1/4-11 1/2	1 1/4-11 1/2
G60132-2024	20MP-24FPL	7259-25495	1 1/4-11 1/2	1 1/2-11 1/2
G60132-2432	24MP-32FPL	7259-07765	1 1/2-11 1/2	2-11 1/2

- EQUIPMENT
- HOSE/CPLG. SELECTION
- G8K COUPLINGS
- GLOBAL SPIRAL COUPLINGS
- STAINLESS STEEL SPIRAL
- MEGACRIMP COUPLINGS
- STAINLESS STEEL BRAID
- POWER CRIMP COUPLINGS
- FIELD ATTACHABLE G1 & G2 COUPLINGS
- FIELD ATTACHABLE C5 COUPLINGS
- GLX COUPLINGS
- GL COUPLINGS
- C14 COUPLINGS
- PCTS THERMOPLASTIC COUPLINGS
- POLARSEAL COUPLINGS
- POLARSEAL II COUPLINGS
- POWER STEERING
- ADAPTERS
- QUICK DISCONNECT COUPLERS
- BALL VALVES
- LIVE SWIVEL
- ASSEMBLY FABRICATION
- ACCESSORIES
- EQUIPMENT AND PARTS
- AIR BRAKE
- BRASS
- KITS

Male Pipe NPTF to Female Pipe NPTF - 90°

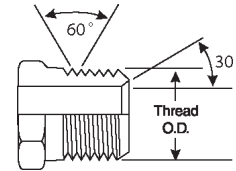
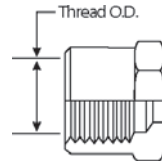
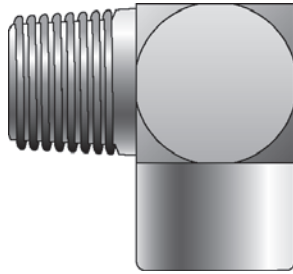
For use up to SAE 100R2 maximum working pressure.



Part No.	Descr.	Prod. No.		
			"	"
G60136-0202	2MP-2FP90	7259-24105	1/8-27	1/8-27
G60136-0204	2MP-4FP90	7259-32835	1/8-27	1/4-18
G60136-0402	4MP-2FP90	7259-32845	1/4-18	1/8-27
G60136-0404	4MP-4FP90	7259-24115	1/4-18	1/4-18
G60136-0406	4MP-6FP90	7259-32855	1/4-18	3/8-18
G60136-0604	6MP-4FP90	7259-32865	3/8-18	1/4-18
G60136-0606	6MP-6FP90	7259-24125	3/8-18	3/8-18
G60136-0608	6MP-8FP90	7259-32875	3/8-18	1/2-14
G60136-0804	8MP-4FP90	7259-08655	1/2-14	1/4-18
G60136-0806	8MP-6FP90	7259-32885	1/2-14	3/8-18
G60136-0808	8MP-8FP90	7259-24135	1/2-14	1/2-14
G60136-0812	8MP-12FP90	7259-32895	1/2-14	3/4-14
G60136-1208	12MP-8FP90	7259-32905	3/4-14	1/2-14
G60136-1212	12MP-12FP90	7259-24145	3/4-14	3/4-14
G60136-1216	12MP-16FP90	7259-08375	3/4-14	1-11 1/2
G60136-1612	16MP-12FP90	7259-08155	1-11 1/2	3/4-14
G60136-1616	16MP-16FP90	7259-24155	1-11 1/2	1-11 1/2
G60136-2016	20MP-16FP90	7259-08665	1 1/4-11 1/2	1-11 1/2
G60136-2020	20MP-20FP90	7259-24165	1 1/4-11 1/2	1 1/4-11 1/2
G60136-2424	24MP-24FP90	7259-24175	1 1/2-11 1/2	1 1/2-11 1/2
G60136-3232	32MP-32FP90	7259-24185	2-11 1/2	2-11 1/2

Male Pipe NPTF to Female Pipe Swivel NPSM

For use up to SAE 100R2 maximum working pressure.

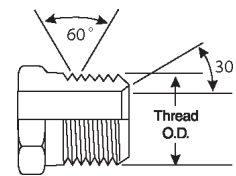
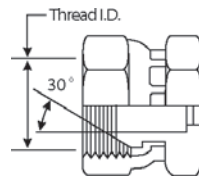
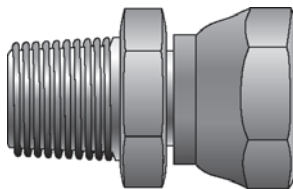

Part No.	Descr.	Prod. No.		
			"	"
G60140-0202	2MP-2FPX	7259-00735	1/8-27	1/8-27
G60140-0204	2MP-4FPX	7259-10635	1/8-27	1/4-18
G60140-0402	4MP-2FPX	7259-05095	1/4-18	1/8-27
G60140-0404	4MP-4FPX	7259-00775	1/4-18	1/4-18
G60140-0406	4MP-6FPX	7259-10455	1/4-18	3/8-18
G60140-0408	4MP-8FPX	7259-07355	1/4-18	1/2-14
G60140-0604	6MP-4FPX	7259-10625	3/8-18	1/4-18

Male Pipe NPTF to Female Pipe Swivel NPSM - Continued

Part No.	Descr.	Prod. No.		
			"	"
G60140-0606	6MP-6FPX	7259-00815	3/8-18	3/8-18
G60140-0608	6MP-8FPX	7259-10375	3/8-18	1/2-14
G60140-0806	8MP-6FPX	7259-10365	1/2-14	3/8-18
G60140-0808	8MP-8FPX	7259-00895	1/2-14	1/2-14
G60140-0812	8MP-12FPX	7259-10865	1/2-14	3/4-14
G60140-1206	12MP-6FPX	7259-06345	3/4-14	3/8-18
G60140-1208	12MP-8FPX	7259-10645	3/4-14	1/2-14
G60140-1212	12MP-12FPX	7259-00255	3/4-14	3/4-14
G60140-1216	12MP-16FPX	7259-32935	3/4-14	1-11 1/2
G60140-1220	12MP-20FPX	7259-08675	3/4-14	1 1/4-11 1/2
G60140-1612	16MP-12FPX	7259-10935	1-11 1/2	3/4-14
G60140-1616	16MP-16FPX	7259-00275	1-11 1/2	1-11 1/2
G60140-1620	16MP-20FPX	7259-11285	1-11 1/2	1 1/4-11 1/2
G60140-2016	20MP-16FPX	7259-05595	1 1/4-11 1/2	1-11 1/2
G60140-2020	20MP-20FPX	7259-10745	1 1/4-11 1/2	1 1/4-11 1/2
G60140-2024	20MP-24FPX	7259-06375	1 1/4-11 1/2	1 1/2-11 1/2
G60140-2420	24MP-20FPX	7259-06305	1 1/2-11 1/2	1 1/4-11 1/2
G60140-2424	24MP-24FPX	7259-11345	1 1/2-11 1/2	1 1/2-11 1/2
G60140-3232	32MP-32FPX	7259-11435	2-11 1/2	2-11 1/2

Male Pipe NPTF to Female Pipe Swivel NPSM - 45°

For use up to SAE 100R2 maximum working pressure.

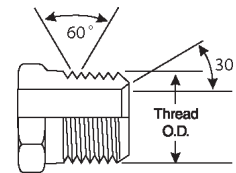
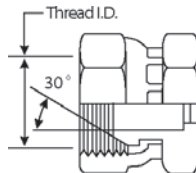
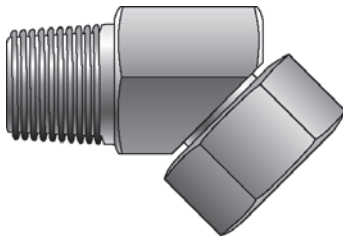

Part No.	Descr.	Prod. No.		
			"	"
G60142-0202	2MP-2FPX45	7259-32945	1/8-27	1/8-27
G60142-0204	2MP-4FPX45	7259-00505	1/8-27	1/4-18
G60142-0402	4MP-2FPX45	7259-05985	1/4-18	1/8-27
G60142-0404	4MP-4FPX45	7259-02115	1/4-18	1/4-18
G60142-0406	4MP-6FPX45	7259-05265	1/4-18	3/8-18
G60142-0604	6MP-4FPX45	7259-05555	3/8-18	1/4-18
G60142-0606	6MP-6FPX45	7259-02155	3/8-18	3/8-18
G60142-0608	6MP-8FPX45	7259-32955	3/8-18	1/2-14
G60142-0804	8MP-4FPX45	7259-06465	1/2-14	1/4-18
G60142-0806	8MP-6FPX45	7259-32965	1/2-14	3/8-18
G60142-0808	8MP-8FPX45	7259-02125	1/2-14	1/2-14
G60142-0812	8MP-12FPX45	7259-06115	1/2-14	3/4-14
G60142-1208	12MP-8FPX45	7259-11535	3/4-14	1/2-14
G60142-1212	12MP-12FPX45	7259-02235	3/4-14	3/4-14
G60142-1216	12MP-16FPX45	7259-06125	3/4-14	1-11 1/2
G60142-1612	16MP-12FPX45	7259-11625	1-11 1/2	3/4-14
G60142-1616	16MP-16FPX45	7259-10765	1-11 1/2	1-11 1/2
G60142-1620	16MP-20FPX45	7259-07855	1-11 1/2	1 1/4-11 1/2
G60142-2016	20MP-16FPX45	7259-06685	1 1/4-11 1/2	1-11 1/2

- EQUIPMENT
- HOSE/CPLG. SELECTION
- G8K COUPLINGS
- GLOBAL SPIRAL COUPLINGS
- STAINLESS STEEL SPIRAL
- MEGACRIMP COUPLINGS
- STAINLESS STEEL BRAID
- POWER CRIMP COUPLINGS
- FIELD ATTACHABLE G1 & G2 COUPLINGS
- FIELD ATTACHABLE C5 COUPLINGS
- GLX COUPLINGS
- GL COUPLINGS
- C14 COUPLINGS
- PCTS THERMOPLASTIC COUPLINGS
- POLARSEAL COUPLINGS
- POLARSEAL II COUPLINGS
- POWER STEERING
- ADAPTERS
- QUICK DISCONNECT COUPLERS
- BALL VALVES
- LIVE SWIVEL
- ASSEMBLY FABRICATION
- ACCESSORIES
- EQUIPMENT AND PARTS
- AIR BRAKE
- BRASS
- KITS

Male Pipe NPTF to Female Pipe Swivel NPSM - 45° - Continued

Part No.	Descr.	Prod. No.		
			"	"
G60142-2020	20MP-20FPX45	7259-11355	1 1/4-11 1/2	1 1/4-11 1/2
G60142-2424	24MP-24FPX45	7259-11745	1 1/2-11 1/2	1 1/2-11 1/2
G60142-3232	32MP-32FPX45	7259-32975	2-11 1/2	2-11 1/2

Male Pipe NPTF to Female Pipe Swivel NPSM - 90°

For use up to SAE 100R2 maximum working pressure.

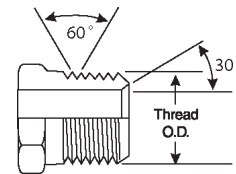
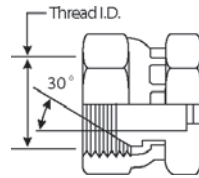
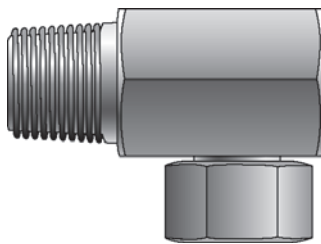



Part No.	Descr.	Prod. No.		
			"	"
G60144-0202	2MP-2FPX90	7259-08305	1/8-27	1/8-27
G60144-0204	2MP-4FPX90	7259-00415	1/8-27	1/4-18
G60144-0402	4MP-2FPX90	7259-05565	1/4-18	1/8-27
G60144-0404	4MP-4FPX90	7259-02135	1/4-18	1/4-18
G60144-0406	4MP-6FPX90	7259-10705	1/4-18	3/8-18
G60144-0408	4MP-8FPX90	7259-08685	1/4-18	1/2-14
G60144-0604	6MP-4FPX90	7259-10525	3/8-18	1/4-18
G60144-0606	6MP-6FPX90	7259-02165	3/8-18	3/8-18
G60144-0608	6MP-8FPX90	7259-10325	3/8-18	1/2-14
G60144-0804	8MP-4FPX90	7259-11175	1/2-14	1/4-18
G60144-0806	8MP-6FPX90	7259-10265	1/2-14	3/8-18
G60144-0808	8MP-8FPX90	7259-02205	1/2-14	1/2-14
G60144-0812	8MP-12FPX90	7259-11075	1/2-14	3/4-14
G60144-1206	12MP-6FPX90	7259-06045	3/4-14	3/8-18
G60144-1208	12MP-8FPX90	7259-02245	3/4-14	1/2-14
G60144-1212	12MP-12FPX90	7259-02265	3/4-14	3/4-14
G60144-1216	12MP-16FPX90	7259-05195	3/4-14	1-11 1/2
G60144-1220	12MP-20FPX90	7259-08705	3/4-14	3/4-14
G60144-1608	16MP-8FPX90	7259-06775	1-11 1/2	1/2-14
G60144-1612	16MP-12FPX90	7259-11275	1-11 1/2	3/4-14
G60144-1616	16MP-16FPX90	7259-10335	1-11 1/2	1-11 1/2
G60144-1620	16MP-20FPX90	7259-11475	1-11 1/2	1 1/4-11 1/2
G60144-2012	20MP-12FPX90	7259-08165	1 1/4-11 1/2	3/4-14
G60144-2016	20MP-16FPX90	7259-05435	1 1/4-11 1/2	1-11 1/2
G60144-2020	20MP-20FPX90	7259-11055	1 1/4-11 1/2	1 1/4-11 1/2
G60144-2024	20MP-24FPX90	7259-07865	1 1/4-11 1/2	1 1/2-11 1/2
G60144-2420	24MP-20FPX90	7259-06355	1 1/2-11 1/2	1 1/4-11 1/2
G60144-2424	24MP-24FPX90	7259-11655	1 1/2-11 1/2	1 1/2-11 1/2
G60144-3232	32MP-32FPX90	7259-32995	2-11 1/2	2-11 1/2

EQUIPMENT
HOSE/CPLG. SELECTION
G8K COUPLINGS
GLOBAL SPIRAL COUPLINGS
STAINLESS STEEL SPIRAL
MEGACRIMP COUPLINGS
STAINLESS STEEL BRAID
POWER CRIMP COUPLINGS
FIELD ATTACHABLE G1 & G2 COUPLINGS
FIELD ATTACHABLE C5 COUPLINGS
GLX COUPLINGS
GL COUPLINGS
C14 COUPLINGS
PCTS THERMOPLASTIC COUPLINGS
POLARSEAL COUPLINGS
POLARSEAL II COUPLINGS
POWER STEERING
ADAPTERS
QUICK DISCONNECT COUPLERS
BALL VALVES
LIVE SWIVEL
ASSEMBLY FABRICATION
ACCESSORIES
EQUIPMENT AND PARTS
AIR BRAKE
BRASS
KITS

Female Pipe NPTF to Female Pipe NPTF

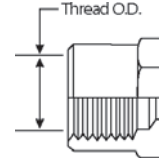
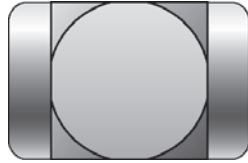
For use up to SAE 100R2 maximum working pressure.



Part No.	Descr.	Prod. No.		
			"	"
G60152-0202	2FP-2FP	7259-24415	1/8-27	1/8-27
G60152-0402	4FP-2FP	7259-05035	1/4-18	1/8-27
G60152-0404	4FP-4FP	7259-24425	1/4-18	1/4-18
G60152-0602	6FP-2FP	7259-08385	3/8-18	1/8-27
G60152-0604	6FP-4FP	7259-00495	3/8-18	1/4-18
G60152-0606	6FP-6FP	7259-24435	3/8-18	3/8-18
G60152-0804	8FP-4FP	7259-05575	1/2-14	1/4-18
G60152-0806	8FP-6FP	7259-00715	1/2-14	3/8-18
G60152-0808	8FP-8FP	7259-24445	1/2-14	1/2-14
G60152-1208	12FP-8FP	7259-00525	3/4-14	1/2-14
G60152-1212	12FP-12FP	7259-24455	3/4-14	3/4-14
G60152-1608	16FP-8FP	7259-08715	1-11 1/2	1/2-14
G60152-1612	16FP-12FP	7259-05745	1-11 1/2	3/4-14
G60152-1616	16FP-16FP	7259-24465	1-11 1/2	1-11 1/2
G60152-2016	20FP-16FP	7259-08395	1 1/4-11 1/2	1-11 1/2
G60152-2020	20FP-20FP	7259-24475	1 1/4-11 1/2	1 1/4-11 1/2
G60152-2424	24FP-24FP	7259-24885	1 1/2-11 1/2	1 1/2-11 1/2
G60152-3232	32FP-32FP	7259-24895	2-11 1/2	2-11 1/2

Female Pipe NPTF to Female Pipe NPTF - 90°

For use up to SAE 100R2 maximum working pressure.

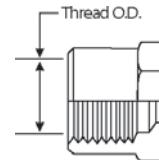
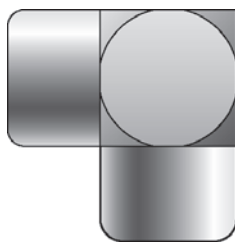

Part No.	Descr.	Prod. No.		
			"	"
G60156-0202	2FP-2FP90	7259-25015	1/8-27	1/8-27
G60156-0402	4FP-2FP90	7259-33005	1/4-18	1/8-27
G60156-0404	4FP-4FP90	7259-25025	1/4-18	1/4-18
G60156-0604	6FP-4FP90	7259-33015	3/8-18	1/4-18
G60156-0606	6FP-6FP90	7259-25035	3/8-18	3/8-18
G60156-0804	8FP-4FP90	7259-08725	1/2-14	1/4-18
G60156-0806	8FP-6FP90	7259-33025	1/2-14	3/8-18
G60156-0808	8FP-8FP90	7259-25045	1/2-14	1/2-14
G60156-1208	12FP-8FP90	7259-33035	3/4-14	1/2-14
G60156-1212	12FP-12FP90	7259-25055	3/4-14	3/4-14
G60156-1612	16FP-12FP90	7259-08175	1-11 1/2	3/4-14
G60156-1616	16FP-16FP90	7259-25065	1-11 1/2	1-11 1/2

- EQUIPMENT
- HOSE/CPLG. SELECTION
- G8K COUPLINGS
- GLOBALSPIRAL COUPLINGS
- STAINLESS STEEL SPIRAL
- MEGACRIMP COUPLINGS
- STAINLESS STEEL BRAID
- POWER CRIMP COUPLINGS
- FIELD ATTACHABLE G1 & G2 COUPLINGS
- FIELD ATTACHABLE C5 COUPLINGS
- GLX COUPLINGS
- GL COUPLINGS
- C14 COUPLINGS
- PCTS THERMOPLASTIC COUPLINGS
- POLARSEAL COUPLINGS
- POLARSEAL II COUPLINGS
- POWER STEERING
- ADAPTERS
- QUICK DISCONNECT COUPLERS
- BALL VALVES
- LIVE SWIVEL
- ASSEMBLY FABRICATION
- ACCESSORIES
- EQUIPMENT AND PARTS
- AIR BRAKE
- BRASS
- KITS

Female Pipe NPTF to Female Pipe NPTF - 90° - Continued

Part No.	Descr.	Prod. No.		
			"	"
G60156-2020	20FP-20FP90	7259-25075	1 1/4-11 1/2	1 1/4-11 1/2
G60156-2424	24FP-24FP90	7259-33055	1 1/2-11 1/2	1 1/2-11 1/2
G60156-3232	32FP-32FP90	7259-07485	2-11 1/2	2-11 1/2

Female Pipe NPTF to Female Pipe Swivel NPSM

For use up to SAE 100R2 maximum working pressure.

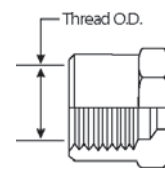
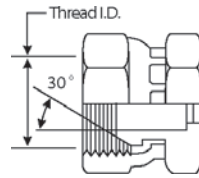
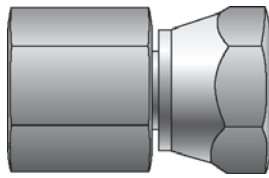



Part No.	Descr.	Prod. No.		
			"	"
G60160-0202	2FP-2FPX	7259-33065	1/8-27	1/8-27
G60160-0204	2FP-4FPX	7259-00435	1/8-27	1/4-18
G60160-0402	4FP-2FPX	7259-07515	1/4-18	1/8-27
G60160-0404	4FP-4FPX	7259-00795	1/4-18	1/4-18
G60160-0406	4FP-6FPX	7259-05205	1/4-18	3/8-18
G60160-0604	6FP-4FPX	7259-33085	3/8-18	1/4-18
G60160-0606	6FP-6FPX	7259-00835	3/8-18	3/8-18
G60160-0608	6FP-8FPX	7259-05105	3/8-18	1/2-14
G60160-0804	8FP-4FPX	7259-08735	1/2-14	1/4-18
G60160-0806	8FP-6FPX	7259-33095	1/2-14	3/8-18
G60160-0808	8FP-8FPX	7259-00915	1/2-14	1/2-14
G60160-0812	8FP-12FPX	7259-06695	1/2-14	3/4-14
G60160-1208	12FP-8FPX	7259-07165	3/4-14	1/2-14
G60160-1212	12FP-12FPX	7259-00925	3/4-14	3/4-14
G60160-1216	12FP-16FPX	7259-07775	3/4-14	1-11 1/2
G60160-1612	16FP-12FPX	7259-11595	1-11 1/2	3/4-14
G60160-1616	16FP-16FPX	7259-00905	1-11 1/2	1-11 1/2
G60160-2020	20FP-20FPX	7259-11015	1 1/4-11 1/2	1 1/4-11 1/2
G60160-2424	24FP-24FPX	7259-11545	1 1/2-11 1/2	1 1/2-11 1/2
G60160-3232	32FP-32FPX	7259-11725	2-11 1/2	2-11 1/2

EQUIPMENT
HOSE/CPLG. SELECTION
G8K COUPLINGS
GLOBAL SPIRAL COUPLINGS
STAINLESS STEEL SPIRAL
MEGACRIMP COUPLINGS
STAINLESS STEEL BRAID
POWER CRIMP COUPLINGS
FIELD ATTACHABLE G1 & G2 COUPLINGS
FIELD ATTACHABLE C5 COUPLINGS
GLX COUPLINGS
GL COUPLINGS
C14 COUPLINGS
PCTS THERMOPLASTIC COUPLINGS
POLARSEAL COUPLINGS
POLARSEAL II COUPLINGS
POWER STEERING
ADAPTERS
QUICK DISCONNECT COUPLERS
BALL VALVES
LIVE SWIVEL
ASSEMBLY FABRICATION
ACCESSORIES
EQUIPMENT AND PARTS
AIR BRAKE
BRASS
KITS

Female Pipe NPTF to Female Pipe Swivel NPSM - 45°

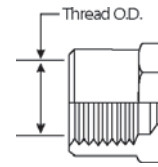
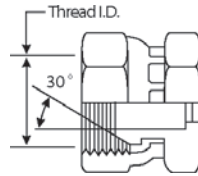
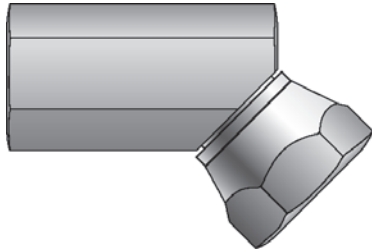
For use up to SAE 100R2 maximum working pressure.



Part No.	Descr.	Prod. No.		
			"	"
G60162-0202	2FP-2FPX45	7259-06145	1/8-27	1/8-27
G60162-0204	2FP-4FPX45	7259-08745	1/8-27	1/4-18
G60162-0404	4FP-4FPX45	7259-11575	1/4-18	1/4-18
G60162-0604	6FP-4FPX45	7259-06785	3/8-18	1/4-18
G60162-0606	6FP-6FPX45	7259-11455	3/8-18	3/8-18
G60162-0608	6FP-8FPX45	7259-08185	3/8-18	1/2-14
G60162-0806	8FP-6FPX45	7259-06415	1/2-14	3/8-18
G60162-0808	8FP-8FPX45	7259-11305	1/2-14	1/2-14
G60162-1212	12FP-12FPX45	7259-11325	3/4-14	3/4-14
G60162-1612	16FP-12FPX45	7259-06565	1-11 1/2	3/4-14
G60162-1616	16FP-16FPX45	7259-11515	1-11 1/2	1-11 1/2
G60162-2020	20FP-20FPX45	7259-33105	1 1/4-11 1/2	1 1/4-11 1/2

Female Pipe NPTF to Female Pipe Swivel NPSM - 90°

For use up to SAE 100R2 maximum working pressure.

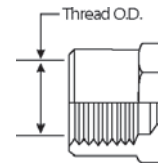
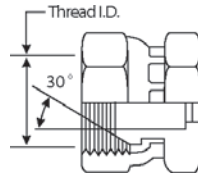
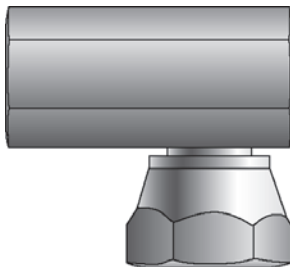

Part No.	Descr.	Prod. No.		
			"	"
G60164-0202	2FP-2FPX90	7259-05475	1/8-27	1/8-27
G60164-0204	2FP-4FPX90	7259-08755	1/8-27	1/4-18
G60164-0402	4FP-2FPX90	7259-06285	1/4-18	1/8-27
G60164-0404	4FP-4FPX90	7259-11005	1/4-18	1/4-18
G60164-0406	4FP-6FPX90	7259-06245	1/4-18	3/8-18
G60164-0604	6FP-4FPX90	7259-06825	3/8-18	1/4-18
G60164-0606	6FP-6FPX90	7259-10955	3/8-18	3/8-18
G60164-0608	6FP-8FPX90	7259-06965	3/8-18	1/2-14
G60164-0806	8FP-6FPX90	7259-06855	1/2-14	3/8-18
G60164-0808	8FP-8FPX90	7259-10615	1/2-14	1/2-14
G60164-0812	8FP-12FPX90	7259-06485	1/2-14	3/4-14
G60164-1208	12FP-8FPX90	7259-06585	3/4-14	1/2-14
G60164-1212	12FP-12FPX90	7259-11095	3/4-14	3/4-14
G60164-1612	16FP-12FPX90	7259-06595	1-11 1/2	3/4-14

- EQUIPMENT
- HOSE/CPLG. SELECTION
- G8K COUPLINGS
- GLOBALSPIRAL COUPLINGS
- STAINLESS STEEL SPIRAL
- MEGACRIMP COUPLINGS
- STAINLESS STEEL BRAID
- POWER CRIMP COUPLINGS
- FIELD ATTACHABLE G1 & G2 COUPLINGS
- FIELD ATTACHABLE C5 COUPLINGS
- GLX COUPLINGS
- GL COUPLINGS
- C14 COUPLINGS
- PCTS THERMOPLASTIC COUPLINGS
- POLARSEAL COUPLINGS
- POLARSEAL II COUPLINGS
- POWER STEERING
- ADAPTERS
- QUICK DISCONNECT COUPLERS
- BALL VALVES
- LIVE SWIVEL
- ASSEMBLY FABRICATION
- ACCESSORIES
- EQUIPMENT AND PARTS
- AIR BRAKE
- BRASS
- KITS

Female Pipe NPTF to Female Pipe Swivel NPSM - 90° - Continued

Part No.	Descr.	Prod. No.		
			"	"
G60164-1616	16FP-16FPX90	7259-11765	1-11 1/2	1-11 1/2
G60164-2016	20FP-16FPX90	7259-08405	1 1/4-11 1/2	1-11 1/2
G60164-2020	20FP-20FPX90	7259-33115	1 1/4-11 1/2	1 1/4-11 1/2
G60164-2424	24FP-24FPX90	7259-33125	1 1/2-11 1/2	1 1/2-11 1/2
G60164-3232	32FP-32FPX90	7259-33135	2-11 1/2	2-11 1/2

Female Pipe NPTF - Tee

For use up to SAE 100R2 maximum working pressure.

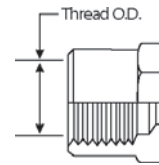
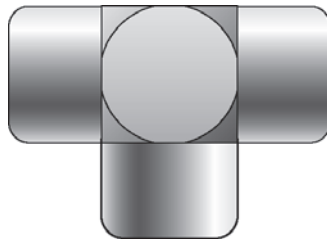

Part No.	Descr.	Prod. No.		
			"	"
G60181-0202	2FP-2FP-2FP	7259-23145	1/8-27	
G60181-0404	4FP-4FP-4FP	7259-23155	1/4-18	
G60181-0606	6FP-6FP-6FP	7259-23165	3/8-18	
G60181-0808	8FP-8FP-8FP	7259-23175	1/2-14	
G60181-1212	12FP-12FP-12FP	7259-23185	3/4-14	
G60181-1616	16FP-16FP-16FP	7259-23195	1-11 1/2	
G60181-2020	20FP-20FP-20FP	7259-33145	1 1/4-11 1/2	
G60181-2424	24FP-24FP-24FP	7259-33155	1 1/2-11 1/2	
G60181-3232	32FP-32FP-32FP	7259-07245	2-11 1/2	

Female Pipe NPTF on Run to Male Pipe NPTF - Tee

For use up to SAE 100R2 maximum working pressure.

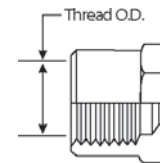
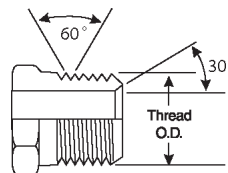
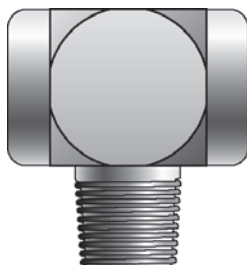

Part No.	Descr.	Prod. No.		
			"	"
G60183-0202	2FP-2FP-2MP	7259-24905	1/8-27	
G60183-0404	4FP-4FP-4MP	7259-24915	1/4-18	
G60183-0606	6FP-6FP-6MP	7259-24925	3/8-18	
G60183-0808	8FP-8FP-8MP	7259-24935	1/2-14	

Female Pipe NPTF on Run to Male Pipe NPTF - Tee - Continued

Part No.	Descr.	Prod. No.	
			"
G60183-1212	12FP-12FP-12MP	7259-24945	3/4-14
G60183-1616	16FP-16FP-16MP	7259-24955	1-11 1/2
G60183-2020	20FP-20FP-20MP	7259-07875	1 1/4-11 1/2
G60183-2424	24FP-24FP-24MP	7259-08765	1 1/2-11 1/2

Female Pipe Swivel NPSM - Tee

For use up to SAE 100R2 maximum working pressure.

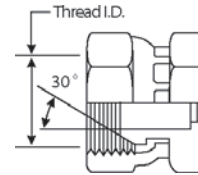
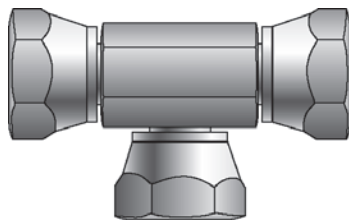

Part No.	Descr.	Prod. No.	
			"
G60184-0202	2FPX-2FPX-2FPX	7253-33165	1/8-27
G60184-0404	4FPX-4FPX-4FPX	7253-33175	1/4-18
G60184-0606	6FPX-6FPX-6FPX	7253-33185	3/8-18
G60184-0808	8FPX-8FPX-8FPX	7259-33195	1/2-14
G60184-1212	12FPX-12FPX-12FPX	7259-33205	3/4-14
G60184-1616	16FPX-16FPX-16FPX	7253-33215	1-11 1/2
G60184-2020	20FPX-20FPX-20FPX	7253-33225	1 1/4-11 1/2

Female Pipe Swivel NPSM on Run to Male Pipe NPTF - Tee

For use up to SAE 100R2 maximum working pressure.

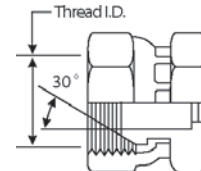
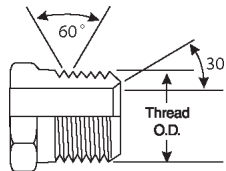
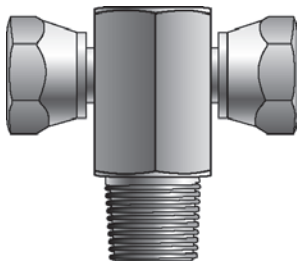

Part No.	Descr.	Prod. No.	
			"
G60186-0202	2FPX-2FPX-2MP	7253-86585	1/8-27
G60186-0404	4FPX-4FPX-4MP	7253-86586	1/4-18
G60186-0606	6FPX-6FPX-6MP	7253-86587	3/8-18
G60186-0808	8FPX-8FPX-8MP	7253-86588	1/2-14
G60186-1212	12FPX-12FPX-12MP	7253-86589	3/4-14
G60186-1616	16FPX-16FPX-16MP	7253-86591	1-11 1/2
G60186-2020	20FPX-20FPX-20MP	7253-33235	1 1/4-11 1/2
G60186-2424	24FPX-24FPX-24MP	7259-07605	1 1/2-11 1/2

- EQUIPMENT
- HOSE/CPLG. SELECTION
- G8K COUPLINGS
- GLOBAL SPIRAL COUPLINGS
- STAINLESS STEEL SPIRAL
- MEGACRIMP COUPLINGS
- STAINLESS STEEL BRAID
- POWER CRIMP COUPLINGS
- FIELD ATTACHABLE G1 & G2 COUPLINGS
- FIELD ATTACHABLE C5 COUPLINGS
- GLX COUPLINGS
- GL COUPLINGS
- C14 COUPLINGS
- PCTS THERMOPLASTIC COUPLINGS
- POLARSEAL COUPLINGS
- POLARSEAL II COUPLINGS
- POWER STEERING
- ADAPTERS
- QUICK DISCONNECT COUPLERS
- BALL VALVES
- LIVE SWIVEL
- ASSEMBLY FABRICATION
- ACCESSORIES
- EQUIPMENT AND PARTS
- AIR BRAKE
- BRASS
- KITS

EQUIPMENT
HOSE/CPLG. SELECTION
G8K COUPLINGS
GLOBALSPIRAL COUPLINGS
STAINLESS STEEL SPIRAL
MEGACRIMP COUPLINGS
STAINLESS STEEL BRAID
POWER CRIMP COUPLINGS
FIELD ATTACHABLE G1 & G2 COUPLINGS
FIELD ATTACHABLE C5 COUPLINGS
GLX COUPLINGS
GL COUPLINGS
C14 COUPLINGS
PCTS THERMOPLASTIC COUPLINGS
POLARSEAL COUPLINGS
POLARSEAL II COUPLINGS
POWER STEERING
ADAPTERS
QUICK DISCONNECT COUPLERS
BALL VALVES
LIVE SWIVEL
ASSEMBLY FABRICATION
ACCESSORIES
EQUIPMENT AND PARTS
AIR BRAKE
BRASS
KITS

Male O-Ring Boss Plug

For use up to SAE 100R2 maximum working pressure.

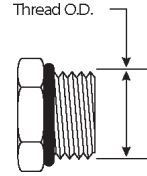

Part No.	Descr.	Prod. No.	Thread	
			"	"
G60250-0002	2MB-PLUG	7259-05415	5/16-24	
G60250-0003	3MB-PLUG	7259-05255	3/8-24	
G60250-0004	4MB-PLUG	7259-22975	7/16-20	
G60250-0005	5MB-PLUG	7259-22985	1/2-20	
G60250-0006	6MB-PLUG	7259-22995	9/16-18	
G60250-0008	8MB-PLUG	7259-23005	3/4-16	
G60250-0010	10MB-PLUG	7259-23015	7/8-14	
G60250-0012	12MB-PLUG	7259-23025	1 1/16-12	
G60250-0014	14MB-PLUG	7259-23035	1 3/16-12	
G60250-0016	16MB-PLUG	7259-23045	1 5/16-12	
G60250-0020	20MB-PLUG	7259-23055	1 5/8-12	
G60250-0024	24MB-PLUG	7259-05185	1 7/8-12	
G60250-0032	32MB-PLUG	7259-07615	2 1/2-12	

Male O-Ring Boss to Female Pipe NPTF

For use up to SAE 100R2 maximum working pressure.

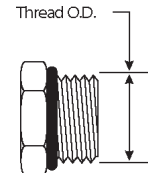
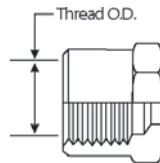
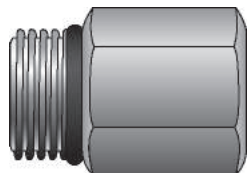

Part No.	Descr.	Prod. No.	Thread	
			"	"
G60275-0302	3MB-2FP	7259-08785	3/8-24	1/8-27
G60275-0402	4MB-2FP	7259-24205	7/16-20	1/8-27
G60275-0404	4MB-4FP	7259-00395	7/16-20	1/4-18
G60275-0406	4MB-6FP	7259-05145	7/16-20	3/8-18
G60275-0502	5MB-2FP	7259-05945	1/2-20	1/8-27
G60275-0504	5MB-4FP	7259-05755	1/2-20	1/4-18
G60275-0602	6MB-2FP	7259-08805	9/16-18	1/8-27
G60275-0604	6MB-4FP	7259-24215	9/16-18	1/4-18
G60275-0606	6MB-6FP	7259-00205	9/16-18	3/8-18
G60275-0608	6MB-8FP	7259-06605	9/16-18	1/2-14
G60275-0804	8MB-4FP	7259-00245	3/4-16	1/4-18
G60275-0806	8MB-6FP	7259-24225	3/4-16	3/8-18
G60275-0808	8MB-8FP	7259-33255	3/4-16	1/2-14
G60275-0812	8MB-12FP	7259-06715	3/4-16	3/4-14
G60275-1004	10MB-4FP	7259-07255	7/8-14	1/4-18
G60275-1006	10MB-6FP	7259-00335	7/8-14	3/8-18
G60275-1008	10MB-8FP	7259-24235	7/8-14	1/2-14

Male O-Ring Boss to Female Pipe NPTF - Continued

Part No.	Descr.	Prod. No.		
			"	"
G60275-1012	10MB-12FP	7259-05315	7/8-14	3/4-14
G60275-1208	12MB-8FP	7259-24245	1 1/16-12	1/2-14
G60275-1212	12MB-12FP	7259-24255	1 1/16-12	3/4-14
G60275-1216	12MB-16FP	7259-06155	1 1/16-12	1-11 1/2
G60275-1412	14MB-12FP	7259-24265	1 3/16-12	3/4-14
G60275-1608	16MB-8FP	7259-05495	1 5/16-12	7/8-14
G60275-1612	16MB-12FP	7259-33265	1 5/16-12	3/4-14
G60275-1616	16MB-16FP	7259-24275	1 5/16-12	1-11 1/2
G60275-2016	20MB-16FP	7259-05445	1 5/8-12	1-11 1/2

Male O-Ring Boss to Female Pipe Swivel NPSM

For use up to SAE 100R2 maximum working pressure.

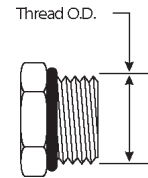
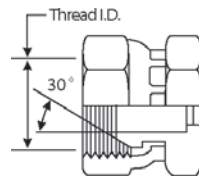
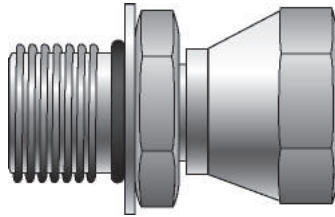

Part No.	Descr.	Prod. No.		
			"	"
G60285-0402	4MB-2FPX	7259-06725	7/16-20	1/8-27
G60285-0404	4MB-4FPX	7259-10475	7/16-20	1/4-18
G60285-0406	4MB-6FPX	7259-05395	7/16-20	3/8-18
G60285-0504	5MB-4FPX	7259-11065	1/2-20	1/4-18
G60285-0508	5MB-8FPX	7259-11735	1/2-20	1/2-14
G60285-0604	6MB-4FPX	7259-10585	9/16-18	1/4-18
G60285-0606	6MB-6FPX	7259-10445	9/16-18	3/8-18
G60285-0608	6MB-8FPX	7259-07495	9/16-18	1/2-24
G60285-0804	8MB-4FPX	7259-11115	3/4-16	1/4-18
G60285-0806	8MB-6FPX	7259-10535	3/4-16	3/8-18
G60285-0808	8MB-8FPX	7259-00295	3/4-16	1/2-14
G60285-0812	8MB-12FPX	7259-11105	3/4-16	3/4-14
G60285-1006	10MB-6FPX	7259-11155	7/8-14	3/8-18
G60285-1008	10MB-8FPX	7259-10215	7/8-14	1/2-14
G60285-1012	10MB-12FPX	7259-10665	7/8-14	3/4-14
G60285-1208	12MB-8FPX	7259-10725	1 1/16-12	1/2-14
G60285-1212	12MB-12FPX	7259-10315	1 1/16-12	3/4-14
G60285-1216	12MB-16FPX	7259-05535	1 1/16-12	1-11 1/2
G60285-1412	14MB-12FPX	7259-33275	1 3/16-12	3/4-14
G60285-1612	16MB-12FPX	7259-05115	1 5/16-12	3/4-14
G60285-1616	16MB-16FPX	7259-33285	1 5/16-12	1-11 1/2
G60285-1620	16MB-20FPX	7259-08035	1 5/16-12	1 1/4-11 1/2
G60285-2012	20MB-12FPX	7259-08815	1 5/8-12	3/4-14
G60285-2016	20MB-16FPX	7259-06925	1 5/8-12	1-11 1/2
G60285-2020	20MB-20FPX	7259-05605	1 5/8-12	1 1/4-11 1/2
G60285-2420	24MB-20FPX	7259-08825	1 7/8-12	1 1/4-11 1/2
G60285-2424	24MB-24FPX	7259-07625	1 7/8-12	1 1/2-11 1/2
G60285-3232	32MB-32FPX	7259-07885	2 1/2-12	2-11 1/2

- EQUIPMENT
- HOSE/CPLG. SELECTION
- G8K COUPLINGS
- GLOBAL SPIRAL COUPLINGS
- STAINLESS STEEL SPIRAL
- MEGACRIMP COUPLINGS
- STAINLESS STEEL BRAID
- POWER CRIMP COUPLINGS
- FIELD ATTACHABLE G1 & G2 COUPLINGS
- FIELD ATTACHABLE C5 COUPLINGS
- GLX COUPLINGS
- GL COUPLINGS
- C14 COUPLINGS
- PCTS THERMOPLASTIC COUPLINGS
- POLARSEAL COUPLINGS
- POLARSEAL II COUPLINGS
- POWER STEERING
- ADAPTERS
- QUICK DISCONNECT COUPLERS
- BALL VALVES
- LIVE SWIVEL
- ASSEMBLY FABRICATION
- ACCESSORIES
- EQUIPMENT AND PARTS
- AIR BRAKE
- BRASS
- KITS

Male O-Ring Boss to Female Pipe Swivel NPSM - 45°

For use up to SAE 100R2 maximum working pressure.

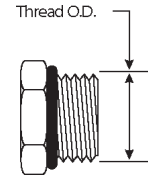
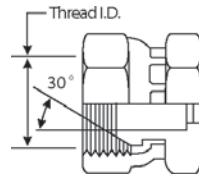
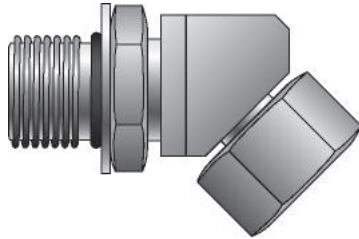

Part No.	Descr.	Prod. No.		
			"	"
G60287-0402	4MB-2FPX45	7259-08835	7/16-20	1/8-27
G60287-0404	4MB-4FPX45	7259-05015	7/16-20	1/4-18
G60287-0406	4MB-6FPX45	7259-07795	7/16-20	3/8-18
G60287-0604	6MB-4FPX45	7259-05825	9/16-18	1/4-18
G60287-0606	6MB-6FPX45	7259-10915	9/16-18	3/8-18
G60287-0608	6MB-8FPX45	7259-06365	9/16-18	1/2-14
G60287-0804	8MB-4FPX45	7259-08845	3/4-16	1/4-18
G60287-0806	8MB-6FPX45	7259-11495	3/4-16	3/8-18
G60287-0808	8MB-8FPX45	7259-10875	3/4-16	1/2-14
G60287-0812	8MB-12FPX45	7259-33295	3/4-16	3/4-14
G60287-1006	10MB-6FPX45	7259-11645	7/8-14	3/8-18
G60287-1008	10MB-8FPX45	7259-10815	7/8-14	1/2-14
G60287-1012	10MB-12FPX45	7259-06575	7/8-14	3/4-14
G60287-1208	12MB-8FPX45	7259-08205	1 1/16-12	1/2-14
G60287-1212	12MB-12FPX45	7259-11315	1 1/16-12	3/4-14
G60287-1216	12MB-16FPX45	7259-07265	1 1/16-12	1-11 1/2
G60287-1612	16MB-12FPX45	7259-07425	1 5/16-12	3/4-14
G60287-1616	16MB-16FPX45	7259-33325	1 5/16-12	1-11 1/2
G60287-2020	20MB-20FPX45	7259-06615	1 5/8-12	1 1/4-11 1/2
G60287-2424	24MB-24FPX45	7259-08415	1 7/8-12	1 1/2-11 1/2

Male O-Ring Boss to Female Pipe Swivel NPSM - 90°

For use up to SAE 100R2 maximum working pressure.

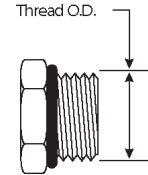
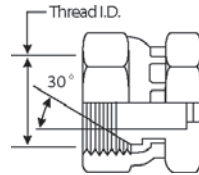
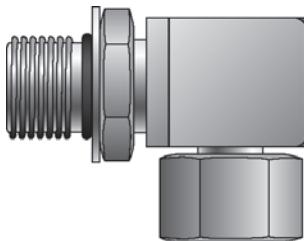

Part No.	Descr.	Prod. No.		
			"	"
G60289-0402	4MB-2FPX90	7259-08215	7/16-20	1/8-27
G60289-0404	4MB-4FPX90	7259-10835	7/16-20	1/4-18
G60289-0406	4MB-6FPX90	7259-06625	7/16-20	3/8-18
G60289-0604	6MB-4FPX90	7259-10405	9/16-18	1/4-18
G60289-0606	6MB-6FPX90	7259-10285	9/16-18	3/8-18
G60289-0608	6MB-8FPX90	7259-05045	9/16-18	1/2-14
G60289-0804	8MB-4FPX90	7259-06175	3/4-16	1/4-18

Male O-Ring Boss to Female Pipe Swivel NPSM - 90° - Continued

Part No.	Descr.	Prod. No.		
			"	"
G60289-0806	8MB-6FPX90	7259-10295	3/4-16	3/8-18
G60289-0808	8MB-8FPX90	7259-10155	3/4-16	1/2-14
G60289-0812	8MB-12FPX90	7259-11335	3/4-16	3/4-14
G60289-1006	10MB-6FPX90	7259-11215	7/8-14	3/8-18
G60289-1008	10MB-8FPX90	7259-10345	7/8-14	1/2-14
G60289-1012	10MB-12FPX90	7259-11295	7/8-14	3/4-14
G60289-1206	12MB-6FPX90	7259-07895	1 1/16-12	3/8-18
G60289-1208	12MB-8FPX90	7259-00515	1 1/16-12	1/2-14
G60289-1212	12MB-12FPX90	7259-10575	1 1/16-12	3/4-14
G60289-1216	12MB-16FPX90	7259-06935	1 1/16-12	1-11 1/2
G60289-1412	14MB-12FPX90	7259-07175	1 3/16-12	3/4-14
G60289-1612	16MB-12FPX90	7259-05805	1 5/16-12	3/4-14
G60289-1616	16MB-16FPX90	7259-11125	1 5/16-12	1-11 1/2
G60289-1620	16MB-20FPX90	7259-06875	1 5/16-12	1 1/4-11 1/2
G60289-2012	20MB-12FPX90	7259-06945	1 5/8-12	3/4-14
G60289-2016	20MB-16FPX90	7259-06635	1 5/8-12	1-11 1/2
G60289-2020	20MB-20FPX90	7259-05905	1 5/8-12	1 1/4-11 1/2
G60289-2424	24MB-24FPX90	7259-08855	1 7/8-12	1 1/2-11 1/2
G60289-3232	32MB-32FPX90	7259-08045	2 1/2-12	2-11 1/2

Female O-Ring Boss to Male Pipe NPTF

For use up to SAE 100R2 maximum working pressure.

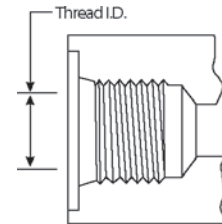
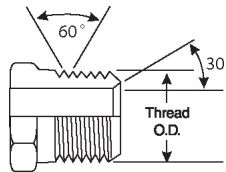
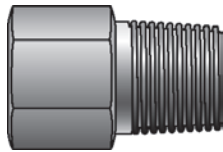



Part No.	Descr.	Prod. No.		
			"	"
G60291-0402	4FB-2MP	7259-33335	7/16-20	1/8-27
G60291-0404	4FB-4MP	7259-06515	7/16-20	1/4-18
G60291-0502	5FB-2MP	7259-33355	1/2-20	1/8-27
G60291-0604	6FB-4MP	7259-33345	9/16-18	1/4-18
G60291-0606	6FB-6MP	7259-00385	9/16-18	3/8-18
G60291-0608	6FB-8MP	7259-00485	9/16-18	1/2-14
G60291-0806	8FB-6MP	7259-33365	3/4-16	3/8-18
G60291-0808	8FB-8MP	7259-08875	3/4-16	1/2-14
G60291-1008	10FB-8MP	7259-33375	7/8-14	1/2-14
G60291-1208	12FB-8MP	7259-06955	1 1/16-12	1/2-14
G60291-1212	12FB-12MP	7259-33385	1 1/16-12	3/4-14
G60291-1612	16FB-12MP	7259-08885	1 5/16-12	3/4-14
G60291-1616	16FB-16MP	7259-33395	1 5/16-12	1-11 1/2

- EQUIPMENT
- HOSE/CPLG. SELECTION
- G&K COUPLINGS
- GLOBALSPIRAL COUPLINGS
- STAINLESS STEEL SPIRAL
- MEGACRIMP COUPLINGS
- STAINLESS STEEL BRAID
- POWER CRIMP COUPLINGS
- FIELD ATTACHABLE G1 & G2 COUPLINGS
- FIELD ATTACHABLE C5 COUPLINGS
- GLX COUPLINGS
- GL COUPLINGS
- C14 COUPLINGS
- PCTS THERMOPLASTIC COUPLINGS
- POLARSEAL COUPLINGS
- POLARSEAL II COUPLINGS
- POWER STEERING
- ADAPTERS
- QUICK DISCONNECT COUPLERS
- BALL VALVES
- LIVE SWIVEL
- ASSEMBLY FABRICATION
- ACCESSORIES
- EQUIPMENT AND PARTS
- AIR BRAKE
- BRASS
- KITS

Male O-Ring Boss to Male JIC 37° Flare

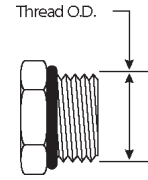
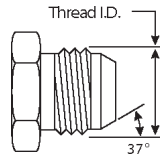
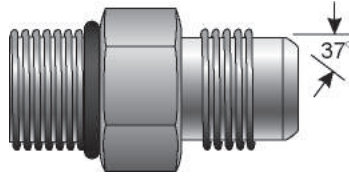
For use up to SAE 100R2 maximum working pressure.



EQUIPMENT	Part No.	Descr.	Prod. No.		
				"	"
HOSE/CPLG. SELECTION	G60301-0202	2MB-2MJ	7259-07275	5/16-24	5/16-24
G8K COUPLINGS	G60301-0204	2MB-4MJ	7259-08895	5/16-24	7/16-20
GLOBAL SPIRAL COUPLINGS	G60301-0304	3MB-4MJ	7259-06255	3/8-24	7/16-20
STAINLESS STEEL SPIRAL	G60301-0403	4MB-3MJ	7259-08905	7/16-20	3/8-24
MEGACRIMP COUPLINGS	G60301-0404	4MB-4MJ	7259-10025	7/16-20	7/16-20
STAINLESS STEEL BRAID	G60301-0405	4MB-5MJ	7259-05005	7/16-20	1/2-20
POWER CRIMP COUPLINGS	G60301-0406	4MB-6MJ	7259-33405	7/16-20	9/16-18
FIELD ATTACHABLE G1 & G2 COUPLINGS	G60301-0408	4MB-8MJ	7259-08915	7/16-20	3/4-16
FIELD ATTACHABLE C5 COUPLINGS	G60301-0503	5MB-3MJ	7253-86885	1/2-20	3/8-24
GLX COUPLINGS	G60301-0504	5MB-4MJ	7259-10775	1/2-20	7/16-20
GL COUPLINGS	G60301-0505	5MB-5MJ	7259-10855	1/2-20	1/2-20
C14 COUPLINGS	G60301-0506	5MB-6MJ	7259-33415	1/2-20	9/16-18
PCTS THERMOPLASTIC COUPLINGS	G60301-0604	6MB-4MJ	7259-10045	9/16-18	7/16-20
POLARSEAL COUPLINGS	G60301-0605	6MB-5MJ	7259-00455	9/16-18	1/2-20
POLARSEAL II COUPLINGS	G60301-0606	6MB-6MJ	7259-04685	9/16-18	9/16-18
ADAPTERS	G60301-0608	6MB-8MJ	7259-10145	9/16-18	3/4-16
QUICK DISCONNECT COUPLERS	G60301-0610	6MB-10MJ	7259-33425	9/16-18	7/8-14
BALL VALVES	G60301-0612	6MB-12MJ	7259-07635	9/16-18	1 1/16-12
LIVE SWIVEL	G60301-0804	8MB-4MJ	7259-00025	3/4-16	7/16-20
ASSEMBLY FABRICATION	G60301-0805	8MB-5MJ	7259-06885	3/4-16	1/2-20
ACCESSORIES	G60301-0806	8MB-6MJ	7259-04775	3/4-16	9/16-18
EQUIPMENT AND PARTS	G60301-0808	8MB-8MJ	7259-10015	3/4-16	3/4-16
AIR BRAKE	G60301-0810	8MB-10MJ	7259-10425	3/4-16	7/8-14
BRASS	G60301-0812	8MB-12MJ	7259-10305	3/4-16	1 1/16-12
KITS	G60301-0816	8MB-16MJ	7259-07285	3/4-16	1 5/16-12
	G60301-1004	10MB-4MJ	7259-00105	7/8-14	7/16-20
	G60301-1006	10MB-6MJ	7259-10095	7/8-14	9/16-18
	G60301-1008	10MB-8MJ	7259-10075	7/8-14	3/4-16
	G60301-1010	10MB-10MJ	7259-10065	7/8-14	7/8-14
	G60301-1012	10MB-12MJ	7259-00235	7/8-14	1 1/16-12
	G60301-1016	10MB-16MJ	7259-00355	7/8-14	1 5/16-12
	G60301-1204	12MB-4MJ	7259-07905	1 1/16-12	7/16-20
	G60301-1206	12MB-6MJ	7259-00305	1 1/16-12	9/16-18
	G60301-1208	12MB-8MJ	7259-10035	1 1/16-12	3/4-16
	G60301-1210	12MB-10MJ	7259-10755	1 1/16-12	7/8-14
	G60301-1212	12MB-12MJ	7259-10115	1 1/16-12	1 1/16-12
	G60301-1214	12MB-14MJ	7259-08225	1 1/16-12	1 3/16-12
	G60301-1216	12MB-16MJ	7259-10885	1 1/16-12	1 5/16-12
	G60301-1220	12MB-20MJ	7259-06005	1 1/16-12	1 5/8-12
	G60301-1410	14MB-10MJ	7259-08425	1 3/16-12	7/8-14
	G60301-1412	14MB-12MJ	7259-06185	1 3/16-12	1 1/16-12
	G60301-1414	14MB-14MJ	7259-07525	1 3/16-12	1 3/16-12
	G60301-1416	14MB-16MJ	7259-08235	1 3/16-12	1 5/16-12
	G60301-1608	16MB-8MJ	7259-00125	1 5/16-12	3/4-16
	G60301-1610	16MB-10MJ	7259-11385	1 5/16-12	7/8-14
	G60301-1612	16MB-12MJ	7259-10135	1 5/16-12	1 1/16-12
	G60301-1616	16MB-16MJ	7259-10055	1 5/16-12	1 5/16-12
	G60301-1620	16MB-20MJ	7259-05485	1 5/16-12	1 5/8-12

Male O-Ring Boss to Male JIC 37° Flare - Continued

Part No.	Descr.	Prod. No.		
			"	"
G60301-2010	20MB-10MJ	7253-86907	1 5/8-12	7/8-14
G60301-2012	20MB-12MJ	7259-11255	1 5/8-12	1 1/16-12
G60301-2016	20MB-16MJ	7259-10245	1 5/8-12	1 5/16-12
G60301-2020	20MB-20MJ	7259-11235	1 5/8-12	1 5/8-12
G60301-2024	20MB-24MJ	7259-06315	1 5/8-12	1 7/8-12
G60301-2416	24MB-16MJ	7259-00365	1 7/8-12	1 5/16-12
G60301-2420	24MB-20MJ	7259-05505	1 7/8-12	1 5/8-12
G60301-2424	24MB-24MJ	7259-05345	1 7/8-12	1 7/8-12
G60301-3224	32MB-24MJ	7259-07645	2 1/2-12	1 7/8-12
G60301-3232	32MB-32MJ	7259-09855	2 1/2-12	2 1/2-12

Male O-Ring Boss to Male JIC 37° Flare - 45°

For use up to SAE 100R2 maximum working pressure.

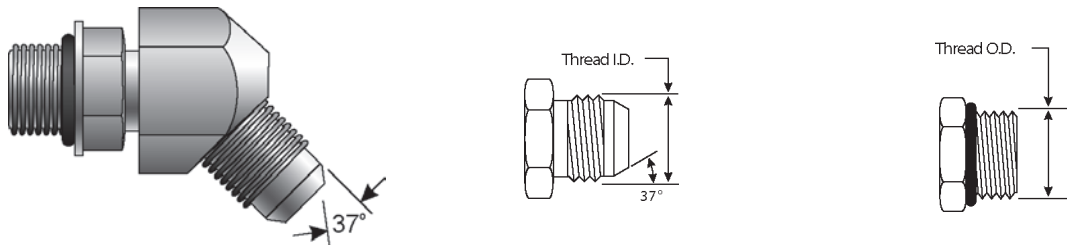

Part No.	Descr.	Prod. No.		
			"	"
G60308-0404	4MB-4MJ45	7259-28565	7/16-20	7/16-20
G60308-0406	4MB-6MJ45	7259-00095	7/16-20	9/16-18
G60308-0505	5MB-5MJ45	7259-28575	1/2-20	1/2-20
G60308-0506	5MB-6MJ45	7259-05405	1/2-20	9/16-18
G60308-0604	6MB-4MJ45	7259-00065	9/16-18	7/16-20
G60308-0606	6MB-6MJ45	7259-28585	9/16-18	9/16-18
G60308-0608	6MB-8MJ45	7259-05335	9/16-18	3/4-16
G60308-0806	8MB-6MJ45	7259-77595	3/4-16	9/16-18
G60308-0808	8MB-8MJ45	7259-28255	3/4-16	3/4-16
G60308-0810	8MB-10MJ45	7259-28415	3/4-16	7/8-14
G60308-0812	8MB-12MJ45	7259-06895	3/4-16	1 1/16-12
G60308-1008	10MB-8MJ45	7259-28425	7/8-14	3/4-16
G60308-1010	10MB-10MJ45	7259-10895	7/8-14	7/8-14
G60308-1012	10MB-12MJ45	7259-05785	7/8-14	1 1/16-12
G60308-1210	12MB-10MJ45	7259-77605	1 1/16-12	7/8-14
G60308-1212	12MB-12MJ45	7259-28595	1 1/16-12	1 1/16-12
G60308-1216	12MB-16MJ45	7259-28435	1 1/16-12	1 5/16-12
G60308-1414	14MB-14MJ45	7259-28605	1 3/16-12	1 3/16-12
G60308-1612	16MB-12MJ45	7259-28445	1 5/16-12	1 1/16-12
G60308-1616	16MB-16MJ45	7259-28615	1 5/16-12	1 5/16-12
G60308-1620	16MB-20MJ45	7259-08065	1 5/16-12	1 5/8-12
G60308-2016	20MB-16MJ45	7259-07295	1 5/8-12	1 5/16-12
G60308-2020	20MB-20MJ45	7259-05955	1 5/8-12	1 5/8-12
G60308-2424	24MB-24MJ45	7259-06975	1 7/8-12	1 7/8-12

- EQUIPMENT
- HOSE/CPLG. SELECTION
- G&K COUPLINGS
- GLOBAL SPIRAL COUPLINGS
- STAINLESS STEEL SPIRAL
- MEGACRIMP COUPLINGS
- STAINLESS STEEL BRAID
- POWER CRIMP COUPLINGS
- FIELD ATTACHABLE G1 & G2 COUPLINGS
- FIELD ATTACHABLE C5 COUPLINGS
- GLX COUPLINGS
- GL COUPLINGS
- C14 COUPLINGS
- PCTS THERMOPLASTIC COUPLINGS
- POLARSEAL COUPLINGS
- POLARSEAL II COUPLINGS
- POWER STEERING
- ADAPTERS
- QUICK DISCONNECT COUPLERS
- BALL VALVES
- LIVE SWIVEL
- ASSEMBLY FABRICATION
- ACCESSORIES
- EQUIPMENT AND PARTS
- AIR BRAKE
- BRASS
- KITS

Male O-Ring Boss to Male JIC 37° Flare - 90°

For use up to SAE 100R2 maximum working pressure.

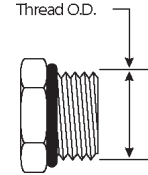
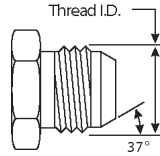
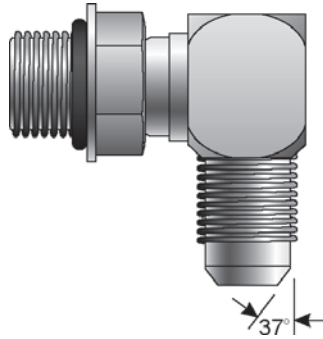

EQUIPMENT
HOSE/CPLG. SELECTION
G8K COUPLINGS
GLOBALSPIRAL COUPLINGS
STAINLESS STEEL SPIRAL
MEGACRIMP COUPLINGS
STAINLESS STEEL BRAID
POWER CRIMP COUPLINGS
FIELD ATTACHABLE G1 & G2 COUPLINGS
FIELD ATTACHABLE C5 COUPLINGS
GLX COUPLINGS
GL COUPLINGS
C14 COUPLINGS
PCTS THERMOPLASTIC COUPLINGS
POLARSEAL COUPLINGS
POLARSEAL II COUPLINGS
POWER STEERING
ADAPTERS
QUICK DISCONNECT COUPLERS
BALL VALVES
LIVE SWIVEL
ASSEMBLY FABRICATION
ACCESSORIES
EQUIPMENT AND PARTS
AIR BRAKE
BRASS
KITS

Part No.	Descr.	Prod. No.		
			"	"
G60312-0202	2MB-2MJ90	7259-08925	5/16-24	5/16-24
G60312-0303	3MB-3MJ90	7259-77615	3/8-24	3/8-24
G60312-0404	4MB-4MJ90	7259-28265	7/16-20	7/16-20
G60312-0405	4MB-5MJ90	7259-77625	7/16-20	1/2-20
G60312-0406	4MB-6MJ90	7259-28455	7/16-20	9/16-18
G60312-0408	4MB-8MJ90	7259-09825	7/16-20	3/4-16
G60312-0504	5MB-4MJ90	7259-05615	1/2-20	7/16-20
G60312-0505	5MB-5MJ90	7259-28625	1/2-20	1/2-20
G60312-0506	5MB-6MJ90	7259-05075	1/2-20	9/16-18
G60312-0508	5MB-8MJ90	7259-06985	1/2-20	3/4-16
G60312-0604	6MB-4MJ90	7259-28465	9/16-18	7/16-20
G60312-0605	6MB-5MJ90	7259-28475	9/16-18	1/2-20
G60312-0606	6MB-6MJ90	7259-28275	9/16-18	9/16-18
G60312-0608	6MB-8MJ90	7259-28485	9/16-18	3/4-16
G60312-0610	6MB-10MJ90	7259-28495	9/16-18	7/8-14
G60312-0612	6MB-12MJ90	7259-07915	9/16-18	1 1/16-12
G60312-0804	8MB-4MJ90	7259-05165	3/4-16	7/16-20
G60312-0805	8MB-5MJ90	7259-08075	3/4-16	1/2-20
G60312-0806	8MB-6MJ90	7259-28505	3/4-16	9/16-18
G60312-0808	8MB-8MJ90	7259-28285	3/4-16	3/4-16
G60312-0810	8MB-10MJ90	7259-28515	3/4-16	7/8-14
G60312-0812	8MB-12MJ90	7259-28525	3/4-16	1 1/16-12
G60312-0816	8MB-16MJ90	7259-08445	3/4-16	3/4-16
G60312-1005	10MB-5MJ90	7259-08935	7/8-14	1/2-20
G60312-1006	10MB-6MJ90	7259-00215	7/8-14	9/16-18
G60312-1008	10MB-8MJ90	7259-28295	7/8-14	3/4-16
G60312-1010	10MB-10MJ90	7259-28635	7/8-14	7/8-14
G60312-1012	10MB-12MJ90	7259-28535	7/8-14	1 1/16-12
G60312-1016	10MB-16MJ90	7259-05275	7/8-14	1 5/16-12
G60312-1206	12MB-6MJ90	7259-05065	1 1/16-12	9/16-18
G60312-1208	12MB-8MJ90	7259-00055	1 1/16-12	3/4-16
G60312-1210	12MB-10MJ90	7259-28545	1 1/16-12	7/8-14
G60312-1212	12MB-12MJ90	7259-28645	1 1/16-12	1 1/16-12
G60312-1214	12MB-14MJ90	7259-08945	1 1/16-12	1 3/16-12
G60312-1216	12MB-16MJ90	7259-28555	1 1/16-12	1 5/16-12
G60312-1220	12MB-20MJ90	7259-08435	1 1/16-12	1 5/8-12
G60312-1412	14MB-12MJ90	7259-06435	1 3/16-12	1 1/16-12
G60312-1414	14MB-14MJ90	7259-28655	1 3/16-12	1 3/16-12
G60312-1416	14MB-16MJ90	7259-07305	1 3/16-12	1 5/16-12
G60312-1420	14MB-20MJ90	7259-08955	1 3/16-12	1 5/8-12
G60312-1608	16MB-8MJ90	7259-05885	1 5/16-12	3/4-16
G60312-1610	16MB-10MJ90	7259-08965	1 5/16-12	7/8-14

Male O-Ring Boss to Male JIC 37° Flare - 90° - Continued

Part No.	Descr.	Prod. No.		
			"	"
G60312-1612	16MB-12MJ90	7259-28315	1 5/16-12	1 1/16-12
G60312-1614	16MB-14MJ90	7259-08975	1 5/16-12	1 3/16-12
G60312-1616	16MB-16MJ90	7259-28325	1 5/16-12	1 5/16-12
G60312-1620	16MB-20MJ90	7259-77655	1 5/16-12	1 5/8-12
G60312-1624	16MB-24MJ90	7259-08255	1 5/16-12	1 7/8-12
G60312-2010	20MB-10MJ90	7259-08265	1 5/8-12	7/8-14
G60312-2012	20MB-12MJ90	7259-05995	1 5/8-12	1 1/16-12
G60312-2016	20MB-16MJ90	7259-05055	1 5/8-12	1 5/16-12
G60312-2020	20MB-20MJ90	7259-77665	1 5/8-12	1 5/8-12
G60312-2024	20MB-24MJ90	7259-06015	1 5/8-12	1 7/8-12
G60312-2420	24MB-20MJ90	7259-06525	1 7/8-12	1 5/8-12
G60312-2424	24MB-24MJ90	7259-77675	1 7/8-12	1 7/8-12
G60312-3232	32MB-32MJ90	7259-07135	2 1/2-12	2 1/2-12

Male O-Ring Boss to Female JIC 37° Flare Swivel

For use up to SAE 100R2 maximum working pressure.

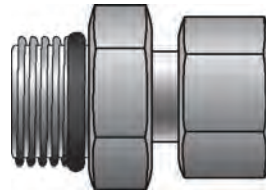

Part No.	Descr.	Prod. No.	
			"
G60320-0606	6MB-6FJX	7259-42155	9/16-18
G60320-0808	8MB-8FJX	7259-42185	3/4-16

Male JIC 37° Flare on Run to Male O-Ring Boss - Tee

For use up to SAE 100R2 maximum working pressure.

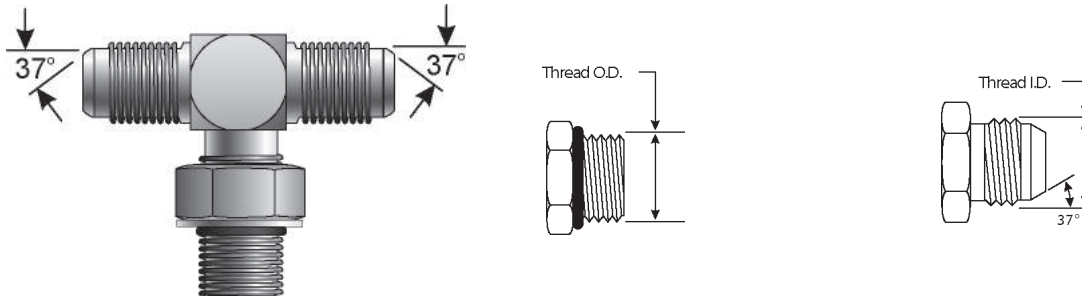

Part No.	Descr.	Prod. No.			
			"	"	"
G60350-0404	4MJ-4MJ-4MB	7259-33615	7/16-20	7/16-20	7/16-20
G60350-0505	5MJ-5MJ-5MB	7259-33625	1/2-20	1/2-20	1/2-20
G60350-0606	6MJ-6MJ-6MB	7259-33635	9/16-18	9/16-18	9/16-18
G60350-0608	6MJ-6MJ-8MB	7259-06165	9/16-18	9/16-18	3/4-16

- EQUIPMENT
- HOSE/CPLG. SELECTION
- G8K COUPLINGS
- GLOBAL SPIRAL COUPLINGS
- STAINLESS STEEL SPIRAL
- MEGACRIMP COUPLINGS
- STAINLESS STEEL BRAID
- POWER CRIMP COUPLINGS
- FIELD ATTACHABLE G1 & G2 COUPLINGS
- FIELD ATTACHABLE C5 COUPLINGS
- GLX COUPLINGS
- GL COUPLINGS
- C14 COUPLINGS
- PCTS THERMOPLASTIC COUPLINGS
- POLARSEAL COUPLINGS
- POLARSEAL II COUPLINGS
- POWER STEERING
- ADAPTERS
- QUICK DISCONNECT COUPLERS
- BALL VALVES
- LIVE SWIVEL
- ASSEMBLY FABRICATION
- ACCESSORIES
- EQUIPMENT AND PARTS
- AIR BRAKE
- BRASS
- KITS

Male JIC 37° Flare on Run to Male O-Ring Boss - Tee - Continued

Part No.	Descr.	Prod. No.			
			"	"	"
G60350-0808	8MJ-8MJ-8MB	7259-33645	3/4-16	3/4-16	3/4-16
G60350-0810	8MJ-8MJ-10MB	7259-07655	3/4-16	3/4-16	7/8-14
G60350-1010	10MJ-10MJ-10MB	7259-33655	7/8-14	7/8-14	7/8-14
G60350-1210	12MJ-12MJ-10MB	7259-08985	1 1/16-12	1 1/16-12	7/8-14
G60350-1212	12MJ-12MJ-12MB	7259-33665	1 1/16-12	1 1/16-12	1 1/16-12
G60350-1414	14MJ-14MJ-14MB	7259-08995	1 3/16-12	1 3/16-12	1 3/16-12
G60350-1616	16MJ-16MJ-16MB	7259-33675	1 5/16-12	1 5/16-12	1 5/16-12
G60350-2020	20MJ-20MJ-20MB	7259-09005	1 5/8-12	1 5/8-12	1 5/8-12
G60350-2424	24MJ-24MJ-24MB	7259-09015	1 7/8-12	1 7/8-12	1 7/8-12

Male O-Ring Boss to Male JIC 37° Flare to Male JIC 37° Flare - Tee

For use up to SAE 100R2 maximum working pressure.

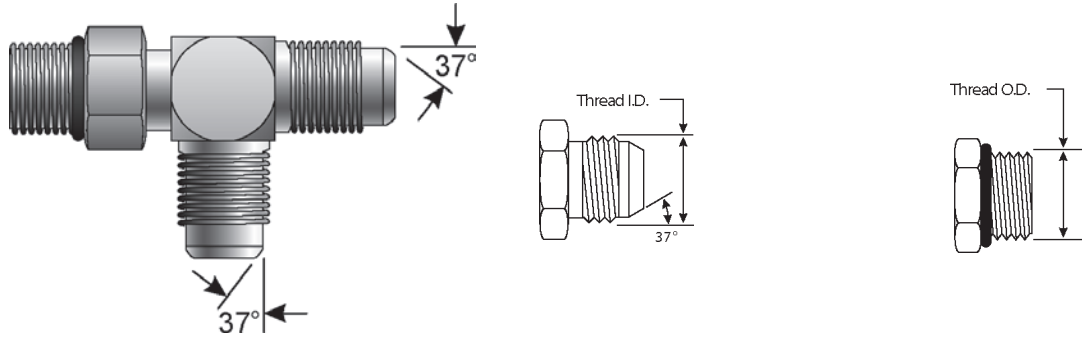

Part No.	Descr.	Prod. No.			
			"	"	"
G60352-0404	4MB-4MJ-4MJ	7259-33685	7/16-20	7/16-20	7/16-20
G60352-0505	5MB-5MJ-5MJ	7259-33695	1/2-20	1/2-20	1/2-20
G60352-0606	6MB-6MJ-6MJ	7259-33705	9/16-18	9/16-18	9/16-18
G60352-0608	6MB-8MJ-6MJ	7259-00185	9/16-18	3/4-16	9/16-18
G60352-0808	8MB-8MJ-8MJ	7259-33715	3/4-16	3/4-16	3/4-16
G60352-1010	10MB-10MJ-10MJ	7259-33725	7/8-14	7/8-14	7/8-14
G60352-1212	12MB-12MJ-12MJ	7259-33735	1 1/16-12	1 1/16-12	1 1/16-12
G60352-1216	12MB-12MJ-16MJ	7259-09025	1 1/16-12	1 1/16-12	1 5/16-12
G60352-1414	14MB-14MJ-14MJ	7259-09035	1 3/16-12	1 3/16-12	1 3/16-12
G60352-1616	16MB-16MJ-16MJ	7259-33745	1 5/16-12	1 5/16-12	1 5/16-12
G60352-2020	20MB-20MJ-20MJ	7259-07535	1 5/8-12	1 5/8-12	1 5/8-12
G60352-2424	24MB-24MJ-24MJ	7259-09045	1 7/8-12	1 7/8-12	1 7/8-12

Female JIC 37° Flare Cap

For use up to SAE 100R2 maximum working pressure.

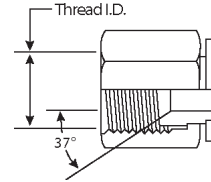
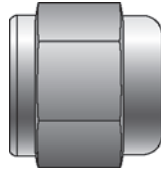

Part No.	Descr.	Prod. No.	
			"
G60401-0002	2FJ-CAP	7259-09865	5/16-24
G60401-0003	3FJ-CAP	7259-07435	3/8-24
G60401-0004	4FJ-CAP	7259-24305	7/16-20
G60401-0005	5FJ-CAP	7259-24315	1/2-20
G60401-0006	6FJ-CAP	7259-24325	9/16-18
G60401-0008	8FJ-CAP	7259-24335	3/4-16
G60401-0010	10FJ-CAP	7259-24345	7/8-14
G60401-0012	12FJ-CAP	7259-24355	1 1/16-12
G60401-0014	14FJ-CAP	7259-00445	1 3/16-12
G60401-0016	16FJ-CAP	7259-24365	1 5/16-12
G60401-0020	20FJ-CAP	7253-24375	1 5/8-12
G60401-0024	24FJ-CAP	7259-24385	1 7/8-12
G60401-0032	32FJ-CAP	7259-24405	2 1/2-12

Male JIC 37° Flare Plug

For use up to SAE 100R2 maximum working pressure.

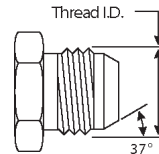
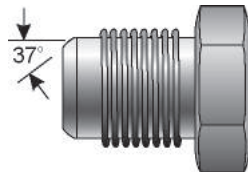

Part No.	Descr.	Prod. No.	
			"
G60402-0003	3MJ-PLUG	7259-09775	3/8-24
G60402-0004	4MJ-PLUG	7259-22885	7/16-20
G60402-0005	5MJ-PLUG	7259-22895	1/2-20
G60402-0006	6MJ-PLUG	7259-22905	9/16-18
G60402-0008	8MJ-PLUG	7259-22915	3/4-16
G60402-0010	10MJ-PLUG	7259-22925	7/8-14
G60402-0012	12MJ-PLUG	7259-22935	1 1/16-12
G60402-0014	14MJ-PLUG	7259-22945	1 5/16-12
G60402-0016	16MJ-PLUG	7259-22955	1 5/16-12
G60402-0020	20MJ-PLUG	7259-22965	1 5/8-12
G60402-0024	24MJ-PLUG	7259-33755	1 7/8-12
G60402-0032	32MJ-PLUG	7259-33765	2 1/2-12

- EQUIPMENT
- HOSE/CPLG. SELECTION
- G8K COUPLINGS
- GLOBALSPIRAL COUPLINGS
- STAINLESS STEEL SPIRAL
- MEGACRIMP COUPLINGS
- STAINLESS STEEL BRAID
- POWER CRIMP COUPLINGS
- FIELD ATTACHABLE G1 & G2 COUPLINGS
- FIELD ATTACHABLE C5 COUPLINGS
- GLX COUPLINGS
- GL COUPLINGS
- C14 COUPLINGS
- PCTS THERMOPLASTIC COUPLINGS
- POLARSEAL COUPLINGS
- POLARSEAL II COUPLINGS
- POWER STEERING
- ADAPTERS
- QUICK DISCONNECT COUPLERS
- BALL VALVES
- LIVE SWIVEL
- ASSEMBLY FABRICATION
- ACCESSORIES
- EQUIPMENT AND PARTS
- AIR BRAKE
- BRASS
- KITS

EQUIPMENT
HOSE/CPLG. SELECTION
G8K COUPLINGS
GLOBALSPIRAL COUPLINGS
STAINLESS STEEL SPIRAL
MEGACRIMP COUPLINGS
STAINLESS STEEL BRAID
POWER CRIMP COUPLINGS
FIELD ATTACHABLE G1 & G2 COUPLINGS
FIELD ATTACHABLE C5 COUPLINGS
GLX COUPLINGS
GL COUPLINGS
C14 COUPLINGS
PCTS THERMOPLASTIC COUPLINGS
POLARSEAL COUPLINGS
POLARSEAL II COUPLINGS
POWER STEERING
ADAPTERS
QUICK DISCONNECT COUPLERS
BALL VALVES
LIVE SWIVEL
ASSEMBLY FABRICATION
ACCESSORIES
EQUIPMENT AND PARTS
AIR BRAKE
BRASS
KITS

Male JIC 37° Flare to Female Braze - On

For use up to SAE 100R2 maximum working pressure.

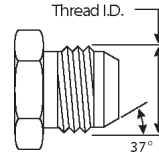
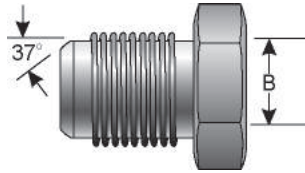

Part No.	Descr.	Prod. No.		
			"	"
G60405-2020	20MJ-20FBO	7253-28735	1 5/8-12	1 1/4

Male JIC 37° Flare to Male JIC 37° Flare

For use up to SAE 100R2 maximum working pressure.

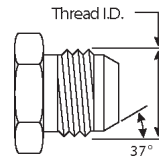
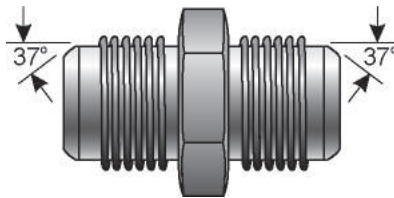

Part No.	Descr.	Prod. No.		
			"	"
G60410-0202	2MJ-2MJ	7259-77775	5/16-24	5/16-24
G60410-0302	3MJ-2MJ	7259-09065	3/8-24	5/16-24
G60410-0303	3MJ-3MJ	7259-77785	3/8-24	3/8-24
G60410-0403	4MJ-3MJ	7259-09075	7/16-20	3/8-24
G60410-0404	4MJ-4MJ	7259-10125	7/16-20	7/16-20
G60410-0504	5MJ-4MJ	7259-77795	1/2-20	7/16-20
G60410-0505	5MJ-5MJ	7259-10735	1/2-20	1/2-20
G60410-0604	6MJ-4MJ	7259-00285	9/16-18	7/16-20
G60410-0605	6MJ-5MJ	7259-77805	9/16-18	1/2-20
G60410-0606	6MJ-6MJ	7259-06265	9/16-18	9/16-18
G60410-0804	8MJ-4MJ	7259-06505	3/4-16	7/16-20
G60410-0805	8MJ-5MJ	7259-09085	3/4-16	1/2-20
G60410-0806	8MJ-6MJ	7259-00075	3/4-16	9/16-18
G60410-0808	8MJ-8MJ	7259-06275	3/4-16	3/4-16
G60410-1004	10MJ-4MJ	7259-07195	7/8-14	7/16-20
G60410-1006	10MJ-6MJ	7259-07805	7/8-14	9/16-18
G60410-1008	10MJ-8MJ	7259-00375	7/8-14	3/4-16
G60410-1010	10MJ-10MJ	7259-10225	7/8-14	7/8-14
G60410-1204	12MJ-4MJ	7259-09095	1 1/16-12	7/16-20
G60410-1206	12MJ-6MJ	7259-08455	1 1/16-12	9/16-18
G60410-1208	12MJ-8MJ	7259-77815	1 1/16-12	3/4-16
G60410-1210	12MJ-10MJ	7259-00565	1 1/16-12	7/8-14
G60410-1212	12MJ-12MJ	7259-10235	1 1/16-12	1 1/16-12
G60410-1412	14MJ-12MJ	7259-09105	1 3/16-12	1 1/16-12
G60410-1414	14MJ-14MJ	7259-77825	1 3/16-12	1 3/16-12
G60410-1608	16MJ-8MJ	7259-07205	1 5/16-12	3/4-16
G60410-1610	16MJ-10MJ	7259-07505	1 5/16-12	7/8-14
G60410-1612	16MJ-12MJ	7259-77835	1 5/16-12	1 1/16-12
G60410-1616	16MJ-16MJ	7259-10655	1 5/16-12	1 5/16-12
G60410-2012	20MJ-12MJ	7259-09115	1 5/8-12	1 1/16-12

Male JIC 37° Flare to Male JIC 37° Flare - Continued

Part No.	Descr.	Prod. No.		
			"	"
G60410-2016	20MJ-16MJ	7259-06555	1 5/8-12	1 5/16-12
G60410-2020	20MJ-20MJ	7259-11145	1 5/8-12	1 5/8-12
G60410-2412	24MJ-12MJ	7259-09125	1 7/8-12	1 1/16-12
G60410-2420	24MJ-20MJ	7259-09135	1 7/8-12	1 5/8-12
G60410-2424	24MJ-24MJ	7259-33845	1 7/8-12	1 7/8-12
G60410-3232	32MJ-32MJ	7259-33855	2 1/2-12	2 1/2-12

Male JIC 37° Flare to Male JIC 37° Flare - 90°

For use up to SAE 100R2 maximum working pressure.

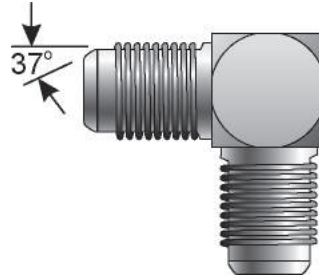



Part No.	Descr.	Prod. No.		
			"	"
G60417-0202	2MJ-2MJ90	7259-09145	5/16-24	5/16-24
G60417-0404	4MJ-4MJ90	7259-77845	7/16-20	7/16-20
G60417-0505	5MJ-5MJ90	7259-05865	1/2-20	1/2-20
G60417-0604	6MJ-4MJ90	7259-07925	9/16-18	7/16-20
G60417-0606	6MJ-6MJ90	7259-77855	9/16-18	9/16-18
G60417-0806	8MJ-6MJ90	7259-06745	3/4-16	9/16-18
G60417-0808	8MJ-8MJ90	7259-77865	3/4-16	3/4-16
G60417-1010	10MJ-10MJ90	7259-77875	7/8-14	7/8-14
G60417-1212	12MJ-12MJ90	7259-77885	1 1/16-12	1 1/16-12
G60417-1414	14MJ-14MJ90	7259-08275	1 3/16-12	1 3/16-12
G60417-1612	16MJ-12MJ90	7259-09155	1 5/16-12	1 1/16-12
G60417-1616	16MJ-16MJ90	7259-77895	1 5/16-12	1 5/16-12
G60417-2020	20MJ-20MJ90	7259-07095	1 5/8-12	1 5/8-12
G60417-2424	24MJ-24MJ90	7259-07105	1 7/8-12	1 7/8-12
G60417-3232	32MJ-32MJ90	7259-08465	2 1/2-12	2 1/2-12

- EQUIPMENT
- HOSE/CPLG. SELECTION
- G8K COUPLINGS
- GLOBAL SPIRAL COUPLINGS
- STAINLESS STEEL SPIRAL
- MEGACRIMP COUPLINGS
- STAINLESS STEEL BRAID
- POWER CRIMP COUPLINGS
- FIELD ATTACHABLE G1 & G2 COUPLINGS
- FIELD ATTACHABLE C5 COUPLINGS
- GLX COUPLINGS
- GL COUPLINGS
- C14 COUPLINGS
- PCTS THERMOPLASTIC COUPLINGS
- POLARSEAL COUPLINGS
- POLARSEAL II COUPLINGS
- POWER STEERING
- ADAPTERS
- QUICK DISCONNECT COUPLERS
- BALL VALVES
- LIVE SWIVEL
- ASSEMBLY FABRICATION
- ACCESSORIES
- EQUIPMENT AND PARTS
- AIR BRAKE
- BRASS
- KITS

Male JIC 37° Flare to Female JIC 37° Flare

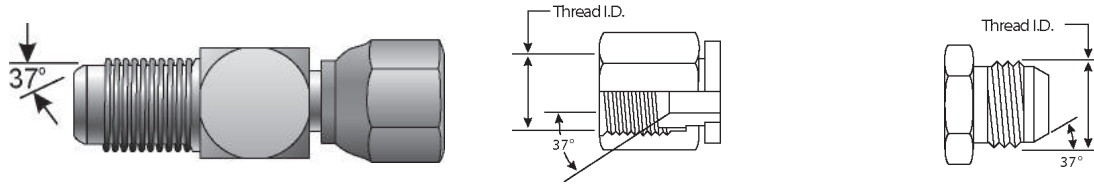
For use up to SAE 100R2 maximum working pressure.



Part No.	Descr.	Prod. No.		
			"	"
G60420-0406	4MJ-6FJ	7259-33865	7/16-20	9/16-18
G60420-0504	5MJ-4FJ	7259-07445	1/2-20	7/16-20
G60420-0506	5MJ-6FJ	7259-09175	1/2-20	9/16-18
G60420-0604	6MJ-4FJ	7259-00015	9/16-18	7/16-20
G60420-0606	6MJ-6FJ	7259-09195	9/16-18	9/16-18
G60420-0608	6MJ-8FJ	7259-33875	9/16-18	3/4-16
G60420-0610	6MJ-10FJ	7259-33885	9/16-18	7/8-14
G60420-0804	8MJ-4FJ	7259-00935	3/4-16	7/16-20
G60420-0808	8MJ-8FJ	7259-06135	3/4-16	3/4-16
G60420-0810	8MJ-10FJ	7253-33895	3/4-16	7/8-14
G60420-0812	8MJ-12FJ	7259-33905	3/4-16	3/4-16
G60420-1004	10MJ-4FJ	7259-05915	7/8-14	7/16-20
G60420-1006	10MJ-6FJ	7259-05375	7/8-14	9/16-18
G60420-1008	10MJ-8FJ	7259-00705	7/8-14	3/4-16
G60420-1012	10MJ-12FJ	7259-33915	7/8-14	1 1/16-12
G60420-1016	10MJ-16FJ	7259-33925	7/8-14	1 5/16-12
G60420-1204	12MJ-4FJ	7259-05235	1 1/16-12	7/16-20
G60420-1206	12MJ-6FJ	7259-00145	1 1/16-12	9/16-18
G60420-1208	12MJ-8FJ	7259-00115	1 1/16-12	3/4-16
G60420-1212	12MJ-12FJ	7259-09205	1 1/16-12	1 1/16-12
G60420-1216	12MJ-16FJ	7253-33935	1 1/16-12	1 5/16-12
G60420-1220	12MJ-20FJ	7253-33945	1 1/16-12	1 5/8-12
G60420-1616	16MJ-16FJ	7259-09215	1 5/16-12	1 5/16-12
G60420-1620	16MJ-20FJ	7259-33955	1 5/16-12	1 5/8-12
G60420-2016	20MJ-16FJ	7259-05085	1 5/8-12	1 5/16-12

Male JIC 37° Flare to Female JIC 37° Flare Swivel - 90°

For use up to SAE 100R2 maximum working pressure.

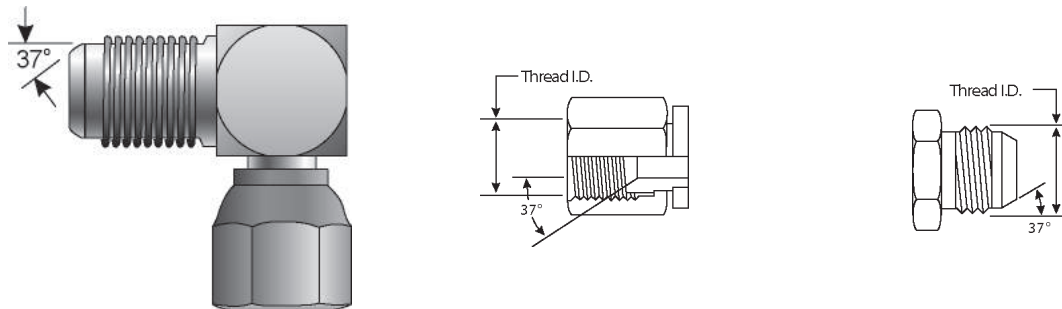

Part No.	Descr.	Prod. No.		
			"	"
G60422-0404	4MJ-4FJX90	7259-23285	7/16-20	7/16-20
G60422-0505	5MJ-5FJX90	7259-24025	1/2-20	1/2-20

Male JIC 37° Flare to Female JIC 37° Flare Swivel - 90° - Continued

Part No.	Descr.	Prod. No.		
			"	"
G60422-0604	6MJ-4FJX90	7259-06905	9/16-18	7/16-20
G60422-0606	6MJ-6FJX90	7259-23295	9/16-18	9/16-18
G60422-0806	8MJ-6FJX90	7259-06205	3/4-16	9/16-18
G60422-0808	8MJ-8FJX90	7259-23305	3/4-16	3/4-16
G60422-0810	8MJ-10FJX90	7259-06385	3/4-16	3/4-16
G60422-1010	10MJ-10FJX90	7259-23315	7/8-14	7/8-14
G60422-1212	12MJ-12FJX90	7259-23325	1 1/16-12	1 1/16-12
G60422-1414	14MJ-14FJX90	7259-06215	1 3/16-12	1 3/16-12
G60422-1616	16MJ-16FJX90	7259-23335	1 5/16-12	1 5/16-12
G60422-2020	20MJ-20FJX90	7259-24075	1 5/8-12	1 5/8-12
G60422-2424	24MJ-24FJX90	7259-24085	1 7/8-12	1 7/8-12
G60422-3232	32MJ-32FJX90	7259-24095	2 1/2-12	2 1/2-12

Male JIC 37° Flare to Female JIC 37° Flare Swivel - 45°

For use up to SAE 100R2 maximum working pressure.

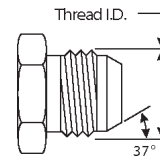
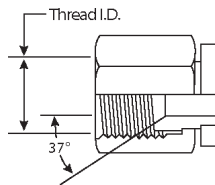
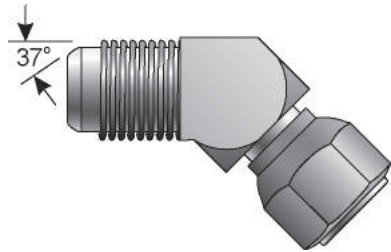

Part No.	Descr.	Prod. No.		
			"	"
G60424-0404	4MJ-4FJX45	7259-23215	7/16-20	7/16-20
G60424-0505	5MJ-5FJX45	7259-33965	1/2-20	1/2-20
G60424-0606	6MJ-6FJX45	7259-23225	9/16-18	9/16-18
G60424-0808	8MJ-8FJX45	7259-23235	3/4-16	3/4-16
G60424-1010	10MJ-10FJX45	7259-23245	7/8-14	7/8-14
G60424-1212	12MJ-12FJX45	7259-23255	1 1/16-12	1 1/16-12
G60424-1414	14MJ-14FJX45	7259-06995	1 3/16-12	1 3/16-12
G60424-1616	16MJ-16FJX45	7259-23265	1 5/16-12	1 5/16-12
G60424-2020	20MJ-20FJX45	7259-23275	1 5/8-12	1 5/8-12
G60424-2424	24MJ-24FJX45	7259-05455	1 7/8-12	1 7/8-12
G60424-3232	32MJ-32FJX45	7259-07935	2 1/2-12	2 1/2-12

- EQUIPMENT
- HOSE/CPLG. SELECTION
- G8K COUPLINGS
- GLOBALSPIRAL COUPLINGS
- STAINLESS STEEL SPIRAL
- MEGACRIMP COUPLINGS
- STAINLESS STEEL BRAID
- POWER CRIMP COUPLINGS
- FIELD ATTACHABLE G1 & G2 COUPLINGS
- FIELD ATTACHABLE C5 COUPLINGS
- GLX COUPLINGS
- GL COUPLINGS
- C14 COUPLINGS
- PCTS THERMOPLASTIC COUPLINGS
- POLARSEAL COUPLINGS
- POLARSEAL II COUPLINGS
- POWER STEERING
- ADAPTERS
- QUICK DISCONNECT COUPLERS
- BALL VALVES
- LIVE SWIVEL
- ASSEMBLY FABRICATION
- ACCESSORIES
- EQUIPMENT AND PARTS
- AIR BRAKE
- BRASS
- KITS

Male JIC 37° Flare to Male JIC 37° Flare Bulkhead

For use up to SAE 100R2 maximum working pressure.

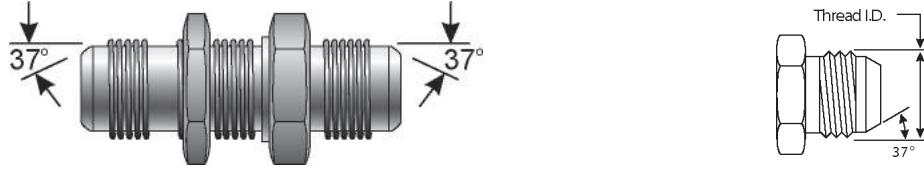

Part No.	Descr.	Prod. No.	Thread	
			Part No.	Prod. No.
G60445-0303	3MJ-3BKHD	7259-09295		3/8-24
G60445-0404	4MJ-4BKHD	7259-24505		7/16-20
G60445-0505	5MJ-5BKHD	7259-24515		1/2-20
G60445-0606	6MJ-6BKHD	7259-24525		9/16-18
G60445-0808	8MJ-8BKHD	7259-24535		3/4-16
G60445-1010	10MJ-10BKHD	7259-24545		7/8-14
G60445-1212	12MJ-12BKHD	7259-24555		1 1/16-12
G60445-1414	14MJ-14BKHD	7259-08495		1 3/16-12
G60445-1616	16MJ-16BKHD	7259-24565		1 5/16-12
G60445-2020	20MJ-20BKHD	7259-34155		1 5/8-12
G60445-2424	24MJ-24BKHD	7259-34165		1 7/8-12

Male JIC 37° Flare to Male JIC 37° Flare Bulkhead - 45°

For use up to SAE 100R2 maximum working pressure.

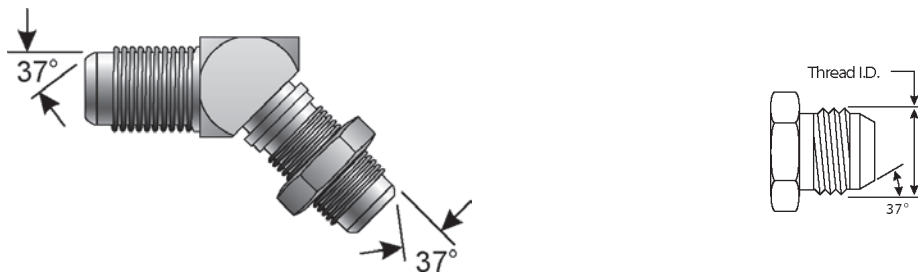

Part No.	Descr.	Prod. No.	Thread	
			Part No.	Prod. No.
G60446-0404	4MJ-4BKHD45	7259-34175		7/16-20
G60446-0505	5MJ-5BKHD45	7259-34185		1/2-20
G60446-0606	6MJ-6BKHD45	7259-34195		9/16-18
G60446-0808	8MJ-8BKHD45	7259-34205		3/4-16
G60446-1010	10MJ-10BKHD45	7259-34215		7/8-14
G60446-1212	12MJ-12BKHD45	7259-34225		1 1/16-12
G60446-1616	16MJ-16BKHD45	7259-34235		1 5/16-12

Male JIC 37° Flare to Male JIC 37° Flare Bulkhead - 90°

For use up to SAE 100R2 maximum working pressure.

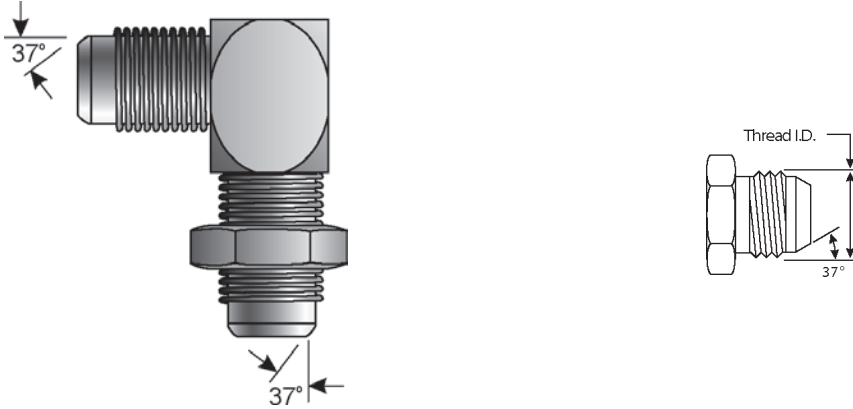

Part No.	Descr.	Prod. No.	Coupling	
			Symbol	Size
G60447-0404	4MJ-4BKHD90	7259-34255		7/16-20
G60447-0505	5MJ-5BKHD90	7259-34265		1/2-20
G60447-0606	6MJ-6BKHD90	7259-34275		9/16-18
G60447-0808	8MJ-8BKHD90	7259-34285		3/4-16
G60447-1010	10MJ-10BKHD90	7259-34295		7/8-14
G60447-1212	12MJ-12BKHD90	7259-34305		1 1/16-12
G60447-1414	14MJ-14BKHD90	7259-09315		1 3/16-12
G60447-1616	16MJ-16BKHD90	7259-34315		1 5/16-12
G60447-2020	20MJ-20BKHD90	7259-34325		1 5/8-12
G60447-2424	24MJ-24BKHD90	7259-09325		1 7/8-12

Male JIC 37° Flare Tee

For use up to SAE 100R2 maximum working pressure.

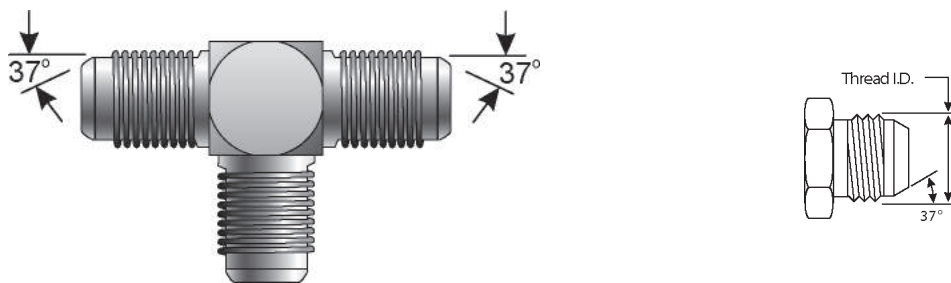

Part No.	Descr.	Prod. No.	Coupling	
			Symbol	Size
G60469-0202	2MJ-2MJ-2MJ	7259-77905		5/16-24
G60469-0303	3MJ-3MJ-3MJ	7259-08095		3/8-24
G60469-0404	4MJ-4MJ-4MJ	7259-23345		7/16-20
G60469-0505	5MJ-5MJ-5MJ	7259-34335		1/2-20
G60469-0606	6MJ-6MJ-6MJ	7259-23355		9/16-18
G60469-0608	6MJ-6MJ-8MJ	7253-34345		9/16-18
G60469-0808	8MJ-8MJ-8MJ	7259-23365		3/4-16
G60469-1010	10MJ-10MJ-10MJ	7259-23375		7/8-14
G60469-1212	12MJ-12MJ-12MJ	7259-23385		1 1/16-12
G60469-1414	14MJ-14MJ-14MJ	7259-09335		1 3/16-12

EQUIPMENT
HOSE/CPLG. SELECTION
G8K COUPLINGS
GLOBALSPIRAL COUPLINGS
STAINLESS STEEL SPIRAL
MEGACRIMP COUPLINGS
STAINLESS STEEL BRAID
POWER CRIMP COUPLINGS
FIELD ATTACHABLE G1 & G2 COUPLINGS
FIELD ATTACHABLE C5 COUPLINGS
GLX COUPLINGS
GL COUPLINGS
C14 COUPLINGS
PCTS THERMOPLASTIC COUPLINGS
POLARSEAL COUPLINGS
POLARSEAL II COUPLINGS
POWER STEERING
ADAPTERS
QUICK DISCONNECT COUPLERS
BALL VALVES
LIVE SWIVEL
ASSEMBLY FABRICATION
ACCESSORIES
EQUIPMENT AND PARTS
AIR BRAKE
BRASS
KITS

Male JIC 37° Flare Tee - Continued

Part No.	Descr.	Prod. No.		
			"	"
G60469-1612	16MJ-16MJ-12MJ	7259-34365	1 5/16-12	
G60469-1616	16MJ-16MJ-16MJ	7259-23395	1 5/16-12	
G60469-2020	20MJ-20MJ-20MJ	7259-23405	1 5/8-12	
G60469-2424	24MJ-24MJ-24MJ	7259-07555	1 7/8-12	
G60469-3232	32MJ-32MJ-32MJ	7259-07455	2 1/2-12	

Male JIC 37° Flare on Run to Female JIC 37° Flare Swivel - Tee

For use up to SAE 100R2 maximum working pressure.

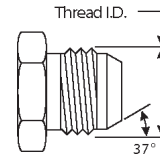
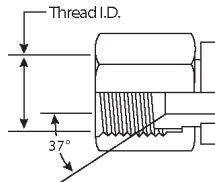
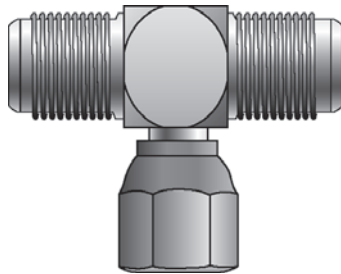

Part No.	Descr.	Prod. No.		
			"	"
G60470-0404	4MJ-4MJ-4FJX	7259-24805	7/16-20	7/16-20
G60470-0505	5MJ-5MJ-5FJX	7259-06535	1/2-20	1/2-20
G60470-0606	6MJ-6MJ-6FJX	7259-24815	9/16-18	9/16-18
G60470-0808	8MJ-8MJ-8FJX	7259-24825	3/4-16	3/4-16
G60470-1010	10MJ-10MJ-10FJX	7259-34405	7/8-14	7/8-14
G60470-1212	12MJ-12MJ-12FJX	7259-24835	1 1/16-12	1 1/16-12
G60470-1414	14MJ-14MJ-14FJX	7259-07945	1 3/16-12	1 3/16-12
G60470-1616	16MJ-16MJ-16FJX	7259-24845	1 5/16-12	1 5/16-12
G60470-2020	20MJ-20MJ-20FJX	7259-34415	1 5/8-12	1 5/8-12
G60470-2424	24MJ-24MJ-24FJX	7259-08505	1 7/8-12	1 7/8-12
G60470-3232	32MJ-32MJ-32FJX	7259-09345	2 1/2-12	2 1/2-12

- EQUIPMENT
- HOSE/CPLG. SELECTION
- G8K COUPLINGS
- GLOBALSPIRAL COUPLINGS
- STAINLESS STEEL SPIRAL
- MEGACRIMP COUPLINGS
- STAINLESS STEEL BRAID
- POWER CRIMP COUPLINGS
- FIELD ATTACHABLE G1 & G2 COUPLINGS
- FIELD ATTACHABLE C5 COUPLINGS
- GLX COUPLINGS
- GL COUPLINGS
- C14 COUPLINGS
- PCTS THERMOPLASTIC COUPLINGS
- POLARSEAL COUPLINGS
- POLARSEAL II COUPLINGS
- POWER STEERING
- ADAPTERS
- QUICK DISCONNECT COUPLERS
- BALL VALVES
- LIVE SWIVEL
- ASSEMBLY FABRICATION
- ACCESSORIES
- EQUIPMENT AND PARTS
- AIR BRAKE
- BRASS
- KITS

Male JIC 37° Flare on Run to Male JIC 37° Flare Bulkhead - Tee

For use up to SAE 100R2 maximum working pressure.

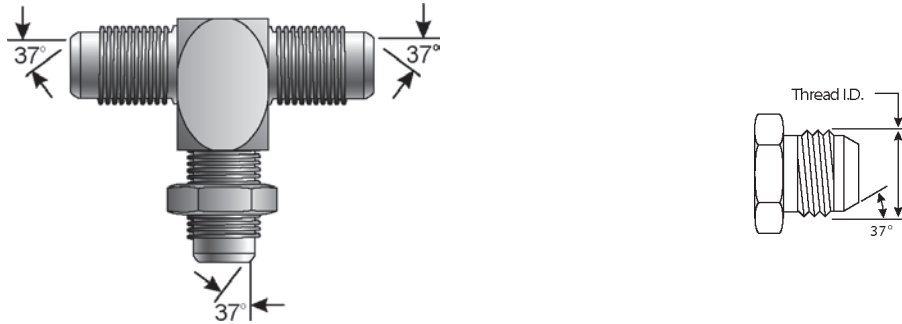

Part No.	Descr.	Prod. No.	Flare	
			"	"
G60471-0404	4MJ-4MJ-4BKHD	7259-34425	7/16-20	
G60471-0505	5MJ-5MJ-5BKHD	7259-34435	1/2-20	
G60471-0606	6MJ-6MJ-6BKHD	7259-34445	9/16-18	
G60471-0808	8MJ-8MJ-8BKHD	7259-34455	3/4-16	
G60471-1010	10MJ-10MJ-10BKHD	7259-34465	7/8-14	
G60471-1212	12MJ-12MJ-12BKHD	7259-34475	1 1/16-12	
G60471-1616	16MJ-16MJ-16BKHD	7259-34485	1 5/16-12	

Male JIC 37° Flare to Male JIC 37° Flare Bulkhead to Male JIC 37° Flare - Tee

For use up to SAE 100R2 maximum working pressure.

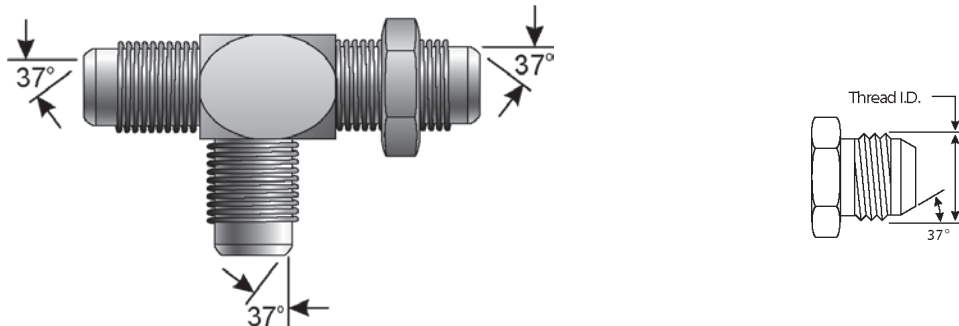



Part No.	Descr.	Prod. No.	Flare	
			"	"
G60472-0404	4MJ-4BKHD-4MJ	7259-34495	7/16-20	
G60472-0606	6MJ-6BKHD-6MJ	7259-34515	9/16-18	
G60472-0808	8MJ-8BKHD-8MJ	7259-34525	3/4-16	
G60472-1010	10MJ-10BKHD-10MJ	7259-34535	7/8-14	
G60472-1212	12MJ-12BKHD-12MJ	7259-34545	1 1/16-12	
G60472-1616	16MJ-16BKHD-16MJ	7259-34555	1 5/16-12	

- EQUIPMENT
- HOSE/CPLG. SELECTION
- G&K COUPLINGS
- GLOBALSPIRAL COUPLINGS
- STAINLESS STEEL SPIRAL
- MEGACRIMP COUPLINGS
- STAINLESS STEEL BRAID
- POWER CRIMP COUPLINGS
- FIELD ATTACHABLE G1 & G2 COUPLINGS
- FIELD ATTACHABLE C5 COUPLINGS
- GLX COUPLINGS
- GL COUPLINGS
- C14 COUPLINGS
- PCTS THERMOPLASTIC COUPLINGS
- POLARSEAL COUPLINGS
- POLARSEAL II COUPLINGS
- POWER STEERING
- ADAPTERS
- QUICK DISCONNECT COUPLERS
- BALL VALVES
- LIVE SWIVEL
- ASSEMBLY FABRICATION
- ACCESSORIES
- EQUIPMENT AND PARTS
- AIR BRAKE
- BRASS
- KITS

Male JIC 37° Flare to Female JIC 37° Flare Swivel to Male JIC 37° Flare - Tee

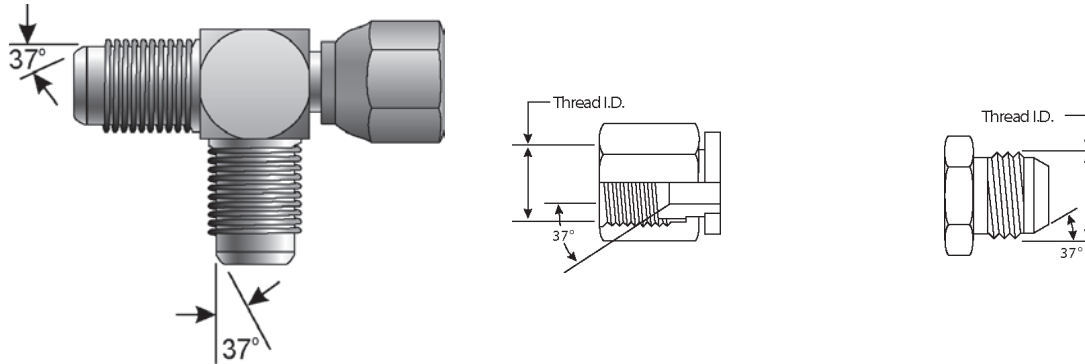
For use up to SAE 100R2 maximum working pressure.



Part No.	Descr.	Prod. No.		
			"	"
G60473-0404	4MJ-4FJX-4MJ	7259-24705	7/16-20	7/16-20
G60473-0505	5MJ-5FJX-5MJ	7259-77915	1/2-20	1/2-20
G60473-0606	6MJ-6FJX-6MJ	7259-24725	9/16-18	9/16-18
G60473-0808	8MJ-8FJX-8MJ	7259-24735	3/4-16	3/4-16
G60473-1010	10MJ-10FJX-10MJ	7259-24745	7/8-14	7/8-14
G60473-1212	12MJ-12FJX-12MJ	7259-24755	1 1/16-12	1 1/16-12
G60473-1414	14MJ-14FJX-14MJ	7259-08325	1 3/16-12	1 3/16-12
G60473-1616	16MJ-16FJX-16MJ	7259-24765	1 5/16-12	1 5/16-12
G60473-2020	20MJ-20FJX-20MJ	7259-77925	1 5/8-12	1 5/8-12
G60473-2424	24MJ-24FJX-24MJ	7259-07955	1 7/8-12	1 7/8-12
G60473-3232	32MJ-32FJX-32MJ	7259-09355	2 1/2-12	2 1/2-12

Male JIC 37° Flare to Male Pipe NPTF

For use up to SAE 100R2 maximum working pressure.

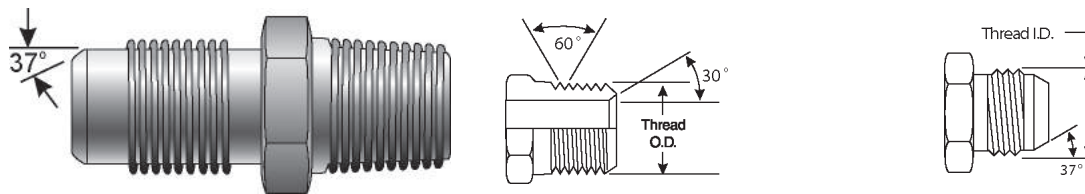

Part No.	Descr.	Prod. No.		
			"	"
G60490-0202	2MJ-2MP	7259-77935	5/16-24	1/8-27
G60490-0302	3MJ-2MP	7259-77945	3/8-24	1/8-27
G60490-0402	4MJ-2MP	7259-10085	7/16-20	1/8-27
G60490-0404	4MJ-4MP	7259-04195	7/16-20	1/4-18
G60490-0406	4MJ-6MP	7259-10385	7/16-20	3/8-18
G60490-0408	4MJ-8MP	7259-70455	7/16-20	1/2-14
G60490-0412	4MJ-12MP	7259-07215	7/16-20	3/4-14
G60490-0502	5MJ-2MP	7259-10995	1/2-20	1/8-27
G60490-0504	5MJ-4MP	7259-10415	1/2-20	1/4-18
G60490-0506	5MJ-6MP	7259-25665	1/2-20	3/8-18
G60490-0508	5MJ-8MP	7259-07835	1/2-20	1/2-14
G60490-0602	6MJ-2MP	7259-10565	9/16-18	1/8-27

Male JIC 37° Flare to Male Pipe NPTF - Continued

Part No.	Descr.	Prod. No.		
			"	"
G60490-0604	6MJ-4MP	7259-25635	9/16-18	1/4-18
G60490-0606	6MJ-6MP	7259-04225	9/16-18	3/8-18
G60490-0608	6MJ-8MP	7259-10205	9/16-18	1/2-14
G60490-0612	6MJ-12MP	7259-00425	9/16-18	3/4-14
G60490-0802	8MJ-2MP	7259-09875	3/4-16	1/8-27
G60490-0804	8MJ-4MP	7259-10435	3/4-16	1/4-18
G60490-0806	8MJ-6MP	7259-10105	3/4-16	3/8-18
G60490-0808	8MJ-8MP	7259-04235	3/4-16	1/2-14
G60490-0812	8MJ-12MP	7259-10545	3/4-16	3/4-14
G60490-0816	8MJ-16MP	7259-05835	3/4-16	1-11 1/2
G60490-1004	10MJ-4MP	7259-07965	7/8-14	1/4-18
G60490-1006	10MJ-6MP	7259-10785	7/8-14	3/8-18
G60490-1008	10MJ-8MP	7259-25715	7/8-14	1/2-14
G60490-1012	10MJ-12MP	7259-10595	7/8-14	3/4-14
G60490-1206	12MJ-6MP	7259-07225	1 1/16-12	3/8-18
G60490-1208	12MJ-8MP	7259-10255	1 1/16-12	1/2-14
G60490-1212	12MJ-12MP	7259-25735	1 1/16-12	3/4-14
G60490-1216	12MJ-16MP	7259-10355	1 1/16-12	1-11 1/2
G60490-1220	12MJ-20MP	7259-05765	1 1/16-12	1 1/4-11 1/2
G60490-1224	12MJ-24MP	7259-07665	1 1/16-12	1 1/2-11 1/2
G60490-1412	14MJ-12MP	7259-77965	1 3/16-12	3/4-14
G60490-1416	14MJ-16MP	7259-07975	1 3/16-12	1-11 1/2
G60490-1608	16MJ-8MP	7259-06095	1 5/16-12	1/2-14
G60490-1612	16MJ-12MP	7259-10485	1 5/16-12	3/4-14
G60490-1616	16MJ-16MP	7259-04275	1 5/16-12	1-11 1/2
G60490-1620	16MJ-20MP	7259-34565	1 5/16-12	1 1/4-11 1/2
G60490-1624	16MJ-24MP	7259-06065	1 5/16-12	1 1/2-11 1/2
G60490-2012	20MJ-12MP	7259-07675	1 5/8-12	3/4-14
G60490-2016	20MJ-16MP	7259-11465	1 5/8-12	1-11 1/2
G60490-2020	20MJ-20MP	7259-10465	1 5/8-12	1 1/4-11 1/2
G60490-2024	20MJ-24MP	7259-34575	1 5/8-12	1 1/2-11 1/2
G60490-2416	24MJ-16MP	7259-07125	1 7/8-12	1-11 1/2
G60490-2420	24MJ-20MP	7259-34585	1 7/8-12	1 1/4-11 1/2
G60490-2424	24MJ-24MP	7259-11245	1 7/8-12	1 1/2-11 1/2
G60490-2432	24MJ-32MP	7259-09375	1 7/8-12	2-11 1/2
G60490-3216	32MJ-16MP	7259-09385	2 1/2-12	1-11 1/2
G60490-3220	32MJ-20MP	7259-09395	2 1/2-12	1 1/4-11 1/2
G60490-3224	32MJ-24MP	7259-34595	2 1/2-12	1 1/2-11 1/2
G60490-3232	32MJ-32MP	7259-11365	2 1/2-12	2-11 1/2

EQUIPMENT

HOSE/CPLG.
SELECTION

G8K COUPLINGS

GLOBAL SPIRAL
COUPLINGSSTAINLESS
STEEL SPIRALMEGACRIMP
COUPLINGSSTAINLESS
STEEL BRAIDPOWER CRIMP
COUPLINGSFIELD
ATTACHABLE G1
& G2 COUPLINGSFIELD
ATTACHABLE C5
COUPLINGS

GLX COUPLINGS

GL COUPLINGS

C14 COUPLINGS

PCTS
THERMOPLASTIC
COUPLINGSPOLARSEAL
COUPLINGSPOLARSEAL II
COUPLINGSPOWER
STEERING

ADAPTERS

QUICK
DISCONNECT
COUPLERS

BALL VALVES

LIVE SWIVEL

ASSEMBLY
FABRICATION

ACCESSORIES

EQUIPMENT AND
PARTS

AIR BRAKE

BRASS

KITS

Male JIC 37° Flare to Male Pipe NPTF - 45°

For use up to SAE 100R2 maximum working pressure.

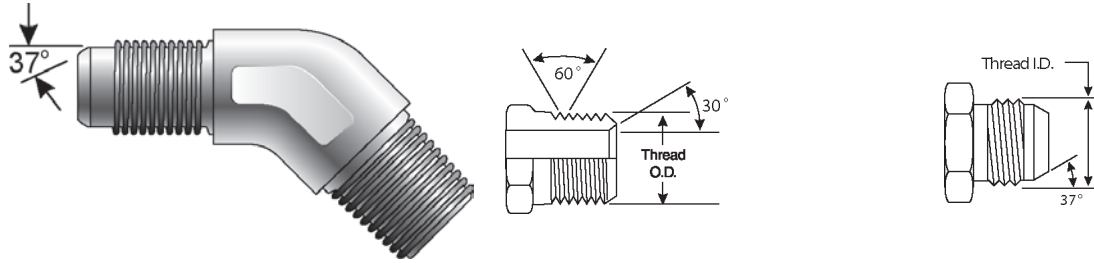

	Part No.	Descr.	Prod. No.		
				"	"
	G60497-0202	2MJ-2MP45	7259-09415	5/16-24	1/8-27
	G60497-0302	3MJ-2MP45	7259-77975	3/8-24	1/8-27
	G60497-0402	4MJ-2MP45	7259-10505	7/16-20	1/8-27
	G60497-0404	4MJ-4MP45	7259-10825	7/16-20	1/4-18
	G60497-0406	4MJ-6MP45	7259-34605	7/16-20	3/8-18
	G60497-0408	4MJ-8MP45	7259-09425	7/16-20	1/2-14
	G60497-0502	5MJ-2MP45	7259-11635	1/2-20	1/8-27
	G60497-0504	5MJ-4MP45	7259-11265	1/2-20	1/4-18
	G60497-0506	5MJ-6MP45	7259-07685	1/2-20	3/8-18
	G60497-0602	6MJ-2MP45	7259-77985	9/16-18	1/8-27
	G60497-0604	6MJ-4MP45	7259-10925	9/16-18	1/4-18
	G60497-0606	6MJ-6MP45	7259-10715	9/16-18	3/8-18
	G60497-0608	6MJ-8MP45	7259-11135	9/16-18	1/2-14
	G60497-0612	6MJ-12MP45	7259-07315	9/16-18	3/4-14
	G60497-0804	8MJ-4MP45	7259-77995	3/4-16	1/4-18
	G60497-0806	8MJ-6MP45	7259-10695	3/4-16	3/8-18
	G60497-0808	8MJ-8MP45	7259-10495	3/4-16	1/2-14
	G60497-0812	8MJ-12MP45	7259-11395	3/4-16	3/4-14
	G60497-1006	10MJ-6MP45	7259-11505	7/8-14	3/8-18
	G60497-1008	10MJ-8MP45	7259-10395	7/8-14	1/2-14
	G60497-1012	10MJ-12MP45	7259-34615	7/8-14	3/4-14
	G60497-1208	12MJ-8MP45	7259-11375	1 1/16-12	1/2-14
	G60497-1212	12MJ-12MP45	7259-10845	1 1/16-12	3/4-14
	G60497-1216	12MJ-16MP45	7259-05775	1 1/16-12	1-11 1/2
	G60497-1412	14MJ-12MP45	7259-09885	1 3/16-12	3/4-14
	G60497-1608	16MJ-8MP45	7259-09435	1 5/16-12	1/2-14
	G60497-1612	16MJ-12MP45	7259-11585	1 5/16-12	3/4-14
	G60497-1616	16MJ-16MP45	7259-11035	1 5/16-12	1-11 1/2
	G60497-1620	16MJ-20MP45	7259-07845	1 5/16-12	1 1/4-11 1/2
	G60497-2016	20MJ-16MP45	7259-07985	1 5/8-12	1-11 1/2
	G60497-2020	20MJ-20MP45	7259-11485	1 5/8-12	1 1/4-11 1/2
	G60497-2024	20MJ-24MP45	7259-08105	1 5/8-12	1 1/2-11 1/2
	G60497-2424	24MJ-24MP45	7259-11695	1 7/8-12	1 1/2-11 1/2
	G60497-3232	32MJ-32MP45	7259-11675	2 1/2-12	2-11 1/2

Male JIC 37° Flare to Male Pipe NPTF - 90°

For use up to SAE 100R2 maximum working pressure.

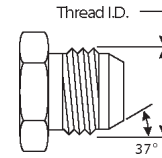
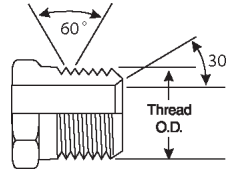
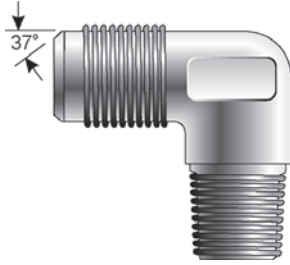



Part No.	Descr.	Prod. No.		
			"	"
G60499-0202	2MJ-2MP90	7259-11755	5/16-24	1/8-27
G60499-0302	3MJ-2MP90	7259-78005	3/8-24	1/8-27
G60499-0402	4MJ-2MP90	7259-10175	7/16-20	1/8-27
G60499-0404	4MJ-4MP90	7259-10195	7/16-20	1/4-18
G60499-0406	4MJ-6MP90	7259-34645	7/16-20	3/8-18
G60499-0408	4MJ-8MP90	7259-09815	7/16-20	1/2-14
G60499-0412	4MJ-12MP90	7259-07695	7/16-20	3/4-14
G60499-0502	5MJ-2MP90	7259-11425	1/2-20	1/8-27
G60499-0504	5MJ-4MP90	7259-11045	1/2-20	1/4-18
G60499-0506	5MJ-6MP90	7259-34655	1/2-20	3/8-18
G60499-0602	6MJ-2MP90	7259-11085	9/16-18	1/8-27
G60499-0604	6MJ-4MP90	7259-28385	9/16-18	1/4-18
G60499-0606	6MJ-6MP90	7259-28185	9/16-18	3/8-18
G60499-0608	6MJ-8MP90	7259-10185	9/16-18	1/2-14
G60499-0612	6MJ-12MP90	7259-05545	9/16-18	3/4-14
G60499-0804	8MJ-4MP90	7259-11025	3/4-16	1/4-18
G60499-0806	8MJ-6MP90	7259-10165	3/4-16	3/8-18
G60499-0808	8MJ-8MP90	7259-28205	3/4-16	1/2-14
G60499-0812	8MJ-12MP90	7259-10275	3/4-16	3/4-14
G60499-0816	8MJ-16MP90	7259-07575	3/4-16	1-11 1/2
G60499-1006	10MJ-6MP90	7259-11195	7/8-14	3/8-18
G60499-1008	10MJ-8MP90	7259-28375	7/8-14	1/2-14
G60499-1012	10MJ-12MP90	7259-10555	7/8-14	3/4-14
G60499-1016	10MJ-16MP90	7259-07705	7/8-14	1-11 1/2
G60499-1206	12MJ-6MP90	7259-07995	1 1/16-12	3/8-18
G60499-1208	12MJ-8MP90	7259-10795	1 1/16-12	1/2-14
G60499-1212	12MJ-12MP90	7259-28395	1 1/16-12	3/4-14
G60499-1216	12MJ-16MP90	7259-34665	1 1/16-12	1-11 1/2
G60499-1220	12MJ-20MP90	7259-06835	1 1/16-12	1 1/4-11 1/2
G60499-1408	14MJ-8MP90	7259-09445	1 3/16-12	1/2-14
G60499-1412	14MJ-12MP90	7259-07585	1 3/16-12	3/4-14
G60499-1608	16MJ-8MP90	7259-09455	1 5/16-12	1/2-14
G60499-1612	16MJ-12MP90	7259-11205	1 5/16-12	3/4-14
G60499-1616	16MJ-16MP90	7259-28405	1 5/16-12	1-11 1/2
G60499-1620	16MJ-20MP90	7259-34675	1 5/16-12	1 1/4-11 1/2
G60499-1624	16MJ-24MP90	7259-07715	1 5/16-12	1 1/2-11 1/2
G60499-2016	20MJ-16MP90	7259-11565	1 5/8-12	1-11 1/2
G60499-2020	20MJ-20MP90	7259-10905	1 5/8-12	1 1/4-11 1/2
G60499-2024	20MJ-24MP90	7259-34685	1 5/8-12	1 1/2-11 1/2
G60499-2420	24MJ-20MP90	7259-34695	1 7/8-12	1 1/4-11 1/2
G60499-2424	24MJ-24MP90	7259-11445	1 7/8-12	1 1/2-11 1/2
G60499-3224	32MJ-24MP90	7259-08335	2 1/2-12	1 1/2-11 1/2
G60499-3232	32MJ-32MP90	7259-11685	2 1/2-12	2-11 1/2

- EQUIPMENT
- HOSE/CPLG. SELECTION
- G&K COUPLINGS
- GLOBAL SPIRAL COUPLINGS
- STAINLESS STEEL SPIRAL
- MEGACRIMP COUPLINGS
- STAINLESS STEEL BRAID
- POWER CRIMP COUPLINGS
- FIELD ATTACHABLE G1 & G2 COUPLINGS
- FIELD ATTACHABLE C5 COUPLINGS
- GLX COUPLINGS
- GL COUPLINGS
- C14 COUPLINGS
- PCTS THERMOPLASTIC COUPLINGS
- POLARSEAL COUPLINGS
- POLARSEAL II COUPLINGS
- POWER STEERING
- ADAPTERS
- QUICK DISCONNECT COUPLERS
- BALL VALVES
- LIVE SWIVEL
- ASSEMBLY FABRICATION
- ACCESSORIES
- EQUIPMENT AND PARTS
- AIR BRAKE
- BRASS
- KITS

Male JIC 37° Flare to Female Pipe NPTF

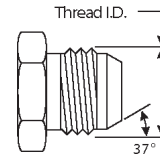
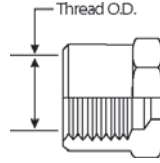
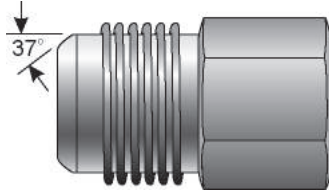
For use up to SAE 100R2 maximum working pressure.





	Part No.	Descr.	Prod. No.		
				"	"
	G60510-0202	2MJ-2FP	7259-78015	5/16-24	1/8-27
	G60510-0302	3MJ-2FP	7259-08515	3/8-24	1/8-27
	G60510-0304	3MJ-4FP	7259-08525	3/8-24	1/4-18
	G60510-0402	4MJ-2FP	7259-11165	7/16-20	1/8-27
	G60510-0404	4MJ-4FP	7259-10965	7/16-20	1/4-18
	G60510-0406	4MJ-6FP	7259-06915	7/16-20	3/8-18
	G60510-0408	4MJ-8FP	7259-09475	7/16-20	1/2-14
	G60510-0502	5MJ-2FP	7259-11665	1/2-20	1/8-27
	G60510-0504	5MJ-4FP	7259-11615	1/2-20	1/4-18
	G60510-0602	6MJ-2FP	7259-09485	9/16-18	1/8-27
	G60510-0604	6MJ-4FP	7259-10515	9/16-18	1/4-18
	G60510-0606	6MJ-6FP	7259-10685	9/16-18	3/8-18
	G60510-0608	6MJ-8FP	7259-34715	9/16-18	1/2-14
	G60510-0804	8MJ-4FP	7259-09495	3/4-16	1/4-18
	G60510-0806	8MJ-6FP	7259-10945	3/4-16	3/8-18
	G60510-0808	8MJ-8FP	7259-10605	3/4-16	1 7/8-12
	G60510-0812	8MJ-12FP	7259-34725	3/4-16	3/4-14
	G60510-1006	10MJ-6FP	7259-34735	7/8-14	3/8-18
	G60510-1008	10MJ-8FP	7259-10805	7/8-14	1/2-14
	G60510-1012	10MJ-12FP	7259-34745	7/8-14	3/4-14
	G60510-1208	12MJ-8FP	7259-34755	1 1/16-12	1/2-14
	G60510-1212	12MJ-12FP	7259-10675	1 1/16-12	3/4-14
	G60510-1216	12MJ-16FP	7259-06655	1 1/16-12	1-11 1/2
	G60510-1412	14MJ-12FP	7259-08345	1 3/16-12	3/4-14
	G60510-1612	16MJ-12FP	7259-07005	1 5/16-12	3/4-14
	G60510-1616	16MJ-16FP	7259-10985	1 5/16-12	1-11 1/2
	G60510-1620	16MJ-20FP	7259-34765	1 5/16-12	1 1/4-11 1/2
	G60510-2016	20MJ-16FP	7259-08535	1 5/8-12	1-11 1/2
	G60510-2020	20MJ-20FP	7259-25925	1 5/8-12	1 1/4-11 1/2
	G60510-2424	24MJ-24FP	7259-25935	1 7/8-12	1 1/2-11 1/2
	G60510-3232	32MJ-32FP	7259-34775	2 1/2-12	2-11 1/2

EQUIPMENT
HOSE/CPLG. SELECTION
G8K COUPLINGS
GLOBALSPIRAL COUPLINGS
STAINLESS STEEL SPIRAL
MEGACRIMP COUPLINGS
STAINLESS STEEL BRAID
POWER CRIMP COUPLINGS
FIELD ATTACHABLE G1 & G2 COUPLINGS
FIELD ATTACHABLE C5 COUPLINGS
GLX COUPLINGS
GL COUPLINGS
C14 COUPLINGS
PCTS THERMOPLASTIC COUPLINGS
POLARSEAL COUPLINGS
POLARSEAL II COUPLINGS
POWER STEERING
ADAPTERS
QUICK DISCONNECT COUPLERS
BALL VALVES
LIVE SWIVEL
ASSEMBLY FABRICATION
ACCESSORIES
EQUIPMENT AND PARTS
AIR BRAKE
BRASS
KITS

Male JIC 37° Flare to Female Pipe NPTF - 90°

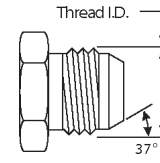
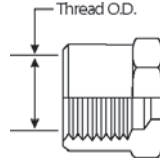
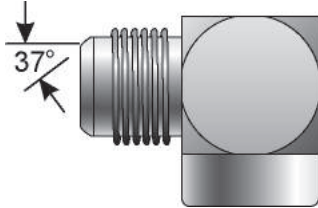
For use up to SAE 100R2 maximum working pressure.



Part No.	Descr.	Prod. No.		
			"	"
G60514-0402	4MJ-2FP90	7259-25105	7/16-20	1/8-27
G60514-0404	4MJ-4FP90	7259-34785	7/16-20	1/4-18
G60514-0502	5MJ-2FP90	7259-07365	1/2-20	1/8-27
G60514-0504	5MJ-4FP90	7259-34805	1/2-20	1/4-18
G60514-0602	6MJ-2FP90	7259-09505	9/16-18	1/8-27
G60514-0604	6MJ-4FP90	7259-25115	9/16-18	1/4-18
G60514-0606	6MJ-6FP90	7259-34825	9/16-18	3/8-18
G60514-0608	6MJ-8FP90	7259-00405	9/16-18	1/2-14
G60514-0804	8MJ-4FP90	7259-09515	3/4-16	1/4-18
G60514-0806	8MJ-6FP90	7259-25125	3/4-16	3/8-18
G60514-0808	8MJ-8FP90	7259-34835	3/4-16	1/2-14
G60514-1008	10MJ-8FP90	7259-25135	7/8-14	1/2-14
G60514-1208	12MJ-8FP90	7259-34845	1 1/16-12	1/2-14
G60514-1212	12MJ-12FP90	7259-25145	1 1/16-12	3/4-14
G60514-1412	14MJ-12FP90	7259-09525	1 3/16-12	3/4-14
G60514-1616	16MJ-16FP90	7259-25155	1 5/16-12	1-11 1/2
G60514-2020	20MJ-20FP90	7259-34855	1 5/8-12	1 1/4-11 1/2
G60514-2424	24MJ-24FP90	7259-07725	1 7/8-12	1 1/2-11 1/2

Female JIC 37° Flare Swivel to Male Pipe NPTF

For use up to SAE 100R2 maximum working pressure.

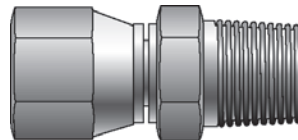



Part No.	Descr.	Prod. No.		
			"	"
G60520-0402	4FJX-2MP	7253-34865	7/16-20	1/8-27
G60520-0404	4FJX-4MP	7259-34875	7/16-20	1/4-18
G60520-0604	6FJX-4MP	7259-34885	9/16-18	1/4-18
G60520-0606	6FJX-6MP	7259-34895	9/16-18	3/8-18
G60520-0806	8FJX-6MP	7259-34905	3/4-16	3/8-18
G60520-0808	8FJX-8MP	7259-34915	3/4-16	1/2-14
G60520-1212	12FJX-12MP	7259-34925	1 1/16-12	3/4-14
G60520-1616	16FJX-16MP	7253-34935	1 5/16-12	1-11 1/2
G60520-2020	20FJX-20MP	7259-34945	1 5/8-12	1 1/4-11 1/2

- EQUIPMENT
- HOSE/CPLG. SELECTION
- G8K COUPLINGS
- GLOBALSPIRAL COUPLINGS
- STAINLESS STEEL SPIRAL
- MEGACRIMP COUPLINGS
- STAINLESS STEEL BRAID
- POWER CRIMP COUPLINGS
- FIELD ATTACHABLE G1 & G2 COUPLINGS
- FIELD ATTACHABLE C5 COUPLINGS
- GLX COUPLINGS
- GL COUPLINGS
- C14 COUPLINGS
- PCTS THERMOPLASTIC COUPLINGS
- POLARSEAL COUPLINGS
- POLARSEAL II COUPLINGS
- POWER STEERING
- ADAPTERS
- QUICK DISCONNECT COUPLERS
- BALL VALVES
- LIVE SWIVEL
- ASSEMBLY FABRICATION
- ACCESSORIES
- EQUIPMENT AND PARTS
- AIR BRAKE
- BRASS
- KITS

Female JIC 37° Flare Swivel to Male Pipe NPTF - 90°

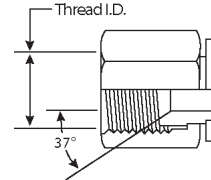
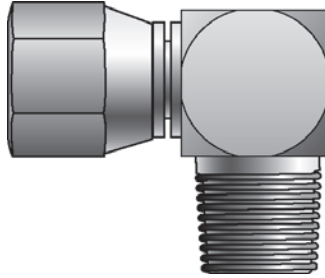
For use up to SAE 100R2 maximum working pressure.



Part No.	Descr.	Prod. No.		
			"	"
G60524-0402	4FJX-2MP90	7253-34955	7/16-20	1/8-27
G60524-0404	4FJX-4MP90	7259-05325	7/16-20	1/4-18
G60524-0604	6FJX-4MP90	7253-34965	9/16-18	1/4-18
G60524-0606	6FJX-6MP90	7253-34975	9/16-18	3/8-18
G60524-0806	8FJX-6MP90	7253-34985	3/4-16	3/8-18
G60524-0808	8FJX-8MP90	7253-34995	3/4-16	1/2-14
G60524-1008	10FJX-8MP90	7253-35015	7/8-14	1/2-14
G60524-1212	12FJX-12MP90	7253-35025	1 1/16-12	3/4-14
G60524-1616	16FJX-16MP90	7259-35285	1 5/16-12	1-11 1/2
G60524-2020	20FJX-20MP90	7259-35295	1 5/8-12	1 1/4-11 1/2
G60524-2424	24FJX-24MP90	7259-35035	1 7/8-12	1 1/2-11 1/2

Female JIC 37° Flare Swivel to Female Pipe NPTF

For use up to SAE 100R2 maximum working pressure.

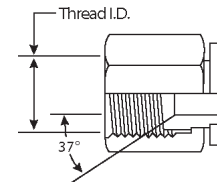
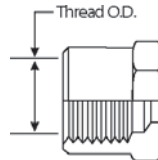
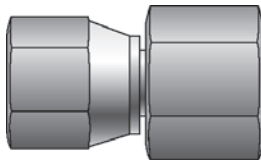

Part No.	Descr.	Prod. No.		
			"	"
G60530-0402	4FJX-2FP	7253-35045	7/16-20	1/8-27
G60530-0404	4FJX-4FP	7253-35055	7/16-20	1/4-18
G60530-0606	6FJX-6FP	7253-35075	9/16-18	3/8-18
G60530-0806	8FJX-6FP	7253-35095	3/4-16	3/8-18
G60530-0808	8FJX-8FP	7253-35105	3/4-16	1/2-14
G60530-1008	10FJX-8FP	7253-35115	7/8-14	1/2-14
G60530-1212	12FJX-12FP	7253-35125	1 1/16-12	3/4-14
G60530-1616	16FJX-16FP	7259-35135	1 5/16-12	1-11 1/2
G60530-2020	20FJX-20FP	7259-35145	1 5/8-12	1 1/4-11 1/2

Male JIC 37° Flare Bulkhead to Male Pipe NPTF

For use up to SAE 100R2 maximum working pressure.

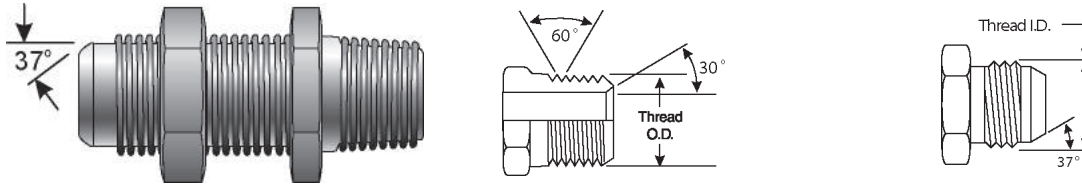

Part No.	Descr.	Prod. No.		
			"	"
G60541-0402	4MJBKHD-2MP	7259-09945	7/16-20	1/8-27
G60541-0404	4MJBKHD-4MP	7259-35155	7/16-20	1/4-18
G60541-0604	6MJBKHD-4MP	7259-35165	9/16-18	1/4-18
G60541-0806	8MJBKHD-6MP	7259-35175	3/4-16	3/8-18
G60541-0808	8MJBKHD-8MP	7259-09905	3/4-16	1/2-14
G60541-1008	10MJBKHD-8MP	7259-35185	7/8-14	1/2-14
G60541-1208	12MJBKHD-8MP	7259-35275	1 1/16-12	1/2-14
G60541-1212	12MJBKHD-12MP	7259-35195	1 1/16-12	3/4-14
G60541-1616	16MJBKHD-16MP	7253-35205	1 5/16-12	1-11 1/2
G60541-2020	20MJBKHD-20MP	7259-09965	1 5/8-12	1 1/4-11 1/2

Male JIC 37° Flare on Run to Male Pipe NPTF - Tee

For use up to SAE 100R2 maximum working pressure.

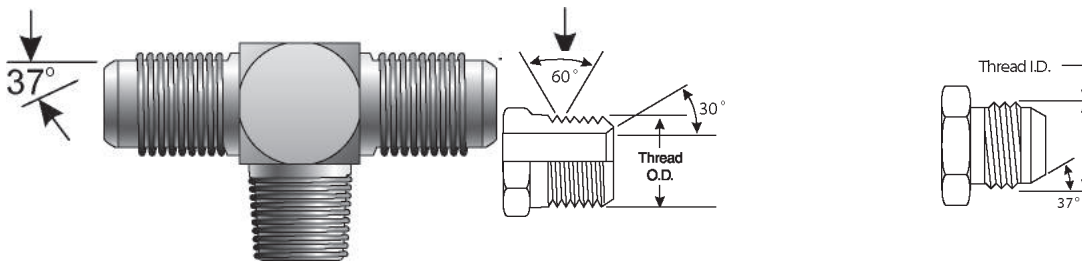

Part No.	Descr.	Prod. No.			
			"	"	"
G60551-0302	3MJ-3MJ-2MP	7259-09605	3/8-24	3/8-24	1/8-27
G60551-0402	4MJ-4MJ-2MP	7259-23415	7/16-20	7/16-20	1/8-27
G60551-0404	4MJ-4MJ-4MP	7259-35215	7/16-20	7/16-20	1/4-18
G60551-0406	4MJ-4MJ-6MP	7259-05855	7/16-20	3/8-18	3/8-18
G60551-0502	5MJ-5MJ-2MP	7259-07385	1/2-20	1/2-20	1/8-27
G60551-0504	5MJ-5MJ-4MP	7259-35225	1/2-20	1/2-20	1/4-18
G60551-0604	6MJ-6MJ-4MP	7259-23425	9/16-18	9/16-18	1/4-18
G60551-0606	6MJ-6MJ-6MP	7259-35235	9/16-18	9/16-18	3/8-18
G60551-0608	6MJ-6MJ-8MP	7259-35245	9/16-18	9/16-18	1/2-14
G60551-0806	8MJ-8MJ-6MP	7259-23435	3/4-16	3/4-16	3/8-18
G60551-0808	8MJ-8MJ-8MP	7259-35255	3/4-16	3/4-16	1/2-14
G60551-0812	8MJ-8MJ-12MP	7259-09615	3/4-16	3/4-16	3/4-14
G60551-1008	10MJ-10MJ-8MP	7259-23445	7/8-14	7/8-14	1/2-14
G60551-1208	12MJ-12MJ-8MP	7259-07395	1 1/16-12	1 1/16-12	1/2-14
G60551-1212	12MJ-12MJ-12MP	7259-23455	1 1/16-12	1 1/16-12	3/4-14
G60551-1216	12MJ-12MJ-16MP	7259-07735	1 1/16-12	1 1/16-12	1-11 1/2
G60551-1412	14MJ-14MJ-12MP	7259-09625	1 3/16-12	1 3/16-12	3/4-14
G60551-1612	16MJ-16MJ-12MP	7259-09635	1 5/16-12	1 5/16-12	3/4-14

- EQUIPMENT
- HOSE/CPLG. SELECTION
- G8K COUPLINGS
- GLOBALSPIRAL COUPLINGS
- STAINLESS STEEL SPIRAL
- MEGACRIMP COUPLINGS
- STAINLESS STEEL BRAID
- POWER CRIMP COUPLINGS
- FIELD ATTACHABLE G1 & G2 COUPLINGS
- FIELD ATTACHABLE C5 COUPLINGS
- GLX COUPLINGS
- GL COUPLINGS
- C14 COUPLINGS
- PCTS THERMOPLASTIC COUPLINGS
- POLARSEAL COUPLINGS
- POLARSEAL II COUPLINGS
- POWER STEERING
- ADAPTERS
- QUICK DISCONNECT COUPLERS
- BALL VALVES
- LIVE SWIVEL
- ASSEMBLY FABRICATION
- ACCESSORIES
- EQUIPMENT AND PARTS
- AIR BRAKE
- BRASS
- KITS

Male JIC 37° Flare on Run to Male Pipe NPTF - Tee - Continued

Part No.	Descr.	Prod. No.			
			"	"	"
G60551-1616	16MJ-16MJ-16MP	7259-23465	1 5/16-12	1 5/16-12	1-11 1/2
G60551-2020	20MJ-20MJ-20MP	7259-35265	1 5/8-12	1 5/8-12	1 5/8-12
G60551-2424	24MJ-24MJ-24MP	7259-08355	1 7/8-12	1 7/8-12	1 1/2-11 1/2

Female Flat-Face O-Ring Cap

For use up to SAE 100R2 maximum working pressure.

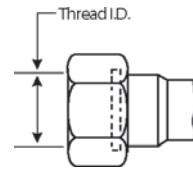
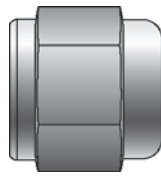

Part No.	Descr.	Prod. No.	
			"
G60701-0004	4FFOR-CAP	7253-32125	9/16-18
G60701-0006	6FFOR-CAP	7253-32135	11/16-16
G60701-0008	8FFOR-CAP	7253-32145	13/16-16
G60701-0010	10FFOR-CAP	7253-32155	1-14
G60701-0012	12FFOR-CAP	7253-32165	1 3/16-12
G60701-0016	16FFOR-CAP	7253-32175	1 7/16-12
G60701-0020	20FFOR-CAP	7253-32185	1 11/16-12
G60701-0024	24FFOR-CAP	7253-32195	2-12

Male Flat-Face O-Ring Plug

For use up to SAE 100R2 maximum working pressure.

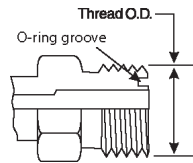
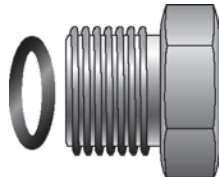

Part No.	Descr.	Prod. No.	
			"
G60702-0004	4MFFOR-PLUG	7259-32045	9/16-18
G60702-0006	6MFFOR-PLUG	7259-32055	11/16-16
G60702-0008	8MFFOR-PLUG	7259-32065	13/16-16
G60702-0010	10MFFOR-PLUG	7259-32075	1-14
G60702-0012	12MFFOR-PLUG	7259-32085	1 3/16-12
G60702-0016	16MFFOR-PLUG	7259-32095	1 7/16-12
G60702-0020	20MFFOR-PLUG	7259-32105	1 11/16-12
G60702-0024	24MFFOR-PLUG	7259-32115	2-12
G60702-0032	32MFFOR-PLUG	7259-09655	2 1/2-12

Male Flat-Face O-Ring to Male Flat-Face O-Ring

For use up to SAE 100R2 maximum working pressure.

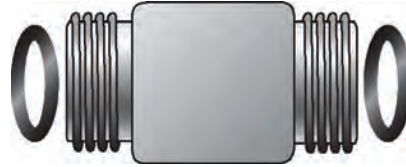

Part No.	Descr.	Prod. No.		
			"	"
G60705-0404	4MFFOR-4MFFOR	7259-43965	9/16-18	9/16-18
G60705-0604	6MFFOR-4MFFOR	7259-43975	11/16-16	9/16-18
G60705-0606	6MFFOR-6MFFOR	7259-43985	11/16-16	11/16-16
G60705-0806	8MFFOR-6MFFOR	7259-43995	13/16-16	11/16-16
G60705-0808	8MFFOR-8MFFOR	7259-44005	13/16-16	13/16-16
G60705-1010	10MFFOR-10MFFOR	7259-44025	1-14	1-14
G60705-1212	12MFFOR-12MFFOR	7259-44045	1 3/16-12	1 3/16-12
G60705-1616	16MFFOR-16MFFOR	7259-44065	1 7/16-12	1 7/16-12
G60705-2020	20MFFOR-20MFFOR	7259-44075	1 11/16-12	1 11/16-12
G60705-2424	24MFFOR-24MFFOR	7259-44085	2-12	2-12

Male Flat-Face O-Ring to Male Flat-Face O-Ring - 90°

For use up to SAE 100R2 maximum working pressure.

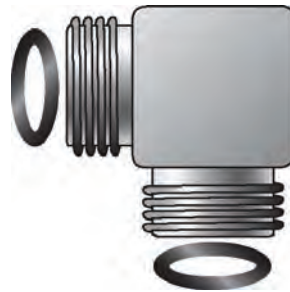



Part No.	Descr.	Prod. No.		
			"	"
G60712-0404	4MFFOR-4MFFOR90	7259-44105	9/16-18	
G60712-0808	8MFFOR-8MFFOR90	7259-44125	13/16-16	

- EQUIPMENT
- HOSE/CPLG. SELECTION
- G&K COUPLINGS
- GLOBALSPIRAL COUPLINGS
- STAINLESS STEEL SPIRAL
- MEGACRIMP COUPLINGS
- STAINLESS STEEL BRAID
- POWER CRIMP COUPLINGS
- FIELD ATTACHABLE G1 & G2 COUPLINGS
- FIELD ATTACHABLE C5 COUPLINGS
- GLX COUPLINGS
- GL COUPLINGS
- C14 COUPLINGS
- PCTS THERMOPLASTIC COUPLINGS
- POLARSEAL COUPLINGS
- POLARSEAL II COUPLINGS
- POWER STEERING
- ADAPTERS
- QUICK DISCONNECT COUPLERS
- BALL VALVES
- LIVE SWIVEL
- ASSEMBLY FABRICATION
- ACCESSORIES
- EQUIPMENT AND PARTS
- AIR BRAKE
- BRASS
- KITS

Male Flat-Face O-Ring to Female Flat-Face Swivel - 90°

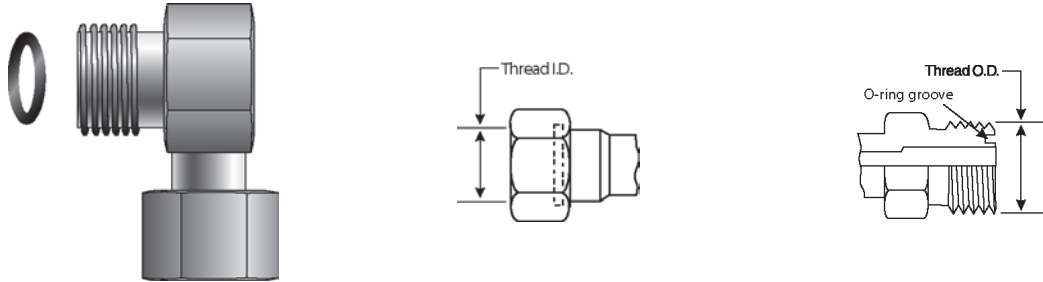
For use up to SAE 100R2 maximum working pressure.



Part No.	Descr.	Prod. No.		
			"	"
G60724-0404	4MFFOR-4FFORX90	7259-06075	9/16-18	9/16-18
G60724-0606	6MFFOR-6FFORX90	7259-31905	11/16-16	11/16-16
G60724-0808	8MFFOR-8FFORX90	7259-00345	13/16-16	13/16-16
G60724-1010	10MFFOR-10FFORX90	7259-05585	1-14	1-14
G60724-1212	12MFFOR-12FFORX90	7259-06085	1 3/16-12	1 3/16-12
G60724-1616	16MFFOR-16FFORX90	7259-05285	1 7/16-12	1 7/16-12
G60724-2020	20MFFOR-20FFORX90	7259-09665	1 11/16-12	1 11/16-12
G60724-2424	24MFFOR-24FFORX90	7259-09675	2-12	2-12

Male Flat-Face O-Ring Tee

For use up to SAE 100R2 maximum working pressure.

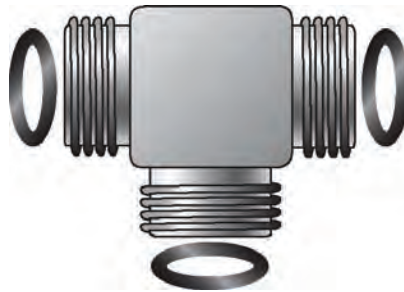

Part No.	Descr.	Prod. No.	
			"
G60740-0404	4MFFOR-4MFFOR-4MFFOR	7259-04805	9/16-18
G60740-0606	6MFFOR-6MFFOR-6MFFOR	7259-04815	11/16-16
G60740-0808	8MFFOR-8MFFOR-8MFFOR	7259-04825	13/16-16
G60740-1010	10MFFOR-10MFFOR-10MFFOR	7259-04835	1-14
G60740-1212	12MFFOR-12MFFOR-12MFFOR	7259-04845	1 3/16-12
G60740-1616	16MFFOR-16MFFOR-16MFFOR	7259-04855	1 7/16-12
G60740-2020	20MFFOR-20MFFOR-20MFFOR	7259-04865	1 11/16-12

Male Flat-Face O-Ring on Run to Female Flat-Face Swivel - Tee

For use up to SAE 100R2 maximum working pressure.

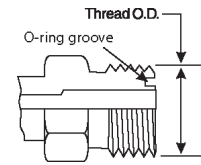
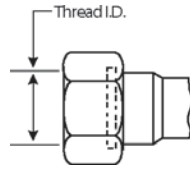
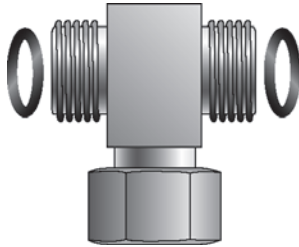

Part No.	Descr.	Prod. No.		
			"	"
G60742-0404	4MFFOR-4MFFOR-4FFORX	7259-31805	9/16-18	9/16-18
G60742-0606	6MFFOR-6MFFOR-6FFORX	7259-31815	11/16-16	11/16-16
G60742-0808	8MFFOR-8MFFOR-8FFORX	7259-31825	13/16-16	13/16-16
G60742-1010	10MFFOR-10MFFOR-10FFORX	7259-09685	1-14	1-14
G60742-1212	12MFFOR-12MFFOR-12FFORX	7259-09695	1 3/16-12	1 3/16-12
G60742-1616	16MFFOR-16MFFOR-16FFORX	7259-09705	1 1/16-12	7/16-20
G60742-2020	20MFFOR-20MFFOR-20FFORX	7259-09715	1 11/16-12	1 11/16-12

Male Flat-Face O-Ring to Female Flat-Face O-Ring to Male Flat-Face O-Ring - Tee

For use up to SAE 100R2 maximum working pressure.

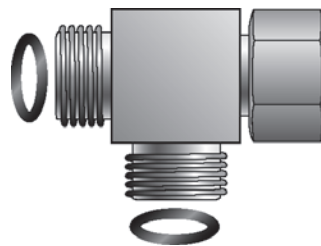

Part No.	Descr.	Prod. No.		
			"	"
G60744-0404	4MFFOR-4FFORX-4MFFOR	7259-00265	9/16-18	
G60744-0606	6MFFOR-6FFORX-6MFFOR	7259-00135	11/16-16	
G60744-0808	8MFFOR-8FFORX-8MFFOR	7259-00225	13/16-16	
G60744-1010	10MFFOR-10FFORX-10MFFOR	7259-06815	1-14	
G60744-1212	12MFFOR-12FFORX-12MFFOR	7259-00555	1 3/16-12	
G60744-1616	16MFFOR-16FFORX-16MFFOR	7259-06025	1 7/16-12	
G60744-2020	20MFFOR-20FFORX-20MFFOR	7259-04785	1 11/16-12	

- EQUIPMENT
- HOSE/CPLG. SELECTION
- G&K COUPLINGS
- GLOBALSPIRAL COUPLINGS
- STAINLESS STEEL SPIRAL
- MEGACRIMP COUPLINGS
- STAINLESS STEEL BRAID
- POWER CRIMP COUPLINGS
- FIELD ATTACHABLE G1 & G2 COUPLINGS
- FIELD ATTACHABLE C5 COUPLINGS
- GLX COUPLINGS
- GL COUPLINGS
- C14 COUPLINGS
- PCTS THERMOPLASTIC COUPLINGS
- POLARSEAL COUPLINGS
- POLARSEAL II COUPLINGS
- POWER STEERING
- ADAPTERS
- QUICK DISCONNECT COUPLERS
- BALL VALVES
- LIVE SWIVEL
- ASSEMBLY FABRICATION
- ACCESSORIES
- EQUIPMENT AND PARTS
- AIR BRAKE
- BRASS
- KITS

EQUIPMENT
HOSE/CPLG. SELECTION
G8K COUPLINGS
GLOBALSPIRAL COUPLINGS
STAINLESS STEEL SPIRAL
MEGACRIMP COUPLINGS
STAINLESS STEEL BRAID
POWER CRIMP COUPLINGS
FIELD ATTACHABLE G1 & G2 COUPLINGS
FIELD ATTACHABLE C5 COUPLINGS
GLX COUPLINGS
GL COUPLINGS
C14 COUPLINGS
PCTS THERMOPLASTIC COUPLINGS
POLARSEAL COUPLINGS
POLARSEAL II COUPLINGS
POWER STEERING
ADAPTERS
QUICK DISCONNECT COUPLERS
BALL VALVES
LIVE SWIVEL
ASSEMBLY FABRICATION
ACCESSORIES
EQUIPMENT AND PARTS
AIR BRAKE
BRASS
KITS

Male Flat-Face O-Ring to Male Pipe NPTF

For use up to SAE 100R2 maximum working pressure.

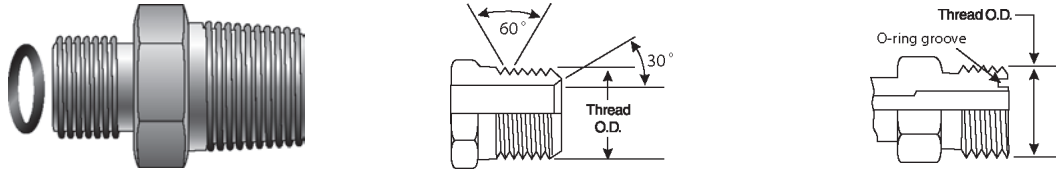

Part No.	Descr.	Prod. No.		
			"	"
G60770-0402	4MFFOR-2MP	7259-30615	9/16-18	1/8-27
G60770-0404	4MFFOR-4MP	7259-30625	9/16-18	1/4-18
G60770-0406	4MFFOR-6MP	7259-30635	9/16-18	3/8-18
G60770-0604	6MFFOR-4MP	7259-30645	11/16-16	1/4-18
G60770-0606	6MFFOR-6MP	7259-30655	11/16-16	3/8-18
G60770-0608	6MFFOR-8MP	7259-30665	11/16-16	1/2-14
G60770-0804	8MFFOR-4MP	7259-09845	13/16-16	1/4-18
G60770-0806	8MFFOR-6MP	7259-30675	13/16-16	3/8-18
G60770-0808	8MFFOR-8MP	7259-30685	13/16-16	1/2-14
G60770-0812	8MFFOR-12MP	7259-06845	13/16-16	3/4-14
G60770-1008	10MFFOR-8MP	7259-30695	1-14	1/2-14
G60770-1012	10MFFOR-12MP	7259-06755	1-14	3/4-14
G60770-1208	12MFFOR-8MP	7259-06035	1 3/16-12	1/2-14
G60770-1212	12MFFOR-12MP	7259-30705	1 3/16-12	3/4-14
G60770-1216	12MFFOR-16MP	7259-08115	1 3/16-12	1-11 1/2
G60770-1612	16MFFOR-12MP	7259-07075	1 7/16-12	3/4-14
G60770-1616	16MFFOR-16MP	7259-30715	1 7/16-12	1-11 1/2
G60770-2020	20MFFOR-20MP	7259-30725	1 11/16-12	1 1/4-11 1/2
G60770-2424	24MFFOR-24MP	7259-07595	2-12	1 1/2-11 1/2

Male Flat-Face O-Ring to Female JIC 37° Flare Swivel

For use up to SAE 100R2 maximum working pressure.

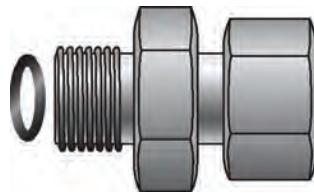

Part No.	Descr.	Prod. No.		
			"	"
G60785-0404	4MFFOR-4FJX	7259-09995	9/16-18	7/16-20
G60785-0606	6MFFOR-6FJX	7259-05135	11/16-16	9/16-18
G60785-0808	8MFFOR-8FJX	7259-05365	13/16-16	3/4-16
G60785-1010	10MFFOR-10FJX	7259-06335	1-14	7/8-14
G60785-1212	12MFFOR-12FJX	7259-05215	1 3/16-12	1 1/16-12
G60785-1616	16MFFOR-16FJX	7259-06765	1 7/16-12	1 5/16-12

Male Flat-Face O-Ring to Male O-Ring Boss

For use up to SAE 100R2 maximum working pressure.

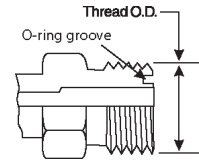
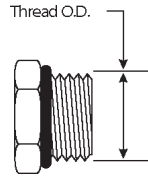
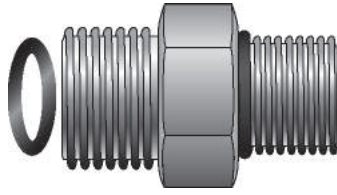

Part No.	Descr.	Prod. No.		
			"	"
G60800-0404	4MFFOR-4MB	7259-30015	9/16-18	7/16-20
G60800-0406	4MFFOR-6MB	7259-29905	9/16-18	9/16-18
G60800-0408	4MFFOR-8MB	7259-30115	9/16-18	3/4-16
G60800-0604	6MFFOR-4MB	7259-30025	11/16-16	9/16-18
G60800-0606	6MFFOR-6MB	7259-00085	11/16-16	7/16-20
G60800-0608	6MFFOR-8MB	7259-29925	11/16-16	3/4-16
G60800-0610	6MFFOR-10MB	7259-30095	11/16-16	7/8-14
G60800-0806	8MFFOR-6MB	7259-30035	13/16-16	3/4-16
G60800-0808	8MFFOR-8MB	7259-29915	13/16-16	9/16-18
G60800-0810	8MFFOR-10MB	7259-30105	13/16-16	7/8-14
G60800-0812	8MFFOR-12MB	7259-30125	13/16-16	1 1/16-12
G60800-0816	8MFFOR-16MB	7259-08005	13/16-16	1 5/16-12
G60800-1008	10MFFOR-8MB	7259-00155	1-14	3/4-16
G60800-1010	10MFFOR-10MB	7259-30045	1-14	7/8-14
G60800-1012	10MFFOR-12MB	7259-00165	1-14	1 1/16-12
G60800-1208	12MFFOR-8MB	7259-30135	1 3/16-12	3/4-16
G60800-1210	12MFFOR-10MB	7259-05385	1 3/16-12	7/8-14
G60800-1212	12MFFOR-12MB	7259-30055	1 3/16-12	1 1/16-12
G60800-1216	12MFFOR-16MB	7259-30175	1 3/16-12	1 5/16-12
G60800-1612	16MFFOR-12MB	7259-30185	1 7/16-12	1 1/16-12
G60800-1616	16MFFOR-16MB	7259-50255	1 7/16-12	1 5/16-12
G60800-1620	16MFFOR-20MB	7259-00045	1 7/16-12	1 5/8-20
G60800-2016	20MFFOR-16MB	7259-30145	1 11/16-12	1 5/16-12
G60800-2020	20MFFOR-20MB	7259-30075	1 11/16-12	1 5/8-12
G60800-2024	20MFFOR-24MB	7259-09745	1 11/16-12	1 7/8-12
G60800-2420	24MFFOR-20MB	7259-09755	2-12	1 5/8-12
G60800-2424	24MFFOR-24MB	7259-00175	2-12	1 7/8-12
G60800-3232	32MFFOR-32MB	7259-00325	2 1/2-12	2 1/2-12

Male Flat-Face O-Ring to Male O-Ring Boss - 45°

For use up to SAE 100R2 maximum working pressure.

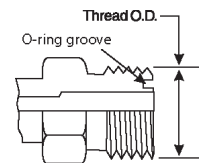
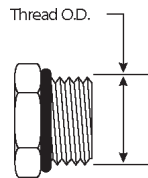
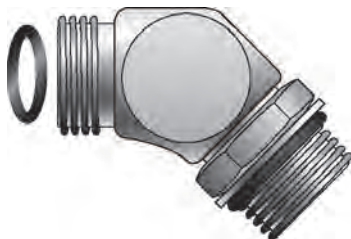

Part No.	Descr.	Prod. No.		
			"	"
G60805-0404	4MFFOR-4MB45	7259-30935	9/16-18	7/16-20

- EQUIPMENT
- HOSE/CPLG. SELECTION
- G&K COUPLINGS
- GLOBALSPIRAL COUPLINGS
- STAINLESS STEEL SPIRAL
- MEGACRIMP COUPLINGS
- STAINLESS STEEL BRAID
- POWER CRIMP COUPLINGS
- FIELD ATTACHABLE G1 & G2 COUPLINGS
- FIELD ATTACHABLE C5 COUPLINGS
- GLX COUPLINGS
- GL COUPLINGS
- C14 COUPLINGS
- PCTS THERMOPLASTIC COUPLINGS
- POLARSEAL COUPLINGS
- POLARSEAL II COUPLINGS
- POWER STEERING
- ADAPTERS
- QUICK DISCONNECT COUPLERS
- BALL VALVES
- LIVE SWIVEL
- ASSEMBLY FABRICATION
- ACCESSORIES
- EQUIPMENT AND PARTS
- AIR BRAKE
- BRASS
- KITS

Male Flat-Face O-Ring to Male O-Ring Boss - 45° - Continued

Part No.	Descr.	Prod. No.		
			"	"
G60805-0406	4MFFOR-6MB45	7259-30305	9/16-18	9/16-18
G60805-0604	6MFFOR-4MB45	7259-30945	11/16-16	7/16-20
G60805-0606	6MFFOR-6MB45	7259-30225	11/16-16	9/16-18
G60805-0608	6MFFOR-8MB45	7259-30955	11/16-16	3/4-16
G60805-0806	8MFFOR-6MB45	7259-30965	13/16-16	9/16-18
G60805-0808	8MFFOR-8MB45	7259-30975	13/16-16	3/4-16
G60805-0810	8MFFOR-10MB45	7259-30295	13/16-16	7/8-14
G60805-0812	8MFFOR-12MB45	7259-30985	13/16-16	1 1/16-12
G60805-1008	10MFFOR-8MB45	7259-30995	1-14	3/4-16
G60805-1010	10MFFOR-10MB45	7259-31005	1-14	7/8-14
G60805-1012	10MFFOR-12MB45	7259-31015	1-14	1 1/16-12
G60805-1210	12MFFOR-10MB45	7259-31025	1 3/16-12	7/8-14
G60805-1212	12MFFOR-12MB45	7259-31035	1 3/16-12	1 1/16-12
G60805-1216	12MFFOR-16MB45	7259-31045	1 3/16-12	1 5/16-12
G60805-1612	16MFFOR-12MB45	7259-31055	1 7/16-12	1 1/16-12
G60805-1616	16MFFOR-16MB45	7259-31065	1 7/16-12	1 5/16-12
G60805-1620	16MFFOR-20MB45	7259-31075	1 7/16-12	1 5/8-12
G60805-2020	20MFFOR-20MB45	7259-31085	1 11/16-12	1 5/8-12
G60805-2424	24MFFOR-24MB45	7259-31095	2-12	1 7/8-12

Male Flat-Face O-Ring to Male O-Ring Boss - 90°

For use up to SAE 100R2 maximum working pressure.

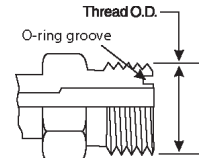
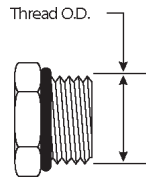
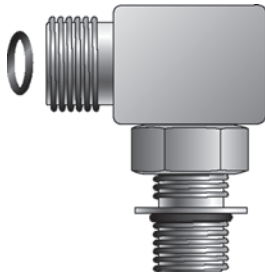

Part No.	Descr.	Prod. No.		
			"	"
G60810-0404	4MFFOR-4MB90	7259-30415	9/16-18	7/16-20
G60810-0406	4MFFOR-6MB90	7259-30735	9/16-18	9/16-18
G60810-0408	4MFFOR-8MB90	7259-30745	9/16-18	3/4-16
G60810-0604	6MFFOR-4MB90	7259-30495	11/16-16	7/16-20
G60810-0606	6MFFOR-6MB90	7259-30425	11/16-16	9/16-18
G60810-0608	6MFFOR-8MB90	7259-30755	11/16-16	3/4-16
G60810-0612	6MFFOR-12MB90	7259-30765	11/16-16	1 1/16-12
G60810-0806	8MFFOR-6MB90	7259-66215	13/16-16	9/16-18
G60810-0808	8MFFOR-8MB90	7259-30435	13/16-16	3/4-16
G60810-0810	8MFFOR-10MB90	7259-30515	13/16-16	7/8-14
G60810-0812	8MFFOR-12MB90	7259-30525	13/16-16	1 1/16-12
G60810-1008	10MFFOR-8MB90	7259-30555	1-14	3/4-16
G60810-1010	10MFFOR-10MB90	7259-30445	1-14	7/8-14
G60810-1012	10MFFOR-12MB90	7259-30775	1-14	1 1/16-12
G60810-1208	12MFFOR-8MB90	7259-30785	1 3/16-12	3/4-16
G60810-1210	12MFFOR-10MB90	7259-30795	1 3/16-12	7/8-14
G60810-1212	12MFFOR-12MB90	7259-30455	1 3/16-12	1 1/16-12
G60810-1216	12MFFOR-16MB90	7259-30805	1 3/16-12	1 5/16-12

Male Flat-Face O-Ring to Male O-Ring Boss - 90° - Continued

Part No.	Descr.	Prod. No.		
			"	"
G60810-1612	16MFFOR-12MB90	7259-30545	1 7/16-12	1 1/16-12
G60810-1616	16MFFOR-16MB90	7259-30465	1 7/16-12	1 5/16-12
G60810-1620	16MFFOR-20MB90	7259-30815	1 7/16-12	1 5/8-12
G60810-2016	20MFFOR-16MB90	7259-30825	1 11/16-12	1 5/16-12
G60810-2020	20MFFOR-20MB90	7259-30475	1 11/16-12	1 5/8-12
G60810-2024	20MFFOR-24MB90	7259-30835	1 11/16-12	1 7/8-12
G60810-2420	24MFFOR-20MB90	7259-30845	2-12	1 5/8-12
G60810-2424	24MFFOR-24MB90	7259-30855	2-12	1 7/8-12

Male Flat-Face O-Ring to Male O-Ring Boss - 90° Long Drop

For use up to SAE 100R2 maximum working pressure.

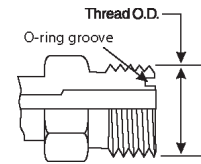
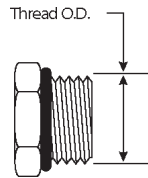
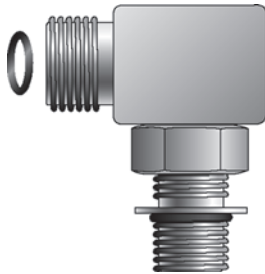

Part No.	Descr.	Prod. No.		
			"	"
G60811-0404	4MFFOR-4MB90L	7259-30875	9/16-18	7/16-20
G60811-0606	6MFFOR-6MB90L	7259-30885	11/16-16	9/16-18
G60811-1212	12MFFOR-12MB90L	7259-30915	1 3/16-12	1 1/16-12
G60811-1616	16MFFOR-16MB90L	7259-30925	1 7/16-12	1 5/16-12

Male Flat-Face O-Ring on Run to Male O-Ring Boss - Tee

For use up to SAE 100R2 maximum working pressure.

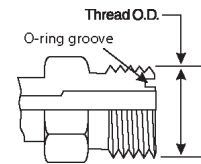
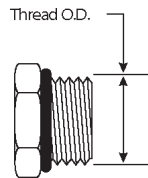
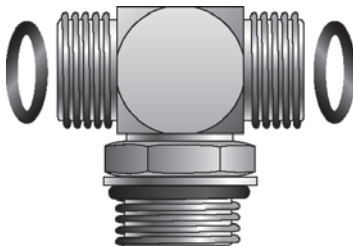

Part No.	Descr.	Prod. No.			
			"	"	"
G60820-0404	4MFFOR-4MFFOR-4MB	7259-31405	9/16-18	9/16-18	7/16-20
G60820-0606	6MFFOR-6MFFOR-6MB	7259-31515	11/16-16	11/16-16	9/16-18
G60820-0808	8MFFOR-8MFFOR-8MB	7259-31415	13/16-16	13/16-16	3/4-16
G60820-1010	10MFFOR-10MFFOR-10MB	7259-31425	1-14	1-14	7/8-14
G60820-1212	12MFFOR-12MFFOR-12MB	7259-31545	1 3/16-12	1 3/16-12	1 1/16-12
G60820-1616	16MFFOR-16MFFOR-16MB	7259-31555	1 7/16-12	1 7/16-12	1 5/16-12

EQUIPMENT

HOSE/CPLG. SELECTION

G8K COUPLINGS

GLOBALSPIRAL COUPLINGS

STAINLESS STEEL SPIRAL

MEGACRIMP COUPLINGS

STAINLESS STEEL BRAID

POWER CRIMP COUPLINGS

FIELD ATTACHABLE G1 & G2 COUPLINGS

FIELD ATTACHABLE C5 COUPLINGS

GLX COUPLINGS

GL COUPLINGS

C14 COUPLINGS

PCTS THERMOPLASTIC COUPLINGS

POLARSEAL COUPLINGS

POLARSEAL II COUPLINGS

POWER STEERING

ADAPTERS

QUICK DISCONNECT COUPLERS

BALL VALVES

LIVE SWIVEL

ASSEMBLY FABRICATION

ACCESSORIES

EQUIPMENT AND PARTS

AIR BRAKE

BRASS

KITS

EQUIPMENT
HOSE/CPLG. SELECTION
G8K COUPLINGS
GLOBAL SPIRAL COUPLINGS
STAINLESS STEEL SPIRAL
MEGACRIMP COUPLINGS
STAINLESS STEEL BRAID
POWER CRIMP COUPLINGS
FIELD ATTACHABLE G1 & G2 COUPLINGS
FIELD ATTACHABLE C5 COUPLINGS
GLX COUPLINGS
GL COUPLINGS
C14 COUPLINGS
PCTS THERMOPLASTIC COUPLINGS
POLARSEAL COUPLINGS
POLARSEAL II COUPLINGS
POWER STEERING
ADAPTERS
QUICK DISCONNECT COUPLERS
BALL VALVES
LIVE SWIVEL
ASSEMBLY FABRICATION
ACCESSORIES
EQUIPMENT AND PARTS
AIR BRAKE
BRASS
KITS

Male Flat-Face O-Ring on Run to Male O-Ring Boss - Tee - Continued

Part No.	Descr.	Prod. No.			
			"	"	"
G60820-2020	20MFFOR-20MFFOR-20MB	7259-31435	1 11/16-12	1 11/16-12	1 5/8-12

Male Flat-Face O-Ring to Male O-Ring Boss to Male Flat-Face O-Ring - Tee

For use up to SAE 100R2 maximum working pressure.

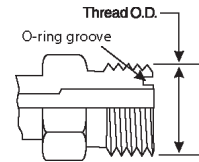
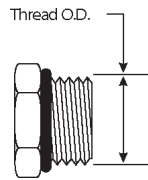
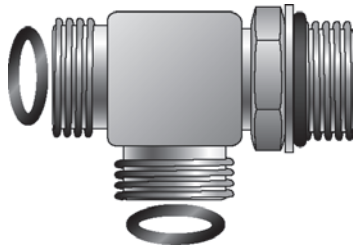

Part No.	Descr.	Prod. No.			
			"	"	"
G60821-0404	4MFFOR-4MB-4MFFOR	7259-31455	9/16-18	7/16-20	9/16-18
G60821-0606	6MFFOR-6MB-6MFFOR	7259-31605	11/16-16	9/16-18	11/16-16
G60821-0808	8MFFOR-8MB-8MFFOR	7259-31465	13/16-16	3/4-16	13/16-16
G60821-1010	10MFFOR-10MB-10MFFOR	7259-31615	1-14	7/8-14	1-14
G60821-1212	12MFFOR-12MB-12MFFOR	7259-31475	1 3/16-12	1 1/16-12	1 3/16-12
G60821-1616	16MFFOR-16MB-16MFFOR	7259-31485	1 7/16-12	1 5/16-12	1 7/16-12
G60821-2020	20MFFOR-20MB-20MFFOR	7259-31495	1 11/16-12	1 5/8-12	1 11/16-12
G60821-2424	24MFFOR-24MB-24MFFOR	7259-31505	2-12	1 7/8-12	2-12

Female Flat-Face Swivel to Male JIC 37° Flare

For use up to SAE 100R2 maximum working pressure.

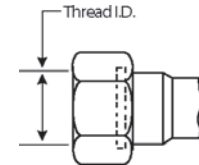
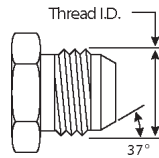
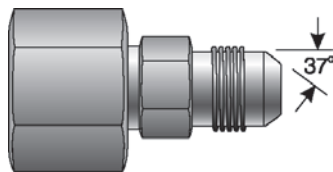

Part No.	Descr.	Prod. No.		
			"	"
G60880-0404	4FFORX-4MJ	7253-31705	9/16-18	7/16-20
G60880-0606	6FFORX-6MJ	7253-31715	11/16-16	9/16-18
G60880-0808	8FFORX-8MJ	7253-31725	13/16-16	3/4-16
G60880-1010	10FFORX-10MJ	7253-31735	1-14	7/8-14
G60880-1212	12FFORX-12MJ	7253-31745	1 3/16-12	1 1/16-12
G60880-1616	16FFORX-16MJ	7253-31755	1 7/16-12	1 1/16-13

Code 61 O-Ring Flange to Male JIC 37° Flare

O-Ring not included. Must be ordered separately.

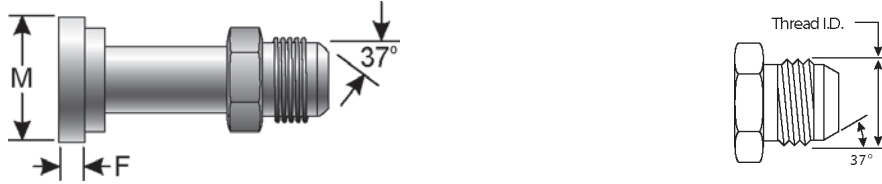

Part No.	Descr.	Prod. No.	Thread		M		F	
			"	"	"	mm	"	mm
G60900-0808	8FL-8MJ	7253-86931	3/4-16		1.19	30.2	.27	6.9
G60900-1212	12FL-12MJ	7253-86932	1 1/16-12		1.50	38.1	.27	6.9
G60900-1616	16FL-16MJ	7253-86933	1 5/16-12		1.75	44.5	.32	8.1
G60900-2020	20FL-20MJ	7253-86934	1 5/8-12		2.00	50.8	.32	8.1
G60900-2424	24FL-24MJ	7253-86935	1 7/8-12		2.38	60.5	.32	8.1
G60900-3232	32FL-32MJ	7253-86936	2 1/2-12		2.81	71.4	.38	9.7

Code 61 O-Ring Flange to Male JIC 37° Flare - High Pressure

No braze joints, solid one-piece construction for increased reliability.
O-Ring not included. Must be ordered separately.

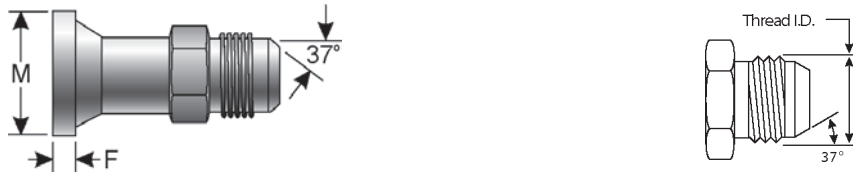

Part No.	Descr.	Prod. No.	Thread		M		F	
			"	"	"	mm	"	mm
G60901-1212	12FL5K-12MJ	7253-13015	1 1/16-12	1 1/16-12	1.50	38.1	.27	6.9
G60901-1612	16FL5K-12MJ	7253-12405	1 1/16-12	1 1/16-12	1.75	44.5	.32	8.1
G60901-1616	16FL5K-16MJ	7253-13035	1 5/16-12	1 1/16-12	1.75	44.5	.32	8.1
G60901-1620	16FL5K-20MJ	7253-12425	1 5/8-12	1 5/16-12	1.75	44.5	.32	8.1
G60901-2016	20FL4K-16MJ	7253-12485	1 5/16-12	1 5/8-12	2.00	50.8	.32	8.1
G60901-2020	20FL4K-20MJ	7253-12475	1 5/8-12	1 7/8-12	2.00	50.8	.32	8.1

NOTE: FL5K maximum working pressure is 5,000 psi; FL4K maximum working pressure is 4,000 psi.

- EQUIPMENT
- HOSE/CPLG. SELECTION
- G8K COUPLINGS
- GLOBALSPIRAL COUPLINGS
- STAINLESS STEEL SPIRAL
- MEGACRIMP COUPLINGS
- STAINLESS STEEL BRAID
- POWER CRIMP COUPLINGS
- FIELD ATTACHABLE G1 & G2 COUPLINGS
- FIELD ATTACHABLE C5 COUPLINGS
- GLX COUPLINGS
- GL COUPLINGS
- C14 COUPLINGS
- PCTS THERMOPLASTIC COUPLINGS
- POLARSEAL COUPLINGS
- POLARSEAL II COUPLINGS
- POWER STEERING
- ADAPTERS
- QUICK DISCONNECT COUPLERS
- BALL VALVES
- LIVE SWIVEL
- ASSEMBLY FABRICATION
- ACCESSORIES
- EQUIPMENT AND PARTS
- AIR BRAKE
- BRASS
- KITS

SAE to SAE - High Pressure

Code 61 O-Ring Flange to Male JIC 37° Flare - 45°

O-Ring not included. Must be ordered separately.

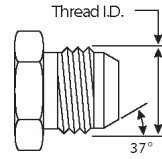
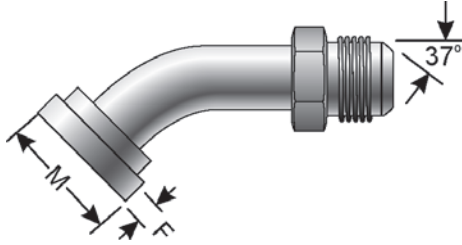

Part No.	Descr.	Prod. No.	Thread		M		F	
			"	"	"	mm	"	mm
G60905-0808	8FL-8MJ45	7253-86937	3/4-16	2 1/2-12	1.19	30.2	.27	6.9
G60905-1212	12FL-12MJ45	7253-86938	1 1/16-12	1 1/16-12	1.50	38.1	.27	6.9
G60905-1616	16FL-16MJ45	7253-86939	1 5/16-12	1 5/16-12	1.75	44.5	.32	8.1
G60905-2020	20FL-20MJ45	7253-86941	1 5/8-12	1 1/16-12	2.00	50.8	.32	8.1
G60905-2424	24FL-24MJ45	7253-86942	1 7/8-12	1 5/16-12	2.38	60.5	.32	8.1
G60905-3232	32FL-32MJ45	7253-86943	2 1/2-12	1 5/8-12	2.81	71.4	.38	9.7

Code 61 O-Ring Flange to Male JIC 37° Flare - 45° - High Pressure

No braze joints, solid one-piece construction for increased reliability.

O-Ring not included. Must be ordered separately.

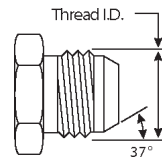
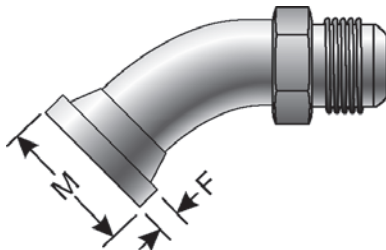

Part No.	Descr.	Prod. No.	Thread		M		F	
			"	"	"	mm	"	mm
G60906-1212	12FL5K-12MJ45	7253-13105	1 1/16-12	1 7/8-12	1.50	38.1	.27	6.9
G60906-1616	16FL5K-16MJ45	7253-13125	1 1/16-13	2 1/2-12	1.75	44.5	.32	8.1
G60906-2016	20FL4K-16MJ45	7253-12625	1 5/16-12	1 1/16-12	2.00	50.8	.37	9.4
G60906-2020	20FL4K-20MJ45	7253-12395	1 5/8-12	1 1/16-13	2.00	50.8	.37	9.4

NOTE: FL5K maximum working pressure is 5,000 psi; FL4K maximum working pressure is 4,000 psi.

EQUIPMENT

HOSE/CPLG.
SELECTION

G8K COUPLINGS

GLOBALSPIRAL
COUPLINGS

STAINLESS
STEEL SPIRAL

MEGACRIMP
COUPLINGS

STAINLESS
STEEL BRAID

POWER CRIMP
COUPLINGS

FIELD
ATTACHABLE G1
& G2 COUPLINGS

FIELD
ATTACHABLE C5
COUPLINGS

GLX COUPLINGS

GL COUPLINGS

C14 COUPLINGS

PCTS
THERMOPLASTIC
COUPLINGS

POLARSEAL
COUPLINGS

POLARSEAL II
COUPLINGS

POWER
STEERING

ADAPTERS

QUICK
DISCONNECT
COUPLERS

BALL VALVES

LIVE SWIVEL

ASSEMBLY
FABRICATION

ACCESSORIES

EQUIPMENT AND
PARTS

AIR BRAKE

BRASS

KITS

Code 61 O-Ring Flange to Male JIC 37° Flare - 90°

O-Ring not included. Must be ordered separately.

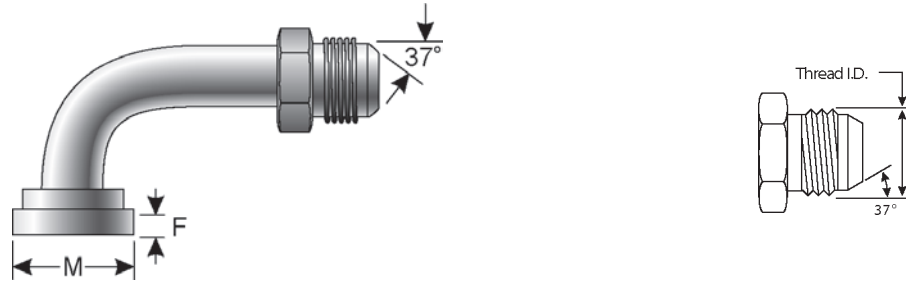

Part No.	Descr.	Prod. No.	Flare		M		F	
			"	"	"	mm	"	mm
G60910-0808	8FL-8MJ90	7253-86944	1/2	3/4-16	1.19	30.2	.27	6.9
G60910-1212	12FL-12MJ90	7253-86945	3/4	1 1/16-12	1.50	38.1	.27	6.9
G60910-1616	16FL-16MJ90	7253-86946	1	1 5/16-12	1.75	44.5	.32	8.1
G60910-2020	20FL-20MJ90	7253-86947	1 1/4	1 5/8-12	2.00	50.8	.32	8.1
G60910-2424	24FL-24MJ90	7253-86948	1 1/2	1 7/8-12	2.38	60.5	.32	8.1
G60910-3232	32FL-32MJ90	7253-86949	2	2 1/2-12	2.81	71.4	.38	9.7

Code 61 O-Ring Flange to Male JIC 37° Flare - 90° - High Pressure

No braze joints, solid one-piece construction for increased reliability.
O-Ring not included. Must be ordered separately.

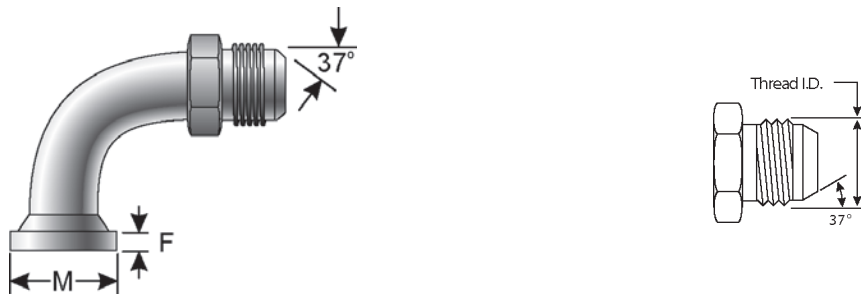

Part No.	Descr.	Prod. No.	Flare		M		F	
			"	"	"	mm	"	mm
G60911-1212	12FL5K-12MJ90	7253-13205	1 1/16-12	1 1/16-12	1.50	38.1	.27	6.9
G60911-1612	16FL5K-12MJ90	7253-12415	1 1/16-12	1 1/16-12	1.75	44.5	.32	8.1
G60911-1616	16FL5K-16MJ90	7253-13225	1 5/16-12	1 5/16-12	1.75	44.5	.32	8.1
G60911-2016	20FL4K-16MJ90	7253-12495	1 1/4	1 5/16-12	2.00	50.8	.32	8.1
G60911-2020	20FL4K-20MJ90	7253-12505	1 1/4	1 5/8-12	2.00	50.8	.32	8.1

NOTE: FL5K maximum working pressure is 5,000 psi; FL4K maximum working pressure is 4,000 psi.

- EQUIPMENT
- HOSE/CPLG. SELECTION
- G&K COUPLINGS
- GLOBALSPIRAL COUPLINGS
- STAINLESS STEEL SPIRAL
- MEGACRIMP COUPLINGS
- STAINLESS STEEL BRAID
- POWER CRIMP COUPLINGS
- FIELD ATTACHABLE G1 & G2 COUPLINGS
- FIELD ATTACHABLE C5 COUPLINGS
- GLX COUPLINGS
- GL COUPLINGS
- C14 COUPLINGS
- PCTS THERMOPLASTIC COUPLINGS
- POLARSEAL COUPLINGS
- POLARSEAL II COUPLINGS
- POWER STEERING
- ADAPTERS
- QUICK DISCONNECT COUPLERS
- BALL VALVES
- LIVE SWIVEL
- ASSEMBLY FABRICATION
- ACCESSORIES
- EQUIPMENT AND PARTS
- AIR BRAKE
- BRASS
- KITS

Code 61 O-Ring Flange to Male Flat-Face O-Ring - High Pressure

For use up to SAE 100R2 maximum working pressure.
 No braze joints, solid one-piece construction for increased reliability.
 O-Ring not included. Must be ordered separately.

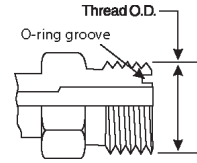
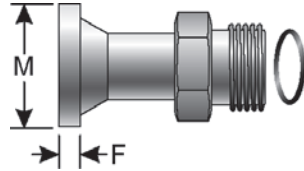

Part No.	Descr.	Prod. No.	Thread		M		F	
			"	"	"	mm	"	mm
G60915-1212	12FL5K-12MFFOR	7253-13695	1 3/16-12	1 1/16-12	1.50	38.1	.27	6.9
G60915-1612	16FL5K-12MFFOR	7253-17155	1	1 1/16-12	1.75	44.5	.32	8.1
G60915-1616	16FL5K-16MFFOR	7253-13705	1 7/16-12	1 1/16-12	1.75	44.5	.32	8.1
G60915-2020	20FL4K-20MFFOR	7253-13715	1 1/4	1 5/8-12	2.00	50.8	.32	8.1

NOTE: FL5K maximum working pressure is 5,000 psi; FL4K maximum working pressure is 4,000 psi.

Code 61 O-Ring Flange to Male Flat-Face O-Ring 45° - High Pressure

No braze joints, solid one-piece construction for increased reliability.
 O-Ring not included. Must be ordered separately.

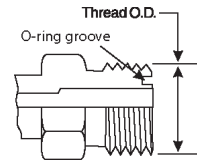
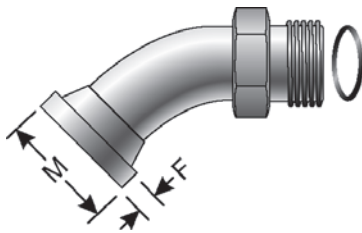

Part No.	Descr.	Prod. No.	Thread		M		F	
			"	"	"	mm	"	mm
G60920-1212	12FL5K-12MFFOR45	7253-13725	1 3/16-12	1 1/16-12	1.50	38.1	.27	6.9
G60920-1616	16FL5K-16MFFOR45	7253-13735	1 7/16-12	1 1/16-12	1.75	44.5	.32	8.1
G60920-2020	20FL4K-20MFFOR45	7253-13745	1 1/4	1 5/8-12	2.00	50.8	.32	8.1

NOTE: FL5K maximum working pressure is 5,000 psi; FL4K maximum working pressure is 4,000 psi.

Code 61 O-Ring Flange to Male Flat-Face O-Ring 90° - High Pressure

No braze joints, solid one-piece construction for increased reliability.
O-Ring not included. Must be ordered separately.

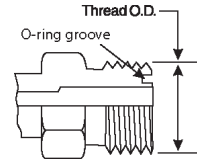
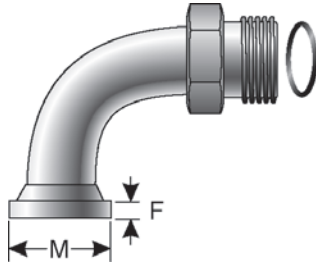

Part No.	Descr.	Prod. No.	Thread		M		F	
			"	"	"	mm	"	mm
G60925-1212	12FL5K-12MFFOR90	7253-13755	1 3/16-12	1 1/16-12	1.50	38.1	.27	6.9
G60925-1616	16FL5K-16MFFOR90	7253-13765	1 7/16-12	1 1/16-12	1.50	38.1	.32	8.1
G60925-2020	20FL4K-20MFFOR90	7253-13775	1 1/4	1 5/8-12	2.00	50.8	.32	8.1

NOTE: FL5K maximum working pressure is 5,000 psi; FL4K maximum working pressure is 4,000 psi.

Code 62 O-Ring Flange Heavy to Male JIC 37° Flare - (6,000 psi)

No braze joints, solid one-piece construction for increased reliability.
O-Ring not included. Must be ordered separately.

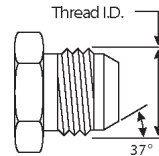
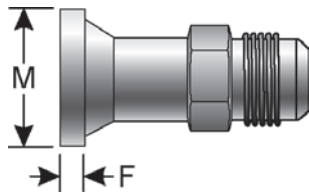

Part No.	Descr.	Prod. No.	Thread		M		F	
			"	"	"	mm	"	mm
G60930-1212	12FLH6K-12MJ	7253-13305	3/4	1 1/16-12	1.63	41.4	.35	8.9
G60930-1612	16FLH6K-12MJ	7253-12445	1	1 1/16-12	1.88	47.8	.38	9.7
G60930-1616	16FLH6K-16MJ	7253-13325	1	1 5/16-12	1.88	47.8	.38	9.7
G60930-1620	16FLH6K-20MJ	7253-12465	1	1 5/8-12	1.88	47.8	.38	9.7
G60930-2016	20FLH6K-16MJ	7253-12515	1 1/4	1 5/16-12	2.13	54.1	.41	10.4
G60930-2020	20FLH6K-20MJ	7253-13345	1 1/4	1 5/8-12	2.13	54.1	.41	10.4
G60930-2420	24FLH6K-20MJ	7253-13375	1 1/2	1 5/8-12	2.50	63.5	.50	12.7
G60930-2424	24FLH6K-24MJ	7253-13365	1 1/2	1 7/8-12	2.50	63.5	.50	12.7

- EQUIPMENT
- HOSE/CPLG. SELECTION
- G&K COUPLINGS
- GLOBALSPIRAL COUPLINGS
- STAINLESS STEEL SPIRAL
- MEGACRIMP COUPLINGS
- STAINLESS STEEL BRAID
- POWER CRIMP COUPLINGS
- FIELD ATTACHABLE G1 & G2 COUPLINGS
- FIELD ATTACHABLE C5 COUPLINGS
- GLX COUPLINGS
- GL COUPLINGS
- C14 COUPLINGS
- PCTS THERMOPLASTIC COUPLINGS
- POLARSEAL COUPLINGS
- POLARSEAL II COUPLINGS
- POWER STEERING
- ADAPTERS
- QUICK DISCONNECT COUPLERS
- BALL VALVES
- LIVE SWIVEL
- ASSEMBLY FABRICATION
- ACCESSORIES
- EQUIPMENT AND PARTS
- AIR BRAKE
- BRASS
- KITS

Code 62 O-Ring Flange Heavy to Male JIC 37° Flare 45° - (6,000 psi)

No braze joints, solid one-piece construction for increased reliability.
O-Ring not included. Must be ordered separately.

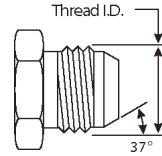
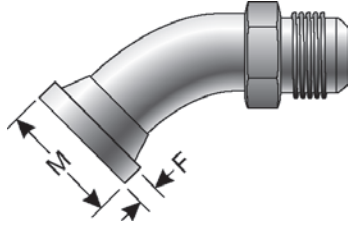

Part No.	Descr.	Prod. No.	Flare		M		F	
			"	"	"	mm	"	mm
G60935-1212	12FLH6K-12MJ45	7253-13405	3/4	1 1/16-12	1.63	41.4	.35	8.9
G60935-1616	16FLH6K-16MJ45	7253-13425	1	1 5/16-12	1.88	47.8	.38	9.7
G60935-2020	20FLH6K-20MJ45	7253-13445	1 1/4	1 5/8-12	2.13	54.1	.41	10.4

Code 62 O-Ring Flange Heavy to Male JIC 37° Flare 90° - (6,000 psi)

No braze joints, solid one-piece construction for increased reliability.
O-Ring not included. Must be ordered separately.

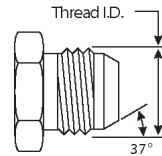
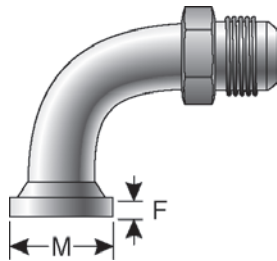

Part No.	Descr.	Prod. No.	Flare		M		F	
			"	"	"	mm	"	mm
G60940-1212	12FLH6K-12MJ90	7253-13505	3/4	1 1/16-12	1.63	41.4	.35	8.9
G60940-1216	12FLH6K-16MJ90	7253-13515	3/4	1 5/16-12	1.63	41.4	.35	8.9
G60940-1612	16FLH6K-12MJ90	7253-12455	1	1 1/16-12	1.88	47.8	.38	9.7
G60940-1616	16FLH6K-16MJ90	7253-13535	1	1 5/16-12	1.88	47.8	.38	9.7
G60940-1620	16FLH6K-20MJ90	7253-13545	1	1 5/8-12	1.88	47.8	.38	9.7
G60940-2016	20FLH6K-16MJ90	7253-12525	1 1/4	1 5/16-12	2.13	54.1	.41	10.4
G60940-2020	20FLH6K-20MJ90	7253-13565	1 1/4	1 5/8-12	2.13	54.1	.41	10.4
G60940-2420	24FLH6K-20MJ90	7253-13575	1 1/2	1 5/8-12	2.50	63.5	.50	12.7

Code 62 O-Ring Flange Heavy to Male Flat-Face O-Ring - (6,000 psi)

No braze joints, solid one-piece construction for increased reliability.
O-Ring not included. Must be ordered separately.

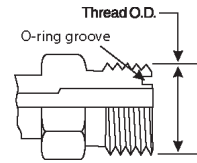
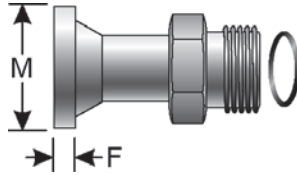

Part No.	Descr.	Prod. No.	Thread		M		F	
			"	"	"	mm	"	mm
G60945-1212	12FLH6K-12MFFOR	7253-13605	3/4	1 3/16-12	1.63	41.4	.35	8.9
G60945-1616	16FLH6K-16MFFOR	7253-13615	1	1 7/16-12	1.88	47.8	.38	9.7
G60945-2020	20FLH6K-20MFFOR	7253-13625	1 1/4	1 7/16-13	2.13	54.1	.41	10.4

Code 62 O-Ring Flange Heavy to Male Flat-Face O-Ring 45° - (6,000 psi)

No braze joints, solid one-piece construction for increased reliability.
O-Ring not included. Must be ordered separately.

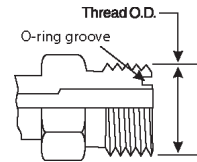
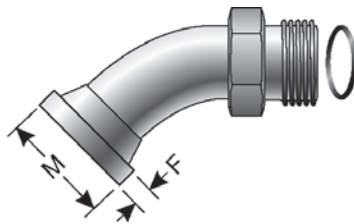

Part No.	Descr.	Prod. No.	Thread		M		F	
			"	"	"	mm	"	mm
G60950-1212	12FLH6K-12MFFOR45	7253-13635	3/4	1 3/16-12	1.63	41.4	.35	8.9
G60950-1616	16FLH6K-16MFFOR45	7253-13645	1	1 7/16-12	1.88	47.8	.38	9.7
G60950-2020	20FLH6K-20MFFOR45	7253-13655	1 1/4	1 7/16-13	2.13	54.1	.41	10.4

Code 62 O-Ring Flange Heavy to Male Flat-Face O-Ring 90° - (6,000 psi)

No braze joints, solid one-piece construction for increased reliability.
O-Ring not included. Must be ordered separately.

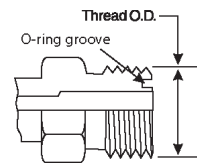
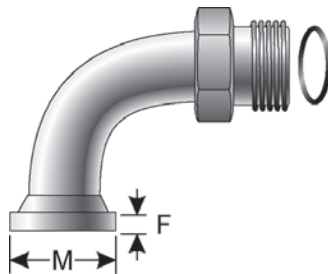

Part No.	Descr.	Prod. No.	Thread		M		F	
			"	"	"	mm	"	mm
G60955-1212	12FLH6K-12MFFOR90	7253-13665	3/4	1 3/16-12	1.63	41.4	.35	8.9
G60955-1612	16FLH6K-12MFFOR90	7253-13465	1 1/16-12	1 7/16-14	1.88	47.8	.38	9.7

- EQUIPMENT
- HOSE/CPLG. SELECTION
- G8K COUPLINGS
- GLOBALSPIRAL COUPLINGS
- STAINLESS STEEL SPIRAL
- MEGACRIMP COUPLINGS
- STAINLESS STEEL BRAID
- POWER CRIMP COUPLINGS
- FIELD ATTACHABLE G1 & G2 COUPLINGS
- FIELD ATTACHABLE C5 COUPLINGS
- GLX COUPLINGS
- GL COUPLINGS
- C14 COUPLINGS
- PCTS THERMOPLASTIC COUPLINGS
- POLARSEAL COUPLINGS
- POLARSEAL II COUPLINGS
- POWER STEERING
- ADAPTERS
- QUICK DISCONNECT COUPLERS
- BALL VALVES
- LIVE SWIVEL
- ASSEMBLY FABRICATION
- ACCESSORIES
- EQUIPMENT AND PARTS
- AIR BRAKE
- BRASS
- KITS

Code 62 O-Ring Flange Heavy to Male Flat-Face O-Ring 90° - (6,000 psi) - Continued

Part No.	Descr.	Prod. No.			M		F	
			"	"	"	mm	"	mm
G60955-1616	16FLH6K-16MFFOR90	7253-13675	1	1 7/16-12	1.88	47.8	.38	9.7
G60955-2020	20FLH6K-20MFFOR90	7253-13685	1 1/4	1 11/16-12	2.13	54.1	.41	10.4

EQUIPMENT
HOSE/CPLG. SELECTION
G8K COUPLINGS
GLOBALSPIRAL COUPLINGS
STAINLESS STEEL SPIRAL
MEGACRIMP COUPLINGS
STAINLESS STEEL BRAID
POWER CRIMP COUPLINGS
FIELD ATTACHABLE G1 & G2 COUPLINGS
FIELD ATTACHABLE C5 COUPLINGS
GLX COUPLINGS
GL COUPLINGS
C14 COUPLINGS
PCTS THERMOPLASTIC COUPLINGS
POLARSEAL COUPLINGS
POLARSEAL II COUPLINGS
POWER STEERING
ADAPTERS
QUICK DISCONNECT COUPLERS
BALL VALVES
LIVE SWIVEL
ASSEMBLY FABRICATION
ACCESSORIES
EQUIPMENT AND PARTS
AIR BRAKE
BRASS
KITS

British Male Standard Pipe Tapered Thread to Male JIC 37° Flare

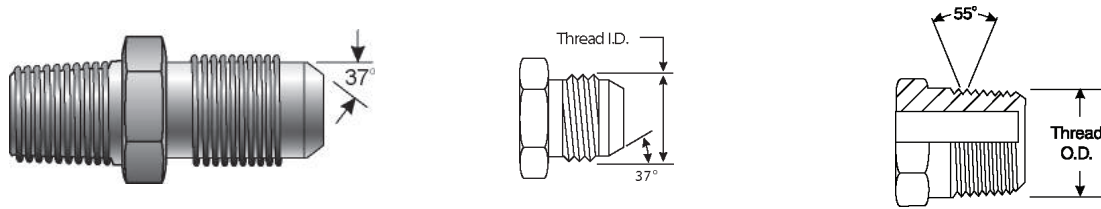

Part No.	Descr.	Prod. No.		
			"	"
G62150-0204	2MBSPT-4MJ	7253-14255	1/8-28	7/16-20
G62150-0205	2MBSPT-5MJ	7253-60005	1/8-28	1/2-20
G62150-0206	2MBSPT-6MJ	7253-60015	1/8-28	9/16-18
G62150-0404	4MBSPT-4MJ	7253-14265	1/4-19	7/16-20
G62150-0405	4MBSPT-5MJ	7253-60025	1/4-19	1/2-20
G62150-0406	4MBSPT-6MJ	7253-60035	1/4-19	9/16-18
G62150-0408	4MBSPT-8MJ	7253-60045	1/4-19	3/4-16
G62150-0604	6MBSPT-4MJ	7253-60055	3/8-19	7/16-20
G62150-0605	6MBSPT-5MJ	7253-60065	3/8-19	1/2-20
G62150-0606	6MBSPT-6MJ	7253-14275	3/8-19	9/16-18
G62150-0608	6MBSPT-8MJ	7253-60075	3/8-19	3/4-16
G62150-0610	6MBSPT-10MJ	7253-60085	3/8-19	7/8-14
G62150-0806	8MBSPT-6MJ	7253-60095	1/2-14	9/16-18
G62150-0808	8MBSPT-8MJ	7253-14285	1/2-14	3/4-16
G62150-0810	8MBSPT-10MJ	7253-14295	1/2-14	7/8-14
G62150-0812	8MBSPT-12MJ	7253-60105	1/2-14	1 1/16-12
G62150-1208	12MBSPT-8MJ	7253-60115	3/4-14	3/4-16
G62150-1210	12MBSPT-10MJ	7253-60125	3/4-14	7/8-14
G62150-1212	12MBSPT-12MJ	7253-14305	3/4-14	1 1/16-12
G62150-1214	12MBSPT-14MJ	7253-60135	3/4-14	1 3/16-12
G62150-1216	12MBSPT-16MJ	7253-60145	3/4-14	1 5/16-12
G62150-1612	16MBSPT-12MJ	7253-60155	1-11	1 1/16-12
G62150-1616	16MBSPT-16MJ	7253-14315	1-11	1 5/16-12
G62150-1620	16MBSPT-20MJ	7253-60165	1-11	1 5/8-12
G62150-2016	20MBSPT-16MJ	7253-60175	1 1/4-11	1 5/16-12
G62150-2020	20MBSPT-20MJ	7253-60185	1 1/4-11	1 5/8-12
G62150-2424	24MBSPT-24MJ	7253-60195	1 1/2-11	1 7/8-12
G62150-3232	32MBSPT-32MJ	7253-60205	2-11	2 1/2-12

British Male Standard Pipe Tapered Thread to Male JIC 37° Flare - 45°

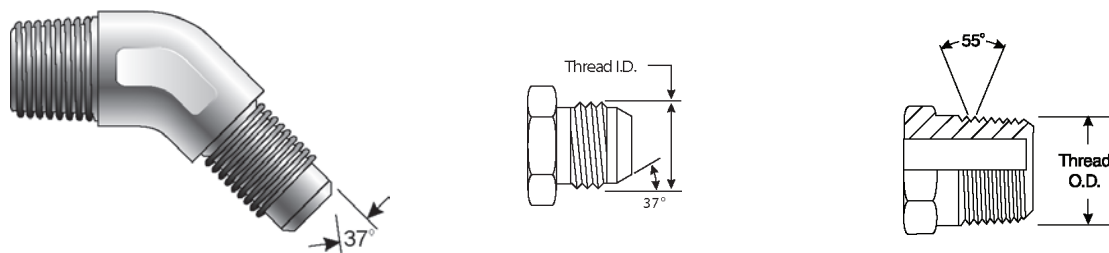

Part No.	Descr.	Prod. No.		
			"	"
G62153-0204	2MBSPT-4MJ45	7253-60215	1/8-28	3/4-16
G62153-0404	4MBSPT-4MJ45	7253-60225	1/4-19	7/16-20

- EQUIPMENT
- HOSE/CPLG. SELECTION
- G8K COUPLINGS
- GLOBALSPIRAL COUPLINGS
- STAINLESS STEEL SPIRAL
- MEGACRIMP COUPLINGS
- STAINLESS STEEL BRAID
- POWER CRIMP COUPLINGS
- FIELD ATTACHABLE G1 & G2 COUPLINGS
- FIELD ATTACHABLE C5 COUPLINGS
- GLX COUPLINGS
- GL COUPLINGS
- C14 COUPLINGS
- PCTS THERMOPLASTIC COUPLINGS
- POLARSEAL COUPLINGS
- POLARSEAL II COUPLINGS
- POWER STEERING
- ADAPTERS
- QUICK DISCONNECT COUPLERS
- BALL VALVES
- LIVE SWIVEL
- ASSEMBLY FABRICATION
- ACCESSORIES
- EQUIPMENT AND PARTS
- AIR BRAKE
- BRASS
- KITS

British Male Standard Pipe Tapered Thread to Male JIC 37° Flare - 45° - Continued

Part No.	Descr.	Prod. No.		
			"	"
G62153-0406	4MBSPT-6MJ45	7253-60235	1/4-19	9/16-18
G62153-0606	6MBSPT-6MJ45	7253-60245	3/8-19	9/16-18
G62153-0608	6MBSPT-8MJ45	7253-60255	3/8-19	3/4-16
G62153-0808	8MBSPT-8MJ45	7253-60265	1/2-14	3/4-16
G62153-0810	8MBSPT-10MJ45	7253-60275	1/2-14	7/8-14
G62153-1212	12MBSPT-12MJ45	7253-60285	3/4-14	1 1/16-12
G62153-1216	12MBSPT-16MJ45	7253-60295	3/4-14	1 5/16-12
G62153-1616	16MBSPT-16MJ45	7253-60305	1-11	1 5/16-12

British Male Standard Pipe Tapered Thread to Male JIC 37° Flare - 90°

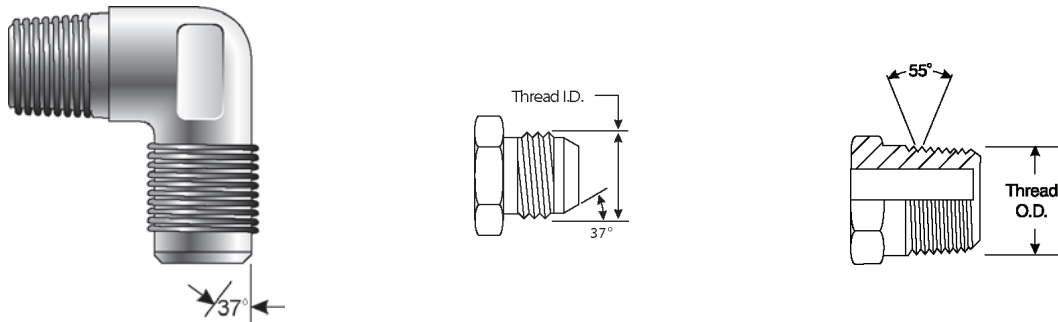

Part No.	Descr.	Prod. No.		
			"	"
G62155-0204	2MBSPT-4MJ90	7253-60315	1/8-28	3/4-16
G62155-0404	4MBSPT-4MJ90	7253-60325	1/4-19	7/16-20
G62155-0405	4MBSPT-5MJ90	7253-60335	1/4-19	1/2-20
G62155-0406	4MBSPT-6MJ90	7253-60345	1/4-19	9/16-18
G62155-0606	6MBSPT-6MJ90	7253-60355	3/8-19	9/16-18
G62155-0608	6MBSPT-8MJ90	7253-60365	3/8-19	3/4-16
G62155-0806	8MBSPT-6MJ90	7253-60375	1/2-14	3/4-16
G62155-0808	8MBSPT-8MJ90	7253-60385	1/2-14	3/4-16
G62155-0810	8MBSPT-10MJ90	7253-60395	1/2-14	7/8-14
G62155-0812	8MBSPT-12MJ90	7253-60405	1/2-14	1 1/16-12
G62155-1212	12MBSPT-12MJ90	7253-60415	3/4-14	1 1/16-12
G62155-1216	12MBSPT-16MJ90	7253-60425	3/4-14	1 5/16-12
G62155-1616	16MBSPT-16MJ90	7253-60435	1-11	1 5/16-12
G62155-2020	20MBSPT-20MJ90	7253-60445	1 1/4-11	1 5/8-12
G62155-2424	24MBSPT-24MJ90	7253-60455	1 1/2-11	1 7/8-12

British Male Standard Pipe Parallel to Male Pipe NPTF

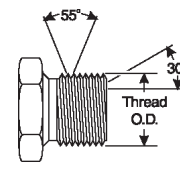
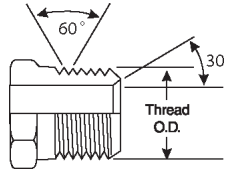
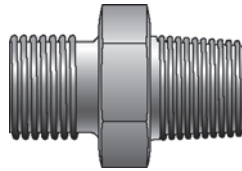

Part No.	Descr.	Prod. No.		
			"	"
G62200-0202	2MBSPP-2MP	7253-60475	1/8-28	1/8-27
G62200-0204	2MBSPP-4MP	7253-60485	1/8-28	1/4-18
G62200-0402	4MBSPP-2MP	7253-60495	1/4-19	1/8-27
G62200-0404	4MBSPP-4MP	7253-15075	1/4-19	1/4-18
G62200-0406	4MBSPP-6MP	7253-60505	1/4-19	3/8-18
G62200-0408	4MBSPP-8MP	7253-60515	1/4-19	1/2-14
G62200-0602	6MBSPP-2MP	7253-60525	3/8-19	1/8-27
G62200-0604	6MBSPP-4MP	7253-60535	3/8-19	1/4-18
G62200-0606	6MBSPP-6MP	7253-15085	3/8-19	3/8-18
G62200-0608	6MBSPP-8MP	7253-60545	3/8-19	1/2-14
G62200-0612	6MBSPP-12MP	7253-60555	3/8-19	3/4-14
G62200-0616	6MBSPP-16MP	7253-60565	3/8-19	1-11 1/2
G62200-0804	8MBSPP-4MP	7253-60575	1/2-14	1/4-18
G62200-0806	8MBSPP-6MP	7253-60585	1/2-14	3/8-18
G62200-0808	8MBSPP-8MP	7253-15095	1/2-14	1/2-14
G62200-0812	8MBSPP-12MP	7253-60595	1/2-14	3/4-14
G62200-0816	8MBSPP-16MP	7253-60605	1/2-14	1-11 1/2
G62200-1008	10MBSPP-8MP	7253-60615	5/8-14	1/2-14
G62200-1012	10MBSPP-12MP	7253-60625	5/8-14	3/4-14
G62200-1208	12MBSPP-8MP	7253-60635	3/4-14	1/2-14
G62200-1212	12MBSPP-12MP	7253-15105	3/4-14	3/4-14
G62200-1216	12MBSPP-16MP	7253-60645	3/4-14	1-11 1/2
G62200-1220	12MBSPP-20MP	7253-60655	3/4-14	1 1/4-11 1/2
G62200-1612	16MBSPP-12MP	7253-60665	1-11	3/4-14
G62200-1616	16MBSPP-16MP	7253-15115	1-11	1-11 1/2
G62200-1620	16MBSPP-20MP	7253-60675	1-11	1 1/4-11 1/2
G62200-2016	20MBSPP-16MP	7253-60685	1 1/4-11	1-11 1/2
G62200-2020	20MBSPP-20MP	7253-60695	1 1/4-11	1 1/4-11 1/2
G62200-2024	20MBSPP-24MP	7253-60705	1 1/4-11	1 1/2-11 1/2
G62200-2420	24MBSPP-20MP	7253-60715	1 1/2-11	1 1/4-11 1/2
G62200-2424	24MBSPP-24MP	7253-60725	1 1/2-11	1 1/2-11 1/2
G62200-3232	32MBSPP-32MP	7253-60735	2-11	2-11 1/2

British Male Standard Pipe Parallel to Female Pipe NPTF

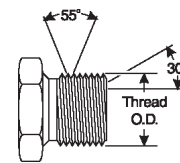
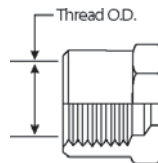
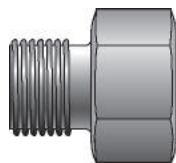

Part No.	Descr.	Prod. No.		
			"	"
G62220-0202	2MBSPP-2FP	7253-60745	1/8-28	1/8-27
G62220-0204	2MBSPP-4FP	7253-60755	1/8-28	1/4-18

- EQUIPMENT
- HOSE/CPLG. SELECTION
- G8K COUPLINGS
- GLOBAL SPIRAL COUPLINGS
- STAINLESS STEEL SPIRAL
- MEGACRIMP COUPLINGS
- STAINLESS STEEL BRAID
- POWER CRIMP COUPLINGS
- FIELD ATTACHABLE G1 & G2 COUPLINGS
- FIELD ATTACHABLE C5 COUPLINGS
- GLX COUPLINGS
- GL COUPLINGS
- C14 COUPLINGS
- PCTS THERMOPLASTIC COUPLINGS
- POLARSEAL COUPLINGS
- POLARSEAL II COUPLINGS
- POWER STEERING
- ADAPTERS
- QUICK DISCONNECT COUPLERS
- BALL VALVES
- LIVE SWIVEL
- ASSEMBLY FABRICATION
- ACCESSORIES
- EQUIPMENT AND PARTS
- AIR BRAKE
- BRASS
- KITS

British Male Standard Pipe Parallel to Female Pipe NPTF - Continued

Part No.	Descr.	Prod. No.		
			"	"
G62220-0402	4MBSPP-2FP	7253-60765	1/4-19	1/8-27
G62220-0404	4MBSPP-4FP	7253-60775	1/4-19	1/4-18
G62220-0406	4MBSPP-6FP	7253-60785	1/4-19	3/8-18
G62220-0602	6MBSPP-2FP	7253-60795	3/8-19	1/8-27
G62220-0604	6MBSPP-4FP	7253-60805	3/8-19	1/4-18
G62220-0606	6MBSPP-6FP	7253-60815	3/8-19	3/8-18
G62220-0804	8MBSPP-4FP	7253-60825	1/2-14	1/4-18
G62220-0806	8MBSPP-6FP	7253-60835	1/2-14	3/8-18
G62220-0808	8MBSPP-8FP	7253-60845	1/2-14	1/2-14
G62220-1208	12MBSPP-8FP	7253-60855	3/4-14	1/2-14
G62220-1212	12MBSPP-12FP	7253-60865	3/4-14	3/4-14
G62220-1616	16MBSPP-16FP	7253-60875	1-11	1-11 1/2
G62220-2016	20MBSPP-16FP	7253-60885	1 1/4-11	1-11 1/2
G62220-2020	20MBSPP-20FP	7253-60895	1 1/4-11	1 1/4-11 1/2
G62220-2420	24MBSPP-20FP	7253-60905	1 1/2-11	1 1/4-11 1/2
G62220-2424	24MBSPP-24FP	7253-60915	1 1/2-11	1 1/2-11 1/2
G62220-3232	32MBSPP-32FP	7253-60925	2-11	2-11 1/2

British Male Standard Pipe Parallel to Male JIC 37° Flare

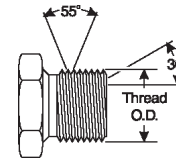
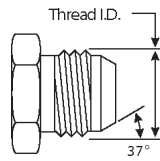
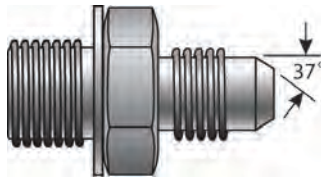



Part No.	Descr.	Prod. No.		
			"	"
G62300-0204	2MBSPP-4MJ	7253-60935	1/8-28	7/16-20
G62300-0205	2MBSPP-5MJ	7253-60945	1/8-28	1/2-20
G62300-0206	2MBSPP-6MJ	7253-60955	1/8-28	9/16-18
G62300-0404	4MBSPP-4MJ	7253-15015	1/4-19	7/16-20
G62300-0405	4MBSPP-5MJ	7253-60965	1/4-19	1/2-20
G62300-0406	4MBSPP-6MJ	7253-60975	1/4-19	9/16-18
G62300-0408	4MBSPP-8MJ	7253-60985	1/4-19	3/4-16
G62300-0604	6MBSPP-4MJ	7253-60995	3/8-19	7/16-20
G62300-0605	6MBSPP-5MJ	7253-61005	3/8-19	1/2-20
G62300-0606	6MBSPP-6MJ	7253-15025	3/8-19	9/16-18
G62300-0608	6MBSPP-8MJ	7253-61015	3/8-19	3/4-16
G62300-0806	8MBSPP-6MJ	7253-61025	1/2-14	9/16-18
G62300-0808	8MBSPP-8MJ	7253-15035	1/2-14	3/4-16
G62300-0810	8MBSPP-10MJ	7253-61035	1/2-14	7/8-14
G62300-0812	8MBSPP-12MJ	7253-61045	1/2-14	1 1/16-12
G62300-1008	10MBSPP-8MJ	7253-61055	5/8-14	3/4-16
G62300-1010	10MBSPP-10MJ	7253-15045	5/8-14	7/8-14
G62300-1012	10MBSPP-12MJ	7253-61065	5/8-14	1 1/16-12
G62300-1208	12MBSPP-8MJ	7253-61075	3/4-14	3/4-16
G62300-1210	12MBSPP-10MJ	7253-61085	3/4-14	7/8-14
G62300-1212	12MBSPP-12MJ	7253-15055	3/4-14	1 1/16-12
G62300-1214	12MBSPP-14MJ	7253-61095	3/4-14	1 3/16-12
G62300-1216	12MBSPP-16MJ	7253-61105	3/4-14	1 5/16-12
G62300-1612	16MBSPP-12MJ	7253-61115	1-11	1 1/16-12

British Male Standard Pipe Parallel to Male JIC 37° Flare - Continued

Part No.	Descr.	Prod. No.		
			"	"
G62300-1614	16MBSPP-14MJ	7253-61125	1-11	1 3/16-12
G62300-1616	16MBSPP-16MJ	7253-15065	1-11	1 5/16-12
G62300-1620	16MBSPP-20MJ	7253-61135	1-11	1 5/8-12
G62300-2016	20MBSPP-16MJ	7253-61145	1 1/4-11	1 5/16-12
G62300-2020	20MBSPP-20MJ	7253-61155	1 1/4-11	1 5/8-12
G62300-2024	20MBSPP-24MJ	7253-61165	1 1/4-11	1 7/8-12
G62300-2420	24MBSPP-20MJ	7253-61175	1 1/2-11	1 5/8-12
G62300-2424	24MBSPP-24MJ	7253-61185	1 1/2-11	1 7/8-12
G62300-3232	32MBSPP-32MJ	7253-61195	2-11	2 1/2-12

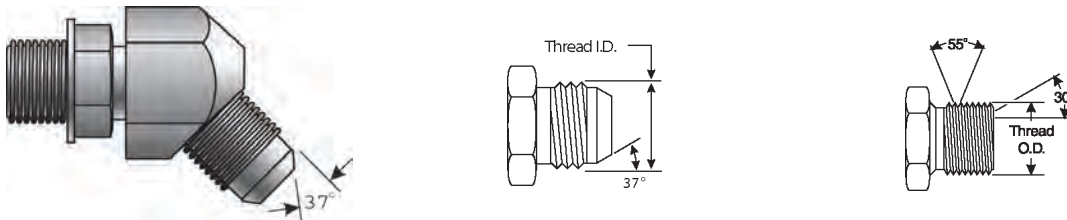
British Male Standard Pipe Parallel to Male JIC 37° Flare - 45°



Part No.	Descr.	Prod. No.		
			"	"
G62305-0204	2MBSPP-4MJ45	7253-61205	1/8-28	7/16-20
G62305-0404	4MBSPP-4MJ45	7253-61215	1/4-19	7/16-20
G62305-0406	4MBSPP-6MJ45	7253-61225	1/4-19	9/16-18
G62305-0606	6MBSPP-6MJ45	7253-61235	3/8-19	9/16-18
G62305-0608	6MBSPP-8MJ45	7253-61245	3/8-19	3/4-16
G62305-0808	8MBSPP-8MJ45	7253-61255	1/2-14	3/4-16
G62305-0810	8MBSPP-10MJ45	7253-61265	1/2-14	7/8-14
G62305-0812	8MBSPP-12MJ45	7253-61275	1/2-14	1 1/16-12
G62305-1212	12MBSPP-12MJ45	7253-61285	3/4-14	1 1/16-12
G62305-1616	16MBSPP-16MJ45	7253-61295	1-11	1 5/16-12

- EQUIPMENT
- HOSE/CPLG. SELECTION
- G8K COUPLINGS
- GLOBALSPIRAL COUPLINGS
- STAINLESS STEEL SPIRAL
- MEGACRIMP COUPLINGS
- STAINLESS STEEL BRAID
- POWER CRIMP COUPLINGS
- FIELD ATTACHABLE G1 & G2 COUPLINGS
- FIELD ATTACHABLE C5 COUPLINGS
- GLX COUPLINGS
- GL COUPLINGS
- C14 COUPLINGS
- PCTS THERMOPLASTIC COUPLINGS
- POLARSEAL COUPLINGS
- POLARSEAL II COUPLINGS
- POWER STEERING
- ADAPTERS
- QUICK DISCONNECT COUPLERS
- BALL VALVES
- LIVE SWIVEL
- ASSEMBLY FABRICATION
- ACCESSORIES
- EQUIPMENT AND PARTS
- AIR BRAKE
- BRASS
- KITS

British Male Standard Pipe Parallel to Male JIC 37° Flare - 90°

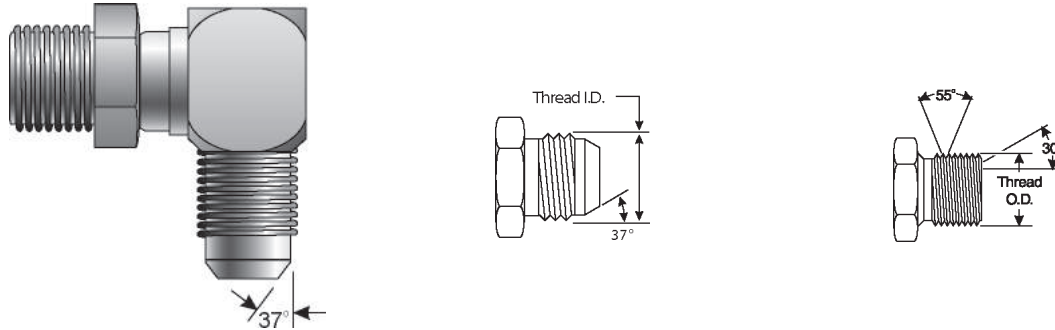

Part No.	Descr.	Prod. No.		
			"	"
G62310-0204	2MBSPP-4MJ90	7253-61305	1/8-28	7/16-20
G62310-0404	4MBSPP-4MJ90	7253-61315	1/4-19	7/16-20
G62310-0405	4MBSPP-5MJ90	7253-61325	1/4-19	1/2-20
G62310-0406	4MBSPP-6MJ90	7253-61335	1/4-19	9/16-18
G62310-0408	4MBSPP-8MJ90	7253-61345	1/4-19	3/4-16
G62310-0604	6MBSPP-4MJ90	7253-61355	3/8-19	7/16-20
G62310-0605	6MBSPP-5MJ90	7253-61365	3/8-19	1/2-20
G62310-0608	6MBSPP-8MJ90	7253-61385	3/8-19	3/4-16
G62310-0806	8MBSPP-6MJ90	7253-61395	1/2-14	9/16-18
G62310-0810	8MBSPP-10MJ90	7253-61415	1/2-14	7/8-14
G62310-0812	8MBSPP-12MJ90	7253-61425	1/2-14	1 1/16-12
G62310-1208	12MBSPP-8MJ90	7253-61435	3/4-14	3/4-16
G62310-1210	12MBSPP-10MJ90	7253-61445	3/4-14	7/8-14
G62310-1216	12MBSPP-16MJ90	7253-61465	3/4-14	1 5/16-12
G62310-1612	16MBSPP-12MJ90	7253-61475	1-11	1 1/16-12
G62310-1616	16MBSPP-16MJ90	7253-61485	1-11	1 5/16-12
G62310-1620	16MBSPP-20MJ90	7253-61495	1-11	1 5/8-12
G62310-2016	20MBSPP-16MJ90	7253-61505	1 1/2-11	1 5/16-12
G62310-2020	20MBSPP-20MJ90	7253-61515	1 1/2-11	1 5/8-12
G62310-2424	24MBSPP-24MJ90	7253-61525	1 1/2-11	1 7/8-12

British Male Standard Pipe Parallel to Female JIC 37° Flare Swivel

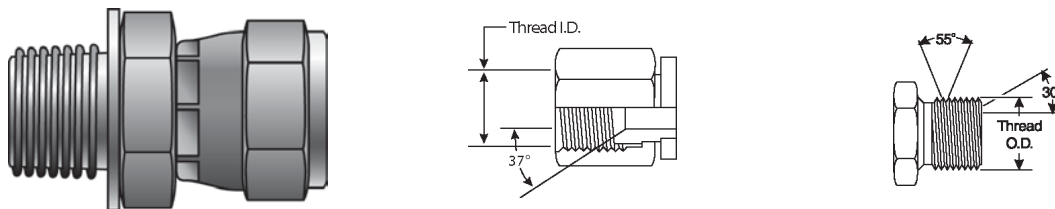



Part No.	Descr.	Prod. No.		
			"	"
G62320-0204	2MBSPP-4FJX	7253-61535	1/8-28	7/16-20
G62320-0404	4MBSPP-4FJX	7253-15125	1/4-19	7/16-20
G62320-0405	4MBSPP-5FJX	7253-61545	1/4-19	1/2-20
G62320-0406	4MBSPP-6FJX	7253-61555	1/4-19	9/16-18
G62320-0604	6MBSPP-4FJX	7253-61565	3/8-19	7/16-20
G62320-0606	6MBSPP-6FJX	7253-15135	3/8-19	9/16-18
G62320-0608	6MBSPP-8FJX	7253-61575	3/8-19	3/4-16

British Male Standard Pipe Parallel to Female JIC 37° Flare Swivel - Continued

Part No.	Descr.	Prod. No.		
			"	"
G62320-0804	8MBSPP-4FJX	7253-61585	1/2-14	7/16-20
G62320-0806	8MBSPP-6FJX	7253-61595	1/2-14	9/16-18
G62320-0808	8MBSPP-8FJX	7253-15145	1/2-14	3/4-16
G62320-0810	8MBSPP-10FJX	7253-61605	1/2-14	7/8-14
G62320-0812	8MBSPP-12FJX	7253-61615	1/2-14	1 1/16-12
G62320-1008	10MBSPP-8FJX	7253-61625	5/8-14	3/4-16
G62320-1010	10MBSPP-10FJX	7253-15155	5/8-14	7/8-14
G62320-1208	12MBSPP-8FJX	7253-61635	3/4-14	3/4-16
G62320-1212	12MBSPP-12FJX	7253-15165	3/4-14	1 1/16-12
G62320-1216	12MBSPP-16FJX	7253-61645	3/4-14	1 5/16-12
G62320-1616	16MBSPP-16FJX	7253-15175	1-11	1 5/16-12
G62320-1620	16MBSPP-20FJX	7253-61655	1-11	1 5/8-12
G62320-2016	20MBSPP-16FJX	7253-61665	1 1/4-11	1 5/16-12
G62320-2020	20MBSPP-20FJX	7253-61675	1 1/4-11	1 5/8-12
G62320-2424	24MBSPP-24FJX	7253-61685	1 1/2-11	1 7/8-12
G62320-3232	32MBSPP-32FJX	7253-61695	2-11	2 1/2-12

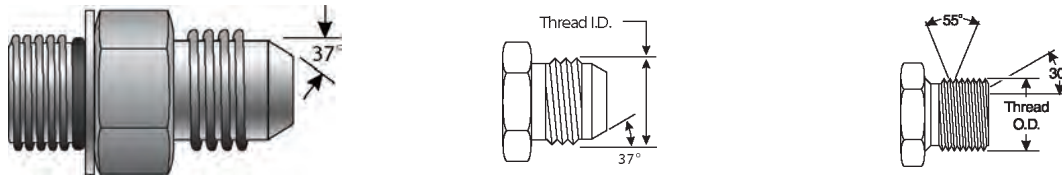
British Male Standard Pipe Parallel with O-Ring to Male JIC 37° Flare



Part No.	Descr.	Prod. No.		
			"	"
G62450-0204	2MBSPPOR-4MJ	7253-14005	1/8-28	7/16-20
G62450-0404	4MBSPPOR-4MJ	7253-14015	1/4-19	7/16-20
G62450-0405	4MBSPPOR-5MJ	7253-61705	1/4-19	1/2-20
G62450-0406	4MBSPPOR-6MJ	7253-14025	1/4-19	9/16-18
G62450-0604	6MBSPPOR-4MJ	7253-14035	3/8-19	7/16-20
G62450-0605	6MBSPPOR-5MJ	7253-61715	3/8-19	1/2-20
G62450-0606	6MBSPPOR-6MJ	7253-14045	3/8-19	9/16-18
G62450-0608	6MBSPPOR-8MJ	7253-14055	3/8-19	3/4-16
G62450-0806	8MBSPPOR-6MJ	7253-14075	1/2-14	9/16-18
G62450-0808	8MBSPPOR-8MJ	7253-14085	1/2-14	3/4-16
G62450-0810	8MBSPPOR-10MJ	7253-61725	1/2-14	7/8-14
G62450-0812	8MBSPPOR-12MJ	7253-14605	1/2-14	1 1/16-12
G62450-1208	12MBSPPOR-8MJ	7253-61735	3/4-14	3/4-16
G62450-1210	12MBSPPOR-10MJ	7253-61745	3/4-14	7/8-14
G62450-1212	12MBSPPOR-12MJ	7253-14095	3/4-14	1 1/16-12
G62450-1216	12MBSPPOR-16MJ	7253-61755	3/4-14	1 5/16-12
G62450-1612	16MBSPPOR-12MJ	7253-61765	1-11	1 1/16-12
G62450-1616	16MBSPPOR-16MJ	7253-14105	1-11	1 5/16-12
G62450-2020	20MBSPPOR-20MJ	7253-14115	1 1/4-11	1 5/8-12
G62450-2024	20MBSPPOR-24MJ	7253-61775	1 1/2-11	1 7/8-12
G62450-2424	24MBSPPOR-24MJ	7253-61785	1 1/2-11	1 7/8-12

- EQUIPMENT
- HOSE/CPLG. SELECTION
- G8K COUPLINGS
- GLOBAL SPIRAL COUPLINGS
- STAINLESS STEEL SPIRAL
- MEGACRIMP COUPLINGS
- STAINLESS STEEL BRAID
- POWER CRIMP COUPLINGS
- FIELD ATTACHABLE G1 & G2 COUPLINGS
- FIELD ATTACHABLE C5 COUPLINGS
- GLX COUPLINGS
- GL COUPLINGS
- C14 COUPLINGS
- PCTS THERMOPLASTIC COUPLINGS
- POLARSEAL COUPLINGS
- POLARSEAL II COUPLINGS
- POWER STEERING
- ADAPTERS
- QUICK DISCONNECT COUPLERS
- BALL VALVES
- LIVE SWIVEL
- ASSEMBLY FABRICATION
- ACCESSORIES
- EQUIPMENT AND PARTS
- AIR BRAKE
- BRASS
- KITS

British Male Standard Pipe Parallel with O-Ring to Male JIC 37° Flare - 90°

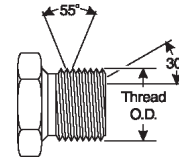
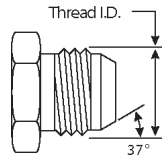
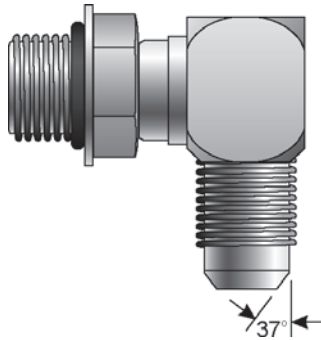

Part No.	Descr.	Prod. No.		
			"	"
G62460-0606	6MBSPPOR-6MJ90	7253-14505	3/8-19	9/16-18
G62460-0808	8MBSPPOR-8MJ90	7253-14515	1/2-14	3/4-16
G62460-1212	12MBSPPOR-12MJ90	7253-14525	3/4-14	1 1/2-12

British Male Standard Pipe Parallel with O-Ring to Male Flat-Face O-Ring

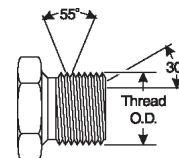
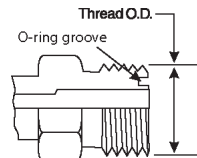
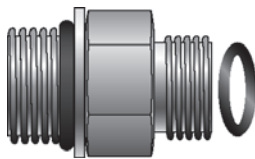

Part No.	Descr.	Prod. No.		
			"	"
G62470-0204	2MBSPPOR-4MFFOR	7253-61795	1/8-28	9/16-18
G62470-0404	4MBSPPOR-4MFFOR	7253-61805	1/4-19	9/16-18
G62470-0406	4MBSPPOR-6MFFOR	7253-61815	1/4-19	11/16-16
G62470-0606	6MBSPPOR-6MFFOR	7253-61825	3/8-19	11/16-16
G62470-0608	6MBSPPOR-8MFFOR	7253-61835	3/8-19	13/16-16
G62470-0806	8MBSPPOR-6MFFOR	7253-61845	1/2-14	11/16-16
G62470-0808	8MBSPPOR-8MFFOR	7253-61855	1/2-14	13/16-16
G62470-0810	8MBSPPOR-10MFFOR	7253-61865	1/2-14	1-14
G62470-1212	12MBSPPOR-12MFFOR	7253-61875	3/4-14	1 3/16-12
G62470-1216	12MBSPPOR-16MFFOR	7253-61885	3/4-14	1 7/16-12
G62470-1612	16MBSPPOR-12MFFOR	7253-61895	1-11	1 3/16-12
G62470-1616	16MBSPPOR-16MFFOR	7253-61905	1-11	1 7/16-12
G62470-2020	20MBSPPOR-20MFFOR	7253-61915	1 1/4-11	1 11/16-12
G62470-2424	24MBSPPOR-24MFFOR	7253-61925	1 1/2-11	2-12

British Male Standard Pipe Parallel with O-Ring to Male Flat-Face O-Ring - Long

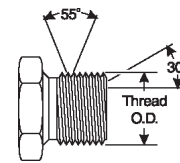
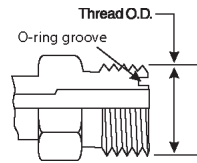
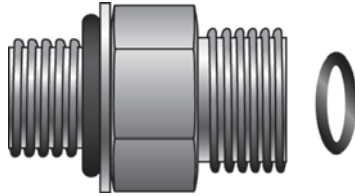

Part No.	Descr.	Prod. No.		
			"	"
G62471-0608	6MBSPPOR-8MFFORL	7253-61935	3/8-19	1/2-16
G62471-0808	8MBSPPOR-8MFFORL	7253-61945	1/2-14	1/2-16
G62471-0810	8MBSPPOR-10MFFORL	7253-61955	1/2-14	5/8-14
G62471-1210	12MBSPPOR-10MFFORL	7253-61965	3/4-14	5/8-14
G62471-1212	12MBSPPOR-12MFFORL	7253-61975	3/4-14	3/4-12
G62471-1616	16MBSPPOR-16MFFORL	7253-61985	1-11	1-12
G62471-2020	20MBSPPOR-20MFFORL	7253-61995	1 1/4-11	1 1/4-12

British Male Standard Pipe Parallel with O-Ring to Male Flat-Face O-Ring - 45°

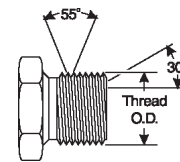
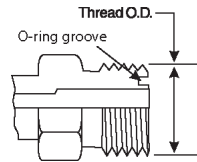
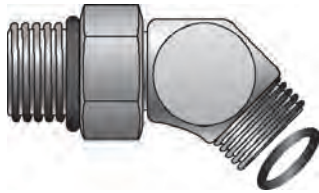

Part No.	Descr.	Prod. No.		
			"	"
G62473-0204	2MBSPPOR-4MFFOR45	7253-62005	1/8-28	1/4-18
G62473-0404	4MBSPPOR-4MFFOR45	7253-62015	1/4-19	1/4-18
G62473-0406	4MBSPPOR-6MFFOR45	7253-62025	1/4-19	3/8-16
G62473-0606	6MBSPPOR-6MFFOR45	7253-62035	3/8-19	3/8-16
G62473-0608	6MBSPPOR-8MFFOR45	7253-62045	3/8-19	1/2-16
G62473-0808	8MBSPPOR-8MFFOR45	7253-62055	1/2-14	1/2-16
G62473-0810	8MBSPPOR-10MFFOR45	7253-62065	1/2-14	5/8-14

- EQUIPMENT
- HOSE/CPLG. SELECTION
- G&K COUPLINGS
- GLOBALSPIRAL COUPLINGS
- STAINLESS STEEL SPIRAL
- MEGACRIMP COUPLINGS
- STAINLESS STEEL BRAID
- POWER CRIMP COUPLINGS
- FIELD ATTACHABLE G1 & G2 COUPLINGS
- FIELD ATTACHABLE C5 COUPLINGS
- GLX COUPLINGS
- GL COUPLINGS
- C14 COUPLINGS
- PCTS THERMOPLASTIC COUPLINGS
- POLARSEAL COUPLINGS
- POLARSEAL II COUPLINGS
- POWER STEERING
- ADAPTERS
- QUICK DISCONNECT COUPLERS
- BALL VALVES
- LIVE SWIVEL
- ASSEMBLY FABRICATION
- ACCESSORIES
- EQUIPMENT AND PARTS
- AIR BRAKE
- BRASS
- KITS

British Male Standard Pipe Parallel with O-Ring to Male Flat-Face O-Ring - 90°

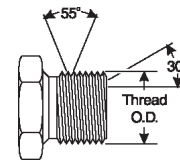
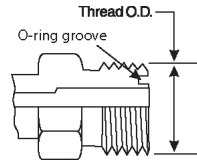
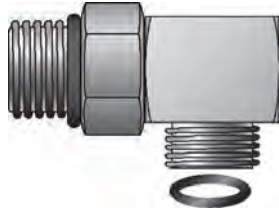

Part No.	Descr.	Prod. No.		
			"	"
G62475-0204	2MBSPPOR-4MFFOR90	7253-62075	1/8-28	1/4-18
G62475-0404	4MBSPPOR-4MFFOR90	7253-62085	1/4-19	1/4-18
G62475-0406	4MBSPPOR-6MFFOR90	7253-62095	1/4-19	3/8-16
G62475-0408	4MBSPPOR-8MFFOR90	7253-62105	1/4-19	1/2-16
G62475-0606	6MBSPPOR-6MFFOR90	7253-62115	3/8-19	3/8-16
G62475-0608	6MBSPPOR-8MFFOR90	7253-62125	3/8-19	1/2-16
G62475-0806	8MBSPPOR-6MFFOR90	7253-62135	1/2-14	3/8-16
G62475-0808	8MBSPPOR-8MFFOR90	7253-62145	1/2-14	1/2-16
G62475-0810	8MBSPPOR-10MFFOR90	7253-62155	1/2-14	5/8-14
G62475-0812	8MBSPPOR-12MFFOR90	7253-62165	1/2-14	3/4-12
G62475-1212	12MBSPPOR-12MFFOR90	7253-62175	3/4-14	3/4-12
G62475-1216	12MBSPPOR-16MFFOR90	7253-62185	3/4-14	1-12
G62475-1612	16MBSPPOR-12MFFOR90	7253-62195	1-11	3/4-12
G62475-1616	16MBSPPOR-16MFFOR90	7253-62205	1-11	1-12
G62475-2016	20MBSPPOR-16MFFOR90	7253-62215	1 1/4-11	1-12
G62475-2020	20MBSPPOR-20MFFOR90	7253-62225	1 1/4-11	1 1/4-12
G62475-2424	24MBSPPOR-24MFFOR90	7253-62235	1 1/2-11	1 1/2-12

Female British Standard Pipe Parallel to Male Pipe NPTF

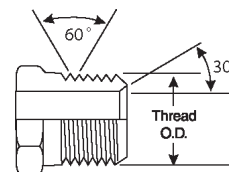
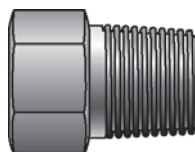



Part No.	Descr.	Prod. No.		
			"	"
G62500-0202	2FBSPP-2MP	7253-62245	1/8-28	1/8-27
G62500-0204	2FBSPP-4MP	7253-62255	1/8-28	1/4-18
G62500-0404	4FBSPP-4MP	7253-62265	1/4-19	1/4-18
G62500-0406	4FBSPP-6MP	7253-62275	1/4-19	3/8-18
G62500-0408	4FBSPP-8MP	7253-62285	1/4-19	1/2-14
G62500-0606	6FBSPP-6MP	7253-62295	3/8-19	3/8-18
G62500-0608	6FBSPP-8MP	7253-62305	3/8-19	1/2-14
G62500-0808	8FBSPP-8MP	7253-62315	1/2-14	1/2-14
G62500-0812	8FBSPP-12MP	7253-62325	1/2-14	3/4-14
G62500-1212	12FBSPP-12MP	7253-62335	3/4-14	3/4-14
G62500-1216	12FBSPP-16MP	7253-62345	3/4-14	1-11 1/2
G62500-1616	16FBSPP-16MP	7253-62355	1-11	1-11 1/2
G62500-2020	20FBSPP-20MP	7253-62365	1 1/4-11	1 1/4-11 1/2
G62500-2024	20FBSPP-24MP	7253-62375	1 1/4-11	1 1/4-11 1/2

Female British Standard Pipe Parallel to Male Pipe NPTF - Continued

Part No.	Descr.	Prod. No.		
			"	"
G62500-2424	24FBSPP-24MP	7253-62385	1 1/2-11	1 1/2-11 1/2
G62500-3232	32FBSPP-32MP	7253-62395	2-11	2-11 1/2

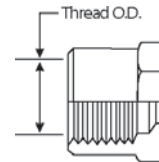
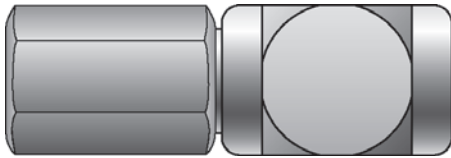
Female British Standard Pipe Parallel to Female Pipe NPTF



Part No.	Descr.	Prod. No.		
			"	"
G62520-0404	4FBSPP-4FP	7253-65525	1/4-19	1/4-18
G62520-0606	6FBSPP-6FP	7253-65535	3/8-19	3/8-18
G62520-0808	8FBSPP-8FP	7253-65545	1/2-14	1/2-14
G62520-1212	12FBSPP-12FP	7253-65555	3/4-14	3/4-14
G62520-1616	16FBSPP-16FP	7253-65565	1-11	1-11 1/2
G62520-2020	20FBSPP-20FP	7253-65575	1 1/4-11	1 1/4-11 1/2

Female British Standard Pipe Parallel to Male JIC 37° Flare

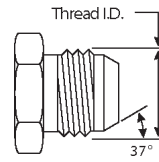
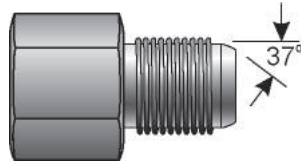

Part No.	Descr.	Prod. No.		
			"	"
G62550-0204	2FBSPP-4MJ	7253-14155	1/8-28	7/16-20
G62550-0404	4FBSPP-4MJ	7253-14225	1/4-19	7/16-20
G62550-0406	4FBSPP-6MJ	7253-14165	1/4-19	9/16-18
G62550-0606	6FBSPP-6MJ	7253-14175	3/8-19	9/16-18
G62550-0808	8FBSPP-8MJ	7253-14185	1/2-14	3/4-16
G62550-1212	12FBSPP-12MJ	7253-14195	3/4-14	1 1/16-12
G62550-1616	16FBSPP-16MJ	7253-14205	1-11	1 5/16-12
G62550-2020	20FBSPP-20MJ	7253-14215	1 1/4-11	1 5/8-12
G62550-2424	24FBSPP-24MJ	7253-62415	1 1/2-11	1 7/8-12

- EQUIPMENT
- HOSE/CPLG. SELECTION
- G&K COUPLINGS
- GLOBAL SPIRAL COUPLINGS
- STAINLESS STEEL SPIRAL
- MEGACRIMP COUPLINGS
- STAINLESS STEEL BRAID
- POWER CRIMP COUPLINGS
- FIELD ATTACHABLE G1 & G2 COUPLINGS
- FIELD ATTACHABLE C5 COUPLINGS
- GLX COUPLINGS
- GL COUPLINGS
- C14 COUPLINGS
- PCTS THERMOPLASTIC COUPLINGS
- POLARSEAL COUPLINGS
- POLARSEAL II COUPLINGS
- POWER STEERING
- ADAPTERS
- QUICK DISCONNECT COUPLERS
- BALL VALVES
- LIVE SWIVEL
- ASSEMBLY FABRICATION
- ACCESSORIES
- EQUIPMENT AND PARTS
- AIR BRAKE
- BRASS
- KITS

Female British Standard Pipe Parallel Swivel to Male Pipe NPTF - 90°

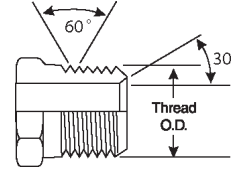
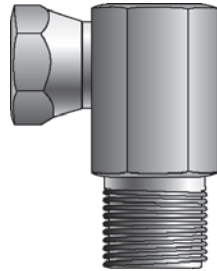

Part No.	Descr.	Prod. No.		
			"	"
G62605-0202	2FBSPPX-2MP90	7253-62425	1/8-28	1/8-27
G62605-0404	4FBSPPX-4MP90	7253-62435	1/4-19	1/4-18
G62605-0606	6FBSPPX-6MP90	7253-62445	3/8-19	3/8-18
G62605-0808	8FBSPPX-8MP90	7253-62455	1/2-14	1/2-14
G62605-1212	12FBSPPX-12MP90	7253-62465	3/4-14	3/4-14
G62605-1616	16FBSPPX-16MP90	7253-62475	1-11	1-11 1/2
G62605-2020	20FBSPPX-20MP90	7253-62485	1 1/4-11	1 1/4-11 1/2
G62605-2424	24FBSPPX-24MP90	7253-62495	1 1/2-11	1 1/4-11 1/2

Female British Standard Pipe Parallel Swivel to Male JIC 37° Flare

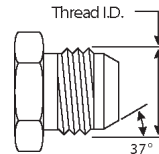
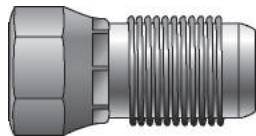

Part No.	Descr.	Prod. No.		
			"	"
G62650-0204	2FBSPPX-4MJ	7253-62545	1/8-28	7/16-20
G62650-0404	4FBSPPX-4MJ	7253-15245	1/4-19	7/16-20
G62650-0405	4FBSPPX-5MJ	7253-62555	1/4-19	1/2-20
G62650-0406	4FBSPPX-6MJ	7253-62565	1/4-19	9/16-18
G62650-0604	6FBSPPX-4MJ	7253-62575	3/8-19	7/16-20
G62650-0605	6FBSPPX-5MJ	7253-62585	3/8-19	1/2-20
G62650-0606	6FBSPPX-6MJ	7253-15255	3/8-19	9/16-18
G62650-0608	6FBSPPX-8MJ	7253-62595	3/8-19	3/4-16
G62650-0610	6FBSPPX-10MJ	7253-62605	3/8-19	7/8-14
G62650-0806	8FBSPPX-6MJ	7253-62615	1/2-14	9/16-18
G62650-0808	8FBSPPX-8MJ	7253-15265	1/2-14	3/4-16
G62650-0810	8FBSPPX-10MJ	7253-62625	1/2-14	7/8-14
G62650-1008	10FBSPPX-8MJ	7253-62635	5/8-14	3/4-16
G62650-1010	10FBSPPX-10MJ	7253-15275	5/8-14	7/8-14
G62650-1208	12FBSPPX-8MJ	7253-62645	3/4-14	3/4-16
G62650-1210	12FBSPPX-10MJ	7253-62655	3/4-14	7/8-14
G62650-1212	12FBSPPX-12MJ	7253-15285	3/4-14	1 1/16-12
G62650-1216	12FBSPPX-16MJ	7253-62665	3/4-14	1 5/16-12
G62650-1612	16FBSPPX-12MJ	7253-62675	1-11	1 1/16-12
G62650-1616	16FBSPPX-16MJ	7253-15295	1-11	1 5/16-12
G62650-2020	20FBSPPX-20MJ	7253-62685	1 1/4-11	1 5/8-12
G62650-2424	24FBSPPX-24MJ	7253-62695	1 1/2-11	1 7/8-12

Female British Standard Pipe Parallel Swivel to Female JIC 37° Flare Swivel

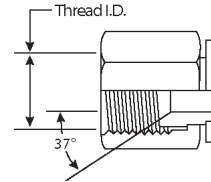
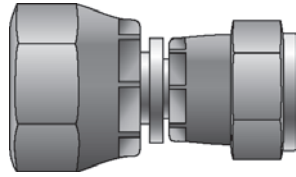

Part No.	Descr.	Prod. No.		
			"	"
G62660-0404	4FBSPPX-4FJX	7253-15305	1/4-19	7/16-20
G62660-0406	4FBSPPX-6FJX	7253-62505	1/4-19	9/16-18
G62660-0606	6FBSPPX-6FJX	7253-15315	3/8-19	9/16-18
G62660-0608	6FBSPPX-8FJX	7253-62515	3/8-19	3/4-16
G62660-0806	8FBSPPX-6FJX	7253-62525	1/2-14	9/16-18
G62660-0808	8FBSPPX-8FJX	7253-15325	1/2-14	3/4-16
G62660-1010	10FBSPPX-10FJX	7253-15335	5/8-14	7/8-14
G62660-1212	12FBSPPX-12FJX	7253-15345	3/4-14	1 1/16-12
G62660-1616	16FBSPPX-16FJX	7253-15355	1-11	1 5/16-12
G62660-2020	20FBSPPX-20FJX	7253-62535	1 1/4-11	1 5/8-12

Female British Flat-Face O-Ring to Male JIC 37° Flare

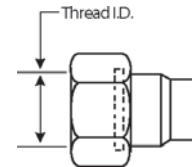
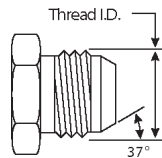
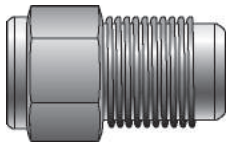

Part No.	Descr.	Prod. No.		
			"	"
G62801-0606	6FBFFOR-6MJ	7253-62705	3/8-19	9/16-18
G62801-0806	8FBFFOR-6MJ	7253-62715	1/2-14	9/16-18
G62801-0808	8FBFFOR-8MJ	7253-62725	1/2-14	3/4-16
G62801-0810	8FBFFOR-10MJ	7253-62735	1/2-14	7/8-14
G62801-1008	10FBFFOR-8MJ	7253-62745	5/8-14	3/4-16
G62801-1208	12FBFFOR-8MJ	7253-62755	3/4-14	3/4-16
G62801-1210	12FBFFOR-10MJ	7253-62765	3/4-14	7/8-14
G62801-1212	12FBFFOR-12MJ	7253-62775	3/4-14	1 1/16-12

- EQUIPMENT
- HOSE/CPLG. SELECTION
- G8K COUPLINGS
- GLOBALSPIRAL COUPLINGS
- STAINLESS STEEL SPIRAL
- MEGACRIMP COUPLINGS
- STAINLESS STEEL BRAID
- POWER CRIMP COUPLINGS
- FIELD ATTACHABLE G1 & G2 COUPLINGS
- FIELD ATTACHABLE C5 COUPLINGS
- GLX COUPLINGS
- GL COUPLINGS
- C14 COUPLINGS
- PCTS THERMOPLASTIC COUPLINGS
- POLARSEAL COUPLINGS
- POLARSEAL II COUPLINGS
- POWER STEERING
- ADAPTERS
- QUICK DISCONNECT COUPLERS
- BALL VALVES
- LIVE SWIVEL
- ASSEMBLY FABRICATION
- ACCESSORIES
- EQUIPMENT AND PARTS
- AIR BRAKE
- BRASS
- KITS

Metric Conversion

Male Metric O-Ring Plug



Part No.	Descr.	Prod. No.	Metric Conversion	
			"	"
G63099-0012	12MMOR-PLUG	7253-65415	M12X1.5	
G63099-0014	14MMOR-PLUG	7253-65425	M14X1.5	
G63099-0016	16MMOR-PLUG	7253-65435	M16X1.5	
G63099-0018	18MMOR-PLUG	7253-65445	M18X1.5	
G63099-0020	20MMOR-PLUG	7253-65455	M20X1.5	
G63099-0022	22MMOR-PLUG	7253-65465	M22X1.5	
G63099-0024	24MMOR-PLUG	7253-65475	M24X1.5	
G63099-0026	26MMOR-PLUG	7253-65485	M26X1.5	
G63099-0030	30MMOR-PLUG	7253-65495	M30X2.0	
G63099-0036	36MMOR-PLUG	7253-65505	M36X2.0	
G63099-0042	42MMOR-PLUG	7253-65515	M42X2.0	

Male Metric with O-Ring to Female Pipe NPTF

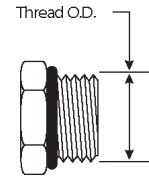
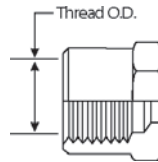
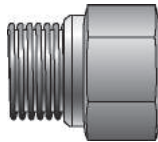

Part No.	Descr.	Prod. No.	Metric Conversion	
			"	"
G63120-1002	10MM-2FP	7253-62785	M10X1.0	1/8-27
G63120-1202	12MM-2FP	7253-62795	M12X1.5	1/8-27
G63120-1204	12MM-4FP	7253-62805	M12X1.5	1/4-18
G63120-1206	12MM-6FP	7253-62815	M12X1.5	3/8-18
G63120-1404	14MM-4FP	7253-62825	M14X1.5	1/4-18
G63120-1606	16MM-6FP	7253-62835	M16X1.5	3/8-18
G63120-1608	16MM-8FP	7253-62845	M16X1.5	1/2-14
G63120-1806	18MM-6FP	7253-62855	M18X1.5	3/8-18
G63120-1808	18MM-8FP	7253-62865	M18X1.5	1/2-14
G63120-2004	20MM-4FP	7253-62875	M20X1.5	1/4-18
G63120-2006	20MM-6FP	7253-62885	M20X1.5	3/8-18
G63120-2008	20MM-8FP	7253-62895	M20X1.5	1/2-14
G63120-2206	22MM-6FP	7253-62905	M22X1.5	3/8-18
G63120-2208	22MM-8FP	7253-62915	M22X1.5	1/2-14
G63120-2212	22MM-12FP	7253-62925	M22X1.5	3/4-14
G63120-2412	24MM-12FP	7253-62935	M24X1.5	3/4-14
G63120-2612	26MM-12FP	7253-62945	M26X1.5	3/4-14
G63120-2712	27MM-12FP	7253-62955	M27X2.0	3/4-14
G63120-3316	33MM-16FP	7253-62965	M33X2.0	1-11 1/2

Metric Conversion

Male Metric with O-Ring to Male JIC 37° Flare

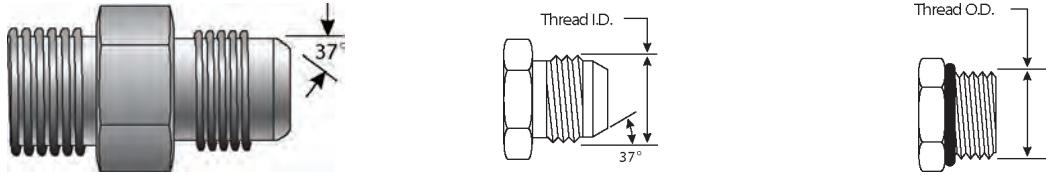

Part No.	Descr.	Prod. No.		
			"	"
G63150-1004	10MM-4MJ	7253-14355	M10X1.0	7/16-20
G63150-1204	12MM-4MJ	7253-14365	M12X1.5	7/16-20
G63150-1205	12MM-5MJ	7253-62975	M12X1.5	1/2-20
G63150-1206	12MM-6MJ	7253-62985	M12X1.5	9/16-18
G63150-1404	14MM-4MJ	7253-62995	M14X1.5	7/16-20
G63150-1406	14MM-6MJ	7253-14375	M14X1.5	9/16-18
G63150-1408	14MM-8MJ	7253-63005	M14X1.5	3/4-16
G63150-1605	16MM-5MJ	7253-63015	M16X1.5	1/2-20
G63150-1606	16MM-6MJ	7253-14385	M16X1.5	9/16-18
G63150-1608	16MM-8MJ	7253-14395	M16X1.5	3/4-16
G63150-1808	18MM-8MJ	7253-14405	M18X1.5	3/4-16
G63150-1810	18MM-10MJ	7253-14415	M18X1.5	7/8-14
G63150-2010	20MM-10MJ	7253-14425	M20X1.5	7/8-14
G63150-2208	22MM-8MJ	7253-63025	M22X1.5	3/4-16
G63150-2210	22MM-10MJ	7253-14435	M22X1.5	7/8-14
G63150-2212	22MM-12MJ	7253-14445	M22X1.5	1 1/16-12
G63150-2612	26MM-12MJ	7253-63035	M26X1.5	1 1/16-12
G63150-2712	27MM-12MJ	7253-14455	M27X2.0	1 1/16-12
G63150-2716	27MM-16MJ	7253-63045	M27X2.0	1 5/16-12
G63150-3316	33MM-16MJ	7253-14465	M33X2.0	1 5/16-12
G63150-3320	33MM-20MJ	7253-63055	M33X2.0	1 5/8-12
G63150-4220	42MM-20MJ	7253-14475	M42X2.0	1 5/8-12
G63150-4824	48MM-24MJ	7253-63065	M48X2.0	1 7/8-12

Male Metric with O-Ring to Male JIC 37° Flare - 90°

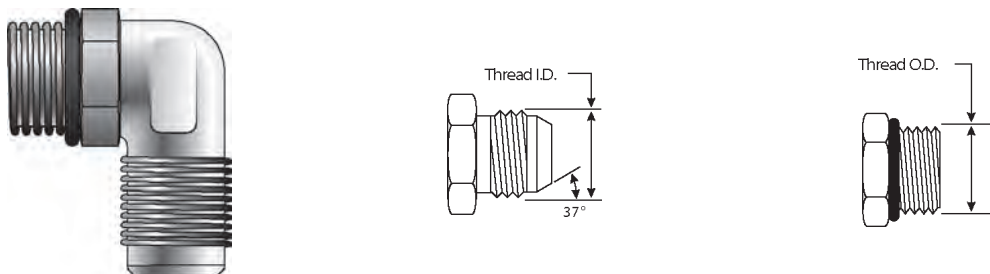

Part No.	Descr.	Prod. No.		
			"	"
G63160-1004	10MM-4MJ90	7253-65585	M10X1.0	7/16-20
G63160-1204	12MM-4MJ90	7253-65595	M12X1.5	7/16-20
G63160-1205	12MM-5MJ90	7253-65615	M12X1.5	1/2-20
G63160-1206	12MM-6MJ90	7253-65625	M12X1.5	9/16-18
G63160-1404	14MM-4MJ90	7253-65605	M14X1.5	7/16-20
G63160-1406	14MM-6MJ90	7253-65635	M14X1.5	9/16-18
G63160-1606	16MM-6MJ90	7253-65645	M16X1.5	9/16-18

- EQUIPMENT
- HOSE/CPLG. SELECTION
- G8K COUPLINGS
- GLOBALSPIRAL COUPLINGS
- STAINLESS STEEL SPIRAL
- MEGACRIMP COUPLINGS
- STAINLESS STEEL BRAID
- POWER CRIMP COUPLINGS
- FIELD ATTACHABLE G1 & G2 COUPLINGS
- FIELD ATTACHABLE C5 COUPLINGS
- GLX COUPLINGS
- GL COUPLINGS
- C14 COUPLINGS
- PCTS THERMOPLASTIC COUPLINGS
- POLARSEAL COUPLINGS
- POLARSEAL II COUPLINGS
- POWER STEERING
- ADAPTERS
- QUICK DISCONNECT COUPLERS
- BALL VALVES
- LIVE SWIVEL
- ASSEMBLY FABRICATION
- ACCESSORIES
- EQUIPMENT AND PARTS
- AIR BRAKE
- BRASS
- KITS

Metric Conversion

Male Metric with O-Ring to Male JIC 37° Flare - 90° - Continued

Part No.	Descr.	Prod. No.		
			"	"
G63160-1608	16MM-8MJ90	7253-65655	M16X1.5	3/4-16
G63160-1808	18MM-8MJ90	7253-65665	M18X1.5	3/4-16
G63160-1810	18MM-10MJ90	7253-65685	M18X1.5	7/8-14
G63160-2010	20MM-10MJ90	7253-65695	M20X1.5	7/8-14
G63160-2208	22MM-8MJ90	7253-65675	M22X1.5	3/4-16
G63160-2210	22MM-10MJ90	7253-65705	M22X1.5	7/8-14
G63160-2212	22MM-12MJ90	7253-65715	M22X1.5	1 1/16-12
G63160-2612	26MM-12MJ90	7253-65725	M26X1.5	1 1/16-12
G63160-2716	27MM-16MJ90	7253-65735	M27X2.0	1 5/16-12
G63160-3316	33MM-16MJ90	7253-65745	M33X2.0	1 5/16-12
G63160-4220	42MM-20MJ90	7253-65755	M42X2.0	1 5/8-12

Male DIN 24° Cone - Light Series to Male JIC 37° Flare

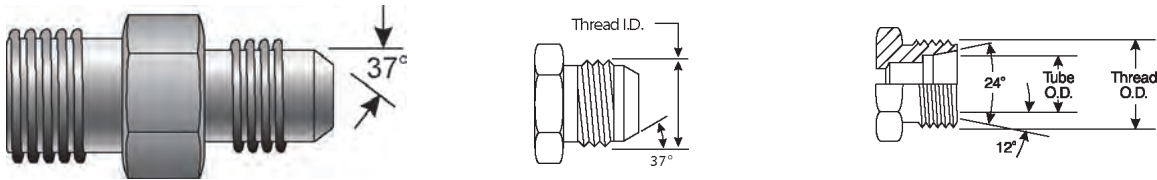

Part No.	Descr.	Prod. No.		
			"	"
G63350-0604	6MDL-4MJ	7253-63075	M12X1.5	7/16-20
G63350-0804	8MDL-4MJ	7253-15365	M14X1.5	7/16-20
G63350-0806	8MDL-6MJ	7253-63095	M14X1.5	9/16-18
G63350-1004	10MDL-4MJ	7253-63105	M16X1.5	7/16-20
G63350-1006	10MDL-6MJ	7253-15375	M16X1.5	9/16-18
G63350-1008	10MDL-8MJ	7253-63115	M16X1.5	3/4-16
G63350-1206	12MDL-6MJ	7253-15585	M18X1.5	9/16-18
G63350-1208	12MDL-8MJ	7253-63135	M18X1.5	3/4-16
G63350-1508	15MDL-8MJ	7253-15385	M22X1.5	3/4-16
G63350-1510	15MDL-10MJ	7253-63145	M22X1.5	7/8-14
G63350-1512	15MDL-12MJ	7253-63155	M22X1.5	1 1/16-12
G63350-1810	18MDL-10MJ	7253-15515	M26X1.5	7/8-14
G63350-1812	18MDL-12MJ	7253-63165	M26X1.5	1 1/16-12
G63350-2212	22MDL-12MJ	7253-15395	M30X2.0	1 1/16-12
G63350-2816	28MDL-16MJ	7253-15405	M36X2.0	1 5/16-12
G63350-3520	35MDL-20MJ	7253-63175	M45X2.0	1 5/8-12
G63350-4224	42MDL-24MJ	7253-63185	M52X2.0	1 7/8-12

Metric Conversion

Female DIN 24° Cone Swivel - Light Series to Male JIC 37° Flare

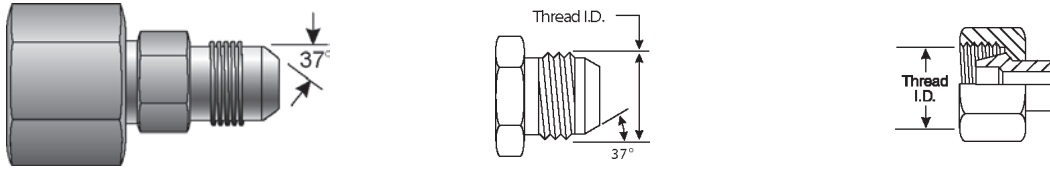

Part No.	Descr.	Prod. No.		
			"	"
G63450-0604	6FDLX-4MJ	7253-64725	M12X1.5	7/16-20
G63450-0605	6FDLX-5MJ	7253-64735	M6X1.5	1/2-20
G63450-0804	8FDLX-4MJ	7253-15465	M14X1.5	7/16-20
G63450-0806	8FDLX-6MJ	7253-64755	M14X1.5	9/16-18
G63450-1006	10FDLX-6MJ	7253-15475	M16X1.5	9/16-18
G63450-1008	10FDLX-8MJ	7253-64775	M16X1.5	3/4-16
G63450-1206	12FDLX-6MJ	7253-15545	M18X1.5	9/16-18
G63450-1208	12FDLX-8MJ	7253-64795	M18X1.5	3/4-16
G63450-1210	12FDLX-10MJ	7253-64805	M18X1.5	7/8-14
G63450-1506	15FDLX-6MJ	7253-64815	M22X1.5	9/16-18
G63450-1508	15FDLX-8MJ	7253-15485	M22X1.5	3/4-16
G63450-1510	15FDLX-10MJ	7253-64835	M22X1.5	7/8-14
G63450-2212	22FDLX-12MJ	7253-15495	M30X2.0	1 1/16-12
G63450-2816	28FDLX-16MJ	7253-15505	M36X2.0	1 5/16-12

Male DIN 24° Cone - Heavy Series to Male JIC 37° Flare

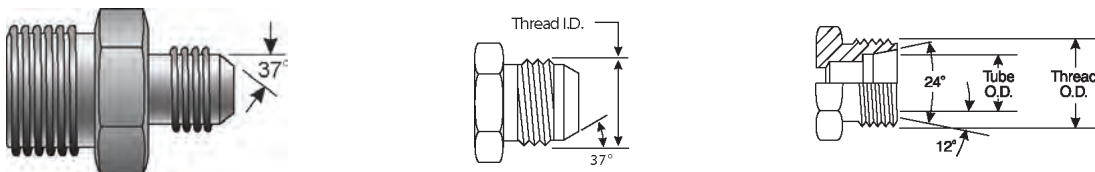



Part No.	Descr.	Prod. No.		
			"	"
G63650-0604	6MDH-4MJ	7253-63195	M14X1.5	7/16-20
G63650-0804	8MDH-4MJ	7253-63205	M16X1.5	7/16-20
G63650-0806	8MDH-6MJ	7253-63215	M16X1.5	9/16-18
G63650-1004	10MDH-4MJ	7253-15415	M18X1.5	7/16-20
G63650-1008	10MDH-8MJ	7253-63225	M18X1.5	3/4-16
G63650-1206	12MDH-6MJ	7253-63235	M20X1.5	9/16-18
G63650-1208	12MDH-8MJ	7253-63245	M20X1.5	3/4-16
G63650-1210	12MDH-10MJ	7253-63255	M20X1.5	7/8-14
G63650-1406	14MDH-6MJ	7253-15425	M22X1.5	9/16-18
G63650-1408	14MDH-8MJ	7253-63265	M22X1.5	3/4-16
G63650-1608	16MDH-8MJ	7253-15435	M24X1.5	3/4-16
G63650-1610	16MDH-10MJ	7253-63285	M24X1.5	1 7/8-12
G63650-1612	16MDH-12MJ	7253-63275	M24X1.5	1 1/16-12
G63650-2010	20MDH-10MJ	7253-15525	M30X2.0	7/8-14
G63650-2012	20MDH-12MJ	7253-63295	M30X2.0	1 1/16-12
G63650-2512	25MDH-12MJ	7253-15445	M36X2.0	1 1/16-12
G63650-2516	25MDH-16MJ	7253-63305	M36X2.0	1 5/16-12
G63650-3016	30MDH-16MJ	7253-15455	M42X2.0	1 5/16-12
G63650-3820	38MDH-20MJ	7253-63315	M52X2.0	1 5/8-12
G63650-3824	38MDH-24MJ	7253-63325	M52X2.0	1 7/8-12

EQUIPMENT
HOSE/CPLG. SELECTION
G8K COUPLINGS
GLOBALSPIRAL COUPLINGS
STAINLESS STEEL SPIRAL
MEGACRIMP COUPLINGS
STAINLESS STEEL BRAID
POWER CRIMP COUPLINGS
FIELD ATTACHABLE G1 & G2 COUPLINGS
FIELD ATTACHABLE C5 COUPLINGS
GLX COUPLINGS
GL COUPLINGS
C14 COUPLINGS
PCTS THERMOPLASTIC COUPLINGS
POLARSEAL COUPLINGS
POLARSEAL II COUPLINGS
POWER STEERING
ADAPTERS
QUICK DISCONNECT COUPLERS
BALL VALVES
LIVE SWIVEL
ASSEMBLY FABRICATION
ACCESSORIES
EQUIPMENT AND PARTS
AIR BRAKE
BRASS
KITS

Metric Conversion

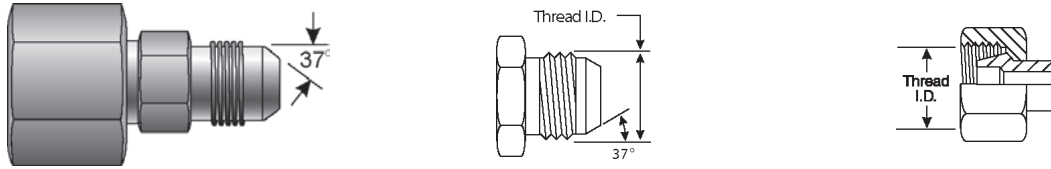
Female DIN 24° Cone Swivel - Heavy Series to Male JIC 37° Flare



Part No.	Descr.	Prod. No.		
			"	"
G63750-1004	10FDHX-4MJ	7253-15605	M18X1.5	7/16-20
G63750-1205	12FDHX-5MJ	7253-15615	M20X1.5	1/2-20
G63750-1206	12FDHX-6MJ	7253-64845	M20X1.5	9/16-18
G63750-1208	12FDHX-8MJ	7253-64855	M20X1.5	3/4-16
G63750-1210	12FDHX-10MJ	7253-64865	M20X1.5	7/8-14
G63750-1406	14FDHX-6MJ	7253-15625	M22X1.5	9/16-18
G63750-1608	16FDHX-8MJ	7253-15635	M24X1.5	3/4-16
G63750-2010	20FDHX-10MJ	7253-15645	M30X2.0	7/8-14
G63750-2512	25FDHX-12MJ	7253-15655	M36X2.0	1 1/16-12
G63750-3016	30FDHX-16MJ	7253-15665	M42X2.0	1 5/16-12
G63750-3820	38FDHX-20MJ	7253-15675	M52X2.0	1 5/8-12

Male Kobelco Plug



Part No.	Descr.	Prod. No.		
			"	"
G63980-0022	22MKB-PLUG	7253-65295	M30X1.5	

Male Kobelco to Male JIC 37° Flare

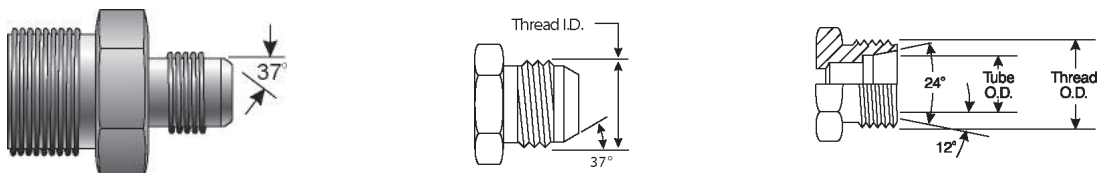

Part No.	Descr.	Prod. No.		
			"	"
G63990-2212	22MKB-12MJ	7253-66105	M30X1.5	1 1/16-12
G63990-2812	28MKB-12MJ	7253-65305	M36X1.5	1 1/16-12
G63990-2816	28MKB-16MJ	7253-65315	M36X1.5	1 5/16-12
G63990-3516	35MKB-16MJ	7253-65325	M45X1.5	1 5/16-12
G63990-3520	35MKB-20MJ	7253-65335	M45X1.5	1 5/8-12

British Bonded Seal



Part No.	Descr.	Prod. No.	
			"
G64075-0002	2BBDs	7253-63335	3/8
G64075-0004	4BBDs	7253-63345	17/32
G64075-0006	6BBDs	7253-63355	21/32
G64075-0008	8BBDs	7253-63365	13/16
G64075-0010	10BBDs	7253-63375	29/32
G64075-0012	12BBDs	7253-63385	1 1/32
G64075-0016	16BBDs	7253-63395	1 11/32
G64075-0020	20BBDs	7253-63405	1 21/32
G64075-0024	24BBDs	7253-63415	1 7/8
G64075-0032	32BBDs	7253-63425	2 11/32
G64075-0040	40BBDs	7253-63435	2 1/2
G64075-0048	48BBDs	7253-63445	3

Male British Standard Pipe Parallel with O-Ring Plug

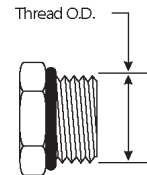
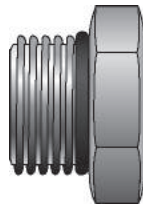

Part No.	Descr.	Prod. No.	
			"
G64094-0002	2MBSPOR-PLUG	7253-65345	1/8-28
G64094-0004	4MBSPOR-PLUG	7253-65355	1/4-19
G64094-0006	6MBSPOR-PLUG	7253-65365	3/8-19
G64094-0008	8MBSPOR-PLUG	7253-65375	1/2-14
G64094-0012	12MBSPOR-PLUG	7253-65385	3/4-14
G64094-0016	16MBSPOR-PLUG	7253-65395	1-11
G64094-0020	20MBSPOR-PLUG	7253-65405	1 1/4-11

- EQUIPMENT
- HOSE/CPLG. SELECTION
- G&K COUPLINGS
- GLOBALSPIRAL COUPLINGS
- STAINLESS STEEL SPIRAL
- MEGACRIMP COUPLINGS
- STAINLESS STEEL BRAID
- POWER CRIMP COUPLINGS
- FIELD ATTACHABLE G1 & G2 COUPLINGS
- FIELD ATTACHABLE C5 COUPLINGS
- GLX COUPLINGS
- GL COUPLINGS
- C14 COUPLINGS
- PCTS THERMOPLASTIC COUPLINGS
- POLARSEAL COUPLINGS
- POLARSEAL II COUPLINGS
- POWER STEERING
- ADAPTERS
- QUICK DISCONNECT COUPLERS
- BALL VALVES
- LIVE SWIVEL
- ASSEMBLY FABRICATION
- ACCESSORIES
- EQUIPMENT AND PARTS
- AIR BRAKE
- BRASS
- KITS

Female British Standard Pipe Parallel Cap



Part No.	Descr.	Prod. No.	
			"
G64097-0002	2FBSPP-CAP	7253-63455	1/8-28
G64097-0004	4FBSPP-CAP	7253-63465	1/4-19
G64097-0006	6FBSPP-CAP	7253-63475	3/8-19
G64097-0008	8FBSPP-CAP	7253-63485	1/2-14
G64097-0010	10FBSPP-CAP	7253-63495	5/8-14
G64097-0012	12FBSPP-CAP	7253-63505	3/4-14
G64097-0016	16FBSPP-CAP	7253-63515	1-11
G64097-0020	20FBSPP-CAP	7253-63525	1 1/4-11
G64097-0024	24FBSPP-CAP	7253-63535	1 1/2-11
G64097-0032	32FBSPP-CAP	7253-63545	2-11

Male British Standard Pipe Tapered Thread Plug

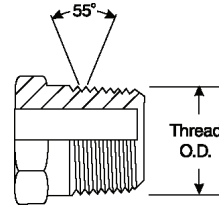
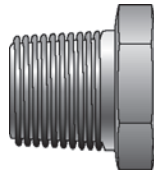

Part No.	Descr.	Prod. No.	
			"
G64098-0002	2MBSPT-PLUG	7253-63555	1/8-28
G64098-0004	4MBSPT-PLUG	7253-63565	1/4-19
G64098-0006	6MBSPT-PLUG	7253-63575	3/8-19
G64098-0008	8MBSPT-PLUG	7253-63585	1/2-14
G64098-0010	10MBSPT-PLUG	7253-63595	5/8-14
G64098-0012	12MBSPT-PLUG	7253-63605	3/4-14
G64098-0016	16MBSPT-PLUG	7253-63615	1-11
G64098-0020	20MBSPT-PLUG	7253-63625	1 1/4-11
G64098-0024	24MBSPT-PLUG	7253-63635	1 1/2-11

Male British Standard Pipe Parallel Plug

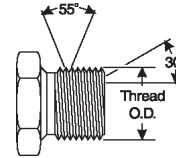
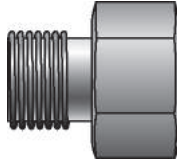

Part No.	Descr.	Prod. No.		
			"	"
G64099-0002	2MBSPP-PLUG	7253-63655	1/8-28	
G64099-0004	4MBSPP-PLUG	7253-63665	1/4-19	
G64099-0006	6MBSPP-PLUG	7253-63675	3/8-19	
G64099-0008	8MBSPP-PLUG	7253-63685	1/2-14	
G64099-0010	10MBSPP-PLUG	7253-63695	5/8-14	
G64099-0012	12MBSPP-PLUG	7253-63705	3/4-14	
G64099-0016	16MBSPP-PLUG	7253-63715	1-11	
G64099-0020	20MBSPP-PLUG	7253-63725	1 1/4-11	
G64099-0024	24MBSPP-PLUG	7253-63735	1 1/2-11	
G64099-0032	32MBSPP-PLUG	7253-63745	2-11	

Male British Standard Pipe Parallel to Female British Standard Pipe Parallel Swivel

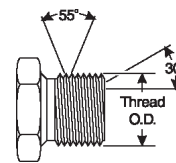
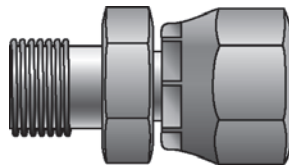

Part No.	Descr.	Prod. No.		
			"	"
G64350-0202	2MBSPP-2FBSPPX	7253-63775	1/8-28	1/8-28
G64350-0204	2MBSPP-4FBSPPX	7253-63785	1/8-28	1/4-19
G64350-0402	4MBSPP-2FBSPPX	7253-63795	1/4-19	1/8-28
G64350-0404	4MBSPP-4FBSPPX	7253-15185	1/4-19	1/4-19
G64350-0406	4MBSPP-6FBSPPX	7253-63805	1/4-19	3/8-19
G64350-0408	4MBSPP-8FBSPPX	7253-63815	1/4-19	1/2-14
G64350-0604	6MBSPP-4FBSPPX	7253-63825	3/8-19	1/4-19
G64350-0606	6MBSPP-6FBSPPX	7253-15195	3/8-19	3/8-19
G64350-0608	6MBSPP-8FBSPPX	7253-63835	3/8-19	1/2-14
G64350-0806	8MBSPP-6FBSPPX	7253-63845	1/2-14	3/8-19
G64350-0808	8MBSPP-8FBSPPX	7253-15205	1/2-14	1/2-14
G64350-0810	8MBSPP-10FBSPPX	7253-63855	1/2-14	5/8-14
G64350-0812	8MBSPP-12FBSPPX	7253-63865	1/2-14	3/4-14
G64350-1008	10MBSPP-8FBSPPX	7253-63875	5/8-14	1/2-14
G64350-1010	10MBSPP-10FBSPPX	7253-15215	5/8-14	7/8-14
G64350-1012	10MBSPP-12FBSPPX	7253-63885	5/8-14	3/4-14
G64350-1206	12MBSPP-6FBSPPX	7253-63895	3/4-14	3/8-19
G64350-1208	12MBSPP-8FBSPPX	7253-63905	3/4-14	1/2-14
G64350-1210	12MBSPP-10FBSPPX	7253-63915	3/4-14	5/8-14
G64350-1212	12MBSPP-12FBSPPX	7253-15225	3/4-14	3/4-14
G64350-1216	12MBSPP-16FBSPPX	7253-63925	3/4-14	1-11
G64350-1220	12MBSPP-20FBSPPX	7253-63935	3/4-14	1 1/4-11
G64350-1612	16MBSPP-12FBSPPX	7253-63945	1-11	3/4-14

- EQUIPMENT
- HOSE/CPLG. SELECTION
- G8K COUPLINGS
- GLOBALSPIRAL COUPLINGS
- STAINLESS STEEL SPIRAL
- MEGACRIMP COUPLINGS
- STAINLESS STEEL BRAID
- POWER CRIMP COUPLINGS
- FIELD ATTACHABLE G1 & G2 COUPLINGS
- FIELD ATTACHABLE C5 COUPLINGS
- GLX COUPLINGS
- GL COUPLINGS
- C14 COUPLINGS
- PCTS THERMOPLASTIC COUPLINGS
- POLARSEAL COUPLINGS
- POLARSEAL II COUPLINGS
- POWER STEERING
- ADAPTERS
- QUICK DISCONNECT COUPLERS
- BALL VALVES
- LIVE SWIVEL
- ASSEMBLY FABRICATION
- ACCESSORIES
- EQUIPMENT AND PARTS
- AIR BRAKE
- BRASS
- KITS

Male British Standard Pipe Parallel to Female British Standard Pipe Parallel Swivel - Continued

Part No.	Descr.	Prod. No.		
			"	"
G64350-1616	16MBSPP-16FBSPPX	7253-15235	1-11	1-11
G64350-1620	16MBSPP-20FBSPPX	7253-63955	1-11	1 1/4-11
G64350-2016	20MBSPP-16FBSPPX	7253-63965	1 1/4-11	1-11
G64350-2020	20MBSPP-20FBSPPX	7253-63975	1 1/4-11	1 1/4-11
G64350-2024	20MBSPP-24FBSPPX	7253-63985	1 1/4-11	1 1/2-11
G64350-2420	24MBSPP-20FBSPPX	7253-63995	1 1/2-11	1 1/4-11
G64350-2424	24MBSPP-24FBSPPX	7253-64005	1 1/2-11	1 1/2-11
G64350-3232	32MBSPP-32FBSPPX	7253-64015	2-11	2-11

Metric Bonded Seal



Part No.	Descr.	Prod. No.	
			mm
G64775-0006	6MBDS	7253-64025	6.0
G64775-0008	8MBDS	7253-64035	8.0
G64775-0010	10MBDS	7253-64045	10.0
G64775-0012	12MBDS	7253-64055	12.0
G64775-0014	14MBDS	7253-64065	14.0
G64775-0016	16MBDS	7253-64075	16.0
G64775-0018	18MBDS	7253-64085	18.0
G64775-0020	20MBDS	7253-64095	20.0
G64775-0022	22MBDS	7253-64105	22.0
G64775-0024	24MBDS	7253-64115	24.0
G64775-0026	26MBDS	7253-64125	26.0
G64775-0027	27MBDS	7253-64135	27.0
G64775-0030	30MBDS	7253-64145	30.0
G64775-0033	33MBDS	7253-64155	33.0
G64775-0036	36MBDS	7253-64165	36.0
G64775-0042	42MBDS	7253-64175	42.0
G64775-0045	45MBDS	7253-64185	45.0
G64775-0050	50MBDS	7253-64195	50.0
G64775-0052	52MBDS	7253-64205	52.0

Male Metric Plug



Part No.	Descr.	Prod. No.	
			"
G64790-0008	8MM-PLUG	7253-64215	M08X1.0
G64790-0010	10MM-PLUG	7253-64225	M10X1.5
G64790-0012	12MM-PLUG	7253-64235	M12X1.5
G64790-0014	14MM-PLUG	7253-64245	M14X1.5
G64790-0016	16MM-PLUG	7253-64255	M16X1.5
G64790-0018	18MM-PLUG	7253-64265	M18X1.5
G64790-0020	20MM-PLUG	7253-64275	M20X1.5
G64790-0022	22MM-PLUG	7253-64285	M22X1.5
G64790-0024	24MM-PLUG	7253-64295	M24X1.5
G64790-0026	26MM-PLUG	7253-64305	M26X1.5
G64790-0030	30MM-PLUG	7253-64315	M30X1.5

Male DIN 24° Cone - Light Series Plug

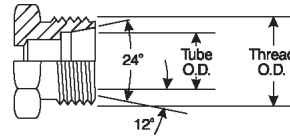



Part No.	Descr.	Prod. No.	
			"
G64792-0006	6MDL-PLUG	7253-64325	M12X1.5
G64792-0008	8MDL-PLUG	7253-64335	M14X1.5
G64792-0010	10MDL-PLUG	7253-64345	M16X1.5
G64792-0012	12MDL-PLUG	7253-64355	M18X1.5
G64792-0015	15MDL-PLUG	7253-64365	M22X1.5
G64792-0018	18MDL-PLUG	7253-64375	M26X1.5
G64792-0022	22MDL-PLUG	7253-64385	M30X2.0
G64792-0028	28MDL-PLUG	7253-64395	M36X2.0
G64792-0035	35MDL-PLUG	7253-64405	M45X2.0
G64792-0042	42MDL-PLUG	7253-64415	M52X2.0

- EQUIPMENT
- HOSE/CPLG. SELECTION
- G&K COUPLINGS
- GLOBALSPIRAL COUPLINGS
- STAINLESS STEEL SPIRAL
- MEGACRIMP COUPLINGS
- STAINLESS STEEL BRAID
- POWER CRIMP COUPLINGS
- FIELD ATTACHABLE G1 & G2 COUPLINGS
- FIELD ATTACHABLE C5 COUPLINGS
- GLX COUPLINGS
- GL COUPLINGS
- C14 COUPLINGS
- PCTS THERMOPLASTIC COUPLINGS
- POLARSEAL COUPLINGS
- POLARSEAL II COUPLINGS
- POWER STEERING
- ADAPTERS
- QUICK DISCONNECT COUPLERS
- BALL VALVES
- LIVE SWIVEL
- ASSEMBLY FABRICATION
- ACCESSORIES
- EQUIPMENT AND PARTS
- AIR BRAKE
- BRASS
- KITS

EQUIPMENT
HOSE/CPLG. SELECTION
G8K COUPLINGS
GLOBALSPIRAL COUPLINGS
STAINLESS STEEL SPIRAL
MEGACRIMP COUPLINGS
STAINLESS STEEL BRAID
POWER CRIMP COUPLINGS
FIELD ATTACHABLE G1 & G2 COUPLINGS
FIELD ATTACHABLE C5 COUPLINGS
GLX COUPLINGS
GL COUPLINGS
C14 COUPLINGS
PCTS THERMOPLASTIC COUPLINGS
POLARSEAL COUPLINGS
POLARSEAL II COUPLINGS
POWER STEERING
ADAPTERS
QUICK DISCONNECT COUPLERS
BALL VALVES
LIVE SWIVEL
ASSEMBLY FABRICATION
ACCESSORIES
EQUIPMENT AND PARTS
AIR BRAKE
BRASS
KITS

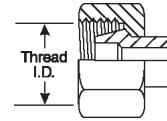
Female DIN 24° Cone - Light Series Cap



Part No.	Descr.	Prod. No.	
G64793-0006	6FDL-CAP	7253-64425	M12X1.5
G64793-0008	8FDL-CAP	7253-64435	M14X1.5
G64793-0010	10FDL-CAP	7253-64445	M16X1.5
G64793-0012	12FDL-CAP	7253-64455	M18X1.5
G64793-0015	15FDL-CAP	7253-64465	M22X1.5
G64793-0018	18FDL-CAP	7253-64475	M26X1.5
G64793-0022	22FDL-CAP	7253-64485	M30X2.0
G64793-0028	28FDL-CAP	7253-64495	M36X2.0
G64793-0035	35FDL-CAP	7253-64505	M45X2.0
G64793-0042	42FDL-CAP	7253-64515	M52X2.0

Male DIN 24° Cone - Heavy Series Plug

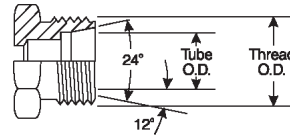

Part No.	Descr.	Prod. No.	
G64794-0008	8MDH-PLUG	7253-64535	M16X1.5
G64794-0010	10MDH-PLUG	7253-64545	M18X1.5
G64794-0012	12MDH-PLUG	7253-64555	M20X1.5
G64794-0014	14MDH-PLUG	7253-64565	M22X1.5
G64794-0016	16MDH-PLUG	7253-64575	M24X1.5
G64794-0020	20MDH-PLUG	7253-64585	M30X2.0
G64794-0025	25MDH-PLUG	7253-64595	M36X2.0
G64794-0030	30MDH-PLUG	7253-64605	M42X2.0
G64794-0038	38MDH-PLUG	7253-64615	M52X2.0

Female DIN 24° Cone - Heavy Series Cap

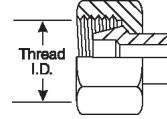
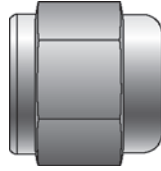

Part No.	Descr.	Prod. No.		
			"	
G64795-0008	8FDH-CAP	7253-64635	M16X1.5	
G64795-0010	10FDH-CAP	7253-64645	M18X1.5	
G64795-0012	12FDH-CAP	7253-64655	M20X1.5	
G64795-0014	14FDH-CAP	7253-64665	M22X1.5	
G64795-0016	16FDH-CAP	7253-64675	M24X1.5	
G64795-0020	20FDH-CAP	7253-64685	M30X2.0	
G64795-0025	25FDH-CAP	7253-64695	M36X2.0	
G64795-0030	30FDH-CAP	7253-64705	M42X2.0	
G64795-0038	38FDH-CAP	7253-64715	M52X2.0	

- EQUIPMENT
- HOSE/CPLG. SELECTION
- G8K COUPLINGS
- GLOBALSPIRAL COUPLINGS
- STAINLESS STEEL SPIRAL
- MEGACRIMP COUPLINGS
- STAINLESS STEEL BRAID
- POWER CRIMP COUPLINGS
- FIELD ATTACHABLE G1 & G2 COUPLINGS
- FIELD ATTACHABLE C5 COUPLINGS
- GLX COUPLINGS
- GL COUPLINGS
- C14 COUPLINGS
- PCTS THERMOPLASTIC COUPLINGS
- POLARSEAL COUPLINGS
- POLARSEAL II COUPLINGS
- POWER STEERING
- ADAPTERS
- QUICK DISCONNECT COUPLERS
- BALL VALVES
- LIVE SWIVEL
- ASSEMBLY FABRICATION
- ACCESSORIES
- EQUIPMENT AND PARTS
- AIR BRAKE
- BRASS
- KITS

Female Japanese Industrial Standard Cap

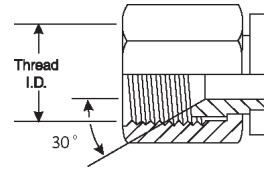
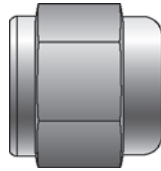

Part No.	Descr.	Prod. No.		
			"	"
G65097-0004	4FJIS-CAP	7253-64875	1/4-19	
G65097-0006	6FJIS-CAP	7253-64885	3/8-19	
G65097-0008	8FJIS-CAP	7253-64895	1/2-14	
G65097-0012	12FJIS-CAP	7253-64905	3/4-14	
G65097-0016	16FJIS-CAP	7253-64915	1-11	
G65097-0020	20FJIS-CAP	7253-64925	1 1/4-11	
G65097-0032	32FJIS-CAP	7253-64945	2-11	

Male Japanese Industrial Standard Plug

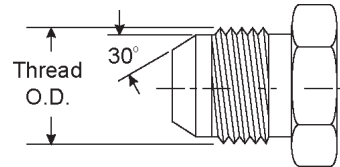
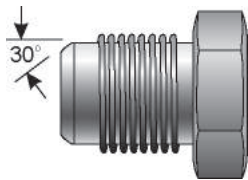

Part No.	Descr.	Prod. No.		
			"	"
G65099-0004	4MJIS-PLUG	7253-64955	1/4-19	
G65099-0006	6MJIS-PLUG	7253-64965	3/8-19	
G65099-0008	8MJIS-PLUG	7253-64975	1/2-14	
G65099-0012	12MJIS-PLUG	7253-64985	3/4-14	
G65099-0016	16MJIS-PLUG	7253-64995	1-11	
G65099-0020	20MJIS-PLUG	7253-65005	1 1/4-11	
G65099-0024	24MJIS-PLUG	7253-65015	1 1/2-11	
G65099-0032	32MJIS-PLUG	7253-65025	2-11	

Female Japanese Industrial Standard to Male JIC 37° Flare

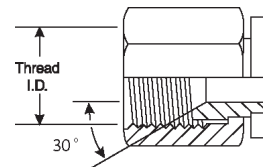
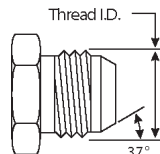
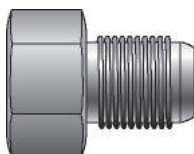



Part No.	Descr.	Prod. No.		
			"	"
G65100-0404	4FJIS-4MJ	7253-65035	1/4-19	7/16-20
G65100-0604	6FJIS-4MJ	7253-65045	3/8-19	7/16-20
G65100-0606	6FJIS-6MJ	7253-65055	3/8-19	9/16-18

Female Japanese Industrial Standard to Male JIC 37° Flare - Continued

Part No.	Descr.	Prod. No.		
			"	"
G65100-0808	8FJIS-8MJ	7253-65075	1/2-14	3/4-16
G65100-1212	12FJIS-12MJ	7253-65085	3/4-14	1 1/16-12
G65100-1616	16FJIS-16MJ	7253-65095	1-11	1 5/16-12
G65100-2020	20FJIS-20MJ	7253-65105	1 1/4-11	1 5/8-12

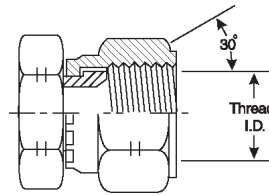
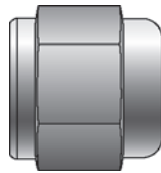
Female Komatsu Cap



Part No.	Descr.	Prod. No.		
			"	"
G65597-0004	4FK-CAP	7253-65115	M14X1.5	
G65597-0006	6FK-CAP	7253-65125	M18X1.5	
G65597-0008	8FK-CAP	7253-65135	M22X1.5	
G65597-0010	10FK-CAP	7253-65145	M24X1.5	
G65597-0012	12FK-CAP	7253-65155	M30X1.5	
G65597-0016	16FK-CAP	7253-65165	M33X1.5	

Male Komatsu Plug

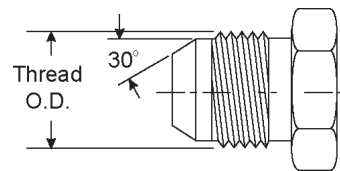
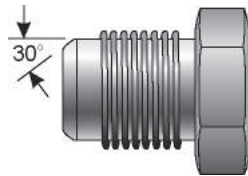

Part No.	Descr.	Prod. No.		
			"	"
G65599-0004	4MK-PLUG	7253-65175	M14X1.5	
G65599-0006	6MK-PLUG	7253-65185	M18X1.5	
G65599-0008	8MK-PLUG	7253-65195	M22X1.5	
G65599-0010	10MK-PLUG	7253-65205	M24X1.5	
G65599-0012	12MK-PLUG	7253-65215	M30X1.5	
G65599-0016	16MK-PLUG	7253-65225	M33X1.5	

- EQUIPMENT
- HOSE/CPLG. SELECTION
- G8K COUPLINGS
- GLOBAL SPIRAL COUPLINGS
- STAINLESS STEEL SPIRAL
- MEGACRIMP COUPLINGS
- STAINLESS STEEL BRAID
- POWER CRIMP COUPLINGS
- FIELD ATTACHABLE G1 & G2 COUPLINGS
- FIELD ATTACHABLE C5 COUPLINGS
- GLX COUPLINGS
- GL COUPLINGS
- C14 COUPLINGS
- PCTS THERMOPLASTIC COUPLINGS
- POLARSEAL COUPLINGS
- POLARSEAL II COUPLINGS
- POWER STEERING
- ADAPTERS
- QUICK DISCONNECT COUPLERS
- BALL VALVES
- LIVE SWIVEL
- ASSEMBLY FABRICATION
- ACCESSORIES
- EQUIPMENT AND PARTS
- AIR BRAKE
- BRASS
- KITS

Female Komatsu to Male JIC 37° Flare

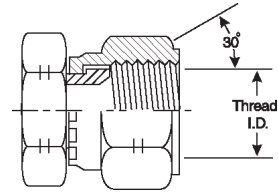
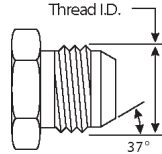
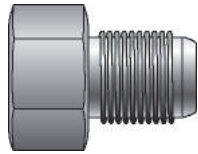

Part No.	Descr.	Prod. No.		
			"	"
G65600-0404	4FK-4MJ	7253-65235	M14X1.5	7/16-20
G65600-0606	6FK-6MJ	7253-65245	M18X1.5	9/16-18
G65600-0808	8FK-8MJ	7253-65255	M22X1.5	3/4-16
G65600-1010	10FK-10MJ	7253-65265	M24X1.5	7/8-14
G65600-1212	12FK-12MJ	7253-65275	M30X1.5	1 1/16-12
G65600-1616	16FK-16MJ	7253-65285	M33X1.5	1 5/16-12

Male Komatsu to Male Komatsu

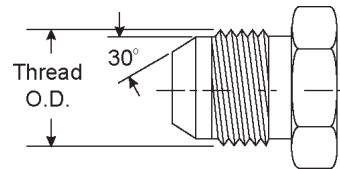
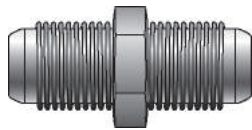

Part No.	Descr.	Prod. No.		
			"	"
G65700-0404	4MK-4MK	7253-65765	M14X1.5	
G65700-0606	6MK-6MK	7253-65775	M18X1.5	
G65700-0808	8MK-8MK	7253-65785	M22X1.5	
G65700-1010	10MK-10MK	7253-65795	M24X1.5	
G65700-1212	12MK-12MK	7253-65805	M30X1.5	
G65700-1616	16MK-16MK	7253-65815	M33X1.5	

Male Komatsu to Male JIC 37° Flare

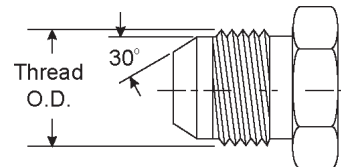
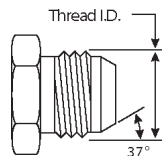
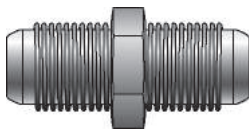

Part No.	Descr.	Prod. No.		
			"	"
G65750-0404	4MK-4MJ	7253-65825	M14X1.5	1/2-20
G65750-0606	6MK-6MJ	7253-65835	M18X1.5	9/16-18
G65750-0808	8MK-8MJ	7253-65845	M22X1.5	3/4-16
G65750-1010	10MK-10MJ	7253-65855	M24X1.5	7/8-14
G65750-1212	12MK-12MJ	7253-65865	M30X1.5	1 1/16-12
G65750-1616	16MK-16MJ	7253-65875	M33X1.5	1 5/16-12

Male Komatsu to Female Komatsu - 90°

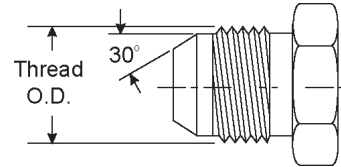
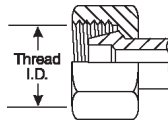
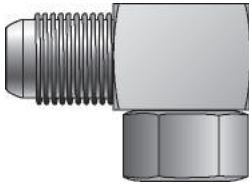

Part No.	Descr.	Prod. No.		
			"	"
G65800-0404	4MK-4FK90	7253-65945	M14X1.5	M14X1.5
G65800-0606	6MK-6FK90	7253-65965	M18X1.5	M18X1.5
G65800-0808	8MK-8FK90	7253-65975	M22X1.5	M22X1.5
G65800-1010	10MK-10FK90	7253-65985	M24X1.5	M24X1.5
G65800-1212	12MK-12FK90	7253-65995	M30X1.5	M30X1.5
G65800-1616	16MK-16FK90	7253-66005	M33X1.5	M33X1.5

Male Komatsu to Female Komatsu to Male Komatsu - Tee

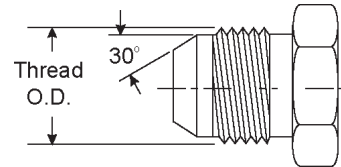
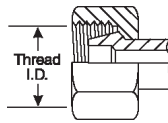
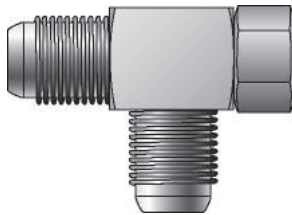

Part No.	Descr.	Prod. No.		
			"	"
G65950-0404	4MK-4FK-4MK	7253-65885	M14X1.5	M14X1.5
G65950-0606	6MK-6FK-6MK	7253-65905	M18X1.5	M18X1.5
G65950-0808	8MK-8FK-8MK	7253-65915	M22X1.5	M22X1.5
G65950-1010	10MK-10FK-10MK	7253-65925	M24X1.5	M24X1.5
G65950-1212	12MK-12FK-12MK	7253-65935	M30X1.5	M30X1.5

- EQUIPMENT
- HOSE/CPLG. SELECTION
- G8K COUPLINGS
- GLOBALSPIRAL COUPLINGS
- STAINLESS STEEL SPIRAL
- MEGACRIMP COUPLINGS
- STAINLESS STEEL BRAID
- POWER CRIMP COUPLINGS
- FIELD ATTACHABLE G1 & G2 COUPLINGS
- FIELD ATTACHABLE C5 COUPLINGS
- GLX COUPLINGS
- GL COUPLINGS
- C14 COUPLINGS
- PCTS THERMOPLASTIC COUPLINGS
- POLARSEAL COUPLINGS
- POLARSEAL II COUPLINGS
- POWER STEERING
- ADAPTERS
- QUICK DISCONNECT COUPLERS
- BALL VALVES
- LIVE SWIVEL
- ASSEMBLY FABRICATION
- ACCESSORIES
- EQUIPMENT AND PARTS
- AIR BRAKE
- BRASS
- KITS

NOTES

EQUIPMENT
HOSE/CPLG. SELECTION
G8K COUPLINGS
GLOBALSPIRAL COUPLINGS
STAINLESS STEEL SPIRAL
MEGACRIMP COUPLINGS
STAINLESS STEEL BRAID
POWER CRIMP COUPLINGS
FIELD ATTACHABLE G1 & G2 COUPLINGS
FIELD ATTACHABLE C5 COUPLINGS
GLX COUPLINGS
GL COUPLINGS
C14 COUPLINGS
PCTS THERMOPLASTIC COUPLINGS
POLARSEAL COUPLINGS
POLARSEAL II COUPLINGS
POWER STEERING
ADAPTERS
QUICK DISCONNECT COUPLERS
BALL VALVES
LIVE SWIVEL
ASSEMBLY FABRICATION
ACCESSORIES
EQUIPMENT AND PARTS
AIR BRAKE
BRASS
KITS

G940 Series [Agriculture Standard-Ball Valve]

Male Ball Valve to Female Pipe

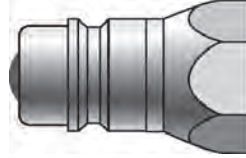

Part No.	Descr.	Prod. No.			
			"		
G94011-0404	4MQBA-4FP	7252-89315	1/4-18	4000	12000
G94011-0606	6MQBA-6FP	7252-89345	3/8-18	3000	9000
G94011-0808	8MQBA-8FP	7252-89325	1/2-14	3000	10500
G94011-0808M	8MQBA-8FP MBK	7252-89320	1/2-14	3000	10500
G94011-0812	8MQBA-12FP	7252-89305	1/2-14	3000	10500
G94011-1212	12MQBA-12FP	7252-89685	3/4-14	4000	11000

NOTE: Merchandiser Packaging with MBK in description.

Male Ball Valve to Female O-Ring Boss

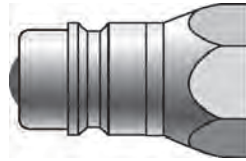

Part No.	Descr.	Prod. No.			
			"		
G94012-0808	8MQBA-8FB	7252-89335	3/4-16	3000	10500
G94012-0808M	8MQBA-8FB MBK	7252-89330	3/4-16	3000	10500

NOTE: Merchandiser Packaging with MBK in description.

Female Ball Valve To Female Pipe

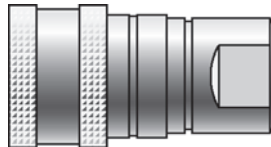

Part No.	Descr.	Prod. No.			
			"		
G94021-0404	4FQBA-4FP	7252-89415	1/4-18	4000	12000
G94021-0404M	4FQBA-4FP MBK	7252-89410	1/4-18	4000	12000
G94021-0606D	6FQBADA-6FP	7252-89695	3/8-18	3000	9000
G94021-0606DM	6FQBADA-6FP MBK	7252-89690	3/8-18	3000	9000
G94021-0808D	8FQBADA-8FP	7252-89445	1/2-14	3000	10500
G94021-0808DM	8FQBADA-8FP MBK	7252-89440	1/2-14	3000	10500
G94021-0808	8FQBA-8FP	7252-89425	1/2-14	3000	10500
G94021-0808M	8FQBA-8FP MBK	7252-89420	1/2-14	3000	10500
G94021-0812D	8FQBADA-12FP	7252-89705	1/2-14	3000	10500



NOTE: Merchandiser Packaging with MBK in description.

EQUIPMENT
HOSE/CPLG. SELECTION
G&K COUPLINGS
GLOBALSPIRAL COUPLINGS
STAINLESS STEEL SPIRAL
MEGACRIMP COUPLINGS
STAINLESS STEEL BRAID
POWER CRIMP COUPLINGS
FIELD ATTACHABLE G1 & G2 COUPLINGS
FIELD ATTACHABLE C5 COUPLINGS
GLX COUPLINGS
GL COUPLINGS
C14 COUPLINGS
PCTS THERMOPLASTIC COUPLINGS
POLARSEAL COUPLINGS
POLARSEAL II COUPLINGS
POWER STEERING
ADAPTERS
QUICK DISCONNECT COUPLERS
BALL VALVES
LIVE SWIVEL
ASSEMBLY FABRICATION
ACCESSORIES
EQUIPMENT AND PARTS
AIR BRAKE
BRASS
KITS

G940 Series [Agriculture Standard-Ball Valve]

EQUIPMENT
HOSE/CPLG. SELECTION
G8K COUPLINGS
GLOBAL SPIRAL COUPLINGS
STAINLESS STEEL SPIRAL
MEGACRIMP COUPLINGS
STAINLESS STEEL BRAID
POWER CRIMP COUPLINGS
FIELD ATTACHABLE G1 & G2 COUPLINGS
FIELD ATTACHABLE C5 COUPLINGS
GLX COUPLINGS
GL COUPLINGS
C14 COUPLINGS
PCTS THERMOPLASTIC COUPLINGS
POLARSEAL COUPLINGS
POLARSEAL II COUPLINGS
POWER STEERING
ADAPTERS
QUICK DISCONNECT COUPLERS
BALL VALVES
LIVE SWIVEL
ASSEMBLY FABRICATION
ACCESSORIES
EQUIPMENT AND PARTS
AIR BRAKE
BRASS
KITS



Female Ball Valve To Female Pipe - Continued

Part No.	Descr.	Prod. No.			
			"		
G94021-0812DM	8FQBADA-12FP MBK	7252-89700	1/2-14	3000	10500
G94021-1212	12FQBA-12FP	7252-89715	3/4-14	4000	11000

NOTE: Merchandiser Packaging with MBK in description.

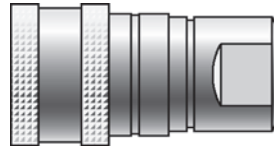
Female Ball Valve To Female O-Ring Boss



Part No.	Descr.	Prod. No.			
			"		
G94022-0808	8FQBA-8FB	7252-89435	3/4-16	3000	10500
G94022-0808M	8FQBA-8FB MBK	7252-89430	3/4-16	3000	10500

NOTE: Merchandiser Packaging with MBK in description.

O-Ring

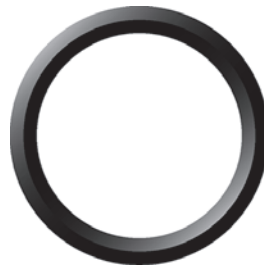

Part No.	Descr.	Prod. No.
G94025-0004	4QDAOR	7252-59415
G94025-0006	6QDAOR	7252-59695
G94025-0008	8QDAOR	7252-59425
G94025-0012	12QDAOR	7252-59715

QD Plug - Cap Combination



Part No.	Descr.	Prod. No.
G94081-0004	4QDADP/C	7252-87685
G94081-0006	6QDADP/C	7252-87695
G94081-0008	8QDADP/C	7252-87705



EQUIPMENT
HOSE/CPLG. SELECTION
G&K COUPLINGS
GLOBALSPIRAL COUPLINGS
STAINLESS STEEL SPIRAL
MEGACRIMP COUPLINGS
STAINLESS STEEL BRAID
POWER CRIMP COUPLINGS
FIELD ATTACHABLE G1 & G2 COUPLINGS
FIELD ATTACHABLE C5 COUPLINGS
GLX COUPLINGS
GL COUPLINGS
C14 COUPLINGS
PCTS THERMOPLASTIC COUPLINGS
POLARSEAL COUPLINGS
POLARSEAL II COUPLINGS
POWER STEERING
ADAPTERS
QUICK DISCONNECT COUPLERS
BALL VALVES
LIVE SWIVEL
ASSEMBLY FABRICATION
ACCESSORIES
EQUIPMENT AND PARTS
AIR BRAKE
BRASS
KITS

G941 Series (Agriculture Standard-Poppet Valve)

EQUIPMENT
HOSE/CPLG. SELECTION
G8K COUPLINGS
GLOBALSPIRAL COUPLINGS
STAINLESS STEEL SPIRAL
MEGACRIMP COUPLINGS
STAINLESS STEEL BRAID
POWER CRIMP COUPLINGS
FIELD ATTACHABLE G1 & G2 COUPLINGS
FIELD ATTACHABLE C5 COUPLINGS
GLX COUPLINGS
GL COUPLINGS
C14 COUPLINGS
PCTS THERMOPLASTIC COUPLINGS
POLARSEAL COUPLINGS
POLARSEAL II COUPLINGS
POWER STEERING
ADAPTERS
QUICK DISCONNECT COUPLERS
BALL VALVES
LIVE SWIVEL
ASSEMBLY FABRICATION
ACCESSORIES
EQUIPMENT AND PARTS
AIR BRAKE
BRASS
KITS

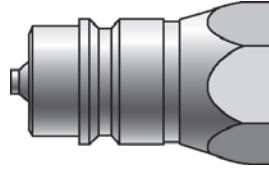

Male Poppet Valve to Female Pipe

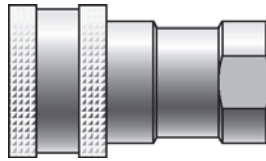

Part No.	Descr.	Prod. No.			
			"		
G94111-0404	4MQPA-4FP	7252-89725	1/4-18	3000	12000
G94111-0606	6MQPA-6FP	7252-89735	3/8-18	3000	12000
G94111-0808	8MQPA-8FP	7252-89365	1/2-14	4000	16000
G94111-1616	16MQPA-16FP	7252-89745	1-11 1/2	3000	12000

Female Poppet Valve to Female Pipe





Part No.	Descr.	Prod. No.			
			"		
G94121-0404	4FQPA-4FP	7252-89755	1/4-18	3000	12000
G94121-0606	6FQPA-6FP	7252-89765	3/8-18	3000	12000
G94121-0606M	6FQPA-6FP MBK	7252-89760	3/8-18	3000	12000
G94121-0808	8FQPA-8FP	7252-89775	1/2-14	4000	16000
G94121-1616	16FQPA-16FP	7252-89785	1-11 1/2	3000	12000

NOTE: Merchandiser Packaging with MBK in description.

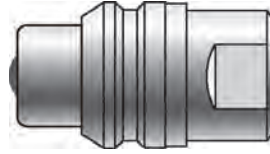
Male Ball Valve to Female Pipe





Part No.	Descr.	Prod. No.		
			"	
G94211-0808	8MQBAJD-8FP	7252-89355	1/2-14	3000
G94211-0808M	8MQBAJD-8FP MBK	7252-89350	1/2-14	3000

NOTE: Merchandiser Packaging with MBK in description.

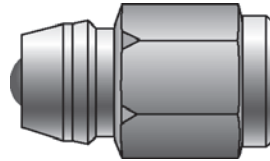
Male Ball Valve to Female O-Ring Boss





Part No.	Descr.	Prod. No.		
			"	
G94212-0808	8MQBAJD-8FB	7252-89375	3/4-16	3000
G94212-0808M	8MQBAJD-8FB MBK	7252-89370	3/4-16	3000

NOTE: Merchandiser Packaging with MBK in description.

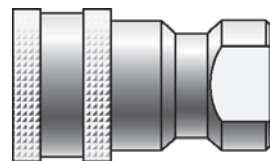
Female Ball Valve to Female Pipe



Part No.	Descr.	Prod. No.		
			"	
G94221-0808	8FQBAJD-8FP	7252-89455	1/2-14	3000

EQUIPMENT

HOSE/CPLG. SELECTION

G8K COUPLINGS

GLOBALSPIRAL COUPLINGS

STAINLESS STEEL SPIRAL

MEGACRIMP COUPLINGS

STAINLESS STEEL BRAID

POWER CRIMP COUPLINGS

FIELD ATTACHABLE G1 & G2 COUPLINGS

FIELD ATTACHABLE C5 COUPLINGS

GLX COUPLINGS

GL COUPLINGS

C14 COUPLINGS

PCTS THERMOPLASTIC COUPLINGS

POLARSEAL COUPLINGS

POLARSEAL II COUPLINGS

POWER STEERING

ADAPTERS

QUICK DISCONNECT COUPLERS

BALL VALVES

LIVE SWIVEL

ASSEMBLY FABRICATION

ACCESSORIES

EQUIPMENT AND PARTS

AIR BRAKE



BRASS

KITS

G943 Series (International Harvester Old Style)

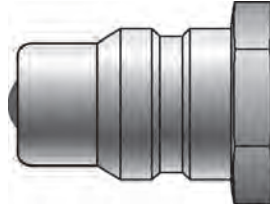
Male Tip - Ball Valve to Female Pipe



Part No.	Descr.	Prod. No.		
			"	
G94311-0808	8MQBAIHC-8FP	7252-89385	1/2-14	2500
G94311-0808M	8MQBAIHC-8FP MBK	7252-89380	1/2-14	2500



NOTE: Merchandiser Packaging with MBK in description.

EQUIPMENT
HOSE/CPLG. SELECTION
G8K COUPLINGS
GLOBALSPIRAL COUPLINGS
STAINLESS STEEL SPIRAL
MEGACRIMP COUPLINGS
STAINLESS STEEL BRAID
POWER CRIMP COUPLINGS
FIELD ATTACHABLE G1 & G2 COUPLINGS
FIELD ATTACHABLE C5 COUPLINGS
GLX COUPLINGS
GL COUPLINGS
C14 COUPLINGS
PCTS THERMOPLASTIC COUPLINGS
POLARSEAL COUPLINGS
POLARSEAL II COUPLINGS
POWER STEERING
ADAPTERS
QUICK DISCONNECT COUPLERS
BALL VALVES
LIVE SWIVEL
ASSEMBLY FABRICATION
ACCESSORIES
EQUIPMENT AND PARTS
AIR BRAKE
BRASS
KITS

G944 Series (J.I. Case Old Style)

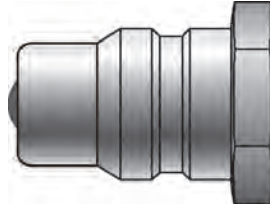
Male Tip - Ball Valve to Female Pipe







Part No.	Descr.	Prod. No.		
			"	
G94411-0808	8MQBAJIC-8FP	7252-89395	1/2-14	3000

EQUIPMENT
HOSE/CPLG. SELECTION
G&K COUPLINGS
GLOBALSPIRAL COUPLINGS
STAINLESS STEEL SPIRAL
MEGACRIMP COUPLINGS
STAINLESS STEEL BRAID
POWER CRIMP COUPLINGS
FIELD ATTACHABLE G1 & G2 COUPLINGS
FIELD ATTACHABLE C5 COUPLINGS
GLX COUPLINGS
GL COUPLINGS
C14 COUPLINGS
PCTS THERMOPLASTIC COUPLINGS
POLARSEAL COUPLINGS
POLARSEAL II COUPLINGS
POWER STEERING
ADAPTERS
QUICK DISCONNECT COUPLERS
BALL VALVES
LIVE SWIVEL
ASSEMBLY FABRICATION
ACCESSORIES
EQUIPMENT AND PARTS
AIR BRAKE
BRASS
KITS

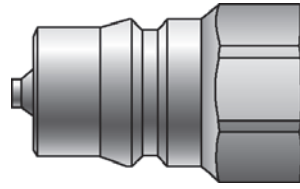
EQUIPMENT
HOSE/CPLG. SELECTION
G8K COUPLINGS
GLOBALSPIRAL COUPLINGS
STAINLESS STEEL SPIRAL
MEGACRIMP COUPLINGS
STAINLESS STEEL BRAID
POWER CRIMP COUPLINGS
FIELD ATTACHABLE G1 & G2 COUPLINGS
FIELD ATTACHABLE C5 COUPLINGS
GLX COUPLINGS
GL COUPLINGS
C14 COUPLINGS
PCTS THERMOPLASTIC COUPLINGS
POLARSEAL COUPLINGS
POLARSEAL II COUPLINGS
POWER STEERING
ADAPTERS
QUICK DISCONNECT COUPLERS
BALL VALVES
LIVE SWIVEL
ASSEMBLY FABRICATION
ACCESSORIES
EQUIPMENT AND PARTS
AIR BRAKE
BRASS
KITS





Male Poppet Valve to Female Pipe

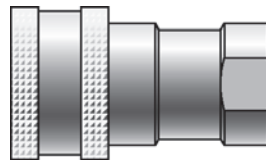

Part No.	Descr.	Prod. No.			
					
G94511-0404	4MQPI-4FP	7252-89015	1/4-18	7500	30000
G94511-0606	6MQPI-6FP	7252-89025	3/8-18	5000	20000
G94511-0808	8MQPI-8FP	7252-89035	1/2-14	5000	20000
G94511-1212	12MQPI-12FP	7252-89045	3/4-14	4000	16000
G94511-1616	16MQPI-16FP	7252-89055	1-11 1/2	4000	16000

Female Poppet Valve to Female Pipe



Part No.	Descr.	Prod. No.			
					
G94521-0404	4FQPI-4FP	7252-89115	1/4-18	7500	30000
G94521-0606	6FQPI-6FP	7252-89125	3/8-18	5000	20000
G94521-0808	8FQPI-8FP	7252-89135	1/2-14	5000	20000
G94521-1212	12FQPI-12FP	7252-89145	3/4-14	4000	16000
G94521-1616	16FQPI-16FP	7252-89155	1-11 1/2	4000	16000

O-Ring

90 Durometer Hardness.

Caution: These O-Rings are compounded from a Nitrile polymer for use with petroleum-base hydraulic fluids, water and glycol and oil-water emulsions. DO NOT USE these O-Rings with phosphate esters, diesters or phosphate ester emulsion hydraulic fluids. Instead, use O-Rings made of Viton, EPDM or CPE polymers or other materials compatible with the fluids.



Part No.	Descr.	Prod. No.
G94525-0004	4QDIOR	7252-59115
G94525-0006	6QDIOR	7252-59125

O-Ring - Continued

Part No.	Descr.	Prod. No.
G94525-0008	8QDIOR	7252-59135
G94525-0012	12QDIOR	7252-59145
G94525-0016	16QDIOR	7252-59155

Backup Ring



Part No.	Descr.	Prod. No.
G94526-0004	4QDIBR	7252-49115
G94526-0006	6QDIBR	7252-49125
G94526-0008	8QDIBR	7252-49135
G94526-0012	12QDIBR	7252-49145
G94526-0016	16QDIBR	7252-49155

QD Plug - Cap Combination



Part No.	Descr.	Prod. No.
G94581-0004	4QDIDP/C	7252-87005
G94581-0006	6QDIDP/C	7252-87595
G94581-0008	8QDIDP/C	7252-87605
G94581-0012	12QDIDP/C	7252-87615
G94581-0016	16QDIDP/C	7252-87625

EQUIPMENT

HOSE/CPLG. SELECTION

G&K COUPLINGS

GLOBAL SPIRAL COUPLINGS

STAINLESS STEEL SPIRAL

MEGACRIMP COUPLINGS

STAINLESS STEEL BRAID

POWER CRIMP COUPLINGS

FIELD ATTACHABLE G1 & G2 COUPLINGS

FIELD ATTACHABLE C5 COUPLINGS

GLX COUPLINGS

GL COUPLINGS

C14 COUPLINGS

PCTS THERMOPLASTIC COUPLINGS

POLARSEAL COUPLINGS

POLARSEAL II COUPLINGS

POWER STEERING

ADAPTERS

QUICK DISCONNECT COUPLERS

BALL VALVES

LIVE SWIVEL

ASSEMBLY FABRICATION

ACCESSORIES

EQUIPMENT AND PARTS

AIR BRAKE



BRASS

KITS

G949 Series (Flush Face - HTMA)

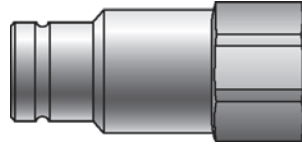
Male Flush Face Valve to Female Pipe





Part No.	Descr.	Prod. No.			
			"		
G94911-0404	4MQFF-4FP	7252-87015	1/4-18	3000	12000
G94911-0606	6MQFF-6FP	7252-88005	3/8-18	3000	12000
G94911-0608	6MQFF-8FP	7252-88015	3/8-14	3000	12000
G94911-0808	8MQFF-8FP	7252-87025	1/2-14	3000	12000
G94911-0808P	8CPMQFF-8FP*	7252-87435	1/2-14	3000	12000
G94911-1212	12MQFF-12FP	7252-87035	3/4-14	3000	12000
G94911-1616	16MQFF-16FP	7252-87045	1-11 1/2	3000	12000

*Connect-under-pressure coupler.

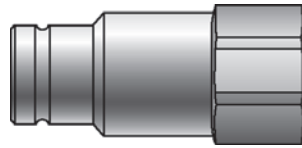
Male Flush Face Valve to Female O-Ring Boss







Part No.	Descr.	Prod. No.			
			"		
G94912-0404	4MQFF-4FB	7252-87055	7/16-20	3000	12000
G94912-0608	6MQFF-8FB	7252-88025	3/4-16	3000	12000
G94912-0808	8MQFF-8FB	7252-87065	3/4-16	3000	12000
G94912-0808P	8CPMQFF-8FB*	7252-87445	3/4-16	3000	12000
G94912-0810P	8CPMQFF-10FB*	7252-87455	7/8-14	3000	12000
G94912-0812	8MQFF-12FB	7252-87075	1 1/16-12	3000	12000
G94912-0812P	8CPMQFF-12FB*	7252-87465	7/8-14	3000	12000
G94912-1012	10MQFF-12FB	7252-87085	1 1/16-12	3000	12000
G94912-1212	12MQFF-12FB	7252-87095	1 1/16-12	3000	12000
G94912-1616	16MQFF-16FB	7252-87105	1 5/16-12	3000	12000

*Connect-under-pressure coupler.

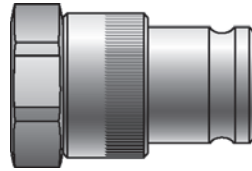
EQUIPMENT
HOSE/CPLG. SELECTION
G8K COUPLINGS
GLOBAL SPIRAL COUPLINGS
STAINLESS STEEL SPIRAL
MEGACRIMP COUPLINGS
STAINLESS STEEL BRAID
POWER CRIMP COUPLINGS
FIELD ATTACHABLE G1 & G2 COUPLINGS
FIELD ATTACHABLE C5 COUPLINGS
GLX COUPLINGS
GL COUPLINGS
C14 COUPLINGS
PCTS THERMOPLASTIC COUPLINGS
POLARSEAL COUPLINGS
POLARSEAL II COUPLINGS
POWER STEERING
ADAPTERS
QUICK DISCONNECT COUPLERS
BALL VALVES
LIVE SWIVEL
ASSEMBLY FABRICATION
ACCESSORIES
EQUIPMENT AND PARTS
AIR BRAKE
BRASS
KITS



Male Flush Face Valve to JIC 37° Flare Bulkhead



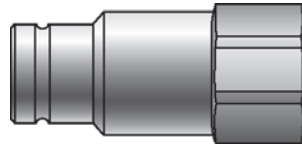

Part No.	Descr.	Prod. No.			
			"		
G94913-0810	8MQFF-10BKHD	7252-87395	7/8-14	3625	14500
G94913-1012	10MQFF-12BKHD	7252-87405	1 1/16-12	3625	14500

Male Flush Face Valve to Female British Pipe Parallel



Part No.	Descr.	Prod. No.			
			"		
G94915-0404	4MQFF-4FBPP	7252-87115	1/4-19	4568	18270
G94915-0808	8MQFF-8FBPP	7252-87125	1/2-14	3625	14500
G94915-1212	12MQFF-12FBPP	7252-87135	3/4-14	3625	14500
G94915-1616	16MQFF-16FBPP	7252-87145	1-11	2900	11600

Female Flush Face Valve to Female Pipe

Part No.	Descr.	Prod. No.			
			"		
G94921-0404	4FQFF-4FP	7252-87155	1/4-18	3000	12000
G94921-0808	8FQFF-8FP	7252-87165	1/2-14	3000	12000
G94921-0808P	8CPFQFF-8FP*	7252-87475	1/2-14	3000	12000
G94921-1212	12FQFF-12FP	7252-87175	3/4-14	3000	12000
G94921-1616	16FQFF-16FP	7252-87185	1-11 1/2	3000	12000

*Connect-under-pressure coupler.

- EQUIPMENT
- HOSE/CPLG. SELECTION
- G&K COUPLINGS
- GLOBAL SPIRAL COUPLINGS
- STAINLESS STEEL SPIRAL
- MEGACRIMP COUPLINGS
- STAINLESS STEEL BRAID
- POWER CRIMP COUPLINGS
- FIELD ATTACHABLE G1 & G2 COUPLINGS
- FIELD ATTACHABLE C5 COUPLINGS
- GLX COUPLINGS
- GL COUPLINGS
- C14 COUPLINGS
- PCTS THERMOPLASTIC COUPLINGS
- POLARSEAL COUPLINGS
- POLARSEAL II COUPLINGS
- POWER STEERING
- ADAPTERS
- QUICK DISCONNECT COUPLERS
- BALL VALVES
- LIVE SWIVEL
- ASSEMBLY FABRICATION
- ACCESSORIES
- EQUIPMENT AND PARTS
- AIR BRAKE
- BRASS
- KITS

G949 Series (Flush Face - HTMA)

EQUIPMENT
HOSE/CPLG. SELECTION
G8K COUPLINGS
GLOBAL SPIRAL COUPLINGS
STAINLESS STEEL SPIRAL
MEGACRIMP COUPLINGS
STAINLESS STEEL BRAID
POWER CRIMP COUPLINGS
FIELD ATTACHABLE G1 & G2 COUPLINGS
FIELD ATTACHABLE C5 COUPLINGS
GLX COUPLINGS
GL COUPLINGS
C14 COUPLINGS
PCTS THERMOPLASTIC COUPLINGS
POLARSEAL COUPLINGS
POLARSEAL II COUPLINGS
POWER STEERING
ADAPTERS
QUICK DISCONNECT COUPLERS
BALL VALVES
LIVE SWIVEL
ASSEMBLY FABRICATION
ACCESSORIES
EQUIPMENT AND PARTS
AIR BRAKE
BRASS
KITS

Female Flush Face Valve to Female Pipe - SureLok™

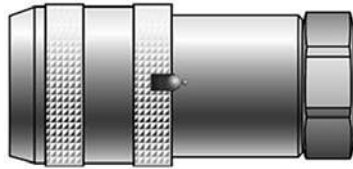

Part No.	Descr.	Prod. No.			
			"		
G94921-0606	6FQFF-6FP	7252-88035	3/8-18	3000	12000
G94921-0608	6FQFF-8FP	7252-88045	1/2-14	3000	12000

Female Flush Face Valve to Female O-Ring Boss

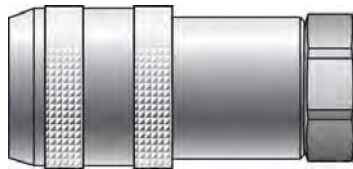

Part No.	Descr.	Prod. No.			
			"		
G94922-0404	4FQFF-4FB	7252-87195	7/16-20	3000	12000
G94922-0608	6FQFF-8FB	7252-88055	3/4-16	3000	12000
G94922-0808	8FQFF-8FB	7252-87205	3/4-16	3000	12000
G94922-0808P	8CPFOFF-8FB*	7252-87485	3/4-16	3000	12000
G94922-0810P	8CPFOFF-10FB*	7252-87495	7/8-14	3000	12000
G94922-0812	8FQFF-12FB	7252-87215	1 1/6-12	3000	12000
G94922-0812P	8CPFOFF-12FB*	7252-87505	1 1/6-12	3000	12000
G94922-1012	10FQFF-12FB	7252-87225	1 1/6-12	3000	12000
G94922-1212	12FQFF-12FB	7252-87235	1 1/6-12	3000	12000
G94922-1616	16FQFF-16FB	7252-87245	1 5/16-12	3000	12000

*Connect-under-pressure coupler.

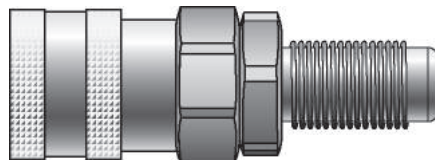

Female Flush Face to JIC 37° Flare Bulkhead

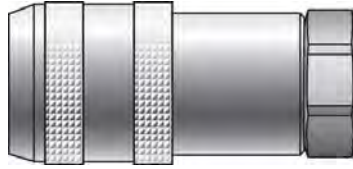

Part No.	Descr.	Prod. No.			
			"		
G94923-0810	8FQFF-10BKHD	7252-87415	7/8-14	3625	14500
G94923-1012	10FQFF-12BKHD	7252-87425	1 1/16-12	3625	14500

Female Flush Face Valve to Female British Pipe Parallel



Part No.	Descr.	Prod. No.			
			"		
G94925-0808	8FQFF-8FBPP	7252-87265	1/2-14	3625	14500
G94925-1212	12FQFF-12FBPP	7252-87275	3/4-14	3625	14500
G94925-1616	16FQFF-16FBPP	7252-87285	1-11	2900	11600

Dust Plug/Cap Combination



Part No.	Descr.	Prod. No.
G94981-0004	4QDFFDP/C	7252-87535
G94981-0006	6QDFFDP/C	7252-87545
G94981-0008	8QDFFDP/C	7252-87555
G94981-0010	10QDFFDP/C	7252-87565
G94981-0012	12QDFFDP/C	7252-87575
G94981-0016	16QDFFDP/C	7252-87585



EQUIPMENT
HOSE/CPLG. SELECTION
G&K COUPLINGS
GLOBALSPIRAL COUPLINGS
STAINLESS STEEL SPIRAL
MEGACRIMP COUPLINGS
STAINLESS STEEL BRAID
POWER CRIMP COUPLINGS
FIELD ATTACHABLE G1 & G2 COUPLINGS
FIELD ATTACHABLE C5 COUPLINGS
GLX COUPLINGS
GL COUPLINGS
C14 COUPLINGS
PCTS THERMOPLASTIC COUPLINGS
POLARSEAL COUPLINGS
POLARSEAL II COUPLINGS
POWER STEERING
ADAPTERS
QUICK DISCONNECT COUPLERS
BALL VALVES
LIVE SWIVEL
ASSEMBLY FABRICATION
ACCESSORIES
EQUIPMENT AND PARTS
AIR BRAKE
BRASS
KITS

G950 Series (Flush Face - High Pressure)

EQUIPMENT
HOSE/CPLG. SELECTION
G8K COUPLINGS
GLOBALSPIRAL COUPLINGS
STAINLESS STEEL SPIRAL
MEGACRIMP COUPLINGS
STAINLESS STEEL BRAID
POWER CRIMP COUPLINGS
FIELD ATTACHABLE G1 & G2 COUPLINGS
FIELD ATTACHABLE C5 COUPLINGS
GLX COUPLINGS
GL COUPLINGS
C14 COUPLINGS
PCTS THERMOPLASTIC COUPLINGS
POLARSEAL COUPLINGS
POLARSEAL II COUPLINGS
POWER STEERING
ADAPTERS
QUICK DISCONNECT COUPLERS
BALL VALVES
LIVE SWIVEL
ASSEMBLY FABRICATION
ACCESSORIES
EQUIPMENT AND PARTS
AIR BRAKE
BRASS
KITS

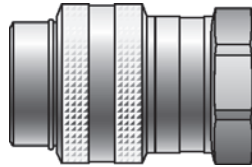
Male Flush Face Valve





Part No.	Descr.	Prod. No.			
			"		
G95011-0604	6MQFFH-4FP	7252-88085	3/8-18	10000	20000
G95011-0606	6MQFFH-6FP	7252-88095	3/8-18	10000	20000
G95011-0808	8MQFFH-8FP	7252-88145	1/2-14	5000	10000
G95011-1212	12MQFFH-12FP	7252-88155	3/4-14	5000	10000
G95011-1616A	16MQFFH-16FPA*	7252-88325	1-11 1/2	5000	10000
G95011-1616	16MQFFH-16FP	7252-88165	1-11 1/2	5000	10000

**This coupling features a higher working pressure and flatter face for minimization of fluid loss.*

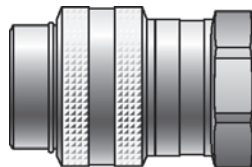
Female Flush Face Valve



Part No.	Descr.	Prod. No.			
			"		
G95021-0604	6FQFFH-4FP	7252-88105	3/8-18	10000	20000
G95021-0606	6FQFFH-6FP	7252-88115	3/8-18	10000	20000
G95021-0808	8FQFFH-8FP	7252-88175	1/2-14	5000	10000
G95021-1212	12FQFFH-12FP	7252-88185	3/4-14	5000	10000
G95021-1616A	16FQFFH-16FPA*	7252-88335	1-11 1/2	5000	10000
G95021-1616	16FQFFH-16FP	7252-88195	1-11 1/2	5000	10000

**This coupling features a higher working pressure and flatter face for minimization of fluid loss.*

QD Plug - Cap Combination



Part No.	Descr.	Prod. No.
G95081-0006	6QDFFHDP/C	7252-87715
G95081-0008	8QDFFHDP/C	7252-87725
G95081-0012	12QDFFHDP/C	7252-87735

G950 Series (Flush Face - High Pressure)

QD Plug - Cap Combination - Continued

Part No.	Descr.	Prod. No.
G95081-0016	16QDFFHDP/C	7252-87745

EQUIPMENT
HOSE/CPLG. SELECTION
G8K COUPLINGS
GLOBAL SPIRAL COUPLINGS
STAINLESS STEEL SPIRAL
MEGACRIMP COUPLINGS
STAINLESS STEEL BRAID
POWER CRIMP COUPLINGS
FIELD ATTACHABLE G1 & G2 COUPLINGS
FIELD ATTACHABLE C5 COUPLINGS
GLX COUPLINGS
GL COUPLINGS
C14 COUPLINGS
PCTS THERMOPLASTIC COUPLINGS
POLARSEAL COUPLINGS
POLARSEAL II COUPLINGS
POWER STEERING
ADAPTERS
QUICK DISCONNECT COUPLERS
BALL VALVES
LIVE SWIVEL
ASSEMBLY FABRICATION
ACCESSORIES
EQUIPMENT AND PARTS
AIR BRAKE
BRASS
KITS

G951 Series (Wing Nut)

EQUIPMENT
HOSE/CPLG. SELECTION
G8K COUPLINGS
GLOBALSPIRAL COUPLINGS
STAINLESS STEEL SPIRAL
MEGACRIMP COUPLINGS
STAINLESS STEEL BRAID
POWER CRIMP COUPLINGS
FIELD ATTACHABLE G1 & G2 COUPLINGS
FIELD ATTACHABLE C5 COUPLINGS
GLX COUPLINGS
GL COUPLINGS
C14 COUPLINGS
PCTS THERMOPLASTIC COUPLINGS
POLARSEAL COUPLINGS
POLARSEAL II COUPLINGS
POWER STEERING
ADAPTERS
QUICK DISCONNECT COUPLERS
BALL VALVES
LIVE SWIVEL
ASSEMBLY FABRICATION
ACCESSORIES
EQUIPMENT AND PARTS
AIR BRAKE
BRASS
KITS

Male (Brass) - Less Flange

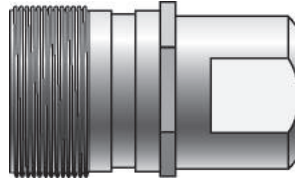

Part No.	Descr.	Prod. No.			
			"		
G95111-1212	12MQW-12FP	7252-88525	3/4-14	3000	9000
G95111-1616	16MQW-16FP	7252-88535	1-11 1/2	3000	9000
G95111-2020	20MQW-20FP	7252-88545	1 5/8-12	2750	8250
G95111-2424	24MQW-24FP	7252-88555	1 7/8-12	2500	7500

Female (Brass) - Wing Nut (Cast Iron)

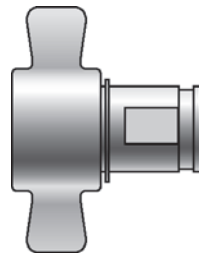

Part No.	Descr.	Prod. No.			
			"		
G95121-1212	12FQW-12FP	7252-88585	3/4-14	3000	9000
G95121-1616	16FQW-16FP	7252-88595	1-11 1/2	3000	9000
G95121-2020	20FQW-20FP	7252-88605	1 5/8-12	2750	8250
G95121-2424	24FQW-24FP	7252-88615	1 7/8-12	2500	7500

Dust Plug



Part No.	Descr.	Prod. No.
G95180-0012	12QWDP	7252-88645
G95180-0016	16QWDP	7252-88655
G95180-0020	20QWDP	7252-88665

Dust Plug - Continued

Part No.	Descr.	Prod. No.
G95180-0024	24QWDP	7252-88675

Dust Cap



Part No.	Descr.	Prod. No.
G95190-0012	12QWDC	7252-88705
G95190-0016	16QWDC	7252-88715
G95190-0020	20QWDC	7252-88725
G95190-0024	24QWDC	7252-88735



EQUIPMENT
HOSE/CPLG. SELECTION
G&K COUPLINGS
GLOBAL SPIRAL COUPLINGS
STAINLESS STEEL SPIRAL
MEGACRIMP COUPLINGS
STAINLESS STEEL BRAID
POWER CRIMP COUPLINGS
FIELD ATTACHABLE G1 & G2 COUPLINGS
FIELD ATTACHABLE C5 COUPLINGS
GLX COUPLINGS
GL COUPLINGS
C14 COUPLINGS
PCTS THERMOPLASTIC COUPLINGS
POLARSEAL COUPLINGS
POLARSEAL II COUPLINGS
POWER STEERING
ADAPTERS
QUICK DISCONNECT COUPLERS
BALL VALVES
LIVE SWIVEL
ASSEMBLY FABRICATION
ACCESSORIES
EQUIPMENT AND PARTS
AIR BRAKE
BRASS
KITS

G952 Series (High Pressure Wing Nut)

EQUIPMENT
HOSE/CPLG. SELECTION
G8K COUPLINGS
GLOBAL SPIRAL COUPLINGS
STAINLESS STEEL SPIRAL
MEGACRIMP COUPLINGS
STAINLESS STEEL BRAID
POWER CRIMP COUPLINGS
FIELD ATTACHABLE G1 & G2 COUPLINGS
FIELD ATTACHABLE C5 COUPLINGS
GLX COUPLINGS
GL COUPLINGS
C14 COUPLINGS
PCTS THERMOPLASTIC COUPLINGS
POLARSEAL COUPLINGS
POLARSEAL II COUPLINGS
POWER STEERING
ADAPTERS
QUICK DISCONNECT COUPLERS
BALL VALVES
LIVE SWIVEL
ASSEMBLY FABRICATION
ACCESSORIES
EQUIPMENT AND PARTS
AIR BRAKE
BRASS
KITS

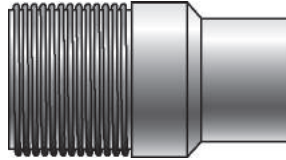

Male Acme Flat Threads to Female Pipe

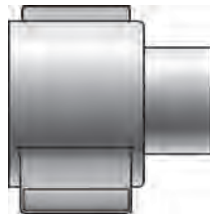

Part No.	Descr.	Prod. No.			
			"		
G95211-1212	12MQWH-12FP	7252-88745	3/4-14	5000	20000
G95211-1616	16MQWH-16FP	7252-88755	1-11 1/2	5000	20000
G95211-2020	20MQWH-20FP	7252-88765	1 1/4-11 1/2	5000	15000
G95211-2424	24MQWH-24FP	7252-88775	1 1/2-11 1/2	5000	15000
G95211-3232	32MQWH-32FP	7252-88785	2-11 1/2	5000	15000

Female Wing Nut to Female Pipe



Part No.	Descr.	Prod. No.			
			"		
G95221-1212	12FQWH-12FP*	7252-88795	3/4-14	5000	20000
G95221-1616	16FQWH-16FP	7252-88805	1-11 1/2	5000	20000
G95221-2020	20FQWH-20FP	7252-88815	1 1/4-11 1/2	5000	15000
G95221-2424	24FQWH-24FP	7252-88825	1 1/2-11 1/2	5000	15000
G95221-3232	32FQWH-32FP	7252-88835	2-11 1/2	5000	15000

*Features a hex nut on the coupler.

Dust Plug

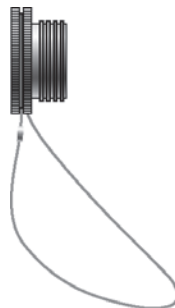

Part No.	Descr.	Prod. No.
G95280-0012	12QWHDP	7252-88845
G95280-0016	16QWHDP	7252-88855

Dust Plug - Continued

Part No.	Descr.	Prod. No.
G95280-0020	20QWHDP	7252-88865
G95280-0024	24QWHDP	7252-88875
G95280-0032	32QWHDP	7252-88885

Dust Cap



Part No.	Descr.	Prod. No.
G95290-0012	12QWHDC	7252-88895
G95290-0016	16QWHDC	7252-88905
G95290-0020	20QWHDC	7252-88915
G95290-0024	24QWHDC	7252-88925
G95290-0032	32QWHDC	7252-88935

EQUIPMENT
HOSE/CPLG. SELECTION
G&K COUPLINGS
GLOBAL SPIRAL COUPLINGS
STAINLESS STEEL SPIRAL
MEGACRIMP COUPLINGS
STAINLESS STEEL BRAID
POWER CRIMP COUPLINGS
FIELD ATTACHABLE G1 & G2 COUPLINGS
FIELD ATTACHABLE C5 COUPLINGS
GLX COUPLINGS
GL COUPLINGS
C14 COUPLINGS
PCTS THERMOPLASTIC COUPLINGS
POLARSEAL COUPLINGS
POLARSEAL II COUPLINGS
POWER STEERING
ADAPTERS
QUICK DISCONNECT COUPLERS
BALL VALVES
LIVE SWIVEL
ASSEMBLY FABRICATION
ACCESSORIES
EQUIPMENT AND PARTS
AIR BRAKE
BRASS
KITS



G953 Series [Very High Pressure]

- EQUIPMENT
- HOSE/CPLG. SELECTION
- G8K COUPLINGS
- GLOBALSPIRAL COUPLINGS
- STAINLESS STEEL SPIRAL
- MEGACRIMP COUPLINGS
- STAINLESS STEEL BRAID
- POWER CRIMP COUPLINGS
- FIELD ATTACHABLE G1 & G2 COUPLINGS
- FIELD ATTACHABLE C5 COUPLINGS
- GLX COUPLINGS
- GL COUPLINGS
- C14 COUPLINGS
- PCTS THERMOPLASTIC COUPLINGS
- POLARSEAL COUPLINGS
- POLARSEAL II COUPLINGS
- POWER STEERING
- ADAPTERS
- QUICK DISCONNECT COUPLERS
- BALL VALVES
- LIVE SWIVEL
- ASSEMBLY FABRICATION
- ACCESSORIES
- EQUIPMENT AND PARTS
- AIR BRAKE
- BRASS
- KITS

Male Poppet Valve to Female Pipe

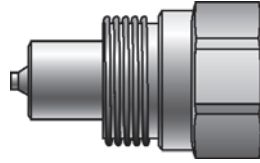

Recommended for MobileCrimp® crimper-to-pump connection.



Part No.	Descr.	Prod. No.			
			"		
G95311-0606	6MOFFVH-6FP	7252-88315	3/8-18	14500	28000

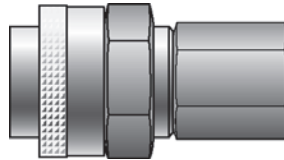

Female Screw to Connect to Female Pipe



Part No.	Descr.	Prod. No.			
			"		
G95321-0606	6FOFFVH-6FP	7252-88305	3/8-18	14500	28000

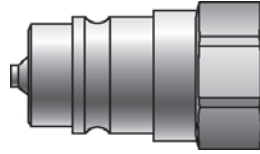

Male Poppet Valve to Female Pipe

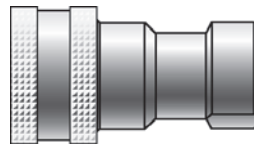

Part No.	Descr.	Prod. No.			
			"		
G95611-0404	4MQP-4FP	7252-89905	1/4-18	4600	18400
G95611-0606	6MQP-6FP	7252-89915	3/8-18	4600	18400
G95611-0808	8MQP-8FP	7252-89925	1/2-14	4000	16000
G95611-1212	12MQP-12FP	7252-89935	3/4-14	4000	16000
G95611-1616	16MQP-16FP	7252-89945	1-11 1/2	3000	12000

Female Poppet Valve to Female Pipe



Part No.	Descr.	Prod. No.			
			"		
G95621-0404	4FQP-4FP	7252-89955	1/4-18	4600	18400
G95621-0606	6FQP-6FP	7252-89965	3/8-18	4600	18400
G95621-0808	8FQP-8FP	7252-89975	1/2-14	4000	16000
G95621-1212	12FQP-12FP	7252-89985	3/4-14	4000	16000
G95621-1616	16FQP-16FP	7252-89995	1-11 1/2	3000	12000

O-Ring



Part No.	Descr.	Prod. No.
G95625-0004	4QDOR	7252-59955
G95625-0006	6QDOR	7252-59965
G95625-0008	8QDOR	7252-59975
G95625-0012	12QDOR	7252-59985
G95625-0016	16QDOR	7252-59995

- EQUIPMENT
- HOSE/CPLG. SELECTION
- G&K COUPLINGS
- GLOBALSPIRAL COUPLINGS
- STAINLESS STEEL SPIRAL
- MEGACRIMP COUPLINGS
- STAINLESS STEEL BRAID
- POWER CRIMP COUPLINGS
- FIELD ATTACHABLE G1 & G2 COUPLINGS
- FIELD ATTACHABLE C5 COUPLINGS
- GLX COUPLINGS
- GL COUPLINGS
- C14 COUPLINGS
- PCTS THERMOPLASTIC COUPLINGS
- POLARSEAL COUPLINGS
- POLARSEAL II COUPLINGS
- POWER STEERING
- ADAPTERS
- QUICK DISCONNECT COUPLERS
- BALL VALVES
- LIVE SWIVEL
- ASSEMBLY FABRICATION
- ACCESSORIES
- EQUIPMENT AND PARTS
- AIR BRAKE
- BRASS
- KITS

EQUIPMENT
HOSE/CPLG. SELECTION
G8K COUPLINGS
GLOBALSPIRAL COUPLINGS
STAINLESS STEEL SPIRAL
MEGACRIMP COUPLINGS
STAINLESS STEEL BRAID
POWER CRIMP COUPLINGS
FIELD ATTACHABLE G1 & G2 COUPLINGS
FIELD ATTACHABLE C5 COUPLINGS
GLX COUPLINGS
GL COUPLINGS
C14 COUPLINGS
PCTS THERMOPLASTIC COUPLINGS
POLARSEAL COUPLINGS
POLARSEAL II COUPLINGS
POWER STEERING
ADAPTERS
QUICK DISCONNECT COUPLERS
BALL VALVES
LIVE SWIVEL
ASSEMBLY FABRICATION
ACCESSORIES
EQUIPMENT AND PARTS
AIR BRAKE
BRASS
KITS

Backup Ring



Part No.	Descr.	Prod. No.
G95626-0004	4QDBR	7252-49955
G95626-0006	6QDBR	7252-49965
G95626-0008	8QDBR	7252-49975
G95626-0012	12QDBR	7252-49985
G95626-0016	16QDBR	7252-49995

QD Plug - Cap Combination



Part No.	Descr.	Prod. No.
G95681-0004	4QDDP/C	7252-87635
G95681-0006	6QDDP/C	7252-87645
G95681-0008	8QDDP/C	7252-87655
G95681-0012	12QDDP/C	7252-87665
G95681-0016	16QDDP/C	7252-87675

G959 Series [Agriculture QD Adapters]

John Deere Old Style to ISO Style

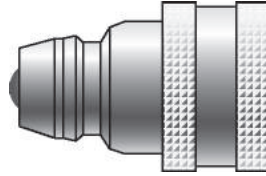

Part No.	Descr.	Prod. No.	
G95961-0808	8MJD-8FISO	7252-89615	3000
G95961-0808M	8MJD-8FISO MBK	7252-89610	3000

NOTE: Merchandiser Packaging with MBK in description.

ISO Style to John Deere Old Style

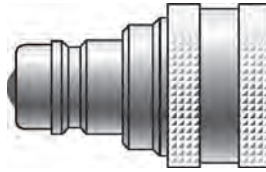

Part No.	Descr.	Prod. No.	
G95962-0808	8MISO-8FJD	7252-89625	3000

Int'l Harvester to John Deere Old Style

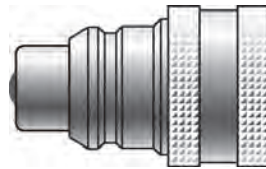

Part No.	Descr.	Prod. No.	
G95963-0808	8MIHC-8FJD	7252-89635	3000

Int'l Harvester Old Style to ISO Style

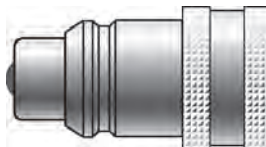

Part No.	Descr.	Prod. No.	
G95964-0808	8MIHC-8FISO	7252-89645	3000

- EQUIPMENT
- HOSE/CPLG. SELECTION
- G8K COUPLINGS
- GLOBALSPIRAL COUPLINGS
- STAINLESS STEEL SPIRAL
- MEGACRIMP COUPLINGS
- STAINLESS STEEL BRAID
- POWER CRIMP COUPLINGS
- FIELD ATTACHABLE G1 & G2 COUPLINGS
- FIELD ATTACHABLE C5 COUPLINGS
- GLX COUPLINGS
- GL COUPLINGS
- C14 COUPLINGS
- PCTS THERMOPLASTIC COUPLINGS
- POLARSEAL COUPLINGS
- POLARSEAL II COUPLINGS
- POWER STEERING
- ADAPTERS
- QUICK DISCONNECT COUPLERS
- BALL VALVES
- LIVE SWIVEL
- ASSEMBLY FABRICATION
- ACCESSORIES
- EQUIPMENT AND PARTS
- AIR BRAKE
- BRASS
- KITS

G959 Series (Agriculture QD Adapters)

EQUIPMENT
HOSE/CPLG. SELECTION
G8K COUPLINGS
GLOBALSPIRAL COUPLINGS
STAINLESS STEEL SPIRAL
MEGACRIMP COUPLINGS
STAINLESS STEEL BRAID
POWER CRIMP COUPLINGS
FIELD ATTACHABLE G1 & G2 COUPLINGS
FIELD ATTACHABLE C5 COUPLINGS
GLX COUPLINGS
GL COUPLINGS
C14 COUPLINGS
PCTS THERMOPLASTIC COUPLINGS
POLARSEAL COUPLINGS
POLARSEAL II COUPLINGS
POWER STEERING
ADAPTERS
QUICK DISCONNECT COUPLERS
BALL VALVES
LIVE SWIVEL
ASSEMBLY FABRICATION
ACCESSORIES
EQUIPMENT AND PARTS
AIR BRAKE
BRASS
KITS

ISO Style to Int'l Harvester Old Style

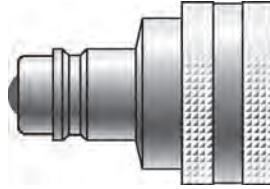

Part No.	Descr.	Prod. No.	
G95965-0808	8MISO-8FIHC	7252-89655	3000

ISO Style to John Deere Old Style - (Double Shutoff)

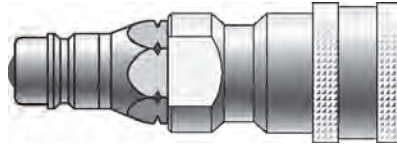

Part No.	Descr.	Prod. No.	
G95966-0808	8MISO-8FJDDSO	7252-89665	3000
G95966-0808M	8MISO-8FJDDSO MBK	7252-89660	3000

NOTE: Merchandiser Packaging with MBK in description.

ISO Style to Int'l Harvester Old Style - (Double Shutoff)



Part No.	Descr.	Prod. No.	
G95967-0808	8MISO-8FIHCDSO	7252-89675	3000

Code 61 O-Ring Flange

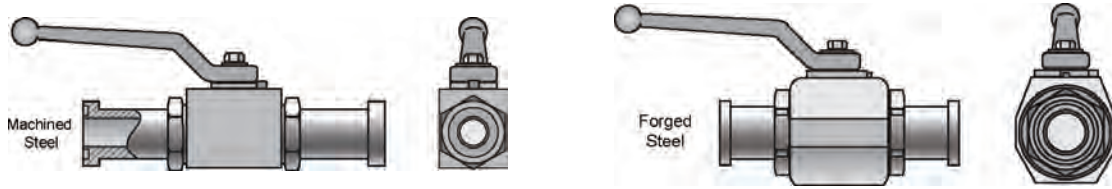

Part No.	Descr.	Prod. No.	⊖	Nom. Flg. Size	⊕
			"		
G96300-0808	8FL-8FLBV	7317-00215	1/2	1/2	3000
G96300-1212	12FL-12FLBV	7317-00225	3/4	3/4	3000
G96300-1616	16FL-16FLBV	7317-00235	1	1	3000
G96310-2020	20FL-20FLBV	7317-00245	1 1/4	1 1/4	3000
G96310-2424	24FL-24FLBV	7317-00255	1 1/2	1 1/2	3000
G96310-3232	32FL-32FLBV	7317-00265	2	2	3000

Code 62 O-Ring Flange



Part No.	Descr.	Prod. No.	⊖	Nom. Flg. Size	⊕
			"		
G96350-0808	8FLH-8FLHBV	7317-00275	1/2	1/2	6000
G96350-1212	12FLH-12FLHBV	7317-00285	3/4	3/4	6000
G96350-1616	16FLH-16FLHBV	7317-00295	1	1	6000
G96355-2020	20FLH-20FLHBV	7317-00305	1 1/4	1 1/4	6000
G96355-2424	24FLH-24FLHBV	7317-00315	1 1/2	1 1/2	6000
G96355-3232	32FLH-32FLHBV	7317-00325	2	2	6000

Female O-Ring Boss

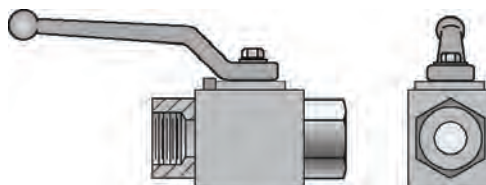



Part No.	Descr.	Prod. No.	⊖	🌀	⊕
			"	"	
G96115-0404	4FB-4FBBV	7317-00075	1/4	7/16-20	7350
G96115-0606	6FB-6FBBV	7317-00085	3/8	9/16-18	7350
G96115-0808	8FB-8FBBV	7317-00095	1/2	3/4-16	7350
G96115-1212	12FB-12FBBV	7317-00105	3/4	1 1/16-12	5880

- EQUIPMENT
- HOSE/CPLG. SELECTION
- G8K COUPLINGS
- GLOBALSPIRAL COUPLINGS
- STAINLESS STEEL SPIRAL
- MEGACRIMP COUPLINGS
- STAINLESS STEEL BRAID
- POWER CRIMP COUPLINGS
- FIELD ATTACHABLE G1 & G2 COUPLINGS
- FIELD ATTACHABLE C5 COUPLINGS
- GLX COUPLINGS
- GL COUPLINGS
- C14 COUPLINGS
- PCTS THERMOPLASTIC COUPLINGS
- POLARSEAL COUPLINGS
- POLARSEAL II COUPLINGS
- POWER STEERING
- ADAPTERS
- QUICK DISCONNECT COUPLERS
- BALL VALVES
- LIVE SWIVEL
- ASSEMBLY FABRICATION
- ACCESSORIES
- EQUIPMENT AND PARTS
- AIR BRAKE
- BRASS
- KITS



Two Way Block Style

Female O-Ring Boss - Continued

Part No.	Descr.	Prod. No.			
			"	"	
G96115-1616	16FB-16FBBV	7317-00115	1	1 5/16-12	5145

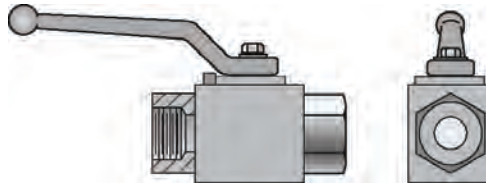
Female Pipe NPTF



Part No.	Descr.	Prod. No.			
			"	"	
G96110-0404	4FP-4FPBV	7317-00015	1/4	1/4	7350
G96110-0606	6FP-6FPBV	7317-00025	3/8	3/8	7350
G96110-0808	8FP-8FPBV	7317-00035	1/2	1/2	7350
G96110-1212	12FP-12FPBV	7317-00045	3/4	3/4	5880
G96110-1616	16FP-16FPBV	7317-00055	1	1	5145
G96110-2016	20FP-16FPBV	7317-00065	1	1 1/4	5145

EQUIPMENT
HOSE/CPLG. SELECTION
G8K COUPLINGS
GLOBALSPIRAL COUPLINGS
STAINLESS STEEL SPIRAL
MEGACRIMP COUPLINGS
STAINLESS STEEL BRAID
POWER CRIMP COUPLINGS
FIELD ATTACHABLE G1 & G2 COUPLINGS
FIELD ATTACHABLE C5 COUPLINGS
GLX COUPLINGS
GL COUPLINGS
C14 COUPLINGS
PCTS THERMOPLASTIC COUPLINGS
POLARSEAL COUPLINGS
POLARSEAL II COUPLINGS
POWER STEERING
ADAPTERS
QUICK DISCONNECT COUPLERS
BALL VALVES
LIVE SWIVEL
ASSEMBLY FABRICATION
ACCESSORIES
EQUIPMENT AND PARTS
AIR BRAKE
BRASS
KITS

Two Way Round Style Large ID

Female Pipe NPTF

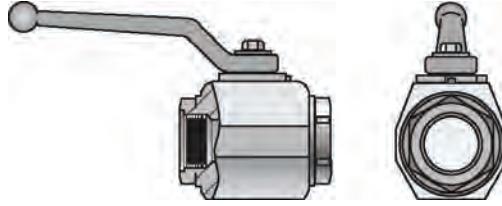

Part No.	Descr.	Prod. No.	⊖	🌀	💡
			"	"	
G96120-2020	20FP-20FPBV	7317-00125	1 1/4	1 1/4	6175
G96120-2424	24FP-24FPBV	7317-00135	1 1/2	1 1/2	6175
G96120-3232	32FP-32FPBV	7317-00145	2	2	6175

- EQUIPMENT
- HOSE/CPLG. SELECTION
- G8K COUPLINGS
- GLOBALSPIRAL COUPLINGS
- STAINLESS STEEL SPIRAL
- MEGACRIMP COUPLINGS
- STAINLESS STEEL BRAID
- POWER CRIMP COUPLINGS
- FIELD ATTACHABLE G1 & G2 COUPLINGS
- FIELD ATTACHABLE C5 COUPLINGS
- GLX COUPLINGS
- GL COUPLINGS
- C14 COUPLINGS
- PCTS THERMOPLASTIC COUPLINGS
- POLARSEAL COUPLINGS
- POLARSEAL II COUPLINGS
- POWER STEERING
- ADAPTERS
- QUICK DISCONNECT COUPLERS
- BALL VALVES**
- LIVE SWIVEL
- ASSEMBLY FABRICATION
- ACCESSORIES
- EQUIPMENT AND PARTS
- AIR BRAKE
- BRASS
- KITS

Three Way Block Style

Female Pipe NPTF

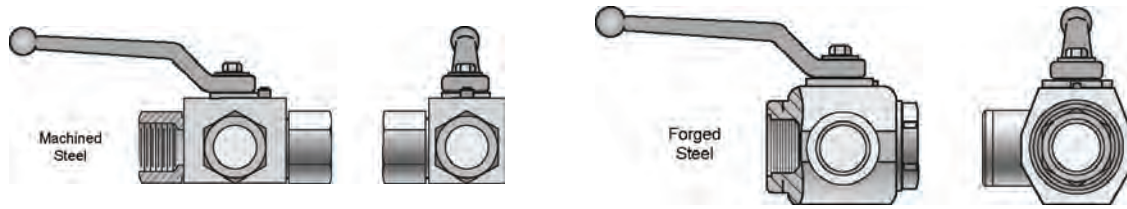

Part No.	Descr.	Prod. No.	⊖	🌀	💡
			"	"	"
G96210-0404	4FP-4FP-4FPBV	7317-00155	1/4	1/4	5880
G96210-0606	6FP-6FP-6FPBV	7317-00165	3/8	3/8	5880
G96210-0808	8FP-8FP-8FPBV	7317-00175	1/2	1/2	5145
G96210-1212	12FP-12FP-12FPBV	7317-00185	3/4	3/4	5145
G96210-1616	16FP-16FP-16FPBV	7317-00195	1	1	5145
G96211-2020	20FP-20FP-20FPBV	7317-00205	1 1/4	1 1/4	5145

Ball Valve Lock Out Kits

Part No.	Descr.	Prod. No.
G96050-0408	1/4" THRU 1/2" BV LOCK OUT KIT	7317-00335
G96050-1216	3/4" THRU 1" BV LOCK OUT KIT	7317-00345
G96050-2032	1 1/4" THRU 2" BV LOCK OUT KIT	7317-00355

EQUIPMENT
HOSE/CPLG. SELECTION
G8K COUPLINGS
GLOBALSPIRAL COUPLINGS
STAINLESS STEEL SPIRAL
MEGACRIMP COUPLINGS
STAINLESS STEEL BRAID
POWER CRIMP COUPLINGS
FIELD ATTACHABLE G1 & G2 COUPLINGS
FIELD ATTACHABLE C5 COUPLINGS
GLX COUPLINGS
GL COUPLINGS
C14 COUPLINGS
PCTS THERMOPLASTIC COUPLINGS
POLARSEAL COUPLINGS
POLARSEAL II COUPLINGS
POWER STEERING
ADAPTERS
QUICK DISCONNECT COUPLERS
BALL VALVES
LIVE SWIVEL
ASSEMBLY FABRICATION
ACCESSORIES
EQUIPMENT AND PARTS
AIR BRAKE
BRASS
KITS

Male BSPP to Male BSPP

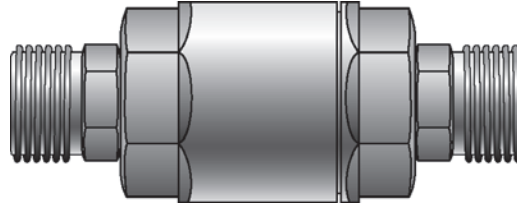

Part No.	Descr.	Prod. No.	⌚	🌀		Hex Shank	Hex Body	Overall Dimension	Diameter
				"	"				
G93345-0808	8BSPP-8BSPP-LX	7252-12415	6000	1/2-14	1/2-14	3/4	1 5/16	3.44	1.53
G93345-1212	12BSPP-12BSPP-LX	7252-12425	6000	3/4-14	3/4-14	15/16	1 5/8	4.52	2.00
G93345-1616	16BSPP-16BSPP-LX	7252-12435	6000	1-11	1-11	1 3/16	1 7/8	5.06	2.22

Male JIC to Male JIC

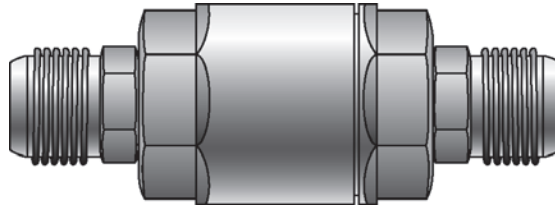

Part No.	Descr.	Prod. No.	⌚	🌀		Hex Shank	Hex Body	Overall Dimension	Diameter
				"	"				
G93410-0606	6MJ-6MJ-LX	7252-12345	6000	9/16-18	9/16-18	1/2	1	2.91	1.25
G93410-0808	8MJ-8MJ-LX	7252-12355	6000	3/4-16	3/4-16	11/16	1 1/4	3.88	1.50
G93410-1212	12MJ-12MJ-LX	7252-12365	6000	1 1/16-12	1 1/16-12	15/16	1 5/8	4.94	2.00
G93410-1616	16MJ-16MJ-LX	7252-12375	6000	1 5/16-12	1 5/16-12	1 3/16	1 7/8	5.56	2.22
G93410-2020	20MJ-20MJ-LX	7252-12385	5500	1 5/8-12	1 5/8-12	1 1/2	2 3/8	6.06	2.75
G93410-2424	24MJ-24MJ-LX	7252-12395	4500	1 7/8-12	1 7/8-12	1 3/4	2 1/2	6.44	3.00
G93410-3232	32MJ-32MJ-LX	7252-12405	3000	2 1/2-12	2 1/2-12	2 5/16	3 1/4	7.69	3.88

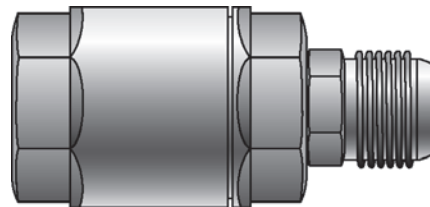

Male JIC to Female Boss



Part No.	Descr.	Prod. No.	⌚	🌀		Hex Shank	Hex Body	Overall Dimension	Diameter
				"	"				
G93450-0808	8MJ-8FJ/FB-LX	7252-12285	6000	3/4-16	3/4-16	11/16	1 1/4	3.31	1.50
G93450-1212	12MJ-12FJ/FB-LX	7252-12295	6000	1 1/16-12	1 1/16-12	15/16	1 5/8	4.12	2.00

EQUIPMENT
HOSE/CPLG. SELECTION
G&K COUPLINGS
GLOBALSPIRAL COUPLINGS
STAINLESS STEEL SPIRAL
MEGACRIMP COUPLINGS
STAINLESS STEEL BRAID
POWER CRIMP COUPLINGS
FIELD ATTACHABLE G1 & G2 COUPLINGS
FIELD ATTACHABLE C5 COUPLINGS
GLX COUPLINGS
GL COUPLINGS
C14 COUPLINGS
PCTS THERMOPLASTIC COUPLINGS
POLARSEAL COUPLINGS
POLARSEAL II COUPLINGS
POWER STEERING
ADAPTERS
QUICK DISCONNECT COUPLERS
BALL VALVES
LIVE SWIVEL
ASSEMBLY FABRICATION
ACCESSORIES
EQUIPMENT AND PARTS
AIR BRAKE
BRASS
KITS

Male JIC to Female Boss - Continued



Part No.	Descr.	Prod. No.				Hex Shank	Hex Body	Overall Dimension	Diameter
				"	"				
G93450-1616	16MJ-16FJ/FB-LX	7252-12305	6000	1 5/16-12	1 5/16-12	1 3/16	1 7/8	4.63	2.22
G93450-2020	20MJ-20FJ/FB-LX	7252-12315	5500	1 5/8-12	1 5/8-12	1 1/2	2 3/8	5.12	2.75
G93450-2424	24MJ-24FJ/FB-LX	7252-12325	4500	1 7/8-12	1 7/8-12	1 3/4	2 1/2	5.34	3.00
G93450-3232	32MJ-32FJ/FB-LX	7252-12335	3000	2 1/2-12	2 1/2-12	2 5/16	3 1/4	6.50	3.88

JIC Seal Kit

Part No.	Descr.	Prod. No.	Standard Pack
G93500-0006	6JIC SWIVEL SEAL KIT	7252-12155	1
G93500-0008	8JIC SWIVEL SEAL KIT	7252-12165	1
G93500-0012	12JIC SWIVEL SEAL KIT	7252-12175	1
G93500-0016	16JIC SWIVEL SEAL KIT	7252-12185	1
G93500-0020	20JIC SWIVEL SEAL KIT	7252-12195	1
G93500-0024	24JIC SWIVEL SEAL KIT	7252-12205	1
G93500-0032	32JIC SWIVEL SEAL KIT	7252-12215	1

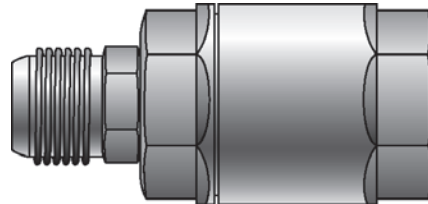
Male JIC to Female Pipe



Part No.	Descr.	Prod. No.				Hex Shank	Hex Body	Overall Dimension	Diameter
				"	"				
G93510-0808	8MJ-8FP-LX	7252-12255	6000	3/4-16	1/2-14	1 1/16	1 1/4	3.31	1.50
G93510-1212	12MJ-12FP-LX	7252-12265	6000	1 1/16-12	3/4-14	15/16	1 5/8	4.19	2.00
G93510-1616	16MJ-16FP-LX	7252-12275	6000	1 5/16-12	1-11 1/2	1 3/16	1 7/8	4.88	2.22

ORS Seal Kit

Part No.	Descr.	Prod. No.	Standard Pack
G93600-0012	12ORS LIVE SWIVEL SEAL KIT	7252-12235	1
G93600-0016	16ORS LIVE SWIVEL SEAL KIT	7252-12245	1

ORS/BSPP Seal Kit

Part No.	Descr.	Prod. No.	Standard Pack
G93700-0008	8ORS/8BSPP LIVE SWVL SEAL KIT	7252-12225	1

Male ORFS to Female ORFS

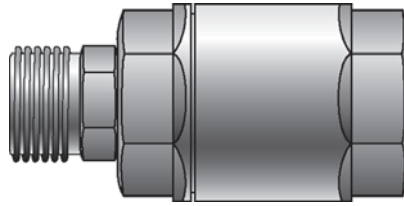

Part No.	Descr.	Prod. No.	⊙	🌀		Hex Shank	Hex Body	Overall Dimension	Diameter
				"	"				
G93724-1212	12MFFOR-12FFORX-LX	7252-12445	6000	3/4-14	3/4-14	1 1/16	1 3/4	3.86	2.09
G93724-1616	16MFFOR-16FFORX-LX	7252-12455	6000	1-11	1-11	1 5/16	2	4.38	2.31

Male ORFS to Male ORFS

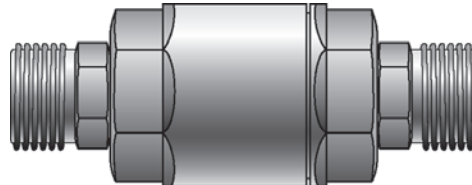

Part No.	Descr.	Prod. No.	⊙	🌀		Hex Shank	Hex Body	Overall Dimension	Diameter
				"	"				
G93742-0808	8MFFOR-8MFFOR-LX	7252-12465	6000	1/2-14	1/2-14	3/4	15/16	3.50	1.53
G93742-1212	12MFFOR-12MFFOR-LX	7252-12475	6000	3/4-14	3/4-14	1 1/16	1 3/4	4.52	2.09
G93742-1616	16MFFOR-16MFFOR-LX	7252-12485	6000	1-11	1-11	1 5/16	2	5.12	2.31

EQUIPMENT
HOSE/CPLG. SELECTION
G8K COUPLINGS
GLOBALSPIRAL COUPLINGS
STAINLESS STEEL SPIRAL
MEGACRIMP COUPLINGS
STAINLESS STEEL BRAID
POWER CRIMP COUPLINGS
FIELD ATTACHABLE G1 & G2 COUPLINGS
FIELD ATTACHABLE C5 COUPLINGS
GLX COUPLINGS
GL COUPLINGS
C14 COUPLINGS
PCTS THERMOPLASTIC COUPLINGS
POLARSEAL COUPLINGS
POLARSEAL II COUPLINGS
POWER STEERING
ADAPTERS
QUICK DISCONNECT COUPLERS
BALL VALVES
LIVE SWIVEL
ASSEMBLY FABRICATION
ACCESSORIES
EQUIPMENT AND PARTS
AIR BRAKE
BRASS
KITS

NOTES

EQUIPMENT
HOSE/CPLG. SELECTION
G8K COUPLINGS
GLOBALSPIRAL COUPLINGS
STAINLESS STEEL SPIRAL
MEGACRIMP COUPLINGS
STAINLESS STEEL BRAID
POWER CRIMP COUPLINGS
FIELD ATTACHABLE G1 & G2 COUPLINGS
FIELD ATTACHABLE C5 COUPLINGS
GLX COUPLINGS
GL COUPLINGS
C14 COUPLINGS
PCTS THERMOPLASTIC COUPLINGS
POLARSEAL COUPLINGS
POLARSEAL II COUPLINGS
POWER STEERING
ADAPTERS
QUICK DISCONNECT COUPLERS
BALL VALVES
LIVE SWIVEL
ASSEMBLY FABRICATION
ACCESSORIES
EQUIPMENT AND PARTS
AIR BRAKE
BRASS
KITS

Tube Assembly Equipment



Part No.	Prod. No.	Descr.	Standard Pack
91025	7468-1040	Bend-N-Fit Tube Bender	1

Fuel Line Repair Kits



Part No.	Prod. No.	Descr.	Standard Pack
A35000-1805	7821-1001	18" - 5/16 Fuel Line Repair Kit	1
A35000-1806	7821-1003	18" - 3/8 Fuel Line Repair Kit	1
A35000-3005	7821-1002	30" - 5/16 Fuel Line Repair Kit	1
A35000-3006	7821-1004	30" - 5/16 Fuel Line Repair Kit	1

Steel Power Steering & Transmission Oil Cooler Tubing - Male O-Ring



Part No.	Prod. No.	Descr.	Standard Pack
A35001-2405	7821-0113	24" - 5/16" Male O-Ring	2
A35001-2406	7821-0118	24" - 3/8" Male O-Ring	2
A35001-2407	7821-0126	24" - 7/16" Male O-Ring	2
A35001-2414	7821-0104	24" - 14mm Male O-Ring	2
A35001-2416	7821-0110	24" - 16mm Male O-Ring	2

EQUIPMENT

HOSE/CPLG. SELECTION

G8K COUPLINGS

GLOBALSPIRAL COUPLINGS

STAINLESS STEEL SPIRAL

MEGACRIMP COUPLINGS

STAINLESS STEEL BRAID

POWER CRIMP COUPLINGS

FIELD ATTACHABLE G1 & G2 COUPLINGS

FIELD ATTACHABLE C5 COUPLINGS

GLX COUPLINGS

GL COUPLINGS

C14 COUPLINGS

PCTS THERMOPLASTIC COUPLINGS

POLARSEAL COUPLINGS

POLARSEAL II COUPLINGS

POWER STEERING

ADAPTERS

QUICK DISCONNECT COUPLERS

BALL VALVES

LIVE SWIVEL

ASSEMBLY FABRICATION

ACCESSORIES

EQUIPMENT AND PARTS

AIR BRAKE

BRASS

KITS

EQUIPMENT
HOSE/CPLG. SELECTION
G8K COUPLINGS
GLOBALSPIRAL COUPLINGS
STAINLESS STEEL SPIRAL
MEGACRIMP COUPLINGS
STAINLESS STEEL BRAID
POWER CRIMP COUPLINGS
FIELD ATTACHABLE G1 & G2 COUPLINGS
FIELD ATTACHABLE C5 COUPLINGS
GLX COUPLINGS
GL COUPLINGS
C14 COUPLINGS
PCTS THERMOPLASTIC COUPLINGS
POLARSEAL COUPLINGS
POLARSEAL II COUPLINGS
POWER STEERING
ADAPTERS
QUICK DISCONNECT COUPLERS
BALL VALVES
LIVE SWIVEL
ASSEMBLY FABRICATION
ACCESSORIES
EQUIPMENT AND PARTS
AIR BRAKE
BRASS
KITS

Steel Power Steering & Transmission Oil Cooler Tubing - Male Inverted Flare



Part No.	Prod. No.	Descr.	Standard Pack
A35003-2406	7821-0117	24" - 3/8" Inverted Male Flare	2
A35003-2414	7821-0103	24" - 14mm Male Inverted Flare	2
A35003-2416	7821-0109	24" - 16mm Male Inverted Flare	2

Steel Power Steering & Transmission Oil Cooler Tubing - Male SAE



Part No.	Prod. No.	Descr.	Standard Pack
A35004-2406	7821-0119	24" - 3/8" Male SAE	2

Steel Power Steering & Transmission Oil Cooler Tubing - Long Swivel O-Ring



Part No.	Prod. No.	Descr.	Standard Pack
A35005-2416	7821-0108	24" - 16mm Long Swivel O-Ring	2

Steel Power Steering & Transmission Oil Cooler Tubing - Swivel O-Ring Type I



Part No.	Prod. No.	Descr.	Standard Pack
A35006-2406	7821-0120	24" - 3/8" Swivel O-Ring Type I	2

Steel Power Steering & Transmission Oil Cooler Tubing - Swivel O-Ring Type II

Part No.	Prod. No.	Descr.	Standard Pack
A35007-2405	7821-0114	24" - 5/16" Swivel O-Ring Type II	2

Steel Power Steering & Transmission Oil Cooler Tubing - Swivel O-Ring Type III

Part No.	Prod. No.	Descr.	Standard Pack
A35008-2416	7821-0111	24" - 16mm Swivel O-Ring Type III	2

Steel Power Steering & Transmission Oil Cooler Tubing - Male Captive O-Ring



Part No.	Prod. No.	Descr.	Standard Pack
A35010-2412	7821-0101	24" - 12mm Male Captive O-Ring	2

Steel Power Steering & Transmission Oil Cooler Tubing - Captive O-Ring



Part No.	Prod. No.	Descr.	Standard Pack
A35011-2418	7821-0112	24" - 18mm Captive O-Ring	2

Steel Power Steering & Transmission Oil Cooler Tubing - Female SAE

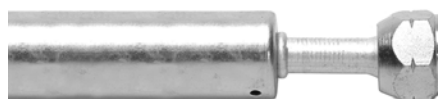

Part No.	Prod. No.	Descr.	Standard Pack
A35012-2406	7821-0116	24" - 3/8" Female SAE	2
A35012-2408	7821-0127	24" - 1/2" Female SAE	2

EQUIPMENT
HOSE/CPLG. SELECTION
G8K COUPLINGS
GLOBALSPIRAL COUPLINGS
STAINLESS STEEL SPIRAL
MEGACRIMP COUPLINGS
STAINLESS STEEL BRAID
POWER CRIMP COUPLINGS
FIELD ATTACHABLE G1 & G2 COUPLINGS
FIELD ATTACHABLE C5 COUPLINGS
GLX COUPLINGS
GL COUPLINGS
C14 COUPLINGS
PCTS THERMOPLASTIC COUPLINGS
POLARSEAL COUPLINGS
POLARSEAL II COUPLINGS
POWER STEERING
ADAPTERS
QUICK DISCONNECT COUPLERS
BALL VALVES
LIVE SWIVEL
ASSEMBLY FABRICATION
ACCESSORIES
EQUIPMENT AND PARTS
AIR BRAKE
BRASS
KITS

EQUIPMENT
HOSE/CPLG. SELECTION
G8K COUPLINGS
GLOBAL SPIRAL COUPLINGS
STAINLESS STEEL SPIRAL
MEGACRIMP COUPLINGS
STAINLESS STEEL BRAID
POWER CRIMP COUPLINGS
FIELD ATTACHABLE G1 & G2 COUPLINGS
FIELD ATTACHABLE C5 COUPLINGS
GLX COUPLINGS
GL COUPLINGS
C14 COUPLINGS
PCTS THERMOPLASTIC COUPLINGS
POLARSEAL COUPLINGS
POLARSEAL II COUPLINGS
POWER STEERING
ADAPTERS
QUICK DISCONNECT COUPLERS
BALL VALVES
LIVE SWIVEL
ASSEMBLY FABRICATION
ACCESSORIES
EQUIPMENT AND PARTS
AIR BRAKE
BRASS
KITS

Steel Power Steering & Transmission Oil Cooler Tubing - Female SAE - Continued

Part No.	Prod. No.	Descr.	Standard Pack
A35012-2416	7821-0107	24" - 16mm Female SAE	2

Steel Power Steering & Transmission Oil Cooler Tubing - Beaded Tube



Part No.	Prod. No.	Descr.	Standard Pack
A35020-2406	7821-0115	24" - 3/8" Beaded Tube	2

Steel Power Steering & Transmission Oil Cooler Tubing - Male Single Bead Quick Connect



Part No.	Prod. No.	Descr.	Standard Pack
A35023-2406	7821-0124	24" - 3/8" Male Single Bead Quick Connect	2

Steel Power Steering & Transmission Oil Cooler Tubing - Double Beaded Pipe



Part No.	Prod. No.	Descr.	Standard Pack
A35025-2406	7821-0121	24" - 3/8" Double Beaded Pipe	2

Steel Power Steering & Transmission Oil Cooler Tubing - GM Quick Connect



Part No.	Prod. No.	Descr.	Standard Pack
A35030-2406	7821-0123	24" - 3/8" GM Quick Connect	2

Aluminum Air Conditioning Tubing - Male Tube O-Ring



Part No.	Prod. No.	Descr.	Standard Pack
A45001-2406	7821-2024	24" - 3/8" Male Tube O-Ring	2
A45001-2408	7821-2025	24" - 1/2" Male Tube O-Ring	2

Aluminum Air Conditioning Tubing - Male SAE



Part No.	Prod. No.	Descr.	Standard Pack
A45004-2406	7821-2020	24" - 3/8" Male SAE	2
A45004-2408	7821-2021	24" - 1/2" Male SAE	2

Aluminum Air Conditioning Tubing - Male Inverted O-Ring

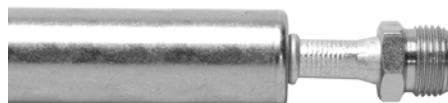

Part No.	Prod. No.	Descr.	Standard Pack
A45009-2406	7821-2029	24" - 3/8" Male Inverted O-Ring	2
A45009-2408	7821-2030	24" - 1/2" Male Inverted O-Ring	2

EQUIPMENT

HOSE/CPLG. SELECTION

G8K COUPLINGS

GLOBAL SPIRAL COUPLINGS

STAINLESS STEEL SPIRAL

MEGACRIMP COUPLINGS

STAINLESS STEEL BRAID

POWER CRIMP COUPLINGS

FIELD ATTACHABLE G1 & G2 COUPLINGS

FIELD ATTACHABLE C5 COUPLINGS

GLX COUPLINGS

GL COUPLINGS

C14 COUPLINGS

PCTS THERMOPLASTIC COUPLINGS

POLARSEAL COUPLINGS

POLARSEAL II COUPLINGS

POWER STEERING

ADAPTERS

QUICK DISCONNECT COUPLERS

BALL VALVES

LIVE SWIVEL

ASSEMBLY FABRICATION

ACCESSORIES

EQUIPMENT AND PARTS

AIR BRAKE

BRASS

KITS

EQUIPMENT
HOSE/CPLG. SELECTION
G8K COUPLINGS
GLOBALSPIRAL COUPLINGS
STAINLESS STEEL SPIRAL
MEGACRIMP COUPLINGS
STAINLESS STEEL BRAID
POWER CRIMP COUPLINGS
FIELD ATTACHABLE G1 & G2 COUPLINGS
FIELD ATTACHABLE C5 COUPLINGS
GLX COUPLINGS
GL COUPLINGS
C14 COUPLINGS
PCTS THERMOPLASTIC COUPLINGS
POLARSEAL COUPLINGS
POLARSEAL II COUPLINGS
POWER STEERING
ADAPTERS
QUICK DISCONNECT COUPLERS
BALL VALVES
LIVE SWIVEL
ASSEMBLY FABRICATION
ACCESSORIES
EQUIPMENT AND PARTS
AIR BRAKE
BRASS
KITS

Aluminum Air Conditioning Tubing - Female Tube O-Ring



Part No.	Prod. No.	Descr.	Standard Pack
A45011-2406	7821-2022	24" - 3/8" Female Tube O-Ring	2
A45011-2408	7821-2023	24" - 1/2" Female Tube O-Ring	2
A45011-2416	7821-2026	24" - 16mm Female Tube O-Ring	2
A45011-2418	7821-2027	24" - 18mm Female Tube O-Ring	2
A45011-2420	7821-2028	24" - 20mm Female Tube O-Ring	2

Aluminum Air Conditioning Tubing - Female SAE



Part No.	Prod. No.	Descr.	Standard Pack
A45012-2406	7821-2018	24" - 3/8" Female SAE	2
A45012-2408	7821-2019	24" - 1/2" Female SAE	2

Aluminum Air Conditioning Tubing - Male Ford Spring Lock



Part No.	Prod. No.	Descr.	Standard Pack
A45035-2406	7821-2031	24" - 3/8" Male Ford Spring Lock	2
A45035-2408	7821-2032	24" - 1/2" Male Ford Spring Lock	2

Aluminum Air Conditioning Tubing - Female Ford Spring Lock



Part No.	Prod. No.	Descr.	Standard Pack
A45036-2406	7821-2033	24" - 3/8" Female Ford Spring Lock	2
A45036-2408	7821-2034	24" - 1/2" Female Ford Spring Lock	2

Fabrication - Steel Tubing Bulk for TOC (25 Ft. per package)



Part No.	Prod. No.	Descr.	Standard Pack
A63004	7704-0214	5/16" X 25'	1
A63005	7704-0215	3/8" X 25'	1

EQUIPMENT
HOSE/CPLG. SELECTION
G&K COUPLINGS
GLOBALSPIRAL COUPLINGS
STAINLESS STEEL SPIRAL
MEGACRIMP COUPLINGS
STAINLESS STEEL BRAID
POWER CRIMP COUPLINGS
FIELD ATTACHABLE G1 & G2 COUPLINGS
FIELD ATTACHABLE C5 COUPLINGS
GLX COUPLINGS
GL COUPLINGS
C14 COUPLINGS
PCTS THERMOPLASTIC COUPLINGS
POLARSEAL COUPLINGS
POLARSEAL II COUPLINGS
POWER STEERING
ADAPTERS
QUICK DISCONNECT COUPLERS
BALL VALVES
LIVE SWIVEL
ASSEMBLY FABRICATION
ACCESSORIES
EQUIPMENT AND PARTS
AIR BRAKE
BRASS
KITS

NOTES

EQUIPMENT
HOSE/CPLG. SELECTION
G8K COUPLINGS
GLOBALSPIRAL COUPLINGS
STAINLESS STEEL SPIRAL
MEGACRIMP COUPLINGS
STAINLESS STEEL BRAID
POWER CRIMP COUPLINGS
FIELD ATTACHABLE G1 & G2 COUPLINGS
FIELD ATTACHABLE C5 COUPLINGS
GLX COUPLINGS
GL COUPLINGS
C14 COUPLINGS
PCTS THERMOPLASTIC COUPLINGS
POLARSEAL COUPLINGS
POLARSEAL II COUPLINGS
POWER STEERING
ADAPTERS
QUICK DISCONNECT COUPLERS
BALL VALVES
LIVE SWIVEL
ASSEMBLY FABRICATION
ACCESSORIES
EQUIPMENT AND PARTS
AIR BRAKE
BRASS
KITS

LifeGuard® Tools

Part No.	Prod. No.	Descr.	Standard Pack
78075	7484-1600	LifeGuard Sleeve Guide Table	1
78076	7482-1604	LifeGuard Sleeve Bullets -4, -6, -8	1

LifeGuard® 3000, 4000 and 5000



Part No.	Descr.	Prod. No.	A Inside Flat	B Sleeve I.D.	Standard Pack
			"	"	
G81102-0014	14LG3K	7277-1850	1.11	.71	120
G81102-0016	16LG3K	7277-1851	1.42	.91	120
G81102-0020	20LG3K	7277-1852	1.67	1.06	120
G81102-0022	22LG3K	7277-1853	2.13	1.35	120
G81102-0026	26LG3K	7277-1854	2.36	1.50	120
G81102-0032	32LG3K	7277-1855	2.78	1.99	120
G81104-0014	14LG4K	7277-1960	1.38	.88	120
G81104-0016	16LG4K	7277-1961	1.62	1.03	120
G81104-0020	20LG4K	7277-1962	1.91	1.22	120
G81104-0022	22LG4K	7277-1963	1.98	1.26	120
G81104-0026	26LG4K	7277-1964	2.50	1.59	120
G81104-0032	32LG4K	7277-1965	2.78	1.99	120
G81105-0014	14LG5K	7277-1950	1.38	.88	120
G81105-0016	16LG5K	7277-1951	1.62	1.03	120
G81105-0020	20LG5K	7277-1952	1.91	1.22	120
G81105-0022	22LG5K	7277-1953	2.13	1.35	120
G81105-0026	26LG5K	7277-1954	2.50	1.59	120

LifeGuard® Clamp Collars - Stainless Steel



Part No.	Descr.	Prod. No.	⊖
			"
G81995-0406S	6SC-4-SS	7334-48535	1.15
G81995-0408S	8SC-4-SS	7334-48545	1.40
G81995-0410S	10SC-4-SS	7334-48605	1.62
G81995-0412S	12SC-4-SS	7334-48615	1.87

- EQUIPMENT
- HOSE/CPLG. SELECTION
- G8K COUPLINGS
- GLOBALSPIRAL COUPLINGS
- STAINLESS STEEL SPIRAL
- MEGACRIMP COUPLINGS
- STAINLESS STEEL BRAID
- POWER CRIMP COUPLINGS
- FIELD ATTACHABLE G1 & G2 COUPLINGS
- FIELD ATTACHABLE C5 COUPLINGS
- GLX COUPLINGS
- GL COUPLINGS
- C14 COUPLINGS
- PCTS THERMOPLASTIC COUPLINGS
- POLARSEAL COUPLINGS
- POLARSEAL II COUPLINGS
- POWER STEERING
- ADAPTERS
- QUICK DISCONNECT COUPLERS
- BALL VALVES
- LIVE SWIVEL
- ASSEMBLY FABRICATION
- ACCESSORIES
- EQUIPMENT AND PARTS
- AIR BRAKE
- BRASS
- KITS

Nylon Protective Sleeve

Clamp Collar for Nylon Sleeve and LifeGuard® Sleeve



Part No.	Descr.	Prod. No.	↔
			"
G81995-0408	8SC-4	7334-48645	1.40
G81995-0408X	8SC-4XBULK	7334-4864	1.40
G81995-0410	10SC-4	7334-48585	1.62
G81995-0410X	10SC-4XBULK	7334-4858	1.62
G81995-0412	12SC-4	7334-48595	1.87
G81995-0412X	12SC-4XBULK	7334-4859	1.87
G81995-0416	16SC-4	7334-48655	2.37
G81995-0416S	16SC-4-SS	7334-48665	2.37
G81995-0416X	16SC-4 XBULK	7334-4865	2.37

Nylon Protective Sleeve

Do not use the Nylon Sleeve where ambient temperatures exceed 250°F.

Description: Gates Nylon Sleeves perform a dual role: (1) they provide excellent abrasion resistance to protect individual hose; and (2) they can be used to bundle several hose assemblies together for maximum protection. Downtime and maintenance costs are reduced. These Nylon Sleeves are unique because they form an extra protective layer against abrasive forces. Specifically, thousands of tiny Nylon filaments, woven into the texturized yarn, "friz" into a self-renewing shield that is extremely resistant to severe abrasion. This nylon sleeving has MSHA flame-resistance approval. Add 1/8" for installation.



Determining the Size of a Sleeve
 $B = \text{Nominal I.D.} = "A" \times 62 \quad 6364$

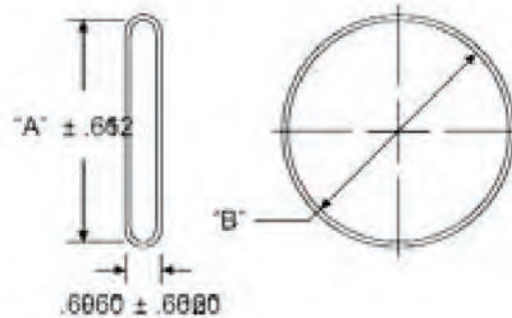

Part No.	Descr.	Prod. No.	A Inside Flat	B Sleeve I.D.	Standard Pack
			"	"	
G81800-0010	HG-10	7277-1067	1.07	.68	300
G81800-0014	HG-14	7277-1010	1.42	.90	300
G81800-0016	HG-16	7277-1011	1.67	1.06	300
G81800-0020	HG-20	7277-1012	1.92	1.22	300
G81800-0024	HG-24	7277-1013	2.24	1.42	300
G81800-0026	HG-26	7277-1377	2.50	1.59	300
G81800-0028	HG-28	7277-1014	2.85	1.81	300
G81800-0032	HG-32	7277-1015	3.44	2.19	300
G81800-0038	HG-38	7277-1016	3.74	2.38	300
G81800-0042	HG-42	7277-1018	4.12	2.62	300

NOTE: Be sure to heat the cut edges of the Nylon Hose Sleeve. You may have to use a banded clamp or nylon tie to fasten the sleeve securely.

Nylon Protective Sleeve

Nylon Protective Sleeve - Continued

Part No.	Descr.	Prod. No.	A Inside Flat	B Sleeve I.D.	Standard Pack
			"	"	
G81800-0046	HG-46	7277-1024	4.53	2.88	300
G81800-0064	HG-64	7277-1276	6.91	4.40	100
G81801-0014	HG 14 X25FT	7277-1278	1.42	.90	25
G81801-0016	HG 16 X25FT	7277-1279	1.67	1.06	25
G81801-0020	HG 20 X25FT	7277-1280	1.92	1.22	25
G81801-0024	HG 24 X25FT	7277-1281	2.24	1.42	25
G81801-0026	HG 26 X25FT	7277-1378	2.50	1.59	25
G81801-0028	HG 28 X25FT	7277-1282	2.85	1.81	25
G81801-0032	HG 32 X25FT	7277-1283	3.44	2.19	25
G81801-0038	HG 38 X25FT	7277-1284	3.74	2.38	25

NOTE: Be sure to heat the cut edges of the Nylon Hose Sleeve. You may have to use a banded clamp or nylon tie to fasten the sleeve securely.

EQUIPMENT

HOSE/CPLG.
SELECTION

G&K COUPLINGS

GLOBAL SPIRAL
COUPLINGS

STAINLESS
STEEL SPIRAL

MEGACRIMP
COUPLINGS

STAINLESS
STEEL BRAID

POWER CRIMP
COUPLINGS

FIELD
ATTACHABLE G1
& G2 COUPLINGS

FIELD
ATTACHABLE C5
COUPLINGS

GLX COUPLINGS

GL COUPLINGS

C14 COUPLINGS

PCTS
THERMOPLASTIC
COUPLINGS

POLARSEAL
COUPLINGS

POLARSEAL II
COUPLINGS

POWER
STEERING

ADAPTERS

QUICK
DISCONNECT
COUPLERS

BALL VALVES

LIVE SWIVEL

ASSEMBLY
FABRICATION

ACCESSORIES

EQUIPMENT AND
PARTS

AIR BRAKE

BRASS

KITS

PolySleeve™ High Density Polyethylene Hose Wrap - Black

Description: Gates PolySleeve is a spiral wrap designed to protect or bundle hose for appearance and safety. PolySleeve protects hose from chaffing, rubbing, crushing, ultraviolet rays and other hazards that cause hose failures. It can be an easy and economical way to protect equipment, reduce downtime, improve sighting and improve overall appearance. PolySleeve can be installed easily – even after the hose assembly or assemblies are in place. The edges are rounded, so installers won't cut their hands. Just wrap a section of Gates PolySleeve in the abrasion area or wrap it around any number of hose for better appearance or safety. It is offered in either black or yellow in a full range of sizes.

This product is made of heavy-wall, high-density polyethylene (HDPE) and has a wide temperature range. At -40°F it starts to become somewhat brittle, and at 280°F it starts to become soft. After temperature is normalized, PolySleeve returns to its original state quickly. PolySleeve is made with an anti-static material, so it won't build up a static charge.

Features Advantages: Available in two colors (black and yellow), multiple sizes for individual hose or bundling. Comes with rounded edges both inside and out for added safety. Easy to install before or after assembly fabrication or installation. Effective temperature range from -40°F to 280°F (-40°C to 130°C). Guards against harsh environmental conditions for reduced downtime. Safe, affordable protection for hydraulic and pneumatic lines.

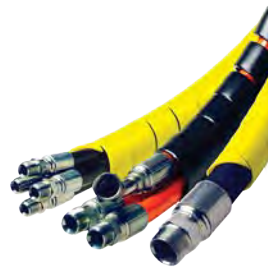

Part No.	Descr.	Prod. No.	Coil I.D.	Fits Max. Hose O.D.	Fits Min. Hose O.D.	Wall Thickness	Width	Standard Pack
			"	"	"			
G80901-0006	6PSB POLY SLEEVE	7277-1174	.38	.52	.38	.060	3/8	165
G80901-0008	8PSB POLY SLEEVE	7277-1175	.50	.64	.52	.070	9/16	66
G80901-0012	12PSB POLY SLEEVE	7277-1176	.63	.85	.63	.080	5/8	66
G80901-0016	16PSB POLY SLEEVE	7277-1177	.84	1.08	.86	.080	7/8	66
G80901-0020	20PSB POLY SLEEVE	7277-1178	1.06	1.35	1.10	.100	15/16	66
G80901-0024	24PSB POLY SLEEVE	7277-1179	1.34	1.74	1.36	.120	1 3/16	66
G80901-0028	28PSB POLY SLEEVE	7277-1180	1.73	2.18	1.75	.120	1 7/16	66
G80901-0036	36PSB POLY SLEEVE	7277-1181	2.17	2.61	2.19	.160	1 1/2	66
G80901-0044	44PSB POLY SLEEVE	7277-1182	2.60	3.11	2.62	.180	1 11/16	66
G80901-0048	48PSB POLY SLEEVE	7277-1183	3.10	3.95	3.12	.220	1 7/8	66
G80901-0056	56PSB POLY SLEEVE	7277-1184	3.90	4.25	3.95	.220	2 1/4	40

PolySleeve™ High Density Polyethylene Hose Wrap - Yellow

Part No.	Descr.	Prod. No.	Coil I.D.	Fits Max. Hose O.D.	Fits Min. Hose O.D.	Wall Thickness	Width	Standard Pack
			"	"	"			
G80902-0006	6PSY POLY SLEEVE	7277-1185	.38	.52	.38	.060	3/8	165
G80902-0008	8PSY POLY SLEEVE	7277-1186	.50	.64	.52	.070	9/16	66
G80902-0012	12PSY POLY SLEEVE	7277-1187	.63	.85	.63	.080	5/8	66
G80902-0016	16PSY POLY SLEEVE	7277-1188	.84	1.08	.86	.080	7/8	66
G80902-0020	20PSY POLY SLEEVE	7277-1189	1.06	1.35	1.10	.100	15/16	66
G80902-0024	24PSY POLY SLEEVE	7277-1190	1.34	1.74	1.36	.120	1 3/16	66
G80902-0028	28PSY POLY SLEEVE	7277-1191	1.73	2.18	1.75	.120	1 7/16	66
G80902-0036	36PSY POLY SLEEVE	7277-1192	2.17	2.61	2.19	.160	1 1/2	66
G80902-0044	44PSY POLY SLEEVE	7277-1193	2.60	3.11	2.62	.180	1 11/16	66
G80902-0048	48PSY POLY SLEEVE	7277-1194	3.10	3.95	3.12	.220	1 7/8	66
G80902-0056	56PSY POLY SLEEVE	7277-1195	3.90	4.25	3.95	.220	2 1/4	40

Plastic Protective Coil Sleeves

Description: Economical, lightweight plastic sleeving protects hose from water, air, gasoline and hydraulic fluids. Effective temperature range from -40°F to +250°F (-40°C to +121°C).



Part No.	Descr.	Prod. No.	A Coil I.D.	B Strip Width	Thickness	Standard Pack
			"	"	"	
G81900-0004	1/4" CS1151-100FT	7277-1151	1/4	1/4	.040	100
G81900-0006	3/8" CS1152-100FT	7277-1152	3/8	1/4	.040	100
G81900-0008	1/2" CS1153-100FT	7277-1153	1/2	3/8	.070	100
G81900-0010	5/8" CS1154-50FT	7277-1154	5/8	3/8	.070	50
G81900-0012	3/4" CS1155-50FT	7277-1155	3/4	3/8	.070	50
G81900-0016	1" CS1156-50FT	7277-1156	1	5/8	.115	50
G81900-0022	1 3/8" CS1157-25FT	7277-1157	1 3/8	5/8	.115	25
G81900-0030	1 7/8" CS1158-25FT	7277-1158	1 7/8	5/8	.115	25

Plated Flat Armor Spring Guards

Description: For proper spring guard selection compare the outside diameter of the hose to the inside diameter of the spring guard. Allow 1/32" for installation.

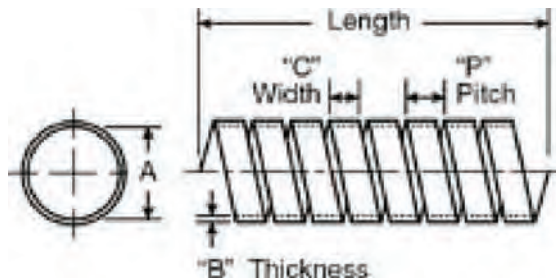

Part No.	Descr.	Prod. No.	A (+.015)	B	C	P	Standard Pack
			"	"	"	"	
G82801-0008	35/64" FSG-25FT	7277-0500	.550	.019	3/8	1/2	25
G82801-0009	21/32" FSG-25FT	7277-0501	.656	.019	3/8	1/2	25
G82801-0010	39/64" FSG-25FT	7277-0533	.609	.032	1/4	3/8	25
G82801-0011	22/32" FSG-25FT	7277-0502	.719	.019	3/8	1/2	25
G82801-0012	13/16" FSG-25FT	7277-0503	.812	.028	1/4	3/8	25
G82801-0013	51/64" FSG-25FT	7277-0534	.797	.032	3/8	1/2	25
G82801-0014	7/8" FSG-25FT	7277-0504	.875	.028	1/2	5/8	25
G82801-0015	61/64" FSG-25FT	7277-0505	.953	.028	1/2	5/8	25
G82801-0016	1" FSG-25FT	7277-0506	1.000	.028	1/2	5/8	25
G82801-0017	1 3/32" FSG-25FT	7277-0530	1.093	.028	1/2	5/8	25
G82801-0019	1 7/32" FSG-25FT	7277-0507	1.219	.028	1/2	5/8	25
G82801-0020	1 9/32" FSG-25FT	7277-0508	1.281	.028	1/2	5/8	25
G82801-0022	1 3/8" FSG-25FT	7277-0532	1.375	.028	1/2	5/8	25
G82801-0025	1 9/16" FSG-25FT	7277-0520	1.562	.028	1/2	5/8	25
G82801-0026	1 5/8" FSG-25FT	7277-0509	1.625	.028	1/2	5/8	25
G82801-0027	1 11/16" FSG-5FT	7277-0529	1.687	.028	1/2	5/8	25
G82801-0028	1 51/64" FSG-15FT	7277-0525	1.797	.028	1/2	5/8	15

- EQUIPMENT
- HOSE/CPLG. SELECTION
- G8K COUPLINGS
- GLOBALSPIRAL COUPLINGS
- STAINLESS STEEL SPIRAL
- MEGACRIMP COUPLINGS
- STAINLESS STEEL BRAID
- POWER CRIMP COUPLINGS
- FIELD ATTACHABLE G1 & G2 COUPLINGS
- FIELD ATTACHABLE C5 COUPLINGS
- GLX COUPLINGS
- GL COUPLINGS
- C14 COUPLINGS
- PCTS THERMOPLASTIC COUPLINGS
- POLARSEAL COUPLINGS
- POLARSEAL II COUPLINGS
- POWER STEERING
- ADAPTERS
- QUICK DISCONNECT COUPLERS
- BALL VALVES
- LIVE SWIVEL
- ASSEMBLY FABRICATION
- ACCESSORIES
- EQUIPMENT AND PARTS
- AIR BRAKE
- BRASS
- KITS

Hose Guards

Plated Flat Armor Spring Guards - Continued

Part No.	Descr.	Prod. No.	A (+.015)	B	C	P	Standard Pack
			"	"	"	"	
G82801-0029	1 27/32" FSG-15FT	7277-0531	1.844	.028	1/2	5/8	15
G82801-0033	2 3/32" FSG-10FT	7277-0527	2.093	.028	1/2	5/8	10
G82801-0037	2 11/32" FSG-5FT	7277-0528	2.343	.028	1/2	5/8	5
G82801-0046	2 7/8" FSG-5FT	7277-0526	2.875	.028	1/2	5/8	5

Plated Wire Spring Guards

Description: For proper spring guard selection compare the outside diameter of the hose to the inside diameter of the spring guard. Allow 1/32" for installation.

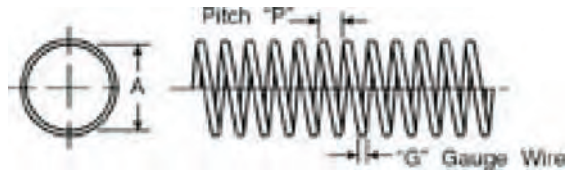

Part No.	Descr.	Prod. No.	A (+.015)	G	P	Standard Pack
			"	"	"	
G83801-0009	35/64" RSG-25FT	7277-0521	.550	14 (.080)	7/32	25
G83801-0010	49/64" RSG-25FT	7277-0510	.676	14 (.080)	7/32	25
C14 COUPLINGS	G83801-0011	11/16" RSG-25FT	.682	16 (.065)	7/32	25
	G83801-0012	47/64" RSG-25FT	.738	14 (.080)	7/32	25
PCTS THERMOPLASTIC COUPLINGS	G83801-0014	55/64" RSG-25FT	.852	14 (.080)	7/32	25
	G83801-0015	59/64" RSG-25FT	.915	14 (.080)	7/32	25
	G83801-0016	63/64" RSG-25FT	.977	14 (.080)	7/32	25
POLARSEAL COUPLINGS	G83801-0017	1 3/64" RSG-25FT	1.040	14 (.080)	7/32	25
	G83801-0018	1 1/8" RSG-25FT	1.122	14 (.080)	7/32	25
POLARSEAL II COUPLINGS	G83801-0020	1 9/32" RSG-25FT	1.278	11 (.120)	11/32	25
	G83801-0021	1 11/32" RSG-25FT	1.340	11 (.120)	11/32	25
	G83801-0025	1 37/64" RSG-25FT	1.578	11 (.120)	11/32	25
POWER STEERING	G83801-0026	1 5/8" RSG-25FT	1.625	11 (.120)	11/32	25
	G83801-0029	1 27/32" RSG-10FT	1.847	14 (.080)	13/32	10
ADAPTERS	G83801-0034	2 1/8" RSG-7FT	2.120	11 (.120)	11/32	7
	G83801-0040	2 7/64" RSG-7FT	2.112	14 (.080)	13/32	7

EQUIPMENT
HOSE/CPLG. SELECTION
G8K COUPLINGS
GLOBAL SPIRAL COUPLINGS
STAINLESS STEEL SPIRAL
MEGACRIMP COUPLINGS
STAINLESS STEEL BRAID
POWER CRIMP COUPLINGS
FIELD ATTACHABLE G1 & G2 COUPLINGS
FIELD ATTACHABLE C5 COUPLINGS
GLX COUPLINGS
GL COUPLINGS
PCTS THERMOPLASTIC COUPLINGS
POLARSEAL COUPLINGS
POLARSEAL II COUPLINGS
POWER STEERING
ADAPTERS
QUICK DISCONNECT COUPLERS
BALL VALVES
LIVE SWIVEL
ASSEMBLY FABRICATION
ACCESSORIES
EQUIPMENT AND PARTS
AIR BRAKE
BRASS
KITS

HeatGuard® Tape

Part No.	Descr.	Prod. No.	Standard Pack
G81100-0100	HTG-1 INCH WIDE HEATGUARD TAPE	7277-0010	100
G81100-0200	HTG-2 INCH WIDE HEATGUARD TAPE	7277-0011	100
G81100-0300	HTG 3-INCH WIDE HEATGUARD TAPE	7277-0012	100
G81100-0400	HTG 4-INCH WIDE HEATGUARD TAPE	7277-0013	100
G81100-0500	HTG 5-INCH WIDE HEATGUARD TAPE	7277-0014	100

HeatGuard® Protective Sheathing

Description: Best of all, HeatGuard can pay for itself in reduced replacement and maintenance costs. It is available in two grades – HeatGuard and HeatGuard Hi-Temp. Contact Hose Product Application for details.
HeatGuard is a completely not-asbestos, heat-resistant, protective sleeving. Its special silicone coating can also withstand a broad range of solvents and fuels. It goes on easily over most hose and couplings, with only hose clamps or wire ties required for fastening. Nominal wall thickness – 0.135".

Temperature Range: HeatGuard Hi-Temp is knitted, coated fiberglass; meets SAE AS1072A specification; temperature range: -65°F to +500°F (-54°C to +260°C) for continuous exposure, up to 2000°F (1093°C) for 15–20 minutes and up to 3000°F (1650°C) for 15–30 seconds.



Part No.	Descr.	Prod. No.	Inside Diameter	Standard Pack
			"	
G81100-0004	HTG-4	7277-1571	.25	50
G81100-0005	HTG-5	7277-1572	.31	50
G81100-0006	HTG-6	7277-1573	.38	50
G81100-0007	HTG-7	7277-1574	.44	50
G81100-0008	HTG-8	7277-1575	.50	50
G81100-0009	HTG-9	7277-1576	.56	50
G81100-0010	HTG-10	7277-1577	.62	50
G81100-0011	HTG-11	7277-1578	.69	50
G81100-0012	HTG-12	7277-1579	.75	50
G81100-0013	HTG-13	7277-1580	.81	50
G81100-0014	HTG-14	7277-1581	.88	50
G81100-0015	HTG-15	7277-1582	.94	50
G81100-0016	HTG-16	7277-1196	1.00	50
G81100-0018	HTG-18	7277-1197	1.12	50
G81100-0020	HTG-20	7277-1583	1.25	50
G81100-0022	HTG-22	7277-1584	1.38	50
G81100-0024	HTG-24	7277-1585	1.50	50
G81100-0026	HTG-26	7277-1586	1.62	50
G81100-0028	HTG-28	7277-1587	1.75	50
G81100-0030	HTG-30	7277-1588	1.88	50
G81100-0032	HTG-32	7277-1589	2.00	50
G81100-0034	HTG-34	7277-1590	2.12	50
G81100-0036	HTG-36	7277-1591	2.25	50
G81100-0038	HTG-38	7277-1592	2.38	50
G81100-0040	HTG-40	7277-1593	2.50	50
G81100-0044	HTG-44	7277-1595	2.75	50
G81100-0056	HTG-56	7277-1600	3.00	50
G81100-0064	HTG-64	7277-1602	4.00	50

EQUIPMENT

HOSE/CPLG.
SELECTION

G8K COUPLINGS

GLOBALSPIRAL
COUPLINGSSTAINLESS
STEEL SPIRALMEGACRIMP
COUPLINGSSTAINLESS
STEEL BRAIDPOWER CRIMP
COUPLINGSFIELD
ATTACHABLE G1
& G2 COUPLINGSFIELD
ATTACHABLE C5
COUPLINGS

GLX COUPLINGS

GL COUPLINGS

C14 COUPLINGS

PCTS
THERMOPLASTIC
COUPLINGSPOLARSEAL
COUPLINGSPOLARSEAL II
COUPLINGSPOWER
STEERING

ADAPTERS

QUICK
DISCONNECT
COUPLERS

BALL VALVES

LIVE SWIVEL

ASSEMBLY
FABRICATION

ACCESSORIES

EQUIPMENT AND
PARTS

AIR BRAKE

BRASS

KITS

HeatGuard® High-Temp Protective Sheathing

Description: Best of all, HeatGuard can pay for itself in reduced replacement and maintenance costs. It is available in two grades – HeatGuard and HeatGuard Hi-Temp. Contact Hose Product Application for details.
HeatGuard is a completely not-asbestos, heat-resistant, protective sleeving. Its special silicone coating can also withstand a broad range of solvents and fuels. It goes on easily over most hose and couplings, with only hose clamps or wire ties required for fastening. Nominal wall thickness – 0.135".
HeatGuard is a completely not-asbestos, heat-resistant, protective sleeving. Its special silicone coating can also withstand a broad range of solvents and fuels. It goes on easily over most hose and couplings, with only hose clamps or wire ties required for fastening. Nominal wall thickness – 0.142".

Temperature Range: HeatGuard Hi-Temp is braided, coated fiberglass; meets SAE AS1072E specification; temperature range: –65°F to +500°F (–54°C to +260°C) for continuous exposure, up to 2000°F (1093°C) for 15–20 minutes and up to 3000°F (1650°C) for 15–30 seconds.
HeatGuard Hi-Temp is knitted, coated fiberglass; meets SAE AS1072A specification; temperature range: –65°F to +500°F (–54°C to +260°C) for continuous exposure, up to 2000°F (1093°C) for 15–20 minutes and up to 3000°F (1650°C) for 15–30 seconds.



Part No.	Descr.	Prod. No.	Inside Diameter	Standard Pack
			"	
G81101-0024	24-HTGH	7277-1611	1.50	50
G81101-0028	28-HTGH	7277-1612	1.75	50
G81101-0034	34-HTGH	7277-1613	2.12	50
G81101-0052	52-HTGH	7277-1616	3.25	50

EQUIPMENT
HOSE/CPLG. SELECTION
G8K COUPLINGS
GLOBALSPIRAL COUPLINGS
STAINLESS STEEL SPIRAL
MEGACRIMP COUPLINGS
STAINLESS STEEL BRAID
POWER CRIMP COUPLINGS
FIELD ATTACHABLE G1 & G2 COUPLINGS
FIELD ATTACHABLE C5 COUPLINGS
GLX COUPLINGS
GL COUPLINGS
C14 COUPLINGS
PCTS THERMOPLASTIC COUPLINGS
POLARSEAL COUPLINGS
POLARSEAL II COUPLINGS
POWER STEERING
ADAPTERS
QUICK DISCONNECT COUPLERS
BALL VALVES
LIVE SWIVEL
ASSEMBLY FABRICATION
ACCESSORIES
EQUIPMENT AND PARTS
AIR BRAKE
BRASS
KITS

Clamp Collars

Description: Crimping Instruction: Care must be taken when crimping clamp collars onto a hydraulic hose. If crimp is too tight, hose will be crushed, dramatically reducing its service life. If crimp is too loose, collar could slide along hose's length causing abrasion and eventual hose cover failure. Remember: Clamp collars must be crimped before the hose couplings.

To locate clamps and protect hose. Previously available only through equipment dealerships, clamp collars are common on many types of construction equipment. The collars are actually crimped onto a hydraulic hose, reducing hose movement and minimizing abrasion.

Use the following instruction to determine crimp diameter, which can then be used to find crimping setting in Gates' Crimp Data Manual (428-7365 Auto./35019 Ind.). The required clamp collar for a specific hydraulic hose is provided in Table 1. 1. Measure hose's outside diameter at the location where clamp collar will be crimped. This can be accomplished by using a pie tape or by using the average hose outside diameter measured with a dial caliper. 2. Measure wall thickness of clamp collar with a dial caliper. 3. Obtain crimp diameter by adding hose outside diameter to twice the clamp collar wall thickness: Crimp Diameter = (Hose O.D.) + (2 x .065).



Part No.	Descr.	Prod. No.	Hydraulic Hose Applications
G52000-0210	CC1.12	7334-45805	10M2T, 10G2, 10M3K
G52000-0210S	CC1.20	7334-37015	12M2T, 12G2, 12M4K
G52000-0212	CC1.25	7334-45885	12M2T, 12G2, 12M4K
G52000-0412	CC1.37	7334-45895	12C12, 12G4K

EQUIPMENT

HOSE/CPLG. SELECTION

G8K COUPLINGS

GLOBALSPIRAL COUPLINGS

STAINLESS STEEL SPIRAL

MEGACRIMP COUPLINGS

STAINLESS STEEL BRAID

POWER CRIMP COUPLINGS

FIELD ATTACHABLE G1 & G2 COUPLINGS

FIELD ATTACHABLE C5 COUPLINGS

GLX COUPLINGS

GL COUPLINGS

C14 COUPLINGS

PCTS THERMOPLASTIC COUPLINGS

POLARSEAL COUPLINGS

POLARSEAL II COUPLINGS

POWER STEERING

ADAPTERS

QUICK DISCONNECT COUPLERS

BALL VALVES

LIVE SWIVEL

ASSEMBLY FABRICATION

ACCESSORIES

EQUIPMENT AND PARTS

AIR BRAKE

BRASS

KITS

Vinyl Bend Restrictor

Vinyl Bend Restrictor - Black

Description: Gates tapered PVC sleeve reduces bending stress in the hose near the coupling to prevent damage, such as in power wash applications. Installed during hose assembly, this smoothly-finished product withstands temperatures from -40°F to +200°F (-40°C to +93°C).

Features Advantages: Friction Fit; no adhesives or clamps required to hold bend restrictor in place on hose assembly. Saves assembly cost. Smooth finish will not scratch finish on equipment being washed. Attractive appearance enhances look of quality. Tapered design reduces bending stress neat the hose-coupling junction so extra long, more trouble-free hose life can be expected. Wide temperature helps give extra long service life for both hot and cold power wash assemblies.



Part No.	Descr.	Prod. No.	Inside Diameter	Length	Hose Size and Type	Standard Pack
			"	"		
G80700-0106	HBR1051	7277-10515	.73	6.0	6G1, 6G1H, 6M3K, 6M2T, 6PC3000, 6PC4000, 4PC6000	27
G80700-0106X	HBR1051 XBULK	7277-1051	.73	6.0	6G1, 6G1H, 6M3K, 6M2T, 6PC3000, 6PC4000, 4PC6000	380
G80700-0108	HBR1052	7277-10525	.84	7.00	8G1, 8G1H, 6PC5000	38
G80700-0108X	HBR1052 XBULK	7277-1052	.84	7.00	8G1, 8G1H, 6PC5000	200
G80700-0110	HBR1053	7277-10535	1.00	8.0	10G1, 10G1H, 10M2T	30
G80700-0110X	HBR1053 XBULK	7277-1053	1.00	8.0	10G1, 10G1H, 10M2T	150
G80700-0204	HBR1050	7277-10505	.63	5.5	4G1, 4G1H, 4G2, 4M3K, 4M2T, 4PC3500	39
G80700-0204X	HBR1050 XBULK	7277-1050	.63	5.5	4G1, 4G1H, 4G2, 4M3K, 4M2T, 4PC3500	410
G80700-0206	HBR1054	7277-10545	.77	7.00	6G2	45
G80700-0206X	HBR1054 XBULK	7277-1054	.77	7.00	6G2	300
G80700-0208	HBR1056	7277-10905	.91	7.00	8PC2500	34
G80700-0404	HBR1055	7277-10555	.53	5.3	4TH7/4TH7NC	42
G80700-0404X	HBR1055 XBULK	7277-1055	.53	5.3	4TH7/4TH7NC	440

Vinyl Bend Restrictor - Red

Description: Gates tapered PVC sleeve reduces bending stress in the hose near the coupling to prevent damage, such as in power wash applications. Installed during hose assembly, this smoothly-finished product withstands temperatures from -40°F to +200°F (-40°C to +93°C).

Features Advantages: Friction Fit; no adhesives or clamps required to hold bend restrictor in place on hose assembly. Saves assembly cost. Smooth finish will not scratch finish on equipment being washed. Attractive appearance enhances look of quality. Tapered design reduces bending stress neat the hose-coupling junction so extra long, more trouble-free hose life can be expected. Wide temperature helps give extra long service life for both hot and cold power wash assemblies.

Part No.	Descr.	Prod. No.	Inside Diameter	Length	Hose Size and Type	Standard Pack
			"	"		
G80705-0108	HBR1098	7277-10985	.91	7.00	8PC2500	34
G80705-0108X	HBR1098 XBULK	7277-1098	.91	7.00	8PC2500	190
G80705-0206	HBR1097	7277-10975	.76	7.00	6G2	45
G80705-0206X	HBR1097 XBULK	7277-1097	.76	7.00	6G2	300

Flange Fittings

Code 61 Flange Cap

For maintenance use only. Not to be used under pressure.

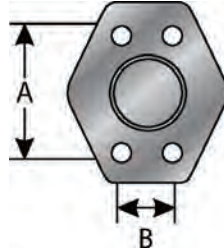

Part No.	Descr.	Prod. No.	Nom. Flg. Size	A	B	Standard Pack
			"	"	"	
G60897-0012	12FL-CAP	7253-66115	3/4	1.88	.41	1
G60897-0016	16FL-CAP	7253-66125	1	2.06	.41	1
G60897-0020	20FL-CAP	7253-66135	1 1/4	2.31	.47	1
G60897-0024	24FL-CAP	7253-66145	1 1/2	2.75	.53	1
G60897-0032	32FL-CAP	7253-66155	2	3.06	.53	1

Flange Half Sets (Code 61 - SAE J518)

Each set contains 2 flange halves, 1 O-Ring and 4 bolts (Grade 8) with lock washers.

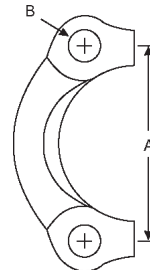

Part No.	Descr.	Prod. No.	Nom. Flg. Size	A	B	Standard Pack
			"	"	"	
G60899-0008	8CFHS	7253-07015	1/2	1.50	.34	1
G60899-0012	12CFHS	7253-07025	3/4	1.88	.41	1
G60899-0016	16CFHS	7253-07035	1	2.06	.41	1
G60899-0020	20CFHS	7253-07045	1 1/4	2.31	.47	1
G60899-0024	24CFHS	7253-07055	1 1/2	2.75	.53	1
G60899-0032	32CFHS	7253-07065	2	3.06	.53	1
G60899-0040	40CFHS	7253-01305	2 1/2	3.50	.54	1
G60899-0048	48CFHS	7253-01315	3	4.19	.66	1
G60899-0056	56CFHS	7253-01325	3 1/2	4.75	.66	1
G60899-0064	64CFHS	7253-01335	4	4.75	.66	1

EQUIPMENT

HOSE/CPLG. SELECTION

G8K COUPLINGS

GLOBALSPIRAL COUPLINGS

STAINLESS STEEL SPIRAL

MEGACRIMP COUPLINGS

STAINLESS STEEL BRAID

POWER CRIMP COUPLINGS

FIELD ATTACHABLE G1 & G2 COUPLINGS

FIELD ATTACHABLE C5 COUPLINGS

GLX COUPLINGS

GL COUPLINGS

C14 COUPLINGS

PCTS THERMOPLASTIC COUPLINGS

POLARSEAL COUPLINGS

POLARSEAL II COUPLINGS

POWER STEERING

ADAPTERS

QUICK DISCONNECT COUPLERS

BALL VALVES

LIVE SWIVEL

ASSEMBLY FABRICATION

ACCESSORIES

EQUIPMENT AND PARTS

AIR BRAKE

BRASS

KITS

Flange Fittings

Code 62 Flange Cap

For maintenance use only. Not to be used under pressure.

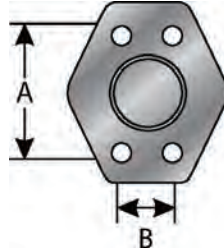

Part No.	Descr.	Prod. No.	Nom. Flg. Size	A	B	Standard Pack
			"	"	"	
G60927-0012	12FLH-CAP	7253-66165	3/4	2.00	.41	1
G60927-0016	16FLH-CAP	7253-66175	1	2.25	.47	1
G60927-0020	20FLH-CAP	7253-66185	1 1/4	2.63	.53	1
G60927-0024	24FLH-CAP	7253-66195	1 1/2	3.13	.66	1
G60927-0032	32FLH-CAP	7253-66205	2	3.81	.78	1

Flange Half Sets (Code 62 - SAE J518)

Each set contains 2 flange halves, 1 O-Ring and 4 bolts (Grade 8) with lock washers.

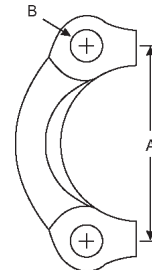
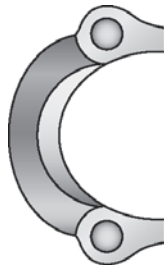

Part No.	Descr.	Prod. No.	Nom. Flg. Size	A	B	Standard Pack
			"	"	"	
G60929-0008	8FHHS	7253-09775	1/2	1.55	.34	1
G60929-0012	12FHHS	7253-09785	3/4	2.00	.41	1
G60929-0016	16FHHS	7253-09795	1	2.25	.47	1
G60929-0020	20FHHS	7253-09805	1 1/4	2.63	.53	1
G60929-0024	24FHHS	7253-09815	1 1/2	3.13	.66	1
G60929-0032	32FHHS	7253-09825	2	3.81	.78	1

EQUIPMENT

HOSE/CPLG.
SELECTION

G8K COUPLINGS

GLOBALSPIRAL
COUPLINGSSTAINLESS
STEEL SPIRALMEGACRIMP
COUPLINGSSTAINLESS
STEEL BRAIDPOWER CRIMP
COUPLINGSFIELD
ATTACHABLE G1
& G2 COUPLINGSFIELD
ATTACHABLE C5
COUPLINGS

GLX COUPLINGS

GL COUPLINGS

C14 COUPLINGS

PCTS
THERMOPLASTIC
COUPLINGSPOLARSEAL
COUPLINGSPOLARSEAL II
COUPLINGSPOWER
STEERING

ADAPTERS

QUICK
DISCONNECT
COUPLERS

BALL VALVES

LIVE SWIVEL

ASSEMBLY
FABRICATION

ACCESSORIES

EQUIPMENT AND
PARTS

AIR BRAKE

BRASS

KITS

Caterpillar-Style Flange Half Sets

Each set contains 2 flange halves, 1 O-Ring and 4 bolts (Grade 8) with lock washers.

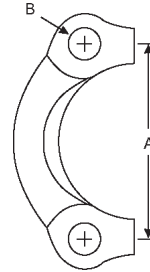
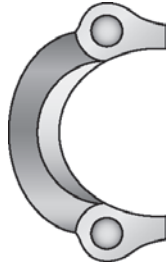

Part No.	Descr.	Prod. No.	Nom. Flg. Size	A	B	Standard Pack
			"	"	"	
G60959-0012	12CATFHS	7253-37025	3/4	2.00	.41	1
G60959-0016	16CATFHS	7253-37035	1	2.25	.47	1
G60959-0020	20CATFHS	7253-37045	1 1/4	2.63	.53	1
G60959-0024	24CATFHS	7253-37055	1 1/2	3.13	.66	1
G60959-0032	32CATFHS	7253-37065	2	3.81	.78	1

EQUIPMENT
HOSE/CPLG. SELECTION
G&K COUPLINGS
GLOBALSPIRAL COUPLINGS
STAINLESS STEEL SPIRAL
MEGACRIMP COUPLINGS
STAINLESS STEEL BRAID
POWER CRIMP COUPLINGS
FIELD ATTACHABLE G1 & G2 COUPLINGS
FIELD ATTACHABLE C5 COUPLINGS
GLX COUPLINGS
GL COUPLINGS
C14 COUPLINGS
PCTS THERMOPLASTIC COUPLINGS
POLARSEAL COUPLINGS
POLARSEAL II COUPLINGS
POWER STEERING
ADAPTERS
QUICK DISCONNECT COUPLERS
BALL VALVES
LIVE SWIVEL
ASSEMBLY FABRICATION
ACCESSORIES
EQUIPMENT AND PARTS
AIR BRAKE
BRASS
KITS

O-Rings

O-Rings for Straight Thread Boss Fittings

90 Durometer Hardness.



Part No.	Descr.	Prod. No.	Inside Diameter	Wall	Standard Pack
			"	"	
G60248-0003	3 O-RING	7254-0003	19/64	1/16	10
G60248-0004	4 O-RING	7254-0004	11/32	5/64	10
G60248-0005	5 O-RING	7254-0005	13/32	5/64	10
G60248-0006	6 O-RING	7254-0006	15/32	5/64	10
G60248-0008	8 O-RING	7254-0008	41/64	3/32	10
G60248-0010	10 O-RING	7254-0010	3/4	3/32	10
G60248-0012	12 O-RING	7254-0012	59/64	7/64	10
G60248-0014	14 O-RING	7254-0014	1 3/64	7/64	10
G60248-0016	16 O-RING	7254-0016	1 11/64	7/64	10
G60248-0020	20 O-RING	7254-0020	1 15/32	7/64	10

O-Rings for Flat-Face Fittings

90 Durometer Hardness.

Caution: These O-Rings are compounded from a Nitrile polymer for use with petroleum-base hydraulic fluids, water and glycol and oil-water emulsions. DO NOT USE these O-Rings with phosphate esters, diesters or phosphate ester emulsion hydraulic fluids. Instead, use O-Rings made of Viton, EPDM or CPE polymers or other materials compatible with the fluids.



Part No.	Descr.	Prod. No.	Reference Coupling	Arp. No.	Standard Pack
			"		
G60698-0004	4 O-RING FF	7254-0125	1/4	011	10
G60698-0006	6 O-RING FF	7254-0126	3/8	012	10
G60698-0008	8 O-RING FF	7254-0127	1/2	014	10
G60698-0010	10 O-RING FF	7254-0128	5/8	016	10
G60698-0012	12 O-RING FF	7254-0129	3/4	018	10
G60698-0016	16 O-RING FF	7254-0130	1	021	10
G60698-0020	20 O-RING FF	7254-0131	1 1/4	025	10
G60698-0024	24 O-RING FF	7254-0132	1 1/2	029	10

NOTE: Standard O-Ring number.

EQUIPMENT
HOSE/CPLG. SELECTION
G8K COUPLINGS
GLOBALSPIRAL COUPLINGS
STAINLESS STEEL SPIRAL
MEGACRIMP COUPLINGS
STAINLESS STEEL BRAID
POWER CRIMP COUPLINGS
FIELD ATTACHABLE G1 & G2 COUPLINGS
FIELD ATTACHABLE C5 COUPLINGS
GLX COUPLINGS
GL COUPLINGS
C14 COUPLINGS
PCTS THERMOPLASTIC COUPLINGS
POLARSEAL COUPLINGS
POLARSEAL II COUPLINGS
POWER STEERING
ADAPTERS
QUICK DISCONNECT COUPLERS
BALL VALVES
LIVE SWIVEL
ASSEMBLY FABRICATION
ACCESSORIES
EQUIPMENT AND PARTS
AIR BRAKE
BRASS
KITS

O-Rings

O-Rings for Code 61, Code 62, and Caterpillar-Style Flange Fittings

90 Durometer Hardness.



Part No.	Descr.	Prod. No.	Inside Diameter	Wall	Standard Pack
			"	"	
G60898-0008	8 FLANGE O-RING	7254-0001	3/4	.139	10
G60898-0010	10 FLANGE O-RING	7254-0142	55/64	.139	10
G60898-0012	12 FLANGE O-RING	7254-0007	1.00	.139	10
G60898-0016	16 FLANGE O-RING	7254-0009	1 5/16	.139	10
G60898-0020	20 FLANGE O-RING	7254-0011	1 1/2	.139	10
G60898-0024	24 FLANGE O-RING	7254-0013	1 7/8	.139	10
G60898-0032	32 FLANGE O-RING	7254-0015	2 1/4	.139	10
G60898-0040	40 FLANGE O-RING	7254-0133	2 3/4	.139	10
G60898-0048	48 FLANGE O-RING	7254-0134	3 3/8	.139	10
G60898-0056	56 FLANGE O-RING	7254-0135	3 7/8	.139	10
G60898-0064	64 FLANGE O-RING	7254-0136	4 3/8	.139	10

O-Rings for British Standard Parallel Pipe (BSPP Couplings)

70 Durometer Hardness.



Part No.	Descr.	Prod. No.	Inside Diameter	Wall	Standard Pack
			mm	mm	
G64095-0004	4 O-RING FBSPP	7254-1166	6.5	1.0	10
G64095-0006	6 O-RING FBSPP	7254-1154	7.1	1.6	10
G64095-0008	8 O-RING FBSPP	7254-1157	11.1	1.6	10
G64095-0010	10 O-RING FBSPP	7254-1159	12.1	1.6	10
G64095-0012	12 O-RING FBSPP	7254-1162	17.1	1.6	10
G64095-0016	16 O-RING FBSPP	7254-1164	22.1	1.6	10
G64095-0020	20 O-RING FBSPP	7254-1165	27.1	1.6	10

EQUIPMENT

HOSE/CPLG. SELECTION

G8K COUPLINGS

GLOBALSPIRAL COUPLINGS

STAINLESS STEEL SPIRAL

MEGACRIMP COUPLINGS

STAINLESS STEEL BRAID

POWER CRIMP COUPLINGS

FIELD ATTACHABLE G1 & G2 COUPLINGS

FIELD ATTACHABLE C5 COUPLINGS

GLX COUPLINGS

GL COUPLINGS

C14 COUPLINGS

PCTS THERMOPLASTIC COUPLINGS

POLARSEAL COUPLINGS

POLARSEAL II COUPLINGS

POWER STEERING

ADAPTERS

QUICK DISCONNECT COUPLERS

BALL VALVES

LIVE SWIVEL

ASSEMBLY FABRICATION

ACCESSORIES

EQUIPMENT AND PARTS

AIR BRAKE

BRASS

KITS

O-Rings

O-Rings for DIN Light & Heavy Series (MegaCrimp® and GlobalSpiral™ Couplings)

70 Durometer Hardness.



Part No.	Descr.	Prod. No.	Inside Diameter	Wall	Standard Pack
			mm	mm	
G64780-0018	18 O-RING DIN L	7254-0201	15.0	2.0	10
G64780-0022	22 O-RING DIN L	7254-0202	20.0	2.0	10
G64780-0028	28 O-RING DIN L	7254-0203	26.0	2.0	10
G64780-0035	35 O-RING DIN L	7254-0204	32.0	2.5	10
G64780-0042	42 O-RING DIN L	7254-0205	38.0	2.5	10
G64781-0006	6 O-RING DIN H	7254-0206	4.0	1.5	10
G64781-0008	8 O-RING DIN H	7254-0207	6.0	1.5	10
G64781-0010	10 O-RING DIN H	7254-0208	7.5	1.5	10
G64781-0012	12 O-RING DIN H	7254-0209	9.0	1.5	10
G64781-0014	14 O-RING DIN H	7254-1132	10.0	2.0	10
G64781-0016	15/16 O-RING DIN L/H	7254-0200	12.0	2.0	10
G64781-0020	20 O-RING DIN H	7254-0210	16.3	2.4	10
G64781-0025	25 O-RING DIN H	7254-0211	20.3	2.4	10
G64781-0030	30 O-RING DIN H	7254-0212	25.3	2.4	10
G64781-0038	38 O-RING DIN H	7254-0213	33.3	2.4	10

O-Rings for DIN Heavy Series (PC, PCM & PCS Couplings)

70 Durometer Hardness.



Part No.	Descr.	Prod. No.	Inside Diameter	Wall	Standard Pack
			mm	mm	
G64782-0008	8 O-RING DIN H	7254-0154	6.0	1.5	10
G64782-0010	10 O-RING DIN H	7254-0151	7.1	1.6	10
G64782-0012	12 O-RING DIN H	7254-0153	9.1	1.6	10
G64782-0014	14 O-RING DIN H	7254-0150	10.5	1.8	10
G64782-0016	16 O-RING DIN H	7254-0149	11.9	1.8	10
G64782-0020	20 O-RING DIN H	7254-0152	16.6	2.4	10
G64782-0025	25 O-RING DIN H	7254-0144	21.6	2.4	10
G64782-0030	30 O-RING DIN H	7254-0146	27.6	2.4	10
G64782-0038	38 O-RING DIN H	7254-0145	34.6	2.4	10

Female Flareless Nut

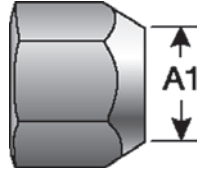

Part No.	Descr.	Prod. No.	A1		H1	Standard Pack
			"	"	"	
G60050-0004	4FFN	7334-40495	1/4	7/16-20	9/16	5
G60050-0005	5FFN	7334-40505	5/16	1/2-20	5/8	5
G60050-0006	6FFN	7334-40515	3/8	9/16-18	11/16	5
G60050-0008	8FFN	7334-40425	1/2	3/4-16	7/8	5
G60050-0010	10FFN	7334-40525	5/8	7/8-14	1	1
G60050-0012	12FFN	7334-40535	3/4	1 1/16-12	1 1/4	1
G60050-0016	16FFN	7334-40545	1	1 5/16-12	1 1/2	1

Female Flareless Sleeve

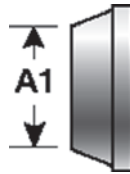

Part No.	Descr.	Prod. No.	A1	Standard Pack
			"	
G60051-0004	4FFS	7334-40555	1/4	5
G60051-0005	5FFS	7334-40565	5/16	5
G60051-0006	6FFS	7334-40575	3/8	5
G60051-0008	8FFS	7334-40435	1/2	5
G60051-0010	10FFS	7334-40585	5/8	1
G60051-0012	12FFS	7334-40595	3/4	1
G60051-0016	16FFS	7334-40605	1	1

Tube Sleeve

For use up to SAE 100R2 maximum working pressure.

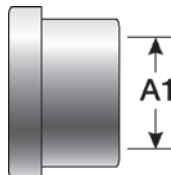

Part No.	Descr.	Prod. No.	A1	Standard Pack
			"	
G60394-0003	3TS	7259-78275	3/16	5
G60394-0004	4TS	7259-23905	1/4	5
G60394-0005	5TS	7259-23915	5/16	5
G60394-0006	6TS	7259-23925	3/8	5

- EQUIPMENT
- HOSE/CPLG. SELECTION
- G&K COUPLINGS
- GLOBALSPIRAL COUPLINGS
- STAINLESS STEEL SPIRAL
- MEGACRIMP COUPLINGS
- STAINLESS STEEL BRAID
- POWER CRIMP COUPLINGS
- FIELD ATTACHABLE G1 & G2 COUPLINGS
- FIELD ATTACHABLE C5 COUPLINGS
- GLX COUPLINGS
- GL COUPLINGS
- C14 COUPLINGS
- PCTS THERMOPLASTIC COUPLINGS
- POLARSEAL COUPLINGS
- POLARSEAL II COUPLINGS
- POWER STEERING
- ADAPTERS
- QUICK DISCONNECT COUPLERS
- BALL VALVES
- LIVE SWIVEL
- ASSEMBLY FABRICATION
- ACCESSORIES
- EQUIPMENT AND PARTS
- AIR BRAKE
- BRASS
- KITS

Tube Nuts and Sleeves

Tube Sleeve - Continued

Part No.	Descr.	Prod. No.	A1	Standard Pack
			"	
G60394-0008	8TS	7259-23935	1/2	5
G60394-0010	10TS	7259-23945	5/8	1
G60394-0012	12TS	7259-23955	3/4	1
G60394-0014	14TS	7259-23965	7/8	1
G60394-0016	16TS	7259-23975	1	1
G60394-0020	20TS	7259-23985	1 1/4	1
G60394-0024	24TS	7259-23995	1 1/2	1
G60394-0032	32TS	7259-24005	2	1

Tube Sleeve Nut

For use up to SAE 100R2 maximum working pressure.

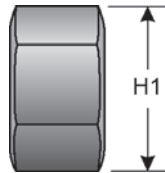

Part No.	Descr.	Prod. No.	A1		H1	Standard Pack
			"	"	"	
G60395-0002	2TSN	7259-06805	1/8	5/16-24	3/8	1
G60395-0003	3TSN	7259-78295	3/16	3/8-24	1/4	1
G60395-0004	4TSN	7259-01105	1/4	7/16-20	9/16	1
G60395-0005	5TSN	7259-01115	5/16	1/2-20	5/8	1
G60395-0006	6TSN	7259-01125	3/8	9/16-18	11/16	1
G60395-0006X	6TSN XBULK	7259-01112	3/8	9/16-18	11/16	950
G60395-0008	8TSN	7259-01135	1/2	3/4-16	7/8	1
G60395-0010	10TSN	7259-01145	5/8	7/8-14	1	1
G60395-0012	12TSN	7259-01155	3/4	1 1/16-12	1 1/4	1
G60395-0014	14TSN	7259-01165	7/8	1 3/16-12	1 3/8	1
G60395-0016	16TSN	7259-01175	1	1 5/16-12	1 1/2	1
G60395-0020	20TSN	7259-01185	1 1/4	1 5/8-12	2	1
G60395-0032	32TSN	7259-09055	2	2 1/2-12	2 7/8	1

Locknuts for Bulkhead Fittings

For use up to SAE 100R2 maximum working pressure.



Part No.	Descr.	Prod. No.		H1	Standard Pack
			"	"	
G60399-0005	5LN	7253-24615	1/2-20	3/4	5
G60399-0006	6LN-SH	7259-24625	9/16-18	11/16	5
G60399-0008	8LN-SH	7259-24635	3/4-16	1	5

Locknuts for Bulkhead Fittings - Continued

Part No.	Descr.	Prod. No.		H1	Standard Pack
			"	"	
G60399-0010	10LN-SH	7259-24645	7/8-14	1 1/8	1
G60399-0016	16LN-SH	7259-24665	1 5/16-12	1 5/8	1

Metric Bite Sleeve

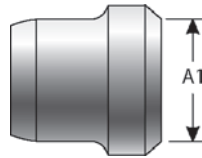

Part No.	Descr.	Prod. No.	A1	Standard Pack
			mm	
G64787-0006	6BS	7253-26815	6.0	1
G64787-0008	8BS	7253-26835	8.0	5
G64787-0010	10BS	7253-26855	10.0	1
G64787-0012	12BS	7253-26875	12.0	1
G64787-0014	14BS	7253-26895	14.0	1
G64787-0015	15BS	7253-26905	15.0	1
G64787-0016	16BS	7253-26915	16.0	1
G64787-0018	18BS	7253-26925	18.0	1
G64787-0020	20BS	7253-26935	20.0	1
G64787-0022	22BS	7253-26945	22.0	1
G64787-0025	25BS	7253-26955	25.0	1
G64787-0028	28BS	7253-26965	28.0	1
G64787-0030	30BS	7253-26975	30.0	1
G64787-0035	35BS	7253-26985	35.0	1
G64787-0038	38BS	7253-26995	38.0	1
G64787-0042	42BS	7253-27005	42.0	1

Metric Bite Nut

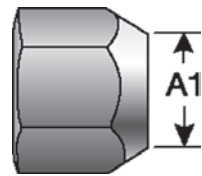

Part No.	Descr.	Prod. No.		A1	Standard Pack
			"	mm	
G64788-0006	6MNL	7253-27105	M12X1.5	6.0	5
G64788-0008	8MNL	7253-27125	M14X1.5	8.0	5
G64788-0010	10MNL	7253-27145	M16X1.5	10.0	1
G64788-0012	12MNL	7253-27165	M18X1.5	12.0	1
G64788-0015	15MNL	7253-27185	M22X1.5	15.0	1
G64788-0018	18MNL	7253-27215	M26X1.5	18.0	1
G64788-0022	22MNL	7253-27235	M30X1.5	22.0	1
G64788-0028	28MNL	7253-27255	M36X1.5	28.0	1

- EQUIPMENT
- HOSE/CPLG. SELECTION
- G8K COUPLINGS
- GLOBAL SPIRAL COUPLINGS
- STAINLESS STEEL SPIRAL
- MEGACRIMP COUPLINGS
- STAINLESS STEEL BRAID
- POWER CRIMP COUPLINGS
- FIELD ATTACHABLE G1 & G2 COUPLINGS
- FIELD ATTACHABLE C5 COUPLINGS
- GLX COUPLINGS
- GL COUPLINGS
- C14 COUPLINGS
- PCTS THERMOPLASTIC COUPLINGS
- POLARSEAL COUPLINGS
- POLARSEAL II COUPLINGS
- POWER STEERING
- ADAPTERS
- QUICK DISCONNECT COUPLERS
- BALL VALVES
- LIVE SWIVEL
- ASSEMBLY FABRICATION
- ACCESSORIES
- EQUIPMENT AND PARTS
- AIR BRAKE
- BRASS
- KITS

Tube Nuts and Sleeves

Metric Bite Nut - Continued

Part No.	Descr.	Prod. No.		A1	Standard Pack
			"	mm	
G64788-0035	35MNL	7253-27275	M45X1.5	35.0	1
G64788-0042	42MNL	7253-27295	M52X1.5	42.0	1
G64789-0006	6MNH	7253-27115	M14X1.5	6.0	5
G64789-0008	8MNH	7253-27135	M16X1.5	8.0	5
G64789-0010	10MNH	7253-27155	M18X1.5	10.0	1
G64789-0012	12MNH	7253-27175	M20X1.5	12.0	1
G64789-0014	14MNH	7253-27195	M22X1.5	14.0	1
G64789-0016	16MNH	7253-27205	M24X1.5	16.0	1
G64789-0020	20MNH	7253-27225	M30X1.5	20.0	1
G64789-0025	25MNH	7253-27245	M36X1.5	25.0	1
G64789-0030	30MNH	7253-27265	M42X1.5	30.0	1
G64789-0038	38MNH	7253-27285	M52X1.5	38.0	1

EQUIPMENT
HOSE/CPLG. SELECTION
G8K COUPLINGS
GLOBALSPIRAL COUPLINGS
STAINLESS STEEL SPIRAL
MEGACRIMP COUPLINGS
STAINLESS STEEL BRAID
POWER CRIMP COUPLINGS
FIELD ATTACHABLE G1 & G2 COUPLINGS
FIELD ATTACHABLE C5 COUPLINGS
GLX COUPLINGS
GL COUPLINGS
C14 COUPLINGS
PCTS THERMOPLASTIC COUPLINGS
POLARSEAL COUPLINGS
POLARSEAL II COUPLINGS
POWER STEERING
ADAPTERS
QUICK DISCONNECT COUPLERS
BALL VALVES
LIVE SWIVEL
ASSEMBLY FABRICATION
ACCESSORIES
EQUIPMENT AND PARTS
AIR BRAKE
BRASS
KITS

GC® 32-XD Parts



Part No.	Prod. No.	Descr.
78678	3663-5161	Hose Assembly
78832	7482-7100	Head Replacement Kit
78833	7482-7101	Panel Replacement Kit
78834	7482-7102	Valve Block Adapters
78835	7482-7103	Pilot Operated Check
78836	7482-7104	Quick Change Tool
78837	7482-7105	Dial Vernier
78840	7482-7108	Depth Stop
78841	7482-7109	Mirror
78843	7482-7111	Foot Pedal
78844	7482-7112	Startup Tool Kit
78845	7482-7113	Control Panel Screws
78847	7482-7115	Control Panel Post
78848	7482-7116	Kicker Tubing (Upper)
78849	7482-7117	Kicker Tubing (Lower)
78851	7482-7119	Foam Fillers GC32-XD Set of 8
78856	7482-7124	Die Tubs
78858	7482-7126	Head Seal
78907	7482-7175	Breather Cap
78908	7482-7176	Fuses
78909	7482-7179	Kickers
78910	7482-7180	2 Position 3-Way Solenoid
78916	7482-7186	Pump Bolts
78918	7482-7188	Dial Vernier Locking Plate
78919	7482-7189	M5X10 Button Cap Screw
78923	7482-7192	Inner Washer (Cont. Panel)
78924	7482-7193	Relief Valve
78925	7482-7194	Back Press. Cont. Cartridge
78927	7482-7196	Oil Filter Element
78679	7482-7207	Die Retention Plates
74827208	7482-7208	Control Box CSA
74827267	7482-7267	GC32 Inverter

EQUIPMENT
HOSE/CPLG. SELECTION
G8K COUPLINGS
GLOBALSPIRAL COUPLINGS
STAINLESS STEEL SPIRAL
MEGACRIMP COUPLINGS
STAINLESS STEEL BRAID
POWER CRIMP COUPLINGS
FIELD ATTACHABLE G1 & G2 COUPLINGS
FIELD ATTACHABLE C5 COUPLINGS
GLX COUPLINGS
GL COUPLINGS
C14 COUPLINGS
PCTS THERMOPLASTIC COUPLINGS
POLARSEAL COUPLINGS
POLARSEAL II COUPLINGS
POWER STEERING
ADAPTERS
QUICK DISCONNECT COUPLERS
BALL VALVES
LIVE SWIVEL
ASSEMBLY FABRICATION
ACCESSORIES
EQUIPMENT AND PARTS
AIR BRAKE
BRASS
KITS

Equipment and Parts

MobileCrimp® 4-20 Parts



Part No.	Prod. No.	Descr.
78429	3663-6922	8' Hose Assy MC4-20
78450	7482-1000	Magnet for Handling Die Sets
78455	7482-1005	Stand
78456	7482-1006	Pivot Spacer
78459	7482-1009	Stand Clamp
78462	7482-1012	Pivot Knob
78463	7482-1013	Positive Stop Pressure Plate
78465	7482-1015	DD Computer Pressure Plate
78466	7482-1016	Computer Crimp Control Box
78467	7482-1017	Hose Assembly
78477	7482-1027	Rubber Die Ring
78437	7482-1036	Pusher
78438	7482-1037	Cover Plate
78440	7482-1041	Seal Kit Includes: Seal, Washer and Backup Ring
78445	7482-1098	Computer Cable
78446	7482-1099	Computer Power Module
78447	7482-1100	Digital Dial Assy. Kit (To Upgrade PS)
78481	7482-1102	B1 Spacer, PS
78482	7482-1103	W1 Spacer, PS
78483	7482-1104	R1 Spacer, PS
78484	7482-1105	B2 Spacer, PS
78485	7482-1106	W2 Spacer, PS
78486	7482-1107	R2 Spacer, PS
78487	7482-1108	B3 Spacer, PS
78488	7482-1109	W3 Spacer, PS
78489	7482-1110	R3 Spacer, PS
78490	7482-1111	B4 Spacer, PS
78491	7482-1112	W4 Spacer, PS
78492	7482-1113	R4 Spacer, PS
78493	7482-1114	B5 Spacer, PS
78494	7482-1115	W5 Spacer, PS
78495	7482-1116	R5 Spacer, PS
78449	7482-1117	Ball Plunger for Top of Cylinder
78427	7482-1147	Spring
78426	7482-1148	Die Link
78428	7482-1149	Shoulder Screws
78419	7482-1157	Slydring for Piston
78420	7482-1163	Tall Handle for DD
78421	7482-1164	Locking Pin
78422	7482-1165	Chain for Locking Pin
78424	7482-1168	Cable Assy. for DD
78396	7482-1170	DD Top Mt Contrl Kit (side to top mount)
78397	7482-1171	DD Controller Top Mount
78425	7482-1190	Retaining Ring for Piston

Power Crimp® 707 Parts



Part No.	Prod. No.	Descr.
78251	7480-6591	PC703 to PC707 Conversion Kit
78717	7482-0054	Crimp Switch Button for PC603/PC707
78718	7482-0105	Piston New Design (Seals Included)
78719	7482-0106	Piston Rod
78722	7482-0109	Piston Rod Guide
78723	7482-0110	Base Plate (Machine)
78724	7482-0111	Tie Rod
78725	7482-0112	Pusher Cup (update design)
78728	7482-0116	Cylinder and Top Plate
78729	7482-0118	Spring Anchor
78730	7482-0119	Mounting Bracket
78732	7482-0147	O-Ring Between Piston and Rod
78734	7482-0229	Actuator Rod
78736	7482-0239	Die Cone With Notch
78737	7482-0243	Tie Rod Nut
78739	7482-0277	Switch Box Complete w/115V Cord Assy.
78740	7482-0280	Digital Readout Meter
78742	7482-0283	PC707 Shroud Only
78745	7482-0289	PC707 Hose Assy. (Pump to Crimper)
78746	7482-0291	Magnet for Removing Dies
78747	7482-0297	Die Cone (No Notch)
78252	7482-0442	Microswitch
78748	7482-0498	230V Cord Assy. for Digital Readout
78760	7482-0499	PC707 230V Converter Kit
78754	7482-0747	115V Cord Assy for Digital Readout
78478	7482-0789	Die Cage Halves (Set of 2) for 700 Series
78758	7482-0919	Stainless Steel Washer
78940	7482-0940	Die Cage Halves for 739
78757	7482-1095	PC707 Seal Kit for New Aluminum Piston Serial Nos. 14,000 and Up
78750	7482-1215	Silver Die Back Up Ring
78761	7482-1422	Large Plate
78762	7482-1423	Large Plate and Die Kit
78749	7482-1672	Screw for Die Fingers
78755	7482-3011	Molykote 3 oz. Jar G Die Lubricant
78751	7482-6959	Piston Return Spring

EQUIPMENT

HOSE/CPLG. SELECTION

G8K COUPLINGS

GLOBALSPIRAL COUPLINGS

STAINLESS STEEL SPIRAL

MEGACRIMP COUPLINGS

STAINLESS STEEL BRAID

POWER CRIMP COUPLINGS

FIELD ATTACHABLE G1 & G2 COUPLINGS

FIELD ATTACHABLE C5 COUPLINGS

GLX COUPLINGS

GL COUPLINGS

C14 COUPLINGS

PCTS THERMOPLASTIC COUPLINGS

POLARSEAL COUPLINGS

POLARSEAL II COUPLINGS

POWER STEERING

ADAPTERS

QUICK DISCONNECT COUPLERS

BALL VALVES

LIVE SWIVEL

ASSEMBLY FABRICATION

ACCESSORIES

EQUIPMENT AND PARTS

AIR BRAKE

BRASS

KITS

Power Crimp® 707 Swager Kits and Parts

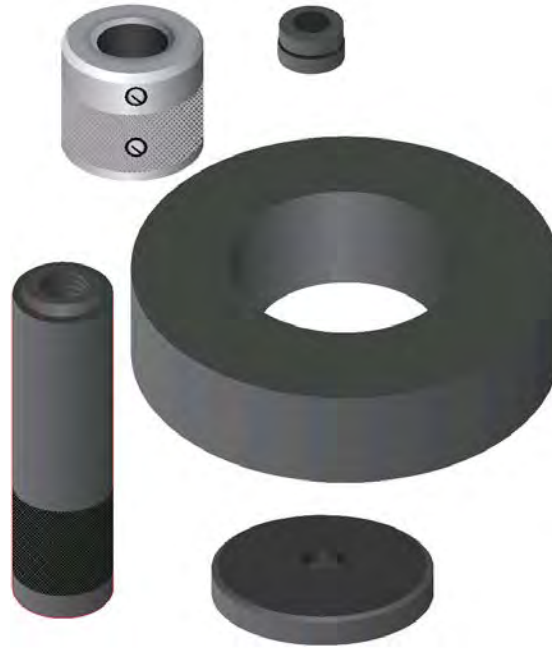

	Part No.	Descr.	Prod. No.
	78081	PC707 SWAGER KIT	7480-0040
	78820	COLLAR SWAGE KIT	7482-0429
	78821	CONE SWAGE KIT	7482-0430
	78824	ADAPTER ASSY	7482-0433
	78753	ACTUATOR ROD 707	7482-0482
	78184	SPACER FOR SWAGER	7482-1253
	78090	G 302 1/8" SWAGER DIE	7483-0300
	78091	G 303 3/16" SWAGER DIE	7483-0301
	78092	G 304 1/4" SWAGER DIE	7483-0302
	78093	G 305 5/16" SWAGER DIE	7483-0303
	78094	G 306 3/8" SWAGER DIE	7483-0304
	78095	G 308 1/2" SWAGER DIE	7483-0305
	78096	G 312 3/4" SWAGER DIE	7483-0306
	78097	G 316 1" SWAGER DIE	7483-0307
	78100	GM001 MALE PUSHER	7483-0308
	78101	GM002 MALE PUSHER	7483-0309
	78102	GM003 MALE PUSHER	7483-0310
	78103	GM004 MALE PUSHER	7483-0311
	78104	GM005 MALE PUSHER	7483-0312
	78105	GM009 MALE PUSHER	7483-0313
	78106	GM010 MALE PUSHER	7483-0314
	78107	GM011 MALE PUSHER	7483-0315
	78108	GM012 MALE PUSHER	7483-0316
	78109	GM013 MALE PUSHER	7483-0317
	78111	GM023 MALE PUSHER	7483-0319
	78124	GF003 FEMALE PUSHER	7483-0332
	78125	GF006 FEMALE PUSHER	7483-0333
	78126	GF008 FEMALE PUSHER	7483-0334
	78127	GF009 FEMALE PUSHER	7483-0335
	78128	GF011 FEMALE PUSHER	7483-0336
	78129	GF012 FEMALE PUSHER	7483-0337

Power Crimp® 707 Swager Kits and Parts - Continued

Part No.	Descr.	Prod. No.
78130	GF013 FEMALE PUSHER	7483-0338
78131	GF014 FEMALE PUSHER	7483-0339
78132	GF015 FEMALE PUSHER	7483-0340
78133	GF016 FEMALE PUSHER	7483-0341
78138	GT204 B TUBE PUSHER	7483-0346
78139	GT205 B TUBE PUSHER	7483-0347
78143	GT312 B TUBE PUSHER	7483-0351
78148	GF005 FEMALE PUSHER	7483-0355
78149	GM007 MALE PUSHER	7483-0356
78150	GM008 MALE PUSHER	7483-0357
78144	GF002 FEMALE PUSHER	7483-0358
78145	GF004 FEMALE PUSHER	7483-0359
78147	GF017 FEMALE PUSHER	7483-0361
78151	GF010 FEMALE PUSHER	7483-0362
78152	GM062 MALE PUSHER	7483-0363
78153	GT206 B TUBE PUSHER	7483-0364
78154	GT308 B TUBE PUSHER	7483-0366
78155	GM006 MALE PUSHER	7483-0367
78156	GT310 B TUBE PUSHER	7483-0368
78539	SD-4C14 SWAGER DIE	7483-0513
78540	SD-5C14 SWAGER DIE	7483-0514
78541	SD-6C14 SWAGER DIE	7483-0515
78542	SD-8C14 SWAGER DIE	7483-0516
78543	SD-10C14 SWAGER DIE	7483-0517
78544	SD-12C14 SWAGER DIE	7483-0518
78545	SD-16C14 SWAGER DIE	7483-0519
78553	P-C14-12TUBE PUSHER	7483-0521
78554	P-C14-12TUBE-JS	7483-0522
78548	P-C14-4TUBE PUSHER	7483-0530
78549	P-C14-5TUBE PUSHER	7483-0531
78550	P-C14-6TUBE PUSHER	7483-0532
78551	P-C14-8TUBE PUSHER	7483-0533
78552	P-C14-10TUBE PUSHER	7483-0534
78500	P-C14-4FJSX PUSHER	7483-0536
78501	P-C14-5FJSX PUSHER	7483-0537
78502	P-C14-6FJX F PUSHER	7483-0538
78503	P-C14-6FSX F PUSHER	7483-0539
78504	P-C14-8FJSX PUSHER	7483-0540
78505	P-C14-10FJSX PUSHER	7483-0541
78506	P-C14-12FJX PUSHER	7483-0542
78507	P-C14-12FSX PUSHER	7483-0543
78508	P-C14-16FJSX PUSHER	7483-0544
78511	P-C14-4MP M PUSHER	7483-0545
78512	P-C14-6MP M PUSHER	7483-0546
78513	P-C14-8MP-8&10ABC	7483-0547
78514	P-C14-12MP-12ABC	7483-0548
78515	P-C14-16MP-PUSHER	7483-0549
78510	P-C14-2MP PUSHER	7483-0550
78565	P-C14-6TBFLX PUSHER	7483-0552
78568	P-C14-12TBFLX PUSHER	7483-0553
78569	P-C14-16TBFLX PUSHER	7483-0554
78555	P-C14-16TUBE-JS	7483-0580

EQUIPMENT
HOSE/CPLG. SELECTION
G8K COUPLINGS
GLOBALSPIRAL COUPLINGS
STAINLESS STEEL SPIRAL
MEGACRIMP COUPLINGS
STAINLESS STEEL BRAID
POWER CRIMP COUPLINGS
FIELD ATTACHABLE G1 & G2 COUPLINGS
FIELD ATTACHABLE C5 COUPLINGS
GLX COUPLINGS
GL COUPLINGS
C14 COUPLINGS
PCTS THERMOPLASTIC COUPLINGS
POLARSEAL COUPLINGS
POLARSEAL II COUPLINGS
POWER STEERING
ADAPTERS
QUICK DISCONNECT COUPLERS
BALL VALVES
LIVE SWIVEL
ASSEMBLY FABRICATION
ACCESSORIES
EQUIPMENT AND PARTS
AIR BRAKE
BRASS
KITS

NOTES

EQUIPMENT
HOSE/CPLG. SELECTION
G8K COUPLINGS
GLOBALSPIRAL COUPLINGS
STAINLESS STEEL SPIRAL
MEGACRIMP COUPLINGS
STAINLESS STEEL BRAID
POWER CRIMP COUPLINGS
FIELD ATTACHABLE G1 & G2 COUPLINGS
FIELD ATTACHABLE C5 COUPLINGS
GLX COUPLINGS
GL COUPLINGS
C14 COUPLINGS
PCTS THERMOPLASTIC COUPLINGS
POLARSEAL COUPLINGS
POLARSEAL II COUPLINGS
POWER STEERING
ADAPTERS
QUICK DISCONNECT COUPLERS
BALL VALVES
LIVE SWIVEL
ASSEMBLY FABRICATION
ACCESSORIES
EQUIPMENT AND PARTS
AIR BRAKE
BRASS
KITS

1/2" ID Hose with 1/2" Fixed Male Pipe NPTF and 3/8" Male Pipe NPTF Swivel

Description: Factory crimped assemblies meet the rigorous demands of the fleet and heavy-duty market.



Part No.	Descr.	Prod. No.	Length	
			"	mm
27286	8AB-8MP-6MPA-18	7745-0286	18	457.20
27287	8AB-8MP-6MPA-20	7745-0287	20	508.00
27289	8AB-8MP-6MPA-24	7745-0289	24	609.60
27291	8AB-8MP-6MPA-28	7745-0291	28	711.20
27292	8AB-8MP-6MPA-30	7745-0292	30	762.00
27293	8AB-8MP-6MPA-32	7745-0293	32	812.80
27294	8AB-8MP-6MPA-34	7745-0294	34	863.60
27295	8AB-8MP-6MPA-36	7745-0295	36	914.40
27297	8AB-8MP-6MPA-42	7745-0297	42	1066.80

1/2" ID Hose with 3/8" Fixed Male Pipe NPTF and 3/8" Male Pipe NPTF Swivel with Adapter

Description: Factory crimped assemblies meet the rigorous demands of the fleet and heavy-duty market.

Part No.	Descr.	Prod. No.	Length	
			"	mm
27252	8AB-6MP-6MPA-18	7745-0300	18	457.20
27253	8AB-6MP-6MPA-20	7745-0301	20	508.00
27254	8AB-6MP-6MPA-24	7745-0302	24	609.60
27255	8AB-6MP-6MPA-28	7745-0303	28	711.20
27256	8AB-6MP-6MPA-30	7745-0304	30	762.00
27257	8AB-6MP-6MPA-32	7745-0305	32	812.80
27258	8AB-6MP-6MPA-36	7745-0306	36	914.40
27259	8AB-6MP-6MPA-42	7745-0307	42	1066.80
27360	8AB-6MP-6MPA-48	7745-0308	48	1219.20
27361	8AB-4MP-6MPA-60	7745-0309	60	1524.00
27362	8AB-4MP-6MPA-72	7745-0310	72	1828.80

EQUIPMENT
HOSE/CPLG. SELECTION
G&K COUPLINGS
GLOBAL SPIRAL COUPLINGS
STAINLESS STEEL SPIRAL
MEGACRIMP COUPLINGS
STAINLESS STEEL BRAID
POWER CRIMP COUPLINGS
FIELD ATTACHABLE G1 & G2 COUPLINGS
FIELD ATTACHABLE C5 COUPLINGS
GLX COUPLINGS
GL COUPLINGS
C14 COUPLINGS
PCTS THERMOPLASTIC COUPLINGS
POLARSEAL COUPLINGS
POLARSEAL II COUPLINGS
POWER STEERING
ADAPTERS
QUICK DISCONNECT COUPLERS
BALL VALVES
LIVE SWIVEL
ASSEMBLY FABRICATION
ACCESSORIES
EQUIPMENT AND PARTS
AIR BRAKE
BRASS
KITS

Air Brake Hose Assemblies

3/8" ID Hose with 1/4" Fixed Male Pipe NPTF and 3/8" Female Air Brake Swivel with Adapter

Description: Factory crimped assemblies meet the rigorous demands of the fleet and heavy-duty market.



Part No.	Descr.	Prod. No.	Length	
			"	mm
27242	6AB-4MP-6MPA-14	7745-0314	14	355.60
27243	6AB-4MP-6MPA-16	7745-0315	16	406.40
27244	6AB-4MP-6MPA-18	7745-0316	18	457.20
27245	6AB-4MP-6MPA-20	7745-0317	20	508.00
27246	6AB-4MP-6MPA-24	7745-0318	24	609.60
27247	6AB-4MP-6MPA-26	7745-0319	26	660.40
27248	6AB-4MP-6MPA-30	7745-0320	30	762.00
27249	6AB-4MP-6MPA-32	7745-0321	32	812.80
27250	6AB-4MP-6MPA-36	7745-0322	36	914.40
27251	6AB-4MP-6MPA-42	7745-0323	42	1066.80
27350	6AB-4MP-6MPA-48	7745-0324	48	1219.20

3/8" ID Hose with 3/8" Fixed Male Pipe NPTF and 3/8" Female Air Brake Swivel with Adapter

Description: Factory crimped assemblies meet the rigorous demands of the fleet and heavy-duty market.

Part No.	Descr.	Prod. No.	Length	
			"	mm
27261	6AB-6MP-6MPA-14	7745-0261	14	355.60
27262	6AB-6MP-6MPA-16	7745-0262	16	406.40
27263	6AB-6MP-6MPA-18	7745-0263	18	457.20
27264	6AB-6MP-6MPA-20	7745-0264	20	508.00
27266	6AB-6MP-6MPA-24	7745-0266	24	609.60
27267	6AB-6MP-6MPA-26	7745-0267	26	660.40
27268	6AB-6MP-6MPA-28	7745-0268	28	711.20
27269	6AB-6MP-6MPA-30	7745-0269	30	762.00
27270	6AB-6MP-6MPA-32	7745-0270	32	812.80
27271	6AB-6MP-6MPA-34	7745-0271	34	863.60
27272	6AB-6MP-6MPA-36	7745-0272	36	914.40
27275	6AB-6MP-6MPA-42	7745-0275	42	1066.80
27277	6AB-6MP-6MPA-45	7745-0277	45	1143.00
27279	6AB-6MP-6MPA-48	7745-0279	48	1219.20
27281	6AB-6MP-6MPA-60	7745-0281	60	1524.00

EQUIPMENT
HOSE/CPLG. SELECTION
G8K COUPLINGS
GLOBAL SPIRAL COUPLINGS
STAINLESS STEEL SPIRAL
MEGACRIMP COUPLINGS
STAINLESS STEEL BRAID
POWER CRIMP COUPLINGS
FIELD ATTACHABLE G1 & G2 COUPLINGS
FIELD ATTACHABLE C5 COUPLINGS
GLX COUPLINGS
GL COUPLINGS
C14 COUPLINGS
PCTS THERMOPLASTIC COUPLINGS
POLARSEAL COUPLINGS
POLARSEAL II COUPLINGS
POWER STEERING
ADAPTERS
QUICK DISCONNECT COUPLERS
BALL VALVES
LIVE SWIVEL
ASSEMBLY FABRICATION
ACCESSORIES
EQUIPMENT AND PARTS
AIR BRAKE
BRASS
KITS

Coiled Air Brake Tubing

Recommended For: Truck air brake lines from back of cab to trailer. Conforms to SAE J844 specifications. Meets D.O.T. FMVSS 106.

Tube: Heat and light stabilized seamless extruded Nylon 11.

Reinforcement: One open ply of fibrous nylon.

Cover: Heat and light stabilized seamless extruded nylon.

Temperature Range: -40°F to +200°F



Part No.	Descr.	Prod. No.			
			"	"	"
G30050-1208	8CABHX12	7250-18655	1/2	150	600
G30050-1508	8CABHX15	7250-18665	1/2	150	600

Tube Sleeve or Plug



Part No.	Descr.	Prod. No.	
			"
G30050-0004	4TS-ABCT	7250-00015	1/4
G30050-0006	6TS-ABCT	7250-00025	3/8
G30050-0008	8TS-ABCT	7250-00035	1/2
G30050-0010	10TS-ABCT	7250-00045	5/8
G30050-0012	12TS-ABCT	7250-00055	3/4

- EQUIPMENT
- HOSE/CPLG. SELECTION
- G&K COUPLINGS
- GLOBAL SPIRAL COUPLINGS
- STAINLESS STEEL SPIRAL
- MEGACRIMP COUPLINGS
- STAINLESS STEEL BRAID
- POWER CRIMP COUPLINGS
- FIELD ATTACHABLE G1 & G2 COUPLINGS
- FIELD ATTACHABLE C5 COUPLINGS
- GLX COUPLINGS
- GL COUPLINGS
- C14 COUPLINGS
- PCTS THERMOPLASTIC COUPLINGS
- POLARSEAL COUPLINGS
- POLARSEAL II COUPLINGS
- POWER STEERING
- ADAPTERS
- QUICK DISCONNECT COUPLERS
- BALL VALVES
- LIVE SWIVEL
- ASSEMBLY FABRICATION
- ACCESSORIES
- EQUIPMENT AND PARTS
- AIR BRAKE**
- BRASS
- KITS

Air Brake Copper Tubing

EQUIPMENT
HOSE/CPLG. SELECTION
G8K COUPLINGS
GLOBAL SPIRAL COUPLINGS
STAINLESS STEEL SPIRAL
MEGACRIMP COUPLINGS
STAINLESS STEEL BRAID
POWER CRIMP COUPLINGS
FIELD ATTACHABLE G1 & G2 COUPLINGS
FIELD ATTACHABLE C5 COUPLINGS
GLX COUPLINGS
GL COUPLINGS
C14 COUPLINGS
PCTS THERMOPLASTIC COUPLINGS
POLARSEAL COUPLINGS
POLARSEAL II COUPLINGS
POWER STEERING
ADAPTERS
QUICK DISCONNECT COUPLERS
BALL VALVES
LIVE SWIVEL
ASSEMBLY FABRICATION
ACCESSORIES
EQUIPMENT AND PARTS
AIR BRAKE
BRASS
KITS

Tube Sleeve Nut



Part No.	Descr.	Prod. No.	⊗
			"
G30060-0004	4TSN-ABCT	7250-00065	1/4
G30060-0006	6TSN-ABCT	7250-00075	3/8
G30060-0008	8TSN-ABCT	7250-00085	1/2
G30060-0010	10TSN-ABCT	7250-00095	5/8
G30060-0012	12TSN-ABCT	7250-00105	3/4

Air Brake to Male Pipe





Part No.	Descr.	Prod. No.	⊗	⌀
			"	"
G30100-0402	4ABCT-2MP	7250-00115	1/4	1/8-27
G30100-0404	4ABCT-4MP	7250-00125	1/4	1/4-18
G30100-0406	4ABCT-6MP	7250-00135	1/4	3/8-18
G30100-0602	6ABCT-2MP	7250-00145	3/8	1/8-27
G30100-0604	6ABCT-4MP	7250-00155	3/8	1/4-18
G30100-0606	6ABCT-6MP	7250-00165	3/8	3/8-18
G30100-0608	6ABCT-8MP	7250-00175	3/8	1/2-14
G30100-0804	8ABCT-4MP	7250-00185	1/2	1/4-18
G30100-0806	8ABCT-6MP	7250-00195	1/2	3/8-18
G30100-0808	8ABCT-8MP	7250-00205	1/2	1/2-14
G30100-1006	10ABCT-6MP	7250-00215	5/8	3/8-18
G30100-1008	10ABCT-8MP	7250-00225	5/8	1/2-14
G30100-1208	12ABCT-8MP	7250-00235	3/4	1/2-14
G30100-1212	12ABCT-12MP	7250-00245	3/4	3/4-14

Air Brake Copper Tubing

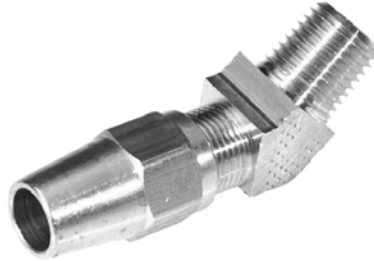

Air Brake to Male Pipe - 45°



Part No.	Descr.	Prod. No.		
			"	"
G30102-0604	6ABCT-4MP45	7250-00255	3/8	1/4-18
G30102-0606	6ABCT-6MP45	7250-00265	3/8	3/8-18
G30102-0806	8ABCT-6MP45	7250-00275	1/2	3/8-18
G30102-1008	10ABCT-8MP45	7250-00285	5/8	1/2-14

Air Brake to Male Pipe - 90°



Part No.	Descr.	Prod. No.		
			"	"
G30104-0402	4ABCT-2MP90	7250-00295	1/4	1/8-27
G30104-0404	4ABCT-4MP90	7250-00305	1/4	1/4-18
G30104-0602	6ABCT-2MP90	7250-00315	3/8	1/8-27
G30104-0604	6ABCT-4MP90	7250-00325	3/8	1/4-18
G30104-0606	6ABCT-6MP90	7250-00335	3/8	3/8-18
G30104-0608	6ABCT-8MP90	7250-00345	3/8	1/2-14
G30104-0804	8ABCT-4MP90	7250-00355	1/2	1/4-18
G30104-0806	8ABCT-6MP90	7250-00365	1/2	3/8-18
G30104-0808	8ABCT-8MP90	7250-00375	1/2	1/2-14
G30104-1006	10ABCT-6MP90	7250-00385	5/8	3/8-18
G30104-1008	10ABCT-8MP90	7250-00395	5/8	1/2-14
G30104-1208	12ABCT-8MP90	7250-00405	3/4	1/2-14

EQUIPMENT

HOSE/CPLG. SELECTION

G8K COUPLINGS

GLOBALSPIRAL COUPLINGS

STAINLESS STEEL SPIRAL

MEGACRIMP COUPLINGS

STAINLESS STEEL BRAID

POWER CRIMP COUPLINGS

FIELD ATTACHABLE G1 & G2 COUPLINGS

FIELD ATTACHABLE C5 COUPLINGS

GLX COUPLINGS

GL COUPLINGS

C14 COUPLINGS

PCTS THERMOPLASTIC COUPLINGS

POLARSEAL COUPLINGS

POLARSEAL II COUPLINGS

POWER STEERING

ADAPTERS

QUICK DISCONNECT COUPLERS

BALL VALVES

LIVE SWIVEL

ASSEMBLY FABRICATION

ACCESSORIES

EQUIPMENT AND PARTS

AIR BRAKE

BRASS

KITS

Air Brake Copper Tubing

EQUIPMENT
HOSE/CPLG. SELECTION
G8K COUPLINGS
GLOBALSPIRAL COUPLINGS
STAINLESS STEEL SPIRAL
MEGACRIMP COUPLINGS
STAINLESS STEEL BRAID
POWER CRIMP COUPLINGS
FIELD ATTACHABLE G1 & G2 COUPLINGS
FIELD ATTACHABLE C5 COUPLINGS
GLX COUPLINGS
GL COUPLINGS
C14 COUPLINGS
PCTS THERMOPLASTIC COUPLINGS
POLARSEAL COUPLINGS
POLARSEAL II COUPLINGS
POWER STEERING
ADAPTERS
QUICK DISCONNECT COUPLERS
BALL VALVES
LIVE SWIVEL
ASSEMBLY FABRICATION
ACCESSORIES
EQUIPMENT AND PARTS
AIR BRAKE
BRASS
KITS

Air Brake to Male Pipe - 90° - Long



Part No.	Descr.	Prod. No.	⊗	⊗
			"	"
G30106-0602	6ABCT-2MP90L	7250-00415	3/8	1/8-27
G30106-0604	6ABCT-4MP90L	7250-00425	3/8	1/4-18
G30106-0806	8ABCT-6MP90L	7250-00435	1/2	3/8-18

Male Pipe to Air Brake to Air Brake - Tee



Part No.	Descr.	Prod. No.	⊗	⊗
			"	"
G30130-0406	4MP-6ABCT-6ABCT	7250-00445	3/8	1/4-18
G30130-0606	6MP-6ABCT-6ABCT	7250-00455	3/8	3/8-18
G30130-0608	6MP-8ABCT-8ABCT	7250-00465	1/2	3/8-18



Air Brake on Run to Male Pipe - Tee



Part No.	Descr.	Prod. No.	⊗	⊗
			"	"
G30135-0602	6ABCT-6ABCT-2MP	7250-00475	3/8	1/8-27
G30135-0604	6ABCT-4ABCT-4MP	7250-00485	3/8	1/4-18
G30135-0606	6ABCT-6ABCT-6MP	7250-00495	3/8	3/8-18



Air Brake Copper Tubing

Air Brake on Run to Male Pipe - Tee - Continued

Part No.	Descr.	Prod. No.		
			"	"
G30135-0806	8ABCT-6ABCT-8MP	7250-00505	1/2	3/8-18



Air Brake to Female Pipe



Part No.	Descr.	Prod. No.		
			"	"
G30150-0602	6ABCT-2FP	7250-00515	3/8	1/8-27
G30150-0604	6ABCT-4FP	7250-00525	3/8	1/4-18
G30150-0606	6ABCT-6FP	7250-00535	3/8	3/8-18
G30150-0806	8ABCT-6FP	7250-00545	1/2	3/8-18

Air Brake to Female Pipe - 90°



Part No.	Descr.	Prod. No.		
			"	"
G30154-0604	6ABCT-4FP90	7250-00555	3/8	1/4-18
G30154-0806	8ABCT-6FP90	7250-00575	1/2	3/8-18

EQUIPMENT
HOSE/CPLG. SELECTION
G&K COUPLINGS
GLOBAL SPIRAL COUPLINGS
STAINLESS STEEL SPIRAL
MEGACRIMP COUPLINGS
STAINLESS STEEL BRAID
POWER CRIMP COUPLINGS
FIELD ATTACHABLE G1 & G2 COUPLINGS
FIELD ATTACHABLE C5 COUPLINGS
GLX COUPLINGS
GL COUPLINGS
C14 COUPLINGS
PCTS THERMOPLASTIC COUPLINGS
POLARSEAL COUPLINGS
POLARSEAL II COUPLINGS
POWER STEERING
ADAPTERS
QUICK DISCONNECT COUPLERS
BALL VALVES
LIVE SWIVEL
ASSEMBLY FABRICATION
ACCESSORIES
EQUIPMENT AND PARTS
AIR BRAKE
BRASS
KITS

Air Brake Copper Tubing

EQUIPMENT
HOSE/CPLG. SELECTION
G8K COUPLINGS
GLOBALSPIRAL COUPLINGS
STAINLESS STEEL SPIRAL
MEGACRIMP COUPLINGS
STAINLESS STEEL BRAID
POWER CRIMP COUPLINGS
FIELD ATTACHABLE G1 & G2 COUPLINGS
FIELD ATTACHABLE C5 COUPLINGS
GLX COUPLINGS
GL COUPLINGS
C14 COUPLINGS
PCTS THERMOPLASTIC COUPLINGS
POLARSEAL COUPLINGS
POLARSEAL II COUPLINGS
POWER STEERING
ADAPTERS
QUICK DISCONNECT COUPLERS
BALL VALVES
LIVE SWIVEL
ASSEMBLY FABRICATION
ACCESSORIES
EQUIPMENT AND PARTS
AIR BRAKE
BRASS
KITS

Air Brake Union



Part No.	Descr.	Prod. No.	Ø
			"
G30400-0404	4ABCT-4ABCT	7250-00595	1/4
G30400-0606	6ABCT-6ABCT	7250-00605	3/8
G30400-0808	8ABCT-8ABCT	7250-00615	1/2
G30400-1010	10ABCT-10ABCT	7250-00625	5/8
G30400-1212	12ABCT-12ABCT	7250-00635	3/4

Air Brake Union - 90°



Part No.	Descr.	Prod. No.	Ø
			"
G30404-0606	6ABCT-6ABCT90	7250-00645	3/8
G30404-0808	8ABCT-8ABCT90	7250-00655	1/2
G30404-1010	10ABCT-10ABCT90	7250-00665	5/8

Air Brake Union - Tee



Part No.	Descr.	Prod. No.	∅
			"
G30450-0606	6ABCT-6ABCT-6ABCT	7250-00675	3/8
G30450-0808	8ABCT-8ABCT-8ABCT	7250-00695	1/2

EQUIPMENT
HOSE/CPLG. SELECTION
G&K COUPLINGS
GLOBALSPIRAL COUPLINGS
STAINLESS STEEL SPIRAL
MEGACRIMP COUPLINGS
STAINLESS STEEL BRAID
POWER CRIMP COUPLINGS
FIELD ATTACHABLE G1 & G2 COUPLINGS
FIELD ATTACHABLE C5 COUPLINGS
GLX COUPLINGS
GL COUPLINGS
C14 COUPLINGS
PCTS THERMOPLASTIC COUPLINGS
POLARSEAL COUPLINGS
POLARSEAL II COUPLINGS
POWER STEERING
ADAPTERS
QUICK DISCONNECT COUPLERS
BALL VALVES
LIVE SWIVEL
ASSEMBLY FABRICATION
ACCESSORIES
EQUIPMENT AND PARTS
AIR BRAKE
BRASS
KITS

Air Brake Plugs

Recommended For: Compressed air as a connector on all air brake systems at locations other than between chassis frame and axle or between towed and towing vehicle. Also as a connector on all air operated systems as applicable to suspension, steering, engine, transmission and auxiliary mechanisms. Fittings and tubing comply to D.O.T. FMVSS 106, mandatory requirements for inch tube fittings is U.S.A., Society for Automotive Engineers (SAE J1131, inch tube and fittings) and meets DIN 74324 and German TUV requirements (metric tube and fittings).

Temperature Range: -40°F to +200°F (-40°C to +100°C).

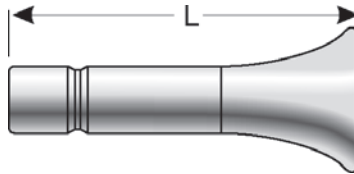

Part No.	Descr.	Prod. No.	L		
			Ø	"	mm
G31050-0004	4AB-PLUG	7250-14505	1/4	1.12	28.5
G31050-0006	6AB-PLUG	7250-14515	3/8	1.34	34.0
G31050-0008	8AB-PLUG	7250-14525	1/2	1.48	37.6
G31050-0025	2.5AB-PLUG	7250-14535	5/32	1.04	26.4

Air Brake Cartridge



Part No.	Descr.	Prod. No.	Ø
			"
G31080-0003	3CARTRIDGE-AB	7250-00705	3/16
G31080-0004	4CARTRIDGE-AB	7250-00715	1/4
G31080-0006	6CARTRIDGE-AB	7250-00725	3/8
G31080-0008	8CARTRIDGE-AB	7250-00735	1/2
G31080-0010	10CARTRIDGE-AB	7250-00745	5/8
G31080-0012	12CARTRIDGE-AB	7250-00755	3/4
G31080-0025	25CARTRIDGE-AB	7250-00765	5/32

EQUIPMENT
HOSE/CPLG. SELECTION
G8K COUPLINGS
GLOBALSPIRAL COUPLINGS
STAINLESS STEEL SPIRAL
MEGACRIMP COUPLINGS
STAINLESS STEEL BRAID
POWER CRIMP COUPLINGS
FIELD ATTACHABLE G1 & G2 COUPLINGS
FIELD ATTACHABLE C5 COUPLINGS
GLX COUPLINGS
GL COUPLINGS
C14 COUPLINGS
PCTS THERMOPLASTIC COUPLINGS
POLARSEAL COUPLINGS
POLARSEAL II COUPLINGS
POWER STEERING
ADAPTERS
QUICK DISCONNECT COUPLERS
BALL VALVES
LIVE SWIVEL
ASSEMBLY FABRICATION
ACCESSORIES
EQUIPMENT AND PARTS
AIR BRAKE
BRASS
KITS

Air Brake to Male Pipe

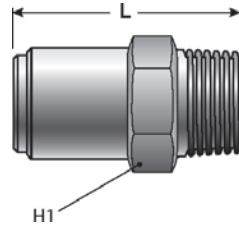

Part No.	Descr.	Prod. No.	IO		H1	L	
			"	"		"	mm
G31100-0202	2AB-2MP	7250-14545	1/8	1/8-27	7/16	.67	17.0
G31100-0302	3AB-2MP	7250-00775	3/16	1/8-27	1/2	1.02	25.9
G31100-0401	4AB-1MP	7250-14555	1/4	1/8-27	7/16	.94	23.9
G31100-0402	4AB-2MP	7250-00785	1/4	1/8-27	1/2	1.04	26.4
G31100-0404	4AB-4MP	7250-00795	1/4	1/4-18	9/16	1.17	29.7
G31100-0406	4AB-6MP	7250-00805	1/4	3/8-18	11/16	1.20	30.5
G31100-0602	6AB-2MP	7250-00815	3/8	1/8-27	11/16	1.32	33.5
G31100-0604	6AB-4MP	7250-00825	3/8	1/4-18	11/16	1.48	37.6
G31100-0606	6AB-6MP	7250-00835	3/8	3/8-18	11/16	1.42	36.1
G31100-0608	6AB-8MP	7250-00845	3/8	1/2-14	7/8	1.46	37.1
G31100-0804	8AB-4MP	7250-00855	1/2	1/4-18	7/8	1.68	42.7
G31100-0806	8AB-6MP	7250-00865	1/2	3/8-18	7/8	1.64	41.7
G31100-0808	8AB-8MP	7250-00875	1/2	1/2-14	7/8	1.72	43.7
G31100-1006	10AB-6MP	7250-00885	5/8	3/8-18	11/16	1.87	47.5
G31100-1008	10AB-8MP	7250-00895	5/8	1/2-14	11/16	2.12	53.9
G31100-1208	12AB-8MP	7250-14565	3/4	1/2-14	13/16	2.11	53.6
G31100-1212	12AB-12MP	7250-00905	3/4	3/4-14	1 1/16	2.21	56.1
G31100-2501	2.5AB-1MP	7250-00915	5/32	1/16-32	11/32	.43	10.9
G31100-2502	2.5AB-2MP	7250-00925	5/32	1/8-27	7/16	.89	22.6

Air Brake to Male Pipe - 45°

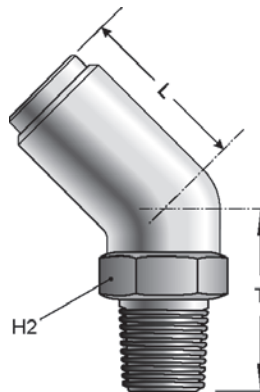

Part No.	Descr.	Prod. No.	IO		H2	T		L	
			"	"		"	mm	"	mm
G31102-0402	4AB-2MP45	7250-00935	1/4	1/8-27	14.3	.81	20.6	1.68	42.7
G31102-0404	4AB-4MP45	7250-00945	1/4	1/4-18	14.3	.98	24.9	1.87	47.5
G31102-0602	6AB-2MP45	7250-00955	3/8	1/8-27	19	.93	23.6	1.95	49.5
G31102-0604	6AB-4MP45	7250-00965	3/8	1/4-18	19	1.10	27.9	2.16	54.9
G31102-0606	6AB-6MP45	7250-00975	3/8	3/8-18	19	1.12	28.5	2.22	56.4

- EQUIPMENT
- HOSE/CPLG. SELECTION
- G8K COUPLINGS
- GLOBALSPIRAL COUPLINGS
- STAINLESS STEEL SPIRAL
- MEGACRIMP COUPLINGS
- STAINLESS STEEL BRAID
- POWER CRIMP COUPLINGS
- FIELD ATTACHABLE G1 & G2 COUPLINGS
- FIELD ATTACHABLE C5 COUPLINGS
- GLX COUPLINGS
- GL COUPLINGS
- C14 COUPLINGS
- PCTS THERMOPLASTIC COUPLINGS
- POLARSEAL COUPLINGS
- POLARSEAL II COUPLINGS
- POWER STEERING
- ADAPTERS
- QUICK DISCONNECT COUPLERS
- BALL VALVES
- LIVE SWIVEL
- ASSEMBLY FABRICATION
- ACCESSORIES
- EQUIPMENT AND PARTS
- AIR BRAKE**
- BRASS
- KITS

Air Brake to Male Pipe - 45° - Continued

Part No.	Descr.	Prod. No.			H2	T		L	
			"	"		"	mm	"	mm
G31102-0608	6AB-8MP45	7250-00985	3/8	1/2-14	22	1.30	33.0	2.44	62.0
G31102-0804	8AB-4MP45	7250-00995	1/2	1/2-18	22	1.10	27.9	2.32	58.9
G31102-0806	8AB-6MP45	7250-01005	1/2	3/8-18	22	1.12	28.5	2.38	60.5
G31102-1006	10AB-6MP45	7250-01025	5/8	3/8-18	27	1.02	25.9	2.48	63.0
G31102-1008	10AB-8MP45	7250-01035	5/8	1/2-14	27	1.22	31.0	2.68	68.1
G31102-1208	12AB-8MP45	7250-14575	3/4	1/2-14	25.4	1.30	33.0	2.82	71.6
G31102-1212	12AB-12MP45	7250-01045	3/4	3/4-14	27	1.91	48.5	3.92	99.6

Air Brake to Male Pipe - 90°

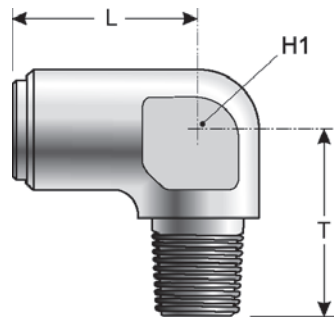

Part No.	Descr.	Prod. No.			H1	T		L	
			"	"		mm	"	mm	"
G31104-0202	2AB-2MP90	7250-14585	1/8	1/8-27	7	.66	16.8	.67	17.0
G31104-0302	3AB-2MP90	7250-01055	3/16	1/8-27	12	.75	19.1	.81	20.6
G31104-0402	4AB-2MP90	7250-01065	1/4	1/8-27	14	.79	20.1	.81	20.6
G31104-0406	4AB-6MP90	7250-01085	1/4	3/8-18	22	1.10	27.9	.94	23.9
G31104-0408	4AB-8MP90	7250-14595	1/4	1/2-14	24	1.38	35.1	.96	24.4
G31104-0602	6AB-2MP90	7250-01095	3/8	1/8-27	18	.87	22.1	1.08	27.4
G31104-0606	6AB-6MP90	7250-01115	3/8	3/8-18	22	1.10	27.9	1.14	29.0
G31104-0608	6AB-8MP90	7250-01125	3/8	1/2-14	24	1.38	35.1	1.14	29.0
G31104-0806	8AB-6MP90	7250-01145	1/2	3/8-18	22	1.14	29.0	1.26	32.0
G31104-0808	8AB-8MP90	7250-01155	1/2	1/2-14	24	1.38	35.1	1.28	32.5
G31104-1006	10AB-6MP90	7250-01165	5/8	3/8-18	22	1.22	31.0	1.44	36.9
G31104-1208	12AB-8MP90	7250-14605	3/4	1/2-14	24	1.48	37.6	1.52	38.6
G31104-1212	12AB-12MP90	7250-14615	3/4	3/4-14	27	2.00	50.8	2.15	54.6
G31104-2501	25AB-1MP90	7250-01185	5/32	1/16-32	7	1.00	25.4	1.00	25.4
G31104-2502	2.5AB-2MP90	7250-01195	5/32	1/8-27	7	1.00	25.4	.87	22.1

Air Brake to Male Pipe - 90° with port

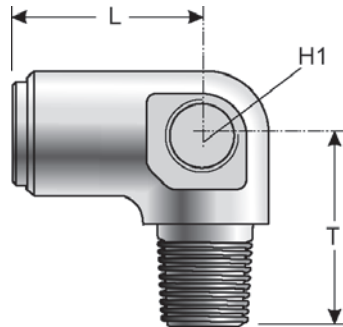

Part No.	Descr.	Prod. No.			H1	T		L	
			"	"		"	mm	"	mm
G31105-0604P	6AB-4MP-2PT90	7250-14625	3/8	1/4-18	22	1.10	27.9	1.20	30.5
G31105-0606P	6AB-6MP-2PT90	7250-14635	3/8	3/8-18	22	1.10	27.9	1.12	28.5
G31105-0806P	8AB-6MP-2PT90	7250-14645	1/2	3/8-18	22	1.14	29.0	1.26	32.0
G31105-0808P	8AB-8MP-4PORT90	7250-14655	1/2	1/2-14	24	1.38	35.1	1.28	32.5
G31105-1212P	12AB-12MP-4PORT90	7250-14665	3/4	3/4-14	24	1.48	37.6	1.52	38.6

Air Brake to Male Pipe Swivel - 45°

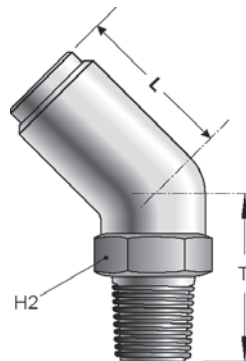

Part No.	Descr.	Prod. No.			H2	T		L	
			"	"		"	mm	"	mm
G31122-0402	4AB-2MPX45	7250-01205	1/4	1/8-27	7/16	1.06	26.9	.74	18.8
G31122-0404	4AB-4MPX45	7250-01215	1/4	1/4-18	9/16	1.11	28.2	.77	19.6
G31122-0604	6AB-4MPX45	7250-01225	3/8	1/4-18	11/16	1.26	32.0	1.05	26.7
G31122-0808	8AB-8MPX45	7250-01255	1/2	1/2-14	7/8	1.62	41.2	1.25	31.8
G31122-1008	10AB-8MPX45	7250-14695	5/8	1/2-14	7/8	1.42	36.1	1.51	38.4

- EQUIPMENT
- HOSE/CPLG. SELECTION
- G&K COUPLINGS
- GLOBALSPIRAL COUPLINGS
- STAINLESS STEEL SPIRAL
- MEGACRIMP COUPLINGS
- STAINLESS STEEL BRAID
- POWER CRIMP COUPLINGS
- FIELD ATTACHABLE G1 & G2 COUPLINGS
- FIELD ATTACHABLE C5 COUPLINGS
- GLX COUPLINGS
- GL COUPLINGS
- C14 COUPLINGS
- PCTS THERMOPLASTIC COUPLINGS
- POLARSEAL COUPLINGS
- POLARSEAL II COUPLINGS
- POWER STEERING
- ADAPTERS
- QUICK DISCONNECT COUPLERS
- BALL VALVES
- LIVE SWIVEL
- ASSEMBLY FABRICATION
- ACCESSORIES
- EQUIPMENT AND PARTS
- AIR BRAKE
- BRASS
- KITS

SureLok™ Air Brake Couplings

Air Brake to Male Pipe Swivel - 90°

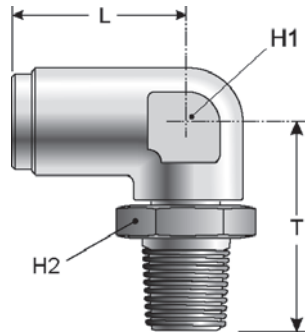

Part No.	Descr.	Prod. No.	⊘	🌀	H1	H2	T		L	
			"	"	mm	mm	"	mm	"	mm
G31124-0402	4AB-2MPX90	7250-01265	1/4	1/8-27	14	11	.91	23.1	.83	21.1
G31124-0404	4AB-4MPX90	7250-01275	1/4	1/4-18	18	14	1.12	28.5	.83	21.1
G31124-0406	4AB-6MPX90	7250-01285	1/4	3/8-18	22	19	1.25	31.8	.85	21.6
G31124-0602	6AB-2MPX90	7250-01295	3/8	1/8-27	18	14	1.05	26.7	1.07	27.2
G31124-0604	6AB-4MPX90	7250-01305	3/8	1/4-18	18	19	1.29	32.8	1.07	27.2
G31124-0606	6AB-6MPX90	7250-01315	3/8	3/8-18	22	19	1.24	31.5	1.07	27.2
G31124-0608	6AB-8MPX90	7250-01325	3/8	1/2-14	24	22	1.44	36.6	1.07	27.2
G31124-0804	8AB-4MPX90	7250-01335	1/2	1/4-18	22	22	1.27	32.3	1.27	32.3
G31124-0806	8AB-6MPX90	7250-01345	1/2	3/8-18	22	22	1.42	36.1	1.27	32.3
G31124-0808	8AB-8MPX90	7250-01355	1/2	1/2-14	24	22	1.62	41.2	1.27	32.3
G31124-1006	10AB-6MPX90	7250-01365	5/8	3/8-18	30	22	1.48	37.6	1.54	39.1
G31124-1008	10AB-8MPX90	7250-01375	5/8	1/2-14	30	22	1.48	37.6	1.54	39.1
G31124-1208	12AB-8MPX90	7250-14705	3/4	1/2-14	24	22	1.53	38.9	1.55	39.4
G31124-2502	2.5AB-2MPX90	7250-14725	5/32	1/8-27	7	11	.91	23.1	.83	21.1

Male Pipe to Air Brake to Air Brake - Tee

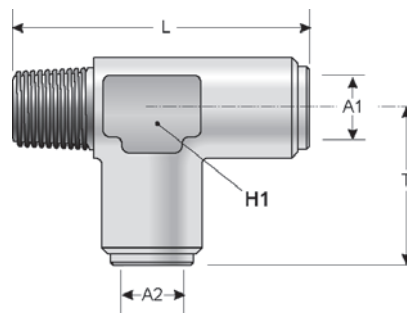



Part No.	Descr.	Prod. No.	A1	A2	🌀	H1	T		L	
			"	"	"	mm	"	mm	"	mm
G31130-0204	2MP-4AB-4AB	7250-01385	1/4	1/4	1/8-18	14	.89	22.6	1.67	42.4
G31130-0404	4MP-4AB-4AB	7250-01395	1/4	1/4	1/4-18	18	.89	22.6	1.85	47.0
G31130-0406	4MP-6AB-6AB	7250-14745	1/4	3/8	1/4-18	18	1.08	27.4	2.05	52.1
G31130-0604	6MP-4AB-4AB	7250-01405	1/4	1/4	3/8-18	22	.93	23.6	2.03	51.6
G31130-0606	6MP-6AB-6AB	7250-01415	3/8	3/8	3/8-18	22	1.14	29.0	2.24	56.9
G31130-0608	6MP-8AB-8AB	7250-01425	1/2	1/2	3/8-18	22	1.30	33.0	2.44	62.0
G31130-0806	8MP-6AB-6AB	7250-14755	3/8	3/8	1/2-14	24	1.22	31.0	2.64	67.1
G31131-0406	4MP-4AB-6AB	7250-14775	1/4	3/8	1/4-18	18	1.08	27.4	1.85	47.0
G31131-0604	6MP-4AB-6AB	7250-14785	1/4	3/8	3/8-18	22	1.14	29.0	2.03	51.6

Male Pipe to Air Brake to Air Brake - Tee - Continued

Part No.	Descr.	Prod. No.	A1	A2		H1	T		L	
			"	"	"	mm	"	mm	"	mm
G31131-0608	6MP-6AB-8AB	7250-14795	3/8	1/2	3/8-18	22	1.30	33.0	2.36	59.9
G31132-0406	4MP-6AB-4AB	7250-14805	3/8	1/4	1/4-18	18	.93	23.6	2.05	52.1
G31132-0604	6MP-6AB-4AB	7250-14815	3/8	1/4	3/8-18	22	.93	23.6	2.24	56.9
G31132-0608	6MP-8AB-6AB	7250-14825	1/2	3/8	3/8-18	22	1.22	31.0	2.44	62.0

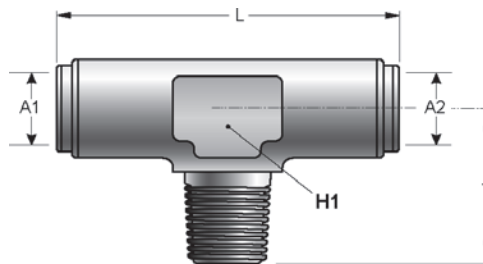
Air Brake on Run to Male Pipe - Tee





Part No.	Descr.	Prod. No.	A1	A2		H1	T		L	
			"	"	"	mm	"	mm	"	mm
G31134-0302	3AB-3AB-2MP	7250-01435	3/16	3/16	1/8-27	14	.79	20.1	1.69	42.9
G31134-0402	4AB-4AB-2MP	7250-01445	1/4	1/4	1/8-27	14	.79	20.1	1.69	42.9
G31134-0404	4AB-4AB-4MP	7250-01455	1/4	1/4	1/4-18	18	.96	24.4	1.77	45.0
G31134-0406	4AB-4AB-6MP	7250-14835	1/4	1/4	3/8-18	22	1.10	27.9	1.93	49.0
G31134-0604	6AB-6AB-4MP	7250-01465	3/8	3/8	1/4-18	18	.96	24.4	2.17	55.1
G31134-0606	6AB-6AB-6MP	7250-01475	3/8	3/8	3/8-18	22	1.10	27.9	2.28	57.9
G31134-0804	8AB-8AB-4MP	7250-01485	1/2	1/2	1/4-18	22	1.14	29.0	2.44	62.0
G31134-0806	8AB-8AB-6MP	7250-01495	1/2	1/2	3/8-18	22	1.14	29.0	2.60	66.0
G31134-0808	8AB-8AB-8MP	7250-01505	1/2	1/2	1/2-14	24	1.42	36.1	2.68	68.1
G31135-0604	6AB-4AB-4MP	7250-14845	3/8	3/8	1/4-18	18	.96	24.4	1.97	50.0
G31135-0806	8AB-6AB-8MP	7250-14865	1/2	3/8	1/2-14	22	1.22	31.0	2.48	63.0
G31136-1008	10AB-8AB-8MP	7250-14885	5/8	1/2	1/2-14	30	1.46	37.1	2.78	70.6

- EQUIPMENT
- HOSE/CPLG. SELECTION
- G8K COUPLINGS
- GLOBALSPIRAL COUPLINGS
- STAINLESS STEEL SPIRAL
- MEGACRIMP COUPLINGS
- STAINLESS STEEL BRAID
- POWER CRIMP COUPLINGS
- FIELD ATTACHABLE G1 & G2 COUPLINGS
- FIELD ATTACHABLE C5 COUPLINGS
- GLX COUPLINGS
- GL COUPLINGS
- C14 COUPLINGS
- PCTS THERMOPLASTIC COUPLINGS
- POLARSEAL COUPLINGS
- POLARSEAL II COUPLINGS
- POWER STEERING
- ADAPTERS
- QUICK DISCONNECT COUPLERS
- BALL VALVES
- LIVE SWIVEL
- ASSEMBLY FABRICATION
- ACCESSORIES
- EQUIPMENT AND PARTS
- AIR BRAKE**
- BRASS
- KITS

SureLok™ Air Brake Couplings

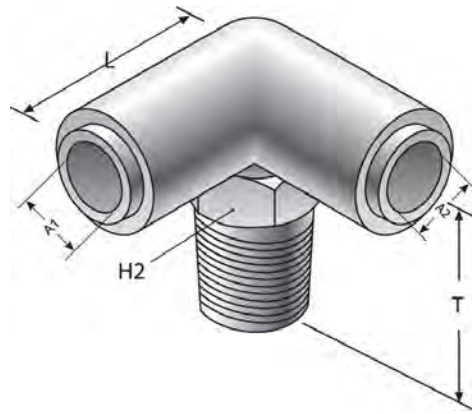
Air Brake to Male Pipe - Tee - 90°



Part No.	Descr.	Prod. No.	A1	A2		H2	T		L	
			"	"	"	mm	"	mm	"	mm
G31138-0606	6AB-6AB-6MP90	7250-14895	3/8	3/8	3/8-18	22	1.34	34.0	1.18	30.0
G31138-0806	8AB-8AB-6MP90	7250-14905	1/2	1/2	3/8-18	20	1.34	34.0	1.30	33.0

Male Pipe Swivel to Air Brake to Air Brake - Tee

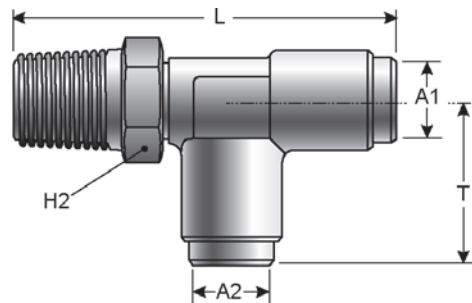

Part No.	Descr.	Prod. No.	A1	A2		H2	T		L	
			"	"	"	mm	"	mm	"	mm
G31140-0204	2MPX-4AB-4AB	7250-01515	1/4	1/4	1/8-27	11	.83	21.1	1.75	44.5
G31140-0404	4MPX-4AB-4AB	7250-01525	1/4	1/4	1/4-18	14	.83	21.1	1.95	49.5
G31140-0406	4MPX-6AB-6AB	7250-14925	3/8	3/8	1/4-18	19	1.07	27.2	2.36	59.9
G31140-0606	6MPX-6AB-6AB	7250-01545	3/8	3/8	3/8-18	19	1.07	27.2	2.32	58.9
G31140-0608	6MPX-8AB-8AB	7250-01555	1/2	1/2	3/8-18	22	1.27	32.3	2.69	68.3
G31140-0808	8MPX-8AB-8AB	7250-01565	1/2	1/2	1/2-14	22	1.27	32.3	2.89	73.4

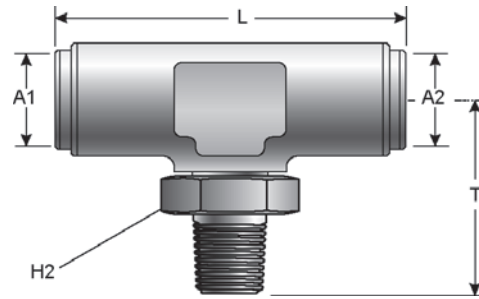

Air Brake on Run to Male Pipe Swivel - Tee

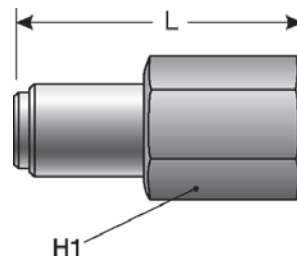

Part No.	Descr.	Prod. No.	A1	A2		H2	T		L	
			"	"	"	mm	"	mm	"	mm
G31142-0302	3AB-3AB-2MPX	7250-14935	3/16	3/16	1/8-27	11	.89	22.6	1.57	39.9
G31142-0402	4AB-4AB-2MPX	7250-01575	1/4	1/4	1/8-27	11	.91	23.1	1.67	42.4
G31142-0404	4AB-4AB-4MPX	7250-01585	1/4	1/4	1/4-18	14	1.12	28.5	1.67	42.4
G31142-0602	6AB-6AB-2MPX	7250-14945	3/8	3/8	1/8-27	14	1.09	27.7	1.92	48.8
G31142-0604	6AB-6AB-4MPX	7250-01595	3/8	3/8	1/4-18	19	1.29	32.8	2.17	55.1
G31142-0606	6AB-6AB-6MPX	7250-14955	3/8	3/8	3/8-18	19	1.24	31.5	2.17	55.1
G31142-0804	8AB-8AB-4MPX	7250-01605	1/2	1/2	1/4-18	22	1.39	35.3	2.56	65.0
G31142-0806	8AB-8AB-6MPX	7250-01615	1/2	1/2	3/8-18	22	1.42	36.1	2.56	65.0
G31142-0808	8AB-8AB-8MPX	7250-14965	1/2	1/2	1/2-14	22	1.62	41.2	2.56	65.0

Air Brake to Female Pipe



Part No.	Descr.	Prod. No.			H1	L	
			"	"	"	"	mm
G31150-0402	4AB-2FP	7250-01625	1/4	1/8-27	9/16	1.31	33.3
G31150-0404	4AB-4FP	7250-01635	1/4	1/4-18	11/16	1.59	40.4
G31150-0602	6AB-2FP	7250-01645	3/8	1/8-27	9/16	1.74	44.2
G31150-0604	6AB-4FP	7250-01655	3/8	1/4-18	11/16	1.74	44.2
G31150-0606	6AB-6FP	7250-01665	3/8	3/8-18	7/8	1.78	45.2
G31150-0804	8AB-4FP	7250-01675	1/2	1/4-18	11/16	2.00	50.8
G31150-0808	8AB-8FP	7250-01695	1/2	1/2-14	11/16	2.11	53.6
G31150-2502	2.5AB-2FP	7250-14975	5/32	1/8-27	9/16	1.18	30.0

- EQUIPMENT
- HOSE/CPLG. SELECTION
- G8K COUPLINGS
- GLOBALSPIRAL COUPLINGS
- STAINLESS STEEL SPIRAL
- MEGACRIMP COUPLINGS
- STAINLESS STEEL BRAID
- POWER CRIMP COUPLINGS
- FIELD ATTACHABLE G1 & G2 COUPLINGS
- FIELD ATTACHABLE C5 COUPLINGS
- GLX COUPLINGS
- GL COUPLINGS
- C14 COUPLINGS
- PCTS THERMOPLASTIC COUPLINGS
- POLARSEAL COUPLINGS
- POLARSEAL II COUPLINGS
- POWER STEERING
- ADAPTERS
- QUICK DISCONNECT COUPLERS
- BALL VALVES
- LIVE SWIVEL
- ASSEMBLY FABRICATION
- ACCESSORIES
- EQUIPMENT AND PARTS
- AIR BRAKE
- BRASS
- KITS

Air Brake to Female Pipe - 90°

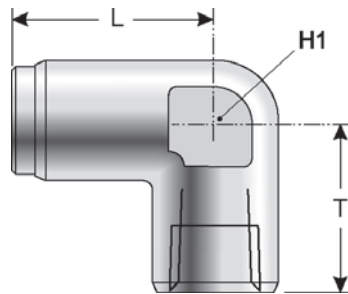

Part No.	Descr.	Prod. No.			H1	T		L	
			"	"		mm	mm	"	mm
G31154-0302	3AB-2FP90	7250-14985	3/16	1/8-27	14	.71	18.0	.87	22.1
G31154-0402	4AB-2FP90	7250-01705	1/4	1/8-27	14	.71	18.0	.94	23.9
G31154-0404	4AB-4FP90	7250-01715	1/4	1/4-18	18	.79	20.1	1.08	27.4
G31154-0406	4AB-6FP90	7250-14995	1/4	3/8-18	18	.79	20.1	1.08	27.4
G31154-0602	6AB-2FP90	7250-01725	3/8	1/8-27	13	.79	20.1	1.31	33.3
G31154-0604	6AB-4FP90	7250-01735	3/8	1/4-18	18	.79	20.1	1.31	33.3
G31154-0606	6AB-6FP90	7250-01745	3/8	3/8-18	22	.79	20.1	1.31	33.3
G31154-0804	8AB-4FP90	7250-01755	1/2	1/4-18	18	.94	23.9	1.16	29.5
G31154-0806	8AB-6FP90	7250-01765	1/2	3/8-18	22	.94	23.9	1.16	29.5
G31154-0808	8AB-8FP90	7250-01775	1/2	1/2-14	16	.94	23.9	1.16	29.5

Air Brake on Run to Female Pipe - Tee

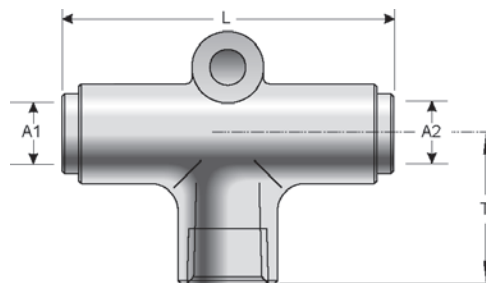

Part No.	Descr.	Prod. No.	A1	A2		T		L	
			"	"	"	"	mm	"	mm
G31160-0604	6AB-6AB-4FP	7250-01785	3/8	3/8	3/8-18	1.06	26.9	2.34	59.4

EQUIPMENT
HOSE/CPLG. SELECTION
G8K COUPLINGS
GLOBALSPIRAL COUPLINGS
STAINLESS STEEL SPIRAL
MEGACRIMP COUPLINGS
STAINLESS STEEL BRAID
POWER CRIMP COUPLINGS
FIELD ATTACHABLE G1 & G2 COUPLINGS
FIELD ATTACHABLE C5 COUPLINGS
GLX COUPLINGS
GL COUPLINGS
C14 COUPLINGS
PCTS THERMOPLASTIC COUPLINGS
POLARSEAL COUPLINGS
POLARSEAL II COUPLINGS
POWER STEERING
ADAPTERS
QUICK DISCONNECT COUPLERS
BALL VALVES
LIVE SWIVEL
ASSEMBLY FABRICATION
ACCESSORIES
EQUIPMENT AND PARTS
AIR BRAKE
BRASS
KITS

Male Pipe to Air Brake to Female Pipe - Tee

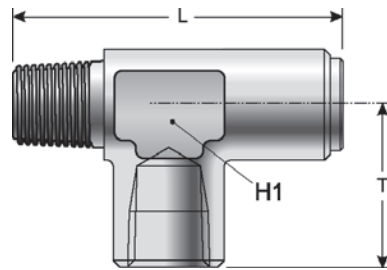

Part No.	Descr.	Prod. No.	⊘	🌀		H1	T		L	
			"	"	"		"	mm	"	mm
G31167-0406	4MP-6AB-4FP	7250-15015	1/4	1/4-18	1/4-18	18	.96	24.4	2.05	52.1
G31167-0808	8MP-8AB-2FP	7250-15045	1/2	1/2-14	1/8-27	24	.96	24.4	2.40	61.0

Air Brake to Male Pipe to Female Pipe

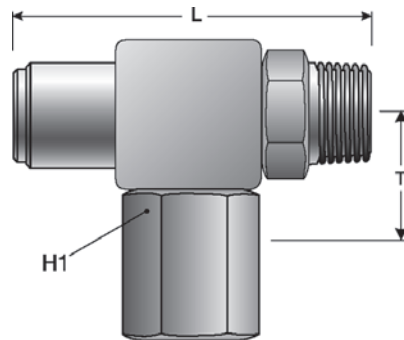

Part No.	Descr.	Prod. No.	⊘	🌀		H1	T		L	
			"	"	"		mm	"	mm	"
G31168-0604	6AB-6MP-4FP	7250-01795	1/2	3/8-18	1/4-18	22	1.14	29.0	2.05	52.1

Air Brake Bulkhead

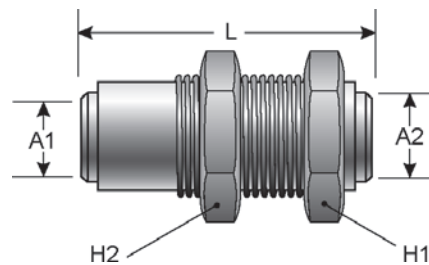

Part No.	Descr.	Prod. No.	A1	A2	🌀	H1	H2	L	
			"	"	"			"	mm
G31300-0404	4AB-4AB-BKHD	7250-01805	1/4	1/4	1/4-18	15/16	15/16	1.41	35.8
G31300-0606	6AB-6AB-BKHD	7250-01815	3/8	3/8	3/8-18	1 1/8	1 1/8	1.75	44.5
G31300-0806	8AB-6AB-BKHD	7250-15055	1/2	3/8	3/8-18	1 1/8	1 1/8	1.89	48.0



- EQUIPMENT
- HOSE/CPLG. SELECTION
- G&K COUPLINGS
- GLOBALSPIRAL COUPLINGS
- STAINLESS STEEL SPIRAL
- MEGACRIMP COUPLINGS
- STAINLESS STEEL BRAID
- POWER CRIMP COUPLINGS
- FIELD ATTACHABLE G1 & G2 COUPLINGS
- FIELD ATTACHABLE C5 COUPLINGS
- GLX COUPLINGS
- GL COUPLINGS
- C14 COUPLINGS
- PCTS THERMOPLASTIC COUPLINGS
- POLARSEAL COUPLINGS
- POLARSEAL II COUPLINGS
- POWER STEERING
- ADAPTERS
- QUICK DISCONNECT COUPLERS
- BALL VALVES
- LIVE SWIVEL
- ASSEMBLY FABRICATION
- ACCESSORIES
- EQUIPMENT AND PARTS
- AIR BRAKE**
- BRASS
- KITS

Air Brake Bulkhead - Continued

Part No.	Descr.	Prod. No.	A1	A2		H1	H2	L	
			"	"	"	"	"	"	"
G31300-0808	8AB-8AB-BKHD	7250-01825	1/2	1/2	1/2-14	1 5/16	1 5/16	2.02	51.3
G31300-1010	10AB-10AB-BKHD	7250-01835	5/8	5/8	1/2-14	1 1/2	1 1/2	2.34	59.4

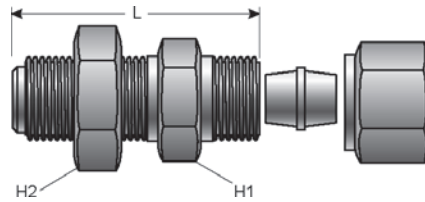

Air Brake to Male Flareless Assembly Bulkhead

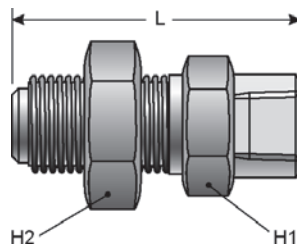

Part No.	Descr.	Prod. No.			H1	H2	L	
			"	"	"	"	"	"
G31350-0404	4AB-4MFA-BKHD	7250-15065	1/4	1/4	11/16	15/16	.50	12.7
G31350-0606	6AB-6MFA-BKHD	7250-15075	3/8	3/8	7/8	7/8	.68	17.3

Air Brake to Female Pipe Bulkhead



Part No.	Descr.	Prod. No.			H1	H2	L	
			"	"	mm	"	"	"
G31360-0402	4AB-2FP-BKHD	7250-15085	1/4	1/8-27	22	15/16	1.32	33.5
G31360-0404	4AB-4FP-BKHD	7250-01845	1/4	1/4-18	22	15/16	1.59	40.4
G31360-0604	6AB-4FP-BKHD	7250-15095	3/8	1/4-18	24	1 1/8	2.20	55.9
G31360-0606	6AB-6FP-BKHD	7250-01855	3/8	3/8-18	27	1 1/8	2.20	55.9
G31360-0608	6AB-8FP-BKHD	7250-15105	3/8	1/2-14	27	1 1/8	2.20	55.9
G31360-0806	8AB-6FP-BKHD	7250-15115	1/2	3/8-18	27	1 5/16	1.89	48.0
G31360-0808	8AB-8FP-BKHD	7250-01865	1/2	1/2-14	27	1 5/16	2.64	67.1

Air Brake Union

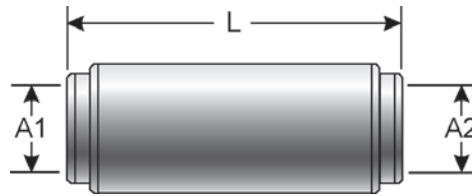

Part No.	Descr.	Prod. No.	A1	A2	L	
			"	"	"	mm
G31400-0202	2AB-2AB	7250-15135	1/8	1/8	1.15	27.2
G31400-0303	3AB-3AB	7250-15145	3/16	3/16	1.36	24.5
G31400-0404	4AB-4AB	7250-01875	1/4	1/4	1.40	35.6
G31400-0604	6AB-4AB	7250-15155	3/8	1/4	1.71	43.4
G31400-0606	6AB-6AB	7250-01885	3/8	3/8	1.74	44.2
G31400-0806	8AB-6AB	7250-15165	1/2	3/8	1.91	48.5
G31400-0808	8AB-8AB	7250-01895	1/2	1/2	2.01	51.1
G31400-1010	10AB-10AB	7250-01905	5/8	5/8	2.42	61.5
G31400-1212	12AB-12AB	7250-15175	3/4	3/4	2.48	63.0
G31400-2525	2.5AB-2.5AB	7250-01915	5/32	5/32	1.18	30.0

Air Brake Union - 90°

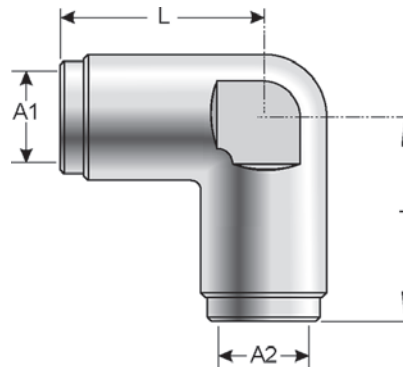

Part No.	Descr.	Prod. No.	A1	A2	T		L	
			"	"	"	mm	"	mm
G31404-0404	4AB-4AB90	7250-01925	1/4	1/4	.83	21.1	.83	21.1
G31404-0606	6AB-6AB90	7250-01935	3/8	3/8	1.07	27.2	1.07	27.2
G31404-0808	8AB-8AB90	7250-01945	1/2	1/2	1.26	32.0	1.26	32.0
G31404-1010	10AB-10AB90	7250-15185	5/8	5/8	1.48	37.6	1.61	40.9

- EQUIPMENT
- HOSE/CPLG. SELECTION
- G8K COUPLINGS
- GLOBALSPIRAL COUPLINGS
- STAINLESS STEEL SPIRAL
- MEGACRIMP COUPLINGS
- STAINLESS STEEL BRAID
- POWER CRIMP COUPLINGS
- FIELD ATTACHABLE G1 & G2 COUPLINGS
- FIELD ATTACHABLE C5 COUPLINGS
- GLX COUPLINGS
- GL COUPLINGS
- C14 COUPLINGS
- PCTS THERMOPLASTIC COUPLINGS
- POLARSEAL COUPLINGS
- POLARSEAL II COUPLINGS
- POWER STEERING
- ADAPTERS
- QUICK DISCONNECT COUPLERS
- BALL VALVES
- LIVE SWIVEL
- ASSEMBLY FABRICATION
- ACCESSORIES
- EQUIPMENT AND PARTS
- AIR BRAKE**
- BRASS
- KITS

EQUIPMENT
HOSE/CPLG. SELECTION
G8K COUPLINGS
GLOBALSPIRAL COUPLINGS
STAINLESS STEEL SPIRAL
MEGACRIMP COUPLINGS
STAINLESS STEEL BRAID
POWER CRIMP COUPLINGS
FIELD ATTACHABLE G1 & G2 COUPLINGS
FIELD ATTACHABLE C5 COUPLINGS
GLX COUPLINGS
GL COUPLINGS
C14 COUPLINGS
PCTS THERMOPLASTIC COUPLINGS
POLARSEAL COUPLINGS
POLARSEAL II COUPLINGS
POWER STEERING
ADAPTERS
QUICK DISCONNECT COUPLERS
BALL VALVES
LIVE SWIVEL
ASSEMBLY FABRICATION
ACCESSORIES
EQUIPMENT AND PARTS
AIR BRAKE
BRASS
KITS

Air Brake Union - Tee

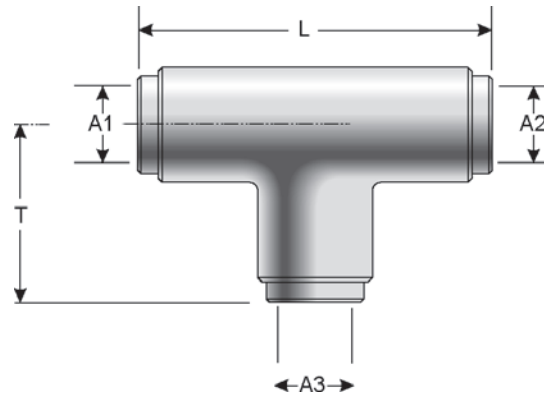

Part No.	Descr.	Prod. No.	A1	A2	A3	T		L	
			"	"	"	"	mm	"	mm
G31450-0202	2AB-2AB-2AB	7250-15195	1/8	1/8	1/8	.63	16.0	1.26	32.0
G31450-0303	3AB-3AB-3AB	7250-15205	3/16	3/16	3/16	.72	18.3	1.44	36.9
G31450-0404	4AB-4AB-4AB	7250-01955	1/4	1/4	1/4	.93	23.6	1.65	41.9
G31450-0606	6AB-6AB-6AB	7250-01965	3/8	3/8	3/8	1.07	27.2	2.13	54.1
G31450-0808	8AB-8AB-8AB	7250-01975	1/2	1/2	1/2	1.26	32.0	2.53	64.3
G31450-1010	10AB-10AB-10AB	7250-15215	5/8	5/8	5/8	1.54	39.1	3.07	78.0
G31450-1212	12AB-12AB-12AB	7250-15225	3/4	3/4	3/4	1.56	39.6	3.12	79.3
G31451-0604	6AB-6AB-4AB	7250-15245	3/8	3/8	1/4	.93	23.6	2.17	55.1
G31451-0608	6AB-6AB-8AB	7250-15255	3/8	3/8	1/2	1.28	32.5	2.36	59.9
G31451-0804	8AB-8AB-4AB	7250-15265	1/2	1/2	1/4	.98	24.9	2.52	64.0
G31451-0806	8AB-8AB-6AB	7250-15275	1/2	1/2	3/8	1.22	31.0	2.44	62.0
G31451-1008	10AB-8AB-10AB	7250-15285	5/8	1/2	5/8	1.56	39.6	3.01	76.5
G31452-0604	6AB-4AB-4AB	7250-15295	3/8	1/4	1/4	.93	23.6	2.01	51.1
G31452-0806	8AB-6AB-6AB	7250-15305	1/2	3/8	3/8	1.18	30.0	2.46	62.5

Air Brake Union - Tee with Mounting Hole

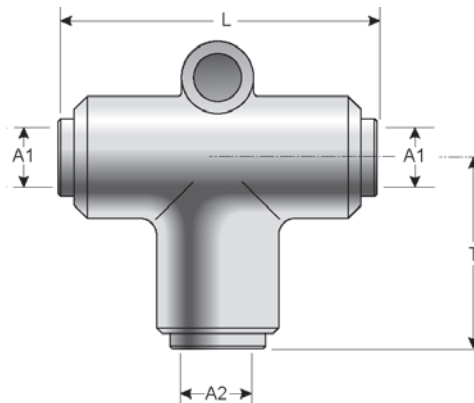

Part No.	Descr.	Prod. No.	A1	A2	T		L	
			"	"	"	mm	"	mm
G31453-0608	6AB-6AB-8ABMH	7250-15315	3/8	1/2	1.42	36.1	2.36	59.9

6-Port Manifold

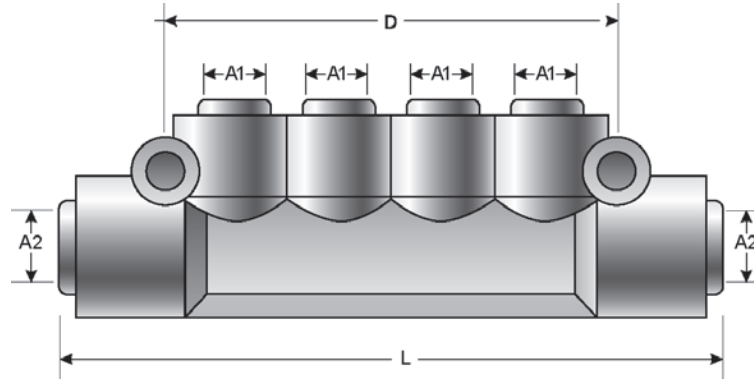

Part No.	Descr.	Prod. No.	A1	A2	D Mounting Hole Length		L	
			"	"	"	mm	"	mm
G31970-0604	6AB-4MANIFOLD	7250-15325	1/4	3/8	2.76	70.10	4.10	104.1

EQUIPMENT
HOSE/CPLG. SELECTION
G8K COUPLINGS
GLOBALSPIRAL COUPLINGS
STAINLESS STEEL SPIRAL
MEGACRIMP COUPLINGS
STAINLESS STEEL BRAID
POWER CRIMP COUPLINGS
FIELD ATTACHABLE G1 & G2 COUPLINGS
FIELD ATTACHABLE C5 COUPLINGS
GLX COUPLINGS
GL COUPLINGS
C14 COUPLINGS
PCTS THERMOPLASTIC COUPLINGS
POLARSEAL COUPLINGS
POLARSEAL II COUPLINGS
POWER STEERING
ADAPTERS
QUICK DISCONNECT COUPLERS
BALL VALVES
LIVE SWIVEL
ASSEMBLY FABRICATION
ACCESSORIES
EQUIPMENT AND PARTS
AIR BRAKE
BRASS
KITS

Air Brake Assortments

Part No.	Prod. No.	Descr.
85111	7369-0111	Air Line Repair Kit
85112	7369-0112	Air Brake Repair Kit
85113	7369-0113	Trans Line Repair Kit
85114	7369-0114	Tubing Repair Kit
A33001	7369-3001	Air Brake Small SureLok Assortment
A33002	7369-3002	Air Brake Large SureLok Assortment
A33003	7369-3003	Air Brake Small Compression Assortment
A33004	7369-3004	Air Brake Large Compression Assortment

EQUIPMENT
HOSE/CPLG. SELECTION
G8K COUPLINGS
GLOBALSPIRAL COUPLINGS
STAINLESS STEEL SPIRAL
MEGACRIMP COUPLINGS
STAINLESS STEEL BRAID
POWER CRIMP COUPLINGS
FIELD ATTACHABLE G1 & G2 COUPLINGS
FIELD ATTACHABLE C5 COUPLINGS
GLX COUPLINGS
GL COUPLINGS
C14 COUPLINGS
PCTS THERMOPLASTIC COUPLINGS
POLARSEAL COUPLINGS
POLARSEAL II COUPLINGS
POWER STEERING
ADAPTERS
QUICK DISCONNECT COUPLERS
BALL VALVES
LIVE SWIVEL
ASSEMBLY FABRICATION
ACCESSORIES
EQUIPMENT AND PARTS
AIR BRAKE
BRASS
KITS

Tube Sleeve Insert

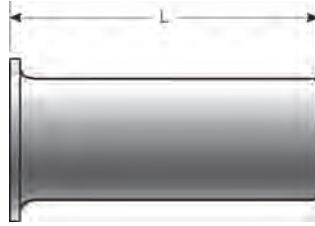

Part No.	Descr.	Prod. No.	∅	L	
			"	"	mm
G32040-0004	4TSI-ABC	7250-01985	1/4	.53	13.5
G32040-0006	6TSI-ABC	7250-01995	3/8	.64	16.3
G32040-0008	8TSI-ABC	7250-02005	1/2	.81	20.6
G32040-0010	10TSI-ABC	7250-02015	5/8	.86	21.9
G32040-0012	12TSI-ABC	7250-02025	3/4	1.04	26.4

Tube Sleeve

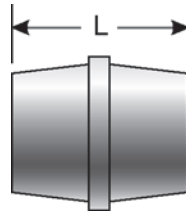

Part No.	Descr.	Prod. No.	∅	L	
			"	"	mm
G32050-0004	4TS-ABC	7250-02035	1/4	.30	7.6
G32050-0006	6TS-ABC	7250-02045	3/8	.39	9.9
G32050-0008	8TS-ABC	7250-02055	1/2	.43	10.9
G32050-0010	10TS-ABC	7250-02065	5/8	.49	12.5
G32050-0012	12TS-ABC	7250-02075	3/4	.54	13.7

Tube Sleeve Nut



Part No.	Descr.	Prod. No.	∅	H2	L	
			"	"	"	mm
G32060-0004	4TSN-ABC	7250-02085	1/4	9/16	.45	11.4
G32060-0006	6TSN-ABC	7250-02095	3/8	5/8	.63	16.0

- EQUIPMENT
- HOSE/CPLG. SELECTION
- G&K COUPLINGS
- GLOBALSPIRAL COUPLINGS
- STAINLESS STEEL SPIRAL
- MEGACRIMP COUPLINGS
- STAINLESS STEEL BRAID
- POWER CRIMP COUPLINGS
- FIELD ATTACHABLE G1 & G2 COUPLINGS
- FIELD ATTACHABLE C5 COUPLINGS
- GLX COUPLINGS
- GL COUPLINGS
- C14 COUPLINGS
- PCTS THERMOPLASTIC COUPLINGS
- POLARSEAL COUPLINGS
- POLARSEAL II COUPLINGS
- POWER STEERING
- ADAPTERS
- QUICK DISCONNECT COUPLERS
- BALL VALVES
- LIVE SWIVEL
- ASSEMBLY FABRICATION
- ACCESSORIES
- EQUIPMENT AND PARTS
- AIR BRAKE
- BRASS
- KITS

Tube Sleeve Nut - Continued

Part No.	Descr.	Prod. No.	∅	H2	L	
			"	"	"	mm
G32060-0008	8TSN-ABC	7250-02105	1/2	13/16	.72	18.3
G32060-0010	10TSN-ABC	7250-02115	5/8	15/16	.77	19.6
G32060-0012	12TSN-ABC	7250-02125	3/4	1 1/8	.81	20.6

Air Brake to Male Pipe

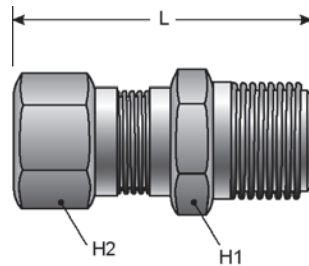

Part No.	Descr.	Prod. No.	∅		H1	H2	L	
			"	"	"	"	"	mm
G32100-0401	4ABC-1MP	7250-02135	1/4	1/16-32	7/16	7/16	1.22	31.0
G32100-0402	4ABC-2MP	7250-02145	1/4	1/8-27	7/16	9/16	1.22	31.0
G32100-0404	4ABC-4MP	7250-02155	1/4	1/4-18	9/16	9/16	1.43	36.3
G32100-0406	4ABC-6MP	7250-02165	1/4	3/8-18	11/16	9/16	1.47	37.3
G32100-0602	6ABC-2MP	7250-02175	3/8	1/8-27	9/16	5/8	1.49	37.9
G32100-0604	6ABC-4MP	7250-02185	3/8	1/4-18	9/16	5/8	1.67	42.4
G32100-0606	6ABC-6MP	7250-02195	3/8	3/8-18	11/16	5/8	1.70	43.2
G32100-0608	6ABC-8MP	7250-02205	3/8	1/2-14	7/8	5/8	1.89	48.0
G32100-0804	8ABC-4MP	7250-02215	1/2	1/4-18	11/16	13/16	1.85	47.0
G32100-0806	8ABC-6MP	7250-02225	1/2	3/8-18	11/16	13/16	1.85	47.0
G32100-0808	8ABC-8MP	7250-02235	1/2	1/2-14	7/8	13/16	2.04	51.8
G32100-0812	8ABC-12MP	7250-02245	1/2	3/4-14	7/8	1 1/8	2.10	53.3
G32100-1006	10ABC-6MP	7250-02255	5/8	3/8-18	13/16	15/16	1.88	47.8
G32100-1008	10ABC-8MP	7250-02265	5/8	1/2-14	7/8	15/16	2.10	53.3
G32100-1012	10ABC-12MP	7250-02275	5/8	3/4-14	1 1/16	15/16	2.19	55.6
G32100-1208	12ABC-8MP	7250-02285	3/4	1/2-14	1	1 1/8	2.19	55.6
G32100-1212	12ABC-12MP	7250-02295	3/4	3/4-14	1 1/16	1 1/8	2.22	56.4

EQUIPMENT
HOSE/CPLG. SELECTION
G8K COUPLINGS
GLOBALSPIRAL COUPLINGS
STAINLESS STEEL SPIRAL
MEGACRIMP COUPLINGS
STAINLESS STEEL BRAID
POWER CRIMP COUPLINGS
FIELD ATTACHABLE G1 & G2 COUPLINGS
FIELD ATTACHABLE C5 COUPLINGS
GLX COUPLINGS
GL COUPLINGS
C14 COUPLINGS
PCTS THERMOPLASTIC COUPLINGS
POLARSEAL COUPLINGS
POLARSEAL II COUPLINGS
POWER STEERING
ADAPTERS
QUICK DISCONNECT COUPLERS
BALL VALVES
LIVE SWIVEL
ASSEMBLY FABRICATION
ACCESSORIES
EQUIPMENT AND PARTS
AIR BRAKE
BRASS
KITS

Air Brake to Male Pipe - 45°

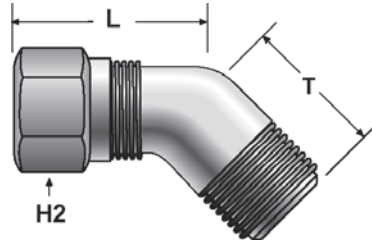

Part No.	Descr.	Prod. No.	∅	🌀	H2	T		L	
			"	"	"	"	mm	"	mm
G32102-0402	4ABC-2MP45	7250-02305	1/4	1/8-27	9/16	.63	16.0	1.44	36.9
G32102-0404	4ABC-4MP45	7250-02315	1/4	1/4-18	9/16	.63	16.0	1.44	36.9
G32102-0602	6ABC-2MP45	7250-02325	3/8	1/8-27	5/8	.71	18.0	1.83	46.5
G32102-0604	6ABC-4MP45	7250-02335	3/8	1/4-18	5/8	.85	21.6	2.02	51.3
G32102-0606	6ABC-6MP45	7250-02345	3/8	3/8-18	5/8	.94	23.9	2.15	54.6
G32102-0608	6ABC-8MP45	7250-02355	3/8	1/2-14	5/8	.94	23.9	2.20	55.9
G32102-0804	8ABC-4MP45	7250-02365	1/2	1/4-18	13/16	.94	23.9	2.20	55.9
G32102-0806	8ABC-6MP45	7250-02375	1/2	3/8-18	13/16	.94	23.9	2.30	58.4
G32102-0808	8ABC-8MP45	7250-02385	1/2	1/2-14	13/16	1.16	29.5	2.55	64.8
G32102-1008	10ABC-8MP45	7250-02395	5/8	1/2-14	15/16	1.16	29.5	2.58	65.5

Air Brake to Male Pipe - 90°

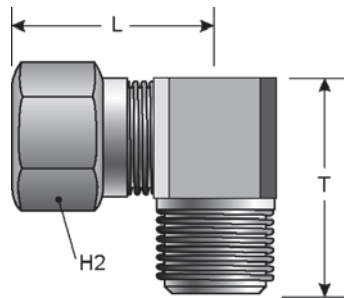



Part No.	Descr.	Prod. No.	∅	🌀	H2	T		L	
			"	"	"	"	mm	"	mm
G32104-0402	4ABC-2MP90	7250-02405	1/4	1/8-27	9/16	.66	16.8	.95	24.1
G32104-0404	4ABC-4MP90	7250-02415	1/4	1/4-18	9/16	.87	22.1	1.00	25.4
G32104-0406	4ABC-6MP90	7250-02425	1/4	3/8-18	9/16	.86	21.8	1.16	29.5
G32104-0602	6ABC-2MP90	7250-02435	3/8	1/8-27	5/8	.75	19.1	1.19	30.2
G32104-0604	6ABC-4MP90	7250-02445	3/8	1/4-18	5/8	.92	23.4	1.25	31.8
G32104-0606	6ABC-6MP90	7250-02455	3/8	3/8-18	5/8	.91	23.1	1.30	33.0
G32104-0608	6ABC-8MP90	7250-02465	3/8	1/2-14	5/8	1.10	27.9	1.40	35.6
G32104-0804	8ABC-4MP90	7250-02475	1/2	1/4-18	13/16	.99	25.2	1.38	35.1
G32104-0806	8ABC-6MP90	7250-02485	1/2	3/8-18	13/16	.99	25.2	1.44	36.9
G32104-0808	8ABC-8MP90	7250-02495	1/2	1/2-14	13/16	1.18	30.0	1.55	39.4
G32104-1006	10ABC-6MP90	7250-02505	5/8	3/8-18	15/16	1.05	26.7	1.49	37.9
G32104-1008	10ABC-8MP90	7250-02515	5/8	1/2-14	15/16	1.24	31.5	1.58	40.1
G32104-1012	10ABC-12MP90	7250-02525	5/8	3/4-14	15/16	1.32	31.5	1.77	45.0
G32104-1206	12ABC-6MP90	7250-02535	3/4	3/8-18	1 1/8	1.32	31.5	1.70	43.2
G32104-1208	12ABC-8MP90	7250-02545	3/4	1/2-14	1 1/8	1.32	31.5	1.70	43.2
G32104-1212	12ABC-12MP90	7250-15335	3/4	3/4-14	1 1/8	1.32	31.5	1.77	45.0

- EQUIPMENT
- HOSE/CPLG. SELECTION
- G8K COUPLINGS
- GLOBALSPIRAL COUPLINGS
- STAINLESS STEEL SPIRAL
- MEGACRIMP COUPLINGS
- STAINLESS STEEL BRAID
- POWER CRIMP COUPLINGS
- FIELD ATTACHABLE G1 & G2 COUPLINGS
- FIELD ATTACHABLE C5 COUPLINGS
- GLX COUPLINGS
- GL COUPLINGS
- C14 COUPLINGS
- PCTS THERMOPLASTIC COUPLINGS
- POLARSEAL COUPLINGS
- POLARSEAL II COUPLINGS
- POWER STEERING
- ADAPTERS
- QUICK DISCONNECT COUPLERS
- BALL VALVES
- LIVE SWIVEL
- ASSEMBLY FABRICATION
- ACCESSORIES
- EQUIPMENT AND PARTS
- AIR BRAKE**
- BRASS
- KITS

Compression Air Brake

Air Brake to Male Pipe - 90° - Long

Part No.	Descr.	Prod. No.		
			"	"
G32106-0602	6ABC-2MP90L	7250-02555	3/8	1/8-27
G32106-0604	6ABC-4MP90L	7250-02565	3/8	1/4-18
G32106-0806	8ABC-6MP90L	7250-02575	1/2	3/8-18

Male Pipe to Air Brake to Air Brake - Tee

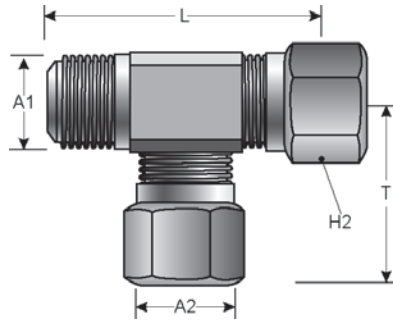

Part No.	Descr.	Prod. No.	A1	A2		H2	T		L	
			"	"	"	"	"	mm	"	mm
G32130-0204	2MP-4ABC-4ABC	7250-02595	1/4	1/4	1/8-27	7/16	1.00	25.4	1.87	47.5
G32130-0406	4MP-6ABC-6ABC	7250-15365	3/8	1/4	1/4-18	5/8	1.25	31.8	2.17	55.1
G32130-0606	6MP-6ABC-6ABC	7250-02615	3/8	3/8	3/8-18	5/8	1.30	33.0	2.21	56.1
G32130-0608	6MP-8ABC-8ABC	7250-15375	1/2	1/2	3/8-18	13/16	1.45	36.8	2.54	64.5
G32130-0808	8MP-8ABC-8ABC	7250-15385	1/2	1/2	3/8-18	13/16	1.45	36.8	2.63	66.8
G32130-0810	8MP-10ABC-10ABC	7250-15395	5/8	5/8	1/2-14	15/16	1.60	40.6	2.84	72.1
G32131-0406	4MP-4ABC-6ABC	7250-02655	3/8	1/4	1/4-18	5/8	1.00	25.4	1.87	47.5

Air Brake on Run to Male Pipe - Tee

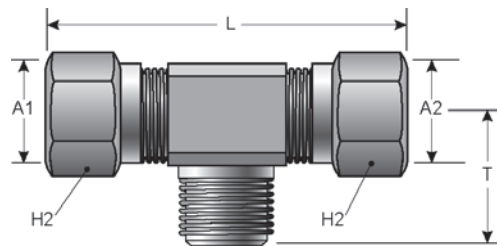



Part No.	Descr.	Prod. No.	A1	A2		H2	T		L	
			"	"	"	"	"	mm	"	mm
G32134-0402	4ABC-4ABC-2MP	7250-02675	1/4	1/4	1/8-27	9/16	.66	16.8	1.90	48.3
G32134-0404	4ABC-4ABC-4MP	7250-15405	1/4	1/4	1/4-18	9/16	.87	22.1	2.00	50.8
G32134-0602	6ABC-6ABC-2MP	7250-02685	3/8	3/8	1/8-27	9/16	.87	22.1	2.00	50.8
G32134-0604	6ABC-6ABC-4MP	7250-02695	3/8	3/8	1/4-18	5/8	.75	19.1	2.36	59.9
G32134-0606	6ABC-6ABC-6MP	7250-02705	3/8	3/8	3/8-18	5/8	.92	23.4	2.50	63.5
G32134-0806	8ABC-8ABC-6MP	7250-02715	1/2	1/2	3/8-18	5/8	.91	23.1	2.60	66.0
G32134-0808	8ABC-8ABC-8MP	7250-02725	1/2	1/2	1/2-14	13/16	.99	25.2	2.90	73.7
G32134-1008	10ABC-10ABC-8MP	7250-15425	5/8	5/8	1/2-14	15/16	1.24	31.5	3.20	81.3

Air Brake on Run to Male Pipe - Tee - Continued

Part No.	Descr.	Prod. No.	A1	A2		H2	T		L	
			"	"	"	"	"	mm	"	mm
G32136-0604	6ABC-4ABC-4MP	7250-02735	3/8	1/4	1/4-18	5/8	.92	23.4	2.50	63.5
G32136-0804	8ABC-8ABC-4MP	7250-02745	1/2	1/2	1/4-18	5/8	.91	23.1	2.60	66.0
G32136-0806	8ABC-6ABC-6MP	7250-02755	1/2	3/8	3/8-18	13/16	.99	25.2	2.90	73.7

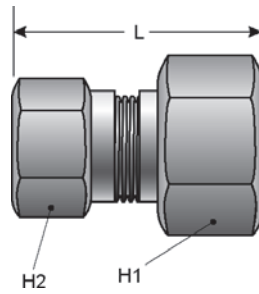

Air Brake to Female Pipe

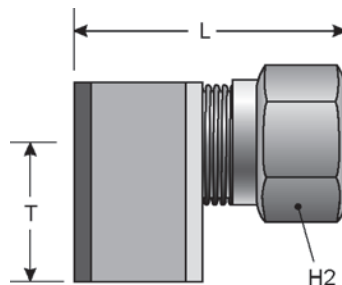

Part No.	Descr.	Prod. No.			H1	H2	L	
			"	"	"	"	"	mm
G32150-0402	4ABC-2FP	7250-02765	1/4	1/8-27	9/16	9/16	1.17	29.7
G32150-0404	4ABC-4FP	7250-15435	1/4	1/4-18	11/16	9/16	1.40	35.6
G32150-0602	6ABC-2FP	7250-02775	3/8	1/8-27	9/16	5/8	1.46	37.1
G32150-0604	6ABC-4FP	7250-02785	3/8	1/4-18	11/16	5/8	1.64	41.7
G32150-0606	6ABC-6FP	7250-02795	3/8	3/8-18	7/8	5/8	1.64	41.7
G32150-0806	8ABC-6FP	7250-02805	1/2	3/8-18	7/8	13/16	1.79	45.5
G32150-0808	8ABC-8FP	7250-15445	1/2	1/2-14	1 1/16	13/16	1.96	49.8
G32150-1006	10ABC-6FP	7250-15455	5/8	3/8-18	7/8	15/16	1.80	45.7
G32150-1008	10ABC-8FP	7250-15465	5/8	1/2-14	1 1/16	15/16	1.99	50.6
G32150-1208	12ABC-8FP	7250-02815	3/4	1/2-14	1 1/16	15/16	2.10	53.3

Air Brake to Female Pipe - 90°



Part No.	Descr.	Prod. No.			H2	T		L	
			"	"	"	"	mm	"	mm
G32154-0402	4ABC-2FP90	7250-02825	1/4	1/8-27	9/16	.52	13.2	1.02	25.9
G32154-0404	4ABC-4FP90	7250-15475	1/4	1/4-18	9/16	.71	18.0	1.11	28.2
G32154-0602	6ABC-2FP90	7250-15485	3/8	1/8-27	5/8	.59	15.0	1.29	32.8
G32154-0604	6ABC-4FP90	7250-02835	3/8	1/4-18	5/8	.77	19.7	1.35	34.3
G32154-0606	6ABC-6FP90	7250-02845	3/8	3/8-18	5/8	.77	19.7	1.39	35.3

EQUIPMENT
HOSE/CPLG. SELECTION
G8K COUPLINGS
GLOBALSPIRAL COUPLINGS
STAINLESS STEEL SPIRAL
MEGACRIMP COUPLINGS
STAINLESS STEEL BRAID
POWER CRIMP COUPLINGS
FIELD ATTACHABLE G1 & G2 COUPLINGS
FIELD ATTACHABLE C5 COUPLINGS
GLX COUPLINGS
GL COUPLINGS
C14 COUPLINGS
PCTS THERMOPLASTIC COUPLINGS
POLARSEAL COUPLINGS
POLARSEAL II COUPLINGS
POWER STEERING
ADAPTERS
QUICK DISCONNECT COUPLERS
BALL VALVES
LIVE SWIVEL
ASSEMBLY FABRICATION
ACCESSORIES
EQUIPMENT AND PARTS
AIR BRAKE
BRASS
KITS

Compression Air Brake

Air Brake to Female Pipe - 90° - Continued

Part No.	Descr.	Prod. No.			H2	T		L	
			"	"	"	"	mm	"	mm
G32154-0806	8ABC-6FP90	7250-02855	1/2	3/8-18	13/16	.82	20.8	1.55	39.4
G32154-0808	8ABC-8FP90	7250-15495	1/2	1/2-14	13/16	1.01	25.7	1.65	41.9
G32154-1008	10ABC-8FP90	7250-15505	5/8	1/2-14	15/16	1.07	27.2	1.70	43.2

Air Brake on Run to Female Pipe - Tee

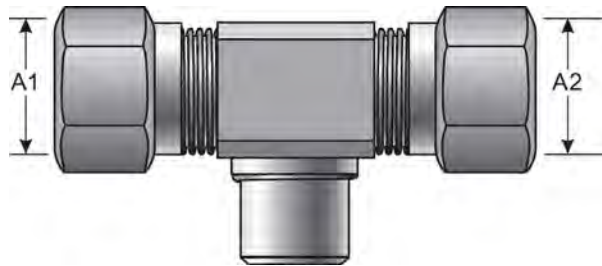

Part No.	Descr.	Prod. No.	A1	A2	
			"	"	"
G32160-0604	6ABC-6ABC-4FP	7250-02865	3/8	3/8	1/4-18
G32160-0804	8ABC-8ABC-4FP	7250-02875	1/2	1/2	1/4-18
G32160-1004	10ABC-10ABC-4FP	7250-02885	5/8	5/8	1/4-18

Air Brake Bulkhead

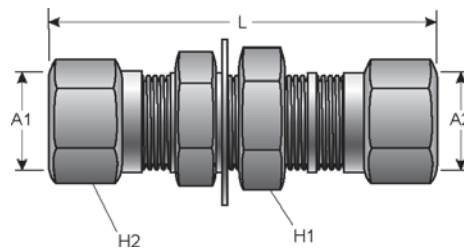

Part No.	Descr.	Prod. No.	A1	A2	H1	H2	L	
			"	"	"	"	"	mm
G32300-0404	4ABC-4ABC-BKHD	7250-02935	1/4	1/4	9/16	9/16	2.04	51.8
G32300-0606	6ABC-6ABC-BKHD	7250-02945	3/8	3/8	11/16	3/4	2.54	64.5
G32300-0808	8ABC-8ABC-BKHD	7250-02955	1/2	1/2	13/16	1	2.92	74.2
G32300-1010	10ABC-10ABC-BKHD	7250-02965	5/8	5/8	15/16	1 1/16	3.04	77.2

Air Brake Union

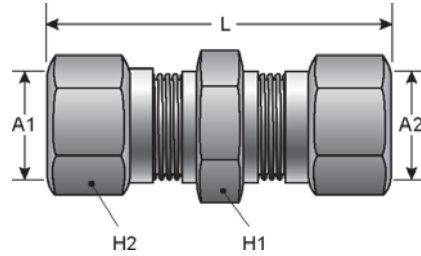

Part No.	Descr.	Prod. No.	A1	A2	H1	H2	L	
			"	"	"	"	"	mm
G32400-0404	4ABC-4ABC	7250-02975	1/4	1/4	7/16	9/16	1.49	37.9
G32400-0606	6ABC-6ABC	7250-02985	3/8	3/8	9/16	5/8	2.00	50.8
G32400-0808	8ABC-8ABC	7250-02995	1/2	1/2	11/16	13/16	2.33	59.2
G32400-1010	10ABC-10ABC	7250-03005	5/8	5/8	13/16	15/16	2.39	60.7
G32400-1212	12ABC-12ABC	7250-03015	3/4	3/4	1	1 1/8	2.60	66.0

Air Brake Union - 90°

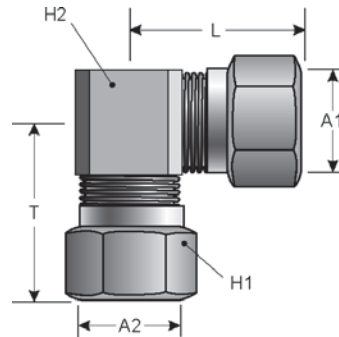

Part No.	Descr.	Prod. No.	A1	A2	H1	H2	T		L	
			"	"	"	"	"	mm	"	mm
G32404-0404	4ABC-4ABC90	7250-03025	1/4	1/4	7/16	9/16	1.00	25.4	.95	24.1
G32404-0606	6ABC-6ABC90	7250-03035	3/8	3/8	9/16	5/8	1.25	31.8	1.25	31.8
G32404-0808	8ABC-8ABC90	7250-03045	1/2	1/2	11/16	13/16	1.45	36.8	1.45	36.8
G32404-1010	10ABC-10ABC90	7250-03055	5/8	5/8	13/16	15/16	1.58	40.1	1.58	40.1

- EQUIPMENT
- HOSE/CPLG. SELECTION
- G8K COUPLINGS
- GLOBALSPIRAL COUPLINGS
- STAINLESS STEEL SPIRAL
- MEGACRIMP COUPLINGS
- STAINLESS STEEL BRAID
- POWER CRIMP COUPLINGS
- FIELD ATTACHABLE G1 & G2 COUPLINGS
- FIELD ATTACHABLE C5 COUPLINGS
- GLX COUPLINGS
- GL COUPLINGS
- C14 COUPLINGS
- PCTS THERMOPLASTIC COUPLINGS
- POLARSEAL COUPLINGS
- POLARSEAL II COUPLINGS
- POWER STEERING
- ADAPTERS
- QUICK DISCONNECT COUPLERS
- BALL VALVES
- LIVE SWIVEL
- ASSEMBLY FABRICATION
- ACCESSORIES
- EQUIPMENT AND PARTS
- AIR BRAKE**
- BRASS
- KITS

Compression Air Brake

Air Brake Union - Tee

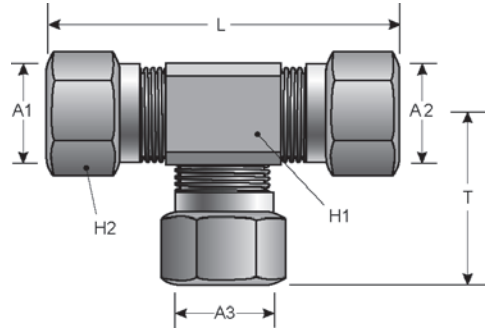

Part No.	Descr.	Prod. No.	A1	A2	A3	H1	H2	T		L	
			"	"	"	"	"	"	mm	"	mm
G32450-0404	4ABC-4ABC-4ABC	7250-03065	1/4	1/4	1/4	7/16	9/16	.95	24.1	1.90	48.3
G32450-0406	4ABC-6ABC-6ABC	7250-03075	1/4	3/8	3/8	1/16	9/16	1.10	27.9	2.20	55.9
G32450-0604	6ABC-6ABC-4ABC	7250-03085	3/8	3/8	1/4	9/16	7/16	1.10	27.9	2.20	55.9
G32450-0606	6ABC-6ABC-6ABC	7250-03095	3/8	3/8	3/8	9/16	5/8	1.24	31.5	2.48	63.0
G32450-0608	6ABC-6ABC-8ABC	7250-03105	3/8	3/8	1/2	9/16	11/16	1.30	33.0	2.60	66.0
G32450-0806	8ABC-8ABC-6ABC	7250-03115	1/2	1/2	3/8	11/16	9/16	1.45	36.8	2.90	73.7
G32450-0808	8ABC-8ABC-8ABC	7250-03125	1/2	1/2	1/2	11/16	13/16	1.45	36.8	2.90	73.7
G32450-1010	10ABC-10ABC-10ABC	7250-03135	5/8	5/8	5/8	13/16	15/16	1.58	40.1	3.16	80.3
G32452-0806	8ABC-6ABC-8ABC	7250-03145	1/2	3/8	1/2	11/16	9/16	1.30	33.0	2.60	66.0

Air Brake to Male Pipe Truck Valve - 90°

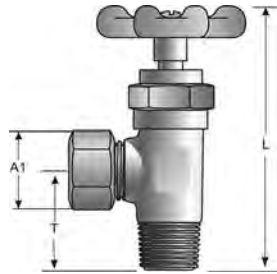

Part No.	Descr.	Prod. No.	A1		T		L	
			"	"	"	mm	"	mm
G32601-0808	8ABC-8MP90TV	7250-15535	1/2	1/2-14	1.88	47.8	2.45	62.2

Compression Air Brake

Male Pipe to Air Brake Truck Valve - 90°

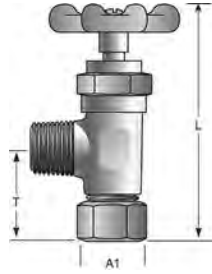

Part No.	Descr.	Prod. No.	A1		T		L	
			"	"	"	mm	"	mm
G32602-0808	8MP-8ABC90TV	7250-15545	1/2	1/2-14	1.88	47.8	2.40	61.0

EQUIPMENT
HOSE/CPLG. SELECTION
G&K COUPLINGS
GLOBAL SPIRAL COUPLINGS
STAINLESS STEEL SPIRAL
MEGACRIMP COUPLINGS
STAINLESS STEEL BRAID
POWER CRIMP COUPLINGS
FIELD ATTACHABLE G1 & G2 COUPLINGS
FIELD ATTACHABLE C5 COUPLINGS
GLX COUPLINGS
GL COUPLINGS
C14 COUPLINGS
PCTS THERMOPLASTIC COUPLINGS
POLARSEAL COUPLINGS
POLARSEAL II COUPLINGS
POWER STEERING
ADAPTERS
QUICK DISCONNECT COUPLERS
BALL VALVES
LIVE SWIVEL
ASSEMBLY FABRICATION
ACCESSORIES
EQUIPMENT AND PARTS
AIR BRAKE
BRASS
KITS

Air Brake Couplings For Rubber Hose

EQUIPMENT
HOSE/CPLG. SELECTION
G8K COUPLINGS
GLOBALSPIRAL COUPLINGS
STAINLESS STEEL SPIRAL
MEGACRIMP COUPLINGS
STAINLESS STEEL BRAID
POWER CRIMP COUPLINGS
FIELD ATTACHABLE G1 & G2 COUPLINGS
FIELD ATTACHABLE C5 COUPLINGS
GLX COUPLINGS
GL COUPLINGS
C14 COUPLINGS
PCTS THERMOPLASTIC COUPLINGS
POLARSEAL COUPLINGS
POLARSEAL II COUPLINGS
POWER STEERING
ADAPTERS
QUICK DISCONNECT COUPLERS
BALL VALVES
LIVE SWIVEL
ASSEMBLY FABRICATION
ACCESSORIES
EQUIPMENT AND PARTS
AIR BRAKE
BRASS
KITS

Air Tank Drain Valve

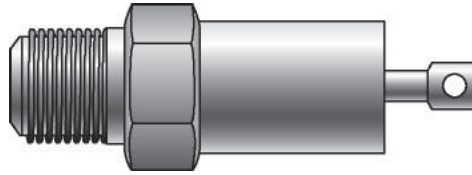

Part No.	Descr.	Prod. No.		
			"	"
G33021-0004	4MP-ATDV	7250-03155	1/4	1/4-18

Air Vent

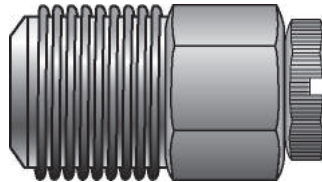

Part No.	Descr.	Prod. No.		
			"	"
G33022-0002	2MP-AV	7250-03165	1/8	1/8-27

One Way Check Valve

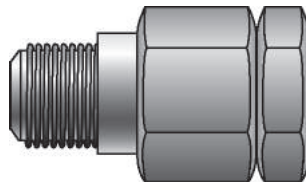

Part No.	Descr.	Prod. No.		
			"	"
G33027-0006	6MP-CV	7250-15565	3/8	3/8-18
G33027-0008	8MP-CV	7250-15575	1/2	1/2-14

Air Brake Adapter

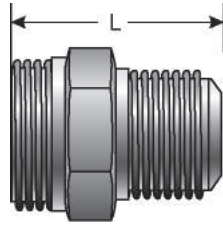

Part No.	Descr.	Prod. No.	⊖		🌀		L	
			"	mm	"	"	"	mm
G33030-0604	6MAB-4MP	7250-03175	3/8	9.7	3/4-20	1/4-18	1.06	26.9
G33030-0606	6MAB-6MP	7250-03185	3/8	9.7	3/4-20	3/8-18	1.12	28.5
G33030-0608	6MAB-8MP	7250-03195	3/8	9.7	3/4-20	1/2-14	1.18	30.0
G33030-0806	8MAB-6MP	7250-03205	1/2	12.7	7/8-20	3/8-18	1.18	30.0
G33030-0808	8MAB-8MP	7250-03215	1/2	12.7	7/8-20	1/2-14	1.37	34.8

Gladhand

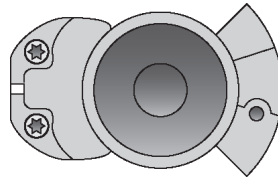

Part No.	Descr.	Prod. No.	Type
G33031-0508	8GH-S	7250-03225	Service
G33031-0608	8GH-U	7250-03235	Universal
G33031-0708	8GH-E	7250-03245	Emergency

Gladhand Seal



Part No.	Descr.	Prod. No.
G33032-0006	6GH-SEAL	7250-15595

- EQUIPMENT
- HOSE/CPLG. SELECTION
- G&K COUPLINGS
- GLOBALSPIRAL COUPLINGS
- STAINLESS STEEL SPIRAL
- MEGACRIMP COUPLINGS
- STAINLESS STEEL BRAID
- POWER CRIMP COUPLINGS
- FIELD ATTACHABLE G1 & G2 COUPLINGS
- FIELD ATTACHABLE C5 COUPLINGS
- GLX COUPLINGS
- GL COUPLINGS
- C14 COUPLINGS
- PCTS THERMOPLASTIC COUPLINGS
- POLARSEAL COUPLINGS
- POLARSEAL II COUPLINGS
- POWER STEERING
- ADAPTERS
- QUICK DISCONNECT COUPLERS
- BALL VALVES
- LIVE SWIVEL
- ASSEMBLY FABRICATION
- ACCESSORIES
- EQUIPMENT AND PARTS
- AIR BRAKE**
- BRASS
- KITS

Air Brake Couplings For Rubber Hose

EQUIPMENT
HOSE/CPLG. SELECTION
G8K COUPLINGS
GLOBALSPIRAL COUPLINGS
STAINLESS STEEL SPIRAL
MEGACRIMP COUPLINGS
STAINLESS STEEL BRAID
POWER CRIMP COUPLINGS
FIELD ATTACHABLE G1 & G2 COUPLINGS
FIELD ATTACHABLE C5 COUPLINGS
GLX COUPLINGS
GL COUPLINGS
C14 COUPLINGS
PCTS THERMOPLASTIC COUPLINGS
POLARSEAL COUPLINGS
POLARSEAL II COUPLINGS
POWER STEERING
ADAPTERS
QUICK DISCONNECT COUPLERS
BALL VALVES
LIVE SWIVEL
ASSEMBLY FABRICATION
ACCESSORIES
EQUIPMENT AND PARTS
AIR BRAKE
BRASS
KITS

Tube Sleeve

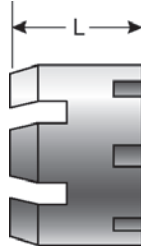

Part No.	Descr.	Prod. No.	⊖		L	
			"	mm	"	mm
G33050-0006	6TS-6ABR	7250-03265	3/8	9.7	.69	17.5
G33050-0008	8TS-8ABR	7250-03275	1/2	12.7	.69	17.5

Tube Sleeve Nut

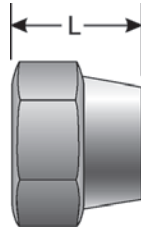

Part No.	Descr.	Prod. No.	⊖			L	
			"	mm	"	"	mm
G33060-0006	6TSN-6ABR	7250-03295	3/8	9.7	1 1/16	1.12	28.5
G33060-0008	8TSN-8ABR	7250-03305	1/2	12.7	1 1/4	1.12	28.5

Spring Guard Nut

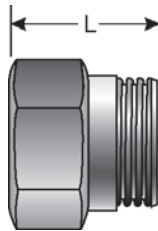

Part No.	Descr.	Prod. No.	⊖			L	
			"	mm	"	"	mm
G33061-0006	6SGN-6ABR	7250-03315	3/8	9.7	1 1/16	1.22	31.0
G33061-0008	8SGN-8ABR	7250-03325	1/2	12.7	1 1/4	1.19	30.2

Air Brake to Male Pipe

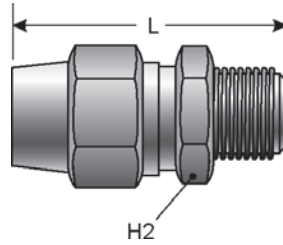

Part No.	Descr.	Prod. No.	⊖		🌀	H2	L	
			"	mm			"	mm
G33100-0604	6ABR-4MP	7250-03335	3/8	9.7	1/4-18	31/32	2.12	53.9
G33100-0606	6ABR-6MP	7250-03345	3/8	9.7	3/8-18	31/32	2.12	53.9
G33100-0608	6ABR-8MP	7250-03355	3/8	9.7	1/2-14	31/32	2.27	57.7
G33100-0806	8ABR-6MP	7250-03365	1/2	12.7	3/8-18	1 1/8	2.13	54.1
G33100-0808	8ABR-8MP	7250-03375	1/2	12.7	1/2-14	1 1/8	2.29	58.2

Air Brake to Male Pipe with Spring Guard

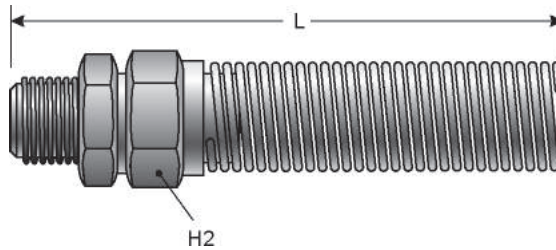

Part No.	Descr.	Prod. No.	⊖		🌀	H2	L	
			"	mm			"	mm
G33110-0604	6ABRSG-4MP	7250-03385	3/8	9.7	1/4-18	31/32	4.80	121.9
G33110-0606	6ABRSG-6MP	7250-03395	3/8	9.7	3/8-18	31/32	4.80	121.9
G33110-0608	6ABRSG-8MP	7250-03405	3/8	9.7	1/2-14	31/32	4.90	124.5
G33110-0806	8ABRSG-6MP	7250-03415	1/2	12.7	3/8-18	1 1/8	5.00	127.0
G33110-0808	8ABRSG-8MP	7250-03425	1/2	12.7	1/2-14	1 1/8	5.20	132.1

Air Brake to Male Pipe without Nut

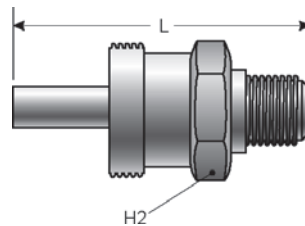

Part No.	Descr.	Prod. No.	⊖		🌀	H2	L	
			"	mm			"	mm
G33111-0604	6ABRI-4MP	7250-03435	3/8	9.7	1/4-18	31/32	1.91	48.5

- EQUIPMENT
- HOSE/CPLG. SELECTION
- G&K COUPLINGS
- GLOBALSPIRAL COUPLINGS
- STAINLESS STEEL SPIRAL
- MEGACRIMP COUPLINGS
- STAINLESS STEEL BRAID
- POWER CRIMP COUPLINGS
- FIELD ATTACHABLE G1 & G2 COUPLINGS
- FIELD ATTACHABLE C5 COUPLINGS
- GLX COUPLINGS
- GL COUPLINGS
- C14 COUPLINGS
- PCTS THERMOPLASTIC COUPLINGS
- POLARSEAL COUPLINGS
- POLARSEAL II COUPLINGS
- POWER STEERING
- ADAPTERS
- QUICK DISCONNECT COUPLERS
- BALL VALVES
- LIVE SWIVEL
- ASSEMBLY FABRICATION
- ACCESSORIES
- EQUIPMENT AND PARTS
- AIR BRAKE**
- BRASS
- KITS

Air Brake Couplings For Rubber Hose

Air Brake to Male Pipe without Nut - Continued

Part No.	Descr.	Prod. No.	⊖		H2	L		
			"	mm		"	mm	
G33111-0606	6ABRI-6MP	7250-03445	3/8	9.7	3/8-18	31/32	1.91	48.5
G33111-0608	6ABRI-8MP	7250-03455	3/8	9.7	1/2-14	31/32	2.06	52.3
G33111-0806	8ABRI-6MP	7250-03465	1/2	12.7	3/8-18	1 1/8	1.90	48.3
G33111-0808	8ABRI-8MP	7250-03475	1/2	12.7	1/2-14	1 1/8	2.07	52.6

Air Brake Spring Guard

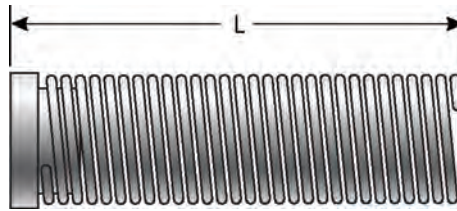

Part No.	Descr.	Prod. No.	⊖		L	
			"	mm	"	mm
G33112-0006	6SGABR	7250-03485	3/8	9.7	2.75	69.9
G33112-0008	8SGABR	7250-03495	1/2	12.7	3.00	76.2

Air Brake to Female Air Brake Swivel

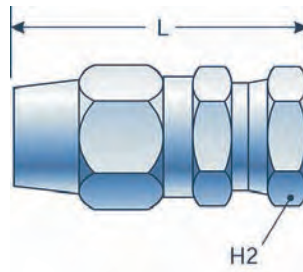

Part No.	Descr.	Prod. No.	⊖		H2	L		
			"	mm		"	mm	
G33150-0606	6ABR-6FABX	7250-03505	3/8	9.7	3/4-20	31/32	2.30	58.4
G33150-0808	8ABR-8FABX	7250-03515	1/2	12.7	7/8-20	1 1/8	2.36	59.9

Air Brake to Female Air Brake Swivel with Adapter

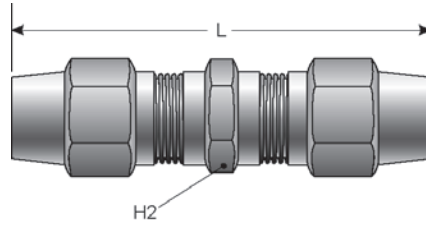

Part No.	Descr.	Prod. No.	⊖		🌀	H2	L	
			"	mm			"	mm
G33151-0604	6ABR-6FABX-4MPA	7250-03525	3/8	9.7	1/4-18	15/16	2.94	74.7
G33151-0606	6ABR-6FABX-6MPA	7250-03535	3/8	9.7	3/8-18	1 1/8	2.94	74.7
G33151-0608	6ABR-8FABX-8MPA	7250-03545	3/8	9.7	1/2-14	1 1/8	2.94	74.7
G33151-0806	8ABR-6FABX-6MPA	7250-15605	3/8	12.7	3/8-18	1 1/8	2.94	74.7

Air Brake Bulkhead

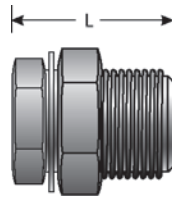

Part No.	Descr.	Prod. No.	⊖		🌀		L	
			"	mm	"	"	"	mm
G33300-0202	2FP-2FPBKHD	7250-15615	1/8	3.2	1/8-27	1/8-27	1.26	32.0
G33300-0404	4FP-4FPBKHD	7250-03555	1/4	6.4	1/4-18	1/4-18	1.50	38.1
G33300-0606	6FP-6FPBKHD	7250-03565	3/8	9.7	3/8-18	3/8-18	.94	23.9
G33300-0804	8FP-4FPBKHD	7250-03575	1/2	12.7	1/2-14	1/4-18	1.50	38.1
G33300-0808	8FP-8FPBKHD	7250-03585	1/2	12.7	1/2-14	1/2-14	1.50	38.1
G33301-0404	4FP-4FPBKHDS	7250-03595	3/8	9.7	1/4-18	1/4-18	.94	23.9
G33301-0804	8FP-4FPBKHDS	7250-03605	1/2	12.7	1/2-14	1/4-18	.94	23.9
G33302-0804	8MP-4FPBKHDL	7250-03615	1/2	12.7	1/2-14	1/4-18	2.88	73.2
G33303-0806	8MP-6FPBKHD	7250-15625	1/2	12.7	1/2-14	3/8-18	1.91	48.5

EQUIPMENT
HOSE/CPLG. SELECTION
G&K COUPLINGS
GLOBALSPIRAL COUPLINGS
STAINLESS STEEL SPIRAL
MEGACRIMP COUPLINGS
STAINLESS STEEL BRAID
POWER CRIMP COUPLINGS
FIELD ATTACHABLE G1 & G2 COUPLINGS
FIELD ATTACHABLE C5 COUPLINGS
GLX COUPLINGS
GL COUPLINGS
C14 COUPLINGS
PCTS THERMOPLASTIC COUPLINGS
POLARSEAL COUPLINGS
POLARSEAL II COUPLINGS
POWER STEERING
ADAPTERS
QUICK DISCONNECT COUPLERS
BALL VALVES
LIVE SWIVEL
ASSEMBLY FABRICATION
ACCESSORIES
EQUIPMENT AND PARTS
AIR BRAKE
BRASS
KITS

Air Brake Couplings For Rubber Hose

EQUIPMENT
HOSE/CPLG. SELECTION
G8K COUPLINGS
GLOBALSPIRAL COUPLINGS
STAINLESS STEEL SPIRAL
MEGACRIMP COUPLINGS
STAINLESS STEEL BRAID
POWER CRIMP COUPLINGS
FIELD ATTACHABLE G1 & G2 COUPLINGS
FIELD ATTACHABLE C5 COUPLINGS
GLX COUPLINGS
GL COUPLINGS
C14 COUPLINGS
PCTS THERMOPLASTIC COUPLINGS
POLARSEAL COUPLINGS
POLARSEAL II COUPLINGS
POWER STEERING
ADAPTERS
QUICK DISCONNECT COUPLERS
BALL VALVES
LIVE SWIVEL
ASSEMBLY FABRICATION
ACCESSORIES
EQUIPMENT AND PARTS
AIR BRAKE
BRASS
KITS

Air Brake Union

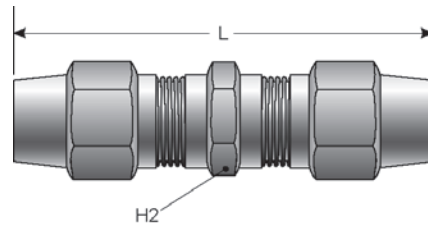

Part No.	Descr.	Prod. No.			
			"	H2	L
G33400-0606	6ABR-6ABR	7250-03625	3/8	31/32	2.98
G33400-0808	8ABR-8ABR	7250-03635	1/2	1 1/8	2.99

Male Pipe to Male SAE 45° Flare Truck Valve - 90°

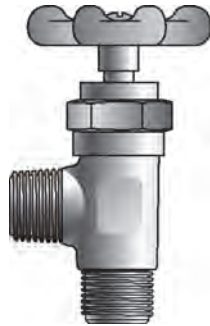

Part No.	Descr.	Prod. No.		
			"	"
G33610-0810	8MP-10MS90-TV	7250-15635	1/2-14	7/8-14

Male SAE 45° Flare to Male Pipe Truck Valve - 90°

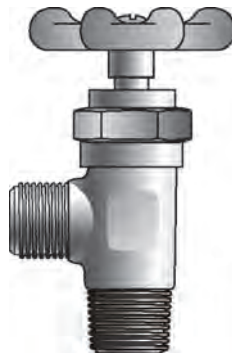

Part No.	Descr.	Prod. No.		
			"	"
G33612-0604	6MS-4MP90-TV	7250-15645	5/8-18	1/4-18



Air Brake Couplings For Rubber Hose

Male SAE 45° Flare to Male Pipe Truck Valve - 90° - Continued

Part No.	Descr.	Prod. No.		
			"	"
G33612-0606	6MS-6MP90-TV	7250-15655	5/8-18	3/8-18
G33612-0608	6MS-8MP90-TV	7250-15665	5/8-18	1/2-14
G33612-0806	8MS-6MP90-TV	7250-15675	3/4-16	3/8-18
G33612-0808	8MS-8MP90-TV	7250-15685	3/4-16	1/2-14
G33612-1008	10MS-8MP90-TV	7250-15695	7/8-14	1/2-14
G33612-1208	12MS-8MP90-TV	7250-15705	1 1/16-14	1/2-14

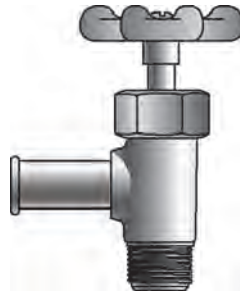

Single Bead Male Pipe Truck Valve - 90°

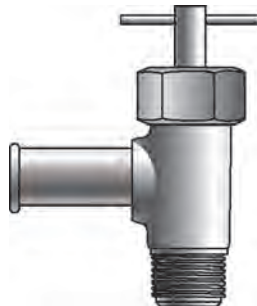

Part No.	Descr.	Prod. No.			
			"	mm	"
G33620-0606	6SB-6MP90-TV	7250-03645	3/8	9.7	3/8-18
G33620-0806	8SB-6MP90-TV	7250-15715	1/2	12.7	3/8-18
G33620-1006	10SB-6MP90-TV	7250-03655	5/8	15.9	3/8-18
G33620-1008	10SB-8MP90-TV	7250-03665	5/8	15.9	1/2-14
G33620-1206	12SB-6MP90-TV	7250-03675	3/4	19.1	3/8-18
G33620-1208	12SB-8MP90-TV	7250-03685	3/4	19.1	1/2-14

Single Bead to Male Pipe Truck Valve with Pin Handle - 90°



Part No.	Descr.	Prod. No.			
			"	mm	"
G33622-0606	6SB-6MP90-TVP	7250-15725	3/8	9.7	3/8-18
G33622-1006	10SB-6MP90-TVP	7250-03695	5/8	15.9	3/8-18

EQUIPMENT

HOSE/CPLG. SELECTION

G8K COUPLINGS

GLOBAL SPIRAL COUPLINGS

STAINLESS STEEL SPIRAL

MEGACRIMP COUPLINGS

STAINLESS STEEL BRAID

POWER CRIMP COUPLINGS

FIELD ATTACHABLE G1 & G2 COUPLINGS

FIELD ATTACHABLE C5 COUPLINGS

GLX COUPLINGS

GL COUPLINGS

C14 COUPLINGS

PCTS THERMOPLASTIC COUPLINGS

POLARSEAL COUPLINGS

POLARSEAL II COUPLINGS

POWER STEERING

ADAPTERS

QUICK DISCONNECT COUPLERS

BALL VALVES

LIVE SWIVEL

ASSEMBLY FABRICATION

ACCESSORIES

EQUIPMENT AND PARTS

AIR BRAKE

BRASS

KITS

Air Brake Couplings For Rubber Hose

Female Pipe to Male Pipe Truck Valve - 90°

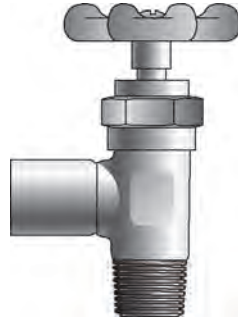

Part No.	Descr.	Prod. No.		
			"	"
G33630-0606	6FP-6MP90-TV	7250-03705	3/8-18	3/8-18
G33630-0608	6FP-8MP90-TV	7250-15735	3/8-18	1/2-14
G33630-0808	8FP-8MP90-TV	7250-03715	1/2-14	1/2-14

3-Way Truck Valve

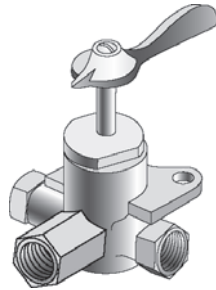

Part No.	Descr.	Prod. No.	
			"
G33650-0202	2FP-2FP-2FP3WTV	7250-03725	1/8-27
G33650-0404	4FP-4FP-4FP3WTV	7250-03735	1/4-18
G33650-0606	6FP-6FP-6FP3WTV	7250-03745	3/8-18

EQUIPMENT
HOSE/CPLG. SELECTION
G8K COUPLINGS
GLOBAL SPIRAL COUPLINGS
STAINLESS STEEL SPIRAL
MEGACRIMP COUPLINGS
STAINLESS STEEL BRAID
POWER CRIMP COUPLINGS
FIELD ATTACHABLE G1 & G2 COUPLINGS
FIELD ATTACHABLE C5 COUPLINGS
GLX COUPLINGS
GL COUPLINGS
C14 COUPLINGS
PCTS THERMOPLASTIC COUPLINGS
POLARSEAL COUPLINGS
POLARSEAL II COUPLINGS
POWER STEERING
ADAPTERS
QUICK DISCONNECT COUPLERS
BALL VALVES
LIVE SWIVEL
ASSEMBLY FABRICATION
ACCESSORIES
EQUIPMENT AND PARTS
AIR BRAKE
BRASS
KITS

4-Way Truck Valve

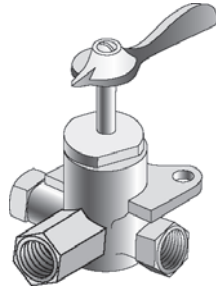

Part No.	Descr.	Prod. No.	
			"
G33655-0404	4FP-4FP-4FP4WTV	7250-03755	1/4-18
G33655-0606	6FP-6FP-6FP4WTV	7250-03765	3/8-18
G33656-0404	4FP-4FP-4FP4WTV-L	7250-03775	1/4-18
G33656-0606	6FP-6FP-6FP4WTV-L	7250-03785	3/8-18

Male Flareless Assembly to Male Flareless Assembly Shut-Off Cock

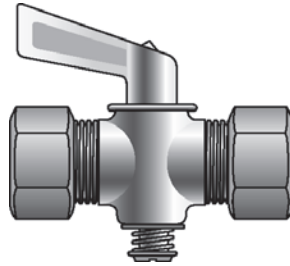



Part No.	Descr.	Prod. No.	
			"
G33701-0404	4MFA-4MFASC	7250-03795	1/4
G33701-0505	5MFA-5MFASC	7250-03805	5/16
G33701-0606	6MFA-6MFASC	7250-03815	3/8
G33701-0808	8MFA-8MFASC	7250-15745	1/2

EQUIPMENT
HOSE/CPLG. SELECTION
G&K COUPLINGS
GLOBALSPIRAL COUPLINGS
STAINLESS STEEL SPIRAL
MEGACRIMP COUPLINGS
STAINLESS STEEL BRAID
POWER CRIMP COUPLINGS
FIELD ATTACHABLE G1 & G2 COUPLINGS
FIELD ATTACHABLE C5 COUPLINGS
GLX COUPLINGS
GL COUPLINGS
C14 COUPLINGS
PCTS THERMOPLASTIC COUPLINGS
POLARSEAL COUPLINGS
POLARSEAL II COUPLINGS
POWER STEERING
ADAPTERS
QUICK DISCONNECT COUPLERS
BALL VALVES
LIVE SWIVEL
ASSEMBLY FABRICATION
ACCESSORIES
EQUIPMENT AND PARTS
AIR BRAKE
BRASS
KITS

Air Brake Couplings For Rubber Hose

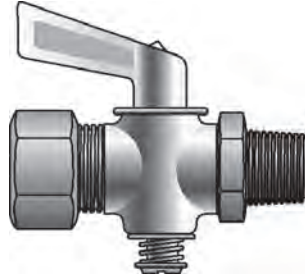
Male Flareless Assembly to Male Pipe Shut-Off Cock



Part No.	Descr.	Prod. No.		
			"	"
G33705-0402	4MFA-2MPSC	7250-03825	1/4	1/8-27
G33705-0404	4MFA-4MPSC	7250-03835	1/4	1/4-18
G33705-0502	5MFA-2MPSC	7250-03845	5/16	1/8-27
G33705-0504	5MFA-4MPSC	7250-03855	5/16	1/4-18
G33705-0604	6MFA-4MPSC	7250-03865	3/8	1/4-18
G33705-0806	8MFA-6MPSC	7250-15765	1/2	3/8-18

Male Pipe to Female Pipe Shut-Off Cock

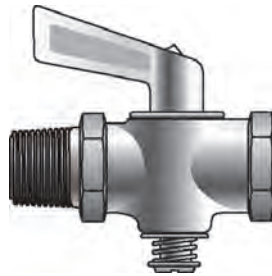

Part No.	Descr.	Prod. No.		
			"	"
G33710-0202	2MP-2FPSC	7250-03875	1/8-27	1/8-27
G33710-0404	4MP-4FPSC	7250-03885	1/4-18	1/4-18
G33710-0606	6MP-6FPSC	7250-15775	3/8-18	3/8-18
G33710-0808	8MP-8FPSC	7250-15785	1/2-14	1/2-14

EQUIPMENT
HOSE/CPLG. SELECTION
G8K COUPLINGS
GLOBAL SPIRAL COUPLINGS
STAINLESS STEEL SPIRAL
MEGACRIMP COUPLINGS
STAINLESS STEEL BRAID
POWER CRIMP COUPLINGS
FIELD ATTACHABLE G1 & G2 COUPLINGS
FIELD ATTACHABLE C5 COUPLINGS
GLX COUPLINGS
GL COUPLINGS
C14 COUPLINGS
PCTS THERMOPLASTIC COUPLINGS
POLARSEAL COUPLINGS
POLARSEAL II COUPLINGS
POWER STEERING
ADAPTERS
QUICK DISCONNECT COUPLERS
BALL VALVES
LIVE SWIVEL
ASSEMBLY FABRICATION
ACCESSORIES
EQUIPMENT AND PARTS
AIR BRAKE
BRASS
KITS

Female Pipe to Female Pipe Shut-Off Cock

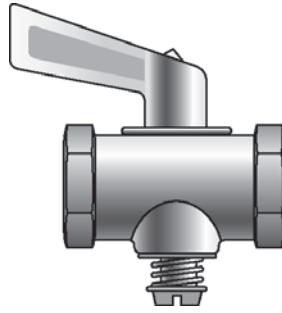

Part No.	Descr.	Prod. No.		
			"	"
G33715-0202	2FP-2FPSC	7250-03895	1/8-27	1/8-27
G33715-0404	4FP-4FPSC	7250-03905	1/4-18	1/8-27
G33715-0606	6FP-6FPSC	7250-15795	3/8-18	3/8-18
G33715-0808	8FP-8FPSC	7250-15805	1/2-14	1/2-14

Male SAE 45° Flare to Male Pipe Shut-Off Cock

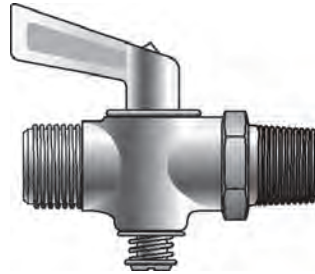



Part No.	Descr.	Prod. No.		
			"	"
G33720-0402	4MS-2MPSC	7250-03915	7/16-20	1/8-27
G33720-0404	4MS-4MPSC	7250-15815	7/16-20	7/16-20
G33720-0502	5MS-2MPSC	7250-03925	1/2-20	1/8-27
G33720-0504	5MS-4MPSC	7250-03935	1/2-20	1/4-18
G33720-0604	6MS-4MPSC	7250-03945	5/8-18	1/4-18
G33720-0606	6MS-6MPSC	7250-15825	5/8-18	3/8-18
G33720-0608	6MS-8MPSC	7250-15835	5/8-18	1/2-14
G33720-0806	8MS-6MPSC	7250-15845	3/4-16	3/8-18
G33720-0808	8MS-8MPSC	7250-15855	3/4-16	1/2-14

EQUIPMENT
HOSE/CPLG. SELECTION
G&K COUPLINGS
GLOBALSPIRAL COUPLINGS
STAINLESS STEEL SPIRAL
MEGACRIMP COUPLINGS
STAINLESS STEEL BRAID
POWER CRIMP COUPLINGS
FIELD ATTACHABLE G1 & G2 COUPLINGS
FIELD ATTACHABLE C5 COUPLINGS
GLX COUPLINGS
GL COUPLINGS
C14 COUPLINGS
PCTS THERMOPLASTIC COUPLINGS
POLARSEAL COUPLINGS
POLARSEAL II COUPLINGS
POWER STEERING
ADAPTERS
QUICK DISCONNECT COUPLERS
BALL VALVES
LIVE SWIVEL
ASSEMBLY FABRICATION
ACCESSORIES
EQUIPMENT AND PARTS
AIR BRAKE
BRASS
KITS

Air Brake Couplings For Rubber Hose

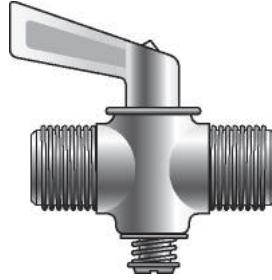

Male SAE 45° Flare to Male SAE 45° Flare Shut-Off Cock

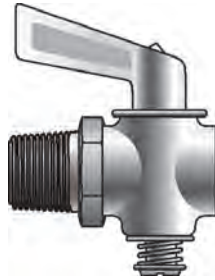

Part No.	Descr.	Prod. No.		
			"	"
G33730-0404	4MS-4MSSC	7250-03955	7/16-20	7/16-20
G33730-0505	5MS-5MSSC	7250-03965	1/2-20	1/2-20
G33730-0606	6MS-6MSSC	7250-03975	5/8-18	5/8-18
G33730-0808	8MS-8MSSC	7250-15865	3/4-16	3/4-16
G33730-1010	10MS-10MSSC	7250-15875	7/8-14	7/8-14

Male Pipe Air Drain Cock



Part No.	Descr.	Prod. No.		
			"	"
G33801-0002	2MP-ADC	7250-03985	1/8	1/8-27
G33801-0004	4MP-ADC	7250-03995	1/4	1/4-18
G33801-0006	6MP-ADC	7250-04005	3/8	3/8-18
G33801-0008	8MP-ADC	7250-15885	1/2	1/2-14

EQUIPMENT
HOSE/CPLG. SELECTION
G8K COUPLINGS
GLOBALSPIRAL COUPLINGS
STAINLESS STEEL SPIRAL
MEGACRIMP COUPLINGS
STAINLESS STEEL BRAID
POWER CRIMP COUPLINGS
FIELD ATTACHABLE G1 & G2 COUPLINGS
FIELD ATTACHABLE C5 COUPLINGS
GLX COUPLINGS
GL COUPLINGS
C14 COUPLINGS
PCTS THERMOPLASTIC COUPLINGS
POLARSEAL COUPLINGS
POLARSEAL II COUPLINGS
POWER STEERING
ADAPTERS
QUICK DISCONNECT COUPLERS
BALL VALVES
LIVE SWIVEL
ASSEMBLY FABRICATION
ACCESSORIES
EQUIPMENT AND PARTS
AIR BRAKE
BRASS
KITS

Female Pipe to Male Pipe Air Drain Cock

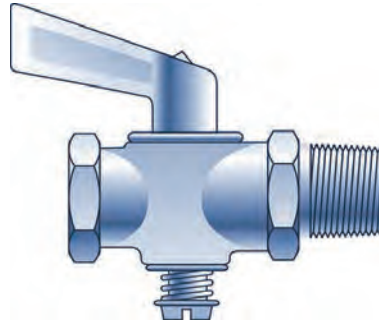

Part No.	Descr.	Prod. No.		
			"	"
G33805-0202	2FP-2MPADC	7250-15895	1/8-27	1/8-27
G33805-0404	4FP-4MPADC	7250-04015	1/4-18	1/4-18
G33805-0808	8FP-8MPADC	7250-15925	1/2-14	1/2-14

Male Pipe Drain Cock - Bibb Nose

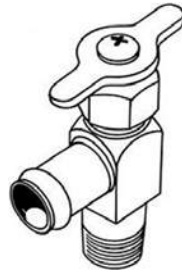

Part No.	Descr.	Prod. No.		
			"	"
G33823-1006	10BN-6MPDC90	7250-04025	3/8-18	

Male Pipe Drain Cock - Internal Seat



Part No.	Descr.	Prod. No.		
			"	"
G33830-0002	2MP-ISDC	7250-15935	1/8-27	
G33830-0004	4MP-ISDC	7250-15945	1/4-18	
G33830-0006	6MP-ISDC	7250-15955	3/8-18	

- EQUIPMENT
- HOSE/CPLG. SELECTION
- G8K COUPLINGS
- GLOBALSPIRAL COUPLINGS
- STAINLESS STEEL SPIRAL
- MEGACRIMP COUPLINGS
- STAINLESS STEEL BRAID
- POWER CRIMP COUPLINGS
- FIELD ATTACHABLE G1 & G2 COUPLINGS
- FIELD ATTACHABLE C5 COUPLINGS
- GLX COUPLINGS
- GL COUPLINGS
- C14 COUPLINGS
- PCTS THERMOPLASTIC COUPLINGS
- POLARSEAL COUPLINGS
- POLARSEAL II COUPLINGS
- POWER STEERING
- ADAPTERS
- QUICK DISCONNECT COUPLERS
- BALL VALVES
- LIVE SWIVEL
- ASSEMBLY FABRICATION
- ACCESSORIES
- EQUIPMENT AND PARTS
- AIR BRAKE**
- BRASS
- KITS

Air Brake Couplings For Rubber Hose

EQUIPMENT
HOSE/CPLG. SELECTION
G8K COUPLINGS
GLOBALSPIRAL COUPLINGS
STAINLESS STEEL SPIRAL
MEGACRIMP COUPLINGS
STAINLESS STEEL BRAID
POWER CRIMP COUPLINGS
FIELD ATTACHABLE G1 & G2 COUPLINGS
FIELD ATTACHABLE C5 COUPLINGS
GLX COUPLINGS
GL COUPLINGS
C14 COUPLINGS
PCTS THERMOPLASTIC COUPLINGS
POLARSEAL COUPLINGS
POLARSEAL II COUPLINGS
POWER STEERING
ADAPTERS
QUICK DISCONNECT COUPLERS
BALL VALVES
LIVE SWIVEL
ASSEMBLY FABRICATION
ACCESSORIES
EQUIPMENT AND PARTS
AIR BRAKE
BRASS
KITS

Male Pipe Drain Cock - External Seat



Part No.	Descr.	Prod. No.		
			"	"
G33831-0004	4MP-ESDC	7250-04075	1/4	1/4-18

Male Pipe Air Drain Cock - Bibb Nose

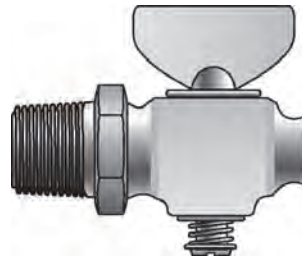

Part No.	Descr.	Prod. No.	
			"
G33832-0202	2MP-ADCBN	7250-15965	1/8-27
G33832-0404	4MP-ADCBN	7250-04085	1/4-18
G33832-0808	8MP-ADCBN	7250-15985	1/2-14

Air Tank Valve



Part No.	Descr.	Prod. No.	
			"
G33850-0202	2ATNKV	7250-15995	1/8-27
G33850-0404	4ATNKV	7250-16005	1/4-18

Male Flareless Assembly to Male Flareless Assembly - Needle Valve

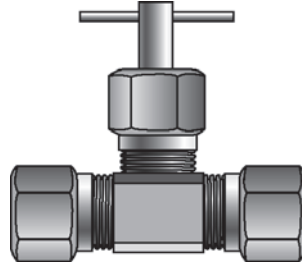

Part No.	Descr.	Prod. No.	⊗	⋈	
			"	"	"
G33901-0303	3MFA-3MFANV	7250-04145	3/16	3/8-24	3/8-24
G33901-0404	4MFA-4MFANV	7250-04155	1/4	7/16-20	7/16-20
G33901-0505	5MFA-5MFANV	7250-04165	5/16	1/2-20	1/2-20
G33901-0606	6MFA-6MFANV	7250-04175	3/8	9/16-18	9/16-18

Male Flareless Assembly to Male Flareless Assembly - Needle Valve - 90°

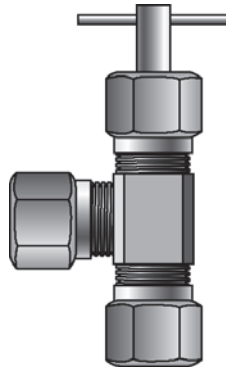

Part No.	Descr.	Prod. No.	⊗	⋈	
			"	"	"
G33905-0302	3MFA-2MP90NV	7250-04185	3/16	3/8-24	1/8-27
G33905-0402	4MFA-2MP90NV	7250-04195	1/4	7/16-20	1/8-27
G33905-0404	4MFA-4MP90NV	7250-16015	1/4	7/16-20	1/4-18
G33905-0502	5MFA-2MP90NV	7250-04205	5/16	1/2-18	1/8-27
G33905-0504	5MFA-4MP90NV	7250-04215	5/16	1/2-18	1/4-18
G33905-0602	6MFA-2MP90NV	7250-16025	3/8	9/16-18	1/8-27
G33905-0604	6MFA-4MP90NV	7250-04225	3/8	9/16-18	1/4-18

EQUIPMENT
HOSE/CPLG. SELECTION
G&K COUPLINGS
GLOBALSPIRAL COUPLINGS
STAINLESS STEEL SPIRAL
MEGACRIMP COUPLINGS
STAINLESS STEEL BRAID
POWER CRIMP COUPLINGS
FIELD ATTACHABLE G1 & G2 COUPLINGS
FIELD ATTACHABLE C5 COUPLINGS
GLX COUPLINGS
GL COUPLINGS
C14 COUPLINGS
PCTS THERMOPLASTIC COUPLINGS
POLARSEAL COUPLINGS
POLARSEAL II COUPLINGS
POWER STEERING
ADAPTERS
QUICK DISCONNECT COUPLERS
BALL VALVES
LIVE SWIVEL
ASSEMBLY FABRICATION
ACCESSORIES
EQUIPMENT AND PARTS
AIR BRAKE
BRASS
KITS

Air Brake Couplings For Rubber Hose

Male Flareless Assembly to Male Pipe - Needle Valve

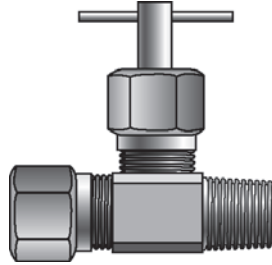

Part No.	Descr.	Prod. No.			
			"	"	"
G33910-0202	2MFA-2MPNV	7250-04235	1/8	1/8-27	1/8-27
G33910-0302	3MFA-2MPNV	7250-04245	3/16	3/8-24	1/8-27
G33910-0402	4MFA-2MPNV	7250-04255	1/4	7/16-20	1/8-27
G33910-0404	4MFA-4MPNV	7250-04265	1/4	7/16-20	1/4-18
G33910-0502	5MFA-2MPNV	7250-04275	5/16	1/2-18	1/8-27
G33910-0504	5MFA-4MPNV	7250-04285	5/16	1/2-18	1/4-18
G33910-0604	6MFA-4MPNV	7250-04295	3/8	9/16-18	1/4-18

Male Pipe to Male Pipe - Needle Valve

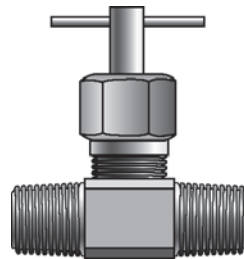

Part No.	Descr.	Prod. No.		
			"	"
G33915-0202	2MP-2MPNV	7250-16035	1/8-27	1/8-27
G33915-0404	4MP-4MPNV	7250-16045	1/4-18	1/4-18

EQUIPMENT
HOSE/CPLG. SELECTION
G8K COUPLINGS
GLOBALSPIRAL COUPLINGS
STAINLESS STEEL SPIRAL
MEGACRIMP COUPLINGS
STAINLESS STEEL BRAID
POWER CRIMP COUPLINGS
FIELD ATTACHABLE G1 & G2 COUPLINGS
FIELD ATTACHABLE C5 COUPLINGS
GLX COUPLINGS
GL COUPLINGS
C14 COUPLINGS
PCTS THERMOPLASTIC COUPLINGS
POLARSEAL COUPLINGS
POLARSEAL II COUPLINGS
POWER STEERING
ADAPTERS
QUICK DISCONNECT COUPLERS
BALL VALVES
LIVE SWIVEL
ASSEMBLY FABRICATION
ACCESSORIES
EQUIPMENT AND PARTS
AIR BRAKE
BRASS
KITS

Male Pipe to Female Pipe - Needle Valve

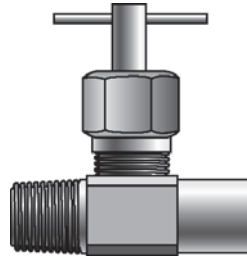

Part No.	Descr.	Prod. No.		
			"	"
G33920-0202	2MP-2FPNV	7250-04305	1/8-27	1/8-27
G33920-0404	4MP-4FPNV	7250-04315	1/4-18	1/4-18

Female Pipe to Female Pipe - Needle Valve

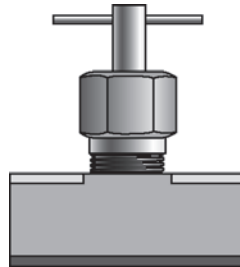

Part No.	Descr.	Prod. No.		
			"	"
G33930-0202	2FP-2FPNV	7250-04325	1/8-27	1/8-27
G33930-0404	4FP-4FPNV	7250-04335	1/4-18	1/4-18

Male SAE 45° Flare to Male Pipe - Needle Valve

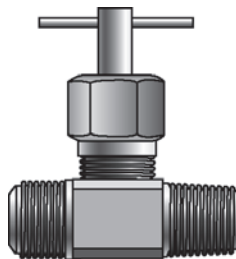



Part No.	Descr.	Prod. No.		
			"	"
G33940-0402	4MS-2MPNV	7250-04345	7/16-20	1/8-27
G33940-0404	4MS-4MPNV	7250-04355	7/16-20	1/4-18
G33940-0502	5MS-2MPNV	7250-04365	1/2-20	1/8-27
G33940-0504	5MS-4MPNV	7250-04375	1/2-20	1/4-18
G33940-0604	6MS-4MPNV	7250-04385	5/8-18	1/4-18

EQUIPMENT
HOSE/CPLG. SELECTION
G&K COUPLINGS
GLOBALSPIRAL COUPLINGS
STAINLESS STEEL SPIRAL
MEGACRIMP COUPLINGS
STAINLESS STEEL BRAID
POWER CRIMP COUPLINGS
FIELD ATTACHABLE G1 & G2 COUPLINGS
FIELD ATTACHABLE C5 COUPLINGS
GLX COUPLINGS
GL COUPLINGS
C14 COUPLINGS
PCTS THERMOPLASTIC COUPLINGS
POLARSEAL COUPLINGS
POLARSEAL II COUPLINGS
POWER STEERING
ADAPTERS
QUICK DISCONNECT COUPLERS
BALL VALVES
LIVE SWIVEL
ASSEMBLY FABRICATION
ACCESSORIES
EQUIPMENT AND PARTS
AIR BRAKE
BRASS
KITS

Air Brake Couplings For Rubber Hose

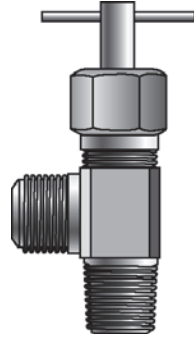
Male SAE 45° Flare to Male Pipe - Needle Valve - 90°



Part No.	Descr.	Prod. No.		
			"	"
G33945-0402	4MS-2MP90NV	7250-04135	7/16-20	1/8-27
G33945-0502	5MS-2MP90NV	7250-04395	1/2-20	1/8-27
G33945-0504	5MS-4MP90NV	7250-04405	1/2-20	1/4-18
G33945-0604	6MS-4MP90NV	7250-04415	5/8-18	1/4-18

Male SAE 45° Flare to Male SAE 45° Flare - Needle Valve

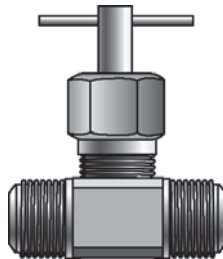

Part No.	Descr.	Prod. No.		
			"	"
G33950-0404	4MS-4MSNV	7250-04425	7/16-20	7/16-20
G33950-0606	6MS-6MSNV	7250-16055	5/8-18	5/8-18

EQUIPMENT
HOSE/CPLG. SELECTION
G8K COUPLINGS
GLOBAL SPIRAL COUPLINGS
STAINLESS STEEL SPIRAL
MEGACRIMP COUPLINGS
STAINLESS STEEL BRAID
POWER CRIMP COUPLINGS
FIELD ATTACHABLE G1 & G2 COUPLINGS
FIELD ATTACHABLE C5 COUPLINGS
GLX COUPLINGS
GL COUPLINGS
C14 COUPLINGS
PCTS THERMOPLASTIC COUPLINGS
POLARSEAL COUPLINGS
POLARSEAL II COUPLINGS
POWER STEERING
ADAPTERS
QUICK DISCONNECT COUPLERS
BALL VALVES
LIVE SWIVEL
ASSEMBLY FABRICATION
ACCESSORIES
EQUIPMENT AND PARTS
AIR BRAKE
BRASS
KITS

Brass Lock-On Field Attachable Couplings for LOC & LOL Hose

Male Pipe (NPTF - 30° Cone Seat)



Part No.	Descr.	Prod. No.	⊖		🌀	C	
			"	mm		"	mm
G36100-0402	4LOC-2RMP	7250-04435	1/4	6.4	1/8-27	.56	14.2
G36100-0404	4LOC-4RMP	7250-04445	1/4	6.4	1/4-18	.81	20.6
G36100-0406	4LOC-6RMP	7250-16065	1/4	6.4	3/8-18	.88	22.4
G36100-0502	5LOC-2RMP	7250-04455	5/16	7.9	1/8-27	.81	20.6
G36100-0504	5LOC-4RMP	7250-04465	5/16	7.9	1/4-18	.77	19.6
G36100-0602	6LOC-2RMP	7250-04475	3/8	9.5	1/8-27	.56	14.2
G36100-0604	6LOC-4RMP	7250-04485	3/8	9.5	1/4-18	.81	20.6
G36100-0606	6LOC-6RMP	7250-04495	3/8	9.5	3/8-18	.88	22.4
G36100-0608	6LOC-8RMP	7250-16075	3/8	9.5	1/2-14	.88	22.4
G36100-0804	8LOC-4RMP	7250-16085	1/2	12.7	1/4-18	.81	20.6
G36100-0806	8LOC-6RMP	7250-04505	1/2	12.7	3/8-18	.88	22.4
G36100-0808	8LOC-8RMP	7250-04515	1/2	12.7	1/2-14	.88	22.4
G36100-0812	8LOC-12RMP	7250-16095	1/2	12.7	3/4-14	1.13	28.7
G36100-1006	10LOC-6RMP	7250-16105	5/8	15.9	3/8-18	.88	22.4
G36100-1008	10LOC-8RMP	7250-04525	5/8	15.9	1/2-14	1.06	26.9
G36100-1012	10LOC-12RMP	7250-16115	5/8	15.9	3/4-14	.88	22.4
G36100-1208	12LOC-8RMP	7250-16125	3/4	19.1	1/2-14	.88	22.4
G36100-1212	12LOC-12RMP	7250-04535	3/4	19.1	3/4-14	1.13	28.7

Male Pipe Swivel (NPTF - Without 30° Cone Seat)



Part No.	Descr.	Prod. No.	⊖		🌀	C	
			"	mm		"	mm
G36105-0404	4LOC-4RMPX	7250-16135	1/4	6.4	1/4-18	1.81	46.0
G36105-0606	6LOC-6RMPX	7250-16145	3/8	9.5	3/8-18	2.00	50.8
G36105-0808	8LOC-8RMPX	7250-16155	1/2	12.7	1/2-14	2.38	60.5
G36105-1212	12LOC-12RMPX	7250-16165	3/4	19.1	3/4-1/4	2.68	68.1

EQUIPMENT

HOSE/CPLG.
SELECTION

G8K COUPLINGS

GLOBALSPIRAL
COUPLINGSSTAINLESS
STEEL SPIRALMEGACRIMP
COUPLINGSSTAINLESS
STEEL BRAIDPOWER CRIMP
COUPLINGSFIELD
ATTACHABLE G1
& G2 COUPLINGSFIELD
ATTACHABLE C5
COUPLINGS

GLX COUPLINGS

GL COUPLINGS

C14 COUPLINGS

PCTS
THERMOPLASTIC
COUPLINGSPOLARSEAL
COUPLINGSPOLARSEAL II
COUPLINGSPOWER
STEERING

ADAPTERS

QUICK
DISCONNECT
COUPLERS

BALL VALVES

LIVE SWIVEL

ASSEMBLY
FABRICATION

ACCESSORIES

EQUIPMENT AND
PARTS

AIR BRAKE

BRASS

KITS

Brass Lock-On Field Attachable Couplings for LOC & LOL Hose

Male Pipe - 90° Block (NPTF - Without 30° Cone Seat)

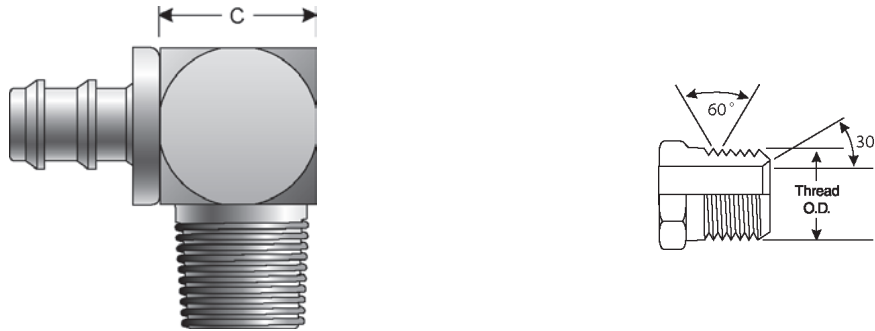

Part No.	Descr.	Prod. No.	⊘		Thread	C	
			"	mm		"	mm
G36106-0402	4LOC-2RMP90	7250-16175	1/4	6.4	1/8-27	.31	7.9
G36106-0404	4LOC-4RMP90	7250-16185	1/4	6.4	1/4-18	.38	9.7
G36106-0502	5LOC-2RMP90	7250-04555	5/16	7.9	1/8-27	.31	7.9
G36106-0504	5LOC-4RMP90	7250-04565	5/16	7.9	1/4-18	.38	9.7
G36106-0602	6LOC-2RMP90	7250-04575	3/8	9.5	1/8-27	.38	9.7
G36106-0604	6LOC-4RMP90	7250-04585	3/8	9.5	1/4-18	.40	10.2
G36106-0606	6LOC-6RMP90	7250-16195	3/8	9.5	3/8-18	.43	10.9
G36106-0808	8LOC-8RMP90	7250-16205	1/2	12.7	1/2-14	.50	12.7
G36106-1212	12LOC-12RMP90	7250-16215	3/4	19.1	3/4-14	.76	19.3

Female Pipe (NPTF - 30° Cone Seat)



Part No.	Descr.	Prod. No.	⊘		Thread	C	
			"	mm		"	mm
G36110-0404	4LOC-4RFP	7250-04595	1/4	6.4	1/4-18	.50	12.7
G36110-0504	5LOC-4RFP	7250-16225	5/16	7.9	1/4-18	.50	12.7
G36110-0606	6LOC-6RFP	7250-04605	3/8	9.5	3/8-18	.63	16.0
G36110-0806	8LOC-6RFP	7250-16235	1/2	12.7	3/8-18	.63	16.0
G36110-0808	8LOC-8RFP	7250-04615	1/2	12.7	1/2-14	.75	19.1
G36110-1008	10LOC-8RFP	7250-16245	5/8	15.9	1/2-14	.75	19.1
G36110-1212	12LOC-12RFP	7250-16255	3/4	19.1	3/4-14	.93	23.6

- EQUIPMENT
- HOSE/CPLG. SELECTION
- G8K COUPLINGS
- GLOBALSPIRAL COUPLINGS
- STAINLESS STEEL SPIRAL
- MEGACRIMP COUPLINGS
- STAINLESS STEEL BRAID
- POWER CRIMP COUPLINGS
- FIELD ATTACHABLE G1 & G2 COUPLINGS
- FIELD ATTACHABLE C5 COUPLINGS
- GLX COUPLINGS
- GL COUPLINGS
- C14 COUPLINGS
- PCTS THERMOPLASTIC COUPLINGS
- POLARSEAL COUPLINGS
- POLARSEAL II COUPLINGS
- POWER STEERING
- ADAPTERS
- QUICK DISCONNECT COUPLERS
- BALL VALVES
- LIVE SWIVEL
- ASSEMBLY FABRICATION
- ACCESSORIES
- EQUIPMENT AND PARTS
- AIR BRAKE
- BRASS
- KITS

Female Pipe Swivel (NPTF - Without 30° Cone Seat)



Part No.	Descr.	Prod. No.	⊖		🌀	C	
			"	mm		"	mm
G36111-0402	4LOC-2RFPX	7250-16265	1/4	6.4	1/8-27	1.81	46.0
G36111-0404	4LOC-4RFPX	7250-16275	1/4	6.4	1/4-18	1.81	46.0
G36111-0406	4LOC-6RFPX	7250-16285	1/4	6.4	3/8-18	2.00	50.8
G36111-0604	6LOC-4RFPX	7250-16295	3/8	9.5	1/4-18	1.81	46.0
G36111-0606	6LOC-6RFPX	7250-16305	3/8	9.5	3/8-18	2.00	50.8
G36111-0608	6LOC-8RFPX	7250-16315	3/8	9.5	1/2-14	2.38	60.5
G36111-0808	8LOC-8RFPX	7250-16325	1/2	12.7	1/2-14	2.38	60.5
G36111-0812	8LOC-12RFPX	7250-16335	1/2	12.7	3/4-14	2.68	68.1
G36111-1012	10LOC-12RFPX	7250-16345	3/4	19.1	3/4-14	2.68	68.1
G36111-1212	12LOC-12RFPX	7250-16355	3/4	19.1	3/4-14	2.68	68.1

Male JIC 37° Flare

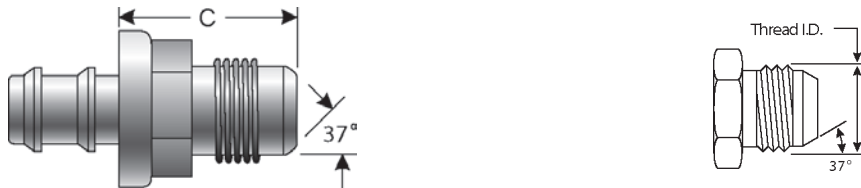

Part No.	Descr.	Prod. No.	⊖		🌀	C	
			"	mm		"	mm
G36165-0404	4LOC-4RMJ	7250-16365	1/4	6.4	7/16-20	.81	20.6
G36165-0405	4LOC-5RMJ	7250-16375	1/4	6.4	1/2-20	.94	23.9
G36165-0406	4LOC-6RMJ	7250-16385	1/4	6.4	9/16-18	1.00	25.4
G36165-0604	6LOC-4RMJ	7250-16395	3/8	9.5	7/16-20	.88	22.4
G36165-0605	6LOC-5RMJ	7250-16405	3/8	9.5	1/2-20	.94	23.9
G36165-0606	6LOC-6RMJ	7250-16415	3/8	9.5	9/16-18	1.00	25.4
G36165-0608	6LOC-8RMJ	7250-16425	3/8	9.5	3/4-16	1.19	30.2
G36165-0808	8LOC-8RMJ	7250-16435	1/2	12.7	3/4-16	1.19	30.2
G36165-0810	8LOC-10RMJ	7250-16445	1/2	12.7	7/8-14	1.27	32.3
G36165-1008	10LOC-8RMJ	7250-16455	5/8	15.9	3/4-16	1.19	30.2
G36165-1010	10LOC-10RMJ	7250-16465	5/8	15.9	7/8-14	1.27	32.3
G36165-1210	12LOC-10RMJ	7250-16475	3/4	19.1	7/8-14	1.27	32.3
G36165-1212	12LOC-12RMJ	7250-16485	3/4	19.1	1 1/16-12	1.33	33.8

- EQUIPMENT
- HOSE/CPLG. SELECTION
- G&K COUPLINGS
- GLOBALSPIRAL COUPLINGS
- STAINLESS STEEL SPIRAL
- MEGACRIMP COUPLINGS
- STAINLESS STEEL BRAID
- POWER CRIMP COUPLINGS
- FIELD ATTACHABLE G1 & G2 COUPLINGS
- FIELD ATTACHABLE C5 COUPLINGS
- GLX COUPLINGS
- GL COUPLINGS
- C14 COUPLINGS
- PCTS THERMOPLASTIC COUPLINGS
- POLARSEAL COUPLINGS
- POLARSEAL II COUPLINGS
- POWER STEERING
- ADAPTERS
- QUICK DISCONNECT COUPLERS
- BALL VALVES
- LIVE SWIVEL
- ASSEMBLY FABRICATION
- ACCESSORIES
- EQUIPMENT AND PARTS
- AIR BRAKE
- BRASS
- KITS

Brass Lock-On Field Attachable Couplings for LOC & LOL Hose

Female JIC 37° Flare Swivel



Part No.	Descr.	Prod. No.	⌀		Thread I.D.	C	
			"	mm		"	mm
G36170-0406	4LOC-6RFJX	7250-16495	1/4	6.4	3/8-18	.74	18.8
G36170-0606	6LOC-6RFJX	7250-04625	3/8	9.5	9/16-18	.81	20.6
G36170-0606X	6LOC-6RFJX XBULK	7250-0462	3/8	9.5	9/16-18	.81	20.6
G36170-1212	12LOC-12RFJX	7250-04635	3/4	19.1	1 1/16-12	1.09	27.7

Male SAE 45° Flare



Part No.	Descr.	Prod. No.	⌀		Thread I.D.	C	
			"	mm		"	mm
G36195-0404	4LOC-4RMS	7250-04645	1/4	6.4	7/16-20	.69	17.5
G36195-0405	4LOC-5RMS	7250-04655	1/4	6.4	1/2-20	.38	9.7
G36195-0406	4LOC-6RMS	7250-04665	1/4	6.4	5/8-18	.88	22.4
G36195-0505	5LOC-5RMS	7250-04675	5/16	7.9	1/2-20	.81	20.6
G36195-0604	6LOC-4RMS	7250-16505	3/8	9.5	7/16-20	.69	17.5
G36195-0605	6LOC-5RMS	7250-16515	3/8	9.5	1/2-20	.81	20.6
G36195-0606	6LOC-6RMS	7250-04685	3/8	9.5	5/8-18	.88	22.4
G36195-0608	6LOC-8RMS	7250-16525	3/8	9.5	3/4-16	1.31	33.3
G36195-0808	8LOC-8RMS	7250-18285	1/2	12.7	3/4-16	1.13	28.7
G36195-0810	8LOC-10RMS	7250-16535	1/2	12.7	7/8-14	1.27	32.3
G36195-1008	10LOC-8RMS	7250-16545	5/8	15.9	3/4-16	1.13	28.7
G36195-1010	10LOC-10RMS	7250-16555	5/8	15.9	7/8-14	1.27	32.3
G36195-1210	12LOC-10RMS	7250-16565	3/4	19.1	7/8-14	1.27	32.3
G36195-1212	12LOC-12RMS	7250-16575	3/4	19.1	1 1/16-14	1.83	46.5

EQUIPMENT
HOSE/CPLG. SELECTION
G8K COUPLINGS
GLOBALSPIRAL COUPLINGS
STAINLESS STEEL SPIRAL
MEGACRIMP COUPLINGS
STAINLESS STEEL BRAID
POWER CRIMP COUPLINGS
FIELD ATTACHABLE G1 & G2 COUPLINGS
FIELD ATTACHABLE C5 COUPLINGS
GLX COUPLINGS
GL COUPLINGS
C14 COUPLINGS
PCTS THERMOPLASTIC COUPLINGS
POLARSEAL COUPLINGS
POLARSEAL II COUPLINGS
POWER STEERING
ADAPTERS
QUICK DISCONNECT COUPLERS
BALL VALVES
LIVE SWIVEL
ASSEMBLY FABRICATION
ACCESSORIES
EQUIPMENT AND PARTS
AIR BRAKE
BRASS
KITS

Female SAE 45° Flare Swivel



Part No.	Descr.	Prod. No.	⊖		🌀	C	
			"	mm		"	mm
G36200-0406	4LOC-6RFSX	7250-16585	1/4	6.4	5/8-18	.69	17.5
G36200-0506	5LOC-6RFSX*	7250-18295	5/16	7.9	5/8-18	.81	20.6
G36200-0606	6LOC-6RFSX	7250-04695	3/8	9.5	5/8-18	.84	21.3
G36200-0606X	6LOC-6RFSX XBULK	7250-0469	3/8	9.5	5/8-18	.84	21.3
G36200-0806	8LOC-6RFSX	7250-16595	1/2	12.7	5/8-18	.84	21.3
G36200-1212	12LOC-12RFSX	7250-04705	3/4	19.1	1 1/16-14	1.09	27.7

*Steel

Dual Seat Female JIC 37°/SAE 45° Flare Swivel

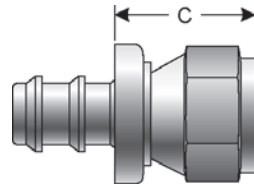

Part No.	Descr.	Prod. No.	⊖		🌀	C	
			"	mm		"	mm
G36210-0404	4LOC-4RFJSX	7250-04715	1/4	6.4	7/16-20	.75	19.1
G36210-0405	4LOC-5RFJSX	7250-04725	1/4	6.4	1/2-20	.78	19.8
G36210-0505	5LOC-5RFJSX*	7250-04735	5/16	7.9	1/2-20	.81	20.6
G36210-0605	6LOC-5RFJSX	7250-04745	3/8	9.5	1/2-20	.81	20.6
G36210-0608	6LOC-8RFJSX	7250-18305	3/8	9.5	3/4-16	.97	24.6
G36210-0808	8LOC-8RFJSX	7250-04755	1/2	12.7	3/4-16	.97	24.6
G36210-0810	8LOC-10RFJSX	7250-18315	1/2	12.7	7/8-14	1.00	25.4
G36210-1010	10LOC-10RFJSX	7250-04765	5/8	15.9	7/8-14	1.00	25.4
G36210-1210	12LOC-10RFJSX	7250-04775	3/4	19.1	7/8-14	1.00	25.4

*Steel

EQUIPMENT
HOSE/CPLG. SELECTION
G&K COUPLINGS
GLOBALSPIRAL COUPLINGS
STAINLESS STEEL SPIRAL
MEGACRIMP COUPLINGS
STAINLESS STEEL BRAID
POWER CRIMP COUPLINGS
FIELD ATTACHABLE G1 & G2 COUPLINGS
FIELD ATTACHABLE C5 COUPLINGS
GLX COUPLINGS
GL COUPLINGS
C14 COUPLINGS
PCTS THERMOPLASTIC COUPLINGS
POLARSEAL COUPLINGS
POLARSEAL II COUPLINGS
POWER STEERING
ADAPTERS
QUICK DISCONNECT COUPLERS
BALL VALVES
LIVE SWIVEL
ASSEMBLY FABRICATION
ACCESSORIES
EQUIPMENT AND PARTS
AIR BRAKE
BRASS
KITS

Brass Lock-On Field Attachable Couplings for LOC & LOL Hose

Male SAE Inverted Swivel

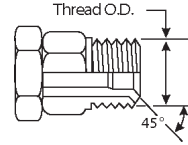
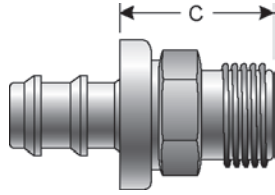

Part No.	Descr.	Prod. No.	⌀		🌀	C	
			"	mm		"	mm
G36500-0403	4LOC-3RMIX	7250-04785	1/4	6.4	3/8-24	.78	19.8
G36500-0404	4LOC-4RMIX	7250-04795	1/4	6.4	7/16-24	.78	19.8
G36500-0405	4LOC-5RMIX	7250-04805	1/4	6.4	1/2-20	.78	19.8
G36500-0505	5LOC-5RMIX	7250-04825	5/16	7.9	1/2-20	.82	20.8
G36500-0506	5LOC-6RMIX	7250-04835	5/16	7.9	5/8-18	.86	21.8
G36500-0605	6LOC-5RMIX	7250-04845	3/8	9.5	1/2-20	.82	20.8
G36500-0606	6LOC-6RMIX	7250-04855	3/8	9.5	5/8-18	.97	24.6
G36500-0608	6LOC-8RMIX	7250-16605	3/8	9.5	3/4-18	1.00	25.4
G36500-0806	8LOC-6RMIX	7250-16615	1/2	12.7	5/8-18	.97	24.6
G36500-0808	8LOC-8RMIX	7250-04865	1/2	12.7	3/4-18	1.00	25.4
G36500-1010	10LOC-10RMIX	7250-18325	5/8	15.9	7/8-18	1.00	25.4

Female Inverted

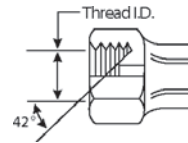
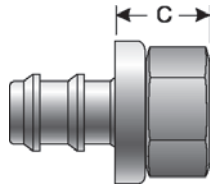

Part No.	Descr.	Prod. No.	⌀		🌀	C	
			"	mm		"	mm
G36508-0403	4LOC-3RFI	7250-04875	1/4	6.4	3/8-24	.75	19.1
G36508-0404	4LOC-4RFI	7250-04885	1/4	6.4	7/16-24	.75	19.1
G36508-0405	4LOC-5RFI	7250-04895	1/4	6.4	1/2-20	.75	19.1
G36508-0505	5LOC-5RFI	7250-04905	5/16	7.9	1/2-20	.75	19.1
G36508-0605	6LOC-5RFI	7250-04915	3/8	9.5	1/2-20	.75	19.1
G36508-0606	6LOC-6RFI	7250-04925	3/8	9.5	5/8-18	.88	22.4
G36508-0808	8LOC-8RFI	7250-04935	3/8	9.5	3/4-18	.93	23.6

BRASS

KITS

Flareless Tube Fitting (Compression Type)

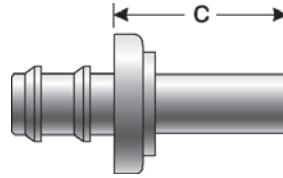

Part No.	Descr.	Prod. No.	⊖		⊕		C	
			"	mm	"	mm	"	mm
G36520-0403	4LOC-3RFT	7250-04945	1/4	6.4	3/16	4.8	.75	19.1
G36520-0404	4LOC-4RFT	7250-04955	1/4	6.4	1/4	6.4	1.00	25.4
G36520-0405	4LOC-5RFT	7250-04965	1/4	6.4	5/16	7.9	1.13	28.7
G36520-0505	5LOC-5RFT	7250-04975	5/16	7.9	5/16	7.9	1.13	28.7
G36520-0606	6LOC-6RSP	7250-04985	3/8	9.5	3/8	9.5	1.25	31.8
G36520-0808	8LOC-8RSP	7250-16625	1/2	12.7	1/2	12.7	1.00	25.4
G36520-1010	10LOC-10RSP	7250-16635	5/8	15.9	5/8	16.0	1.00	25.4

Hose Mender

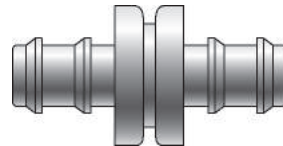

Part No.	Descr.	Prod. No.	⊖	
			"	mm
G36535-0404	4LOC-4RHM	7250-04995	1/4	6.4
G36535-0505	5LOC-5RHM	7250-05005	5/16	7.9
G36535-0606	6LOC-6RHM	7250-05015	3/8	9.5
G36535-0808	8LOC-8RHM	7250-05025	1/2	12.7
G36535-0808X	8LOC-8RHMXBULK	7250-0502	1/2	12.7
G36535-1010	10LOC-10RHM	7250-18335	5/8	15.9
G36535-1212	12LOC-12RHM	7250-18345	3/4	19.1

- EQUIPMENT
- HOSE/CPLG. SELECTION
- G&K COUPLINGS
- GLOBALSPIRAL COUPLINGS
- STAINLESS STEEL SPIRAL
- MEGACRIMP COUPLINGS
- STAINLESS STEEL BRAID
- POWER CRIMP COUPLINGS
- FIELD ATTACHABLE G1 & G2 COUPLINGS
- FIELD ATTACHABLE C5 COUPLINGS
- GLX COUPLINGS
- GL COUPLINGS
- C14 COUPLINGS
- PCTS THERMOPLASTIC COUPLINGS
- POLARSEAL COUPLINGS
- POLARSEAL II COUPLINGS
- POWER STEERING
- ADAPTERS
- QUICK DISCONNECT COUPLERS
- BALL VALVES
- LIVE SWIVEL
- ASSEMBLY FABRICATION
- ACCESSORIES
- EQUIPMENT AND PARTS
- AIR BRAKE
- BRASS
- KITS

Single Bead

Male Pipe (NPTF - 30° Cone Seat)

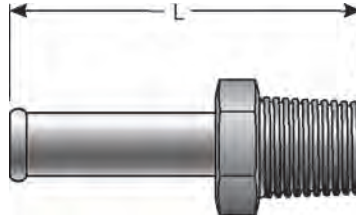

Part No.	Descr.	Prod. No.	⌀		🌀	L	
			"	mm		"	mm
G37100-0302	3SB-2RMP	7250-05035	3/16	4.8	1/8-27	1.26	32.0
G37100-0402	4SB-2RMP	7250-05045	1/4	6.4	1/8-27	1.32	33.5
G37100-0404	4SB-4RMP	7250-05055	1/4	6.4	1/4-18	1.63	41.4
G37100-0502	5SB-2RMP	7250-05065	5/16	7.9	1/8-27	1.55	39.4
G37100-0504	5SB-4RMP	7250-05075	5/16	7.9	1/4-18	1.55	39.4
G37100-0602	6SB-2RMP	7250-05085	3/8	9.7	1/8-27	1.55	39.4
G37100-0604	6SB-4RMP	7250-05095	3/8	9.7	1/4-18	1.63	41.4
G37100-0606	6SB-6RMP	7250-05105	3/8	9.7	3/8-18	1.72	43.7
G37100-0806	8SB-6RMP	7250-05115	1/2	12.7	3/8-18	1.72	43.7
G37100-0808	8SB-8RMP	7250-05125	1/2	12.7	1/2-14	1.79	45.5
G37100-1006	10SB-6RMP	7250-05135	5/8	15.9	3/8-18	1.78	45.2
G37100-1008	10SB-8RMP	7250-05145	5/8	15.9	1/2-14	1.78	45.2
G37100-1012	10SB-12RMP	7250-16645	5/8	15.9	3/4-14	1.92	48.8
G37100-1208	12SB-8RMP	7250-05155	3/4	19.1	1/2-14	1.78	45.2
G37100-1212	12SB-12RMP	7250-16655	3/4	19.1	3/4-14	1.92	48.8

Male Straight Thread Connector

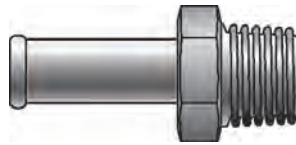

Part No.	Descr.	Prod. No.	⌀		🌀
			"	mm	
G37103-0609	6SB-9MSC	7250-05165	3/8	9.7	9/16-24
G37103-0610	6SB-10MSC	7250-05175	3/8	9.7	5/8-20
G37103-0614	6SB-14MSC	7250-05185	3/8	9.7	7/8-20

Male Pipe - 90° Block (NPTF - Without 30° Cone Seat)

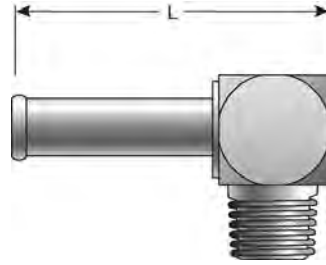

Part No.	Descr.	Prod. No.	⊕		🌀	L	
			"	mm		"	mm
G37106-0402	4SB-2RMP90	7250-05195	1/4	6.4	1/8-27	1.00	25.4
G37106-0502	5SB-2RMP90	7250-05205	5/16	7.9	1/8-27	1.01	25.7
G37106-0504	5SB-4RMP90	7250-05215	5/16	7.9	1/4-18	1.01	25.7
G37106-0602	6SB-2RMP90	7250-05225	3/8	9.7	1/8-27	1.01	25.7
G37106-0604	6SB-4RMP90	7250-05235	3/8	9.7	1/4-18	1.04	26.4
G37106-0606	6SB-6RMP90	7250-05245	3/8	9.7	3/8-18	1.08	27.4
G37106-0806	8SB-6RMP90	7250-16665	1/2	12.7	3/8-14	1.08	27.4
G37106-0808	8SB-8RMP90	7250-16675	1/2	12.7	1/2-14	1.16	29.5
G37106-1006	10SB-6RMP90	7250-05255	5/8	15.9	3/8-18	1.13	28.7
G37106-1008	10SB-8RMP90	7250-16685	5/8	15.9	1/2-14	1.21	30.7
G37106-1208	12SB-8RMP90	7250-16695	3/4	19.1	1/2-14	1.28	32.5

Male SAE 45° Flare Connector

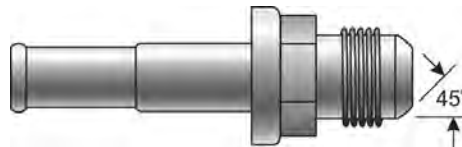

Part No.	Descr.	Prod. No.	⊕		🌀	L	
			"	mm		"	mm
G37195-0605	6SB-5RMS	7250-05265	3/8	9.7	1/2-20	2.00	50.8
G37195-0606	6SB-6RMS	7250-16705	3/8	9.7	3/8-18	2.00	50.8

Male SAE Inverted Swivel



Part No.	Descr.	Prod. No.	⊕		🌀	L	
			"	mm		"	mm
G37500-0404	4SB-4RMIX	7250-16715	1/4	6.4	7/16-24	1.72	43.7
G37500-0405	4SB-5RMIX	7250-16725	1/4	6.4	1/2-20	1.78	45.2
G37500-0504	5SB-4RMIX	7250-05275	5/16	7.9	7/16-24	1.58	40.1
G37500-0505	5SB-5RMIX	7250-05285	5/16	7.9	1/2-20	1.58	40.1

- EQUIPMENT
- HOSE/CPLG. SELECTION
- G&K COUPLINGS
- GLOBALSPIRAL COUPLINGS
- STAINLESS STEEL SPIRAL
- MEGACRIMP COUPLINGS
- STAINLESS STEEL BRAID
- POWER CRIMP COUPLINGS
- FIELD ATTACHABLE G1 & G2 COUPLINGS
- FIELD ATTACHABLE C5 COUPLINGS
- GLX COUPLINGS
- GL COUPLINGS
- C14 COUPLINGS
- PCTS THERMOPLASTIC COUPLINGS
- POLARSEAL COUPLINGS
- POLARSEAL II COUPLINGS
- POWER STEERING
- ADAPTERS
- QUICK DISCONNECT COUPLERS
- BALL VALVES
- LIVE SWIVEL
- ASSEMBLY FABRICATION
- ACCESSORIES
- EQUIPMENT AND PARTS
- AIR BRAKE
- BRASS
- KITS

Male SAE Inverted Swivel - Continued

Part No.	Descr.	Prod. No.	⊖		🌀	L	
			"	mm		"	mm
G37500-0506	5SB-6RMIX	7250-05295	5/16	7.9	5/8-18	1.63	41.4
G37500-0605	6SB-5RMIX	7250-05305	3/8	9.7	1/2-20	1.73	44.0
G37500-0606	6SB-6RMIX	7250-05315	3/8	9.7	5/8-18	2.00	50.8

Male SAE Inverted Swivel - 45°

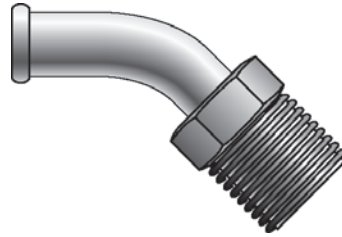

Part No.	Descr.	Prod. No.	⊖		🌀	L	
			"	mm		"	mm
G37503-0605	6SB-5RMIX45	7250-05325	3/8	9.7	1/2-20	1.25	31.8

Male SAE Inverted Swivel - 90°



Part No.	Descr.	Prod. No.	⊖		🌀	L	
			"	mm		"	mm
G37504-0404	4SB-4RMIX90	7250-05345	1/4	6.4	7/16-24	1.01	25.7
G37504-0405	4SB-5RMIX90	7250-05355	1/4	6.4	1/2-20	1.01	25.7
G37504-0506	5SB-6RMIX90	7250-05365	5/16	7.9	5/8-18	1.21	30.7
G37504-0605	6SB-5RMIX90	7250-05375	3/8	9.7	1/2-20	1.21	30.7
G37504-0606	6SB-6RMIX90	7250-05385	3/8	9.7	5/8-18	1.40	35.6

Female SAE Inverted

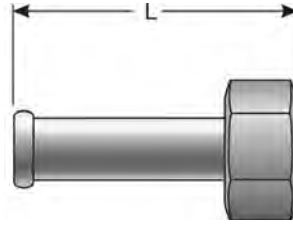

Part No.	Descr.	Prod. No.	⊖		🌀	L	
			"	mm		"	mm
G37508-0505	5SB-5RFI	7250-16735	5/16	7.9	1/2-20	2.03	51.6
G37508-0605	6SB-5RFI	7250-16745	3/8	9.7	1/2-20	2.09	53.1
G37508-0606	6SB-6RFI	7250-16755	3/8	9.7	5/8-18	2.16	54.9

EQUIPMENT
HOSE/CPLG. SELECTION
G&K COUPLINGS
GLOBALSPIRAL COUPLINGS
STAINLESS STEEL SPIRAL
MEGACRIMP COUPLINGS
STAINLESS STEEL BRAID
POWER CRIMP COUPLINGS
FIELD ATTACHABLE G1 & G2 COUPLINGS
FIELD ATTACHABLE C5 COUPLINGS
GLX COUPLINGS
GL COUPLINGS
C14 COUPLINGS
PCTS THERMOPLASTIC COUPLINGS
POLARSEAL COUPLINGS
POLARSEAL II COUPLINGS
POWER STEERING
ADAPTERS
QUICK DISCONNECT COUPLERS
BALL VALVES
LIVE SWIVEL
ASSEMBLY FABRICATION
ACCESSORIES
EQUIPMENT AND PARTS
AIR BRAKE
BRASS
KITS

Barbed Stem

Male Pipe NPTF

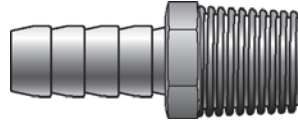

Part No.	Descr.	Prod. No.		
			"	"
G38100-0202	2BS-2MP	7250-05395	1/8	1/8-27
G38100-0302	3BS-2MP	7250-05405	3/16	1/8-27
G38100-0304	3BS-4MP	7250-05415	3/16	1/4-18
G38100-0402	4BS-2MP	7250-05425	1/4	1/8-27
G38100-0404	4BS-4MP	7250-05435	1/4	1/4-18
G38100-0406	4BS-6MP	7250-05445	1/4	3/8-18
G38100-0502	5BS-2MP	7250-05455	5/16	1/8-27
G38100-0504	5BS-4MP	7250-05465	5/16	1/4-18
G38100-0602	6BS-2MP	7250-05475	3/8	1/8-27
G38100-0604	6BS-4MP	7250-05485	3/8	1/4-18
G38100-0606	6BS-6MP	7250-05495	3/8	3/8-18
G38100-0608	6BS-8MP	7250-05505	3/8	1/2-14
G38100-0804	8BS-4MP	7250-05515	1/2	1/4-18
G38100-0806	8BS-6MP	7250-05525	1/2	3/8-18
G38100-0808	8BS-8MP	7250-05535	1/2	1/2-14
G38100-0812	8BS-12MP	7250-05545	1/2	3/4-14
G38100-1006	10BS-6MP	7250-05555	5/8	3/8-18
G38100-1008	10BS-8MP	7250-05565	5/8	1/2-14
G38100-1012	10BS-12MP	7250-05575	5/8	3/4-14
G38100-1208	12BS-8MP	7250-05585	3/4	1/2-14
G38100-1212	12BS-12MP	7250-05595	3/4	3/4-14

Female Pipe

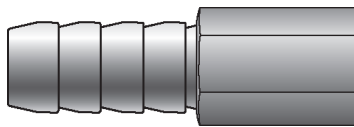

Part No.	Descr.	Prod. No.		
			"	"
G38110-0202	2BS-2FP	7250-05605	1/8	1/8-27
G38110-0302	3BS-2FP	7250-05615	3/16	1/8-27
G38110-0402	4BS-2FP	7250-05625	1/4	1/8-27
G38110-0404	4BS-4FP	7250-05635	1/4	1/4-18
G38110-0502	5BS-2FP	7250-05645	5/16	1/8-27
G38110-0504	5BS-4FP	7250-05655	5/16	1/4-18
G38110-0602	6BS-2FP	7250-05665	3/8	1/8-27
G38110-0604	6BS-4FP	7250-05675	3/8	1/4-18
G38110-0606	6BS-6FP	7250-05685	3/8	3/8-18
G38110-0804	8BS-4FP	7250-05695	1/2	1/4-18
G38110-0806	8BS-6FP	7250-05705	1/2	3/8-18
G38110-0808	8BS-8FP	7250-05715	1/2	1/2-14

BRASS

KITS

Double Compression



Part No.	Descr.	Prod. No.	
			"
G60593-0202	2DCN	7250-10255	1/8
G60593-0303	3DCN	7250-10265	3/16
G60593-0404	4DCN	7250-10275	1/4
G60593-0505	5DCN	7250-10285	5/16
G60593-0606	6DCN	7250-10295	3/8

Double Compression to Male Pipe



Part No.	Descr.	Prod. No.		
			"	"
G60594-0202	2DCN-2MP	7250-10305	1/8	1/8-27
G60594-0302	3DCN-2MP	7250-10325	3/16	1/8-27
G60594-0402	4DCN-2MP	7250-10335	1/4	1/8-27
G60594-0502	5DCN-2MP	7250-10345	5/16	1/8-27
G60594-0604	6DCN-4MP	7250-10355	3/8	1/4-18

Double Compression to Male Pipe - 90°





Part No.	Descr.	Prod. No.		
			"	"
G60595-0202	2DCN-2MP90	7250-10365	1/8	1/8-27

- EQUIPMENT
- HOSE/CPLG. SELECTION
- G&K COUPLINGS
- GLOBALSPIRAL COUPLINGS
- STAINLESS STEEL SPIRAL
- MEGACRIMP COUPLINGS
- STAINLESS STEEL BRAID
- POWER CRIMP COUPLINGS
- FIELD ATTACHABLE G1 & G2 COUPLINGS
- FIELD ATTACHABLE C5 COUPLINGS
- GLX COUPLINGS
- GL COUPLINGS
- C14 COUPLINGS
- PCTS THERMOPLASTIC COUPLINGS
- POLARSEAL COUPLINGS
- POLARSEAL II COUPLINGS
- POWER STEERING
- ADAPTERS
- QUICK DISCONNECT COUPLERS
- BALL VALVES
- LIVE SWIVEL
- ASSEMBLY FABRICATION
- ACCESSORIES
- EQUIPMENT AND PARTS
- AIR BRAKE
- BRASS**
- KITS



Brass Adapters

Double Compression to Male Pipe - 90° - Continued

Part No.	Descr.	Prod. No.		
			"	"
G60595-0221	2DCN-21MP90	7250-10375	1/8	1/4-28
G60595-0302	3DCN-2MP90	7250-10385	3/16	1/8-27
G60595-0402	4DCN-2MP90	7250-10395	1/4	1/8-27
G60595-0502	5DCN-2MP90	7250-10405	5/16	1/8-27
G60595-0604	6DCN-4MP90	7250-10415	3/8	1/4-18



Steel Tubing Male Inverted Swivel Nut - Steel



Part No.	Descr.	Prod. No.		
			"	"
G60596-0202	2T-2MIXN-S	7250-10425	1/8	1/8-27
G60596-0303	3T-3MIXN-S	7250-10435	3/16	3/8-24
G60596-0404	4T-4MIXN-S	7250-10445	1/4	7/16-24
G60596-0505	5T-5MIXN-S	7250-10455	5/16	1/2-20
G60596-0606	6T-6MIXN-S	7250-10465	3/8	5/8-18
G60596-0607	6T-7MIXN-S	7250-10475	3/8	11/16-18
G60596-0707	7T-7MIXN-S	7250-10485	7/16	11/16-18
G60596-0808	8T-8MIXN-S	7250-10495	1/2	3/4-18
G60596-1010	10T-10MIXN-S	7250-10505	5/8	7/8-18
G60596-1212	12T-12MIXN-S	7250-10515	3/4	1 1/16-16
G60596-1414	14T-14MIXN-S	7250-10525	7/8	1 3/16-16
G60596-1616	16T-16MIXN-S	7250-10535	1	1 5/16-16

Steel Tubing Male Inverted Swivel Nut - Steel - Long



Part No.	Descr.	Prod. No.		
			"	"
G60597-0303	3T-3MIXN-SL	7250-10545	3/16	3/8-24
G60597-0404	4T-4MIXN-SL	7250-10555	1/4	7/16-24

Brass Tubing Male Inverted Swivel Nut



Part No.	Descr.	Prod. No.		
			"	"
G60599-0303	3T-3MIXN-B	7250-10565	3/16	3/8-24
G60599-0404	4T-4MIXN-B	7250-10575	1/4	7/16-24
G60599-0505	5T-5MIXN-B	7250-10585	5/16	1/2-20
G60599-0606	6T-6MIXN-B	7250-10595	3/8	5/8-18
G60599-0808	8T-8MIXN-B	7250-10605	1/2	3/4-18

Female Pipe Cap - Brass



Part No.	Descr.	Prod. No.	
			"
G60600-0002	2FPB-CAP	7250-10615	1/8-27
G60600-0004	4FPB-CAP	7250-10625	1/4-18
G60600-0006	6FPB-CAP	7250-10635	3/8-18
G60600-0008	8FPB-CAP	7250-10645	1/2-14
G60600-0012	12FP-BCAP	7250-16765	3/4-1/4

Male Pipe Plug - Hex Head - Brass



Part No.	Descr.	Prod. No.	
			"
G60601-0001	1MPB-PLUG	7250-10655	1/16-32
G60601-0002	2MPB-PLUG	7250-10665	1/8-27
G60601-0004	4MPB-PLUG	7250-10675	1/4-18
G60601-0006	6MPB-PLUG	7250-10685	3/8-18
G60601-0008	8MPB-PLUG	7250-10695	1/2-14

EQUIPMENT
HOSE/CPLG. SELECTION
G&K COUPLINGS
GLOBALSPIRAL COUPLINGS
STAINLESS STEEL SPIRAL
MEGACRIMP COUPLINGS
STAINLESS STEEL BRAID
POWER CRIMP COUPLINGS
FIELD ATTACHABLE G1 & G2 COUPLINGS
FIELD ATTACHABLE C5 COUPLINGS
GLX COUPLINGS
GL COUPLINGS
C14 COUPLINGS
PCTS THERMOPLASTIC COUPLINGS
POLARSEAL COUPLINGS
POLARSEAL II COUPLINGS
POWER STEERING
ADAPTERS
QUICK DISCONNECT COUPLERS
BALL VALVES
LIVE SWIVEL
ASSEMBLY FABRICATION
ACCESSORIES
EQUIPMENT AND PARTS
AIR BRAKE
BRASS
KITS

Brass Adapters

EQUIPMENT

HOSE/CPLG.
SELECTION

Male Pipe Plug - Hex Head - Brass - Continued

G8K COUPLINGS

Part No.	Descr.	Prod. No.	
			"
G60601-0012	12MPB-PLUG	7250-10705	3/4-14

GLOBALSPIRAL
COUPLINGS

STAINLESS
STEEL SPIRAL

Male Pipe Plug - Square Head - Brass

MEGACRIMP
COUPLINGS



STAINLESS
STEEL BRAID

POWER CRIMP
COUPLINGS

FIELD
ATTACHABLE G1
& G2 COUPLINGS

Part No.	Descr.	Prod. No.	
			"
G60602-0002	2MPB-PLUG SQ HEAD	7250-10715	1/8-27
G60602-0004	4MPB-PLUG SQ HEAD	7250-10725	1/4-18
G60602-0006	6MPB-PLUG SQ HEAD	7250-10735	3/8-18
G60602-0008	8MPB-PLUG SQ HEAD	7250-10745	1/2-14
G60602-0012	12MPB-PLUG SQ HEAD	7250-10755	3/4-14

FIELD
ATTACHABLE C5
COUPLINGS

GLX COUPLINGS

GL COUPLINGS

C14 COUPLINGS

PCTS
THERMOPLASTIC
COUPLINGS

Male Pipe Plug - Hex Key Head - Brass

POLARSEAL
COUPLINGS



POLARSEAL II
COUPLINGS

POWER
STEERING

ADAPTERS

QUICK
DISCONNECT
COUPLERS

Part No.	Descr.	Prod. No.	
			"
G60603-0001	1MPB-PLUG HK HEAD	7250-10765	1/16-32
G60603-0002	2MPB-PLUG HK HEAD	7250-10775	1/8-27
G60603-0004	4MPB-PLUG HK HEAD	7250-10785	1/4-18
G60603-0006	6MPB-PLUG HK HEAD	7250-10795	3/8-18
G60603-0008	8MPB-PLUG HK HEAD	7250-10805	1/2-14

BALL VALVES

LIVE SWIVEL

ASSEMBLY
FABRICATION

ACCESSORIES

EQUIPMENT AND
PARTS

AIR BRAKE

BRASS

KITS

Brass Adapters

Male Pipe Plug - Slotted Head - Brass



Part No.	Descr.	Prod. No.		
			"	"
G60604-0002	2MPB-PLUG-SL	7250-10815	1/8-27	
G60604-0004	4MPB-PLUG-SL	7250-10825	1/4-18	
G60604-0006	6MPB-PLUG-SL	7250-10835	3/8-18	

Male Pipe to Male Pipe - Brass



Part No.	Descr.	Prod. No.		
			"	"
G60605-0102	1MP-2MPB	7250-10845	1/16-32	1/8-27
G60605-0202	2MP-2MPB	7250-10855	1/8-27	1/8-27
G60605-0204	2MP-4MPB	7250-10865	1/8-27	1/4-18
G60605-0206	2MP-6MPB	7250-10875	1/8-27	3/8-18
G60605-0404	4MP-4MPB	7250-10885	1/4-18	1/4-18
G60605-0406	4MP-6MPB	7250-10895	1/4-18	3/8-18
G60605-0408	4MP-8MPB	7250-16775	1/4-18	1/2-14
G60605-0606	6MP-6MPB	7250-10905	3/8-18	3/8-18
G60605-0608	6MP-8MPB	7250-16785	3/8-18	1/2-14
G60605-0808	8MP-8MPB	7250-10915	1/2-14	1/2-14
G60605-0812	8MP-12MPB	7250-16795	1/2-14	3/4-14
G60605-1212	12MP-12MPB	7250-10925	3/4-14	3/4-14

Male Pipe to Male Pipe - Short - Brass



Part No.	Descr.	Prod. No.		
			"	"
G60606-0202	2MP-2MPB-CNS	7250-10935	1/8-27	1/8-27

EQUIPMENT

HOSE/CPLG. SELECTION

G&K COUPLINGS

GLOBALSPIRAL COUPLINGS

STAINLESS STEEL SPIRAL

MEGACRIMP COUPLINGS

STAINLESS STEEL BRAID

POWER CRIMP COUPLINGS

FIELD ATTACHABLE G1 & G2 COUPLINGS

FIELD ATTACHABLE C5 COUPLINGS

GLX COUPLINGS

GL COUPLINGS

C14 COUPLINGS

PCTS THERMOPLASTIC COUPLINGS

POLARSEAL COUPLINGS

POLARSEAL II COUPLINGS

POWER STEERING

ADAPTERS

QUICK DISCONNECT COUPLERS

BALL VALVES

LIVE SWIVEL

ASSEMBLY FABRICATION

ACCESSORIES

EQUIPMENT AND PARTS

AIR BRAKE

BRASS

KITS

Brass Adapters

Male Pipe to Male Pipe - Short - Brass - Continued

Part No.	Descr.	Prod. No.		
			"	"
G60606-0404	4MP-4MPB-CNS	7250-10945	1/4-18	1/4-18
G60606-0606	6MP-6MPB-CNS	7250-10955	3/8-18	3/8-18
G60606-0808	8MP-8MPB-CNS	7250-10965	1/2-14	1/2-14
G60606-1212	12MP-12MPB-CNS	7250-10975	3/4-14	3/4-14

Male Pipe to Male Pipe - Long - Brass



Part No.	Descr.	Prod. No.		
			"	"
G60607-0202	2MP-2MPB-CNL	7250-10985	1/8-27	1/8-27
G60607-0404	4MP-4MPB-CNL	7250-10995	1/4-18	1/4-18
G60607-0606	6MP-6MPB-CNL	7250-11005	3/8-18	3/8-18

Male Pipe to Male Pipe - Extra Long - Brass



Part No.	Descr.	Prod. No.		
			"	"
G60608-0202	2MP-2MPB-CNXL	7250-11015	1/8-27	1/8-27
G60608-0404	4MP-4MPB-CNXL	7250-11025	1/4-18	1/4-18
G60608-0606	6MP-6MPB-CNXL	7250-11035	3/8-18	3/8-18
G60608-0808	8MP-8MPB-CNXL	7250-11045	1/2-14	1/2-14
G60608-1212	12MP-12MPB-CNXL	7250-11055	3/4-14	3/4-14

EQUIPMENT
HOSE/CPLG. SELECTION
G8K COUPLINGS
GLOBAL SPIRAL COUPLINGS
STAINLESS STEEL SPIRAL
MEGACRIMP COUPLINGS
STAINLESS STEEL BRAID
POWER CRIMP COUPLINGS
FIELD ATTACHABLE G1 & G2 COUPLINGS
FIELD ATTACHABLE C5 COUPLINGS
GLX COUPLINGS
GL COUPLINGS
C14 COUPLINGS
PCTS THERMOPLASTIC COUPLINGS
POLARSEAL COUPLINGS
POLARSEAL II COUPLINGS
POWER STEERING
ADAPTERS
QUICK DISCONNECT COUPLERS
BALL VALVES
LIVE SWIVEL
ASSEMBLY FABRICATION
ACCESSORIES
EQUIPMENT AND PARTS
AIR BRAKE
BRASS
KITS

Brass Adapters

Male Pipe NPTF to Male Pipe NPTF - 90° - Brass



Part No.	Descr.	Prod. No.		
			"	"
G60610-0202	2MP-2MPB90	7250-16805	1/8-27	1/8-27
G60610-0204	2MP-4MPB90	7250-16815	1/8-27	1/4-18
G60610-0206	2MP-6MPB90	7250-16825	1/8-27	3/8-18
G60610-0404	4MP-4MPB90	7250-16835	1/4-18	1/4-18
G60610-0406	4MP-6MPB90	7250-16845	1/4-18	3/8-18
G60610-0606	6MP-6MPB90	7250-16855	3/8-18	3/8-18
G60610-0608	6MP-8MPB90	7250-16865	3/8-18	1/2-14
G60610-0808	8MP-8MPB90	7250-16875	1/2-14	1/2-14

Male Pipe NPTF - Tee



Part No.	Descr.	Prod. No.		
			"	"
G60612-0202	2MP-2MP-2MPB	7250-16885	1/8-27	
G60612-0404	4MP-4MP-4MPB	7250-16895	1/4-18	
G60612-0606	6MP-6MP-6MPB	7250-16905	3/8-18	
G60612-0808	8MP-8MP-8MPB	7250-16915	1/2-14	
G60612-1212	12MP-12MP-12MPB	7250-16925	3/4-14	

EQUIPMENT

HOSE/CPLG. SELECTION

G8K COUPLINGS

GLOBALSPIRAL COUPLINGS

STAINLESS STEEL SPIRAL

MEGACRIMP COUPLINGS

STAINLESS STEEL BRAID

POWER CRIMP COUPLINGS

FIELD ATTACHABLE G1 & G2 COUPLINGS

FIELD ATTACHABLE C5 COUPLINGS

GLX COUPLINGS

GL COUPLINGS

C14 COUPLINGS

PCTS THERMOPLASTIC COUPLINGS

POLARSEAL COUPLINGS

POLARSEAL II COUPLINGS

POWER STEERING

ADAPTERS

QUICK DISCONNECT COUPLERS

BALL VALVES

LIVE SWIVEL

ASSEMBLY FABRICATION

ACCESSORIES

EQUIPMENT AND PARTS

AIR BRAKE

BRASS

KITS

Brass Adapters

Male Pipe to Female Pipe - Brass - Reducer



Part No.	Descr.	Prod. No.		
			"	"
G60614-0402	4MP-2FPB	7250-11095	1/4-18	1/8-27
G60614-0602	6MP-2FPB	7250-11135	3/8-18	1/8-27
G60614-0604	6MP-4FPB	7250-11145	3/8-18	1/4-18
G60614-0802	8MP-2FPB	7250-11175	1/2-14	1/8-27
G60614-0804	8MP-4FPB	7250-11185	1/2-14	1/8-27
G60614-0806	8MP-6FPB	7250-11195	1/2-14	3/8-18
G60614-1206	12MP-6FPB	7250-11215	3/4-14	3/8-18
G60614-1208	12MP-8FPB	7250-11225	3/4-14	1/2-14

Male Pipe to Female Pipe - Long - Brass



Part No.	Descr.	Prod. No.		
			"	"
G60615-0102	1MP-2FPB-L	7250-11065	1/16-32	1/8-27
G60615-0202	2MP-2FPB-L	7250-11075	1/8-27	1/8-27
G60615-0204	2MP-4FPB-L	7250-11085	1/8-27	1/4-18
G60615-0206	2MP-6FPB-L	7250-16935	1/8-27	3/8-18
G60615-0404	4MP-4FPB-L	7250-11105	1/4-18	1/4-18
G60615-0406	4MP-6FPB-L	7250-11115	1/4-18	3/8-18
G60615-0408	4MP-8FPB-L	7250-11125	1/4-18	1/2-14
G60615-0606	6MP-6FPB-L	7250-11155	3/8-18	3/8-18
G60615-0608	6MP-8FPB-L	7250-11165	3/8-18	1/2-14
G60615-0808	8MP-8FPB-L	7250-16945	1/2-14	1/2-14
G60615-0812	8MP-12FPB-L	7250-11205	1/2-14	3/4-14
G60615-1212	12MP-12FPB-L	7250-16955	3/4-14	3/4-14

EQUIPMENT
HOSE/CPLG. SELECTION
G8K COUPLINGS
GLOBAL SPIRAL COUPLINGS
STAINLESS STEEL SPIRAL
MEGACRIMP COUPLINGS
STAINLESS STEEL BRAID
POWER CRIMP COUPLINGS
FIELD ATTACHABLE G1 & G2 COUPLINGS
FIELD ATTACHABLE C5 COUPLINGS
GLX COUPLINGS
GL COUPLINGS
C14 COUPLINGS
PCTS THERMOPLASTIC COUPLINGS
POLARSEAL COUPLINGS
POLARSEAL II COUPLINGS
POWER STEERING
ADAPTERS
QUICK DISCONNECT COUPLERS
BALL VALVES
LIVE SWIVEL
ASSEMBLY FABRICATION
ACCESSORIES
EQUIPMENT AND PARTS
AIR BRAKE
BRASS
KITS

Brass Adapters

Male Pipe to Female Pipe - 45° - Brass



Part No.	Descr.	Prod. No.		
			"	"
G60618-0202	2MP-2FP45	7250-11235	1/8-27	1/8-27
G60618-0404	4MP-4FP45	7250-11245	1/4-18	1/4-18
G60618-0606	6MP-6FP45	7250-11255	3/8-18	3/8-18
G60618-0808	8MP-8FP45	7250-11265	1/2-14	1/2-14
G60618-1212	12MP-12FP45	7250-11275	3/4-14	3/4-14

Male Pipe to Female Pipe - 90° - Brass



Part No.	Descr.	Prod. No.		
			"	"
G60620-0101	1MP-1FPB90	7250-11285	1/16-32	1/16-32
G60620-0202	2MP-2FPB90	7250-11295	1/8-27	1/8-27
G60620-0204	2MP-4FPB90	7250-16965	1/8-27	1/4-18
G60620-0402	4MP-2FPB90	7250-11305	1/4-18	1/8-27
G60620-0404	4MP-4FPB90	7250-11315	1/4-18	1/4-18
G60620-0406	4MP-6FPB90	7250-16975	1/4-18	3/8-18
G60620-0604	6MP-4FPB90	7250-16985	3/8-18	1/4-18
G60620-0606	6MP-6FPB90	7250-11325	3/8-18	3/8-18
G60620-0608	6MP-8FPB90	7250-16995	3/8-18	1/2-14
G60620-0806	8MP-6FPB90	7250-17005	1/2-14	3/8-18
G60620-0808	8MP-8FPB90	7250-11335	1/2-14	1/2-14
G60620-1212	12MP-12FPB90	7250-11345	3/4-14	3/4-14

EQUIPMENT
HOSE/CPLG. SELECTION
G8K COUPLINGS
GLOBALSPIRAL COUPLINGS
STAINLESS STEEL SPIRAL
MEGACRIMP COUPLINGS
STAINLESS STEEL BRAID
POWER CRIMP COUPLINGS
FIELD ATTACHABLE G1 & G2 COUPLINGS
FIELD ATTACHABLE C5 COUPLINGS
GLX COUPLINGS
GL COUPLINGS
C14 COUPLINGS
PCTS THERMOPLASTIC COUPLINGS
POLARSEAL COUPLINGS
POLARSEAL II COUPLINGS
POWER STEERING
ADAPTERS
QUICK DISCONNECT COUPLERS
BALL VALVES
LIVE SWIVEL
ASSEMBLY FABRICATION
ACCESSORIES
EQUIPMENT AND PARTS
AIR BRAKE
BRASS
KITS

Brass Adapters

Male Pipe to Female Pipe to Male SAE 45° Flare - Brass



Part No.	Descr.	Prod. No.			
			"	"	"
G60623-0203	2MP-2FP-3MS	7250-11355	1/8-27	1/8-27	3/8-24

Male Pipe to Female Inverted - Brass



Part No.	Descr.	Prod. No.		
			"	"
G60625-0202	2MP-2FI	7250-11375	1/8-27	5/16-28
G60625-0203	2MP-3FI	7250-11385	1/8-27	3/8-24
G60625-0204	2MP-4FI	7250-11395	1/8-27	7/16-24
G60625-0205	2MP-5FI	7250-11405	1/8-27	1/2-20
G60625-0206	2MP-6FI	7250-11415	1/8-27	5/8-18
G60625-0404	4MP-4FI	7250-11425	1/4-18	7/16-24
G60625-0405	4MP-5FI	7250-11435	1/4-18	1/2-20
G60625-0406	4MP-6FI	7250-11445	1/4-18	5/8-18
G60625-0408	4MP-8FI	7250-11485	1/4-18	3/4-18
G60625-0606	6MP-6FI	7250-11455	3/8-18	5/8-18
G60625-0607	6MP-7FI	7250-11465	1/4-18	11/16-18
G60625-0608	6MP-8FI	7250-11475	3/8-18	3/4-18
G60625-0808	8MP-8FI	7250-11495	1/2-14	3/4-18
G60625-0810	8MP-10FI	7250-11505	1/2-14	7/8-18
G60625-0812	8MP-12FI	7250-11515	1/2-14	1 1/16-16
G60625-1212	12MP-12FI	7250-11525	3/4-14	3/4-14
G60625-1214	12MP-14FI	7250-11535	3/4-14	1 3/16-16
G60625-1616	16MP-16FI	7250-11545	1-11 1/2	1 5/16-16

EQUIPMENT
HOSE/CPLG. SELECTION
G8K COUPLINGS
GLOBAL SPIRAL COUPLINGS
STAINLESS STEEL SPIRAL
MEGACRIMP COUPLINGS
STAINLESS STEEL BRAID
POWER CRIMP COUPLINGS
FIELD ATTACHABLE G1 & G2 COUPLINGS
FIELD ATTACHABLE C5 COUPLINGS
GLX COUPLINGS
GL COUPLINGS
C14 COUPLINGS
PCTS THERMOPLASTIC COUPLINGS
POLARSEAL COUPLINGS
POLARSEAL II COUPLINGS
POWER STEERING
ADAPTERS
QUICK DISCONNECT COUPLERS
BALL VALVES
LIVE SWIVEL
ASSEMBLY FABRICATION
ACCESSORIES
EQUIPMENT AND PARTS
AIR BRAKE
BRASS
KITS

Male Pipe to Female Inverted - 45° - Brass



Part No.	Descr.	Prod. No.		
			"	"
G60626-0202	2MP-2FI45	7250-11555	1/8-27	5/16-28
G60626-0203	2MP-3FI45	7250-11565	1/8-27	3/8-24
G60626-0204	2MP-4FI45	7250-11575	1/8-27	7/16-24
G60626-0205	2MP-5FI45	7250-11585	1/8-27	1/2-20
G60626-0206	2MP-6FI45	7250-11595	1/8-27	5/8-18
G60626-0405	4MP-5FI45	7250-11605	1/4-18	1/2-20
G60626-0406	4MP-6FI45	7250-11615	1/4-18	5/8-18
G60626-0608	6MP-8FI45	7250-11625	3/8-18	3/4-18
G60626-0810	8MP-10FI45	7250-11635	1/2-14	7/8-18

Male Pipe to Female Inverted - 90° - Brass



Part No.	Descr.	Prod. No.		
			"	"
G60627-0202	2MP-2FI90	7250-11645	1/8-27	5/16-28
G60627-0203	2MP-3FI90	7250-11655	1/8-27	3/8-24
G60627-0204	2MP-4FI90	7250-11665	1/8-27	7/16-24
G60627-0205	2MP-5FI90	7250-11685	1/8-27	1/2-20
G60627-0206	2MP-6FI90	7250-11695	1/8-27	5/8-18
G60627-0404	4MP-4FI90	7250-11705	1/4-18	7/16-24
G60627-0405	4MP-5FI90	7250-11715	1/4-18	1/2-20
G60627-0406	4MP-6FI90	7250-11725	1/4-18	5/8-18
G60627-0408	4MP-8FI90	7250-11745	1/4-18	3/4-18
G60627-0605	6MP-5FI90	7250-11755	3/8-18	1/2-20
G60627-0606	6MP-6FI90	7250-11765	3/8-18	5/8-18
G60627-0608	6MP-8FI90	7250-11775	3/8-18	3/4-18
G60627-0610	6MP-10FI90	7250-11785	3/8-18	7/8-18
G60627-0808	8MP-8FI90	7250-11795	1/2-14	3/4-18
G60627-0810	8MP-10FI90	7250-11805	1/2-14	7/8-18
G60627-0812	8MP-12FI90	7250-11815	1/2-14	1 1/16-16
G60627-1212	12MP-12FI90	7250-11825	3/4-14	1 1/16-16
G60627-1214	12MP-14FI90	7250-11835	3/4-14	1 3/16-16
G60627-1616	16MP-16FI90	7250-11845	1-11 1/2	1 5/16-16

- EQUIPMENT
- HOSE/CPLG. SELECTION
- G&K COUPLINGS
- GLOBALSPIRAL COUPLINGS
- STAINLESS STEEL SPIRAL
- MEGACRIMP COUPLINGS
- STAINLESS STEEL BRAID
- POWER CRIMP COUPLINGS
- FIELD ATTACHABLE G1 & G2 COUPLINGS
- FIELD ATTACHABLE C5 COUPLINGS
- GLX COUPLINGS
- GL COUPLINGS
- C14 COUPLINGS
- PCTS THERMOPLASTIC COUPLINGS
- POLARSEAL COUPLINGS
- POLARSEAL II COUPLINGS
- POWER STEERING
- ADAPTERS
- QUICK DISCONNECT COUPLERS
- BALL VALVES
- LIVE SWIVEL
- ASSEMBLY FABRICATION
- ACCESSORIES
- EQUIPMENT AND PARTS
- AIR BRAKE
- BRASS**
- KITS

Brass Adapters

Female Inverted on Run to Male Pipe NPTF - Brass



Part No.	Descr.	Prod. No.			
			"	"	"
G60628-0302	3FI-3FI-2MP	7250-11855	3/8-24	3/8-24	1/8-27
G60628-0402	4FI-4FI-2MP	7250-11865	7/16-24	7/16-24	1/8-27
G60628-0504	5FI-5FI-4MP	7250-11875	1/2-20	1/2-20	1/4-18
G60628-0604	6FI-6FI-4MP	7250-11885	5/8-18	5/8-18	1/4-18

Male Pipe to Female Inverted to Female Inverted - Brass



Part No.	Descr.	Prod. No.			
			"	"	"
G60629-0203	2MP-3FI-3FI	7250-11905	1/8-27	3/8-24	3/8-24
G60629-0204	2MP-4FI-4FI	7250-11915	1/8-27	7/16-24	7/16-24
G60629-0205	2MP-5FI-5FI	7250-11925	1/8-27	1/2-20	1/2-20
G60629-0406	4MP-6FI-6FI	7250-11935	7/16-24	5/8-18	5/8-18
G60629-0408	4MP-8FI-8FI	7250-11945	7/16-24	3/4-18	3/4-18

EQUIPMENT
HOSE/CPLG. SELECTION
G8K COUPLINGS
GLOBALSPIRAL COUPLINGS
STAINLESS STEEL SPIRAL
MEGACRIMP COUPLINGS
STAINLESS STEEL BRAID
POWER CRIMP COUPLINGS
FIELD ATTACHABLE G1 & G2 COUPLINGS
FIELD ATTACHABLE C5 COUPLINGS
GLX COUPLINGS
GL COUPLINGS
C14 COUPLINGS
PCTS THERMOPLASTIC COUPLINGS
POLARSEAL COUPLINGS
POLARSEAL II COUPLINGS
POWER STEERING
ADAPTERS
QUICK DISCONNECT COUPLERS
BALL VALVES
LIVE SWIVEL
ASSEMBLY FABRICATION
ACCESSORIES
EQUIPMENT AND PARTS
AIR BRAKE
BRASS
KITS

Brass Adapters

Female Pipe to Female Inverted - Brass



Part No.	Descr.	Prod. No.		
			"	"
G60630-0202	2FP-2FI	7250-11955	1/8-27	5/16-28
G60630-0203	2FP-3FI	7250-11965	1/8-27	3/8-24
G60630-0204	2FP-4FI	7250-11975	1/8-27	7/16-24
G60630-0205	2FP-5FI	7250-11985	1/8-27	1/2-20
G60630-0404	4FP-4FI	7250-17095	1/4-18	7/16-24
G60630-0406	4FP-6FI	7250-11995	1/4-18	5/8-18
G60630-0407	4FP-7FI	7250-12005	1/4-18	11/16-18
G60630-0608	6FP-8FI	7250-12015	3/8-18	3/4-18
G60630-0810	8FP-10FI	7250-12025	1/2-14	7/8-18
G60630-0812	8FP-12FI	7250-12035	1/2-14	1 1/16-16

Female Pipe to Female Pipe - Brass



Part No.	Descr.	Prod. No.		
			"	"
G60631-0101	1FP-1FPB	7250-12045	1/16-32	1/16-32
G60631-0202	2FP-2FPB	7250-12055	1/8-27	1/8-27
G60631-0402	4FP-2FPB	7250-12065	1/4-18	1/8-27
G60631-0404	4FP-4FPB	7250-12075	1/4-18	1/4-18
G60631-0602	6FP-2FPB	7250-12085	3/8-18	1/8-27
G60631-0604	6FP-4FPB	7250-12095	3/8-18	1/4-18
G60631-0606	6FP-6FPB	7250-12105	3/8-18	3/8-18
G60631-0806	8FP-6FPB	7250-12115	1/2-14	3/8-18
G60631-0808	8FP-8FPB	7250-12125	1/2-14	1/2-14
G60631-1208	12FP-8FPB	7250-17105	3/4-14	1/2-14
G60631-1212	12FP-12FPB	7250-12135	3/4-14	3/4-14

EQUIPMENT
HOSE/CPLG. SELECTION
G&K COUPLINGS
GLOBALSPIRAL COUPLINGS
STAINLESS STEEL SPIRAL
MEGACRIMP COUPLINGS
STAINLESS STEEL BRAID
POWER CRIMP COUPLINGS
FIELD ATTACHABLE G1 & G2 COUPLINGS
FIELD ATTACHABLE C5 COUPLINGS
GLX COUPLINGS
GL COUPLINGS
C14 COUPLINGS
PCTS THERMOPLASTIC COUPLINGS
POLARSEAL COUPLINGS
POLARSEAL II COUPLINGS
POWER STEERING
ADAPTERS
QUICK DISCONNECT COUPLERS
BALL VALVES
LIVE SWIVEL
ASSEMBLY FABRICATION
ACCESSORIES
EQUIPMENT AND PARTS
AIR BRAKE
BRASS
KITS

Brass Adapters

Female Pipe to Female Pipe Swivel Union - Brass



Part No.	Descr.	Prod. No.		
			"	"
G60632-0202	2FP-2FPXB	7250-12145	1/8-27	
G60632-0404	4FP-4FPXB	7250-12155	1/4-18	
G60632-0606	6FP-6FPXB	7250-12165	3/8-18	
G60632-0808	8FP-8FPXB	7250-12175	1/2-14	
G60632-1212	12FP-12FPXB	7250-17125	3/4-14	

Female Pipe NPTF to Female Pipe NPTF - 45° - Brass

Part No.	Descr.	Prod. No.		
			"	"
G60635-0202	2FP-2FPB45	7250-17135	1/8-27	
G60635-0404	4FP-4FPB45	7250-17145	1/4-18	
G60635-0606	6FP-6FPB45	7250-17155	3/8-18	
G60635-0808	8FP-8FPB45	7250-17165	1/2-14	
G60635-1212	12FP-12FPB45	7250-17175	3/4-14	

Female Pipe to Female Pipe - 90° - Brass



Part No.	Descr.	Prod. No.		
			"	"
G60637-0202	2FP-2FPB90	7250-12235	1/8-27	1/8-27
G60637-0204	2FP-4FPB90	7250-17185	1/8-27	1/4-18
G60637-0404	4FP-4FPB90	7250-12245	1/4-18	1/4-18
G60637-0406	4FP-6FPB90	7250-17195	1/4-18	3/8-18
G60637-0606	6FP-6FPB90	7250-12255	3/8-18	3/8-18
G60637-0608	6FP-8FPB90	7250-17205	3/8-18	1/2-14
G60637-0808	8FP-8FPB90	7250-12265	1/2-14	1/2-14
G60637-1212	12FP-12FPB90	7250-12275	3/4-14	3/4-14

Female Pipe - Cross - Brass



Part No.	Descr.	Prod. No.			
			"	"	"
G60639-0202	2FP-2FP-2FP-2FPB	7250-12285	1/8-27		
G60639-0404	4FP-4FP-4FP-4FPB	7250-12295	1/4-18		
G60639-0606	6FP-6FP-6FP-6FPB	7250-12305	3/8-18		
G60639-0808	8FP-8FP-8FP-8FPB	7250-12315	1/2-14		
G60639-1212	12FP-12FP-12FP-12FPB	7250-12325	3/4-14		

Female Pipe - Union Tee - Brass



Part No.	Descr.	Prod. No.			
			"	"	"
G60640-0101	1FP-1FP-1FPB	7250-12335	1/16-32	1/16-32	1/16-32
G60640-0202	2FP-2FP-2FPB	7250-12345	1/8-27	1/8-27	1/8-27
G60640-0204	2FP-2FP-4FPB	7250-17215	1/8-27	1/8-27	1/4-18
G60640-0402	4FP-4FP-2FPB	7250-17225	1/4-18	1/4-18	1/8-27
G60640-0404	4FP-4FP-4FPB	7250-12355	1/4-18	1/4-18	1/4-18
G60640-0604	6FP-6FP-4FPB	7250-17235	3/8-18	3/8-18	1/4-18
G60640-0606	6FP-6FP-6FPB	7250-12365	3/8-18	3/8-18	3/8-18
G60640-0806	8FP-8FP-6FPB	7250-17245	1/2-14	1/2-14	3/8-18
G60640-0808	8FP-8FP-8FPB	7250-12375	1/2-14	1/2-14	1/2-14
G60640-1208	12FP-12FP-8FPB	7250-17255	3/4-14	3/4-14	1/2-14
G60640-1212	12FP-12FP-12FPB	7250-12385	3/4-14	3/4-14	3/4-14

- EQUIPMENT
- HOSE/CPLG. SELECTION
- G&K COUPLINGS
- GLOBALSPIRAL COUPLINGS
- STAINLESS STEEL SPIRAL
- MEGACRIMP COUPLINGS
- STAINLESS STEEL BRAID
- POWER CRIMP COUPLINGS
- FIELD ATTACHABLE G1 & G2 COUPLINGS
- FIELD ATTACHABLE C5 COUPLINGS
- GLX COUPLINGS
- GL COUPLINGS
- C14 COUPLINGS
- PCTS THERMOPLASTIC COUPLINGS
- POLARSEAL COUPLINGS
- POLARSEAL II COUPLINGS
- POWER STEERING
- ADAPTERS
- QUICK DISCONNECT COUPLERS
- BALL VALVES
- LIVE SWIVEL
- ASSEMBLY FABRICATION
- ACCESSORIES
- EQUIPMENT AND PARTS
- AIR BRAKE
- BRASS**
- KITS

Brass Adapters

Female Pipe to Male Pipe to Female Pipe - Brass



Part No.	Descr.	Prod. No.		
			"	"
G60641-0202	2FP-2MP-2FPB	7250-12395	1/8-27	1/8-27
G60641-0404	4FP-4MP-4FPB	7250-12405	1/4-18	1/4-18
G60641-0606	6FP-6MP-6FPB	7250-12415	3/8-18	3/8-18
G60641-0808	8FP-8MP-8FPB	7250-12425	1/2-14	1/2-14
G60641-1212	12FP-12MP-12FPB	7250-12435	3/4-14	3/4-14

Female Pipe on Run to Male Pipe - Tee - Brass



Part No.	Descr.	Prod. No.		
			"	"
G60642-0202	2FP-2FP-2MPB	7250-12445	1/8-27	1/8-27
G60642-0404	4FP-4FP-4MPB	7250-12455	1/4-18	1/4-18
G60642-0606	6FP-6FP-6MPB	7250-12465	3/8-18	3/8-18
G60642-0808	8FP-8FP-8MPB	7250-12475	1/2-14	1/2-14
G60642-1212	12FP-12FP-12MPB	7250-12485	3/4-14	3/4-14

EQUIPMENT

HOSE/CPLG.
SELECTION

G8K COUPLINGS

GLOBALSPIRAL
COUPLINGSSTAINLESS
STEEL SPIRALMEGACRIMP
COUPLINGSSTAINLESS
STEEL BRAIDPOWER CRIMP
COUPLINGSFIELD
ATTACHABLE G1
& G2 COUPLINGSFIELD
ATTACHABLE C5
COUPLINGS

GLX COUPLINGS

GL COUPLINGS

C14 COUPLINGS

PCTS
THERMOPLASTIC
COUPLINGSPOLARSEAL
COUPLINGSPOLARSEAL II
COUPLINGSPOWER
STEERING

ADAPTERS

QUICK
DISCONNECT
COUPLERS

BALL VALVES

LIVE SWIVEL

ASSEMBLY
FABRICATION

ACCESSORIES

EQUIPMENT AND
PARTS

AIR BRAKE

BRASS

KITS

Female SAE 45° Flare Cap - Brass



Part No.	Descr.	Prod. No.	
			"
G60643-0003	3FSCAP	7250-17265	3/8-24
G60643-0004	4FSCAP	7250-17275	7/16-20
G60643-0005	5FSCAP	7250-17285	1/2-20
G60643-0006	6FSCAP	7250-17295	5/8-18
G60643-0008	8FSCAP	7250-17305	1 1/16-24
G60643-0010	10FSCAP	7250-17315	7/8-14
G60643-0012	12FSCAP	7250-17325	1 1/16-14

Male SAE Plug - Brass





Part No.	Descr.	Prod. No.	
			"
G60644-0003	3MSPLUG	7250-17335	3/8-24
G60644-0004	4MSPLUG	7250-17345	7/16-20
G60644-0005	5MSPLUG	7250-17355	1/2-20
G60644-0006	6MS-PLUG	7250-17365	5/8-18
G60644-0008	8MSPLUG	7250-17375	1 1/16-24
G60644-0010	10MS-PLUG	7250-17385	7/8-14
G60644-0012	12MS-PLUG	7250-17395	1 1/16-14

EQUIPMENT
HOSE/CPLG. SELECTION
G&K COUPLINGS
GLOBALSPIRAL COUPLINGS
STAINLESS STEEL SPIRAL
MEGACRIMP COUPLINGS
STAINLESS STEEL BRAID
POWER CRIMP COUPLINGS
FIELD ATTACHABLE G1 & G2 COUPLINGS
FIELD ATTACHABLE C5 COUPLINGS
GLX COUPLINGS
GL COUPLINGS
C14 COUPLINGS
PCTS THERMOPLASTIC COUPLINGS
POLARSEAL COUPLINGS
POLARSEAL II COUPLINGS
POWER STEERING
ADAPTERS
QUICK DISCONNECT COUPLERS
BALL VALVES
LIVE SWIVEL
ASSEMBLY FABRICATION
ACCESSORIES
EQUIPMENT AND PARTS
AIR BRAKE
BRASS
KITS

Brass Adapters

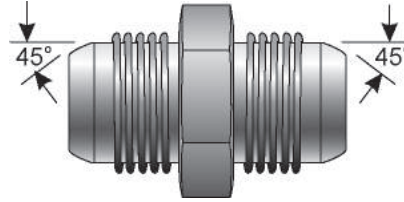
Male SAE 45° Flare to Male SAE 45° Flare - Brass



Part No.	Descr.	Prod. No.		
			"	"
G60645-0202	2MS-2MS	7250-12495	5/16-24	5/16-24
G60645-0303	3MS-3MS	7250-12505	3/8-24	3/8-24
G60645-0403	4MS-3MS	7250-17405	7/16-20	3/8-24
G60645-0404	4MS-4MS	7250-12515	7/16-20	7/16-20
G60645-0504	5MS-4MS	7250-17415	1/2-20	7/16-20
G60645-0505	5MS-5MS	7250-12525	1/2-20	1/2-20
G60645-0604	6MS-4MS	7250-17425	5/8-18	7/16-20
G60645-0605	6MS-5MS	7250-17435	5/8-18	1/2-20
G60645-0606	6MS-6MS	7250-12535	5/8-18	5/8-18
G60645-0804	8MS-4MS	7250-17445	3/4-16	7/16-20
G60645-0806	8MS-6MS	7250-17455	3/4-16	5/8-18
G60645-0808	8MS-8MS	7250-12545	3/4-16	3/4-16
G60645-1006	10MS-6MS	7250-17465	7/8-14	5/8-18
G60645-1008	10MS-8MS	7250-17475	7/8-14	3/4-16
G60645-1010	10MS-10MS	7250-12555	7/8-14	7/8-14
G60645-1208	12MS-8MS	7250-17485	1 1/16-14	3/4-16
G60645-1210	12MS-10MS	7250-17495	1 1/16-14	7/8-14
G60645-1212	12MS-12MS	7250-12565	1 1/16-14	1 1/16-14

Male SAE 45° Flare to Male SAE 45° Flare - 90° - Brass

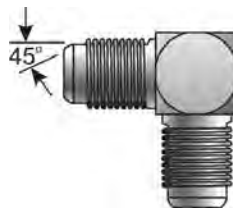

Part No.	Descr.	Prod. No.		
			"	"
G60648-0404	4MS-4MS90	7250-12575	7/16-20	7/16-20
G60648-0505	5MS-5MS90	7250-12585	1/2-20	1/2-20
G60648-0604	6MS-4MS90	7250-17515	5/8-18	7/16-20
G60648-0605	6MS-5MS90	7250-17525	5/8-18	1/2-20
G60648-0606	6MS-6MS90	7250-12595	5/8-18	5/8-18
G60648-0804	8MS-4MS90	7250-17535	3/4-16	7/16-20
G60648-0806	8MS-6MS90	7250-17545	3/4-16	5/8-18
G60648-0808	8MS-8MS90	7250-12605	3/4-16	3/4-16
G60648-1006	10MS-6MS90	7250-17555	7/8-14	5/8-18
G60648-1008	10MS-8MS90	7250-17565	7/8-14	3/4-16
G60648-1010	10MS-10MS90	7250-12615	7/8-14	7/8-14
G60648-1210	12MS-10MS90	7250-17585	1 1/16-14	7/8-14
G60648-1212	12MS-12MS90	7250-17595	1 1/16-14	1 1/16-14

Brass Adapters

Male SAE 45° Flare to Male Pipe - Brass

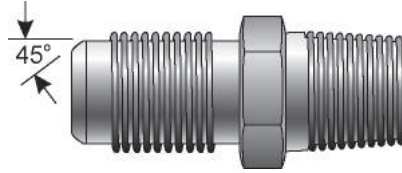

Part No.	Descr.	Prod. No.		
			"	"
G60650-0202	2MS-2MP	7250-12625	5/16-24	1/8-27
G60650-0302	3MS-2MP	7250-12635	3/8-24	1/8-27
G60650-0402	4MS-2MP	7250-12645	7/16-20	1/8-27
G60650-0404	4MS-4MP	7250-12655	7/16-20	1/4-18
G60650-0406	4MS-6MP	7250-18525	7/16-20	3/8-18
G60650-0408	4MS-8MP	7250-18535	7/16-20	1/2-14
G60650-0502	5MS-2MP	7250-12665	1/2-20	1/8-27
G60650-0504	5MS-4MP	7250-12675	1/2-20	1/4-18
G60650-0506	5MS-6MP	7250-18545	1/2-20	3/8-18
G60650-0602	6MS-2MP	7250-12685	5/8-18	1/8-27
G60650-0604	6MS-4MP	7250-12695	5/8-18	1/4-18
G60650-0606	6MS-6MP	7250-12705	5/8-18	3/8-18
G60650-0608	6MS-8MP	7250-12715	5/8-18	1/2-14
G60650-0704	7MS-4MP	7250-12725	11/16-16	1/4-18
G60650-0804	8MS-4MP	7250-12735	3/4-16	1/4-18
G60650-0806	8MS-6MP	7250-12745	3/4-16	3/8-18
G60650-0808	8MS-8MP	7250-12755	3/4-16	1/2-14
G60650-0812	8MS-12MP	7250-18555	3/4-16	3/4-14
G60650-1006	10MS-6MP	7250-12765	7/8-14	3/8-18
G60650-1008	10MS-8MP	7250-12775	7/8-14	1/2-14
G60650-1012	10MS-12MP	7250-18565	7/8-14	3/4-14
G60650-1208	12MS-8MP	7250-12785	1 1/16-14	1/2-14
G60650-1212	12MS-12MP	7250-12795	1 1/16-14	3/4-14

Male SAE 45° Flare to Male Pipe - 45° - Brass

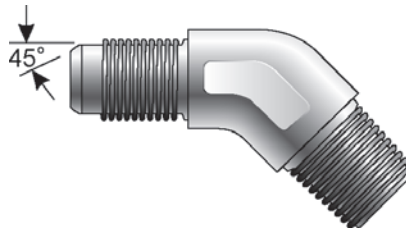

Part No.	Descr.	Prod. No.		
			"	"
G60652-0402	4MS-2MP45	7250-12805	7/16-20	1/8-27
G60652-0404	4MS-4MP45	7250-12815	7/16-20	1/4-18
G60652-0502	5MS-2MP45	7250-12825	7/16-20	1/4-18
G60652-0504	5MS-4MP45	7250-12835	7/16-20	1/4-18
G60652-0604	6MS-4MP45	7250-12845	5/8-18	1/4-18
G60652-0606	6MS-6MP45	7250-12855	5/8-18	3/8-18
G60652-0608	6MS-8MP45	7250-17605	5/8-18	1/2-14
G60652-0806	8MS-6MP45	7250-12875	3/4-16	3/8-18
G60652-0808	8MS-8MP45	7250-12885	3/4-16	1/2-14

EQUIPMENT
HOSE/CPLG. SELECTION
G&K COUPLINGS
GLOBALSPIRAL COUPLINGS
STAINLESS STEEL SPIRAL
MEGACRIMP COUPLINGS
STAINLESS STEEL BRAID
POWER CRIMP COUPLINGS
FIELD ATTACHABLE G1 & G2 COUPLINGS
FIELD ATTACHABLE C5 COUPLINGS
GLX COUPLINGS
GL COUPLINGS
C14 COUPLINGS
PCTS THERMOPLASTIC COUPLINGS
POLARSEAL COUPLINGS
POLARSEAL II COUPLINGS
POWER STEERING
ADAPTERS
QUICK DISCONNECT COUPLERS
BALL VALVES
LIVE SWIVEL
ASSEMBLY FABRICATION
ACCESSORIES
EQUIPMENT AND PARTS
AIR BRAKE
BRASS
KITS

Brass Adapters

Male SAE 45° Flare to Male Pipe - 45° - Brass - Continued

Part No.	Descr.	Prod. No.		
			"	"
G60652-1006	10MS-6MP45	7250-12865	7/8-14	3/8-18
G60652-1008	10MS-8MP45	7250-12895	7/8-14	3/4-16
G60652-1208	12MS-8MP45	7250-17615	1 1/16-14	1/2-14
G60652-1212	12MS-12MP45	7250-12905	1 1/16-14	1 1/16-14

Male SAE 45° Flare to Male Pipe - 90° - Brass

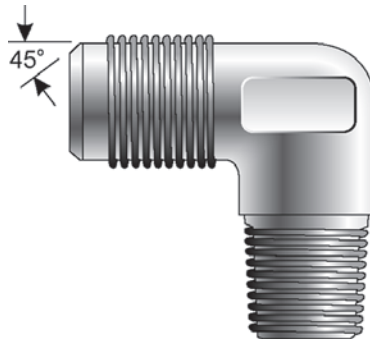

Part No.	Descr.	Prod. No.		
			"	"
G60654-0202	2MS-2MP90	7250-12915	5/16-24	1/8-27
G60654-0302	3MS-2MP90	7250-12925	3/8-24	1/8-27
G60654-0402	4MS-2MP90	7250-12935	7/16-20	1/8-27
G60654-0404	4MS-4MP90	7250-12945	7/16-20	1/4-18
G60654-0406	4MS-6MP90	7250-12955	7/16-20	3/8-18
G60654-0502	5MS-2MP90	7250-12965	1/2-20	1/8-27
G60654-0504	5MS-4MP90	7250-12975	1/2-20	1/4-18
G60654-0506	5MS-6MP90	7250-17625	1/2-20	5/8-18
G60654-0602	6MS-2MP90	7250-12985	5/8-18	1/8-27
G60654-0604	6MS-4MP90	7250-12995	5/8-18	1/4-18
G60654-0606	6MS-6MP90	7250-13005	5/8-18	3/8-18
G60654-0607	6MS-7MP90	7250-13015	3/8-18	5/8-18
G60654-0608	6MS-8MP90	7250-13025	5/8-18	1/2-14
G60654-0612	6MS-12MP90	7250-18575	5/8-18	3/4-14
G60654-0804	8MS-4MP90	7250-13035	3/4-16	1/4-18
G60654-0806	8MS-6MP90	7250-13045	3/4-16	3/8-18
G60654-0808	8MS-8MP90	7250-13055	3/4-16	1/2-14
G60654-0812	8MS-12MP90	7250-18495	3/4-16	3/4-14
G60654-1006	10MS-6MP90	7250-13065	7/8-14	3/8-18
G60654-1008	10MS-8MP90	7250-13075	7/8-14	1/2-14
G60654-1012	10MS-12MP90	7250-18585	7/8-14	3/4-14
G60654-1208	12MS-8MP90	7250-13085	1 1/16-14	1/2-14
G60654-1212	12MS-12MP90	7250-13095	1 1/16-14	3/4-14

Brass Adapters

Male SAE 45° Flare on Run to Male Pipe - Brass

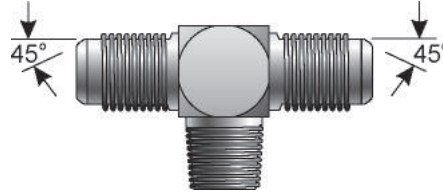

Part No.	Descr.	Prod. No.		
			"	"
G60657-0202	2MS-2MS-2MP	7250-17635	3/16-24	1/8-27
G60657-0302	3MS-3MS-2MP	7250-13105	3/8-24	1/8-27
G60657-0402	4MS-4MS-2MP	7250-13115	7/16-20	1/8-27
G60657-0404	4MS-4MS-4MP	7250-13125	7/16-20	1/4-18
G60657-0406	4MS-4MS-6MP	7250-17645	7/16-20	3/8-18
G60657-0408	4MS-4MS-8MP	7250-17655	7/16-20	1/2-14
G60657-0502	5MS-5MS-2MP	7250-13135	1/2-20	1/4-27
G60657-0504	5MS-5MS-4MP	7250-13145	1/2-20	1/4-18
G60657-0602	6MS-6MS-2MP	7250-17665	5/8-18	1/8-27
G60657-0604	6MS-6MS-4MP	7250-13155	5/8-18	1/4-18
G60657-0606	6MS-6MS-6MP	7250-13165	5/8-18	3/8-18
G60657-0608	6MS-6MS-8MP	7250-17675	5/8-18	1/2-14
G60657-0804	8MS-8MS-4MP	7250-17685	3/4-16	1/4-18
G60657-0806	8MS-8MS-6MP	7250-13175	3/4-16	3/8-18
G60657-0808	8MS-8MS-8MP	7250-13185	3/4-16	1/2-14
G60657-0812	8MS-8MS-12MP	7250-17695	3/4-16	3/4-14
G60657-1008	10MS-10MS-8MP	7250-13195	7/8-14	1/2-14
G60657-1012	10MS-10MS-12MP	7250-17705	7/8-14	3/4-14
G60657-1208	12MS-12MS-8MP	7250-17715	1 1/6-14	1/2-14
G60657-1212	12MS-12MS-12MP	7250-13215	1 1/6-14	3/4-14

Male Pipe NPTF to Male SAE 45° Flare to Male SAE 45° Flare - Brass

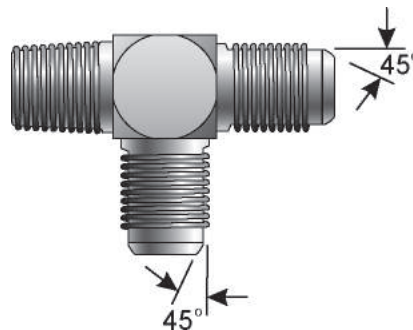

Part No.	Descr.	Prod. No.		
			"	"
G60659-0203	2MP-3MS-3MS	7250-13225	1/8-27	3/8-24
G60659-0204	2MP-4MS-4MS	7250-13235	1/8-27	7/16-20
G60659-0205	2MP-5MS-5MS	7250-13245	1/8-27	1/2-20
G60659-0206	2MP-6MS-6MS	7250-17725	1/8-27	5/8-18
G60659-0404	4MP-4MS-4MS	7250-13255	1/4-18	7/16-20
G60659-0405	4MP-5MS-5MS	7250-13265	1/4-18	1/2-20
G60659-0406	4MP-6MS-6MS	7250-13275	1/4-18	5/8-18

EQUIPMENT

HOSE/CPLG.
SELECTION

G8K COUPLINGS

GLOBALSPIRAL
COUPLINGSSTAINLESS
STEEL SPIRALMEGACRIMP
COUPLINGSSTAINLESS
STEEL BRAIDPOWER CRIMP
COUPLINGSFIELD
ATTACHABLE G1
& G2 COUPLINGSFIELD
ATTACHABLE C5
COUPLINGS

GLX COUPLINGS

GL COUPLINGS

C14 COUPLINGS

PCTS
THERMOPLASTIC
COUPLINGSPOLARSEAL
COUPLINGSPOLARSEAL II
COUPLINGSPOWER
STEERING

ADAPTERS

QUICK
DISCONNECT
COUPLERS

BALL VALVES

LIVE SWIVEL

ASSEMBLY
FABRICATION

ACCESSORIES

EQUIPMENT AND
PARTS

AIR BRAKE

BRASS

KITS

Brass Adapters

Male Pipe NPTF to Male SAE 45° Flare to Male SAE 45° Flare - Brass - Continued

Part No.	Descr.	Prod. No.		
			"	"
G60659-0408	4MP-8MS-8MS	7250-17735	1/4-18	3/4-16
G60659-0604	6MP-4MS-4MS	7250-17745	3/8-18	7/16-20
G60659-0606	6MP-6MS-6MS	7250-13285	3/8-18	5/8-18
G60659-0608	6MP-8MS-8MS	7250-13295	3/8-18	3/4-16
G60659-0610	6MP-10MS-10MS	7250-17755	3/8-18	7/8-14
G60659-0806	8MP-6MS-6MS	7250-17765	1/2-14	5/8-18
G60659-0808	8MP-8MS-8MS	7250-13305	1/2-14	3/4-16
G60659-0810	8MP-10MS-10MS	7250-13315	1/2-14	7/8-14
G60659-0812	8MP-12MS-12MS	7250-17775	1/2-14	1 1/6-14
G60659-1212	12MP-12MS-12MS	7250-13325	3/4-14	1 1/6-14

Male SAE 45° Flare to Female Pipe - Brass

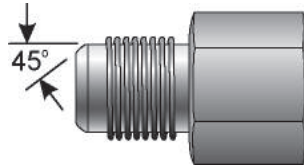

Part No.	Descr.	Prod. No.		
			"	"
G60660-0202	2MS-2FP	7250-17785	7/16-20	1/8-27
G60660-0302	3MS-2FP	7250-13335	3/8-24	1/8-27
G60660-0402	4MS-2FP	7250-13345	7/16-20	1/8-27
G60660-0404	4MS-4FP	7250-13355	7/16-20	1/4-18
G60660-0406	4MS-6FP	7250-18595	7/16-20	1/2-14
G60660-0408	4MS-8FP	7250-17795	7/16-20	1/2-14
G60660-0502	5MS-2FP	7250-13365	1/2-20	1/8-27
G60660-0504	5MS-4FP	7250-13375	1/2-20	1/4-18
G60660-0506	5MS-6FP	7250-17805	1/2-20	3/8-18
G60660-0602	6MS-2FP	7250-13385	1/2-20	3/8-18
G60660-0604	6MS-4FP	7250-13395	5/8-18	1/4-18
G60660-0606	6MS-6FP	7250-13405	5/8-18	3/8-18
G60660-0608	6MS-8FP	7250-13415	5/8-18	1/2-14
G60660-0804	8MS-4FP	7250-13425	3/4-16	1/4-18
G60660-0806	8MS-6FP	7250-13435	3/4-16	3/8-18
G60660-0808	8MS-8FP	7250-13445	3/4-16	1/2-14
G60660-1006	10MS-6FP	7250-18605	7/8-14	3/8-18
G60660-1008	10MS-8FP	7250-13455	7/8-14	1/2-14
G60660-1012	10MS-12FP	7250-18615	7/8-14	3/4-14
G60660-1208	12MS-8FP	7250-17815	1 1/6-14	1/2-14

Brass Adapters

Male SAE 45° Flare to Female Pipe - 90° - Brass

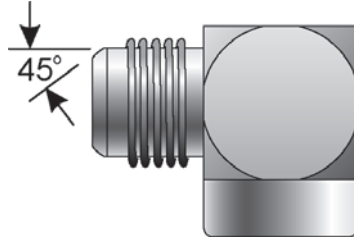

Part No.	Descr.	Prod. No.		
			"	"
G60664-0302	3MS-2FP90	7250-13465	3/8-24	1/8-27
G60664-0402	4MS-2FP90	7250-13475	7/16-20	1/8-27
G60664-0404	4MS-4FP90	7250-13485	7/16-20	1/4-18
G60664-0406	4MS-6FP90	7250-17835	7/16-20	3/8-18
G60664-0502	5MS-2FP90	7250-13495	1/2-20	1/8-27
G60664-0504	5MS-4FP90	7250-13505	1/2-20	1/4-18
G60664-0604	6MS-4FP90	7250-13515	5/8-18	1/4-18
G60664-0606	6MS-6FP90	7250-13525	5/8-18	3/8-18
G60664-0806	8MS-6FP90	7250-13535	3/4-16	3/8-18
G60664-0808	8MS-8FP90	7250-13545	3/4-16	1/2-14
G60664-1006	10MS-6FP90	7250-18625	7/8-14	3/8-18
G60664-1008	10MS-8FP90	7250-13555	7/8-14	1/2-14
G60664-1208	12MS-8FP90	7250-18635	1 1/16-14	1/2-14
G60664-1212	12MS-12FP90	7250-18645	1 1/16-14	3/4-14

Male SAE 45° Flare - Tee 1 - Brass

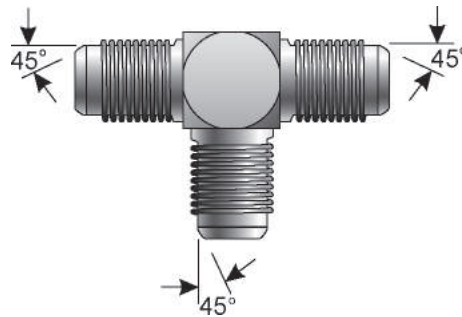

Part No.	Descr.	Prod. No.		
			"	"
G60669-0202	2MS-2MS-2MS	7250-13565	5/16-24	5/16-24
G60669-0303	3MS-3MS-3MS	7250-13575	3/8-24	3/8-24
G60669-0404	4MS-4MS-4MS	7250-13585	7/16-20	7/16-20
G60669-0406	4MS-4MS-6MS	7250-17855	7/16-20	5/8-18
G60669-0504	5MS-5MS-4MS	7250-17865	1/2-20	7/16-20
G60669-0505	5MS-5MS-5MS	7250-13595	1/2-20	1/2-20
G60669-0604	6MS-6MS-4MS	7250-17875	5/8-18	7/16-20
G60669-0606	6MS-6MS-6MS	7250-13605	5/8-18	5/8-18
G60669-0608	6MS-6MS-8MS	7250-17885	5/8-18	3/4-16
G60669-0610	6MS-6MS-10MS	7250-17895	5/8-18	5/8-18
G60669-0804	8MS-8MS-4MS	7250-17905	3/4-16	7/16-20
G60669-0806	8MS-8MS-6MS	7250-17915	3/4-16	5/8-18

EQUIPMENT
HOSE/CPLG. SELECTION
G8K COUPLINGS
GLOBALSPIRAL COUPLINGS
STAINLESS STEEL SPIRAL
MEGACRIMP COUPLINGS
STAINLESS STEEL BRAID
POWER CRIMP COUPLINGS
FIELD ATTACHABLE G1 & G2 COUPLINGS
FIELD ATTACHABLE C5 COUPLINGS
GLX COUPLINGS
GL COUPLINGS
C14 COUPLINGS
PCTS THERMOPLASTIC COUPLINGS
POLARSEAL COUPLINGS
POLARSEAL II COUPLINGS
POWER STEERING
ADAPTERS
QUICK DISCONNECT COUPLERS
BALL VALVES
LIVE SWIVEL
ASSEMBLY FABRICATION
ACCESSORIES
EQUIPMENT AND PARTS
AIR BRAKE
BRASS
KITS

Brass Adapters

Male SAE 45° Flare - Tee 1 - Brass - Continued

Part No.	Descr.	Prod. No.		
			"	"
G60669-0808	8MS-8MS-8MS	7250-13615	3/4-16	3/4-16
G60669-0810	8MS-8MS-10MS	7250-17925	3/4-16	7/8-14
G60669-0812	8MS-8MS-12MS	7250-17935	3/4-16	1 1/6-14
G60669-1004	10MS-10MS-4MS	7250-17945	7/8-14	7/16-20
G60669-1006	10MS-10MS-6MS	7250-17955	7/8-14	5/8-18
G60669-1008	10MS-10MS-8MS	7250-17965	7/8-14	3/4-16
G60669-1010	10MS-10MS-10MS	7250-13625	7/8-14	7/8-14
G60669-1208	12MS-12MS-8MS	7250-17975	1 1/6-14	3/4-16
G60669-1210	12MS-12MS-10MS	7250-17985	1 1/6-14	7/8-14
G60669-1212	12MS-12MS-12MS	7250-13635	1 1/6-14	1 1/6-14

Male SAE 45° Flare - Tee 2 - Brass

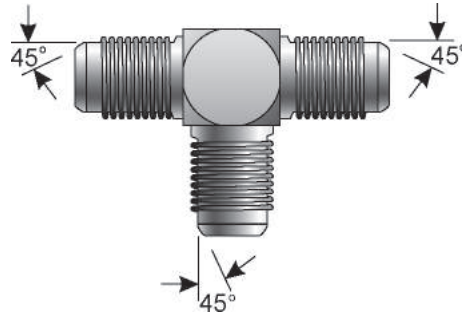

Part No.	Descr.	Prod. No.		
			"	"
G60670-0604	6MS-4MS-4MS	7250-17995	5/8-18	7/16-20
G60670-0806	8MS-6MS-6MS	7250-18005	3/4-16	5/8-18
G60670-1006	10MS-6MS-6MS	7250-18015	7/8-14	5/8-18
G60670-1008	10MS-8MS-8MS	7250-18025	7/8-14	3/4-16

Male SAE 45° Flare - Tee 3 - Brass

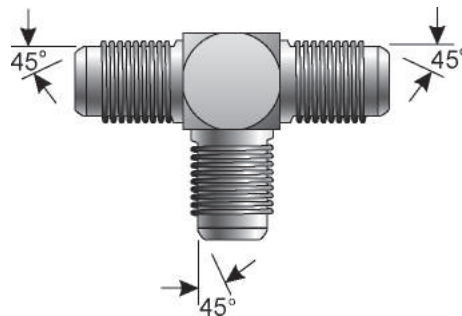

Part No.	Descr.	Prod. No.		
			"	"
G60671-0604	6MS-4MS-6MS	7250-18035	5/8-18	7/16-20
G60671-0804	8MS-4MS-8MS	7250-18045	3/4-16	7/16-20

Brass Adapters

Male SAE 45° Flare - Tee 3 - Brass - Continued

Part No.	Descr.	Prod. No.		
			"	"
G60671-0806	8MS-6MS-8MS	7250-18055	3/4-16	5/8-18
G60671-1006	10MS-6MS-10MS	7250-18065	7/8-14	5/8-18
G60671-1008	10MS-8MS-10MS	7250-18075	7/8-14	3/4-16
G60671-1210	12MS-10MS-12MS	7250-18085	1 1/6-14	7/8-14

Female SAE 45° Flare Nut - Short - Brass



Part No.	Descr.	Prod. No.		
			"	"
G60675-0002	2FSN-S	7250-13675	5/16-24	
G60675-0003	3FSN-S	7250-13685	3/8-24	
G60675-0004	4FSN-S	7250-13695	7/16-20	
G60675-0005	5FSN-S	7250-13705	1/2-20	
G60675-0006	6FSN-S	7250-13715	5/8-18	
G60675-0007	7FSN-S	7250-13725	11/16-16	
G60675-0008	8FSN-S	7250-13735	3/4-16	
G60675-0010	10FSN-S	7250-13745	7/8-14	
G60675-0012	12FSN-S	7250-13755	1 1/16-14	

Female SAE 45° Flare Nut - Long - Brass



Part No.	Descr.	Prod. No.		
			"	"
G60676-0003	3FSN-L	7250-13765	3/8-24	
G60676-0004	4FSN-L	7250-13775	7/16-20	
G60676-0005	5FSN-L	7250-13785	1/2-20	
G60676-0006	6FSN-L	7250-13795	5/8-18	
G60676-0008	8FSN-L	7250-13805	3/4-16	
G60676-0010	10FSN-L	7250-13815	7/8-14	

EQUIPMENT

HOSE/CPLG.
SELECTION

G&K COUPLINGS

GLOBALSPIRAL
COUPLINGSSTAINLESS
STEEL SPIRALMEGACRIMP
COUPLINGSSTAINLESS
STEEL BRAIDPOWER CRIMP
COUPLINGSFIELD
ATTACHABLE G1
& G2 COUPLINGSFIELD
ATTACHABLE C5
COUPLINGS

GLX COUPLINGS

GL COUPLINGS

C14 COUPLINGS

PCTS
THERMOPLASTIC
COUPLINGSPOLARSEAL
COUPLINGSPOLARSEAL II
COUPLINGSPOWER
STEERING

ADAPTERS

QUICK
DISCONNECT
COUPLERS

BALL VALVES

LIVE SWIVEL

ASSEMBLY
FABRICATION

ACCESSORIES

EQUIPMENT AND
PARTS

AIR BRAKE

BRASS

KITS

Brass Adapters

EQUIPMENT
HOSE/CPLG. SELECTION
G8K COUPLINGS
GLOBALSPIRAL COUPLINGS
STAINLESS STEEL SPIRAL
MEGACRIMP COUPLINGS
STAINLESS STEEL BRAID
POWER CRIMP COUPLINGS
FIELD ATTACHABLE G1 & G2 COUPLINGS
FIELD ATTACHABLE C5 COUPLINGS
GLX COUPLINGS
GL COUPLINGS
C14 COUPLINGS
PCTS THERMOPLASTIC COUPLINGS
POLARSEAL COUPLINGS
POLARSEAL II COUPLINGS
POWER STEERING
ADAPTERS
QUICK DISCONNECT COUPLERS
BALL VALVES
LIVE SWIVEL
ASSEMBLY FABRICATION
ACCESSORIES
EQUIPMENT AND PARTS
AIR BRAKE
BRASS
KITS

Male SAE 45° - Male Inverted





Part No.	Descr.	Prod. No.		
			"	"
G60679-0403	4MS-3MI	7250-13645	7/16-20	3/8-24
G60679-0404	4MS-4MI	7250-13655	7/16-20	7/16-24
G60679-0606	6MS-6MI	7250-13665	5/8-18	5/8-18

Male SAE 45° Flare - Cross



Part No.	Descr.	Prod. No.	
			"
G60680-0404	4MSCROSS	7250-18095	7/16-20
G60680-0505	5MSCROSS	7250-18105	1/2-20
G60680-0606	6MSCROSS	7250-18115	5/8-18
G60680-0808	8MSCROSS	7250-18125	3/4-16

SAE Tubing Sleeve Nut

Part No.	Descr.	Prod. No.		
			"	"
G60685-0004	4STSN	7250-18195	1/4	7/16-20
G60685-0005	5STSN	7250-18205	5/16	1/2-20
G60685-0006	6STSN	7250-18215	3/8	5/8-18
G60685-0008	8STSN	7250-18225	1/2	3/4-16
G60685-0010	10STSN	7250-18235	5/8	7/8-14
G60685-0012	12STSN	7250-18245	3/4	1 1/16-14

Male SAE 45° Flare to Male Pipe - Check Valve



Part No.	Descr.	Prod. No.		
			"	"
G60690-0204	2MS-4MP-CV	7250-13825	5/16-24	1/4-18
G60690-0402	4MS-2MP-CV	7250-13835	7/16-20	1/8-27
G60690-0502	5MS-2MP-CV	7250-18505	1/2-20	1/8-27
G60690-0604	6MS-4MP-CV	7250-13845	5/8-18	1/4-18

Male Inverted Plug



Part No.	Descr.	Prod. No.		
			"	"
G60691-0003	3MI-PLUG	7250-13855	3/8-24	
G60691-0004	4MI-PLUG	7250-13865	7/16-24	
G60691-0005	5MI-PLUG	7250-13875	1/2-20	
G60691-0006	6MI-PLUG	7250-13885	5/8-18	

Female Inverted to Female Inverted



Part No.	Descr.	Prod. No.		
			"	"
G60693-0202	2FI-2FI	7250-13955	5/16-28	5/16-28
G60693-0303	3FI-3FI	7250-13965	3/8-24	3/8-24

- EQUIPMENT
- HOSE/CPLG. SELECTION
- G&K COUPLINGS
- GLOBALSPIRAL COUPLINGS
- STAINLESS STEEL SPIRAL
- MEGACRIMP COUPLINGS
- STAINLESS STEEL BRAID
- POWER CRIMP COUPLINGS
- FIELD ATTACHABLE G1 & G2 COUPLINGS
- FIELD ATTACHABLE C5 COUPLINGS
- GLX COUPLINGS
- GL COUPLINGS
- C14 COUPLINGS
- PCTS THERMOPLASTIC COUPLINGS
- POLARSEAL COUPLINGS
- POLARSEAL II COUPLINGS
- POWER STEERING
- ADAPTERS
- QUICK DISCONNECT COUPLERS
- BALL VALVES
- LIVE SWIVEL
- ASSEMBLY FABRICATION
- ACCESSORIES
- EQUIPMENT AND PARTS
- AIR BRAKE
- BRASS**
- KITS

Brass Adapters

EQUIPMENT
HOSE/CPLG. SELECTION
G8K COUPLINGS
GLOBALSPIRAL COUPLINGS
STAINLESS STEEL SPIRAL
MEGACRIMP COUPLINGS
STAINLESS STEEL BRAID
POWER CRIMP COUPLINGS
FIELD ATTACHABLE G1 & G2 COUPLINGS
FIELD ATTACHABLE C5 COUPLINGS
GLX COUPLINGS
GL COUPLINGS
C14 COUPLINGS
PCTS THERMOPLASTIC COUPLINGS
POLARSEAL COUPLINGS
POLARSEAL II COUPLINGS
POWER STEERING
ADAPTERS
QUICK DISCONNECT COUPLERS
BALL VALVES
LIVE SWIVEL
ASSEMBLY FABRICATION
ACCESSORIES
EQUIPMENT AND PARTS
AIR BRAKE
BRASS
KITS

Female Inverted to Female Inverted - Continued

Part No.	Descr.	Prod. No.		
			"	"
G60693-0404	4FI-4FI	7250-13975	7/16-24	7/16-24
G60693-0505	5FI-5FI	7250-13985	1/2-20	1/2-20
G60693-0606	6FI-6FI	7250-13995	5/8-18	5/8-18
G60693-0808	8FI-8FI	7250-14005	3/4-16	3/4-18
G60693-1010	10FI-10FI	7250-14015	7/8-18	7/8-18

Female Inverted to Female Inverted - 90°



Part No.	Descr.	Prod. No.		
			"	"
G60694-0404	4FI-4FI90	7250-14025	7/16-24	7/16-24
G60694-0505	5FI-5FI90	7250-14035	1/2-20	1/2-20
G60694-0606	6FI-6FI90	7250-14045	5/8-18	5/8-18
G60694-0808	8FI-8FI90	7250-14055	3/4-18	3/4-18

Female Inverted - Tee



Part No.	Descr.	Prod. No.			
			"	"	"
G60695-0303	3FI-3FI-3FI	7250-14085	3/8-24	3/8-24	3/8-24
G60695-0404	4FI-4FI-4FI	7250-18675	1/4-18	1/4-18	1/4-18
G60695-0505	5FI-5FI-5FI	7250-14135	1/2-20	1/2-20	1/2-20
G60695-0606	6FI-6FI-6FI	7250-18685	3/8-18	3/8-18	3/8-18
G60695-0808	8FI-8FI-8FI	7250-18695	1/2-14	1/2-14	1/2-14
G60695-1414	14FI-14FI-14FI	7250-14215	1 3/16-16	1 3/16-16	1 3/16-16

Brass Adapters

Female Inverted on Run to Female Pipe - Tee



Part No.	Descr.	Prod. No.			
			"	"	"
G60696-0303	3FI-3FI-3FP	7250-14225	3/8-24	3/8-24	1/8-27
G60696-0404	4FI-4FI-4FP	7250-14235	7/16-24	7/16-24	1/4-18
G60696-0505	5FI-5FI-5FP	7250-14245	1/2-20	1/2-20	1/4-18
G60696-0604	6FI-6FI-4FP	7250-14255	5/8-18	5/8-18	3/8-18
G60696-0808	8FI-8FI-8FP	7250-14265	3/4-18	3/4-18	1/2-14

EQUIPMENT

HOSE/CPLG. SELECTION

G&K COUPLINGS

GLOBALSPIRAL COUPLINGS

STAINLESS STEEL SPIRAL

MEGACRIMP COUPLINGS

STAINLESS STEEL BRAID

POWER CRIMP COUPLINGS

FIELD ATTACHABLE G1 & G2 COUPLINGS

FIELD ATTACHABLE C5 COUPLINGS

GLX COUPLINGS

GL COUPLINGS

C14 COUPLINGS

PCTS THERMOPLASTIC COUPLINGS

POLARSEAL COUPLINGS

POLARSEAL II COUPLINGS

POWER STEERING

ADAPTERS

QUICK DISCONNECT COUPLERS

BALL VALVES

LIVE SWIVEL

ASSEMBLY FABRICATION

ACCESSORIES

EQUIPMENT AND PARTS

AIR BRAKE

BRASS

KITS

NOTES

EQUIPMENT
HOSE/CPLG. SELECTION
G8K COUPLINGS
GLOBALSPIRAL COUPLINGS
STAINLESS STEEL SPIRAL
MEGACRIMP COUPLINGS
STAINLESS STEEL BRAID
POWER CRIMP COUPLINGS
FIELD ATTACHABLE G1 & G2 COUPLINGS
FIELD ATTACHABLE C5 COUPLINGS
GLX COUPLINGS
GL COUPLINGS
C14 COUPLINGS
PCTS THERMOPLASTIC COUPLINGS
POLARSEAL COUPLINGS
POLARSEAL II COUPLINGS
POWER STEERING
ADAPTERS
QUICK DISCONNECT COUPLERS
BALL VALVES
LIVE SWIVEL
ASSEMBLY FABRICATION
ACCESSORIES
EQUIPMENT AND PARTS
AIR BRAKE
BRASS
KITS

Stop searching and start saving with these great hydraulic assortments. For once, all your hydraulic components will be in one place. And they are organized by size and style.

O-Ring (OR, FLOR, ORFF) Assortment Kit

Part Number: 85001

Product Number: 7369-0001



O-Rings for Straight-Thread Boss Fittings		
Descr	#	Quantity
40R	G60248-0004	10
60R	G60248-0006	10
80R	G60248-0008	10
100R	G60248-0010	10
120R	G60248-0012	10
160R	G60248-0016	10
200R	G60248-0020	10

O-Rings for Code 61 & 62 Flange Fittings		
Descr	#	Quantity
12FLOR	G60898-0012	10
16FLOR	G60898-0016	10
20FLOR	G60898-0020	10

O-Rings for Flat-Face Fittings		
Descr	#	Quantity
4ORFF	G60698-0004	10
6ORFF	G60698-0006	10
8ORFF	G60698-0008	10
10ORFF	G60698-0010	10
12ORFF	G60698-0012	10
16ORFF	G60698-0016	10

Flat-Face Plug (MFFOR) and Cap (FFOR) Kit

Part Number: 85002

Product Number: 7369-0002



Flat-Face O-Ring Caps		
Descr	#	Quantity
4FFOR-CAP	G60701-0004	2
6FFOR-CAP	G60701-0006	2
8FFOR-CAP	G60701-0008	2
10FFOR-CAP	G60701-0010	2
12FFOR-CAP	G60701-0012	2
16FFOR-CAP	G60701-0016	2

Flat-Face O-Ring Plugs		
Descr	#	Quantity
4MFFOR-PLUG	G60702-0004	2
6MFFOR-PLUG	G60702-0006	2
8MFFOR-PLUG	G60702-0008	2
10MFFOR-PLUG	G60702-0010	2
12MFFOR-PLUG	G60702-0012	2
16MFFOR-PLUG	G60702-0016	2

EQUIPMENT

HOSE/CPLG. SELECTION

G&K COUPLINGS

GLOBALS COUPLINGS

STAINLESS STEEL SPIRAL

MEGACRIMP COUPLINGS

STAINLESS STEEL BRAID

POWER CRIMP COUPLINGS

FIELD ATTACHABLE G1 & G2 COUPLINGS

FIELD ATTACHABLE C5 COUPLINGS

GLX COUPLINGS

GL COUPLINGS

C14 COUPLINGS

PCTS THERMOPLASTIC COUPLINGS

POLARSEAL COUPLINGS

POLARSEAL II COUPLINGS

POWER STEERING

ADAPTERS

QUICK DISCONNECT COUPLERS

BALL VALVES

LIVE SWIVEL

ASSEMBLY FABRICATION

ACCESSORIES

EQUIPMENT AND PARTS

AIR BRAKE

BRASS

KITS

JIC Plug (MJ) and Cap (FJ) Kit

Part Number: 85003

Product Number: 7369-0003



Male 37° Flare (JIC) Plug		
Descr	#	Quantity
4MJ-PLUG	G60402-0004	2
5MJ-PLUG	G60402-0005	2
6MJ-PLUG	G60402-0006	2
8MJ-PLUG	G60402-0008	2
10MJ-PLUG	G60402-0010	2
12MJ-PLUG	G60402-0012	2
14MJ-PLUG	G60402-0014	2
16MJ-PLUG	G60402-0016	2
20MJ-PLUG	G60402-0020	2

Female 37° Flare (JIC) Cap		
Descr	#	Quantity
4FJ-CAP	G60401-0004	2
5FJ-CAP	G60401-0005	2
6FJ-CAP	G60401-0006	2
8FJ-CAP	G60401-0008	2
10FJ-CAP	G60401-0010	2
12FJ-CAP	G60401-0012	2
16FJ-CAP	G60401-0016	2
20FJ-CAP	G60401-0020	2

Male Pipe (MP) and O-Ring Boss (MB) Plug Kit

Part Number: 85004

Product Number: 7369-0004



*Space for plugs,
but not included in kit.

Male Pipe Plug		
Descr	#	Quantity
2MP-PLUG	G60102-0002	2
4MP-PLUG	G60102-0004	2
6MP-PLUG	G60102-0006	2
8MP-PLUG	G60102-0008	2
12MP-PLUG	G60102-0012	2
16MP-PLUG	G60102-0016	2
20MP-PLUG	G60102-0020	2
24MP-PLUG	G60102-0024	Optional*

Male O-Ring Boss Plug		
Descr	#	Quantity
4MB-PLUG	G60250-0004	2
5MB-PLUG	G60250-0005	2
6MB-PLUG	G60250-0006	2
8MB-PLUG	G60250-0008	2
10MB-PLUG	G60250-0010	2
12MB-PLUG	G60250-0012	2
16MB-PLUG	G60250-0016	1

EQUIPMENT
HOSE/CPLG. SELECTION
G8K COUPLINGS
GLOBALSPIRAL COUPLINGS
STAINLESS STEEL SPIRAL
MEGACRIMP COUPLINGS
STAINLESS STEEL BRAID
POWER CRIMP COUPLINGS
FIELD ATTACHABLE G1 & G2 COUPLINGS
FIELD ATTACHABLE C5 COUPLINGS
GLX COUPLINGS
GL COUPLINGS
C14 COUPLINGS
PCTS THERMOPLASTIC COUPLINGS
POLARSEAL COUPLINGS
POLARSEAL II COUPLINGS
POWER STEERING
ADAPTERS
QUICK DISCONNECT COUPLERS
BALL VALVES
LIVE SWIVEL
ASSEMBLY FABRICATION
ACCESSORIES
EQUIPMENT AND PARTS
AIR BRAKE
BRASS
KITS

SureLok™ Coupling Assortments

Air Line Repair Kit

Part Number: 85111
Product Number: 7369-0111

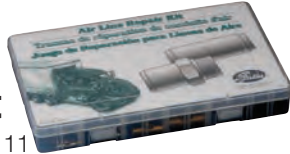

Descr	Part No.	Quantity
2AB-2MP	G31100-0202	2 ea.
4AB-2MP	G31100-0402	2 ea.
4AB-4MP	G31100-0404	2 ea.
4AB-6MP	G31100-0406	1 ea.
6AB-2MP	G31100-0602	1 ea.
6AB-4MP	G31100-0604	1 ea.
4AB-2MP90	G31104-0402	1 ea.
4AB-4MP90	G31104-0404	1 ea.
6AB-4MP90	G31104-0604	1 ea.
2AB-2AB	G31400-0202	2 ea.
3AB-3AB	G31400-0303	2 ea.
4AB-4AB	G31400-0404	2 ea.
6AB-6AB	G31400-0606	2 ea.
2AB-2AB-2AB	G31450-0202	1 ea.
3AB-3AB-3AB	G31450-0303	1 ea.
4AB-4AB-4AB	G31450-0404	1 ea.
6AB-6AB-6AB	G31450-0606	1 ea.
Tubing Cutter	78015	1 ea.

Transmission Line Repair Kit

Part Number: 85113
Product Number: 7369-0113



Descr	Part No.	Quantity
2AB-2MP	G31100-0202	2 ea.
2.5AB-1MP	G31100-2501	2 ea.
2.5AB-2MP	G31100-2502	2 ea.
2AB-2MP90	G31104-0202	1 ea.
2.5AB-2MP90	G31104-2502	1 ea.
2AB-2AB	G31400-0202	2 ea.
2.5AB-2.5AB	G31400-2525	2 ea.
3AB-3AB	G31400-0303	2 ea.
2NABTAX100	H30002-02	2 ft.
2.5NABTAX100	H30002-25	2 ft.
3NABTAX100	H30002-03	2 ft.
Tubing Cutter	78015	1 ea.
8" Nylon Cable Ties	-	25 ea.

Air Brake Repair Kit

Part Number: 85112
Product Number: 7369-0112

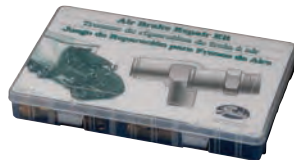

Descr	Part No.	Quantity
6AB-4MP	G31100-0604	2 ea.
6AB-6MP	G31100-0606	2 ea.
6AB-8MP	G31100-0608	2 ea.
8AB-4MP	G31100-0804	1 ea.
8AB-6MP	G31100-0806	2 ea.
8AB-8MP	G31100-0808	2 ea.
6AB-6AB	G31400-0606	2 ea.
8AB-6AB	G31400-0806	2 ea.
8AB-8AB	G31400-0808	2 ea.
6AB-6MP90	G31104-0606	1 ea.
6AB-8MP90	G31104-0608	1 ea.
8AB-4MP90	G31104-0804	1 ea.
8AB-6MP90	G31104-0806	1 ea.
8AB-8MP90	G31104-0808	1 ea.
6AB-6AB-6AB	G31450-0606	2 ea.
8AB-8AB-8AB	G31450-0808	2 ea.
Tubing Cutter	78015	1 ea.

Tubing Repair Kit

Part Number: 85114
Product Number: 7369-0114

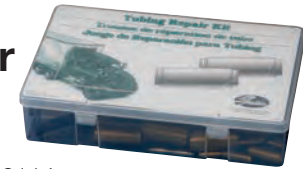

Descr	Part No.	Quantity
2AB-2AB	G31400-0202	2 ea.
2.5AB-2.5AB	G31400-2525	2 ea.
3AB-3AB	G31400-0303	2 ea.
4AB-4AB	G31400-0404	2 ea.
6AB-4AB	G31400-0604	1 ea.
6AB-6AB	G31400-0606	2 ea.
8AB-6AB	G31400-0806	1 ea.
8AB-8AB	G31400-0808	2 ea.
10AB-10AB	G31400-1010	2 ea.
12AB-12AB	G31400-1212	2 ea.
2NABTAX100	H30002-02	2 ft.
2.5NABTAX100	H30002-25	2 ft.
3NABTAX100	H30002-03	2 ft.
4NABTAX100	H30002-04	2 ft.
5NABTAX100	H30002-05	1 ft.
6NABTAX100	H30002-06	2 ft.
8NABTAX100	H30002-08	2 ft.
10NABTAX50	H30002-10	1 ft.
12NABTAX50	H30002-12	1 ft.
Tubing Cutter	78015	1 ea.
8" Nylon Cable Ties	-	25 ea.

EQUIPMENT

HOSE/CPLG. SELECTION

G&K COUPLINGS

GLOBALSPIRAL COUPLINGS

STAINLESS STEEL SPIRAL

MEGACRIMP COUPLINGS

STAINLESS STEEL BRAID

POWER CRIMP COUPLINGS

FIELD ATTACHABLE G1 & G2 COUPLINGS

FIELD ATTACHABLE C5 COUPLINGS

GLX COUPLINGS

GL COUPLINGS

C14 COUPLINGS

PCTS THERMOPLASTIC COUPLINGS

POLARSEAL COUPLINGS

POLARSEAL II COUPLINGS

POWER STEERING

ADAPTERS

QUICK DISCONNECT COUPLERS

BALL VALVES

LIVE SWIVEL

ASSEMBLY FABRICATION

ACCESSORIES

EQUIPMENT AND PARTS

AIR BRAKE

BRASS

KITS

Air Brake – Continued

Small SureLok™ Assortment

This small SureLok™ assortment is a basic starter package for the jobber or fleet. The SureLok coupling allows for repairs or replacement of J844 nylon air brake lines without the need of tools.

Assortment Contains:

- 4 Sizes of Hoses
- 16 Coupling Configurations
- 158 Individual Couplings

Part Number:
A33001

Product Number:
7369-3001



EQUIPMENT
HOSE/CPLG. SELECTION
G8K COUPLINGS
GLOBALSPIRAL COUPLINGS
STAINLESS STEEL SPIRAL
MEGACRIMP COUPLINGS
STAINLESS STEEL BRAID
POWER CRIMP COUPL
FIELD ATTACHABLE G1 & G2 COUPLINGS
FIELD ATTACHABLE C5 COUPLINGS
GLX COUPLINGS
GL COUPLINGS
C14 COUPLINGS
PCTS THERMOPLASTIC COUPLINGS
POLARSEAL COUPLINGS
POLARSEAL II COUPLINGS
POWER STEERING
ADAPTERS
QUICK DISCONNECT COUPLERS
BALL VALVES
LIVE SWIVEL
ASSEMBLY FABRICATION
ACCESSORIES
EQUIPMENT AND PARTS
AIR BRAKE
BRASS
KITS

Descr	#	Quantity	Descr	#	Quantity
4NABTAX100	H30002-04	1	4AB-4AB	G31400-0404	10
6NABTAX100	H30002-06	1	6AB-6AB	G31400-0606	10
8NABTAX100	H30002-08	1	8AB-8AB	G31400-0808	10
10NABTAX50	H30003-10	1	10AB-10AB	G31400-1010	5
4AB-2MP	G31100-0402	10	4AB-4AB-4AB	G31450-0404	10
4AB-4MP	G31100-0404	10	6AB-6AB-6AB	G31450-0606	10
6AB-6MP	G31100-0606	10	8AB-8AB-8AB	G31450-0808	10
8AB-6MP	G31100-0806	10	8GH-S	G33031-0508	1
8AB-8MP	G31100-0808	10	8GH-U	G33031-0608	1
10AB-8MP	G31100-1008	5	8GH-E	G33031-0708	1
4AB-4MP90	G31104-0404	10	6GHSEAL	G33032-0006	10
6AB-6MP90	G31104-0606	10	Tubing Cutter	78015	2
8AB-8MP90	G31104-0808	5			

Large SureLok™ Assortment

The large SureLok assortment is perfect for the jobber or fleet. SureLok couplings allow for repairs or replacement of J844 nylon air brake lines without tools. Along with the SureLok couplings, this assortment features brass field attachable couplings for SAE J1402 DOT All hose.

Assortment Contains:

- 7 Sizes of Hoses
- 51 Coupling Configurations
- 318 Individual Couplings



Part Number: A33002

Product Number: 7369-3002

Descr	#	Quantity	Descr	#	Quantity
2NABTAX 100	H30002-02	1	4AB-4AB	G31400-0404	10
3NABTAX 100	H30002-03	1	6AB-6AB	G31400-0606	10
4NABTAX100	H30002-04	1	8AB-8AB	G31400-0808	10
6NABTAX100	H30002-06	1	10AB-10AB	G31400-1010	5
8NABTAX100	H30002-08	1	12AB-12AB	G31400-1212	2
10NABTAX50	H30003-10	1	2B-2AB-2AB	G31450-0202	10
12NABTAX50	H30003-12	1	4AB-4AB-4AB	G31450-0404	10
8CABHX12	G30050-1208	1	6AB-6AB-6AB	G31450-0606	10
4AB-2MP	G31100-0402	10	8AB-8AB-8AB	G31450-0808	10
4AB-4MP	G31100-0404	10	10AB-10A-10AB	G31450-1010	5
6AB-4MP	G31100-0604	10	4MP-ATDV	G33021-0004	1
6AB-6MP	G31100-0606	10	6MP-CV	G33027-0006	1
6AB-8MP	G31100-0608	5	8MP-CV	G33027-0008	1
8AB-6MP	G31100-0806	10	6MAB-4MP	G33030-0604	10
8AB-8MP	G31100-0808	10	6MAB-6MP	G33030-0606	10
10AB-8MP	G31100-1008	5	8MAB-6MP	G33030-0806	10
12AB-8MP	G31100-1208	2	8MAB-8MP	G33030-0808	5
12AB-12MP	G31100-1212	2	8GH-S	G33031-0508	1
4AB-2MP90	G31104-0402	10	8GH-U	G33031-0608	1
4AB-4MP90	G31104-0404	10	8GH-E	G33031-0708	1
6AB-4MP90	G31104-0604	10	6GH-SEAL	G33032-0006	10
6AB-6MP90	G31104-0606	10	6ABR-4MP	G33100-0604	2
8AB-6MP90	G31104-0806	5	6ABR-6MP	G33100-0606	2
8AB-8MP90	G31104-0808	5	6ABR-8MP	G33100-0608	2
10AB-8MP90	G31104-1008	2	8ABR-6MP	G33100-0806	2
12AB-8MP90	G31104-1208	2	8ABR-8MP	G33100-0808	2
12AB-12MP90	G31104-1212	2	6ABRSG-4MP	G33110-0604	2
4AB-4AB-4MPX	G31142-0404	5	6ABRSG-6MP	G33110-0606	2
6AB-6AB-6MPX	G31142-0606	5	6ABRSG-8MP	G33110-0608	2
8AB-8AB-8MPX	G31142-0808	5	8ABRSG-6MP	G33110-0806	2
2AB-2AB	G31400-0202	5	8ABRSG-8MP	G33110-0808	2
3AB-3AB	G31400-0303	5	Tubing Cutter	78015	2

EQUIPMENT
HOSE/CPLG. SELECTION
G&K COUPLINGS
GLOBAL SPIRAL COUPLINGS
STAINLESS STEEL SPIRAL
MEGACRIMP COUPLINGS
STAINLESS STEEL BRAID
POWER CRIMP COUPLINGS
FIELD ATTACHABLE G1 & G2 COUPLINGS
FIELD ATTACHABLE C5 COUPLINGS
GLX COUPLINGS
GL COUPLINGS
C14 COUPLINGS
PCTS THERMOPLASTIC COUPLINGS
POLARSEAL COUPLINGS
POLARSEAL II COUPLINGS
POWER STEERING
ADAPTERS
QUICK DISCONNECT COUPLERS
BALL VALVES
LIVE SWIVEL
ASSEMBLY FABRICATION
ACCESSORIES
EQUIPMENT AND PARTS
AIR BRAKE
BRASS
KITS

Small Compression Assortment

Handy, small compression assortment is a basic starter package for the jobber or fleet. This assortment features brass compression couplings for J844 nylon air brake hose.

Assortment Contains:

- 4 Sizes of Hoses
- 31 Coupling Configurations
- 211 Individual Couplings



Part Number:

A33003

Product Number:

7369-3003

Descr	#	Quantity	Descr	#	Quantity
4NABTAX100	H30002-04	1	8ABC-8MP	G32100-0808	5
6NABTAX100	H30002-06	1	10ABC-8MP	G32100-1008	2
8NABTAX100	H30002-08	1	4ABC-2MP90	G32104-0402	5
10NABTAX50	H30003-10	1	4ABC-4MP90	G32104-0404	5
4TSI-ABC	G32040-0004	10	6ABC-6MP90	G32104-0606	5
6TSI-ABC	G32040-0006	10	8ABC-8MP90	G32104-0808	5
8TSI-ABC	G32040-0008	10	10ABC-8MP90	G32104-1008	2
10TSI-ABC	G32040-0010	10	4ABC-4ABC	G32400-0404	5
4TS-ABC	G32050-0004	10	6ABC-6ABC	G32400-0606	5
6TS-ABC	G32050-0006	10	8ABC-8ABC	G32400-0808	5
8TS-ABC	G32050-0008	10	10ABC-10ABC	G32400-1010	2
10TS-ABC	G32050-0010	10	4ABC-4ABC-4ABC	G32450-0404	5
4TSN-ABC	G32060-0004	10	6ABC-6ABC-6ABC	G32450-0606	5
6TSN-ABC	G32060-0006	10	8ABC-8ABC-8ABC	G32450-0808	5
8TSN-ABC	G32060-0008	10	10ABC-10ABC-10ABC	G32450-1010	2
10TSN-ABC	G32060-0010	5	8GH-S	G33031-0508	1
4ABC-2MP	G32100-0402	5	8GH-U	G33031-0608	1
4ABC-4MP	G32100-0404	5	8GH-E	G33031-0708	1
6ABC-6MP	G32100-0606	5	6GH-SEAL	G33032-0006	10
8ABC-6MP	G32100-0806	5	Tubing Cutter	78015	2

EQUIPMENT
HOSE/CPLG. SELECTION
G8K COUPLINGS
GLOBALSPIRAL COUPLINGS
STAINLESS STEEL SPIRAL
MEGACRIMP COUPLINGS
STAINLESS STEEL B
POWER CRIMP COUPLINGS
FIELD ATTACHABLE G1 & G2 COUPLINGS
FIELD ATTACHABLE C5 COUPLINGS
GLX COUPLINGS
GL COUPLINGS
C14 COUPLINGS
PCTS THERMOPLASTIC COUPLINGS
POLARSEAL COUPLINGS
POLARSEAL II COUPLINGS
POWER STEERING
ADAPTERS
QUICK DISCONNECT COUPLERS
BALL VALVES
LIVE SWIVEL
ASSEMBLY FABRICATION
ACCESSORIES
EQUIPMENT AND PARTS
AIR BRAKE
BRASS
KITS

Large Compression Assortment

The large compression assortment is perfect for the jobber or fleet. This assortment features both brass compression couplings for J844 nylon air brake hose and brass field attachable couplings for SAE J1402 DOT All hose.

Assortment Contains:

- 7 Sizes of Hoses
- 59 Coupling Configurations
- 330 Individual Couplings

Part Number:
A33004

Product Number:
7369-3004



Descr	#	Quantity	Descr	#	Quantity	Descr	#	Quantity
2NABTAX 100	H30002-02	1	6ABC-8MP	G32100-0608	5	6MP-CV	G33027-0006	1
3NABTAX 100	H30002-03	1	8ABC-6MP	G32100-0806	5	8MP-CV	G33027-0008	1
4NABTAX100	H30002-04	1	10ABC-8MP	G32100-1008	6	6MAB-4MP	G33030-0604	10
6NABTAX100	H30002-06	1	12ABC-12MP	G32100-1212	2	6MAB-6MP	G33030-0606	10
8NABTAX100	H30002-08	1	4ABC-2MP90	G32104-0402	5	8MAB-6MP	G33030-0806	10
10NABTAX50	H30003-10	1	4ABC-4MP90	G32104-0404	5	8MAB-8MP	G33030-0808	10
12NABTAX50	H30003-12	1	6ABC-6MP90	G32104-0606	5	8GH-S	G33031-0508	1
4TSI-ABC	G32040-0004	10	8ABC-6MP90	G32104-0806	5	8GH-U	G33031-0608	1
6TSI-ABC	G32040-0006	10	8ABC-8MP90	G32104-0808	5	8GH-E	G33031-0708	1
8TSI-ABC	G32040-0008	10	10ABC-8MP90	G32104-1008	2	6GH-SEAL	G33032-0006	10
10TSI-ABC	G32040-0010	10	12ABC-12MP90	G32104-1212	2	6ABR-4MP	G33100-0604	2
12TSI-ABC	G32040-0012	5	4ABC-4ABC	G32400-0404	5	6ABR-6MP	G33100-0606	2
4TS-ABC	G32050-0004	10	6ABC-6ABC	G32400-0606	5	6ABR-8MP	G33100-0608	2
6TS-ABC	G32050-0006	10	8ABC-8ABC	G32400-0808	5	8ABR-6MP	G33100-0806	2
8TS-ABC	G32050-0008	10	10ABC-10ABC	G32400-1010	2	8ABR-8MP	G33100-0808	2
10TS-ABC	G32050-0010	10	12ABC-12ABC	G32400-1212	2	6ABRSG-4MP	G33110-0604	2
12TS-ABC	G32050-0012	5	4ABC-4ABC90	G32404-0404	5	6ABRSG-6MP	G33110-0606	2
4TSN-ABC	G32060-0004	10	6ABC-6ABC90	G32404-0606	5	6ABRSG-8MP	G33110-0608	2
6TSN-ABC	G32060-0006	10	8ABC-8ABC90	G32404-0808	5	8ABRSG-6MP	G33110-0806	2
8TSN-ABC	G32060-0008	10	10ABC-10ABC90	G32404-1010	2	8ABRSG-8MP	G33110-0808	2
10TSN-ABC	G32060-0010	5	4ABC-4ABC-4ABC	G32450-0404	5	Tubing Cutter	78015	2
12TSN-ABC	G32060-0012	5	6ABC-6ABC-6ABC	G32450-0606	5			
4ABC-2MP	G32100-0402	5	8ABC-8ABC-8ABC	G32450-0808	5			
4ABC-4MP	G32100-0404	5	10ABC-10ABC-10ABC	G32450-1010	2			
6ABC-6MP	G32100-0606	5	4MP-ATDV	G33021-0004	1			

- EQUIPMENT
- HOSE/CPLG. SELECTION
- G8K COUPLINGS
- GLOBALSPIRAL COUPLINGS
- STAINLESS STEEL SPIRAL
- MEGACRIMP COUPLINGS
- STAINLESS STEEL BRAID
- POWER CRIMP COUPLINGS
- FIELD ATTACHABLE G1 & G2 COUPLINGS
- FIELD ATTACHABLE C5 COUPLINGS
- GLX COUPLINGS
- GL COUPLINGS
- C14 COUPLINGS
- PCTS THERMOPLASTIC COUPLINGS
- POLARSEAL COUPLINGS
- POLARSEAL II COUPLINGS
- POWER STEERING
- ADAPTERS
- QUICK DISCONNECT COUPLERS
- BALL VALVES
- LIVE SWIVEL
- ASSEMBLY FABRICATION
- ACCESSORIES
- EQUIPMENT AND PARTS
- AIR BRAKE
- BRASS
- KITS

Rubber Air Brake & C14 Assortments

Assortment Part Number: 91181, Assortment Product Number: 7626-0105

Part No.	Descr	Length	Unit Count
G89170-1068	10C14-10FJSX-10FJSX-36	36"	1
G89170-1048	10C14-10FJSX-10FJSX-48	48"	1
G89170-1054	10C14-10FJSX-10FJSX-54	54"	1
G89170-1084	10C14-10FJSX-10FJSX-84	84"	1
27245	3/8" Hose 1/4" MPT Fixed & Swivel	20"	1
27246	3/8" Hose 1/4" MPT Fixed & Swivel	24"	1
27248	3/8" Hose 1/4" MPT Fixed & Swivel	30"	1
27252	1/2" Hose 3/8" MPT Fixed & Swivel	18"	1
27253	1/2" Hose 3/8" MPT Fixed & Swivel	20"	1
27254	1/2" Hose 3/8" MPT Fixed & Swivel	24"	2
27255	1/2" Hose 3/8" MPT Fixed & Swivel	28"	2
27256	1/2" Hose 3/8" MPT Fixed & Swivel	30"	2
27257	1/2" Hose 3/8" MPT Fixed & Swivel	32"	1
27258	1/2" Hose 3/8" MPT Fixed & Swivel	36"	2
27259	1/2" Hose 3/8" MPT Fixed & Swivel	42"	2
27266	3/8" Hose 3/8" MPT Fixed & Swivel	24"	2
27267	3/8" Hose 3/8" MPT Fixed & Swivel	26"	1
27268	3/8" Hose 3/8" MPT Fixed & Swivel	28"	2
27269	3/8" Hose 3/8" MPT Fixed & Swivel	30"	1
27270	3/8" Hose 3/8" MPT Fixed & Swivel	32"	1
27272	3/8" Hose 3/8" MPT Fixed & Swivel	36"	1
27275	3/8" Hose 3/8" MPT Fixed & Swivel	42"	1
27279	3/8" Hose 3/8" MPT Fixed & Swivel	48"	1
27281	3/8" Hose 3/8" MPT Fixed & Swivel	60"	1
—	Assembly Merchandisers	—	2
—	Content Sheet	—	1
—	Part No. Decals	—	24



Assortment Part Number: 91182, Assortment Product Number: 7626-0104

Part No.	Descr	Length	Unit Count
G89170-1048	10C14-10FJSX-10FJSX-48	48"	1
G89170-1054	10C14-10FJSX-10FJSX-54	54"	1
27246	3/8" Hose 1/4" MPT Fixed & Swivel	24"	1
27254	1/2" Hose 3/8" MPT Fixed & Swivel	24"	2
27255	1/2" Hose 3/8" MPT Fixed & Swivel	28"	1
27256	1/2" Hose 3/8" MPT Fixed & Swivel	30"	2
27258	1/2" Hose 3/8" MPT Fixed & Swivel	36"	2
27259	1/2" Hose 3/8" MPT Fixed & Swivel	42"	1
27266	3/8" Hose 3/8" MPT Fixed & Swivel	24"	2
27268	3/8" Hose 3/8" MPT Fixed & Swivel	28"	1
27269	3/8" Hose 3/8" MPT Fixed & Swivel	30"	1
27272	3/8" Hose 3/8" MPT Fixed & Swivel	36"	1
—	Assembly Merchandisers	—	1
—	Content Sheet	—	1
—	Part No. Decals	—	12

Kits



Bonded Seals

Part Number: 85041

Product Number: 7369-5041

Descr	#	Quantity
2BBDS	G64075-0002	Optional*
4BBDS	G64075-0004	10
6BBDS	G64075-0006	10
8BBDS	G64075-0008	10
10BBDS	G64075-0010	10
12BBDS	G64075-0012	10
16BBDS	G64075-0016	10
20BBDS	G64075-0020	Optional*
24BBDS	G64075-0024	Optional*
32BBDS	G64075-0032	Optional*
6MBDS	G64775-0006	10
8MBDS	G64775-0008	10
10MBDS	G64775-0010	10
12MBDS	G64775-0012	10
14MBDS	G64775-0014	10
16MBDS	G64775-0016	10
18MBDS	G64775-0018	10
20MBDS	G64775-0020	10
22MBDS	G64775-0022	10
24MBDS	G64775-0024	Optional*
26MBDS	G64775-0026	Optional*
27MBDS	G64775-0027	Optional*
30MBDS	G64775-0030	Optional*
33MBDS	G64775-0033	Optional*
36MBDS	G64775-0036	Optional*
42MBDS	G64775-0042	Optional*

*Space for bonded seals, but not included in kit.



British

Part Number: 85042

Product Number: 7369-5042

Descr	#	Quantity
2MBSPOR-PLUG	G64094-0002	2
4MBSPOR-PLUG	G64094-0004	2
6MBSPOR-PLUG	G64094-0006	2
8MBSPOR-PLUG	G64094-0008	2
12MBSPOR-PLUG	G64094-0012	Optional*
16MBSPOR-PLUG	G64094-0016	Optional*
20MBSPOR-PLUG	G64094-0020	Optional*
2MBSPP-PLUG	G64099-0002	2
4MBSPP-PLUG	G64099-0004	2
6MBSPP-PLUG	G64099-0006	2
8MBSPP-PLUG	G64099-0008	2
10MBSPP-PLUG	G64099-0010	2
12MBSPP-PLUG	G64099-0012	2
16MBSPP-PLUG	G64099-0016	Optional*
20MBSPP-PLUG	G64099-0020	Optional*
24MBSPP-PLUG	G64099-0024	Optional*
32MBSPP-PLUG	G64099-0032	Optional*
2MBSPT-PLUG	G64098-0002	2
4MBSPT-PLUG	G64098-0004	2
6MBSPT-PLUG	G64098-0006	2
8MBSPT-PLUG	G64098-0008	2
10MBSPT-PLUG	G64098-0010	2
12MBSPT-PLUG	G64098-0012	2
16MBSPT-PLUG	G64098-0016	Optional*
20MBSPT-PLUG	G64098-0020	Optional*
24MBSPT-PLUG	G64098-0024	Optional*
32MBSPT-PLUG	G64098-0032	Optional*
2FBSPP-CAP	G64097-0002	2
4FBSPP-CAP	G64097-0004	2
6FBSPP-CAP	G64097-0006	2
8FBSPP-CAP	G64097-0008	2
10FBSPP-CAP	G64097-0010	2
12FBSPP-CAP	G64097-0012	2
16FBSPP-CAP	G64097-0016	Optional*
20FBSPP-CAP	G64097-0020	Optional*
24FBSPP-CAP	G64097-0024	Optional*
32FBSPP-CAP	G64097-0032	Optional*

*Space for plugs and caps, but not included in kit.

EQUIPMENT

HOSE/CPLG.
SELECTION

G&K COUPLINGS

GLOBALSPIRAL
COUPLINGS

STAINLESS
STEEL SPIRAL

MEGACRIMP
COUPLINGS

STAINLESS
STEEL BRAID

POWER CRIMP
COUPLINGS

FIELD
ATTACHABLE G1
& G2 COUPLINGS

FIELD
ATTACHABLE C5
COUPLINGS

GLX COUPLINGS

GL COUPLINGS

C14 COUPLINGS

PCTS
THERMOPLASTIC
COUPLINGS

POLARSEAL
COUPLINGS

POLARSEAL II
COUPLINGS

POWER
STEERING

ADAPTERS

QUICK
DISCONNECT
COUPLERS

BALL VALVES

LIVE SWIVEL

ASSEMBLY
FABRICATION

ACCESSORIES

EQUIPMENT AND
PARTS

AIR BRAKE

BRASS

KITS

Kits

EQUIPMENT
HOSE/CPLG. SELECTION
G8K COUPLINGS
GLOBALSPIRAL COUPLINGS
STAINLESS STEEL SPIRAL
MEGACRIMP COUPLINGS
STAINLESS STEEL BRAID
POWER CRIMP COUPL
FIELD ATTACHABLE G1 & G2 COUPLINGS
FIELD ATTACHABLE C5 COUPLINGS
GLX COUPLINGS
GL COUPLINGS
C14 COUPLINGS
PCTS THERMOPLASTIC COUPLINGS
POLARSEAL COUPLINGS
POLARSEAL II COUPLINGS
POWER STEERING
ADAPTERS
QUICK DISCONNECT COUPLERS
BALL VALVES
LIVE SWIVEL
ASSEMBLY FABRICATION
ACCESSORIES
EQUIPMENT AND PARTS
AIR BRAKE
BRASS
KITS



DIN Light

Part Number: 85043
Product Number: 7369-5043

Descr	#	Quantity
6MDL-PLUG	G64792-0006	2
8MDL-PLUG	G64792-0008	2
10MDL-PLUG	G64792-0010	2
12MDL-PLUG	G64792-0012	2
15MDL-PLUG	G64792-0015	2
18MDL-PLUG	G64792-0018	2
22MDL-PLUG	G64792-0022	2
28MDL-PLUG	G64792-0028	Optional*
35MDL-PLUG	G64792-0035	Optional*
42MDL-PLUG	G64792-0042	Optional*
6FDL-CAP	G64793-0006	2
8FDL-CAP	G64793-0008	2
10FDL-CAP	G64793-0010	2
12FDL-CAP	G64793-0012	2
15FDL-CAP	G64793-0015	2
18FDL-CAP	G64793-0018	2
22FDL-CAP	G64793-0022	2
28FDL-CAP	G64793-0028	Optional*
35FDL-CAP	G64793-0035	Optional*
42FDL-CAP	G64793-0042	Optional*

*Space for plugs and caps, but not included in kit.



DIN Heavy

Part Number: 85044
Product Number: 7369-5044

Descr	#	Quantity
8MDH-PLUG	G64794-0008	2
10MDH-PLUG	G64794-0010	2
12MDH-PLUG	G64794-0012	2
14MDH-PLUG	G64794-0014	2
16MDH-PLUG	G64794-0016	2
20MDH-PLUG	G64794-0020	2
25MDH-PLUG	G64794-0025	2
30MDH-PLUG	G64794-0030	Optional*
38MDH-PLUG	G64794-0038	Optional*
8FDH-CAP	G64795-0008	2
10FDH-CAP	G64795-0010	2
12FDH-CAP	G64795-0012	2
14FDH-CAP	G64795-0014	2
16FDH-CAP	G64795-0016	2
20FDH-CAP	G64795-0020	2
25FDH-CAP	G64795-0025	2
30FDH-CAP	G64795-0030	Optional*
38FDH-CAP	G64795-0038	Optional*

*Space for plugs and caps, but not included in kit.

Kits



Metric

Part Number: 85045
Product Number: 7369-5045

Descr	#	Quantity
8MM-PLUG	G64790-0008	2
10MM-PLUG	G64790-0010	2
12MM-PLUG	G64790-0012	2
14MM-PLUG	G64790-0014	2
16MM-PLUG	G64790-0016	2
18MM-PLUG	G64790-0018	2
20MM-PLUG	G64790-0020	2
22MM-PLUG	G64790-0022	2
24MM-PLUG	G64790-0024	2
26MM-PLUG	G64790-0026	2
30MM-PLUG	G64790-0030	2
22MKB-PLUG	G63980-0022	2



Japanese

Part Number: 85046
Product Number: 7369-5046

Descr	#	Quantity
4FK-CAP	G65597-0004	2
6FK-CAP	G65597-0006	2
8FK-CAP	G65597-0008	2
10FK-CAP	G65597-0010	2
12FK-CAP	G65597-0012	2
16FK-CAP	G65597-0016	Optional*
4MK-PLUG	G65599-0004	2
6MK-PLUG	G65599-0006	2
8MK-PLUG	G65599-0008	2
10MK-PLUG	G65599-0010	2
12MK-PLUG	G65599-0012	2
16MK-PLUG	G65599-0016	Optional*
4FJIS-CAP	G65097-0004	2
6FJIS-CAP	G65097-0006	2
8FJIS-CAP	G65097-0008	2
12FJIS-CAP	G65097-0012	2
16FJIS-CAP	G65097-0016	2
20FJIS-CAP	G65097-0020	Optional*
24FJIS-CAP	G65097-0024	Optional*
32FJIS-CAP	G65097-0032	Optional*
4MJIS-PLUG	G65099-0004	2
6MJIS-PLUG	G65099-0006	2
8MJIS-PLUG	G65099-0008	2
12MJIS-PLUG	G65099-0012	2
16MJIS-PLUG	G65099-0016	2
20MJIS-PLUG	G65099-0020	Optional*
24MJIS-PLUG	G65099-0024	Optional*
32MJIS-PLUG	G65099-0032	Optional*

*Space for plugs and caps, but not included in kit.

- EQUIPMENT
- HOSE/CPLG. SELECTION
- G8K COUPLINGS
- GLOBALSPIRAL COUPLINGS
- STAINLESS STEEL SPIRAL
- MEGACRIMP COUPLINGS
- STAINLESS STEEL BRAID
- POWER CRIMP COUPLINGS
- FIELD ATTACHABLE G1 & G2 COUPLINGS
- FIELD ATTACHABLE C5 COUPLINGS
- GLX COUPLINGS
- GL COUPLINGS
- C14 COUPLINGS
- PCTS THERMOPLASTIC COUPLINGS
- POLARSEAL COUPLINGS
- POLARSEAL II COUPLINGS
- POWER STEERING
- ADAPTERS
- QUICK DISCONNECT COUPLERS
- BALL VALVES
- LIVE SWIVEL
- ASSEMBLY FABRICATION
- ACCESSORIES
- EQUIPMENT AND PARTS
- AIR BRAKE
- BRASS
- KITS

INDEX

TYPE	DESCRIPTION (EXAMPLE)	PAGE	TYPE	DESCRIPTION (EXAMPLE)	PAGE
Hydraulic Hose			LOL Plus Lock-On Hose		
G8K Spiral Wire Hose	71096	A17	PowerClean™ Hose	70650	A49
EFG6K Spiral Wire Hose - SAE 100R15	70163	A17	LP350 Hose	70840	A51
EFG6K Spiral Wire Hose - SAE 100R15 - MegaTuff® Cover	85471	A18	Nylon Air Brake Tubing	85717	A51
EFG6KL Low Temp Spiral Wire Hose	70257	A19	AB Series Air Brake Hose	H30002-25	A52
EFG5K Spiral Wire Hose - SAE 100R13	70160	A19	Heavy-Duty Green Stripe® Air Brake Hose	27240	A53
EFG5K Spiral Wire Hose - SAE 100R13 - MegaTuff® Cover	85459	A20	Green Stripe® Vacuum Brake Hose	28304	A54
EFG5KL Low Temp Spiral Wire Hose	70256	A21	TR500 High-Temp/Air Brake/Engine Hose	27210	A54
EFG4K Spiral Wire Hose - SAE 100R12	70157	A21	MegaTech™ G5TB Xtreme® Heat Oil-Air Return	85745	A54
EFG4K Spiral Wire Hose - SAE 100R12 - MegaTuff® Cover	85483	A22	MegaTech™ II - SAE 100R2 Type AT - ACP Carton Pack	85391	A55
EFG4KL Low Temp Spiral Wire Hose	77001	A22	MegaTech™ 3000 High-Temp Oil-Air Return	70975	A56
EFG3K Spiral Wire Hose - SAE 100R12	85489	A23	MegaTech™ 1000 High-Temp Oil-Air Return	70960	A56
EFG3K Spiral Wire Hose - SAE 100R12 - MegaTuff® Cover	85490	A24	MegaTech™ 500 High-Temp Oil-Air Return	70850	A57
Global M6K Mega6000™ Hose	70599	A24	MegaTech™ 250 High-Temp Transmission Oil Cooler (TOC) Hose	70854	A57
Global M5K Mega5000™ Hose	85607	A24	S/R-XH Suction/Return-Extreme Heat Hose	70891	A58
Global M5K Mega5000™ Hose - MegaTuff® Cover	70386	A25	C5C Hydraulic Hose - SAE 100R5	85439	A58
Global M5K Mega5000™ Hose - XtraTuff™ Cover	70423	A25	C5CXX Xtreme® Heat Hose - SAE 100R5	86605	A59
Global M4K Mega4000™ Hose - SAE 100R19	85616	A25	C5D High-Temp Multi-Fluid Hose	86992	A59
Global M4K Mega4000™ Hose - SAE 100R19 - MegaTuff® Cover	85519	A26	C5M Marine Fuel Line Hose	85680	A60
Global M4K Mega4000™ Hose - SAE 100R19 - XtraTuff™ Cover	85541	A26	C5E High-Temp Flexline Hose	70614	A61
M4KH Wire Braid Hose - High-Temp - SAE 100R19	85540	A26	C14 PTFE Hose - SAE 100R14 Type A - Nonconductive	85690	A61
M4KH Wire Braid Hose - High-Temp - SAE 100R19 - MegaTuff® Cover	85448	A27	C14CT PTFE Hose - SAE 100R14 Type B - Conductive	85700	A62
Global M4KL Mega4000™ PolarFlex® Hose - SAE 100R19	70148	A27	PolarSeal® Hose	85730	A63
Global M3K Mega3000® Hose - SAE 100R17	70352	A28	PolarSeal® II Hose	85664	A63
Global M3K Mega3000® Hose - SAE 100R17 - MegaTuff® Cover	85525	A29	PS188 Power Steering Hose	85384	A64
Global M3K Mega3000® Hose - SAE 100R17 - XtraTuff™ Cover	70969	A29	TH7 Hydraulic Hose - SAE 100R7	86049	A64
M3KH Wire Braid Hose - High-Temp - SAE 100R17	70898	A30	TH7NC Non Conductive Hydraulic Hose - SAE 100R7	71011	A65
M3KH Wire Braid Hose - High-Temp - SAE 100R17 - MegaTuff® Cover	71030	A30	TH7DL Dual Line Hydraulic Hose - SAE 100R7	71072	A65
M2T® MegaFlex® 2-Wire Braid Hose - SAE 100R16	85600	A30	TH7NCDL Non Conductive Dual Line Hydraulic Hose - SAE 100R7	71084	A66
M2T® MegaFlex® 2-Wire Braid Hose - SAE 100R16 - MegaTuff® Cover	85534	A31	TH8 Hydraulic Hose - SAE 100R8	85786	A67
M2T® MegaFlex® 2-Wire Braid Hose - SAE 100R16 - XtraTuff™ Cover	71061	A32	TH8NC Non Conductive Hydraulic Hose - SAE 100R8	85415	A67
CM2TDL MegaFlex® Connected Twin-Line 2- Wire Braid - SAE 100R16 - XtraTuff™ Cover	85389	A32	TH18 Constant Pressure Hydraulic Hose - SAE 100R18	85419	A68
Global G2 2-Wire Braid Hose - SAE 100R2 Type S	86620	A33	TH18NC Constant Pressure Non Conductive Hydraulic Hose - SAE 100R18	71001	A68
Global G2H High-Temp 2-Wire Braid Hose Type AT	86520	A33	Equipment		
Global G2H High-Temp - MegaTuff® Cover Type AT	70897	A34	Equipment		
G2XH 2-Wire Braid Xtreme® Heat Hose - SAE 100R2 Type S	85798	A35	Hose/Cplg. Selection		
Global G2L PolarFlex® Hose - SAE 100R2 Type S	85732	A35	Hose/Cplg. Selection		
Hot Oilier 2-Wire Braid Hose	70860	A36	G8K Couplings		
Hot Oilier 2-Wire Braid Hose - MegaTuff® Cover	70015	A37	G8K Couplings		
M-XP™ Million Impulse Xtra Performance Wire Braid Hose	71105	A37	G8K Couplings		D1
J2AT 2-Wire Braid Jack Hose - 10,000 Static Pressure Only	85650	A40	Caterpillar Style O-Ring Flange	G19400-1212	D2
J2AT 2-Wire Braid Jack Hose - MegaTuff® Cover - 10,000 Static Pressure Only	70469	A40	Caterpillar Style O-Ring Flange - 45° Bent Tube	G19407-1212	D2
G1 1-Wire Braid Hose - SAE 100R1 Type S	70200	A41	Caterpillar Style O-Ring Flange - 90° Bent Tube	G19415-1212	D2
G1H 1-Wire Braid Hose - High-Temp - SAE 100R1 Type AT	85922	A41	G8K Ferrule for G8K Spiral Hose	G19995-0012	D3
RFS Red Fire Suppressant Hose	H24100-03F	A42	GlobalSpiral Couplings		
G3H High-Temp 2-Fiber Braid Hose - SAE 100R3	85951	A42	GlobalSpiral™ Couplings		
GTH High-Temp 1-Fiber Braid Hose - SAE 100R6	70106	A43	GlobalSpiral™ Couplings		E1
GTHX High-Temp Fiber Spiral Hose - SAE 100R6	86688	A43	Male Pipe (NPTF - 30° Cone Seat)	G20100-0606	E3
M500 Wire Braid Hose	85442	A43	API Line Pipe Connection	G20102-2020	E3
M500 Wire Braid Hose - XtraTuff™	70979	A44	Male Pipe (NPTF - 30° Cone Seat) - Long Hex	G20103-1616	E4
M500 Wire Braid Hose - MegaTuff®	70985	A44	Male O-Ring Boss	G20120-0606	E4
GMV Global MegaVac® Return Line and Suction Hose	85577	A45	Female MegaSeal® Swivel	G20140-1212	E5
G4H MegaVac® Return Line and Suction Hose	85580	A45	Female MegaSeal® Swivel - 45° Bent Tube	G20145-1212	E5
RLA 1-Fiber Braid Return Line and Low Pressure Hose	85940	A45	Female MegaSeal® Swivel - 90° Bent Tube	G20149-1212	E5
RLC 3-Fiber Braid Return Line and Low Pressure Hose	70142	A45	Male JIC 37° Flare	G20165-0606	E6
MegaTech® LOC 1-Fiber Braid High-Temp Lock- On Hose	76993	A46	Female JIC 37° Flare Swivel	G20170-0606	E6
LOC 1-Fiber Braid Lock-On Hose	86691	A46	Female JIC 37° Flare Swivel - 30° Bent Tube	G20172-1616	E7
		A46	Female JIC 37° Flare Swivel - 45° Bent Tube	G20174-0606	E7
		A46	Female JIC 37° Flare Swivel - 60° Bent Tube	G20177-1212	E8
		A47	Female JIC 37° Flare Swivel - 90° Bent Tube	G20179-0606	E8
		A47	Male Flat-Face O-Ring	G20225-0606	E9
		A48	Female Flat-Face O-Ring Swivel	G20230-0606	E10
		A48	Female Flat-Face O-Ring Swivel - 22 1/2° Bent Tube	G20232-1616	E10
		A48	Female Flat-Face O-Ring Swivel - 30° Bent Tube	G20233-1616	E11
		A48	Female Flat-Face O-Ring Swivel - 45° Bent Tube	G20234-0606	E11
		A48	Female Flat-Face O-Ring Swivel - 90° Bent Tube	G20239-0606	E12
		A48	Female Flat-Face O-Ring Swivel - 135° Bent Tube	G20248-1216	E13
		A49	Code 61 O-Ring Flange	G20300-0608	E13
		A49	Code 61 O-Ring Flange Long Neck	G20301-1212	E14

INDEX

TYPE	DESCRIPTION (EXAMPLE)	PAGE	TYPE	DESCRIPTION (EXAMPLE)	PAGE
Code 61 O-Ring Flange - 22 1/2° Bent Tube	G20302-0808	E14	1 1/4" Special One-Piece Couplings - Code 61 O-Ring Flange - 45° Bent Tube	G21307-2020	E44
Code 61 O-Ring Flange - 30° Bent Tube	G20304-0812	E15	1 1/4" Special One-Piece Couplings - Code 61 O-Ring Flange - 90° Bent Tube	G21315-2020	E44
Code 61 O-Ring Flange - 45° Bent Tube	G20307-0608	E15	1 1/4" Special One-Piece Couplings - Code 62 O-Ring Flange	G21350-2020	E45
Code 61 O-Ring Flange - 60° Bent Tube	G20309-0808	E16	1 1/4" Special One-Piece Couplings - Male DIN 24° Cone - Heavy Series	G21715-2038	E45
Code 61 O-Ring Flange - 67 1/2° Bent Tube	G20311-0812	E16	1 1/4" Special One-Piece Couplings - Female DIN 24° Cone Swivel - Heavy Series with O-Ring	G21720-2038	E45
Code 61 O-Ring Flange - 90° Bent Tube		E17	1 1/4" Special One-Piece Couplings - Female British Standard Pipe Parallel O-Ring Swivel	G21830-2020	E46
Code 61 O-Ring Flange - 100° Bent Tube	G20323-1216	E18	GlobalSpiral™ Plus Couplings		
Code 61 O-Ring Flange - 110° Bent Tube	G20325-1212	E18	Male Pipe (NPTF - 30° Cone Seat)	G22100-2424	E47
Code 61 O-Ring Flange - 135° Bent Tube	G20331-1212	E19	API Line Pipe Connection	G22102-2424	E47
Code 62 O-Ring Flange Heavy	G20350-0808	E19	Male Pipe (NPTF - 30° Cone Seat) - Long Hex	G22103-2424	E47
Code 62 O-Ring Flange Heavy - 22 1/2° Bent Tube	G20352-1216	E20	Male JIC 37° Flare	G22165-2420	E48
Code 62 O-Ring Flange Heavy - 30° Bent Tube	G20354-1212	E20	Female JIC 37° Flare Swivel	G22170-2424	E48
Code 62 O-Ring Flange Heavy - 45° Bent Tube	G20357-0808	E21	Female JIC 37° Flare Swivel - 45° Bent Tube	G22175-2424	E48
Code 62 O-Ring Flange Heavy - 60° Bent Tube	G20359-1212	E21	Female JIC 37° Flare Swivel - 90° Bent Tube	G22179-2424	E49
Code 62 O-Ring Flange Heavy - 67 1/2° Bent Tube	G20360-1616	E22	Male Flat-Face O-Ring	G22225-2424	E49
Code 62 O-Ring Flange Heavy - 90° Bent Tube	G20365-0808	E22	Female Flat-Face O-Ring Swivel	G22230-2424	E49
Code 62 O-Ring Flange Heavy - 110° Bent Tube	G20369-1212	E23	Female Flat-Face O-Ring Swivel - 45° Bent Tube	G22235-2424	E50
Caterpillar Style O-Ring Flange	G20400-1212	E24	Female Flat-Face O-Ring Swivel - 90° Bent Tube	G22240-2424	E50
Caterpillar Style O-Ring Flange - 22 1/2° Bent Tube	G20402-1212	E24	Code 61 O-Ring Flange	G22300-2420	E51
Caterpillar Style O-Ring Flange - 30° Bent Tube	G20404-1212	E25	Code 61 O-Ring Flange - 22 1/2° Bent Tube	G22302-2424	E51
Caterpillar Style O-Ring Flange - 45° Bent Tube	G20407-1212	E25	Code 61 O-Ring Flange - 30° Bent Tube	G22304-2424	E52
Caterpillar Style O-Ring Flange - 60° Bent Tube	G20409-1216	E26	Code 61 O-Ring Flange - 45° Bent Tube	G22306-2420	E52
Caterpillar Style O-Ring Flange - 67 1/2° Bent Tube	G20410-1616	E26	Code 61 O-Ring Flange - 60° Bent Tube	G22308-2424	E53
Caterpillar Style O-Ring Flange - 90° Bent Tube	G20415-1212	E27	Code 61 O-Ring Flange - 67 1/2° Bent Tube	G22311-2424	E53
Female French GAZ (Poclairn) 24° High Pressure Flange	G20420-0817	E27	Code 61 O-Ring Flange - 90° Bent Tube	G22314-2420	E54
Male French GAZ (Poclairn) 24° High Pressure Flange	G20480-0817	E28	Code 61 O-Ring Flange - 110° Bent Tube	G22325-2424	E54
Male French GAZ (Poclairn) 24° High Pressure Flange - 90° Bent Tube	G20482-1021	E28	Code 61 O-Ring Flange - 120° Bent Tube	G22327-2424	E55
Hose Length Extender Caterpillar	G20534-1212	E28	Code 61 O-Ring Flange - 125° Bent Tube	G22329-3232	E55
Hose Length Extender	G20535-0808	E29	Code 61 Flange Without O-Ring Groove	G22370-2424	E56
Hose Length Extender - 45° Bent Tube	G20536-2020	E29	Code 62 O-Ring Flange Heavy	G22350-2424	E56
Hose Length Extender - 90° Bent Tube	G20537-0808	E30	Code 62 O-Ring Flange Heavy - 45° Bent Tube	G22357-2424	E56
Male DIN 24° Cone - Light Series	G20615-0612	E30	Code 62 O-Ring Flange Heavy - 90° Bent Tube	G22365-2424	E57
Female DIN 24° Cone Swivel - Light Series with O-Ring	G20645-0612	E31	Hose Length Extender	G22535-2424	E57
Female DIN 24° Cone Swivel - Light Series with O-Ring - 45° Bent Tube	G20650-0815	E31	Hose Length Extender - 90° Bent Tube	G22537-2424	E58
Female DIN 24° Cone Swivel - Light Series with O-Ring - 90° Bent Tube	G20655-0612	E32	Male British Standard Pipe Tapered	G22795-2424	E58
Male French GAZ	G20675-0817	E32	Female British Standard Parallel Pipe O-Ring Swivel	G22830-2424	E58
Female French GAZ Swivel (Female Kobelco)	G20680-0817	E33	Female British Standard Parallel Pipe O-Ring Swivel - 45° Bent Tube	G22831-2424	E59
Female French GAZ Swivel - 90° Bent Tube	G20690-1021	E33	Female British Standard Parallel Pipe O-Ring Swivel - 90° Bent Tube	G22832-2424	E59
Male DIN 24° Cone - Heavy Series	G20715-0612	E34	Female Komatsu Style Japanese Metric Swivel	G22910-2424	E60
Female DIN 24° Cone Swivel - Heavy Series with O-Ring	G20720-0610	E34	Female Japanese Industrial Standard 30° Flare Swivel	G22930-2424	E60
Female DIN 24° Cone Swivel - Heavy Series with O-Ring - 45° Bent Tube	G20725-0612	E35	GSP Ferrule for Wire Braid Hose	G22995-0224	E60
Female DIN 24° Cone Swivel - Heavy Series with O-Ring - 90° Bent Tube	G20730-0612	E35	GSP Ferrule for 4-Spiral Hose	G22995-0424	E61
Male Kobelco Style	G20735-1222	E36	GlobalSpiral™ MAX Pressure Couplings		
Male British Standard Pipe Parallel	G20810-0606	E36	Male Pipe (NPTF - 30° Cone Seat)	G24100-2424	E62
Female British Standard Parallel Pipe O-Ring Swivel	G20830-0606	E37	API Line Pipe Connection	G24102-2424	E62
Female British Standard Parallel Pipe O-Ring Swivel - 45° Bent Tube	G20831-0606	E37	Male JIC 37° Flare	G24165-2424	E62
Female British Standard Parallel Pipe O-Ring Swivel - 90° Bent Tube	G20832-0606	E38	Female JIC 37° Flare Swivel	G24170-2424	E63
Female British Standard Parallel Pipe O-Ring Swivel - 90° Block	G20845-1212	E38	Female JIC 37° Flare Swivel - 45° Bent Tube	G24174-2424	E63
Female British Flat Face Swivel	G20855-1616	E39	Female JIC 37° Flare Swivel - 90° Bent Tube	G24180-2424	E63
Female Komatsu Style Japanese Metric Swivel	G20910-0808	E39	Female Flat-Face Swivel	G24230-2424	E64
Female Japanese Industrial Standard 30° Flare Swivel	G20930-1212	E39	Female Flat-Face Swivel - 45° Bent Tube	G24234-2424	E64
GS Ferrule for Wire Braid Hose	G20995-0106	E40	Female Flat-Face Swivel - 90° Bent Tube	G24240-2424	E64
GS Ferrule for 4-Spiral Hose	G20995-0406	E40	Code 61 O-Ring Flange	G24300-2424	E65
GS Ferrule for 6-Spiral Hose	G20995-0620	E40	Code 61 O-Ring Flange - 30° Bent Tube	G24304-2424	E65
1 1/4" Special One-Piece Couplings - Male Pipe (NPTF - 30° Cone Seat)	G21100-2020	E41	Code 61 O-Ring Flange - 45° Bent Tube	G24307-2424	E65
1 1/4" Special One-Piece Couplings - Male JIC 37° Flare	G21165-2020	E41	Code 61 O-Ring Flange - 60° Bent Tube	G24309-2424	E66
1 1/4" Special One-Piece Couplings - Female JIC 37° Flare Swivel	G21170-2020	E41	Code 61 O-Ring Flange - 90° Bent Tube	G24314-2424	E66
1 1/4" Special One-Piece Couplings - Female JIC 37° Flare Swivel - 90° Bent Tube	G21180-2020	E42	Code 62 O-Ring Flange Heavy	G24350-2420	E67
1 1/4" Special One-Piece Couplings - Female Flat-Face O-Ring Swivel	G21230-2020	E42	Code 62 O-Ring Flange Heavy - 22° Bent Tube	G24352-2424	E67
1 1/4" Special One-Piece Couplings - Female Flat-Face O-Ring Swivel - 90° Bent Tube	G21240-2020	E43	Code 62 O-Ring Flange Heavy - 30° Bent Tube	G24354-2424	E67
1 1/4" Special One-Piece Couplings - Code 61 O-Ring Flange	G21300-2020	E43	Code 62 O-Ring Flange Heavy - 45° Bent Tube	G24357-2424	E68
			Code 62 O-Ring Flange Heavy - 60° Bent Tube	G24359-2424	E68
			Code 62 O-Ring Flange Heavy - 90° Bent Tube	G24365-2424	E69
			Caterpillar Style O-Ring Flange	G24400-2424	E69
			Caterpillar Style O-Ring Flange - 22° Bent Tube	G24402-2424	E70
			Caterpillar Style O-Ring Flange - 30° Bent Tube	G24404-2424	E70
			Caterpillar Style O-Ring Flange - 45° Bent Tube	G24407-2424	E70
			Caterpillar Style O-Ring Flange - 60° Bent Tube	G24409-2424	E71
			Caterpillar Style O-Ring Flange - 90° Bent Tube	G24415-2424	E71
			Hose Length Extender	G23534-3232	E71
			Hose Length Extender for Caterpillar with Clamping Area	G24534-2424	E72

INDEX

TYPE	DESCRIPTION (EXAMPLE)	PAGE	TYPE	DESCRIPTION (EXAMPLE)	PAGE
Female DIN 24° Cone Swivel - Heavy Series with O-Ring	G24720-2438	E72	Female DIN 24° Cone Swivel - Light Series with O-Ring		G29
Female DIN 24° Cone Swivel - Heavy Series with O-Ring - 45° Bent Tube	G24725-2438	E72	Female DIN 24° Cone Swivel - Light Series with O-Ring - 45° Bent Tube	G25650-0408	G30
Female DIN 24° Cone Swivel - Heavy Series with O-Ring - 90° Bent Tube	G24730-2438	E73	Female DIN 24° Cone Swivel - Light Series with O-Ring - 90° Bent Tube	G25655-0406	G30
Male British Standard Pipe Parallel	G24810-2424	E73	Female French GAZ Swivel	G25680-0817	G31
Female British Standard Parallel Pipe O-Ring Swivel	G24830-2424	E73	Male DIN 24° Cone - Heavy Series	G25715-0408	G31
Female British Standard Parallel Pipe O-Ring Swivel - 45° Bent Tube	G24831-2424	E74	Female DIN 24° Cone Swivel - Heavy Series with O-Ring	G25720-0408	G32
Female British Standard Parallel Pipe O-Ring Swivel - 90° Bent Tube	G24832-2424	E74	Female DIN 24° Cone Swivel - Heavy Series with O-Ring - 45° Bent Tube	G25725-0408	G32
Stainless Steel Spiral			Female DIN 24° Cone Swivel - Heavy Series with O-Ring - 90° Bent Tube	G25730-0408	G33
Stainless Steel Spiral Couplings			Metric Light Stand Pipe	G25750-0406	G33
Stainless Steel Spiral Couplings			International Thread Metric 7642 DIN Banjo	G25770-0412	G34
Male Pipe (NPTF - 30° Cone Seat)	G18100-0606	F1	Male British Standard Pipe Tapered/Japanese Tapered Thread	G25795-0404	G34
Female JIC 37° Flare Swivel	G18170-0606	F2	Male British Standard Parallel Pipe	G25810-0404	G35
Female Flat-Face O-Ring Swivel Metric Hex	G18230-0606	F3	Female British Standard Parallel Pipe O-Ring Swivel	G25830-0402	G35
Code 61 O-Ring Flange	G18300-1212	F3	Female British Standard Parallel Pipe O-Ring Swivel - 45° Bent Tube	G25831-0404	G36
Code 62 O-Ring Flange Heavy	G18350-1212	F4	Female British Standard Parallel Pipe O-Ring Swivel - 90° Bent Tube	G25832-0404	G36
Non-Skive Ferrules	G18995-0210	F4	Female British Standard Parallel Pipe O-Ring Swivel - 90° Block	G25845-0404	G37
Skive Ferrules	G18995-0624	F5	International Thread British Std Pipe Banjo	G25850-0404	G37
MegaCrimp Couplings			Female British Flat-Face Swivel	G25855-0606	G37
MegaCrimp® Couplings			Female Komatsu Style Japanese Metric Swivel	G25910-0404	G38
MegaCrimp® Couplings			Female Komatsu Style Japanese Metric Swivel - 45° Bent Tube	G25911-0404	G38
Male Pipe (NPTF - 30° Cone Seat)	G25100-0402	G1	Female Komatsu Style Japanese Metric Swivel - 90° Bent Tube	G25913-0404	G39
Male Pipe Long Nose	G25101-0404	G4	Female Japanese Industrial Standard Swivel	G25930-0404	G39
Male Pipe Swivel (NPTF - Without 30° Cone Seat)	G25105-0402	G4	Male Quick-Lok® High	G25970-0404	G40
Male Pipe Swivel - 90° Block (NPTF - Without 30° Cone Seat)	G25106-0402	G5	Male Quick-Lok® High - 45° Bent Tube	G25971-0404	G40
Male Pipe Swivel - 90° Long Block (NPTF - Without 30° Cone Seat)	G25107-0608	G6	Male Quick-Lok® High - 90° Bent Tube	G25972-0404	G41
Female Pipe (NPTF - Without 30° Cone Seat)	G25110-0402	G6	Female Quick-Lok® High to Male O-Ring Boss Adapter	G25974-0404	G41
Female Pipe Swivel (NPSM - 30° Cone Seat)	G25111-0404	G6	Stainless Steel Braid		
Male O-Ring Boss	G25120-0404	G7	Stainless Steel Braid Couplings		
Male O-Ring Boss Swivel	G25121-0404	G7	Stainless Steel Braid Couplings		
Male O-Ring Boss Swivel - 45° Block	G25122-0606	G8	Male Pipe (NPTF - 30° Cone Seat)	G17100-0404	H1
Male O-Ring Boss Swivel - 90° Block	G25123-0405	G8	Female JIC 37° Flare Swivel	G17170-0606	H2
Male O-Ring Boss Swivel - 45° Bent Tube	G25126-0606	G9	Female JIC 37° Flare Swivel - 45° Bent Tube	G17174-0606	H3
Male O-Ring Boss Swivel - 90° Bent Tube	G25128-0406	G9	Female JIC 37° Flare Swivel - 90° Bent Tube	G17180-0606	H3
Male O-Ring Boss Adapterless Swivel - 90° Bent Tube	G25134-0404	G10	Female SAE 45° Flare Swivel	G17200-1212	H3
Male JIC 37° Flare	G25165-0404	G10	Dual Seat Female JIC 37°/SAE 45° Flare Swivel	G17210-0404	H4
Female JIC 37° Flare Swivel	G25170-0404	G11	Dual Seat Female JIC 37°/SAE 45° Flare Swivel - 45° Bent Tube	G17211-0404	H4
Female JIC 37° Flare Swivel - 30° Bent Tube	G25172-1012	G12	Dual Seat Female JIC 37°/SAE 45° Flare Swivel - 90° Bent Tube	G17213-0404	H4
Female JIC 37° Flare Swivel - 45° Bent Tube	G25175-0404	G13	Female Flat-Face O-Ring Swivel Metric Hex	G17230-0404	H5
Female JIC 37° Flare Swivel - 90° Bent Tube	G25179-0404	G13	Code 61 O-Ring Flange	G17300-2424	H5
Female JIC 37° Flare Swivel - 90° Block	G25187-1216	G14	Non-Skive Ferrule	G17995-0104	H6
Male SAE 45° Flare	G25195-0404	G15	Power Crimp Couplings		
Female SAE 45° Flare Swivel	G25200-0404	G16	Power Crimp® Couplings		
Female SAE 45° Flare Swivel - 45° Bent Tube	G25202-0404	G16	Power Crimp® Couplings		
Female SAE 45° Flare Swivel - 90° Bent Tube	G25205-0404	G17	Male Pipe (NPTF - 30° Cone Seat)	80001	I1
Male Flat-Face O-Ring	G25225-0404	G17	Male Special Grease Fitting	80120	I2
Male Flat-Face O-Ring Bulk Head Long Nose	G25226-0606	G18	Male Pipe Swivel (NPTF - Without 30° Cone Seat)	80031	I2
Female Flat-Face O-Ring Swivel	G25230-0404	G18	Female Pipe (NPTF - Without 30° Cone Seat)	80061	I3
Female Flat-Face O-Ring Swivel - 30° Bent Tube	G25233-0810	G19	Male JIC 37° Flare	80181	I3
Female Flat-Face O-Ring Swivel - 45° Bent Tube	G25235-0404	G19	Female JIC 37° Flare Swivel	80131	I3
Female Flat-Face O-Ring Swivel - 67 1/2° Bent Tube	G25238-0808	G20	Female JIC 37° Flare Swivel - 45° Bent Tube	83105	I4
Female Flat-Face O-Ring Swivel - 90° Bent Tube	G25239-0404	G20	Female JIC 37° Flare Swivel - 90° Bent Tube	83125	I4
Code 61 O-Ring Flange	G25300-0808	G20	Female Flat-Face O-Ring Swivel	83603	I4
Code 61 O-Ring Flange - 22 1/2° Bent Tube	G25302-1212	G22	SAE Male Inverted Swivel	83301	I5
Code 61 O-Ring Flange - 30° Bent Tube	G25304-1212	G22	SAE Male Inverted Swivel - 45° Bent Tube	83302	I5
Code 61 O-Ring Flange - 45° Bent Tube	G25307-0808	G22	SAE Male Inverted Swivel - 90° Bent Tube	83303	I5
Code 61 O-Ring Flange - 60° Bent Tube	G25309-1212	G23	Female Braze-On Stems	80410	I6
Code 61 O-Ring Flange - 67 1/2° Bent Tube	G25311-1212	G23	Female DIN 24° Cone Swivel - Light Series	83709	I6
Code 61 O-Ring Flange - 90° Bent Tube	G25500-0403	G24	Female DIN 24° Cone Swivel - Light Series - 90° Bent Tube	83740	I7
SAE Male Inverted Swivel	G25502-0403	G24	Power Crimp® Two Ferrules (Steel) - PC2F Series	80415	I7
SAE Male Inverted Swivel - 45° Bent Tube	G25504-0404	G25	Power Crimp® One Non-Skive Ferrules (Steel) - PC1FS Series	80481	I8
SAE Male Inverted Swivel - 90° Bent Tube	G25510-0404	G26			
SAE Male Flareless Assembly	G25520-0404	G26			
North American Stand Pipe	G25535-2020	G27			
Hose Length Extender	G25540-0606	G27			
Female Air Brake Swivel	G25561-0408	G27			
Female Grease	G25562-1616	G28			
Female Parker Triple Thread Flare	G25563-0406	G28			
Pressure Wash Swivel	G25564-0606	G28			
US Banjo	G25615-0406	G28			
Male DIN 24° Cone - Light Series		G29			

INDEX

TYPE	DESCRIPTION (EXAMPLE)	PAGE	TYPE	DESCRIPTION (EXAMPLE)	PAGE
Field Attachable G1 & G2 Couplings			Dual Seat Female JIC 37°/SAE 45° Flare Swivel - 90° Bent Tube - Steel		
Field Attachable Type T for G1 Hose (1 Wire)				G35212-0404	K18
Male Pipe (NPTF - 30° Cone Seat)	G27100-0402	J1	Special Flange - 90° - Engine Oil Connection (Code 61-2 bolt) - Steel	G35342-2020	K18
Male Pipe Swivel (NPTF - Without 30° Cone Seat)	G27105-0404	J1	Male SAE 45° Flare Inverted Swivel - Steel	G35500-0404	K19
Male O-Ring Boss	G27120-0606	J1	Male SAE 45° Flare Inverted Swivel - 45° Bent Tube - Steel	G35502-0606	K19
Male JIC 37° Flare	G27165-0606	J2	Male SAE 45° Flare Inverted Swivel - 90° Bent Tube - Steel	G35504-0404	K20
Female JIC 37° Flare Swivel	G27170-0404	J2	SAE Male Flareless Assembly - Steel	G35510-0404	K20
Female JIC 37° Flare Swivel - 45° Bent Tube	G27175-0404	J3	Parker Triple Thread Female Swivel - Steel	G35562-1616	K22
Female JIC 37° Flare Swivel - 90° Bent Tube	G27180-0404	J3			
Field Attachable Type T for G2 Hose (2 Wire)			GLX Couplings		
Male Pipe (NPTF - 30° Cone Seat)	G28100-0402	J4	GLX® Couplings		L1
Male Pipe Swivel (NPTF - Without 30° Cone Seat)	G28105-0404	J4	GLX® Couplings		L1
Male O-Ring Boss	G28120-0606	J5	Male Pipe (NPTF 30° Cone Seat)	G44100-0402	L2
Male JIC 37° Flare	G28165-0606	J5	MPX Male NPTF Swivel	G44105-0404	L2
Female JIC 37° Flare Swivel	G28170-0404	J5	FP Female NPTF	G44110-0404	L3
Female JIC 37° Flare Swivel - 45° Bent Tube	G28175-0404	J6	FPX Female NPSM Swivel	G44111-0404	L3
Female JIC 37° Flare Swivel - 90° Bent Tube	G28180-0404	J6	Female JIC 37° Flare Swivel	G44170-0404	L3
Female Flat-Face O-Ring Swivel	G28230-0404	J7	MS 45° SAE Male Solid	G44195-0404	L4
Female Flat-Face O-Ring Swivel - 45° Bent Tube	G28234-0404	J7	FSX 45° SAE Female Swivel	G44200-0404	L4
Female Flat-Face O-Ring Swivel - 90° Bent Tube	G28239-0404	J8			
Field Attachable C5 Couplings			GL Couplings		
Field Attachable for C5CXH, C5C, C5D & C5M Hose			GL Couplings		M1
Field Attachable for C5CXH, C5C, C5D & C5M Hose			GL Couplings		M1
Male Pipe (NPTF - 30° Cone Seat) - Steel	G34100-0402	K1	Male Pipe (NPTF - 30° Cone Seat)	G43100-1212	M2
Male Pipe (NPTF - 30° Cone Seat) - Brass	G34100-0504B	K2	Male Pipe Swivel (NPTF - Without 30° Cone Seat)	G43105-1212	M2
Male O-Ring Boss - Steel	G34120-0404	K2	Female JIC 37° Flare Swivel	G43170-1212	M2
Male JIC 37° Flare - Steel	G34165-0404	K3	Female JIC 37° Flare Swivel - 90° Bent Tube	G43179-1212	M3
Female JIC 37° Flare Swivel - Steel	G34170-0606	K3	Female Flat-Face Swivel	G43230-1212	M3
Female JIC 37° Flare Swivel - Brass	G34170-0606B	K3	Female Flat-Face Swivel - 45° Bent Tube	G43234-1212	M4
Female JIC 37° Flare Swivel - 45° Bent Tube - Steel	G34175-0606	K4	Female Flat-Face Swivel - 90° Bent Tube	G43239-1212	M4
Female JIC 37° Flare Swivel - 90° Bent Tube - Steel	G34180-0606	K4	Code 61 O-Ring Flange	G43300-1212	M5
Male SAE 45° Flare - Steel	G34195-0404	K5	Code 61 O-Ring Flange - 22° Bent Tube	G43302-2424	M5
Female SAE 45° Flare Swivel - Steel	G34200-0606	K5	Code 61 O-Ring Flange - 30° Bent Tube	G43304-1212	M6
Female SAE 45° Flare Swivel - Brass	G34200-0606B	K6	Code 61 O-Ring Flange - 45° Bent Tube	G43307-1212	M6
Female SAE 45° Flare Swivel - 45° Bent Tube - Steel	G34202-0606	K6	Code 61 O-Ring Flange - 60° Bent Tube	G43309-1212	M7
Female SAE 45° Flare Swivel - 90° Bent Tube - Steel	G34205-0606	K6	Code 61 O-Ring Flange - 67 1/2° Bent Tube	G43311-3232	M7
Dual Seat Female JIC 37°/SAE 45° Flare Swivel - Steel	G34210-0404	K7	Code 61 O-Ring Flange - 90° Bent Tube	G43315-1212	M8
Dual Seat Female JIC 37°/SAE 45° Flare Swivel - Brass	G34210-0505B	K7			
Dual Seat Female JIC 37°/SAE 45° Flare Swivel - 45° Bent Tube - Steel	G34211-0404	K8	C14 Couplings		
Dual Seat Female JIC 37°/SAE 45° Flare Swivel - 90° Bent Tube - Steel	G34212-0404	K8	C14 Couplings		N1
Female Flat-Face Swivel - Steel	G34230-0404	K9	Male Pipe (NPTF - 30° Cone Seat) - Stainless Steel	G40100-0402S	N2
Female Flat-Face Swivel - 45° Bent Tube - Steel	G34235-0404	K9	Male Pipe (NPTF - 30° Cone Seat) - Brass	G40100-0402B	N2
Female Flat-Face Swivel - 90° Bent Tube - Steel	G34240-0404	K10	Dual Seat Female JIC 37°/SAE 45° Flare Swivel - Stainless Steel	G40170-0404S	N3
Special Flange - 90° - Engine Oil Connection (Code 61-2 bolt)	G34342-2020	K10	Dual Seat Female JIC 37°/SAE 45° Flare Swivel - Brass	G40170-0404B	N3
Male SAE 45° Flare Inverted Swivel - Steel	G34500-0404	K11	Female JIC 37° Flare Swivel - Stainless Steel	G40170-0606S	N4
Male SAE 45° Flare Inverted Swivel - 45° Bent Tube - Steel	G34502-0404	K11	Female JIC 37° Flare Swivel - Brass	G40170-0606B	N4
Male SAE 45° Flare Inverted Swivel - 90° Bent Tube - Steel	G34504-0404	K12	Female JIC 37° Flare Swivel - 45° Bent Tube - Steel	G40175-0404	N4
SAE Male Flareless Assembly - Steel	G34510-0404	K12	Female JIC 37° Flare Swivel - 90° Bent Tube - Steel	G40179-0404	N5
Female Air Brake Swivel - Steel	G34540-0606	K13	Female SAE 45° Flare Swivel - Brass	G40200-0606B	N5
Parker Triple Thread Female Swivel - Steel	G34562-1616	K13	Female SAE 45° Flare Swivel - 45° Bent Tube - Steel	G40202-0404	N6
			Female SAE 45° Flare Swivel - 90° Bent Tube - Steel	G40205-0404	N6
Field Attachable for C5E Hose			Air Brake Compression - Brass	G40460-0808B	N7
Male Pipe (NPTF - 30° Cone Seat) - Steel	G35100-0402	K14	Straight Tube Assembly - Brass	G40461-1008B	N7
Female JIC 37° Flare Swivel - Steel	G35170-0606	K14	SAE Male Inverted Swivel - Steel	G40500-0404	N7
Female JIC 37° Flare Swivel - 45° Bent Tube - Steel	G35175-0606	K15	SAE Male Inverted Swivel - 45° Bent Tube - Steel	G40502-0404	N8
Female JIC 37° Flare Swivel - 90° Bent Tube - Steel	G35180-0606	K15	SAE Male Inverted Swivel - 90° Bent Tube - Steel	G40504-0404	N8
Female SAE 45° Flare Swivel - Steel	G35200-0606	K15	Two-Bolt Flange Swivel - Brass (Steel Flange) - Laundry Flange	G40543-1212	N9
Female SAE 45° Flare Swivel - 45° Bent Tube - Steel	G35202-0606	K16	C14 Assembly with Two Female Dual Seat JIC 37°/SAE 45° Flare Swivel (FJSX) Couplings-Steel	G89170-1018	N9
Female SAE 45° Flare Swivel - 90° Bent Tube - Steel	G35205-0606	K16	C14 Assembly with Two Air Brake Compression (ABC) Couplings - Steel	G89460-1018	N9
Dual Seat Female JIC 37°/SAE 45° Flare Swivel - Steel	G35210-0404	K17	C14 Assembly with Two Straight Tube Assembly (STA) Couplings - Steel	G89461-1018	N10
Dual Seat Female JIC 37°/SAE 45° Flare Swivel - 45° Bent Tube - Steel	G35211-0404	K17	C14 One Straight Tube Assembly (STA) and One Air Brake Compression (ABC) Couplings - Steel	G89462-1018	N10
			Power Trim Assemblies - Steel	G89502-0414	N10
			PCTS Thermoplastic Couplings		
			PCTS Thermoplastic Couplings (One-Piece)		O1
			PCTS Thermoplastic Couplings (One-Piece)		O2
			Male Pipe (NPTF - 30° Cone Seat)	G51100-0202	O2

INDEX

TYPE	DESCRIPTION (EXAMPLE)	PAGE	TYPE	DESCRIPTION (EXAMPLE)	PAGE
Male Pipe Swivel (NPTF - Without 30° Cone Seat)	G51105-0202	O2	Female SAE Tube Dual O-Ring Nut - 90° Bent Tube - Aluminum	G45606-0808	P24
Female JIC 37° Flare Swivel	G51170-0203	O2	Female SAE Tube Dual O-Ring Metric Nut - Aluminum	G45607-0824	P24
Female JIC 37° Flare Swivel - 90° Bent Tube	G51179-0304	O3	Female SAE Tube Dual O-Ring Metric Nut - 45° Bent Tube - Aluminum	G45608-0824	P25
Dual Seat Female JIC 37°/SAE 45° Flare Swivel - 45° Bent Tube	G51210-0204	O3	Female SAE Tube Dual O-Ring Metric Nut - 90° Bent Tube - Aluminum	G45609-0824	P25
PolarSeal Couplings			Female SAE Tube O-Ring Nut - 180° Bent Tube - Aluminum	G45610-0606	P26
PolarSeal® Couplings		P1	Male Inverted O-Ring with R134a Service Port - Aluminum	G45611-0606	P26
PolarSeal® Couplings		P2	Male Inverted O-Ring with R134a Service Port - 90° Bent Tube - Aluminum	G45613-0606	P27
Male SAE 45° Flare - Aluminum	G45195-0606	P2	Universal Tee O-Ring Splicer English Threads - Aluminum	G45614-0606	P27
Male SAE 45° Flare - 45° Bent Tube - Aluminum	G45196-0606	P2	Female SAE Tube O-Ring Nut Swivel with R134a High Pressure Service Port - Aluminum	G45688-1010	P28
Male SAE 45° Flare - 90° Bent Tube - Aluminum	G45197-0606	P2	Male Metric Flareless Assembly - Aluminum	G45935-0608	P28
Female SAE 45° Flare Swivel - Aluminum	G45200-0606	P3	Female (Ford) Spring Lock Tee O-Ring Splicer - Aluminum	G45947-0608	P28
Female SAE 45° Flare Swivel - Steel	G45200-0606S	P3	Female (Ford) Spring Lock Liquid Line Splicer - Aluminum	G45948-0608	P29
Female SAE 45° Flare Swivel - 45° Bent Tube - Aluminum	G45202-0606	P4	Male (Ford) Spring Lock - 45° Bent Tube - Aluminum	G45949-0606	P29
Female SAE 45° Flare Swivel - 90° Bent Tube - Aluminum	G45205-0606	P4	Male (Ford) Spring Lock - Aluminum	G45950-0606	P29
Female SAE 45° Flare Swivel - 90° Bent Tube - Steel	G45205-0606S	P5	Male (Ford) Spring Lock - 90° Bent Tube - Aluminum	G45951-0606	P30
Male SAE Flareless Assembly - Aluminum	G45510-0606	P5	Female (Ford) Spring Lock - Aluminum	G45952-0606	P30
Male SAE Flareless Assembly - 90° Block - Aluminum	G45511-0606	P6	Female (Ford) Spring Lock - 90° Bent Tube - Aluminum	G45953-0606	P31
Female Braze-On Stems - Aluminum	G45527-0606	P6	Hose Splicer with R12 Thread Service Port - Aluminum	G45954-0606	P31
Female Braze-On Stems - Steel	G45527-0606S	P7	Female (Ford) Spring Lock - 45° Bent Tube - Aluminum	G45955-0606	P32
Hose Length Extender - Aluminum	G45535-0606	P7	Hose Splicer with R134a Service Port - Aluminum	G45956-0606	P32
Hose Length Extender - 90° Bent Tube - Aluminum	G45537-0606	P8	Hose Splicer with R134a Service Port - Steel	G45956-0606S	P33
Hose Length Extender with Sight Glass - Aluminum	G45538-0606	P8	Female Rotalok (Compressor Connection) with R134a Service Port - 90° Block - Aluminum	G45957-0816	P33
Hose Length Extender - Tee - Aluminum	G45539-0606	P9	Compressor Female SAE Tube O-Ring Nut Swivel - 90° Bent Tube - Steel	G45958-0810S	P34
Hose Length Extender - 180° Bent Tube - Aluminum	G45541-0606	P9	Compressor Female SAE Tube O-Ring Nut Swivel - 90° Block - Steel	G45959-0810S	P34
Male SAE Tube O-Ring Nut Swivel with R134a Service Port - Aluminum	G45580-0606	P10	Compressor Female Tube O-Ring Nut with 134a Service Port - 90° Block - Steel	G45960-0810S	P35
Male SAE Tube O-Ring Nut Swivel with R134a Service Port - 90° Bent Tube - Aluminum	G45582-1010	P10	Compressor Block - Single w/Switch or Service Port - 90° Bent Tube - Aluminum	G45961-0808	P35
Male SAE Tube O-Ring Nut Swivel - Aluminum	G45583-0606	P11	Compressor Block - Single Reverse w/Switch or Service Port - 90° Bent Tube - Aluminum	G45962-0808	P36
Male SAE Tube O-Ring Nut Swivel - Steel	G45583-0606S	P11	R12 Ferrules	83930	P36
Male SAE Tube O-Ring Nut - 45° Bent Tube - Aluminum	G45584-0606	P12	Inline Orifice Tube	G46011-0057	P36
Male SAE Tube O-Ring Nut - 90° Bent Tube - Aluminum	G45585-0606	P12	Female Flareless Nut - Aluminum	G46050-0006	P37
Male SAE Tube O-Ring Nut - 90° Bent Tube - Steel	G45585-0606S	P13	Female Flareless Sleeve	G46051-0006	P37
Female SAE Tube O-Ring Nut Swivel with R12 Service Port - Aluminum	G45586-0606	P13	Metric Female Flareless Sleeve	G46052-0008	P38
Female SAE Tube O-Ring Nut Swivel with R12 Service Port - 90° Bent Tube - Aluminum	G45587-0606	P14	Accumulator/Compressor Sealing Washer	G46091-0010	P38
Female SAE Tube O-Ring Nut Swivel with R134a Service Port - Aluminum	G45588-0606	P14	Valve Core	G46093-0000	P38
Female SAE Tube O-Ring Nut Swivel with R134a Service Port - Steel	G45588-0808S	P15	Valve Cap for R12 Service Port	G46094-0004	P39
Female SAE Tube O-Ring Nut Swivel with R134a Service Port - 90° Bent Tube - Aluminum	G45589-0606	P15	Red High Side Cap R134a Port	G46095-0008	P39
Female SAE Tube O-Ring Nut Swivel with R134a Service Port - 90° Bent Tube - Steel	G45590-0605	P16	Blue Low Side Cap R134a Port	G46096-0008	P39
Female SAE Tube O-Ring Nut Swivel - Aluminum	G45590-0605S	P16	O-Ring for Switch	G46097-0006	P40
Female SAE Tube O-Ring Nut Swivel - Steel	G45591-0606	P17	O-Rings for PolarSeal® Couplings	G46098-0006	P40
Female SAE Tube O-Ring Nut Swivel - 45° Bent Tube - Aluminum	G45591-0606S	P18	O-Ring for Ford Spring Lock	G46099-0006	P40
Female SAE Tube O-Ring Nut Swivel - 45° Bent Tube - Steel	G45592-0605	P18	PolarSeal II Couplings		
Female SAE Tube O-Ring Nut Swivel - 90° Bent Tube - Aluminum	G45592-0605S	P19	PolarSeal® II Couplings		
Female SAE Tube O-Ring Nut Swivel - 90° Bent Tube - Steel	G45592-0606S	P19	PolarSeal® II Couplings		
Female SAE Tube O-Ring Metric Nut Swivel - Aluminum	G45593-0616	P19	Male Flareless Assembly	G46510-0606	Q1
Female SAE Tube O-Ring Metric Nut Swivel - 45° Bent Tube - Aluminum	G45594-0614	P20	Male Flareless Assembly - 90° Bent Tube	G46511-0606	Q2
Female SAE Tube O-Ring Metric Nut Swivel - 90° Bent Tube - Aluminum	G45595-0616	P20	Weld On Hose End	G46527-0606	Q2
Female SAE Tube O-Ring Nut Swivel - 90° Block - Steel	G45596-0808S	P21	Splicer	G46535-0606	Q2
Male Inverted O-Ring - Aluminum	G45597-0606	P21	T Splicer	G46539-0606	Q3
Male Inverted O-Ring - Steel	G45597-0606S	P21	Y Splicer	G46542-0808	Q3
Male Inverted O-Ring - 45° Bent Tube - Aluminum	G45598-0606	P22	Male O-Ring (MOR) - 180° Bent Tube	G46578-0606	Q3
Male Inverted O-Ring - 90° Bent Tube - Aluminum	G45599-0606	P22	Male O-Ring (MOR) with Switch or Service Port - 90° Bent Tube	G46582-0808H	Q4
Male Inverted O-Ring Bulkhead - Aluminum	G45600-0606	P22	Male O-Ring (MOR)	G46583-0606	Q4
Male Inverted O-Ring Bulkhead - 90° Bent Tube - Aluminum	G45602-0606	P23	Male O-Ring (MOR) - 45° Bent Tube	G46584-0606	Q4
Female SAE Tube Dual O-Ring Nut - Aluminum	G45604-0808	P23	Male O-Ring (MOR) - 90° Bent Tube	G46585-0606	Q5
Female SAE Tube Dual O-Ring Nut - 45° Bent Tube - Aluminum	G45605-0808	P24	Straight Female O-Ring (FOR) with Switch or Service Port	G46588-0808H	Q5
			Female O-Ring (FOR) with Switch or Service Port - 90° Bent Tube	G46589-0608H	Q5
			Straight Female O-Ring	G46590-0606	Q6

INDEX

TYPE	DESCRIPTION (EXAMPLE)	PAGE	TYPE	DESCRIPTION (EXAMPLE)	PAGE
Female O-Ring (FOR) - 45° Bent Tube	G46591-0606	Q6	Male JIC 37° Flare on Run to Male JIC 37° Flare		
Female O-Ring (FOR) - 90° Bent Tube	G46592-0606	Q7	Bulkhead - Tee	G60471-0404	S29
Metric Female O-Ring (FOR)	G46593-0820	Q7	Male JIC 37° Flare to Male JIC 37° Flare		
Metric Female O-Ring (FOR) - 90° Bent Tube	G46595-0618	Q7	Bulkhead to Male JIC 37° Flare - Tee	G60472-0404	S29
Male Insert O-Ring (MIO)	G46597-0606	Q8	Male JIC 37° Flare to Female JIC 37° Flare		
Male Insert O-Ring (MIO) - 90° Bent Tube	G46599-0606	Q8	Swivel to Male JIC 37° Flare - Tee	G60473-0404	S30
Male Insert O-Ring (MIO) Bulkhead	G46600-0606	Q8	Male JIC 37° Flare to Male Pipe NPTF	G60490-0202	S30
Male Insert O-Ring (MIO) Bulkhead - 90° Bent Tube	G46602-0606	Q9	Male JIC 37° Flare to Male Pipe NPTF - 45°	G60497-0202	S32
Splicer with Switch or Service Port	G46956-0606H	Q9	Male JIC 37° Flare to Male Pipe NPTF - 90°	G60499-0202	S33
Metric Female O-Ring (FOR) with Switch or Service Port - 90° Bent Tube	G46963-0610	Q9	Male JIC 37° Flare to Female Pipe NPTF	G60510-0202	S34
Metric Male Insert O-Ring (MIO)	G46965-1020	Q10	Male JIC 37° Flare to Female Pipe NPTF - 90°	G60514-0402	S35
Clamp Assemblies	G46995-0006	Q10	Female JIC 37° Flare Swivel to Male Pipe NPTF	G60520-0402	S35
Power Steering			Female JIC 37° Flare Swivel to Male Pipe NPTF - 90°	G60524-0402	S36
Power Steering Couplings			Female JIC 37° Flare Swivel to Female Pipe NPTF	G60530-0402	S36
SAE Male Flareless (includes Sleeve and Nut)	G50510-0604	R1	Male JIC 37° Flare Bulkhead to Male Pipe NPTF	G60541-0402	S37
SAE Metric Male Flareless (includes Sleeve and Nut)	G50510-0608	R1	Male JIC 37° Flare on Run to Male Pipe NPTF - Tee	G60551-0302	S37
Adapters			Female Flat-Face O-Ring Cap	G60701-0004	S38
SAE to SAE			Male Flat-Face O-Ring Plug	G60702-0004	S38
Male Pipe NPTF Plug	G60102-0002	S1	Male Flat-Face O-Ring to Male Flat-Face O-Ring	G60705-0404	S39
Male Pipe NPTF to Male Pipe NPTF	G60110-0202	S1	Male Flat-Face O-Ring to Male Flat-Face O-Ring - 90°	G60712-0404	S39
Male Pipe NPTF to Male Pipe NPTF - 90°	G60115-0202	S2	Male Flat-Face O-Ring to Female Flat-Face		
Male Pipe NPTF to Female Pipe NPTF Reducer Bushing - Short	G60130-0402	S2	Swivel - 90°	G60724-0404	S40
Male Pipe NPTF to Female Pipe NPTF Increasing Bushing - Long	G60132-0204	S3	Male Flat-Face O-Ring Tee	G60740-0404	S40
Male Pipe NPTF to Female Pipe NPTF - 90°	G60136-0202	S4	Male Flat-Face O-Ring on Run to Female Flat-Face Swivel - Tee	G60742-0404	S41
Male Pipe NPTF to Female Pipe Swivel NPSM	G60140-0202	S4	Male Flat-Face O-Ring to Female Flat-Face O-Ring to Male Flat-Face O-Ring - Tee	G60744-0404	S41
Male Pipe NPTF to Female Pipe Swivel NPSM - 45°	G60142-0202	S5	Male Flat-Face O-Ring to Male Pipe NPTF	G60770-0402	S42
Male Pipe NPTF to Female Pipe Swivel NPSM - 90°	G60144-0202	S6	Male Flat-Face O-Ring to Female JIC 37° Flare Swivel	G60785-0404	S42
Female Pipe NPTF to Female Pipe NPTF	G60152-0202	S7	Male Flat-Face O-Ring to Male O-Ring Boss	G60800-0404	S43
Female Pipe NPTF to Female Pipe NPTF - 90°	G60156-0202	S7	Male Flat-Face O-Ring to Male O-Ring Boss - 45°	G60805-0404	S43
Female Pipe NPTF to Female Pipe Swivel NPSM	G60160-0202	S8	Male Flat-Face O-Ring to Male O-Ring Boss - 90°	G60810-0404	S44
Female Pipe NPTF to Female Pipe Swivel NPSM - 45°	G60162-0202	S9	Male Flat-Face O-Ring to Male O-Ring Boss - 90° Long Drop	G60811-0404	S45
Female Pipe NPTF to Female Pipe Swivel NPSM - 90°	G60164-0202	S9	Male Flat-Face O-Ring on Run to Male O-Ring Boss - Tee	G60820-0404	S45
Female Pipe NPTF - Tee	G60181-0202	S10	Male Flat-Face O-Ring to Male O-Ring Boss to Male Flat-Face O-Ring - Tee	G60821-0404	S46
Female Pipe NPTF on Run to Male Pipe NPTF - Tee	G60183-0202	S10	Female Flat-Face Swivel to Male JIC 37° Flare	G60880-0404	S46
Female Pipe Swivel NPSM - Tee	G60184-0202	S11	SAE to SAE - High Pressure		
Female Pipe Swivel NPSM on Run to Male Pipe NPTF - Tee	G60186-0202	S11	Code 61 O-Ring Flange to Male JIC 37° Flare	G60900-0808	S47
Male O-Ring Boss Plug	G60250-0002	S12	Code 61 O-Ring Flange to Male JIC 37° Flare - High Pressure	G60901-1212	S47
Male O-Ring Boss to Female Pipe NPTF	G60275-0302	S12	Code 61 O-Ring Flange to Male JIC 37° Flare - 45°	G60905-0808	S48
Male O-Ring Boss to Female Pipe Swivel NPSM	G60285-0402	S12	Code 61 O-Ring Flange to Male JIC 37° Flare - 90°	G60906-1212	S48
Male O-Ring Boss to Female Pipe Swivel NPSM - 45°	G60287-0402	S13	Code 61 O-Ring Flange to Male JIC 37° Flare - 90° - High Pressure	G60910-0808	S49
Male O-Ring Boss to Female Pipe Swivel NPSM - 90°	G60289-0402	S14	Code 61 O-Ring Flange to Male Flat-Face O-Ring - High Pressure	G60911-1212	S49
Female O-Ring Boss to Male Pipe NPTF	G60291-0402	S14	Code 61 O-Ring Flange to Male Flat-Face O-Ring 45° - High Pressure	G60915-1212	S50
Male O-Ring Boss to Male JIC 37° Flare	G60301-0202	S15	Code 61 O-Ring Flange to Male Flat-Face O-Ring 90° - High Pressure	G60920-1212	S50
Male O-Ring Boss to Male JIC 37° Flare - 45°	G60308-0404	S16	Code 61 O-Ring Flange to Male Flat-Face O-Ring 90° - High Pressure	G60925-1212	S51
Male O-Ring Boss to Male JIC 37° Flare - 90°	G60312-0202	S17	Code 62 O-Ring Flange Heavy to Male JIC 37° Flare - (6,000 psi)	G60930-1212	S51
Male O-Ring Boss to Female JIC 37° Flare Swivel	G60320-0606	S18	Code 62 O-Ring Flange Heavy to Male JIC 37° Flare 45° - (6,000 psi)	G60935-1212	S52
Male JIC 37° Flare on Run to Male O-Ring Boss - Tee	G60350-0404	S19	Code 62 O-Ring Flange Heavy to Male JIC 37° Flare 90° - (6,000 psi)	G60940-1212	S52
Male O-Ring Boss to Male JIC 37° Flare to Male JIC 37° Flare - Tee	G60352-0404	S20	Code 62 O-Ring Flange Heavy to Male Flat-Face O-Ring - (6,000 psi)	G60945-1212	S53
Female JIC 37° Flare Cap	G60401-0002	S21	Code 62 O-Ring Flange Heavy to Male Flat-Face O-Ring 45° - (6,000 psi)	G60950-1212	S53
Male JIC 37° Flare Plug	G60402-0003	S21	Code 62 O-Ring Flange Heavy to Male Flat-Face O-Ring 90° - (6,000 psi)	G60955-1212	S53
Male JIC 37° Flare to Female Braze - On	G60405-2020	S22	British to SAE		
Male JIC 37° Flare to Male JIC 37° Flare	G60410-0202	S22	British Male Standard Pipe Tapered Thread to Male JIC 37° Flare	G62150-0204	S55
Male JIC 37° Flare to Male JIC 37° Flare - 90°	G60417-0202	S22	British Male Standard Pipe Tapered Thread to Male JIC 37° Flare - 45°	G62153-0204	S55
Male JIC 37° Flare to Female JIC 37° Flare	G60420-0406	S23	British Male Standard Pipe Tapered Thread to Male JIC 37° Flare - 90°	G62155-0204	S56
Male JIC 37° Flare to Female JIC 37° Flare Swivel - 90°	G60422-0404	S24	British Male Standard Pipe Parallel to Male Pipe NPTF	G62200-0202	S57
Male JIC 37° Flare to Female JIC 37° Flare Swivel - 45°	G60424-0404	S25	British Male Standard Pipe Parallel to Female Pipe NPTF	G62220-0202	S57
Male JIC 37° Flare to Male JIC 37° Flare Bulkhead	G60445-0303	S26			
Male JIC 37° Flare to Male JIC 37° Flare Bulkhead - 45°	G60446-0404	S26			
Male JIC 37° Flare to Male JIC 37° Flare Bulkhead - 90°	G60447-0404	S27			
Male JIC 37° Flare Tee	G60469-0202	S27			
Male JIC 37° Flare on Run to Female JIC 37° Flare Swivel - Tee	G60470-0404	S28			

INDEX

TYPE	DESCRIPTION (EXAMPLE)	PAGE	TYPE	DESCRIPTION (EXAMPLE)	PAGE
British Male Standard Pipe Parallel to Male JIC 37° Flare	G62300-0204	S58	Male Ball Valve to Female O-Ring Boss	G94012-0808	T1
British Male Standard Pipe Parallel to Male JIC 37° Flare - 45°	G62305-0204	S59	Female Ball Valve To Female Pipe	G94021-0404	T1
British Male Standard Pipe Parallel to Male JIC 37° Flare - 90°	G62310-0204	S60	Female Ball Valve To Female O-Ring Boss	G94022-0808	T2
British Male Standard Pipe Parallel to Female JIC 37° Flare Swivel	G62320-0204	S60	O-Ring	G94025-0004	T2
British Male Standard Pipe Parallel with O-Ring to Male JIC 37° Flare	G62450-0204	S61	G940 and G941 Series (Agricultural) QD Plug - Cap Combination	G94081-0004	T3
British Male Standard Pipe Parallel with O-Ring to Male JIC 37° Flare - 90°	G62460-0606	S62	G941 Series (Agriculture Standard-Poppet Valve) Male Poppet Valve to Female Pipe	G94111-0404	T4
British Male Standard Pipe Parallel with O-Ring to Male Flat-Face O-Ring	G62470-0204	S62	Female Poppet Valve to Female Pipe	G94121-0404	T4
British Male Standard Pipe Parallel with O-Ring to Male Flat-Face O-Ring - Long	G62471-0608	S63	G942 Series (John Deere Old Style) Male Ball Valve to Female Pipe	G94211-0808	T5
British Male Standard Pipe Parallel with O-Ring to Male Flat-Face O-Ring - 45°	G62473-0204	S63	Male Ball Valve to Female O-Ring Boss	G94212-0808	T5
British Male Standard Pipe Parallel with O-Ring to Male Flat-Face O-Ring - 90°	G62475-0204	S64	Female Ball Valve to Female Pipe	G94221-0808	T5
Female British Standard Pipe Parallel to Male Pipe NPTF	G62500-0202	S64	G943 Series (International Harvester Old Style) Male Tip - Ball Valve to Female Pipe	G94311-0808	T6
Female British Standard Pipe Parallel to Female Pipe NPTF	G62520-0404	S65	G945 Series (Industrial ISO 7241-1 - Series B) Male Poppet Valve to Female Pipe	G94511-0404	T8
Female British Standard Pipe Parallel to Male JIC 37° Flare	G62550-0204	S65	Female Poppet Valve to Female Pipe	G94521-0404	T8
Female British Standard Pipe Parallel Swivel to Male Pipe NPTF - 90°	G62605-0202	S66	O-Ring	G94525-0004	T8
Female British Standard Pipe Parallel Swivel to Male JIC 37° Flare	G62650-0204	S66	Backup Ring	G94526-0004	T9
Female British Standard Pipe Parallel Swivel to Female JIC 37° Flare Swivel	G62660-0404	S67	QD Plug - Cap Combination	G94581-0004	T9
Female British Flat-Face O-Ring to Male JIC 37° Flare	G62801-0606	S67	G949 Series (Flush Face - HTMA) Male Flush Face Valve to Female Pipe	G94911-0404	T10
Metric Conversion			Male Flush Face Valve to Female O-Ring Boss	G94912-0404	T10
Male Metric O-Ring Plug	G63099-0012	S68	Male Flush Face Valve to JIC 37° Flare Bulkhead	G94913-0810	T11
Male Metric with O-Ring to Female Pipe NPTF	G63120-1002	S68	Male Flush Face Valve to Female British Pipe Parallel	G94915-0404	T11
Male Metric with O-Ring to Male JIC 37° Flare	G63150-1004	S69	Female Flush Face Valve to Female Pipe	G94921-0404	T11
Male Metric with O-Ring to Male JIC 37° Flare - 90°	G63160-1004	S69	Female Flush Face Valve to Female Pipe - SureLok™	G94921-0606	T12
Male DIN 24° Cone - Light Series to Male JIC 37° Flare	G63350-0604	S70	Female Flush Face Valve to Female O-Ring Boss	G94922-0404	T12
Female DIN 24° Cone Swivel - Light Series to Male JIC 37° Flare	G63450-0604	S71	Female Flush Face to JIC 37° Flare Bulkhead	G94923-0810	T12
Male DIN 24° Cone - Heavy Series to Male JIC 37° Flare	G63650-0604	S71	Female Flush Face Valve to Female British Pipe Parallel	G94925-0808	T13
Female DIN 24° Cone Swivel - Heavy Series to Male JIC 37° Flare	G63750-1004	S72	Dust Plug/Cap Combination	G94981-0004	T13
Male Kobelco Plug	G63980-0022	S72	G950 Series (Flush Face - High Pressure) Male Flush Face Valve	G95011-0604	T14
Male Kobelco to Male JIC 37° Flare	G63990-2212	S72	Female Flush Face Valve	G95021-0604	T14
International to International			QD Plug - Cap Combination	G95081-0006	T14
British Bonded Seal	G64075-0002	S73	G951 Series (Wing Nut) Male (Brass) - Less Flange	G95111-1212	T16
Male British Standard Pipe Parallel with O-Ring Plug	G64094-0002	S73	Female (Brass) - Wing Nut (Cast Iron)	G95121-1212	T16
Female British Standard Pipe Parallel Cap	G64097-0002	S74	Dust Plug	G95180-0012	T16
Male British Standard Pipe Tapered Thread Plug	G64098-0002	S74	Dust Cap	G95190-0012	T17
Male British Standard Pipe Parallel Plug	G64099-0002	S75	G952 Series (High Pressure Wing Nut) Male Acme Flat Threads to Female Pipe	G95211-1212	T18
Male British Standard Pipe Parallel to Female British Standard Pipe Parallel Swivel	G64350-0202	S75	Female Wing Nut to Female Pipe	G95221-1212	T18
Metric Bonded Seal	G64775-0006	S76	Dust Plug	G95280-0012	T18
Male Metric Plug	G64790-0008	S77	Dust Cap	G95290-0012	T19
Male DIN 24° Cone - Light Series Plug	G64792-0006	S77	G953 Series (Very High Pressure) Male Poppet Valve to Female Pipe	G95311-0606	T20
Female DIN 24° Cone - Light Series Cap	G64793-0006	S78	Female Screw to Connect to Female Pipe	G95321-0606	T20
Male DIN 24° Cone - Heavy Series Plug	G64794-0008	S78	G956 Series (Industrial ISO 7241 - Series A) Male Poppet Valve to Female Pipe	G95611-0404	T21
Female DIN 24° Cone - Heavy Series Cap	G64795-0008	S79	Female Poppet Valve to Female Pipe	G95621-0404	T21
Japanese Conversion			O-Ring	G95625-0004	T21
Female Japanese Industrial Standard Cap	G65097-0004	S80	Backup Ring	G95626-0004	T22
Male Japanese Industrial Standard Plug	G65099-0004	S80	QD Plug - Cap Combination	G95681-0004	T22
Female Japanese Industrial Standard to Male JIC 37° Flare	G65100-0404	S80	G959 Series (Agriculture QD Adapters) John Deere Old Style to ISO Style	G95961-0808	T23
Female Komatsu Cap	G65597-0004	S81	ISO Style to John Deere Old Style	G95962-0808	T23
Male Komatsu Plug	G65599-0004	S81	Int'l Harvester to John Deere Old Style	G95963-0808	T23
Female Komatsu to Male JIC 37° Flare	G65600-0404	S82	Int'l Harvester Old Style to ISO Style	G95964-0808	T23
Male Komatsu to Male Komatsu	G65700-0404	S82	ISO Style to Int'l Harvester Old Style	G95965-0808	T24
Male Komatsu to Male JIC 37° Flare	G65750-0404	S82	ISO Style to John Deere Old Style - (Double Shutoff)	G95966-0808	T24
Male Komatsu to Female Komatsu - 90°	G65800-0404	S83	ISO Style to Int'l Harvester Old Style - (Double Shutoff)	G95967-0808	T24
Male Komatsu to Female Komatsu to Male Komatsu - Tee	G65950-0404	S83	Ball Valves		
Quick Disconnect Couplers			Two Way Block Style		
G940 Series (Agriculture Standard-Ball Valve)			Code 61 O-Ring Flange	G96300-0808	U1
Male Ball Valve to Female Pipe	G94011-0404	T1	Code 62 O-Ring Flange	G96350-0808	U1
			Female O-Ring Boss	G96115-0404	U1
			Female Pipe NPTF	G96110-0404	U2

INDEX

TYPE	DESCRIPTION (EXAMPLE)	PAGE	TYPE	DESCRIPTION (EXAMPLE)	PAGE
Three Way Block Style Ball Valve Lock Out Kits	G96050-0408	U4	Gates OE-Style Clamp Collars Clamp Collars	G52000-0210	X9
Live Swivel			Vinyl Bend Restrictor		
Male BSPP to Male BSPP	G93345-0808	V1	Vinyl Bend Restrictor - Black	G80700-0106	X10
Male JIC to Male JIC	G93410-0606	V1	Vinyl Bend Restrictor - Red	G80705-0108	X10
Male JIC to Female Boss	G93450-0808	V1			
JIC Seal Kit	G93500-0006	V2	Flange Fittings		
Male JIC to Female Pipe	G93510-0808	V2	Code 61 Flange Cap	G60897-0012	X11
ORS Seal Kit	G93600-0012	V2	Flange Half Sets (Code 61 - SAE J518)	G60899-0008	X11
ORS/BSPP Seal Kit	G93700-0008	V3	Code 62 Flange Cap	G60927-0012	X12
Male ORFS to Female ORFS	G93724-1212	V3	Flange Half Sets (Code 62 - SAE J518)	G60929-0008	X12
Male ORFS to Male ORFS	G93742-0808	V3	Caterpillar-Style Flange Half Sets	G60959-0012	X13
Assembly Fabrication			O-Rings		
Tube Assembly Equipment	91025	W1	O-Rings for Straight Thread Boss Fittings	G60248-0003	X14
Fuel Line Repair Kits	A35000-1805	W1	O-Rings for Flat-Face Fittings	G60698-0004	X14
Steel Power Steering & Transmission Oil Cooler Tubing - Male O-Ring	A35001-2405	W1	O-Rings for Code 61, Code 62, and Caterpillar- Style Flange Fittings	G60898-0008	X15
Steel Power Steering & Transmission Oil Cooler Tubing - Male Inverted Flare	A35003-2406	W2	O-Rings for British Standard Parallel Pipe (BSPP Couplings)	G64095-0004	X15
Steel Power Steering & Transmission Oil Cooler Tubing - Male SAE	A35004-2406	W2	O-Rings for DIN Light & Heavy Series (MegaCrimp® and GlobalSpiral™ Couplings)	G64780-0018	X16
Steel Power Steering & Transmission Oil Cooler Tubing - Long Swivel O-Ring	A35005-2416	W2	O-Rings for DIN Heavy Series (PC, PCM & PCS Couplings)	G64782-0008	X16
Steel Power Steering & Transmission Oil Cooler Tubing - Swivel O-Ring Type I	A35006-2406	W2	Tube Nuts and Sleeves		
Steel Power Steering & Transmission Oil Cooler Tubing - Swivel O-Ring Type II	A35007-2405	W3	Female Flareless Nut	G60050-0004	X17
Steel Power Steering & Transmission Oil Cooler Tubing - Swivel O-Ring Type III	A35008-2416	W3	Female Flareless Sleeve	G60051-0004	X17
Steel Power Steering & Transmission Oil Cooler Tubing - Male Captive O-Ring	A35010-2412	W3	Tube Sleeve	G60394-0003	X17
Steel Power Steering & Transmission Oil Cooler Tubing - Captive O-Ring	A35011-2418	W3	Tube Sleeve Nut	G60395-0002	X18
Steel Power Steering & Transmission Oil Cooler Tubing - Female SAE	A35012-2406	W3	Locknuts for Bulkhead Fittings	G60399-0005	X18
Steel Power Steering & Transmission Oil Cooler Tubing - Beaded Tube	A35020-2406	W4	Metric Bite Sleeve	G64787-0006	X19
Steel Power Steering & Transmission Oil Cooler Tubing - Male Single Bead Quick Connect	A35023-2406	W4	Metric Bite Nut	G64788-0006	X19
Steel Power Steering & Transmission Oil Cooler Tubing - Double Beaded Pipe	A35025-2406	W4	Equipment and Parts		
Steel Power Steering & Transmission Oil Cooler Tubing - GM Quick Connect	A35030-2406	W5	GC® 32-XD Parts	78678	Y1
Aluminum Air Conditioning Tubing - Male Tube O- Ring	A45001-2406	W5	MobileCrimp® 4-20 Parts	78429	Y2
Aluminum Air Conditioning Tubing - Male SAE	A45004-2406	W5	Power Crimp® 707 Parts	78251	Y3
Aluminum Air Conditioning Tubing - Male Inverted O-Ring	A45009-2406	W5	Power Crimp® 707 Swager Kits and Parts	78081	Y4
Aluminum Air Conditioning Tubing - Female Tube O-Ring	A45011-2406	W6	Air Brake		
Aluminum Air Conditioning Tubing - Female SAE	A45012-2406	W6	1/2" ID Hose with 1/2" Fixed Male Pipe NPTF and 3/8" Male Pipe NPTF Swivel	27286	Z1
Aluminum Air Conditioning Tubing - Male Ford Spring Lock	A45035-2406	W6	1/2" ID Hose with 3/8" Fixed Male Pipe NPTF and 3/8" Male Pipe NPTF Swivel with Adapter	27252	Z1
Aluminum Air Conditioning Tubing - Female Ford Spring Lock	A45036-2406	W6	3/8" ID Hose with 1/4" Fixed Male Pipe NPTF and 3/8" Female Air Brake Swivel with Adapter	27242	Z2
Fabrication - Steel Tubing Bulk for TOC (25 Ft. per package)	A63004	W7	3/8" ID Hose with 3/8" Fixed Male Pipe NPTF and 3/8" Female Air Brake Swivel with Adapter	27261	Z2
Accessories			Coiled Air Brake Tubing	G30050-1208	Z3
Nylon Protective Sleeve			Tube Sleeve or Plug	G30050-0004	Z3
LifeGuard® Tools	78075	X1	Tube Sleeve Nut	G30060-0004	Z4
LifeGuard® 3000, 4000 and 5000	G81102-0014	X1	Air Brake to Male Pipe	G30100-0402	Z4
LifeGuard® Clamp Collars - Stainless Steel	G81995-0406S	X1	Air Brake to Male Pipe - 45°	G30102-0604	Z5
Clamp Collar for Nylon Sleeve and LifeGuard® Sleeve	G81995-0408	X2	Air Brake to Male Pipe - 90°	G30104-0402	Z5
Nylon Protective Sleeve	G81800-0010	X2	Air Brake to Male Pipe - 90° - Long	G30106-0602	Z6
Hose Guards			Male Pipe to Air Brake to Air Brake - Tee	G30130-0406	Z6
PolySleeve™ High Density Polyethylene Hose Wrap - Black	G80901-0006	X4	Air Brake on Run to Male Pipe - Tee	G30135-0602	Z6
PolySleeve™ High Density Polyethylene Hose Wrap - Yellow	G80902-0006	X4	Air Brake to Female Pipe	G30150-0602	Z7
Plastic Protective Coil Sleeves	G81900-0004	X5	Air Brake to Female Pipe - 90°	G30154-0604	Z7
Plated Flat Armor Spring Guards	G82801-0008	X5	Air Brake Union	G30400-0404	Z8
Plated Wire Spring Guards	G83801-0009	X6	Air Brake Union - 90°	G30404-0606	Z8
HeatGuard®			Air Brake Union - Tee	G30450-0606	Z9
HeatGuard® Tape	G81100-0100	X7	Air Brake Plugs	G31050-0004	Z10
HeatGuard® Protective Sheathing	G81100-0004	X7	Air Brake Cartridge	G31080-0003	Z10
HeatGuard® High-Temp Protective Sheathing	G81101-0024	X8	Air Brake to Male Pipe	G31100-0202	Z11
			Air Brake to Male Pipe - 45°	G31102-0402	Z11
			Air Brake to Male Pipe - 90°	G31104-0202	Z12
			Air Brake to Male Pipe - 90° with port	G31105-0604P	Z13
			Air Brake to Male Pipe Swivel - 45°	G31122-0402	Z13
			Air Brake to Male Pipe Swivel - 90°	G31124-0402	Z14
			Male Pipe to Air Brake to Air Brake - Tee	G31130-0204	Z14
			Air Brake on Run to Male Pipe - Tee	G31134-0302	Z15
			Air Brake to Male Pipe - Tee - 90°	G31138-0606	Z16
			Male Pipe Swivel to Air Brake to Air Brake - Tee	G31140-0204	Z16
			Air Brake on Run to Male Pipe Swivel - Tee	G31142-0302	Z17
			Air Brake to Female Pipe	G31150-0402	Z17
			Air Brake to Female Pipe - 90°	G31154-0302	Z18
			Air Brake on Run to Female Pipe - Tee	G31160-0604	Z18
			Male Pipe to Air Brake to Female Pipe - Tee	G31167-0406	Z19
			Air Brake to Male Pipe to Female Pipe	G31168-0604	Z19
			Air Brake Bulkhead	G31300-0404	Z19
			Air Brake to Male Flareless Assembly Bulkhead	G31350-0404	Z20
			Air Brake to Female Pipe Bulkhead	G31360-0402	Z20

INDEX

TYPE	DESCRIPTION (EXAMPLE)	PAGE	TYPE	DESCRIPTION (EXAMPLE)	PAGE
Air Brake Union	G31400-0202	Z21	Male Pipe - 90° Block (NPTF - Without 30° Cone Seat)	G36106-0402	AA2
Air Brake Union - 90°	G31404-0404	Z21	Female Pipe (NPTF - 30° Cone Seat)	G36110-0404	AA2
Air Brake Union - Tee	G31450-0202	Z22	Female Pipe Swivel (NPTF - Without 30° Cone Seat)	G36111-0402	AA3
Air Brake Union - Tee with Mounting Hole	G31453-0608	Z22	Male JIC 37° Flare	G36165-0404	AA3
6-Port Manifold	G31970-0604	Z23	Female JIC 37° Flare Swivel	G36170-0406	AA4
Air Brake Assortments	85111	Z24	Male SAE 45° Flare	G36195-0404	AA4
Tube Sleeve Insert	G32040-0004	Z25	Female SAE 45° Flare Swivel	G36200-0406	AA5
Tube Sleeve	G32050-0004	Z25	Dual Seat Female JIC 37°/SAE 45° Flare Swivel	G36210-0404	AA5
Tube Sleeve Nut	G32060-0004	Z25	Male SAE Inverted Swivel	G36500-0403	AA6
Air Brake to Male Pipe	G32100-0401	Z26	Female Inverted	G36508-0403	AA6
Air Brake to Male Pipe - 45°	G32102-0402	Z27	Flareless Tube Fitting (Compression Type)	G36520-0403	AA7
Air Brake to Male Pipe - 90°	G32104-0402	Z27	Hose Mender	G36535-0404	AA7
Air Brake to Male Pipe - 90° - Long	G32106-0602	Z28	Male Pipe (NPTF - 30° Cone Seat)	G37100-0302	AA8
Male Pipe to Air Brake to Air Brake - Tee	G32130-0204	Z28	Male Straight Thread Connector	G37103-0609	AA8
Air Brake on Run to Male Pipe - Tee	G32134-0402	Z28	Male Pipe - 90° Block (NPTF - Without 30° Cone Seat)	G37106-0402	AA9
Air Brake to Female Pipe	G32150-0402	Z29	Male SAE 45° Flare Connector	G37195-0605	AA9
Air Brake to Female Pipe - 90°	G32154-0402	Z29	Male SAE Inverted Swivel	G37500-0404	AA9
Air Brake on Run to Female Pipe - Tee	G32160-0604	Z30	Male SAE Inverted Swivel - 45°	G37503-0605	AA10
Air Brake Bulkhead	G32300-0404	Z30	Male SAE Inverted Swivel - 90°	G37504-0404	AA10
Air Brake Union	G32400-0404	Z31	Female SAE Inverted	G37508-0505	AA11
Air Brake Union - 90°	G32404-0404	Z31	Male Pipe NPTF	G38100-0202	AA12
Air Brake Union - Tee	G32450-0404	Z32	Female Pipe	G38110-0202	AA12
Air Brake to Male Pipe Truck Valve - 90°	G32601-0808	Z32	Double Compression	G60593-0202	AA13
Male Pipe to Air Brake Truck Valve - 90°	G32602-0808	Z33	Double Compression to Male Pipe	G60594-0202	AA13
Air Tank Drain Valve	G33021-0004	Z34	Double Compression to Male Pipe - 90°	G60595-0202	AA13
Air Vent	G33022-0002	Z34	Steel Tubing Male Inverted Swivel Nut - Steel	G60596-0202	AA14
One Way Check Valve	G33027-0006	Z34	Steel Tubing Male Inverted Swivel Nut - Steel - Long	G60597-0303	AA14
Air Brake Adapter	G33030-0604	Z35	Brass Tubing Male Inverted Swivel Nut	G60599-0303	AA15
Gladhand	G33031-0508	Z35	Female Pipe Cap - Brass	G60600-0002	AA15
Gladhand Seal	G33032-0006	Z35	Male Pipe Plug - Hex Head - Brass	G60601-0001	AA15
Tube Sleeve	G33050-0006	Z36	Male Pipe Plug - Square Head - Brass	G60602-0002	AA16
Tube Sleeve Nut	G33060-0006	Z36	Male Pipe Plug - Hex Key Head - Brass	G60603-0001	AA16
Spring Guard Nut	G33061-0006	Z36	Male Pipe Plug - Slotted Head - Brass	G60604-0002	AA17
Air Brake to Male Pipe	G33100-0604	Z37	Male Pipe to Male Pipe - Brass	G60605-0102	AA17
Air Brake to Male Pipe with Spring Guard	G33110-0604	Z37	Male Pipe to Male Pipe - Short - Brass	G60606-0202	AA17
Air Brake to Male Pipe without Nut	G33111-0604	Z37	Male Pipe to Male Pipe - Long - Brass	G60607-0202	AA18
Air Brake Spring Guard	G33112-0006	Z38	Male Pipe to Male Pipe - Extra Long - Brass	G60608-0202	AA18
Air Brake to Female Air Brake Swivel	G33150-0606	Z38	Male Pipe NPTF to Male Pipe NPTF - 90° - Brass	G60610-0202	AA19
Air Brake to Female Air Brake Swivel with Adapter	G33151-0604	Z39	Male Pipe NPTF - Tee	G60612-0202	AA19
Air Brake Bulkhead	G33300-0202	Z39	Male Pipe to Female Pipe - Brass - Reducer	G60614-0402	AA20
Air Brake Union	G33400-0606	Z40	Male Pipe to Female Pipe - Long - Brass	G60615-0102	AA20
Male Pipe to Male SAE 45° Flare Truck Valve - 90°	G33610-0810	Z40	Male Pipe to Female Pipe - 45° - Brass	G60618-0202	AA21
Male SAE 45° Flare to Male Pipe Truck Valve - 90°	G33612-0604	Z40	Male Pipe to Female Pipe - 90° - Brass	G60620-0101	AA21
Single Bead Male Pipe Truck Valve - 90°	G33620-0606	Z41	Male Pipe to Female Pipe to Male SAE 45° Flare - Brass	G60623-0203	AA22
Single Bead to Male Pipe Truck Valve with Pin Handle - 90°	G33622-0606	Z41	Male Pipe to Female Inverted - Brass	G60625-0202	AA22
Female Pipe to Male Pipe Truck Valve - 90°	G33630-0606	Z42	Male Pipe to Female Inverted - 45° - Brass	G60626-0202	AA23
3-Way Truck Valve	G33650-0202	Z42	Male Pipe to Female Inverted - 90° - Brass	G60627-0202	AA23
4-Way Truck Valve	G33655-0404	Z43	Female Inverted on Run to Male Pipe NPTF - Brass	G60628-0302	AA24
Male Flareless Assembly to Male Flareless Assembly Shut-Off Cock	G33701-0404	Z43	Male Pipe to Female Inverted to Female Inverted - Brass	G60629-0203	AA24
Male Flareless Assembly to Male Pipe Shut-Off Cock	G33705-0402	Z44	Female Pipe to Female Inverted - Brass	G60630-0202	AA25
Male Pipe to Female Pipe Shut-Off Cock	G33710-0202	Z44	Female Pipe to Female Pipe - Brass	G60631-0101	AA25
Female Pipe to Female Pipe Shut-Off Cock	G33715-0202	Z45	Female Pipe to Female Pipe Swivel Union - Brass	G60632-0202	AA26
Male SAE 45° Flare to Male Pipe Shut-Off Cock	G33720-0402	Z45	Female Pipe NPTF to Female Pipe NPTF - 45° - Brass	G60635-0202	AA26
Male SAE 45° Flare to Male SAE 45° Flare Shut-Off Cock	G33730-0404	Z46	Female Pipe to Female Pipe - 90° - Brass	G60637-0202	AA26
Male Pipe Air Drain Cock	G33801-0002	Z46	Female Pipe - Cross - Brass	G60639-0202	AA27
Female Pipe to Male Pipe Air Drain Cock	G33805-0202	Z47	Female Pipe - Union Tee - Brass	G60640-0101	AA27
Male Pipe Drain Cock - Bibb Nose	G33823-1006	Z47	Female Pipe to Male Pipe to Female Pipe - Brass	G60641-0202	AA28
Male Pipe Drain Cock - Internal Seat	G33830-0002	Z48	Female Pipe on Run to Male Pipe - Tee - Brass	G60642-0202	AA28
Male Pipe Drain Cock - External Seat	G33831-0004	Z48	Female SAE 45° Flare Cap - Brass	G60643-0003	AA29
Male Pipe Air Drain Cock - Bibb Nose	G33832-0202	Z48	Male SAE Plug - Brass	G60644-0003	AA29
Air Tank Valve	G33850-0202	Z48	Male SAE 45° Flare to Male SAE 45° Flare - Brass	G60645-0202	AA30
Male Flareless Assembly to Male Flareless Assembly - Needle Valve	G33901-0303	Z49	Male SAE 45° Flare to Male SAE 45° Flare - 90° - Brass	G60648-0404	AA30
Male Flareless Assembly to Male Flareless Assembly - Needle Valve - 90°	G33905-0302	Z49	Male SAE 45° Flare to Male Pipe - Brass	G60650-0202	AA31
Male Flareless Assembly to Male Pipe - Needle Valve	G33910-0202	Z50	Male SAE 45° Flare to Male Pipe - 45° - Brass	G60652-0402	AA31
Male Pipe to Male Pipe - Needle Valve	G33915-0202	Z50	Male SAE 45° Flare to Male Pipe - 90° - Brass	G60654-0202	AA32
Male Pipe to Female Pipe - Needle Valve	G33920-0202	Z51	Male SAE 45° Flare on Run to Male Pipe - Brass	G60657-0202	AA33
Female Pipe to Female Pipe - Needle Valve	G33930-0202	Z51	Male Pipe NPTF to Male SAE 45° Flare to Male SAE 45° Flare - Brass	G60659-0203	AA33
Male SAE 45° Flare to Male Pipe - Needle Valve	G33940-0402	Z51	Male SAE 45° Flare to Female Pipe - Brass	G60660-0202	AA34
Male SAE 45° Flare to Male Pipe - Needle Valve - 90°	G33945-0402	Z52	Male SAE 45° Flare to Female Pipe - 90° - Brass	G60664-0302	AA35
Male SAE 45° Flare to Male SAE 45° Flare - Needle Valve	G33950-0404	Z52	Male SAE 45° Flare - Tee 1 - Brass	G60669-0202	AA35
Brass			Male SAE 45° Flare - Tee 2 - Brass	G60670-0604	AA36
Male Pipe (NPTF - 30° Cone Seat)	G36100-0402	AA1	Male SAE 45° Flare - Tee 3 - Brass	G60671-0604	AA36
Male Pipe Swivel (NPTF - Without 30° Cone Seat)	G36105-0404	AA1	Female SAE 45° Flare Nut - Short - Brass	G60675-0002	AA37
			Female SAE 45° Flare Nut - Long - Brass	G60676-0003	AA37

INDEX

<u>TYPE</u>	<u>DESCRIPTION (EXAMPLE)</u>	<u>PAGE</u>
Male SAE 45° - Male Inverted	G60679-0403	AA38
Male SAE 45° Flare - Cross	G60680-0404	AA38
SAE Tubing Sleeve Nut	G60685-0004	AA38
Male SAE 45° Flare to Male Pipe - Check Valve	G60690-0204	AA39
Male Inverted Plug	G60691-0003	AA39
Female Inverted to Female Inverted	G60693-0202	AA39
Female Inverted to Female Inverted - 90°	G60694-0404	AA40
Female Inverted - Tee	G60695-0303	AA40
Female Inverted on Run to Female Pipe - Tee	G60696-0303	AA41
Kits		
Kits		
Kits		AB1