

01

G-Line Hose and Fittings



**STREET
PERFORMANCE
& RACING**

SECTION: 01
G-Line Hose and Fittings

Material Key
B: Brass, C: Stainless Steel, CH: Chrome Plated, D: Aluminium,
EN: Electroless Nickel, P: Zinc Plated Carbon Steel, T: Titanium

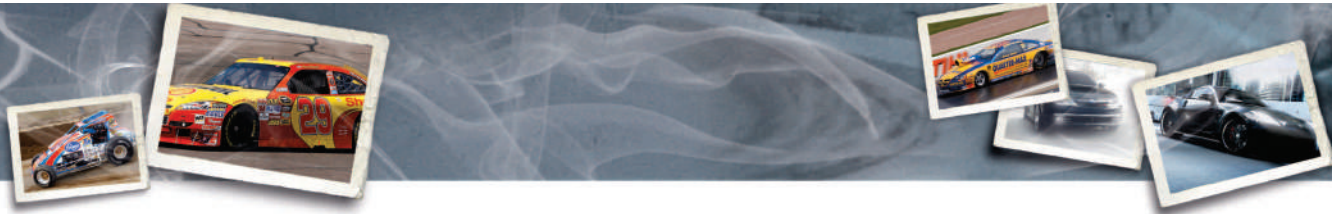

STREET
PERFORMANCE
& RACING

G-Line XF



CONVENTIONAL convoluted PTFE liner

SMOOTH BORE PTFE liner

At the cutting edge of motorsport, a fraction of a second is the difference between winning and just taking part. **You need the best.** At Goodridge we have combined our 40 years of motorsport experience with a continuous research and development program, to bring you the ultimate PTFE hose... one product that incorporates all the advantages of both convoluted and smooth bore designs.

Advantages
G-Line XF has outstanding resistance to pressure, much higher than that of conventional convoluted PTFE lined hose. In addition, G-Line XF hose flow rates are always significantly higher than convoluted PTFE hose and may allow you to reduce the bore size providing subsequent weight and cost savings. All sizes of G-Line XF are usable at full vacuum up to 130°C. Above this, the vacuum resistance should be reduced 1% for every degree above 130°C. Stainless Steel braided hose is used in applications involving higher temperatures. High tensile grade 304 stainless steel wire is used, to give maximum pressure resistance and external protection to the hose.

Hose 910

Application :
Fuel, Oil, Water, Methanol, Air
Temperature range :
-45°C to + 170°C
-49°F to + 338°F
Material : **Anti-Static**
PTFE smoothbore, Aramid fibre Braid

910 is the number one choice of leading motorsport teams, and our flagship lightweight hose. 910 combines a woven super-light Aramid braid, with a PTFE inner bore - smooth inside for increased flow and convoluted outside for amazing flexibility. Compatible with fully crimped fittings or the revolutionary 811 series Re-usable fittings.

PART NO	BORE SIZE		BRAID OD		WORKING PRES		BURST PRES		WEIGHT		MIN BEND RAD	
	MM	IN	MM	IN	BAR	PSI	BAR	PSI	KG/M	LB/FT	MM	IN
910-04	6.85	.270	10.3	.406	90	1320	360	5290	0.055	.0367	23.5	.925
910-06	9.53	.375	13.0	.512	80	1180	320	4700	0.088	.0591	20	.787
910-08	12.70	.500	16.5	.650	70	1030	280	4120	0.141	.0947	38	1.426
910-10	15.88	.625	20.8	.819	65	955	260	3820	0.201	.1351	45	1.772
910-12	19.05	.750	24.4	.961	60	880	240	3530	0.292	.1962	50	1.969
910-16	25.40	1.000	32.3	1.272	50	740	200	2940	0.416	.3199	70	2.756
910-20	32.00	1.260	38.4	1.512	45	666	180	2645	0.850	.6536	100	3.937

Hose 811

Application :
Fuel, Oil, Water, Methanol, Air
Temperature range :
-70°C to 260°C
-94°F to 500°F
Material : **Anti-Static**
PTFE smoothbore, Stainless steel braid

811 hose has all the flexibility and flow rate advantages of 910 hose with a stainless steel braid for additional protection. Compatible with fully crimped fittings or the revolutionary 811 series Re-usable fittings

PART NO	BORE SIZE		BRAID OD		WORKING PRES		BURST PRES		WEIGHT		MIN BEND RAD	
	MM	IN	MM	IN	BAR	PSI	BAR	PSI	KG/M	LB/FT	MM	IN
811-04	6.85	.270	9.6	.378	90	1320	360	5290	0.09	.0414	19	.750
811-06	9.53	.375	13.0	.512	80	1180	320	4700	0.14	.0941	20	.787
811-08	12.70	.500	16.5	.650	70	1030	280	4120	0.29	.1949	38	1.496
811-10	15.88	.625	20.8	.819	65	955	260	3820	0.35	.2352	45	1.772
811-12	19.05	.750	24.4	.961	60	880	240	3530	0.40	.2688	50	1.969
811-16	25.40	1.000	32.3	1.272	50	740	200	2940	0.63	.4233	70	2.756

Hose 910 FC (Fuel Cell)

Application :
Fuel cell systems
Temperature range :
-45°C to 50°C
-49°F to 122°F
Material :
PTFE smoothbore tube
2 x Options:
• **Clear PTFE**
• **Black PTFE (Anti-Static)**

This product is perfect for the inside of fuel cells, for lift pump applications. 910-06FC and 910-08FC uses just the center PTFE tube of G-Line hose, removing the outer braid to reduce weight and ensure cleanliness in the cell. Compatible with all fuels including methanol, it can be cut to specific lengths for use with the standard G-Line fittings.

PART NO	BORE SIZE		WORKING PRES		BURST PRES		WEIGHT		MIN BEND RADIUS	
	MM	IN	BAR	PSI	BAR	PSI	KG/M	LB/FT	MM	IN
910-06FC	9.53	.375	5	74	20	295	.06	.0403	60.0	2.362
910-08FC	12.70	.500	5	74	20	295	.15	.1008	60.0	2.362

G-Line Hose Fully Convoluted

The ultimate range of ultra flexible and light weight hose and fittings. Developed exclusively by Goodridge - the world's leading supplier of light weight PTFE hose. Our G-Line product ranges are the

first choice of leading F1, IRL, NASCAR teams and of W.R.C. competitors. 710 G-Line combines lightness with superb strength and flexibility.

The wide fitting range is designed to meet all possible applications and requirements.

G-Line Hose Fully Convoluted - Hose 710

Application :
Fuel, Oil, Water, Methanol, Air
Temperature range :
-45°C to + 170°C
-49°F to + 338°F
Material : **Anti-Static**
Convoluted PTFE bore, Aramid fibre Braid

This exclusive Goodridge development has changed the perception of traditional fluid transfer hoses, worldwide. Constructed of a convoluted PTFE inner tube with a carbon impregnated static dissipation liner (impervious to virtually all chemicals) and covered with the industry's only source of black Aramid Fibre. This combination offers a fluid transfer hose with strength and pres-

sure ratings superior to most stainless steel braided hoses. Our exclusive 710 Series Hose is over 60% lighter than stainless braided Ni hose. Its convoluted form gives it collapse resistant flexibility that offers a 70% tighter bend radius saving time, material and weight. The Aramid Fibre outer braid is literally a bullet-proof material, offering superior strength and fire resistance.

PART NO	BORE SIZE		PTFE WALL THICKNESS		OUTER DIAMETER		WORKING PRES		BURST PRES		WEIGHT		MIN BEND RADIUS	
	MM	IN	MM	IN	MM	IN	BAR	PSI	BAR	PSI	KG/M	LB/FT	MM	IN
710-04	7.1	0.280	0.58	0.023	11.3	0.445	70	1025	330	4850	0.075	0.05	20	0.787
710-06	9.5	0.375	0.68	0.027	14.4	0.567	64	940	256	3760	0.089	0.06	25	0.985
710-08	13.3	0.525	0.68	0.027	19.2	0.756	58	850	235	3450	0.134	0.09	25	0.985
710-10	16.0	0.630	0.76	0.030	21.5	0.846	50	735	200	2930	0.164	0.11	32	1.260
710-12	19.5	0.768	0.80	0.031	25.6	1.008	35	510	170	2495	0.193	0.13	40	1.575
710-16	25.4	1.000	0.94	0.037	33.9	1.335	33	485	133	1950	0.237	0.16	50	1.968
710-20	31.8	1.250	0.96	0.038	36.5	1.457	25	367	75	1102	0.461	0.31	70	2.756

SECTION: 01
G-Line Hose and Fittings

Material Key
B: Brass, C: Stainless Steel, CH: Chrome Plated, D: Aluminum,
EN: Electroless Nickel, P: Zinc Plated Carbon Steel, T: Titanium

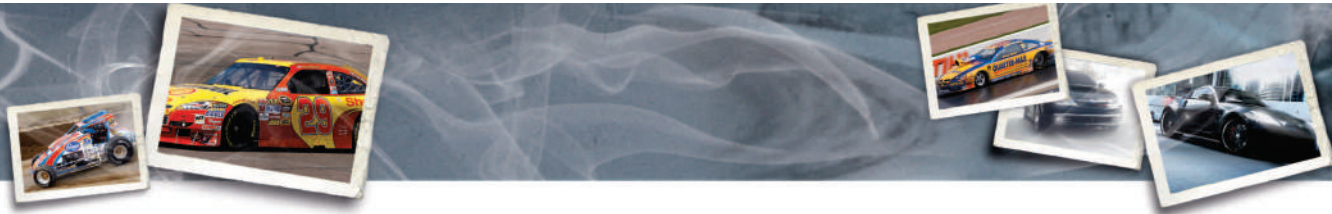

STREET
PERFORMANCE
& RACING

Fully Machined G-Line Swage/Crimp Fittings
for: G-Line and G-Line XF 910, 710, 811

Fitting Type :
Swage / Crimp
Application :
Fuel, Oil, Water, Methanol, Air
To Suit Hose :
910, 710, 811
Material : D, P

The only choice of fitting when the goal is to achieve the World's lightest fluid transfer system offering the utmost in racing environment performance, reliability and weight saving. These fully machined, one-piece fittings are designed for permanent attachment to all our G-Line hose ranges. Our qualified Hose Technicians will individually build your assembly to your exacting specifications. Additionally, Goodridge Technical Centers can build lines to your exact specifications and are located in several regions for fast service.

Please Note:
Collars need to be ordered separately for all swage / crimp fittings.

4001 STRAIGHT FEMALE CONCAVE

PART NO.	MATERIAL	HOSE	NUT
4001-04	D, P	-4	-4
4001-06-M14	D	-6	M14 X 1.50
4001-06	D	-6	-6
4001-08-10	D	-8	-10
4001-08	D	-8	-8
4001-10-M22	D	-10	M22 X 1.50
4001-10-08	D	-10	-8
4001-10-12	D	-10	-12
4001-10	D	-10	-10
4001-12-10	D	-12	-10
4001-12	D	-12	-12
4001-16-12	D	-16	-12
4001-16	D	-16	-16
4001-20	D	-20	-20

4031 30° FORGED SWEPT FEMALE CONCAVE SEAT

PART NO.	MATERIAL	HOSE	NUT
4031-04	P	-4	-4
4031-04	LP	-4	-4

NOTE: P INDICATES ALLOY NUT ON STEEL TAILFORM

NOTE: The latest designs of G-Line fittings in -10 and larger feature a turned-down hex for the ultimate weight savings. Sizes up to -8 still offer light weight designs while providing maximum strength.



4046-08
Deeper hex for fittings -08 and below



4046-10
Shallow hex for fittings -10 and above

4045 45° FORGED SWEPT FEMALE CONCAVE SEAT

PART NO.	MATERIAL	HOSE	NUT
4045-04	D	-4	-4
4045-06	D	-6	-6
4045-08	D	-8	-8
4045-10	D	-10	-10
4045-12	D	-12	-12

4046 45° SWEPT TUBE FEMALE CONCAVE SEAT

PART NO.	MATERIAL	HOSE	NUT
4046-04	D, P	-4	-4
4046-04	LP	-4	-4
4046-06	D	-6	-6
4046-08	D	-8	-8
4046-10	D	-10	-10
4046-12	D	-12	-12
4046-16	D	-16	-16

4061 45° FORGED SWEPT FEMALE CONCAVE SEAT

PART NO.	MATERIAL	HOSE	NUT
4061-04	P	-4	-4
4061-04	LP	-4	-4

NOTE: P INDICATES ALLOY NUT ON STEEL TAILFORM

4090 90° FORGED FEMALE CONCAVE SEAT

PART NO.	MATERIAL	HOSE	NUT
4090-04	D	-4	-4
4090-06	D	-6	-6
4090-08	D	-8	-8
4090-10	D	-10	-10
4090-12	D	-12	-12

4091 90° SWEPT TUBE FEMALE CONCAVE SEAT

PART NO.	MATERIAL	HOSE	NUT
4091-04	D, P	-4	-4
4091-06-M14	D	-6	M14 X 1.5
4091-06	D	-6	-6
4091-08	D	-8	-8
4091-10	D	-10	-10
4091-12	D	-12	-12
4091-16	D	-16	-16

Fully Machined G-Line Swage/Crimp Fittings
for: G-Line and G-Line XF 910, 710, 811

4120 120° SWEPT TUBE FEMALE CONCAVE SEAT

PART NO.	MATERIAL	HOSE	NUT
4120-04	D, P	-4	-4
4120-06	D	-6	-6
4120-08	D	-8	-8
4120-10	D	-10	-10
4120-12	D	-12	-12
4120-16	D	-16	-16

4150 150° SWEPT TUBE FEMALE CONCAVE SEAT

PART NO.	MATERIAL	HOSE	NUT
4150-04	D, P	-4	-4
4150-04	LP	-4	-4
4150-06	D	-6	-6
4150-08	D	-8	-8
4150-10	D	-10	-10
4150-12	D	-12	-12
4150-16	D	-16	-16

4180 180° SWEPT TUBE FEMALE CONCAVE SEAT

PART NO.	MATERIAL	HOSE	NUT
4180-04	D, P	-4	-4
4180-06	D	-6	-6
4180-08	D	-8	-8
4180-10	D	-10	-10
4180-12	D	-12	-12
4180-16	D	-16	-16

4441 STRAIGHT MALE CONVEX SEAT

PART NO.	MATERIAL	HOSE	NUT
4441-04	D	-4	4 MALE
4441-06	D	-6	6 MALE
4441-08	D	-8	8 MALE
4441-12-16	D	-12	16 MALE

NOTE: P INDICATES ALLOY NUT ON STEEL TAILFORM

NOTE: The latest designs of G-Line fittings in -10 and larger feature a turned-down hex for the ultimate weight savings. Sizes up to -8 still offer light weight designs while providing maximum strength.



4046-08
Deeper hex for fittings -08 and below



4046-10
Shallow hex for fittings -10 and above

G-Line Flexible Coupling Fittings for Wiggins
for: G-Line & G-Line XF 910, 710, 811

Fitting Type :
Swage / Crimp
Application :
Fuel, Oil, Water, Methanol, Air
To Suit Hose :
910, 710, 811
Material : D

For rapid disconnection and where the need is to connect flexible hose to rigid tube use the Goodridge cup end fittings designed for use with our Wiggins flexible couplings. Step sizes available upon request. Please contact our Sales Department for pricing and availability.

4001DFL STRAIGHT



4031DFL 30°



4046DFL 45°



4061DFL 60°



4091DFL 90°



4120DFL 120°



4150DFL 150°



4180DFL 180°



NOTE: See page 16 For full details on Wiggins couplings



With Wiggins clamp attached

SECTION: 01
G-Line Hose and Fittings

Material Key
B: Brass, C: Stainless Steel, CH: Chrome Plated, D: Aluminum,
EN: Electroless Nickel, P: Zinc Plated Carbon Steel, T: Titanium

GOODRIDGE
FLUID TRANSFER SYSTEMS

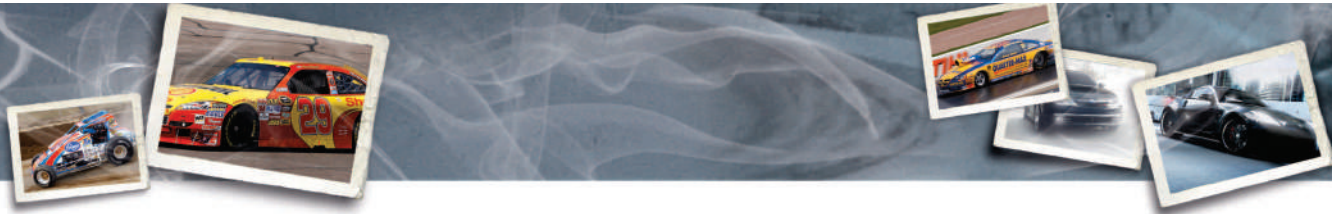

**STREET
PERFORMANCE
& RACING**

Brazed Swage/Crimp Fittings
for: G-Line and G-Line XF, 910, 710, 811

Fitting Type :
Swage / Crimp
Application :
Fuel, Oil, Water, Methanol, Air
To Suit Hose :
910, 710, 811
Material : **D**

Please Note:
Collars need to be ordered separately
for all swage / crimp fittings.

Where the requirement is for a lower cost fitting to a standard bend radius the G-Line brazed range is the product of choice. Manufactured and brazed in house to the highest standards, the Goodridge care and quality requirements are evident.

4016DBZ 15° SWEPT TUBE FEMALE CONCAVE SEAT

PART NO.	MATERIAL	HOSE	NUT
4016-12DBZ	D	-12	-12
4016-16DBZ	D	-16	-16

4031DBZ 30° SWEPT TUBE FEMALE CONCAVE SEAT

PART NO.	MATERIAL	HOSE	NUT
4031-06DBZ	D	-6	-6
4031-08DBZ	D	-8	-8
4031-10DBZ	D	-10	-10
4031-12DBZ	D	-12	-12
4031-16DBZ	D	-16	-16
4031-20DBZ	D	-20	-20

4046DBZ 45° SWEPT TUBE FEMALE CONCAVE SEAT

PART NO.	MATERIAL	HOSE	NUT
4046-06DBZ	D	-6	-6
4046-08DBZ	D	-8	-8
4046-10-08DBZ	D	-10	-8
4046-10DBZ	D	-10	-10
4046-12DBZ	D	-12	-12
4046-16DBZ	D	-16	-16
4046-20DBZ	D	-20	-20

NOTE: The latest designs of G-Line fittings in -10 and larger feature a turned-down hex for the ultimate weight savings. Sizes up to -8 still offer light weight designs while providing maximum strength.



4046-08
Deeper hex for fittings -08 and below



4046-10
Shallow hex for fittings -10 and above

4061DBZ 60° SWEPT TUBE FEMALE CONCAVE SEAT

PART NO.	MATERIAL	HOSE	NUT
4061-06DBZ	D	-6	-6
4061-08DBZ	D	-8	-8
4061-10DBZ	D	-10	-10
4061-12DBZ	D	-12	-12
4061-16DBZ	D	-16	-16
4061-20DBZ	D	-20	-20

4076DBZ 75° SWEPT TUBE FEMALE CONCAVE SEAT

PART NO.	MATERIAL	HOSE	NUT
4076-10DBZ	D	-10	-10
4076-12DBZ	D	-12	-12
4076-16DBZ	D	-16	-16

4091DBZ 90° SWEPT TUBE FEMALE CONCAVE SEAT

PART NO.	MATERIAL	HOSE	NUT
4091-06DBZ	D	-6	-6
4091-08DBZ	D	-8	-8
4091-10-08DBZ	D	-10	-8
4091-10DBZ	D	-10	-10
4091-12-10DBZ	D	-12	-10
4091-12DBZ	D	-12	-12
4091-16DBZ	D	-16	-16
4091-20DBZ	D	-20	-20

4120DBZ 120° SWEPT TUBE FEMALE CONCAVE SEAT

PART NO.	MATERIAL	HOSE	NUT
4120-06DBZ	D	-6	-6
4120-08DBZ	D	-8	-8
4120-10DBZ	D	-10	-10
4120-12DBZ	D	-12	-12
4120-16DBZ	D	-16	-16
4120-20DBZ	D	-20	-20

Brazed Swage/Crimp Fittings
for: G-Line and G-Line XF, 910, 710, 811

4150DBZ 150° SWEPT TUBE FEMALE CONCAVE SEAT

PART NO.	MATERIAL	HOSE	NUT
4150-06DBZ	D	-6	-6
4150-08DBZ	D	-8	-8
4150-10DBZ	D	-10	-10
4150-12DBZ	D	-12	-12
4150-16DBZ	D	-16	-16
4150-20DBZ	D	-20	-20

4180DBZ 180° SWEPT TUBE FEMALE CONCAVE SEAT

PART NO.	MATERIAL	HOSE	NUT
4180-06DBZ	D	-6	-6
4180-08DBZ	D	-8	-8
4180-10DBZ	D	-10	-10
4180-12DBZ	D	-12	-12
4180-16DBZ	D	-16	-16

40776 NON SWIVEL BANJO

PART NO.	MATERIAL	HOSE	HOLE SIZE
40776-04-M14	D	-6	M14
40776-06-M12	D	-8	M12

4001DFLM

PART NO.	MATERIAL	HOSE	WIGGINS
4001-06-08DFLM	D	-6	-8 BKHD

4091DFM

PART NO.	MATERIAL	HOSE	WIGGINS
4091-12-12DFM	D	-12	-12 MALE

4824 -8 CRIMP WITH TEE

PART NO.	MATERIAL	HOSE
4824-08-04-08	D	-8
4824-08-08-08	D	-8

ALSO AVAILABLE IN BLACK

RCC910 CRIMP COLLAR TO SUIT 811 & 910 HOSE FOR CRIMPING

PART NO.	MATERIAL	HOSE
RCC910-04	D	-4
RCC910-06	D	-6
RCC910-08	D	-8
RCC910-10	D	-10
RCC910-12	D	-12
RCC910-16	D	-16

To Suit Hose Type : G-Line XF 910, 811
Please Note : Collars need to be ordered separately for all swage / crimp fittings

SECTION: 01
G-Line Hose and Fittings

Material Key
B: Brass, C: Stainless Steel, CH: Chrome Plated, D: Aluminum,
EN: Electroless Nickel, P: Zinc Plated Carbon Steel, T: Titanium

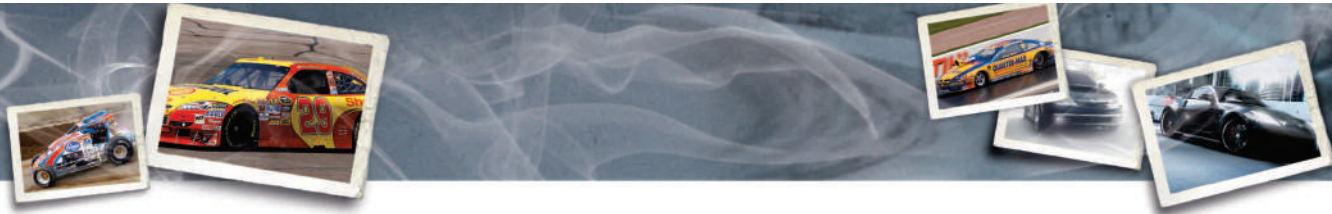

STREET
PERFORMANCE
& RACING

Adjustable Swage/Crimp Fittings
for: G-Line and G-Line XF, 910, 710, 811

Fitting Type :
Swage / Crimp
Application :
Fuel, Oil, Water, Methanol, Air
To Suit Hose :
910, 710, 811
Material : D

Please Note:
Collars need to be ordered separately for all swage / crimp fittings.

Adjustable Swage G-Line Fittings are essential when last minute hose end orientation or in-field alignments are required. Additionally, they allow for hose assemblies to be used in multiple locations. Our 360-degree adjustable, 4400 Series G-Line Hose ends offer trouble free installation of pre-fabricated hose assemblies, with the reliability of a swage design. Our qualified Hose Technicians will individually build your assembly to your exacting specifications. Additionally, Goodridge Technical Centers can build lines to your exact specifications and are located in several regions for fast service

4461 60° SWEPT TUBE FEMALE CONCAVE SEAT

PART NO.	MATERIAL	HOSE	NUT
4461-08	D	-8	-8
4461-10	D	-10	-10
4461-12	D	-12	-12
4461-16	D	-16	-16

4476 75° SWEPT TUBE FEMALE CONCAVE SEAT

PART NO.	MATERIAL	HOSE	NUT
4476-08	D	-8	-8
4476-10	D	-10	-10
4476-12	D	-12	-12
4476-16	D	-16	-16

4490 90° FORGED FEMALE CONCAVE SEAT

PART NO.	MATERIAL	HOSE	NUT
4490-04	D	-4	-4
4490-06	D	-6	-6
4490-08	D	-8	-8
4490-10	D	-10	-10

4491 90° SWEPT TUBE FEMALE CONCAVE SEAT

PART NO.	MATERIAL	HOSE	NUT
4491-04	D	-4	-4
4491-06	D	-6	-6
4491-08	D	-8	-8
4491-10	D	-10	-10
4491-12	D	-12	-12
4491-16	D	-16	-16

44120 120° SWEPT TUBE FEMALE CONCAVE SEAT

PART NO.	MATERIAL	HOSE	NUT
44120-04	D	-4	-4
44120-06	D	-6	-6
44120-08	D	-8	-8
44120-10	D	-10	-10
44120-12	D	-12	-12
44120-16	D	-16	-16

4431 30° SWEPT TUBE FEMALE CONCAVE SEAT

PART NO.	MATERIAL	HOSE	NUT
4431-08	D	-8	-8
4431-10	D	-10	-10
4431-12	D	-12	-12
4431-16	D	-16	-16

4445 45° FORGED FEMALE CONCAVE SEAT

PART NO.	MATERIAL	HOSE	NUT
4445-04	D	-4	-4
4445-06	D	-6	-6
4445-08	D	-8	-8
4445-10	D	-10	-10
4445-12	D	-12	-12

4446 45° SWEPT TUBE FEMALE CONCAVE SEAT

PART NO.	MATERIAL	HOSE	NUT
4446-04	D	-4	-4
4446-06	D	-6	-6
4446-08	D	-8	-8
4446-10	D	-10	-10
4446-12	D	-12	-12
4446-16	D	-16	-16



Adjustable Swage/Crimp Fittings
for: G-Line and G-Line XF, 910, 710, 811

44150 150° SWEPT TUBE FEMALE CONCAVE SEAT

PART NO.	MATERIAL	HOSE	NUT
44150-04	D	-4	-4
44150-06	D	-6	-6
44150-08	D	-8	-8
44150-10	D	-10	-10
44150-12	D	-12	-12
44150-16	D	-16	-16

44180 180° SWEPT TUBE FEMALE CONCAVE SEAT

PART NO.	MATERIAL	HOSE	NUT
44180-04	D	-4	-4
44180-06	D	-6	-6
44180-08	D	-8	-8
44180-10	D	-10	-10
44180-12	D	-12	-12
44180-16	D	-16	-16

G-Line Male Swivel Fittings

Fitting Type :
Swage / Crimp
Application :
Fuel, Oil, Water, Methanol, Air
To Suit Hose :
910, 710, 811
Material : D

Please note:
To avoid large 'step-ups' in size, not all tail sizes are available with all thread sizes. Collars need to be ordered separately for all swage / crimp fittings. (See Page 7)

These fittings allow for 'low profile' installation where space is limited. They feature a swivelling male spigot in UNF and metric sizes, which seals on an integral Buna-N 'O' ring and will fit into standard female ports.

All parts are assembled and quoted to order. Please contact our Sales Department for pricing and availability.

	G-LINE PREFIX	MALE O-RING SEAL SWIVEL	STRAIGHT MALE	TAIL SIZE- HOSE	JIC UNF THREAD	METRIC THREAD	MATERIAL
EXAMPLE PART NO. UNF	4	00	001	-04	-04		D
	400001-04-04-D						
EXAMPLE PART NO. METRIC	4	00	001	-04		M12	D
	400001-04-M12D						

G-LINE PREFIX		RANGE NUMBER		FITTING ANGLE		TAIL SIZE		JIC UNF THREAD		METRIC THREAD SIZE		MATERIAL	
PREFIX	PART NO.	PREFIX	PART NO.	PREFIX	PART NO.	PREFIX	PART NO.	PREFIX	PART NO.	PREFIX	PART NO.	PREFIX	PART NO.
G-LINE PREFIX	4	MALE O-RING SEAL SWIVEL	00	STRAIGHT MALE	001	-04 HOSE	-04	7/16 X 20	-04	12 X 1.5MM	M12	ALUMINIUM	D
				45° BRAZED TUBE	046	-06 HOSE	-06	9/16 X 18	-06	14 X 1.5MM	M14	ALUMINIUM	D
				90° BRAZED TUBE	091	-08 HOSE	-08	3/4 X 16	-08	16 X 1.5MM	M16	ALUMINIUM	D



★ 30° AND 60° SWEPT TUBE AVAILABLE IN LARGER SIZES BY REQUEST.

Section: 01
G-Line Hose and Fittings

Material Key
B: Brass, C: Stainless Steel, CH: Chrome Plated, D: Aluminium,
EN: Electroless Nickel, P: Zinc Plated Carbon Steel, T: Titanium

GOODRIDGE
FLUID TRANSFER SYSTEMS





**STREET
PERFORMANCE
& RACING**

811 Hose and Re-usable Fittings
for: 811 and 910 Hose

811-01	STRAIGHT FEMALE		
	PART NO.	HOSE	NUT
	811-0104	-4	-4
	811-0106	-6	-6
	811-0108	-8	-8
	811-0110	-10	-10
	811-0112	-12	-12
	811-0116	-16	-16
	811-0120	-20	-20

811-90	90° SWEEP FEMALE		
	PART NO.	HOSE	NUT
	811-9004	-4	-4
	811-9006	-6	-6
	811-9008	-8	-8
	811-9010	-10	-10
	811-9012	-12	-12
	811-9016	-16	-16
	811-9020	-20	-20

812-45	45° FORGED FEMALE		
	PART NO.	HOSE	NUT
	812-4506	-6	-6
	812-4508	-8	-8
	812-4510	-10	-10
	812-4512	-12	-12

811-120	120° SWEEP TUBE FEMALE		
	PART NO.	HOSE	NUT
	811-12004	-4	-4
	811-12006	-6	-6
	811-12008	-8	-8
	811-12010	-10	-10
	811-12012	-12	-12
	811-12016	-16	-16
	811-12020	-20	-20

811-45	45° SWEEP TUBE FEMALE		
	PART NO.	HOSE	NUT
	811-4504	-4	-04
	811-4506	-6	-06
	811-4508	-8	-08
	811-4510	-10	-10
	811-4512	-12	-12
	811-4516	-16	-16
	811-4520	-20	-20

811-150	150° SWEEP TUBE FEMALE		
	PART NO.	HOSE	NUT
	811-15004	-4	-4
	811-15006	-6	-6
	811-15008	-8	-8
	811-15010	-10	-10
	811-15012	-12	-12
	811-15016	-16	-16
	811-15020	-20	-20

811-30	30° SWEEP TUBE FEMALE		
	PART NO.	HOSE	NUT
	811-3010	-10	-10

811-180	180° SWEEP TUBE FEMALE		
	PART NO.	HOSE	NUT
	811-18004	-4	-4
	811-18006	-6	-6
	811-18008	-8	-8
	811-18010	-10	-10
	811-18012	-12	-12
	811-18016	-16	-16

812-90	90° FORGED FEMALE		
	PART NO.	HOSE	NUT
	812-9006	-6	-6
	812-9008	-8	-8
	812-9010	-10	-10
	812-9012	-12	-12

Hose 811

Application :
Fuel, Oil, Water, Methanol, Air
Temperature range :
-70°C to 260°C
-94°F to 500°F
Material : Anti-Static
PTFE smoothbore, Stainless steel
braid

811 hose has all the flexibility and flow rate advantages of 910 hose with a stainless steel braid for additional protection. Compatible with fully crimped fittings or the revolutionary 811 series Re-usable fittings



Hose 910







Application :
Fuel, Oil, Water, Methanol, Air
Temperature range :
-45°C to + 170°C
-49°F to + 338°F
Material : Anti-Static
PTFE smoothbore, Aramid fibre Braid

910 is the number one choice of leading motorsport teams, and our flagship lightweight hose. 910 combines a woven super-light Aramid braid, with a PTFE inner bore- smooth inside for increased flow and convoluted outside for amazing flexibility. Compatible with fully crimped fittings or the revolutionary 811 series Re-usable fittings.

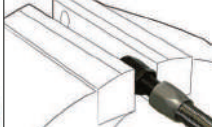

NOTE: See page 2 for full hose specification

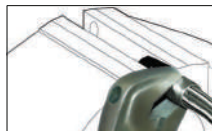
Assembly Instructions for 811 Fittings & 811/910 Series Hose

			
STEP 1 Remove socket from fitting.	STEP 2 Feed the hose into the socket with a turning motion, feeding the braid in as you turn the hose.	STEP 3 Hold the fitting in a vice with smooth or soft jaws, and lubricate the threads with a light oil.	STEP 4 Push the hose firmly onto the thread whilst rotating the hose. Keep turning the hose until the first three to four threads have engaged.
			
STEP 5 Tighten socket using a spanner or adjustable, continue turning the socket until it reaches the base of the thread.	STEP 6 When the socket reaches the base of the thread keep turning for two complete turns.		



Section: 01 G-Line Hose and Fittings

Material Key

B: Brass, **C:** Stainless Steel, **CH:** Chrome Plated, **D:** Aluminium,
EN: Electroless Nickel, **P:** Zinc Plated Carbon Steel, **T:** Titanium

GOODRIDGE
FLUID TRANSFER SYSTEMS



811 Flexible Coupling Fittings for Wiggins for: G-Line & G-Line XF 910, 710, 811

Fitting Type : Re-usable

To Suit Hose : 811, 910

Fitting Material : D

Fitting Colour : Black/Silver

811 Hose Application :

Fuel, Oil, Water, Methanol, Air

Temperature range :

-45°C to + 170°C

-49°F to + 338°F

Material : Anti-Static

PTFE smoothbore, Aramid fibre Braid

For rapid disconnection and where the need is to connect flexible hose to rigid tube use the Goodridge cup end fittings designed for use with our Wiggins flexible couplings. Listed below is our standard range – other sizes can be made to order. For a complete listing of flexible couplings please contact our sales department.

811-150

150° SWEEP TUBE



PART NO.	MATERIAL	HOSE	WIGGINS
811-15006-08DFL	D	-6	-6
811-15008DFL	D	-8	-8
811-15010DFL	D	-10	-10
811-15012DFL	D	-12	-12
811-15016DFL	D	-16	-16

NOTE: See page 16 For full details on Wiggins couplings



811-120

With Wiggins clamp attached

811-01

STRAIGHT FEMALE



PART NO.	MATERIAL	HOSE	WIGGINS
811-0106-08DFL	D	-6	-6
811-0108DFL	D	-8	-8
811-0110DFL	D	-10	-10
811-0112DFL	D	-12	-12
811-0116DFL	D	-16	-16

811-45

45° SWEEP TUBE



PART NO.	MATERIAL	HOSE	WIGGINS
811-4506-08DFL	D	-6	-6
811-4508DFL	D	-8	-8
811-4510DFL	D	-10	-10
811-4512DFL	D	-12	-12
811-4516DFL	D	-16	-16

811-90

90° SWEEP TUBE



PART NO.	MATERIAL	HOSE	WIGGINS
811-9006-08DFL	D	-6	-6
811-9008DFL	D	-8	-8
811-9010DFL	D	-10	-10
811-9012DFL	D	-12	-12
811-9016DFL	D	-16	-16

811-120

120° SWEEP TUBE



PART NO.	MATERIAL	HOSE	WIGGINS
811-12006-08DFL	D	-6	-6
811-12008DFL	D	-8	-8
811-12010DFL	D	-10	-10
811-12012DFL	D	-12	-12
811-12016DFL	D	-16	-16

02

G-link Quick Release Couplings
Wiggins Flexible Couplings

STREET
PERFORMANCE
& RACING

Section: 02
G-link Quick Release Couplings, Wiggins Flexible Couplings

Material Key
B: Brass, C: Stainless Steel, CH: Chrome Plated, D: Aluminium,
EN: Electroless Nickel, P: Zinc Plated Carbon Steel, T: Titanium

GOODRIDGE
FLUID TRANSFER SYSTEMS

G-LINK
Quick Disconnect Couplings

G-Link Bayonet-Type

The Quick Disconnect Couplings of the Advantage series, G-Link Bayonet-Type are compact and lightweight couplings, developed for hydraulic and pneumatic

purposes in motorsport with operating pressure up to 200 bar. The locking mechanism with bayonet is designed for one-hand operation,

pushing and twisting the outer sleeve, with no separate actuation required for operation. Both halves, coupler and nipple, are equipped with self-acting

valves to stop fluid loss during uncoupling, as well as air inclusion during coupling.

NOMINAL SIZE 03	DIMENSIONS			DETAILS			
	HEX A/F	O/A LENGTH	COUPLED LENGTH	NOMINAL DIAM.	MWP	WEIGHT IN GRAMS	
G003BP03E	QDV BAYONET-TYPE PLUG -03 JIC EPDM SEAL	13MM	34.7MM	38MM	3.5MM	200BAR	7
G003BS03E	QDV BAYONET-TYPE SOCKET -03 JIC EPDM SEAL	13MM	42.5MM	38MM	3.5MM	200BAR	10
G003BP03F	QDV BAYONET-TYPE PLUG -03 JIC FPM SEAL	13MM	34.7MM	38MM	3.5MM	200BAR	7
G003BS03F	QDV BAYONET-TYPE SOCKET -03 JIC FPM SEAL	13MM	42.5MM	38MM	3.5MM	200BAR	10
G003BP04E	QDV BAYONET-TYPE PLUG -04 JIC EPDM SEAL	13MM	36.2MM	38MM	3.5MM	200BAR	7
G003BS04E	QDV BAYONET-TYPE SOCKET -04 JIC EPDM SEAL	13MM	44.05MM	38MM	3.5MM	200BAR	11
G003BP04F	QDV BAYONET-TYPE PLUG -04 JIC FPM SEAL	13MM	36.2MM	38MM	3.5MM	200BAR	7
G003BS04F	QDV BAYONET-TYPE SOCKET -04 JIC FPM SEAL	13MM	44.05MM	38MM	3.5MM	200BAR	11
NOMINAL SIZE 05							
G005BP04F	QDV BAYONET-TYPE PLUG -04 JIC FPM SEAL	17MM	39.6MM	43MM	5.5MM	150BAR	13
G005BS04F	QDV BAYONET-TYPE SOCKET -04 JIC FPM SEAL	17MM	47.5MM	43MM	5.5MM	150BAR	17
G005BP04E	QDV BAYONET-TYPE PLUG -04 JIC EPDM SEAL	17MM	39.6MM	43MM	5.5MM	150BAR	13
G005BS04E	QDV BAYONET-TYPE SOCKET -04 JIC EPDM SEAL	17MM	47.5MM	43MM	5.5MM	150BAR	17
G005BP06F	QDV BAYONET-TYPE PLUG -06 JIC FPM SEAL	17MM	39.6MM	43MM	5.5MM	150BAR	14
G005BS06F	QDV BAYONET-TYPE SOCKET -06 JIC FPM SEAL	17MM	47.5MM	43MM	5.5MM	150BAR	18
NOMINAL SIZE 08							
G008BP06F	QDV BAYONET-TYPE PLUG -06 JIC FPM SEAL	24MM	49.1MM	58MM	8.5MM	100BAR	26
G008BS06F	QDV BAYONET-TYPE SOCKET -06 JIC FPM SEAL	24MM	58.6MM	58MM	8.5MM	100BAR	38
G008BP08F	QDV BAYONET-TYPE PLUG -08 JIC FPM SEAL	24MM	51.6MM	58MM	8.5MM	100BAR	30
G008BS08F	QDV BAYONET-TYPE SOCKET -08 JIC FPM SEAL	24MM	61.1MM	58MM	8.5MM	100BAR	42

G-Link Bayonet-Type

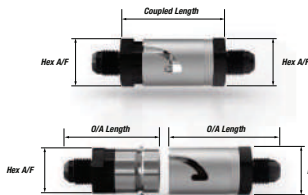

G-Link Pull-Type

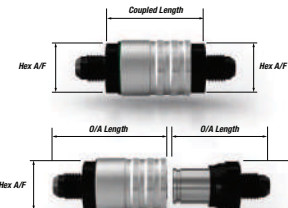

Optionally the dry break coupling can be used as a security shut-off device, e.g. for fuel lines. For this purpose one half of the coupling is equipped with a lanyard to separate the halves in case of an accident. The unique locking mechanism design allows activation of separation by pulling the male half. So it is possible to install two inversely arranged couplings to avoid the risk of mistakes.

All body sizes of the G-Link Pull-Type series Quick Disconnect Couplings are also available in a non-locking version, designed for the use in refill units. Please ask for additional information on couplings and refill units.

G-LINK
Quick Disconnect Couplings

G-Link Pull-Type

The Quick Disconnect Couplings of the Advantage series, G-Link Pull-Type, are compact and lightweight couplings, developed for hydraulic and pneumatic purposes in motorsport with operating pressure up to 200 bar. The locking

mechanism is designed for one-hand operation; no separate actuation of the retaining sleeve is required for operation. To verify the correct connection, the female half is equipped with a green indicator ring. This indicator ring can,

alternatively, be replaced by a retaining clamp. This can only be attached when the halves are coupled and eliminates the risk of unintentional uncoupling. Additionally the whole operating mechanism is O-ring sealed to achieve

particular suitability for rough conditions and to reduce environmental effects. Both halves, coupler and nipple, are equipped with self-acting valves to stop fluid loss during uncoupling, as well as air inclusion, during coupling.

NOMINAL SIZE 05	DIMENSIONS			DETAILS			
	HEX A/F	O/A LENGTH	COUPLED LENGTH	NOMINAL DIAM.	MWP	WEIGHT IN GRAMS	
G005PP04F	QDV PULL-TYPE PLUG -04 JIC FPM SEAL	22MM	38.1MM	43.6MM	4.5MM	200BAR	20
G005PP04B	QDV PULL-TYPE PLUG -04 JIC BULKHEAD FPM SEAL	22MM	46.1MM	43.6MM	4.5MM	200BAR	22
G005PS04F	QDV PULL-TYPE SOCKET -04 JIC FPM SEAL	17MM	45.5MM	43.6MM	4.5MM	200BAR	32
G005PS04L	QDV PULL-TYPE SOCKET -04 JIC LANYARD FPM SEAL	17MM	45.5MM	43.6MM	4.5MM	200BAR	36
G005PP06F	QDV PULL-TYPE PLUG -06 JIC FPM SEAL	22MM	38.1MM	43.6MM	4.5MM	200BAR	21
G005PP06B	QDV PULL-TYPE PLUG -06 JIC BULKHEAD FPM SEAL	22MM	49.1MM	43.6MM	4.5MM	200BAR	24
G005PS06F	QDV PULL-TYPE SOCKET -06 JIC FPM SEAL	17MM	45.5MM	43.6MM	4.5MM	200BAR	33
G005PS06L	QDV PULL-TYPE SOCKET -06 JIC LANYARD FPM SEAL	17MM	45.5MM	43.6MM	4.5MM	200BAR	37
NOMINAL SIZE 08							
G008PP06F	QDV PULL-TYPE PLUG -06 JIC FPM SEAL	27MM	42.6MM	52.6MM	8.0MM	150BAR	36
G008PP06B	QDV PULL-TYPE PLUG -06 JIC BULKHEAD FPM SEAL	27MM	53.6MM	52.6MM	8.0MM	150BAR	39
G008PS06F	QDV PULL-TYPE SOCKET -06 JIC FPM SEAL	24MM	52MM	52.6MM	8.0MM	150BAR	56
G008PS06L	QDV PULL-TYPE SOCKET -06 JIC LANYARD FPM SEAL	24MM	52MM	52.6MM	8.0MM	150BAR	60
G008PP08F	QDV PULL-TYPE PLUG -08 JIC FPM SEAL	27MM	45.1MM	52.6MM	8.0MM	150BAR	38
G008PP08B	QDV PULL-TYPE PLUG -08 JIC BULKHEAD FPM SEAL	27MM	58.6MM	52.6MM	8.0MM	150BAR	46
G008PS08F	QDV PULL-TYPE SOCKET -08 JIC FPM SEAL	24MM	54.5MM	52.6MM	8.0MM	150BAR	59
G008PS08L	QDV PULL-TYPE SOCKET -08 JIC LANYARD FPM SEAL	24MM	54.5MM	52.6MM	8.0MM	150BAR	64
G00PC08	QDV PULL-TYPE CAP FOR PLUG NOMINAL SIZE 08						
NOMINAL SIZE 14							
G014PP12F	QDV PULL-TYPE PLUG -12 JIC FPM SEAL	36MM	56.1MM	64.6MM	14.0MM	100BAR	84
G014PP12B	QDV PULL-TYPE PLUG -12 JIC BULKHEAD FPM SEAL	36MM	72.1MM	64.6MM	14.0MM	100BAR	106
G014PPL	ADAPTOR-PLATE FOR PANEL MOUNTING (OPTIONAL)						
G014PS12F	QDV PULL-TYPE SOCKET -12 JIC FPM SEAL	32MM	71.1MM	64.6MM	14.0MM	100BAR	140

Technical Information

FKM (Viton) seals, in use in fuel systems for many years, don't have the chemical resistance for use with current fuel mixtures, where ethanol or methanol are incorporated. Goodridge found the perfect solution for this challenge: a compound also resistant to all currently used fuel blends, e.g.

- Adblue (additive for scr; selective catalytic reduction)
- B5 (Diesel Blend; Containing 5% Biodiesel)
- B10
- B20 (Biodiesel)
- B100 (Biodiesel)
- E85 (gasoline blend; containing 85% Ethanol)
- Vegetable Oil
- Ethanol

Additionally this applied compound has at least the same resistance to temperature and mechanical stress as the standard FKM compound and is even better qualified for lower temperatures than FKM compounds e.g. Kalrez. The consequence for motorsport applications is that the complete range can be covered with only two different sealing materials.

Seal materials, choice

The standard sealing material is a modified fluorinated rubber compound (FPM, FKM, Viton), which is identified with the suffix "B". This new material is only available in G-Link Quick Disconnect Couplings and allows the use for fuel-alcohol mixtures, pure ethanol and vegetable oil. Other materials as nitrile rubber (NBR), Ethylene-Propylene-Dien-rubber (EPDM) are available on request.

The operating temperatures are the following, dependent upon sealing material:

Material	Chemical description	Operating temperatures	Representative fluids
FPM B	Fluorcarbon, mod.	-20°C to +200°C	Fuel, ethanol, vegetable oil
NBR	Nitril-Butadien	-25°C to +120°C	Oils, mineral grea ses
EPDM	Ethylen-Propylen-Dien	-50°C to +150°C	Brake fluids

Each coupling half is laser-etched with Part-Nr. and sealing material (see part number guide).

Hydraulic ports

The hydraulic connection is unioned by a male thread with a conical seal of 37° according to MS 33656 (standard) or MS 33657 (bulkhead version).

Size	Nominal size	Threads
05	5mm	7/16-20 UNF or 9/16-18 UNF
08	8mm	9/16-18 UNF or 3/4 -16 UNF
14	14mm	7/8-14 UNF or 1-11/16-12 UNF

Of course any other connector style can be produced upon request.

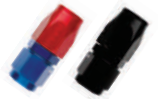

Section: **02**
G-link Quick Release Couplings, Wiggins Flexible Couplings

Material Key
B: Brass, C: Stainless Steel, CH: Chrome Plated, D: Aluminium,
EN: Electroless Nickel, P: Zinc Plated Carbon Steel, T: Titanium



Wiggins Flexible Fluid Couplings

Design Features:
One-handed Installation, Standard Profile, Medium Pressure, Integral Electrical Bonding, Available in Aluminium and Stainless Steel.

W994-XX-DE Clamp only (no sleeve, no ferrule)
W991-XX-DE Clamp + sleeve (no ferrule)
W903-XX-D Weld Ferrule
W908-XX-D Sleeve
OR-XX Green Viton O-Ring

-XX- insert your required size from -08 to -64

Clamps and ferrules also available in stainless steel

The W900 Series Clamshell Coupling is the result of more than three decades of experience at Adel Wiggins in the design and production of reliable flexible tube connectors.

The W900 Series Clamshell Connectors utilize a locking latch design, eliminating the installation of safety wire and offering one-handed installation. Integral electrical bonding eliminates the need for external clamps, fasteners and jumper wire required by most other connectors. The elimination of safety wire, grounding clamps and jumpers provides for a low weight connector. Goodridge offer a complete range of light weight hose fittings designed to connect directly onto Wiggins clamshell couplings, allowing you to connect from hard tube to flexible hose quickly and reliably.



WIGGINS FULL CONNECTORS (W991) (LESS FERRULES)

TUBE O.D. SIZE	ALUMINUM		SEAL SIZE PER MS 33386	DIMENSIONS		
	PART NO.	WT. LBS.		A MAX	B MAX	C MAX
1/2	W991-08DE	.034	-015	.739	.851	.90
5/8	W991-10DE	.038	-017	.739	.976	.96
3/4	W991-12DE	.043	-117	.829	1.156	1.04
1	W991-16DE	.052	-214	.923	1.432	1.16
1 1/4	W991-20DE	.058	-218	.923	1.682	1.27
1 1/2	W991-24DE	.062	-222	.923	1.952	1.40
1 3/4	W991-28DE	.070	-224	.923	2.211	1.52
2	W991-32DE	.083	-226	.989	2.505	1.66
2 1/2	W991-40DE	.097	-230	.989	2.996	1.90
3	W991-48DE	.144	-234	.989	3.554	2.17

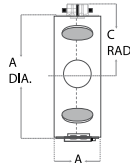

WIGGINS WELD FERRULE (W903)

*Material of ferrule must be compatible with material of tube.

TUBE O.D. SIZE	ALUMINUM		STAINLESS STEEL		SEAL SIZE PER MS 33386	DIMENSIONS	
	PART NO.	WT. LBS.	PART NO.	WT. LBS.		A MAX	B MAX
1/2	W903-08D	.010			-015	.749	.689
5/8	W903-10D	.012			-017	.749	.814
3/4	W903-12D	.016	W903-12C	.046	-117	.783	.994
1	W903-16D	.022	W903-16C	.062	-214	.838	1.270
1 1/4	W903-20D	.027	W903-20C	.076	-218	.838	1.520
1 1/2	W903-24D	.033	W903-24C	.093	-222	.838	1.790
1 3/4	W903-28D	.038	W903-28C	.107	-224	.838	2.040
2	W903-32D	.047			-226	.854	2.313
2 1/2	W903-40D	.056			-230	.854	2.813
3	W903-48D	.069			-234	.854	3.313

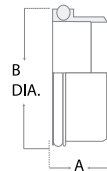

03

200, 210 Series Braided Hose and Fittings

STREET
PERFORMANCE
& RACING

Section: **03**
200, 210 Series Braided Hose and Fittings

Material Key
B: Brass, C: Stainless Steel, CH: Chrome Plated, D: Aluminium,
EN: Electroless Nickel, P: Zinc Plated Carbon Steel, T: Titanium

GOODRIDGE
FLUID TRANSFER SYSTEMS

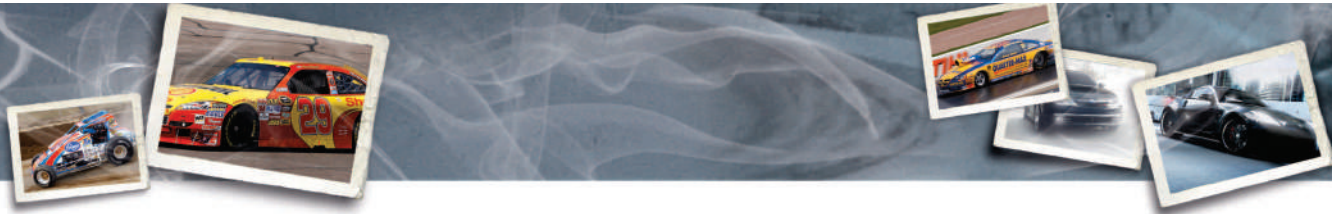

**STREET
PERFORMANCE
& RACING**

200 Series Hose

Application :
Fuel, Oil, Coolants, Methanol, Water
Material / Construction :
Integral stainless steel reinforced
synthetic rubber with hi-tensile outer
stainless steel braid
Please Note:
Not to be used for fuel use inside
a cockpit.

Goodridge 200 Series hose is the premier stainless steel braided hose. 200 Hose is designed for use with a wide range of re-usable aluminium hose ends and provides essential protection and resistance to high pressure, temperature, vibration, fire risks and chafing. It is constructed of a seamless synthetic CPE inner with an integral stainless steel braid and a high tensile stainless steel outer braid. 200 Series hose has the highest corrosion and fire resistance threshold of any stainless braided hose available. It can be used with all synthetic lubricants, fuels, oils, coolants and alcohols including methanol and nitromethane.

This hose is perfectly manufactured for efficient and reliable use with 136, 1136, 236, 336 and 2776 Series Hose Ends. The traditional racing hose.



PART NO	BORE SIZE		BRAID OD		WORKING PRES		BURST PRES		WEIGHT		TEMPERATURE RANGE		MIN BEND RADIUS	
	MM	INCH	MM	INCH	BAR	PSI	BAR	PSI	KG/M	LB/FT	MIN	MAX	MM	INCH
200-04	5.56	0.219	11.13	0.438	69	1000	414	6000	0.167	0.112	-46°C (-51°F)	150°C (302°F)	50.80	2.00
200-05	6.25	0.250	12.50	0.500	69	1000	414	6000	0.184	0.123	-46°C (-51°F)	150°C (302°F)	56.25	2.25
200-06	8.73	0.344	13.89	0.547	69	1000	414	6000	0.201	0.135	-46°C (-51°F)	150°C (302°F)	63.50	2.50
200-07	9.38	0.380	15.63	0.625	69	1000	345	5000	0.236	0.158	-46°C (-51°F)	150°C (302°F)	76.20	2.75
200-08	11.12	0.438	16.28	0.641	69	1000	345	5000	0.271	0.182	-46°C (-51°F)	150°C (302°F)	88.90	3.50
200-10	14.27	0.562	20.24	0.797	69	1000	345	5000	0.348	0.234	-46°C (151°F)	150°C (302°F)	101.60	4.00
200-12	17.47	0.688	23.82	0.928	69	1000	259	3750	0.421	0.283	-46°C (-51°F)	150°C (302°F)	114.30	4.50
200-16	22.22	0.875	29.36	1.156	52	750	172	2500	0.552	0.377	-46°C (-51°F)	150°C (302°F)	139.70	5.50
200-20	28.70	1.125	36.49	1.437	35	500	138	2000	0.732	0.492	-46°C (-51°F)	150°C (302°F)	203.20	8.00

PART NO	HOSE SERIES	LENGTH
2000	200-04	BULK
2001	200-04	3'
2002	200-04	6'
2003	200-04	10'
2004	200-04	15'
2005	200-04	20'
2006	200-06	BULK
2007	200-06	3'
2008	200-06	6'
2009	200-06	10'
2010	200-06	15'
2011	200-06	20'
2012	200-08	BULK
2013	200-08	3'
2014	200-08	6'

PART NO	HOSE SERIES	LENGTH
2015	200-08	10'
2016	200-08	15'
2017	200-08	20'
2018	200-10	BULK
2019	200-10	3'
2020	200-10	6'
2021	200-10	10'
2022	200-10	15'
2023	200-10	20'
2024	200-12	BULK
2025	200-12	3'
2026	200-12	6'
2027	200-12	10'
2028	200-12	15'
2029	200-12	20'

PART NO	HOSE SERIES	LENGTH
2030	200-16	BULK
2031	200-16	3'
2032	200-16	6'
2033	200-16	10'
2034	200-16	15'
2035	200-16	20'
2036	200-20	BULK
2037	200-20	3'
2038	200-20	6'
2039	200-20	10'
2040	200-20	15'
2041	200-20	20'
2042	200-24	BULK
2043	200-28	BULK
2044	200-32	BULK

210 Series Hose

Application :
Fuel, Oil, Coolants, Methanol, Water
Material / Construction :
Integral stainless steel reinforced
synthetic rubber with lightweight
outer fibre braid
Please Note:
Not to be used for fuel use inside
a cockpit.

210 series is a new development, based on the conventional 200 series stainless steel braided hose, widely used in all forms of racing. The 210 series has a lightweight fibre braid, with high abrasion resistance, and is ideal for breather hoses, or oil and water circuits. It is the perfect solution as a lightweight alternative to 200 series, where the robust stainless steel braid is not necessary, and weight saving is paramount. The 210 series hose is a great option for show cars and street performance when used with the 1136 black and electroplate hose ends.



PART NO	BORE SIZE		BRAID OD		WORKING PRES		BURST PRES		WEIGHT		TEMPERATURE RANGE		MIN BEND RADIUS	
	MM	INCH	MM	INCH	BAR	PSI	BAR	PSI	KG/M	LB/FT	MIN	MAX	MM	INCH
210-04	5.56	0.219	11.17	0.44	34	500	138	2000	0.112	0.075	-40°C (-40°F)	148.9°C (300°F)	50.8	2.00
210-06	8.71	0.343	14.22	0.56	34	500	138	2000	0.141	0.095	-40°C (-40°F)	148.9°C (300°F)	63.5	2.50
210-08	11.13	0.438	17.02	0.67	34	500	138	2000	0.179	0.120	-40°C (-40°F)	148.9°C (300°F)	88.9	3.50
210-10	14.29	0.562	20.83	0.82	34	500	138	2000	0.231	0.155	-40°C (-40°F)	148.9°C (300°F)	101.6	4.00
210-12	17.46	0.688	24.38	0.96	24	350	97	1400	0.372	0.250	-40°C (-40°F)	148.9°C (300°F)	114.3	4.50
210-16	22.23	0.875	29.21	1.15	24	350	97	1400	0.476	0.320	-40°C (40°F)	148.9°C (300°F)	139.7	5.50

PART NO	HOSE SERIES	LENGTH
2100	210-04	BULK
2101	210-04	3'
2102	210-04	6'
2103	210-04	10'
2104	210-04	15'
2105	210-04	20'
2106	210-06	BULK
2107	210-06	3'
2108	210-06	6'
2109	210-06	10'
2110	210-06	15'
2111	210-06	20'

PART NO	HOSE SERIES	LENGTH
2112	210-08	BULK
2113	210-08	3'
2114	210-08	6'
2115	210-08	10'
2116	210-08	15'
2117	210-08	20'
2118	210-10	BULK
2119	210-10	3'
2120	210-10	6'
2121	210-10	10'
2122	210-10	15'
2123	210-10	20'

PART NO	HOSE SERIES	LENGTH
2124	210-12	BULK
2125	210-12	3'
2126	210-12	6'
2127	210-12	10'
2128	210-12	15'
2129	210-12	20'
2130	210-16	BULK
2131	210-16	3'
2132	210-16	6'
2133	210-16	10'
2134	210-16	15'
2135	210-16	20'



Section: **03**
200, 210 Series Braided Ni Hose and Fittings

Material Key
B: Brass, C: Stainless Steel, CH: Chrome Plated, D: Aluminium,
EN: Electroless Nickel, P: Zinc Plated Carbon Steel, T: Titanium

GOODRIDGE
FLUID TRANSFER SYSTEMS

**STREET
PERFORMANCE
& RACING**

1136 Swivel Single Nipple Max-flow Alloy Hose
Fittings for: 200, 210 Series Hose (BK)

Fitting Type :
Single nipple Re-usable
Application :
Fuel, Oil, Coolants, Methanol, Water
To Suit Hose :
200, 210
Material : D
Colour : D = Red and Blue,
BK = Black, DE = Electroplate

This series combines the popular single nipple design with a full 360° adjustable capability all at an affordable price. Fittings can be produced in black, electroplate finish or red and blue.





1136 Swivel Single Nipple Max-flow Alloy Hose
Fittings for: 200, 210 Series Hose (E)

Fitting Type :
Single nipple Re-usable
Application :
Fuel, Oil, Coolants, Methanol, Water
To Suit Hose :
200, 210
Material : D
Colour : D = Red and Blue,
BK = Black, E = Electroplate





1136BK

1136-01	STRAIGHT FEMALE		
	PART NO.	HOSE	NUT
	1136-0104BK	200/210-04	-4
	1136-0106BK	200/210-06	-6
	1136-0108BK	200/210-08	-8
	1136-0110BK	200/210-10	-10
	1136-0112BK	200/210-12	-12
	1136-0116BK	200/210-16	-16

1136-120	120° FEMALE SWEEP TUBE		
	PART NO.	HOSE	NUT
	1136-12004BK	200/210-04	-4
	1136-12006BK	200/210-06	-6
	1136-12008BK	200/210-08	-8
	1136-12010BK	200/210-10	-10
	1136-12012BK	200/210-12	-12
	1136-12016BK	200/210-16	-16

1136-45	45° FEMALE SWEEP TUBE		
	PART NO.	HOSE	NUT
	1136-4504BK	200/210-04	-4
	1136-4506BK	200/210-06	-6
	1136-4508BK	200/210-08	-8
	1136-4510BK	200/210-10	-10
	1136-4512BK	200/210-12	-12
	1136-4516BK	200/210-16	-16

1136-150	150° FEMALE SWEEP TUBE SWIVEL		
	PART NO.	HOSE	NUT
	1136-15004BK	200/210-04	-4
	1136-15006BK	200/210-06	-6
	1136-15008BK	200/210-08	-8
	1136-15010BK	200/210-10	-10
	1136-15012BK	200/210-12	-12
	1136-15016BK	200/210-16	-16

1136-90	90° FEMALE SWEEP TUBE		
	PART NO.	HOSE	NUT
	1136-9004BK	200/210-04	-4
	1136-9006BK	200/210-06	-6
	1136-9008BK	200/210-08	-8
	1136-9010BK	200/210-10	-10
	1136-9012BK	200/210-12	-12
	1136-9016BK	200/210-16	-16

1136-180	180° FEMALE SWEEP TUBE SWIVEL		
	PART NO.	HOSE	NUT
	1136-18004BK	200/210-04	-4
	1136-18006BK	200/210-06	-6
	1136-18008BK	200/210-08	-8
	1136-18010BK	200/210-10	-10
	1136-18012BK	200/210-12	-12
	1136-18016BK	200/210-16	-16

1136E

1136-01	STRAIGHT FEMALE		
	PART NO.	HOSE	NUT
	1136-0104E	200/210-04	-4
	1136-0106E	200/210-06	-6
	1136-0108E	200/210-08	-8
	1136-0110E	200/210-10	-10
	1136-0112E	200/210-12	-12
	1136-0116E	200/210-16	-16
	1136-0120E	200/210-20	-20

1136-120	120° FEMALE SWEEP TUBE		
	PART NO.	HOSE	NUT
	1136-12004E	200/210-04	-4
	1136-12006E	200/210-06	-6
	1136-12008E	200/210-08	-8
	1136-12010E	200/210-10	-10
	1136-12012E	200/210-12	-12
	1136-12016E	200/210-16	-16

1136-45	45° FEMALE SWEEP TUBE		
	PART NO.	HOSE	NUT
	1136-4504E	200/210-04	-4
	1136-4506E	200/210-06	-6
	1136-4508E	200/210-08	-8
	1136-4510E	200/210-10	-10
	1136-4512E	200/210-12	-12
	1136-4516E	200/210-16	-16
	1136-4520E	200/210-20	-20

1136-150	150° FEMALE SWEEP TUBE SWIVEL		
	PART NO.	HOSE	NUT
	1136-15004E	200/210-04	-4
	1136-15006E	200/210-06	-6
	1136-15008E	200/210-08	-8
	1136-15010E	200/210-10	-10
	1136-15012E	200/210-12	-12
	1136-15016E	200/210-16	-16

1136-90	90° FEMALE SWEEP TUBE		
	PART NO.	HOSE	NUT
	1136-9004E	200/210-04	-4
	1136-9006E	200/210-06	-6
	1136-9008E	200/210-08	-8
	1136-9010E	200/210-10	-10
	1136-9012E	200/210-12	-12
	1136-9016E	200/210-16	-16
	1136-9020E	200/210-20	-20

1136-180	180° FEMALE SWEEP TUBE SWIVEL		
	PART NO.	HOSE	NUT
	1136-18004E	200/210-04	-4
	1136-18006E	200/210-06	-6
	1136-18008E	200/210-08	-8
	1136-18010E	200/210-10	-10
	1136-18012E	200/210-12	-12
	1136-18016E	200/210-16	-16

Section: **03**
200, 210 Series Braided Hose and Fittings

Material Key
B: Brass, **C:** Stainless Steel, **CH:** Chrome Plated, **D:** Aluminium,
EN: Electroless Nickel, **P:** Zinc Plated Carbon Steel, **T:** Titanium

GOODRIDGE
 FLUID TRANSFER SYSTEMS

**STREET
 PERFORMANCE
 & RACING**

1136 Swivel Single Nipple Max-flow Alloy Hose
 Fittings for: 200, 210 Series Hose

Fitting Type :
Single nipple Re-usable
 Application :
Fuel, Oil, Coolants, Methanol, Water
 To Suit Hose :
200, 210
 Material : **D**
 Colour : **D = Red and Blue,**
BK = Black, E = Electroplate

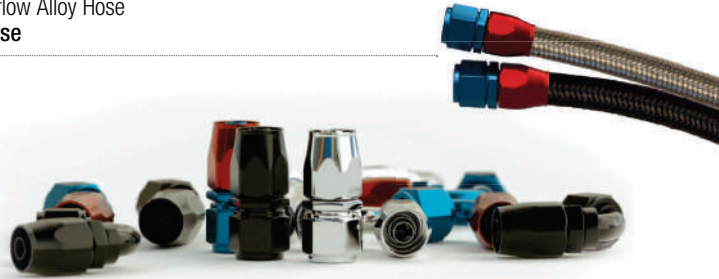



1136

1136-01	STRAIGHT FEMALE SWIVEL		
	PART NO.	HOSE	NUT
	1136-0104	200/210-04	-4
	1136-0106	200/210-06	-6
	1136-0108	200/210-08	-8
	1136-0110	200/210-10	-10
	1136-0112	200/210-12	-12
	1136-0116	200/210-16	-16

1136-30	30° FEMALE SWEEP TUBE SWIVEL		
	PART NO.	HOSE	NUT
	1136-3006	200/210-06	-6
	1136-3008	200/210-08	-8
	1136-3010	200/210-10	-10
	1136-3012	200/210-12	-12
	1136-3016	200/210-16	-16

1136-120	120° FEMALE SWEEP TUBE SWIVEL		
	PART NO.	HOSE	NUT
	1136-12006	200/210-06	-6
	1136-12008	200/210-08	-8
	1136-12010	200/210-10	-10
	1136-12012	200/210-12	-12
	1136-12016	200/210-16	-16

1136-150	150° FEMALE SWEEP TUBE SWIVEL		
	PART NO.	HOSE	NUT
	1136-15006	200/210-06	-6
	1136-15008	200/210-08	-8
	1136-15010	200/210-10	-10
	1136-15012	200/210-12	-12
	1136-15016	200/210-16	-16

1136-45	45° FEMALE SWEEP TUBE SWIVEL		
	PART NO.	HOSE	NUT
	1136-4504	200/210-04	-4
	1136-4506	200/210-06	-6
	1136-4508	200/210-08	-8
	1136-4510	200/210-10	-10
	1136-4512	200/210-12	-12
	1136-4516	200/210-16	-16

1136-60	60° FEMALE SWEEP TUBE SWIVEL		
	PART NO.	HOSE	NUT
	1136-6006	200/210-06	-6
	1136-6008	200/210-08	-8
	1136-6010	200/210-10	-10
	1136-6012	200/210-12	-12
	1136-6016	200/210-16	-16

1136-90	90° FEMALE SWEEP TUBE SWIVEL		
	PART NO.	HOSE	NUT
	1136-9004	200/210-04	-4
	1136-9006	200/210-06	-6
	1136-9008	200/210-08	-8
	1136-9010	200/210-10	-10
	1136-9012	200/210-12	-12
	1136-9016	200/210-16	-16

1136-180	180° FEMALE SWEEP TUBE SWIVEL		
	PART NO.	HOSE	NUT
	1136-18006	200/210-06	-6
	1136-18008	200/210-08	-8
	1136-18010	200/210-10	-10
	1136-18012	200/210-12	-12
	1136-18016	200/210-16	-16

236 Swivel Cutter Alloy Fittings
 for : 200, 210 Series Hose

Fitting Type :
Cutter-style Re-usable
 Application :
Fuel, Oil, Coolants, Methanol, Water
 To Suit Hose :
200, 210
 Material : **D**
 Colour : **D = Red and Blue,**
BK = Black, E = Electroplate

The most comprehensive range of lightweight, re-usable alloy hose ends precisely engineered to fit our 200, 210 Series Hose. Our Aerospace standard Triple Seal/Double O-ring, cutter design ensures a secure, leak free connection every time. All 236, 336 and 1136 Series Hose Ends allow for all time alignment with their 360-degree swivel ends. The 336 Series has forged style bodies, offering that added measure of strength. They are available in bright anodised red and blue.

236-01	STRAIGHT FEMALE		
	PART NO.	HOSE	NUT
	236-0106BK	200/210-06	-6
	236-0108BK	200/210-08	-8
	236-0110BK	200/210-10	-10
	236-0112BK	200/210-12	-12
	236-0116BK	200/210-16	-16

236-31	30° FEMALE SWEEP TUBE		
	PART NO.	HOSE	NUT
	236-3006	200/210-06	-6
	236-3008	200/210-08	-8
	236-3010	200/210-10	-10
	236-3012	200/210-12	-12
	236-3016	200/210-16	-16

236-45	30° FEMALE SWEEP TUBE		
	PART NO.	HOSE	NUT
	236-4506	200/210-06	-6
	236-4508	200/210-08	-8
	236-4510	200/210-10	-10
	236-4512	200/210-12	-12
	236-4516	200/210-16	-16

236-60	60° FEMALE SWEEP TUBE		
	PART NO.	HOSE	NUT
	236-6006	200/210-06	-6
	236-6008	200/210-08	-8
	236-6010	200/210-10	-10
	236-6012	200/210-12	-12
	236-6016	200/210-16	-16

236-90	90° FEMALE SWEEP TUBE		
	PART NO.	HOSE	NUT
	236-9006	200/210-06	-6
	236-9008	200/210-08	-8
	236-9010	200/210-10	-10
	236-9012	200/210-12	-12
	236-9016	200/210-16	-16

236-120	120° FEMALE SWEEP TUBE		
	PART NO.	HOSE	NUT
	236-12006	200/210-06	-6
	236-12008	200/210-08	-8
	236-12010	200/210-10	-10
	236-12012	200/210-12	-12
	236-12016	200/210-16	-16

236-150	150° FEMALE SWEEP TUBE		
	PART NO.	HOSE	NUT
	236-15006	200/210-06	-6
	236-15008	200/210-08	-8
	236-15010	200/210-10	-10
	236-15012	200/210-12	-12
	236-15016	200/210-16	-16

236-180	150° FEMALE SWEEP TUBE		
	PART NO.	HOSE	NUT
	236-18006	200/210-06	-6
	236-18008	200/210-08	-8
	236-18010	200/210-10	-10
	236-18012	200/210-12	-12
	236-18016	200/210-16	-16

Section: **03**
200, 210 Series Braided Hose and Fittings

Material Key
B: Brass, C: Stainless Steel, CH: Chrome Plated, D: Aluminium,
EN: Electroless Nickel, P: Zinc Plated Carbon Steel, T: Titanium

GOODRIDGE
FLUID TRANSFER SYSTEMS

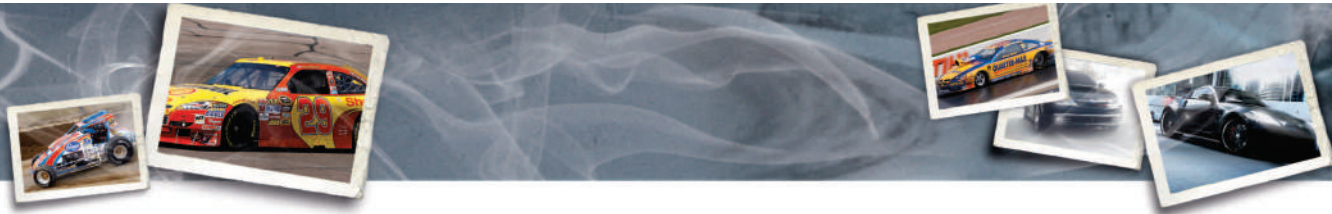



**STREET
PERFORMANCE
& RACING**

236BK Swivel Cutter Alloy Fittings
for : 200, 210 Series Hose

Fitting Type :
Cutter-style Re-usable
Application :
Fuel, Oil, Coolants, Methanol, Water
To Suit Hose :
200, 210
Material : D
Colour : D = Red and Blue,
BK = Black, E = Electroplate

The most comprehensive range of lightweight, re-usable alloy hose ends precisely engineered to fit our 200, 210 Series Hose. Our Aerospace standard Triple Seal/Double O-ring, cutter design ensures a secure, leak free connection every time. All 236, 336 and 1136 Series Hose Ends allow for all time alignment with their 360-degree swivel ends. The 336 Series has forged style bodies, offering that added measure of strength. They are available in bright anodized red and blue.

236-01BK	STRAIGHT FEMALE		
	PART NO.	HOSE	NUT
	236-0106BK	200/210-06	-6
	236-0108BK	200/210-08	-8
	236-0110BK	200/210-10	-10
	236-0112BK	200/210-12	-12
	236-0116BK	200/210-16	-16

236-45BK	30° FEMALE SWEPT TUBE		
	PART NO.	HOSE	NUT
	236-4506BK	200/210-06	-6
	236-4508BK	200/210-08	-8
	236-4510BK	200/210-10	-10
	236-4512BK	200/210-12	-12
	236-4516BK	200/210-16	-16

236-90BK	90° FEMALE SWEPT TUBE		
	PART NO.	HOSE	NUT
	236-9006BK	200/210-06	-6
	236-9008BK	200/210-08	-8
	236-9010BK	200/210-10	-10
	236-9012BK	200/210-12	-12
	236-9016BK	200/210-16	-16

236-120BK	120° FEMALE SWEPT TUBE		
	PART NO.	HOSE	NUT
	236-12006BK	200/210-06	-6
	236-12008BK	200/210-08	-8
	236-12010BK	200/210-10	-10
	236-12012BK	200/210-12	-12
	236-12016BK	200/210-16	-16

236-150BK	150° FEMALE SWEPT TUBE		
	PART NO.	HOSE	NUT
	236-15006BK	200/210-06	-6
	236-15008BK	200/210-08	-8
	236-15010BK	200/210-10	-10
	236-15012BK	200/210-12	-12
	236-15016BK	200/210-16	-16

236-180BK	150° FEMALE SWEPT TUBE		
	PART NO.	HOSE	NUT
	236-18006BK	200/210-06	-6
	236-18008BK	200/210-08	-8
	236-18010BK	200/210-10	-10
	236-18012BK	200/210-12	-12
	236-18016BK	200/210-16	-16

200 Series and 811 series Fuel Line Kits

Goodridge Fuel Line kits

These products are fully assembled and ready for installation. The kits are designed for maximum flow and ease of installation. The 200 series Fuel Line Kits are available in traditional red & blue and black anodized aluminum fittings with 200 series Nitrile rubber inner core and Stainless Steel integral and outer braid reinforcement.

The premium 811 series Fuel Line Kits use the patent pending "ferrule free" brightly anodized aluminum fittings that are available in black & silver with 811

series PTFE inner core with stainless steel outer braid reinforcement. The utilization of PTFE hose does not allow the hose to degrade or allow vapor permeation. This is especially useful when using alternative fuels that tend to permeate through rubber based products. When nothing but the best will do, lightweight, improve flow characteristics, and no permeation.

200 SERIES RED & BLUE	200 SERIES BLACK	811 SERIES BLACK & SILVER	DESCRIPTION
4000	4008BK		-06 FUEL KIT 9.25" CENTERS 7/8X20 THREAD- SINGLE INLET - FOR HOLLEY 800 & 850 CFM
4001	4018BK		-06 FUEL KIT 8.625" CENTERS 7/8X20 THREAD- SINGLE INLET - FOR HOLLEY 600 & 650 CFM
4002	4028BK		-06 FUEL KIT 9.25" CENTERS 7/8X20 THREAD- DUAL INLET - FOR HOLLEY 800 & 850 CFM
4003	4038BK		-06 FUEL KIT 8.625" CENTERS 7/8X20 THREAD- DUAL INLET - FOR HOLLEY 600 & 650 CFM
4004	4048BK	4040	*-06 FUEL KIT 9.50" CENTERS 7/8X20 THREAD- SINGLE INLET - FOR HOLLEY 4150/4150HP CARBURETORS*
4005	4058BK	4041	-06 FUEL KIT 12.00" CENTERS 7/8X20 THREAD- SINGLE INLET - FOR HOLLEY 4500 DOMINATORS® CARBURETORS
4006	4068BK	4042	-06 FUEL KIT 9.50" CENTERS 7/8X20 THREAD- DUAL INLET - FOR HOLLEY 4150/4150HP CARBURETORS
4007	4078BK	4043	-06 FUEL KIT 12.00" CENTERS 7/8X20 THREAD- DUAL INLET - FOR HOLLEY 4500 DOMINATORS® CARBURETORS
4010	4010BK		-08 FUEL KIT 9.25" CENTERS 7/8X20 THREAD- SINGLE INLET - FOR HOLLEY 600 & 650 CFM
4011	4011BK		-08 FUEL KIT 8.625" CENTERS 7/8X20 THREAD- SINGLE INLET - FOR HOLLEY 600 & 650 CFM*
4012	4012BK		-08 FUEL KIT 9.25" CENTERS 7/8X20 THREAD- DUAL INLET - FOR HOLLEY 800 & 850 CFM
4013	4013BK		-08 FUEL KIT 8.625" CENTERS 7/8X20 THREAD- DUAL INLET - FOR HOLLEY 600 & 650 CFM
4014	4014BK	4050	-08 FUEL KIT 9.50" CENTERS 7/8X20 THREAD- SINGLE INLET - FOR HOLLEY 4150/4150HP CARBURETORS
4015	4015BK	4051	-08 FUEL KIT 12.00" CENTERS 7/8X20 THREAD- SINGLE INLET - FOR HOLLEY 4500 DOMINATORS® CARBURETORS
4016	4016BK	4052	-08 FUEL KIT 9.50" CENTERS 7/8X20 THREAD- DUAL INLET - FOR HOLLEY 4150/4150HP CARBURETORS
4017	4017BK	4053	-08 FUEL KIT 12.00" CENTERS 7/8X20 THREAD- DUAL INLET - FOR HOLLEY 4500 DOMINATORS® CARBURETORS

910 Series Hose



811 Series Hose



200 Series Hose





Material Key
B: Brass, **C:** Stainless Steel, **CH:** Chrome Plated, **D:** Aluminium,
EN: Electroless Nickel, **P:** Zinc Plated Carbon Steel, **T:** Titanium



Hose Finisher for No-Thread Applications of: 200, 202, 210 & 536 Hoses

Application :
Fuel, Oil, Coolants, Water
Material / Construction :
Anodised aluminium with stainless steel gear drive clamp
***Anodised Aluminium Colour : DBU = Blue, DCH = Chrome, DR = Red**

When your hoses are not exposed to pressures or working environments that demand our race ready 1136, 236 or 336 Series Hose Ends our hose finishers are just what you need. These 936-Series Hose Finishers hide a 100% stainless steel Gear Drive Hose Clamp, giving the look of racing fittings at an affordable price.

936 BLUE HOSE FINISHER

PART NO.	200/210 HOSE	202 HOSE
936-04DBU	-4 & -5	-4
936-06DBU	-6 & -7	-5 & -6
936-08DBU	-8	
936-10DBU	-10	
936-12DBU	-12	
936-16DBU	-16	



936 RED HOSE FINISHER

PART NO.	200/210 HOSE	202 HOSE
936-04DR	-4 & -5	-4
936-06DR	-6 & -7	-5 & -6
936-08DR	-8	
936-10DR	-10	
936-12DR	-12	
936-16DR	-16	





936 SILVER HOSE FINISHER

PART NO.	200/210 HOSE	202 HOSE
936-04DCH	-4 & -5	-4
936-06DCH	-6 & -7	-5 & -6
936-08DCH	-8	
936-10DCH	-10	
936-12DCH	-12	
936-16DCH	-16	

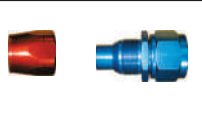

Assembly Instructions for 1136,236 & 336 Series Fittings & 200, 210 Series Hose

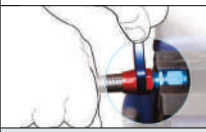
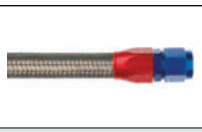
			
STEP 1 Bind masking tape tightly around the hose at the required length and cut through using a fine tooth saw blade or cut off wheel, leaving tape on both ends so that it retains the braid. Clean any debris from both the cut ends and inside the hose.	STEP 2 SOCKET (RED) MAIN FITTING BODY (BLUE) On a clean flat surface disassemble the fitting. This consists of two parts.	STEP 3 Hold the socket in a smooth jaw vice and feed one end of the hose into the socket by turning clockwise and pushing until the hose finishes just behind the socket threads.	STEP 4 Holding the main fitting body in the vice, lubricate the thread and push the hose and socket over the nipple end and start to thread the socket onto the fitting by hand.
			
STEP 5 Finish tightening the socket onto the fitting using a good quality wrench until the socket is one full turn from the back of the fitting hex.	STEP 6 PRESSURE TEST.		

04

536 Push Fit Hose and Fittings
185 Power Steering Hose and Fittings



Section: **04**
536 Push Fit Hose and Fittings / 185 Power Steering Hose and Fittings

Material Key
B: Brass, **C:** Stainless Steel, **CH:** Chrome Plated, **D:** Aluminium,
EN: Electroless Nickel, **P:** Zinc Plated Carbon Steel, **T:** Titanium

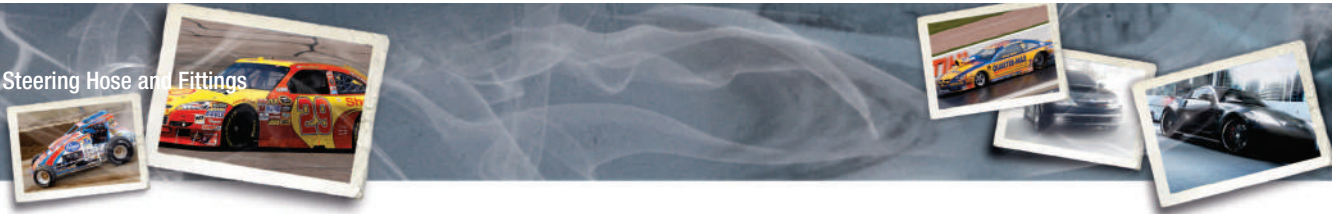

**STREET
 PERFORMANCE
 & RACING**

536 Hose

Application :

***Fuel, Oil, Coolants, Air, Water**
 Material / Construction :
Textile reinforced rubber with elastomer cover

Temperature Range :
-40°C (-40°F) to 100°C (212°F)

***Note:**
NOT suitable for all fuel types.
 Please contact Goodridge

Goodridge Push Fit 536 Series Hose is an exclusive product manufactured with a special reinforced internal textile braiding and blue elastomer cover. This high quality hose is designed for use in lower pressure applications with our new range of 536 Series Push Fit Hose Ends. When the superior performance of stainless braided Ni hose is not required, Push Fit is an excellent choice offering high quality, reliability, durability and affordability. (not recommended for suction systems)



PART NO	BORE SIZE		BRAID O/D		WORK PRES		BURST PRES		WEIGHT		MIN BEND RADIUS	
	MM	IN	MM	IN	PSI	BAR	PSI	BAR	KG/M	LB/FT	MM	IN
536-04	6.35	0.250	12.70	0.500	246.56	17	1000	69	0.10	0.070	76.20	3.00
536-06	9.52	0.375	15.87	0.620	246.56	17	1000	69	0.16	0.107	76.20	3.00
536-08	12.70	0.500	19.05	0.750	246.56	17	1000	69	0.22	0.148	127.00	5.00
536-10	15.87	0.625	23.00	0.900	246.56	17	1000	69	0.30	0.202	152.40	6.00
536-12	19.05	0.750	26.19	1.030	246.56	17	1000	69	0.36	0.242	177.80	7.00

PART NO	HOSE SERIES	LENGTH
2050	536-04 (BU)	BULK
2051	536-04 (BK)	BULK
2052	536-04 (BU)	3'
2053	536-04 (BU)	6'
2054	536-04 (BU)	10'
2055	536-04 (BU)	15'
2056	536-04 (BU)	20'
2057	536-06 (BU)	BULK
2058	536-06 (BK)	BULK
2059	536-06 (BU)	3'
2060	536-06 (BU)	6'
2061	536-06 (BU)	10'

PART NO	HOSE SERIES	LENGTH
2062	536-06 (BU)	15'
2063	536-06 (BU)	20'
2064	536-08 (BU)	BULK
2065	536-08 (BK)	BULK
2066	536-08 (BU)	3'
2067	536-08 (BU)	6'
2068	536-08 (BU)	10'
2069	536-08 (BU)	15'
2070	536-08 (BU)	20'
2071	536-10 (BU)	BULK
2072	536-10 (BK)	BULK
2073	536-10 (BU)	3'

PART NO	HOSE SERIES	LENGTH
2074	536-10 (BU)	6'
2075	536-10 (BU)	10'
2076	536-10 (BU)	15'
2077	536-10 (BU)	20'
2078	536-12 (BU)	BULK
2079	536-12 (BK)	BULK
2080	536-12 (BU)	3'
2081	536-12 (BU)	6'
2082	536-12 (BU)	10'
2083	536-12 (BU)	15'
2084	536-12 (BU)	20'

536B Hose

Application :

***Fuel, Oil, Coolants, Air, Water**
 Material / Construction :
Textile reinforced rubber with elastomer cover

Temperature Range :
-40°C (-40°F) to 100°C (212°F)

***Note:**
NOT suitable for all fuel types.
 Please contact Goodridge

Goodridge Push Fit 536 Series Hose is an exclusive product manufactured with a special reinforced internal textile braiding and black elastomer cover. This high quality hose is designed for use in lower pressure applications with our new range of 536 Series Push Fit Hose Ends. When the superior performance of stainless braided Ni hose is not required, Push Fit is an excellent choice offering high quality, reliability, durability and affordability. (not recommended for suction systems)



PART NO	BORE SIZE		BRAID O/D		WORK PRES		BURST PRES		WEIGHT		MIN BEND RADIUS	
	MM	IN	MM	IN	PSI	BAR	PSI	BAR	KG/M	LB/FT	MM	IN
536-04B	6.35	0.250	12.70	0.500	246.56	17	1000	69	0.10	0.070	76.20	3.00
536-06B	9.52	0.375	15.87	0.620	246.56	17	1000	69	0.16	0.107	76.20	3.00
536-08B	12.70	0.500	19.05	0.750	246.56	17	1000	69	0.22	0.148	127.00	5.00
536-10B	15.87	0.625	23.00	0.900	246.56	17	1000	69	0.30	0.202	152.40	6.00
536-12B	19.05	0.750	26.19	1.030	246.56	17	1000	69	0.36	0.242	177.80	7.00

Push Fit Aluminum Hose Fittings for: 536 Hose

Fitting Type :

Push Fit

Application :

Fuel, Oil, Water, Air, Coolants

To Suit Hose :

536

Material : **D**

Colour : **BU = Blue, BK = Black**

A complete range of 536 Series Push Fit Hose Ends have been designed and manufactured to match our 536 Series Hose. All 536 Series Push Fit Hose Ends are manufactured to the same high standards as our Red and Blue alloy hose ends. The Goodridge developed Sure Lock barbed end securely locks into the hose, giving a cost effective, safe and reliable connection. Once pushed on you will have to cut it off. Great for all low pressure applications and breathers.

536-01

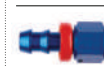

STRAIGHT FEMALE CONCAVE SEAT

PART NO.	HOSE	NUT
536-0104	536-04	-4
536-0106	536-06	-6
536-0108	536-08	-8
536-0110	536-10	-10
536-0112	536-12	-12

536-45



45° SWEPT TUBE FEMALE CONCAVE SEAT

PART NO.	HOSE	NUT
536-4504	536-04	-4
536-4506	536-06	-6
536-4508	536-08	-8
536-4510	536-10	-10
536-4512	536-12	-12

536-90



90° SWEPT TUBE FEMALE CONCAVE SEAT

PART NO.	HOSE	NUT
536-9004	536-04	-4
536-9006	536-06	-6
536-9008	536-08	-8
536-9010	536-10	-10
536-9012	536-12	-12

536-120



120° SWEPT TUBE FEMALE CONCAVE SEAT

PART NO.	HOSE	NUT
536-12004	536-04	-4
536-12006	536-06	-6
536-12008	536-08	-8
536-12010	536-10	-10
536-12012	536-12	-12

536-150



150° SWEPT TUBE FEMALE CONCAVE SEAT

PART NO.	HOSE	NUT
536-15004	536-04	-4
536-15006	536-06	-6
536-15008	536-08	-8
536-15010	536-10	-10
536-15012	536-12	-12

536-180



180° SWEPT TUBE FEMALE CONCAVE SEAT

PART NO.	HOSE	NUT
536-18004	536-04	-4
536-18006	536-06	-6
536-18008	536-08	-8
536-18010	536-10	-10
536-18012	536-12	-12

536-01E



STRAIGHT FEMALE CONCAVE SEAT

PART NO.	HOSE	NUT
536-0106E	536-06	-6

536-45E

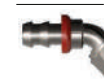

45° SWEPT TUBE FEMALE CONCAVE SEAT

PART NO.	HOSE	NUT
536-4506E	536-06	-6

536-90E



90° SWEPT TUBE FEMALE CONCAVE SEAT

PART NO.	HOSE	NUT
536-9006E	536-06	-6

Section: **04**
536 Push Fit Hose and Fittings / 185 Power Steering Hose and Fittings

Material Key
B: Brass, **C:** Stainless Steel, **CH:** Chrome Plated, **D:** Aluminium,
EN: Electroless Nickel, **P:** Zinc Plated Carbon Steel, **T:** Titanium

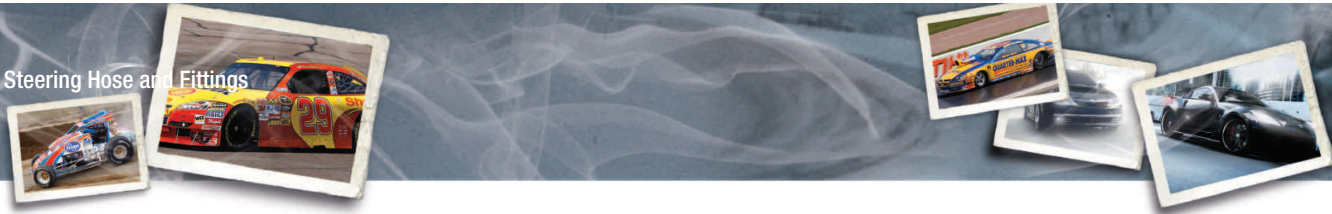

**STREET
 PERFORMANCE
 & RACING**

Push Fit Hose Aluminum Fittings DBK (Black)
for: 536 Hose

536-01DBK STRAIGHT FEMALE CONCAVE SEAT

PART NO.	HOSE	NUT
536-0104DBK	536-04	-4
536-0106DBK	536-06	-6
536-0108DBK	536-08	-8
536-0110DBK	536-10	-10
536-0112DBK	536-12	-12

536-90DBK 90° SWEEP TUBE FEMALE CONCAVE SEAT

PART NO.	HOSE	NUT
536-9004DBK	536-04	-4
536-9006DBK	536-06	-6
536-9008DBK	536-08	-8
536-9010DBK	536-10	-10
536-9012DBK	536-12	-12

536-150DBK 150° SWEEP TUBE FEMALE CONCAVE SEAT

PART NO.	HOSE	NUT
536-15004DBK	536-04	-4
536-15006DBK	536-06	-6
536-15008DBK	536-08	-8
536-15010DBK	536-10	-10
536-15012DBK	536-12	-12

536-45DBK 45° SWEEP TUBE FEMALE CONCAVE SEAT

PART NO.	HOSE	NUT
536-4504DBK	536-04	-4
536-4506DBK	536-06	-6
536-4508DBK	536-08	-8
536-4510DBK	536-10	-10
536-4512DBK	536-12	-12

536-120DBK 120° SWEEP TUBE FEMALE CONCAVE SEAT

PART NO.	HOSE	NUT
536-12004DBK	536-04	-4
536-12006DBK	536-06	-6
536-12008DBK	536-08	-8
536-12010DBK	536-10	-10
536-12012DBK	536-12	-12

536-180DBK 180° SWEEP TUBE FEMALE CONCAVE SEAT

PART NO.	HOSE	NUT
536-18004DBK	536-04	-4
536-18006DBK	536-06	-6
536-18008DBK	536-08	-8
536-18010DBK	536-10	-10
536-18012DBK	536-12	-12

Assembly Instructions for TF-TU25 & 536 Hose & Push Fit Fittings

STEP 1 Cut hose at the required length using a fine tooth saw blade or cut off wheel. Clean any loose debris from both the cut ends and inside the hose.	STEP 2 Hold the fitting in a bench vice, lubricate the fitting tail and inside the hose. (to make for easier fitting gently heat the hose with a hot air gun).	STEP 3 Push the hose over the fitting tail until it is tight behind the red hose finisher.	STEP 4 Please Note: Straight female fittings require the use of a male adaptor during hose assembly to stop the fitting tail turning.

185 Power Steering Hose

Application :
Power Steering
Material / Construction :
Synthetic rubber outer with an oil resisting seamless rubber compound inner reinforced with a one wire braid.
Temperature Range :
-40°C (-40°F) to 93°C (199°F)

Used primarily in racing and marine power steering applications our 185 Series Hose is an excellent choice for a cost effective system. Designed to be used with re-usable steel fittings, this hose is constructed with a synthetic rubber outer with an oil resisting seamless rubber compound inner reinforced with a one wire braid. It is compatible with oils and hydraulic fluids.



PART NO	BORE SIZE		BRAID O/D		WORK PRES		BURST PRES		WEIGHT		MIN BEND RADIUS	
	MM	IN	MM	IN	PSI	BAR	PSI	BAR	KG/M	LB/FT	MM	IN
185-06	10.00	3/8	19.8	0.78	2610	180	10440	720	0.342	0.253	130	5.11
185-10	16.00	5/8	26.2	1.03	1885	130	7540	520	0.580	0.39	200	7.87

Hose Fittings for: 185 Power Steering Hose

Fitting Type :
Push Fit
Application :
Power Steering
To Suit Hose :
185
Material : P

These fittings in JIC/UNF Female are engineered to operate with our 185 Series Hose for power steering applications. Manufactured of carbon steel, these re-usable type fittings are the perfect choice for a cost effective alternative to our 600HP Series.

185-01 STRAIGHT FEMALE

PART NO.	HOSE	NUT
185-0106	185-06	-6
185-0108	185-08	-8
185-0110	185-10	-10

185-45 45° TUBE FEMALE

PART NO.	HOSE	NUT
185-4506	185-06	-6
185-4508	185-08	-8
185-4510	185-10	-10

185-90 90° TUBE FEMALE

PART NO.	HOSE	NUT
185-9006	185-06	-6
185-9008	185-08	-8
185-9010	185-10	-10

185 POWER STEERING ADAPTOR

PART NO.	THREAD A	NUT B	DESCRIPTION
185001	1/2 X 20 INV	-06	PS ADAPTER
185002	5/8 X 18 INV	-06	GM/SAG PS BOX
185003	11/16 X 18 INV	-06	GM/SAG PS BOX
185004	M14 X 1.50	-06	O-RING STYLE
185005	M16 X 1.50	-06	GM/SAG PS BOX-O-RING
185006	M18 X 1.50	-06	GM/SAG PS BOX-O-RING

GOODRIDGE
FLUID TRANSFER SYSTEMS

PERFORMANCE BRAKELINES

G-STOP BRAKELINE KITS

G-STOP kits are Constructed from the finest quality hose, consisting of a PTFE inner and stainless steel overbraid.

- ELIMINATES SPONGINESS UNDER HEAVY BRAKING
- INCREASES BRAKING EFFICIENCY
- ABRASION AND CORROSION RESISTANT



05

600, 700 Series Smoothbore

**STREET
PERFORMANCE
& RACING**

Section: **05**
600, 700 Series Smoothbore

Material Key
B: Brass, C: Stainless Steel, CH: Chrome Plated, D: Aluminium,
EN: Electroless Nickel, P: Zinc Plated Carbon Steel, T: Titanium

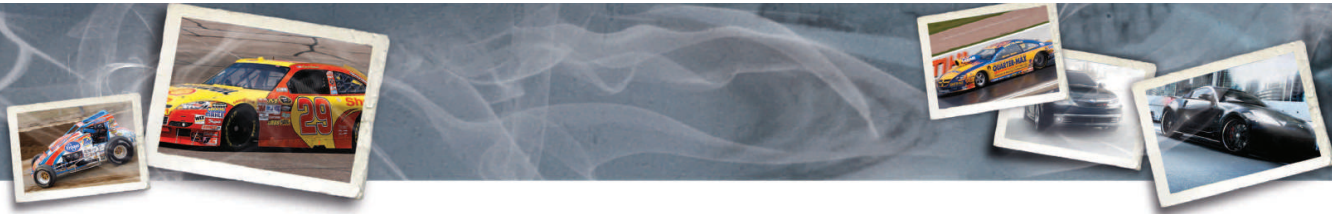

**STREET
PERFORMANCE
& RACING**

600 Series Hose -02 To -04
for: Brake and Clutch

Application :
Brake, clutch, hydraulics
Material / Construction :
Outer cover Corrosion and fire resistant Stainless steel braid, PTFE inner tube compatible with all brake and clutch fluids.
600-03 Hose is also available with abrasion resistant covers in a range of different colours for easy identification, ease of cleaning and cosmetic appearance.

High speed, constant rapid gear changes and heavy braking put great strains on competition hydraulic systems, where failure can be disastrous. 600 series hose strongly resists expansion under high pressure and temperature, provides consistent brake and clutch pedal pressure giving firmer and more efficient operation without that spongy feeling. Offering protection against abrasion and fire, these hoses are also recommended

for all pressure gauge lines and fire extinguisher systems. Use dash size 3 for most braking systems and dash size 3 or 4 for clutch systems. Dash 2 hose is the smallest brake hose available. Its micro-bore construction can give increased line pressure and more responsive and sensitive brake feel. Excellent for all 4 and 2 wheel braking applications whether for the circuit or road.



PART NO	BORE SIZE		PTFE WALL		BRAID O/D		COVER WALL		COVER O/D		WORKING PRES		BURST PRES		WEIGHT		TEMPERATURE		MIN BEND RAD	
	MM	INCH	MM	INCH	MM	INCH	MM	INCH	MM	INCH	BAR	PSI	BAR	PSI	KG/M	LB/FT	MIN	MAX	MM	INCH
600-02	2.0	0.079	1.0	0.039	5.0	0.197	-	-	-	-	450	6526	1350	19580	0.045	0.03	-70°C (-94°F)	260°C (500°F)	13	0.511
600-03	3.5	0.138	1.0	0.039	6.45	0.254	-	-	-	-	290	4206	870	12618	0.060	0.04	-70°C (-94°F)	260°C (500°F)	38	1.496
600-03BK	3.5	0.138	1.0	0.039	6.45	0.254	0.5	0.019	7.5	0.295	290	4206	870	12618	0.088	0.06	-20°C (-4°F)	85°C (185°F)	38	1.496
600-03SB	3.5	0.138	1.0	0.039	6.45	0.254	0.5	0.019	7.5	0.295	290	4206	870	12618	0.088	0.06	-20°C (-4°F)	85°C (185°F)	38	1.496
600-03CB	3.5	0.138	1.0	0.039	6.45	0.254	0.5	0.019	7.5	0.295	290	4206	870	12618	0.088	0.06	-20°C (-4°F)	85°C (185°F)	38	1.496
600-03CL	3.5	0.138	1.0	0.039	6.45	0.254	0.5	0.019	7.5	0.295	290	4206	870	12618	0.088	0.06	-20°C (-4°F)	85°C (185°F)	38	1.496
600-03CLG	3.5	0.138	1.0	0.039	6.45	0.254	0.5	0.019	7.5	0.295	290	4206	870	12618	0.088	0.06	-20°C (-4°F)	85°C (185°F)	38	1.496
600-03EB	3.5	0.138	1.0	0.039	6.45	0.254	0.5	0.019	7.5	0.295	290	4206	870	12618	0.088	0.06	-20°C (-4°F)	85°C (185°F)	38	1.496
600-03GN	3.5	0.138	1.0	0.039	6.45	0.254	0.5	0.019	7.5	0.295	290	4206	870	12618	0.088	0.06	-20°C (-4°F)	85°C (185°F)	38	1.496
600-03OR	3.5	0.138	1.0	0.039	6.45	0.254	0.5	0.019	7.5	0.295	290	4206	870	12618	0.088	0.06	-20°C (-4°F)	85°C (185°F)	38	1.496
600-03RD	3.5	0.138	1.0	0.039	6.45	0.254	0.5	0.019	7.5	0.295	290	4206	870	12618	0.088	0.06	-20°C (-4°F)	85°C (185°F)	38	1.496
600-03YE	3.5	0.138	1.0	0.039	6.45	0.254	0.5	0.019	7.5	0.295	290	4206	870	12618	0.088	0.06	-20°C (-4°F)	85°C (185°F)	38	1.496
600-04	5.0	0.197	0.76	0.030	7.65	0.301	-	-	-	-	280	4061	840	12183	0.075	0.05	-70°C (-94°F)	260°C (500°F)	50	1.968

600 Series Hose -02 To -04
Packaged Parts

PART NO	HOSE SERIES	LENGTH
3000	600-02	BULK
3001	600-03	BULK
3002	600-03	3'
3003	600-03	6'
3004	600-03	10'
3005	600-03	15'
3006	600-03	20'
3010	600-04	BULK
3011	600-04	3'

PART NO	HOSE SERIES	LENGTH
3012	600-04	6'
3013	600-04	10'
3014	600-04	15'
3015	600-04	20'
3016	600-05	BULK
3020	600-06	BULK
3021	600-06	3'
3022	600-06	6'
3023	600-06	10'

PART NO	HOSE SERIES	LENGTH
3024	600-06	15'
3025	600-06	20'
3030	600-08	BULK
3031	600-08	3'
3032	600-08	6'
3033	600-08	10'
3034	600-08	15'
3035	600-08	20'

JIC/UNF Re-usable Hose Fittings
for: 600 Hose

Fitting Type :
Re-usable
Application :
Brake / Clutch
To Suit Hose :
600 series

Material : P, CH, C, T, D

P = Zinc Plated Carbon Steel
CH = Chrome Plated
C = Stainless Steel
T = Titanium
D = Anodised Aluminium

6690	90° DOUBLE SWIVEL CONCAVE SEAT		
	PART NO.	MATERIAL	HOSE/NUT
6690-02	C	-2/-2	
6690-02-03	C	-2/-3	
6690-03	P, C	-3/-3	
6690-04*	C, D	-4/-4	
6690-31	C	-03/M10 X 1.00	

6046	45° SWEPT TUBE FEMALE CONCAVE SEAT		
	PART NO.	MATERIAL	HOSE/NUT
6046-03*	C, CH, D, P	-3/-3	
6046-04*	P, C, D	-4/-4	

6001	STRAIGHT FEMALE CONCAVE SEAT		
	PART NO.	MATERIAL	HOSE/NUT
6001-02	C, T	-2/-2	
6001-02-03	C, T	-2/-3	
6001-03*	C, CH, D, P	-3/-3	
6001-03-04	C	-3/-4	
6001-04*	P, C, D	-4/-4	

6091	90° SWEPT TUBE FEMALE CONCAVE SEAT		
	PART NO.	MATERIAL	HOSE/NUT
6091-03*	C, CH, D, P	-3/-3	
6091-04*	C, CH, D, P	-4/-4	

6045	45° FORGED FEMALE CONCAVE SEAT		
	PART NO.	MATERIAL	HOSE/NUT
6045-02	C, T	-2/-2	
6045-02-03	C	-2/-3	
6045-03*	P, C, D	-3/-3	
6045-04	D	-4/-4	

6120	120° SWEPT TUBE FEMALE		
	PART NO.	MATERIAL	HOSE/NUT
6120-06	D	-6/-6	
6120-08	D	-8/-8	

6090	90° FORGED FEMALE CONCAVE SEAT		
	PART NO.	MATERIAL	HOSE/NUT
6090-02	C, T	-2/-2	
6090-02-03	C	-2/-3	
6090-03*	P, C, D,	-3/-3	
6090-04	D	-4/-4	

6150	150° SWEPT TUBE FEMALE		
	PART NO.	MATERIAL	HOSE/NUT
6150-06	D	-6/-6	
6150-08	D	-8/-8	

6645	45° DOUBLE SWIVEL CONCAVE SEAT		
	PART NO.	MATERIAL	JIC/UNF THREAD
6645-02	C	-2/-2	
6645-02-03	C	-2/-3	
6645-03	P, C	-3/-3	
6645-04	C	-4/-4	

6180	180° SWEPT TUBE FEMALE		
	PART NO.	MATERIAL	HOSE/NUT
6180-06	D	-6/-6	
6180-08	D	-8/-8	

Section: **05**
600, 700 Series Smoothbore

Material Key
B: Brass, C: Stainless Steel, CH: Chrome Plated, D: Aluminium,
EN: Electroless Nickel, P: Zinc Plated Carbon Steel, T: Titanium

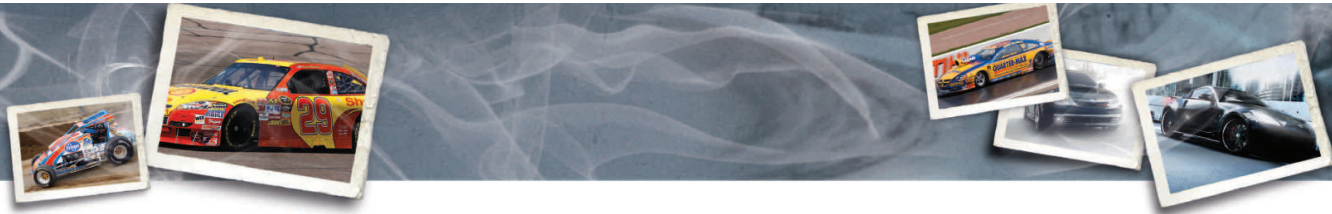

STREET PERFORMANCE & RACING

Re-usable Banjo Hose Fittings
for: **600 Hose**

Fitting Type :
Re-usable
Application :
Brake / Clutch
To Suit Hose :
600 series

Material : P, CH, C, T, D

P = Zinc Plated Carbon Steel
CH = Chrome Plated
C = Stainless Steel
T = Titanium
D = Anodised Aluminium

5091 BANJO

PART NO.	TO SUIT BOLT	MATERIAL	HOSE SIZE
5091-02-03	3/8, 10MM	C, T	-2
5091-03	3/8, 10MM	C, CH, P, D	-3
5091-03-04	7/16	P, CH, C	-3
5091-04-03	3/8, 10MM	P	-4
5091-04	7/16	D	-4

5092 BANJO STRAIGHT EXTENDED NECK

PART NO.	TO SUIT BOLT	MATERIAL	HOSE SIZE
5092-02	5/16, 8MM	C, T	-2
5092-02-03	3/8, 10MM	C, T	-2
5092-03-02	5/16, 8MM	C, CH, D, P	-3
*5092-03	3/8, 10MM	C, CH, D, P	-3
5092-03DSW	3/8, 10MM	D (SWIVEL)	-3
5092-03-04	7/16	CH, C, P	-3
5092-03-M12	12MM	C, CH	-3

5093 20° BANJO EXTENDED NECK

PART NO.	TO SUIT BOLT	MATERIAL	HOSE SIZE
5093-02	5/16, 8MM	C, T	-2
5093-02-03	3/8, 10MM	C, T	-2
*5093-03	3/8, 10MM	C, CH, D, P	-3
5093-03-04	7/16	CH, C, P	-3
5093-03DSW	3/8, 10MM	D (SWIVEL)	-3
5093-03-M12	12MM	C, CH	-3

5094 45° BANJO EXTENDED NECK

PART NO.	TO SUIT BOLT	MATERIAL	HOSE SIZE
5094-02-03	3/8, 10MM	C	-2
*5094-03	3/8, 10MM	C, CH, D, P	-3

5095 STRAIGHT TWIN BANJO

PART NO.	TO SUIT BOLT	MATERIAL	HOSE SIZE
5095-03-04	7/16	P	-3
5095-03	3/8, 10MM	C, P	-3

5096 BANJO SIDE 20° EXTENDED NECK

PART NO.	TO SUIT BOLT	MATERIAL	HOSE SIZE
5096-02-03	3/8, 10MM	C	-2
5096-03	3/8, 10MM	C	-3

5097 BANJO SIDE 20° EXTENDED NECK

PART NO.	TO SUIT BOLT	MATERIAL	HOSE SIZE
5097-02	5/16, 8MM	C	-2
*5097-03	3/8, 10MM	C, CH, D, P	-3

5098 BANJO TWIN EXTENDED NECK

PART NO.	TO SUIT BOLT	MATERIAL	HOSE SIZE
5098-03	3/8, 10MM	C, CH, D, P	-3

5070 BANJO 70° EXTENDED NECK

PART NO.	TO SUIT BOLT	MATERIAL	HOSE SIZE
5070-03	3/8, 10MM	C, CH, P	-3

5099 BANJO 90° EXTENDED NECK

PART NO.	TO SUIT BOLT	MATERIAL	HOSE SIZE
*5099-03	3/8, 10MM	C, CH, D, P	-3
5099-03-04	7/16	CH	-3

5099S BANJO SIDE 90° EXTENDED NECK

PART NO.	TO SUIT BOLT	MATERIAL	HOSE SIZE
5099S-03	3/8, 10MM	P, C	-3

700 Series Aramid Fibre Hose (crimp only)

Application :
Brake, clutch, hydraulics
Material / Construction :
Light weight, flexible and extremely strong woven Aramid Fibre outer braid, PTFE inner tube compatible with all brake and clutch fluids.
Colour : BK BU RD
BK = Black, BU = Blue, RD = Red
Please Note :
700 series for competition use only



700 Series Hose is used for lightweight brake and wing line assemblies. This hose can be used with various ends ranging from aluminum through stainless, but these assemblies must be crimped by Goodridge or an approved Goodridge Technical Center.

Please contact Goodridge for additional information of these products. Goodridge Technical centers can build lines to your exact specifications and are located in several regions for fast service.

PART NO	BORE SIZE		PTFE WALL		BRAID O/D		COVER WALL		COVER O/D		WORKING PRES		BURST PRES		WEIGHT KG/M LB/FT	TEMPERATURE		MM INCH		
	MM	INCH	MM	INCH	MM	INCH	MM	INCH	MM	INCH	BAR	PSI	BAR	PSI		MIN	MAX	MM	INCH	
700K-03	3.5	0.138	1.0	0.039	6.7	0.264	-	-	-	-	200	2900	600	8702	0.044	0.03	-45°C (-49°F)	170°C (338°F)	38	1.496
700K-03BK	3.5	0.138	1.0	0.039	8.1	0.320	0.5	0.019	7.7	0.303	200	2900	600	8702	0.059	0.04	-20°C (-4°F)	85°C (185°F)	38	1.496
700K-03BU	3.5	0.138	1.0	0.039	8.1	0.320	0.5	0.019	7.7	0.303	200	2900	600	8702	0.059	0.04	-20°C (-4°F)	85°C (185°F)	38	1.496
700K-03RD	3.5	0.138	1.0	0.039	8.1	0.320	0.5	0.019	7.7	0.303	200	2900	600	8702	0.059	0.04	-20°C (-4°F)	85°C (185°F)	38	1.496
700K-04BK	5.0	0.197	0.76	0.030	9.2	0.363	0.9	0.035	9.6	0.378	150	2175	450	6526	0.074	0.05	-20°C (-4°F)	85°C (185°F)	50	1.968

Assembly Instructions for Re-usable 600 Series (PTFE Smooth Bore) Hose & Fittings

STEP 1 Using a fine tooth saw blade or cut off wheel, cut hose to the required length. Clean any loose debris from both the cut ends and inside the hose	STEP 2 Main fitting body - Olive - Socket On a clean flat surface disassemble the fitting, this consists of 3 parts, the Main fitting body, Olive and Socket.	STEP 3 Push two sockets back to back over the overbraid working from the non flared end	STEP 4 Using an appropriate sized Goodridge mandrel, flare out both ends of the stainless steel overbraid from the PTFE inner tube
STEP 5 Push an olive onto each end of the PTFE inner tube under the stainless steel over braid by hand and finish off by pushing against a flat solid surface making sure the PTFE tube is fully home in the olive.	STEP 6 Holding the main fitting body in a smooth jaw vice, lubricate the thread and push the hose over the nipple end and start to thread the socket onto the fitting by hand.	STEP 7 Finish tightening the socket onto the fitting with a good quality spanner until the socket is one full turn from the main fitting hex. PRESSURE TEST.	UNDER NO CIRCUMSTANCES SHOULD THE SOCKET BE LOOSENED IN AN ATTEMPT TO ADJUST THE ALIGNMENT AFTER ASSEMBLY



Section: **05**
600, 700 Series Smoothbore

Material Key
B: Brass, C: Stainless Steel, CH: Chrome Plated, D: Aluminium,
EN: Electroless Nickel, P: Zinc Plated Carbon Steel, T: Titanium



Hose Assemblies -3

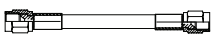

-03 AN FEMALE TO -03 FEMALE TUBE		
DOT P/N	RACING P/N	LENGTH
93110	3110	10"
93112	3112	12"
93114	3114	14"
93115	3115	15"
93116	3116	16"
93117	3117	17"
93118	3118	18"
93119	3119	19"
93120	3120	20"
93122	3122	22"
93124	3124	24"
93128	3128	28"
93132	3132	32"
93136	3136	36"
93140	3140	40"
93144	3144	44"
93148	3148	48"



-03 AN FEMALE TO -03 45° FEMALE TUBE		
DOT P/N	RACING P/N	LENGTH
93410	3410	10"
93412	3412	12"
93414	3414	14"
93415	3415	15"
93416	3416	16"
93417	3417	17"
93418	3418	18"
93419	3419	19"
93420	3420	20"
93422	3422	22"
93424	3424	24"
93428	3428	28"
93432	3432	32"
93436	3436	36"
93440	3440	40"
93444	3444	44"
93448	3448	48"

Hose Assemblies -4 and Metric Assemblies

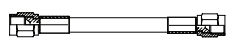

-04 FEMALE TO -04 FEMALE	
RACING P/N	LENGTH
4110	10"
4112	12"
4114	14"
4115	15"
4116	16"
4117	17"
4118	18"
4119	19"
4120	20"
4122	22"
4124	24"
4128	28"
4132	32"
4136	36"
4140	40"
4144	44"
4148	48"



-04 FEMALE TO -04 45° TUBE	
RACING P/N	LENGTH
4410	10"
4412	12"
4414	14"
4415	15"
4416	16"
4417	17"
4418	18"
4419	19"
4420	20"
4422	22"
4424	24"
4428	28"
4432	32"
4436	36"
4440	40"
4444	44"
4448	48"

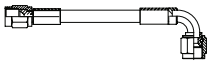

-03 FEMALE TO -03 90° FEMALE TUBE		
DOT P/N	RACING P/N	LENGTH
93910	3910	10"
93912	3912	12"
93914	3914	14"
93915	3915	15"
93916	3916	16"
93917	3917	17"
93918	3918	18"
93919	3919	19"
93920	3920	20"
93922	3922	22"
93924	3924	24"
93928	3928	28"
93932	3932	32"
93936	3936	36"
93940	3940	40"
93944	3944	44"
93948	3948	48"

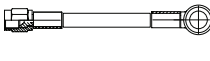

-03 AN FEMALE TO 10MM / 3/8 NO NECK BANJO		
DOT P/N	RACING P/N	LENGTH
93212	3212	12"
93218	3218	18"
93220	3220	20"
93224	3224	24"
93236	3236	36"

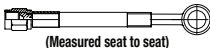

(Measured seat to seat)

-03AN FEMALE TO 10MM / 3/8 EXT. NECK BANJO		
DOT P/N	RACING P/N	LENGTH
93312	3312	12"
93318	3318	18"
93320	3320	20"
93324	3324	24"
93336	3336	36"

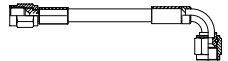

-04 FEMALE TO -04 90° TUBE	
RACING P/N	LENGTH
4910	10"
4912	12"
4914	14"
4915	15"
4916	16"
4917	17"
4918	18"
4919	19"
4920	20"
4922	22"
4924	24"
4928	28"
4936	36"
4940	40"
4944	44"
4948	48"

10MM X 1.0 CONCAVE FEMALE TO 10MM X 1.0 CONCAVE FEMALE		
DOT P/N	RACING P/N	LENGTH
93812	3812	12"
93818	3818	18"
93820	3820	20"
93824	3824	24"
93836	3836	36"

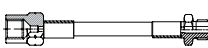

10MM X 1.0 CONCAVE FEMALE TO 10MM X 1.0 CONCAVE MALE		
DOT P/N	RACING P/N	LENGTH
93712	3712	12"
93718	3718	18"
93720	3720	20"
93724	3724	24"
93736	3736	36"

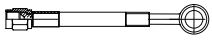

-03 AN FEMALE TO 12MM / 7/16 EXT NECK BANJO		
DOT P/N	RACING P/N	LENGTH
93512	3512	12"
93518	3518	18"
93520	3520	20"
93524	3524	24"
93536	3536	36"

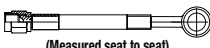

(Measured seat to seat)

-03 AN FEMALE TO 7/16 / 12MM EXT. NECK BANJO		
DOT P/N	RACING P/N	LENGTH
93612	3612	12"
93618	3618	18"
93620	3620	20"
93624	3624	24"
93636	3636	36"

Note: If you do not find an assembly to meet your needs, we will custom make an assembly to any length and with any fitting configuration. Please call your Goodridge Sales Rep for assistance.

06

Adaptors



Section: 06 Adaptors

Material Key

B: Brass, **C:** Stainless Steel, **CH:** Chrome Plated, **D:** Aluminum,
EN: Electroless Nickel, **P:** Zinc Plated Carbon Steel, **T:** Titanium

GOODRIDGE
FLUID TRANSFER SYSTEMS

**STREET
PERFORMANCE
& RACING**

AN's and Adaptors

Our international position allows us to offer the worlds widest and most diverse range of AN's and adaptors at economic prices. Whether it is a true AN or a metric adaptor, Goodridge provides the natural link from one thread to another. All Goodridge adaptors are manufactured to

the highest possible specifications, metric adaptors meet the ISO specification, other adaptors are manufactured to the correct AN specification where such a specification exists. No company carries more thread applications. Our international customers require it.

JIC To JIC Equal Thread

Fitting Type :

Adaptor

Material : P, CH, C, D, DE

AN

REFERENCE CHART

-AN SIZE	JIC/UNF THREAD	-AN SIZE	JIC/UNF THREAD
2	5/16 X 24	8	3/4 X 16
3	3/8 X 24	10	7/8 X 14
4	7/16 X 20	12	1 1/16 X 12
5	1/2 X 20	16	1 5/16 X 12
6	9/16 X 18	20	1 5/8 X 12
7	5/8 X 18	24	1 7/8 X 12

AN804

BULKHEAD TEE ON RUN

PART NO.	MATERIAL	THREAD
AN804-03	D, C, P	-3
AN804-04-03-04	D	-4
AN804-04	D, C, P	-4
AN804-06	D, C, P	-6
AN804-08	D	-8
AN804-10	D	-10
AN804-12	D	-12
AN804-16	D	-16

AN806

PLUG

PART NO.	MATERIAL	THREAD
AN806-02	D	-2
AN806-03	D, DR, C, P	-3
AN806-04	D, DBK, DRD, C, P	-4
AN806-05	D, P	-5
AN806-06	D, DBK, DRD, C, P	-6
AN806-07	D	-7
AN806-08	D, DBK, P	-8
AN806-10	D, DBK, P	-10
AN806-12	D, DBK, C, P	-12
AN806-16	D, DBK, P	-16
AN806-20	D	-20

AN814S

PORT PLUG WITH SOCKET HEX (O RING)

PART NO.	MATERIAL	THREAD
AN814-03S	D	-3
AN814-04S	D	-4
AN814-06S	D, DBK	-6
AN814-08S	D, DBK	-8
AN814-10S	D	-10
AN814-12S	D	-12

AN814

PORT PLUG

PART NO.	MATERIAL	THREAD
AN814-02	D	-2
AN814-03	D	-3
AN814-04	D, DBK	-4
AN814-05	D	-5
AN814-06	D, DBK, DE, C, P	-6
AN814-07	D	-7
AN814-08	D, DBK, DE	-8
AN814-10	D, DBK, P	-10
AN814-12	D, DBK, P	-12
AN814-16	D	-16
AN814-20	D	-20
AN814-24	D	-24

AN815

EQUAL MALE

PART NO.	MATERIAL	THREAD
AN815-02	D, C, P, LP	-2
AN815-02	LP	-2 (LONG)
AN815-02	VC	-2 (INV)
AN815-03	D, DBK, C, CH, P	-3
AN815-03	VC, VCH	-3 (INV)
AN815-04	D, DBK, C, P	-4
AN815-05	D	-5
AN815-06	D, DBK, C, P	-6
AN815-07	D, P	-7
AN815-08	D, DBK, C, P	-8
AN815-10	D, DBK, C, P	-10
AN815-12	D, DBK, C, P	-12
AN815-16	D, DBK, C, P	-16
AN815-20	D	-20
AN815-24	D	-24
AN815-28	D	-28
AN815-32	D	-32

AN818

TUBE NUT

PART NO.	MATERIAL	THREAD
AN818-03	P, CH, C, D, DBK, DE, DRD	-3
AN818-04	P, C, CH, D, DBK, DE, DRD	-4
AN818-06	P, C, CH, D, DBK, DE	-6
AN818-08	C, D, DBK, DE, P	-8
AN818-10	C, DE, D, P, DBK	-10
AN818-12	C, D, DBK, DE, P	-12
AN818-16	P, C, D	-16
AN818-20	D	-20

JIC To JIC Equal Thread - continued

AN819

TUBE SLEEVE

PART NO.	MATERIAL	THREAD
AN819-03	P, CH, C, D, DBK, DE, DRD	-3
AN819-04	P, CH, C, D, DBK, DE, DRD	-4
AN819-06	P, CH, C, D, DBK, DE	-6
AN819-08	P, C, D, DBK, DE	-8
AN819-10	P, C, D, DBK, DE	-10
AN819-12	P, C, D	-12
AN819-16	P, C, D	-16
AN819-20	C, D	-20
AN819-24	C, D	-24

AN821

90° ELBOW MALE

PART NO.	MATERIAL	THREAD
AN821-03	P, C, D, DBK, DE	-3
AN821-04	P, C, D, DBK	-4
AN821-06	P, C, D, DBK, DE	-6
AN821-08	P, C, D, DBK, DE	-8
AN821-10	P, C, D, DBK, DE	-10
AN821-12	P, C, D, DBK, DE	-12
AN821-16	P, C, D	-16
AN821-20	D	-20

AN824

MALE TEE

PART NO.	MATERIAL	JIC/UNF THREAD
AN824-03	P, C, D, DBK, CH, DE	-3
AN824-04	P, C, D, DBK, DE	-4
AN824-06	P, C, D, DBK, DE	-6
AN824-08	P, C, D, DBK, DE	-8
AN824-10	P, C, D, DBK, DE	-10
AN824-12	P, C, D, DBK, DE	-12
AN824-16	P, D	-16

AN827

MALE TEE

PART NO.	MATERIAL	THREAD
AN827-04	D	-4
AN827-06	D	-6
AN827-08	D	-8
AN827-10	D	-10

AN REFERENCE CHART

-AN SIZE	JIC/UNF THREAD	-AN SIZE	JIC/UNF THREAD
2	5/16 X 24	8	3/4 X 16
3	3/8 X 24	10	7/8 X 14
4	7/16 X 20	12	1 1/16 X 12
5	1/2 X 20	16	1 5/16 X 12
6	9/16 X 18	20	1 5/8 X 12
7	5/8 X 18	24	1 7/8 X 12

AN832

MALE BULKHEAD

PART NO.	MATERIAL	JIC/UNF THREAD
AN832-03	P, C, D, DBK, DE	-3
AN832-04	P, C, D, DBK, DE	-4
AN832-06	P, C, D, DBK, DE	-6
AN832-08	P, C, D, DBK, DE	-8
AN832-10	P, C, D, DBK, DE	-10
AN832-12	P, C, D, DBK, DE	-12
AN832-16	P, C, D, DE	-16
AN832-20	D	-20

AN833

90° MALE BULKHEAD

PART NO.	MATERIAL	THREAD
AN833-03	P, C, D, DBK, DE	-3
AN833-04	P, C, D, DBK, DE	-4
AN833-06	P, C, D, DBK, DE	-6
AN833-08	P, C, D, DBK, DE	-8
AN833-10	P, C, D, DBK, DE	-10
AN833-12	P, C, D, DBK, DE	-12
AN833-16	D	-16
AN833-20	D	-20

AN834

MALE BULKHEAD TEE

PART NO.	MATERIAL	THREAD
AN834-03	P, C, D, DBK	-3
AN834-04	P, C, D, DBK	-4
AN834-06	P, C, D, DBK	-6
AN834-08	P, C, D, DBK	-8
AN834-10	P, D	-10
AN834-12	P, D	-12
AN834-16	D	-16

AN837

45° MALE BULKHEAD

PART NO.	MATERIAL	THREAD
AN837-03	P, C, D	-3
AN837-04	P, D	-4
AN837-05	D	-5
AN837-06	P, C, D	-6
AN837-08	P, C, D	-8
AN837-10	P, C, D	-10
AN837-12	P, D	-12
AN837-16	D	-16

Section: **06**
Adaptors

Material Key
B: Brass, **C:** Stainless Steel, **CH:** Chrome Plated, **D:** Aluminium,
EN: Electroless Nickel, **P:** Zinc Plated Carbon Steel, **T:** Titanium

GOODRIDGE
 FLUID TRANSFER SYSTEMS

**STREET
 PERFORMANCE
 & RACING**

JIC To JIC Equal Thread - *continued*



AN938 FEMALE TEE

PART NO.	MATERIAL	THREAD
AN938-04	D, DBK	-4
AN938-05	P, D, DBK	-5
AN938-06	P, D, DBK	-6
AN938-08	P, D, DBK	-8
AN938-10	P, D, DBK	-10
AN938-12	P, D, DBK	-12
AN938-16	D	-16

AN971 MALE WELD FLANGE ADAPTOR

PART NO.	MATERIAL	THREAD
AN971-04	D	-4
AN971-06	D	-6
AN971-07	D	-7
AN971-08	D	-8
AN971-10	D	-10
AN971-12	D	-12
AN971-16	D	-16
AN971-20	D	-20

AN924 NUT

PART NO.	MATERIAL	THREAD
AN924-02	D, C, P	-2
AN924-03	P, C, D, DE	-3
AN924-04	P, C, D, DBK, DE	-4
AN924-05	D	-5
AN924-06	P, C, D, DBK, DE	-6
AN924-08	P, C, D, DBK, DE	-8
AN924-10	P, C, D, DBK, DE	-10
AN924-12	C, P, D, DBK, DE	-12
AN924-16	C, P, D, DBK	-16
AN924-20	D	-20

AN929 CAP

PART NO.	MATERIAL	THREAD
AN929-02	D, DRD	-2
AN929-03	P, C, D, DRD	-3
AN929-04	P, C, D, DBK, DRD	-4
AN929-05	P, C, D, DBK, DRD	-5
AN929-06	P, C, D, DBK, DRD	-6
AN929-08	P, C, D, DBK, DRD	-8
AN929-10	P, C, D, DBK	-10
AN929-12	P, D, DBK	-12
AN929-16	P, D, DBK	-16
AN929-20	D	-20

JIC To JIC Unequal Thread

Fitting Type :
 Adaptor
 Material : P, C, CH, D

AN824 TEE WITH UNEQUAL LEG

PART NO.	MATERIAL	JIC/UNF THREAD		
		A	B	C
AN824-06-06-03	D	-6	-6	-3
AN824-06-06-08	D	-6	-6	-8
AN824-08-04-08	D	-8	-4	-8
AN824-08-08-04	D	-8	-8	-4
AN824-08-08-10	D	-8	-8	-10
AN824-10-10-12	D	-10	-10	-12

AN919 MALE TO MALE

PART NO.	MAT	A	B
AN919-0	D, C	-02	-03
AN919-01	D	-02	-04
AN919-02	D, DBK	-03	-04
AN919-03	D	-04	-05
AN919-06-02	D	-06	-02
AN919-06	D	-06	-04
AN919-07	D	-06	-05
AN919-10	D	-08	-04
AN919-12	D, DBK	-06	-08
AN919-13	D	-10	-04

PART NO.	MAT	A	B
AN919-14	D	-10	-06
AN919-15	D, DBK	-10	-08
AN919-18	D	-12	-06
AN919-19	D	-12	-08
AN919-20	D, DBK	-12	-10
AN919-22	D	-16	-10
AN919-23	D, DBK	-16	-12
AN919-25	D	-20	-12
AN919-26	D	-20	-16

JIC To JIC Unequal Thread - *continued*



919 MALE TO MALE

PART NO.	MATERIAL	A	B	PART NO.	MATERIAL	A	B
919-04-03	P, C	-4	-3	919-10-08	P	-10	-8
919-06-03	P	-6	-3	919-12-10	P	-12	-10
919-06-04	P	-6	-4	919-16-10	P	-16	-10
919-08-06	P	-8	-6	919-16-12	P	-16	-12
919-10-06	P	-10	-6				

JIC Male To Female

AN894 MALE REDUCER FEMALE SEALS ON O-RING

PART NO.	MATERIAL	A	B	PART NO.	MATERIAL	A	B
AN894-04-03	D	-4	-3	AN894-10-08	D	-10	-8
AN894-05-04	D	-5	-4	AN894-10-08	D, DBK	-10	-8
AN894-06-03	D	-6	-3	AN894-12-06	D	-12	-6
AN894-06-04	D	-6	-4	AN894-12-08	D	-12	-8
AN894-06-04	D, DBK	-6	-4	AN894-12-10	D	-12	-10
AN894-08-04	D	-8	-4	AN894-16-08	D	-16	-8
AN894-08-06	D	-8	-6	AN894-16-10	D	-16	-10
AN894-08-06	D, DBK	-8	-6	AN894-16-12	D	-16	-12
AN894-10-06	D	-10	-6	AN894-20-16	D	-20	-16
AN894-10-06	D, DBK	-10	-6				

AN950 MALE TO FEMALE ADAPTOR (JIC SEATS)

PART NO.	MAT	A	B	PART NO.	MAT	A	B	PART NO.	MAT	A	B
AN950-04-03	D	-4	-3	AN950-08-04	D, DBK	-8	-4	AN950-12-08	P	-12	-8
AN950-04-03	P	-4	-3	AN950-08-04	P	-8	-4	AN950-12-10	D	-12	-10
AN950-06-03	D	-6	-3	AN950-08-06	D	-8	-6	AN950-12-10	D, DBK	-12	-10
AN950-06-04	D	-6	-4	AN950-08-06	D, DBK	-8	-6	AN950-16-10	D	-16	-10
AN950-06-04	D, DBK	-6	-4	AN950-10-06	D	-10	-6	AN950-16-12	D	-16	-12
AN950-06-04	P	-6	-4	AN950-10-08	D	-10	-8	AN950-16-12	D, DBK	-16	-12
AN950-08-04	D	-8	-4	AN950-12-08	D	-12	-8	AN950-20-16	D	-20	-16

AN951 MALE TO FEMALE ADAPTOR (JIC SEATS)

PART NO.	MAT	A	B
AN951-03-04	P	-3	-4
AN951-04-06	D	-4	-6
AN951-04-06	P	-4	-6
AN951-06-08	D	-6	-8
AN951-08-10	D	-8	-10
AN951-10-12	D	-10	-12



AN REFERENCE CHART

-AN SIZE	JIC/UNF THREAD	-AN SIZE	JIC/UNF THREAD
2	5/16 X 24	8	3/4 X 16
3	3/8 X 24	10	7/8 X 14
4	7/16 X 20	12	1 1/16 X 12
5	1/2 X 20	16	1 5/16 X 12
6	9/16 X 18	20	1 5/8 X 12
7	5/8 X 18	24	1 7/8 X 12

Section: **06**
Adaptors

Material Key
B: Brass, C: Stainless Steel, CH: Chrome Plated, D: Aluminium,
EN: Electroless Nickel, P: Zinc Plated Carbon Steel, T: Titanium

GOODRIDGE
FLUID TRANSFER SYSTEMS

**STREET
PERFORMANCE
& RACING**

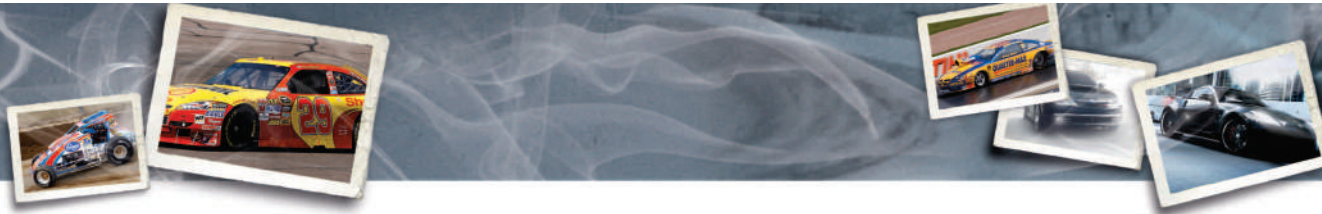

Jic Unequal Thread Inverted (B Thread)



Fitting Type :
Brake Adaptor
Application :
Brake systems
To Suit Hose :
600 series
Material : P, CH
Please Note :
INV = Convex
B.F = Concave

The Goodridge range of brake adaptors has evolved over the past 40 years to cover almost every combination of thread, dimension and application. Whether you are working on a race car, passenger vehicle, motorcycle or custom project, you are sure to find the adaptor you need.

10100 BRAKE ADAPTOR

PART NO.	MAT	A	B
10100-03	P	-3	10 X 1.00MM
10100-04	P	-4	10 X 1.00MM

10120 BRAKE ADAPTOR

PART NO.	MAT	A	B
10120-03	P	-3	1/2 X 20 INV

10125 BRAKE ADAPTOR

PART NO.	MAT	A	B
10125-03	P	-3	M10 X 1.25INV
10125-04	P	-4	M10 X 1.25INV

10324 BRAKE ADAPTOR

PART NO.	MAT	A	B
10324-03	P	-3	3/8 X 24INV
10324-04	P	-4	3/8 X 24INV

10716 BRAKE ADAPTOR

PART NO.	MAT	A	B
10716-03	P	-3	7/16 X 24INV
10716-04	P	-4	7/16 X 24INV

10720 BRAKE ADAPTOR

PART NO.	MAT	A	B
10720-03	P	-3	7/16 X 20INV
10720-04	P	-4	7/16 X 20INV

10916 BRAKE ADAPTOR

PART NO.	MAT	A	B
10916-03	P	-3	9/16 X 18INV

FM10100 BRAKE ADAPTOR

PART NO.	MAT	A	B
FM10100-03	P	-3	M10 X 1.0INV
FM10100-31	P	-4	M10 X 1.0B.F
FM10100-04	P	-3	M10 X 1.0INV
FM10100-44	P	-4	M10 X 1.0B.F

FM10125 BRAKE ADAPTOR

PART NO.	MAT	A	B
FM10125-03	P	-3	M10 X 1.25INV
FM10125-031	P	-3	M10 X 1.25B.F

FM10324 BRAKE ADAPTOR

PART NO.	MAT	A	B
FM10324-03	P	-3	3/8 X 24INV
FM10324-03IF	P	-3INV	3/8 X 24INV
FM10324-31	P	-3	3/8 X 24B.F
FM10324-03CH	CH	-3	3/8 X 24INV
FM10324-04	P	-4	3/8 X 24INV
FM10324-04BH	P	-4	3/8 X 24INV BH
FM10324-41	P	-4	3/8 X 24B.F

FM10716 BRAKE ADAPTOR

PART NO.	MAT	A	B
10716-03	P	-3	7/16 X 24INV
10716-04	P	-4	7/16 X 24INV

JIC To NPT Male To Male Adaptors



AN816 ADAPTOR STRAIGHT MALE JIC TO STRAIGHT MALE NPT

PART NO.	MATERIAL	A JIC	B NPT	PART NO.	MATERIAL	A JIC	B NPT
AN816-02	C, D	-2	1/8 X 27	AN816-08	D, DBK	-6	3/8 X 18
AN816-03-01	D	-3	1/16 X 27	AN816-08-08	D, DBK	-8	1/2 X 14
AN816-03	P, C, D, DBK, DRD	-3	1/8 X 27	AN816-08-12	D, DBK	-8	3/4 X 14
AN816-03-04	C, D	-3	1/4 X 18	AN816-10-06	D, DBK	-10	3/8 X 18
AN816-04	P, C, D, DBK, DRD	-4	1/8 X 27	AN816-10	D, DBK	-10	1/2 X 14
AN816-04-04	C, P, D, DBK, DRD	-4	1/4 X 18	AN816-10-12	D, DBK	-10	3/4 X 14
AN816-05	D	-5	1/4 X 18	AN816-10-16	D	-16	1 X 11 1/2
AN816-05-02	D	-5	1/8 X 27	AN816-12-08	D, DBK	-12	1/2 X 14
AN816-04-06	P, D, DBK	-4	3/8 X 18	AN816-12	D, DBK	-12	3/4 X 14
AN816-06-02	P, D, DBK	-6	1/8 X 27	AN816-12-16	D, DBK	-12	1 X 11 1/2
AN816-06	P, D, DBK	-6	1/4 X 18	AN816-16	D, DBK	-16	1 X 11 1/2
AN816-06-06	P, D, DBK	-6	3/8 X 18	AN816-16-12	D, DBK	-16	3/4 X 14
AN816-06-08	P, D, DBK	-8	1/2 X 14	AN816-20	D	-20	1 X 11 1/2
AN816-07	P, D, DBK	-7	1/4 X 18	AN816-20-16	D	-20	1 X 11 1/2

AN822 90° MALE ELBOW JIC TO MALE NPT

PART NO.	MATERIAL	A JIC	B NPT	PART NO.	MATERIAL	A JIC	B NPT
AN822-02	D	-2	1/8 X 27	AN822-08-08	P, D, DBK	-8	1/2 X 14
AN822-03	P, C, D, DBK	-3	1/8 X 27	AN822-08-12	D, DBK	-8	3/4 X 14
AN822-03-01	D	-3	1/16 X 27	AN822-10	P, D, DBK	-10	1/2 X 14
AN822-04	P, C, D, DBK, DRD	-4	1/8 X 27	AN822-10-06	D, DBK	-10	3/8 X 18
AN822-04-04	P, D, DBK	-4	1/4 X 18	AN822-10-12	D, DBK	-10	3/4 X 14
AN822-05	D	-5	1/4 X 18	AN822-12	D, DBK	-12	1/4 X 14
AN822-05-04	D	-5	1/8 X 27	AN822-12-08	D, DBK	-12	1/2 X 14
AN822-06	D, DBK	-6	1/8 X 27	AN822-12-16	D, DBK	-12	1 X 11 1/2
AN822-06-02	P, D, DBK, DRD	-6	1/4 X 18	AN822-16	D, DBK	-16	1 X 11 1/2
AN822-06-06	P, D, DBK	-6	3/8 X 18	AN822-16-12	D	-16	3/4 X 14
AN822-06-08	P, D, DBK	-6	1/2 X 14				
AN822-07	P, D, DBK	-7	1/4 X 18				
AN822-08	P, D, DBK	-8	3/8 X 18				

AN823 45° MALE ELBOW JIC TO NPT MALE

PART NO.	MATERIAL	A JIC	B NPT	PART NO.	MATERIAL	A JIC	B NPT
AN823-02	D	-2	1/8 X 27	AN823-08-08	D, DBK	-8	1/2 X 14
AN823-03	D, DBK	-3	1/8 X 27	AN823-10	D, DBK	-10	1/2 X 14
AN823-04	D, DBK, DRD	-4	1/8 X 27	AN823-10-06	D, DBK	-10	3/8 X 18
AN823-04-04	D	-4	1/4 X 18	AN823-10-12	D, DBK	-10	3/4 X 14
AN823-04-06	D	-4	1/4 X 18	AN823-12	D, DBK	-12	3/4 X 14
AN823-05-02	D	-5	1/16 X 27	AN823-12-08	D, DBK	-12	1/2 X 14
AN823-05	D	-5	1/4 X 18	AN823-12-16	D	-12	1 X 11 1/2
AN823-06-02	D	-6	1/8 X 27	AN823-16	D	-16	1 X 11 1/2
AN823-06	D, DBK	-6	1/4 X 18	AN823-16-12	D	-16	3/4 X 14
AN823-06-06	D, DBK	-6	3/8 X 18				
AN823-06-08	D, DBK	-6	1/2 X 14				
AN823-07	D, DBK	-7	1/4 X 18				
AN823-08D	D, DBK	-08	3/8 X 18				

Section: 06
Adaptors

Material Key
B: Brass, C: Stainless Steel, CH: Chrome Plated, D: Aluminium,
EN: Electroless Nickel, P: Zinc Plated Carbon Steel, T: Titanium

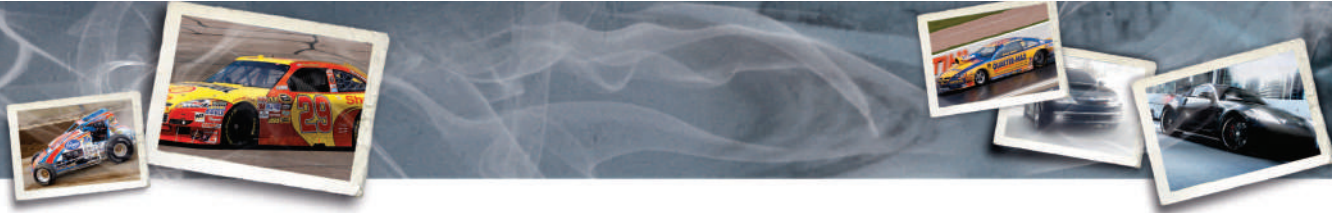

STREET
PERFORMANCE
& RACING

JIC To NPT Male To Male Adaptors - *continued*



AN826 JIC TEE NPT ON RUN



PART NO.	MAT	THREAD	
		A JIC	B NPT
AN826-03	C, D, DBK, P	-3	1/8X27
AN826-03-04	D	-4	1/4X18
AN826-04	C, D, DBK, P	-4	1/8X27
AN826-06	C, D, DBK, P	-6	1/4X18
AN826-08	D	-8	3/8X18
AN826-08-04	D	-4	3/8X19
AN826-10	D	-10	1/2X14
AN826-12	D	-12	3/4X14
AN826-16	D	-16	1X 11 1/2

AN825 JIC TEE NPT ON LEG



PART NO.	MAT	THREAD	
		A JIC	B NPT
AN825-02	C, D	-2	1/16X27
AN825-03	C, D, DE, P	-3	1/8X27
AN825-04	C, D, P	-4	1/8X27
AN825-06	CH, D, DE, P	-6	1/4X18
AN825-06-06	D	-6	3/8X24
AN825-08	D, P	-8	3/8X18
AN825-10	D	-10	1/2X14
AN825-12	D	-12	3/4X14
AN825-16	D	-16	1X 11 1/2

AN914 NPT FEMALE TO MALE 90° EQUAL



PART NO.	MAT	NPT THREAD
AN914-01	D	1/8 X 27
AN914-02	D	1/4 X 18
AN914-03	D	3/8 X 18
AN914-04	D	1/2 X 14

AN915 NPT FEMALE TO MALE 45° EQUAL



PART NO.	MATERIAL	NPT THREAD
AN915-01	D	1/8 X 27
AN915-02	D	1/4 X 18
AN915-03	D	3/8 X 18
AN915-04	D	1/2 X 14

AN916 NPT FEMALE TO FEMALE 90° EQUAL



PART NO.	MAT	NPT THREAD
AN916-01	D	1/8 X 27
AN916-02	D	1/4 X 18
AN916-03	D	3/8 X 18

NPT Adaptors

Fitting Type :
Adaptor
Material : D

AN910 FEMALE PIPE COUPLER

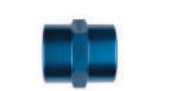

PART NO.	MATERIAL	NPT THREAD
AN910-01	D	1/8 X 27
AN910-02	D	1/4 X 18
AN910-03	D	3/8 X 18
AN910-04	D	1/2 X 14
AN910-06	D	3/4 X 14
AN910-08	D	1 X 11 1/2

NPT Adaptors - *continued*



AN911 MALE TO MALE ADAPTOR



PART NO.	MATERIAL	NPT THREAD
AN911-01	D, DE	1/8 X 27
AN911-02	D, DBK	1/4 X 18
AN911-03	D, DE, P	3/8 X 18
AN911-04	D, DE, P	1/2 X 14
AN911-06	D	3/4 X 14
AN911-08	D	1 X 11.5

AN913 PLUG HEX HEAD NPT



PART NO.	MATERIAL	NPT THREAD
AN913-01	D	1/16 X 26
AN913-02	D	1/8 X 27
AN913-03	D	1/4 X 18
AN913-04	D	3/8 X 18
AN913-05	D	1/2 X 14
AN913-06	D	3/4 X 14
AN913-08	D	1 X 11 1/2

AN912 ADAPTOR MALE - FEMALE



PART NO.	MAT	NPT MALE	NPT FEMALE
AN912-01	D, DBK	1/4 X 18	1/8 X 27
AN912-02	D, DBK	3/8 X 18	1/4 X 18
AN912-03	D, DBK	3/8 X 18	1/8 X 27
AN912-04	D, DBK	1/2 X 14	3/8 X 18
AN912-05	D	1/2 X 14	1/4 X 18
AN912-06	D, DBK	1/2 X 14	1/8 X 27
AN912-07	D	3/4 X 14	1/2 X 14
AN912-08	D, DBK	3/4 X 14	3/8 X 18
AN912-09	D	3/4 X 14	1/4 X 18
AN912-10	D, DBK	1 X 11 1/2	3/4 X 14
AN912-11	D	1 X 11 1/2	1/2 X 14
AN912-12	D	1 X 11 1/2	1/2 X 14

AN917 NPT TEE



PART NO.	MATERIAL	NPT THREAD
AN917-01	D	1/8 X 27
AN917-02	D	1/4 X 18
AN917-03	D	3/8 X 18
AN917-04	D	1/2 X 14
AN917-06	D	3/4 X 14
AN917-08	D	1 X 11 1/2

AN932 PLUG SOCKET HEAD



PART NO.	MATERIAL	NPT THREAD
AN932-01	D, P	1/16 X 27
AN932-02	D, DBK, DE, P, DR	1/8 X 27
AN932-03	D, DBK, DE, DR	1/4 X 18
AN932-04	D, DBK, DE, DR	3/8 X 18
AN932-05	D, DBK, DE, DR	1/2 X 14
AN932-06	D, DBK, DE, DR	3/4 X 14
AN932-07	D, DBK	1 X 11 1/2

AN REFERENCE CHART

-AN SIZE	JIC/UNF THREAD	-AN SIZE	JIC/UNF THREAD
2	5/16 X 24	8	3/4 X 16
3	3/8 X 24	10	7/8 X 14
4	7/16 X 20	12	1 1/16 X 12
5	1/2 X 20	16	1 5/16 X 12
6	9/16 X 18	20	1 5/8 X 12
7	5/8 X 18	24	1 7/8 X 12

Section: **06**
Adaptors

Material Key
B: Brass, **C:** Stainless Steel, **CH:** Chrome Plated, **D:** Aluminium,
EN: Electroless Nickel, **P:** Zinc Plated Carbon Steel, **T:** Titanium

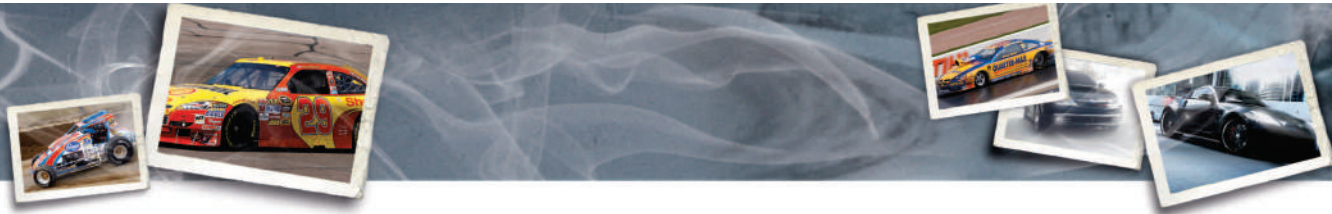

STREET PERFORMANCE & RACING

JIC Male To Metric Male



Fitting Type : Adaptor
 Material : P, C, CH, D

305 ADAPTOR JIC TO METRIC CONVEX

PART NO.	MATERIAL	A JIC	B METRIC	PART NO.	MATERIAL	A JIC	B METRIC
305-03-31	C, CH, D, P	-3	10 X 1.00MM	305-06-M121	D	-6	12 X 1.00MM
305-03-32	P, C, D	-3	10 X 1.25MM	305-06-M122	D	-6	12 X 1.25MM
305-03-21	C	-3	8 X 1.00MM	305-06-M12	P, D	-6	12 X 1.50MM
305-03-M12	C	-3	12 X 1.50MM	305-06-M14	D	-6	14 X 1.50MM
305-03-M121	P, C	-3	12 X 1.00MM	305-06-M16	D	-6	16 X 1.50MM
305-03-M122	P, C	-3	12 X 1.25MM	305-08-31	D	-8	10 X 1.00MM
305-04-M12	D	-4	12 X 1.50MM	305-08-35	D	-8	10 X 1.50MM
305-04-M121	P	-4	12 X 1.00MM	305-08-M122	D	-8	12 X 1.25MM
305-04-M122	P	-4	12 X 1.25MM	305-08-M12	D	-8	12 X 1.50MM
305-04-M14	P	-4	14 X 1.50MM	305-08-M14	D	-8	14 X 1.50MM
305-04-31	P, D	-4	10 X 1.00MM	305-08-M16	D	-8	16 X 1.50MM
305-04-32	C	-4	10 X 1.25MM	305-10-M18	D	-10	18 X 1.50MM
305-04-35	P	-4	10 X 1.50MM	305-12-M20	D	-12	20 X 1.50MM
305-06-31	D	-6	10 X 1.00MM	305-16-M24	D	-16	24 X 1.50MM

306 ADAPTOR JIC TO METRIC CONCAVE



PART NO.	MAT	A JIC	B METRIC	PART NO.	MAT	A JIC	B METRIC	PART NO.	MAT	A JIC	B METRIC
306-02-31	C	-2	10 X 1.00MM	306-04-M20	D	-4	20 X 1.50MM	306-08-M20	D	-8	20 X 1.50MM
306-02-32	C, T	-2	10 X 1.25MM	306-04-M22	D	-4	22 X 1.50MM	306-08-M22	D	-8	22 X 1.50MM
306-03-M12	C, CH, D	-3	12 X 1.50MM	306-04-31	D	-4	10 X 1.00MM	306-10-M14	D	-10	14 X 1.50MM
306-03-M121	D	-3	12 X 1.00MM	306-04-32	D	-4	10 X 1.25MM	306-10-M16	P, D	-10	16 X 1.50MM
306-03-M16	D	-3	16 X 1.50MM	306-06-31	D	-6	10 X 1.00MM	306-10-M18	D	-10	18 X 1.50MM
306-03-M18	P, D	-3	18 X 1.50MM	306-06-32	P, D	-6	10 X 1.25MM	306-10-M20	D	-10	20 X 1.50MM
306-03-M20	D	-3	20 X 1.50MM	306-06-M121	D	-6	12 X 1.00MM	306-10-M22	D	-10	22 X 1.50MM
306-03-M22	D	-3	22 X 1.50MM	306-06-M12	P, D	-6	12 X 1.50MM	306-10-M24	D	-10	24 X 1.50MM
306-03-31	C, CH, D, P	-3	10 X 1.00MM	306-06-M14	P, D	-6	14 X 1.50MM	306-10-M26	D	-10	26 X 1.50MM
306-03-32	C, CH, D, P	-3	10 X 1.25MM	306-06-M16	P, D	-6	16 X 1.50MM	306-12-M18	D	-12	18 X 1.50MM
306-03-35	P	-3	10 X 1.50MM	306-06-M18	P, D	-6	18 X 1.50MM	306-12-M20	D	-12	20 X 1.50MM
306-04-M12	P	-4	12 X 1.50MM	306-06-M20	D	-6	20 X 1.50MM	306-12-M22	D	-12	22 X 1.50MM
306-04-M121	D	-4	12 X 1.00MM	306-08-M12	P, D	-8	12 X 1.50MM	306-12-M24	D	-12	24 X 1.50MM
306-04-M14	D	-4	14 X 1.50MM	306-08-M14	P	-8	14 X 1.50MM	306-16-M26	D	-16	26 X 1.50MM
306-04-M16	P	-4	16 X 1.50MM	306-08-M16	P, D	-8	16 X 1.50MM	306-16-M30	P, D	-16	30 X 1.50MM
306-04-M18	D	-4	18 X 1.50MM	306-08-M18	P, D	-8	18 X 1.50MM				

Carburetor & Fuel Adaptors



Fitting Type :
 Adaptor
 Material : P, D, CH,
 Application :
 All common carburetor systems
 Standard Color is Blue
 E = Electroless Nickel BK = Black

CAB STRAIGHT MALE CONVEX SEAT

PART NO.	DESCRIPTION	THREAD A	THREAD B
CAB206	DUAL FEED HOLLEY	7/8 X 20	-06 JIC
CAB206BK	DUAL FEED HOLLEY	7/8 X 20	-06 JIC
CAB206E	DUAL FEED HOLLEY	7/8 X 20	-06 JIC
CAB246	SINGLE FEED HOLLEY	9/16 X 24	-06 JIC
CAB246BK	SINGLE FEED HOLLEY	9/16 X 24	-06 JIC
CAB246E	SINGLE FEED HOLLEY	9/16 X 24	-06 JIC
CAB208	DUAL FEED HOLLEY	7/8 X 20	-08 JIC
CAB208BK	DUAL FEED HOLLEY	7/8 X 20	-08 JIC
CAB208E	DUAL FEED HOLLEY	7/8 X 20	-08 JIC
CAB1215	WEBER	M12 X 1.50	-06 JIC
CAB5820	CARTER	5/8 X 20	-06 JIC
CAB5820BK	CARTER	5/8 X 20	-06 JIC
CAB5820E	CARTER	5/8 X 20	-06 JIC
CAB1212	DELLORTO	M12 X 1.25	-06 JIC

AN REFERENCE CHART

-AN SIZE	JIC/UNF THREAD	-AN SIZE	JIC/UNF THREAD
2	5/16 X 24	8	3/4 X 16
3	3/8 X 24	10	7/8 X 14
4	7/16 X 20	12	1 1/16 X 12
5	1/2 X 20	16	1 5/16 X 12
6	9/16 X 18	20	1 5/8 X 12
7	5/8 X 18	24	1 7/8 X 12

FB FUEL PUMP AND GAUGE FITTINGS

PART NO.	DESCRIPTION	THREAD A	THREAD B
FB206	FUEL PUMP FITTING	1/2 X 20	-6 JIC
FB206BK	FUEL PUMP FITTING	1/2 X 20	-6 JIC
FB206E	FUEL PUMP FITTING	1/2 X 20	-6 JIC
FB186	FUEL PUMP FITTING	5/8 X 18	-6 JIC
FB186BK	FUEL PUMP FITTING	5/8 X 18	-6 JIC
FB186E	FUEL PUMP FITTING	5/8 X 18	-6 JIC

GA FUEL AND OIL PRESSURE GAUGE FITTINGS

PART NO.	MATERIAL	THREAD A	THREAD B
GA-03	CH, D, P	MALE-3AN	FEMALE 1/8NPT
GA-04	D, P	MALE-4AN	FEMALE 1/8NPT
GA-06	P	MALE-6AN	FEMALE 1/4NPT
GA-903	CH, D, P	MALE-3AN	90 FEMALE 1/8NPT
GA-904	D, P	MALE-4AN	90 FEMALE 1/8NPT

Section: **06**
Adaptors

Material Key
B: Brass, C: Stainless Steel, CH: Chrome Plated, D: Aluminium,
EN: Electroless Nickel, P: Zinc Plated Carbon Steel, T: Titanium

GOODRIDGE
FLUID TRANSFER SYSTEMS

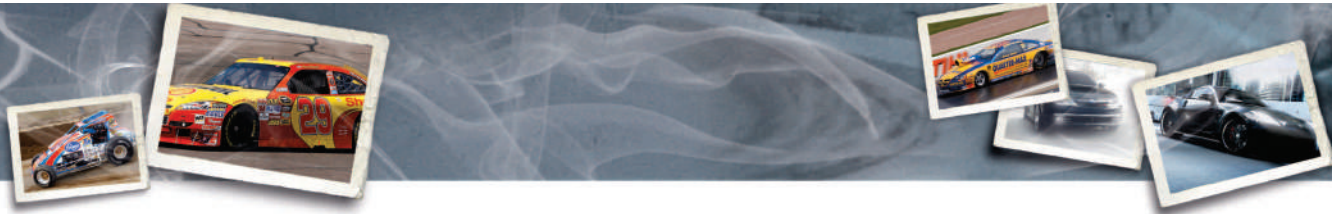

**STREET
PERFORMANCE
& RACING**

Special Adaptors
(Modified AN parts for motorsport requirements)



Fitting Type :
Adaptor
Material : P, C, D, CH, DE
Colours Available :
Coloured anodised aluminium
*Colour :
DBK = Black, D = Blue, DCL = Clear
DE = Electroless Nickel

CPL-824 ADAPTOR TEE MALE THREAD ON RUN SWIVEL FEMALE ON LEG

PART NO.	MAT	A	B	C
CPL-824-03	P, D	-3	-3	-3
CPL-824-04	P, D	-4	-4	-4
CPL-824-06	D, DE	-6	-6	-06
CPL-824-08	D	-8	-8	-08
CPL-824-10	D	-10	-10	-10
CPL-824-12	D	-12	-12	-12
CPL-824-16	D	-16	-16	-16

CPL-450 ADAPTOR 45° FEMALE TO FEMALE SWIVEL

PART NO.	MATERIAL	THREAD
CPL-45004	D	-4
CPL-45006	D	-6
CPL-45008	D	-8
CPL-45010	D	-10
CPL-45012	D	-12

CPL-900 ADAPTOR 90° FEMALE TO FEMALE SWIVEL

PART NO.	MATERIAL	THREAD
CPL-9003	D	-3
CPL-9004	D	-4
CPL-9006	D	-6
CPL-9008	D	-8
CPL-9010	D	-10
CPL-9012	D	-12
CPL-9016	D	-16

CPL-816 ADAPTOR JIC/UNF FEMALE SWIVEL TO MALE NPT

PART NO.	MAT	A	B
CPL-8164	D	-4	1/8
CPL-8164	P	-4	1/8
CPL-81644	D	-4	1/4
CPL-8166	C	-6	1/4
CPL-8166	D	-6	1/4
CPL-8166	DBK	-6	1/4
CPL-81662	D	-6	1/8
CPL-81666	D	-6	3/8
CPL-8168	D	-8	3/8
CPL-8168	DBK	-8	3/8
CPL-81684	D	-8	1/4
CPL-81688	D	-8	1/2
CPL-81610	D	-10	1/2
CPL-816106	D	-10	3/8
CPL-8161012	D	-10	3/4
CPL-81612	D	-12	3/4

CPL-826 ADAPTOR TEE SWIVEL FEMALE ON RUN

PART NO.	MAT	A	B	C
CPL-826-03	D, DBK, P	-03	-03	-03
CPL-826-04	C, D, P	-04	-04	-04
CPL-826-06	D, P	-06	-06	-06
CPL-826-08	D	-08	-08	-08
CPL-826-10	D	-10	-10	-10
CPL-826-12	C, D	-12	-12	-12
CPL-826-16	D	-16	-16	-16

Special Adaptors
(Modified AN parts for motorsport requirements) - *continued*



CPL-910 ADAPTOR 90° FEMALE TO FEMALE SWIVEL

PART NO.	MAT	A	B
CPL-9104	D	-04	-04
CPL-9106	D	-06	-06
CPL-9108	D	-08	-08
CPL-9110	D	-10	-10
CPL-9112	D	-12	-12
CPL-9116	D	-16	-16

CPL-460 ADAPTOR 45° FEMALE TO FEMALE SWIVEL

PART NO.	MAT	A	B
CPL-4604	D	-04	-04
CPL-4606	D	-06	-06
CPL-4608	D	-08	-08
CPL-4610	D	-10	-10
CPL-4612	D	-12	-12
CPL-4616	D	-16	-16

CPL ADAPTOR SWIVEL FEMALE COUPLING

PART NO.	MAT	A	B
CPL-03	C, D	-03	-03
CPL-04	C, D, CBK, DCL	-04	-04
CPL-06	C, D, DBK, DCL	-06	-06
CPL-08	C, D, DBK, DE	-08	-08
CPL-08-06	D, DBK	-08	-06
CPL-10	D, DBK, DCL	-10	-10
CPL-12	D, DBK, DCL	-12	-12
CPL-16	D	-16	-16
CPL-20	D	-20	-20

CPL-823 ADAPTOR 45° MALE TO SWIVEL FEMALE

PART NO.	MAT	A	B
CPL-823-03	D	-03	-03
CPL-823-04	P, D	-04	-04
CPL-823-06	D	-06	-06
CPL-823-08	D	-08	-08
CPL-823-10	D	-10	-10
CPL-823-12	D	-12	-12
CPL-823-16	D	-16	-16

AN REFERENCE CHART

-AN SIZE	JIC/UNF THREAD	-AN SIZE	JIC/UNF THREAD
2	5/16 X 24	8	3/4 X 16
3	3/8 X 24	10	7/8 X 14
4	7/16 X 20	12	1 1/16 X 12
5	1/2 X 20	16	1 5/16 X 12
6	9/16 X 18	20	1 5/8 X 12
7	5/8 X 18	24	1 7/8 X 12

Section: **06**
Adaptors

Material Key
B: Brass, C: Stainless Steel, CH: Chrome Plated, D: Aluminium,
EN: Electroless Nickel, P: Zinc Plated Carbon Steel, T: Titanium

GOODRIDGE
FLUID TRANSFER SYSTEMS



Special Adaptors
(Modified AN parts for motorsport requirements) - *continued*



Fitting Type :
Adaptor

Material : CH, P, C, D

Colours Available :
Coloured anodised aluminium
*Colour :
DBK = Black, D = Blue

AN921 90° O RING BOSS TO MALE UNION

PART NO.	MATERIAL	A	AN O-RING
AN921-04	D	-4	-4
AN921-06	D, DBK	-6	-6
AN921-08	D	-8	-8
AN921-10	D	-10	-10
AN921-10-08	D	-10	-8
AN921-12	D	-12	-12
AN921-12-10	D	-12	-10
AN921-16	D	-16	-16

AN922 45° O RING BOSS TO MALE UNION

PART NO.	MATERIAL	A	AN O-RING
AN922-04	D	-4	-4
AN922-06	D	-6	-6
AN922-08	D	-8	-8
AN922-10	D, DBK	-10	-10
AN922-12	D, DBK	-12	-12
AN922-16	D	-16	-16
AN922-16-12	D	-16	-12

AN920 STRAIGHT O RING BOSS TO MALE UNION

PART NO.	MATERIAL	A	AN O-RING
AN920-04	D	-4	-4
AN920-04-06	D	-4	-6
AN920-06	D, DBK	-6	-6
AN920-06-08	DBK	-6	-8
AN920-06-10	DBK	-6	-10
AN920-08	D, DBK	-8	-8
AN920-08-04	DBK	-8	-4
AN920-08-10	D, DBK	-8	-10
AN920-08-12	D	-8	-12
AN920-10	D, DBK	-10	-10
AN920-10-06	D	-10	-6
AN920-10-08	D	-10	-8
AN920-10-12	D	-10	-12
AN920-12	D	-12	-12
AN920-12-10	D	-12	-10
AN920-16	D	-16	-16
AN920-16-12	D	-16	-12

FP192/199 JIC FEMALE TO MALE WITH FEMALE NPT IN HEX

PART NO.	MATERIAL	A	B NPT HEX	C
FP192	D	-6	1/8 NPT	-6
FP193	D	-8	1/8 NPT	-8
FP198	D	-12	1/8 NPT	-12
FP199	D	-4	1/8 NPT	-4

FP194 to 197 JIC MALE TO NPT MALE WITH NPT FEMALE IN HEX

PART NO.	MATERIAL	A	B NPT HEX	C NPT HEX
FP194	D	-6	1/8 NPT	1/4 NPT
FP195	D	-6	1/8 NPT	3/8 NPT
FP196	D	-8	1/8 NPT	1/4 NPT
FP197	D	-8	1/8 NPT	3/8 NPT

FP190/FP191 JIC MALE TO MALE WITH FEMALE NPT IN HEX

PART NO.	MATERIAL	A	B NPT HEX	C
FP190	D	-6	1/8 NPT	-6
FP190E	E	-6	1/8 NPT	-6
FP191	D	-8	1/8 NPT	-8
FP191E	E	-8	1/8 NPT	-8

AN867 FEMALE WELD BUNG (UNANODIZED)

PART NO.	MATERIAL	NPT THREAD
AN867-01	D	1/8 X 27 NPT
AN867-02	D	1/4 X 18 NPT
AN867-03	D	3/8 X 18 NPT
AN867-04	D	1/2 X 14 NPT
AN867-06	D	3/4 X 14 NPT

AN871 FEMALE WELD ADAPTOR

PART NO.	MATERIAL	THREAD
AN871-04	P, D	-4
AN871-06	D	-6
AN871-08	D	-8
AN871-10	D	-10
AN871-12	D	-12
AN871-16	D	-16
AN871-20	D	-20

AN971 MALE WELD FLANGE ADAPTOR

PART NO.	MATERIAL	THREAD
AN971-03	P, C, D	-3
AN971-04	P, C, D	-4
AN971-06	P, C, D	-6
AN971-07	P, C, D	-7
AN971-08	P, C, D	-8
AN971-10	P, C, D	-10
AN971-12	P, C, D	-12
AN971-16	P, C, D	-16
AN971-20	P, C, D	-20



07

Banjo Bolts, Bleed Nipple Banjo Bolts & Nipples, Bleed Nipples

**STREET
PERFORMANCE
& RACING**

Section: **07**
Banjo Bolts and Crush Washers

Material Key

B: Brass, C: Stainless Steel, CH: Chrome Plated, D: Aluminium,
EN: Electroless Nickel, P: Zinc Plated Carbon Steel, T: Titanium

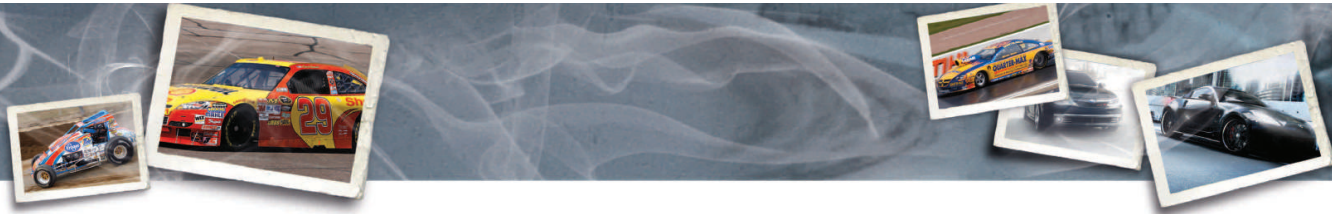

Banjo Bolts

Fitting Type :

Bolt

Application :
Brake / Clutch

To Suit Hose :

600 series

Material : **P, CH, C, D**

Manufactured to exacting specifications to ensure an accurate fit to our Banjo Hose Ends every time, the Goodridge range of Banjo Bolts covers all possible applications. They are available in a wide range of materials, colours, lengths and threads.

Long bolts are for use with 5091, 5095, 5096.
Under hex length:
Short: 18mm (S) Single: 20mm
Single Long: 25mm (L)
Double: 30mm Double Long: 40mm

775 SINGLE BANJO BOLT UNF			
PART NO.	MATERIAL	THREAD	
775-02	C	-02	
775-03-02	P	-02	
775-03	C, CH, D, P	-03	
775-03L	C, CH, P	-03	
775-04	C, D, P	-04	
775-04L	C, D, P	-04	
775-44	P, C, CH	-44	

992 SINGLE BANJO BOLT METRIC			
PART NO.	MATERIAL	METRIC THREAD	
992-02-21	C	M8 X 1.0	
992-02-22	C, P	M8 X 1.25	
992-03-21	C	M8 X 1.0	
992-03-22	C	M8 X 1.25	
*992-03-31	C, CH, P, D	M10 X 1.0	
992-03-31L	C, P	LONG M10 X 1.0	
992-03-31S	C, P	SHORT M10 X 1.0	
*992-03-32	C, CH, P, D	M10 X 1.25	
992-03-32L	C, P	LONG M10 X 1.25	
992-03-35	P	M10 X 1.5	
992-04-M12	C, CH, D	M12 X 1.5	
992-04-M121	D, P	M12 X 1.0	
992-04-M121S	P	SHORT M 12 X 1.0	
992-04-M122	D, P	M12 X 1.25	
992-04-32	C	M10 X 1.25	

1012 SINGLE BANJO BOLT BSP			
PART NO.	MATERIAL	BSP THREAD	
1012-03	P, C	1/8 BSP	
1012-04	P	1/4 BSP	

993 DOUBLE BANJO BOLT METRIC			
PART NO.	MATERIAL	METRIC THREAD	
*993-03-31	C, CH, D, P	10 X 1.00MM	
993-03-31L	P, C	10 X 1.00MM	
993-03-31S	P, D	10 X 1.00MM 28MM U/HEX	
993-03-32	C, CH, D, P	10 X 1.25MM	
993-04-32	C	10 X 1.25MM	

773 DOUBLE BANJO BOLT UNF			
PART NO.	MATERIAL	UNF THREAD	
773-03	C, CH, D, P	3/8 X 24	
773-03L	P, CH	3/8 X 24	
773-44	P, CH	7/16 X 24	
773-44L	P, CH	7/16 X 24	

1013 DOUBLE BANJO BOLT BSP			
PART NO.	MATERIAL	BSP THREAD	
1013-03	P, C, CH	1/8 BSP	

Brakelight Banjo

BL775 SINGLE BRAKELIGHT BANJO BOLT UNF			
PART NO.	MATERIAL	THREAD	
BL775-03	C	3/8 X 24	
BL775-44	C	7/16 X 24	

BL992 SINGLE BRAKELIGHT BANJO BOLT METRIC			
PART NO.	MATERIAL	THREAD	
BL992-31	C	10 X 1.00MM	
BL992-32	C	10 X 1.25MM	
BL992-31S	C	10 X 1.00MM (18.5MM U/HEX)	

BL993 DOUBLE BRAKELIGHT BANJO BOLT METRIC			
PART NO.	MATERIAL	THREAD	
BL993-31	C	10 X 1.00MM	
BL993-32	C	10 X 1.25MM	
BL993-31S	C	10 X 1.00MM (28MM U/HEX)	

Bleed Nipple Banjo Bolts & Nipples

Fitting Type :

Bolt

Application :
Brake / Clutch

To Suit Hose :

600 series

Material : **P, CH, C**

Goodridge developed Bleed Nipple Banjo Bolts in response to concerns about the length of time required to bleed hydraulic systems. Our design allows the installer to bleed the system at the source of the problem, at the master cylinder where the air is located. Use of our proprietary design allows the installer to burp the hydraulic system, ensuring safe and efficient bleeding.

775BN SINGLE BANJO BOLT WITH BLEED NIPPLE UNF			
PART NO.	MATERIAL	UNF THREAD	
775-03BN	C, P	3/8 X 24	

992BN SINGLE BANJO BOLT WITH BLEED NIPPLE METRIC			
PART NO.	MATERIAL	METRIC THREAD	
992-31BN	C, P	10 X 1.00MM	
992-32BN	C, P	10 X 1.25MM	

773BN SINGLE BANJO BOLT WITH BLEED NIPPLE UNF			
PART NO.	MATERIAL	UNF THREAD	
773-03BN	C, P	3/8 X 24	

993BN BLEED NIPPLE DOUBLE BANJO BOLT METRIC			
PART NO.	MATERIAL	METRIC THREAD	
993-31BN	C, P	10 X 1.00MM	
993-32BN	C, P	10 X 1.25MM	

Bleed Nipples

Fitting Type :

Bleed Nipple

Application :
Brake systems

To Suit Hose :

600 series

Material : **P, C**

Goodridge provide a wide range of bleed nipples in many thread configurations to suit every common application.

BN506 BLEED NIPPLE UNF			
PART NO.	MATERIAL	UNF THREAD	
BN506	P	3/8 X 24	

BN507 BLEED NIPPLE METRIC			
PART NO.	MATERIAL	METRIC THREAD	
BN507	P, C	7 X 1.00MM	

BN508 BLEED NIPPLE METRIC			
PART NO.	MATERIAL	METRIC THREAD	
BN508	P, C	8 X 1.25MM	

BN510 BLEED NIPPLE METRIC			
PART NO.	MATERIAL	METRIC THREAD	
BN510	P	10 X 1.00MM	

BN704 BLEED NIPPLE METRIC UNF			
PART NO.	MATERIAL	UNF THREAD	
BN704	P, C	1/4 X 28	

BNSB SPEED BLEEDER			
PART NO.	MATERIAL	THREAD	
BN506PSB	P	3/8 X 24	
BN507PSB	P	7 X 1.00MM	
BN508PSB	P	8 X 1.25MM	
BN510PSB	P	10 X 1.00MM	
BN512PSB	P	10 X 1.25MM	
BN561PSB	P	6 X 1.00MM	
BN704PSB	P	1/4 X 28	

BN-CAP BLEED NIPPLE CAP			
PART NO.			
BN-CAP			

Material Key
B: Brass, **C:** Stainless Steel, **CH:** Chrome Plated, **D:** Aluminium,
EN: Electroless Nickel, **P:** Zinc Plated Carbon Steel, **T:** Titanium



Metric & JIC/UNF Banjo Adaptors and Banjo Bolts

Fitting Type :
Re-usable

Colours Available :
Coloured anodised aluminium
 *Colour :
BK = Black, D = Blue

Material : P, D, C, CH

592 STRAIGHT BANJO ADAPTOR

PART NO.	MATERIAL	THREAD	TO SUIT BOLT
592-03	C, CH, DBK, PE	-3	3/8, 10MM
592-03-04	C, CH, PE	-3	7/16
592-03-M12	CH	-3	12MM



593 30° BANJO ADAPTOR

PART NO.	MATERIAL	THREAD	TO SUIT BOLT
593-03	C, CH, DBK, PE	-3	3/8, 10MM
593-03-04	C, CH, PE, DBK	-3	7/16
593-03-M12	CH	-3	12MM



599 90° BANJO ADAPTOR

PART NO.	MATERIAL	THREAD	TO SUIT BOLT
599-03	C, CH, DBK, PE	-3	3/8, 10MM
599-03-04	BK, CH, DBK, PE	-3	7/16



776 SINGLE BANJO ADAPTOR

PART NO.	MATERIAL	THREAD	TO SUIT BOLT	PART NO.	MATERIAL	THREAD	TO SUIT BOLT
776-02	C	-2	5/16	776-06-M12	D, DBK, P	-6	12MM
776-02-03	C	-2	3/8, 10MM	776-06-M14	D, DBK	-6	14MM
776-03	C, CH, D, P	-3	3/8, 10MM	776-06-M16	C, D	-6	16MM
776-03-04	C, CH, D, P	-3	7/16	776-08-M14	D	-8	14MM
776-04	C, P	-4	7/16	776-08-M16	D, DBK	-8	16MM
776-04-03	D, P	-4	3/8	776-08-M18	D	-8	18MM
776-04-M12	D, P	-4	12MM	776-10-M18	D	-10	18MM
776-04-M14	D, DBK	-4	14MM	776-10-M20	D	-10	20MM
776-04-06	D, P	-4	9/16				
776-06	D	-6	9/16				
776-06-04	D	-6	7/16				



779 TWIN BANJO ADAPTOR

PART NO.	MATERIAL	THREAD	TO SUIT BOLT
779-02	C	-2	5/16
779-03	C, D, P	-3	3/8, 10MM
779-04	D	-4	7/16
779-04-06	D	-4	9/16
779-06	D	-6	9/16
779-06-04	D	-6	7/16
779-08	D	-8	3/4



08
 Ancillary

STREET
 PERFORMANCE
 & RACING

Section: **08**
Ancillary

Material Key
B: Brass, **C:** Stainless Steel, **CH:** Chrome Plated, **D:** Aluminium,
EN: Electroless Nickel, **P:** Zinc Plated Carbon Steel, **T:** Titanium

GOODRIDGE
 FLUID TRANSFER SYSTEMS



**STREET
 PERFORMANCE
 & RACING**

Washers and Seals

Fitting Type : O-Ring
Application :
 Suitable for all petroleum products
Please Note :
 These 'O' rings conform to AN6290 specifications.
 To suit :
 AN920, AN921, AN922, AN814SD and swivel G-Line fittings

OR6290 BUNA O-RING

PART NO.	SECTION (INCHES)	LD (INCHES)	SECTION (MM)	LD (MM)
OR6290-03	0.064 ± 0.003	0.301 ± 0.005	1.6	7.65
OR6290-04	0.072 ± 0.003	0.351 ± 0.005	1.8	8.92
OR6290-06	0.078 ± 0.003	0.468 ± 0.005	2.0	11.89
OR6290-08	0.087 ± 0.003	0.644 ± 0.005	2.2	16.36
OR6290-10	0.097 ± 0.003	0.755 ± 0.005	2.5	19.18
OR6290-12	0.116 ± 0.004	0.924 ± 0.006	2.9	23.47
OR6290-16	0.116 ± 0.004	1.171 ± 0.006	2.9	29.74

NOTE: VITRON O-RINGS ARE AVAILABLE - JUST ADD A 'V' TO THE PART NO. **EXAMPLE:** OR6290-03V

Application : Sealing
 Sealing washer for use with chrome plated steel, mild steel and stainless fittings.

445/CUW COPPER CRUSH WASHERS

PART NO.	I.D.	O.D.	THICKNESS
44514	8.00MM	11.00MM	1.00MM
44516 (-03)	3/8, 10MM	0.590"	0.050"
44517	10.00MM	14.00MM	2.00MM
44518 (-04)	0.437"	0.685"	0.050"
44518HD	11.50MM	16.00MM	1.50MM
44519	12.50MM	15.00MM	1.30MM
44520	14.50MM	18.00MM	1.50MM
CUW-M12	12.25MM	16.00MM	1.50MM
CUW-M14	14.30MM	18.40MM	1.20MM
CUW-M16	16.00MM	22.50MM	1.00MM
CUW-M18	18.20MM	24.20MM	2.00MM

Application : Sealing
 Sealing washer for use with aluminium fittings.

445/CW901 ALLOY CRUSH WASHERS

PART NO.	I.D.	O.D.	THICKNESS
44515 (-3)	0.400"	0.590"	0.050"
CW901-04	0.443"	0.683"	0.050"
CW901-06	0.568"	0.808"	0.050"
CW901-08	0.755"	0.995"	0.050"
CW901-10	0.880"	1.120"	0.050"
CW901-12	1.068"	1.370"	0.050"
CW901-M12	12.2MM	17.9MM	1.1MM
CW901-M14	14.5MM	19.0	1.4MM
CW901-M16	16.3MM	19.8MM	1.4MM
CUW-M18	18.20MM	24.20MM	2.00MM

Application : Sealing
 The stat-o-seal is the best sealing washer available. It consists of a synthetic rubber 'O' ring mechanically locked to the I.D. of an aluminium crush washer. This provides the advantages of an O ring seal, but with ease of fitting. Stat-o-seals will tolerate temperatures from: -30°C (-22°F) to 233°C (450°F)

SS902 STAT-O-SEALS

PART NO.	I.D.	O.D.	THICKNESS
SS902-03	3/16	11.4	1.25
SS902-04	1/4	12.7	1.25
SS902-05	5/16	15.3	1.25
SS902-06	3/8	16.9	1.25
SS902-07	7/16	19.2	1.25
SS902-08	1/2	22.2	1.25
SS902-09	9/16	27.0	1.25
SS902-10	5/8	30.2	1.25
SS902-12	3/4	33.4	1.5
SS902-14	7/8	28.3	1.5

Large Capacity Fuel Filter
 Part No: **FF572**

Application :
 All Fuel and Oil systems

A 149 micron fuel or oil filter designed to be placed in line. These filters have a fine mesh filter which can be removed and cleaned.

FF572 LARGE CAPACITY FUEL FILTER

PART NO.	THREAD	TYPE	APPLICATIONS
FF572-04	7/16 X 20	GAUZE	OIL/FUEL
FF572-06	9/16 X 18	GAUZE	OIL/FUEL
FF572-08	3/4 X 16	GAUZE	OIL/FUEL
FF572-10	7/8 X 14	GAUZE	OIL/FUEL



Application :
 All filtration requirements
Material : D
 Red Anodised Aluminium (DR)
 Blue Anodised Aluminium (DB)

A high capacity fuel or oil filter designed to be placed in line. These filters have a fine mesh filter which can be removed and cleaned.

FF FUEL FILTER

PART NO.	MATERIAL	COLOUR	THREAD
FF-06	DB	BLACK	-06
FF-08	DB	BLACK	-08



Alloy Check (Flap) Valve
 Part No: **FCV**

Application :
 All Fuel and Oil systems

Alloy cased flap check valves for low pressure oil and fuel applications.

FCV ALLOY CHECK VALVE

PART NO.	THREAD
FCV-04	-04
FCV-06	-06
FCV-08	-08
FCV-10	-10



Fuel Shut off Taps
 Part No: **PV72**

Application :
 Fuel systems

Lightweight and compact tap, allowing full flow or 100% shut-off.

PV72 FUEL SHUT OFF TAPS

PART NO.	MATERIAL	INLET THREAD	OUTLET THREAD
PV72-04	CH	1/4 NPT	1/4 NPT
PV72-06	D	3/8 NPT	9/16 X 18 JIC/UNF
PV72-08	D	3/8 NPT	3/4 X 16 JIC/UNF



Section: **08**
Ancillary

Material Key
B: Brass, C: Stainless Steel, CH: Chrome Plated, D: Aluminium,
EN: Electroless Nickel, P: Zinc Plated Carbon Steel, T: Titanium

GOODRIDGE
FLUID TRANSFER SYSTEMS

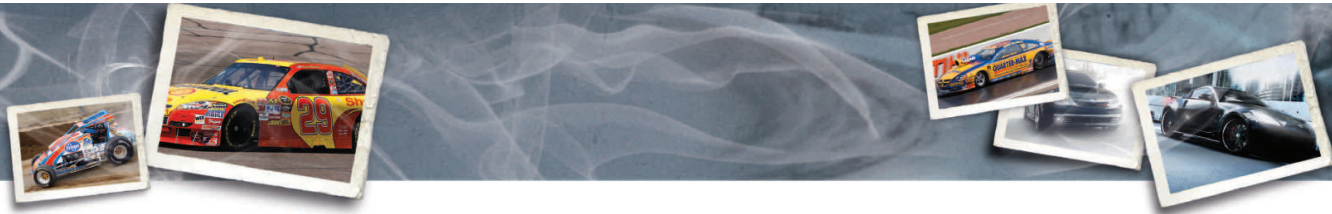

**STREET
PERFORMANCE
& RACING**

Fireproof Sleeve: Part No: **FG900**

Application :
Insulation and fire retardant, 1090°C (2000°F) short term flame protection.
Operating temp:
-54°C (-65°F) to 260°C (500°F)
To Suit Hose : All
Material: **Silicone**

A silicone covered sleeve which acts as a fire retardant, an insulator and a chafe protector. Installed by inserting the hose into the sleeve prior to hose fitting assembly. The standard colour is silver, but also available in orange on request.

FG900

FIREPROOF SLEEVE

PART NO.	TUBE O.D SIZE TO BE COVERED	TO SUIT HOSE
FG900-03S	1/4	600-02/03/04
FG900-06S	3/8	600-06/200-04
FG900-08S	1/2	200-06/08
FG900-12S	3/4	200-10/12
FG900-16S	1	200-16
FG900-20S	1 1/4	710-16



Textalu: Part No: **TEXTALU**

Application :
Insulation and fire retardant protection,
To Suit Hose : All
Material: **Silicone**
Temp:
**Under continuous use:
Up to 220°C (428°F)**

An insulative fibreglass sleeving with a silicone coating designed to protect components in high temperature areas where the heavier fireproof sleeving is not required. It provides superior insulation to components that must maintain stable temperatures to assure performance efficiency. Its braided construction allows good flexibility in temperatures as low as -40°C.

TEXTALU

TEXTALU

PART NO.	TO SUIT HOSE
TEXTALU-3/8	600-03 / 04
TEXTALU-1/2	200-04
TEXTALU-5/8	200-06
TEXTALU-3/4	200-08
TEXTALU-1	200-10 / 12



Raychem Heatshrink: Part No: **DR-25**

Application :
Heat, abrasion and chemical resistant covering, capable of withstanding temperatures from: -75°C (-103°F) to 150°C (302°F)
To Suit Hose :
600, 200, 210, 910, 710, 811, 510
Material: **Raychem**
Colour: **Black**

An insulative fibreglass sleeving with a silicone coating designed to protect components in high temperature areas where the heavier fireproof sleeving is not required. It provides superior insulation to components that must maintain stable temperatures to assure performance efficiency. Its braided construction allows good flexibility in temperatures as low as -40°C.

DR-25

RAYCHEM HEATSHRINK

PART NO.	TO SUIT HOSE
DR-25-1/4	600-02
DR-25-3/8	600-03/04
DR-25-1/2	200-06
DR-25-3/4	200-06/08
DR-25-1	200-10/12
DR-25-1 1/2	710-12/200-16
DR-25-2	ANY 2 INCH APPLICATION

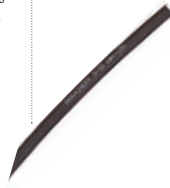

Aluminized Fibreglass: Part No: **TCD**

Application :
Aluminized Fibreglass Sleeving, offers continuous temperature protection, withstanding temperatures to: 343°C (650°F) and short term temperatures of 538°C (1000°F)
To Suit Hose : All
Material: **Aluminized Fibreglass**

Aluminized Fibreglass Sleeving, offers continuous temperature protection to 650°F and short term thermal exposure to 1000°F. The sleeve reflects 90% of radiant heat energy.

TCD

ALUMINIZED FIBREGLASS

PART NO.	TO SUIT HOSE
TCD-206G	-6 GLASS LINE SLEEVE
TCD-208G	-8 GLASS LINE SLEEVE
TCD-210G	-10 GLASS LINE SLEEVE
TCD-212G	-12 GLASS LINE SLEEVE
TCD-212K	-12 KEVLAR LINE SLEEVE
TCD-216G	-16 GLASS LINE SLEEVE

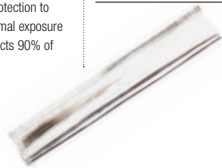

Universal Test Rig
Part No: **SP-825**

Application :
The universal test rig allows hose assemblies to be pressure tested at up to 10,000 psi. A compressed air supply is required.
A 7/16" x 20 UNF female port is provided for connecting assemblies.

SP-825

UNIVERSAL TEST RIG

PART NO.
SP-825



Crimper
Part No: **GR30H**

Application :
The GR30H crimper is a self contained, hand operated hydraulic crimper used to crimp G-Line XF hose assemblies.
This versatile machine comes in a fitted steel box with enough space to store all the tooling and a full set of dies.

Please Note:
Additional power alternatives are available on request - Electric pump or pneumatic foot operated pump.



PART NO.	DESCRIPTION
GR30H	CRIMPER WITH HAND PUMP
GR30P	CRIMPER WITH PNEUMATIC PUMP

Crimper Die
Part No: **SP800 series**

Application :
Crimper Die
To Suit:
Crimper GR30H

Please Note:
Special dies for other applications are available on request



PART NO.	DIE	TO SUIT COLLAR
101083-04	-04	RCC910-04
101073-06	-06	RCC910-06
101073-08	-08	RCC910-08
101073-10	-10	RCC910-10
101073-12	-12	RCC910-12
101073-16	-16	RCC910-16
101073-20	-20	RCC910-20

Material Key
B: Brass, **C:** Stainless Steel, **CH:** Chrome Plated, **D:** Aluminium,
EN: Electroless Nickel, **P:** Zinc Plated Carbon Steel, **T:** Titanium

GOODRIDGE
 FLUID TRANSFER SYSTEMS

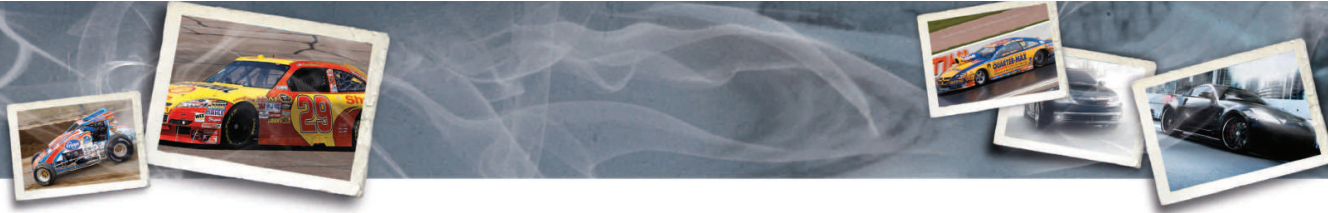

**STREET
 PERFORMANCE
 & RACING**

Technical Information

Correct Alignments

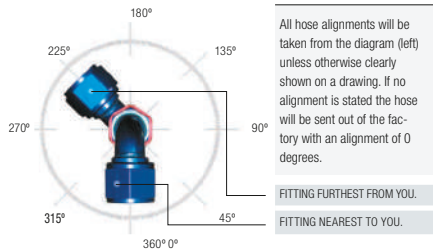

Correct Measurements

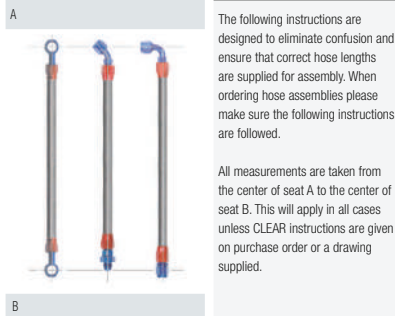

Hose Assembly Instructions

Wherever a hose assembly is used in either a static or dynamic flexing application, it is necessary to ensure that the center line bend radius is not taken below the minimum bend radius for the hose.

Hose assemblies should not be installed in such a manner that a torque loading is imposed, either during installation, or in subsequent use. Torque loading of the hose creates stresses in the hose, which can shorten the hose life, or cause the hose to collapse.

Whilst assembling the second end fitting, especially if it is a female union type or fitting, it is necessary to ensure that the final tightening of the nut does not also rotate the spigot, thus imposing the torque to the hose.

In the case of Re-usable fittings the hex on the body should be held with a spanner to prevent rotation.

When the hose includes elbow fittings at both ends, it is important to ensure the correct alignment of the elbows relative to each other during hose manufacture. It is important to ensure that the hose is connected the right way round when installed. When the hose has an elbow at one end and a straight fitting the other end, always connect the elbow end first, to prevent possible mis-alignment.

In applications where the hose undergoes dynamic flexing, it is necessary to ensure that all bends in the hose are in one plane.

A hose which is bent in two or more planes and then flexed is subject to torsional forces which may damage the hose.

Damage
 Any visible evident damage to the hose, such as broken strands of braid, or severe distortion of the hose, or damage to the end fittings is cause for the hose to be withdrawn from service. The cause of the damage should then be identified, and steps taken to ensure that it does not re-occur.

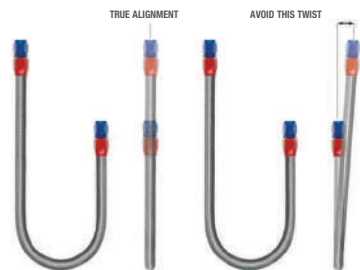

Terms and Conditions of Sale

Prices

Prices are in US dollars and are subject to change without notice. Quoted prices are valid for 30 days. Prices are suggested prices and possession of a price list does not guarantee the purchaser the prices therein. Your resale number must be provided for an opening order or sales tax may be charged depending on the state parts are delivered to. All prices exclude any freight charge or sales tax. Title of product transfers to buyer when product is paid in full.

Terms

Terms are Net 30 upon approval of credit. Orders can also ship COD or be paid with a credit card at time of shipment. Account is put on hold at 60 days from invoice date.

No shipments will be made until account is current. Finance charges of 1 ½% per month will be assessed on any past due amount retroactive to the original invoice date.

Freight

All orders are F.O.B. Goodridge USA Inc. locations in Torrance, CA, Mooresville, NC or Tijuana, Mexico. Please inspect all packages immediately. Any damaged goods or shortages must be reported promptly to the freight carrier and it is the buyer's responsibility to file a claim with the freight carrier. Non-shipping related damaged goods or shortages must be reported to the originating Goodridge facility within seven days of receipt of goods.

Returns

All sales are considered final. Authorization must be obtained before returning any merchandise and is at the sole discretion of Goodridge USA Inc. Please contact the originating facility of the goods to obtain the RGA number. All returns are subject to the inspection of the item by Goodridge. All returned items must be in resalable condition in their original sealed packaging. All unauthorized returns, those shipped freight collect or those that do not mark the RGA number on the outside of the carton will be refused and returned at the buyer's expense.

Any special orders cannot be returned unless incorrect or defective. An RGA number must be obtained from the originating Goodridge facility and a 35% handling charge will be deducted from the credit. Special order goods will not be accepted after 7 days from the delivery date.

Warranty

Goodridge USA Inc. warrants that all Goodridge products will be free from defects in material and workmanship for 90 days from the date of the original purchase. Goodridge will not be liable for any defect in the goods based on any drawing, design or specification provided by the buyer; for any defect based on wear and tear, willful damage, negligence, misuse, improper installation, alteration or repair; or if the parts have not been paid in full.

This warranty is limited to the repair or replacement of parts and shall not exceed the original price of the goods. The buyer must obtain an RGA number from the originating Goodridge facility and send the parts back at the buyer's expense. If the cause of failure is determined to be defective material or workmanship and not misuse, abuse, accident or improper installation, then Goodridge will repair or replace the product free of charge and return the product to the buyer at Goodridge expense. Goodridge shall not be liable for any special, incidental, progressive or consequential damages.

Material Key

B: Brass, **C:** Stainless Steel, **CH:** Chrome Plated, **D:** Aluminium, **EN:** Electroless Nickel, **P:** Zinc Plated Carbon Steel, **T:** Titanium

GOODRIDGE
FLUID TRANSFER SYSTEMS



PARTS INDEX

PART NO	PG	PART NO	PG	PART NO	PG	PART NO	PG	PART NO	PG	PART NO	PG	PART NO	PG
910-04	2	40776	7	GQD05PS06F	15	1136-01	21	185-45	31	AN837	41	993	54
910-06	2	4001DFLM	7	GQD05PS06LF	15	1136-45	21	185	31	AN938	42	773	54
910-08	2	4091DFM	7	GQD08PP06F	15	1136-90	21	185-06	31	AN924	42	1013	54
910-10	2	4824	7	GQD08PP06BF	15	1136-120	21	185-10	31	AN919	42	BL775	54
910-12	2	RCC910	7	GQD08PS06F	15	1136-150	21	185-01	31	AN971	42	BL992	54
910-16	2	4431	8	GQD08PS06LF	15	1136-180	21	185-90	31	AN824	42	BL993	54
910-20	2	4445	8	GQD08PP08F	15	1136-01	22	600-02	34	919	43	BN506	55
811-04	2	4446	8	GQD08PP08BF	15	1136-30	22	600-03	34	AN894	43	BN507	55
811-06	2	4046-08	8	GQD08PS08F	15	1136-120	22	600-03BK	34	AN95	43	BN508	55
811-08	2	4046-10	8	GQD08PS08LF	15	1136-150	22	600-03SB	34	10100	44	BN510	55
811-10	2	4461	8	GQDPC08	15	1136-45	22	600-03CB	34	10120	44	BN704	55
811-12	2	4476	8	GQD14PP12F	15	1136-60	22	600-03CL	34	10125	44	BNSB	55
811-16	2	4490	8	GQD14PP12BF	15	1136-90	22	600-03CLG	34	10324	44	BN-CAP	55
710-04	3	4491	8	GQD14PPL	15	1136-180	22	600-03EB	34	10716	44	592	56
710-06	3	44120	8	GQD14PS12F	15	236-01	23	600-03GN	34	10720	44	776	56
710-08	3	44150	9	W991-08DE	16	236-31	23	600-03OR	34	10916	44	593	56
710-10	3	44180	9	W991-10DE	16	236-45	23	600-03RD	34	FM10100	44	599	56
710-12	3	811-01	10	W991-12DE	16	236-60	23	600-03YE	34	FM10125	44	OR6290	58
710-16	3	812-45	10	W991-16DE	16	236-90	23	600-04	34	FM10324	44	445/CUW	58
710-20	3	811-45	10	W991-20DE	16	236-120	23	6001	35	FM10716	44	445/CW90158	58
910-06FC	3	811-30	10	W991-24DE	16	236-150	23	6045	35	AN816	45	SS902	58
910-08FC	3	812-90	10	W991-28DE	16	236-180	23	6090	35	AN823	45	FF572	59
4001	4	811-90	10	W991-32DE	16	236-01BK	24	6645	35	AN826	46	FF	59
4031	4	811-120	10	W991-40DE	16	236-45BK	24	6690	35	AN914	46	FCV	59
4046-08	4	811-150	10	W991-48DE	16	236-90BK	24	6046	35	AN916	46	PV72	59
4046-10	4	811-180	10	W903-08D	16	236-120BK	24	6091	35	AN825	46	FG900	60
4045	4	811-01	12	W903-10D	16	236-150BK	24	6120	35	AN915	46	TEXTALU	60
4046	4	811-45	12	W903-12D	16	236-180BK	24	6150	35	AN910	46	DR-25	60
4061	4	811-90	12	W903-16D	16	936	26	6180	35	AN911	47	TCD	60
4090	4	811-120	12	W903-20D	16	936	26	5091	36	AN912	47	SP-825	61
4091	4	811-150	12	W903-24D	16	936	26	5092	36	AN913	47		
4120	5	811-120	12	W903-28D	16	536-04	28	5093	36	AN917	47		
4150	5	GQD03BP03E	14	W903-32D	16	536-06	28	5095	36	AN932	47		
4180	5	GQD03BS03E	14	W903-40D	16	536-08	28	5096	36	306	48		
4441	5	GQD03BP03F	14	W903-48D	16	536-10	28	5097	36	305	48		
4046-08	5	GQD03BS03F	14	200-04	18	536-12	28	5098	36	CAB	49		
4046-10	5	GQD03BP04E	14	200-05	18	536-04B	28	5070	36	FB	49		
4001DFL	5	GQD03BS04E	14	200-06	18	536-06B	28	5099	36	GA	49		
4031DFL	5	GQD03BP04F	14	200-07	18	536-08B	28	5099S	36	CPL-824	50		
4046DFL	5	GQD03BS04F	14	200-08	18	536-10B	28	700K-03	37	CPL-450_	50		
4061DFL	5	GQD05BP04F	14	200-10	18	536-12B	28	700K-03BK	37	CPL-900_	50		
4091DFL	5	GQD05BS04F	14	200-12	18	536-90	29	700K-03BU	37	CPL-816	50		
4120DFL	5	GQD05BP04E	14	200-16	18	536-150	29	700K-03RD	37	CPL-910_	51		
4150DFL	5	GQD05BS04E	14	200-20	18	536-01E	29	700K-04BK	37	CPL	51		
4180DFL	5	GQD05BP06F	14	210-04	19	536-01	29	AN804	40	CPL-460_	51		
4016DBZ	6	GQD05BS06F	14	210-06	19	536-45	29	AN806	40	CPL-823	51		
4031DBZ	6	GQD08BP06F	14	210-08	19	536-120	29	AN814S	40	AN921	52		
4046DBZ	6	GQD08BS06F	14	210-10	19	536-180	29	AN814	40	AN922	52		
4046-08	6	GQD08BP08F	14	210-12	19	536-45E	29	AN815	40	FP192/199	52		
4046-10	6	GQD08BS08F	14	210-16	19	536-90E	29	AN818	40	FP190/FP191	52		
4061DBZ	6	GQD05PP04F	15	1136-01	20	536-01DBK	30	AN819	41	AN867	52		
4076DBZ	6	GQD05PP04BF	15	1136-45	20	536-90DBK	30	AN821	41	AN871	52		
4091DBZ	6	GQD05PS04F	15	1136-90	20	536-150DBK	30	AN827	41	AN971	52		
4120DBZ	6	GQD05PS04LF	15	1136-120	20	536-45DBK	30	AN832	41	775	54		
4150DBZ	7	GQD05PP06F	15	1136-150	20	536-120DBK	30	AN833	41	992	54		
4180DBZ	7	GQD05PP06BF	15	1136-180	20	536-180DBK	30	AN834	41	1012	54		