



# LIGHTING SYSTEMS CATALOG

LED Interior & Exterior | Trailer Kits | Power Cords | Emergency | Wire Harness | Off Road



**Grote**

# Grote: A Worldwide Leader in Vehicle Lighting and Safety Systems

**ECHOING OUR GROWING PROPORTION OF INTERNATIONAL BUSINESS, GROTE HAS TRANSITIONED FROM A NORTH AMERICAN-BASED INTERNATIONAL TO A TRUE MULTI-NATIONAL ORGANIZATION.**

Grote's Madison, Indiana facility is our international headquarters, where a large proportion of our strategic lighting development and manufacturing takes place. We are transitioning our non-U.S. facilities to true strategic design and production centers of excellence for the entire enterprise.



Grote Europe, Niederwinkling, Germany, is Grote's European headquarters and is responsible for design and production of lighting safety systems to meet specific European requirements.



Grote of Canada, located in Markham, Ontario, is the headquarters for the manufacturing and development of Grote's Accessory lines. Grote of Canada serves both the original equipment and aftermarket channels for the entire Canadian market, and its new state-of-the-art facility operates at the forefront of industry manufacturing and distribution efficiency.



Grote Electronics, located in Waterloo, Canada, is a state-of-the-art, high-volume manufacturing facility dedicated to assembling Grote's light emitting diode (LED) circuit boards and electronic-based specialty products. Today, we are leading the industry in LED technology, not only for exterior lighting solutions, but for interior designs as well.



Grote De Mexico, located in Monterrey, is responsible for development and production of Grote wiring and trailer harnesses, including Grote's patented ULTRA-BLUE-SEAL<sup>®</sup> pigtail and harness system.



Grote China, located in Shanghai, China is a wholly-owned, foreign enterprise of Grote Industries. Grote's new facility is the launching pad for our Asian OE business growth.



<b>Clearance / Marker Lamps</b>	21-54
<b>Stop / Tail / Turn Lamps</b>	55-84
<b>RV, Marine and Utility Trailer Lighting</b>	85-92
<b>License and Backup</b>	93-102
<b>Interior Lighting</b>	103-116
<b>Task Lighting</b>	117-118
<b>Work Lighting</b>	119-133
<b>Forward Lighting</b>	134-140
<b>Warning and Hazard</b>	141-160
<b>Flashers and Turn Signal Switches</b>	161-170
<b><u>Mirrors</u></b>	171-184
<b>Trailer Wiring and Communications Systems</b>	185-193
<b>Pigtails, Brackets and Grommets</b>	194-220
<b>Reflectors</b>	221-225
<b>Lenses</b>	226-230
<b>Technical Information</b>	231-264

# If you specify a Total Grote Lighting System, it is probable you will never incur unplanned maintenance caused by lighting.

Except for a catastrophic incident such as an accident, physical contact damage, or damage from a tire tread delamination, you should not incur unplanned downtime caused by lighting failure if you follow simple procedures during initial equipment acceptance and avoid certain practices that compromise the equipment.

## THE BENEFICIAL BOTTOM LINE SAVINGS OF INVESTMENT GRADE LIGHTING WILL BE SIGNIFICANT.

A 1,000 trailer fleet typically has 4,000 stop/tail/turn lamps in circulation. At a 3.5 year average life expectancy per bulb, divided by 365 days per year, that fleet will experience approximately 3 failures per day. Calculate that with your maintenance and lost load time and you will quickly begin to understand the significance.

### EXPECT THESE RESULTS:

- If you replace incandescent lighting, Grote guarantees a dramatic reduction in lighting-caused CSA points.
- In ten years, you will save approximately four times the cost of the entire lighting package.

### ACHIEVING A NO/LOW MAINTENANCE PROGRAM

#### Improve and Protect Your CSA Rating

##### Lamp and wiring malfunctions are a leading contributor to poor CSA scores.

Six points for a malfunctioning stop/tail/turn lamp, for instance. Poor CSA scores and high maintenance costs usually go hand in hand. If your lighting acquisition strategy is based on low initial cost, you'll probably end up with higher overall lighting costs – and most likely a higher CSA score.

That's why one of the best investments you can make in the profitability of your company is to use only Grote Investment Grade LED lamps, harnesses, and power cords – products that vastly outperform and outlast products from bargain basement suppliers.

Grote only provides Investment Grade products – that's why our products are worth your investment.

## The Financial Case Against Incandescent Stop/Tail/Turn Lamps

How much will a 1000 trailer fleet have to spend to save \$36,000 in initial cost?



# Grote LED Interior Lamps Provide the Right Kind of Light With a Full Range of Fixtures

## FULL RANGE OF FEATURES

LED technology models provide 50,000 hours of operation, low power draw (use 70% less power than incandescents), moisture and vibration protection, plus built-in automatic thermal protection.

## FULL RANGE OF STYLES

Low profile and recessed mount models maximize head and storage room. Many rectangular and circular styles to choose from. Custom shapes for specialized lighting requirements – stepwell, courtesy, compact, rope, beehive, map; some with manual, automatic, or sensor-driven switch-off features.



# UltraLink™ Power Cords: Superior Power Delivery

**GROTE'S ULTRALINK™ CORDS PROVIDE MAXIMUM RELIABILITY IN THE HARSHTEST ENVIRONMENTS.**

### Plug Design

Solid brass nickel-plated pins

Crush resistant weather-tight elastomeric material

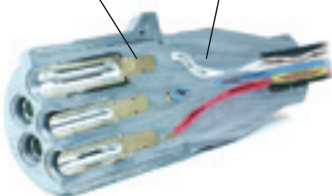

### Cable-to-Plug Seal

Wire jacket is molded into the plug with a patented bonding agent sealing it from the elements and eliminating the need for a spring



### Crush Resistant

Grote's UltraLink's crush-resistant design can survive the harshest environments while conventional hollow core designs are permanently deformed and rendered useless.



# Grote UBS™ Harness Systems: Designed to Prevent Unplanned Downtime

**GROTE'S UBS HARNESS SYSTEMS ARE DESIGNED TO PREVENT UNPLANNED DOWNTIME OVER THE LIFE OF THE VEHICLE. THEY'RE MODULAR FOR FLEXIBILITY AND TOTALLY SEALED TO LOCK OUT THE CORROSION FOUND IN TODAY'S HIGHWAY ENVIRONMENT.**

## **Grote's Double Seal Advantage**

The Double Seal is a molded-in circular ring that corresponds to the lamp connection. The inner sealing ring covers the terminal area. The outer ring seals around the outside area of the lamp plug connection creating the double seal.

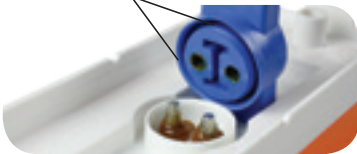

## **Avoid Corrosion**

Our exclusive locking collar prevents accidental disconnects, allows for dielectric grease applications and provides a means of securing the connection to the trailer.



## **Grote's Male Pin Termination**

Center grease reservoir protects against hydraulic pressure forcing connection open.

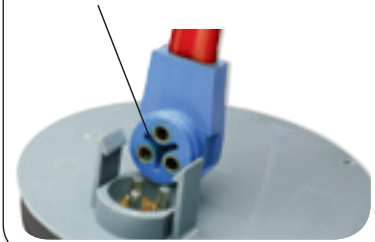

## **LOCKS OUT CORROSION**

Grote's UBS harness system is so corrosion resistant it may never need service in normal use. Both within harness and at critical harness/lamp connection, Grote's patented Double Seal design provides complete and permanent protection from moisture and contamination.

## **PREVENTS DANGEROUS SHORT CIRCUITS**

Grote's UBS male pin system is accepted in the market as superior to any other harness design. Solid, spun-brass terminals are tin-plated for maximum durability and corrosion resistance. Combining male pin lamps with female connectors on the wiring harness prevents the harness from causing shorts if ever disconnected from the lamps while on the road.

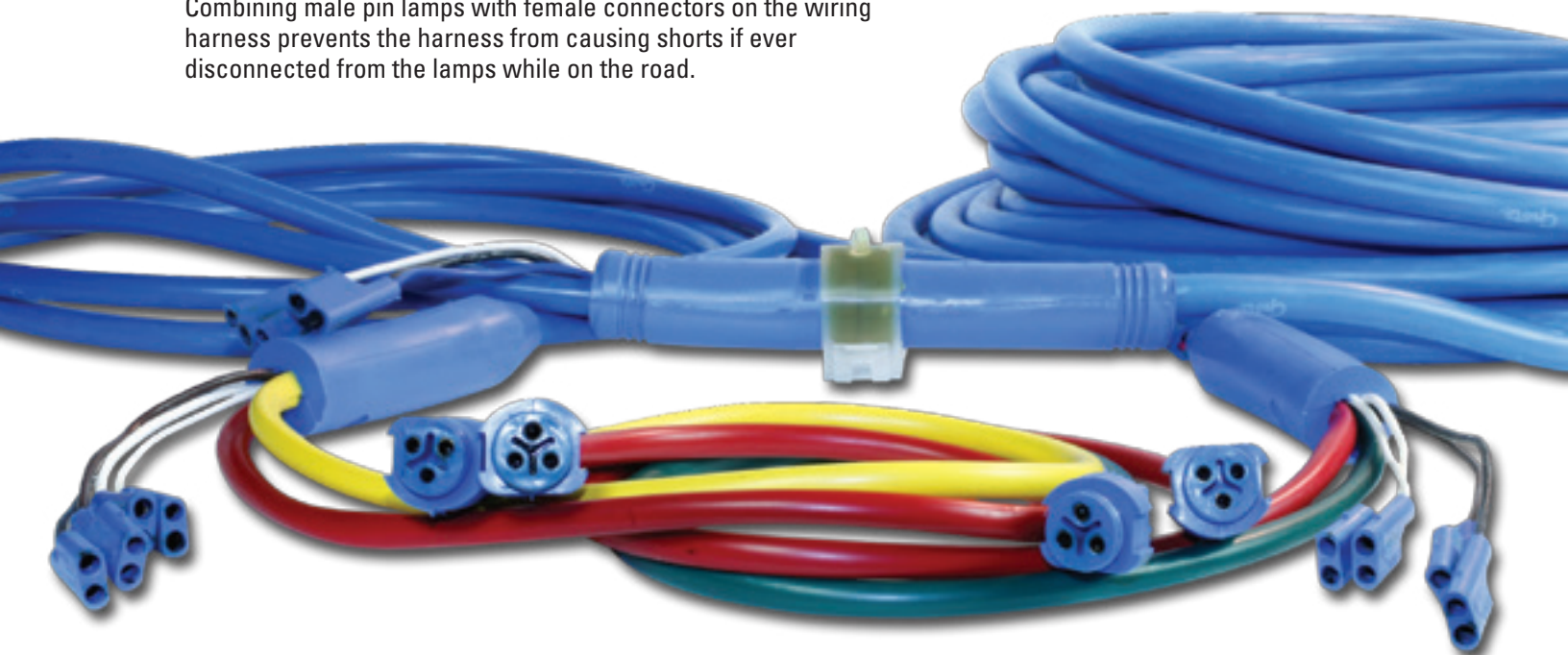

# Grote Knows Lighting

**GROTE KNOWS OPTIMUM PERFORMANCE IS CRITICAL IN TODAY'S RUGGED, HARSH AND DEMANDING ENVIRONMENTS. THAT'S WHY GROTE OFFERS A COMPLETE LINE OF ELECTRICAL CONNECTIONS AND ACCESSORIES.**

**WITH OVER 3000 PARTS AVAILABLE,** Grote is the ONLY full line lighting supplier that offers everything needed to connect and protect vehicle lighting and electrical systems. Grote's complete line of terminals and connectors, wire and cable products, and protective and support items as well as switches and electrical assemblies, trailer connectors, battery connectors and cables and tools, gives you everything you need to meet the repair, maintenance and installation needs of today's vehicles.

**PROFESSIONALS CHOOSE GROTE** products to ensure top performance and professional results. Quality lighting and electrical connections and accessories....**GROTE'S GOT IT!**



# Grote LED Work Lamps: High Output, Ultra Rugged

## WHEN THE WORK JUST HAS TO GET DONE

### **HIGH OUTPUT:**

Advanced LED technology plus sophisticated reflector optics waste less light, put more usable light on the task.

### **ULTRA RUGGED:**

Field tested to excel in brutal off-road conditions. SAE J575E-compliant designs protect against vibration, corrosion, moisture, dust, and most direct impacts.

### **COLOR TEMPERATURE OPTIMIZED FOR PRODUCTIVITY:**

Noon time sun-like color temperature output allows work crews to do better work over longer periods of time without eye fatigue.

**READY FOR ANYTHING:** Grote work lamps provide superior performance on mining, construction, off road, agriculture, utility, and emergency vehicles.





# 4<sup>IN</sup>1

## *Four Functions in One Lamp*



### ***CHANGE TO THE NEW 4<sup>IN</sup>1 INTEGRATED BACK-UP LIGHTS FROM GROTE***

As an all-in-one stop, tail, turn, back-up combination light, Grote's patented integrated technology lets you save time, money and space on both installation and maintenance.

These new lights fit most standard 4-inch round or 6-inch oval mounting hardware, and allow for fewer lamps, connections, and mounting holes resulting in a more robust system, less frequent repairs and decreased time off the road awaiting parts.



# *Rugged, dependable coverage for safety and security*

## ***GROTE RADIUS LIGHT: THE IDEAL LIGHT SOURCE FOR ANYWHERE YOU ENTER OR EXIT THE VEHICLE.***

Thanks to Grote's Radius Light, you now have clear, bright illumination—so there is less need to worry about injury.

### ***EASY TO INSTALL***

Included with Grote's Radius Light are both a spacer and a gasket to make it easy to install on any vehicle. Additionally it comes with easy to follow step by step installation instructions.

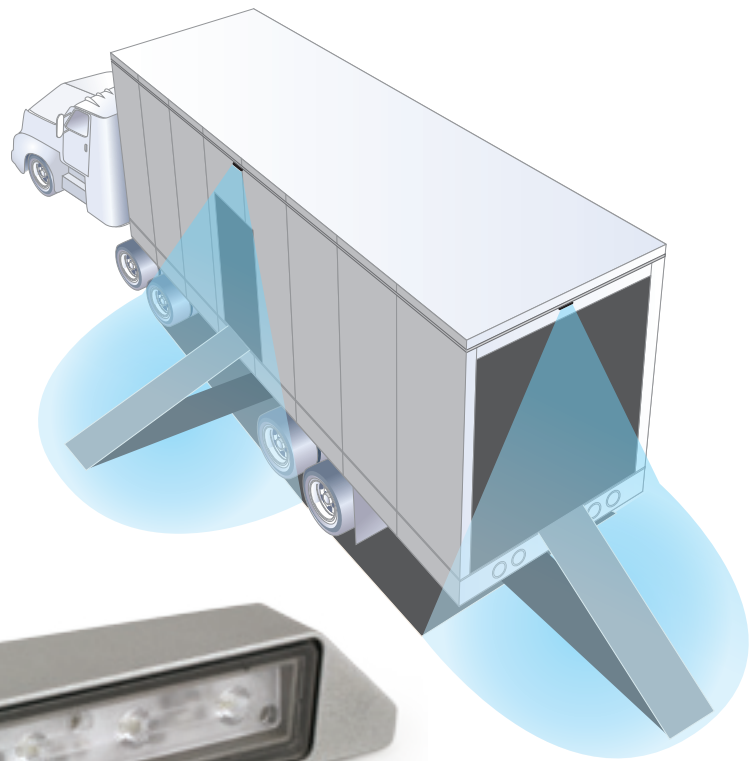

## Grote Product Numbering System

Grote uses a meaningful product numbering system that makes it possible to quickly locate the correct product and verify the correct product has been selected. The typical Grote part number contains five digits, followed by a hyphen, followed by a single digit. Here's what it all means.

The first four digits or alpha characters (00000-0) indicate the product category.

0000 Displays  
 4000 Reflectors  
 4210 Brackets and Permit Holders  
 4400 Switches  
 4450 Flashers  
 4500 Clearance/Marker/Cab/ID or Bar Lamps  
 4600 Clearance/Marker/Cab/ID or Bar Lamps  
 4700 Clearance/Marker/Cab/ID or Bar Lamps  
 4800 Turn Signal Switch  
 4900 Clearance/Marker/Cab/ID or Bar Lamps  
 5000 Combination STT or single function turn lamps  
 5100 Combination STT or single function turn lamps  
 5200 Combination STT or single function turn lamps  
 5300 Combination STT or single function turn lamps  
 5400 Combination STT or single function turn lamps  
 5500 Combination STT or single function turn lamps  
 5600 Combination STT or single function turn lamps  
 5700 Combination STT or single function turn lamps  
 5800 Combination STT or single function turn lamps  
 5900 Combination STT or single function turn lamps  
 6000 License Lamp/Courtesy Lamps  
 6100 Dome/Map/Stepwell  
 6200 Backup lamps  
 6300 Flood/Fog/Tractor/Driving Lamp  
 6400 Flood/Fog/Tractor/Driving Lamp  
 6500 Boat Kits  
 6600 Spliceless Harness System  
 6700 Wire Kits/Pigtail and wire ass'y European System  
 6750 Rear Sills  
 6800 Wire Kits/Pigtails  
 6850 Main Harnesses  
 6900 T/S harness Kits  
 7000 Flags  
 7100 Flares  
 7200 Fuses and Horns  
 7300 Backup Alarms  
 7600 Roto Beacons  
 7700 School Bus  
 7800 Warning  
 8200 Military Lamps  
 8300 Military Lamps  
 8500 Automotive Replacement lenses  
 8600 Automotive Replacement lenses  
 8700 Cable Assemblies  
 8720 7 Way Plug and Socket  
 8730 7 Way Plug and Socket

8740 Spring  
 8750 Inserts used on 6/7 plug and sockets  
 8760 Boots  
 8770 Replacement motors and elec. Equip.  
 9000 Lens Assemblies  
 9800 Misc. Packaged Items  
 9900 Misc. Packaged Items

The next digit or alpha character (00000-0) indicate the product color or finish.

Lens	Finish
0 2 colors	
1 Clear, white or moonstone	1 White
2 Red	2 Black
3 Yellow	3 Chrome/Stainless Steel
4 Green	4 Aluminum
5 Blue	5 Zinc

The sixth digit (00000-0) indicates packaging.

0 Item only  
 1 Ind. Display  
 2 Ind. Plain  
 3 Bulk  
 4 Pair Pack  
 5 Bubble Pack, Display Pack, Clam Shell or Retail Pack (Crystal-Pack or Slide Lock)  
 6 Fleet Pack  
 7 Multiple Pack (Kit)

The absence of the sixth digit indicates product is in standard shelf packaging, e.g., individual pack or polybag, and in the case of lenses a standard shelf pack will have 6 to 12 to a container. Refer to your price sheet for exact quantity and other pack types.

### Reference Notes:

For each product listing we have included the latest applicable Federal Motor Vehicle Standards [FMVSS], SAE code and technical specifications. In this area we have also listed related accessory items such as Pigtails, Brackets and Grommets.

The part numbers listed are suggested items; they may not be the only alternative. However, additional part numbers that may better fit your application can be located in the Pigtails, Brackets and Grommets section.

\* Some of the foregoing marks, including those identified with an asterisk, are names or marks of third-parties who are not affiliated with Grote Industries, Inc.

**NEW** = New

**PC** = PC lamp rating

**ECE** = ECE

**24** = 24 Volts

**MULTI** = Multiple Voltage

**RETAIL** = Retail Packaging

**FOG** = Compliant for J583 2004

<i>Model No.</i>	<i>Page</i>	<i>Model No.</i>	<i>Page</i>	<i>Model No.</i>	<i>Page</i>	<i>Model No.</i>	<i>Page</i>	<i>Model No.</i>	<i>Page</i>
01-5444-73.....	70	63J31.....	122	12053.....	175	28033.....	175	41032.....	223
01-5445-73.....	70	63L31.....	120	12071.....	179	28033-5.....	175	41032-5.....	223
61E01.....	105	63L41.....	120	12072.....	179	28041.....	175	41033.....	223
61E11.....	105	63L51.....	120	12073.....	179	28042.....	175	41033-5.....	223
61E31.....	105	63L61.....	120	12073-5.....	179	28043.....	175	41042.....	223
61E41.....	105	63L71.....	120	12101.....	180	28051.....	181	41043.....	223
61E51.....	105	63L81.....	120	12102.....	180	28063.....	178	41050.....	221
61E61.....	103	64E01.....	125	12111-5.....	179, 180	28091-5.....	180	41080.....	221
61E81.....	109	64E01-5.....	125	12113-5.....	179, 180	28093-5.....	180	41121.....	221
61E91.....	109	64E11.....	125	12122.....	181	28152.....	175	41122.....	221
61F01.....	109	64E11-5.....	125	12153.....	178	28162.....	175	41133.....	221
61F11.....	109	64F01.....	125	12164.....	182	28193.....	177	41142.....	222
61F30.....	104	64F11.....	125	12164-5.....	182	28252-5.....	181	41142-5.....	222
61F40.....	104	64G01.....	125	12172.....	176	28293-5.....	180	41143.....	222
61F51.....	104	64G01-5.....	125	12173.....	176	28323-5.....	180	41152.....	222
61F61.....	103	64G11.....	125	12182.....	176	28393-5.....	181	41153.....	222
61F81.....	109	64G11-5.....	125	12183.....	176, 177, 178	28443.....	177	41160.....	221
61G01.....	109	64H01-1.....	128	12193-5.....	180	28453.....	179	41271.....	221
61G21.....	103	64H01-5.....	128	12201-5.....	182	28461.....	171	41273.....	221
61G31.....	109	64J11.....	126	12243-5.....	179	28463.....	171	42052.....	212
61G81.....	109	64J21.....	126	12263-5.....	181	28481.....	178	42063.....	201
61G91.....	105	64J31.....	126	12272-5.....	176	28491.....	178	42070.....	208
61H01.....	105	64J41.....	126	12283.....	176	28493.....	178	42103.....	214
61H11.....	105	64J51.....	126	12293.....	176	28663.....	175	42110.....	206
61H21.....	105	64M11-5.....	117	12301.....	179	28763.....	181	42112.....	206
61H31.....	105	02001-4.....	138	12303.....	179	29060.....	175	42120.....	206
61H41.....	105	05001-5.....	138	12312-5.....	182	40052.....	223	42131.....	206
61H51.....	105	05041-5.....	138	12331.....	179	40052-5.....	223	42141.....	207
61H91.....	103	05051-5.....	138	12333.....	179	40053.....	223	42152.....	214
61M11.....	103	05151.....	138	12813.....	176	40053-5.....	223	42153.....	214
63E01.....	119	05301-5.....	138	12983.....	176	40062.....	223	42162.....	207
63E11.....	119	06001-4.....	138	16021.....	172	40063.....	223	42170.....	204
63E21.....	119	06013-4.....	138	16023.....	172	40072.....	223	42180.....	204
63E23.....	119	06021-4.....	138	16032.....	176	40072-5.....	223	42190.....	201
63E31.....	119	06201.....	138	16033.....	176	40073.....	223	42282.....	208
63E41.....	124	6608-E9.....	188	16041.....	171	40073-5.....	223	42292.....	208
63E51.....	124	6608-F9.....	188	16043.....	171	40092.....	224	42302.....	208
63E61.....	124	07001-4.....	139	16053.....	171	40093.....	224	42312.....	208
63E71.....	124	07021-4.....	139	16091.....	174	40132.....	222	43022.....	218
63E81.....	120	07401.....	139	16092.....	174	40132-5.....	222	43022-5.....	218
63E91.....	120	07803.....	139	16093.....	174	40133.....	222	43030.....	210
63F01.....	120	09561.....	228	16101.....	173	40133-5.....	222	43040.....	202
63F11.....	120	09681.....	228	16102.....	173	40152.....	224	43050.....	206
63F21.....	120	09781.....	228	16123.....	172	40153.....	224	43074.....	209
63F31.....	120	09793.....	228	16142.....	173	40162.....	224	43100.....	215
63F41.....	120	10002.....	183	16153.....	173	40163.....	224	43112.....	216
63F51.....	120	10012.....	183	16202.....	172	40192.....	224	43120.....	210
63F61.....	120	10013.....	183	16244.....	172	40193.....	224	43144.....	210
63F71.....	120	10025.....	183	16273.....	173	40232.....	224	43150.....	202
63F81.....	121	10045.....	183	16284.....	173	40232-5.....	224	43152.....	202
63F81-5.....	121	10073.....	183	16294.....	173	40233.....	224	43153.....	202
63F91.....	121	10173.....	184	16304.....	173	40233-5.....	224	43160.....	203
63G01.....	121	10433.....	177	18103-5.....	182	40302.....	222	43162.....	203
63G11.....	121	10623.....	183	18252-5.....	182	40303.....	222	43163.....	203
63G21.....	121	11133.....	184	18302-5.....	182	40440-5.....	222	43172.....	214
63G31.....	121	11195.....	178	22013.....	174	40460-5.....	222	43212.....	215
63G81.....	122	11293.....	184	22063.....	174	40641.....	221	43220.....	214
63G91.....	122	11303.....	184	22193.....	177	40641-5.....	221	43222.....	214
63H01.....	127	12004.....	182	22232.....	174	40650.....	221	43223.....	214
63H11.....	127	12004-5.....	182	22233.....	174	40650-5.....	221	43240.....	152
63H31.....	119	12010.....	177	26001-5.....	174	40701.....	221	43230.....	210
63H81.....	127	12014.....	182	26012-5.....	174	41002.....	223	43253.....	212
63J01.....	122	12014-5.....	182	26021-5.....	173	41003.....	223	43262-5.....	218
63J11.....	122	12020.....	177	28031.....	175	41012.....	224	43272.....	218
63J21.....	122	12052.....	175	28032.....	175	41013.....	224	43272-5.....	218

<i>Model No.</i>	<i>Page</i>	<i>Model No.</i>	<i>Page</i>	<i>Model No.</i>	<i>Page</i>	<i>Model No.</i>	<i>Page</i>	<i>Model No.</i>	<i>Page</i>
43282.....	215	44730.....	163	45382.....	35	46073.....	45	46873.....	44
43292.....	215	44740.....	157	45383.....	35	46082.....	45	46873-5.....	44
43300.....	217	44810.....	162	45412.....	28	46083.....	45	46882.....	36
43325.....	217	44810-5.....	162	45412-5.....	28	46092.....	47	46882-5.....	36
43335.....	217	44820.....	162	45413.....	28	46132.....	23	46883.....	36
43343.....	212	44840-5.....	140	45413-5.....	28	46133.....	23	46883-5.....	36
43362.....	214	44850.....	162	45432.....	38	46142.....	26	46892.....	48
43370.....	206	44860.....	162	45433.....	38	46143.....	26	46892-5.....	48
43380.....	207	44890.....	161	45442.....	46	46282.....	47	46893.....	48
43390.....	209	44891.....	161	45443.....	46	46283.....	47	46893-5.....	48
43411.....	219	44892.....	163	45462.....	46	46292.....	47	46983.....	37, 86, 87
43424.....	219	44893.....	163	45463.....	46	46293.....	47	46902.....	35
43430.....	204	44910.....	116	45503.....	53	46302.....	46	46903.....	35
43512.....	205	45002-5.....	33	45512.....	36	46303.....	46	46913.....	53
43522.....	205	45003-5.....	33	45512-5.....	36	46322.....	54	46922.....	35
43532.....	205	45012.....	48	45513.....	36	46323.....	54	46933.....	35
43540.....	216	45013.....	48	45513-5.....	36	46332.....	54	46982-5.....	37, 87
43572.....	212	45021-5.....	115	45522.....	36	46333.....	54	46983-5.....	37, 87
43642.....	213	45022.....	30	45523.....	36	46392.....	36	47012.....	33
43651.....	218	45022-5.....	30	45562.....	24	46392-5.....	36	47013.....	33
43652.....	218	45023.....	30	45563.....	24	46393.....	36	47051.....	37
43655.....	212	45023-5.....	30	45572.....	40	46393-5.....	36	47052.....	37
43673.....	210	45042.....	28	45573.....	40	46412.....	31	47053.....	37
43673-5.....	210	45043.....	28	45582.....	40	46412-5.....	31	47063.....	52
43684.....	187	45062.....	24	45583.....	40	46413.....	31	47072.....	43
43690.....	204	45063.....	24	45593.....	40	46413-5.....	31	47073.....	43
43723.....	214	45072.....	28	45603.....	40	46422-5.....	31	47082.....	30
43732.....	213	45073.....	28	45613.....	40	46423-5.....	31	47083.....	30
43744.....	217	45092.....	32	45623.....	40	46433.....	52	47092.....	31
43760.....	205	45093.....	32	45633.....	40	46493-5.....	38	47093.....	31
43780.....	209	45102.....	35	45643.....	40	46543.....	53	47102.....	25
43783.....	209	45103.....	35	45662.....	42	46543-5.....	53	47103.....	25
43790.....	209	45132.....	35	45663.....	42	46702.....	37	47112.....	23
43823.....	204	45133.....	35	45672.....	35	46703.....	37	47113.....	23
43830.....	208	45142.....	32	45673.....	35	46703-5.....	37	47122.....	26
43842.....	218	45143.....	32	45712.....	42	46712.....	37	47123.....	26
43850.....	209	45162.....	31	45713.....	42	46712-5.....	37	47162.....	43
43901.....	220	45163.....	31	45762.....	41	46713.....	37	47163.....	43
43942.....	216	45172.....	47	45763.....	41	46713-5.....	37	47183.....	52
43952.....	215	45173.....	47	45772.....	41	46740.....	32	47202.....	26
43960.....	207	45182.....	28	45773.....	41	46742.....	32	47212.....	24
43962.....	207	45183.....	28	45783.....	41	46742-5.....	32	47213.....	24
43970.....	206	45202.....	24	45792.....	41	46743.....	32	47222.....	29
43980.....	206	45203.....	24	45793.....	41	46743-5.....	32	47223.....	29
44010.....	166	45222.....	28	45811.....	112	46772.....	39	47232.....	26
44030.....	166	45223.....	28	45812.....	28	46773.....	39	47233.....	26
44070.....	166	45232.....	33	45812-5.....	28	46782.....	39	47242.....	34
44090.....	161	45233.....	33	45813.....	28	46783.....	39	47243.....	34
44110.....	161	45242-5.....	33	45813-5.....	28	46791.....	112	47252.....	42
44134.....	157	45243-5.....	33	45821.....	94	46792.....	39	47253.....	42
44140.....	162	45252.....	35	45822.....	24	46792-5.....	39	47262.....	42
44160.....	161	45252-5.....	35	45822-5.....	24	46793.....	39	47263.....	42
44242.....	116	45253.....	35	45823.....	24	46793-5.....	39	47322.....	26
44380.....	116	45253-5.....	35	45823-5.....	24	46802.....	45	47323.....	26
44421.....	157	45262.....	38	45832.....	28	46803.....	45	47332.....	23
44440.....	115	45262-5.....	38	45833.....	28	46813.....	52	47333.....	23
44460.....	166	45263.....	38	45853.....	41	46823.....	51	47352.....	43
44530.....	162	45263-5.....	38	45932.....	38	46832.....	44	47353.....	43
44530-5.....	162	45282.....	22	45932-5.....	38	46832-5.....	44	47362.....	34
44540.....	162	45283.....	22	45933.....	38	46833.....	44	47363.....	34
44540-5.....	162	45302.....	21, 22	45933-5.....	38	46833-5.....	44	47372.....	26
44690.....	162	45303.....	21, 22	45973-5.....	85	46862.....	45	47373.....	26
44700.....	162	45322.....	29	45993.....	54	46863.....	45	47423.....	26
44710.....	163	45323.....	29	46003.....	52	46872.....	44	47462.....	34
44720.....	163	45333.....	53	46072.....	45	46872-5.....	44	47463.....	34

<i>Model No.</i>	<i>Page</i>	<i>Model No.</i>	<i>Page</i>	<i>Model No.</i>	<i>Page</i>	<i>Model No.</i>	<i>Page</i>	<i>Model No.</i>	<i>Page</i>
47472	26	49333	21	51942	88	52812	76	53623	63
47473	26	49341	21	51962	85, 91	52822	76	53630	72
47492	31	49342	21	51962-5	85	52832	76	53640	72
47493	31	49343	21	51972	91	52892	65	53650	72
47502	33	49351	21	51972-5	85, 91	52892-5	65	53662	87
47503	33	49352	21	51982	86	52893	65	53672	87
47732	43	49353	21	51982-5	86	52893-5	65	53702	73
47733	43	49362	21	51992	86	52902	74	53712	73
47772	40	49363	21	51992-5	86	52912	74	53722	74
47773	40	49372	22	52002	91	52922	59	53762	74
47852-5	86	49373	22	52023	68	52922-5	59	53782	73
47853-5	86	49382	22	52062	68	52923	59	53792	73
47912	42	49383	22	52063	68	52972	77	53812	88
47913	42	49392	43	52072	63	53000	81	53822	88
47922	42	49393	43	52073	63	53012	59	53833	69
47923	42	49412	21	52082	90	53012-5	59	53853	69
47952	22	49413	21	52092	55	53020	81	53883	83
47953	22	49452	21	52093	55	53023	81	53962	63
47962	22	49453	21	52112	91	53032	81	53963	63
47963	22	49460	22	52122	91	53052	81	53972	63
47972	22	50132	84	52152	58	53053	81	53973	63
47973	22	50222	61	52153	58	53062	69	54002	70
47982	22	50232	61	52162	56	53063	69	54003	43, 44, 70
47983	22	50232-5	61	52163	56	53082-5	86	54012	69
48072	167	50352	83	52182	66	53092	66	54032	55
48132	169	50502	61	52182-5	66	53093	66	54042	55
48272	167	50532-5	87	52183	66	53100	58	54132	63
48282	167	50542	87	52183-5	66	53102	58	54133	63
48283	170	50542-5	87	52193	68	53102-5	58	54142	63
48284	170	50630	82	52202	71	53103	58	54143	63
48402	167	50630-5	82	52203	71	53112	58	54162	64
48432	170	50642	82	52253	68	53122	63	54163	64
48442	170	50642-5	82	52302	86	53123	63	54172	64
48522	169	50652	82	52302-5	86	53132	71	54173	64
48532	168	50662	82	52312	86	53133	71	54183	67
48542	169	50762	91	52312-5	86	53163	69	54193	67
48552	169	50820	60	52362	92	53182	56	54203	67
49002	49	50852	77	52372	92	53192	56	54213	67
49062	50	50852-5	77	52423	67	53252	55	54223	67
49072	51	50862	77	52442	87	53253	55	54233	67
49082	51	50862-5	77	52452	87	53272	55	54243	67
49112	51	50872	78	52482	88	53273	55	54253	67
49112-5	51	50872-5	78	52492	88	53282	55	54263	67
49122	50	50882	78	52512	68	53292	55	54332	57
49132	49	50892	78	52513	68	53293	55	54333	57
49140	205	50902	75	52522	61	53302	55	54342	58
49142	48	50912	75	52533	68	53303	55	54343	58
49162	48	50920	72	52543	68	53312	56	54362	57
49172	49	50942	75	52553	68	53313	56	54363	57
49173	49	50952	75	52562	65	53322	56	54472	57
49182	49	50972	76	52563	65	53342	55	54482	57
49192	50	50972-5	76	52572	65	53413	56	54483	57
49202	50	50992	75	52573	65	53422	83	54492	57
49212-5	51	51002	59	52582	65	53432	55	54493	57
49223	50	51012	59	52592-5	65	53462	55	54562	56
49242-5	50	51022	60	52602	77	53493	66	54572	57
49252	34	51032	60	52612	60	53523	56	54582	57
49262	21	51042	90	52672	58	53532	55	54593	46
49263	21	51052	59	52682	58	53552	55	54602	57
49253	34	51090	212	52770	58	53553	55	54622	55
49282	21	51142	90	52772	58	53582	70	54633	57
49283	21	51242	90	52772-5	58	53592	63	54643	57
49322	21	51242-5	90	52773	58	53593	63	54663	46
49323	21	51342-5	90	52782	58	53612	59	54672	62
49332	21	51932	88	52802	76	53622	63	54682	62

<i>Model No.</i>	<i>Page</i>	<i>Model No.</i>	<i>Page</i>	<i>Model No.</i>	<i>Page</i>	<i>Model No.</i>	<i>Page</i>	<i>Model No.</i>	<i>Page</i>
54702.....	62	60351.....	112	61961.....	104	63610.....	123	64943.....	131
54722.....	62	60361.....	113	61991.....	104	63611.....	123	64971.....	107
54752.....	62	60381.....	93	62011.....	101	63611-5.....	123	64991.....	132
54762.....	62	60391.....	109	62021.....	101	63621.....	123	65190-5.....	87
55092.....	61	60401.....	109	62021-5.....	101	63621-5.....	123	65202.....	31
55103.....	56	60411.....	111	62051.....	100	63651.....	123	65203.....	31
55162.....	55	60421.....	110	62091.....	98	63661.....	123	65230-5.....	87
55202.....	55	60460.....	95	62101.....	98	63671.....	124	65240-5.....	87
55212.....	55	60481.....	115	62111.....	99	63681.....	124	65300-5.....	88
55220.....	82	60561.....	111	62121.....	98	63691.....	124	65312.....	88
55220-5.....	82	60571.....	112	62151.....	102	63731.....	123	65320-5.....	86
55223.....	82	60581.....	109	62171.....	98	63741.....	123	65330-5.....	86
55223-5.....	82	60591.....	109	62181.....	98	63751.....	123	65350-5.....	87
55243.....	82	60631.....	96	62211.....	97	63761.....	124	65370-5.....	86
55280.....	81	60651.....	93	62221.....	97	63771.....	124	65380-5.....	86
55290.....	81	60661.....	93	62231.....	100	63821.....	127	65390-5.....	85
55340.....	79	60671.....	93	62241.....	100	63821-5.....	127	65402-4.....	89
55410.....	79	60681.....	93	62251.....	100	63831.....	127	65410-5.....	85
55420.....	79	60691.....	93	62271.....	97	63831-5.....	127	65432-4.....	89
55430.....	80	60701.....	93	62291.....	102	63861.....	127	65440-5.....	88
55440.....	80	60711.....	93	62321.....	98	63861-5.....	127	65512.....	34
55450.....	80	60721.....	92, 93, 113	62331.....	97	63871.....	127	65513.....	34
55460.....	80	60824.....	23	62381.....	101	63871-5.....	127	65720-5.....	89
55470.....	79	60841.....	118	62391.....	97	63901.....	124	65730-5.....	89
55572.....	58	60841-3.....	118	62401.....	97	63921.....	131	65870-5.....	85
55573.....	58	61021.....	107	62521.....	101	63941.....	131	65880-5.....	85
55772.....	65	61031.....	104	62561.....	99	63971.....	127	66071.....	188
55773.....	65	61051.....	107	62571.....	97	63981.....	119	66081.....	188
55982.....	83	61061.....	108	62591.....	99	63981-5.....	119	66100.....	191
55983.....	83	61091.....	108	62601.....	99	63991.....	119	66101.....	191
55992.....	83	61091-5.....	108	62691.....	98	63991-5.....	119	66110.....	191
55993.....	83	61111.....	103	62751.....	100	64061-5.....	137	66111.....	198
56000.....	81	61121.....	106	62781.....	98	64071.....	137	66113.....	191
56020.....	81	61131.....	106	62791.....	98	64101.....	132	66121.....	192
56052.....	81	61141.....	107	62811.....	98	64231.....	131	66122.....	191
56053.....	81	61161.....	108	63051.....	102	64241.....	136	66123.....	191
56072.....	84	61171.....	105	63111-5.....	133	64251.....	136	66124.....	191
56073.....	84	61221.....	110	63121-5.....	133	64261-4.....	136	66125.....	191
56083.....	84	61261.....	103	63131-5.....	133	64271.....	136	66133.....	193
56150-5.....	78	61281.....	109	63151-5.....	133	64281.....	136	66135.....	193
56160-5.....	78	61291.....	103	63161-5.....	133	64291-4.....	136	66141.....	193
56170-5.....	78	61301.....	110	63171-5.....	133	64341.....	131	66143.....	193
56180-5.....	78	61371.....	106	63181-5.....	134	64351-5.....	137	66145.....	193
60001.....	95	61391.....	106	63191-5.....	134	64371-5.....	136	66150.....	193
60011.....	95	61401.....	106	63201-5.....	134	64391.....	131	66151.....	193
60011-5.....	95	61411.....	106	63211-5.....	133	64401-5.....	137	66152.....	193
60081.....	96	61421.....	106	63221-5.....	133	64411.....	132	66153.....	193
60101.....	114	61431.....	107	63231-5.....	133	64441.....	132	66154.....	193
60101-5.....	114	61451.....	107	63241-5.....	133	64461.....	132	66155.....	193
60121.....	95	61461.....	107	63251-5.....	134	64471.....	131	66160.....	191
60131.....	96	61491-5.....	110	63291-5.....	132	64481-5.....	137	66161.....	191
60151.....	114	61501.....	115	63301-5.....	132	64491.....	131	66162.....	191
60151-5.....	114	61501-5.....	115	63321-5.....	133	64501-5.....	137	66163.....	191
60191.....	94	61511.....	103	63381.....	136	64541-5.....	134	66164.....	192
60251.....	113	61611.....	103	63391.....	136	64611.....	133	66165.....	193
60251-5.....	113	61760.....	104	63451-4.....	136	64621.....	133	66170.....	190
60261.....	95	61791.....	108	63531.....	137	64890.....	133	66171.....	193
60271.....	111	61793.....	108	63551.....	132	64891.....	133	66190.....	192
60280.....	95	61811.....	108	63561.....	107	64901.....	134	66200.....	192
60291.....	95	61821.....	108	63571.....	124	64921.....	132	66210.....	192
60301.....	111	61861.....	104	63581.....	124	64930.....	219	66220.....	192
60311.....	102	61871.....	104	63591.....	124	64931.....	132	66221.....	192
60321.....	94	61881.....	103	63601.....	123	64931-5.....	132	66222.....	192
60331.....	94	61890.....	104	63601-5.....	123	64940.....	131	66223.....	189
60341.....	93	61931.....	104	63602.....	123	64941.....	131	66224.....	189

<i>Model No.</i>	<i>Page</i>	<i>Model No.</i>	<i>Page</i>	<i>Model No.</i>	<i>Page</i>	<i>Model No.</i>	<i>Page</i>	<i>Model No.</i>	<i>Page</i>
66225.....	191	67014.....	198	73140-5.....	160	77615.....	143	87190.....	185
66311.....	189	67016.....	197	73150-5.....	160	77623.....	143	87193.....	185
66360.....	195	67020.....	198	73160.....	158	77643.....	144	87210.....	188
66701.....	189	67050.....	194	73220.....	159	77653.....	144	87211.....	188
66702.....	189	67050-5.....	194	73240.....	159	77671.....	142	87212.....	188
66705.....	188	67070.....	195	73250.....	159	77673.....	142	87214.....	188
66711.....	189	67071.....	195	76032.....	151	77693.....	143	87215.....	188
66800.....	194	67090.....	197	76033.....	151	77713.....	144	87220.....	186
66801.....	194	67090-5.....	197	76035.....	151	77753.....	151	87240.....	186
66810.....	199	67120.....	194	76043.....	149	77773.....	155	87250.....	186
66811.....	197	67150.....	211	76053.....	149	77813.....	141	87270.....	186
66812.....	197	67151.....	213	76063.....	149	77823.....	141	87590.....	187
66813.....	199	67250.....	190	76083.....	150	77833.....	141	87781.....	157
66814.....	199	67260.....	190	76183.....	149	77843.....	141	87790.....	158
66815.....	196	67270.....	190	76203.....	149	77873.....	148	87830.....	187
66816.....	196	67271.....	190	76223.....	148	77912.....	147	87860.....	186
66820.....	199	67301.....	190	76253.....	141	77913.....	147	90011.....	228
66823.....	199	67302.....	190	76333.....	148	77923.....	147	90012.....	228
66825.....	197	67303.....	190	76443.....	150	77931.....	156	90012-5.....	228
66826.....	199	67304.....	190	76493.....	146	77932.....	156	90013.....	228
66830.....	200	67305.....	190	76653.....	155	77933.....	156	90051.....	228
66831.....	200	67315.....	192	76663.....	148	77953.....	141	90052.....	228
66831-5.....	200	67400.....	190	76683.....	150	78002.....	84	90053.....	228
66836.....	200	67401.....	190	76685.....	150	78003.....	84	90062.....	228
66840.....	194	67402.....	190	76703.....	152	78150.....	84	90063.....	228
66841.....	196	67403.....	190	76770.....	151	78152.....	84	90072.....	228
66842.....	196	67404.....	190	76793.....	156	78153.....	84	90073.....	228
66843.....	197	67405.....	190	76795.....	156	78303.....	84	90092.....	228
66843-5.....	197	67413.....	192	76803.....	152	78313.....	84	90093.....	228
66844.....	197	67570.....	189	76813.....	152	78333.....	24	90103.....	228
66845.....	196	67571.....	189	76943.....	151	78343.....	28	90121.....	228
66846.....	197	67580.....	189	76953.....	151	78363.....	44	90122.....	228
66850.....	194	67581.....	189	76963.....	146	78393.....	32	90122-5.....	228
66851.....	194	68010.....	198	76983.....	151	78403.....	43	90123.....	228
66860.....	200	68020.....	198	76985.....	151	78423.....	26	90123-5.....	228
66861.....	199	68030.....	198	76993.....	151	78433.....	23	90133.....	228
66862.....	199	68060.....	198	77013.....	145	78453.....	34	90152.....	228
66863.....	200	68080.....	200	77101.....	145	78473.....	153	90152-5.....	228
66864.....	200	68110.....	200	77102.....	145	78563.....	156	90153.....	228
66865.....	200	68130.....	200	77103.....	145	78573.....	156	90153-5.....	228
66870.....	196	68150.....	200	77105.....	145	82080.....	104	90162.....	228
66900.....	195	68170.....	200	77123.....	144	82400.....	104	90163.....	228
66902.....	196	68380.....	201	77133.....	144	82562.....	224	90172.....	87, 228
66903.....	195	68420.....	92	77163.....	152	82563.....	224	90173.....	228
66904.....	195	68540-5.....	92	77192.....	154	85450-5.....	226	90202.....	228
66905.....	195	68580.....	198	77193.....	154	85460-5.....	226	90202-5.....	228
66910.....	195	68630.....	135	77203.....	146	87020.....	185	90203.....	228
66911.....	195	68680.....	199	77263.....	153	87023.....	185	90203-5.....	228
66920.....	195	69680.....	168	77352.....	154	87100.....	185	90221.....	228
66930.....	194	69681.....	168	77353.....	154	87101.....	185	90232.....	228
66931.....	194	69690.....	168	77355.....	154	87103.....	185	90233.....	228
66932.....	198	71152.....	225	77361.....	154	87104.....	185	90252.....	228
66980.....	194	71422.....	225	77362.....	154	87105.....	185	90302.....	228
66981.....	194	71440.....	225	77363.....	154	87110.....	185	90303.....	228
66982.....	194	71450.....	225	77365.....	154	87111.....	185	90342.....	228
67000.....	197	72010-5.....	160	77443.....	147	87112.....	185	90353.....	228
67001.....	194	72050-5.....	160	77453.....	142	87141.....	186	90373.....	228
67001-5.....	194	72100-5.....	160	77461.....	155	87151.....	186	90383.....	228
67002.....	196	72110-5.....	160	77462.....	155	87170.....	185	90393.....	228
67005.....	196	73030.....	158	77463.....	155	87171.....	185	90401.....	228
67006.....	200	73040.....	159	77465.....	155	87172.....	185	90481.....	228
67010.....	198	73040-5.....	159	77473.....	145	87173.....	185	90482.....	228
67011.....	198	73080.....	158	77483.....	145	87180.....	185	90483.....	228
67012.....	198	73090.....	159	77611.....	143	87181.....	185	90620.....	140
67013.....	196	73110.....	159	77613.....	143	87182.....	185	90642.....	228



# Model Number Index

<i>Model No.</i>	<i>Page</i>	<i>Model No.</i>	<i>Page</i>	<i>Model No.</i>	<i>Page</i>	<i>Model No.</i>	<i>Page</i>	<i>Model No.</i>	<i>Page</i>
90652.....	88	92031.....	229	93252.....	230	99595.....	213	G3002-5.....	23
90742.....	228	92032.....	229	93383.....	230	99600.....	186, 187	G3003.....	23
90743.....	228	92033.....	229	93393.....	230	99601.....	186, 187	G3003-5.....	23
90752.....	229	92035.....	229	93400.....	207	99630.....	153	G3092.....	25
90761.....	229	92062.....	229	93402.....	207	99680.....	186, 187	G3093.....	25
90762.....	229	92063.....	229	93453.....	209	99802.....	230	G4002.....	57
90861-5.....	140	92070.....	202	93473.....	209	99803.....	230	G4002-5.....	57
90901.....	140	92120.....	201	93552.....	211	99832.....	230	G4003.....	57
90922.....	229	92150.....	201	93553.....	211	99833.....	230	G4003-5.....	57
90923.....	229	92162.....	229	93600.....	217	99842.....	230	G4012.....	57
90941-5.....	135	92163.....	229	93610.....	95, 96	99843.....	230	G4022.....	57
90951-5.....	135	92172.....	229	93670.....	203	99912.....	230	G4502.....	71
90971-5.....	140	92173.....	229	93683.....	211	99913.....	230	G4503.....	71
91042.....	229	92183.....	229	93723.....	230	BZ101-5.....	130	G4602.....	39
91043.....	229	92193.....	229	93750.....	204	BZ201-5.....	130	G4602-5.....	39
91051.....	140	92382.....	229	93760.....	202	BZ301-5.....	130	G4603.....	39
91101.....	229	92420.....	213	93780.....	115	BZ401-5.....	129	G4603-5.....	39
91112.....	229	92432.....	229	93803.....	207	BZ501-5.....	129	G4613.....	39
91113.....	229	92433.....	229	93860.....	201, 204	BZ601-5.....	130	G5052.....	54
91122.....	229	92453.....	229	93891.....	230	BZ701.....	129	G5053.....	54
91302.....	229	92510.....	212	93982.....	216	BZ702.....	129	G5053-5.....	54
91311.....	229	92511.....	212	94000.....	203	BZ703.....	129	G5082.....	73
91323.....	228	92512.....	212	94010.....	202	BZ705.....	129	G5082-5.....	73
91380.....	205	92513.....	212	94100.....	201	BZ801-5.....	129	G5092.....	73
91400.....	202	92583.....	209	94180.....	216	BZ901-5.....	129	G5092-5.....	73
91410.....	203	92611.....	229	94233.....	206	G1002.....	27	G5202.....	73
91482.....	229	92701-5.....	140	94300.....	230	G1003.....	27	G5212.....	73
91502.....	229	92720.....	213	94310.....	230	G1032.....	27	G5300.....	80
91503.....	229	92773.....	229	94350.....	208	G1032-5.....	27	G5530.....	79
91513.....	229	92792.....	229	94360.....	201	G1033.....	27	G5530-5.....	79
91572.....	229	92883.....	229	94580.....	230	G1033-5.....	27	G5540.....	79
91573.....	229	92885.....	229	94590.....	230	G1042.....	27	G5540-5.....	79
91581.....	229	92892.....	230	94600.....	230	G1043.....	27	G5543-5.....	79
91582.....	229	92893.....	230	94690.....	219	G1082.....	29	G6002.....	64
91583.....	229	92901.....	230	99401-5.....	135	G1083.....	29	G6002-5.....	64
91683.....	229	92920.....	203	99411-5.....	135	G1092.....	27	G6003.....	64
91740.....	211	92960.....	157	99421-5.....	135	G1093.....	27	G6003-5.....	64
91880.....	203	92970.....	157	97750.....	217	G1502.....	30	G6012.....	64
91890.....	203	92980.....	157	99170.....	220	G1503.....	30	G6013.....	64
91950.....	211	92993.....	230	99170-1.....	220	G1902.....	32	G6121.....	114
91961.....	229	93003.....	230	99170-GT.....	220	G1902-5.....	32	G6131.....	114
91962.....	229	93005.....	230	99180.....	220	G1903.....	32	G6151.....	114
91962-5.....	229	93013.....	230	99460-5.....	92	G1903-5.....	32	G6261.....	113
91963.....	229	93015.....	230	99500-3.....	190	G1913.....	32		
91963-5.....	229	93131.....	230	99501-3.....	190	G2102.....	44		
91964.....	229	93151.....	230	99502.....	190	G2102-5.....	44		
91965.....	229	93163.....	230	99510.....	186, 187	G2103.....	44		
91992.....	229	93171.....	230	99580.....	220	G2103-5.....	44		
91993.....	229	93190.....	212	99593.....	213	G3002.....	23		

## Multi-Volt and Non 12-Volt Product Index

<i>Model No.</i>	<i>Page</i>	<i>Model No.</i>	<i>Page</i>	<i>Model No.</i>	<i>Page</i>	<i>Model No.</i>	<i>Page</i>	<i>Model No.</i>	<i>Page</i>					
61E11	24V	105	63L61	12/24V	120	47363	24V	34	63681	24V	124	77013	12-110V	145
61E31	24V	105	63L71	12/24V	120	47732	24V	43	63691	24V	124	77101	11-110V	145
61E51	24V	105	63L81	12/24V	120	47733	24V	43	63731	24V	123	77102	11-110V	145
61E91	24V	109	64E01	10-48V	125	49262	9/32V	21	63741	24V	123	77103	11-110V	145
61F11	24V	109	64E01-5	10-48V	125	49263	9/32V	21	63751	24V	123	77105	11-110V	145
61F30	10-32V	104	64E11	10-48V	125	49282	9/32V	21	63761	12/24V	124	77123	12-48V	144
61F40	10-32V	104	64F01	10-48V	125	49283	9/32V	21	63771	24V	124	77133	12-48V	144
61H11	24V	105	64F11	10-48V	125	49351	24V	21	63821	12/24V	127	77203	12-80V	146
61H21	24V	105	64G01	10-48V	125	49352	24V	21	63821-5	12/24V	127	77263	12-24V	153
61H31	24V	105	64G01-5	10/48V	125	49353	24V	21	63831	12/24V	127	77453	12-24V	142
63E01	12/24V	119	64J11	10/48V	125	52072	24V	63	63831-5	12/24V	127	77583	12-48V	143
63E11	12/24V	119	64G11-5	10/48V	125	52073	24V	63	63861	12/24V	127	77611	12-24V	143
63E21	12/24V	119	64H01-5	12/36V	128	52092	24V	55	63861-5	12/24V	127	77613	12-24V	143
63E23	12/24V	119	64J11	12/24V	126	52093	24V	55	63871	12/24V	127	77615	12-24V	143
63E31	12/24V	119	64J21	12/24V	126	52152	24V	58	63871-5	12/24V	127	77623	12-24V	143
63E41	12/24V	124	64J31	12/24V	126	52153	24V	58	63901	12/24V	124	77643	12-24V	144
63E51	12/24V	124	64J41	12/24V	126	52162	24V	56	63971	12/24V	127	77653	12-24V	144
63E61	12/24V	124	64J51	12/24V	126	52163	24V	56	63981	12/24V	119	77671	12-24V	142
63E71	24V	124	64M11-5	12/24V	117	56150-5	12/24V	78	63981-5	12/24V	119	77673	12-24V	142
63F11	24V	120	44010	12-24V	166	56160-5	12/24V	78	63991	12/24	119	77693	12-24V	143
63F31	24V	120	44030	12-24V	166	56170-5	12/24V	78	63991-5	12/24V	119	77713	12-24V	144
63F41	24V	120	44070	18-32V	166	56180-5	12/24V	78	64391	24V	131	77753	12-24V	151
63F51	24V	120	44134	12-36V	157	60391	24V	109	64461	24V	132	77873	12-24V	148
63F81	12/24V	121	44421	12-80V	157	60401	24V	109	64491	24V	131	77931	10-16V	156
63F81-5	12/24V	121	44850	24V	162	60711	9/32V	93	64921	24V	132	77932	10-16V	156
63F91	12/24V	121	44860	24V	162	61021	24V	107	73030	12-36V	158	77933	10-16V	156
63G01	12/24V	121	45142	24V	32	61061	24V	108	73040	12-24V	159	82080	10-30V	104
63G11	12/24V	121	45143	24V	32	61111	24V	103	73040-5	12-24V	159	82400	18-32V	104
63G21	12/24V	121	45162	12V	31	61131	24V	106	73080	12-24V	158	90901	12/24V	140
63G31	12/24V	121	45163	12V	31	61401	24V	106	73090	12-24V	159	91051	12/24V	140
63G81	12/24V	122	45182	24V	28	61421	24V	106	73110	12-24V	159	99401-5	9/32V	135
63G91	12/24V	122	45183	24V	28	61760	10-32V	104	73160	12-36V	158	99411-5	9/32V	135
63H01	12/24V	127	45202	24V	24	61861	9-30V	104	73220	12-24V	159	99421-5	9/32V	135
63H11	12/24V	127	45203	24V	24	61871	9-30V	104	73240	12-24V	159	BZ101-5	32V	130
63H31	48V	119	45222	12V	28	61890	10-32V	104	73250	12-36V	159	BZ201-5	32V	130
63H81	12/24V	127	45223	12V	28	62321	24V	98	76063	24V	149	BZ301-5	32V	130
63J01	12/24V	122	47322	24V	26	62571	24V	97	76663	12-36V	148	BZ601-5	32V	130
63J11	12/24V	122	47323	24V	26	63241-5	24V	133	76683	12-24V	150			
63J21	12/24V	122	47332	24V	23	63251-5	24V	134	76685	12-24V	150			
63J31	12/24V	122	47333	24V	23	63571	12/24V	124	76703	12-24V	152			
63L31	12/24V	120	47352	24V	43	63581	12/24V	124	76793	11-30V	156			
63L41	12/24V	120	47353	24V	43	63591	12/24V	124	76795	11-30V	156			
63L51	12/24V	120	47362	24V	34	63671	24V	124	76963	12-48V	146			

# Featured Products

**THESE PRODUCTS PROVIDE UNIQUE FUNCTIONALITY FOR HIGHER PRODUCTIVITY AND OPERATIONAL LONGEVITY.**



## **INTEGRATED FLANGE LED STOP | TAIL | TURN LIGHTS**

Page 62

As the newest of its kind, the patented design of the Grote LED S/T/T with Integrated Backup lights integrates the functions of Stop, Tail, Turn and Back-up lights into a single, industry-standard size combination.



## **GROTE LED TASK LIGHTING**

Page 117  
Page 118

Top to bottom, left to right and all areas in between. Grote task lighting offers rugged, dependable coverage for safety and security at an affordable price.



## **GROTE T26 LED WORK LAMP**

Page 125

The new standard for Trilliant® performance in a small, mount-anywhere work light, including a far pattern and near pattern flood design, with a choice of pinch or pedestal mountings.



## **GROTE BRITZONE LED WORK LIGHTS**

Page 129

Grote's line of affordable LED lights are designed to work when you need them—no excuses. Rain or shine, day or night, wet or dry—Grote's signature design, quality and performance are on display.



## **LED SEALED BEAM REPLACEMENT HEADLIGHTS**

Page 135

With both seven-inch round and five-by-seven inch rectangular lights, you can replace your existing lights with the durable, long-lasting LED lights Grote is famous for.

## MICRONOVA® DOT LED CLEARANCE/MARKER LAMP

Available in PC and P2 versions with .180 bullet connectors • Sleek aerodynamic styling extends less than 3/8" from mounted surface • No fasteners required

P2 RATED:			
49322	Red, w/ Grommet		
49323	Yellow, w/ Grommet	<b>NEW</b>	
PC RATED:			
49452	Red, w/ Bracket	<b>PC</b>	<b>NEW</b>
49453	Yellow, w/ Bracket	<b>PC</b>	<b>NEW</b>
49332	Red, w/ Grommet	<b>PC</b>	
49333	Yellow, P2/PC w/ Grommet	<b>PC</b>	
49412	Red, w/ Adapter Bracket	<b>PC</b>	
49413	Yellow, w/ Adapter Bracket	<b>PC</b>	
45302	Red, w/ Hardshell	<b>PC</b>	<b>NEW</b>
45303	Yellow, w/ Hardshell	<b>PC</b>	<b>NEW</b>
ECE RATED:			
49341	White, w/ Grommet	<b>ECE</b>	
49342	Red, w/ Grommet	<b>ECE</b>	
49343	Yellow, w/ Grommet	<b>ECE</b>	
49351	White, w/ Grommet	<b>ECE</b>	<b>24VOLT</b>
49352	Red, w/ Grommet	<b>ECE</b>	<b>24VOLT</b>
49353	Yellow, w/ Grommet	<b>ECE</b>	<b>24VOLT</b>
MULTI VOLT			
49262	Red, w/ Grommet	<b>PC</b>	<b>MULTI NEW</b>
49282	Red, w/ Grommet	<b>PC</b>	<b>MULTI NEW ECE</b>
49263	Yellow, w/ Grommet	<b>PC</b>	<b>MULTI NEW</b>
49283	Yellow, w/ Grommet	<b>PC</b>	<b>MULTI NEW ECE</b>

Material: Lens - Acrylic; Bracket - Polycarbonate; Grommet - PVC  
 FMVSS: P2, P3, PC, ECE  
 Finish: Red, Yellow, White  
 Volts / Amps: 12V / .05A  
 24V / .05A  
 9-32V / .03A  
 Brackets: 42110, 42270, 94350

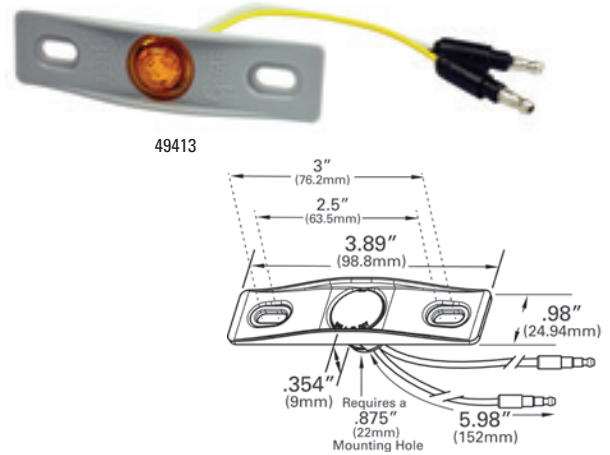
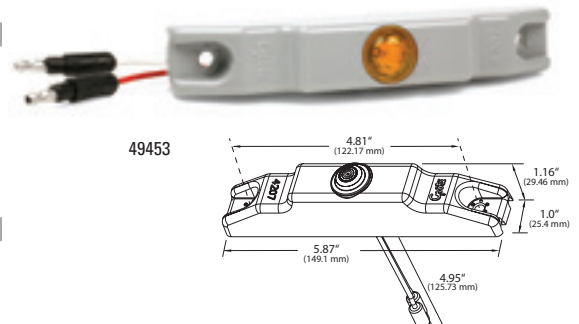
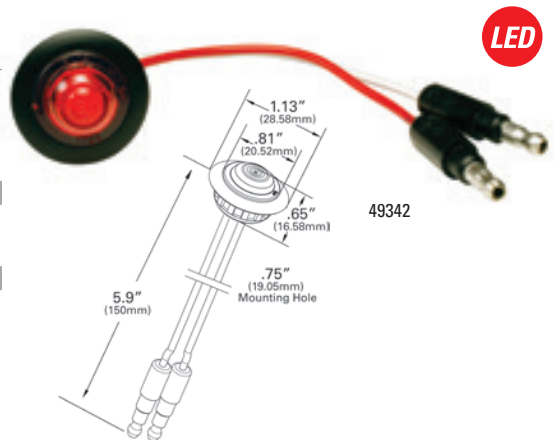

## DUAL INTENSITY MICRONOVA® DOT LED CLEARANCE/MARKER LAMP

Dual Intensity allows for better visibility • Hermetic lens-to-housing seal • Encapsulant potting for total circuit board protection against vibration and corrosion • Sleek aerodynamic styling, small size fits in narrow applications

- 49362 Red, w/ Grommet, Standard
- 49363 Yellow, w/ Grommet, Standard

Material: Lens - Acrylic; Grommet - PVC  
 FMVSS: P2  
 Finish: Red/ Black ; Yellow/ Black  
 Volts / Amps: High - 12V / .05A; Low - 12V / .02A;

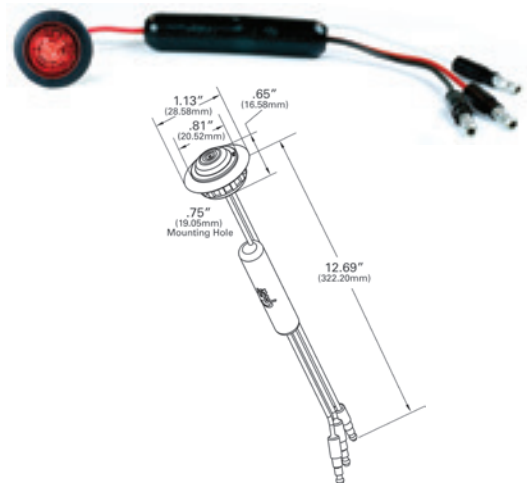

# Clearance/Marker Lamps

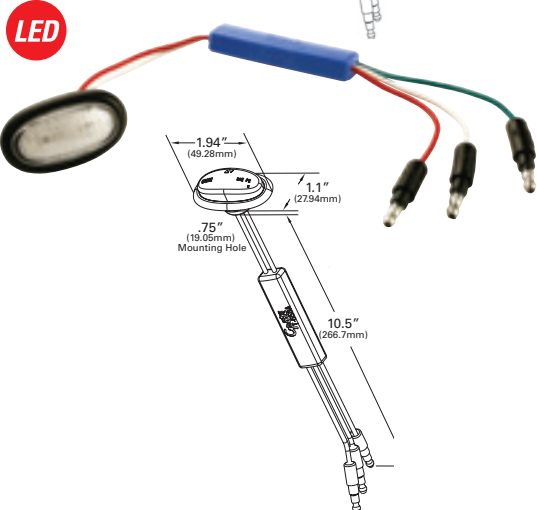
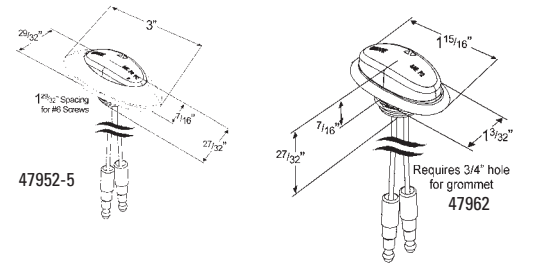

## MICRONOVA® LED CLEARANCE/MARKER LAMP

Low profile makes lamp less susceptible to damage • Small size fits narrow applications • Hermetic lens-to-housing seal • Potted for total circuit board protection against vibration and corrosion • All PC versions meet requirements when mounted at 45° angle

- 47952** Red, w/ Chrome Bezel
- 47982** Red, Clear Lens w/ Chrome Bezel
- 47953** Yellow, w/ Chrome Bezel
- 47983** Yellow, Clear Lens w/ Chrome Bezel
- 47962** Red, w/ Grommet
- 47963** Yellow, w/ Grommet

PC RATED:		
<b>45282</b>	Red, surface mount	<b>PC</b>
<b>45283</b>	Yellow, surface mount	<b>PC</b>
<b>47972</b>	Red, w/ Grommet	<b>PC</b>
<b>47973</b>	Yellow, w/ Grommet	<b>PC</b>
<b>45302</b>	Red, w/ Hardshell	<b>PC NEW</b>
<b>45303</b>	Yellow, w/ Hardshell	<b>PC NEW</b>

Material: Lens - Acrylic; Bracket - Polycarbonate; Grommet - PVC  
 FMVSS: P2, PC  
 Finish: Red / Yellow / Chrome  
 Volts / Amps: 12V / .05A  
 Pigtail: 68580  
 Accessory: Bezel Chrome 93803; Mounting Gasket: 94220  
 Bracket: 42110

## DUAL INTENSITY MICRONOVA® LED CLEARANCE/MARKER LAMP

Dual Intensity enhances signaling visibility and safety • Hermetic lens-to-housing seal • Encapsulant potting for total circuit board protection against vibration and corrosion • Small size fits in narrow applications • Grommet mount versions have no exposed fasteners

- 49372** Red, w/ Grommet, Slim-Line .180
- 49373** Yellow, w/ Grommet, Slim-Line .180
- 49382** Red, w/ Grommet, Standard .180
- 49383** Yellow, w/ Grommet, Standard .180

Material: Lens - Acrylic; Grommet - PVC  
 FMVSS: P2  
 Finish: Red, Yellow  
 Volts / Amps: 12V / .05A  
 Brackets: 42110, 42112

## MICRONOVA® RED/GREEN INDICATOR LAMP

Suitable for bright sunlight applications • Dual color circuiting molded into pigtail with Bullet Connectors • Clear lens with Red / Green LEDs • Grommet mount with no exposed fasteners

- 49460** Red/Green, Clear Lens w/ Grommet

Material: Lens - Clear; Grommet - Polycarbonate  
 Ingress Protection: IP69K  
 Voltage Amp: 12 Volt

## MICRONOVA® DOT LED INDICATOR LAMP



Durable one-piece LED lamp • No mounting hardware required • Hardwired with .180 standard UBS plug connectors for maximum performance

**60824** Green, w/Grommet

Material: Polycarbonate  
 Finish: Green  
 Voltage Amp: 12V / .05A  
 Brackets: 42110, 42270, 94350

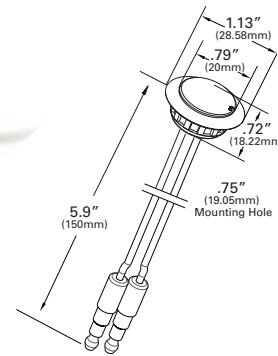

## SUPERNOVA® 2" LED CLEARANCE/MARKER LAMP

Encapsulant potting for total circuit board protection • Hermetic lens-to-housing seal • Uses same UBS double-seal pigtail as incandescent for quick Plug-and-Go® retrofit • Tin-plated, solid-brass terminals are sealed to housing to resist corrosion and eliminate failure causing leak paths

- 47112** Red
- 47113** Yellow
- 47332** Red
- 47333** Yellow
- 46132** Red
- 46133** Yellow

### ABS LAMP:

**78433** Yellow

Material: Polycarbonate  
 FMVSS: P2, PC, P3  
 Finish: Red/Yellow  
 Volts / Amps: 12V / .06A  
 Volts / Amps: Red - 24V / .03A  
 Volts / Amps: Yellow - 24V / .04A  
 Bracket: 43690, 49140, 43150, 43152, 43153, 43532, 43760, 42180, 42190, 43430  
 Grommet: 92120, 92150, 93760  
 Pigtail: 66851, 67001, 66850, 66801, 67050, 66800, 66840



47112

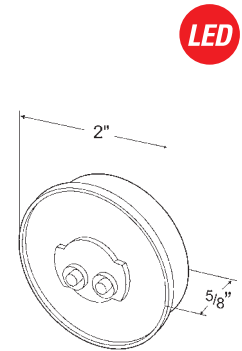

46133

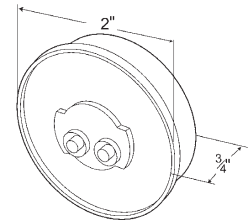

## HI COUNT® 2" 9-DIODE LED CLEARANCE/MARKER LAMP



Hermetic lens-to-housing seal • Uses the same UBS double-seal pigtail as our incandescent version for a quick Plug-and-Go® retrofit • Twist-on mounting for easy installation • Fits all popular mountings and grommets

- G3002** Red
- G3002-5** Red
- G3003** Yellow
- G3003-5** Yellow

Material: Polycarbonate  
 FMVSS: P2  
 Finish: Red / Yellow  
 Volts / Amps: 12V / .09A  
 Bracket: 43690, 49140, 43150, 43152, 43153, 43532, 43760, 42180, 42190  
 Grommet: 92120, 92150, 93760  
 Pigtail: 66851, 67001, 66850, 66801, 67050, 66800, 66840

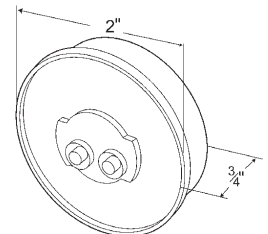

# Clearance/Marker Lamps

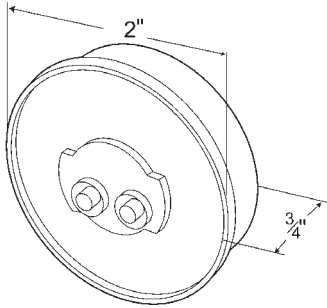

## 2" CLEARANCE/MARKER LAMP

Hermetic lens-to-housing seal • Twist-on mounting for easy installation  
 • Fits all popular mountings and grommets • 12-Volt version features a 12,000+ hour bulb • All versions meet PC requirements when mounted at a 45° angle, recommended bracket 43690

<b>45822</b>	Red	<b>PC</b>
<b>45822-5</b>	Red	<b>PC RETAIL</b>
<b>45823</b>	Yellow	<b>PC</b>
<b>45823-5</b>	Yellow	<b>PC RETAIL</b>
<b>45202</b>	Red	<b>PC 24 VOLT</b>
<b>45203</b>	Yellow	<b>PC 24 VOLT</b>

<b>KITS:</b>		
<b>45062</b>	Red (45822 + 92120 + 67050)	<b>PC</b>
<b>45063</b>	Yellow (45823 + 92120 + 67050)	<b>PC</b>
<b>45562</b>	Red (45822 + 43150)	<b>PC</b>
<b>45563</b>	Yellow (45823 + 43150)	<b>PC</b>

<b>ABS LAMP:</b>		
<b>78333</b>	Yellow	<b>PC</b>

Material: Polycarbonate  
 FMVSS: P2, P3, PC, PC2  
 Finish: Red / Yellow  
 Bulb: 2 CP  
 Volts / Amps: 12V / .33A  
 Bulb: 3 CP  
 Volts / Amps: 24V / .17A  
 Bracket: 43690, 49140, 43150, 43152, 43153, 43532, 43760, 42180, 42190  
 Grommet: 92120, 92150, 93760  
 Pigtail: 66851, 67001, 66850, 66801, 67050, 66800, 66840

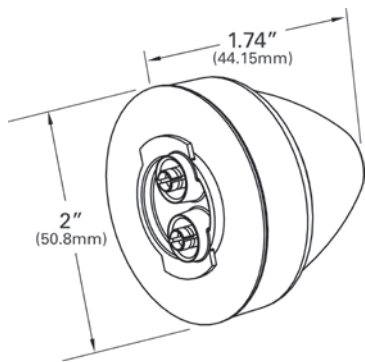

## SUPERNOVA® 2" BEEHIVE LED CLEARANCE/MARKER LAMP

Encapsulant potting for total circuit board protection • Tin-plated, solid-brass terminals are sealed to housing to resist corrosion and eliminate failure causing leak paths • Uses same UBS double-seal pigtail as incandescent for a quick Plug-and-Go® retrofit • Hermetic lens-to-housing seal

<b>47212</b>	Red
<b>47213</b>	Yellow

Material: Polycarbonate  
 FMVSS: P2  
 Finish: Red / Yellow  
 Volts / Amps: 12V / .06A  
 Bracket: 43690, 49140, 43150, 43152, 43153, 43532, 43760, 42180, 42190  
 Grommet: 92120, 92150, 93760  
 Pigtail: 66851, 67001, 66850, 66801, 67050, 66800, 66840

## HI COUNT® 2" 9-DIODE BEEHIVE LED CLEARANCE/MARKER LAMP

Uses the same UBS double-seal pigtail as the incandescent version for a quick Plug-and-Go® retrofit • Twist-on mounting for easy installation  
 • Concentric, multiple diode layout • Fits all popular mountings and grommets

**G3092** Red **PC**  
**G3093** Yellow **PC**

Material: Polycarbonate  
 FMVSS: P2, PC  
 Finish: Red / Yellow  
 Volts / Amps: 12V / .09A  
 Bracket: 43690, 49140, 43150, 43152, 43153, 43532, 43760, 42180, 42190  
 Grommet: 92120, 92150, 93760  
 Pigtail: 66851, 67001, 66850, 66801, 67050, 66800, 66840

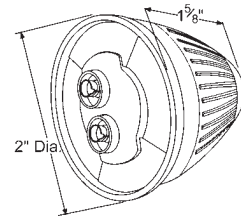

## 2" BEEHIVE CLEARANCE/MARKER LAMP

12-Volt version features a 12,000+ hour bulb • Fits popular grommet and bracket mountings • Hermetic lens-to-housing seal • Twist-on mounting for easy installation • Fits all popular mountings and grommets • Meets PC function only when mounted at a 45° angle, recommended bracket 43690

**47102** Red **PC**  
**47103** Yellow **PC**

Material: Polycarbonate  
 FMVSS: P2, PC  
 Finish: Red / Yellow  
 Bulb: 2 CP  
 Volts / Amps: 12V / .33A  
 Bracket: 43690, 49140, 43150, 43152, 43153, 43532, 43760, 42180, 42190  
 Grommet: 92120, 92150, 93760  
 Pigtail: 66851, 67001, 66850, 66801, 67050, 66800, 66840

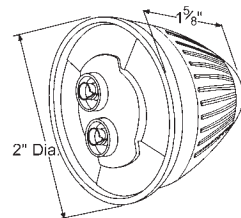



# Clearance/Marker Lamps

LED



47122

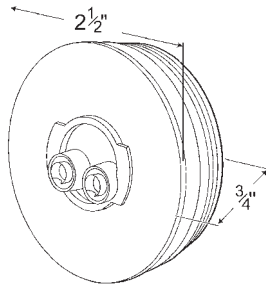

46142

## SUPERNOVA® 2 1/2" LED CLEARANCE/MARKER LAMP

Encapsulant potting for total circuit board protection • Hermetic lens-to-housing seal • Uses same UBS double-seal pigtail as incandescent version for a quick Plug-and-Go® Retrofit • Tin-plated, solid-brass terminals are sealed to housing, to resist corrosion and eliminate failure causing leak paths

47122	Red	
47123	Yellow	
47202	Red w/ Black, Theft-Resistant Flange	
47322	Red	24V
47323	Yellow	24V
46142	Red	PC
46143	Yellow	PC

## KITS:

47472	Red (47122 + 91400 + 67001)
47473	Yellow (47123 + 91400 + 67001)

## ABS LAMP:

78423	Yellow
-------	--------

Material: Polycarbonate  
 FMVSS: P2, PC, P3  
 Finish: Red / Yellow  
 Volts / Amps: 12V / .06A  
 Volts / Amps: 24V / .03A  
 Bracket: 43690, 43160, 43162, 43163, 43512, 43522, 49140, 93750, 42180, 42170  
 Grommet: 91400, 91410, 92070, 91890, 91880, 92920  
 Pigtail: 66851, 67001, 66850, 66801, 67050, 66800, 66840

LED



47373

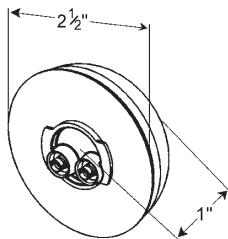

## SUPERNOVA® 2 1/2" PC RATED, LED CLEARANCE/MARKER LAMP

Hermetic lens-to-housing seal • Optic lens optimizes photometric performance and broadens light pattern • Encapsulant potting for total circuit board protection • Uses same UBS double-seal pigtail as incandescent for a quick Plug-and-Go® Retrofit • Tin-plated, solid-brass terminals are sealed to housing, to resist corrosion and eliminate failure causing leak paths  
 • Available with lamp sealed to flange, for direct mounting in the side of a trailer without creating leaks in the trailer

47232	Red	PC
47233	Yellow	PC

## SEALED FLANGE APPLICATIONS:

47423	Yellow w/ Black, Theft-Resistant Flange	PC
47372	Red w/ Gray, Theft-Resistant Flange	PC
47373	Yellow w/ Gray, Theft-Resistant Flange	PC

Material: Polycarbonate  
 FMVSS: P2, P3, PC  
 Finish: Red / Yellow  
 Volts / Amps: 12V / .06A  
 Bracket: 43690, 43160, 43162, 43163, 43512, 43522, 49140, 93750, 42180, 42170  
 Grommet: 91400, 91410, 92070, 91890, 91880, 92920  
 Pigtail: 66851, 67001, 66850, 66801, 67050, 66800, 66840

## HI COUNT® 2 1/2" LED CLEARANCE/MARKER LAMP

Hermetic lens-to-housing seal • Uses the same UBS double-seal pigtail as the incandescent version for a quick Plug-and-Go® retrofit • Twist-on mounting for easy installation • Fits all popular mountings and grommets

### OPTIC LENS:

<b>G1032</b>	Red	
<b>G1032-5</b>	Red	<b>RETAIL</b>
<b>G1033</b>	Yellow	
<b>G1033-5</b>	Yellow	<b>RETAIL</b>
<b>G1042</b>	Red, Clear Lens	
<b>G1043</b>	Yellow, Clear Lens	

### REFLEX LENS:

<b>G1002</b>	Red
<b>G1003</b>	Yellow

Material: Polycarbonate  
 FMVSS: Optic - P2, Reflex - A, P2  
 Finish: Red / Yellow  
 Volts / Amps: Optic - 12V / .15A  
 Volts / Amps: Reflex - 12V / .13A  
 Bracket: 43690, 43160, 43162, 43163, 43512, 43522, 49140, 93750, 42180, 42170  
 Grommet: 91400, 91410, 92070, 91890, 91880, 92920  
 Pigtail: 66851, 67001, 66850, 66801, 67050, 66800, 66840

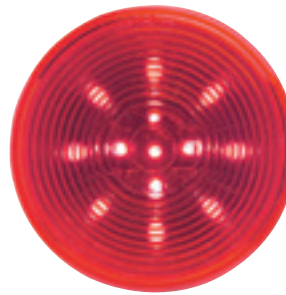

G1032

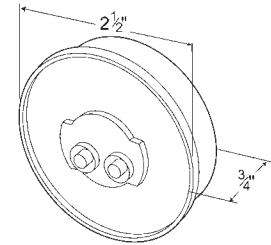

G1003

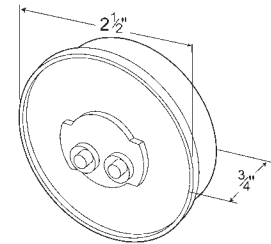

## HI COUNT® 2 1/2" 9-DIODE LED CLEARANCE/MARKER LAMP

Hermetic lens-to-housing seal • Uses the same UBS double-seal pigtail as our incandescent version for a quick Plug-and-Go® retrofit • Twist-on mounting for easy installation • Fits all popular mountings and grommets

<b>G1092</b>	Red
<b>G1093</b>	Yellow

Material: Polycarbonate  
 FMVSS: P2  
 Finish: Red / Yellow  
 Volts / Amps: 12V / .09A  
 Bracket: 43690, 43160, 43162, 43163, 43512, 43522, 49140, 93750, 42180, 42170  
 Grommet: 91400, 91410, 92070, 91890, 91880, 92920  
 Pigtail: 66851, 67001, 66850, 66801, 67050, 66800, 66840

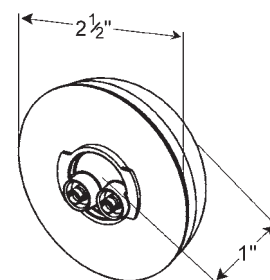

# Clearance/Marker Lamps



45812



45833

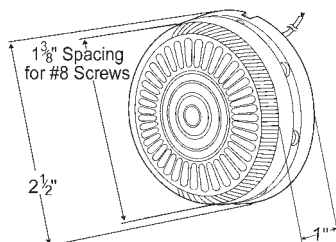
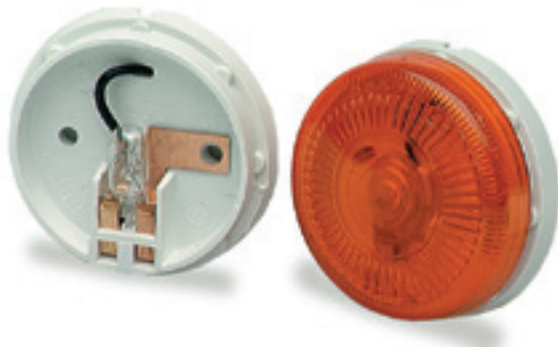
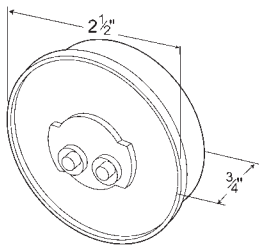

## 2 1/2" CLEARANCE/MARKER LAMP

Hermetic lens-to-housing seal • Twist-on mounting for easy installation  
 • Fits all popular mountings and grommets • 12-Volt version features a 12,000+ hour bulb • Optic lens versions meet PC function only when mounted at a 45° angle, recommended bracket: 43690; grommets: 91880, or 91890 or 92920

### OPTIC LENS:

45812	Red	PC
45812-5	Red	PC RETAIL
45813	Yellow	PC
45813-5	Yellow	PC RETAIL
45182	Red	PC 24 VOLT
45183	Yellow	PC 24 VOLT

### OPTIC LENS KITS:

45042	Red (45812 + 91400 + 67050)	PC
45043	Yellow (45813 + 91400 + 67050)	PC

### REFLEX LENS:

45222	Red	24 VOLT
45223	Yellow	24 VOLT
45832	Red	
45833	Yellow	

### BUILT-IN REFLECTOR KITS:

45072	Red (45832 + 91400 + 67050)	
45073	Yellow (45833 + 91400 + 67050)	

### ABS LAMP:

78343	Yellow, Optic Lens	PC
-------	--------------------	----

Material: Lens - Acrylic; Housing - Polycarbonate  
 FMVSS: Optic - P2, P3, PC, PC2; Reflex - A, P2, P3  
 Finish: Red / Yellow

Bulb: 2 CP; Volts / Amps: 12V / .33A

Bulb: 3 CP; Volts / Amps: 24V / .17A

Bracket: 43690, 43160, 43162, 43163, 43512, 43522, 49140, 93750, 42180, 42170

Grommet: 91400, 91410, 92070, 91890, 91880, 92920

Pigtail: 66851, 67001, 66850, 66801, 67050, 66800, 66840

## 2 1/2" SURFACE MOUNT SINGLE-BULB CLEARANCE/MARKER LAMP

12,000+ hour bulb • Snap-on lens for easy bulb replacement • Heavy-duty 2 CP wedge-base bulb • OE replacement on Mack® MR models • Meets PC function only when mounted at a 45° angle

45412	Red	PC
45412-5	Red	PC RETAIL
45413	Yellow	PC
45413-5	Yellow	PC RETAIL

Material: Polypropylene / Acrylic

FMVSS: P2, PC

Finish: Red/Yellow

Bulb: #193, 2 CP

Volts / Amps: 12V / .33A

Lens: Red 90162, Yellow 90163

## SUPERNOVA® 2 1/2" BEEHIVE LED CLEARANCE/MARKER LAMP

Encapsulant potting for total circuit-board protection • Tin-plated, solid-brass terminals are sealed to housing to resist corrosion and eliminate failure-causing leak paths • Uses same UBS double-seal pigtail as incandescent for a quick Plug-and-Go® retrofit • Hermetic lens-to-housing seal

**47222** Red  
**47223** Yellow

Material: Polycarbonate  
 FMVSS: P2  
 Finish: Red / Yellow  
 Volts / Amps: 12V / .06A  
 Bracket: 43690, 43160, 43162, 43163, 43512, 43522, 49140, 93750, 42180, 42170  
 Grommet: 91400, 91410, 92070, 91890, 91880, 92920  
 Pigtail: 66851, 67001, 66850, 66801, 67050, 66800, 66840

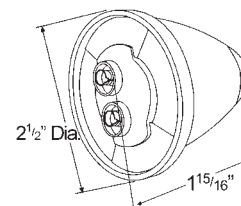

## HI COUNT® 2 1/2" 13-DIODE BEEHIVE LED CLEARANCE/MARKER LAMP

Hermetic lens-to-housing seal • Twist-on mounting for easy installation  
 • Fits all popular mountings and grommets

**G1082** Red  
**G1083** Yellow

Material: Polycarbonate  
 Reflective: P2  
 Finish: Red / Yellow  
 Volts / Amps: 12V / .09A  
 Bracket: 43690, 43160, 43162, 43163, 43512, 43522, 49140, 93750, 42180, 42170  
 Grommet: 91400, 91410, 92070, 91890, 91880, 92920  
 Pigtail: 66851, 67001, 66850, 66801, 67050, 66800, 66840

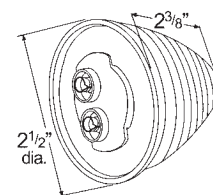

## 2 1/2" BEEHIVE CLEARANCE/MARKER LAMP

Hermetic lens-to-housing seal • Twist-on mounting for easy installation  
 • Fits all popular mountings and grommets • All PC versions meet requirements when mounted at 45° angle.

**45322** Red **PC**  
**45323** Yellow **PC**

Material: Polycarbonate  
 Reflective: P2, PC  
 Finish: Red / Yellow  
 Bulb: 2 CP  
 Volts / Amps: 12V / .33A  
 Bracket: 43690, 43160, 43162, 43163, 43512, 43522, 49140, 93750, 42180, 42170  
 Grommet: 91400, 91410, 92070, 91890, 91880, 92920  
 Pigtail: 66851, 67001, 66850, 66801, 67050, 66800, 66840

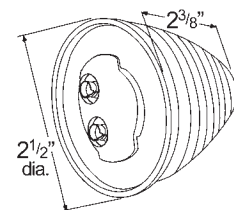

# Clearance/Marker Lamps

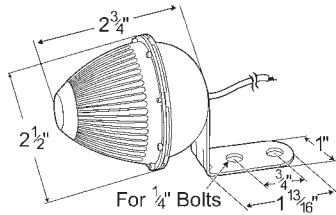

## BEEHIVE CLEARANCE/MARKER LAMP WITH FIXED-ANGLE MOUNTING BRACKET

Wide light diffusion optic design • Fade-resistant, snap-on acrylic lens  
 • Bracket is permanently attached • Meets PC function only when mounted at a 45° angle

45022	Red	PC
45022-5	Red	PC RETAIL
45023	Yellow	PC
45023-5	Yellow	PC RETAIL

Material: ABS / Steel / Acrylic  
 FMVSS: P2, PC  
 Finish: Red / Yellow  
 Bulb: #67, 4 CP  
 Volts / Amps: 12V / .59A  
 Lens: Yellow 90303

LED

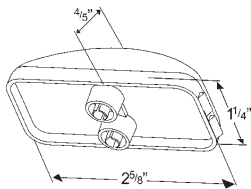

## SUPERNOVA® LED CLEARANCE/MARKER LAMP

Encapsulant potting for total circuit board protection • Hermetic lens-to-housing seal • Tin-plated, solid-brass terminals are sealed to housing, to resist corrosion and eliminate failure causing leak paths • Uses the same UBS double-seal pigtail as incandescent for a quick Plug-and-Go® retrofit

47082	Red
47083	Yellow

Material: Polycarbonate  
 FMVSS: P2  
 Finish: Red / Yellow  
 Volts / Amps: 12V / .06A  
 Bracket: 43370, 43970, 43980, 42131, 42141, 94233, 43380  
 Grommet: 91380  
 Pigtail: 66851, 67001, 66850, 66801, 67050, 66800, 66840

LED

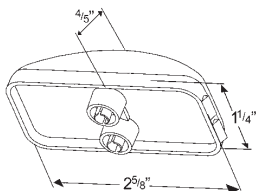

## HI COUNT® 3-DIODE LED CLEARANCE/MARKER LAMP

Hermetic lens-to-housing seal • Uses the same UBS double-seal pigtail as the incandescent version for a quick Plug-and-Go® retrofit • Fits popular mountings and grommets

G1502	Red
G1503	Yellow

Material: Polycarbonate  
 FMVSS: P2  
 Finish: Red / Yellow  
 Volts / Amps: 12V / .06A  
 Bracket: 43370, 43970, 43980, 42131, 42141, 94233, 43380  
 Grommet: 91380  
 Pigtail: 66851, 67001, 66850, 66801, 67050, 66800, 66840

## CLEARANCE/MARKER LAMP

Hermetic lens-to-housing seal • 12-Volt version features a 12,000+ hour bulb • Uses double-seal UBS pigtail • Rectangular shape fits narrow applications • Meets PC function only when mounted at a 45° angle, recommend bracket 43370 or 43380

<b>45162</b>	Red	<b>PC</b> <b>24</b> VOLT
<b>45163</b>	Yellow	<b>PC</b> <b>24</b> VOLT
<b>46412</b>	Red	<b>PC</b>
<b>46412-5</b>	Red, Pair Pack	<b>PC</b> RETAIL
<b>46413</b>	Yellow	<b>PC</b>
<b>46413-5</b>	Yellow, Pair Pack	<b>PC</b> RETAIL

<b>KITS:</b>		
<b>46422-5</b>	Red (43980 + 67050)	<b>PC</b>
<b>46423-5</b>	Yellow (43980 + 67050)	<b>PC</b>

Material: Polycarbonate  
 FMVSS: P2, PC  
 Finish: Red / Yellow  
 Bulb: 2 CP; Volts / Amps: 12V / .33A; Bulb: 3 CP; Volts / Amps: 24V / .17A  
 Bracket: 43370, 43970, 43980, 42131, 42141, 94233, 43380  
 Grommet: 91380;  
 Pigtail: 66851, 67001, 66850, 66801, 67050, 66800, 66840

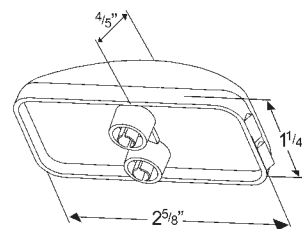

## SUPERNOVA® LED CLEARANCE/MARKER LAMP

Encapsulant potting for total circuit board protection • Hermetic lens-to-housing seal • Advanced pin connection system • Uses same UBS pigtail as incandescent for a quick Plug-and-Go® retrofit • Meets PC function only when mounted at a 45° angle.

<b>P2 RATED::</b>	
<b>47092</b>	Red
<b>47093</b>	Yellow

<b>KITS:</b>	
<b>65202</b>	Red (47092 + 43850)
<b>65203</b>	Yellow (47093 + 43850)

<b>PC RATED:</b>	
<b>47492</b>	Red <b>PC</b>
<b>47493</b>	Yellow <b>PC</b>

Material: Polycarbonate  
 FMVSS: P2, PC  
 Finish: Red / Yellow  
 Volts / Amps: P2 Rated - 12V / .06A; PC Rated - 12V / .12A  
 Accessory: Lamp Guard: 43120  
 Bracket: 43780, 43783, 43850  
 Pigtail: 66982, 66980, 66981

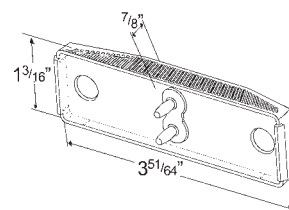

# Clearance/Marker Lamps

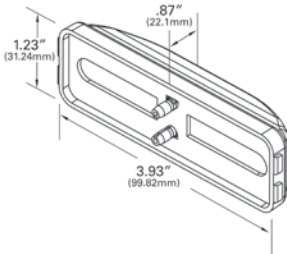

## HI COUNT® 3-DIODE LED CLEARANCE/MARKER LAMP

Hermetic lens-to-housing seal • Uses the same UBS double-seal pigtail as the incandescent version for a quick Plug-and-Go® retrofit • Fits all popular mountings and grommets

<b>G1902</b>	Red	
<b>G1902-5</b>	Red	RETAIL
<b>G1903</b>	Yellow	
<b>G1903-5</b>	Yellow	RETAIL
<b>G1913</b>	Yellow, Clear Lens	

Material: Polycarbonate  
 FMVSS: P2  
 Finish: Red / Yellow  
 Volts / Amps: 12V / .06A  
 Accessory: Lamp Guard: 43120; Bracket: 43780, 43783, 43850  
 Pigtail: 66982, 66980, 66981



46743



46740

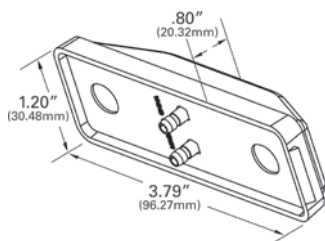

## CLEARANCE/MARKER LAMP

Rectangular, double bulb lamp • 12-Volt version features a 12,000+ hour bulb • Narrow mounting applications • Hermetic lens-to-housing seal • Meets PC function only when mounted at a 45° angle

<b>46742</b>	Red	PC
<b>46742-5</b>	Red	PC RETAIL
<b>46743</b>	Yellow	PC
<b>46743-5</b>	Yellow	PC RETAIL
<b>45142</b>	Red	PC 24 VOLT
<b>45143</b>	Yellow	PC 24 VOLT

### KITS:

<b>45092</b>	Red (46742 + 43850)	PC
<b>45093</b>	Yellow (46743 + 43850)	PC

### ABS LAMP:

<b>78393</b>	Yellow	PC
--------------	--------	----

### SPLIT LENS COLOR

<b>46740</b>	Red & Yellow
--------------	--------------

Material: Polycarbonate  
 FMVSS: P2, P3, PC, PC2, (46740) - P2  
 Finish: Red / Yellow  
 Bulb: (2) 2 CP  
 Volts / Amps: 12V / .66A  
 Bulb: (2) 3 CP  
 Volts / Amps: 24V / .34A  
 Accessory: Lamp Guard: 43120  
 Bracket: 43780, 43783, 43850  
 Pigtail: 66980, 66982, 66981

## 2 1/2" OVAL LED CLEARANCE/MARKER LAMP

Surface mount design for easy installation • Sealed lamps provide better protection from moisture intrusion • Self-grounding eyelet grounds lamp when attached to metal plate (47012 and 47013)

<b>45002-5</b>	Red	<b>RETAIL</b>
<b>45003-5</b>	Yellow	<b>RETAIL</b>
<b>45242-5</b>	Red, Clear Lens	<b>RETAIL</b>
<b>45243-5</b>	Yellow, Clear Lens	<b>RETAIL</b>

**SELF GROUNDING:**

<b>47012</b>	Red
<b>47013</b>	Yellow

Material: Polycarbonate  
 FMVSS: P2, P3  
 Finish: Red/Yellow  
 Volts / Amps: 12V / .05A

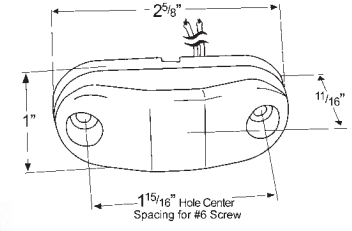

## SUPERNOVA® LED CLEARANCE/MARKER LAMP WITH BUILT-IN REFLECTOR

Encapsulant potting for total circuit board protection • Hermetic lens-to-housing seal • Tin-plated, solid-brass terminals are sealed to housing, to resist corrosion and eliminate failure causing leak paths • Fits popular grommets and pigtailed

<b>47502</b>	Red
<b>47503</b>	Yellow

Material: Polycarbonate  
 FMVSS: A, P2  
 Finish: Red / Yellow  
 Volts / Amps: 12V / .06A  
 Grommet: 93400, 93402  
 Pigtail: 66851, 67001, 66850, 66801, 67050, 66800, 66840

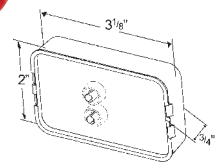

## CLEARANCE/MARKER LAMP WITH BUILT-IN REFLECTOR

Fits popular grommets, pigtailed and harnesses  
 • Hermetic lens-to-housing seal • 12,000+ hour bulb

<b>45232</b>	Red
<b>45233</b>	Yellow

Material: Polycarbonate  
 FMVSS: A, P2  
 Finish: Red / Yellow  
 Bulb: 2 CP; Volts / Amps: 12V / .33A  
 Grommet: 93400, 93402  
 Pigtail: 66851, 67001, 66850, 66801, 67050, 66800, 66840

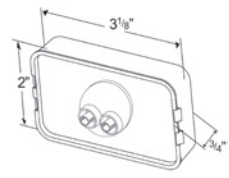



# Clearance/Marker Lamps

LED

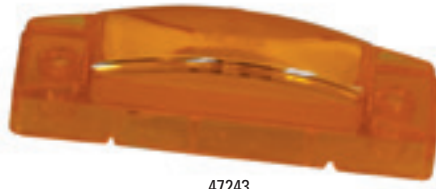

47243



47462

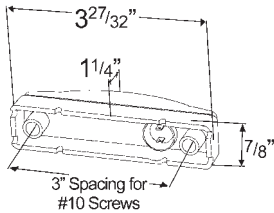

## SUPERNOVA® 3" THIN-LINE LED CLEARANCE/MARKER LAMP

3" mounting center • Field-replaceable lens • Encapsulant potting for total circuit board protection • Anti-torque design protects against over tightening and lens cracking • Wire exit holes at ends allow for flow-through harnessing • All PC versions meet requirements when mounted at a 45° angle.

47242	Red	
47243	Yellow	
47362	Red	24 VOLT
47363	Yellow	24 VOLT

## KITS:

65512	Red (47242 + 66930)
65513	Yellow (47243 + 66930)

## PC RATED:

47462	Red	PC
47463	Yellow	PC

## ABS LAMP:

78453	Yellow
-------	--------

Material: Polycarbonate  
 FMVSS: P2, PC  
 Finish: Red / Yellow  
 Volts / Amps: 47242, 47243, 78453 - 12V / .06A  
 Volts / Amps: 47462, 47463 - 12V / .12A  
 Volts / Amps: Red - 24V / .03A; Yellow - 24V / .04A  
 Bracket: 43230  
 Pigtail: 66931, 66930, 66932

LED

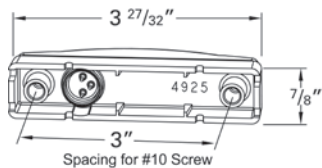

## SUPERNOVA® 3" THIN-LINE DUAL INTENSITY LED CLEARANCE/MARKER LAMP

3" mounting center • Multi-function lamp enhances signaling visibility and safety • Compact size for narrow mounting locations • Lamp functions as a marker, clearance, identification and supplemental high mount stop or turn lamp. • Long-life lamp features replaceable lens and a circuit board encapsulated in potting to protect against vibration and water intrusion.

49252	Red
49253	Yellow

Material: Polycarbonate  
 FMVSS: P2, PC  
 Finish: Red / Yellow  
 Volts / Amps: 14V / .02A / .06A  
 Pigtail: 66870

## SUPERNOVA® THIN-LINE LED CLEARANCE/MARKER LAMP

Sealed marker lamp • Encapsulant potting for total circuit board protection  
 • Thin-Line design fits narrow rails and channels • Uses UBS double-seal pigtail for maximum protection against corrosion

- 46902 Red Lens, White Body
- 46903 Yellow Lens, White Body
- 46922 Red Lens, Red Body
- 46933 Yellow Lens, Yellow Body

**KITS:**

- 45132 Red Lens, White Body (46902 + 66930)
- 45133 Yellow Lens, White Body (46903 + 66930)
- 45102 Red Lens, Red Body (46922 + 66930)
- 45103 Yellow Lens, Yellow Body (46933 + 66930)

Material: Polycarbonate  
 FMVSS: P2  
 Finish: Red / Yellow / White  
 Volts / Amps: 12V / .07A  
 Bracket: 43074  
 Pigtail: 66931, 66930, 66932

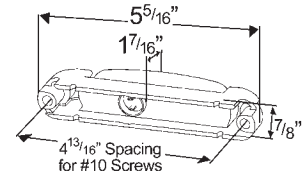

## THIN-LINE SINGLE-BULB CLEARANCE/MARKER LAMP

Narrow rail and channel mounting • Snap-on lens for easy bulb replacement • Attached pigtail

- 45252 Red RETAIL
- 45252-5 Red RETAIL
- 45253 Yellow RETAIL
- 45253-5 Yellow RETAIL

**WITH GROUND WIRE:**

- 45672 Red
- 45673 Yellow

Material: Lens - Acrylic; Housing - Polycarbonate  
 FMVSS: P2  
 Finish: Red / Yellow  
 Bulb: #193, 2 CP  
 Volts / Amps: 12V / .33A  
 Lens: Red 90152, Yellow 90153

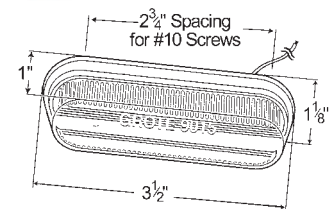

## TURTLEBACK® THIN-LINE SINGLE-BULB CLEARANCE/MARKER LAMP

Turtleback® lens design for maximum durability • Narrow rail and channel mounting • Attached pigtail

- 45382 Red
- 45383 Yellow

Material: Lens - Polycarbonate; Housing - Polypropylene  
 FMVSS: P2, P3  
 Finish: Red / Yellow  
 Bulb: #193, 2 CP  
 Volts / Amps: 12V / .33A

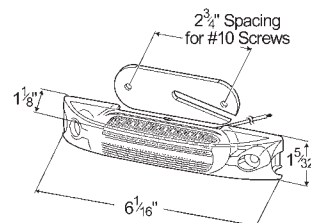

# Clearance/Marker Lamps

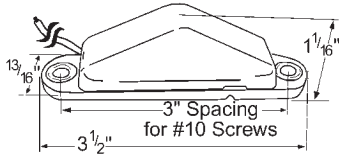

## CLEARANCE/MARKER LAMP WITH PEAK LENS

Shock-resistant bulb mount • Snap-on lens for easy bulb replacement  
All PC versions meet requirements when mounted at a 45° angle.

### BLUNT CUT:

45512	Red	PC
45512-5	Red	PC RETAIL
45513	Yellow	PC
45513-5	Yellow	PC RETAIL

### .180 MALE BULLET TERMINATION:

45522	Red	PC
45523	Yellow	PC

Material: Polycarbonate  
FMVSS: P2, PC  
Finish: Red / Yellow  
Bulb: #194, 2 CP  
Volts / Amps: 12V / .27A  
Lens: Red 93252

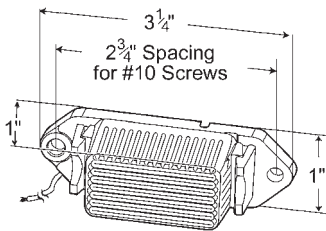

## ECONOMY CLEARANCE/MARKER LAMP

Snap-on lens for easy bulb replacement • Brass, ground eyelet  
• Compact design

46882	Red	
46882-5	Red	RETAIL
46883	Yellow	
46883-5	Yellow	RETAIL

Material: Lens - Polycarbonate; Housing - Polypropylene  
FMVSS: P2  
Finish: Red / Yellow  
Bulb: #194, 2 CP  
Volts / Amps: 12V / .27A  
Lens: Red 92432, Yellow 92433

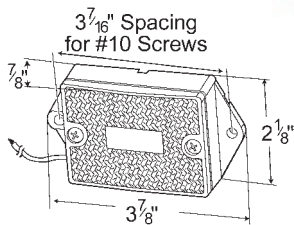

## RECTANGULAR SINGLE-BULB CLEARANCE/MARKER LAMP WITH BUILT-IN REFLECTOR

Corrosion-resistant body • Flange mounting • Boat, snowmobile, trailer, and RV applications

46392	Red	
46392-5	Red	RETAIL
46393	Yellow	
46393-5	Yellow	RETAIL

Material: Lens - Acrylic; Housing - Polypropylene  
FMVSS: A, P2, P3  
Finish: Red/Yellow  
Volts / Amps: 12V / .27A  
Lens: Red 91112, Yellow 91113

## RECTANGULAR SUBMERSIBLE CLEARANCE/MARKER LAMP WITH BUILT-IN REFLECTOR

Used with a large variety of boat, snowmobile and utility trailer lighting kits

### REPLACEMENT PARTS:

- 46982-5** Red, Clearance/Marker RETAIL
- 46983-5** Yellow, Clearance/Marker RETAIL

Material: Lens - Acrylic; Housing - ABS  
 FMVSS: P2, A  
 Finish: Red / Yellow  
 Volts / Amps: 12V / .27A  
 Lens: Red: 91112, Yellow 91113

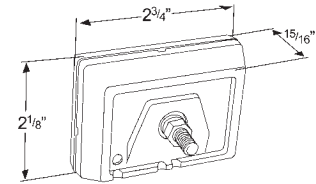

## RECTANGULAR CLEARANCE/MARKER LAMP

Chrome-plated, Polycarbonate housing • 2" mounting centers  
 • 1 1/8" socket hole required • Universal uses: interior, courtesy or trunk applications

- 47052** Red
- 47053** Yellow

### AUXILIARY:

- 47051** Clear

Material: Lens - Acrylic; Housing - Polycarbonate  
 FMVSS: P2  
 Finish: Chrome/Red/Yellow  
 Bulb: #1895, 2 CP  
 Volts / Amps: 12V / .27A

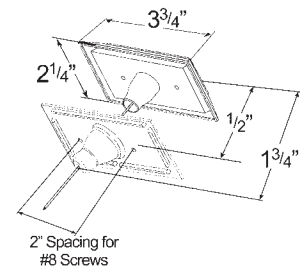

## SINGLE-BULB OVAL CLEARANCE/MARKER LAMP

Snap-on lens • Corrosion-resistant contact and ground • Reflex version is a combined side marker, clearance lamp, and reflector

### OPTIC LENS:

- 46702** Red
- 46703** Yellow
- 46703-5** Yellow RETAIL

### BUILT-IN REFLECTOR:

- 46712** Red
- 46712-5** Red RETAIL
- 46713** Yellow
- 46713-5** Yellow RETAIL

Material: Lens - Acrylic; Housing - Polypropylene  
 FMVSS: Optic - P2; Reflex - A, P2  
 Finish: Red / Yellow  
 Bulb: #193, 2 CP  
 Volts / Amps: 12V / .33A  
 Bracket: 43144, 43673  
 Lens: Optic - Red 90122, Yellow 90123; Reflex - Red 90202, Yellow 90203

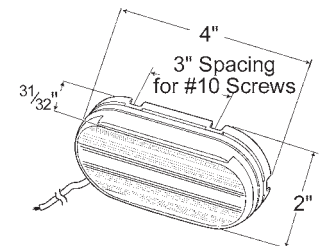

# Clearance/Marker Lamps

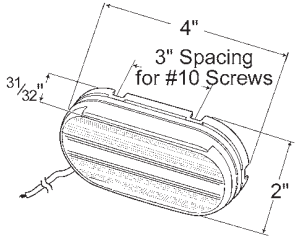

## TWO-BULB OVAL PIGTAIL-TYPE CLEARANCE/MARKER LAMP

Standard snap-on lens for easy bulb replacement • Two stainless steel grounds • Exclusive internal armor for additional bulb protection • Corrosion-resistant contacts • Reflex version is a combined side marker, clearance lamp, and reflector • Optic lens version meets PC function only when mounted at a 45° angle

### OPTIC LENS:

45262	Red	PC
45262-5	Red	PC RETAIL
45263	Yellow	PC
45263-5	Yellow	PC RETAIL

### BUILT-IN CLASS "A" REFLECTOR:

45932	Red	
45932-5	Red	RETAIL
45933	Yellow	
45933-5	Yellow	RETAIL

Material: Lens - Acrylic; Housing - Polypropylene  
 FMVSS: Optic - P2, PC; Reflex - A, P2  
 Finish: Red / Yellow  
 Bulb: (2) #1893, 2 CP  
 Volts / Amps: 12V / .66A  
 Bracket: 43144, 43673  
 Pigtail: 67120  
 Lens: Optic - Red 91572, Yellow 91573; Reflex - Red 90202, Yellow 90203

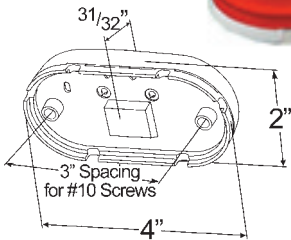

## TWO-BULB NO-SPLICE CLEARANCE/MARKER LAMP

Exclusive, no-splice wiring system • Exclusive, internal armor for additional protection • Standard snap-on lens for easy bulb replacement • Meets PC function only when mounted at a 45° angle

45432	Red	PC
45433	Yellow	PC

Material: Lens - Acrylic; Housing - Polypropylene  
 FMVSS: P2, P3, PC  
 Finish: Red / Yellow  
 Bulb: (2) #1893, 2 CP  
 Volts / Amps: 12V / .66A  
 Bracket: 43144, 43673  
 Lens: Red 91572, Yellow 91573

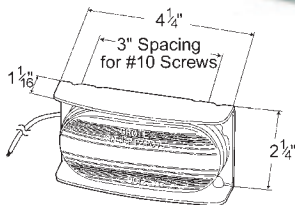

## ECONOMY STEEL-ARMORED CLEARANCE/MARKER LAMP

Corrosion-proof, shock-absorbing lamp base • External guard of formed steel for additional lamp protection • Snap-on lens for easy bulb replacement • Flat back; no need for lamp socket hole • Meets PC function only when mounted at a 45° angle

46493-5	Yellow	RETAIL PC
---------	--------	-----------

Material: Lens - Acrylic; Housing - Polypropylene/Steel  
 FMVSS: P2, PC  
 Finish: Yellow  
 Bulb: #193, 2 CP  
 Volts / Amps: 12V / .33A  
 Bracket: 43144  
 Lens: Red 90122, Yellow 90123

## FRUEHAUF SPECIAL CLEARANCE/MARKER LAMP

Fluted optics for wide light dispersion • Molded T-terminal wiring connection for easy replacements • Replaces Fruehauf® L-CE8750 and competitive versions • Meets PC function only when mounted at a 45° angle

<b>46772</b>	Red	<b>PC</b>
<b>46773</b>	Yellow	<b>PC</b>

Material: Lens - Acrylic; Housing - Polypropylene  
 FMVSS: P2, PC  
 Finish: Red / Yellow  
 Bulb: (2) #1893, 2 CP  
 Volts / Amps: 12V / .66A  
 Bracket: 43144, 43673  
 Pigtail: 67120  
 Lens: Red 91992, Yellow 91993

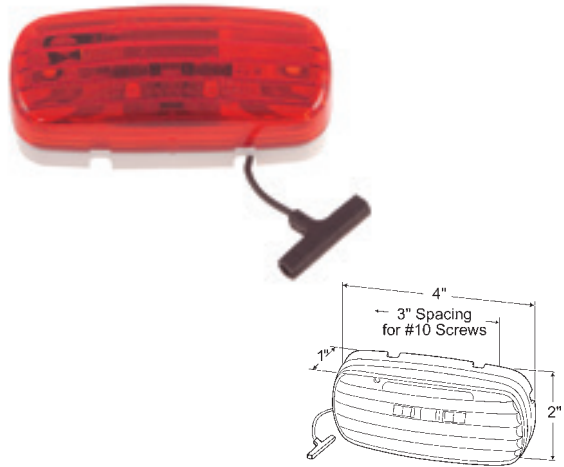

## HI COUNT® SQUARE-CORNER 13-DIODE LED CLEARANCE/MARKER LAMP

Molded snap-ring • Potted for total circuit board protection • Field-replaceable lens

<b>G4602</b>	Red	
<b>G4602-5</b>	Red	<b>RETAIL</b>
<b>G4603</b>	Yellow	
<b>G4603-5</b>	Yellow	<b>RETAIL</b>
<b>G4613</b>	Yellow, Clear Lens/Base	

Material: Lens - Acrylic; Housing - Polycarbonate  
 FMVSS: P2  
 Finish: Red / Yellow  
 Volts / Amps: 12V / .15A  
 Bracket: 43144, 43673  
 Lens: Red 91962, Yellow 91963, Clear 91961

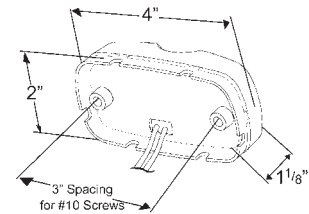
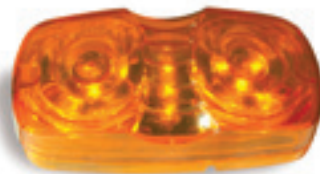

## TWO-BULB SQUARE-CORNER CLEARANCE/MARKER LAMP

Corrosion-resistant contacts • Snap-on lens for easy bulb replacement • Attached blunt cut pigtail • Meets PC function only when mounted at a 45° angle

DURAMOLD		
<b>46792</b>	Red	<b>PC</b>
<b>46792-5</b>	Red	<b>PC RETAIL</b>
<b>46793</b>	Yellow	<b>PC</b>
<b>46793-5</b>	Yellow	<b>PC RETAIL</b>

DIE CAST		
<b>46782</b>	Red	<b>PC</b>
<b>46783</b>	Yellow	<b>PC</b>

Materials:  
 Duramold - Lens: Polycarbonate; Housing - Polypropylene  
 Die Cast - Lens: Acrylic; Housing - Steel  
 FMVSS: P2, P3, PC  
 Finish: Red / Yellow  
 Bulb: (2) #1893, 2 CP; Volts / Amps: 12V / .66A  
 Bracket: 43144, 43673  
 Pigtail: 67120  
 Lens: Red 91962, Yellow 91963, Auxiliary - Clear 91961, Green 91964, Blue 91965

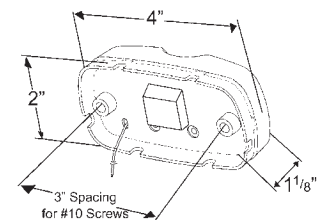

# Clearance/Marker Lamps

LED

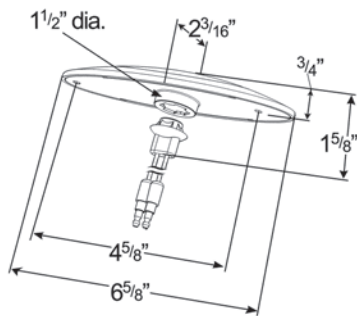
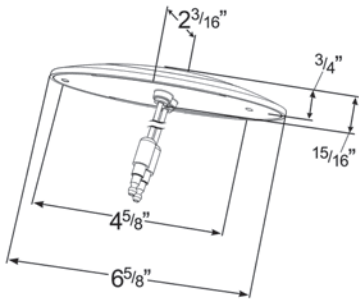

## M1 SERIES LED CLEARANCE/ MARKER LAMP

Sleek, aerodynamic styling • Hermetic lens-to-housing seal • Corrosion-resistant, chrome-plated bezels • Molded bullet kits come with two replacement mating connectors • Potted for total circuit board protection

### LAMP KITS WITH BEZEL:

<b>45582</b>	Red, .180 Molded Bullet	<b>NEW</b>
<b>45583</b>	Yellow, .180 Molded Bullet	
<b>47772</b>	Red, Clear Lens, .180 Molded Bullet	
<b>47773</b>	Yellow, Clear Lens, .180 Molded Bullet	
<b>45603</b>	Yellow, Metripack® Plug	

### LAMP KITS WITHOUT BEZEL:

<b>45623</b>	Yellow, .180 Molded Bullet
<b>45643</b>	Yellow, Metripack® Plug

Material: Lens - Polycarbonate; Housing - Polycarbonate; Bezel - ABS  
 FMVSS: P2  
 Finish: Chrome / Red / Yellow  
 Volts / Amps: 12V / .12A  
 Accessory: Bezel Chrome 93453  
 Pigtail: 66200

## M1 SERIES CLEARANCE/ MARKER LAMP

Sleek, aerodynamic styling • Molded bullet versions are bulb replaceable • Corrosion-resistant, chrome-plated bezels • Metripack® versions have a hermetic lens-to-housing seal

### LAMP KITS WITH BEZEL:

<b>45572</b>	Red, .180 Molded Bullet
<b>45573</b>	Yellow, .180 Molded Bullet
<b>45593</b>	Yellow, Metripack® Plug

### LAMP KITS WITHOUT BEZEL:

<b>45613</b>	Yellow, .180 Molded Bullet
<b>45633</b>	Yellow, Metripack® Plug

Material: Lens and Housing - Polycarbonate; Bezel - Chrome plated ABS  
 FMVSS: P2  
 Finish: Chrome / Red / Yellow  
 Bulb: #193, 2 CP Volts / Amps: 12V / .33A  
 Bulb: #464, 3 CP Volts / Amps: 24V / .17A  
 Accessory: Bezel Chrome 93453  
 Pigtail: 66200

## M3 SERIES LED CLEARANCE/ MARKER LAMP

Sleek, aerodynamic styling • Hermetic lens-to-housing seal  
 • Corrosion-resistant, chrome-plated bezels • Potted for total circuit board protection against vibration and corrosion • Kits contain two replacement mating connectors

### LAMP KITS WITH BEZEL:

- 45772** Red, .180 Molded Bullet
- 45773** Yellow, .180 Molded Bullet

### LAMP KITS WITHOUT BEZEL:

- 45792** Red, .180 Molded Bullet
- 45793** Yellow, .180 Molded Bullet

Material: Lens and Housing - Polycarbonate; Bezel - Chrome plated ABS  
 FMVSS: P2  
 Finish: Red / Yellow  
 Volts / Amps: 12V / .06A  
 Accessory: Bezel Chrome 93473  
 Pigtail: 66200

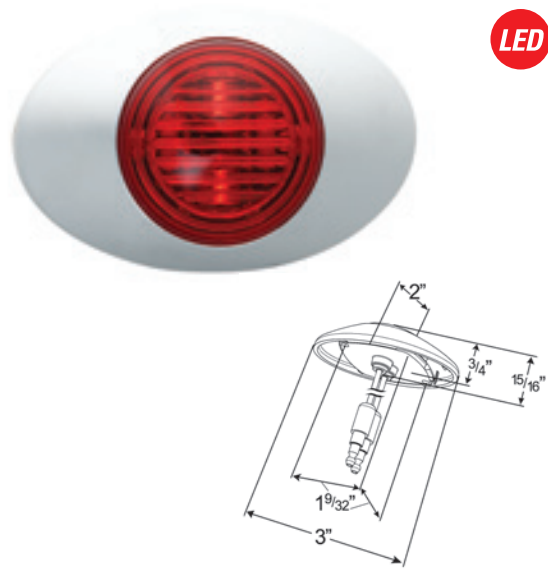

## M3 SERIES CLEARANCE/ MARKER LAMP

Sleek, aerodynamic styling • Field replaceable, bulb design • Corrosion-resistant, chrome-plated bezels • No exposed fasteners

### LAMP KITS WITH BEZEL:

- 45762** Red, .180 Molded Bullet
- 45763** Yellow, .180 Molded Bullet

### LAMP KITS WITHOUT BEZEL:

- 45783** Yellow, .180 Molded Bullet

Material: Lens and Housing - Polycarbonate; Bezel - Chrome plated ABS  
 FMVSS: P2  
 Finish: Red / Yellow  
 Bulb: #193, 2 CP  
 Volts / Amps: 12V / .33A  
 Accessory: Bezel: Chrome 93473  
 Pigtail: 66200

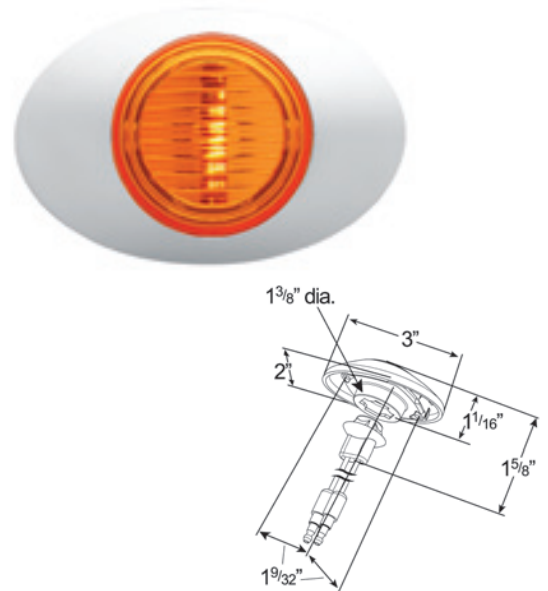

## M4 SERIES LED CLEARANCE/ MARKER LAMP

Sleek, aerodynamic styling • Hermetic lens-to-housing seal  
 • Corrosion-resistant chrome-plated bezels • Kits contain two replacement mating connectors

### LAMP KITS WITH BEZEL:

- 45853** Yellow, .180 Molded Bullet

Material: Lens and Housing - Polycarbonate; Bezel - Chrome plated ABS  
 FMVSS: P2  
 Finish: Yellow  
 Volts / Amps: 12V / .12A  
 Pigtail: 66200

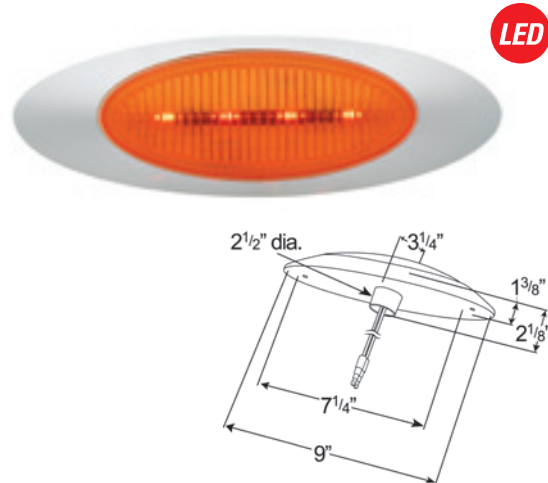



# Clearance/Marker Lamps



## M5 SERIES LED CLEARANCE/ MARKER LAMP

Sleek, aerodynamic styling • Hermetic lens-to-housing seal • Corrosion-resistant chrome-plated bezels • Potted for total circuit board protection against vibration and corrosion • Kits contain two replacement mating connectors • Small size fits into narrow applications

### LAMP KITS WITH BEZEL:

<b>47912</b>	Red, .180 Molded Bullet
<b>47913</b>	Yellow, .180 Molded Bullet
<b>47922</b>	Red, Clear Lens, .180 Molded Bullet
<b>47923</b>	Yellow, Clear Lens, .180 Molded Bullet

Material: Lens and Housing - Polycarbonate; Bezel - Chrome plated ABS  
FMVSS: P2  
Finish: Chrome / Clear / Red / Yellow  
Pigtail: 66200

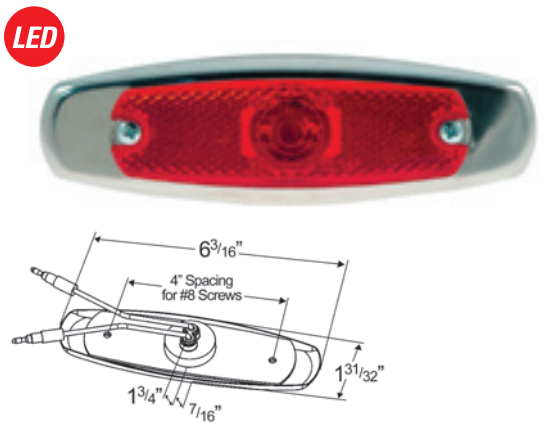

## SUPERNOVA® LOW-PROFILE LED CLEARANCE/MARKER LAMP

Potted for total circuit board protection • Sealed hardwire terminations with .180 molded, UBS Slim-Line bullets • Field replaceable lens • Requires 1 1/4" hole for mounting • Popular marker lamp on Peterbilt® trucks • Built-in reflector

### WITHOUT BEZEL:

<b>47262</b>	Red
<b>47263</b>	Yellow

### WITH BEZEL:

<b>47252</b>	Red
<b>47253</b>	Yellow

Material: Lens - Acrylic; Housing - Polypropylene; Bezel - Stainless Steel  
FMVSS: A, P2  
Finish: Stainless Steel / Red / Yellow  
Volts / Amps: 12V / .06A  
Lens: Red 90072, Yellow 90073

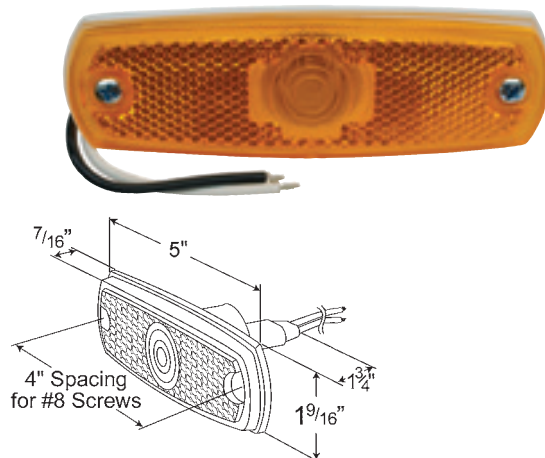

## LOW-PROFILE CLEARANCE/ MARKER LAMP

Field-replaceable lens • Requires 1 1/4" socket hole for mounting • Twist-in bulb socket for easy bulb replacement • Built-in reflector

### WITHOUT BEZEL:

<b>45712</b>	Red
<b>45713</b>	Yellow

### WITH BEZEL:

<b>45662</b>	Red
<b>45663</b>	Yellow

Material: Lens - Acrylic; Housing - Polypropylene; Bezel - Stainless Steel  
FMVSS: A, P2  
Finish: Stainless Steel / Red / Yellow  
Bulb: #194, 2 CP  
Volts / Amps: 12V / .27A  
Pigtail: 68380  
Lens: Red 90072, Yellow 90073

## SEALED RECTANGULAR LED CLEARANCE/MARKER LAMP

Potted for total circuit board protection against vibration and corrosion  
 • Hermetic lens-to-housing seal • Fits standard mounting holes, no bracket required • Uses same .180 molded bullet connections as incandescent versions for a quick, easy retrofit • Replaces Truck-Lite® 18050R (red) or 18050Y (yellow)

- 47732 Red 
- 47733 Yellow 

Material: Acrylic  
 FMVSS: A, P2  
 Finish: Red / Yellow  
 Volts / Amps: 12V / .06A, 24V / .06A

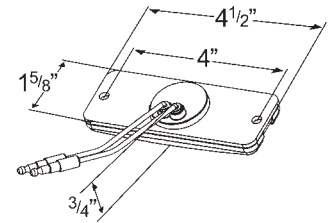
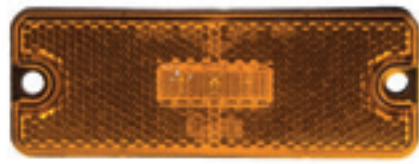

## SUPERNOVA® SEALED TURTLEBACK® II LED CLEARANCE/MARKER LAMP

Potted for total circuit board protection • Hermetic lens-to-housing seal  
 • Tin-plated, solid-brass terminals are sealed to housing to resist corrosion and eliminate failure causing leak paths • Meets PC function only when mounted at a 45° angle • Not designed for vertical mount

### BUILT-IN REFLECTOR:

- 47072 Red, Male Pin
- 47073 Yellow, Male Pin
- 47352 Red, Male Pin 
- 47353 Yellow, Male Pin 

### PC RATED OPTIC LENS:

- 47162 Red, Male Pin 
- 47163 Yellow, Male Pin 
- 49392 Red, Hardwire 
- 49393 Yellow, Hardwire 

### DUAL INTENSITY:

- 54003 Yellow, Optic Lens, Male Pin 

### ABS LAMP:

- 78403 Yellow, Reflex Lens, Male Pin 

Material:  
 Reflex - Lens: Acrylic; Housing - Polycarbonate  
 Optic - Lens - Polycarbonate  
 Duel - Housing - Polycarbonate

FMVSS: Optic - P2, PC; Reflex - A, P2  
 Finish: Red / Yellow  
 Volts / Amps: P2 - 12V / .06A  
 Volts / Amps: PC - 12V / .12A  
 Volts / Amps: Red - 24V / .03A  
 Volts / Amps: Yellow - 24V / .04A  
 Bracket: 43030, 43050  
 Pigtail: 66911, 66910, 67070, 67071



47073

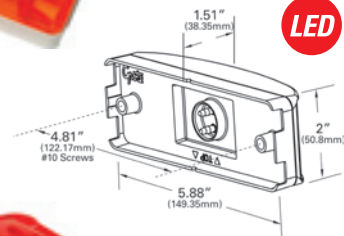

47162

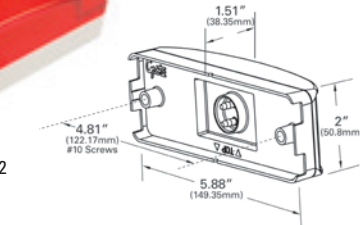

54003

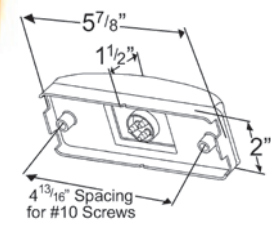

49393

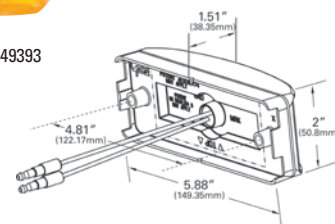

# Clearance/Marker Lamps

LED

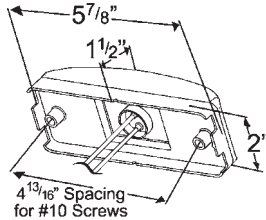
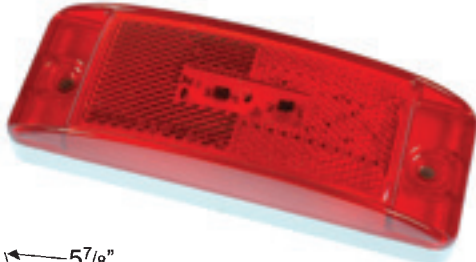

## HI COUNT® TURTLEBACK® II LED CLEARANCE/MARKER LAMP

Hermetic lens-to-housing seal • Molded bullet with chassis ground-ring terminal connection • Shock absorbing, heat-resistant lens and lamp base • Red lamp has 8 diodes, yellow lamp has 10 diodes

<b>G2102</b>	Red	
<b>G2102-5</b>	Red	RETAIL
<b>G2103</b>	Yellow	
<b>G2103-5</b>	Yellow	RETAIL

Material: Lens: Acrylic; Housing - Polycarbonate  
 FMVSS: A, P2  
 Finish: Red / Yellow  
 Volts / Amps: Red - 12V / .12A  
 Volts / Amps: Yellow - 12V / .15A  
 Bracket: 43030, 43050

LED

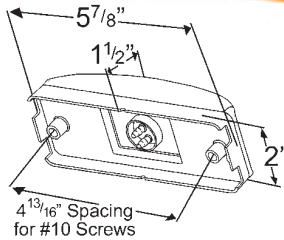

## SUPERNOVA® SEALED TURTLEBACK® II LED DUAL INTENSITY CLEARANCE/MARKER LAMP

Potted for total circuit board protection • Hermetic lens-to-housing seal • Tin-plated, solid-brass terminals are sealed to housing, to resist corrosion and eliminate failure-causing leak paths • Meets PC function when mounted at a 45° angle • Not designed for vertical mount

**54003** Yellow, Male Pin

Material: Polycarbonate  
 FMVSS: P2, PC  
 Color: Yellow  
 Voltage Amp: 12V / .12A

## SEALED TURTLEBACK® II CLEARANCE/MARKER LAMP

Shock-absorbing, heat-resistant lens and lamp base • Hermetic lens-to-housing seal • Waterproof male pin connections accept UBS pigtail • Turtleback® lens design for maximum durability • Two 12,000+ hour bulbs • Optic lens version meets PC function only when mounted at a 45° angle



46832



46873

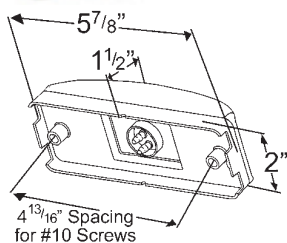

### OPTIC LENS:

<b>46832</b>	Red	PC
<b>46832-5</b>	Red	PC RETAIL
<b>46833</b>	Yellow	PC
<b>46833-5</b>	Yellow	PC RETAIL

### REFLEX LENS:

<b>46872</b>	Red	
<b>46872-5</b>	Red	RETAIL
<b>46873</b>	Yellow	
<b>46873-5</b>	Yellow	RETAIL

### ABS LAMP:

**78363** Yellow, Optic Lens PC

Material:  
 Reflex - Lens: Acrylic; Housing - Polycarbonate  
 Optic - Lens and Housing - Polycarbonate  
 FMVSS: Optic - P2, P3, PC; Reflex - A, P2  
 Finish: Red / Yellow  
 Bulb: (2) 2 CP  
 Volts / Amps: 12V / .66A  
 Bracket: 43030, 43050  
 Pigtail: 66910, 66911, 67070, 67071

## FIELD RESEALABLE LENS TURTLEBACK® II CLEARANCE/ MARKER LAMP

Weather-tight lens gasket seal • Resealable for bulb replacement  
 • Impact-resistant bulb contacts • Turtleback® lens design for maximum durability  
 • 12-Volt version features two 12,000+ hour bulbs • Optic lens version meets PC function only when mounted at a 45° angle

### OPTIC LENS:

<b>46802</b>	Red	<b>PC</b>
<b>46803</b>	Yellow	<b>PC</b>

### REFLEX LENS::

<b>46862</b>	Red
<b>46863</b>	Yellow

Material:

Optic Lens and Housing - Polycarbonate  
 Reflex Lens: Acrylic; Housing - Polycarbonate

FMVSS: Optic - P2, P3, PC, PC2; Reflex - A, P2

Finish: Red / Yellow

Bulb: (2) #193, 2 CP; Volts / Amps: 12V / .66A

Bracket: 43030, 43050

Pigtail: 66911, 66910, 67070, 67071

Lens: Optic: Red 92162, Yellow 92163; Reflex: Red 92172, Yellow 92173

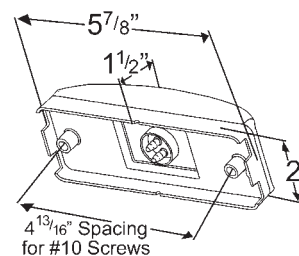

## ECONOMY SEALED CLEARANCE/ MARKER LAMP

Hermetic lens to housing seal • 12,000 hour bulb • Self grounding eyelet grounds lamp when attached to a metal plate • Retrofits to competitor lamps easily with hot wire termination • Interchanges to Truck-Lite® 21201R (red) or 21201Y (yellow)

<b>46072</b>	Red
<b>46073</b>	Yellow

### KITS:

<b>46082</b>	Red (46072 + 66360)
<b>46083</b>	Yellow (46073 + 66360)

Material: Acrylic

FMVSS: A, P2

Finish: Red / Yellow

Bulb: 2 CP; Volts / Amps: 12V / .33A

Pigtail: 66360

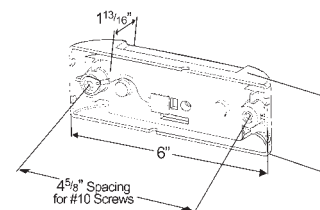
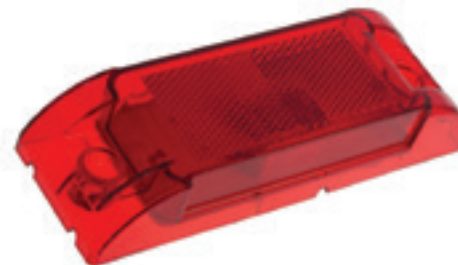

# Clearance/Marker Lamps

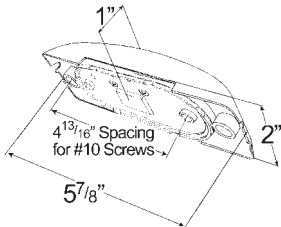
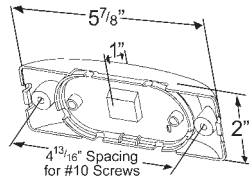

LED

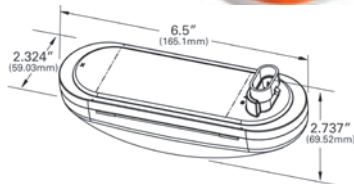

## TWO-BULB TURTLEBACK® CLEARANCE/MARKER LAMP

Turtleback® lens design for maximum durability • Two stainless steel grounds

### OPTIC LENS:

**45462** Red  
**45463** Yellow

### BUILT-IN REFLECTOR:

**46302** Red  
**46303** Yellow

### Material:

Optic Lens - Polycarbonate; Housing - Polypropylene  
Reflex Lens: Acrylic; Housing - Polypropylene

FMVSS: Optic - P2; Reflex - A, P2

Finish: Red / Yellow

Bulb: (2) #1893, 2 CP Volts / Amps: 12V / .66A

Pigtail: 67120

Lens: Optic - Red 90172, Yellow 90173; Reflex - Red 91042, Yellow 91043

## TWO-BULB TURTLEBACK® NO-SPLICE CLEARANCE/MARKER LAMP

Exclusive, no-splice wiring system • Turtleback® lens design for maximum durability • Corrosion-resistant contacts

**45442** Red  
**45443** Yellow

Material: Lens - Polycarbonate; Housing - Polypropylene

FMVSS: P2

Finish: Red / Yellow

Bulb: (2) #1893, 2 CP

Volts / Amps: 12V / .66A

Lens: Red 90172, Yellow 90173

## RAZORBACK™ MID-POSITION FLASHING LED MARKER LAMP

Patent pending electronic design meets all FMVSS 108 marker requirements and also flashes in concert with the turn signal circuitry to act as a mid-position flasher • 50 State Legal flashing mid-position marker • Easily visible from the cab during operation • Encapsulant potting for total circuit board protection • Fits current mounting flanges and grommets

**54593** Yellow, Hardshell  
**54663** Yellow, Male Pin

Material: Polycarbonate

Finish: Yellow

FMVSS: P2

Voltage Amp: 13.5V / .18A

Brackets: 43220, 43222, 43223, 43732, 43362,

43952, 43172, 43100, 42152, 42153

Grommet: 92420, 92720, 67151

Pigtails: 66861

## SMALL SQUARE PC-RATED CLEARANCE/MARKER LAMP

Direct replacement for Truck-Lite® 12200R • Standard lamps on UPS  
 • Comes with gasket • Sonic sealed lens • Service life rated at 15,000 hours

**46092** Red **PC**

Material: Polycarbonate  
 FMVSS: P2, PC  
 Finish: Red  
 Bulb: 2 CP  
 Volts / Amps: 12V / .33A

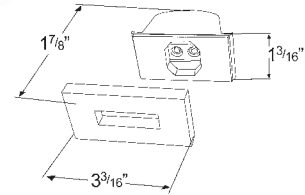

## DIE-CAST, ALUMINUM CLEARANCE/MARKER LAMP

Mounts without disassembly • Holes interchange with competitive lamps for easy retrofits • Lens replaces comparable competitor models • Meets PC function only when mounted at a 45° angle

FLAT BACK, NO SOCKET HOLE REQUIRED:

**46282** Red **PC**  
**46283** Yellow **PC**

REAR SOCKET:

**46292** Red **PC**  
**46293** Yellow **PC**

Material: Lens - Acrylic; Housing - Aluminum  
 FMVSS: P2, PC  
 Finish: Red / Yellow  
 Bulb: 46292, 46293: #67, 4 CP  
 Volts / Amps: 12V / .59A  
 Bulb: 46282, 46283 - #193, 2 CP  
 Volts / Amps: 12V / .33A  
 Lens: Red 90922, Yellow 90923

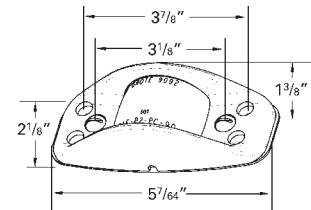

## NARROW-RAIL CLEARANCE/MARKER LAMP

Seal-tight expanded rubber gasket • Steel housing for additional lamp protection • Two- or four-hole mounting for easy retrofits • Flat back; no need for lamp socket hole • Meets PC function only when mounted at a 45° angle

**45172** Red **PC**  
**45173** Yellow **PC**

Material: Lens - Acrylic; Housing - Steel  
 FMVSS: P2, P3, PC  
 Finish: Red / Yellow  
 Bulb: #193, 2 CP  
 Volts / Amps: 12V / .33A  
 Lens: Red 90052, Yellow 90053, Auxiliary - Clear 90051

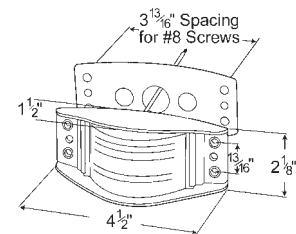

# Clearance/Marker Lamps

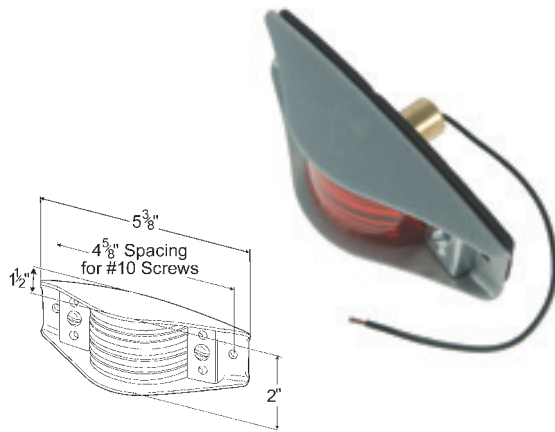

## ARMORED CLEARANCE/ MARKER LAMP

Seal-tight, expanded rubber gasket • Steel housing for additional lamp protection • Two- or four-hole mounting for easy retrofits • Rear socket hole required • Meets PC function only when mounted at a 45° angle

**45012** Red **PC**  
**45013** Yellow **PC**

Material: Lens - Acrylic; Housing - Steel  
FMVSS: P2, P3, PC  
Finish: Red / Yellow  
Bulb: #67, 4 CP  
Volts / Amps: 12V / .59A  
Pigtail: 68080  
Lens: Red 90052, Yellow 90053; Auxiliary: Clear 90051

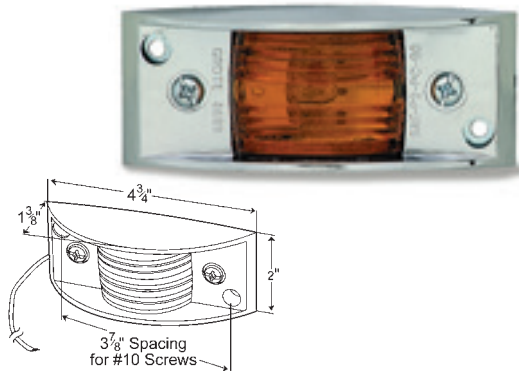

## CHROME-ARMORED CLEARANCE/ MARKER LAMP

Direct interchange for competitive models • Flat back; no bulb socket hole required • Meets PC function only when mounted at a 45° angle

**46892** Red **PC**  
**46892-5** Red **PC RETAIL**  
**46893** Yellow **PC**  
**46893-5** Yellow **PC RETAIL**

Material: Lens - Acrylic; Housing - Chrome Plated ABS  
FMVSS: P2, PC  
Finish: Red / Yellow  
Bulb: #194, 2 CP  
Volts / Amps: 12V / .27A  
Lens: Red 90922, Yellow 90923



## SUPERNOVA® LOW-PROFILE LED BAR LAMP

Twist-in, locking feature • Sealed UBS harness • Uses 2.5" round LED replacement lamps

**49162** Red

Material: Lens - Polycarbonate; Housing - Steel  
FMVSS: P2  
Finish: Red  
Volts / Amps: 12V / .18A  
Accessory: Lamp: Red 47122; Harness: 67740  
Bracket: 49140

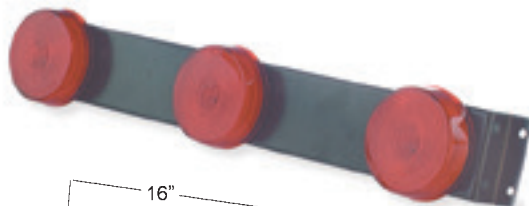

## LOW-PROFILE BAR LAMP

Uses 2 1/2" round, replaceable lamps • Twist-in, locking feature • Sealed UBS harness

**49142** Red

Material: Lens - Polycarbonate; Housing - Steel  
FMVSS: P2  
Finish: Red  
Bulb: (3) 2 CP  
Volts / Amps: 12V / .99A  
Accessory: Harness: 67740, Lamp: Red 45812  
Bracket: 49140

## BEEHIVE TYPE BAR LAMP

Black enamel metal bar • Includes heat-sealed, splice-on pigtail

**49002** Red

Material: Lens - Acrylic; Housing - ABS/Steel  
 FMVSS: P2  
 Finish: Red  
 Bulb: (3) #67, 4 CP  
 Volts / Amps: 12V / 1.77A

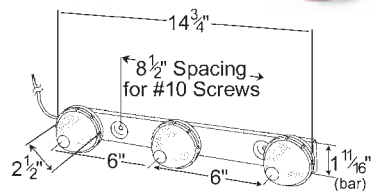

## SUPERNOVA® LED BAR LAMP

Snap-on replacement lamps • Sealed flow-through UBS harness • Rugged reinforced polycarbonate bar • Easy to install

**49182** Red

Material: Polycarbonate  
 FMVSS: P2  
 Finish: Red  
 Volts / Amps: 12V / .18A  
 Accessory: Lamp: Red 47082; Harness: 69710



## BAR LAMP

Three replaceable snap-on lamps • Sealed flow-through harness • Rugged reinforced polycarbonate bar • Easy to install

**49172** Red

**49173** Yellow

Material: Polycarbonate  
 FMVSS: P2  
 Finish: Red  
 Bulb: (3) 2 CP  
 Volts / Amps: 12V / .99A  
 Accessory: Lamp: Red 46412, Yellow 46413; Harness: 69710



## ALUMINUM BAR LAMP

Thin-line design fits narrow rails and channels • Three two-bulb replaceable snap-on lamps • Easy installation • UBS wire harness included

**49132** Red

Material: Lens - Polycarbonate; Housing - Aluminum  
 FMVSS: P2  
 Finish: Red  
 Bulb: (6) 2 CP  
 Volts / Amps: 12V / 1.98A  
 Accessory: Lamp: Red 46742

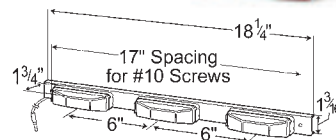



# Clearance/Marker Lamps

LED

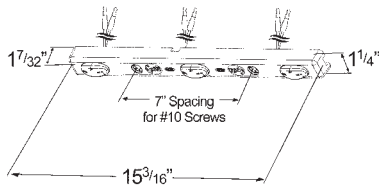

## MICRONOVA® LED BAR LAMP

Replaceable sealed lamps • Low-profile design fits narrow rail applications  
 • Encapsulant potting for total circuit board protection against vibration and corrosion • Sealed harness • Easy to install • Rugged reinforced polycarbonate bar

**49202** Red

Material: Polycarbonate  
 FMVSS: P2  
 Finish: Red  
 Volts / Amps: 12V / .16A  
 Accessory: Lamps: Red 47962

LED

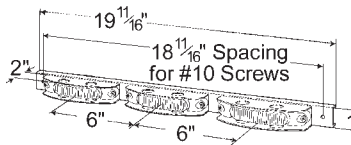

## SUPERNOVA® THIN-LINE LED BAR LAMP

Thin-Line design fits narrow rails and channels • Easy installation  
 • Sealed UBS harness included • Replaceable external guard made of formed aluminum

**49122** Red

Material: Lens - Polycarbonate; Housing - Aluminum  
 FMVSS: P2  
 Finish: Red  
 Volts / Amps: 12V / .18A  
 Accessory: Lamp: Red 46902  
 Branch Guard: 43074

LED

49243



49242-5

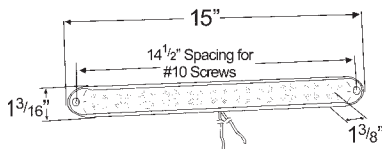

## 15" THIN-LINE LED BAR LAMP

Rated to 100,000 hours of service life • Sealed marker lamps are shock- and vibration-resistant • Impact-resistant housing is sealed for moisture protection • 3 LEDs

**49192** Red  
**49223** Yellow  
**49242-5** Red **NEW**

Material: Polycarbonate  
 FMVSS: P2, P3  
 Finish: Red / Yellow  
 Volts / Amps: 12V / .25A

## THIN-LINE BAR LAMP

Three bulb-replaceable 45252 lamps • Black powder-coated, formed steel bar

**49062** Red

Material: Lens - Acrylic; Housing - Polycarbonate; Bar - Formed Steel  
 FMVSS: P2  
 Finish: Red  
 Bulb: (3) #193, 2 CP  
 Volts / Amps: 12V / .99A  
 Replacement Lens: Red 90152

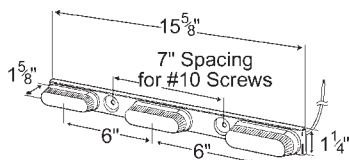

## ECONOMY BAR LAMP

Three bulb-replaceable 46882 lamps • Formed steel bar with white enamel

**49112** Red  
**49112-5** Red **RETAIL**

Material: Lens - Acrylic; Housing - Polycarbonate; Bar - Formed Steel  
 FMVSS: P2  
 Finish: Red  
 Bulb: (3) #194, 2 CP  
 Volts / Amps: 12V / .81A  
 Lens: Red 92432

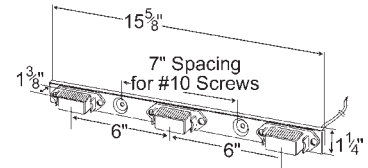

## 2 1/2" OVAL LED BAR LAMP

Impact resistant housing with sonic sealed, shock and vibration-resistant lamps • Uses three dual-diode LED lamps

**49212-5** Red **RETAIL**

Material: Lens and Housing - Polycarbonate; Bar - ABS  
 FMVSS: P2  
 Finish: Red  
 Volts / Amps: 12V / .15A  
 Accessory: Lamp: Red 47012

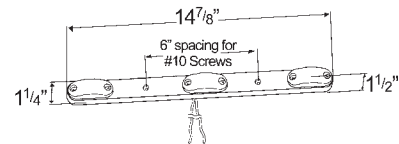

## LOW-PROFILE BAR LAMP

Three-bulb, replaceable 45262 or 46792 lamps

### OVAL STYLE:

**49072** Red

### SQUARE CORNER STYLE:

**49082** Red

Material: Lens and Housing - Polycarbonate; Housing and Bar - Polypropylene  
 FMVSS: P2  
 Finish: Red / Yellow  
 Bulb: (6) #1893, 2 CP  
 Volts / Amps: 12V / 1.98A  
 Lens: Oval - Red 90122, Yellow 90123; Square - Red 91962

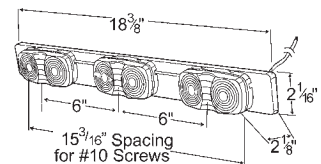

## OEM-STYLE, LARGE AERODYNAMIC CAB MARKER LAMP

3/8" thick mounting gasket • Mounting holes interchange with most popular torpedo-type cab marker lamps • Chrome-plated body, long-life bulb • Used on Ford®, Navistar®, and Freightliner® trucks • Meets side marker and front clearance requirements simultaneously

**46823** Yellow **PC**

Material: Lens - Polycarbonate; Housing - Chrome Plated ABS  
 FMVSS: P2, P3, PC  
 Finish: Chrome / Yellow  
 Bulb: #904, 4 CP  
 Volts / Amps: 12V / .69A  
 Lens: Yellow 92193

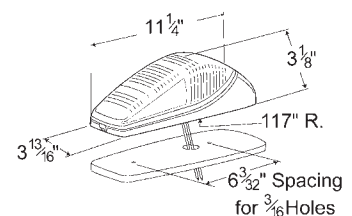

# Clearance/Marker Lamps

LED

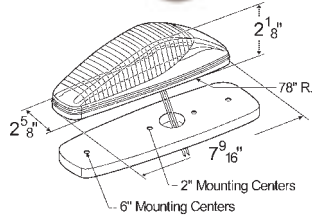

## SUPERNOVA® SMALL AERODYNAMIC LED CAB MARKER LAMP

Replaceable lens • Same mounting and lens as incandescent (46813)  
 • Encapsulant potting for total circuit board protection • Meets side marker and front clearance requirements simultaneously

**47183** Yellow **PC**

Material: Lens - Polycarbonate; Housing - Valox  
 FMVSS: P2, PC  
 Finish: Yellow  
 Volts / Amps: 12V / .12A  
 Accessory: Chrome Bezel: 92583  
 Lens: Yellow 92183

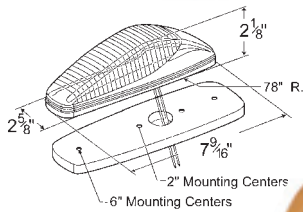

## SMALL AERODYNAMIC CAB MARKER LAMP

Easy snap-on lens • Optics illuminate full lens • Used on Mack®, Navistar®, Freightliner®, Ford®, and Peterbilt® trucks • Meets sidemarker and front clearance requirements simultaneously

WITHOUT CHROME BEZEL:

**46813** Yellow **PC**

WITH CHROME BEZEL:

**46433** Yellow **PC**

Material: Lens - Polycarbonate; Housing - Valox  
 FMVSS: P2, P3, PC  
 Finish: Yellow  
 Bulb: #168, 3 CP  
 Volts / Amps: 12V / .35A  
 Accessory: Chrome Bezel: 92583  
 Lens: Yellow 92183

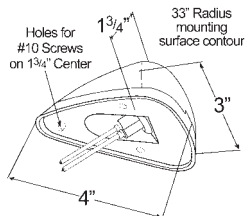

## LOW-PROFILE AERODYNAMIC CAB MARKER LAMP

Aerodynamic design • Cab marker replacement for heavy-duty Ford® trucks • Field replaceable lens • Mounting screws included

**46003** Yellow

Material: Lens and Housing - Polycarbonate  
 FMVSS: P2, PC  
 Finish: Yellow  
 Bulb: #168, 3 CP  
 Volts / Amps: 12V / .27A  
 Lens: Yellow 93393

LED

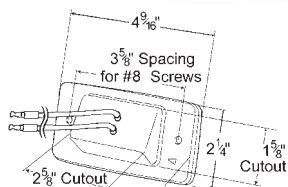

## SUPERNOVA® FLUSH-MOUNT LED CAB MARKER LAMP

Hermetic lens-to-housing seal • Potted for total circuit board protection • Sealed hardwire connections with UBS molded .180 bullet terminals • Freightliner®, Sterling, and Navistar® replacement

**47063** Yellow

Material: Lens and Housing - Polycarbonate  
 FMVSS: P2  
 Finish: Yellow  
 Volts / Amps: 12V / .12A

## FLUSH-MOUNT CAB MARKER LAMP

Application for visors • Hermetic lens-to-housing seal • Used on Freightliner®

**46913** Yellow

Material: Polycarbonate  
 FMVSS: P2  
 Finish: Yellow  
 Pigtail: 68380

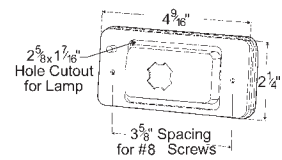

## DELUXE DIE-CAST CAB MARKER LAMP

Easy installation • Neoprene mounting pad • Chrome-plated • Meets side marker and front clearance requirements simultaneously

**45333** Yellow

Material: Lens - Acrylic; Housing - Chrome Plated Zinc Die-cast  
 FMVSS: P2, P3  
 Finish: Chrome / Yellow  
 Bulb: #67, 4 CP  
 Volts / Amps: 12V / .59A  
 Pigtail: 68080  
 Lens: Yellow 90133

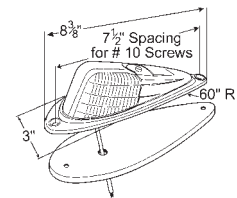

## ECONOMY CAB MARKER LAMP

Fits flat or slight contour surfaces • Replaces original equipment on Ford® trucks  
 • Meets side marker and front clearance requirements simultaneously

**46543** Yellow **PC**  
**46543-5** Yellow **PC RETAIL**

Material: Lens - Acrylic; Housing - ABS  
 FMVSS: P2, PC  
 Finish: Yellow  
 Bulb: #67, 4 CP  
 Volts / Amps: 12V / .59A  
 Pigtail: 68170  
 Lens: Yellow 91683

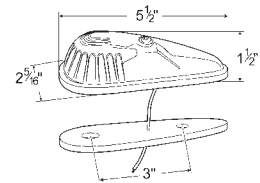

## FORD® LIGHT DUTY CAB MARKER LAMP

Replaces surface mount, cab marker on Ford® F-Series trucks • Hermetic lens-to-housing seal • Replaceable bulb design • Mounting pad and screws included

**45503** Yellow **PC**

Material: Lens - Polycarbonate; Housing - ABS  
 FMVSS: P2, PC  
 Finish: Yellow  
 Bulb: #194, 2 CP  
 Volts / Amps: 12V / .27A

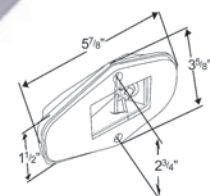

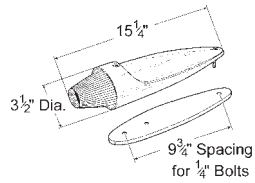

### SHOCK-RESISTANT TORPEDO-STYLE CAB MARKER LAMP

Replacement for Mack® and Kenworth® • Includes two 1/4" bolts on 9 3/4" centers for mounting

**45993** Yellow **PC**

Material: Lens - Acrylic; Housing - Chrome Plates ABS  
 FMVSS: P2, PC  
 Finish: Yellow  
 Bulb: #67, 4 CP  
 Volts / Amps: 12V / .59A  
 Lens: Yellow 92773

**LED**

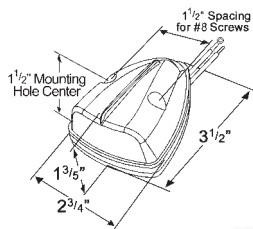

### HI COUNT® SCHOOL BUS WEDGE LED MARKER LAMP

Hermetically sealed construction • Potted circuit board • Mounting gasket included • Blunt cut, hardwire termination • 15 Diodes in both red and yellow lamps • Meets PC when mounted at a 45° only

**G5052** Red **PC**  
**G5053** Yellow **PC**  
**G5053-5** Yellow **PC RETAIL**

Material: Polycarbonate  
 FMVSS: P2, PC  
 Finish: Red / Yellow  
 Volts / Amps: 12V / .1A

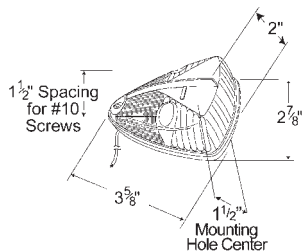

### SCHOOL BUS WEDGE MARKER LAMP

Adaptable front/side/rear mount • Galvanized steel housing  
 • Fits most school bus applications

**46322** Red  
**46323** Yellow

Material: Lens - Acrylic; Housing - Galvanized Steel  
 FMVSS: P2  
 Finish: Red / Yellow  
 Bulb: #168, 3 CP  
 Volts / Amps: 12V / .35A  
 Lens: Red 99912, Yellow 99913

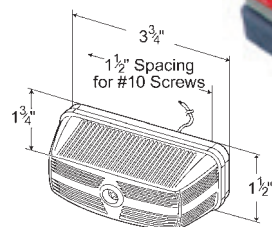

### SCHOOL BUS RECTANGULAR MARKER LAMP

OEM-style • Fits most school bus applications • Includes mounting pad

**46332** Red  
**46333** Yellow

Material: Lens - Acrylic; Housing - Zinc  
 FMVSS: P2  
 Bulb: #168, 3 CP  
 Volts / Amps: 12V / .35A  
 Lens: Red 99802, Yellow 99803

## 4" LED STOP/TAIL/TURN WITH INTEGRATED BACK-UP LAMP

Innovative patent-pending design combines all Stop/Tail/Turn and Back-up functions into one industry standard size lamp • Symmetrical design meets legal requirements at any mounting angle • LED technology provides less maintenance costs and long life • Industry-standard design fits existing mounting grommets, brackets, and flanges • Reduces inventory, SKUs, and carrying costs

- 55162** Red, Hard Shell NEW
- 55202** Red, Stainless Steel, Theft Resistant Flange, Hardshell NEW
- 55212** Red, Gray, Theft Resistant Flange, Hardshell NEW

Material: Lens: Red/Clear Polycarbonate; Housing: Black Polycarbonate/ABS blend  
 Flange: Stainless Steel/Polycarbonate  
 FMVSS 108: I, S, T, R2  
 Voltage: 14 Volts Design Current  
 Current Draw: (±15%) @ 14V  
 Stop: Range 80mA - 185mA  
 Tail: Range 19mA - 22mA  
 Back-Up: 306mA



55162

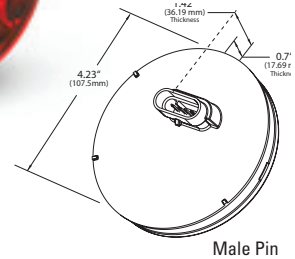

Male Pin

## SUPERNOVA® 4" 10-DIODE PATTERN LED STOP/TAIL/TURN LAMP

Lens design spreads light for maximum dispersion • Potted for total circuit board protection • Hermetic lens-to-housing seal • Advanced Pin Connection System uses tin-plated, solid brass pin terminals • Uses same UBS pigtail as male pin incandescent

### STOP/TAIL/TURN:

- 53252** Red, Grommet Mount, Male Pin
- 53272** Red, Gray Theft-Resistant Flange, Male Pin
- 53282** Red, White Theft-Resistant Flange, Male Pin
- 53292** Red, Black Theft-Resistant Flange, Male Pin
- 53302** Red, Stainless Steel Theft-Resistant Flange, Male Pin
- 52092** Red, Grommet Mount, Male Pin 24
- 54622** Red, Integrated Flange w/ Gasket, Male Pin
- 53552** Red, Grommet Mount, Hard Shell
- 54032** Red, Gray Snap-In Flange, Hard Shell
- 54042** Red, Stainless Steel Snap-In Flange, Hard Shell
- 53532** Red, Grommet Mount, Hardwire

### STOP/TAIL/TURN KITS:

- 53462** Red, Male Pin, (53252 + 91740 + 67002)
- 53432** Red, Male Pin, (53302 + 67002)
- 53342** Red, Male Pin, (53252 + 66830)

### AUXILIARY:

- 53253** Yellow, Grommet Mount, Male Pin
- 52093** Yellow, Grommet Mount, Male Pin 24
- 53273** Yellow, Gray Theft-Resistant Flange, Male Pin
- 53293** Yellow, Black Theft-Resistant Flange, Male Pin
- 53303** Yellow, Stainless Steel Theft-Resistant Flange, Male Pin
- 53553** Yellow, Grommet Mount, Hard Shell

Material: Lens - Acrylic; Housing - ABS; Flange - Polycarbonate / Stainless Steel  
 FMVSS: S/T/T - I, P2, S, T; Auxiliary - P2  
 Finish: Red / Yellow  
 Volts / Amps: Red - 12V / .24A (I,S)/.03A (T)  
 Volts / Amps: Yellow - 12V / .15A (P2)  
 Volts / Amps: Red - 24V / .24A(I,S)/.03A (T)  
 Volts / Amps: Yellow - 24V / .12A (P2)  
 Bracket: 93552, 43253, 92510, 92512, 92513, 43572, 43642, 43655, 43732, 93190, 93553, 93683, 92511, 51090  
 Grommet: 91740, 91950  
 Pigtail: Male Pin: 66815, 67002, 66841, 66816, 67005, 66845  
 Hard Shell: 66861, 66862



53252

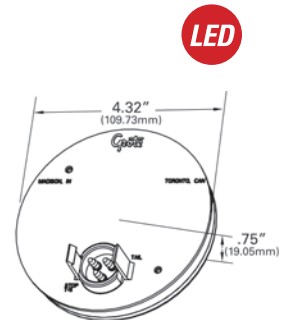

53303

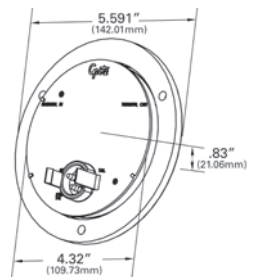

54622

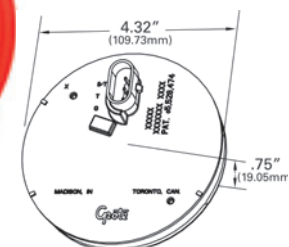
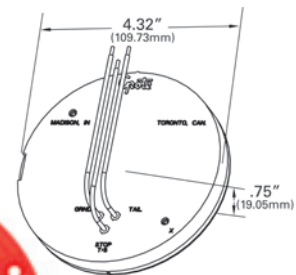

LED

LED

# Stop/Tail/Turn Lamps

Feux Arrêt / Arrière / Direction L mparas de Freno / Cuarto / Direccional

LED

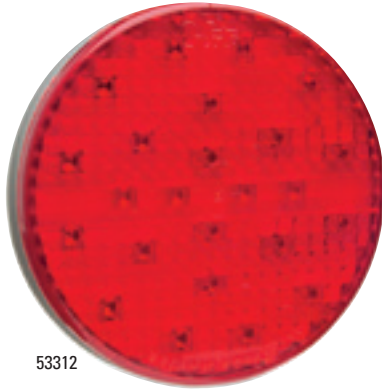

53312

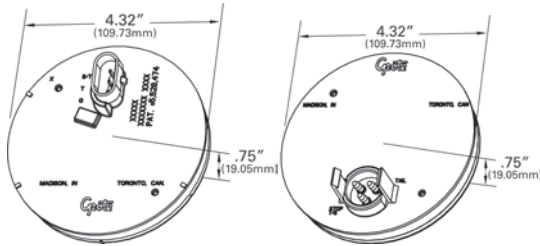

53523



53182

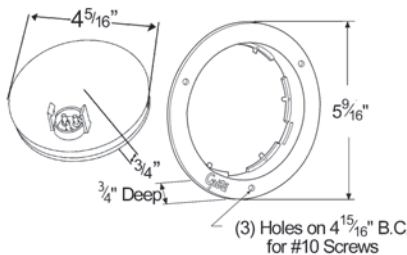

## SUPERNOVA® 4" FULL-PATTERN LED STOP/TAIL/TURN LAMP

Potted for total circuit board protection • Hermetic lens-to-housing seal  
 • Advanced pin connection system uses tin-plated, solid brass pin terminations

### STOP/TAIL/TURN:

- 53312 Red, Grommet Mount, Male Pin
- 52162 Red, Grommet Mount, Male Pin 24 Volts
- 53322 Red, White Theft-Resistant Flange, Male Pin
- 53182 Red, Black Theft-Resistant Flange, Male Pin
- 53192 Red, Stainless Steel Theft-Resistant Flange, Male Pin
- 54562 Red, Grommet Mount, Hard Shell

### 3 PIN REAR TURN:

- 53413 Yellow, Grommet Mount, Male Pin
- 53523 Yellow, Stainless Steel Theft-Resistant Flange, Male Pin
- 52163 Yellow, Grommet Mount, Male Pin 24 Volts

### FRONT PARK/TURN:

- 53313 Yellow, Grommet Mount, Male Pin

### 2 PIN REAR TURN:

- 55103 Yellow, Grommet Mount, Male Pin

Material: Lens - Acrylic; Housing - ABS  
 FMVSS: S / T / T - I, P2, S, T; Rear Turn - I; Front P / T - I, P  
 Finish: Red / Yellow  
 Volts / Amps: Red - 12V / .48A (I,S) / .04A (P2,T)  
 Volts / Amps: Rear Turn - 12V / .71A (I) / .14A (P2)  
 Volts / Amps: Front P/T - 12V / 1.06A (I) / .13A (P,P2)  
 Volts / Amps: Red - 24V / .2A (I,S) / .02A (P2,T)  
 Volts / Amps: Yellow - 24V / .34A (I) / .06A (P2)  
 Bracket: 93552, 43253, 92510, 92512, 92513, 43572, 43642, 43655, 43732, 93190, 93553, 93683  
 Grommet: 91740, 91950  
 Pigtail: Male Pin: 66815, 67002, 66841, 66816, 67005, 66845  
 Hard Shell: 66861, 66862

## SUPERNOVA® 4" NEXGEN™ LED STOP/TAIL/TURN

Less current draw than standard incandescent lamps, leaving more power available to other vehicle systems • Uses existing pigtails and wiring for cost-effective retrofit • 20% less current draw than major competitor LED products • Fits all Grote bracket and grommet mounting options • Fully encapsulated circuitry for total circuit board protection • Similar look to incandescent light, which helps prevent theft

### STOP/TAIL/TURN:

- 54332** Red, Grommet Mount, Male Pin
- 54472** Red, Gray Flange, Male Pin
- 54482** Red, Black Flange, Male Pin
- 54492** Red, Stainless Steel Flange, Male Pin
- 54602** Red, Integrated Flange w/ Gasket, Male Pin
- 54362** Red, Grommet Mount, Hard Shell
- 54572** Red, Integrated Flange w/ Gasket, Hard Shell
- 54582** Red, Integrated Flange w/ Gasket, Hardwire

### AUXILIARY:

- 54333** Yellow, Grommet Mount, Male Pin
- 54483** Yellow, Black Flange, Male Pin
- 54493** Yellow, Stainless Steel Flange, Male Pin
- 54363** Yellow, Grommet Mount, Hard Shell

### 2-PIN TURN LAMP:

- 54643** Yellow, Grommet Mount, Male Pin
- 54633** Yellow, Integrated Flange w/ Gasket, Male Pin

Material: Lens - Acrylic; Housing - ABS  
 FMVSS: S / T / T-1, P2, S, T- Auxiliary- P2  
 Finish: Red / Yellow  
 Volts / Amps: 12V / .24A (I,S) / .03A (T)  
 Bracket: 93552, 43253, 92510, 92511, 92512, 92513, 43572, 43642, 43655, 43732, 93190, 93683, 51090  
 Grommet: 91740, 91950  
 Pigtail: Male Pin: 66815, 67002, 66841, 66816, 67005, 66845; Hard Shell: 66861, 66862

## HI COUNT® 4" LED STOP/TAIL/TURN LAMP

Standard female connection accepts all popular plug-in connectors  
 • Concentric, high-count diode design: 24 in red, 39 in yellow • Fits all popular mountings and grommets

### STOP/TAIL/TURN:

- G4002** Red
- G4002-5** Red **RETAIL**
- G4022** Red, Clear Lens

### STOP/TAIL/TURN KIT:

- G4012** Red (G4002 + 91740 + 67090)

### AUXILIARY:

- G4003** Yellow
- G4003-5** Yellow **RETAIL**
- G4023** Yellow

Material: Lens - Acrylic; Housing - ABS  
 FMVSS: Red - I, P2, S, T; Yellow - Auxiliary  
 Finish: Red / Yellow  
 Volts / Amps: Red - 12V / .48A (I,S) / .04A (P2,T); Yellow - 12V / .71A (I)  
 Bracket: 93552, 43253, 92510, 92511, 92512, 92513, 43572, 43642, 43655, 43732, 93190, 93683, 51090  
 Grommet: 91740, 91950  
 Pigtail: 66825, 67000, 66812, 66844, 66843, 66811, 67090



54332

LED

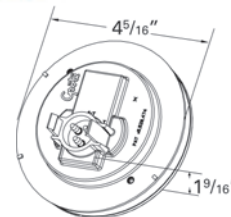

54602

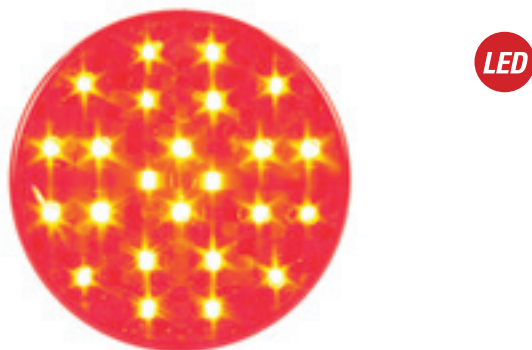
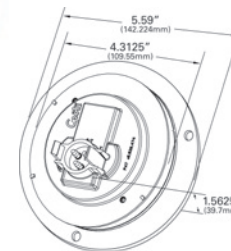

LED

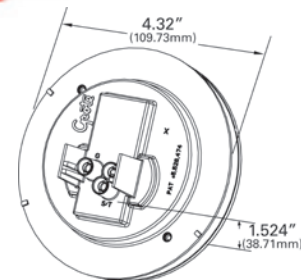



# Stop/Tail/Turn Lamps

Feux Arrêt / Arrière / Direction L mparas de Freno / Cuarto / Direccional

LED

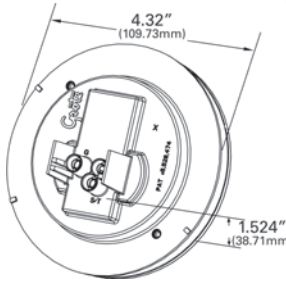

## GROTE SELECT™ 4" LED STOP/TAIL/TURN

Faster light-on response time provides greater stopping alert distance than incandescent lamps • Longer life and less current draw than standard incandescent lamps leaves more voltage available to other vehicle systems • Uses existing pigtails and wiring for cost-effective retrofit • Similar look to incandescent light which helps prevent theft • Hermetic lens-to-housing seal prevents moisture intrusion

- 54342** Red, Female Pin
- 54343** Yellow, Female Pin

Material: Lens - Acrylic; Housing - ABS  
 FMVSS: S / T / T- I, P2, S, T; Auxiliary- P2  
 Finish: Red / Yellow  
 Volts / Amps: 12V / .24A (I,S) / .03A (T)  
 Bracket: 93552, 43253, 92510, 92511, 92512, 92513, 43572, 43642, 43655, 43732, 93190, 93553, 93683, 51090  
 Grommet: 91740, 91950  
 Pigtail: 66825, 67000, 66812, 66844, 66843, 66811, 67090



53102



53103

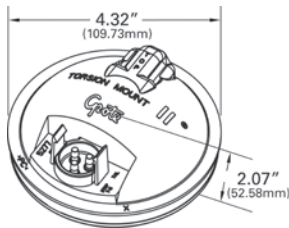
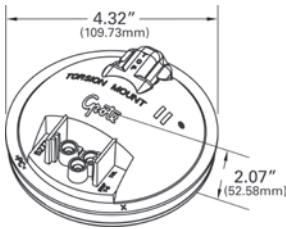

## TORSION MOUNT® II 4" STOP/TAIL/TURN LAMP

Torsion Mount® II Gel-Mount®, bulb cradle design • Heavy-duty bulb provides greater reliability • O-ring seal and male pin design reduce corrosion • Locking tabs ensure solid pigtail connection • 53100 lamp has clear back for interior illumination

### STOP/TAIL/TURN:

- 53102** Red, Male Pin
- 53102-5** Red, Male Pin RETAIL
- 53100** Red, Clear Housing, Male Pin
- 52770** Red, Clear Housing, Female Pin
- 52772** Red, Female Pin
- 52772-5** Red, Female Pin RETAIL
- 52152** Red, Female Pin 24 VOLT

### STOP/TAIL/TURN KIT:

- 53112** Red, Male Pin (53102 + 91740 + 67002)
- 52782** Red, Female Pin (52772 + 91740 + 67000)

### FRONT PARK/TURN:

- 53103** Yellow, Male Pin
- 52773** Yellow, Female Pin
- 52153** Yellow, Female Pin 24 VOLT

### SINGLE FUNCTION:

- 55572** Red, Female Pin
- 55573** Yellow, Female Pin

### BUILT-IN REFLECTOR:

- 52672** Red, Female Pin
- 52682** Red, Female Pin (52672 + 91740 + 67000)

Material: Polycarbonate  
 FMVSS: Red - I, P2, S, T; Yellow - I, P; 53100, 52770 - I, S, T  
 Finish: Red / Yellow  
 Bulb: 2057, 32/2 CP  
 Volts / Amps: Red - 12V / 2.1A (I,S)/.48A (P2,T)  
 Volts / Amps: Yellow - 12V / 2.1A (I)/.48A (P)  
 Bracket: 43572, 43253, 92510, 92512, 92513, 43642, 43655  
 Grommet: 91740, 91950  
 Pigtail: Male Pin: 66815, 67002, 66841, 66816, 67005, 66845; Female Pin: 66825, 67000, 66812, 66844, 66843, 66811, 67090

## 4" ECONOMY STOP/TAIL/TURN LAMP

Standard female connection • Fits all competitive pigtails, brackets and grommets • Hermetic lens-to-housing seal

STOP/TAIL/TURN:	
52922	Red, Female Pin
52922-5	Red, Female Pin <b>RETAIL</b>
53612	Red, Gray Theft-Resistant Flange, Female Pin

STOP/TAIL/TURN KIT:	
53012	Red, Female Pin (52922 + 91740 + 67090)
53012-5	Red, Female Pin (52922 + 91740 + 67090) <b>RETAIL</b>

FRONT PARK/TURN:	
52923	Yellow, Female Pin

Material: Polycarbonate  
 FMVSS: Red - I, P2, S, T; Yellow - I, P  
 Finish: Red / Yellow  
 Bulb: 2057, 32/2 CP  
 Volts / Amps: 12V / 2.1A (I,S)/.48A (T,P,P2)  
 Bracket: 43572,92510, 92512, 92513  
 Grommet: 91740, 91950  
 Pigtail: 66825, 67000, 66812, 66844, 66843, 66811, 67090

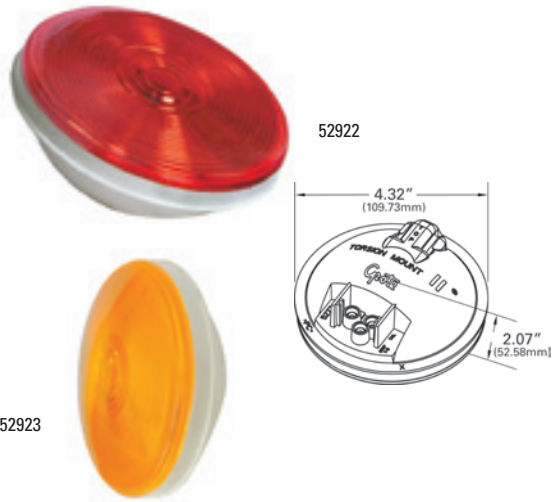

## SUPERNOVA® 10-DIODE LED STOP/TAIL/TURN POWER MODULE WITH SIDEMARKER

Heavy-gauge steel plate and can • Pre-assembled with wiring • Uses SuperNova® 10-Diode Pattern 4" LED lamps • Exceeds SAE J914, Nov. '87 • Includes reflector

51002	Red, Male Pin, RH
51012	Red, Male Pin, LH

Material: Lens - Acrylic; Housing - Steel; Grommet - PVC  
 FMVSS: A, I, P2, S, T  
 Finish: Gray/Red  
 Volts / Amps: 12V / .24A (I,S)/.06A (P2)/.03A (T)  
 Accessory: Lamp: S/T/T 53252; Marker 47092  
 Grommet: 91740

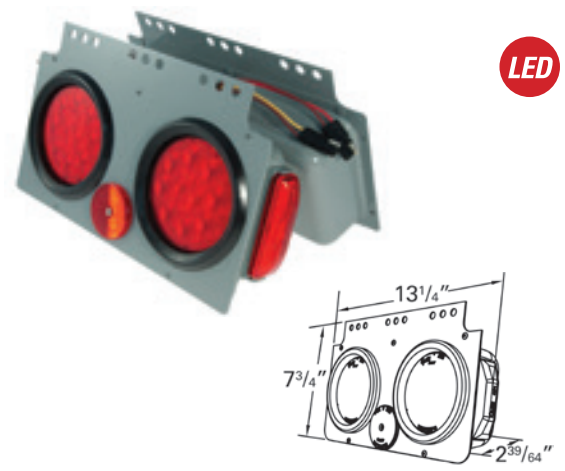

## STOP/TAIL/TURN 4" LAMP POWER MODULE

Heavy-gauge steel plate and can • Torsion Mount® II 4" round sealed lamps • Right or left hand application • Includes reflector

51052	Red
-------	-----

Material: Material: Lens - Polycarbonate; Housing - Steel; Grommet - PVC  
 FMVSS: A, I, P2, S, T  
 Finish: Gray/Red  
 Bulb: 2057, 32/2 CP  
 Volts / Amps: 12V / 2.1A (I)/2.1A (S)/.48A (P2)/.48A (T)  
 Accessory: Lamp: S/T/T - Red 52922  
 Bracket: 51090  
 Grommet: 91740

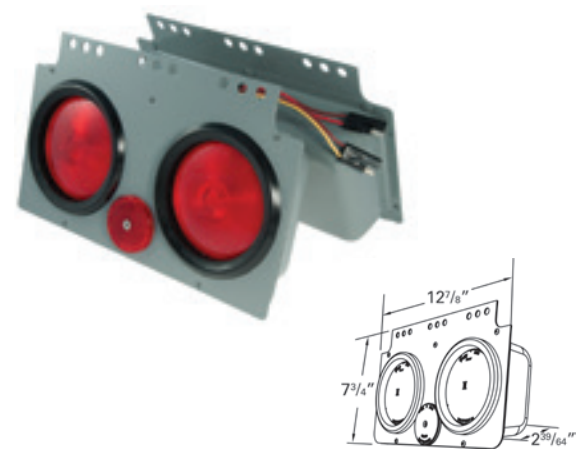

# Stop/Tail/Turn Lamps

Feux Arrêt / Arrière / Direction Lámparas de Freno / Cuarto / Direccional

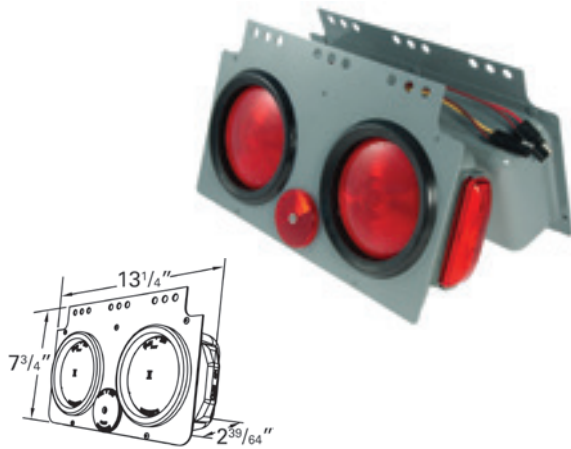

## STOP/TAIL/TURN 4" LAMP POWER MODULE WITH SIDEMARKER

Heavy-gauge steel plate and can • Includes reflector

**51022** Red, RH

**51032** Red, LH

Material: Lens - Polycarbonate; Housing - Steel; Grommet - PVC

FMVSS: A, I, P2, S, T

Finish: Gray

Bulb: 2057, 32/2 CP

Volts / Amps: 12V / 2.1A (I,S) / .48A (P2,T)

Bulb: 193 (2), 2 CP

Volts / Amps: 12V / .54A (P2)

Accessory: Lamps: S/T/T 52922; Marker 46742

Grommet: 91740

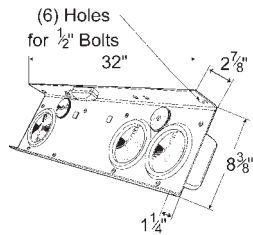

## POWER UNIT MODULE

Heavy-gauge steel plate and can • Torsion Mount® II 4" round female pin S/T/T lamps • Pre-assembled wiring harness and 5-way connector

• Includes reflector

**50820** Female Pin Lamps

Material: Lens - Polycarbonate ; Housing - Stainless Steel

FMVSS: A, I, L, R, S, T

Finish: Black

Bulb: 2057 (2), 32/2 CP

Volts / Amps: 12V - 4.2A (I,S) / .96A (P2,T)

Bulb: 2057, 32/2 CP

Volts / Amps: 12V / 2.1A (R)

Bulb: 193 (2), 2 CP

Volts / Amps: 12V / .66A (L)

Accessory: Lamp: S/T/T - Female Pin 52772; Backup - Female Pin 62271;

License - 62271; License Bracket 43780; Reflector - 40092; Grommet: 91740

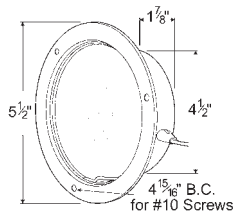

## FIELD RESEALABLE STAINLESS STEEL LAMP

Electro-polished stainless steel body • Torsion Mount® bulb cradle design • Polycarbonate lens

### DOUBLE CONTACT:

**52612** Red

Material: Stainless Steel/Polycarbonate

FMVSS: I, P2, P3, S, T

Finish: Red / Stainless

Bulb: 1157, 32/3 CP

Volts / Amps: 12V / 2.1A (I,S) / .59A (P2,P3,T)

Pigtail: 68130

Lens: 90762

## PLASTIC HOUSING LAMP

Snap-ring lens application • 2-wire pigtail

### DOUBLE CONTACT:

**50222** Red

Material: Lens - Acrylic; Housing - Polypropylene  
 FMVSS: I, P2, P3, S, T  
 Finish: Red / Black  
 Bulb: 1157, 32/3 CP  
 Volts / Amps: 12V / 2.1A (I,S)/.59A (P2,P3,T)  
 Accessory: Snap Ring 99593  
 Pigtail: 68130  
 Lens: Red 90012

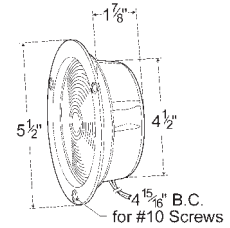

## RUBBER HOUSING LAMP

Lens held in by rubber flange • Standard exterior wiring • Brass eyelets in two mounting holes

### DOUBLE CONTACT:

**50502** Red

Material: Lens - Acrylic; Housing - Rubber  
 FMVSS: I, P2, P3, S, T  
 Finish: Red / Black  
 Bulb: 1157, 32/3 CP  
 Volts / Amps: 12V / 2.1A (I,S)/.59A (P2,P3,T)  
 Pigtail: 68150  
 Lens: Red 90012

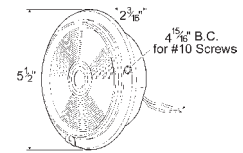

## ECONOMY STAINLESS STEEL LAMP

Easy snap-on lens • Rugged stainless steel construction

### DOUBLE CONTACT:

**52522** Red

Material: Lens - Polycarbonate; Housing - Stainless Steel  
 FMVSS: I, P2, P3, S, T  
 Finish: Red / Stainless  
 Bulb: 1157, 32/3 CP  
 Volts / Amps: 12V / 2.1A (I,S)/.59A (P2,P3,T)  
 Pigtail: 68150  
 Lens: Red 90762

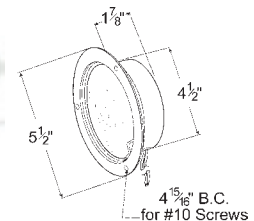

## ECONOMY STEEL LAMP

Easy snap-on lens • Rugged steel construction

### DOUBLE CONTACT:

**50232** Red

**50232-5** Red **RETAIL**

### SINGLE CONTACT:

**55092** Red

Material: Lens - Acrylic; Housing - Steel  
 FMVSS: Double - I, P2, P3, S, T; Single - I, S  
 Finish: Red / Black  
 Bulb: 1156, 32 CP  
 Volts / Amps: 12 V - 2.1(I,S)/.59A(T)  
 Bulb: 1157, 32/3 CP  
 Volts / Amps: 12V / 2.1A (I,S)/.59A (P2,P3,T)  
 Accessory: Snap Ring 99595  
 Pigtail: 68130, 68150  
 Lens: Red 90012

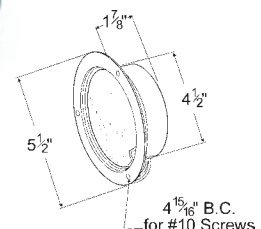

# Stop/Tail/Turn Lamps

Feux Arrêt / Arrière / Direction L mparas de Freno / Cuarto / Direccional

LED

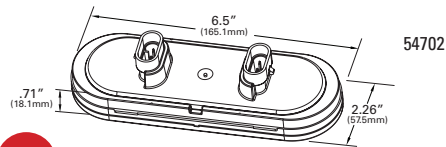
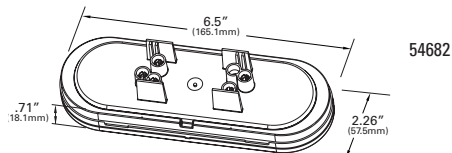
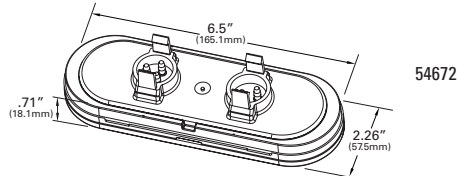

LED

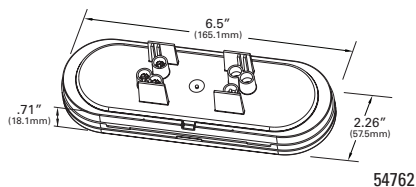
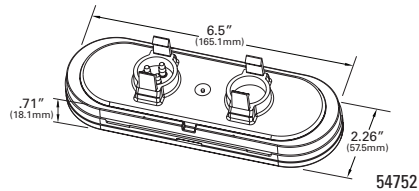
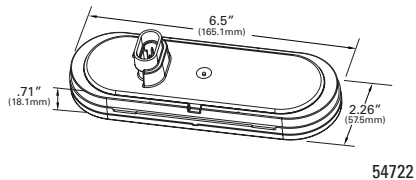
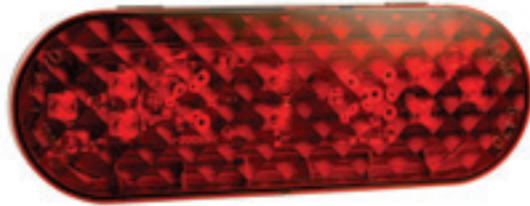

## OVAL LED STOP/TAI/TURN WITH INTEGRATED BACK-UP LAMP

Innovative patent-pending design combines all Stop/Tail/Turn and Back-up functions into one industry standard size lamp • Symmetrical design meets legal requirements at any mounting angle • LED technology provides less maintenance costs and long life • Industry-standard design fits existing mounting grommets, brackets, and flanges • Reduces inventory, SKUs, and carrying costs

- 54672 Red, Male Pin
- 54682 Red, Female Pin
- 54702 Red, Hard Shell

Material: Red High Impact Acrylic, Clear Polycarbonate  
FMVSS: I, S, T, R2  
Voltage Amp: 12V

## OVAL LED STOP/TAI/TURN WITHOUT INTEGRATED BACK-UP LAMP

Thin profile design minimizes chance of external impact damage • LED technology provides less maintenance costs and long life • Industry-standard design fits existing mounting grommets, brackets, and flanges • Symmetrical design meets legal requirements at any mounting angle

- 54722 Red, Hard Shell
- 54752 Red, Male Pin
- 54762 Red, Female Pin

Material: Red High Impact Acrylic  
FMVSS: I, S, T  
Voltage Amp: 12V

## SUPERNOVA® OVAL LED STOP/TAIL/TURN LAMP

Advanced pin connection system uses tin-plated, solid brass terminals

- Potted for total circuit board protection
- Male pin connection for maximum moisture and corrosion protection
- Meets specifications for vertical and horizontal mounting

STOP/TAIL/TURN:	
53962	Red, Grommet Mount
53592	Red, Gray Theft-Resistant Flange
53622	Red, Black Theft-Resistant Flange
53972	Red, Stainless Steel Theft-Resistant Flange
52072	Red, Grommet Mount <b>24 Volt</b>
STOP/TAIL/TURN KIT:	
53122	Red (53962 + 92420 + 67005)
AUXILIARY:	
53963	Yellow, Grommet Mount
53593	Yellow, Gray Theft-Resistant Flange
53623	Yellow, Black Theft-Resistant Flange
53973	Yellow, Stainless Steel Theft-Resistant Flange
52073	Yellow, Grommet Mount <b>24 Volt</b>
AUXILIARY KITS:	
53123	Yellow (53963 + 92420 + 67005)

Material: Lens - Acrylic; Housing - ABS  
 FMVSS: Red - I, P2, S, T; Yellow - P2  
 Finish: Red / Yellow  
 Volts / Amps: Red - 12V / .48A (I,S) / .06A (T)  
 Volts / Amps: Yellow - 12V / .48A  
 Volts / Amps: Red - 24V / .48A (I,S) / .06A (T)  
 Volts / Amps: Yellow - 24V / .48A  
 Bracket: 43362, 43952, 43220, 43223, 43222, 43100, 43723, 42152, 42153, 42103, 43172; Grommet: 92420, 92720  
 Pigtail: Male Pin: 66815, 67002, 66841, 66816, 67005, 66845, 67006, 66813, 66823, 66830, 66836  
 Male Pin 2-Wire: 66842, 67013, 66846, 67016



LED

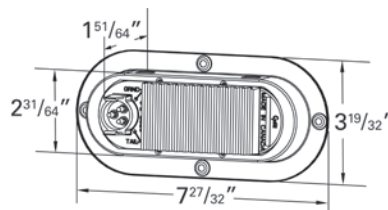
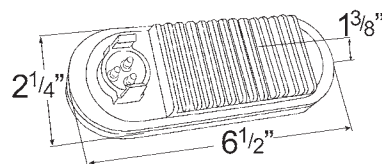

## SUPERNOVA® 9-DIODE OVAL LED STOP/TAIL/TURN LAMP

Available in male pin, hard shell and, hardwired connection options for easy retrofit or replacement

- Electronics completely encapsulated with durable epoxy for maximum protection from the environment
- Fits current mounting flanges and grommets

54132	Red, Male Pin
54133	Yellow, Male Pin
54142	Red, Hard Shell
54143	Yellow, Hard Shell

Material: Lens - Acrylic; Housing - ABS  
 FMVSS: I6, P, S, T, P2  
 Finish: Red/Yellow  
 Volts / Amps: 13.5V / .02A (T) / .14A (I,S)  
 Accessory: Chrome Bezel 42153  
 Bracket: 43362, 43952, 43220, 43223, 43222, 43100, 43723, 42152, 42153, 42103, 43132  
 Grommet: 92420, 92720  
 Pigtail: Male Pin: 66815, 67002, 66841, 66816, 67005, 66845  
 Hard Shell: 66861, 66862



LED

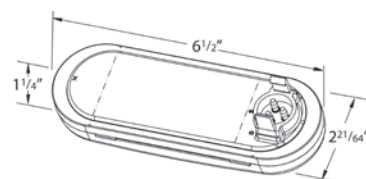
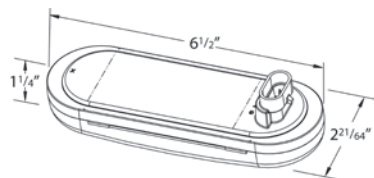

# Stop/Tail/Turn Lamps

Feux Arrêt / Arrière / Direction Lámparas de Freno / Cuarto / Direccional

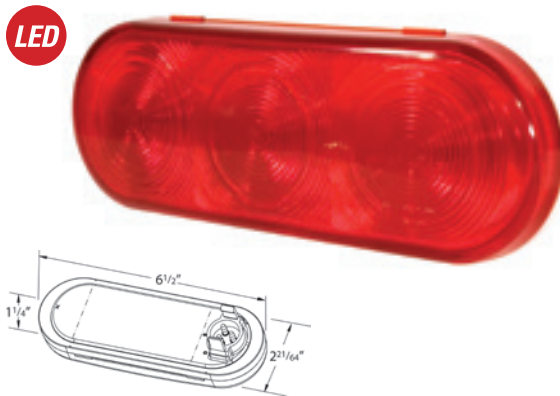

## SUPERNOVA® NEXGEN™ OVAL LED STOP/TAI/TURN LAMP

Available in male pin and hardwire for retrofit or replacement  
 • Electronics encapsulated with durable epoxy for maximum protection from the environment  
 • Fits current mounting flanges and grommets

### STOP/TAI/TURN:

**54162** Red, Male Pin

### AUXILIARY:

**54163** Yellow, Male Pin

Material: Lens - Acrylic; Housing - ABS

FMVSS: I6, P, S, T, P2

Finish: Red/Yellow

Volts / Amps: 13.5V / .02A (T)/.14A (I,S)

Bracket: 43362, 43952, 43220, 43223, 43222, 43100, 43723, 42152, 42153, 42103, 42173

Grommet: 92420, 92720

Pigtail: 66815, 67002, 66841, 66816, 67005, 66845

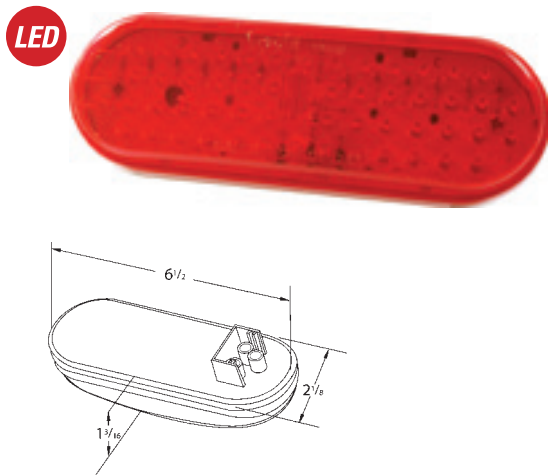

## HI COUNT® 56-DIODE OVAL LED STOP/TAI/TURN LAMP

Female pin connection accepts all popular plug-in connectors  
 • Fits same connections as female incandescent lamps  
 • Lower amp draw of LEDs allows use of more lamps without draining vehicle power  
 • LEDs provide faster stop warning for trailing vehicles

**G6002** Red

**G6002-5** Red

RETAIL

**G6003** Yellow

**G6003-5** Yellow

RETAIL

**G6012** Red, Clear Lens

**G6013** Yellow, Clear Lens

Material: Polycarbonate

FMVSS: I, S, T, P, P2

Finish: Red / Yellow

Volts / Amps: 12V / .43A (I,S)/.05A (T)

Bracket: 43362, 43952, 43220, 43223, 43222, 43100, 43723, 42152, 42153, 42103, 43173

Grommet: 92420, 92720

Pigtail: 67090



## GROTE SELECT™ OVAL LED STOP/TAI/TURN LAMP

Encapsulant potting protects against moisture, vibration, and corrosion  
 • Fits current mounting flanges and grommets  
 • Female pin connection accepts all popular connectors

### STOP/TAI/TURN:

**54172** Red

### AUXILIARY:

**54173** Yellow

Material: Lens - Acrylic; Housing - ABS

FMVSS: I6, P, S, T, P2

Finish: Red/Yellow

Volts / Amps: Red 12V / .48A (I,S)/.04A (P2, T)

Volts / Amps: Yellow 12V / .71A (I)

Bracket: 43362, 43952, 43220, 43223, 43222, 43100, 43723, 42152, 42153, 42103, 43173

Grommet: 92420, 92720

Pigtail: 66825, 67000, 66812, 66844, 66843, 66811, 67090

## OVAL LED STOP/TAIL/TURN LIGHT

10 LED configuration • 100,000 hours of service life • Sonically sealed polycarbonate light • Mounted vertical, horizontal, or 45° degrees • Impact resistant

**52592-5** Chrome Trim Ring - Red

Material: Polycarbonate  
 FMVSS: I, S, T  
 Color: Red  
 Voltage Amp: 12V / .22A (I,S) / .04A (T)



LED

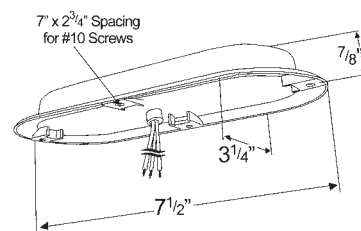

## TORSION MOUNT® III OVAL STOP/TAIL/TURN LAMP

Torsion Mount® III, Gel-Mount® bulb cradle design minimizes bulb vibration  
 • Locking tabs ensure solid pigtail connection

### STOP/TAIL/TURN:

- 52562** Red, Male Pin
- 52892** Red, Female Pin
- 52892-5** Red, Female Pin RETAIL

### STOP/TAIL/TURN KIT:

- 52582** Red, Male Pin (52562 + 92420 + 67002)
- 52572** Red, Female Pin (52892 + 92420 + 67000)

### FRONT PARK/TURN:

- 52563** Yellow, Male Pin
- 52893** Yellow, Female Pin
- 52893-5** Yellow, Female Pin RETAIL

### FRONT PARK/TURN KIT:

- 52573** Yellow, Female Pin (52893 + 92420 + 67000)

### TURN LAMPS:

- 55772** Red, Female Pin
- 55773** Yellow, Female Pin

Material: Lens and Housing - Polycarbonate; Grommet - PVC (Kits)  
 FMVSS: Red - I, P2, S, T; Yellow - I, P  
 Finish: Red / Yellow  
 Bulb: 1157, 32/3 CP  
 Volts / Amps: 12V / 2.1A (I,S) / .59A (P,P2,T)  
 Bracket: 43362, 43952, 43220, 43223, 43222, 43100, 43723, 42152, 42153, 42103  
 Grommet: 92420, 92720  
 Pigtail: Male Pin: 66815, 67002, 66841, 66816, 67005, 66845;  
 Female Pin: 66825, 67000, 66812, 66844, 66843, 66811, 67090

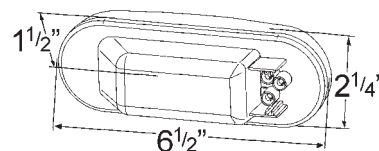
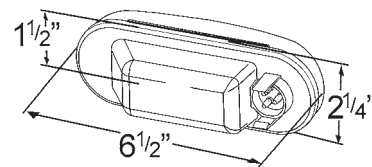



# Stop/Tail/Turn Lamps

Feux Arrêt / Arrière / Direction Lámparas de Freno / Cuarto / Direccional

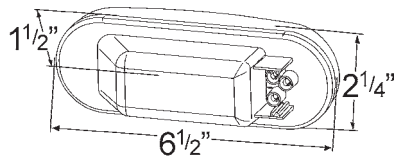

## ECONOMY OVAL STOP/TAIL/TURN

Female pin connection • Available in both red and amber

### STOP/TAIL/TURN:

**52182** Red  
**52182-5** Red **RETAIL**

### STOP/TAIL/TURN KIT:

**53092** Red (52182 + 92420 + 67090)

### FRONT PARK/TURN:

**52183** Yellow  
**52183-5** Yellow **RETAIL**

### FRONT PARK/TURN KIT:

**53093** Yellow (52183 + 92420 + 67090)

Material: Polycarbonate  
 FMVSS: Red - I, P2, S, T; Yellow - I, P  
 Finish: Red/Yellow  
 Bulb: 1157, 32/3 CP  
 Volts / Amps: 12V / 2.1A (I,S) / .59A (P,P2,T)  
 Bracket: 43362, 43952, 43220, 43223, 43222, 43100, 43723, 42152, 42153, 42103  
 Grommet: 92420, 92720  
 Pigtail: 66825, 67000, 66812, 66844, 66843, 66811, 67090

**LED**

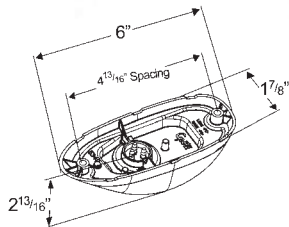

## SUPERNOVA® SURFACE MOUNT LED SIDE TURN/MARKER LAMP

50 state legal, meets SAE J914 E/E2 and California Title 13 requirements •  
 Lamp is visible from driver's rearview mirror while flashing • Metal-core  
 circuit board dissipates heat from electronic components to extend LED life  
 • Durable screw bosses withstand excessive screw torque without cracking  
 • Industry-standard 122.2-mm mounting for easy retrofits

**53493** Yellow

Material: Polycarbonate  
 FMVSS: Optic - E, E2, P2  
 Finish: Yellow  
 Volts / Amps: 12V / .35A (E/E2) / .82A (P2)  
 Pigtail: 66905, 66904, 66900

## SUPERNOVA® OVAL LED SIDETURN/MARKER LAMP

Flashing turn signal is visible to driver during operation • Available in recessed grommet/flange, surface, and integrated flange mount versions  
 • Male pin and hard shell connection options • 50 state legal, meets SAE J914 E/E2 and California Title 13 • Single circuit board and single reflector component design

### GROMMET MOUNT:

<b>54183</b>	Yellow, Male Pin	<b>NEW</b>
<b>54193</b>	Yellow, Hard Shell	<b>NEW</b>
<b>54253</b>	Yellow, Male Pin, w/ Black Theft-Resistant Flange	<b>NEW</b>
<b>54263</b>	Yellow, Male Pin, w/ Stainless Steel Theft-Resistant Flange	<b>NEW</b>
<b>54243</b>	Yellow, Male Pin, w/ Gray Theft-Resistant Flange	<b>NEW</b>

### INTERGRATED FLANGE MOUNT:

<b>54203</b>	Yellow, Male Pin	<b>NEW</b>
<b>54213</b>	Yellow, Hard Shell	<b>NEW</b>

### SURFACE MOUNT:

<b>54223</b>	Yellow, Male Pin	<b>NEW</b>
<b>54233</b>	Yellow, Hard Shell	<b>NEW</b>

Material: Polycarbonate  
 FMVSS: Optic - E, E2, P2  
 Finish: Yellow  
 Volts / Amps: 13.5V / .45A/.06A  
 Bracket: 43362, 43952, 43220, 43223, 43222, 43100, 43723, 42152, 42153, 42103, 43172  
 Grommet: 92420, 92720  
 Pigtail: Male Pin: 66815, 67002, 66841, 66816, 67005, 66845  
 Hard Shell: 66861, 66862

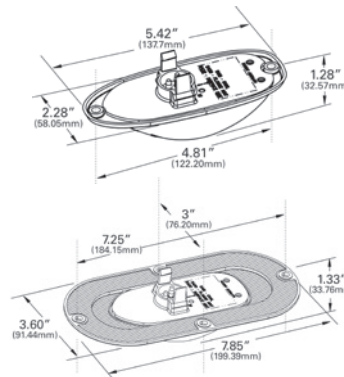
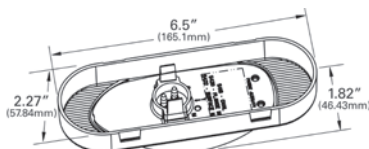

## LED HYBRID SIDETURN/MARKER LAMP

Hybrid LED/Incandescent technology provides a low cost-to-life ratio with an incandescent flashing function and an LED marker • 1,200-hour, field-replaceable midturn bulb • Vent filters in housing expel water vapor when lamp is lit to prevent water pooling inside lamp • Foam gasket provides protection against moisture intrusion • Sealed Packard® style connector minimizes potential failure points associated with conventional pigtail connections • Used on Navistar® vehicles

**52423** Yellow

Material: Polycarbonate  
 FMVSS: E, E2, P2  
 Finish: Yellow  
 LED: Volts / Amps: 12V / .06A (P2)  
 Bulb: 3156, 32 CP; Volts / Amps: 12V / 2.1A (E, E2)  
 Pigtail: 66826

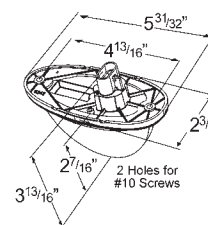

# Stop/Tail/Turn Lamps

Feux Arrêt / Arrière / Direction Lámparas de Freno / Cuarto / Direccional

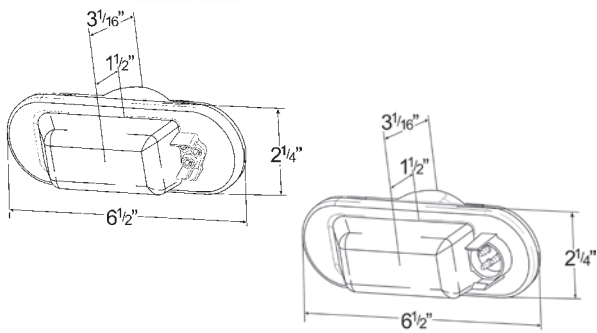

## TORSION MOUNT™ III OVAL SIDETURN/MARKER LAMP

Torsion Mount® III, Gel-Mount® bulb cradle design minimizes bulb vibration

- Extended dome for added visibility from front and rear
- Fits standard oval lamp grommets and brackets
- Contains reflex reflector
- Exceeds SAE J914, Nov. '87

### SIDE TURN/MARKER:

**52533** Yellow, Male Pin

**52513** Yellow, Female Pin

### SIDE TURN/MARKER KIT:

**52553** Yellow, Male Pin (52533 + 92420 + 67002)

**52543** Yellow, Female Pin (52513 + 92420 + 67000)

### SIDE MARKER:

**52512** Red, Female Pin

Material: Polycarbonate

FMVSS: A, E, P2, P3

Finish: Red, Yellow

Bulb: 1157, 32/3 CP; Volts / Amps: 12V / 2.1A (E)/.59A (P2,P3)

Bracket: 43362, 43952, 43220, 43223, 43222, 43100, 43723, 42152, 42153, 42103

Grommet: 92420, 92720

Pigtail: Male Pin: 66815, 67002, 66841, 66816, 67005, 66845

Female Pin: 66825, 67000, 66812, 66844, 66843, 66811, 67090

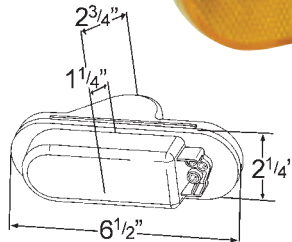

## ECONOMY OVAL SIDETURN/MARKER LAMP

Hermetic lens-to-housing seal • Vibration resistant bulb mounting system • Standard female pin connection

**52193** Yellow

### KITS:

**52253** Yellow (52193 + 92420 + 67090)

Material: Polycarbonate

FMVSS: A, E, P2

Finish: Yellow

Bulb: 2057, 32/2 CP

Volts / Amps: 12V / 2.1A (E)/.48A (P2)

Bracket: 43362, 43952, 43220, 43223, 43222, 43100, 43723, 42152, 42153, 42103

Grommet: 92420, 92720

Pigtail: 66825, 67000, 66812, 66844, 66843, 66811, 67090

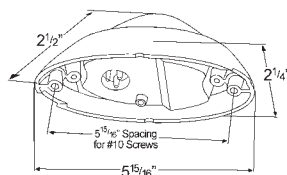

## SMALL AERODYNAMIC COMBINATION MARKER/SIDETURN LAMP

One-way check valve expels water • High-impact base, polycarbonate lens

- Uses reliable 3157, wedge base bulb
- Retrofits to Sentry lamp 53063 and 53163
- Great upgrade/replacement on Freightliner® midturn lamps
- Exceeds SAE J2039 June '94

### SIDE TURN/MARKER:

**52023** Yellow, Black Base

**52063** Yellow, White Base

### SIDE MARKER:

**52062** Red, White Base **PC**

Material: Polycarbonate

FMVSS: Red - P2, PC; Yellow - E, P2

Finish: Red / Yellow

Bulb: 3157, 32/2 CP

Volts / Amps: 12V / 2.1A (E)/.59A (P2,P3,PC)

Pigtail: 66905, 66904, 66900, 66901, 66920, 66903

Lens: Red 92892, Yellow 92893

## OEM SIDETURN MARKER LAMP

- Surface mount lamp • Combination turn signal and side marker (53853 only)
- 4.54" mounting holes • Lens hermetically sealed to the base
  - Includes Packard connector and mounting pad

<b>SIDETURN:</b>	
<b>53833</b>	Yellow, Sealed
<b>SIDETURN/MARKER:</b>	
<b>53853</b>	Yellow, Bulb Replaceable

Material: Polycarbonate  
 FMVSS: 53853 - E, P2 / 53833 - E  
 Finish: Yellow  
 Bulb: 53833- 3156, 26 Watts  
 Volts / Amps: 12.8V / 2.1A  
 Bulb: 53853 - P27/7W  
 Volts / Amps: 12.8V - 14.0V / 2.1A - .59A

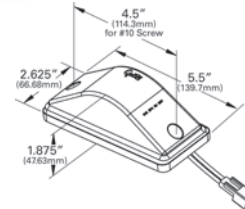

53833

## SENTRY SEALED COMBINATION MARKER/SIDETURN LAMP

- High-impact base • Uses male pin connection; accepts UBS pigtail
- Not recommended for rear of vehicles in padded dock applications
  - Yellow exceeds SAE J914 Nov. '87

<b>SIDE MARKER:</b>	
<b>53062</b>	Red, White Base
<b>SIDETURN/MARKER:</b>	
<b>53063</b>	Yellow, White Base
<b>SIDETURN:</b>	
<b>53163</b>	Yellow, Black Base

Material: Polycarbonate  
 FMVSS: 53062 - P2/ 53063 - E2, P2; 53163 - E2  
 Finish: Red / Yellow  
 Bulb: 1141, 21 CP - Single Function, 53163  
 Volts / Amps: 12V / 1.34A (E2)  
 Bulb: 1016, 21/6 CP - Multi-Function, 53062, 53063  
 Volts / Amps: 12V / 1.34A (E2)/.59A (P2)  
 Pigtail: 53062, 53063: 66905, 66900, 66903, 66904  
 53163: 66902, 66920

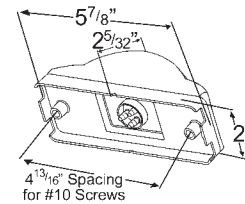

## SENTRY SUPPLEMENTAL HIGH MOUNT STOP LAMP

- Application for vehicles over 80" only • High-impact base • Single filament bulb
- Not recommended for rear of vehicle in padded dock applications
  - Must be used in conjunction with a legal CHMSL

**54012** Red

Material: Polycarbonate  
 FMVSS: U  
 Finish: Red  
 Bulb: 1141, 21 CP  
 Volts / Amps: 12V / 1.34A  
 Pigtail: 66902

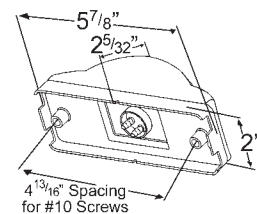

# Stop/Tail/Turn Lamps

Feux Arrêt / Arrière / Direction Lâmparas de Freno / Cuarto / Direccional

LED

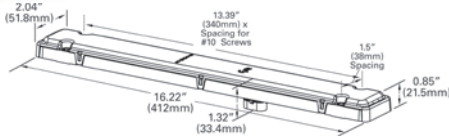

01-5444-71

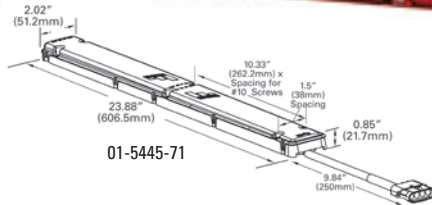

01-5445-71

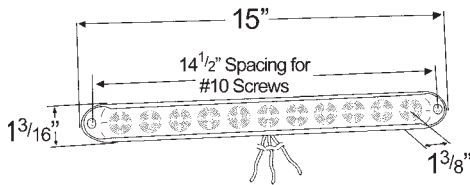

## FONTAINE® REVOLUTION LED LAMP SYSTEM

Unique and innovative lighting system developed for Fontaine® Trailers

- Stop, tail, turn system utilizes one lamp that can be rotated for left-hand or right-hand installations

01-5445-73

S/T/T Lamp LH/RH

01-5444-73

High Mount Stop/Turn Clearance or ID Lamp

Material: Lens - Acrylic; Housing - ABS

FMVSS: I, P2, S, T (STT), P2, U (CHMSL)

Finish: Red

Volts / Amps: 01-5444-71 - 12V / .03A / .21A

Volts / Amps: 01-5445-71 - 12V / .127A / .21A / .21A

## STOP/TAI/TURN LED BAR LAMP

11-LED configuration • Can be mounted in vertical, horizontal or 45° angle

- Impact-resistant housing is sealed for moisture protection • 15" length

53582 Red

Material: Polycarbonate

FMVSS: I, S, T

Color: Red

Voltage Amp: 12V / .35 (S, I) / .04 (P2, T)

LED

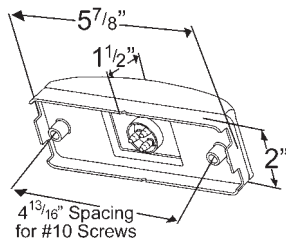

## SUPERNOVA® TURTLEBACK® II LED HIGH-MOUNT STOP/TURN AND MARKER LAMP

Lamp functions as a marker, clearance, ID, and supplemental high-mount stop or turn lamp

- Supplemental high-mount function provides greater visibility in a location that normally serves as an ID function or clearance function

- Sealed Turtleback® II lens profile makes lamp more durable and impact resistant
- Potted for total circuit board protection against vibration and corrosion.
- Three-wire connection

54002 Red

54003 Yellow

Material: Polycarbonate

FMVSS: P2, U

Finish: Red

Volts / Amps: 12V / .25A (U) / .025A (P2)

Bracket: 43030, 43050

Pigtail: 66900, 66904, 66905

## HI COUNT® RECTANGULAR LED STOP/TAIL/TURN LAMP

15 Diodes • Vertical or horizontal mount • Hermetically sealed polycarbonate lens and body • Standard female pin connection provides easy retrofits • LED instant-on feature provides early stop warning for trailing motorists • Yellow lens meets photometric requirements for front park and turn • Potted circuit board protects against vibration and corrosion

**G4502** Red  
**G4503** Yellow

Material: Polycarbonate  
FMVSS: I, P2, S, T  
Finish: Red / Yellow  
Volts / Amps: Red - 12V / .50A (I,S)/.07 (P2,T)  
Volts / Amps: Yellow - 12V / .52A (I)/.09A (P)  
Bracket: 43212  
Grommet: 94180  
Pigtail: 66825, 67000, 66812, 66844, 66843, 66811, 67090

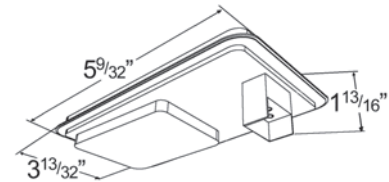

## RECTANGULAR STOP/TAIL/TURN LAMP

Rubber shock mounted bulb socket • Hermetic lens-to-housing sealed lamp • Industry standard female pin connection

**STOP/TAIL/TURN LAMP (DOUBLE CONTACT):**  
**52202** Red

**PARK/TURN LAMP (DOUBLE CONTACT):**  
**52203** Yellow

Material: Polycarbonate  
FMVSS: 52202 - I, P2, S, T; 52203 - I, P  
Finish: Red / Yellow  
Bulb: 2057, 32/2 CP  
Volts / Amps: 52202 - 12V / 2.1A (S,I)/.48A (P2,T)  
Volts / Amps: 52203 - 12V / 2.1A (I)/.48A (P)  
Bracket: 43212  
Grommet: 94180  
Pigtail: 66825, 67000, 66812, 66844, 66843, 66811, 67090

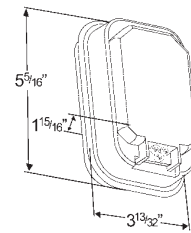

## RECTANGULAR SURFACE MOUNT TURN LAMP

Double-filament bulb provides park and turn function • 3 1/2" mounting centers • Less than 75 sq. cm lens area • For use on vehicles less than 80" wide

**53132** Red  
**53133** Yellow

Material: Steel/Polycarbonate  
FMVSS: Red - I, S, T; Yellow - I, P  
Finish: Red / Yellow  
Bulb: 2057, 32/2 CP  
Volts / Amps: 12V / 2.1A (I,S)/.48A (P,T)

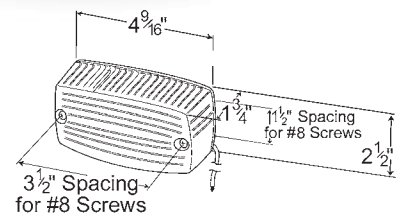

# Stop/Tail/Turn Lamps

Feux Arrêt / Arrière / Direction Lâmparas de Freno / Cuarto / Direccional

LED

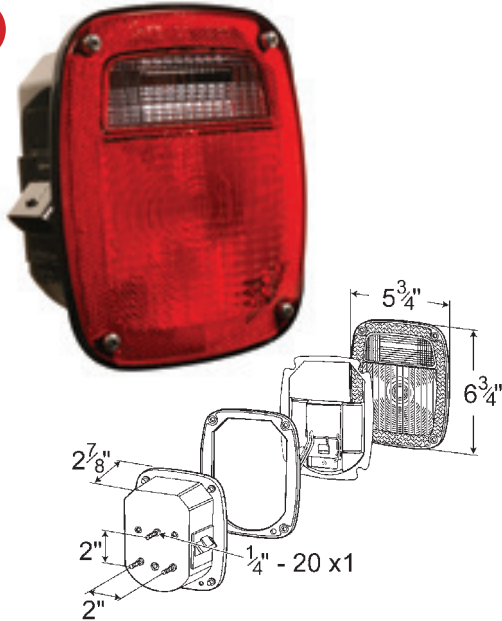

## SUPERNOVA® THREE-STUD METRI-PACK® LED STOP/TAI/TURN LAMP

SuperNova® single-LED technology in both the S/T/T and license function

- Encapsulant potting for total circuit board protection
- Replaces GM® 15613944 and 15565732 (53630), 15613943 and 15565731 (53640)
- LED replacement for Navistar® 1661282C91 (53630)
- Includes reflex reflector

**53630** Red, RH

**53640** Red, LH w/ License Window

Material: Polycarbonate

FMVSS: A, I, L, (2)R, S, T

Finish: Red

Bulb: 1156, 32CP (L)

Volts / Amps: 12V / 2.1A (R2)/.35A (I,S)/.16A (L,T)

Bracket: 43842

Pigtail: 68680

Lens: 91302

LED



## SUPERNOVA® THREE-STUD METRI-PACK® LED STOP/TAI/TURN LAMP WITH DOUBLE CONNECTOR

Features Grote's latest SuperNova® single-LED technology in both the S/T/T and license function

- Encapsulant potting for total circuit board protection
- LED replacement for Navistar® 1661281C91
- Backup function remains incandescent
- Includes reflex reflector

WITH LICENSE LAMP:

**53650** Red

Material: Polycarbonate

FMVSS: A, I, L, (2)R, S, T

Finish: Red

Bulb: 1156, 32CP (L)

Volts / Amps: 12V / 2.1A (R2)/.35A (I,S)/.16A (L,T)

Bracket: 43842

Pigtail: 68680

Lens: 91302

LED



## SUPERNOVA® THREE-STUD LED STOP/TAI/TURN LAMP

SuperNova® single-LED technology in both the S/T/T and license functions

- Encapsulant potting for total circuit board protection
- Replaces Chevrolet®/GMC® 370867 and 370868
- Replaces Jeep® SF5457197 and SF5457198
- Replaces Peterbilt® 16-02600R and 16-02600L
- Backup function remains incandescent
- Includes reflex reflector

**50920** Red w/ License Window

Material: Polycarbonate

FMVSS: A, I, L, (2)R, S, T

Finish: Red

Bulb: 1156, 32CP (L)

Volts / Amps: 12V / 2.1A (R2)/.35A (I,S)/.16A (L,T)

Bracket: 43842

Lens: 91302

## HI COUNT® LED STOP/TAIL/TURN LAMP

All functions utilize LED technology • Gasket between lens and housing protects against moisture intrusion • Potted circuit board protects against vibration and corrosion • Sidemarker version directly replaces Jeep® Wrangler® lamps through 2006 • Sidemarker version features circuit board protection that is compatible with the existing flasher technology • 3 stud mounting design incorporates ground function • Sidemarker version has 16 stop/tail/turn diodes, 22 backup diodes, 4 license diodes and 2 sidemarker diodes • Standard version has 16 stop/tail/turn diodes, 22 backup diodes and 4 license diodes • Mounting hardware and instructions included for easy installation / retrofit • Includes reflex reflector

### WITH SIDEMARKER:

- G5202** Red, RH w/ Sidemarker
- G5212** Red, LH w/ License Window & Sidemarker

### WITHOUT SIDEMARKER:

- G5082** Red, RH
- G5082-5** Red, RH RETAIL
- G5092** Red, LH w/ License Window
- G5092-5** Red, LH w/ License Window RETAIL

Material: Lens - Acrylic; Housing - Polycarbonate  
 FMVSS: RH - A, I, (2)R, S, T; LH - A, I, L, R2, S, T

Finish: Red

- G5092 - Volts / Amps: 12V / .21A (I,S)/.34A (R2)/.12A (L)
  - G5082 - Volts / Amps: 12V / .21A (I,S)/.34A (R2)/.06A (T)
  - G5212 - Volts / Amps: 12V / 1.4A (I,S)/.34A (R2)/.12A (T,L)
  - G5202 - Volts / Amps: 12V / 1.4A (I,S)/.34A (R2)/.06A (T)
- Bracket: 43842

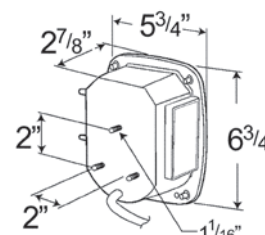

## THREE-STUD METRI-PACK® STOP/TAIL/TURN LAMP

Replaces GM® 15613943 and 15565731 • Features a license window  
 • Metri-Pack® connector on right side • Includes reflex reflector

- 53702** Red, RH w/ License Window
- 53712** Red, LH w/ License Window

Material: Lens - Acrylic and Polycarbonate; Housing - Polycarbonate  
 FMVSS: A, I, L, R2, S, T

Finish: Red

- Bulb: 1156, 32 CP; Volts / Amps: 12V / 2.1A (R2)
  - Bulb: 2057, 32/3 CP; Volts / Amps: 12V / 2.1A (I,S)/.59A (T,L)
- Bracket: 43842  
 Pigtail: 68680  
 Lens: Red 91302

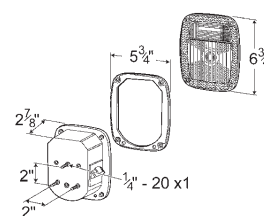

## FORD® STOP/TAIL/TURN BOX LAMP

Junction box with Ford® OEM connector • Features a license window  
 • Ford® Drivers Side: F4HZ 13404 A • Ford® Passengers Side: F4HZ 13405 A • Includes reflex reflector

- 53782** Red, RH w/ License Window
- 53792** Red, LH w/ License Window

Material: Polycarbonate/Acrylic

FMVSS: A, I, L, P2, (2)R, S, T

Finish: Red

- Bulb: 3057, 32/3 CP; Volts / Amps: 12V / 2.1A (I,S, R2) / .59A (T,L,P2)
- Bracket: 43842  
 Pigtail: 01-6868-82  
 Lens: Red 91302

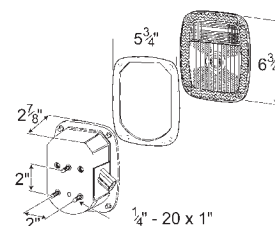



# Stop/Tail/Turn Lamps

Feux Arrêt / Arrière / Direction Lámparas de Freno / Cuarto / Direccional

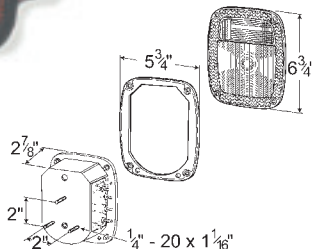
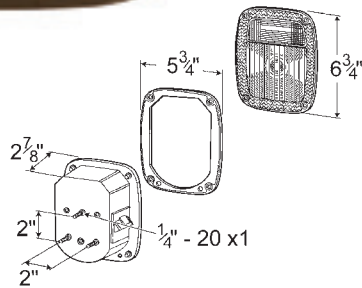
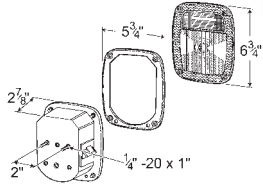

## TWO-STUD METRI-PACK® STOP/TAIL/TURN LAMP WITH SINGLE CONNECTOR

Features a license window • Metri-Pack® connector on left side  
• Replaces Mack® 14M052M • Includes reflex reflector

**53722** Red

Material: Lens - Acrylic and Polycarbonate; Housing - Polycarbonate  
FMVSS: A, I, L, (2)R, S, T

Finish: Red

Bulb: 1156, 32 CP; Volts / Amps: 12V / 2.1A (R2)

Bulb: 1157, 32/3 CP; Volts / Amps: 12V / 2.1 (I,S)/.59A (T,L)

Bracket: 43262-5, 43022, 43022-5, 43272, 43272-5, 43842

Pigtail: 68680

Lens: Red 91302

## THREE-STUD METRI-PACK® STOP/TAIL/TURN LAMP WITH DOUBLE CONNECTOR

Features a license window • Metri-Pack® connectors on both sides  
• Replaces Navistar® 1661281C91 • Includes reflex reflector

**53762** Red

Material: Lens - Acrylic and Polycarbonate; Housing - Polycarbonate  
FMVSS: A, I, L, (2)R, S, T

Finish: Red

Bulb: 1156, 32 CP

Volts / Amps: 12V / 2.1A (R2)

Bulb: 1157, 32/3 CP

Volts / Amps: 12V / 2.1A (I,S)/.59A (T,L)

Bracket: 43842

Pigtail: 68680

Lens: Red 91302

## TORSION MOUNT® UNIVERSAL STOP/TAIL/TURN LAMP

6-in-1 lamp • Four screw posts in junction box • Fits all 3-stud mounting on heavy duty trucks • Includes reflex reflector

**52902** Red, RH w/ License Window

**52912** Red, LH w/ License Window

Material: Lens - Acrylic and Polycarbonate; Housing - Polycarbonate  
FMVSS: A, I, L, (2)R, S, T

Finish: Red

Bulb: 1156, 32 CP

Volts / Amps: 12V / 2.1A (R2)

Bulb: 1157, 32/3 CP

Volts / Amps: 12V / 2.1A (I,S)/.59A (T,L)

Bracket: 43842

Lens: Red 91302

## TORSION MOUNT® THREE-STUD GMC® STOP/TAIL/TURN LAMP

Junction box with quick splice or ring connectors • Replaces GMC® 715103 or 2063933 (RH) • Replaces GMC® 715104 or 2063931 (LH) • Includes reflex reflector and wire cover

**50902** Red, RH w/ License Window

**50912** Red, LH w/ License Window

Material: Lens - Acrylic and Polycarbonate; Housing - Polycarbonate  
FMVSS: A, I, L, R2, S, T

Finish: Red

Bulb: 1156, 32 CP; Volts / Amps: 12V / 2.1A (R2)

Bulb: 2057, 32/2 CP; Volts / Amps: 12V / 2.1A (I,S)/.59A (T,L)

Bracket: 43842

Lens: Red 91302

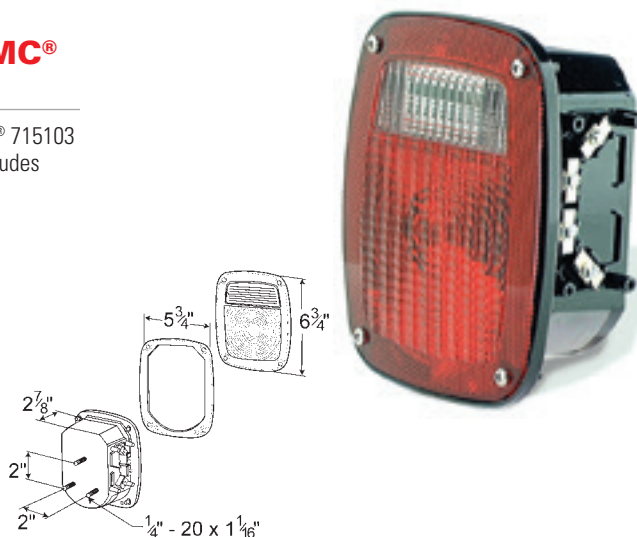

## TORSION MOUNT® THREE-STUD NAVISTAR®/VOLVO® STOP/TAIL/TURN LAMP

Replaces LH Navistar® 424537-C91 and 424538-C91 • Replaces RH Volvo® 83701-0002 • Replaces RH Navistar® 424539-C91 • Replaces LH Volvo® 83702-0002 • Includes reflex reflector and wire cover

**50942** Red, RH w/ License Window

**50952** Red, LH w/ License Window

Material: Lens - Acrylic and Polycarbonate; Housing - Polycarbonate  
FMVSS: A, I, L, R2, S, T

Finish: Red

Bulb: 1156, 32 CP; Volts / Amps: 12V / 2.1A (R2)

Bulb: 2057, 32/2 CP; Volts / Amps: 12V / 2.1A (I,S)/.59A (T,L)

Bracket: 43842

Lens: Red 91302

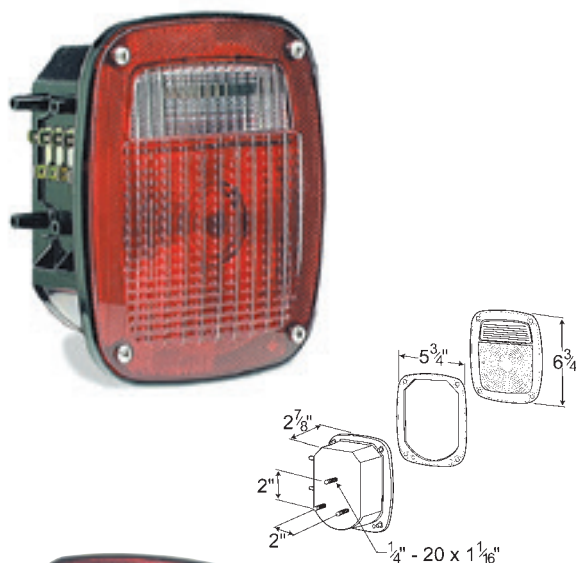

## TORSION MOUNT® TWO-STUD MACK®/DODGE® STOP/TAIL/TURN LAMP

Fits both right hand and left hand • Includes OE 39" pigtail with ring terminal • Replaces Mack® 14M0444RP1 and 14M0444RP4 shock mount • Features a license window • Includes reflex reflector

**50992** Red

Material: Lens - Acrylic and Polycarbonate; Housing - Polycarbonate  
FMVSS: A, I, L, R2, S, T

Finish: Red

Bulb: 1156, 32 CP; Volts / Amps: 12V / 2.1A (R2)

Bulb: 2057, 32/3 CP; Volts / Amps: 12V / 2.1A (I,S)/.59A (T,L)

Bracket: 43262-5, 43022, 43022-5, 43272, 43272-5, 43842

Lens: Red 91302

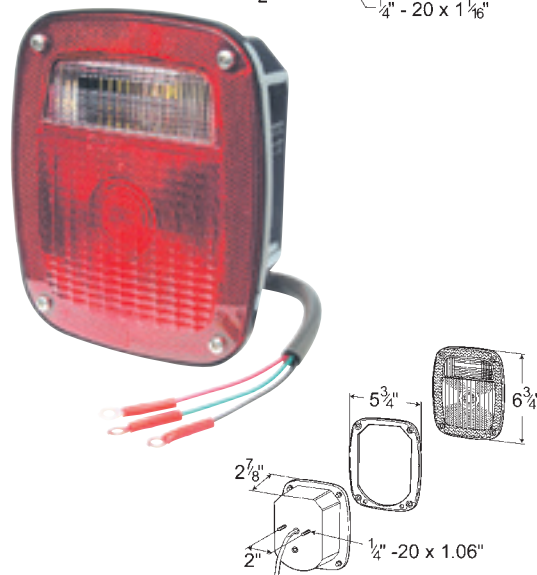

# Stop/Tail/Turn Lamps

Feux Arrêt / Arrière / Direction Lámparas de Freno / Cuarto / Direccional

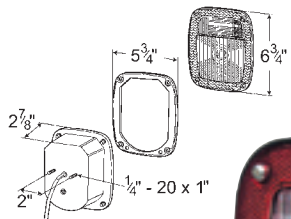
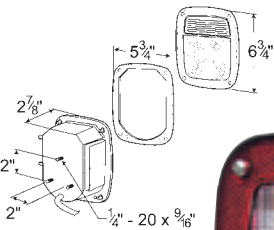
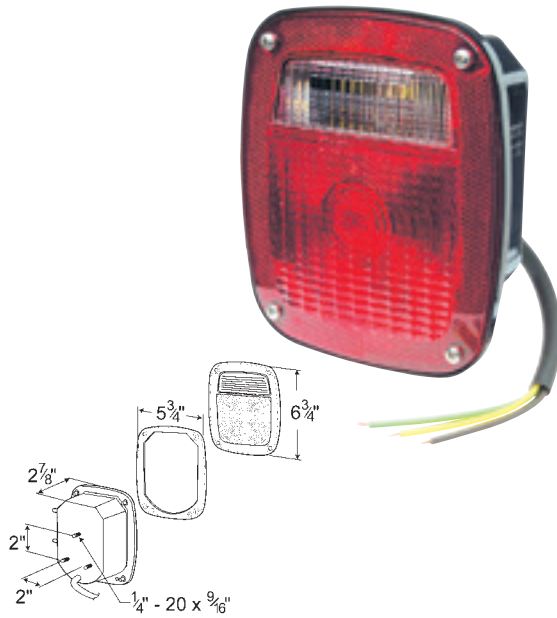

## THREE-STUD PETERBILT®/CHEVROLET®/JEEP®/GMC® STOP/TAI/TURN LAMP WITH PIGTAIL

Replaces Peterbilt® 16-02600R and 16-02600L • Replaces Chevrolet®/GMC® 370867 and 370868 • Replaces Jeep® SF5457197 and SF5457198  
• Features license window • Includes reflex reflector

**50972** Red w/ License Window

**50972-5** Red w/ License Window

RETAIL

Material: Lens - Acrylic and Polycarbonate; Housing - Polycarbonate  
FMVSS: A, I, L, R2, S, T

Finish: Red

Bulb: 1156, 32 CP

Volts / Amps: 12 V / 2.1A (R2)

Bulb: 1157, 32/3 CP

Volts / Amps: 12V / 2.1A (I,S)/.59A (T,L)

Bracket: 43842

Lens: Red 91302

## THREE-STUD, CHEVROLET®/FORD®/JEEP® STOP/TAI/TURN LAMP WITH SIDE MARKER LAMP AND MOLDED PIGTAIL TERMINATION

Round molded terminals • Replaces Chevrolet®/GMC® 477331 and 477332 (RH) • Replaces Jeep® SF5758255 and SF5758254 (LH)  
• Features sidemarkers • Includes reflex reflector

WITHOUT LICENSE WINDOW:

**52802** Red, RH

WITH LICENSE WINDOW:

**52812** Red, LH

Material: Lens - Acrylic; Housing - Polycarbonate  
FMVSS: RH - A, I, P2, R2, S, T; LH - A, I, L, P2, R2, S, T

Finish: Red

Bulb: 1156, 32 CP; Volts / Amps: 12V / 2.1A (R2)

Bulb: 1157, 32/3 CP; Volts / Amps: 12V / 2.1A (I,S)/.59A (T,L)

Bracket: 43842

Lens: Red 91302

## TORSION MOUNT® TWO-STUD DODGE® STOP/TAI/TURN LAMP WITH SIDE MARKER LAMP AND MOLDED PIGTAIL TERMINATION

Replaces Dodge® 4114562 (RH) • Replaces Dodge® 4114561 and 4114563 (LH) • Includes reflex reflector

WITHOUT LICENSE WINDOW:

**52822** Red, RH

WITH LICENSE WINDOW:

**52832** Red, LH

Material: Lens - Acrylic; Housing - Polycarbonate  
FMVSS: RH - A, I, P2, R2, S, T; LH - A, I, L, P2, R2, S, T

Finish: Red

Bulb: 1156, 32 CP; Volts / Amps: 12 V / 2.1A (R2)

Bulb: 1157, 32/3 CP; Volts / Amps: 12 V / 2.1(I,S)/.59A (T,L)

Bulb: 193, 2CP; Volts / Amps: 12V / .33A(P2)

Bracket: 43262-5, 43022, 43022-5, 43272, 43272-5, 43842

Lens: Red 91302

## TORSION MOUNT® TWO-STUD DODGE® STOP/TAIL/TURN LAMP

Standard mount pigtail • Replaces Dodge® truck 3895020 and 3895021  
 • Features license window • Includes reflex reflector

**52602** Red

Material: Lens - Acrylic and Polycarbonate; Housing - Polycarbonate  
 FMVSS: A, I, L, R2, S, T  
 Finish: Red  
 Bulb: 1156, 32 CP  
 Volts / Amps: 12V / 2.1A (R2)  
 Bulb: 1157, 32/2 CP  
 Volts / Amps: 12V / 2.1A (I,S)/.59A (T,L)  
 Bracket: 43262-5, 43022, 43022-5, 43272, 43272-5, 43842  
 Lens: Red 91302

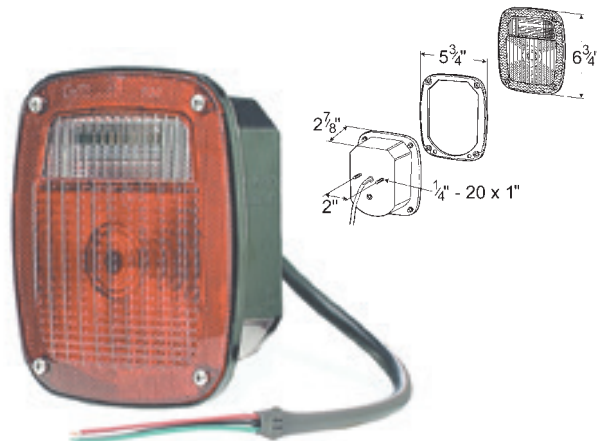

## TWO-STUD FORD® STOP/TAIL/TURN LAMP WITH PIGTAIL AND MOLDED PLUG

Studs on 1 3/4" centers • Retrofits Ford® OEM C7TZ13404C, DOTZ13404A, D3KZ13404A, D3TZ13403B, E2TB13404A, E2TB13405A • Features license window • Includes reflex reflector

**52972** Red

Material: Lens - Acrylic and Polycarbonate; Housing - Polycarbonate  
 FMVSS: A, I, L, R2, S, T  
 Finish: Red  
 Bulb: 1156, 32 CP  
 Volts / Amps: 12 V / 2.1A (R2)  
 Bulb: 2057, 32/2 CP  
 Volts / Amps: 12V / 2.1A (I,S)/.59A (T,L)  
 Bracket: 43262-5, 43022, 43022-5, 43272, 43272-5, 43842  
 Lens: Red 91302

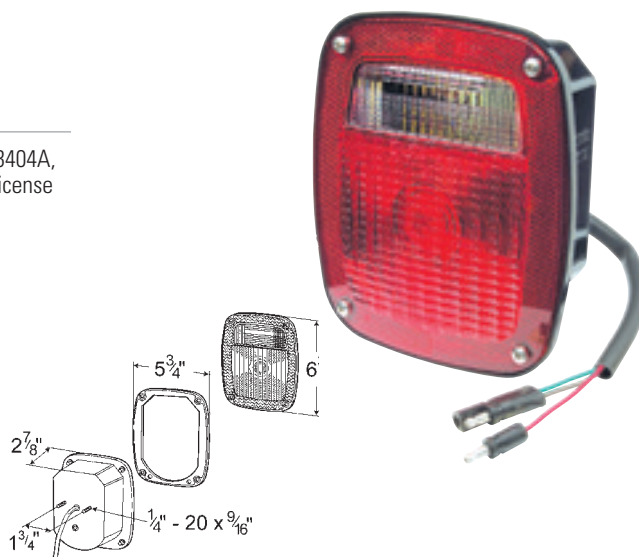

## 4" TWO-STUD STOP/TAIL/TURN LAMP

Snap-on lens • Rubber compression-sealed pigtail • Removable studs for school bus application

**WITH LICENSE WINDOW:**

**50852** Red

**50852-5** Red **RETAIL**

**WITHOUT LICENSE WINDOW:**

**50862** Red

**50862-5** Red **RETAIL**

Material: Lens - Acrylic and Polycarbonate (50832/-5); Housing - Polycarbonate  
 Lens - Acrylic and Polycarbonate (50862/-5)  
 FMVSS: I, L, P2, S, T  
 Finish: Red  
 Bulb: 1157, 32/3 CP  
 Volts / Amps: 12V / 2.1A (I,S)/.59A (P2,T,L)  
 Bracket: 43262-5, 43022, 43022-5, 43272, 43272-5, 43842  
 Pigtail: 68150  
 Lens: Red 90232

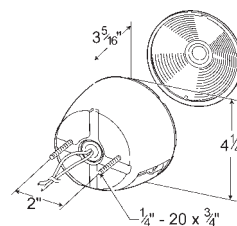

# Stop/Tail/Turn Lamps

Feux Arrêt / Arrière / Direction L mparas de Freno / Cuarto / Direccional

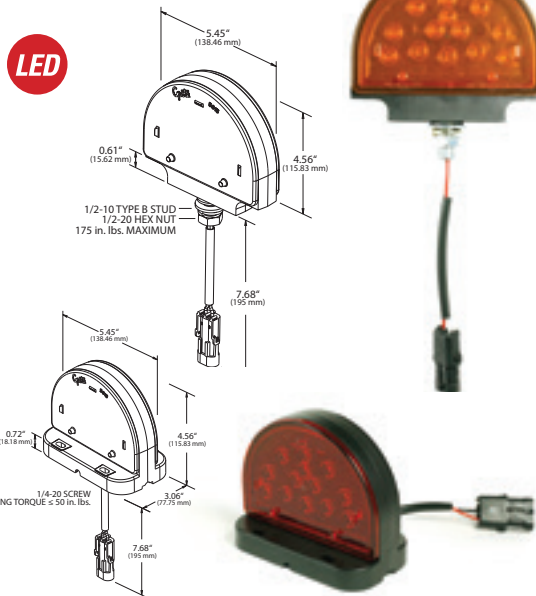
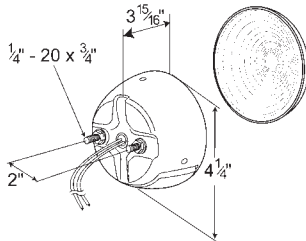
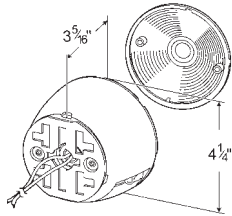
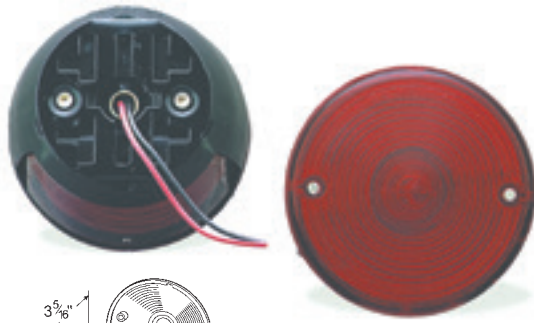

## 4" UNIVERSAL MOUNT STOP/TAIL/TURN LAMP

2-screw lens • Less than 75 sq. cm. of effective, projected luminous lens area • Rubber compression-sealed pigtail • Features license window  
• For use on vehicles less than 80" wide

### WITH LICENSE WINDOW:

**50872** Red

**50872-5** Red **RETAIL**

Material: Lens - Acrylic ; Housing - Polypropylene

FMVSS: I, L, P2, S, T

Finish: Red

Bulb: 1157, 32/3 CP

Volts / Amps: 12V / 2.1A (I,S)/.59A (L,P2,T)

Bracket: 43262-5, 43022, 43022-5, 43272, 43272-5, 43842

Pigtail: 68150

Lens: Red 91482

## 4" STEEL TWO-STUD MOUNT STOP/TAIL/TURN LAMP

Less than 75 sq. cm. of effective, projected luminous lens area

• Heavy-gauge, formed steel body • Rubber compression-sealed pigtail  
• For use on vehicles less than 80" wide

### WITH LICENSE WINDOW:

**50882** Red

### WITHOUT LICENSE WINDOW:

**50892** Red

Material: Lens - Acrylic ; Housing - Steel

FMVSS: 50882 - I, L, P2, S, T; 50892 - I, P2, S, T

Finish: Red

Bulb: 1157, 32/3 CP

Volts / Amps: 12V / 2.1A (I,S)/.59A (L,P2,T)

Bracket: 43262-5, 43022, 43022-5, 43272, 43272-5, 43842

Pigtail: 68150

Lens: Red 90252

## LED STOP/TAIL/TURN LAMP FOR AGRICULTURE & OFF-HIGHWAY APPLICATIONS

Lamps meet the latest ASABE S279 specifications • Lamps may be mounted right side up, upside down, or vertically and still meet compliance specifications • Lamps employ bi-voltage circuitry – 12/24 volt

**56150-5** Yellow and Yellow, Pedestal

**56160-5** Yellow and Yellow, Surface Mount

**56170-5** Red, Pedestal

**56180-5** Red, Surface Mount

Material: Lens - High Impact Acrylic / Housing - ABS

FMVSS: 56150-5 & 56160-5: I6; 56170-5 & 56180-5: I, S, T

Other: IP67 Compliant

Finish: Yellow, Red

Voltage: Bi-voltage, 12 and 24 Vol

## HI COUNT® DOUBLE-FACE LED STOP/TAIL/TURN LAMP WITH SIDEMARKER

Attractive multiple diode design • 2-stud mounting bolts • 25 diodes on either front or back with two diodes in the sidemarker • Attached three-wire harness • Includes reflex reflector

- G5530** Red and Yellow, LH
- G5530-5** Red and Yellow, LH RETAIL
- G5540** Red and Yellow, RH
- G5540-5** Red and Yellow, RH RETAIL
- G5543-5** Yellow and Yellow, w/ Packard Connector RETAIL

Material: Lens - Acrylic ; Housing - Chrome Plated ABS  
 FMVSS: A, I, T, P, P2  
 Finish: Chrome/Red/Amber  
 Volts / Amps: 12V / .775A (I)/.038A (P/P2/T)

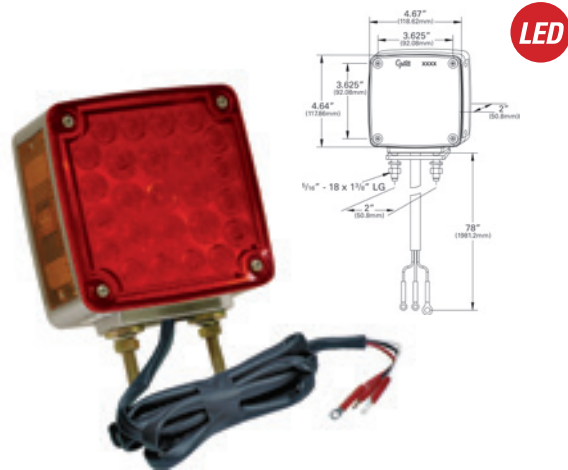

## TWO-STUD PLUG-IN LAMP WITH SIDEMARKER

Incorporates sidemarker light • Fits right or left side • Keyed, plug-in receptacle, accepts OEM harness • Standard with Navistar®/Volvo®  
 • Vertical mount • Includes reflex reflector

- 55470** Red and Yellow

Material: Lens - Acrylic ; Housing - Polycarbonate  
 FMVSS: A, I, P2  
 Finish: Red / Yellow  
 Bulb: 1156, 32 CP  
 Volts / Amps: 12V 2.1A (I)  
 Bulb: 193, 2 CP  
 Volts / Amps: 12V / .33A (P2)  
 Lens: Red 91502; Yellow 91503; Sidemarker - Yellow 91513

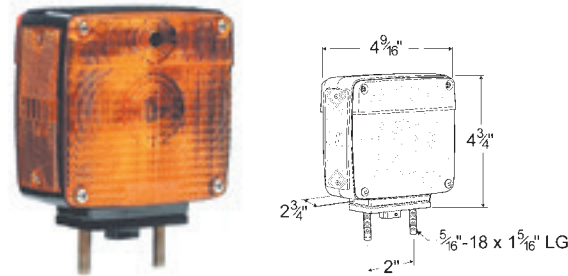

## TWO-STUD CHROME LAMP WITH PIGTAIL

Switch lens for right or left applications • Ground wire plus tab • PVC wire jacket material • 73" color coded pigtail • Vertical mount • Includes reflex reflector

- 55340** Red and Yellow

Material: ABS/Acrylic/Polycarbonate  
 FMVSS: A, I, P2  
 Finish: Red / Yellow  
 Bulb: 1156, 32 CP  
 Volts / Amps: 12V / 2.1A (I)  
 Bulb: 193, 2 CP  
 Volts / Amps: 12V / .33A (P2)  
 Lens: Red 90482, Yellow 90483; Sidemarker - Yellow 94643

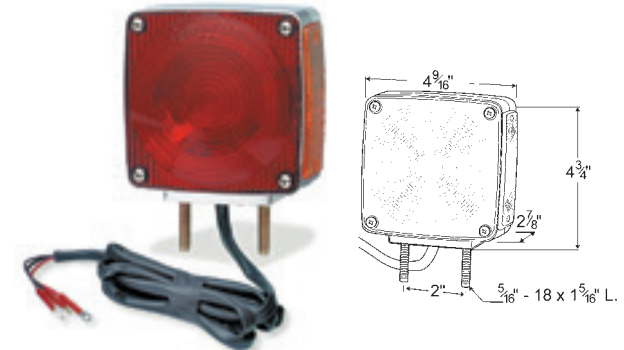

## TWO-STUD LAMP WITH PIGTAIL

High-heat acrylic lens • 2" mounting centers • Incorporates sidemarker light • Replaces Chevrolet®/GMC® 2017747 (RH) and 2017751 (LH)  
 • Includes reflex reflector

- 55410** Red and Yellow, RH
- 55420** Red and Yellow, LH

Material: Lens - Acrylic; Housing - Polycarbonate  
 FMVSS: A, I, P, P2  
 Finish: Red / Yellow  
 Bulb: 1156, 32 CP  
 Volts / Amps: 12V / 2.1A (I)  
 Bulb: 193, 2 CP (X2)  
 Volts / Amps: 12V / .66A (P,P2)  
 Lens: Red 91502, Yellow 91503; Sidemarker - Yellow 91513

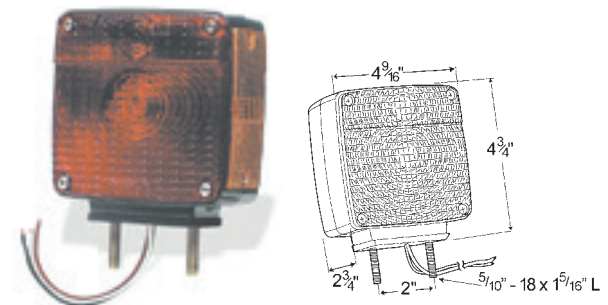

# Stop/Tail/Turn Lamps

Feux Arrêt / Arrière / Direction Lámparas de Freno / Cuarto / Direccional

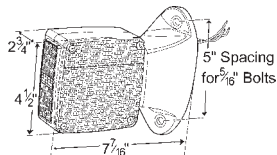

## PEDESTAL-MOUNT LAMP WITH PIGTAIL

Polycarbonate pedestal for fender contours • Incorporates sidemarker light  
 • Replaces Chevrolet®/GMC® 2017745 and 2006674 (RH) • Replaces Chevrolet®/GMC® 2017746 and 2006673 (LH) • Includes reflex reflector

**55430** Red and Yellow, RH

**55440** Red and Yellow, LH

Material: Lens - Acrylic; Housing - ABS/Polycarbonate

FMVSS: A, I, P, P2

Finish: Red / Yellow

Bulb: 1156, 32 CP

Volts / Amps: 12V / 2.1 A(I)

Bulb: 193, 2 CP (x2)

Volts / Amps: 12V / .66A (P,P2)

Lens: Red 91502, Yellow 91503; Sidemarker - Yellow 91513

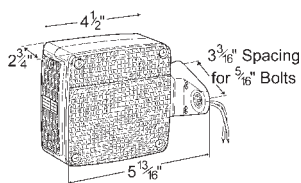

## PEDESTAL-MOUNT LAMP WITH PIGTAIL

High-heat acrylic-lens • Incorporates sidemarker light • Replaces Chevrolet®/GMC® 694628 (RH) • Replaces Chevrolet®/GMC® 694627 (LH) • Includes reflex reflector

**55450** Red and Yellow, RH

**55460** Red and Yellow, LH

Material: Lens - Acrylic; Housing - ABS/Polycarbonate

FMVSS: A, I, P, P2

Finish: Red / Yellow

Bulb: 1156, 32 CP

Volts / Amps: 12V / 2.1A (I)

Bulb: 193, 2 CP (X2)

Volts / Amps: 12V / .66A (P,P2)

Lens: Red 91502, Yellow 91503; Sidemarker - Yellow 91513

LED

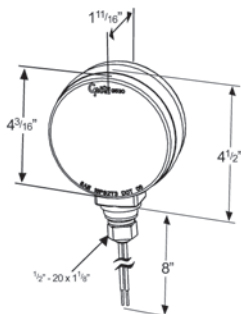

## 4" HI COUNT® DOUBLE-FACE LED LAMP

Attractive multiple diode design • Heavy-duty housing with hardwired connection for variable wiring options • Two-wire, double-contact installation

**G5300** Red and Yellow

Material: Lens - Acrylic; Housing - Chrome Plated Die-cast Zinc

FMVSS: I, T

Finish: Chrome/Red/Yellow

Volts / Amps: 12V / .77A (I), .038A (T)

Lens: Red: 92062; Yellow: 92063

## 4" ZINC DIE-CAST DOUBLE-FACE LAMP

Less than 75 sq cm of effective, projected luminous lens area • For use on vehicles less than 80" wide

### DOUBLE CONTACT:

- 53000** Red and Yellow, Chrome-Plated
- 53020** Red and Yellow, Black Enamel Finish
- 53023** Yellow and Yellow, Black Enamel Finish

### SINGLE CONTACT:

- 56000** Red and Yellow, Chrome-Plated
- 56020** Red and Yellow, Black Enamel Finish

Material: Lens - Acrylic; Housing - Chrome Plated Die-cast Zinc  
 FMVSS: Double - I, P; Single - I  
 Finish: Red / Yellow  
 Bulb: (53000, 53020, 53023) 1157, 32/3 CP  
 Volts / Amps: 12V / .59A (P)/2.1A (I)  
 Bulb: (56000, 56020) 1156, 32 CP  
 Volts / Amps: 12V / 2.1A (I)  
 Pigtail: 68130, 68170  
 Lens: Red 91582; Yellow 91583

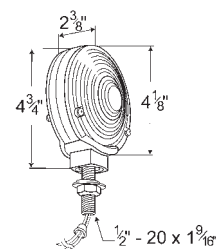

## 4" DIE-CAST SINGLE-FACE LAMP

Less than 75 sq cm of effective, projected luminous lens area • For use on vehicles under 80" wide • Wire exit includes a grommet to protect the jacket from abrasion

### DOUBLE CONTACT:

- 53032** Red, Chrome-Plated
- 53052** Red, Black Finish
- 53053** Yellow, Black Finish

### SINGLE CONTACT:

- 56052** Red, Black Finish
- 56053** Yellow, Black Finish

Material: Lens - Acrylic; Housing - Chrome Plated Die-cast Zinc  
 FMVSS: Double - I, S, T; Single - I, S  
 Finish: Red / Yellow  
 Bulb: (53032, 53093) 1157, 32/3 CP  
 Volts / Amps: 12V / .59A (P,T)/2.1A (I)  
 Bulb: (56052, 56033) 1156, 32 CP  
 Volts / Amps: 12V / 2.1A (I,S)  
 Bulb: (53032) 2057, 32 CP  
 Volts / Amps: 12V / 2.1A (I,S)/.48A (T)  
 Pigtail: 68130, 68170  
 Lens: Red 91582

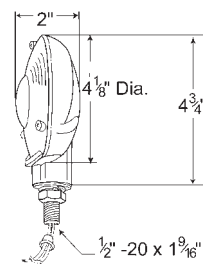

## THIN-LINE ZINC DIE-CAST DOUBLE-FACE LAMP

For fender or front bracket mount • Wire exit has a grommet to protect the jacket from abrasion • Single contact

- 55280** Red and Yellow, Baked Aluminum Finish
- 55290** Red and Yellow, Chrome-Plated

Material: Lens - Polycarbonate; Housing - Die-cast Zinc  
 FMVSS: I  
 Finish: Red/ Yellow  
 Bulb: 1156, 32 CP  
 Volts / Amps: 12V / 2.1A  
 Pigtail: 68170  
 Lens: Red 90232, Yellow 90233

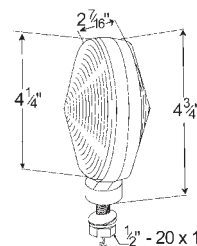



# Stop/Tail/Turn Lamps

Feux Arrêt / Arrière / Direction Lámparas de Freno / Cuarto / Direccional

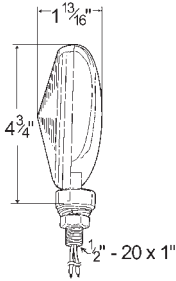

## THIN-LINE DIE-CAST SINGLE-FACE LAMP

Snap-grip acrylic lens • Rubber o-rings • Easy bulb and lens replacement  
• Wire exit has a grommet to protect the jacket from abrasion

### DOUBLE CONTACT:

**50652** Red, Chrome-Plated  
**50662** Red, Silver Finish

Material: Lens - Acrylic; Housing - Chrome Plated Die-cast Zinc  
FMVSS: Double - I, S, T; Red  
Finish: Red  
Bulb: 1157, 32/3 CP  
Volts / Amps: 12V / 2.1A (I,S)/.59A (T)  
Pigtail: 68130, 68170  
Lens: Red 90232, Yellow 90233

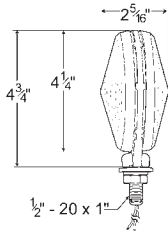

## THIN-LINE DOUBLE-FACE LAMP

Easy snap-on lenses • Molded-in baffle • Molded-in o-ring • Wire exit has a grommet to protect jacket against abrasion

### DOUBLE CONTACT:

**50630** Red and Yellow  
**50630-5** Red and Yellow **RETAIL**

### SINGLE CONTACT:

**55220** Red and Yellow  
**55220-5** Red and Yellow **RETAIL**  
**55223** Yellow and Yellow  
**55223-5** Yellow and Yellow **RETAIL**

Material: Lens - Acrylic; Housing - Polycarbonate  
FMVSS: Double - I, P; Single - I  
Finish: Red / Yellow  
Bulb: (50630, 50630-5) 1157, 32/3 CP  
Volts / Amps: 12V / 2.1A (I), .59A (P)  
Bulb: (55220, 55220-5, 55223, 55223-5) 1156, 32 CP  
Volts / Amps: 12V / 2.1A (I)  
Pigtail: 68170, 68130  
Lens: Red 90232, Yellow 90233

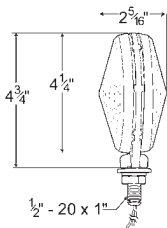

## SINGLE-FACE LAMP

Easy snap-on lens • Molded-on baffle • Rubber plug-in pedestal

### DOUBLE CONTACT:

**50642** Red  
**50642-5** Red **RETAIL**

### SINGLE CONTACT:

**55243** Yellow

Material: Polycarbonate  
FMVSS: (50642, 50642-5) Red; I, S, T; (55243) Yellow; I  
Finish: Red / Yellow  
Bulb: (50642, 50642-5) - 1157, 32/3 CP  
Volts / Amps: 12V / 2.1A (I,S)/.59A (T)  
Bulb: (55243) 1156, 32 CP  
Volts / Amps: 12V / 2.1A (I,S)  
Pigtail: 68130, 68170  
Lens: Red 90232, Yellow 90233

## STEEL SINGLE-FACE LAMP

Snap-ring lens application • Two-wire pigtail • Long-life bulb

**DOUBLE CONTACT:**

**50352**    Red

Material: Lens - Acrylic; Housing - Steel  
 FMVSS: I, P2, P3, S, T  
 Finish: Red  
 Bulb: 1157, 32/3 CP  
 Volts / Amps: 12V / 2.1A (I,S)/.59A (P2,P3,T)  
 Accessory: Snap Ring 99593  
 Pigtail: 68130  
 Lens: Red 90012

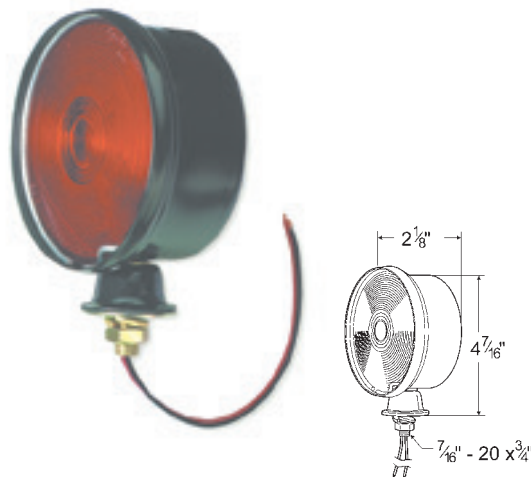

## 7" LED STOP/TAIL/TURN LAMP

Encapsulant potting provides protection for the circuit board • UV-protected lenses • Male .180 bullet connectors • Surface mount installation (no cut-outs required) • Install using 10 screws

**STOP/TAIL/TURN LAMP**

**53422**    Red, Stop/Tail/Turn Lamp w/Reflex

**SINGLE FUNCTION:**

- 55982**    Red, Turn Lamp w/ Reflex
- 55983**    Yellow, Front Turn Lamp w/ Reflex
- 55992**    Red, Turn Lamp w/o Reflex
- 55993**    Yellow, Turn Lamp w/o Reflex

Material: Polycarbonate  
 FMVSS: 53422 - A, I, P2, S, T; 55982 - A, I, S; 55983 - A, I; 55992/3 - I  
 Finish: Red/Yellow  
 Volts / Amps: S/T/T - 12V / .39A (A,I)/.03A (P2,T)  
 Volts / Amps: Single Function - 12V / .39A (I,S)  
 Bracket: 93982

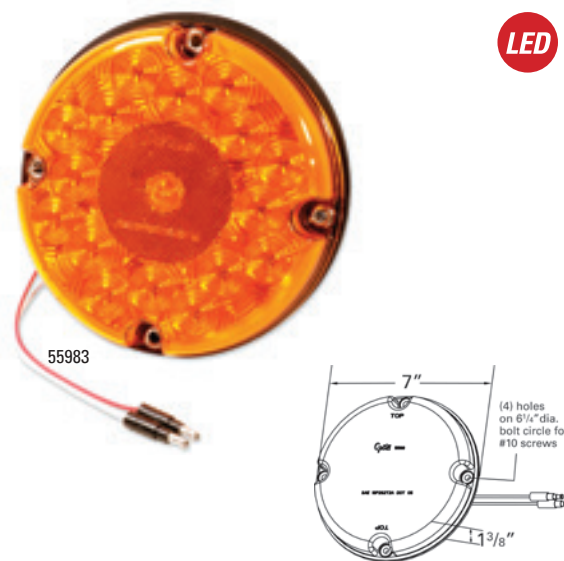

## 7" LED ARROWTURN LAMP

Large arrow pattern makes it easier for road traffic to identify turning vehicles • Meets FMVSS 108 Front and Rear Turn requirements • Auxiliary for midturn and/or wide turn indications • Surface mount for easy installation • UV-coated lens prevents weathering from the elements • Mounts with 10 screws

**53883**    Yellow, Turn Lamp

Material: Polycarbonate  
 FMVSS: I  
 Finish: Yellow  
 Volts / Amps: 12V / .327A  
 Bracket: 93982



# Stop/Tail/Turn Lamps

Feux Arrêt / Arrière / Direction Lámparas de Freno / Cuarto / Direccional

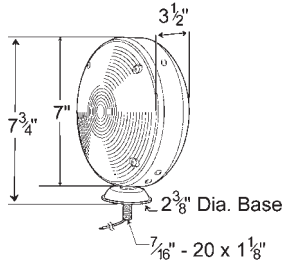

## 7" DOUBLE-FACE PEDESTAL LAMP

For simultaneous front and rear warning • Pedestal mounting • Baked black enamel finish

### TURN:

**78150** Red and Yellow  
**78153** Yellow and Yellow

### AUXILIARY:

**78152** Red and Red

Material: Lens - Acrylic; Housing - Steel  
 FMVSS: 78150, 78153 - I, S  
 Finish: Red / Yellow  
 Bulb: 1156, 32 CP  
 Volts / Amps: 12V / 2.1A (I)  
 Pigtail: 68080  
 Lens: Red 90092, Yellow 90093



## 7" SINGLE-FACE LAMP

Two-stud or bracket mounting • Heavy-gauge formed steel housing  
 • Yellow arrow design for rear turn only • 78303 and 78313 not for front turn use

**78002** Red  
**78003** Yellow  
**78303** Yellow, Arrow Lens, Molded .180 Terminal Pigtail  
**78313** Yellow, Arrow Lens, Blunt Cut Pigtail

Material: Lens - Acrylic; Housing - Steel  
 FMVSS: Red - I, S; Yellow & Yellow Arrow - I; Arrow Lens - I  
 Finish: Yellow / Red / Black  
 Bulb: 1156, 32 CP  
 Volts / Amps: 12V / 2.1A (I,S)  
 Bracket: 43282, 93982  
 Pigtail: 68080  
 Lens: Red 90092, Yellow 90093; Arrow Lens - Yellow 90103

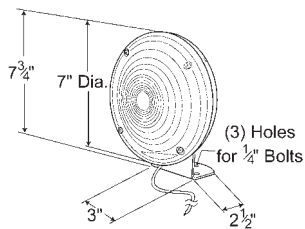

56083



56072

## 7" SCHOOL BUS LAMPS

Rugged housing • Acrylic lens • Flush mount • Blunt cut wires

### SINGLE CONTACT:

**56072** Red  
**56073** Yellow  
**56083** Yellow w/ Arrow Lens

### DOUBLE CONTACT:

**50132** Red

Material: Lens - Acrylic; Housing - Steel  
 FMVSS: I, S, T  
 Finish: Red / Yellow / Black  
 Bulb: 1157, 32/3 CP (x2) (50132)  
 Volts / Amps: 12V / 2.1A (I,S)/.59A (T) Double Contact  
 Bulb: 1156, 32 CP (56072, 56073, 56083)  
 Volts / Amps: 12V / 2.1A (I,S) Single Contact  
 Lens: Red 99842, Yellow 99843

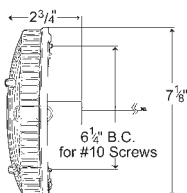

## ULTIMATE LED TRAILER LIGHTING KIT



Easily retrofits any 14' to 28' boat trailer • Maintenance- and hassle- free  
 • Water resistant • Rear combination clearance/marker must be mounted at a 45° angle

**65410-5** Lighting and Wiring Kit **RETAIL**

Material: Steel/Polycarbonate/ABS/PVC/Acrylic  
 FMVSS: Tail Lamps: I, S, T; C/M Lamps: Red - P2, Amber - PC  
 Finish: Red / Yellow / Black  
 Accessories: S/T/T Lamp: Red 53962; Sidemarker and Clearance/Marker: Red 47962, Yellow 47973; Bar Lamp: 49182; License Lamp: 60341;  
 Reflective Tape: Yellow 41153, Red 41152; Grommet: 92420;  
 Brackets: 43272, 43362, 92420; Harness: 01-6604-D7



## SUBMERSIBLE LED TRAILER LIGHTING KIT



7-function tail lamps: stop/tail/turn, side/rear reflector clearance/marker and license lamp. Kit includes lamps, 4 - foot trunk and 25 - foot trailer harness, license bracket, and mounting hardware.

**65870-5** w/ Clearance/Marker **RETAIL**  
**65880-5** w/o Clearance/Marker **RETAIL**

REPLACEMENT LAMP:		
<b>51962</b>	Red, RH, S/T/T	<b>RETAIL</b>
<b>51962-5</b>	Red, RH, S/T/T	<b>RETAIL</b>
<b>51972</b>	Red, LH, S/T/T w/ License Window	<b>RETAIL</b>
<b>51972-5</b>	Red, LH, S/T/T w/ License Window	<b>RETAIL</b>
<b>45973-5</b>	Yellow, C/M	<b>RETAIL</b>

Material: Polypropylene/Acrylic/ABS  
 FMVSS: RH - A, I, P2, S, T; LH - A, I, L, P2, S, T; C/M - P2  
 Finish: Red/Yellow  
 Volts / Amps: S/T/T - 12V / .22A (per lamp); C/M - 12V / .11A (per lamp)  
 Bracket: 43262-5

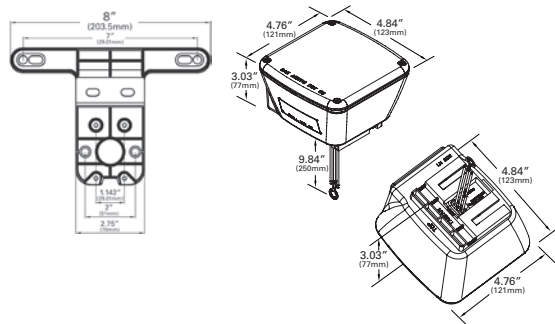

## SUPERNOVA® LED OVAL TRAILER STOP/TAIL/TURN SUBMERSIBLE LIGHTING KIT



Kit includes two each of: LED lamps (54132), brackets (43362), grommets (92420) and 3-wire, 11" plug-in pigtails (67002) • Electronics completely encapsulated with durable epoxy for maximum protection from the environment • Fits current mounting flanges and grommets

**65390-5** Red **RETAIL**

Material: ABS/Acrylic/Steel/PVC  
 FMVSS: I, S, T  
 Finish: Red  
 Volts / Amps: 12V / .48A (I,S), .06A (P2,T) per lamp  
 Accessory: Lamp: Red 54132  
 Bracket: 43362  
 Grommet: 92420  
 Pigtail: 67002

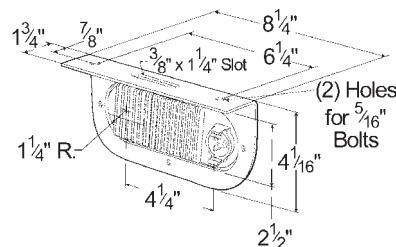

# RV, Marine and Utility Trailer Lighting

Phares Nautiques, de Véhicules Récréatifs et de Remorques Faros de Marina y Luces de Vehiculos Recreativos

LED

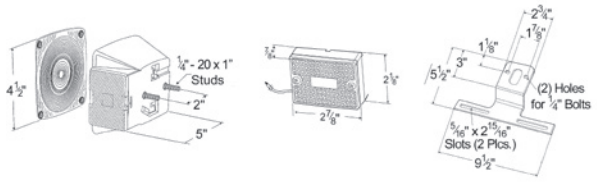
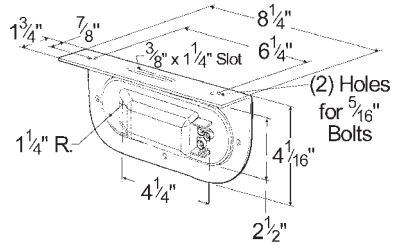
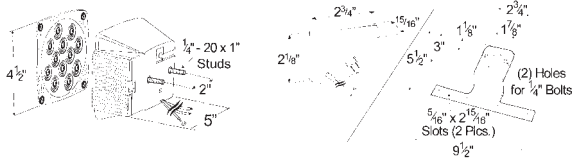

## SUBMERSIBLE LED TRAILER LIGHTING KIT

Popular square design • 7-function kit • Kit includes lamps, trailer harness, license bracket and mounting hardware

- 65330-5** w/ Clearance/Marker RETAIL
- 65320-5** w/o Clearance/Marker RETAIL

### REPLACEMENT LAMP:

- 51982** Red, RH, S/T/T
- 51982-5** Red, RH, S/T/T RETAIL
- 51992** Red, LH, S/T/T
- 51992-5** Red, LH, S/T/T RETAIL
- 47852-5** Red, C/M
- 47853-5** Yellow, C/M RETAIL

Material: Polypropylene/Acrylic/ABS  
 FMVSS: RH - A, I, P2, S, T; LH - A, I, L, P2, S, T; C/M - P2  
 Finish: Red/Yellow  
 Volts / Amps: S/T/T - 12V / .22A (per lamp); C/M - 12V / .11A (per lamp)  
 Bracket: 43262-5  
 Lens: S/T/T - Red 90642

## OVAL TRAILER STOP/TAIL/TURN SUBMERSIBLE LIGHTING KIT

Kit includes two of each: lamps (52182), brackets (43362), grommets (92420) and 3-wire 11" plug-in pigtails (67000)

### BOAT TRAILER KIT:

- 53082-5** RETAIL

Material: Steel/Polycarbonate/PVC  
 FMVSS: I, S, T  
 Finish: Red  
 Bulb: 1157, 32/3 CP; Volts / Amps: 12V / 2.1A (I,S)/.59A (T) per lamp  
 Accessory: Lamp: Red 52182  
 Bracket: 43362  
 Grommet: 92420  
 Pigtail: 67000

## TRAILER LIGHTING KIT

Twist-in bulb design makes it easy to replace • Kit includes lamps, 25 - foot harness, license plate bracket, and complete wiring and installation kit

- 65370-5** w/ Clearance/Marker RETAIL
- 65380-5** w/o Clearance/Marker RETAIL

### REPLACEMENT PARTS:

- 52302** Red, RH, S/T/T
- 52302-5** Red, RH, S/T/T RETAIL
- 52312** Red, LH, S/T/T
- 52312-5** Red, LH, S/T/T RETAIL
- 46983-5** Yellow, Clearance/Marker RETAIL

Material: Acrylic / ABS / Polypropylene  
 FMVSS: A, I, L, P2, S, T  
 Finish: Red/Yellow  
 Bulb: S/T/T - 1157, 32/3 CP; Volts / Amps: 12V / 2.1A (I,S)/.59(T)  
 Bulb: Marker - 1895, 2 CP; Volts / Amps: 12V / .27A (P2)  
 Lens: S/T/T - Red 92792; Clearance/Marker; Red 91112; Yellow 91113



## TRAILER LIGHTING KIT WITH CLEARANCE/MARKER LAMP

7-function tail lamps: stop/tail/turn, side/rear reflector clearance marker and license lamp • Kit includes right and left tail lamps (50532, 50542), two clearance/marker lamps (46393), 4-foot trunk and 25-foot split-Y trailer harnesses, license bracket (43262-5), mounting hardware



- 65350-5** w/ Yellow Clearance/Marker RETAIL
- 65190-5** w/o Yellow Clearance/Marker RETAIL

### REPLACEMENT LAMP:

- 50542** Red, RH, S/T/T
- 50542-5** Red, RH, S/T/T RETAIL
- 50532-5** Red, LH, S/T/T w/ License Window RETAIL
- 46713** Yellow, C/M
- 46713-5** Yellow, C/M RETAIL

Material: Acrylic/ABS/Polypropylene  
 FMVSS: RH - A, I, L P2, S, T; LH - A, I, P2, S, T; C/M A, P2, P3  
 Finish: Red/Yellow  
 Bulb: S/T/T - 1157, 32/3 CP; Volts / Amps: 12V / 2.1A (I, S), .59A (T)  
 Bulb: Sidemarker - 1895, 2 CP; Volts / Amps: 12V / .59A (T,L,P2)  
 Bulb: C/M - 1895, 2 CP; Volts / Amps: 12V / .27A (P2)  
 Lens: C/M Red 91112; S/T/T Red 90342

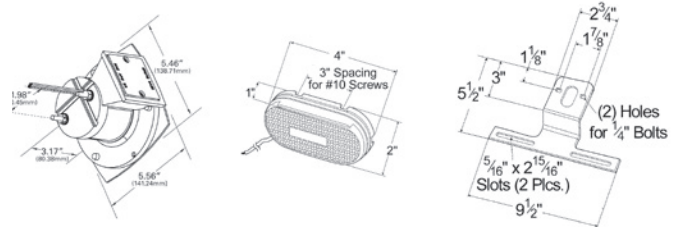

## SUBMERSIBLE TRAILER LIGHTING KIT

7 - function tail lamps: Stop/Tail/Turn, Clearance/Marker, License, and Reflector. • Kit includes 25 - foot harness, lamps, license bracket and mounting hardware



- 65230-5** w/ Clearance/Marker RETAIL

### REPLACEMENT PARTS:

- 53662** Red, RH, S/T/T
- 53672** Red, LH, S/T/T
- 46982-5** Red, C/M RETAIL
- 46983-5** Yellow, C/M RETAIL
- 90172** Red, S/T/T Lens Kit (90642 & 91112)

Material: Acrylic/ABS/Polypropylene  
 FMVSS: RH - A, I, P2, S, T; LH - A, I, L, P2, S, T; C/M - P2  
 Finish: Red/Yellow  
 Bulb: STT - 1157; Volts / Amps: 12V / 2.1A (I, S), .59A (T) / .27A (P2) per lamp  
 Bulb: C/M - 1895, 2 CP; Volts / Amps: 12V / .27A (P2) per lamp  
 Lens: S/T/T - Red 92792  
 Sidemarker and Clearance/Marker Red 91112, Yellow 91113

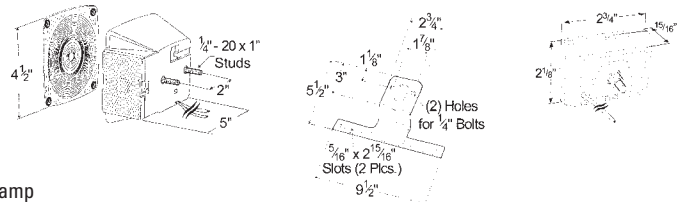

## UTILITY LIGHTING KIT FOR TRAILERS OVER 80" WIDE

7 - function tail lamps: Stop/Tail/Turn, Clearance/Marker, License, and Reflector. Twist-in bulb design for easy maintenance • Kit includes lamps, 25 - foot harness, license plate bracket, and complete wiring/installation kit



### REPLACEMENT PARTS:

- 52442** Red, RH, S/T/T and C/M
- 52452** Red, LH, S/T/T w/License Window and C/M

Material: Acrylic/ABS/Polypropylene  
 FMVSS: RH - A, I, P2, P3, S, T; LH - A, I, L, P2, P3, S, T  
 Finish: Red  
 Bulb: S/T/T - 1157, 168 CP; Volts / Amps: 12V / .27A (P2); C/M - 1895, 2 CP;  
 Bracket: 43262-5  
 Lens: S/T/T - Red 92792; C/M - Red 91122

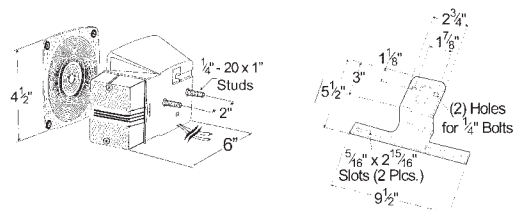

# RV, Marine and Utility Trailer Lighting

Phares Nautiques, de Véhicules Récréatifs et de Remorques Faros de Marina y Luces de Vehiculos Recreativos

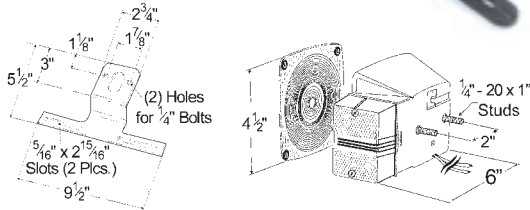

## SUBMERSIBLE TRAILER LIGHTING KIT FOR TRAILERS OVER 80" WIDE

7 - function tail lamps: Stop/Tail/Turn, Clearance/Marker, License, and Reflector. • Kit includes 25 - foot harness, lamps, license bracket and mounting hardware

**65440-5** RETAIL

### REPLACEMENT PARTS:

**51932** Red, RH, S/T/T & C/M

**51942** Red, LH, S/T/T w/ License Window and C/M

Material: Acrylic/ABS/Polypropylene

FMVSS: S/T/T RH - A, I, P2, P3, S, T; S/T/T LH - A, I, P2, P3, L, S, T

Finish: Red

Bulb: 1157, 168 CP; Volts / Amps: 12V / .59A

Accessory: Harness: 68420

Bracket: 43262-5

Lens: S/T/T- Red 92792; C/M- Red 91122

## SUBMERSIBLE COMPACT TRAILER LIGHTING KIT

Compact size and shape to fit where space is limited • Sonically sealed makes lamp fully submersible • Pre-wired with molded plugs for easy installation • 7 - function tail lamps: Stop/Tail/Turn, Clearance/Marker, License, and Reflector. Kit includes two lamps, a 25' trailer harness, connectors, license bracket, and mounting hardware

**65312** Red

### REPLACEMENT LAMP:

**53812** Red, RH, S/T/T, W/ License Window

**53822** Red, LH, S/T/T, W/ License Window

Material: Acrylic/ABS

FMVSS: A, I, P2, S, T, L

Finish: Red

Bulb: 1157, 32/2 CP; Volts / Amps: 12V / 2.1A (I,S,O) .59A (T)

Bulb: 194, 2 CP; Volts / Amps: 12V / .27A (P2,T)

Bracket: 01-9321-20

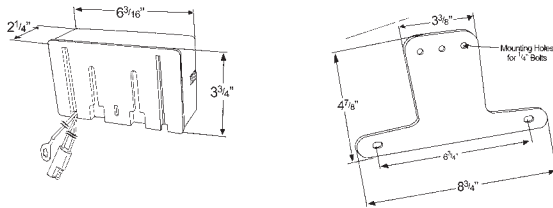

## SUBMERSIBLE LOW-PROFILE TRAILER LIGHTING KIT

Unique compact size fits where space is limited • Lens is sonically sealed to make a fully submersible lamp • 5 - function tail lamps: Stop/Tail/Turn, License, and Reflector. • Kit includes: Lamps, 4 - foot trunk and 25 - foot trailer harness, license bracket, and mounting hardware.

**65300-5** Red RETAIL

### REPLACEMENT PARTS:

**52492** Red, LH, S/T/T w/ License Window

**52482** Red, RH, S/T/T

**90652** Lens Kit (2 S/T/T and 2 C/M)

Material: ABS/Acrylic

FMVSS: RH - A, I, S, T; LH - A, I, L, S, T

Finish: Red

Volts / Amps: 12V / 2.1 / .48A

Accessory: Bulb: 90630

Bracket: 01-9321-20

Lens: Red (kit-front and side) 90652

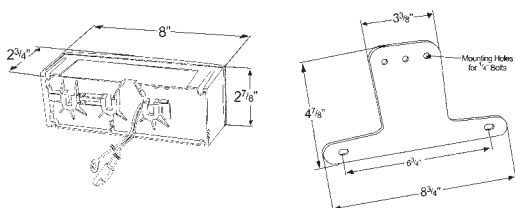

## HEAVY DUTY SUPERNOVA® LED MAGNETIC TOWING KIT

Durable rubber housings • Strong 50lb. pull mounting magnets for each lamp • Rubber adhesive magnet covers prevent scratching paint of towed vehicle • Adjustable lamp mounting for maximum visibility and safety • Die-cast 4-pole round plug • 30 ft. abrasion-resistant jacketed cable

**65432-4** Red

Material: Rubber/ABS/Acrylic  
 FMVSS: I, P2, S, T  
 Finish: Red  
 Volts / Amps: 12V / .24A (I,S) / .03A (P2,T) per lamp  
 Accessory: Lamp: Red 53252; Magnetic Mount: 43300; Plug: 82-1021;  
 Vehicle Socket: 82-1020



## MAGNETIC LED TOWING KIT

Kit includes lamps, harness and hook-up connectors • Kit specifications include truck harness and 20 ft. connecting harness • Plugs into a standard flat four-way vehicle trailer light connector

**65720-5** Red

**RETAIL**

Material: ABS/Acrylic/Polycarbonate/PVC  
 FMVSS: I, P2, S, T  
 Finish: Red  
 Volts / Amps: 12V / .25A (I, S) / .04A (P2, T)



## HEAVY DUTY MAGNETIC TOWING KIT

Durable rubber lamp housings • Strong 40lb. mounting magnets for each lamp • Rubber adhesive magnet covers to prevent scratching of towed vehicle • Adjustable lamp mounting for maximum visibility and safety • Durable die-cast 4-pole plug • 30-foot Abrasion resistant double jacketed cable

**65402-4** Red

Material: Rubber/Polycarbonate  
 FMVSS: I, P2, S, T  
 Finish: Red/Black  
 Bulb: (2) #2057, 32/2 C.P.; Volts / Amps: 12 V / .48A (P2,T)/2.1A (I,S) per lamp  
 Accessory: Lamp: Red 52922; Magnetic Mount: 43300; Plug: 82-1021;  
 Vehicle Socket: 82-1020

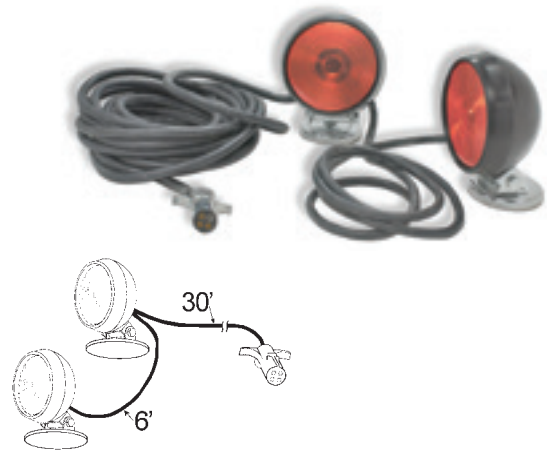

## MAGNETIC TOWING KIT

Kit includes harness, lamp and hook-up connectors • Kit specifications include truck harness and 20 ft. connecting harness • Plugs into a standard, flat four-way vehicle trailer light connector • Lens and bulb are replaceable

**65730-5** Red

**RETAIL**

Material: ABS/Acrylic  
 FMVSS: I, P2, S, T  
 Finish: Red  
 Bulb: (2) 32 CP, 1157; Volts / Amps: 12V / 2.1A (I, S) / .59A (P2, T)  
 Lens: 90232





# RV, Marine and Utility Trailer Lighting

Phares Nautiques, de Véhicules Récréatifs et de Remorques Faros de Marina y Luces de Vehiculos Recreativos

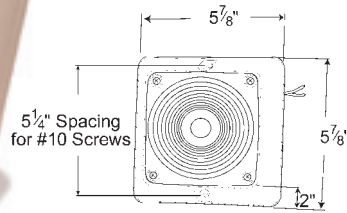

## VERSALITE® SINGLE-POD SURFACE MOUNT LAMP

Three functions: stop, tail and turn • Corrosion-resistant, shock-absorbing construction

**51142** Red

Material: Polycarbonate/ABS  
 FMVSS: I, S, T  
 Finish: White/ Red  
 Bulb: 1157, 32/3 CP; Volts / Amps: 12V / 2.1A (I,S)/.59A(T)  
 Lens: Red 90742

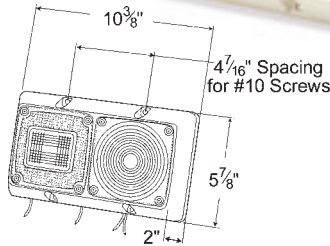
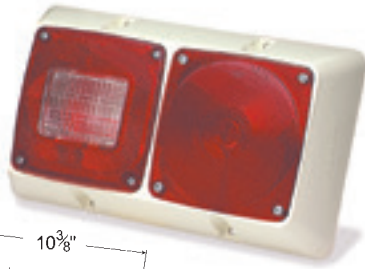

## VERSALITE® DOUBLE-POD SURFACE MOUNT LAMP

Five functions: stop, tail, turn, back-up light and reflector • Corrosion-resistant, shock-absorbing construction • Fits both right and left hand applications

**51242** Red

**51242-5** Red **RETAIL**

Material: ABS/Acrylic  
 FMVSS: A, I, R, S, T  
 Finish: White/ Red  
 Bulb: S/T/T - 1157, 32/3 CP; Volts / Amps: 12V / 4.2A (I,R,S)/.59A (T)  
 Bulb: 1156, 32 CP; Volts / Amps: 12V / .59A (T)  
 Lens: Red 90742; Reflex - Red 90752

52002

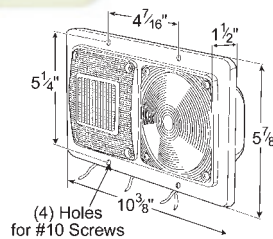

## VERSALITE® DOUBLE-POD RECESSED-MOUNT LAMP

Five functions: stop, tail, turn, back-up light and reflector • Corrosion-resistant, shock-absorbing construction

**51042** Red

Material: ABS/Acrylic  
 FMVSS: A, I, R, S, T  
 Finish: White/ Red  
 Bulb: S/T/T - 1157, 32/3 CP; Volts / Amps: 12V / 4.2A (I,R,S)/.59A (T)  
 Bulb: 1156, 32 CP; Volts / Amps: 12V / .59A (T)  
 Lens: Red 90742; Reflex - Red 90752

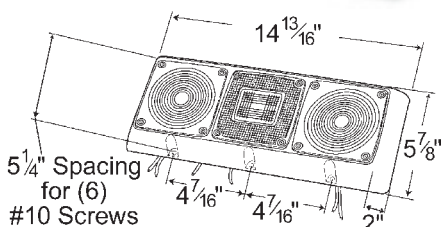

## VERSALITE® TRIPLE-POD SURFACE MOUNT LAMP

Six functions: stop, tail, turn, clearance marker, back-up light and reflector • Corrosion-resistant, shock-absorbing construction

**51342-5** Red, Colonial White **RETAIL**

**52082** Red, Chrome Finish

Material: ABS/Acrylic  
 FMVSS: A, I, P2, R, S, T  
 Finish: White/Chrome/Red  
 Bulb: S/T/T - 1157, 32/3 CP; Volts / Amps: 12V / 4.2A (I,S) / 1.18A(T)  
 Bulb: 1156, 32 CP; Volts / Amps: 12V / 1.18A (P2,T) / 4.2A (I,S) / 2.1A (R)  
 Lens: Red 90742; Reflex - Red 90752

# RV, Marine and Utility Trailer Lighting

Phares Nautiques, de Véhicules Récréatifs et de Remorques Faros de Marina y Luces de Vehiculos Recreativos

## LED SUBMERSIBLE TRAILER LAMP

Popular square design fits standard mounting hole configurations  
 • Ideal for utility, snowmobile, camping, motorcycle, horse, and boat trailers

- 51962 Red, RH
- 51972 Red, LH
- 51972-5 Red, LH

Material: Red High Impact Acrylic, Clear Polycarbonate  
 FMVSS: I, S, T, R2  
 Voltage Amp: 12V

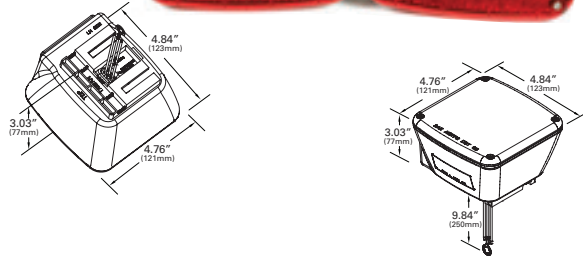

## VERSALITE® TRIPLE-POD RECESSED-MOUNT LAMP

Six functions: stop, tail, turn, clearance marker, back-up light and reflector  
 • Corrosion-resistant, shock-absorbing construction

- 52002 Red, Chrome Finish

Material: ABS/Acrylic  
 FMVSS: A, I, P2, R, S, T  
 Finish: Chrome/Red  
 Bulb: S/T/T - 1157, 32/3 CP; Volts / Amps: 12V / 4.2A (I,S)/2.1A (R)/1.18A (P2,T)  
 Bulb: 1156, 32 CP; Volts / Amps: 12V / .59A (T)  
 Lens: Red 90742; Reflex - Red 90752

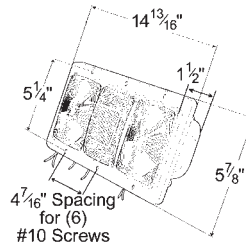
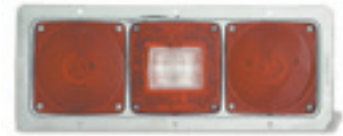

## VERSALITE® TRIPLE-POD RECESSED-MOUNT LAMP WITH YELLOW TURN LENS

Five functions: stop, tail, turn signal, back-up light and reflector  
 • Corrosion-resistant, shock-absorbing construction

- 52112 LH
- 52122 RH

Material: ABS/Acrylic  
 FMVSS: A, I, P2, R, S, T  
 Finish: Chrome/Red/Yellow  
 Bulb: 1157, 32/3 CP; Volts / Amps: 12V / 4.2A (I,S) / 2.1A (R)/1.18A (T)  
 Bulb: 1156, 32 CP; Volts / Amps: 12V / .59A (T)  
 Lens: Red 90742; Yellow 90743; Reflex - Red 90752

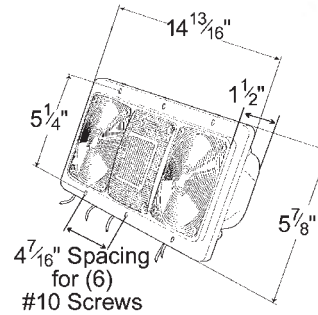

## 5 FUNCTION COMBINATION REAR LAMP

For recreational vehicles and mobile homes • Combination lamp with stop, tail, turn, reflector and license functions • Flat-back, corrosion-resistant, shock-absorbing base • 180° full lens illumination

- 50762 Red

Material: Polypropylene/Acrylic  
 FMVSS: A, I, L, S, T  
 Finish: Red  
 Bulb: 1157, 32/3 CP  
 Volts / Amps: 12V / 2.1A (I,S) / .59A (L,T)  
 Pigtail: 68150; Lens 90602

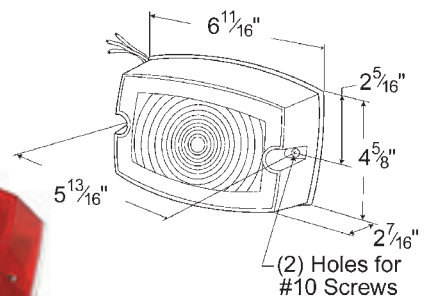

# RV, Marine and Utility Trailer Lighting

Phares Nautiques, de Véhicules Récréatifs et de Remorques Faros de Marina y Luces de Vehiculos Recreativos

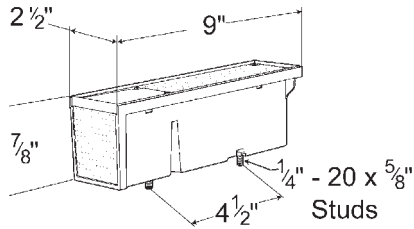

## LARGE WRAP-AROUND 5 FUNCTION REAR LAMP

For utility and snowmobile trailers • 5 function: stop, tail, turn, clearance marker and reflector

**52372** RH  
**52362** LH

Material: Polypropylene/Acrylic  
FMVSS: A, I, P2, S, T  
Finish: Red  
Bulb: 1157, 32/3 CP; Volts / Amps: 12V / .59A (T)/.27A (P2)  
Bulb: 1895, 2 CP; Volts / Amps: 12V / 2.1A (I,S)  
Lens: Kit - Red 92382



## TRAILER WIRING FRAME CLIP

Holds wire harness to frame and trailer

**99460-5** 10 Pack **RETAIL**

Material: Spring Steel  
Finish: Black



## 25' SPLIT-WIRE HARNESS

4-wire, split-Y trailer harness with male connector

**68420** Wire Harness



## BOAT & UTILITY TRAILER WIRING KIT

For durable re-wiring of boat, bike, snowmobile, or utility trailers

• A complete wire-harness package: 25' trailer harness, 4' trunk harness and (6) no-splice connectors

**68540-5** **RETAIL**

## SUPERNOVA® LED LICENSE LAMP

Low-profile shape helps prevent damage from dock collisions • Vibration-resistant lamp is ideal for dump trucks, refuse haulers and cement mixers

- Slotted mounting holes fit most lamp mounting screw patterns and withstand excessive torque without cracking
- Not polarity sensitive
- Encapsulant potting for total circuit-board protection

- 60381** Gray
- 60341** Black

Material: Polycarbonate  
 FMVSS: L  
 Finish: Gray/Black  
 Volts / Amps: 12V / .04A

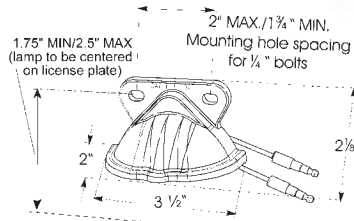

## MICRONOVA® MULTI-VOLT LED LICENSE LAMP

Durable one-piece LED lamp design • Hardwire with .180 slim-line UBS plug connections for maximum performance • Indexed, snap-fit mounting to brackets • Angled drain slots to prevent buildup behind the light • Direct replacement to existing 60601 (LED) and 60261 (Incandescent) offerings

- 60671** Lamp Only **ECE**

### VERTICAL MOUNT KIT:

- 60701** Black (60671 + 43962) **ECE**
- 60681** Gray (60671 + 43960) **ECE**
- 60781** Gray (60671 + 42332) **ECE**
- 60681** Black (60671 + 42322) **ECE**

### HORIZONTAL MOUNT

- 60691** Black (60671 + 42162) **ECE**

Material: Polycarbonate  
 FMVSS: L  
 Finish: Clear/Gray/Black  
 Volts / Amps: 9-32V / .03A  
 Brackets: 43960, 43962, 42162

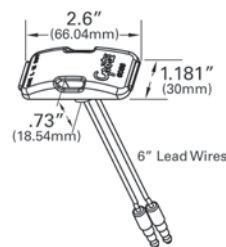

60671



60701

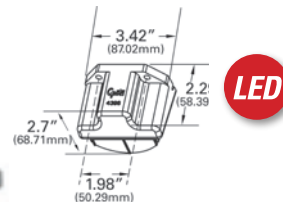

60691

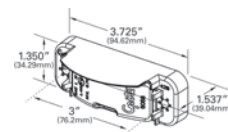

## MICRONOVA® MULTI-VOLT DOT LED LICENSE LAMP

Durable one-piece LED lamp design • Hardwire with .180 slim-line UBS plug connections for maximum performance • 60661 direct replacement to existing 60291 (Incandescent) offering

- 60721** Lamp with Hooded Grommet **ECE**
- 60661** DOT Lamp with Adaptor Bracket **ECE**
- 60651** DOT Lamp **ECE**

### KITS

- 60711** Gray, (60661 + 43780) **ECE**

Material: Lens and Bracket - Polycarbonate; Grommet - PVC  
 FMVSS: L  
 Finish: Clear/Gray/Black  
 Volts / Amps: 9-32V / .03A  
 Grommets: 94360; Brackets: 43780, 43783, 43850;  
 Adaptor Plate: 94350



60721

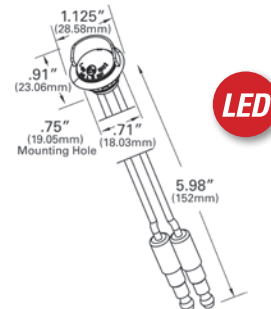

60661

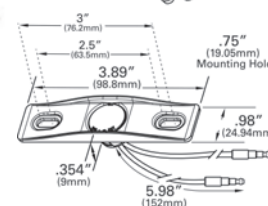

60711

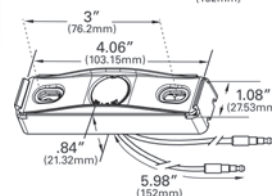

# License and Backup

Feux de Plaque d'Immatriculation et de Recul    Lámparas de Placa / Reversa

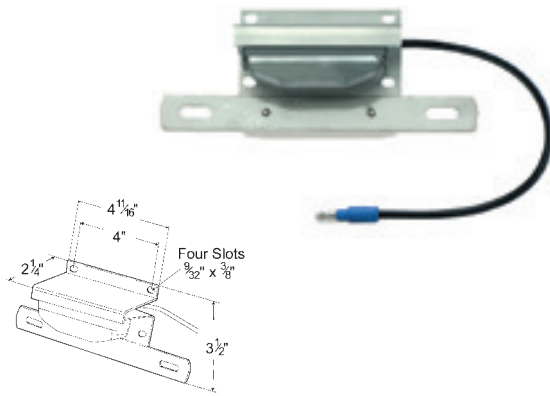

## RECTANGULAR LICENSE LAMP WITH BRACKET

Aluminum lamp bracket and stainless steel license-plate bracket  
 • Complete assembly includes dual-function bracket, license lamp (60291), lamp bracket (43390) and 48", 14 gauge .180 bullet UBS pigtail • License bracket not sold separately

**60321**    Clear w/ Stainless Steel Bracket

Material: Lens - Polycarbonate; Housing - Aluminum; Bracket - Stainless Steel  
 FMVSS: L  
 Finish: Aluminum  
 Bulb: 193, 2 CP (x2)  
 Volts / Amps: 12V / .66A



## SEALED TURTLEBACK® II LICENSE LAMP

Impact-resistant bulb contacts • Waterproof male pin connection accepts UBS pigtail

**60331**    Clear

Material: Polycarbonate  
 FMVSS: L  
 Finish: Clear  
 Bulb: 193, 2 CP (x2)  
 Volts / Amps: 12V / .66A  
 Pigtail: 66910, 66911, 67070, 67071

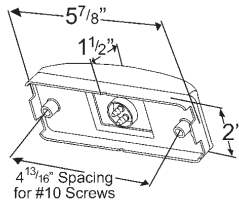

## 2" TWIST-IN SEALED LICENSE LAMP

Kit includes hooded mounting bracket with lamp • Twist-on mounting  
 • Accepts UBS pigtail

**45821**    Clear

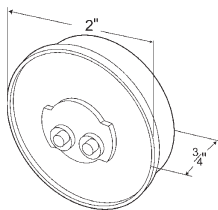

43040

**KITS:**  
**60191**    Clear (45821 + 43040)

Material: Polycarbonate  
 FMVSS: L when used with 43040 bracket  
 Finish: Clear  
 Bulb: 193, 2 CP  
 Volts / Amps: 12V / .33A  
 Bracket: 43040, 43960, 42160, 43962, 42162  
 Pigtail: 66850, 66851, 66800, 66840, 67001, 67050, 66801



43040

## SMALL RECTANGULAR LICENSE LAMP

Sonically sealed lens design • Single 15,000-hour bulb

### LICENSE LAMPS:

**60261** Clear

### LICENSE LAMP KITS:

**60280** Clear (60261 + 43830)

**60460** Clear Lamp, Gray Flange (60261 + 43960)

Material: Polycarbonate

FMVSS: L

Finish: Clear

Bulb: 2 CP

Volts / Amps: 12V / .33A

Bracket: 43830, 43960, 42160, 43952, 42162

Grommet: 92520

Pigtail: 66850, 67050, 67001, 66851, 66800, 66840

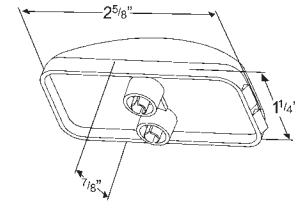

## RECTANGULAR LICENSE LAMP

Sonically sealed rectangular double-bulb lamp • Narrow mounting applications • 15,000-hour bulbs

**60291** Clear

Material: Polycarbonate

FMVSS: L

Finish: Clear

Bulb: 193, 2 CP (x2)

Volts / Amps: 12V / .66A

Bracket: 43780, 43783, 43850

Pigtail: 66980, 66981, 66982

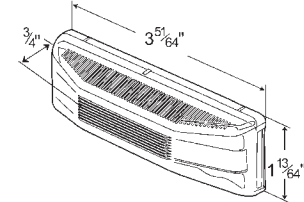

## RESEALABLE LICENSE LAMP

Compact license lamp protrudes less than 2" • Housing snaps firmly into molded o-ring

**60001** Gray

**60011** Triple Chrome

**60011-5** Triple Chrome **RETAIL**

**60121** Gray w/ UBS .180-Bullet Plug-In Pigtail

### PROTECTIVE LENS CAP:

**93610** Gray

Material: Lens - Polycarbonate; Housing - Chrome Plated ABS

FMVSS: L

Finish: Gray/Chrome

Bulb: 67, 4 CP

Volts / Amps: 12V / .59A

Accessory: Gray Cap: 93610

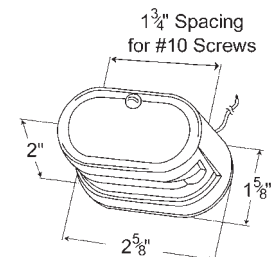

# License and Backup

Feux de Plaque d'Immatriculation et de Recul    Lámparas de Placa / Reversa

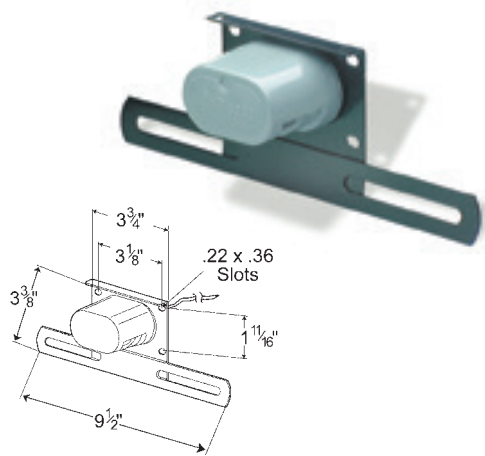

## LICENSE LAMP WITH METAL BRACKET

Compact license lamp protrudes less than 2" • Housing snaps firmly into molded-in o-ring • Uses 60001 license lamp with 36" pigtail

**60081** Clear

**PROTECTIVE LENS CAP:**

**93610** Gray

Material: Lens - Polycarbonate; Housing - Steel  
 FMVSS: L  
 Finish: Black/Gray  
 Bulb: 67, 4 CP  
 Volts / Amps: 12V / .59A

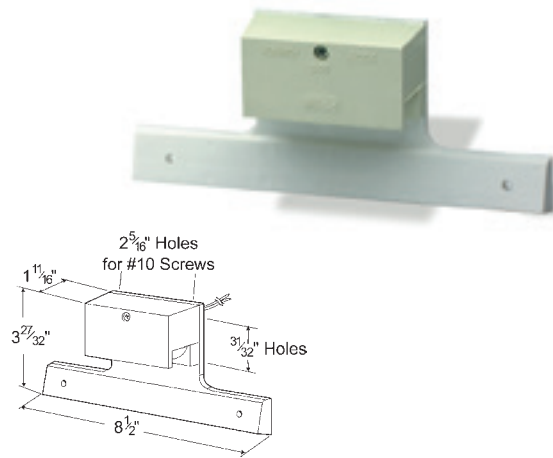

## VERSALITE® LICENSE LAMP WITH BRACKET

Corrosion-proof, shock-absorbing ABS construction

**60131** Clear

Material: ABS  
 FMVSS: L  
 Finish: White  
 Bulb: 67, 4 CP  
 Volts / Amps: 12V / .59A

**LED**



## SUPERNOVA® 4" FLANGED LED HOOK UP LAMP

Directly mounts and replaces existing hook-up lamps • Sealed flange-to-lens design • Housing to truck gasket included to keep moisture and elements out • Male pin connection • provides more light to hook up lines and nose box area than existing lamps

**60631** Clear **NEW**

Material: Polycarbonate  
 Finish: Clear  
 Volts / Amps: 12V / 0.5A  
 Pigtail: 66842, 67013, 66846, 66016

## SUPERNOVA® 4" SINGLE-SYSTEM LED BACKUP LAMP

Meets backup function with single-lamp system • Encapsulant potting for total circuit-board protection • Advanced pin connection system uses tin-plated, solid-brass pin terminals • Uses USB male pin pigtail • Hard coated lens for long-term UV protection

**62401**    Clear, Male Pin

Material: Polycarbonate  
 FMVSS: R  
 Finish: Clear  
 Volts / Amps: 12V / .6A  
 Bracket: 43343, 92510, 92512, 92513, 43253  
 Grommet: 91740, 91950  
 Pigtail: 66842, 67013, 66846, 66816

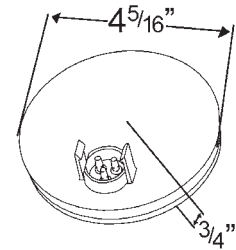
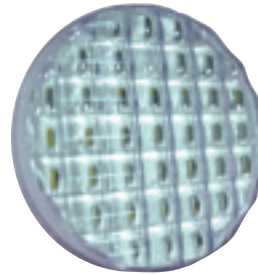

## 4" TORSION MOUNT® II SINGLE-SYSTEM BACKUP LAMP

Torsion Mount® II Gel-Mount® bulb cradle design • Meets backup function with single-lamp system • Hermetic lens-to-housing seal

**62211**    Clear, Male Pin  
**62271**    Clear, Female Pin

**KITS:**

**62221**    Clear, Male Pin (62211 + 91740 + 67013)  
**62331**    Clear, Female Pin (62271 + 91740 + 67010)

Material: Polycarbonate  
 FMVSS: R  
 Finish: Clear  
 Bulb: 2057 32/2 CP  
 Volts / Amps: 12V / 2.1A  
 Bracket: 43572, 43253, 92510, 92512, 92513  
 Grommet: 91740, 91950  
 Pigtail: Male Pin: 66842, 67013, 66846, 66816  
 Female Pin: 67011, 67010, 67014, 67020

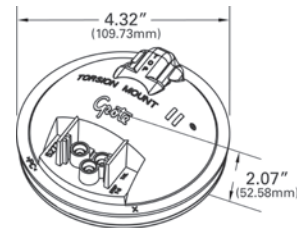
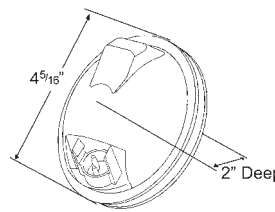

## SUPERNOVA® 4" DUAL-SYSTEM LED BACKUP LAMP

Requires two lamps to meet backup function • Encapsulant potting for total circuit board protection • Advanced pin connection system uses tin-plated, solid-brass terminations • Uses USB male pin pigtail • Hard coated lens for long-term UV protection

**62391**    Clear  
**62571**    Clear **24**

Material: Polycarbonate  
 FMVSS: (2)R  
 Finish: Clear  
 Volts / Amps: 12V / .25A  
 Volts / Amps: 24V / .15A  
 Bracket: 43343, 92510, 92512, 92513, 43253  
 Grommet: 91740, 91950  
 Pigtail: 66842, 67013, 66846, 66816

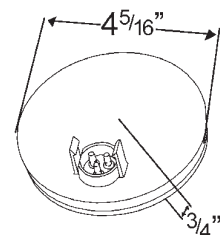
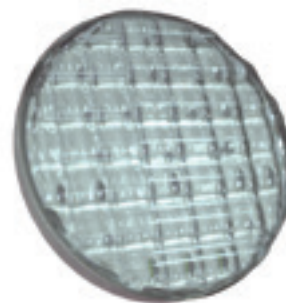



# License and Backup

Feux de Plaque d'Immatriculation et de Recul    Lámparas de Placa / Reversa

**LED**

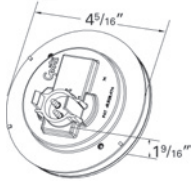

62091

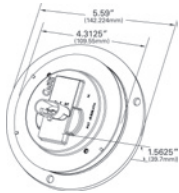

62811

## SUPERNOVA® NEXGEN™ 4" DUAL-SYSTEM LED BACKUP LAMP

Fits standard 4" lamp grommets and brackets • Hermetically sealed lamp prevents water intrusion • Requires two lamps to meet backup function • Encapsulant potting for total circuit board protection • Flanged lamps require no additional mounting brackets

**62091** Clear, Male Pin  
**62101** Clear, Hard Shell

### FLANGED W/GASKET

**62781** Clear, Male Pin  
**62791** Clear, Hard Shell  
**62811** Clear, Male Pin **ECE**

Material: Lens - Acrylic; Housing - ABS

FMVSS: (2)R

Finish: Clear

Volts / Amp: 12V / .55A

Bracket: 93552, 43253, 92510, 92511, 92513, 43572, 43642, 43655, 43732, 93190, 93553, 93683, 51090

Grommet: 91740, 91950

Pigtail: Male pin: 66842, 67013, 66846, 66816; Hard shell: 66862

**LED**

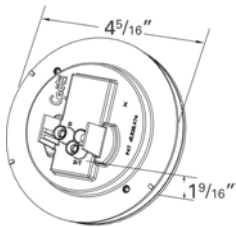

## GROTE SELECT™ 4" DUAL-SYSTEM LED BACKUP LAMP

Fits standard 4" lamp grommets and brackets • Hermetically sealed lamp prevents water intrusion • Requires two lamps to meet backup function • Standard aftermarket connection provides for ease of replacement

**62691** Female Pin

Material: Lens - Acrylic; Housing - ABS

FMVSS: (2)R

Finish: Clear

Volts / Amps: 12V / .55A

Bracket: 93552, 43253, 92510, 92511, 92512, 92513, 43572, 43642, 43655, 43732, 93190, 93553, 93683, 51090

Grommet: 91740, 91950

Pigtail: 66812, 66811

## 4" TORSION MOUNT® II DUAL-SYSTEM BACKUP LAMP

Requires two lamps to meet backup function • Torsion Mount® II Gel-Mount® bulb cradle design • Hermetic lens-to-housing seal • Kit includes lamp, grommet (91740) and pigtail (67010)

**62121** Frosted Clear, Male Pin  
**62171** Frosted Clear, Female Pin  
**62321** Frosted Clear, Female Pin **24**

### KITS:

**62181** Frosted Clear, Female Pin (62171 + 91740 + 67010)

Material: Polycarbonate

FMVSS: (2)R

Finish: Frosted

Bulb: 2057, 32 CP Volts / Amps: 12V / 2.1A

Bracket: 43572, 43253, 92510, 92512, 92513

Grommet: 91740, 91950

Pigtail: Male Pin: 66842, 67013, 66846, 67016; Female Pin: 67010, 67014, 67011, 67020

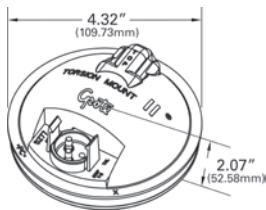

## SUPERNOVA® OVAL SINGLE-SYSTEM LED BACKUP LAMP

Legal for horizontal mount only • Uses USB male pin pigtails  
 • Retrofit upgrade for original equipment Volvo® trucks using the Grote tail lamp system • Encapsulant potting for total circuit board protection

**62561**    Clear, Grommet Mount

Material: Lens - Acrylic; Housing - ABS  
 FMVSS: R  
 Finish: Clear  
 Volts / Amps: 12V / .30A  
 Bracket: 43362, 43952, 43220, 43223, 43222, 43723, 43100  
 Grommet: 92420, 92720  
 Pigtail: 66842, 67013, 66846, 66816

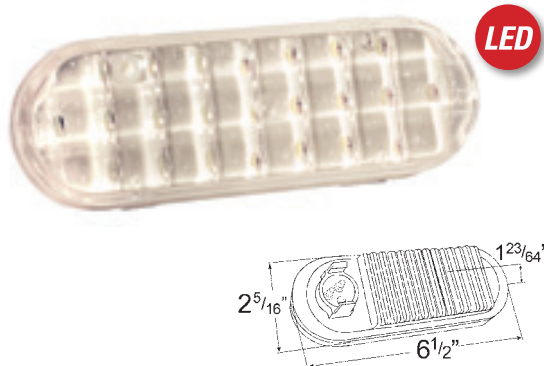

## TORSION MOUNT® III OVAL MALE-PIN SINGLE-SYSTEM BACKUP LAMP

Fits standard oval lamp grommets and brackets • Torsion Mount® III, Gel Mount® bulb cradle technology increases bulb life and reduces vibration damage • Male pin UBS® connection technology utilizes o-ring seals and pigtail locking tabs to help eliminate corrosion from water intrusion  
 • Meets backup function with single-lamp system

**62111**    Frosted Clear Lens

Material: Polycarbonate  
 FMVSS: R  
 Finish: Clear  
 Bulb: 2057, 40 CP  
 Volts / Amps: 12V / 2.2A  
 Bracket: 43362, 43952, 43220, 43222, 43223  
 Grommet: 92420, 92720  
 Pigtail: 66842, 67013, 66846, 67016



## SUPERNOVA® OVAL DUAL-SYSTEM LED BACKUP LAMP

Requires two lamps to meet backup function • Fewer diodes reduces power consumption • Encapsulant potting for total circuit board protection  
 • Uses USB male pin pigtails

### MALE PIN, HORIZONTAL MOUNT:

**62601**    Clear, Grommet Mount

### MALE PIN, VERTICAL MOUNT:

**62591**    Clear, Grommet Mount

Material: Lens - Acrylic; Housing - ABS  
 FMVSS: (2)R  
 Finish: Clear  
 Volts / Amps: 12 V / .30A  
 Bracket: 43362, 43952, 43220, 43223, 43222, 43723, 43100  
 Grommet: 92420, 92720  
 Pigtail: 66842, 67013, 66846, 66816



# License and Backup

Feux de Plaque d'Immatriculation et de Recul    Lámparas de Placa / Reversa

LED

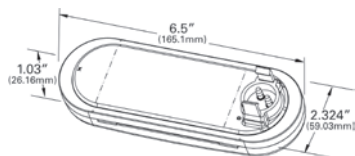

## SUPERNOVA® NEXGEN™ OVAL DUAL-SYSTEM LED BACKUP LAMP

Fits standard oval lamp grommets and brackets • Hermetically sealed lamp prevents water intrusion • Requires two lamps to meet backup function • Lamps must be mounted vertically • Encapsulant potting provides total circuit board protection

**62051**    Male Pin

Material: Lens - Acrylic; Housing - ABS

FMVSS: (2)R

Finish: Clear

Volts / Amps: 12V / .30A

Bracket: 43362, 43952, 43220, 43223, 43222, 43723, 43100

Grommet: 92420, 92720

Pigtail: 66842, 67013, 66846, 66816

LED

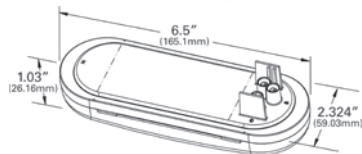

## GROTE SELECT™ OVAL DUAL-SYSTEM LED BACKUP LAMP

Fits standard oval lamp grommets and brackets • Hermetically sealed lamp prevents water intrusion • Requires two lamps to meet back-up function • Lamps must be mounted vertically • Product uses standard aftermarket connection for ease of installation

**62751**    Female Pin

Material: Lens - Acrylic; Housing - ABS

FMVSS: (2)R

Finish: Clear

Volts / Amps: 12V / .30A

Bracket: 43362, 43952, 43220, 43223, 43222, 43723, 43100

Grommet: 92420, 92720

Pigtail: 67010, 67011, 67014, 67020

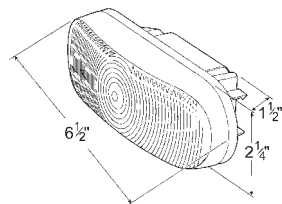

## TORSION MOUNT® III OVAL MALE-PIN DUAL-SYSTEM BACKUP LAMP

Fits standard oval lamp grommets and brackets • Torsion Mount® III, Gel Mount® bulb cradle design ensures longer bulb life • O-ring seal design eliminates corrosion (male pin) • Requires two lamps to meet backup function

**62241**    Clear, Male Pin

**62231**    Clear, Female Pin

### KITS:

**62251**    Clear, Female Pin (62231 + 92420 + 67010)

Material: Polycarbonate

FMVSS: (2)R

Finish: Clear

Bulb: 1157, 32 CP

Volts / Amps: 12V / 2.1A

Bracket: 43362, 43952, 43220, 43222, 43223

Grommet: 92420, 92720

Pigtail: Male pin: 66842, 67013, 66846, 67016

Female pin: 67010, 67011, 67014, 67020

## ECONOMY OVAL DUAL-SYSTEM BACKUP LAMP

Requires two lamps to meet backup function • Hermetic lens-to-housing seal • Fits standard oval lamp grommets and brackets • Standard female pin termination

**62521**    Clear, Female Pin

Material: Polycarbonate  
 FMVSS: (2)R  
 Finish: Clear  
 Bulb: 1141  
 Volts / Amps: 12V / 2.1A  
 Bracket: 43362, 43952, 43220, 43222, 43223  
 Grommet: 92420, 92720  
 Pigtail: 67010, 67011, 67014, 67020

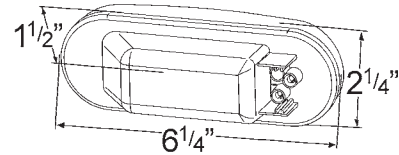

## RECTANGULAR DUAL-SYSTEM BACKUP LAMP

Tough polycarbonate lens • Hermetic lens-to-housing seal • Requires two lamps to meet backup function

**62381**    Clear, Female Pin

Material: Polycarbonate  
 FMVSS: (2)R  
 Finish: Clear  
 Bulb: 2057, 32 CP  
 Volts / Amps: 12V / 2.1A  
 Bracket: 43212  
 Grommet: 94180  
 Pigtail: 67010, 67011, 67014, 67020

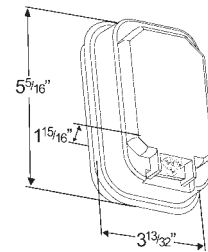

## OE-STYLE DUAL-SYSTEM BACKUP LAMP

Requires small 1 1/16" hole for installation • Mounting pad included • For use on buses and trucks • Requires two lamps to meet backup function

**62011**    Gray Bezel  
**62021**    Chrome-Plated Bezel  
**62021-5**    Chrome-Plated Bezel, Retail Pack

Material: Lens - Acrylic; Housing - Steel; Bezel - ABS, Chrome plated ABS  
 FMVSS: (2)R  
 Finish: Clear  
 Bulb: 1156, 32 CP  
 Volts / Amps: 12V / 2.1A  
 Pigtail: 68080  
 Lens: Clear 90221

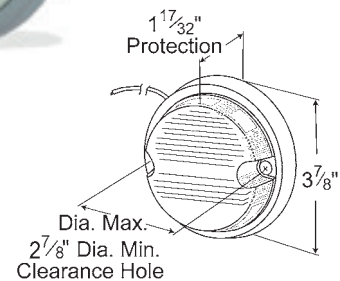

# License and Backup

Feux de Plaque d'Immatriculation et de Recul    Lámparas de Placa / Reversa

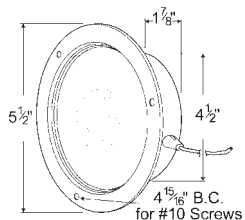

## STAINLESS STEEL RECESSED DUAL-SYSTEM BACKUP LAMP

Snap-in lens for easy replacement • Requires two lamps to meet backup function

**62151**    Clear

Material: Lens - Polycarbonate; Housing - Stainless Steel  
 FMVSS: (2)R  
 Finish: Clear  
 Bulb: 1156, 32 CP  
 Volts / Amps: 12V / 2.1A  
 Lens: Clear 91311, Clear 90011

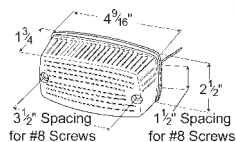

## RECTANGULAR SURFACE MOUNT DUAL-SYSTEM BACKUP LAMP

Raised lens for maximum light output • Surface mount requires no socket hole or cutout • Requires two lamps to meet backup function

**62291**    Clear

Material: Lens - Polycarbonate; Housing - Steel  
 FMVSS: (2)R  
 Finish: Clear  
 Bulb: 1156, 32 CP  
 Volts / Amps: 12V / 2.1A

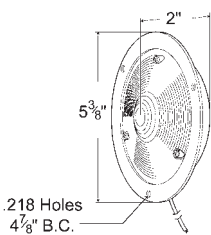

## SHALLOW DIE-CAST UTILITY LAMP

Chrome-plated die-cast housing • Shallow profile for exterior sleeper cab application • Blunt cut wires

**60311**    Clear

Material: Lens - Acrylic; Housing - Zinc plated steel material  
 Finish: Clear  
 Bulb: 1156, 32 CP  
 Volts / Amps: 12V / 2.1A  
 Lens: Clear 91581, Red 91582, Yellow 91583

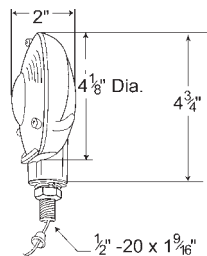

## 4" ZINC DIE-CAST SINGLE-FACE LAMP

3-screw acrylic lens • Grommeted wire exit • Single contact

**63051**    Clear, Black Enamel Finish

Material: Lens - Acrylic; Housing - Zinc plated steel material  
 Finish: Clear  
 Bulb: 1156, 32 CP  
 Volts / Amps: 12V / 2.1A  
 Pigtail: 68170  
 Lens: Clear 91581

## LED WHITERLIGHT™ RECESSED-MOUNT 18" DOME LAMP

### FEATURES & BENEFITS

- Encapsulant potting for total circuit board protection
- Robust, one-piece, aluminum housing and removable acrylic lens (LED versions)
- Built-in automatic thermal protection circuit

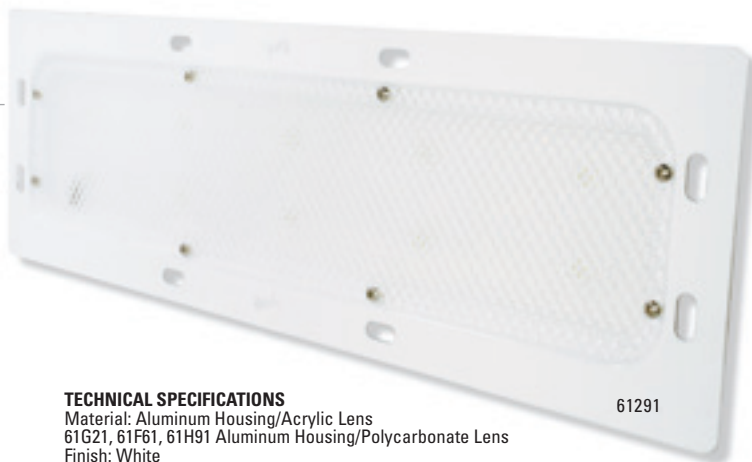

### TECHNICAL SPECIFICATIONS

Material: Aluminum Housing/Acrylic Lens  
61G21, 61F61, 61H91 Aluminum Housing/Polycarbonate Lens  
Finish: White



61261



61F61



61511

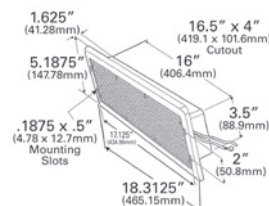
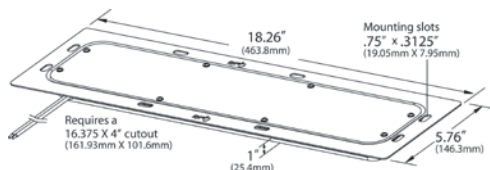

Part Number	Product Description	Lighting Technology	Light Output (Usable)	Operating Temperature	Design Voltage (V)	Amp Draw (A)
61611	High output, 18 diodes	LED	1200 Lm	-40°F to +122°F	12	2.16
61G21	High output, 18 diodes, w/motion sensor	LED	1200 Lm	-4°F to +122°F	12	2.16
61E61	High output, 18 diodes, dimmable	LED	1200 Lm	-40°F to +122°F	12	2.17/.71
61111	High output, 16 diodes	LED	1000 Lm	-40°F to +122°F	24	1
61261	Standard output, 10 diodes	LED	800 Lm	-40°F to +122°F	12	1.75
61F61	Standard output, 10 diodes w/motion sensor	LED	800 Lm	-4°F to +122°F	12	1.75/.02
61881	Low output, 10 diodes	LED	400 Lm	-40°F to +122°F	12	1.2
61291	Standard output, 6 diodes	LED	940 Lm	-40°F to +122°F	12	1.7
61H91	Standard output, 6 diodes w/motion sensor	LED	940 Lm	-4°F to +122°F	12	1.7/.02
61511	Standard output, interior dome	Fluorescent	950 Lm	0°F to +125°F	12	2.5
61M11 <b>NEW</b>	Standard output, 6 diodes interconnected	LED	940 Lm	-40°F to +122°F	12	1.7/.02

### Accessories

Part Number	Description	Fits
94621	Replacement Lens	Round Corner Lenses
94631	Replacement Lens	Square Corner Lenses
92901	Replacement Lens	61511
92911	Fluorescent Tube	61511
43540	Mounting Pan	All 18" Dome Lamps



# Interior Lighting

Lumières d'Intérieur Lámparas para Interior

## LED WHITELIGHT™ RECESSED-MOUNT INTERIOR DOME LAMP



### FEATURES & BENEFITS

- LED lamp is rated to 50,000 service hours
- Fits existing, similar incandescent lamp mountings
- Low heat; will not melt lens
- Encapsulant potting for total circuit board protection against moisture and corrosion



61760

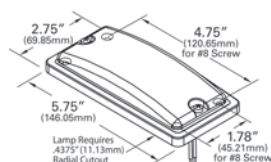

61931

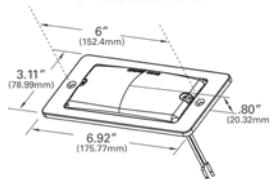

61F51

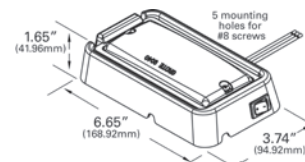

Part Number	Product Description	Designation	Lighting Technology	Connection Type	Light Output (Usable)	Design Voltage (V)	Amp Draw (A)
61861	Gray aluminum housing, 6 diodes	Dome	LED	Hardwire	300 Lm	9-30	.6 @ 9V .155 @ 30V
61991	Gray aluminum housing, 6 diodes	Dome	LED	Hardwire	300 Lm	12	0.48
61871	Gray aluminum housing, 3 diodes	Courtesy	LED	Hardwire	150 Lm	9-30	.32 @ 9V .094 @ 30V
61961	Gray aluminum housing, 3 diodes	Courtesy	LED	Hardwire	150 Lm	12	0.24
61931	Gray aluminum, flange mount housing, 6 diodes	Dome	LED	Hardwire	300 Lm	12	0.48
61760	Black aluminum housing, 3 white, 3 red diodes	Dome	LED	Hardwire	150 Lm	10-32	.250 @ 12V .140 @ 24V
61890	Gray aluminum housing, 3 white, 3 blue diodes	Dome	LED	Hardwire	150 Lm	10-32	.250 @ 12V .140 @ 24V
82080	Black aluminum housing, 3 white, 3 red diodes	Dome	LED	Tyco #770331-1	150 Lm	10-30	.250 @ 12V .140 @ 24V
82400	Black aluminum housing, 3 white, 3 blue diodes	Dome	LED	Tyco #770331-1	150 Lm	18-32	.125 @ 24V
61F30	Black surface mount plastic housing w/switch, 4 white, 4 red diodes	Dome	LED	Hardwire	200 Lm	10-32	.250 @ 12.8V .140 @ 25.6V
61F40	Black surface mount plastic housing w/switch, 4 white, 4 blue diodes	Dome	LED	Hardwire	200 Lm	10-32	.250 @ 12.8V .140 @ 25.6V
61F51	Black surface mount plastic housing w/switch, 6 white diodes	Dome	LED	Hardwire	300 Lm	12	.480 @ 14V
61031	Gray steel housing	Dome	Incandescent	Hardwire	15 CP	12	1.1 @ 12V

### Accessories

Part Number	Description	Fits
90401	Replacement Lens	All

## LED WHITELIGHT™ 4" DOME LAMP



### FEATURES & BENEFITS

- Shock-absorbing, weather-proof housing with long-life LEDs makes this a very durable lamp
- Cost-effective LED lighting option is rated at 50,000 hours
- LEDs utilize lower amp draw, putting less load on strained electrical systems
- Hardwired for easy integration into current wiring system
- Uses 70% less power than incandescent options



61E41



61E01



61H41



61171

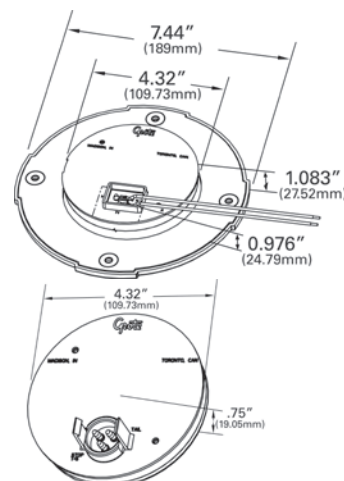
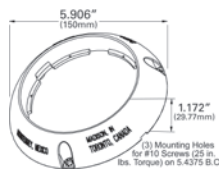
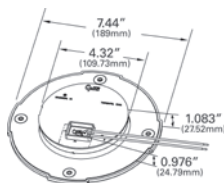
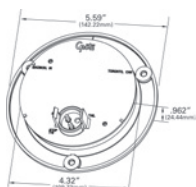

Part Number	Product Description	Lighting Technology	Light Output (Usable)	Connection Type	Design Voltage (V)	Amp Draw (A)
61E01	4" integrated flange	LED	400 Lm	Male Pin	12	.6A
61E11	4" integrated flange	LED	400 Lm	Male Pin	24	.3A
61G91	4" integrated flange	LED	400 Lm	Hardwire	12	.6A
61H21	4" integrated flange	LED	400 Lm	Hardwire	24	.3A
61H51	4" integrated flange	LED	400 Lm	Hardwire w/2-Way Female	12	.6A
61E41	4" grommet mount	LED	400 Lm	Male Pin	12	.6A
61E51	4" grommet mount	LED	400 Lm	Male Pin	24	.3A
61H01	4" grommet mount	LED	400 Lm	Hardwire	12	.6A
61H11	4" grommet mount	LED	400 Lm	Hardwire	24	.3A
61E31	4" euro flange	LED	400 Lm	Male Pin	24	.3A
61H31	4" euro flange	LED	400 Lm	Hardwire	24	.3A
61H41	4" euro flange	LED	400 Lm	Hardwire	12	.6A
61171	4" surface mount w/ switch	LED	400 Lm	Hardwire	12	.6A

### Accessories

Part Number	Description	Fits
67013, 66842, 66846, 67016	Male Pin Pigtail	61E01, 61E11, 61E41, 61E51, 61E21, 61E31



# Interior Lighting

Lumières d'Intérieur Lámparas para Interior



## SURFACE MOUNT FLUORESCENT DOME LAMP

Ballast design prevents electromagnetic and radio frequency interference (EMI/RFI) • Shock tested per SAE requirements • Rigid anodized aluminum base • High efficiency / low power consumption/low heat • Internally fused • Locking bulb mounts • Operating temperatures +32°F to +185°F

**61371** White

Material: ABS  
Finish: Clear  
Bulb: Dual F15T8 CW  
Volts / Amps: 12V / 2.25A  
Accessory: Bulb: 92681  
Lens: Clear 92611

**LED**



## LED WHITELIGHT™ X-100 DOME LAMP

Built-in automatic thermal protection circuit • Surface mountable; versatile design means both wall or ceiling mountings are possible • Fast installation with 2 self-tapping screws and no holes to cut

**61121** White

**61131** White **24** Volts

Material: Polycarbonate  
Finish: Clear  
Volts / Amps: 61121: 12V / .6A  
Volts / Amps: 61131: 24V / .3A

**LED**



## S100 LED WHITELIGHT™ SURFACE MOUNT DOME LAMP

Low profile sleek design, less than 15.0mm height • Moisture proof construction allows for a wide variety of uses • Surface mount allows for quick and easy installation • 480 lumens of output • Operates at -40F to +122F • ECE R10, Dir. 72/ 245/ EEC, Amended by 2006/ 28/ EC

**61391** S100

**61401** S100 **24** Volts

**61411** S100 w/Motion Sensor

**61421** S100 w/Motion Sensor **24** Volts

Material: Polycarbonate  
Finish: White / Clear  
Volts / Amps: 12V / .7A (61391, 61411)  
Volts / Amps: 24V / .38A (61401, 61421)

## 4" ROUND FLANGE MOUNT LED DOME LAMP

Encapsulant potting for total circuit board protection • Hardwire terminations allow for easy connections to the existing wiring system • Chemical resistant acrylic lens, white powder coated housing • Operates at a wide temperature range: from -40°F to +122°F

- 61141 White
- 61021 White 

Material: Aluminum/Acrylic  
 Finish: Clear  
 Volts / Amps: 61141: 12V / .48A  
 Volts / Amps: 61021: 24V / .25A

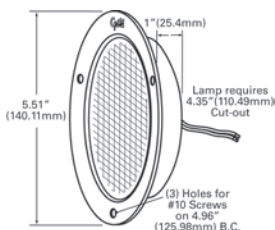

## 4" ROUND UTILITY LAMP

Cost-effective LED lighting option is rated at 50,000 hours • LEDs utilize lower amp draw, putting less load on strained electrical systems • Hardwired for easy integration into current wiring system • Pattern closely resembles a spot pattern

- 64971 Clear
- 63561 Clear, Rubber housing

Material: Polycarbonate/Rubber (63561)  
 Finish: Clear/Black (63561)  
 Volts / Amps: 12V / .6A; 282 Lumens  
 Brackets: 43572, 43253, 92510, 92512, 92513  
 Grommet: 91740, 91950  
 2 Wire: 67016

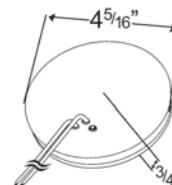

## TORSION MOUNT® II 4" ROUND DOME LAMP

Gel-Mount® bulb cradle design • O-ring seal pigtail design eliminates corrosion • Locking tabs ensure solid pigtail connection • Hermetic lens-to-housing seal

- 61451 Clear, Male Pin
- 61051 Clear, Female Pin

- KITS:**
- 61461 Clear (61451 + 91740 + 67013)
  - 61431 Clear (61051 + 91740 + 67010)

Material: Polycarbonate  
 Finish: Clear  
 Bulb: 15 CP  
 Volts / Amps: 12V / 1.04A  
 Bracket: 43572, 43253, 92510, 92512, 92513  
 Grommet: 91740, 91950  
 Pigtail: Male Pin: 67013, 66842, 66846, 67016;  
 Female Pin: 67010, 67011, 67020, 67015, 67014

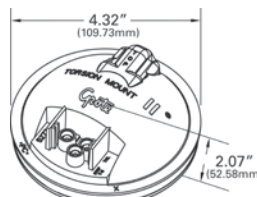

61051

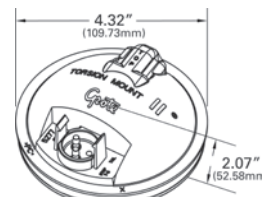

61451

# Interior Lighting

Lumières d'Intérieur Lámparas para Interior

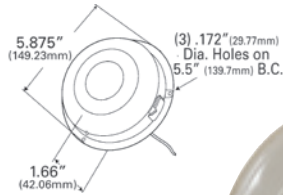

## ROUND DOME LAMP WITH SWITCH

Surface mount • Design resists corrosion and lens shattering due to heat build up • Low profile to protect against knock-off by load or personnel

**61161** White Base  
**61091** Chrome Base  
**61091-5** Chrome Base

RETAIL

Material: Polycarbonate  
 Finish: Clear  
 Bulb: 93, 15 CP  
 Volts / Amps: 12V / 1.04A  
 Pigtail: 68170  
 Lens: White 91101

## 6" SURFACE MOUNT DOME LAMP WITH SWITCH

Surface mount lamp • Perfect for use as a compartment lamp • Popular lamp for bus and RV applications • Separate ground wire • Not suitable for use in headliners or confined spaces

**61821** Clear

Material: Aluminum  
 Finish: Clear  
 Bulb: 1141, 21 CP  
 Volts / Amps: 12V / 1.44A

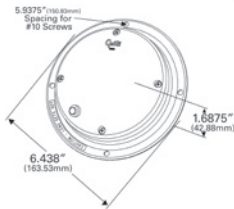

LED

## LED WHITELIGHT™ 7" ROUND DOME LAMP

High output white LED dome lamp • Encapsulant potting for total circuit board protection against moisture and corrosion • Designed to operate in extreme-cold temperatures down to -40° • Shallow recess requires only 1 1/4" depth for mounting pan • Self-resetting cut-off feature to protect against excess heat

**61811** Clear

**61061** Clear

24

Material: Powder Coated Steel/Acrylic  
 Finish: White/Clear  
 Volts / Amps: 61811 - 12V / 1.92A  
 Volts / Amps: 61061 - 24V / .75A  
 Accessory: Mounting Pan: 43744  
 Lens: Clear 93821

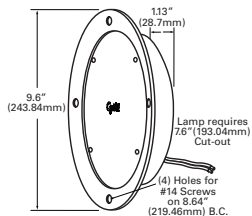

## 8" SURFACE MOUNT DOME LAMP

7" diameter lens • Surface mount lamp • Separate ground wire • Popular for use as a scare lamp on RVs • Not suitable for use in headliners or confined spaces

**61791** Clear, White Housing  
**61793** Clear, Stainless Steel Housing

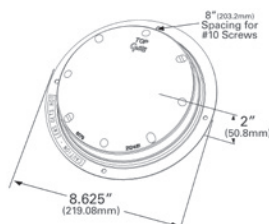

Material: Steel  
 Finish: Stainless/White/Clear Lens  
 Bulb: 1156, 32 CP  
 Volts / Amps: 12V / 2.1A  
 Lens: 93891



61793

## LED SLIMWHITE

High output 500 lumen LED dome lamp emits low heat • Tough polycarbonate lens • Sturdy aluminum base • Profile is less than 3/4" high • Rated at 50,000 service hours • 61G01 multi-function - all, 2- outside segments, 1 middle segment

18" LENGTH	
61E81	500 Lm, Frosted
61E91	500 Lm, Frosted 
61G81	700 Lm, Clear
61F01	500 Lm, Frosted, w/ Switch
61F11	500 Lm, Frosted, w/ Switch 



48" LENGTH	
61281	1500 Lm, Frosted
61G01	2100 Lm, Clear, Multi-Function

Material: Polycarbonate/ Aluminum  
 Finish: White  
 Volts / Amps: 18" 12V / .6A; 24V / .3A  
 Volts / Amps: 48" 12V / 1.2A



## LED SLIMLITE COURTESY LAMP

Lamp features a low profile of less than one inch • High efficiency lamp generates good light output; uses little power and generates minimal heat • Excellent option for cabinet lighting and other interior uses

60391	Clear, 24V	
60401	Clear, 24V w/switch	
60581	Clear	
60591	Clear, w/ Switch	

Material: Polycarbonate  
 Finish: Clear  
 Volts / Amps: 12V / .28A  
 Volts / Amps: 24V / .14-.18A

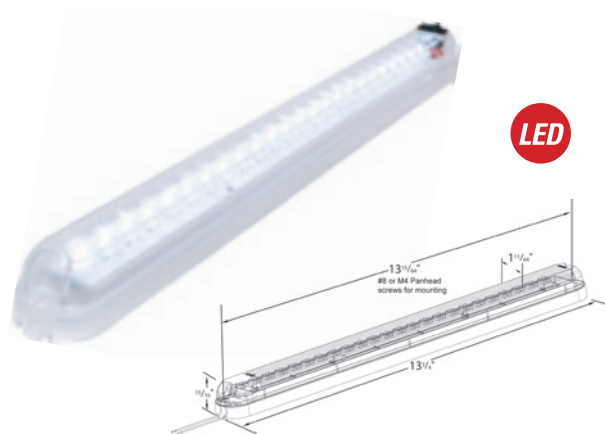

## LED CABINET/COMPARTMENT DOME LAMP

Self-resetting cut-off switch to protect against excess current • Designed to operate in extreme-cold temperatures down to -40° • Encapsulant potting for total circuit board protection against moisture and corrosion • Optic lens design focuses light downward/upward based on orientation

61F81	Clear
-------	-------

Material: Polycarbonate  
 FMVSS: SAE J575  
 Finish: Clear  
 Volts / Amps: 12V / .35A

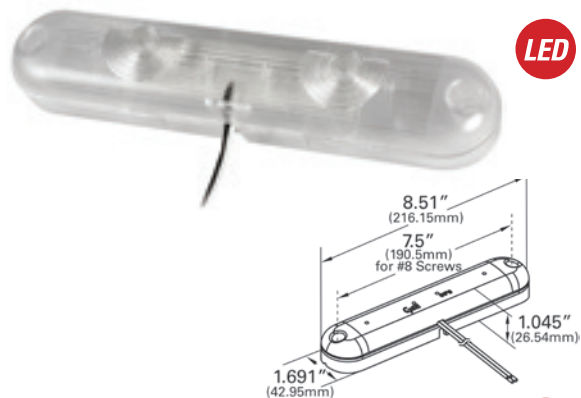

## OVAL LED WHITELIGHT™ DOME LAMP

Grote LEDs provide valuable light output with low amp draw • Cost-effective LED lighting option is rated at 50,000 hours

61G31	Clear, Male Pin
-------	-----------------

Material: ABS/Acrylic  
 FMVSS: SAE J2139  
 Finish: Clear  
 Volts / Amps: 12.8V / .6A  
 Bracket (requires grommet or flange): 43362, 43952  
 Flange: 43220, 43223, 43222, 43723, 42153  
 Grommet: 92420, 92720  
 Pigtail: 67013, 66842, 66846, 67016



# Interior Lighting

Lumières d'Intérieur Lámparas para Interior

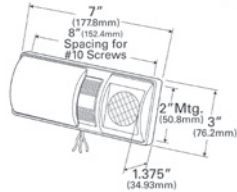

## EUROSTYLE MAP & DOME LAMP

3-way switch: map only, dome/map light, or off • Two options for wiring: either dome lights or not lights when door is open

**61301** Clear

Material: Nylon/Polycarbonate  
 Finish: Black  
 Bulb: Dome - 561, 12 C.P.  
 Volts / Amps: 12 V / .97A  
 Bulb: Map - 1816, 3 C.P.  
 Volts / Amps: 12V / .33A

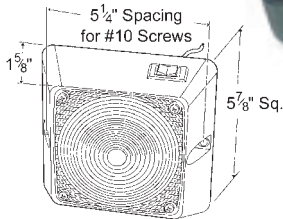

## SQUARE DOME LAMP WITH SWITCH

Three-position switch enables variable intensity: low-6 CP, high-21 CP, or off  
 • Surface mount • Large enough to cover most existing holes

**61221** Clear

Material: ABS/Polycarbonate  
 Finish: Clear  
 Bulb: 1016, 21/6 CP  
 Volts / Amps: 12V / 1.5A max  
 Lens: Clear 90481

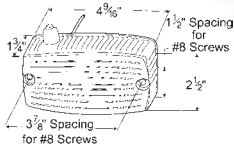

## DOMELAMP WITH SWITCH

Durable polycarbonate lens • Integrated on/off toggle switch • Raised lens for maximum light dispersion • Comes with ground wire

**61491-5** Clear **RETAIL**

Material: Steel/Polycarbonate  
 Finish: Clear  
 Bulb: 1156, 32 CP  
 Volts / Amps: 12V / 2.1A

**LED**

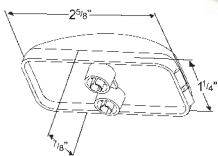

## SMALL RECTANGULAR LED UTILITY LAMP

Long-life LED light source makes this lamp the perfect choice for difficult-to-reach mounting locations • Uses same UBS pigtailed as incandescent for a quick Plug-and-Go® retrofit • Encapsulant potting for total circuit board protection • Hermetic lens-to-housing seal prevents lamp from fogging due to moisture

**60421** Clear

Material: Polycarbonate  
 Finish: Clear  
 Volts / Amps: 12V / .2A  
 Bracket: 43380, 43370, 43970, 43980  
 Pigtail: 66850, 67050, 67001, 66851, 66800, 66840  
 Grommet: 91380

## SMALL RECTANGULAR UTILITY LAMP

Sonically sealed lens • Single 15,000 hour bulb

**60271** Clear

Material: Polycarbonate  
 Finish: Clear  
 Bulb: 2 CP  
 Volts / Amps: 12V / .33A  
 Bracket: 43380, 43370, 43970, 43980  
 Pigtail: 66850, 67050, 67001, 66851, 66800, 66840  
 Grommet: 91380

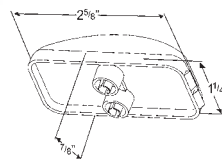

## RECTANGULAR LED UTILITY LAMP

Long-life LED light source makes this lamp the perfect choice for difficult-to-reach mounting locations • Uses same UBS pigtails as incandescent for a quick Plug-and-Go® retrofit • Encapsulant potting for total circuit board protection from corrosion • Hermetic lens-to-housing seal

**60411** Clear

Material: Polycarbonate  
 Finish: Clear  
 Volts / Amps: 12V / .2A  
 Bracket: 43780, 43783, 43390, 43790, 43850  
 Pigtail: 66982, 66980, 66981

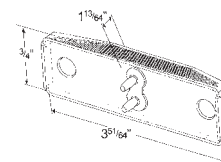

## RECTANGULAR UTILITY LAMP

Sonically sealed, rectangular double-bulb lamp • Designed for narrow mounting applications • 15,000 hour bulbs

**60301** Clear

Material: Polycarbonate  
 Finish: Clear  
 Bulb: 2 CP  
 Volts / Amps: 12V - .66A  
 Bracket: 43390, 43780, 43790, 43850, 43783  
 Pigtail: 66981, 66982

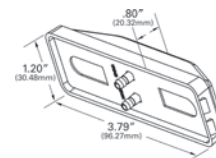

## 2" LED INTERIOR COURTESY LAMP

Bright, single LED provides ample light for tool boxes, cabinets, and other hard to light areas • Encapsulant potting for total circuit board protection against vibration and corrosion

**60561** White

Material: Polycarbonate  
 Finish: Clear  
 Volts / Amps: 14V / .2A  
 Bracket: 42190, 43690, 43150, 43152, 43153, 43532  
 Grommet: 92120, 92150, 94100  
 Pigtail: 66851, 66850, 66840, 67001, 67050, 66801

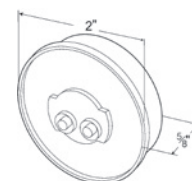

# Interior Lighting

Lumières d'Intérieur Lámparas para Interior

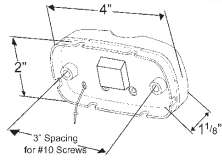

## TWO-BULB SQUARE CORNER UTILITY LAMP

Ideal courtesy or dome lamp • Attached pigtail with two stainless steel grounds

**46791** Clear

Material: Polypropylene/Polycarbonate  
 Finish: Clear  
 Bulb: 1893 (2), 2 CP  
 Volts / Amps: 12V / .66A  
 Pigtail: 67120  
 Lens: 91961

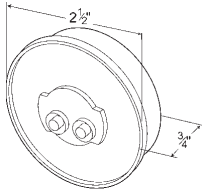

## 2 1/2" ROUND UTILITY LAMP

Ideal for utility, courtesy or dome applications • Hermetic lens-to-housing seal • 15,000 hour bulb • Twist-on mounting

**45811** Clear

Material: Polycarbonate  
 Finish: Clear  
 Bulb: 2 CP  
 Volts / Amps: 12V / .33A  
 Bracket: 43690, 43160, 43163, 43512, 43522  
 Grommet: 91880, 91890, 91400, 91410, 92070  
 Pigtail: 66851, 66850, 67001, 67050, 66801, 66800, 66840

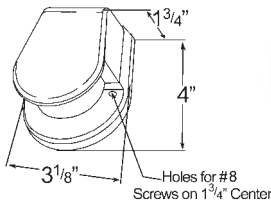

## STEPWELL UTILITY LAMP

Rugged, heavy-duty design • Brilliant chrome finish • Easy to install • Includes foam mounting pad

**60351** Clear

Material: Die-cast/Polycarbonate  
 FMVSS: L  
 Finish: Chrome  
 Bulb: 906, 6 CP  
 Volts / Amps: 12V / .7A

LED

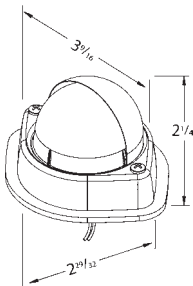

## LED COURTESY STEPWELL LAMP

Electronics completely encapsulated with durable epoxy for maximum environmental protection • Same mounting as popular incandescent versions • Connections can be easily adjusted for typical installations • Designed to integration into existing bus electronic platforms • ADA compliant (LED)

**60571** White

Material: Stainless Steel/Polycarbonate  
 Finish: Stainless  
 Volts / Amps: 14V / .3A  
 Lens: 93201

## COURTESY STEP LAMP

Bright, polished stainless steel construction • High heat and impact resistant lens • Adjustable hood for directional lighting • Bulb replaceable • Mounting pad and screws included

**60361** Clear

Material: Stainless Steel/Polycarbonate  
 Finish: Stainless  
 Bulb: 1142, 21 CP  
 Volts / Amps: 12V / 1.34A

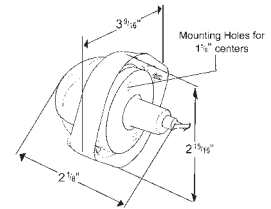

## MICRONOVA® DOT LED COURTESY STEPWELL LAMP

Durable one-piece LED lamp design • Hardwire with .180 slim-line UBS plug connections for maximum performance

**60721** Lamp with Hooded Grommet

Material: Polycarbonate/PVC  
 FMVSS: L  
 Finish: Clear/Black  
 Volts / Amps: 9-32V / .03A  
 Grommets: 94360

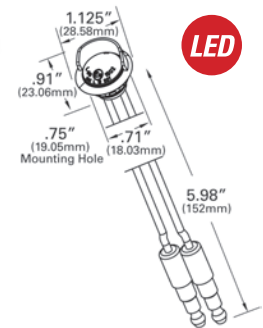

## HI COUNT® LED COURTESY LAMP

Mounts using two #6 screws • Longer life than incandescent; uses LED technology to reduce maintenance costs

**G6261** Chrome Plated Steel

Material: Chrome Plated Steel  
 Finish: Chrome  
 Volts / Amps: 12V / .02A

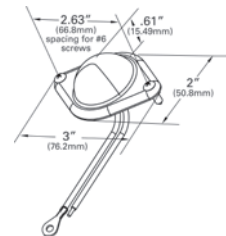

## COURTESY LAMP

Chrome plated steel housing • Single-bulb unit similar to lamps on Chevrolet®/GM® vehicles

**60251** Clear  
**60251-5** Clear **RETAIL**

Material: Steel  
 Finish: Chrome  
 Bulb: 67, 4 CP  
 Volts / Amps: 12V / .59A

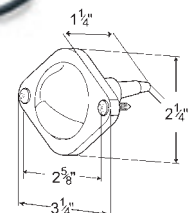



# Interior Lighting

Lumières d'Intérieur Lámparas para Interior

**LED**

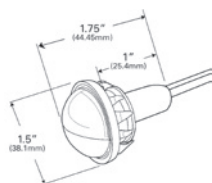

## LED COMPACT COURTESY LAMP

Fits 1 1/4" hole in panels from 1/16" to 1/8" thick • Rubber-sealed spring and pigtail assembly • Translucent white plastic lens with chrome shade

**G6121** Clear

Material: Steel  
Finish: Chrome  
Volts / Amps: 12V / .02A

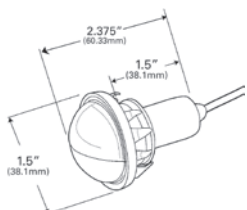

## COMPACT COURTESY LAMP

Fits 1 1/4" hole in panels from 1/16" to 1/8" thick • Rubber-sealed spring and pigtail assembly • Translucent white plastic lens with chrome shade

**60101** Clear

**60101-5** Clear **RETAIL**

Material: Steel  
Finish: Chrome  
Bulb: 67, 4 CP  
Volts / Amps: 12V / .59A  
Accessory: Socket Wire: 84-1003

**LED**

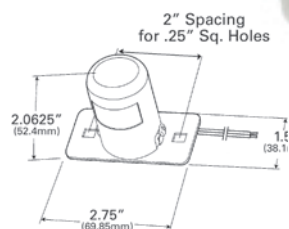

## LED COURTESY LAMP

Illuminates instrument panel and compartments • Clear plastic lens

**G6131** Clear

Material: Steel  
Finish: Chrome  
Volts / Amps: 12V / .002A

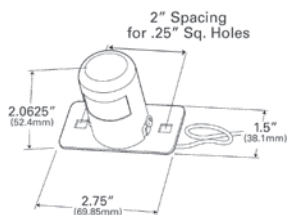

## ECONOMY COURTESY LAMP

Illuminates instrument panel and compartments • Clear plastic lens

**60151** Clear

**60151-5** Clear **RETAIL**

Material: Steel  
Finish: Polished Chrome  
Bulb: 67, 4 CP  
Volts / Amps: 12V / .59A  
Pigtail: 68080

**LED**

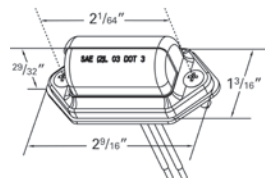

## HI COUNT® INTERIOR/UTILITY LAMP

LED offering provides maximum lighting output in tight spaces • Low power consumption and heat production • Hooded guard to reduce glare

**G6151** Clear

Material: Steel/Polycarbonate  
Finish: Chrome  
Volts / Amps: 12V / .025A

## INTERIOR/UTILITY LAMP

Chrome plated housing • Hooded guard to reduce glare • Separate ground wire

**61501** Clear  
**61501-5** Clear **RETAIL**

Material: Brass/Polycarbonate  
 Finish: Chrome  
 Bulb: 194, 2 CP  
 Volts / Amps: 12V / .27A

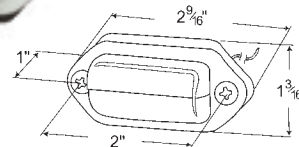

## LED ROPE LIGHTING

Flexible rope lighting is perfect for compartments and tool boxes  
 • 50' roll comes with 10 wire connectors, 50 mounting clips and 10 end caps  
 • 1/2" diameter rope • LEDs spaced 1 per inch

**60481** White

### ACCESSORIES:

**93780** 10 Power Wires & End Caps

Finish: Clear  
 Volts / Amps: 12V / .07A per foot



**LED**

## BEEHIVE LAMP WITH FIXED ANGLE MOUNTING BRACKET

Maximum light diffusion • Fade-proof acrylic lens

**45021-5** Clear **RETAIL**

Material: ABS/Acrylic  
 Finish: Clear  
 Bulb: 67, 4 CP  
 Volts / Amps: 12V / .59A

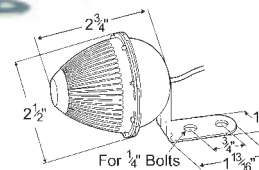

## AUTOMATIC ELECTRONIC DOME LIGHT SWITCH WITH TIMER

Reduces the overall number of components of an interior lighting system  
 • Eliminates tapping into the air brake delivery system • Automatic shut-down of circuit for no-fuss on/off • Allows for multiple, simple ground-sensing switches while maintaining the integrity of the interior lighting system • Timer is factory pre-set for 40 minutes on-time and can be manually shut off or automatically when the vehicle experiences forward/backward acceleration • Operates at -40C to +85C • Four wire design • Designed to replace Grote part number 44360

**44440** Dome Lamp Switch

Material: Nylon/ G.F., UL94HB/ Polycarbonate  
 FMVSS: SAE J1455, J2139, IP65  
 Finish: Gray  
 Volts / Amps: 9-16 Volt Range / 15A max load

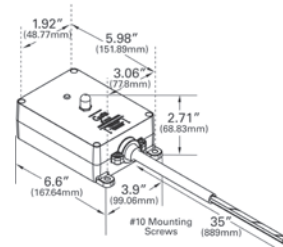

# Interior Lighting

Lumières d'Intérieur Lámparas para Interior

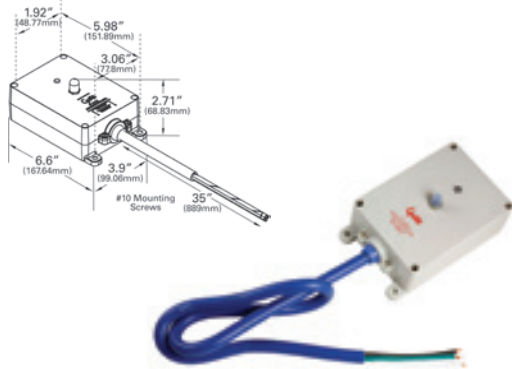

## ELECTRONIC DOME LAMP SWITCH

Solid-state electronic circuitry • Impact resistant PVC construction  
 • Sealed trigger switch • High current-switching capacity of 30 amps, not to exceed 15 operating amps • Wide voltage range: 9 to 16 volts  
 • Three-wire design • Designed to replace Grote part number 44240

**44910** Full Feature, Surface Mount

Material: PVC  
 FMVSS: IP65  
 Finish: Gray  
 Volts / Amps: 9-14V / .9A max  
 Accessory: automotive style 15A fuse

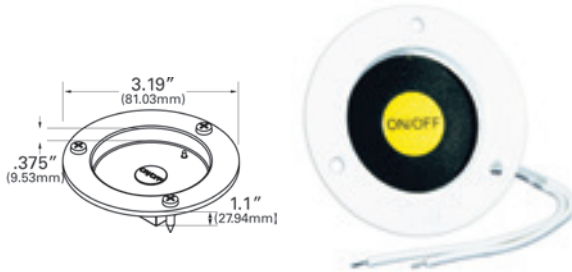

## RECESSED MOMENTARY GROUND SWITCH

Simple switch to reset the timer function of standard "outside-the-trailer" switches • Recessed into the trailer wall to eliminate bumps and knock-offs  
 • Easy to integrate into the current system • For use with 44360, 44440 and 44190 switches

**44380** Switch

Material: ABS  
 FMVSS: SAE J575e 1970  
 Finish: White  
 Volts / Amps: .02V - 30V (D.C)

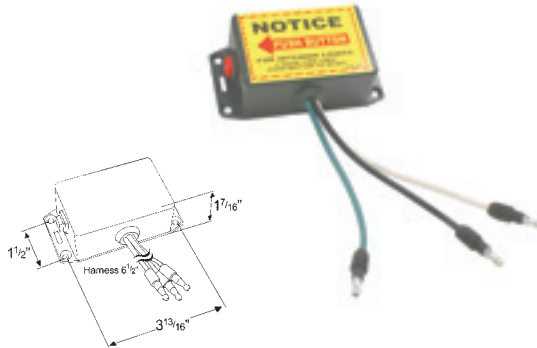

## ECONOMY FULL-FEATURE TIMER SWITCH

Solid-state, low profile design • Two-hour timer • Fully potted for protection against moisture • 5-Amp, field-replaceable blade fuse

**44242** Switch

Material: Polycarbonate  
 Finish: Gray  
 Volts: 10-14V

## GROTE LED RADIUS LIGHT



### FEATURES & BENEFITS

- Tough, durable and lightweight cast aluminum housing.
- Six-200 lumen LEDs that produce daylight-like visibility in a broad area
- TIR Lens for efficiently distributed lighting
- Bi-Voltage System for 12 volt and 24 volt sytems
- Vibration, dust, corrosion and moisture resitant
- Overvoltage protection to prevent voltage spike damage
- Spacer designed for extended installation and housing of wired

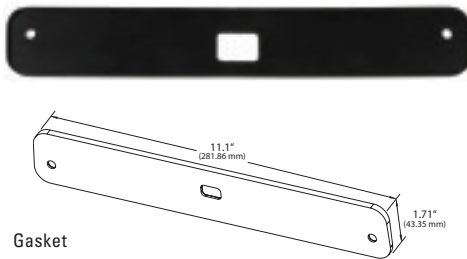
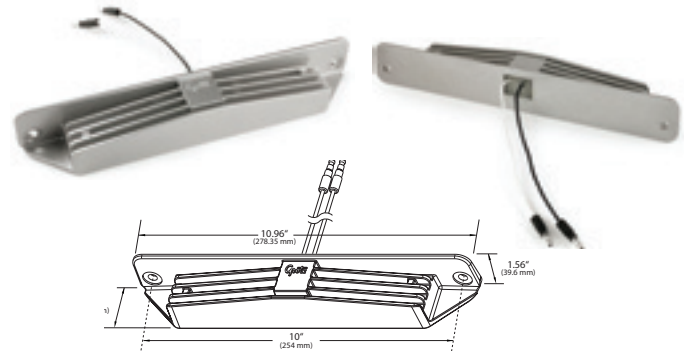

Gasket



Spacer/Wire Guide

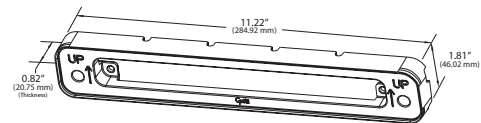

Part Number	Product Description	Voltage (V)	Amperage (A)
64M11-5 <b>NEW</b>	Grote Entrance Lamp Assembly Spacer/Wire Guide/ Gasket	12/24	1.5@12V/.75@24V

Materials	Ratings and Compliances	Ingress Protection	Electronic Characteristics
Optics Lens Optics: Total Internal Reflection	Light Engine: LED Lumens: 1200 Instant On	IP69K	12/24 Volts, 1.5/0.75 Amps 18 Watts, Overvoltage

Materials	Ratings and Compliances	Ingress Protection
Polycarbonate Lens Cast Aluminum Housing Weight: 16 oz.	FMVSS 108 14.5.1. (Vibration) FMVSS 108 14.5.3. (Dust) FMVSS 108 14.5.4. (Corrosion) SAE 2139 4.2.2 (Submersion) SAE J1455 4.2 (Humidity/Temperature)	IP69K

## GROTE LED KING PIN LIGHT



Grote's King Pin Lamp helps increase driver safety by illuminating the king pin / 5th wheel area.

### FEATURES & BENEFITS

- Aids in visual verification of engagement (CSA inspection requirement)
- Retro-fits to most tractor frames easily (.125" to .25")
- Places light to aid locking the 5th wheel via the tractor King Pin
- Helps prevent "high hitches" and dropped trailers
- A permanent solution
- Designed to work on Converter Dollies and trucks
- Swivel bracket allows lamp to be "aimed" and then locked into place

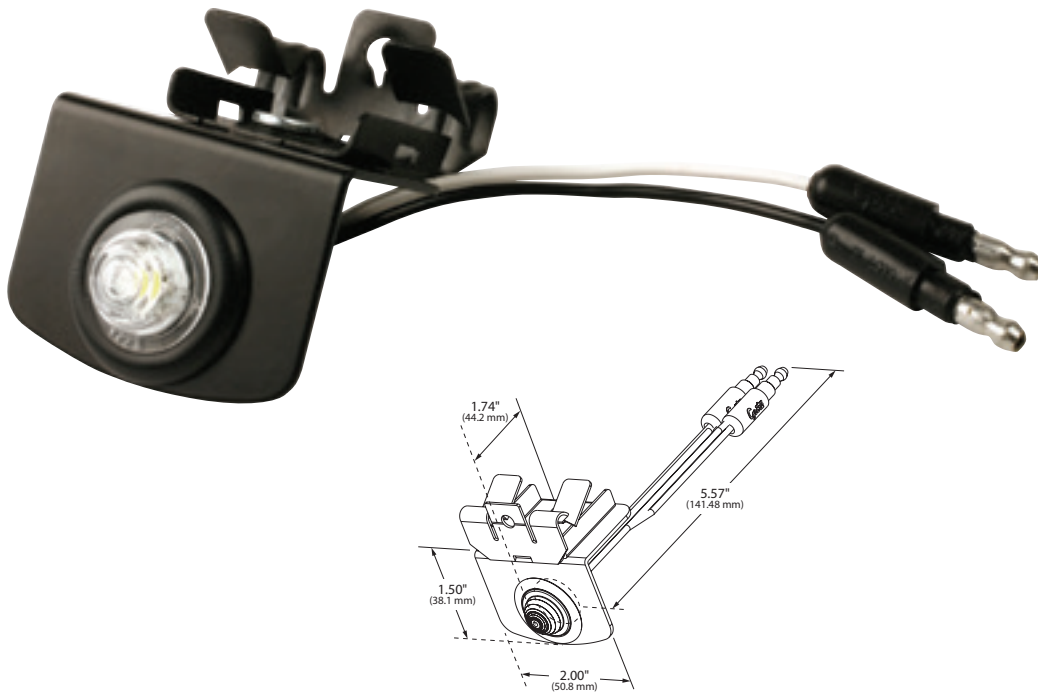

Part Number	Product Description	Quantity
60841	Grote King Pin Light Kit (Aftermarket)	12 Per Box
60841-3	Grote King Pin Light Kit (Bulk)	25 Per Box

Materials	Light Engine	Electronic Characteristics
Lamp: Acrylic/PVC Bracket: Powdered Coated Steel	LED	Voltage/Amp 12 V/0.5A Negative Transient Protection

## TRILLIANT® CUBE LED WORK LAMP TIER 1 OUTPUT



### FEATURES & BENEFITS

- Compact 4" x 4" lamps available in 1200 lumen model
- Highest quality electronic components and advanced Grote circuit design provides electronically quiet operation. This ensures long life, consistent light output, and protection from voltage spikes and electromagnetic interference
- All-weather design means consistent, reliable light for the task duration regardless of conditions
- Rugged SAE J575E-compliant construction protects against vibration, corrosion, moisture, and dust
- Sophisticated reflector optics waste less light, focuses more light on task



63991



63E23

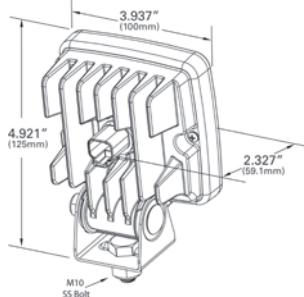

63981

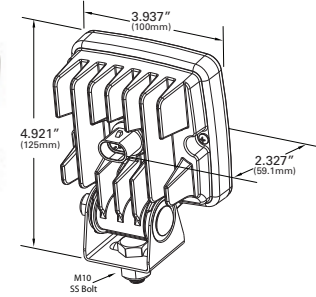

Part Number	Light Pattern	Connection Type	Product Description	Light Output (Usable Lumens)	Wattage (W)	Voltage (V)	Amperage (A)
63981		Flood	Hard Shell SuperSeal 4 x 4 work lamp w/pigtail	1200	17	12/24	1.4/.7
63981-5		Flood	Hard Shell SuperSeal 4 x 4 work lamp w/pigtail	1200	17	12/24	1.4/.7
63991		Wide Flood	Hard Shell SuperSeal 4 x 4 work lamp w/pigtail	1200	17	12/24	1.4/.7
63991-5		Wide Flood	Hard Shell SuperSeal 4 x 4 work lamp w/pigtail	1200	17	12/24	1.4/.7
63E01		Flood	Hard Shell Type C 4 x 4 work lamp, no pigtail, Europe only	1200	17	12/24	1.4/.7
63E11		Wide Flood	Hard Shell Type C 4 x 4 work lamp, no pigtail, Europe only	1200	17	12/24	1.4/.7
63E21		Flood	Deutsch 4 x 4 work lamp no pigtail	1200	17	12/24	1.4/.7
63E31		Wide Flood	Deutsch 4 x 4 work lamp no pigtail	1200	17	12/24	1.4/.7
63H31		Flood	Deutsch 4 x 4 work lamp no pigtail	1200	17	48	0.35
63E23		Flood	Deutsch 4 x 4 work lamp, Amber lens	1200	17	12/24	1.4/.7

All figures listed are based on nominal voltage

### Accessories

Part Number	Description	Fits
68580	Hard Shell SuperSeal Pigtail Blunt Cut	All Hard Shell SuperSeal lamps
68610	Deutsch Pigtail Blunt Cut	All Deutsch lamps
98111	Hard Shell Type C connector, Europe only	63E01 and 63E11

Materials	Certifications	Ingress Protection
Powder Coated Cast Aluminum Housing/CRS, Zinc Plated Bracket/ Polycarbonate Lens	ECE R10, Dir. 72/245/EEC, Amended by 2006/28/EC 	IP69K



## TRILLIANT® CUBE LED WORK LAMP TIER 2 OUTPUT

### FEATURES & BENEFITS

- Compact 4" x 4" lamps available in 2500 lumen model and 2800 lumen model
- Highest quality electronic components and advanced Grote circuit design provides electronically quiet operation. This ensures long life, consistent light output, and protection from voltage spikes and electromagnetic interference
- All-weather design means consistent, reliable light for the task duration regardless of conditions
- Rugged SAE J575E-compliant construction protects against vibration, corrosion, moisture, and dust
- Sophisticated reflector optics waste less light, focuses more light on task



63F61



63F71

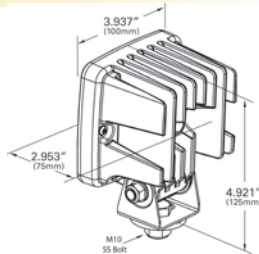

Part Number	Light Pattern	Connection Type	Product Description	Light Output (Usable Lumens)	Wattage (W)	Voltage (V)	Amperage (A)
63E81	<span style="color: blue;">ECE</span> <span style="color: orange;">IND</span>	Hard Shell Type C	4 x 4 work lamp, no pigtail, Europe only	2500	36	12	3
63E91	<span style="color: blue;">ECE</span> <span style="color: orange;">IND</span>	Hard Shell Type C	4 x 4 work lamp, no pigtail, Europe only	2500	36	12	3
63F01	<span style="color: blue;">ECE</span> <span style="color: orange;">IND</span>	Hard Shell Type C	4 x 4 work lamp, no pigtail, Europe only	2500	36	12	3
63F11	<span style="color: blue;">ECE</span> <span style="color: orange;">IND</span>	Hard Shell Type C	4 x 4 work lamp, no pigtail, Europe only	2500	36	24	1.5
63F21	<span style="color: blue;">ECE</span> <span style="color: orange;">IND</span>	Deutsch	4 x 4 work lamp, no pigtail	2500	36	12	3
63F31	<span style="color: blue;">ECE</span> <span style="color: orange;">IND</span>	Deutsch	4 x 4 work lamp, no pigtail	2500	36	24	1.5
63F41	<span style="color: blue;">ECE</span> <span style="color: orange;">IND</span>	Deutsch	4 x 4 work lamp no pigtail	2500	36	12	3
63F51	<span style="color: blue;">ECE</span> <span style="color: orange;">IND</span>	Deutsch	4 x 4 work lamp no pigtail	2500	36	24	1.5
63F61	<span style="color: blue;">ECE</span> <span style="color: orange;">IND</span>	Hard Shell SuperSeal	4 x 4 work lamp	2500	36	12	3
63F71	<span style="color: blue;">ECE</span> <span style="color: orange;">IND</span>	Hard Shell SuperSeal	4 x 4 work lamp	2500	36	12	3
63L31	<span style="color: blue;">ECE</span> <span style="color: orange;">IND</span> <span style="color: green;">NEW</span>	Hard Shell Type C	4 x 4 work lamp, no pigtail, Europe only	2800	45	12/24	3.4/1.7
63L41	<span style="color: blue;">ECE</span> <span style="color: orange;">IND</span> <span style="color: green;">NEW</span>	Hard Shell Type C	4 x 4 work lamp, no pigtail, Europe only	2800	45	12/24	3.4/1.7
63L51	<span style="color: blue;">ECE</span> <span style="color: orange;">IND</span> <span style="color: green;">NEW</span>	Deutsch	4 x 4 work lamp no pigtail	2800	45	12/24	3.4/1.7
63L61	<span style="color: blue;">ECE</span> <span style="color: orange;">IND</span> <span style="color: green;">NEW</span>	Deutsch	4 x 4 work lamp no pigtail	2800	45	12/24	3.4/1.7
63L71	<span style="color: blue;">ECE</span> <span style="color: orange;">IND</span> <span style="color: green;">NEW</span>	Hard Shell SuperSeal	4 x 4 work lamp	2800	45	12/24	3.4/1.7
63L81	<span style="color: blue;">ECE</span> <span style="color: orange;">IND</span> <span style="color: green;">NEW</span>	Hard Shell SuperSeal	4 x 4 work lamp	2800	45	12/24	3.4/1.7

All figures listed are based on nominal voltage

### Accessories

Part Number	Description	Fits	Materials	Certifications	Ingress Protection
98111	Hard Shell Type C connector, Europe only	63E81, 63E91, 63F01, 63F11	Powder Coated Cast Aluminum Housing/CRS, Zinc Plated Bracket/ Polycarbonate Lens	ECE R10, Dir. 72/245/EEC, Amended by 2006/28/EC	IP69K
68580	Hard Shell SuperSeal, Blunt Cut	All Hard Shell SuperSeal lamps		CE	

## TRILLIANT® OVAL LED TIER 1 WORK LAMPS



### FEATURES & BENEFITS

- Highest quality electronic components and advanced Grote circuit design provides electronically quiet operation. This ensures long life, consistent light output, and protection from voltage spikes and electromagnetic interference
- All-weather design means consistent, reliable light for the task duration regardless of conditions
- Rugged SAE J575E-compliant construction protects against vibration, corrosion, moisture, and dust
- Two beam patterns to choose from (Flood and Wide Flood). Sophisticated reflector optics waste less light, focuses more light on task



1200 Lumen Flood

63F81



63F91

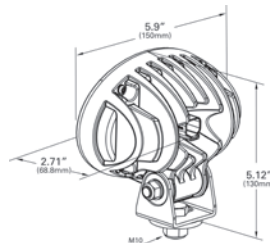

Deutsch

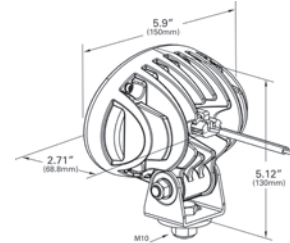

Hard Shell SuperSeal

Part Number	Light Pattern	Connection Type	Product Description	Light Output (Usable Lumens)	Wattage (W)	Voltage (V)	Amperage (A)
63F81	Flood	Hard Shell SuperSeal	Oval work lamp w/pigtail	1200	24	12/24	2/1
63F81-5	Flood	Hard Shell SuperSeal	Oval work lamp w/pigtail	1200	24	12/24	2/1
63F91	Wide Flood	Hard Shell SuperSeal	Oval work lamp w/pigtail	1200	24	12/24	2/1
63G01	Flood	Deutsch	Oval work lamp	1200	24	12/24	2/1
63G11	Wide Flood	Deutsch	Oval work lamp	1200	24	12/24	2/1
63G21	Flood	Hard Shell Type C	Oval work lamp, Europe only	1200	24	12/24	2/1
63G31	Wide Flood	Hard Shell Type C	Oval work lamp, Europe only	1200	24	12/24	2/1

All figures listed are based on nominal voltage

### Accessories

Part Number	Description	Fits	Materials	Certifications	Ingress Protection
68580	Hard Shell SuperSeal Pigtail Blunt Cut	All Hard Shell SuperSeal Lamps	Powder Coated Cast Aluminum Housing/CRS, Zinc Plated Bracket/ Polycarbonate Lens	ECE R10, Dir. 72/245/EEC, Amended by 2006/28/EC 	IP69K
68610	Deutsch Pigtail Blunt Cut	All Deutsch Lamps			
98111	Hard Shell Type C Pigtail, Europe only	63G21 and 63G31			



## TRILLIANT® OVAL LED TIER 2 WORK LAMPS



### FEATURES & BENEFITS

- Highest quality electronic components and advanced Grote circuit design provides electronically quiet operation. This ensures long life, consistent light output, and protection from voltage spikes and electromagnetic interference
- All-weather design means consistent, reliable light for the task duration regardless of conditions
- Rugged SAE J575E-compliant construction protects against vibration, corrosion, moisture, and dust
- Two beam patterns to choose from (Flood and Wide Flood). Sophisticated reflector optics waste less light, focuses more light on task



2500  
Lumen  
Wide Flood

63J11



63J01

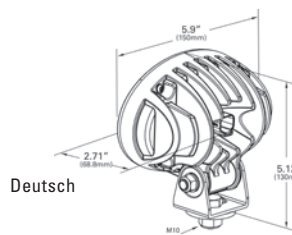

Deutsch

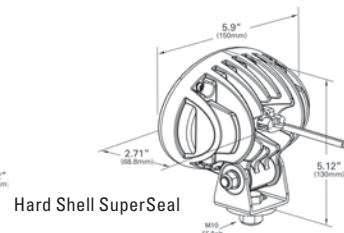

Hard Shell SuperSeal

Part Number	Light Pattern	Connection Type	Product Description	Light Output (Usable Lumens)	Wattage (W)	Voltage (V)	Amperage (A)
63J01	Flood	Hard Shell SuperSeal	High output oval work lamp, w/pigtail	2500	36	12/24	3/1.5
63J11	Wide Flood	Hard Shell SuperSeal	High output oval work lamp, w/pigtail	2500	36	12/24	3/1.5
63J21	Flood	Deutsch	High output oval work lamp	2500	36	12/24	3/1.5
63J31	Wide Flood	Deutsch	High output oval work lamp	2500	36	12/24	3/1.5
63G81	Flood	Hard Shell Type C	High output oval work lamp, Europe only	2500	36	12/24	3/1.5
63G91	Wide Flood	Hard Shell Type C	High output oval work lamp, Europe only	2500	36	12/24	3/1.5

All figures listed are based on nominal voltage

### Accessories

Part Number	Description	Fits	Materials	Certifications	Ingress Protection
68580	Hard Shell SuperSeal Pigtail Blunt Cut	All Hard Shell SuperSeal Lamps	Powder Coated Cast Aluminum	ECE R10, Dir. 72/245/EEC, Amended by 2006/28/EC	IP69K
68610	Deutsch Pigtail Blunt Cut	All Deutsch Lamps	Housing/CRS, Zinc Plate Bracket/ Polycarbonate Lens		
98111	Hard Shell Type C Pigtail, Europe only	63G81 and 63G91			

## TRILLIANT® MINI LED WORK LAMPS



### FEATURES & BENEFITS

- LEDs are rated for 50,000-hour for long-lasting service
- Polycarbonate hard coated lens provides many years of service
- 3X5 size makes this lamp a natural LED upgrade for many incandescent and halogen sealed beams



63602

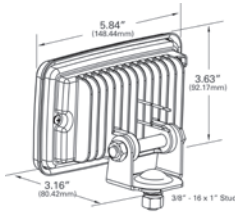

In Per-lux® Housing

63651

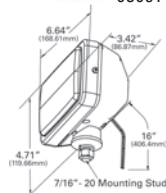

63610

Flush Mount Version

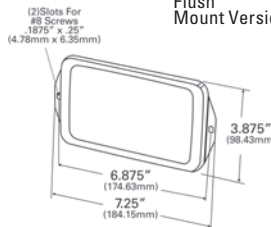

Part Number	Light Pattern	Connection Type	Product Description	Light Output (Usable Lumens)	Wattage (W)	Voltage (V)	Amperage (A)	
63601		Spot	Hardwire	3 x 5 work lamp	700	17	12	1.4
63601-5		Spot	Hardwire	3 x 5 work lamp	700	17	12	1.4
63602		Spot	Hardwire	3 x 5 work lamp featuring red LEDs	135	10	12	0.8
63731		Spot	Hardwire	3 x 5 work lamp	700	17	24	0.7
63610		Flood	Hardwire	3 x 5 flush mount work lamp	700	17	12	1.4
63611		Flood	Hardwire	3 x 5 work lamp	700	17	12	1.4
63611-5		Flood	Hardwire	3 x 5 work lamp	700	17	12	1.4
63651		Flood	Hardwire	3 x 5 work lamp in Per-Lux® housing	700	17	12	1.4
63741		Flood	Hardwire	3 x 5 work lamp	700	17	24	0.7
63621		Trapezoid	Hardwire	3 x 5 work lamp	700	17	12	1.4
63621-5		Trapezoid	Hardwire	3 x 5 work lamp	700	17	12	1.4
63661		Trapezoid	Hardwire	3 x 5 work lamp in Per-Lux® housing	700	17	12	1.4
63751		Trapezoid	Hardwire	3 x 5 work lamp	700	17	24	0.7

All figures listed are based on nominal voltage

### Accessories

Part Number	Description	Fits
94690	Flush mount bracket and gasket	All Trilliant® Mini lamps to convert to Flush Mount

Materials	Certifications	Ingress Protection
Powder Coated Die-Cast Aluminium Housing/ Polycarbonate Lens Stainless Steel Hardware	ECE R10, Dir. 72/245/EEC, Amended by 2006/28/EC	IP69K

## TRILLIANT® LED WORK LAMPS



### FEATURES & BENEFITS

- Long-lasting, high output LED work lamp
- Field tested in brutal off-road conditions
- Easily mountable with a durable 1/2" stud mounting bracket, also features Aim-N-Go technology

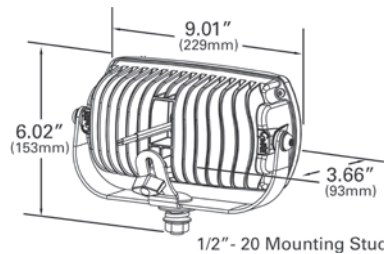

63E41

63571  
Lens Optics Version

Part Number	Light Pattern	Housing Color	Product Description	Optic Design	Light Output (Usable Lumens)	Wattage (W)	Voltage (V)	Current (A)
63571 <a href="#">ECE</a>	Spot	Black	Beam pattern can be changed via lens	Lens	1300	50	12/24	4.2/2.1
63671 <a href="#">ECE</a>	Spot	Black	Beam pattern can be changed via lens	Lens	1300	50	24	2.1
63901 <a href="#">ECE</a>	Spot	White	Beam pattern can be changed via lens	Lens	1300	50	12/24	4.2/2.1
63581 <a href="#">ECE</a>	Flood	Black	Beam pattern can be changed via lens	Lens	1600	50	12/24	4.2/2.1
63681 <a href="#">ECE</a>	Flood	Black	Beam pattern can be changed via lens	Lens	1600	50	24	2.1
63E41 <a href="#">ECE</a>	Flood	Black	Lens repairable	Reflector	2400	50	12/24	4.2/2.1
63E61 <a href="#">ECE</a>	Flood	Black	Lens repairable	Reflector	2400	50	24	4.2/2.1
63761 <a href="#">ECE</a>	Wide Flood	Black	Lens repairable	Lens	1500	50	12/24	4.2/2.1
63771 <a href="#">ECE</a>	Wide Flood	Black	Lens repairable	Lens	1500	50	24	2.1
63E51 <a href="#">ECE</a>	Wide Flood	Black	Lens repairable	Reflector	2200	50	12/24	4.2/2.1
63E71 <a href="#">ECE</a>	Wide Flood	Black	Lens repairable	Reflector	2200	50	24	2.1
63591 <a href="#">ECE</a>	Trapezoid	Black	Beam pattern can be changed via lens	Lens	1600	50	12/24	4.2/2.1
63691 <a href="#">ECE</a>	Trapezoid	Black	Beam pattern can be changed via lens	Lens	1600	50	24	2.1

All figures listed are based on nominal voltage

### Accessories

Part Number	Description	Fits
94580	Spot Lens	63571; 63671; 63881; 63901
94590	Trapezoid Lens	63591; 63691
94600	Flood Lens	63581; 63681
43651	White Bracket	All Trilliant® Lamps
43652	Black Bracket	All Trilliant® Lamps

Materials	Certifications	Ingress Protection
Housing: Powder Coated Aluminum Bracket: CRS, Black Zinc Plated Lens: Polycarbonate	ECE R10, Dir. 72/245/EEC, Amended by 2006/28/EC	IP69K

## T26 LED WORK LAMP



### FEATURES & BENEFITS

- Efficient light engine projects 1790 effective Lumens using only 18 Watts of power across 10-48 Volts.
- Rugged mechanical design ensures consistent performance and long life in the harshest environments.
- Small size combined with tough construction allows mounting in places where larger or less rugged lamps cannot fit or survive.
- Advanced circuit design provides electronically quiet operation; protects against EMI without interfering with other electronic devices.
- Clean, white light designed to represent true colors, just like day light.



64G01

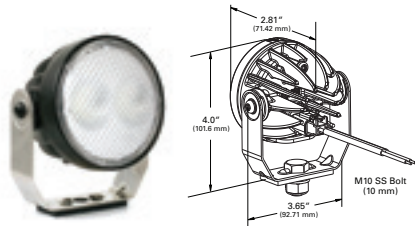

64E11 - Pinch Mount

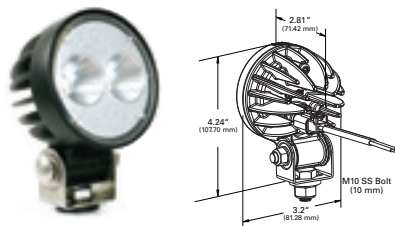

64G11 - Pendant Mount

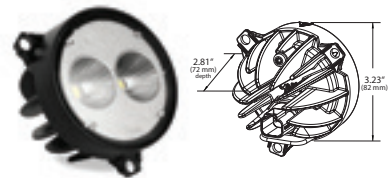

64F01 - Flush Mount

Part Number	Light Pattern	Connection Type	Product Description	Light Output (Usable Lumens)	Wattage (W)	Voltage (V)	Amperage (A)
64E01	<span>ECE</span> <span>IND</span> <span>NEW</span>	Deutsch	Pinch Mount	1800	18	10-48	1.75-.36
64E01-5	<span>ECE</span> <span>RETAIL</span> <span>NEW</span>	Deutsch	Pinch Mount	1800	18	10-48	1.75-.36
64E11	<span>ECE</span> <span>IND</span> <span>NEW</span>	Deutsch	Pinch Mount	1800	18	10-48	1.75-.36
64E11-5	<span>ECE</span> <span>RETAIL</span> <span>NEW</span>	Deutsch	Pinch Mount	1800	18	10-48	1.75-.36
64F01	<span>ECE</span> <span>IND</span> <span>NEW</span>	Deutsch	Flush Mount	1800	18	10-48	1.75-.36
64F11	<span>ECE</span> <span>IND</span> <span>NEW</span>	Deutsch	Flush Mount	1800	18	10-48	1.75-.36
64G01	<span>ECE</span> <span>IND</span> <span>NEW</span>	Deutsch	Pendant Mount	1800	18	10-48	1.75-.36
64G01-5	<span>ECE</span> <span>RETAIL</span> <span>NEW</span>	Deutsch	Pendant Mount	1800	18	10-48	1.75-.36
64G11	<span>ECE</span> <span>IND</span> <span>NEW</span>	Deutsch	Pendant Mount	1800	18	10-48	1.75-.36
64G11-5	<span>ECE</span> <span>RETAIL</span> <span>NEW</span>	Deutsch	Pendant Mount	1800	18	10-48	1.75-.36

All figures listed are based on nominal voltage

### Accessories

Part Number	Description
68610	Replacement Harness - Deutsch pigtail
01-9950-H1	Flush Mount Clips

Materials	Certifications	Ingress Protection
Material: Powder Coated Aluminum Housing Lens: Polycarbonate CRS, Zinc Plated Hardware	Certifications: SAE J575 and ISO 60068-2-6:1996 (impact), SAE J1455 (thermal stress), SAE J2139 (corrosion), ISO16750-4:2003 (storage temperature)	Ingress Protection: IP69K
	CE	

## LED BAR LAMPS



### FEATURES & BENEFITS

- Rugged bar lamps feature LEDs to produce a high intensity light output with a color temperature that is easy on the eyes.
- Multiple lengths and patterns to make choosing the right lamp a simple process
- Each lamp ships with cast aluminum brackets, harness, relay, fuse and in-dash switch



64J11

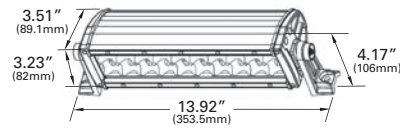

64J21

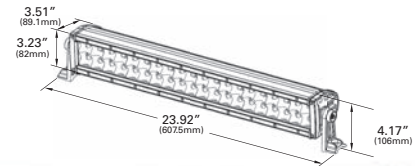

64J31

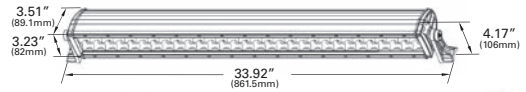

Part Number	Light Pattern	Product Description	Light Output (Usable Lumens)	LPW	Voltage (V)	Amperage (A)
64J11	Far Flood	10" Double Row	2700	61	12/24	3.5/1.5
64J21	Far Flood	20" Double Row	5400	61	12/24	7/3
64J31	Far Flood	30" Double Row	8100	61	12/24	10.5/4.5

All figures listed are based on nominal voltage

### Accessories

Replacement Harness: 67760 (10" lamp), 67770 (20"-50" lamps)  
 Hardware Kit: 98160

Materials	Certifications	Ingress Protection
Material: Anodized Aluminum Housing Lens: Polycarbonate	400N pull test (harness), ASTM B117 Corrosion, 3.3G Vibration test	IP67 and IP69K

## TRILLIANT® 36 LED WORK LAMPS



### FEATURES & BENEFITS

- Hard coated lens for durability and protection against UV
- Thermal pull back circuit to protect the LEDs from overheating
- Aluminum housing with black powder coating
- Encapsulant potting for total circuit board protection against moisture and corrosion
- Bulb termination accommodates either screw or FastOn cable connections
- Color temperature provides a natural contrast most like sunlight, reducing eye fatigue and optimizing job performance
- Replaceable lens with three stainless steel Phillips head screws



63821



63831

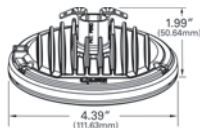

63861



63871

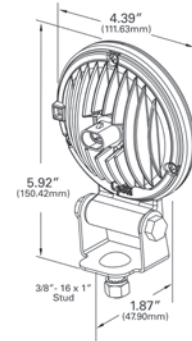

Part Number	Light Pattern	Connection Type	Product Description	Light Output (Usable Lumens)	Wattage (W)	Voltage (V)	Amperage (A)
63971 <a href="#">ECE</a>	TractorPlus	Hard Shell SuperSeal	Replaceable bulb version	800	17	12/24	1.4/.7
63H81 <a href="#">ECE</a>	Wide Flood	Hard Shell SuperSeal	Replaceable bulb version	800	17	12/24	1.4/.7
63H01 <a href="#">ECE</a>	Wide Flood	Deutsch	Integrated bracket	800	17	12/24	1.4/.7
63H11 <a href="#">ECE</a>	TractorPlus	Deutsch	Integrated bracket	800	17	12/24	1.4/.7
63821-5 <a href="#">ECE</a> <a href="#">RETAIL</a>	TractorPlus	Spade/Screw Terminals	Replaceable bulb version	800	17	12/24	1.4/.7
63821 <a href="#">ECE</a>	TractorPlus	Spade/Screw Terminals	Replaceable bulb version	800	17	12/24	1.4/.7
63831-5 <a href="#">ECE</a> <a href="#">RETAIL</a>	Wide Flood	Spade/Screw Terminals	Replaceable bulb version	800	17	12/24	1.4/.7
63831 <a href="#">ECE</a>	Wide Flood	Spade/Screw Terminals	Replaceable bulb version	800	17	12/24	1.4/.7
63861-5 <a href="#">ECE</a> <a href="#">RETAIL</a>	TractorPlus	Hard Shell SuperSeal	Integrated bracket	800	17	12/24	1.4/.7
63861 <a href="#">ECE</a>	TractorPlus	Hard Shell SuperSeal	Integrated bracket	800	17	12/24	1.4/.7
63871-5 <a href="#">ECE</a> <a href="#">RETAIL</a>	Wide Flood	Hard Shell SuperSeal	Integrated bracket	800	17	12/24	1.4/.7
63871 <a href="#">ECE</a>	Wide Flood	Hard Shell SuperSeal	Integrated bracket	800	17	12/24	1.4/.7

All figures listed are based on nominal voltage

### Accessories

Part Number	Description	Fits
94300	TractorPlus™ Lens	All TractorPlus™ T36 Lamps
94310	Flood Lens	All Flood T36 Lamps
68580	Hard Shell SuperSeal Pigtail Blunt Cut	All AMP SS T36 Lamps
68610	Deutsch Pigtail Blunt Cut	63H01,63H11

Materials	Certifications	Ingress Protection
Powder Coated Aluminum Housing/ Polycarbonate Lens	ECE R10, Dir. 72/245/ EEC, Amended by 2006/28/EC	IP69K

## GROTE SELECT LED FLOOD LAMP



### FEATURES & BENEFITS

- LED technology means high output with low power draw
- 12v-36v allows the user flexibility to use this lamp in multiple power systems
- 775 raw lumens, 350 usable lumens
- Great lamp for use around the home, farm or wherever light is needed in a small space,
- Includes mounting hardware



64H01-5

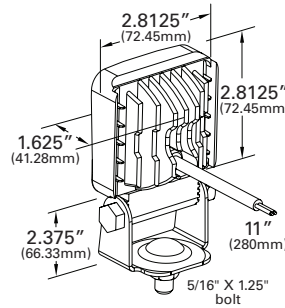

64H01-5



00891-1



64H01-1

Part Number	Light Pattern	Connection Type	Product Description	Light Output (Usable Lumens)	Wattage (W)	Voltage (V)	Amperage (A)
64H01-5 <small>ECE NEW RETAIL</small>	Flood		Pedestal mount	350	7.7	12/36	.643A (@12V)
64H01-1 <small>ECE NEW</small>	Flood	N/A	(4) Four 64H01-5 lamps in a retail display	N/A	N/A	N/A	N/A

All figures listed are based on nominal voltage

### Materials

Housing: Powder Coated Aluminum Housing  
 Lens: Polycarbonate  
 Finish: Black  
 Voltage: 12v-36v  
 Amperage: .643A @12V, .315A @ 24V



## BRITeZONE™ HANDHELD LED WORK LAMPS

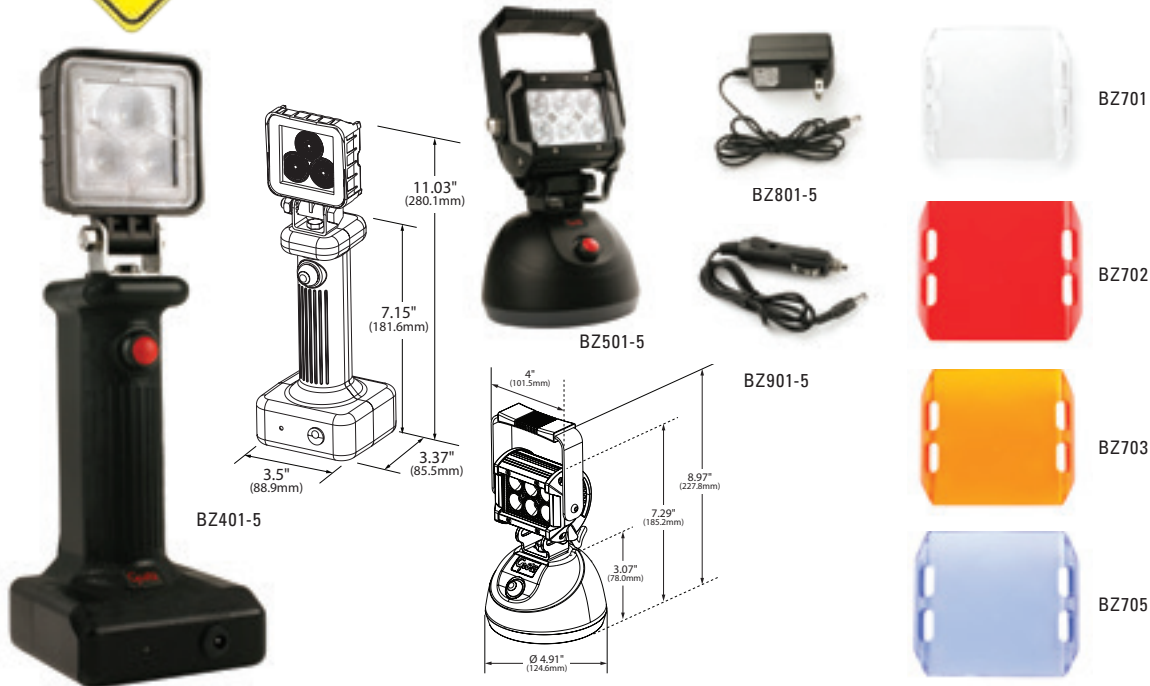

**NO EXCUSES. Rain or Shine... Day or Night... Wet or Dry...**  
 Grote's line of affordable LED lamps are designed to work when you need them.

### FEATURES & BENEFITS

- Chargers are provided with both lamps: Go Anywhere LED Work Lamp comes with wall & car chargers. EZ Grip LED Work Lamp comes with a wall charger.
- The magnetic polymer base allows you to secure the lamp to most metal surfaces.
- With rugged, durable construction and LED power that far outshines halogen, BriteZone lamps get the job done.
- Boating. Moving. Off-roading. Working. Long after the sun goes down, you need a lamp that's as tough and tireless as you are.
- Grote's BriteZone range has the LED lamp to shed light on any use – even tow trucks, garbage trucks and forklifts – without breaking the bank.

Part Number	Description	LEDS	Power Consumption	Raw Lumens	Voltage (V)
BZ501-5	Go Anywhere Led Work Lamp	6	12 Watts	1100	12 Volts DC
BZ401-5	EZ Grip Led Work Lamp	3	12 Watts	775	12 Volts DC
BZ701	Clear Lens For BZ501-5				
BZ702	Red Lens For BZ501-5				
BZ703	Amber Lens For BZ501-5				
BZ705	Blue Lens For BZ501-5				
BZ801-5	Wall Charger for BZ401-5 or BZ501-5				
BZ901-5	Car Charger for BZ401-5 or BZ501-5				

Materials	Light Output
Lens: Polycarbonate	Flood Pattern With
Housing: Die-Cast Aluminum Lamp with Polymer Base	Cool White Color
Bracket: Stainless Steel	

All figures listed are based on nominal voltage



# Work Lighting

Lampe de Travail Iluminación de Trabajo

## BRITEZONE™ LED WORK LAMPS

LED



BZ201-5



BZ101-5



BZ601-5



BZ301-5

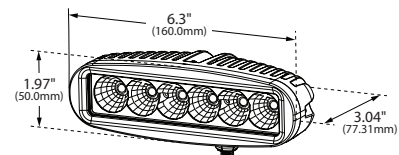
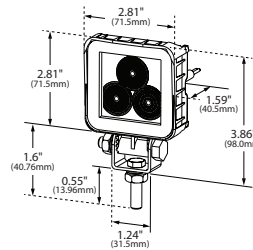
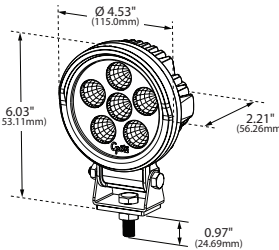
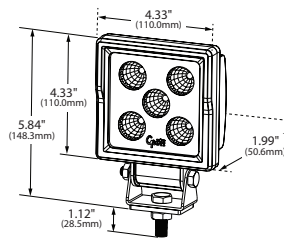

NO EXCUSES. Rain or Shine... Day or Night... Wet or Dry...

Grote's line of affordable LED lamps are designed to work when you need them.

### FEATURES & BENEFITS

- With rugged, durable construction and LED power that far outshines halogen, BriteZone lamps get the job done.
- Boating. Mowing. Off-roading. Working. Long after the sun goes down, you need a lamp that's as tough and tireless as you are.
- Grote's BriteZone range has the LED lamp to shed light on any use –even tow trucks, garbage trucks and forklifts – without breaking the bank.
- Value priced to meet any budget.

Part Number	Description	LEDS	Power Consumption	Raw Lumens	Voltage (V)
BZ101-5	Round Work Lamp	6	16 Watts	1600	9/32 Volts
BZ201-5	Square Work Lamp	5	11 Watts	1100	9/32 Volts
BZ301-5	Slim Work Lamp	6	16 Watts	1400	9/32 Volts
BZ601-5	Mini Square Work Lamp	3	8.1 Watts	775	12/36 Volts

*All figures listed are based on nominal voltage*

### Materials

Lens: Polycarbonate  
Housing: Die-Cast Aluminum  
Bracket: Stainless Steel

### Light Output

Flood Pattern With Cool White  
Colorbulb: 24-Volt - H3, 70

## PAR 46 UTILITY LAMPS

### FEATURES & BENEFITS

- For versatile application as utility, fifth wheel, back up, tractor, or off-road vehicle lamp

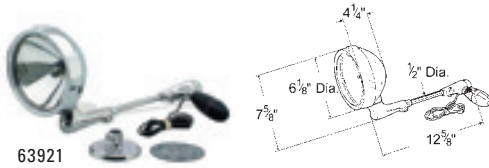

63921



64341  
64391



64231



63941



64471  
64941  
64491

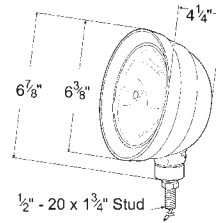
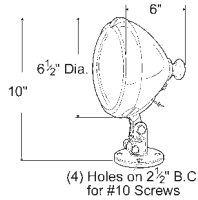
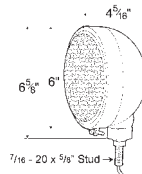
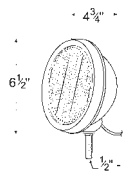

Part Number	Light Pattern	Product Description	Housing Material	Light Output (CP)	Wattage (W)	Voltage (V)	Amperage (A)
64941	Flood	Incandescent work lamp	Rubber	1,100	35	12	2.7
64491	Flood	Incandescent work lamp	Rubber	32,000	150	24	5.4
64471	Flood	Halogen work lamp	Rubber	200,000	100	12	7.7
64943	Flood	Incandescent work lamp, yellow lens	Rubber	8,800	35	12	2.7
64341	Tractor	Incandescent work lamp	Steel	1,110	35	12	2.7
64391	Tractor	Incandescent work lamp	Steel	32,000	150	24	5.4
64231	Tractor	Incandescent work lamp, chrome finish	Brass	11,000	35	12	2.7
63921	Spot	Halogen adjustable surveillance lamp w/ handle, chrome finish	Steel	160,000	50	12	3.9
63941	Spot	Halogen adjustable surveillance lamp, chrome finish	Steel	75,000	30	12	2.3

All figures listed are based on nominal values

### Accessories

Part Number	Description	Fits
64940	Rubber Housing	Par 46 Bulbs
64340	Steel (Black) Housing	Par 46 Bulbs
64011	Steel Housing	Par 46 Bulbs
64021	Steel (Chrome) Housing	Par 46 Bulbs

### Other Replacement Bulbs

Part Number	Description	Fits
4435	Spot Pattern Par 46 Lamps	64471, 63921, 63941
4413	Flood Pattern Par 46 Lamps	64941, 64491
4537	Par 46 Lamps	64471, 64941, 64341, 64231, 63921, 63941

## PAR 36 UTILITY LAMPS

### FEATURES & BENEFITS

- For versatile application as utility, fifth-wheel, backup, tractor, forklift or off-road vehicle lamp

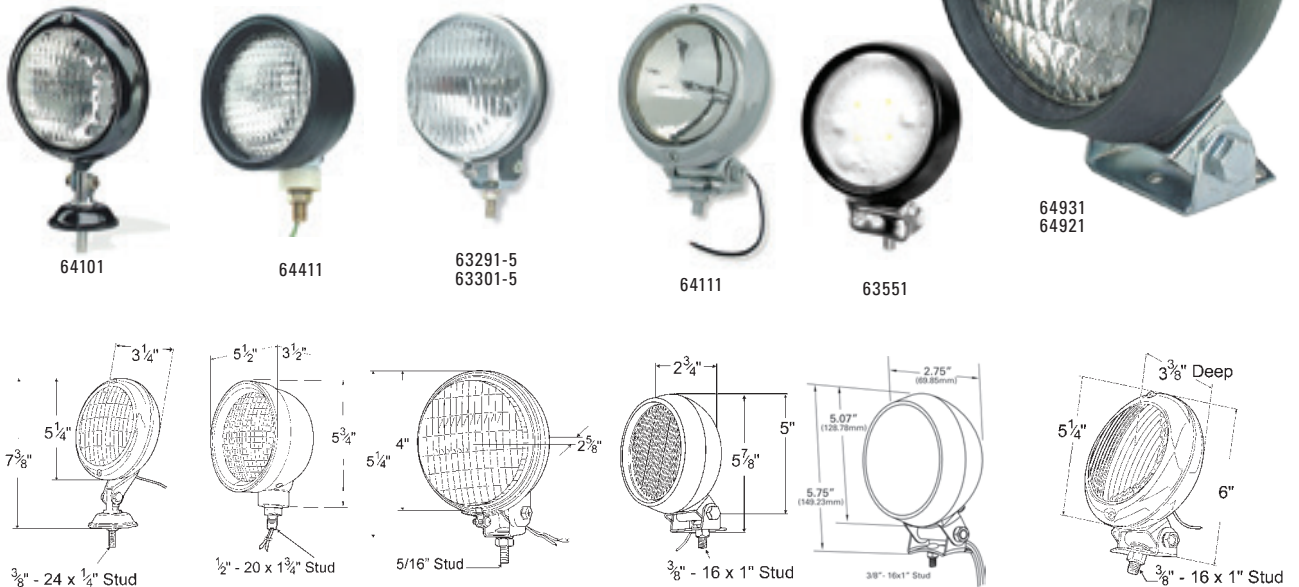

Part Number	Light Pattern	Product Description	Housing Material	Light Output (CP)	Wattage (W)	Voltage (V)	Amperage (A)
64931	Tractor	Incandescent work lamp	Rubber	3,000	35	12	2.7
64931-5	RETAIL Tractor	Incandescent work lamp	Rubber	3,000	35	12	2.7
64921	Tractor	Incandescent work lamp	Rubber	5,000	50	24	1.8
64991	Tractor	Halogen work lamp	Rubber	1,000	50	12	3.9
64101	Tractor	Incandescent work lamp	Steel	3,000	35	12	2.7
64441	Trapezoid	Incandescent work lamp	Steel	3,000	35	12	2.7
64461	Trapezoid	Incandescent work lamp	Steel	5,000	50	24	1.8
64411	Tractor	Halogen work lamp	Plastic	1,000	50	12	3.9
63291-5	RETAIL Tractor	Retail display pack	Plastic	121	55	12	4.7
63301-5	RETAIL Spot	Retail display pack	Plastic	146	55	12	2.6
64111	Spot	Chrome surveillance lamp	Steel	33,000	35	12	2.7
63551	LED	4" in a rubber housing	Rubber	400 Lm	7.7	12	0.6

All figures listed are based on nominal values

### Accessories

Part Number	Product Description	Fits
64930	Rubber Housing	Par 36 bulbs
43300	Magnet Mounting Hardware	Pedestal Mount Lamps
64120	Chrome Housing	Par 36 bulbs
90861-5	H3 Bulb	63291-5
90971-5	H3 Bulb	63291-5
91051	H3 Bulb	63301-5
63821	LED Replacement Bulb, TractorPlus™	Rubber Lamps
63821-5	LED Replacement Bulb, TractorPlus™	Rubber Lamps
63831	LED Replacement Bulb, Wide Flood	Rubber Lamps
63831-5	LED Replacement Bulb, Wide Flood	Rubber Lamps

### Other Replacement Bulbs

Part Number	Product Description	Fits
4411	PAR 36 Bulb	64931(-5), 64101 and 64441
4589	PAR 36 Bulb	64921 and 64461
H7606	Halogen Par 36 Bulb	64991, 64411 and 64561
7400	Halogen Par 36 Bulb	64111

## COMPOSITE WORK LAMP

Composite design (bulb replaceable) • Multiple beam patterns for use in any application • Side or top mount • John Deere® replacement lamp

- 63111-5 Top Mount, Flood RETAIL
- 63121-5 Top Mount, Spot RETAIL
- 63131-5 Top Mount, Trapezoid RETAIL
- 63321-5 Side Mount, Flood RETAIL
- 64611 Top Mount, Flood
- 64621 Side Mount, Flood

Material: Nylon/Glass  
 Finish: Black  
 Bulb: 888, 95 CP; Volts / Amps: 12V / 3.9A

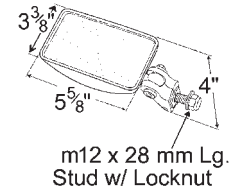
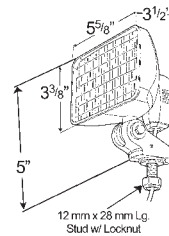

## 4" X 6" RECTANGULAR RUBBER WORK LAMP

Lamps maintains structural integrity through all weather conditions (-50°F to +150°F) • Reinforced, ribbed housing for added strength • Adjustable bracket with 12 mm diameter stud

- 64891 Flood
- 63211-5 Flood RETAIL
- 63221-5 Halogen, Spot RETAIL
- 63231-5 Trapezoid RETAIL
- 64890 Housing only

Material: Rubber  
 Finish: Black  
 Bulb: Spot: H7935-1, 50 Watt, 175,000 CP; Volts / Amps: 12V / 3.9A  
 Bulb: Trapezoid: H4651, 50 Watt, 55,000 CP; Volts / Amps: 12V / 3.9A

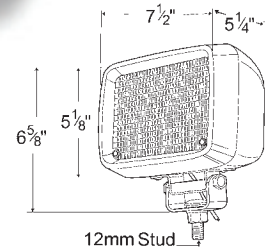

## RECTANGULAR HALOGEN WORK LAMP

Available in trapezoid, spot and flood beam patterns • Rugged corrosion- and shock- resistant construction • For versatile application needs such as tractor, utility, fifth wheel, or off-road

- 63151-5 Flood RETAIL
- 63161-5 Spot RETAIL
- 63171-5 Trapezoid RETAIL
- 63241-5 Flood 24 RETAIL

Material: Nylon  
 Finish: Black  
 Bulb: 12-Volt - H3, 55 Watt, 121 CP; Volts / Amps: 12V / 4.7A  
 Bulb: 24-Volt - H3, 70 Watt, 146 CP; Volts / Amps: 24V / 2.7A  
 Accessory: Bulb: 12V 90861-5/90971-5, 24V 91051

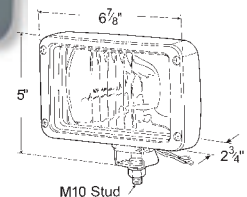

# Work Lighting

Lampe de Travail Iluminación de Trabajo

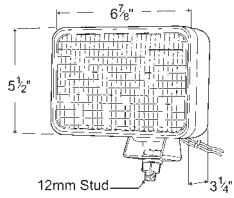

## LARGE RECTANGULAR HALOGEN WORK LAMP

Rugged corrosion and shock-resistant construction • Trapezoid, spot, and flood versions • For heavy or light duty • Versatile design suitable for applications such as tractor, utility, fifth-wheel, or off-road

- 63181-5 Flood RETAIL
- 63191-5 Spot RETAIL
- 63201-5 Trapezoid RETAIL
- 63251-5 Flood 24 RETAIL

Material: Nylon  
 Finish: Black  
 Bulb: 12-Volt: H3, 55 Watt, 121 CP; Volts / Amps: 12V / 4.7A  
 Bulb: 24-Volt - H3, 70 Watt, 146 CP; Volts / Amps: 24V / 2.7A  
 Accessory: Bulb: 12V 90861-5/90971-5, 24V 91051

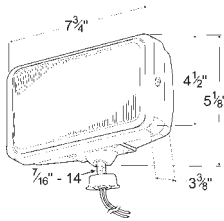

## 7" RECTANGULAR OFF-ROAD LAMP

Rugged steel housing • Universal swivel mounting bolt

- 64541-5 Black RETAIL

Material: Steel  
 Finish: Chrome, Black  
 Bulb: H3, 100 Watt, 192 CP; Volts / Amps: 12V / 8.33A  
 Accessory: Bulb: 92701-5  
 Lens: Clear 93151

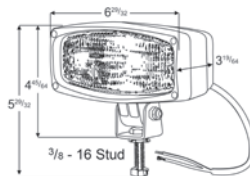

## TWIN-BEAM HALOGEN WORK LAMP

Reinforced nylon housing for strength and durability • Hardened-glass lens resists breakage from road hazards • Complies with SAE J575e vibration and corrosion standards

- 64901 Flood

Material: Nylon, Glass  
 Finish: Black  
 Bulb: H3 (x 2); Volts / Amps: 12V / 9.4A, 55 Watt  
 Accessory: Bulb: 90861-5, 90971-5

## LED SEALED BEAM REPLACEMENT HEADLAMP BULBS



### FEATURES & BENEFITS

- Designed to swap into existing housings that H6024 (90941-5) and H6054 (90951-5) currently fit into.
- Designed for a standard H4 connection, no additional wiring needed for vehicles featuring standard H4 wiring.
- Long lasting LEDs and impact resistant polycarbonate lens outperform OEM halogen and incandescent bulbs in longevity, light output and pattern.



90941-5

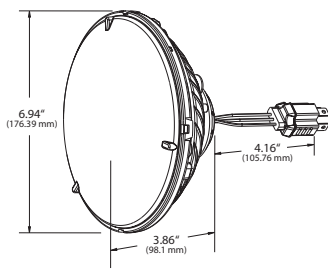

90941-5

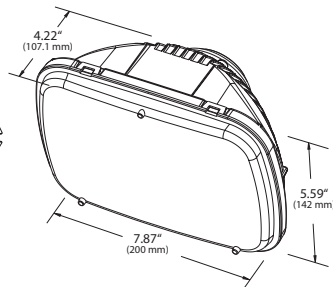

90951-5



90951-5

Part Number	FMVSS/SAE	Product Description	Low Beam Watt	High Beam Watt	Voltage (V)	Amperage (A)
90941-5 <span style="color: green;">NEW</span>	2D-1	Grote 7 LED Head Lamp	15	27	9-32	1.4 @12.8 low 2.13 @12.8 low
90951-5 <span style="color: green;">NEW</span>	2B-1	Grote 5/7 LED Head Lamp	21	33	9-32	1.59 @12.8 low 2.54 @12.8 high
99401-5 <span style="color: green;">NEW</span>	2A-1	Grote 4x6 LED Head Lamp Combination	18.84@12V 18.84@24V	18.84@12V 18.84@24V	9-32	1.57 @12V 0.77 @24V
99411-5 <span style="color: green;">NEW</span>	1A-1	Grote 4x6 LED Head Lamp High Beam	N/A	17.16@12V 16.08@24V	9-32	1.43 @12V 0.67 @24V
99421-5 <span style="color: green;">NEW</span>	2A-1	Grote 4x6 LED Head Lamp Low Beam	13.08@12V 12.72@24V	N/A	9-32	1.09 @12V 0.53 @12V

All figures listed are based on nominal voltage

### Accessories

Part Number	Description
68630	self-addressable pigtail for vehicles with non-standard H4 wiring

Materials	Certifications
Housing anodized aluminum, Lens uv-coated polycarbonate	7" lamp meets DOT, FMVSS, SAE standards for 2D-1
	5x7 lamp meets DOT, FMVSS, SAE standards for 2B-1

# Forward Lighting

Phares Utilitaires Faros Delanteros

**per-lux**  
BY **Grote**



64291-4

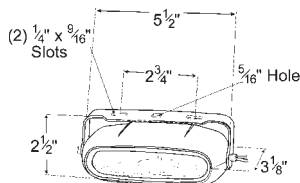
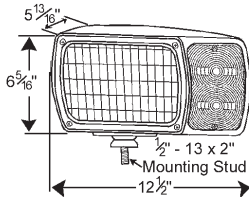

## PER-LUX® SNOWPLOW LAMPS

Resilient, polycarbonate housing and halogen sealed beam withstands hours of use at sub-zero temperatures • Features integrated parking and turn signal lights • Rubber shock mount and center mounting stud absorbs road shock • Optional 5-way Packard® Connector

### SEALED BEAM:

<b>64261-4</b>	Pair Pack
<b>64241</b>	LH
<b>64251</b>	RH

### SEALED BEAM WITH CONNECTOR:

<b>64291-4</b>	Pair Pack
<b>64271</b>	LH
<b>64281</b>	RH

Material: Polycarbonate  
 FMVSS: H, I2, P  
 Finish: Black  
 Bulb: H6545, Major - 65 Watt, 40,000 C.P./Minor - 45 Watt, 25,000 CP  
 Volts / Amps: 12V / 5.0/3.5A  
 Bulb: 1157, 32/3 CP; Volts / Amps: 12V / 2.1/.59A; Pigtail: 68680 (64291-4)  
 Lens: Yellow 90483

## SNOWPLOW LAMP KIT WITH UNIVERSAL WIRING HARNESS

Integrated turn signal/parking lamp lens • Vibration-dampening mounting system prolongs bulb life • Kit includes left and right side lamps, heavy-duty selector switch, wiring connectors, mounting hardware, and easy installation instructions

**63451-4** Pair Pack

### REPLACEMENT LAMP:

<b>63381</b>	LH
<b>63391</b>	RH

Material: Polycarbonate  
 FMVSS: H, I2, P  
 Finish: Black  
 Bulb: H6054, Major - 65 Watt/Minor - 35 Watt; Volts / Amps: 12V / 5/2.7A  
 Bulb: 1157, 32/2 CP; Volts / Amps: 12V / 2.1/.59A  
 Bulb: 1156, 32 CP; Volts / Amps: 12V / 2.1A  
 Lens: Yellow 93163

## SLIM-LINE HALOGEN FOG LIGHTS

Housing made of die-cast aluminum • Ion coated lens • Kit includes lamps, switch, wiring, and instructions • Not compliant for FMCSA 393.24(b) applications

**64371-5** Clear, Fog Lamp Kit **FOG** **RETAIL**

Material: Die-Cast Aluminum  
 FMVSS: F  
 Finish: Black  
 Bulb: H3, 55 Watt, 121 CP; Volts / Amps: 12V / 4.7A  
 Accessory: Bulb: 90861-5/90971-5  
 Lens: Clear 93131

## MINI HALOGEN FOG AND DRIVING LAMP KIT

Low-profile styling • High-impact nylon housing • Kit includes lamps, rocker switch and installation kit • Not compliant for FMCSA 393.24(b) applications

**64061-5** Clear, Driving Lamp Kit **FOG RETAIL**

Material: Nylon  
 Finish: Black  
 Bulb: H3, 55 Watt, 121 CP  
 Volts / Amps: 12V / 4.7A  
 Accessory: Bulb: 90861-5/90971-5



## HALOGEN FOG LAMP

Glass lens resists hazing • Aluminized reflector for increased brightness  
 • Black powder coated hardware • Industry-standard electrical connector  
 • Watertight design on the front of the lamp • Meets FMCSA 393.25 (b)

**63531** Black **FOG**

Material: Glass/Plastic Housing  
 FMVSS: F  
 Finish: Black  
 Bulb: H3, 55 Watt, 121 CP  
 Volts / Amps: 12V / 4.7A

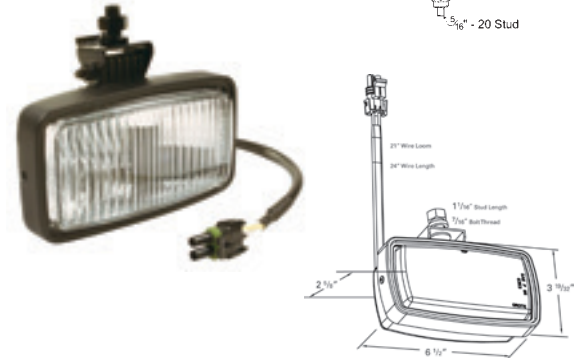

## SPORT AND UTILITY LAMP KIT

Rugged, high-impact plastic construction • Hardened glass lens  
 • Mounts above or below bumper • Kit includes lamps, rocker switch and installation kit • Meets FMCSA 393.25(b) applications

**64351-5** Clear, Fog Lamp Kit **FOG RETAIL**

**64401-5** Clear, Driving Lamp Kit **RETAIL**

Material: ABS  
 Finish: Clear  
 Bulb: H3, 55 Watt, 121 CP  
 Volts / Amps: 12V / 4.7A  
 Accessory: Bulb: 90861-5/90971-5



## PAR 56 7" HEADLAMP

7-inch headlamp • Includes sealed beam #6014 for 12-volt systems  
 • Ideal for many trucks, road maintenance vehicles, off-road equipment, in-plant vehicles, material handling trucks, mine cars, dune buggies, etc.

**64071** Black, Powder Coated

Material: Steel  
 Finish: Black  
 Bulb: 6014, PAR 56, 50 Watt/60 Watt, 25,000/32,000 CP  
 Volts / Amps: 12V / 4.7/3.9A



## ROUND OFF-ROAD LAMP

Rugged steel housing • Universal-swivel, rubber-cushioned mounting pedestal

**64481-5** Black **RETAIL**

**64501-5** Chrome **RETAIL**

Material: Steel  
 FMVSS: O  
 Finish: Chrome, Black  
 Bulb: H3, 100 Watt, 192 CP; Volts / Amps: 12V / 8.33A  
 Accessory: Bulb: 92701-5  
 Lens: Clear 93171





# Forward Lighting

Phares Utilitaires Faros Delanteros

**per-lux**  
BY  
**Grote**

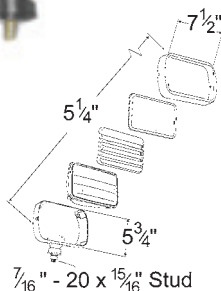
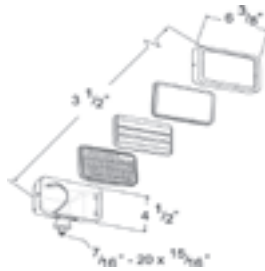
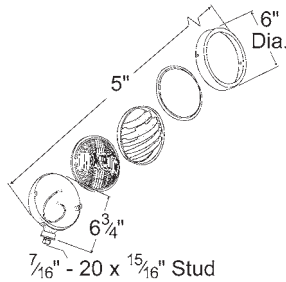

## PER-LUX® 200 SERIES FOG AND DRIVING LAMPS

Louvers direct the beam low to the road so reflected glare from fog, rain, or snow is safely avoided • Pierces 100 feet through the densest fog • Rugged stainless steel housing

### HALOGEN:

**02001-4** Clear, Fog / Driving Lamp, Swivel Mount, Pair Pack **FOG**

Material: Stainless-Steel  
Finish: Stainless  
Bulb: H7621-1, 20,000 CP  
Volts / Amps: 12V / 3.9A; 50 Watt  
Accessory: Springs for Sealed Beam Ret. For Swivel Mount Lamps 09510 (pair pack);  
Lens: Clear Glass 09561

## PER-LUX® 500 SERIES FOG AND DRIVING LAMPS

Pair Packs include wiring kits • All lamps come with swivel mount • Fog lamp beam pattern pierces through fog, rain, snow, or dust effectively, focused ahead and low to the road, and giving a side-to-side as well as forward illumination

### HALOGEN:

**05001-5** All Weather Louvered, H9421, Pair Pack, Stainless Steel **RETAIL**  
**05151** All Weather Louvered, H9421, Single, Stainless Steel **RETAIL**  
**05301-5** All Weather Louvered, H9421, Pair Pack, Powder Coated **RETAIL**  
**05041-5** Driving Lights, H9420, Pair Pack, Stainless Steel **RETAIL**  
**05051-5** Fog Lamps, H9415, Pair Pack, Stainless Steel **FOG RETAIL**

Material: Stainless Steel  
Finish: Stainless / Powder Coat  
Bulb: H9421 - 14,000 CP; Volts / Amps: 12V / 3.9A; 50 Watt  
Bulb: H9420 - 47,000 CP; Volts / Amps: 12V / 3.9A; 50 Watt  
Bulb: H9415 - 12,000 CP; Volts / Amps: 12V / 2.9A; 37.5 Watt  
Accessory: Springs for Sealed Beam 09510; Black Louver 09712  
Lens: Glass Lens Clear 09681  
Sealed Beam: All-Weather, Halogen, Sealed Beam Clear H9421 Fog Lamp, Halogen, Sealed Beam Clear H9415

## PER-LUX® 600 SERIES FOG AND DRIVING LAMPS

Louvers direct the beam low to the road so reflected glare from fog, rain or snow is safely avoided • Pierces 100 feet through the densest fog • Rugged stainless steel housing • Pair packs come with wiring kits • Meets FMCSA 393.25(b) applications (except 06001-4 & 06013-4)

### INCANDESCENT

**06021-4** Clear, All-Weather Lamp, Swivel Mount, Pair Pack **FOG**

### HALOGEN:

**06001-4** Clear, All-Weather Lamp, Swivel Mount, Pair Pack  
**06201** Clear, All-Weather Lamp, Swivel Mount  
**06013-4** Yellow, All-Weather Lamp, Swivel Mount, Pair Pack

Material: Stainless Steel  
Finish: Stainless  
Bulb: #H7921-1, 23,900 CP; Volts / Amps: 12V / 3.9A; 50 Watt  
Bulb: #4921-1, 25,000 CP; Volts / Amps: 12V / 7.7A; 100 Watt  
Accessory: Black Louver 09802  
Lens: Clear, Glass 09781; Yellow, Glass 09793  
Sealed Beam: Clear, All-Weather, Incandescent 4921-1; Clear, All-Weather, Halogen 6006H



## PER-LUX® 700 SERIES FOG AND DRIVING LAMPS

Fog lamp beam pattern pierces through fog, rain, snow or dust effectively, focused ahead and low to the road giving side-to-side as well as forward illumination • Off-road spot lamps provide pure focused light that pierces far into the night for long distance viewing of a specific area, great for off-road and 4-wheel-drive applications • Off-road wide flood lamp applications provide wide illumination for RVs, motor-homes, tractors, utility, and off-road construction great for backing, loading, fueling, or troubleshooting

- Rugged stainless steel housing
- Pair packs come with wiring kit
- Meets FMCSA 393.25(b)- (except 07021-4 & 07031-4)

### INCANDESCENT:

**07001-4** Clear, All-Weather Lamp, Swivel Mount, Pair Pack **FOG**  
**07401** Clear, Fog Lamp, Rigid Mount **FOG**

### HALOGEN:

**07021-4** Clear, Spot Lamp, Swivel Mount, Pair Pack

Material: Stainless Steel  
 FMVSS: Street Legal (except for 07021-4, 07031-4)  
 Finish: Stainless  
 Bulb: #4912-1, 14,000 CP; Volts / Amps: 12V / 3.9A; 50 Watt  
 Bulb: #H7935-1, 175,000 CP; Volts / Amps: 12V / 3.9A; 50 Watt  
 Bulb: #H7921-1, 23,900 CP; Volts / Amps: 12V / 3.9A; 50 Watt  
 Sealed Beam: Clear, Fog, Incandescent 4912-1;  
 Clear, Spot, Halogen H7935-1

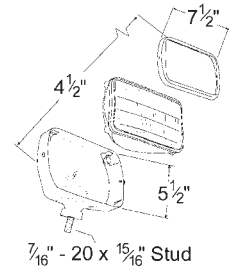

## PER-LUX® DOCKING LIGHT

Flush mounted • Multi-purpose docking/utility light

### HALOGEN:

**07803** Lamp w/ Stainless Steel Bezel

Material: Stainless Steel  
 Finish: Stainless  
 Bulb: H9406, 1,350CP  
 Volts / Amps: 12V / 3.9A; 50 Watt

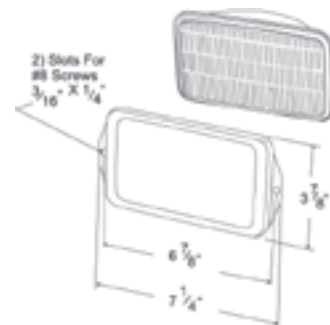

# Forward Lighting

Phares Utilitaires Faros Delanteros

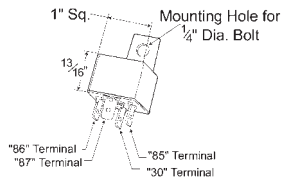

## FOG AND DRIVING LAMP RELAY

30 AMP relay • Guards against arcing and overloads

44840-5 **RETAIL**

Volts / Amps: 12 V / 30A max



90861-5

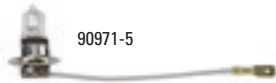

90971-5

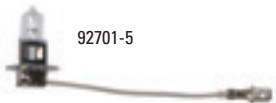

92701-5



90620

## REPLACEMENT 12-VOLT HALOGEN BULBS

Replacement bulb for auxiliary lights

90861-5 55 Watt, Bullet Terminal **RETAIL**

90971-5 55 Watt, Spade Terminal **RETAIL**

92701-5 100 Watt, Spade Terminal **RETAIL**

90620 55 Watt, High Output

Bulb: 90861-5, 90971-5 - H3, 55 Watt, 121 CP; Volts / Amps: 12V / 4.7A

Bulb: 92701-5 - H3, 100 Watt, 187 CP; Volts / Amps: 12V / 7A

Bulb: 90620- H1, 55 Watt, 121 CP; Volts / Amps: 12V / 5.2A



91051



90901 - 24V

90900 - 12V

## REPLACEMENT 24-VOLT HALOGEN BULBS

91051 70 Watt, Spade Terminal **24 VOLT**

90901 50 Watt, Standard Socket **24 VOLT**

Bulb: 91051 - H3, 70 Watt, 135 CP; Volts / Amps: 24V / 2.7A

Bulb: 90901 - 50 Watt; Volts / Amps: 24V / 2A

### Electronic Characteristics

12/24 Volts, 1.5/0.75 Amps, 18 Watts  
Overvoltage Protection

## CLASS I LED BEACON

Class I LED beacon is designed to provide optimal lighting for all application needs • Available in low or high dome options and 12 volt or 24 volt models • LED technology benefits also include low power draw and reduced on-going maintenance costs and downtime • Permanent Mount

- 76253**    Yellow, Low Profile
- 77953**    Yellow, High Profile

Class: I  
 Material: Polycarbonate  
 SAE: J845  
 Finish: Yellow  
 Volts / Amps: 12V / .5A/1A max  
 Volts / Amps: 24V / .2A/.5A max

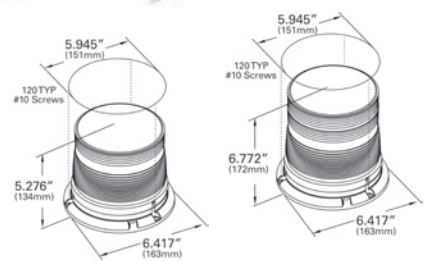

## MEDIUM PROFILE CLASS II LED STROBE

Rated life of LED strobes is up to 50 times longer than standard strobes • SignalAlert™ provides greater visibility by creating a varied flash pattern vs standard strobes with a consistent flash pattern • LED beacon design internally houses the flash control eliminating the need for an external power supply or ballast • Scan-Lock® flash pattern allows the user to manually select from 14 permanent flash patterns

- 77813**    Yellow

**MAGNET MOUNT WITH CIGARETTE LIGHTER ADAPTER:**

- 77823**    Yellow

Class: II  
 Material: Polycarbonate  
 SAE: J845  
 Finish: Clear/ Yellow  
 Volts / Amps: 12V / .65A max  
 Lens: Yellow 93733

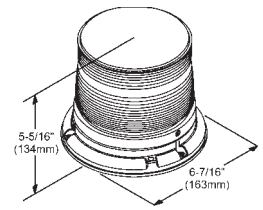

## HIGH PROFILE CLASS II LED STROBE

Rated life of LED strobes is up to 50 times longer than standard strobes • SignalAlert™ provides greater visibility by creating a varied flash pattern as opposed to standard strobes with a consistent flash pattern • Scan-Lock™ flash pattern allows the user to manually select the permanent flash pattern, 14 to choose from • LED Beacon design internally houses the flash control so there is no need for an external power supply or ballast

- 77833**    Yellow

**MAGNET MOUNT WITH CIGARETTE LIGHTER ADAPTER:**

- 77843**    Yellow

Class: II  
 Material: Polycarbonate  
 SAE: J845  
 Finish: Yellow  
 Volts / Amps: 12V / .65A max  
 Lens: Yellow 93743

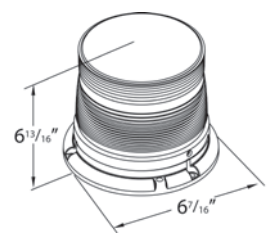

# Warning and Hazard

Gyrophares et Feux d'Avertissement Lámparas de advertencia y precaución

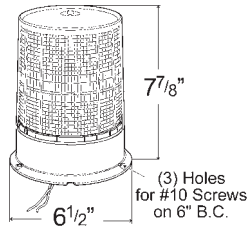

## HIGH PROFILE HIGH-INTENSITY SMART STROBE®

Rugged die-cast base specifically designed for vibration resistance and heat dissipation • Optional: clear lens, dust cover • Two mounting options: external and 1" pipe • Field selectable double or quad flash and intensity • Flashes per minute: Class I 80 / 65 Double / Quad; Class II 65 / 60 Double / Quad • Thread-on lens • Smart Strobe® flash automatically adjusts for day or night work conditions • LED Indicator alert for flash tube failure on 7767X Class I strobes

### CLASS I:

<b>77671</b>	Clear	<b>MULTI</b>
<b>77673</b>	Yellow	<b>MULTI</b>

### Class I

Material: Die-Cast Aluminum/Polycarbonate

SAE: J1318

Finish: Clear / Red / Yellow / Blue

Volts / Amps: 12V - 24V / 2.3-2.9A at 12V

Accessory: Flash Tube: 92970

Lens: Clear 93001, 93002 Red, Yellow 93003, Blue 93005; Dust Cover: Clear 93701

## HIGH PROFILE SMART STROBE® LAMP

Die-cast aluminum base with a smooth surface outer dome that protects the inner lens • Field selectable double or quad flash settings • Voltage spike and surge-protected • Seven support points of contact on the circuit board mounting reduce the damage caused by vibration • Ideal for light- and heavy-duty applications • Field replaceable flash tube • Smart Strobe® automatically adjusts intensity based on ambient lighting

**77453** Yellow **MULTI**

### Class: II

Material: Polycarbonate

SAE: J845

Finish: Silver

Volts / Amps: 12V / 2.1A High Intensity Mode

Volts / Amps: 12V / 1.6A Low Intensity Mode

Volts / Amps: 24V / 1.0A High Intensity Mode

Volts / Amps: 24V / .8A Low Intensity Mode

Accessory: Flash Tube: 92970; Lens: Interior: Yellow 92993

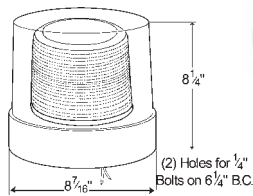

## MEDIUM PROFILE CLASS I & II HEAVY-DUTY STROBE

Popular with school buses and construction equipment • Two mounting options: external and 1" pipe • Field selectable double or quad flash and intensity • Epoxy version has a potted circuit board for added protection against vehicle vibration and road shock • Smart Strobe® flash intensity automatically adjusts for day and night working conditions • Thread-on lens • Joules: Class I 15/20; Class I, Smart Strobe 10/20; Class II 8/17 • Flashes per minute: Class I 65/80; Class II 60/65 • Class I strobes have an LED indicator for flash tube failure (does not apply to Class II heavy duty lamps)

### CLASS I:

<b>77611</b>	Clear	<b>MULTI</b>
<b>77613</b>	Yellow	<b>MULTI</b>
<b>77615</b>	Blue	<b>MULTI</b>

### CLASS II, EPOXY BASE:

<b>77623</b>	Yellow	<b>MULTI</b>
--------------	--------	--------------

### CLASS II, HEAVY DUTY:

<b>77693</b>	Yellow	<b>MULTI</b>
--------------	--------	--------------

Class: Class I / Class II  
 Material: Die-cast Aluminum/Polycarbonate  
 SAE: J1318  
 Finish: Clear / Yellow  
 Volts / Amps: 12V - 24V / 2.3A - 2.9A at 12V  
 Accessory: Flash Tube: 92970; Branch Guard: 43910  
 Lens: Clear 92991, Red 92992, Yellow 92993, Blue 92995

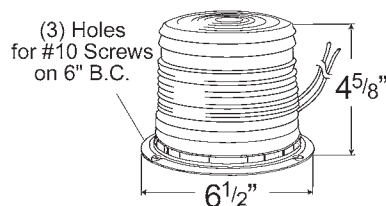

## MEDIUM PROFILE CLASS II STROBE

Three wire leads allow user to choose double flash or quad flash • Field replaceable flash tube • Heavy duty epoxy-filled, reinforced nylon base • UV stabilized polycarbonate thread-on lens allows user to change the flash tube without tools • Voltage-spike and surge-protected • 80 (double) or 65 (quad) flashes per minute

<b>77583</b>	Yellow	<b>MULTI</b>
--------------	--------	--------------

Class: II  
 Material: Glass Filled Nylon/Polycarbonate  
 SAE: J1318  
 Finish: Yellow  
 Bulb: 12V - 48V  
 Volts / Amps: 12V / 1.5A  
 Accessory: Flash Tube: 92970  
 Lens: Yellow 92993, Blue 92995

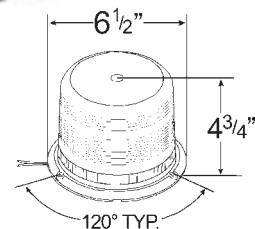

# Warning and Hazard

Gyrophares et Feux d'Avertissement Lámparas de advertencia y precaución

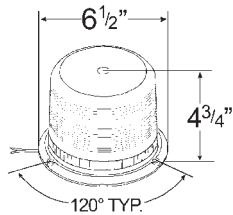

## MEDIUM PROFILE CLASS II PLASTIC BASE STROBE

Fresnel lens provides 360° coverage • Includes 1" pipe-mount and flange-mount • Choose double or quad flash • 7 joules (double), 10 joules (quad) • 80 (double) or 65 (quad) flashes per minute • Reverse polarity, voltage, and surge protected

**77123** Yellow **MULTI**

Class: II  
Material: Polycarbonate  
SAE: J1318  
Volts / Amps: 12V - 48 V / 1.5A at 12 V  
Accessory: Flash Tube: 92970  
Lens: Yellow 92993

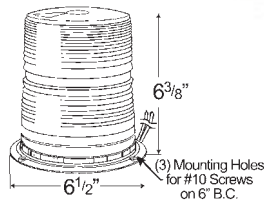

## HIGH PROFILE CLASS I & II STROBE

Popular for maintenance and utility vehicles • Rugged, coated die-cast base • Two mounting options: external and 1" pipe • Joules: Class I, 15/20; Class I, Smart Strobe® 10/20; Class II 8/17 • Flashes per minute: Class I 65/80; Class II 60/65 • Smart Strobe® flash automatically adjusts for day or night work conditions • Thread-on lens • Class I strobes has an LED alert for flash tube failure (does not apply to Class II heavy duty lamps) • Epoxy version has a potted circuit board for added protection against vehicle vibration and road shock • Field selectable double or quad flash and intensity

**CLASS I, SMART STROBE®:**

**77653** Yellow **MULTI**

**CLASS I:**

**77643** Yellow **MULTI**

**CLASS II, HEAVY DUTY:**

**77713** Yellow **MULTI**

Material: Die-Cast Aluminum/Polycarbonate  
SAE: J1318  
Finish: Clear / Red / Yellow / Blue  
Volts / Amps: 12V - 24V / 2.3A - 2.9A at 12V  
Accessory: Flash Tube: 92970; Branch Guard: 43550  
Lens: Clear 93001, Red 93002, Yellow 93003, Blue 93005; Dust Cover: Clear 93701

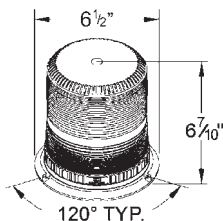

## HIGH PROFILE CLASS II PLASTIC-BASE STROBE

Includes 1" pipe-mount and flange-mount • Choose double or quad flash • Reverse polarity, voltage, and surge protected • 80 flashes per minute (double), 65 flashes per minute (quad)

**77133** Yellow **MULTI**

Class: II  
Material: Polycarbonate  
SAE: J1318  
Finish: Yellow  
Volts / Amps: 12V - 48V (DC) / 2.3A max  
Accessory: Flash Tube: 92970  
Lens: Yellow 93003; Dust Cover: Clear 93701

## MIGHTY MINI LED STROBE

Rated life of LED strobes is up to 100 times longer than standard strobes

- SignalAlert™ provides greater visibility by creating a varied flash pattern (vs. standard strobes with a consistent flash pattern)
- Exclusive side-emitting LED technology rivals standard strobe intensity with a single super LED diode
- LED beacon design internally houses the flash control eliminating the need for an external power supply or ballast
- 90 flashes per minute

PERMANENT MOUNT:	
<b>77473</b>	Yellow
MAGNET MOUNT WITH CIGARETTE LIGHTER ADAPTER:	
<b>77483</b>	Yellow

Class: III  
 Material: Polycarbonate  
 Finish: Yellow  
 Volts / Amps: 12V / .15A  
 Lens: Yellow 93723

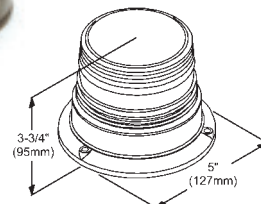

## MIGHTY MINI STROBE

Rugged fiberglass-filled nylon base and polycarbonate lens

- Wide voltage operating range
- Field replaceable lens and flash tube
- Thread-on lens
- 80 flashes per minute; 1.5 joules
- Reverse polarity and voltage spike protected

SINGLE FLASH:		
<b>77101</b>	Clear	MULTI
<b>77102</b>	Red	MULTI
<b>77103</b>	Yellow	MULTI
<b>77105</b>	Blue	MULTI

Material: ABS/Polycarbonate  
 Finish: Clear / Red / Yellow / Blue  
 Volts / Amps: 11V - 110 V / .25 A at 12V  
 Accessory: Flash Tube: 92980  
 Lens: Red 92032, Yellow 92033, Blue 92035, Clear 92031

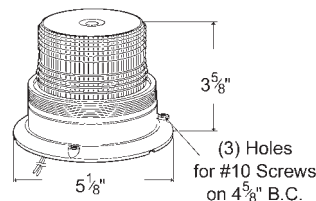

## MATERIAL HANDLING STROBE

Electronics sealed in epoxy to protect against dust, moisture and vibration

- Thread-on lens for easy maintenance
- Field replaceable flash tube
- Meets UL 583 and SAE J1381
- 80 flashes per minute (single flash)
- 2 joules per flash

<b>77013</b>	Yellow	MULTI
--------------	--------	-------

Material: Nylon/Polycarbonate  
 Finish: Red / Amber / Blue  
 Volts / Amps: 12V - 110V / .6A at 12V  
 Accessory: Flash Tube: 92960  
 Lens: Yellow 93013, Blue 93015

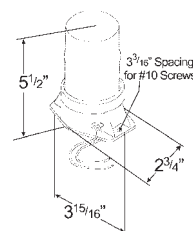



# Warning and Hazard

Gyrophares et Feux d'Avertissement Lámparas de advertencia y precaución

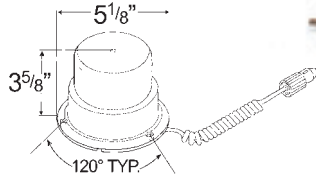

## ECONOMY MATERIAL HANDLING STROBE

Thread-on lens for easy maintenance • Polycarbonate lens and fiberglass-filled nylon base • Reverse polarity and voltage spike protected • 45 lbs. pull magnet for temporary mounting with 12" adapter plug • 1.5 joules per flash, 70 flashes per minute (single flash) • Replaceable flash tube  
• Removable 1/2 hood included

**77203** Yellow **MULTI**

Material: Polycarbonate  
Finish: Yellow  
Volts / Amps: 12V - 80V / .3A at 12V  
Accessory: Flash Tube: 92980  
Lens: Yellow 92033

## FLEXIBLE-BASE STROBE LAMP

DIN fixing allows product to be quickly installed or moved with use of mounting stems • 75 flashes per minute (double flash), 7 joules • Flexible rubber stem allows for 30° angle deflection • Shock-absorbing features make this lamp suitable in rugged applications, such as on forestry, agricultural and industrial vehicles • Robust polycarbonate thread-on lens is secured with a single set-screw • Corrosion-resistant materials • Mounting stems ordered separately

**76963** Yellow **MULTI**

Class: II  
Material: Polycarbonate  
Finish: Yellow  
Volts / Amps: 12V - 48V (DC) / 1.5A  
Accessory: Flash Tube: 92970  
Lens: Yellow 93383  
Mounting Brackets: Stem - 43665

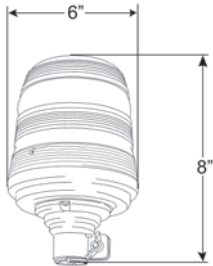

## STEALTH LOW-PROFILE STROBE LIGHT

Durable belt drive rotator • 160 flashes per minute • Thread-on lens is secured quickly with a single screw • Quick-connect base allows for easy installation and removal

**76493** Yellow

Class: I  
Material: ABS/Polycarbonate  
SAE: J845  
Finish: Yellow  
Bulb: H1, 55 Watt  
Volts / Amps: 12V / 5.2A  
Accessory: Flash Tube: 90620;  
Mounting Brackets: Stem - 43665

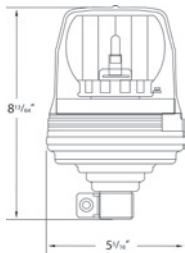

## 360° PORTABLE BATTERY OPERATED LED WARNING LIGHT

24 ultra-bright LEDs help conserve battery life • 300 - 400 hours of operation on two D batteries (not included) • 60 triple flashes per minute • Strong magnet base holds lamp in place on a metal surface • Photocell adjust intensity for low light situation

**77912**    Red  
**77913**    Yellow

Material: Nylon/Polycarbonate  
 Finish: Red/Yellow  
 Bracket: 96010

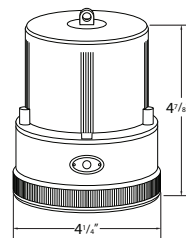

## DIRECTIONAL, PORTABLE, BATTERY-OPERATED LED WARNING LIGHT

Push button operation • 72 hours of operation on two AA batteries (not included) • Includes a magnetic base and is adjustable 180° • Additional reflective lens as added safety feature • 3 user-selectable flash patterns

**77923**    Yellow

Material: Nylon / Polycarbonate  
 Finish: Yellow

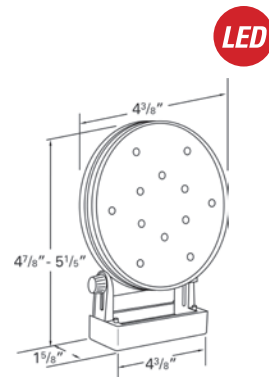

## LED MATERIAL HANDLING STROBE

LEDs use 1/4 the power of a standard strobe, putting less drain on batteries and other power sources • LEDs are a long life, reduced cost solution to frequent replacement of flash tubes • Electronics are fully potted to provide protection against the elements and vibration • 60 flashes per minute • Dual LEDs provide extra visibility • Single flash pattern

**77443**    Yellow

Material: Polycarbonate  
 Finish: Yellow  
 Volts / Amps: 12V / .13A - 1.5 Watt

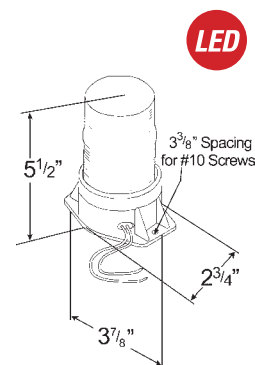

# Warning and Hazard

Gyrophares et Feux d'Avertissement Lámparas de advertencia y precaución

LED

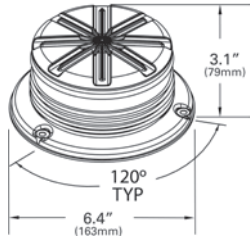

## LOW PROFILE CLASS I LED BEACON

Eight 3-watt LED's and a parabolic reflector produce an SAE Class I light output product • Unique flash pattern increases visibility to the human eye • Overhead heat sink design allows for a very low profile pipe mounted solution when flange is removed • Meets SAE J845 Class I • Temperature range: -22°F to +122°F (-30°C to +50°C)

**76663** Yellow

MULTI

Class: Class I  
Material: Glass-Filled Nylon/Polycarbonate  
SAE: J845  
Finish: Amber / Black  
Volts / Amps: 12V - 36V / 1A

LED

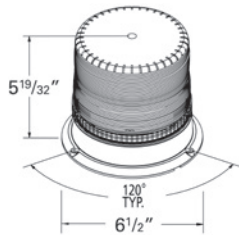

## LED CLASS I BEACON

Sixteen 3-watt LEDs provide unrivaled flash intensity • Eleven flash patterns with hi/lo intensity control • Designed for vibration resistance and heat dispersion • Die-cast aluminum base is coated against corrosion • Thread-on polycarbonate lens allows for easy "no-tool" pattern selection • Reverse polarity, voltage spike and surge protected • 12V to 24V operation spread

**77873** Yellow MULTI

Class: I  
Material: Aluminum/Polycarbonate  
SAE: J845  
Finish: Yellow  
Volts / Amps: 12V - 24V / 3.7A

## TWO SEALED-BEAM ROTO-BEACON

Clutched gear box is sealed and permanently lubricated • Revolves 360°, 60-120 flashes per minute

**76223** Yellow

**76333** Yellow w/ Polycarbonate Lens

Class: I: Red, Yellow; II: Blue  
Material: Stainless Steel/ Aluminum/Acrylic/ Polycarbonate  
Finish: Red / Yellow / Blue  
Bulb: 7400 SB, 33,000 CP  
Volts / Amps: 12V / 5.9A  
Lens: Yellow 90373; Polycarbonate: Yellow 91323

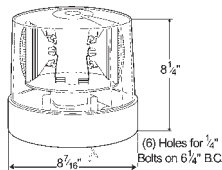

## COMPACT FOUR SEALED-BEAM ROTO-BEACON

Clutched gear box design and "suitcase" latch design • Permanently lubricated, sealed gear box • Revolves 360°, 60-120 flashes per minute

**76203**    Yellow

Class: I - Yellow  
Material: Stainless Steel/Aluminum/Acrylic  
SAE: J845 & W  
Finish: Yellow  
Bulb: 7400 SB, 33,000 CP  
Volts / Amps: 12V / 11.7A  
Lens: Yellow 90373, Blue 90375  
Polycarbonate: Yellow 91323

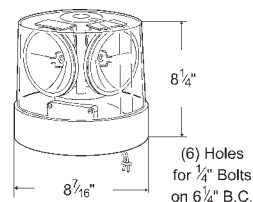

## ECONOLITE WITH REVOLVING REFLECTOR

Single 50 CP bulb with rotating parabolic reflector • Compact economy model • 90 - 100 flashes per minute • Separate round steel mounting plate

**MAGNET MOUNT WITH CIGARETTE LIGHTER ADAPTER:**

**76183**    Yellow w/ 10' cord

Class: III  
Material: Stainless Steel/Acrylic  
Finish: Amber  
Bulb: 1295, 50 CP  
Volts / Amps: 12V / 3.3A  
Lens: Yellow 90383

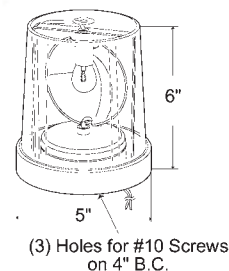

## BELT DRIVE ROTATING BEACON

Flush-mount European-style beacon • E-mark approval • Belt drive with stainless steel bearings • 160 flashes per minute • Thread-on lens, quickly secured with a single screw • Magnet mount versions include 15' coiled cord w/lighter plug

**PERMANENT MOUNT:**

**76043**    Yellow

**76063**    Yellow

**MAGNETIC MOUNT W/ 15' SWITCHED LIGHTER PLUG CORD:**

**76053**    Yellow

Class: I  
Material: Polycarbonate  
Finish: Yellow  
Bulb: H1, 55 Watt (90620)  
Volts / Amps: 12V / 5.2A  
Bulb: H1, 70 Watt (91051)  
Volts / Amps: 24V / 2.4A

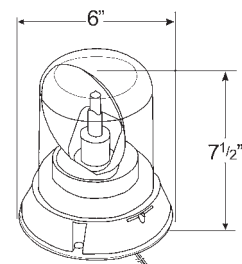

# Warning and Hazard

Gyrophares et Feux d'Avertissement Lámparas de advertencia y precaución

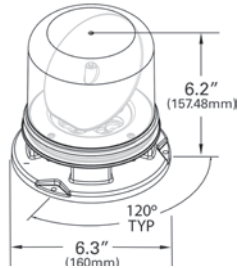

## ROTOLED™ CLASS I LED HYBRID BEACON

High intensity LEDs in a rotating warning device with no gears, brushes or bulbs to wear out • Eight – 3 watt LED's with TIR optics produce an exceptionally bright warning device • SAE J845 Class I (Amber and Clear/Blue)  
 • Temperature range: -22°F to +122° F (-30°C to +50°C) • Polycarbonate lens with UV hard coating – reduces cracking/hazing/fading

**76683** Yellow  
**76685** Blue



Class: Class I (Yellow and Blue)  
 Material: Polycarbonate  
 SAE: J845 (Amber and Clear/Blue)  
 Volts / Amps: 12V - 24V / 1.7A  
 Bracket: 3-bolt Flange/1" Pipe (76683, 76685)

## LOW-PROFILE BELT DRIVE REVOLVING BEACON

Durable belt-drive rotator • 160 flashes per minute • Thread-on lens is quickly secured with a single screw • Flush mount

**76443** Yellow

Class: I  
 Material: ABS/Polycarbonate  
 SAE: J845  
 Finish: Yellow  
 Bulb: H1, 55 Watt  
 Volts / Amps: 12V. / 5.2A  
 Accessory: Bulb: 90620

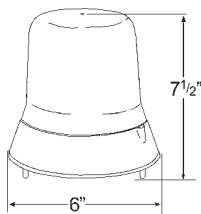

## ECONOMY 360° FLASHING AUXILIARY WARNING LAMP KIT

For use when maximum warning is not required • Bright chrome-plated steel weather-proof base • 60-90 flashes per minute • Flasher can be bypassed for steady burn

**76083** Yellow

Material: Steel/Acrylic  
 Finish: Yellow  
 Bulb: #1295, 50 CP  
 Volts / Amps: 12V / 3.0A  
 Lens: Yellow 90353

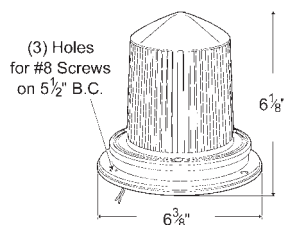

## TEARDROP "KOJAK" LIGHT

Low-power consumption light • Cigarette lighter plug with coiled cord  
• Magnetic mount

<b>76032</b>	Red	<b>RETAIL</b>
<b>76033</b>	Yellow	<b>RETAIL</b>
<b>76035</b>	Blue	<b>RETAIL</b>

Material: Acrylic  
Finish: Red / Yellow / Blue  
Bulb: 67, 4 CP  
Volts / Amps: 12V / 1.64A  
Accessory: Coil Cord: 87090

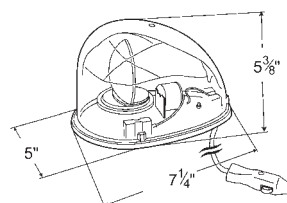

## 17" LOW-PROFILE LED MINI LIGHTBAR

Low profile provides high performance characteristics of LED lighting in a small size • 6 internal LED modules provide 360° light output • Built-in electronic flasher with 46 Scan-Lock™ flash patterns (30 for 76770, 76983, 76993) plus 4 simulated rotating patterns (permanent-mount version only)  
• Permanent mount includes 6" pigtail; magnetic mount includes 8' straight cord with accessory plug that includes LED indicator switch • Permanent mount on 14 1/16" x 3 7/16" hole centers • Mounting hardware and instructions included

### PERMANENT MOUNT:

<b>76983</b>	Yellow
<b>76770</b>	Yellow/Blue, Clear Lens, Dual Function
<b>76943</b>	Yellow, Clear Lens
<b>76985</b>	Blue

### MAGNET MOUNT WITH CIGARETTE LIGHTER ADAPTER:

<b>76993</b>	Yellow
<b>76953</b>	Yellow, Clear Lens

Class: I  
Material: Polycarbonate  
SAE: J845  
Volts / Amps: 12V / 3A peak / 1.2A avg

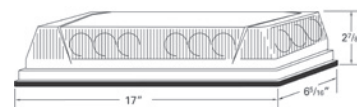

## 15" STROBE MINI BAR LAMP

Compact, low profile design • Hi / lo intensity • Field selectable dual (70) or quad (65) flash • Reverse polarity, voltage, spike and surge protected

<b>77753</b>	Yellow	<b>MULTI</b>
--------------	--------	--------------

Class: II  
Material: Polycarbonate  
SAE: J1318  
Finish: Yellow  
Volts / Amps: 12V - 24V; 12V at 3.8A  
Accessory: Flash Tube: 92970; Vacuum/Magnet Mount Kit: 43090  
Lens: Outer : Yellow 93443

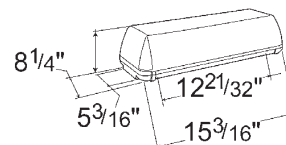

# Warning and Hazard

Gyrophares et Feux d'Avertissement Lámparas de advertencia y precaución

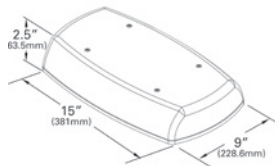
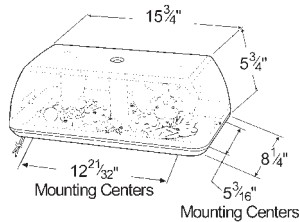
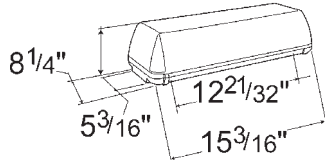
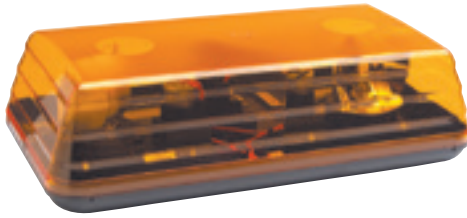

## 15" ROTATING LOW PROFILE BAR LAMP

Permanent-mount hardware included • Dual belt drive rotators • 55 Watt halogen bulbs • 480 flashes per minute • Sleek, low-profile lens design • Silicon belt and stainless steel bearings for long life; belt is resistant to heat and UV light damage

**76813** Yellow

Class: I  
Material: Polycarbonate  
SAE: J845  
Finish: Yellow  
Bulb: #H1, 55 Watt; Volts / Amps: 12V / 10.5A  
Accessory: Motor: Belt Drive 99370; Belt: 99250; Bulb: 90620; Vacuum/Magnet Mount Kit: 43090; Lens: Yellow 93443

## 15" ROTATING MINI-BAR LAMP

Gear-driven versions have a self-lubricating, heavy-duty motor and gear assembly • Belt-driven versions have a silicon belt and stainless steel bearings for long life; belt is resistant to heat and UV light damage • Halogen bulbs • 300 flashes per minute • Separate magnetic mount kit available • Dual rotating reflectors with fixed mirrors

### GEAR DRIVE:

**76803** Yellow

### BELT DRIVE:

**77163** Yellow

### MOUNTING OPTIONS:

**43240** Magnetic Mounting Kit

Class: I  
Material: Polycarbonate  
Finish: Yellow  
Bulb: (2) #90900 50 Watt; Volts / Amps: 12V / 8.8A  
Bulb: (2) #90901 50 Watt; Volts / Amps: 24V / 4.1A  
Accessory: Motor: Gear Driven 99260; Belt Driven 99370; Belt 99250;  
Bulb: Halogen 12V 90900, 24V 90901; Replacement Mirror: 99230; Clear 92881  
Lens: Yellow 92883

## 15" LOW PROFILE REFLEX™ CLASS II LED MINI BAR LAMP

Effective 360° visibility to hazardous conditions • Eight (8) LED reflector modules each containing 3 high intensity LED's • Polycarbonate lens and base • Low power draw • LED technology minimizes maintenance and repair downtime

**76703** Yellow, Permanent Mount



Material: Polycarbonate  
Volts / Amps: 12V - 24V/3.5A

## LED SAFETY DIRECTOR, DIRECTIONAL LIGHT



Extruded aluminum housing and clear polycarbonate LED module (illuminates yellow) • Epoxy-sealed electronics provide maximum environmental protection • Wigwag and alternating flash patterns • 35 ft. cable length

**78473**    Yellow

Class: I  
Material: Aluminum/Polycarbonate  
SAE: J845  
Finish: Clear/ Yellow  
Volts / Amps: 12V - 7A  
Replacement Modules: 78843

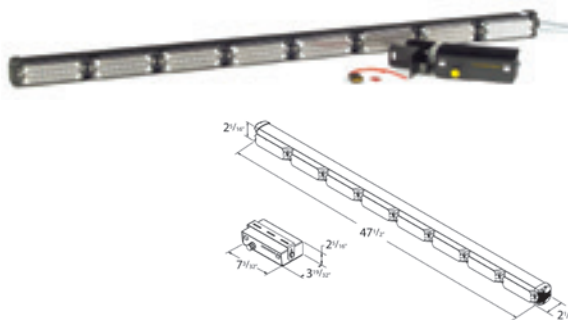

## OVAL STROBE HEAD

Twist-in socket design for flash tube replacement • Vibration and shock resistant construction • Polycarbonate lens and base

**77263**    Yellow    **MULTI**

Material: Polycarbonate  
Finish: Yellow  
Volts / Amps: 12V - 24V / 2.25A at peak  
Accessory: Flash Tube/Pigtail: 92820; Cable Assembly: 15' 67060, 35' 67061  
Bracket: 43100, 43362  
Grommet: 92420, 92720

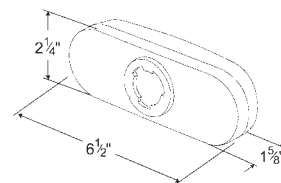

## STROBE POWER MODULE

The Grote 99630 'X' control strobe module is ideal for use on refuse and waste management vehicles, yard work machines and construction vehicles using a 12 V power system - wherever a strobing 'X' pattern is desired. This module will provide the necessary strobing functionality with both LED oval and round lamp systems. The system utilizes Grote designed and built circuitry for optimum signal management. Unit is designed with over-voltage circuit protection and signal and backup over-rides turn strobe function off when the backup, left and right turn signals are engaged.



**99630**    Strobe Power Module

Class: II Strobe Function Only  
Material: Polycarbonate  
Strobe Function: 'X' Pattern function  
Input Voltage: 12.8V  
Dimensions: 1.265 high x 5.44 inches long  
Max amp draw: Unit contains a 5 AMP fuse  
Unit comes complete with: Slimline molded .180 male bullets and Slimline female plugs for ease of connection to Grote UBS systems





# Warning and Hazard

Gyrophares et Feux d'Avertissement Lámparas de advertencia y precaución

LED

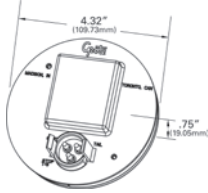
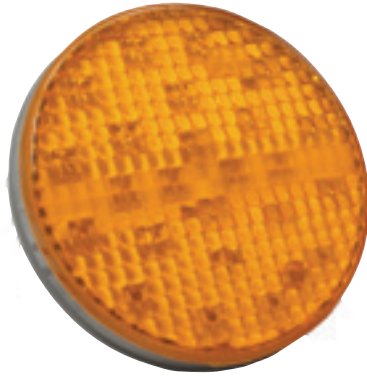

## 4" LED STROBE LIGHTS

Encapsulant potting offers maximum protection of the circuit board against dirt, moisture and corrosion • Internal circuitry eliminates the need for an external power supply or control module • Requires only a 12 Volt DC connection for power • Functions as either a dual flash strobe or a quad flash strobe • Lamps fit 4 inch standard mountings • Lamps mount in any orientation • Grote's rugged Plug-and-Go® terminals make for a quick, easy connection every time

<b>77352</b>	Red
<b>77353</b>	Yellow
<b>77355</b>	Blue

Class: II - Red, Yellow; III - Blue  
 Material: Polycarbonate/Acrylic  
 Finish: Red / Yellow / Blue  
 Volts / Amps: 12V / .25A  
 Bracket: 43253, 92510, 92512, 92513, 43572, 43642, 43655; Grommet: 91740, 91950;  
 Pigtail: 66815, 66841, 67002, 66842, 67013, 66816, 66845, 67005, 66823, 66830, 67016, 66846

LED

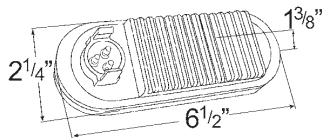

## OVAL LED STROBE LIGHTS

Encapsulant potting offers maximum protection of the circuit board against dirt, moisture and corrosion • Internal circuitry eliminates the need for an external power supply or control module • Requires only a 12 Volt DC connection for power • Functions as either a dual flash strobe or a quad flash strobe • Lamps fit oval standard mounting holes • Lamps mount in any orientation • Grote's rugged Plug-and-Go® terminals ensure a quick, easy connections every time

<b>77361</b>	Clear
<b>77362</b>	Red
<b>77363</b>	Yellow
<b>77365</b>	Blue

Class: II - Red, Yellow (quad); III Blue, Yellow (dual)  
 Material: ABS/Acrylic  
 Finish: Clear / Red / Yellow / Blue  
 Volts / Amps: 12V / .25A  
 Bracket: 43362, 43952, 43220, 43223, 43222, 43100; Grommet: 92420, 92720  
 Pigtail: 66815, 66841, 67002, 66842, 67013

LED

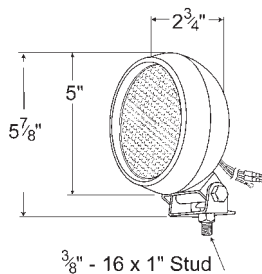

## LED STROBE LAMP IN RUBBER HOUSING

Durable rubber lamp housings • Versatile mounting (hardware included)  
 • Molded UBS .180 bullet terminals • Pre-wired for quad or dual flash

<b>77192</b>	Red
<b>77193</b>	Yellow

Class: II - Red, Yellow; III - Blue  
 Material: Rubber/Polycarbonate/Acrylic  
 Finish: Black / Red / Yellow  
 Volts / Amps: 12V / .25A  
 Accessory: Lamp: Red 77352, Yellow 77353, Blue 77355, Clear 77351;  
 Housing 64930; Magnet Mount 43300

## SURFACE MOUNT CLASS I LED LIGHT HEAD

24 – 1 watt, high intensity LED's • 16 flash patterns including single, double, quad, and cycle all • Synchronizable with multiple light heads  
 • UV stabilized polycarbonate lens and 9' cable • SAE J595 Class I  
 • Temperature range: -22°F to +122°F (-30°C to +50°C)

**76653** Yellow

Class: 1  
 Material: Polycarbonate  
 SAE: J595  
 Volts / Amps: 12V / .75A

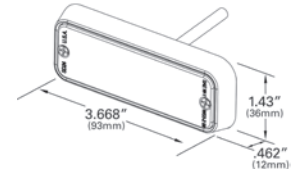

## HIGH-OUTPUT LED DIRECTIONAL LIGHT SURFACE OR GROMMET MOUNT

42 individual 1/4 watt LEDs with individual reflectors • Tough, clear polycarbonate housing with urethane encapsulated electronics  
 • 75 to 80 flashes per minute

**77773** Yellow

Class: I  
 Material: Polycarbonate  
 SAE: J845  
 Finish: Yellow  
 Bulb: 12V  
 Volts / Amps: 12.8V / .90A  
 Grommet: 92420, 92720

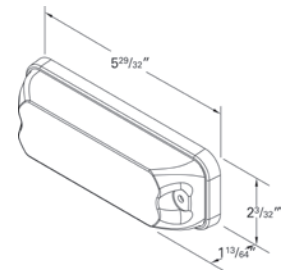

## LED DIRECTIONAL WARNING LAMP

Versatile LED directional warning light can be synchronized with up to 8 interconnected modules and 25 different built-in flash patterns • Fully-encapsulated, sturdy polycarbonate construction coupled with a dependable gasket design ensures superb moisture and vibration resistance  
 • Self-contained high intensity, wide angle LED module • Horizontal/vertical surface mount

**77461** Clear  
**77462** Red  
**77463** Yellow  
**77465** Blue

Class: Class I  
 Material: Polycarbonate/Aluminum  
 SAE: J595 and J845  
 Finish: Clear / Red / Yellow  
 Volts / Amps: 12V / .40A peak  
 Volts / Amps: 12V / .16A ave.  
 Bracket: 94652, 94662

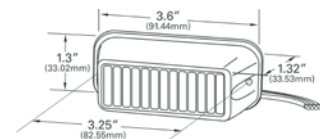

# Warning and Hazard

Gyrophares et Feux d'Avvertissement Lámparas de advertencia y precaución

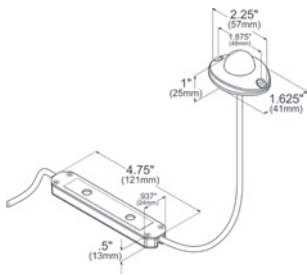

97942 Flange



97943 Flange

## LED VERTEX™ HIDEAWAY STROBE LAMP

Ultra small, self-contained, hemispheric LED light for surface or internal mount within composite headlight, cornering lights and taillight assemblies.

- Flange kit options (in black or chrome) allow easy surface mounting anywhere on your vehicle.
- 25 Scan-Lock™ flash patterns include a synchronize feature for alternating and synchronous flashing of multiple lamps.
- Simple installation: with no separate lamp drivers, flashers, ballast or power supplies to install
- 9 ft. cable length

<b>77931</b>	Clear	<b>MULTI</b>
<b>77932</b>	Red	<b>MULTI</b>
<b>77933</b>	Yellow	<b>MULTI</b>

Class: 5  
 Material: Polycarbonate / Aluminum  
 SAE: J1113-41  
 Finish: Clear / Red / Yellow  
 Volts / Amps: 10V - 16V  
 Bracket: 97943 Black, 97942 Chrome

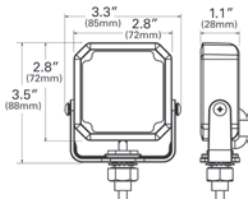

## AUXILIARY LED STROBE LAMP

4 high power LEDs with 19 flash patterns • Synchronize option lets you connect multiple heads • Mount anywhere with adjustable bracket

- Compact unit with robust aluminum housing for all types of 12V - 24V application

<b>76795</b>	Blue	<b>MULTI</b>
<b>76793</b>	Yellow	<b>MULTI</b>

SAE: Class II, Title XIII, e13 certified  
 Material: Aluminum  
 Finish: Black  
 Volts / Amps: 11V - 30VDC / 12V at .055A; 24V at .026A

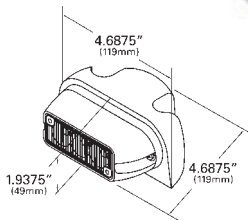

## WING-TIP LED SNOWPLOW LAMPS

Fully encapsulated housing makes LED modules resistant to vibration, water, and salt and chemical resistance • Water-proof heavy-duty TPR cabling with built-in strain relief connectors is standard • Set of two light heads (Sold separately) provides complete coverage whether snowplow blade is down and in use or in the stored travel position • Super effective Class I LED strobe light modules have 11 light patterns to choose from

<b>78573</b>	Vertical
<b>78563</b>	Horizontal

Class: Class I  
 Material: Die-Cast  
 SAE: J845  
 Finish: Clear  
 Volts / Amps: 12V / .16A avg. / .4A peak

## REPLACEMENT FLASH TUBES

Grote offers several options for replacement flash tubes • See part listing for recommended tube replacement part number

- 92960**    3-Pin, Hard Shell Connector
- 92970**    3-Pin, Needle Style
- 92980**    3-Pin, Flat Pin Style



92960

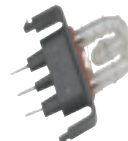

92970



92980

## PROFESSIONAL EMERGENCY FLASHER

Wigwag pattern • Hi-beam override • Completely sealed in epoxy potting  
• Not for use with negative-activation headlight systems

**44740**    Flasher

Volts / Amps: 12V / 20A max each side

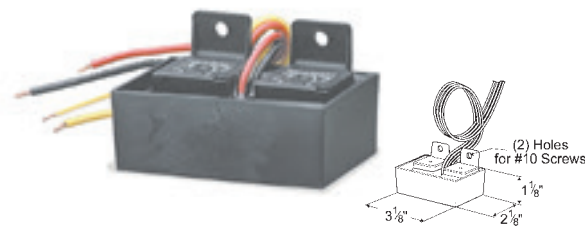

## ACTUATION SWITCH

Often utilized with back-up alarms • Activates when shifting vehicle into reverse

**44134**    Switch    **MULTI**

Material: Steel  
Finish: Zinc Plate  
Volts / Amps: 12V - 36V / 5A max

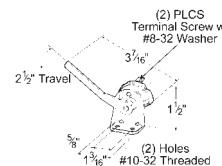

## ACTUATION SWITCH

Heavy-duty usage • Mechanical actuation • Includes mounting bracket and weather-proof compression fitting

**44421**    Switch    **MULTI**

Material: DURAMOLD® / Steel  
Finish: Zinc  
Volts / Amps: 12V - 80V / 10A max

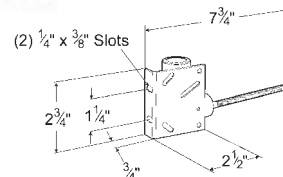

## FULL-FEATURED SIREN (POLICE/FIRE PROFESSIONAL)

100 Watt output • Wail / Yelp / Hi-low plus horn • Public address function • Built-in microphone

**87781**    Black

Volts / Amps: 12V

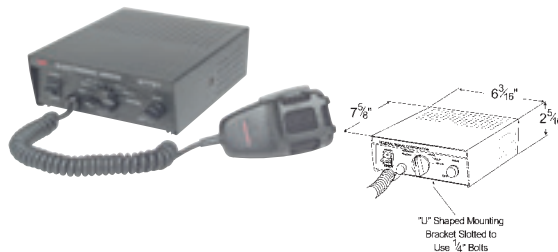

# Warning and Hazard

Gyrophares et Feux d'Avertissement Lámparas de advertencia y precaución



## 100-WATT SPEAKER

Mates with Grote Full-Featured Siren (87781) • Outside or concealed mounting • 120 decibels at 10 ft.

**87790** Speaker

Volts / Amps: 12V / 3.57A

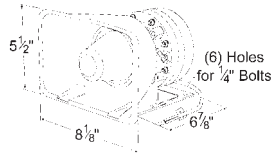

## HEAVY-DUTY SMART ALARM® BACKUP ALARM

Electronics sealed in epoxy for protection against dust, vibration and moisture • Measures ambient noise level and instantly self adjusts to at least 5 decibels louder • Automatically adjusts to eliminate user confusion on which volume to select • Volume: 87 to 112 decibels • Universal mount

**73080** 87 to 112 Decibels, Smart Alarm **MULTI**

Material: Nylon  
FMVSS: F  
Finish: Blue  
Volts / Amps: 12V - 24V / .6A

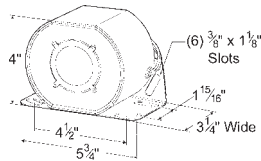

## FIELD-SELECTABLE BACKUP ALARM

Electronics sealed in epoxy for protection against dust, vibration, and moisture • Adjusts to SAE type A or B for medium to high noise • 12 to 36 volts • Selectable volume control, 107 or 112 decibels by reversing the leads • Universal mount

**73030** 107 or 112 Selectable Decibels **MULTI**

Material: Nylon  
SAE: J994 Type A or B  
Finish: Blue  
Volts / Amps: 12V - 36V / .6A at 12V

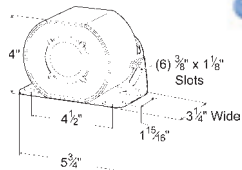

## 4" GROMMET MOUNTED BACKUP ALARM

Mounts in standard 4" grommet (grommet not included) • Epoxy sealed to protect against dust, moisture and, vibration

**73160** 112 Decibels **MULTI**

Material: Nylon  
SAE: J994 Type A  
Finish: Black  
Volts / Amps: 12V - 36V / .4A at 12V  
Grommet: 91740

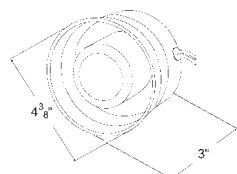

## 4" ECONOMY GROMMET MOUNTED BACKUP ALARM

Mounts in standard 4" grommets • Electronics completely encapsulated in potting for total circuit board protection • Grommet style mounting for added protection against damage and knock-offs from debris • Features Grote's hardwired UBS bullet termination to create a sealed wiring connection

**73220**    97 Decibels



Material: Nylon  
SAE: J994 Type C  
Finish: Black  
Volts / Amps: 12V -24V /.2A at 12V (DC)  
Grommet: 91740  
Pigtail: 66200

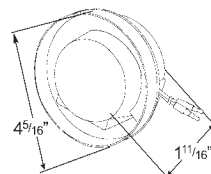

## MEDIUM NOISE SURROUND BACKUP ALARM

Features hardwire terminations • Integral mounting bracket • Electronics completely encapsulated in potting for total circuit board protection

**73250**    107 Decibel



**73240**    82 to 107 Decibels, Smart Alarm®



Material: Nylon  
SAE: J994 73250 - Type B  
Finish: Blue  
Volts / Amps: 12V - 36V (73250); 12V (DC) at 1.7A  
Volts / Amps: 12V - 24V (73240); 12V (DC) at .3A

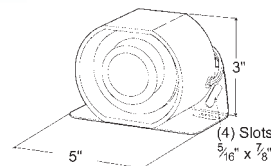

## MEDIUM / LOW NOISE SURROUND BACKUP ALARM

Electronics sealed in epoxy for protection against dust, vibration and moisture • Self-grounding, eliminates potential corrosion points  
• Universal integral mounting bracket • Voltage-spike and surge-protected  
• UL Approved

**73040**    97 Decibels, w/ Wire Studs

**73040-5**    97 Decibels, w/ Wire Studs

**73090**    107 Decibel w/ Wire Leads

**73110**    92 to 102 Decibels, Smart Alarm®



Material: Nylon  
SAE: J994 : 73090 - Type B; 73040 - Type C  
Finish: Blue  
Volts / Amps: 12V - 24V / .4A at 12V

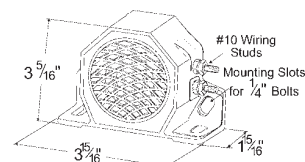

# Warning and Hazard

Gyrophares et Feux d'Avertissement Lámparas de advertencia y precaución

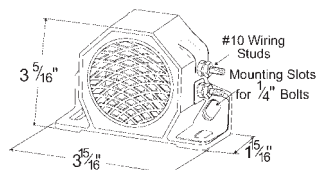

## BEeping BACKUP HALOGEN BULB

Combination audible back-up safety device and lamp in one • Provides a clear beeping sound when vehicle shifts into reverse gear • Alarm does not meet OSHA or SAE J994 requirements for commercial back-up alarms

BAYONET BASE: (1156 REPLACEMENT)

**73140-5** RETAIL

WEDGE BASE: (3156 REPLACEMENT)

**73150-5** RETAIL

Volts / Amps: 12V / 1.67A

## ELECTRIC AUTOMOTIVE HORNS

Complete with mounting bracket

FOR IMPORT VEHICLES:

**72010-5** High, 135 Decibels RETAIL

**72050-5** Low RETAIL

FOR DOMESTIC VEHICLES:

**72100-5** High, 125 Decibels RETAIL

**72110-5** Low RETAIL

Material: Steel  
SAE: J377  
Finish: Black Enamel  
Volts / Amps: 12V

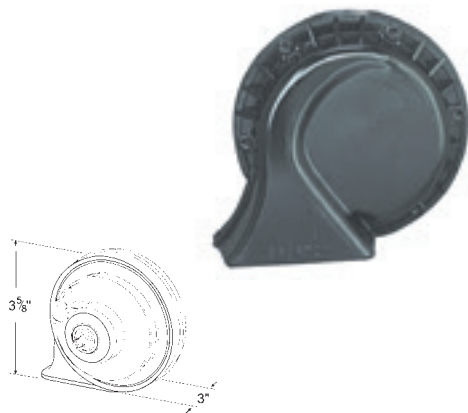

## VARIABLE-LOAD ELECTRONIC LED FLASHER

60 to 120 flashes per minute • Heavy-duty contacts; external wire provides ground • Steady flash rate for all LED and incandescent loads • Fits in round flasher socket • Flash rate is electronically controlled

**3 TERMINAL (PILOT):**

**44890** Flasher

**2 TERMINAL:**

**44891** Flasher

FMVSS: 108; SAE J945, J590  
Volts / Amp: 12V / 1A to 20A; 1 to 10 Lamp Load (Incandescent)

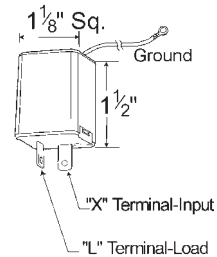
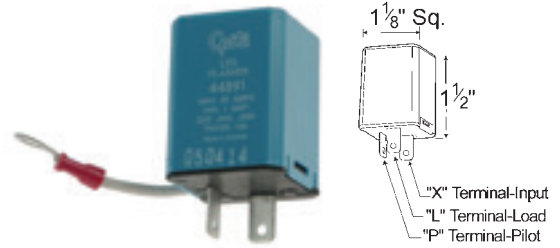

## 3-PIN LED FLASHER

3-pin electronic LED flasher, 12-Volt • Max load: 20 Amps • Min Load: .25 Amps • Flash rate: 60-120 flashes per minute

**44110** Flasher

FMVSS: 108; SAE J945, J590

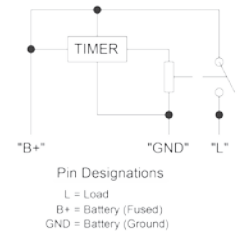
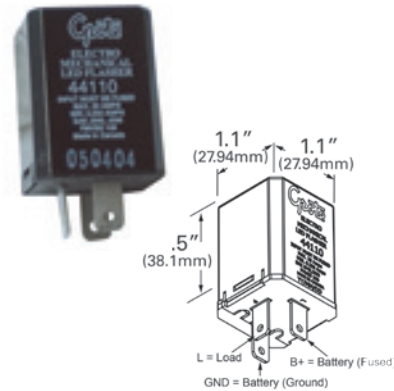

## 5-PIN ELECTRONIC LED FLASHER

Direct replacement for OE flasher • Doesn't require a separate ground wire; uses factory wiring • Provides a steady flash rate for turn signals and hazard lamps even when using LED lamps • Electronic controlled flash rate, maintains the legally compliant flash rate.

**5 PIN:**

**44090** ISO Terminals

FFMVSS: 108; SAE J945, J590  
Volts / Amp: 12V / 1 to 20A

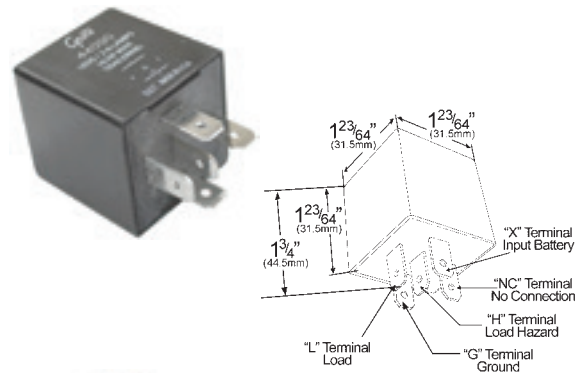

## 13-PIN ELECTRONIC LIGHTING CONTROL MODULE

Maintains factory flash rate when retrofitting to LED lamps • Direct replacement to OEM lighting control module for easy retrofit and replacement • Operates DRL, flasher, brake light control and trailer lamps on 2003 GM® full size vans or later • Replaces GM25746427

**44160** 13-Pin

FMVSS: 108; SAE J945, J590  
Volts / Amp: 12V / 162 Watts max

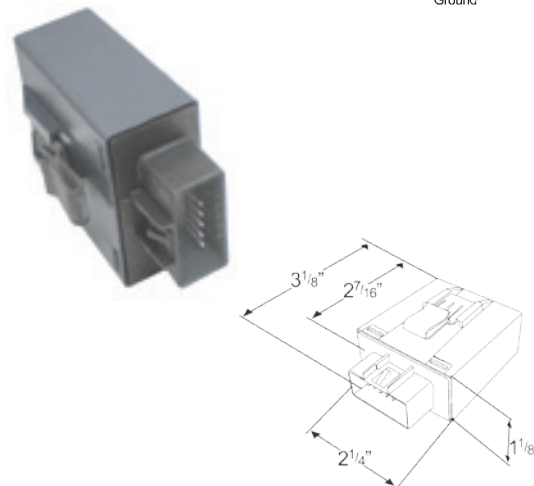



# Flashers and Turn Signal Switches

Clignotants et Commutateurs Palancas Direccionales / Destelladores

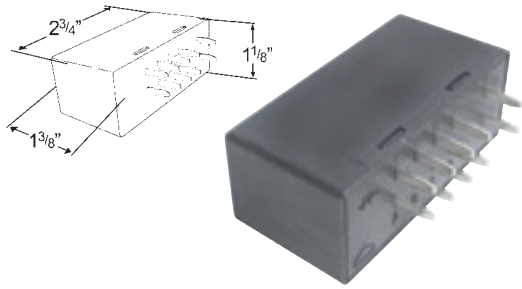

## 10-PIN ELECTRONIC LIGHTING CONTROL MODULE

Maintains factory flash rate when retrofitting to LED lamps

- Direct replacement to OEM lighting control module for easy retrofit and replacement
- Replaces GM12450284

**44140** 10-Pin

FMVSS: 108; SAE J945, J590

Volts / Amp: 12V / 25A max; Lamp Load: 12 lamps max



## 10-LAMP ELECTROMECHANICAL FLASHER

Molded base and terminals • Heavy-duty contacts • 60-120 flashes per minute

**2 TERMINAL:**

**44810** Flasher

**44810-5** Flasher **RETAIL**

**3 TERMINAL (PILOT):**

**44820** Flasher

FMVSS: 108; SAE J945, J590

Volts / Amp: 12V / 2 to 20A; Lamp Load: 1-10 lamps

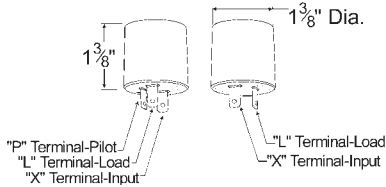

## 12-LAMP ELECTROMECHANICAL FLASHER

60 to 120 flashes per minute • Available in standard (12-Volt) and 24-Volt models • Less than 4 mill volts per amp voltage drop • Exceeds SAE 100-hour test • Fits in a round flasher socket

**2 TERMINAL:**

**44530** Flasher

**44530-5** Flasher **RETAIL**

**44850** Flasher **24 VOLT**

**3 TERMINAL (PILOT):**

**44540** Flasher

**44540-5** Flasher **RETAIL**

**44860** Flasher **24 VOLT**

FMVSS: 108; SAE J945, J590

Volts / Amp: 12V / 2 to 25A; Lamp Load: 1-12 lamps

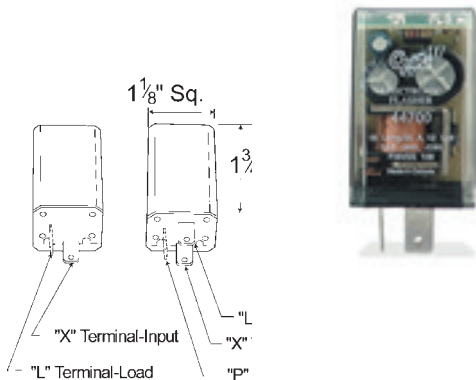
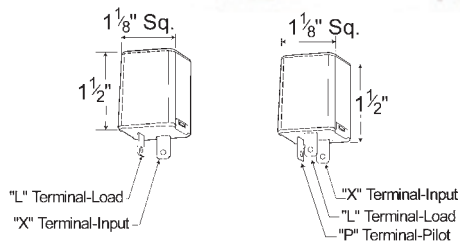

## 16-LAMP ELECTRONIC FLASHER

60 to 120 flashes per minute • 11 to 15-Volts DC • Less than 4-millivolts per amp voltage drop • Exceeds SAE 100-hour test • Fits in a round flasher socket

**2 TERMINAL:**

**44690** Flasher

**3 TERMINAL (PILOT):**

**44700** Flasher

FMVSS: 108; SAE J945, J590

Volts / Amp: 12V / 2 to 33A; Lamp Load: 1-16 lamps

## 20-LAMP HEAVY DUTY ELECTRONIC FLASHER

60 to 120 flashes per minute • 11 to 15-Volts DC • Less than 3-millivolts per amp voltage drop • Fits standard round socket • Exceeds SAE 100-hour test

<b>2 TERMINAL:</b>	
<b>44710</b>	Flasher
<b>3 TERMINAL:</b>	
<b>44720</b>	Flasher

FMVSS: 108; SAE J945, J590  
Volts / Amp: 12V / 2 to 42A; Lamp Load: 1-20 lamps

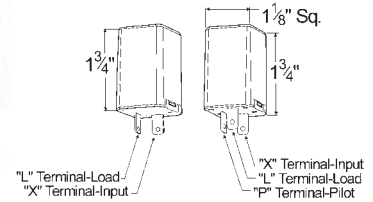

## NORTH AMERICAN (J50) PINOUT

Heavy-duty contacts • 44750 only, lamp outage at one lamp • Flash rate electronically timed • Fits most Dodge®, Ford®, Honda®, Mitsubishi®, Nissan®, and Subaru® vehicles (see application guide) • Steady flash rate for all incandescent and LED leads

<b>3 TERMINAL:</b>	
<b>44892</b>	Flasher

FMVSS: 108; SAE J945, J590  
Volts / Amp: 12V / 1 to 20A; Lamp Load: 1-10 Lamps

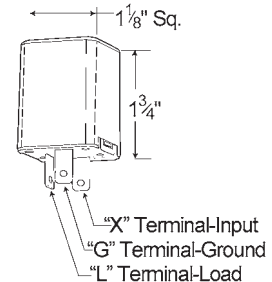

## EUROPEAN (ISO) PINOUT

Heavy-duty contacts • Flash rate electronically timed • Fits most Toyota®, Chrysler®, and pre '92 Chevrolet® ST Trucks (see application guide) • Steady flash rate for all incandescent and LED leads

<b>3 TERMINAL:</b>	
<b>44893</b>	Flasher

FMVSS: 108; SAE J945, J590  
Volts / Amp: 44893 - 12V / 1 to 20A; Lamp Load: 1-10 Lamps

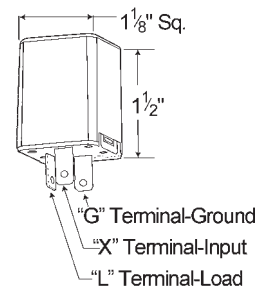

## 6-LAMP HEAVY-DUTY ALTERNATING ELECTRONIC FLASHER

11 to 15-Volts DC • Less than 4-millivolts per amp voltage drop

<b>3 TERMINAL:</b>	
<b>44730</b>	Flasher

FMVSS: 108; SAE J945, J590  
Volts / Amp: 12V / 25A; Lamp Load: 1-10 lamps

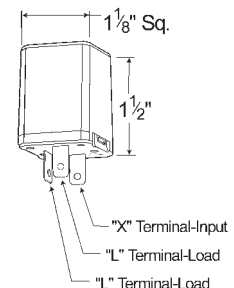

# Flashers and Turn Signal Switches

Clignotants et Commutateurs Palancas Direccionales / Destelladores

## Flasher Application Guide

Variable-load flashers may not have lamp outage indicators and may continue to flash at a normal rate even though one or more bulbs have failed. Inspect your lighting system frequently and replace any burned-out bulbs immediately. These flashers are designed for heavy-duty or trailer load applications.

### Acura

Year	Vehicle / Model	Exceptions	Part
1991-1986	Legend		44810
1997-1986	All others	CL, NSX, RL	44892

### AMC

Year	Vehicle / Model	Exceptions	Part
1988-1975	All		44810

### Audi

Year	Vehicle / Model	Exceptions	Part
1991-1970	All	1986 5000S / CS and CS Turbo Quattro and 1997 A4	44893

### BMW

Year	Vehicle / Model	Exceptions	Part
1974-1976	All		44820

### Buick

Year	Vehicle / Model	Exceptions	Part
1996-1992	Century		44810
1990-1985	Electra		44810
2005-2000	LeSabre		44140
1997	LeSabre		44810
2007-2004	Ranier		44140
2007-2002	Rendezvous		44140
1997	Riviera		44810

### Cadillac

Year	Vehicle / Model	Exceptions	Part
1993-1970	All	Allante, 1993 El Dorado and older	44810
1997-1994	All	others below	44892
1999-1989	Seville and STS	1990 Seville	44892
1997-1994	Catera		44810
1997-1994	Fleetwood		44810
2006-2003	Escalade		44140
1996-1970	All	1996 Skylark	44810

### Chevrolet / GMC

Year	Vehicle / Model	Exceptions	Part
Pre-1997	2-Terminal Flasher	others if noted below	44810
Pre-1997	3-Terminal Flasher	others if noted below; LUV, 1985-1988 Nova, 1980-1984 El Camino, 1982 Suburban	44893
Pre-1993	3-Terminal Flasher, Commercial Trucks Only		44540
2006-2003	Avalanche		44140
1988-1987	Spectrum		44892
1988-1987	Sprint		44892
1993-1992	Vans with tow package		44530
2002-1996	Yukon		44120
2001-1998	Blazer		44120
2002-2000	Express		44120
2007-2003	Express		44160
2002-1998	S-Series Pickup		44120
2002-2000	Savanna		44120
2007-2003	Silverado		44140
2002-1999	Silverado		44120
2006-2004	Suburban		44140
2002-1996	Suburban		44120
2006-2003	SSR		44140
2002-2000	Tahoe		44120
2005-2003	Tahoe		44160
2008-2002	Trailblazer		44160

### Chrysler

Year	Vehicle / Model	Exceptions	Part
	2-Terminal Flasher		44810
	3-Terminal Flasher		44893
	5-Terminal Flasher		44090

### Daihatsu

Year	Vehicle / Model	Exceptions	Part
1992-1984	All	Rocky	44892

### Dodge

Year	Vehicle / Model	Exceptions	Part
	2-Terminal Flasher	others noted below	44810
	3-Terminal Flasher	others noted below	44893
1995-1970	All Cars	Monaco, Raider, 1985 Ram Van Wagon and Pickup	44810
1996-1986	Colt		44892
1993-1983	Ram 50		44892
1996-1986	Stealth		44892

### Eagle

Year	Vehicle / Model	Exceptions	Part
1989-1988	Medallion		44820
1996-1994	Summit		44892
1996-1992	Summit Wagon		44892
1993-1990	Talon		44892
1995-1993	Vision		44893

### Fiat

Year	Vehicle / Model	Exceptions	Part
1983-1970	All		44820

### Ford

Year	Vehicle / Model	Exceptions	Part
	2-Terminal Flasher		44810
Pre-1993	3-Terminal Flasher, Commercial Trucks Only		44540
	3-Terminal Flasher		44892
	5-Terminal Flasher		44090
1997-1972	E-Series Truck		44530
1964	Thunderbird		44820

### GMC

Year	Vehicle / Model	Exceptions	Part
2005-2004	Canyon		44140
2008-2002	Envoy		44140
2000-1998	Envoy		44120
2002-1996	Full Size C / K Pickup		44120
2001-1998	Jimmy		44120
2006-2003	Yukon		44140
2007-2003	Savannah		44160
2007-2003	Sierra-Series		44140
1991-1978	All		44810

### Geo

Year	Vehicle / Model	Exceptions	Part
1996-1989	Metro		44892
1997-1989	Prizm		44893
1989	Spectrum		44892
1993-1990	Storm		44892
1995-1989	Tracker		44892

### Honda

Year	Vehicle / Model	Exceptions	Part
	2-Terminal Flasher		44810
	3-Terminal Flasher		44892
1981-1976	Accord		44810

### Hyundai

Year	Vehicle / Model	Exceptions	Part
1988-1986	All		44893
1995-1989	All		44892

### Hummer

Year	Vehicle / Model	Exceptions	Part
2007-2003	H2		44140

### Infiniti

Year	Vehicle / Model	Exceptions	Part
1996-1990	All	1996 I30	44892

## Flasher Application Guide

### International

Year	Vehicle / Model	Exceptions	Part
1980-1974	All		44810

### Isuzu

Year	Vehicle / Model	Exceptions	Part
2006-2003	Ascender		44140
2004-1987	All		44892

### Jaguar

Year	Vehicle / Model	Exceptions	Part
1996-1978	XJ6, XJS, XJ12		44820
1989-1986	XJ6, XJS		44892
1996-1990	XJS		44893

### Jeep

Year	Vehicle / Model	Exceptions	Part
1997-1994	Grand Cherokee		44090
1996-1978	All	1993 Grand Wagoneer, 1996 Grand Cherokee, 1986 CJ and Scramble	44810

### Lexus

Year	Vehicle / Model	Exceptions	Part
1996-1990	All		44893

### Lincoln

Year	Vehicle / Model	Exceptions	Part
	2-Terminal Flasher		44810
	3-Terminal Flasher		44892
	5-Terminal Flasher		44090

### Mazda

Year	Vehicle / Model	Exceptions	Part
1984-1971	2-Pin		44180

### Mercury

Year	Vehicle / Model	Exceptions	Part
	2-Terminal Flasher		44810
	3-Terminal Flasher		44892
	5-Terminal Flasher		44090

### Mitsubishi

Year	Vehicle / Model	Exceptions	Part
	2-Terminal Flasher		44810
	3-Terminal Flasher	others noted below	44892
1989-1987	Precis		44893

### Nissan

Year	Vehicle / Model	Exceptions	Part
	2-Terminal Flasher		44810
	3-Terminal Flasher		44892

### Oldsmobile

Year	Vehicle / Model	Exceptions	Part
	2-Terminal Flasher		44810
	3-Terminal Flasher		44893
	4-Terminal Flasher		44120
	5-Terminal		44090
2004-2002	Bravada		44140

### Peugeot

Year	Vehicle / Model	Exceptions	Part
1991-1982	All		44820

### Plymouth

Year	Vehicle / Model	Exceptions	Part
1991-1975	All		44810

### Pontiac

Year	Vehicle / Model	Exceptions	Part
	2-Terminal Flasher		44810
	3-Terminal Flasher		44893
	5-Terminal		44090
2005-2001	Aztec		44140
1991-1989	LeMans		44892

### Porsche

Year	Vehicle / Model	Exceptions	Part
	2-Terminal Flasher	others noted below	44810
	3-Terminal Flasher	others noted below	44893
1986-1978	924 (Hazard Flasher)		44820
1982-1978	928 (Hazard Flasher)		44820
1986-1978	944 (Hazard Flasher)		44820

### Renault

Year	Vehicle / Model	Exceptions	Part
1986-1983	2 Pin		44810
1986-1983	3 Pin		44820
1980-1978	All (Hazard Flasher)		44820
1985-1982	Alliance		44810
1985-1984	Encore		44810
1985-1982	Fuego		44820

### SAAB

Year	Vehicle / Model	Exceptions	Part
1996-1982	All	others noted below	44893
2008-2005	9-7X		44140
1980-1978	99 and 99GL		44892
1980-1978	900		44893
1981	900		44892
1997	9000CS Hatchback		44893
1999	Sonett		44820
1975-1974	All		44820

### Saturn

Year	Vehicle / Model	Exceptions	Part
	All	S-Series	44893

### Sterling

Year	Vehicle / Model	Exceptions	Part
	All		44893

### Subaru

Year	Vehicle / Model	Exceptions	Part
	2-Terminal Flasher		44810
	3-Terminal Flasher		44892

### Suzuki

Year	Vehicle / Model	Exceptions	Part
	All		44892

### Toyota

Year	Vehicle / Model	Exceptions	Part
	All	others noted below	44893
1980-1978	Cresida		44892
1980-1978	Land Cruiser		44810
1997	Previa		44892

### Triumph

Year	Vehicle / Model	Exceptions	Part
1982-1970	All (Turn Flasher)		44810
1982-1970	All (Hazard Flasher)	44820	

### Volkswagon

Year	Vehicle / Model	Exceptions	Part
	All		44893

### Volvo

Year	Vehicle / Model	Exceptions	Part
	All		44893

### Yugo

Year	Vehicle / Model	Exceptions	Part
	All		44820

# Flashers and Turn Signal Switches

Clignotants et Commutateurs Palancas Direccionales / Destelladores



## NON-LATCHING HEADLAMP DIMMER RELAY

Used for converting from floor mounted dimmer switch to turn signal switch with lift-to-dim feature • Heavy-duty contact design provides years of trouble-free operation

**44460** Relay

Volts / Amp: 12V / 20 to 30A capacity

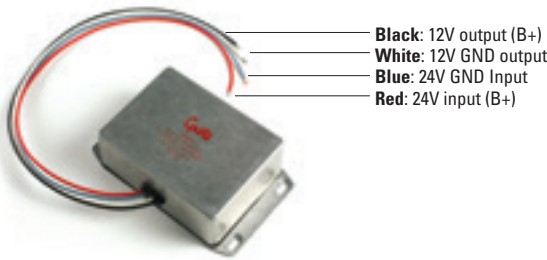

**Black:** 12V output (B+)  
**White:** 12V GND output  
**Blue:** 24V GND Input  
**Red:** 24V input (B+)

## 24-TO 12-VOLT CONVERTER

Allows use of 12-Volt lighting/accessories on 24-Volt vehicles • Rugged die-cast housing • Solid-state, fully potted electronics

**44070** Converter **MULTI**

Material: Aluminum  
 Finish: Bright  
 Volts / Amp: 18 to 32V input, 13.8V output / 3A max

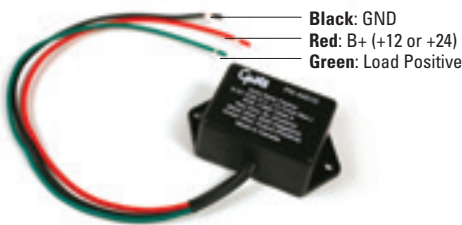
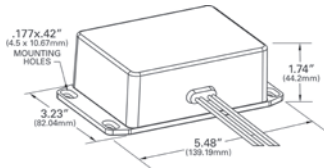

**Black:** GND  
**Red:** B+ (+12 or +24)  
**Green:** Load Positive

## SOLID-STATE ELECTRONIC FLASHER

Designed for use with LED lighting • Provides steady flash rate over any load up to 12 Amps • Fully-potted, solid-state electronics • Self-resetting feature provides internal protection against short circuits

**44010** 3-Wire **MULTI**  
**44030** Alternating Flasher **MULTI**

Material: Aluminum  
 Finish: Black  
 FMVSS: 108; SAE J945, J590  
 Volts / Amp: 12V - 24V / 12A max (44030: 6A per side)

44010

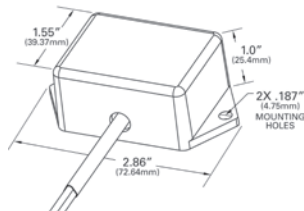
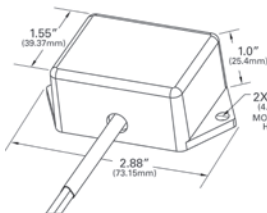

**Black:** GND  
**Red:** B+ (+12 or +24)  
**Green:** Load 1  
**Green:** Load 2

44030

## TURN SIGNAL SWITCH WITH FLASH-TO-PASS AND MARKER FLASH

Provides 2 M-4 threaded holes for column mounting • 18-bulb capacity makes switch ideal for triple-trailer configurations • Replaces Grote® 01-4840-70 / 71 • Replaces Mack® 1MR574

**48402**



## UNIVERSAL 7-WIRE / 4-WIRE TURN SIGNAL SWITCH KIT

Replaces Truck-Lite® and Signal-Stat® 900-902, 920 and 2900-3 • Includes switch, mounting hardware and 24" blunt-cut, harness • 4- or 7- wire system • Adapts to applications without brake override functions • For applications with floor-mounted dimmer switch • 18 bulb capacity makes switch ideal for triple trailer configurations • Compatible with 24-Volt systems if indicator bulb is replaced with Grote's 24-Volts bulb (1450) • Mounting hardware kit includes threaded inserts with screws for mounting to existing brackets and a worm gear clamp with a range of 1.6" to 2.5" for mounting to circular column tubes

**48072** Turn Signal Switch Kit

FMVSS: Q  
Finish: Black  
Bulb: (Indicator) 53, 1 CP  
Voltage/Amp: 12V / .12A  
Accessory: Switch: 48272; Harness: 69680



## UNIVERSAL TURN SIGNAL SWITCH

Universal replacement without hi-low beam function • 18-bulb capacity makes switch ideal for triple-trailer configurations • Mounting hardware kit includes tapped inserts with screws for mounting to existing brackets and a worm gear clamp with a range of 1." to 2.5" for mounting to circular column trucks • Integral RH and LH turn / hazard indicator lights • Adapts to applications without brake override functions • Compatible with 24-Volt systems if indicator bulb is replaced with Grote's 24-Volt bulb (1450)

**48272** Turn Signal Switch

FMVSS: Q  
Finish: Black  
Bulb: (Indicator) 53, 1 CP; Voltage/Amp: 12V / .12A  
Accessory: Harness: 69680



## UNIVERSAL TURN SIGNAL SWITCH WITH LIFT-TO-DIM

18 bulb capacity makes switch ideal for triple trailer configurations • Mounting hardware kit includes tapped inserts with screws for mounting to existing brackets and a worm gear clamp with a range of 1."-2.5" for mounting to circular column trucks • Adapts to applications without brake override functions

**48282** Universal Turn Signal Switch

FMVSS: Q  
Finish: Black  
Accessory: Harness: 69690



# Flashers and Turn Signal Switches

Clignotants et Commutateurs Palancas Direccionales / Destelladores



## UNIVERSAL REPLACEMENT HARNESS

Fits 48272 switch • Overall length of 24" is sufficient for most applications  
 • Flexible, black PVC loom adds protection without adding rigidity • 4 to 7 wire system compatible • Includes circuitry for switches with integral RH and LH turn/hazard indicator light

**69680** Universal Harness



## UNIVERSAL PLUG-IN 12 WIRE HARNESS FOR SWITCHES WITH CRUISE OR WIPER CONTROL

Overall length of 24" is sufficient for most applications • Flexible PVC loom adds protection without adding rigidity • Provides 12 connections for any Grote switch requiring up to 12 circuits • Provides circuits for cruise control, wiper control, flash-to-pass or marker flash • Use with switch numbers 48442 or 48563

**69681** Harness

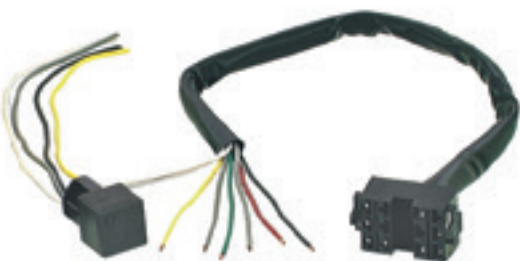

## UNIVERSAL PLUG-IN WIRING HARNESS WITH LIFT-TO-DIM

Fits 48282 switch • Includes 44460 non-latching relay • Includes connector for headlamp relay • 4 to 7 wire system compatible • Overall length of 24" is sufficient for most applications • Flexible, black PVC loom adds protection without adding rigidity

**69690** Universal Harness



## KENWORTH® OEM REPLACEMENT SWITCH WITH HARNESS

Replaces Freightliner® GRO 01-4811-87, Grote® 01-4811-87, and Paccar® K301-295-3 • Black worm gear mounting clamp included • OEM-style, 20" plug-in wiring harness included • 18-bulb capacity makes switch ideal for triple-trailer configurations

**48532** Turn Signal Switch Kit

FMVSS: Q  
 Finish: Black

## FREIGHTLINER® OEM REPLACEMENT SWITCH

Replaces Freightliner® GRO 01-4811-77 • 18-bulb capacity makes switch ideal for triple-trailer configurations • Plugs into OE harness on truck • Mounts with a separate worm gear clamp

**48522** Turn Signal Switch Kit

FMVSS: Q  
Finish: Black



## OEM-STYLE TURN SIGNAL SWITCH

Replaces Freightliner® GRO 01-4811-82 • Includes 15" plug-in harness with fuse holder • 18-bulb capacity makes switch ideal for triple-trailer configurations • Mounts with separate worm gear clamp

**48542** Turn Signal Switch

FMVSS: Q  
Finish: Black



## OEM-STYLE TURN SIGNAL SWITCH

Replaces Freightliner® GRO 01-4813-80 and GRO 01-4813-81 • 18-bulb capacity makes switch ideal for triple-trailer configurations • Mounting bracket included

**48552** Turn Signal Switch

FMVSS: Q  
Finish: Black



## OEM-STYLE TURN SIGNAL SWITCH FOR PACCAR®

Replaces PACCAR® 01-4813-91, TRW® 480819 without harness • 18-bulb capacity makes switch ideal for triple-trailer configurations • Adapts to applications without brake override function • Provides hazard / warning, right / left turn, lift-to-dim functions

**48132** Turn Signal Switch

FMVSS: Q  
Finish: Black





# Flashers and Turn Signal Switches

Clignotants et Commutateurs Palancas Direccionales / Destelladores



## OEM-STYLE TURN SIGNAL SWITCH FOR INTERNATIONAL®

Replaces International® 354493C92 without harness • 18-bulb capacity makes switch ideal for triple-trailer configurations • Adapts to applications without brake override function • Provides hazard / warning, left / right turn, lift-to-dim functions

**48283** Turn Signal Switch

FMVSS: Q  
Finish: Black



## UNIVERSAL OEM-STYLE RUBBER-GRIP TURN SIGNAL SWITCH

New style 1" diameter rubber grip • 18-bulb capacity makes switch ideal for triple-trailer configurations • Adapts to applications without brake override function • Provides hazard / warning, left / right turn, lift-to-dim functions • Mounting hardware kit includes tapped inserts with screws for mounting to existing brackets and a worm gear clamp with a range of 1" to 2.5" for mounting to round columns

**48284** Turn Signal Switch

Reflective: Q  
Finish: Black



## OEM-STYLE MARKER / FLASH TURN SIGNAL SWITCH FOR PACCAR®

Replaces PACCAR® 01-4843-75, TRW® 480829 without harness • Chrome-plated end push-button for flashing marker lamps • 18-bulb capacity makes switch ideal for triple-trailer configurations • Adapts to applications without brake override function

**48432** Turn Signal Switch

Reflective: Q  
Finish: Black



## OEM-STYLE MARKER / FLASH AND WIPER TURN SIGNAL SWITCH FOR INTERNATIONAL®

Replaces International® 2004505C91 without harness • 18-bulb capacity makes switch ideal for triple-trailer configurations • Adapts to applications without brake override function • Provides hazard / warning, left / right turn, lift to dim functions • Mounting hardware kit includes tapped inserts with screws for mounting to existing brackets and a worm gear clamp with a range of 1" to 2.5" for mounting to round columns • Chrome-plated end push-button for flashing marker lamps • Slide switch for 2-speed wiper control

**48442** Turn Signal Switch

FMVSS: Q  
Finish: Black

## 7" X 16" REMOTE-CONTROL HEATED WEST COAST MIRROR

40% lighter than competitive similar models • Stainless steel housing resists corrosion • Complete wiring, control switch and simple installation instructions included

- 28461** Stainless Steel, Heated, Motorized
- 28463** Stainless Steel, Heated, Non-motorized

Material: Stainless Steel  
 Reflective: 94 sq. in.  
 Finish: Stainless  
 Volts / Amps: 12V / 3.1A  
 C-Loop Bracket: 22233/22232  
 Bracket: 22013, 22063, 22061

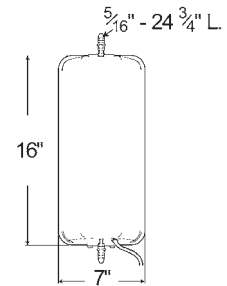

## ICE & FROST-FREE HEATED WEST COAST MIRROR

OEM-style, 7"x16" mirror head • Internal heating element

- 16053** Stainless Steel

Material: Stainless Steel  
 Reflective: 101 sq. in.  
 FMVSS: 111 Vehicles with GVWR greater than 10,000 lbs.  
 Finish: Stainless  
 Volts / Amps: 12V / 3.1A  
 C-Loop Bracket: 22233/22232  
 Bracket: 22013, 22063, 22061

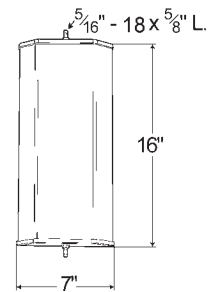

## OEM-STYLE SPLIT-FOCUS WEST COAST BOX MIRROR

Built-in adjustable convex blind spot mirror • Provides close-in side view • Double-strength silvered mirror

- 16041** White Enamel
- 16043** Stainless Steel

Material: Stainless Steel, Steel  
 Reflective: 57 sq. in. flat area; 20 sq. in. convex  
 FMVSS: 111 Vehicles with GVWR greater than 10,000 lbs.  
 Finish: White/Stainless  
 Accessory: C-Loop: 22233/22232  
 Bracket: 22013, 22063, 22061

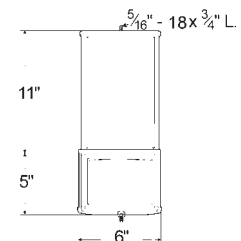

# Mirrors

Rétroviseurs Espejos

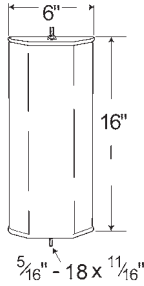

## OEM-STYLE WEST COAST BOX MIRROR

Double-strength silvered mirror • Weather-sealed in vinyl • Painted mirrors feature rugged powder coat finish

### 6" X 16" MIRROR:

**16021** White  
**16023** Stainless Steel

### 7" X 16" MIRROR:

**16123** Stainless Steel

Material: Stainless Steel, Steel  
Reflective: 87 sq. in. (16021, 16023); 101 sq. in. (16123)  
FMVSS: 111 Vehicles with GVWR greater than 10,000 lbs.  
Finish: White/Stainless  
Accessory: C-Loop: 22233/22232  
Bracket: 22013, 22063, 22061

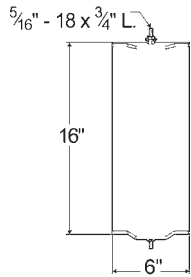

## ECONOMY WEST COAST MIRROR

Aluminum back mirror • 5/16" plated rod • Silvered mirror

**16244** Aluminum

Material: Aluminum  
Reflective: 87 sq. in.  
Finish: Aluminum  
Accessory: C-Loop: 22233/22232  
Bracket: 22013, 22061, 22063

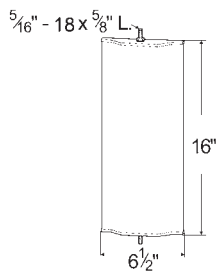

## ECONOMY WEST COAST MIRROR

Composite construction • Rigid warp-proof design features an aero wing, honeycomb-type structure

**16202** Black

Material: Polypropylene  
Reflective: 95 sq. in.  
FMVSS: 111 Vehicles with GVWR greater than 10,000 lbs.  
Finish: Black  
Accessory: C-Loop: 22233/22232  
Bracket: 22013, 22061, 22063

## NAVISTAR® ALUMINUM WEST COAST REPLACEMENT MIRROR

Anodized, polished aluminum finish (matches OE finish) • Glass-filled nylon end caps for durability and strength • Includes mounting hardware  
 • Heated mirrors feature molded Navistar® plug

**16284** Aluminum

**HEATED MIRROR:**

**16294** Aluminum, Passenger Side

**16304** Aluminum, Driver Side

Material: Aluminum/Nylon  
 Reflective: 101 sq. inch  
 FMVSS: 111 Vehicles with GVWR greater than 10,000 lbs.  
 Finish: Aluminum  
 Volts / Amps: Heated - 12V / 1.25A

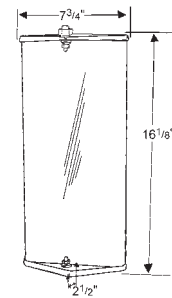

## OEM-STYLE PEAK-BACK WEST COAST MIRROR

Distinctive pyramid-style back interchanges functionally and aesthetically with competitive units • Shock-resistant mirror glass mounting with a rugged outer gasket • Heated mirror features 5' jacketed power cable  
 • 5/16"-18 mounting stud

**16273** Stainless Steel

**16142** Black

**HEATED MIRROR:**

**16153** Stainless Steel

Material: Stainless Steel, Steel  
 Reflective: 101 sq. inch  
 FMVSS: 111 Vehicles with GVWR greater than 10,000 lbs.  
 Finish: Black/Stainless  
 Volts / Amps: Heated - 12V / 1.25A  
 Accessory: C-Loop: 22233, 22232  
 Bracket: 22013, 22063, 22061

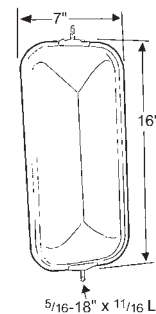

## OEM-STYLE BUBBLE-BACK WEST COAST MIRROR

Double-strength silvered mirror • 7" x 16" mirror • Rugged powder coat finish

**16101** White

**16102** Black

**MIRROR & ARM ASSEMBLY**

**26021-5** White, w/Arm Assembly

**RETAIL**

Material: Steel  
 Reflective: 93 sq. in.  
 FMVSS: 111 Vehicles with GVWR greater than 10,000 lbs.  
 Finish: White/Black  
 Accessory: C-Loop: 22233/22232  
 Bracket: 22013, 22061, 22063

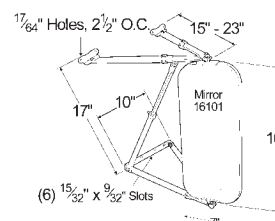

# Mirrors

Rétroviseurs Espejos



## OEM-STYLE FLAT RIBBED-BACK WEST COAST MIRROR

Double-strength silvered mirror • 7" x 16" mirror • Painted mirrors feature rugged powder coat finish

<b>16091</b>	White
<b>16092</b>	Black
<b>16093</b>	Stainless Steel

### MIRROR & ARM ASSEMBLY

<b>26001-5</b>	White, w/Arm Assembly	<b>RETAIL</b>
<b>26012-5</b>	Black, w/Arm Assembly	<b>RETAIL</b>

Material: Stainless Steel, Steel  
 Reflective: 93 sq. in.  
 FMVSS: 111 Vehicles with GVWR greater than 10,000 lbs.  
 Finish: White/Black/Stainless  
 Accessory: C-Loop: 22233/22232  
 Bracket: 22013, 22063, 22061

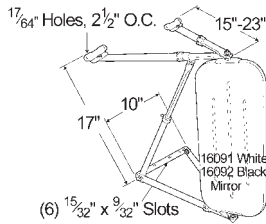

## WEST COAST MIRROR BRACKET ASSEMBLY

Complete kit includes mirror arms, mounting, hardware and instructions  
 • Rigid mounting for West Coast style mirrors • Accommodates additional spot mirrors

<b>22013</b>	Stainless Steel
--------------	-----------------

Material: Stainless Steel

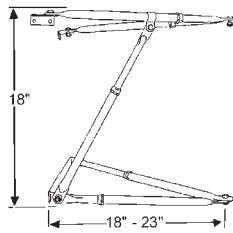

## CUSTOM WEST COAST MIRROR BRACKET ASSEMBLY

Bracket assembly for personal design • Braces included • Fully adjustable from 18" to 23"

<b>22063</b>	Chrome Plated
--------------	---------------

Material: Steel  
 Finish: White/Chrome

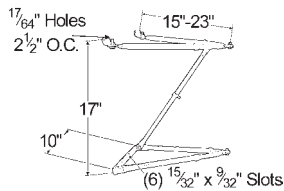

## C-LOOP BRACKET

Can be used in conjunction with most West Coast bracket assemblies  
 • Allows for adjustable, "break-away" mounting of any 7"x16" or 6"x16" West Coast mirror • Accommodates additional stack-on spot mirrors

<b>22233</b>	Stainless Steel
<b>22232</b>	Black

Material: Stainless Steel, Steel  
 Finish: Black/Stainless



## WEST COAST HEATING ELEMENT REPLACEMENT

Defroster element fits West Coast style mirrors • Water resistant  
 • 40 Watts • Fits 6" x 16" or 7" x 16" West Coast Mirrors

**29060** Element

Material: Adhesive Black Heated Board  
 Volts / Amps: 12V - 3.1 AMP

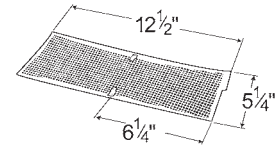

## 5" ROUND CLAMP-ON SPOT MIRROR

Provides wider vision • Includes arm and clamp to attach securely to mirror arm • Single-strength silvered mirror

### 5" CONVEX:

- 28031** White, Powder Coated, w/ Arm Assembly
- 28032** Black, Powder Coated, w/ Arm Assembly
- 28033** Stainless Steel, w/ Arm Assembly
- 28033-5** Stainless Steel, w/ Arm Assembly RETAIL

### 5" FLAT GLASS:

- 28162** Black, Powder Coated, w/ Arm Assembly
- 28152** Black w/ "L" Bracket

Material: Stainless Steel, Steel  
 FMVSS: 111 Vehicles with GVWR greater than 10,000 lbs.  
 Reflective: 20 sq. in.  
 Finish: Stainless, White, Black  
 Accessory: Extension Arm: 10073

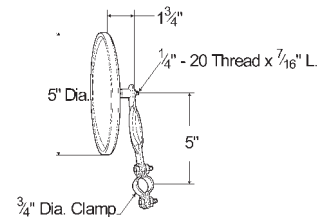

## 6" CONVEX CENTER-MOUNT SPOT MIRROR

Features stainless steel construction and adjustable ball swivel  
 • Available with or without 'L' bracket

### MIRROR HEAD ONLY

- 12053** Stainless Steel
- 12052** Black

### MIRROR HEAD AND "L" BRACKET

- 28663** Stainless Steel

### MIRROR HEAD AND ARM ASSEMBLY

- 28041** White, Powder Coated
- 28042** Black, Powder Coated
- 28043** Stainless Steel

Material: Stainless Steel, Steel  
 FMVSS: 111 Vehicles with GVWR greater than 10,000 lbs.  
 Reflective: 28 sq. inch  
 Finish: Stainless, White, Black  
 Accessory: Arm Assembly: 10173 (with "L" Bracket)  
 Bracket: 11303 ("L" Bracket Only); 10073 (Arm Assembly Only)

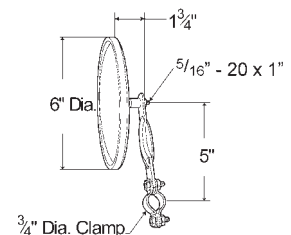

# Mirrors

Rétroviseurs Espejos

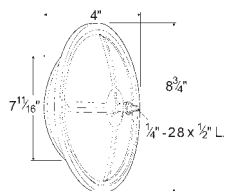
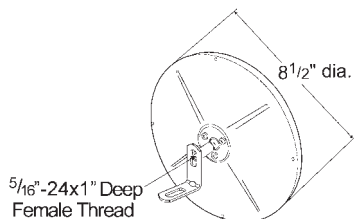
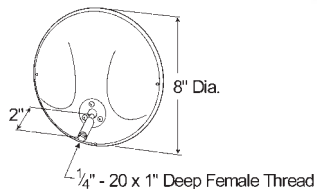
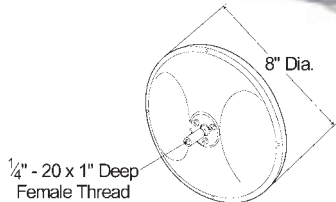

## 8" CONVEX MIRROR WITH LED 8" ROUND CONVEX MIRROR WITH CENTER-MOUNT BALL-STUD

Three-screw stud tightens firmly • 1/4" UNC female ball stud • Painted mirrors feature rugged powder coat finish • Heated mirror includes 60" two-conductor jacketed blunt-cut cable and adhesive heater board (12283)

- 12182** Black  
**12183** Stainless Steel  
**12293** Stainless Steel with Attached "L" Bracket

### HEATED MIRROR:

- 12283** Stainless Steel

### PLASTIC HOUSING:

- 12983** Chrome

Material: Stainless Steel/Polypropylene  
 Reflective: 46.7 sq. in.  
 Finish: Stainless, Black, Chrome  
 Volts / Amps: 12V / 1.18 AMP  
 Bracket: 11133

## 8" ROUND CONVEX MIRROR WITH OFFSET BALL-STUD

Easy mounting in tight installations • Ball-stud offset 2" from center • Heated mirror includes 60" two-conductor jacketed blunt-cut cable and adhesive heater board (12813)

- 12172** Black, Powder Coated  
**12173** Stainless Steel

### HEATED MIRROR:

- 12813** Stainless Steel

Material: Stainless-Steel, Steel  
 Reflective: 46 sq. in.  
 Finish: Stainless, Black  
 Volts / Amps: 12V / 1.18 AMP

## 8 1/2" CONVEX MIRROR WITH CENTER-MOUNT, BALL-STUD

Adjustable ball stud mounting • Single strength, silvered mirror • Includes "L" Bracket

- 16033** Stainless Steel  
**16032** Black

### PLASTIC HOUSING:

- 12983** Chrome

Material: Stainless Steel, Steel/Polypropylene  
 Reflective: 56 sq. inch  
 Finish: Stainless, Black, Chrome  
 Bracket: 11303

## 8" ELLIPTICAL MIRROR

Eliminates blind spots • Optimum crossover viewing • 4 1/4" radius x 7 11/16" dia.

- 12272-5** Black, Mirror Head Only

RETAIL

Material: Steel/Acrylic  
 Reflective: 45 sq. in.  
 Finish: Black

## CONVEX MIRROR WITH CENTER MOUNT

Popular for highway service vehicles • Reinforced internal retainers  
 • Large steel ball-stud for precise positioning • Replacement for 10 1/2" crossover mirrors

**10 1/2" CONVEX MIRROR:**  
**12010** Stainless Steel

**12" CONVEX MIRROR:**  
**12020** Gray, 3/8 - 24 11/16, Deep-Thread Ball-Stud

Material: Stainless Steel / Steel  
 Reflective: 10 1/2" - 95 sq. in./12" - 135 sq. in.  
 Finish: Stainless/Gray

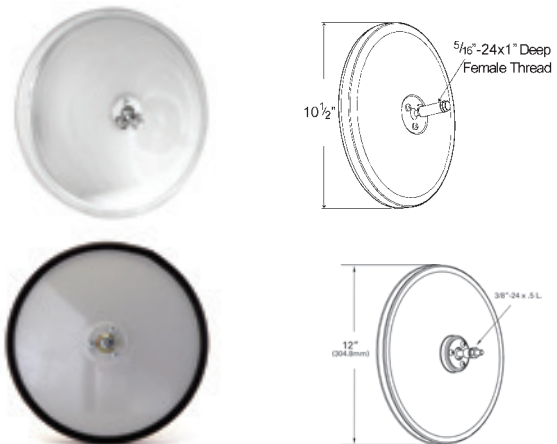

## ADJUSTABLE MIRROR ASSEMBLY

Arm adjustable from 10" to 13" • Swivel bracket enables precise adjustment • Chrome arm and brackets

**28193** 6" Mirror (12053) and Adjustable Arm Assembly

**ARM ASSEMBLY ONLY**  
**10433** Arm & Swivel Bracket Only

Material: Stainless Steel (12053), Steel (10433)  
 Reflective: 26 sq. in.  
 Finish: Stainless (mirror head)/Chrome (arm assembly)

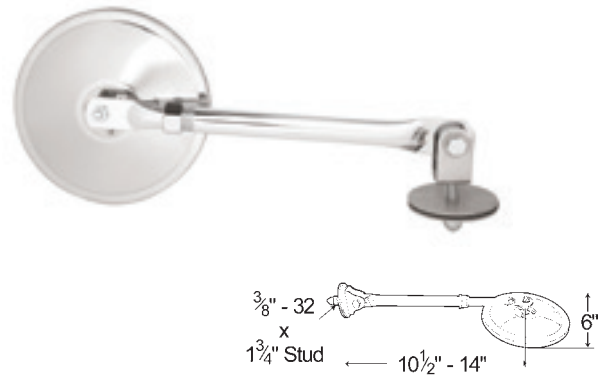

## CONVENTIONAL FENDER-MOUNT MIRROR

8" stainless steel convex mirror • Stainless steel brackets • Bell cup mounting for fiberglass fenders • Grote 8" convex mirror (12182/3) will fit bracketry

**28443** Stainless Steel (Assembly Including Mirror)

**ARM ASSEMBLY ONLY**  
**22193** Stainless Steel

**MIRROR HEAD ONLY**  
**12183** Stainless Steel

Material: Stainless Steel  
 Reflective: 46 sq. in.  
 Finish: Stainless





# Mirrors

Rétroviseurs Espejos

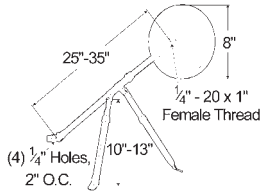

## SCHOOL BUS EXTERIOR BLIND SPOT MIRROR

Meets state laws for blind spot visibility • Zinc-plated bracketry  
• 8" convex mirror

**28063** Vertical-Mount Assembly, Stainless Steel  
**11195** Bracket Only w/o Mirror

### MIRROR HEAD ONLY

**12183** Stainless Steel

Material: Stainless Steel, Steel  
Reflective: 46 sq. in.  
Finish: Stainless

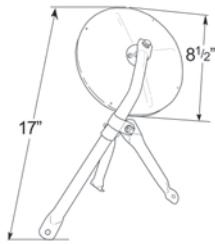

## 8 1/2" CONVEX CROSS-OVER MIRROR

Ideal for improving safety on straight trucks and delivery trucks  
• Features rugged tripod mount for front or rear

**28481** White, Mirror Assembly

Material: Steel  
Reflective: 56 sq. in.  
Finish: White

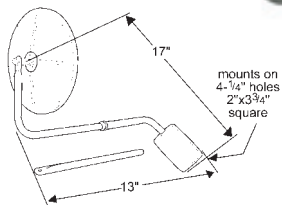

## HOOD-MOUNTED MIRROR

Bright stainless steel finish • Assembly comes with both a curved and straight extension for improved vision and range of application  
• Kit includes backing plate, gasket, mounting hardware, and instructions  
• 8 1/2" convex stainless steel mirror head included

**12153** Stainless Steel

Material: Stainless Steel  
Reflective: 56 sq. inch  
Finish: Stainless

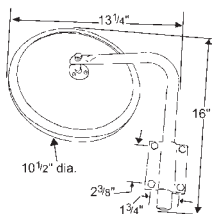

## 10 1/2" CONVEX CROSS-OVER MIRROR

Ideal for improving safety on straight trucks and delivery trucks • Features rigid 90° bracket

**28491** White, Mirror Assembly  
**28493** Stainless Steel, Mirror Assembly

Material: Stainless Steel, Steel  
Reflective: 95 sq. in.  
Finish: Stainless/White

## SPLIT MIRROR

Swing-away feature with detent • Fits right or left side • Top mirror is 6 1/2" x 10" flat glass • Bottom mirror is 6 1/2" x 6" convex

**28453** Stainless Steel

**REPLACEMENT 6 1/2" X 10" MIRRORS:**

**12301** White

**12303** Stainless Steel

**REPLACEMENT 6 1/2" X 6" MIRRORS:**

**12331** White

**12333** Stainless Steel

Material: Stainless Steel, Steel  
Reflective: 10" : 56 sq. in. 6" : 33 sq. in.  
Finish: Stainless/White

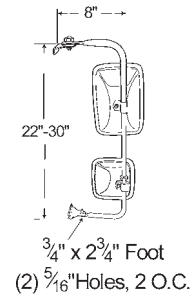

## ROLLED-RIM MIRROR WITH BALL SWIVEL

1/4" - 20" x 7/16" ball swivel • Painted mirrors feature rugged powder coated finish

**12071** White

**12072** Black

**12073** Stainless Steel

**12073-5** Stainless Steel

RETAIL

Material: Stainless Steel, Steel  
Reflective: 33 sq. in.  
Finish: Stainless, White, Black

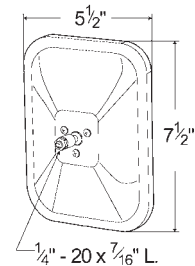

## ROLLED-RIM MIRROR WITH CENTER MOUNT

Inner glass cushion

**12243-5** Stainless Steel

RETAIL

Material: Stainless Steel  
Reflective: 33 sq. in.  
Finish: Stainless

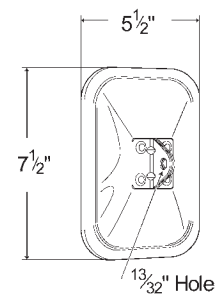

## BELOW-EYE-LEVEL MIRROR

Offset mount • 7 1/2" x 10 1/2" mirror • Painted mirrors feature rugged powder coated finish

**12111-5** White

**12113-5** Stainless Steel

RETAIL

RETAIL

Material: Stainless Steel, Steel  
Reflective: 61 sq. in.  
Finish: Stainless, White, Black

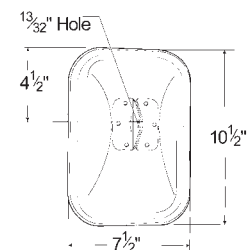

# Mirrors

Rétroviseurs Espejos

M I R R O R S

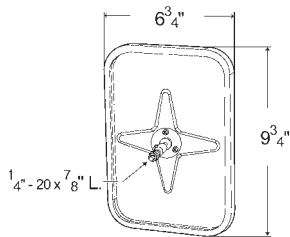

## OUTER PROTECTIVE BUMPER MIRROR

Ball swivel • 7" x 10" rectangular mirror • Features rugged powder coated finish

- 12101** White
- 12102** Black

Material: Steel  
 Reflective: 52 sq. in.  
 Finish: White, Black

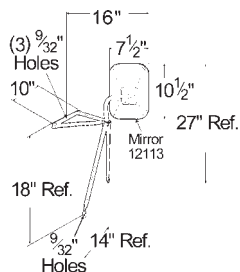

## SUPER TRIPOD-MOUNT MIRROR

Stainless steel tripod brackets • Offset mounting • Flips to total field of vision • Jumbo 7 1/2" x 10 1/2" stainless steel head

- 28323-5** Stainless Steel RETAIL

**MIRROR HEAD:**

- 12113-5** Stainless Steel RETAIL
- 12111-5** White RETAIL

Material: Stainless Steel  
 Reflective: 61 sq. in.  
 Finish: Stainless  
 Accessory: 90° Arm: 10623; Extension Arm: 10083

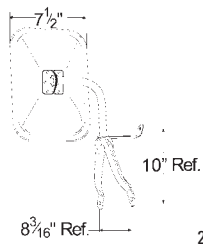

28091-5

## VERSATILE TRIPOD MIRROR

For Chevrolet®, GMC®, Ford® and other pickups • Universal mounting; 7 1/2" x 10 1/2" mirror head • Painted mirrors feature rugged powder coat finish

- 28091-5** White RETAIL
- 28093-5** Stainless Steel RETAIL

Material: Stainless Steel/Steel  
 Reflective: 60 sq. in.  
 Finish: Stainless/White  
 Accessory: 90° Arm: 10623

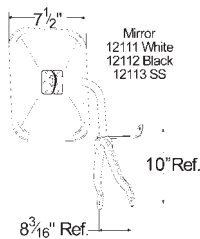

28093-5

## 50" WIDE-VIEW MIRROR

OEM-styled mirror, fits right or left side • Two-screw ball swivel • Fits full-size pickup trucks and vans

- 28293-5** Stainless Steel RETAIL
- 12193-5** Stainless Steel, Mirror Only RETAIL

Material: Stainless Steel  
 Reflective: 50 sq. in.  
 Finish: Stainless

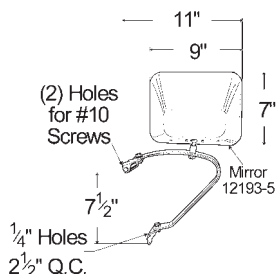

## FORD® TRUCK & VAN MIRROR

Swings back against body on impact • Memory detent locks back into original position

**28393-5** Chrome Mirror w/ Anodized Aluminum Bracket **RETAIL**  
**12263-5** Mirror Only **RETAIL**

Material: Steel, Aluminum  
 Reflective: 38 sq. in.  
 Finish: Aluminum

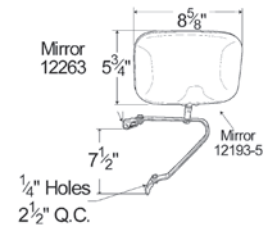

## MINI-TRUCK MIRROR

Fits door contours of mini-import trucks • Easy-to-mount, plastic connectors  
 • 5 1/2" x 7 1/2" mirror head

**28252-5** Black, Powder Coated **RETAIL**

Material: Steel  
 Reflective: 33 sq. in.  
 Finish: Black

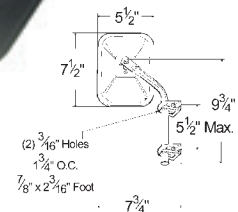

## RECTANGULAR STACK & SPOT MIRROR

Greater coverage of blind spots • Includes arm and clamp  
 • Painted mirrors feature rugged powder coated finish

**28051** White w/ Arm Assembly  
**12122** Black, Mirror Only

Material: Steel  
 Reflective: 20 sq. in.  
 Finish: White/ Black

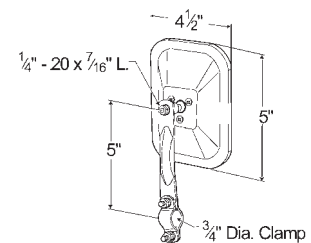

## RECTANGULAR OVER-THE-DOOR CONVEX MIRROR

9/16" x 5/16" mounting holes • For "look-down" mirror applications over passenger side door

**28763** Over Door Convex

Material: Stainless Steel  
 Reflective: 26 sq. in.  
 Finish: Stainless

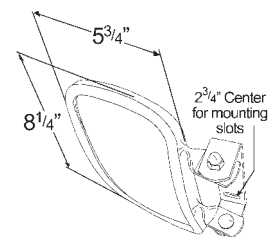

# Mirrors

Rétroviseurs Espejos

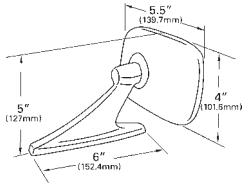

## UNIVERSAL REPLACEMENT MIRROR

Lock-tight swivel • Fits both right and left side • Chrome finish  
• Glass cushioned in weatherproof vinyl

**18103-5** Rectangular **RETAIL**

Material: ABS  
Finish: Chrome



Mounting Base 4 1/2" overall L.  
Mounting Holes 1 1/2" - 3 3/4" O.C.



## EUROPEAN WEDGE STYLE MIRROR

Fits both right and left side

**18252-5** Black **RETAIL**

Material: Polypropylene  
Finish: Black

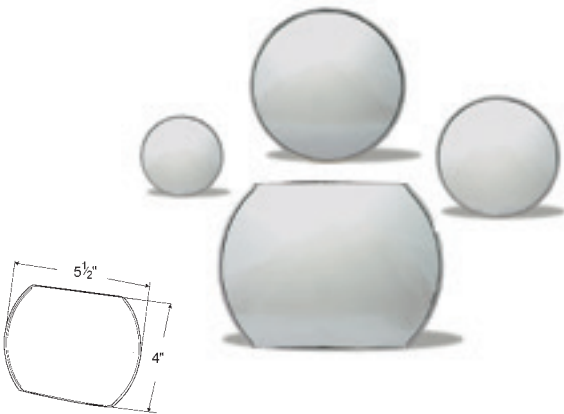

## STICK-ON CONVEX MIRROR

Extends driver's view • Bonds instantly • Single-strength silvered mirror  
• Aluminum mirror back

### ROUND:

<b>12004</b>	3"	
<b>12004-5</b>	3"	<b>RETAIL</b>
<b>12014</b>	3 3/4"	
<b>12014-5</b>	3 3/4"	<b>RETAIL</b>
<b>12201-5</b>	2"	<b>RETAIL</b>

### RECTANGULAR:

<b>12164</b>	4" x 5 1/2"	
<b>12164-5</b>	4" x 5 1/2"	<b>RETAIL</b>

Material: Aluminum  
FMVSS: 96 hr corrosion test per ASTM B 117, will withstand 30 lb. pull test  
Finish: Aluminum

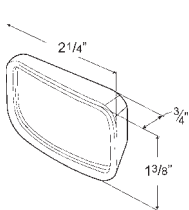

## HOT SPOT MIRROR

Fits any flat surface • Weather-resistant high-strength adhesive

**12312-5** Black **RETAIL**

Material: Polypropylene  
Finish: Black



## 10" INSIDE REAR VIEW MIRROR

Non-glare adjustment lever • OEM styling • Includes mirror, mount, instructions, and adhesive

**18302-5** Black **RETAIL**

Material: Polypropylene  
Finish: Black

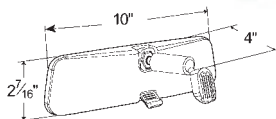

## HEAVY-DUTY ADJUSTABLE BRACE ARM

19"-28" • Zinc-coated steel

**10025** Adjustable Arm

Material: Steel  
Finish: Zinc

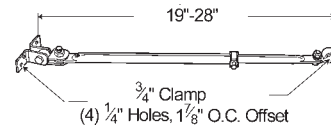

## ADJUSTABLE MIRROR ARM

Features rugged powder coated finish

10" - 13" ARM:

**10002** Black

14" - 22" ARM:

**10012** Black

**10013** Chrome

Material: Steel  
Finish: Black, Chrome

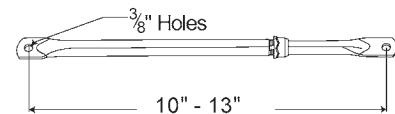

## 90° EXTENSION ARM

4 1/2" offset length

**10623** Aluminum

Material: Aluminum  
Finish: Chrome

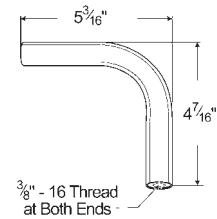

## 8" FLAT MIRROR ARM

Silver metallic powder coated finish

**10045** Silver Finish

**RETAIL**

Material: Steel  
Finish: Silver metallic

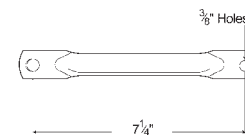

## EXTENSION ARM & CLAMP ASSEMBLY FOR STACK MIRRORS

**10073** Extension Arm

Material: Stainless Steel  
Finish: Stainless

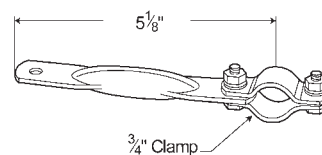

# Mirrors

Rétroviseurs Espejos



## UNIVERSAL MOUNTING KIT

Complete kit includes extension arm, clamp mounting, and hardware  
 • Perfect for adding on spot mirrors • Suited for 5" and 6" spot mirrors

**10173** "L" Bracket

Material: Stainless Steel, Steel



## STAINLESS STEEL "L" BRACKET

Allows mounting of convex mirror on West Coast mirror bracket

**11133** Stainless Steel

Material: Stainless Steel



## THROUGH-HOLE STYLE "L" BRACKET

Rugged construction • Perfect accessory for adding on spot mirrors  
 • For 3/4" mirror arm tubing

**11303** "L" Bracket

Material: Stainless Steel



## TUBE CLAMP

Kit includes clamp and hardware • Perfect accessory for adding spot mirrors  
 • Rugged, bright stainless steel bracket construction

**11293** 3/4" Clamp, 3/8" Holes

Material: Stainless Steel, Steel

## ULTRALINK™ ABS POWER CORDS

Provides superior power delivery, exceeds power delivery minimum legal lamp requirements for single or double trailer configurations • UltraLink™ zinc die-cast plugs are filled with elastomeric material that resists crushing and acts as potting to seal solid brass terminals from moisture • Special adhesive bonds the cable to the plug, eliminating the need for a supporting spring and preventing moisture from entering the back of the plug • Solid brass terminals are corrosion resistant, and provide superior current capacity with minimal voltage drop • Provides excellent recoil memory, chemical, and abrasion resistance (Coiled versions) • Advanced polymer jacketing material provides complete sealing and abrasion protection between -55°F and 190°F (Premium versions)



### COILED:

<b>87100</b>	1/8-2/10-4/12, 12', w/12" Leads, Coiled
<b>87103</b>	1/8-2/10-4/12, 12', w/12" Leads, Coiled, Premium
<b>87101</b>	1/8-2/10-4/12, 15', w/12" Leads, Coiled
<b>87104</b>	1/8-2/10-4/12, 15', w/12" Leads, Coiled, Premium
<b>87170</b>	1/8-2/10-4/12, 15', w/48" and 12" Leads, Coiled
<b>87105</b>	1/8-2/10-4/12, 20' w/36" and 12" Leads, Coiled, Premium

### STRAIGHT:

<b>87190</b>	1/8-2/10-4/12, 7', Straight	<b>NEW</b>
<b>87193</b>	1/8-2/10-4/12, 10', Straight	<b>NEW</b>
<b>87171</b>	1/8-2/10-4/12, 12', Straight	
<b>87172</b>	1/8-2/10-4/12, 15', Straight	
<b>87173</b>	1/8-2/10-4/12, 20', Straight	<b>NEW</b>

Material: Polyurethane (Premium), EVA (Standard)  
 FMVSS: J560b, J2222, J2394  
 Finish: Green

## ULTRALINK™ POWER CORDS (NON-ABS)

Provides superior power delivery, exceeds power delivery minimum legal lamp requirements for single or double trailer configurations • UltraLink™ zinc die-cast plugs are filled with elastomeric material that resists crushing and acts as potting to seal solid brass terminals from moisture • Special adhesive bonds the cable to the plug, eliminating the need for a supporting spring and preventing moisture from entering the back of the plug • Solid brass terminals are corrosion resistant, and provide superior current capacity with minimal voltage drop • Provides excellent recoil memory, chemical, and abrasion resistance (Coiled versions) • Advanced polymer jacketing material provides complete sealing and abrasion protection between -55°F and 190°F (Premium versions)



### COILED:

<b>87110</b>	1/12-6/14, 12', w/12" Leads
<b>87020</b>	1/10-6/12, 12', w/12" Leads, HD
<b>87111</b>	1/12-6/14, 15', w/12" Leads
<b>87023</b>	1/10-6/12, 15', w/12" Leads, HD
<b>87181</b>	1/10-6/12, 15', w/48" and 12" Leads, HD
<b>87112</b>	1/12-6/14, 15', w/72" and 12" Leads
<b>87180</b>	1/10-6/12, 15', w/72" and 12" Leads, HD

### STRAIGHT:

<b>87182</b>	1/10-6/12, 15'
--------------	----------------

Material: EVA (Standard)  
 FMVSS: J560, J2222  
 Finish: Black



# Trailer Wiring and Communications Systems

Systèmes de Communication et Filage de Remorques    Sistemas de arneses para remolque / Caja de conexión

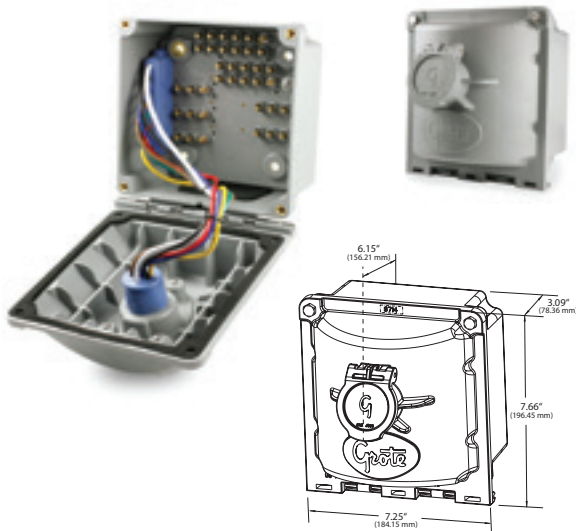

## ULTRA NOSE BOX®

Replaceable 7-pin insert for easy maintenance • 39-pin connections eliminates overcrowding of wires • Hinged door keeps elements out, while providing easy access • Insert-molded pins helps prevent accidental disconnects

**87141** Gray, Solid Pin

**87151** Gray, Split Pin

Material: Nylon

FMVSS: J560

Finish: Gray

Accessory: 7-pin insert: 97900 (solid pin), 97800 (split pin)

Replacement Door Kit: 97910 (spring, pin, door)

Rubber Grommet: 97810

Pigtail: 01-6623-P9

20A Circuit Breaker: 01-6624-W4

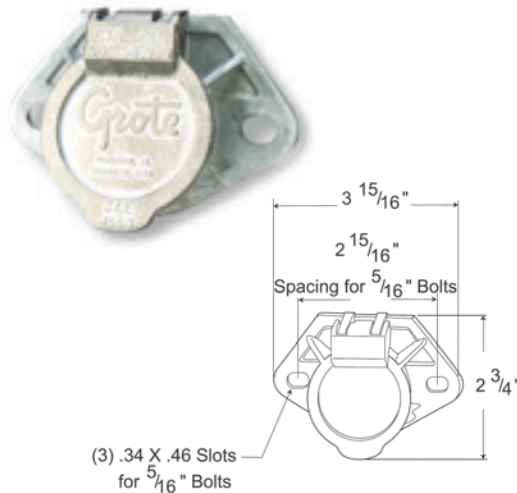

## ULTRAPIN RECEPTACLE TWO-HOLE MOUNT

No-rust, die-cast zinc • Heavy bosses for extra rigidity • Barrel slanted to drain moisture • Mounting holes slotted for universal fit • Floating pins for easy alignment and solid mating • Two male terminals for grounding • Brass pins • 87270 includes 99510 retrofit kit • 99510 consists of 14 terminals and 9 boots

**87250** Receptacle Only, Split Pin

**87860** Receptacle Only, Solid Pin

**87270** Receptacle w/ Terminal Kit, Split Pin

### RETROFIT KIT

**99510** Plug-In Terminal Kit

**99600** Mounting Gasket

**99680** Door Replacement Kit

Material: Die-cast Zinc

FMVSS: J560



## ULTRA-PIN RECEPTACLE THREE-HOLE MOUNT

No-rust, die-cast zinc • Heavy bosses for extra rigidity • Barrel slanted to drain moisture • Mounting holes slotted for universal fit • Floating pins for easy alignment and solid mating • Two male terminals for grounding • Brass Pins • 87240 includes 99510 retrofit kit • 99510 consists of 14 terminals and 9 boots

**87240** Receptacle w/ Terminal Kit, Split Pin

**87220** Receptacle Only, Split Pin

### RETROFIT KIT

**99510** Plug-In Terminal Kit

**99601** Mounting Gasket

**99680** Door Replacement Kit

Material: Die-cast Zinc

FMVSS: J560

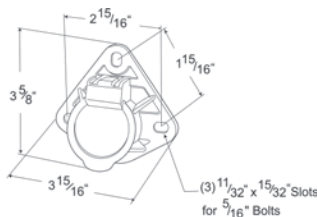

## ULTRA-PIN™ RECEPTACLE FOUR-HOLE MOUNT NOSE BOX

Extra heavy bosses • Slanted barrel for drainage • Floating pins for easy alignment and solid mating connection • High impact retainer plate • Brass pins • Die-cast aluminum housing resists rust

- 87590**    Solid Pin
- 87830**    Split Pin

Material: Die-cast Aluminum

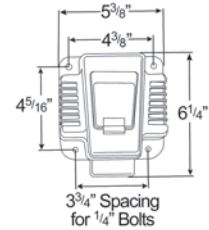

## RECEPTACLE MOUNTING BOX

Mounting for 87250, 87860, 87270, 87220, 87850, 87240

- 43684**    Receptacle Box
- 99680**    Door Replacement Kit - Used on 87250, 87860, 87270, 87240 and 87220. Kit contains die-cast zinc door, brass hinge pin and spring
- 99600**    Mounting Gasket - Used on 87250, 87860 and 87270. Kit contains PVC mounting gasket for 2-hole receptacle. Gasket is designed so the receptacle is recessed. Gasket to protect galvanic corrosion and water intrusion.

Material: Cast Aluminum

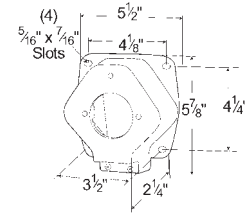

## RETROFIT PLUG-IN TERMINAL KIT

- 99510**    Plug-In Terminal Kit - Plugs into 87220, 87850, 87250, 87860, 87590 and 87830 receptacles • Kit contains 9 boots and 14 terminals • 5 terminals for larger gauge wire
- 99680**    Door Replacement Kit - Used on 87250, 87860, 87270, 87240 and 87220. Kit contains die-cast zinc door, brass hinge pin and spring
- 99600**    Mounting Gasket - Used on 87250, 87860 and 87270. Kit contains PVC mounting gasket for 2-hole receptacle. Gasket is designed so the receptacle is recessed. Gasket to protect against galvanic corrosion and water intrusion.
- 99601**    Mounting Gasket - Used on 87290 and 87220. Kit contains PVC mounting gasket for 3-hole receptacle. Gasket is designed so the receptacle is recessed. Gasket to protect against galvanic corrosion and water intrusion.



99510



99680

99601



99600



# Trailer Wiring and Communications Systems

Systèmes de Communication et Filage de Remorques    Sistemas de arneses para remolque / Caja de conexión



66071



66705

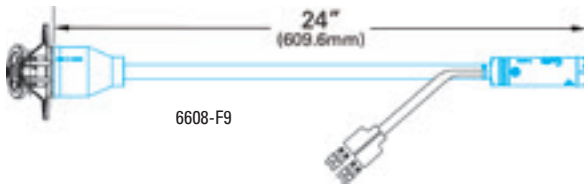
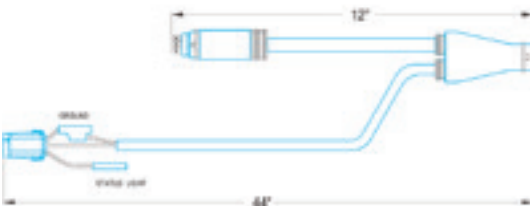

6608-F9

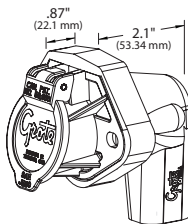

87212



87214

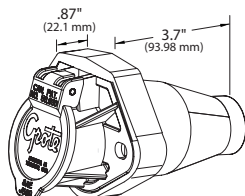

## UBS® MAIN HARNESS

Extends from front of nose box or receptacle and provides sealed plug-in connection to real sill harness

1-8 GAUGE, 2-10 GAUGE, 4-12 GAUGE:

66071 60' Long

66081 35' Long

## UBS® MAIN HARNESS ABS ADAPTER

Junction between main harness and real sill harness • Provides sealed plug-in connection and a drop-out extension for ABS • Ground return  
• ABS fault lamp connection

ABS FAULT LIGHT:

66705 12" Long

## UBS® 7-CONDUCTOR RECEPTACLE MAIN HARNESS

Ultra-Pin™ receptacle is overmolded • Two-hole mount, solid pin (87860)

6608-E9 Main Harness with Drop (female 7-way)

6608-F9 Main Harness (male 7-way)  
Ultra-Seal G7 Sectionvv

## ULTRA SEAL G7 **NEW**

Ultra-Seal G7 set the standard for low-profile, water-resistant harness connection • Spacer made of thicker, and harder durometer PVC that resists deforming under mounting pressure • Flush mount design allows water to be directed away from the wire exit hole in the trailer • Two alignment pins aid in installation, allowing for easier terminal connections • Plug design seals the back of the receptacle • Receptacle is recessed into the gasket for sealing • Receptacle is non-rust, die cast zinc with solid brass pins

87214 Straight Plug & receptacle with 7-way female  
Length: 24in/609.6mm

Gauge: 10/12

87215 Straight Plug & receptacle with 7-way male  
Length: 24in/609.6mm

Gauge: 8/10/10/12

87210 90° Plug & receptacle with 7-way female and drops for marker lamps (grounded and black)  
Length: 24in/609.6mm

Gauge: 10/12

87211 90° Plug & receptacle with 7 standard females and drops for marker lamps (grounded and black)  
Length: 24in/609.6mm

Gauge: 10/12

87212 90° Plug & receptacle blunt cut with drops for marker lamps (grounded and black)  
Length: 24in/609.6mm

Gauge: 10/12

Gauge: 10/12

## UBS® MAIN HARNESS 44" ABS DROP-OUT

Provides sealed plug-in connection to rear sill harness • Drop-out extends to ABS universal connector • Blunt-cut, 7-conductor cable

**1-10 GAUGE, 6-12 GAUGE:**  
**66701**    60' Long

**1-8 GAUGE, 2-10 GAUGE, 4-12 GAUGE:**  
**66702**    35' Long

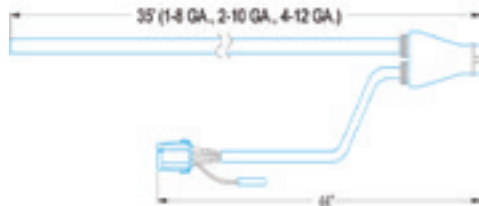

66701



66702



## UBS® MAIN HARNESS 48" DROP-OUT FOR DOUBLE-TRAILER CONNECTION

Provides sealed plug-in connection to rear sill harness • Drop-out extends to receptacle at rear of trailer • Blunt-cut, 7-conductor cable

**1-8 GAUGE, 2-10 GAUGE, 4-12 GAUGE:**  
**66311**    60' Long  
**66711**    35' Long

66311

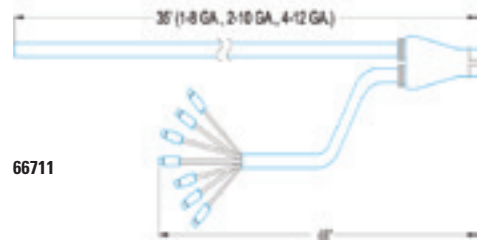

66711

## UBS® HARNESS REAR SILL OPTION

All connections weather-sealed by simple, foolproof UBS plugs • Entire harness double-jacketed for extra resistance to road-splash and abrasion • Redundant frame ground with ring terminal

**FOR FEMALE PIN LAMPS:**  
**67570**    56" Long, Ground Return, Blue Drop  
**67571**    56" Long, Ground Return, ABS Connection

**FOR MALE PIN LAMPS:**  
**67581**    56" Long, Ground Return, Blue Drop  
**67580**    56" Long, Ground Return, ABS Connection

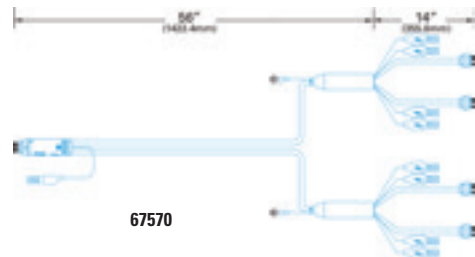

67570

## UBS® GROUND RETURN TRACKING HARNESS

For use with elbow-style rear sill

**STANDARD MALE/STANDARD FEMALE TO 2 SLIM-LINE UNDERLAMP FEMALES:**  
**66223**    2' Long  
**66224**    3' Long



66223

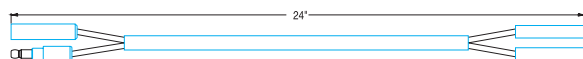

# Trailer Wiring and Communications Systems

Systèmes de Communication et Filage de Remorques    Sistemas de arneses para remolque / Caja de conexión

## CUT-TO-FIT® WIRE HARNESS SYSTEMS



This Cut-To-Fit® Wire Harness System adapts to the standard Grote Ultra-Blue-Seal® rear sill and main harness • Part number 67271 (24" standard male to Cut-To-Fit® Slim-Line jumper) plugs into rear sill, making a corrosion-proof connection • Cut-To-Fit® jumpers can then be plugged directly into the double Slim-Line plugs • Cut-To-Fit® wire harness mates with the Grote 7-pin receptacle (nose box) with the use of either the 67260 adapter or the 67250 • All wires 12 gauge

- 67271** Rear Sill Adapter
- 67270** Ground Return Adapter
- 67260** Nose Box Adapter
- 67250** Double Nose Box Adapter

## SLIM-LINE UNDER-LAMP FEMALES (CUT-TO-FIT®)



Abrasion-resistant double-jacketed wire lengths with molded-on Slim-Line under-lamp double females includes sealing boot for crimp-on bullet connectors • Blunt-cut, Cut-To-Fit® wires are black

- 67301** 14-Gauge, 3' 2" (38")
- 67302** 14-Gauge, 6' 8" (80")
- 67303** 14-Gauge, 14' (168")
- 67304** 14-Gauge, 25' 10" (310")
- 67305** 14-Gauge, 34' 7" (415")
- 67400** 12-Gauge, 1' 2" (14")
- 67401** 12-Gauge, 3' 2" (38")
- 67402** 12-Gauge, 6' 8" (80")
- 67403** 12-Gauge, 14' (168")
- 67404** 12-Gauge, 25' 10" (310")
- 67405** 12-Gauge, 34' 7" (415")

## CRIMP-ON .180 BULLET TERMINALS



99500-3



99501-3

- 99500-3** Field Service Terminal for 14-Gauge Wire
- 99501-3** Field Service Terminal for 12-Gauge Wire

## DUMMY PLUG (FOR SLIM-LINE PLUGS)



All open plugs should be sealed with a dummy plug

- 99502** Dummy Plug

## STANDARD MALE TO SLIM-LINE UNDER-LAMP FEMALE



Rear tracking lamp jumper

- 66170** 2' (24")

## STANDARD MALE TO STANDARD FEMALE

66100 - License lamp jumper (as shown) • 66101 - Intermediate turn signal jumper, use with 66200 from front receptacle

- 66100**    4' 4" (50")
- 66101**    28' 3" (339")

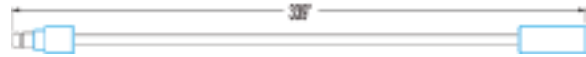

## SLIM-LINE UNDER-LAMP MALE TO STANDARD FEMALE

Jumper to access auxiliary drop-out on rear sill harness

- 66110**    5' (60")



## STANDARD FEMALE TO DOUBLE SLIM-LINE UNDER-LAMP FEMALE

- 66225**    Ground Jumper, 3' (36")



## SLIM-LINE UNDER-LAMP MALE TO SLIM-LINE UNDER-LAMP FEMALE

- 66162**    Intermediate side marker crossover jumper, 8' 9" (105")



## SLIM-LINE UNDER-LAMP MALE TO SLIM-LINE UNDER-LAMP FEMALE

- 66160**    Multiple ID lamp jumper, 1' (12")
- 66124**    Front marker and rear marker lamp jumper, 2' 6" (30")
- 66161**    Front lower side marker from front receptacle. Use with 66190, 4' 7" (55")
- 66125**    Marker lamp jumper, 7' (84")
- 66123**    Marker lamp jumper, 10' 9" (129")
- 66163**    Front upper clearance / marker from front receptacle. Use with 66190, 12' 8" (152")
- 66122**    Marker lamp jumper 26' 11" (323")
- 66113**    Clearance lamp jumper



# Trailer Wiring and Communications Systems

Systèmes de Communication et Filage de Remorques    Sistemas de arneses para remolque / Caja de conexión

## BLUNT-CUT TO DOUBLE SLIM-LINE UNDER-LAMP FEMALE

**66190** Wire into front receptacle terminals, 8" blunt cut



## BLUNT-CUT TO STANDARD FEMALE

**66200** Wire into front receptacle terminals, 8" blunt cut



## BLUNT-CUT TO STANDARD FEMALE

**67315** 14-Gauge, 1' 2" (14")

**67413** 12-Gauge, 1' 2" (14")

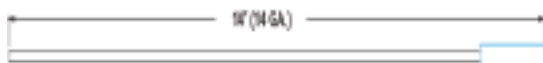

## DOUBLE SLIM-LINE FEMALE TO RING TERMINAL

Jumper accommodates insulated ground return system • Affixed to brass ground on rear sill harness • Crimp-on 1/4" ring terminal and heat-shrink tube supplied unattached

**66210** Jumper, 12"



## TWO STANDARD MALES TO TWO SLIM-LINE UNDER-LAMP FEMALES

66220 - Use the 5306 combination clearance / marker and auxiliary stop / turn signal lamp, use with 66400 when triple-ID / Auxiliary stop is located on upper rail, 10' 10" (130") • Wire is 14 gauge

**66220** ID / auxiliary stop jumper

**66121** Midturn and marker lamp harness, 30' (360")



## TWO SLIM-LINE MALES TO TWO SLIM-LINE UNDER-LAMP FEMALES

**66221** Marker lamp or ABS fault lamp, 5' (60")

**66222** Jumper, 8' (96")

**66164** Jumper, 8' 9" (105")



## TWO STANDARD MALES TO TWO STANDARD FEMALES

**66133**    Marker lamp jumper, 4' 4" (52")



## TWO STANDARD MALES TO TWO DOUBLE FEMALES

**66171**    Marker lamp jumper, 14' (168")

**66145**    Marker lamp jumper, 26' (312")

**66143**    Marker lamp jumper, 31' (372")

**66141**    Marker lamp jumper, 34' (408")



## TWO SLIM-LINE MALE TO TWO DOUBLE FEMALES

**66165**    Marker lamp jumper, 1' (12")

**66155**    Marker lamp jumper, 2' 6" (30")

**66154**    Marker lamp jumper, 4' 7" (55")

**66153**    Marker lamp jumper, 7' (84")

**66152**    Marker lamp jumper, 10' 9" (129")

**66151**    Marker lamp jumper, 12' 8" (152")

**66150**    Marker lamp jumper, 16' (192")

**66135**    Marker lamp jumper, 26' 11" (323")

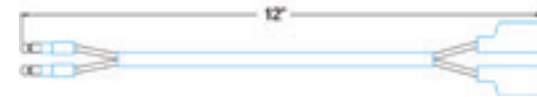



# Pigtails, Brackets and Grommets

Spirales de Raccord, Bague de Montage et Supports Conectores / Soportes rígidos y flexibles



66930



66931



67001



66850



66851



66801



67050

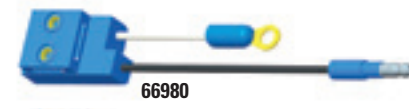

66980



66981



66982



67120

## THIN-LINE LED PIGTAILS

Factory-molded plugs for use with ULTRA-BLUE-SEAL® trailer wiring system

- UBS sealing ring
- Uses patented double-seal protection
- Grease grooves for additional sealing protection
- Slim-Line .180 male

**66930** 5" Long, Chassis Ground System

**66931** 6" Long, Ground Return

## SEALED MARKER LAMP PIGTAILS

Factory-molded plugs for use with ULTRA-BLUE-SEAL® trailer wiring system

- Double seal resists corrosion
- Fits 2", and 2 1/2" round and beehive-style LED and incandescent lamps
- Slim-Line .180 male

### DOUBLE SEAL:

**67001** 6" Long, Ring Terminal Ground, Blunt Cut Wire

**67001-5** 6" Long, Ring Terminal Ground, Blunt Cut Wire

RETAIL

**66850** 6" Long, Chassis Ground

**66851** 6" Long, Ground Return

### SINGLE SEAL:

**66801** 6" Long, Ground Return

**67050** 6" Long, Ring Terminal Ground, Blunt Cut Wire

**67050-5** 6" Long, Ring Terminal Ground, Blunt Cut Wire

RETAIL

**66840** 6" Long, Chassis Ground, Standard .180 Male

**66800** 6" Long, Chassis Ground, Slim-Line .180 Male



66800



66840

## CLEARANCE / MARKER PIGTAILS

Factory-molded plugs for use with ULTRA-BLUE-SEAL® trailer wiring system

- Fits 4674 series clearance / marker lamps, and 4709 and 6029 / 6030 license and utility lamps
- Pigtail designed to be integral part of mounting bracket (43780)

**66980** 6" Long, Chassis Ground, Slim-Line .180 Male

**66981** 6" Long, Universal Replacement, Blunt Cut, Ring Terminal Grommet

**66982** 8" Long, Ground Return

## MARKER LAMP PIGTAIL

Fits all Grote 2-bulb marker lamps with flag terminals, including 4526-, 4546-, 4593-, 4630-, 4678- and 4679- series lamps

**67120** 7 3/4" Long, .180 Slim-Line Male

## SEALED, ECONOMY CLEARANCE/ MARKER LAMP PIGTAIL

Fits 4607 series lamps

**66360**    6 3/4" Long w/ 3/8" Wire Strip



## TURTLEBACK® II DOUBLE-SEAL LAMP PIGTAILS

Factory-molded plugs for use with ULTRA-BLUE-SEAL® trailer wiring system

• Pigtail for 4680-, 4684-, 4686- and 4687- series lamps • All connections fit under lamps

- 66910**    6" Long, Chassis Ground, Slim-Line .180 Male
- 66911**    6" Long, Ground Return, Standard .180 Male
- 67070**    2 1/2" Long, Ground Wire, Standard .180 Male
- 67071**    Two-Wire, Standard .180 Male



66910



66911



67070



67071

## SENTRY LAMP PIGTAILS

Factory-molded plugs for use with ULTRA-BLUE-SEAL® trailer wiring system

• Sealed plug-in pigtail for 5206-, 5202-, and 5306- lamps • O-ring helps prevent moisture and corrosion

- 66900**    6" Long, Chassis Ground, Slim-Line .180 Male, 3 1/2" Ground, Star Ring Terminal
- 66903**    Three-Wire, Standard .180 Male (5306 Lamps Only)
- 66904**    6" Long, Ground Return, Slim-Line .180 Male
- 66905**    6" Long, Chassis Ground, Slim-Line .180 Male



66900



66903



66905



66904

## SENTRY LAMP SINGLE FUNCTION 90° PIGTAIL

90° molded plug at lamp • Packard connector at power end (15300027)

• O-ring resists moisture and corrosion

**66920**    30" Long, 90° Plug



# Pigtails, Brackets and Grommets

Spirales de Raccord, Bague de Montage et Supports    Conectores / Soportes rígidos y flexibles



## SENTRY HIGH-MOUNT STOP PIGTAIL

Fits 54012 lamp • Sealin -ring to lamp base • O-ring resists moisture and corrosion

**66902** 6" Long, Slim-Line .180 Male, 3" Ground, Star Ring Terminal



## HIGH-MOUNT STOP LAMP PIGTAIL

Factory-molded plugs for use with the ULTRA-BLUE-SEAL® trailer wiring system • Fits 4925 series lamps for use in HMSL applications

**66870** 12 1/2" Long, Slim-Line .180 Male



**66815**



**66841**



**67002**

## STOP /TAIL /TURN THREE-WIRE PLUG-IN PIGTAILS FOR MALE PIN LAMPS

Dual function for S/T/T lamps • O-ring seal resists moisture and corrosion • Quality ULTRA-BLUE-SEAL® construction • Grease grooves for additional sealing protection

**66815** 6" Long, Ground Return, Slim-Line .180 Male

**66841** 8" Long, Chassis Ground, Slim-Line .180 Male

**67002** 11" Long, Chassis Ground, Blunt Cut Wire



**66816**



**66845**



**67005**

## STOP /TAIL /TURN THREE-WIRE 90° PLUG-IN PIGTAILS FOR MALE PIN LAMPS

Dual function for S/T/T lamps • O-ring seal resists moisture and corrosion • 90° plug for reduced clearance applications • Quality ULTRA-BLUE-SEAL® construction • Grease grooves for additional sealing protection

**66816** 6" Long, Ground Return System, 90° Plug, Slim-Line .180 Male

**66845** 8" Long, Chassis Ground, 90° Plug, Slim-Line .180 Male

**67005** 11" Long, Chassis Ground, 90° Plug, Blunt Cut Wires



**67013**



**66842**

## STOP /TAIL /TURN TWO-WIRE PLUG-IN PIGTAILS FOR MALE PIN LAMPS

Straight-in pigtail • Single function • O-ring seal resists moisture and corrosion • Quality ULTRA-BLUE-SEAL® construction • Grease grooves for additional sealing protection

**67013** 11" Long, Chassis Ground, Blunt Clut Wire

**66842** 10" Long, Chassis Ground, Slim-Line .180 Male

## STOP /TAIL /TURN TWO-WIRE 90° PLUG-IN PIGTAILS FOR MALE PIN LAMPS

Factory-molded plugs for use with quality ULTRA-BLUE-SEAL® trailer wiring system • 90° plug for reduced clearance applications • Single function • O-ring seal resists moisture and corrosion • Grease grooves for additional sealing protection

- 66846**    10" Long, Chassis Ground, 90° Plug, Slim-Line .180 Male
- 67016**    11" Long, Chassis Ground, 90° Plug, Blunt Cut Wires



66846



67016

## STOP /TAIL /TURN THREE-WIRE PLUG-IN PIGTAILS FOR FEMALE PIN LAMPS

Dual function for S/T/T lamps • Factory molded plugs for use with ULTRA-BLUE-SEAL® trailer wiring system

- 66812**    6" Long, Chassis Ground, Slim-Line .180 Male
- 66825**    8" Long, Ground Return, Slim-Line .180 Male
- 67000**    11 1/2" Long, Chassis Ground, Blunt Cut Wires

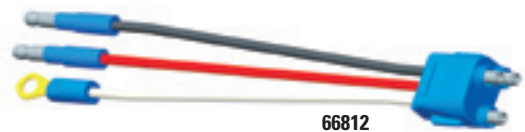

66812



66825



67000

## STOP /TAIL /TURN THREE-WIRE 90° PLUG-IN PIGTAILS FOR FEMALE PIN LAMPS

Factory-molded plugs for use with ULTRA-BLUE-SEAL® trailer wiring system • Dual function for S/T/T lamps

- 66811**    18" Long, Chassis Ground, Slim-Line .180 Male, Star Ring Terminal
- 66843**    18" Long, Chassis Ground, Blunt Cut Wires, Star Ring Terminal
- 66843-5**    18" Long, Chassis Ground, Blunt Cut Wires, Star Ring Terminal **RETAIL**
- 66844**    18" Long, Ground Return, Slim-Line .180 Male



66811



66843



66844

## UNIVERSAL 3-WIRE 90° PLUG-IN PIGTAIL FOR FEMALE-PIN LAMPS

90° construction for reduced clearance applications • Dual function for S/T/T lamps • Mates to Grote® and competitive lamps with female termination

- 67090**    13" Long, Chassis Ground, 90° Plug, Blunt Cut Wires
- 67090-5**    13" Long, Chassis Ground, 90° Plug, Blunt Cut Wires **RETAIL**



67090

# Pigtails, Brackets and Grommets

Spirales de Raccord, Bague de Montage et Supports    Conectores / Soportes rígidos y flexibles



67010



67011



67012

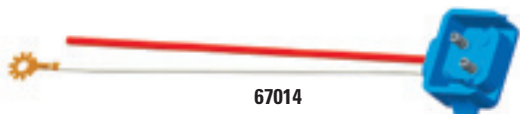

67014

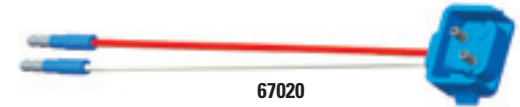

67020



66111



66932



68580

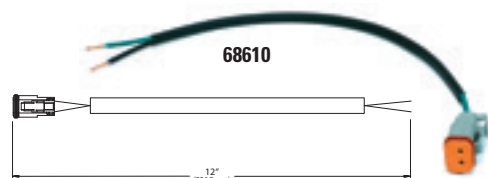

68610



68010

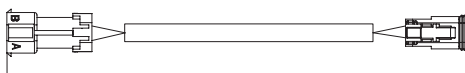

68060

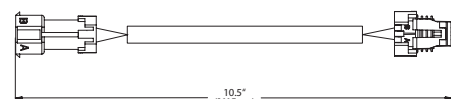
10.5"  
(266.7 mm)

## TWO-WIRE PLUG-IN PIGTAILS FOR FEMALE-PIN LAMPS

Factory-molded plugs for use with ULTRA-BLUE-SEAL® trailer wiring system • Single function • Includes dummy pin to help guide the pigtail into lamp

### STRAIGHT:

- 67010** 11 1/2" Long, Chassis Ground, Blunt Cut  
**67011** 10 1/4" Long, Chassis Ground, Standard .180 Male  
**67012** 10" Long, (2) Standard .180 Male

### 90° PLUG:

- 67014** 10" Long, Chassis Ground, Blunt Cut  
**67020** 10" Long, Ground Return, Slim-Line .180 Male

## TRIPLE-LAMP ID HARNESSSES

Designed for use with ULTRA-BLUE-SEAL® wiring system • Factory-molded plugs resist moisture and corrosion • Slim-Line .180 male terminations at power end

- 66111** 54" Long, Universal Triple-ID Jumper (31"x12"x12")  
**66932** 60" Long, LED Triple-ID Jumper (36"x12"x12")

## HARD SHELL SUPERSEAL CONNECTOR

Mates with Trilliant® Work Lamps and competitive lamps using AMP superseal connectors

- 68580** 9" Long, Blunt Cut Wires

## DEUTSCH CONNECTOR

Mates with Trilliant® Work Lamps and competitive lamps using Deutsch connectors

- 68010** Deutsch to Packard  
**68020** Packard to Deutsch  
**68030** Deutsch to Packard (Hard Shell SuperSeal)  
**68060** Packard to Packard  
**68610** 12" Long, Blunt Cut Wires

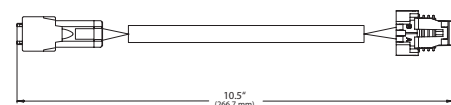

68020

10.5"  
(266.7 mm)

68030

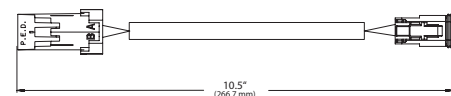
10.5"  
(266.7 mm)

## HARD-SHELL CONNECTOR PIGTAILS

Mates with Grote and competitive lamps using Hard Shell SuperSeal 1.5 series connectors

**DUAL FUNCTION:**

**66861**    11" Long, Chassis Ground, Blunt Cut Wires

**SINGLE FUNCTION:**

**66862**    11" Long, Chassis Ground, Blunt Cut Wires



66861



66862

## PACKARD® CONNECTOR PIGTAIL

Sealed plug-in style pigtail for Grote® Hybrid Midturn / Marker LED lamp

**66826**    6" Long, Slim-Line .180 Males



## METRI-PACK® PLUG-IN SEALED PIGTAIL

Fits either 4- or 5-wire applications • Fits 5370-, 5371-, 5372- and 5376- series lamps

**66880**    20" Long, Sealed, Blunt Cut Wires



## TWO LAMP 9" Y ADAPTER PIGTAILS

Accommodates 6-lamp systems • Molded termination avoids moisture and corrosion buildup • For use with 4" round and oval S/T/T lamps • Retrofits to superior Grote male pin LED lamps without the need for new wiring

**90° PLUG:**

**66814**    9" Long, Adapter, Female-to-Male Pin

**STRAIGHT:**

**66810**    9" Long, Adapter, Female-to-Female Pin

**66813**    9" Long, Adapter, Male-to-Male Pin



66814



66810

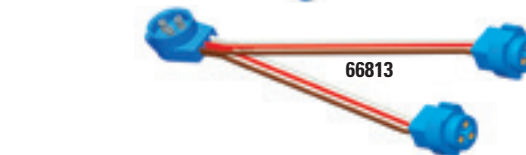

66813

## MIDTURN ADAPTER PIGTAILS

Factory-molded plugs for use with ULTRA-BLUE-SEAL® trailer wiring system • For use with 4" round and oval S/T/T lamps • 6" midturn adapter harness • Dummy plug in brown female .180 receptacle

**66820**    Adapter, Female-to-Female Pin, (2) Additional Standard .180 Receptacles

**66823**    Adapter, Male-to-Male Pin, (2) Additional Standard .180 Receptacles

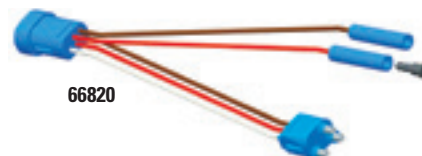

66820

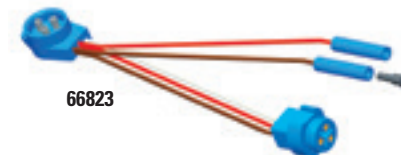

66823

# Pigtails, Brackets and Grommets

Spirales de Raccord, Bague de Montage et Supports    Conectores / Soportes rígidos y flexibles



66830



66831



66836



67006



66860



66863



66864



66865



68110



68130



68150



68080



68170

## ADAPTER PLUGS

Includes female-to-male pin lamp termination, and male-to-female pin lamp termination • For use with 4" round and oval, S/T/T lamps

**66830** 6" Long, Female Pin to Male Pin Lamp Termination

**66831** 6" Long, Male Pin to Female Pin Lamp Termination

**66831-5** 6" Long, Female Pin to 90° Male Pin Lamp Termination

**66836** 6" Long, Female Pin to 90° Male Pin Lamp Termination

## ADAPTER PLUGS FOR HARD SHELL CONNECTORS

For use with 4" round and oval S / T / T lamps

### COMPETITIVE HARNESS TO MALE PIN:

**67006** 6" Long, Hard Shell to Male Pin Connector

### FEMALE PIN HARNESS TO AMP CONNECTOR:

**66860** 6" Long, Female Pin to Hard Shell Connector

## COMBO PIGTAILS

For new 4" integrated B/U Lamp

**66863** Male Pin to Lamp Termination (10" Long)

**66864** Female Pin to Lamp Termination (10" Long)

**66865** Hard Shell to Lamp Termination (10" Long)

## REPLACEMENT LAMP SOCKET PIGTAILS

Ensures positive bulb contact in all types of weather • Exceeds all existing automotive requirements • Heavy gauge thermoplastic wire with brass contacts, terminals and flags

### DOUBLE CONTACT:

**68110** 9 1/2" Long

**68130** 7 1/2" Long

**68150** 6 1/2" Long

### SINGLE CONTACT:

**68080** 9 1/2" Long

**68170** 9 1/2" Long

## TWIST-IN SOCKET PIGTAIL

Includes 194 bulb • Fits 46002, 46003, 46913, 45662, 45563, 45712 and 45713 marker lamps

**68380** 9 1/2" Long, Socket, Blunt Cut Wires

Voltage / Amp: 12V / .27A



## HOODED MICRONOVA® DOT GROMMET

Fits MicroNova® Dot lamps • For plate thickness to 1/4"

**94360** Black

Material: PVC  
Finish: Black

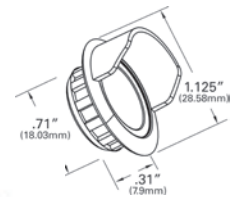

## MICRONOVA® SECURITY PLATE

Installs over grommet mounted MicroNova® Dot without impeding light output performance • Use stainless steel rivets (.119 rivet) or screws (not included) to mount directly to the vehicle

**42063** Stainless Steel

Material: Stainless Steel  
Finish: Stainless Steel

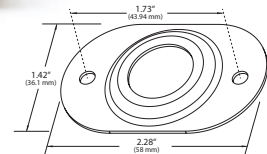

## RECESSED MOUNTING GROMMET FOR 2" ROUND LAMPS

Requires 2 5/16" mounting hole • Fits panel thickness up to 1/4"

**92120** Open Grommet

**92150** Closed Back Grommet

**KITS:**

**94100** Open Grommet (92120 + 67050)

Material: PVC  
Finish: Black



92120

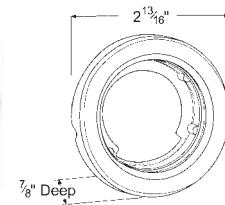

## SNAP-IN THEFT-RESISTANT MOUNTING FLANGE FOR 2" ROUND LAMPS

Snap-in flanges make installation more efficient in a variety of situations • Lamp snaps into the flange and flange snaps into the trailer body, making it more theft resistant • Requires a 2 5/16" hole and panel thickness from 1/16" up to 1/4" thick

**42190** Gray

**CAP:**

**93860** Gray

Material: Polycarbonate  
Finish: Gray

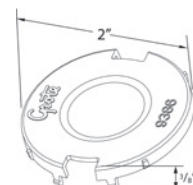
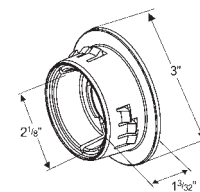



# Pigtails, Brackets and Grommets

Spirales de Raccord, Bague de Montage et Supports Conectores / Soportes rígidos y flexibles

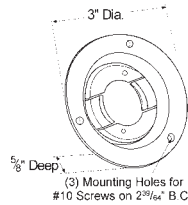

## THEFT-RESISTANT MOUNTING FLANGE FOR 2" ROUND LAMPS

Patented twist-in locking system keeps lamp from backing out • Ideal for LED lighting • For use with 2" LED and incandescent lamps • Requires 2 1/4" mounting hole

- 43150** Gray, Polycarbonate
- 43152** Black, Polycarbonate
- 43153** Chrome-Plated, ABS

Material: Polycarbonate/ABS  
Finish: Gray/Black/Chrome

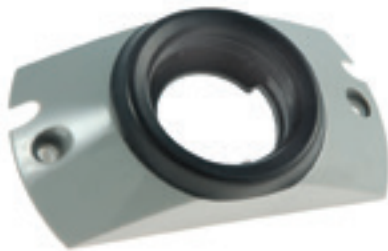

## SURFACE MOUNT BRACKET WITH GROMMET FOR 2" ROUND LAMPS

4 1/4" mounting screw hole spacing

- 93760** Gray

Material: Polycarbonate  
Finish: Gray  
Grommet: 92120

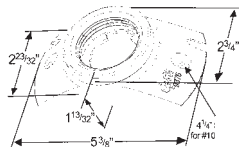

## LICENSE LAMP MOUNTING BRACKET

Anti-glare shield eliminates stray light from distracting following motorists

- 43040** White

Material: Polycarbonate  
Finish: White

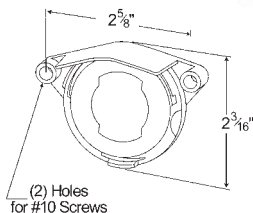

## RECESSED MOUNTING GROMMET FOR 2 1/2" ROUND LAMPS

• Requires 2 25/32" hole • Fits panel thickness up to 1/8"

- 91400** Open Grommet
- 92070** Closed Back Grommet

### KITS:

- 94010** Open Grommet (91400 + 67050)

Material: PVC  
Finish: Black

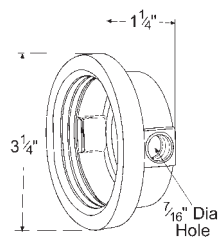

## RECESSED MOUNTING GROMMET FOR 2 1/2" ROUND LAMPS

- Requires 3" hole • Fits panel thickness up to 1/4"

**91410**    Open Grommet

**KITS:**

**94000**    Open Grommet (91410 + 67050)

Material: PVC  
Finish: Black

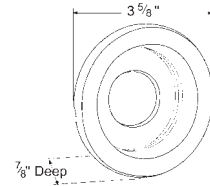

## 45° ANGLED BEVELED-EDGE RECESSED MOUNTING GROMMET FOR 2 1/2" ROUND LAMPS

- Fits 2 3/4" hole • Open back fits panel thickness up to 3/16", closed back fits up to 3/8"

**91880**    Open Grommet

**92920**    Closed Back Grommet

Material: PVC  
Finish: Black

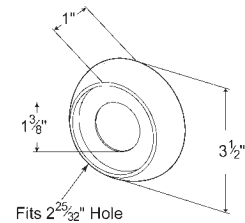

## SURFACE MOUNT GROMMET FOR 2 1/2" ROUND LAMPS

Protective brass eyelets for mounting screw

**91890**    Open Grommet

Material: PVC  
Finish: Black

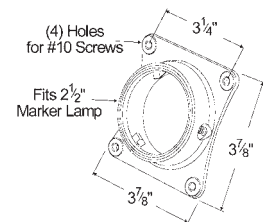

## THEFT-RESISTANT MOUNTING FLANGE FOR 2 1/2" ROUND LAMPS

- Patented twist-in locking system keeps lamp from backing out • Ideal for LED lighting • Fits 2 1/2" LED and incandescent lamps • Requires 2 5/8" mounting hole

**MOUNTING FLANGE:**

**43160**    Gray, Polycarbonate

**43162**    Black, Polycarbonate

**43163**    Chrome-Plated, ABS

**PIGTAIL RETENTION CAP:**

**93670**    Gray

Material: Polycarbonate/ABS  
Finish: Gray/Black/Chrome

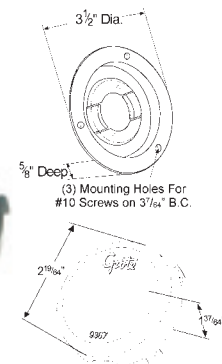

# Pigtails, Brackets and Grommets

Spirales de Raccord, Bague de Montage et Supports Conectores / Soportes rígidos y flexibles

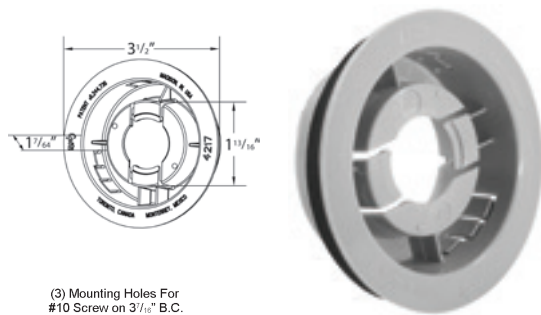

(3) Mounting Holes For #10 Screw on 3 1/16" B.C.

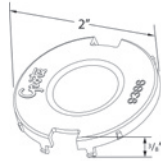
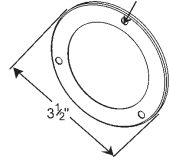

## SNAP-IN MOUNTING FLANGE FOR 2 1/2" ROUND LAMPS

Flange is held into place by snap tabs for a quicker, easier installation

- Snap tabs on the flange lock the flange into place, keeping it from backing out of the hole
- Foam gasket allows for mounting in materials from 1/8" to 1/4" thick
- Requires 2 25/32" mounting hole

### MOUNTING FLANGE:

**42170** Gray

### CAP:

**93860** Gray

### SECURITY RING:

**43823** Stainless Steel

Material: Polycarbonate/Stainless Steel  
Finish: Gray/Chrome

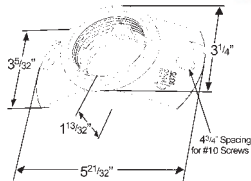
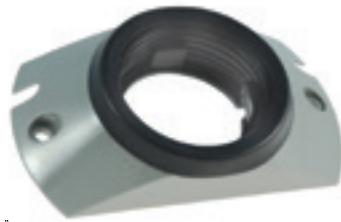

## SURFACE MOUNTING BRACKET WITH GROMMET FOR 2 1/2" ROUND LAMPS

- Includes grommet 91400
- 4 3/4" mounting screw hole spacing

**93750** Gray

Material: Polycarbonate/PVC  
Finish: Gray/Black

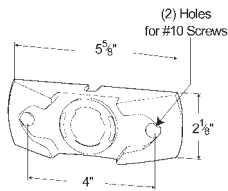

## TWIST-IN SURFACE MOUNT BRACKET FOR 2" AND 2 1/2" ROUND LAMPS

- 4" mounting screw hole spacing

**43690** Gray

### KITS:

**43430** Gray (43690 + 67050)

Material: Polycarbonate  
Finish: Gray

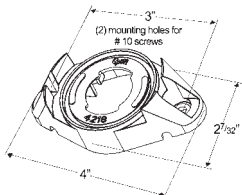

## TWIST-IN SURFACE MOUNT BRACKET FOR 2" AND 2 1/2" ROUND LAMPS

- 3" mounting screw hole spacing
- Supports the use of PC-rated lamps for greater visibility

**42180** Gray

Material: Polycarbonate  
Finish: Gray

## 4 5/8" CORNER RADIUS SURFACE MOUNT BRACKET FOR 2" AND 2 1/2" ROUND LAMPS

Fits 4 5/8" corner radius • Use with PC-rated lights

**43760**    Gray

Material: Polycarbonate  
Finish: Gray

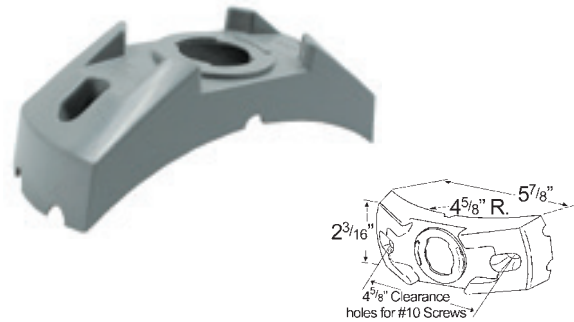

## 90° ANGLE MOUNTING BRACKET FOR 2" AND 2 1/2" ROUND LAMPS

Baked black enamel finish • Grommet required for mounting • 2 1/4" mounting screw hole spacing

**FOR 2 1/2" LAMPS:**

**43512**    Accommodates 94010, 91400, 92070 Grommets (2 25/32" Hole)

**43522**    Accommodates 94000, 91410 Grommets (3" Hole)

**FOR 2" LAMPS:**

**43532**    Accommodates 94100, 92120, and 92150 Grommets (2 5/16" Hole)

Material: Steel  
Finish: Black Enamel

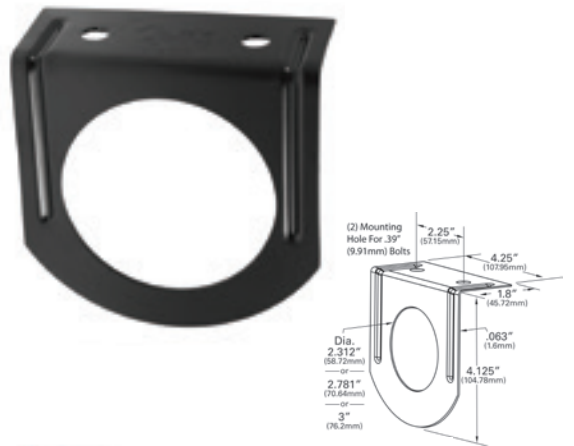

## BAR LAMP BRACKET FOR 2" AND 2 1/2" ROUND LAMPS

Includes chassis ground UBS harness with blunt-cut power feed

**49140**    Black

Material: Steel  
Finish: Black Enamel  
Accessory: Harness: 67740



## GROMMET FOR SMALL RECTANGULAR LAMPS

Requires 1 1/2" x 2 7/8" hole (with 3/8" radius corners) • Fits panel thickness up to .2"

**91380**    Black

Material: PVC  
Finish: Black

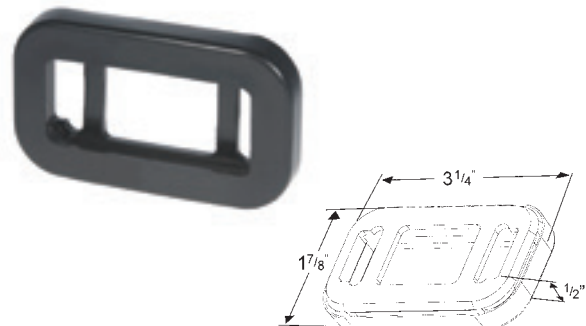

# Pigtails, Brackets and Grommets

Spirales de Raccord, Bague de Montage et Supports Conectores / Soportes rígidos y flexibles

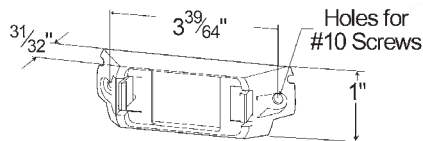
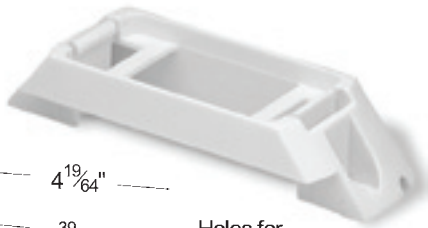
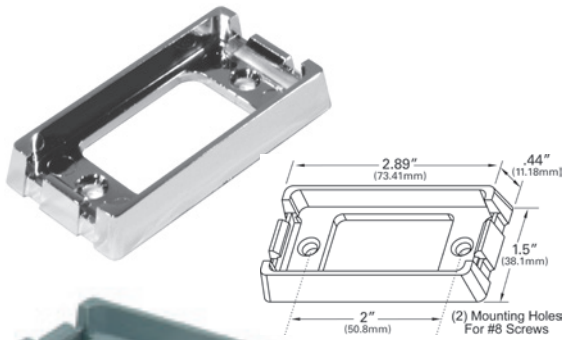

42110

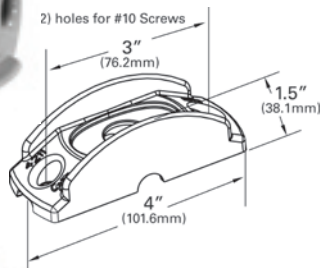

42120

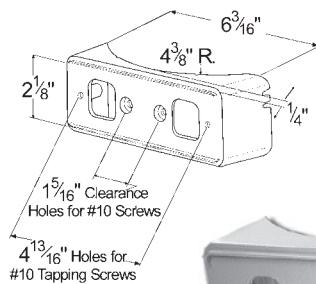

## BRACKET FOR SMALL RECTANGULAR LAMPS

2" mounting screw hole spacing • Kits include pigtail and mounting pad

94233 Chrome-Plated

### KITS:

43970 Gray

43980 Chrome-Plated

Material: Polycarbonate/ABS  
Finish: Chrome/Gray

## RAIL-MOUNT BRACKET FOR SMALL RECTANGULAR LAMPS

Mountable at 45° angle for PC applications • Cut-out design for rail mountings • 3 39/64" mounting screw hole spacing • Kit includes single-seal pigtail

42131 White

### KITS:

43370 White (42131 + 67050)

Material: Polycarbonate  
Finish: White

## SURFACE MOUNT BRACKET FOR MICRONOVA® OR MICRONOVA DOT

Armored design to protect the lamp from damage • 3" mounting screw hole spacing (2 3/4" spacing for radius bracket)

42110 Gray

42112 Black

42120 Gray, Corner Radius Bracket

Material: Polycarbonate  
Finish: Gray/Black

## 4 3/4" CORNER RADIUS BRACKET

For use with PC-rated lights • 4 13/16" mounting screw hole spacing • works with Turtleback® II style lamps

43050 Gray

Material: Polycarbonate  
Finish: Gray

## HEADER-MOUNT BRACKET FOR SMALL RECTANGULAR LAMPS

Mountable at 45° angle for PC applications • Narrow rail applications  
 • 3 39/64" mounting screw hole spacing • Kit includes single-seal pigtail

**42141**    White

**KITS:**  
**43380**    White (42141 + 67050)

Material: Polycarbonate  
 Finish: White

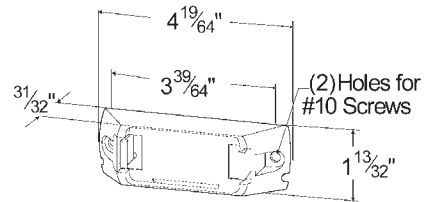

## GROMMET FOR SMALL RECTANGULAR LAMPS

• Requires 2 1/2" x 3 1/2" hole (with 17/32" corners) • Fits panel thickness up to 3/16"

**93400**    White

**93402**    Black

Material: PVC  
 Finish: Black/White

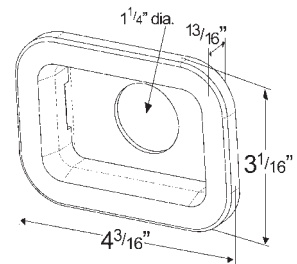

## MICRONOVA® LAMP BEZEL

Corrosion resistant, chrome-plated • Snap-fit mounting

**93803**    Chrome-Plated

Material: ABS  
 Finish: Chrome

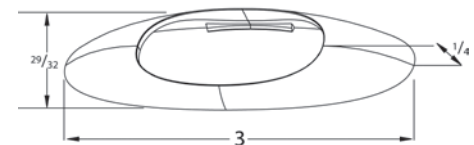

## LICENSE LAMP BRACKET FOR SMALL RECTANGULAR LAMPS

Anti-glare shield eliminates stray light from distracting following motorists  
 • 3" mounting screw hole spacing • Snap-in lamp installation

**42162**    Black

Material: Polycarbonate  
 Finish: Black

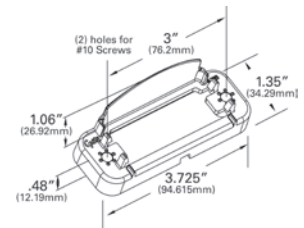

## LICENSE LAMP MOUNTING BRACKET

Features Snap-in lamp installation • Fits license lamp 60671, 60261, 60601  
 Anti-glare shield eliminates stray light from distracting following motorists  
 • 2" mounting screw hole spacing

**43960**    Gray

**43962**    Black

Material: Polycarbonate  
 Finish: Gray/Black

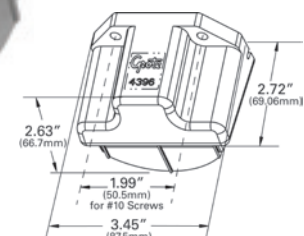

# Pigtails, Brackets and Grommets

Spirales de Raccord, Bague de Montage et Supports Conectores / Soportes rígidos y flexibles

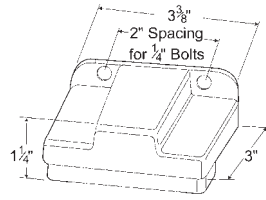

## LICENSE LAMP MOUNTING BRACKET

Fits license lamp 60261 • 2" mounting screw hole spacing • Thin design reduces mounting space requirements

**43830** Gray

Material: Polycarbonate  
Finish: Gray  
Grommet: 92520

**42302**

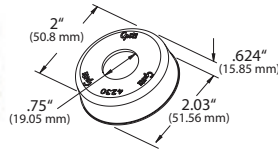

## MICRONOVA® DOT ROUND ADAPTER BRACKETS

Assembles directly into 2" and 2.5" PVC grommets • Replaces any incandescent or LED 2" or 2.5" round clearance/marker • Flanges torque to a maximum of 25 in-lbs and mount with three #10 pan or round head screws into existing hole patterns of 2" and 2.5" flanges

**42312**

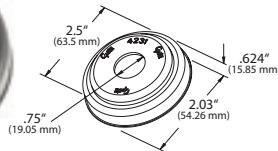

- 42302** 2" Round Grommet Adapter
- 42312** 2.5" Round Grommet Adapter
- 42292** 3" Round Flange Adapter
- 42282** 3.5" Round Flange Adapter

**42292**

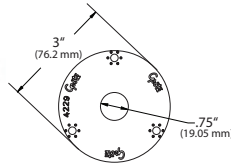

**42282**

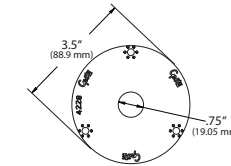

## MICRONOVA® SURFACE MOUNT BRACKET

4 13/16" mounting hole separation provides easy retrofit  
• Great for narrow surface mounting applications

**42070** Gray

Material: Polycarbonate  
Finish: Gray

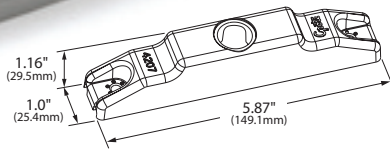

## MICRONOVA® DOT ADAPTER BRACKET

Allows the MicroNova® DOT to mount directly to the vehicle using this bracket or snap-fit into compatible 4378 series mounting brackets  
• 2 1/2" - 3" mounting screw hole spacing

**94350** Gray

Material: Polycarbonate  
Finish: Gray

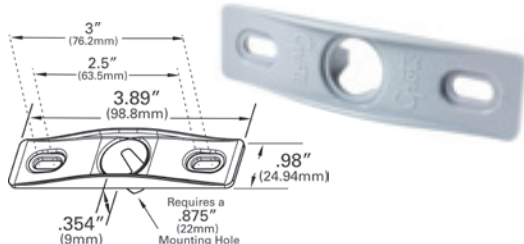

## MOUNTING BRACKET FOR LARGE RECTANGULAR LAMPS

- 3" mounting screw hole spacing
- Kits include unique connector design with plug-in pigtail

**43780**    Gray Bracket  
**43783**    Chrome-Plated Bracket, ABS

**KITS:**  
**43390**    Gray (43780 + 66981)  
**43790**    Gray (43780 + 66980)

Material: Polycarbonate/ABS  
 Finish: Gray/Chrome

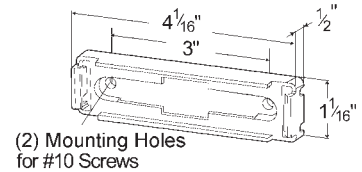

## LOW PROFILE MOUNTING BRACKET

- Integrated plug connection
- Legal mount for combination clearance/ marker lamp when mounted on a 45° angle (PC)
- 3" mounting screw hole spacing

**43850**    Gray

Material: Polycarbonate  
 Finish: Gray

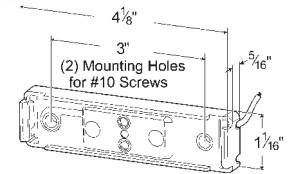

## M3 SERIES LAMP BEZEL

For use with M3 style cab markers

**93473**    Chrome

Material: ABS  
 Finish: Chrome

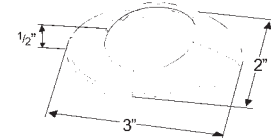

## M1 SERIES LAMP BEZEL

For use with M1 style cab markers

**93453**    Chrome

Material: ABS  
 Finish: Chrome

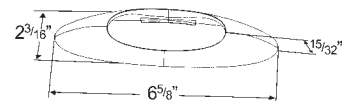

## SMALL CAB MARKER BEZEL

Can be installed while lamps are mounted

**92583**    Bezel

Material: ABS  
 Finish: Chrome

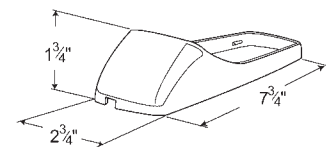

## THIN-LINE LED LAMP GUARD

- Cutaway to accept plug-in pigtail
- For use with 4690, 4692, and 4693 series lamps

**43074**    Aluminum

Material: Aluminum  
 Finish: Aluminum

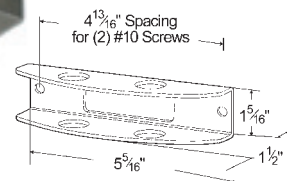



# Pigtails, Brackets and Grommets

Spirales de Raccord, Bague de Montage et Supports Conectores / Soportes rígidos y flexibles

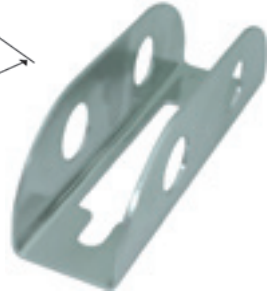
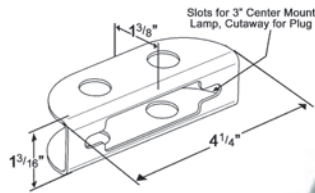

## THIN-LINE 3" LAMP GUARD

Cutaway to accept plug-in pigtail • For use with Supernova® thin line lamps

**43230** Aluminum

Material: Aluminum  
Finish: Aluminum

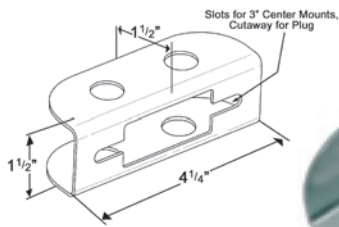

## LAMP GUARD FOR SMALL RECTANGULAR LAMPS

Cutaway to accept plug-in pigtail

**43120** Aluminum

Material: Aluminum  
Finish: Aluminum

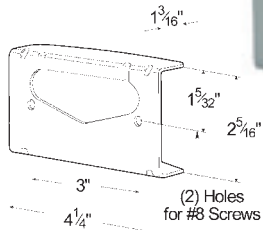

## STEEL LAMP GUARD

For use with 2" x 4" oval and square corner surface mount clearance/marker lamps • 3" mounting screw hole spacing

**43144** Steel

Material: Steel  
Finish: Silver

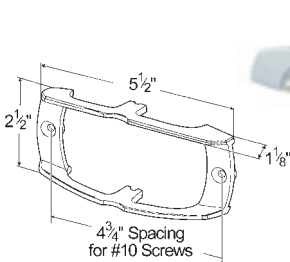

## CHROME BUTTRESS-STYLE LAMP GUARD

For use with 2" x 4" oval and square corner surface mounted lamps • 4 3/4" mounting screw hole spacing

**43673** Chrome-Plated

**43673-5** Chrome-Plated RETAIL

Material: ABS  
Finish: Chrome

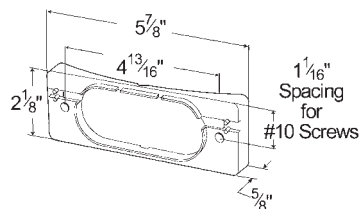

## 9 1/2" CORNER RADIUS BRACKET

PC-regulation mount for Turtleback® II • 4 13/16" mounting screw hole spacing

**43030** White

Material: Polycarbonate  
Finish: White

## RECESSES MOUNTING GROMMET FOR 4" ROUND LAMPS

Requires 4 1/2" mounting hole • Fits panel thickness up to 1/4"

**91740** Grommet

**KITS:**

**67150** Grommet w/Pigtail (91740 + 67000)

Material: PVC  
Finish: Black

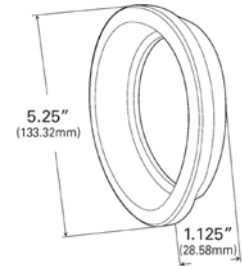

## CLOSED BACK RECESSED MOUNTING GROMMET FOR 4" ROUND LAMPS

For open installations where splash plate is not used • Requires a 4 1/2" mounting hole • Fits panel thickness up to 1/4"

**91950** Grommet

Material: PVC  
Finish: Black

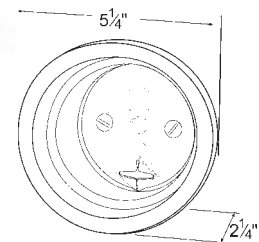

## STAINLESS STEEL SNAP-IN THEFT-RESISTANT MOUNTING FLANGE FOR 4" ROUND LED LAMPS

Foam gasket allows for mounting in materials from 1/8" to 1/4" thick • Requires 4 1/2" mounting hole • No drilling necessary to install

**93683** Stainless Steel

Material: Stainless Steel  
Finish: Stainless Steel

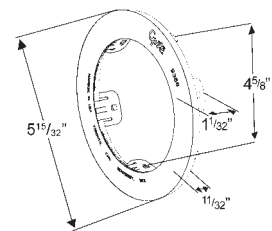

## SNAP-IN THEFT-RESISTANT MOUNTING FLANGE FOR 4" ROUND LED LAMPS

Fits panel thickness 1/8" to 1/4" • Requires 4 1/2" mounting hole

**93552** Black  
**93553** Chrome-Plated

Material: ABS  
Finish: Black/Chrome

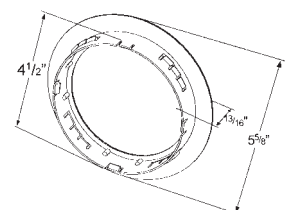

# Pigtails, Brackets and Grommets

Spirales de Raccord, Bague de Montage et Supports Conectores / Soportes rígidos y flexibles

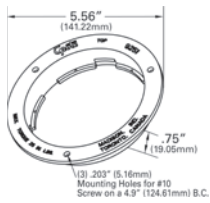

(3) Mounting Holes for #10 Screw on 4.52" B.C.

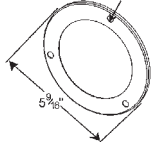

43343



## THEFT-RESISTANT MOUNTING FLANGE FOR 4" ROUND LAMPS

For use with 4" round LED and incandescent lamps • Mounting hole size 4 1/2" diameter

- 92510 White, Polycarbonate
- 92512 Black, Polycarbonate
- 92513 Chrome-Plated, ABS
- 92511 Gray, Polycarbonate
- 43253 Stainless Steel

### SECURITY RING

- 43343 Stainless Steel Security Ring (must be used with flange)

Material: Polycarbonate; Stainless Steel; ABS  
Finish: White; Gray; Black; Chrome; Stainless Steel

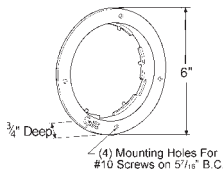

(4) Mounting Holes For #10 Screws on 5 1/8" B.C.



## THEFT-RESISTANT BETTS LIGHTING MOUNTING ADAPTER

Allows users to retrofit their Betts® brand lighting to Grote mounting dimensions • Retrofits to Grote 4" round sealed lamps and LEDs  
• Requires 4 1/2" diameter mounting hole

- 93190 Gray

Material: Polycarbonate  
Finish: Gray

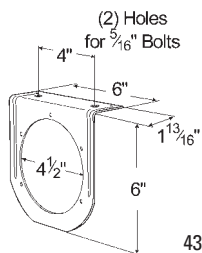

43572



## ANGLED MOUNTING BRACKET FOR 4" ROUND LAMPS

Accepts lamp equipped with a grommet or flange • 4" mounting screw hole spacing

- 43572 Black, 90° angle bracket
- 42052 Black, 45° angle bracket

Material: Steel  
Finish: Black Powder Coated  
Grommet: 91740

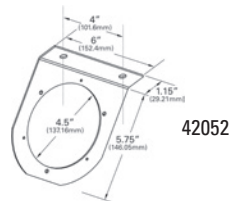

42052



## MOUNTING MODULE FOR 4" ROUND LAMPS

Closed back, rear lamp module for lamps requiring 4 1/2" mounting hole opening • Accepts lamps equipped with a grommet or flange

- 43655 Yellow Zinc
- 51090 Gray

Material: Steel  
Finish: Yellow Zinc/Gray Powder Coated

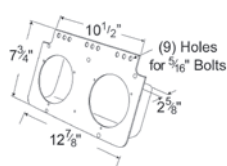

## 2-LAMP MOUNTING MODULE FOR 4" ROUND LAMPS

Two 4 1/2" mounting holes to hold standard recessed lamps or grommet-mounted 4" round lamps • Accepts lamps equipped with a grommet or flange • #10 mounting screw hole in center accepts 2 1/2" round reflector

**43642**    Black, Powder Coated

Material: Steel  
Finish: Black

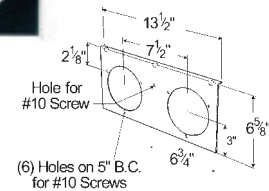

## MOUNTING MODULE FOR 4" ROUND LAMPS

Black enamel-coated steel construction • Use with 4" LED strobes or any 4" round lamp • Accepts lamp equipped with a grommet or flange

**43732**    Black

Material: Steel  
Finish: Black

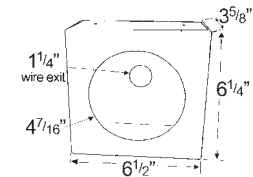

## O - RING

**94110**    O-Ring for use with 46782 and 46783 lamps.

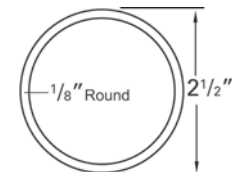

## SNAP RING

**99593**    Use with 50222 and 50352  
**99595**    Use with 50232 and 55092

Material: Stainless Steel  
Finish: Stainless Steel



## RECESSED MOUNTING GROMMET FOR 6" OVAL LAMPS

Fits 2 1/2" x 6 3/4" oval mounting hole • Fits panel thickness up to 1/4"

**92420**    Open Grommet  
**92720**    Closed Back Grommet

**KITS:**  
**67151**    Open Grommet (92420 + 67000)

Material: PVC  
Finish: Black

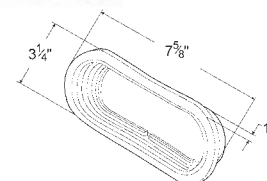

# Pigtails, Brackets and Grommets

Spirales de Raccord, Bague de Montage et Supports Conectores / Soportes rígidos y flexibles



## SURFACE MOUNT SNAP-IN BRACKET FOR 6" OVAL LAMPS

Allows for quick and easy surface mount application • Designed to work with 5413, 5414, 5416, 5417 product lines only. • 6" mounting screw hole spacing

**42152** Black, Polycarbonate  
**42153** Chrome, ABS

Material: Polycarbonate/ABS  
Finish: Black/Chrome

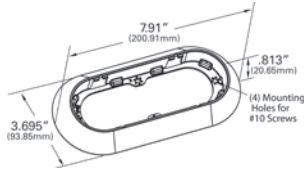

## SURFACE MOUNT BRACKET FOR 6" OVAL LAMPS

Can be used with any Grote 6" oval LED or incandescent lamp • Ideal for adding LED strobe lamps to a vehicle • 7 5/16" mounting screw hole spacing

**43172** Black

Material: Polycarbonate  
Finish: Black

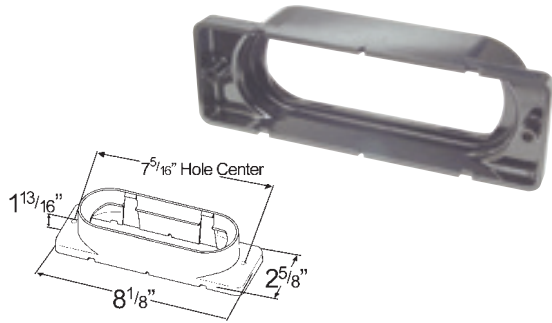

## THEFT-RESISTANT MOUNTING FLANGE FOR 6" OVAL LAMPS

For use with most LED and incandescent lamps • Security ring fits over oval theft resistant mounting flanges • 7 1/4" x 3" mounting screw hole spacing

**43220** Gray, Polycarbonate  
**43222** Black, Polycarbonate  
**43223** Chrome-Plated, ABS  
**43723** Stainless Steel

### SECURITY RING

**42103** Stainless Steel Security Ring (must be used with flange)

Material: Polycarbonate/Stainless Steel/ABS  
Finish: Gray/Black/Stainless Steel/Chrome



## ANGLED MOUNTING BRACKET FOR 6" OVAL LAMPS

Accepts lamp equipped with a grommet or flange • 6 1/4" mounting screw hole spacing

**43362** Black, 90° angle bracket

Material: Steel  
Finish: Black  
Grommet: 92420

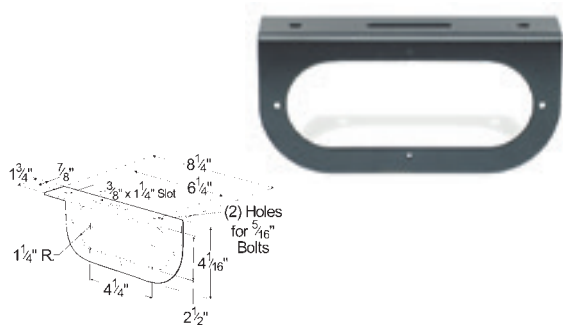

## "Z" MOUNTING BRACKET FOR 6" OVAL LAMPS

Heavy gauge steel, baked black enamel finish • Accepts lamp equipped with a grommet or flange • 6 1/4" mounting screw hole spacing

**43952**    Black

Material: Steel  
Finish: Black  
Grommet: 92420

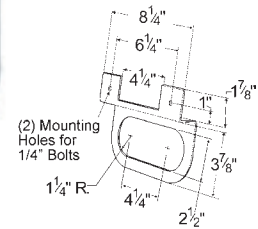

## MOUNTING BRACKET FOR 7" ROUND LAMPS

Heavy gauge steel • For use with 7800, 7830 and 7831 series lamps

**43282**    Black, Powder Coated

Material: Steel  
Finish: Black

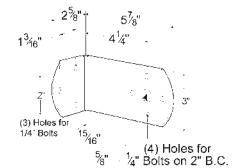

## MOUNTING BRACKET FOR UTILITY LAMPS

Detachable angle mounting bracket for utility work lamps with standard 3/8" mounting

**43292**    Black, Powder Coated

Material: Steel  
Finish: Black

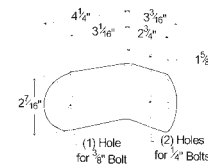

## MOUNTING BRACKET FOR 6" OVAL LAMPS AND STROBES

Accepts lamp equipped with a grommet or flange • 8 1/4" mounting screw hole spacing

**43100**    Black

Material: Steel  
Finish: Black  
Grommet: 92420

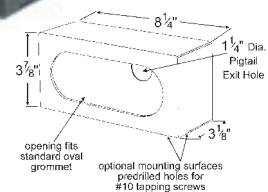

## 90° ANGLE BRACKET FOR RECTANGULAR STOP/TAIL/TURN LAMPS

Rugged 11 gauge steel construction • Black enamel-coated finish • 4" mounting screw hole spacing • Accepts lamp equipped with a grommet

**43212**    Black

Material: Steel  
Finish: Black

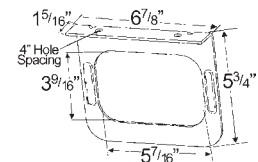

# Pigtails, Brackets and Grommets

Spirales de Raccord, Bague de Montage et Supports Conectores / Soportes rígidos y flexibles

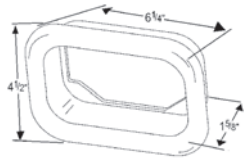

## RECESSED MOUNTING GROMMET FOR RECTANGULAR LAMPS

Requires 5 7/16" x 3 9/16" mounting hole with 1" radius corners  
 • Fits panel thicknesses up to 5/16"

**94180** Mounting Grommet

Material: PVC  
 Finish: Black

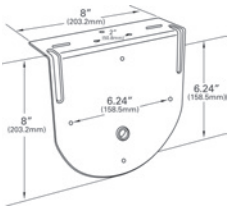

## 90° ANGLE BRACKET FOR 7" ROUND LAMPS

Provides multiple mounting options for flush mount 7" round lamps

**93982** Black, Powder Coated

Material: Steel  
 Finish: Black

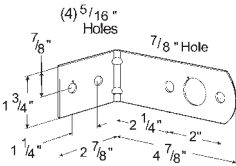

## MOUNTING BRACKET FOR PEDESTAL LAMPS

For use with right- or left-hand 2-stud class "A" pedestal lamps

**43112** Black, Powder Coated

Material: Steel  
 Finish: Black

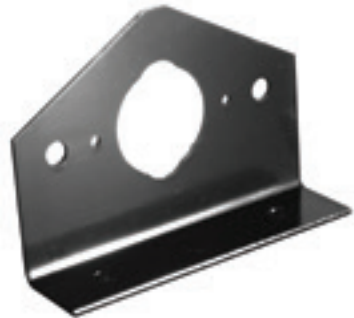

## 4/5/6 POLE KNOCKOUT MOUNTING BRACKET

Can accommodate 4-pole to 6-pole socket requirements • Made of anti-corrosive steel, painted black

**43942** 4 and 6 pole socket bracket

Material: Steel  
 Finish: Black

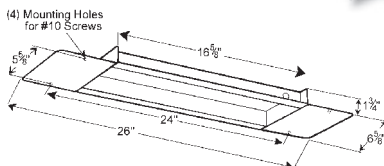
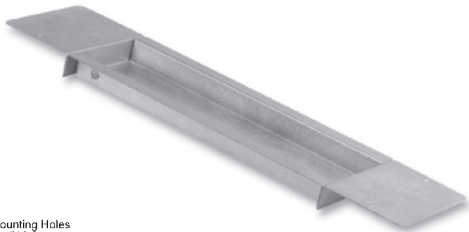

## RECESSED FLUORESCENT LAMP PAN

Provides a rigid mounting surface for fluorescent lamps • Fits Grote's fluorescent lamp 61511 • Keeps insulation away from lamp

**43540** Recessed Pan

Material: Aluminum  
 Finish: Polished

## 12" RECESSED MOUNTING PAN FOR 7" LED DOME LAMPS

Provides a rigid mounting surface for LED lamps • Fits Grote® LED 61811 and 61061 lamps • Grommet available for wire exit hole, 60-1000-06 • Keeps insulation away from lamp

**43744** Recessed Pan

Material: Aluminum  
Finish: Aluminum



## SLOW-MOVING VEHICLE EMBLEM BRACKETRY

Easy installation • Use with slow moving vehicle emblem 71152 (emblem not included)

**EMBLEM BRACKET:**

**43325** Steel

**MOUNTING BRACKET:**

**43335** Steel

Material: Steel  
Finish: Galvanized

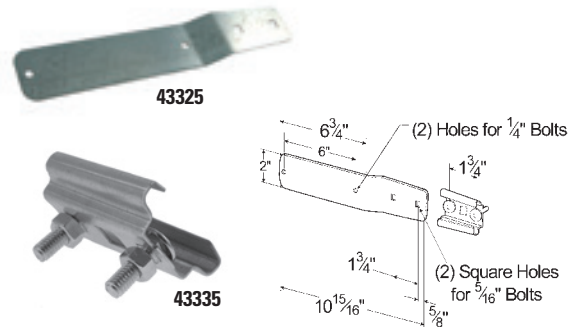

## STROBE AND BEACON MOUNTING ADAPTER FOR MIRROR BRACKET ASSEMBLY

Allows for mounting of strobe and beacon warning lamps to mirror bracket assembly

**PIPE MOUNT:**

**93600** Aluminum/Steel Bracket w/ 1" Built-in Mount

Material: Aluminum / Steel  
Finish: Gray

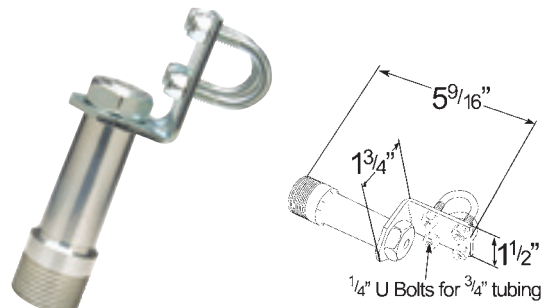

## STROBE MOUNTING KIT

Use with low-, medium-, and high-profile strobe lamps • Includes an adhesive magnet pad to prevent scratching of vehicle surface

**97750** Magnet Kit & Lighter Plug



## REPLACEMENT MAGNETIC MOUNT

Can be used as a magnetic mount on PAR 36 rubber tractor and utility lamps • Has adhesive magnet pad to prevent scratching of vehicle • 80 lbs. pull magnet

**43300** Magnetic Mount

Material: Steel  
Finish: Chrome





# Pigtails, Brackets and Grommets

Spirales de Raccord, Bague de Montage et Supports Conectores / Soportes rígidos y flexibles

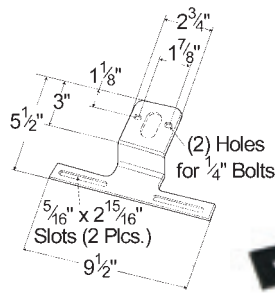

## UNIVERSAL OFFSET LICENSE PLATE BRACKET

For use with most standard two-stud box-style lamps and license plates

43262-5 Black **RETAIL**

Material: Polypropylene  
Finish: Black

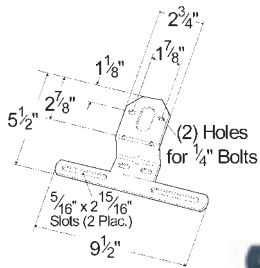

## UNIVERSAL STEEL OFFSET LICENSE PLATE BRACKET

For use with most standard two-stud box-style lamps and license plates

43022 Black, Powder Coated  
43022-5 Black, Powder Coated **RETAIL**

Material: Steel  
Finish: Black

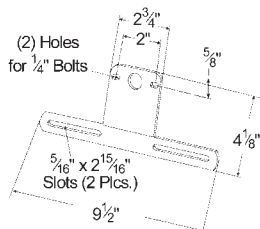

## UNIVERSAL STEEL LICENSE PLATE BRACKET

For use with most standard two-stud box-style lamps and license plates

43272 Black, Powder Coated  
43272-5 Black, Powder Coated **RETAIL**

Material: Steel  
Finish: Black

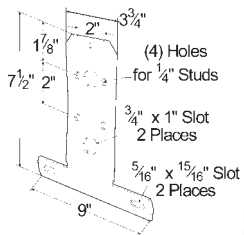

## UNIVERSAL STEEL LICENSE PLATE BRACKET

For use with most standard two- or three-stud box-style lamps and license plates

43842 Black, Powder Coated

Material: Steel  
Finish: Black

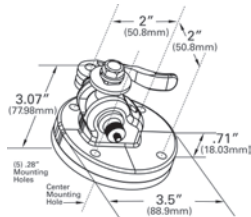

## ADJUSTABLE BRACKET FOR TRILLIANT® LAMPS

Adjustable and lockable bracket for the Trilliant® LED Whitelight™ lamps

- Provides more aiming control and more reliability than the standard bracket
- Cantilever locking mechanism stays in place in even the harshest environments

43651 Bracket, White  
43652 Bracket, Black

Material: Zinc  
Finish: Black or White

## FLUSH-MOUNT WORK LAMP BRACKET

Add-on bracket to convert the Trilliant® Mini LED Work Lamp into a flush-mount lamp

**94690**    Stainless Steel

Material: Stainless Steel  
Finish: Stainless Steel

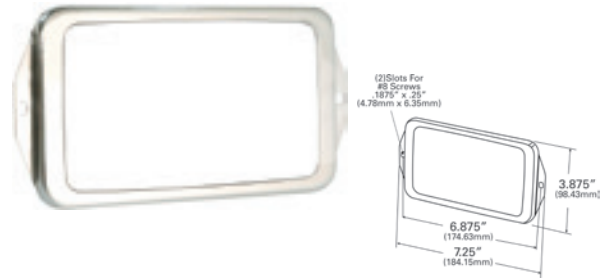

## PAR 36 RUBBER TRACTOR HOUSING

Shock-absorbing, weather-proof body • Swivel mount

**64930**    Black

Material: Rubber  
Finish: Black

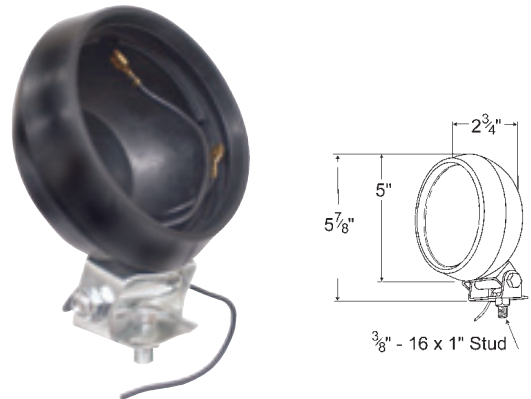

## VINYL PERMIT HOLDER

Laminated for all-weather protection • Sealing zipper for easy insertion of paper

**43411**    Vinyl

Material: Vinyl/Aluminum  
Finish: Green/Aluminum

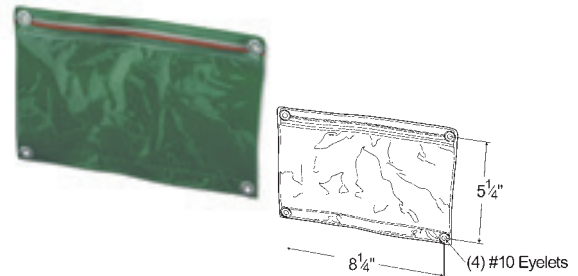

## ALUMINUM PERMIT HOLDER

Heavy-formed, rustproof housing • Includes vinyl pouch  
• 6 3/8" mounting screw hole spacing

**43424**    Aluminum

Material: Aluminum w/ Vinyl Pouch  
Accessory: Vinyl Pouch: 43441

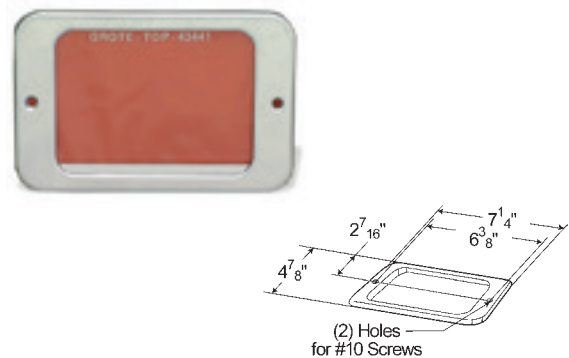

# Pigtails, Brackets and Grommets

Spirales de Raccord, Bague de Montage et Supports    Conectores / Soportes rígidos y flexibles

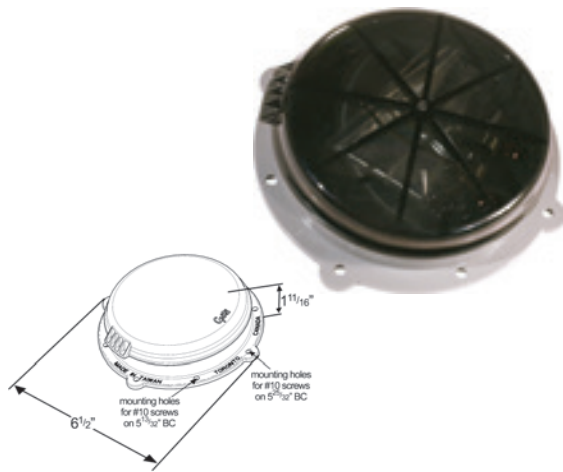

## DOCUMENT HOLDER

Rugged construction • Chemical-resistant, Ray-Ban® colored lens now has a darker tint • Comes with document protector polybag • Two mounting options for flexibility • Can be installed using pop-rivets

**43901**    Gray

Material: Polycarbonate  
Finish: Gray/Smoke  
Lens: Smoke 93351



## ELECTRICAL SEALANT

Special dielectric silicone compound seals out moisture, salt and corrosives.  
• Protects plug-ins and other electrical fittings

**99580**    1 1/4 Oz. Tube



## ULTRA-SEAL CORROSION-PREVENTIVE SEALANT

Cost-effective product prevents rust and corrosion • Good mechanical stability • Added tackifiers improve adhesion and resistance to washout  
• Has a 25% higher non-conductivity rating compared to the competition  
• Operating range -40°F to 302°F

**99170**    4 oz. (118 ml.) Tube

**99180**    8 oz. (236 ml.) Tub

**99170-GT**    14 oz. (414 ml.) Tub

### RETAIL DISPLAY:

**99170-1**    Display (12 of 99170)

**RETAIL**

## CONSPICUITY TAPE

Exceeds DOT requirements • Durable, impact and solvent resistant • Easy installation • Reflects light even in daytime • Bright prismatic appearance

### ALTERNATING 7" SILVER/11" RED:

- 40650** 2" x 150' Roll
- 40650-5** 2" x 18" (5) Strips **RETAIL**
- 41160** 2" x 150' Roll
- 41080** 1 1/2" x 150' Roll

### ALTERNATING 6" SILVER/6" RED:

- 41050** 2" x 150' Roll

### SILVER:

- 40641** 2" x 150' Roll
- 40641-5** 2" x 12" (4) Strips, Poly Bag, 10 Year Warranty **RETAIL**

### SCHOOL BUS APPLICATIONS:

- 41133** Yellow, 2" x 150' Roll

### WHITE:

- 40701** 1" x 150' Roll

FMVSS: DOT-C2 (40650, 40650-5, 41160)

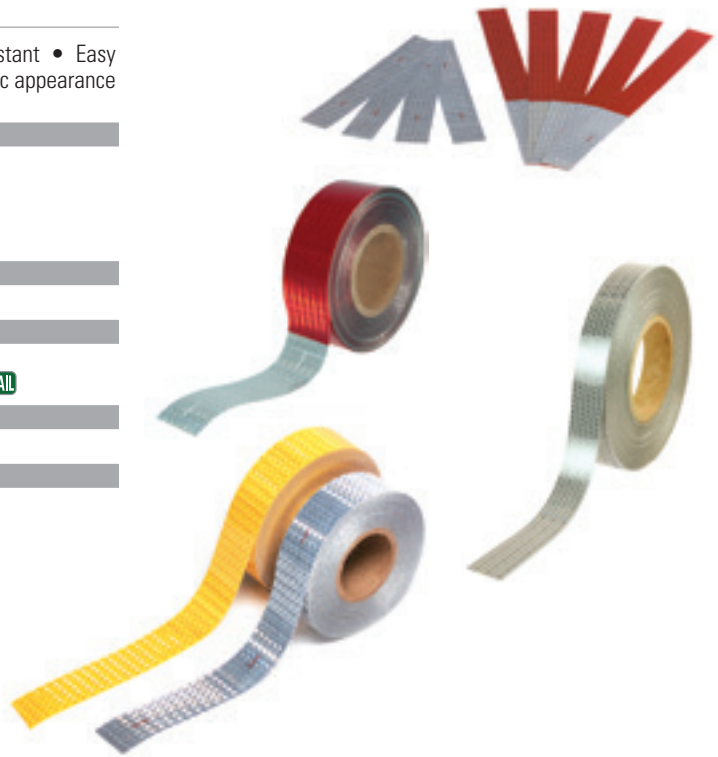

## CONSPICUITY TAPE FOR RAIL CARS

Adhesive will adhere to cold surfaces • Reflects light even in daytime • Bright prismatic appearance • Marked FRA-224 every 4"

### 4" X 150' ROLL:

- 41271** White, Kiss-Cut
- 41273** Yellow, Kiss-Cut

Meets ASTM D-4956-01a and FRA-224 requirements

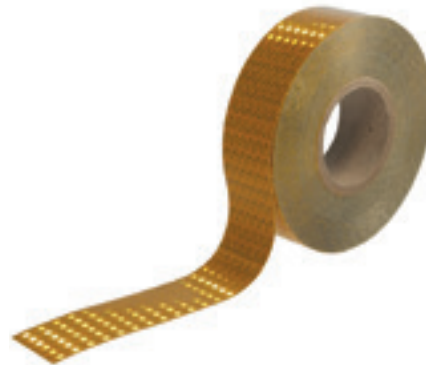

## REFLECTIVE STRIPS

Sealed optics • Adhesive-backed or screw-on mounting versions • 7 1/4" mounting screw hole spacing

### 12" STRIPS:

- 41122** Red
- 41121** Silver

Material: ABS/Acrylic  
FMVSS: DOT-C

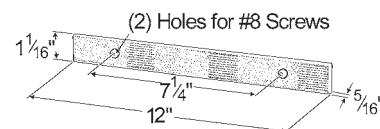

# Reflectors

Réfecteurs Reflectantes

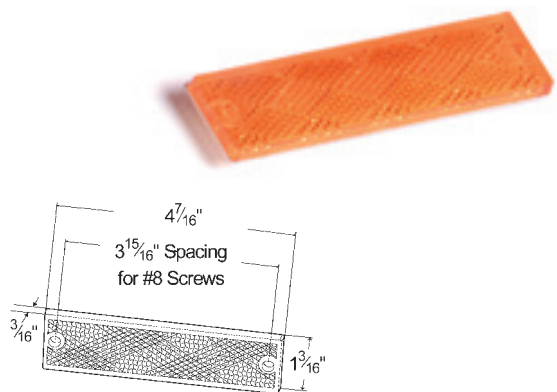
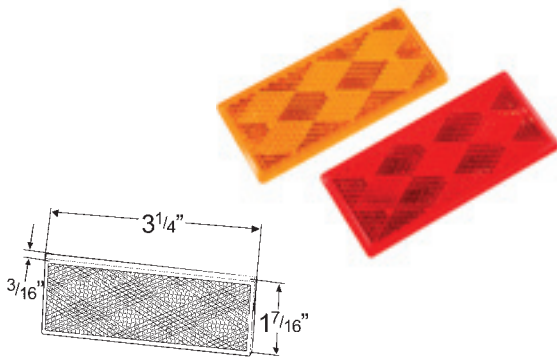
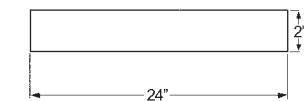
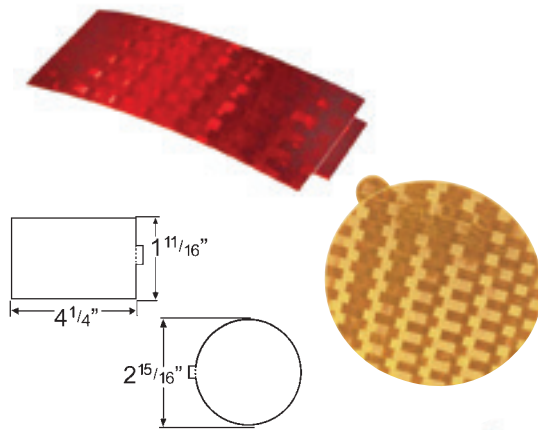

## STICK-ON TAPE REFLECTORS

Adheres permanently to flat or curved surfaces • Exceeds DOT and SAE "A" reflex requirements • Durable, impact resistant

### 1 11/16" X 4 1/4" RECTANGULAR REFLECTOR:

- 41152** Red, 5 Year Warranty  
**41153** Yellow, 5 year Warranty

### 2 15/16" ROUND REFLECTOR:

- 41142** Red, 5 Year Warranty  
**41142-5** Red, Pair Pack, 5 Year Warranty **RETAIL**  
**41143** Yellow, 5 year Warranty

FMVSS: A

## REFLECTIVE TAPE

Use in marking fence posts, mail boxes, etc. • 2" x 24" strips • Not for use as trailer conspicuity tape

- 40440-5** Red w/ White, 1 Strip **RETAIL**  
**40460-5** Black w/ Yellow, 1 Strip **RETAIL**

## STICK-ON RECTANGULAR REFLECTORS

Adhesive backing protects prisms against dirt • Fits narrow rails and tight spaces • Firm-stick backing for instant bond and lasting adhesion

- 40302** Red  
**40303** Yellow

Material: Acrylic  
 FMVSS: A

## MINI STICK-ON RECTANGULAR REFLECTORS

Fits narrow rails and tight spaces • Mountable with two #8 screws (optional) • 3 15/16" mounting screw hole spacing • Firm-stick backing for instant bond and lasting adhesion

### STICK-ON/SCREW MOUNTABLE:

- 40132** Red  
**40132-5** Red, Pair Pack **RETAIL**  
**40133** Yellow  
**40133-5** Yellow, Pair Pack **RETAIL**

Material: Acrylic  
 FMVSS: A

## OVAL REFLECTOR

Firm-stick backing for instant bond and lasting adhesion • Mountable with two #8 screws (optional) • 3 15/16" mounting screw hole spacing

### SCREW MOUNTABLE:

- 41042** Red
- 41043** Yellow

### STICK-ON/SCREW MOUNTABLE:

- 41032** Red
- 41032-5** Red, Pair Pack **RETAIL**
- 41033** Yellow
- 41033-5** Yellow, Pair Pack **RETAIL**

Material: Acrylic  
FMVSS: A

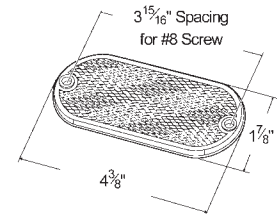

## ROUND STICK-ON REFLECTOR

Adhesive backing protects prisms against dirt • Firm-stick backing for instant bond and lasting adhesion

### 3" REFLECTOR:

- 40052** Red
- 40052-5** Red **RETAIL**
- 40053** Yellow
- 40053-5** Yellow **RETAIL**

### 2" REFLECTOR:

- 41002** Red
- 41003** Yellow

Material: Acrylic  
FMVSS: A

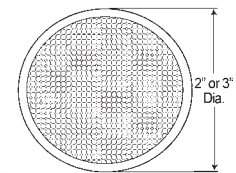
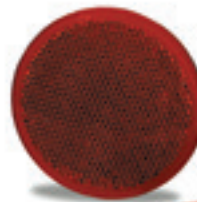

## SEALED 3" ROUND STICK-ON REFLECTOR

Hermetically sealed • Firm-stick backing for instant bond and lasting adhesion

- 40062** Red
- 40063** Yellow

Material: Acrylic  
FMVSS: A

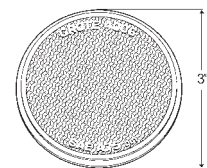
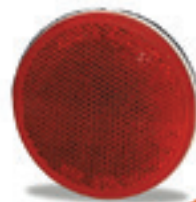

## 2 1/2" ROUND STICK-ON REFLECTOR

Adhesive backing protects prisms against dirt • Firm-stick backing for instant bond and lasting adhesion

- 40072** Red
- 40072-5** Red, Pair Pack **RETAIL**
- 40073** Yellow
- 40073-5** Yellow, Pair Pack **RETAIL**

Material: Acrylic  
FMVSS: A

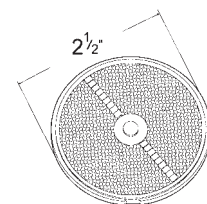

# Reflectors

Réfecteurs Reflectantes

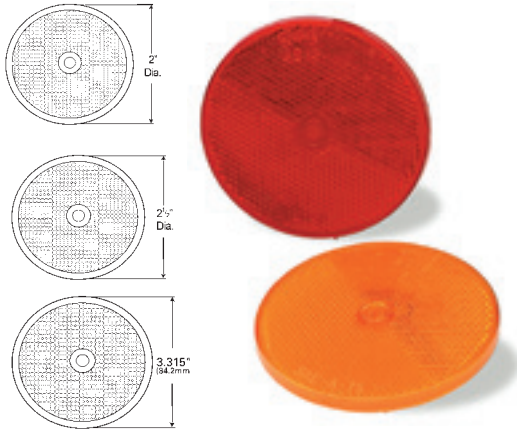

## SEALED CENTER-MOUNT REFLECTOR

Hermetically sealed • Simple installation with single #10 screw

### 2" ROUND:

**41012** Red  
**41013** Yellow

### 2 1/2" ROUND:

**40092** Red  
**40093** Yellow

### 3 1/2" ROUND:

**40152** Red  
**40153** Yellow

Material: Acrylic  
FMVSS: A

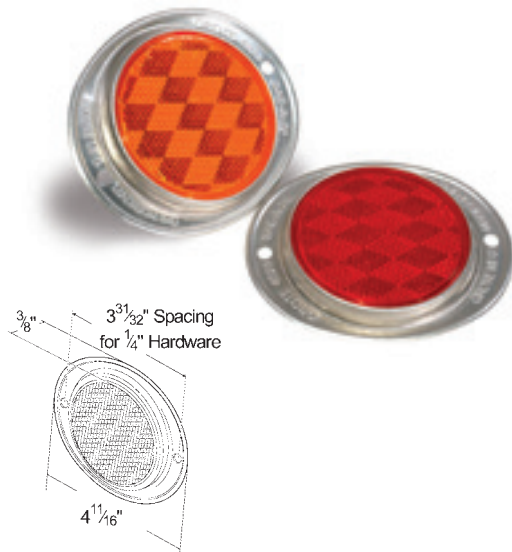

## ALUMINUM TWO-HOLE MOUNTING REFLECTOR

Lens gasket cushions lens and protects prisms against dirt • Lightweight housing • Low profile • 3 15/16" mounting screw hole spacing

**40232** Red  
**40232-5** Red **RETAIL**  
**40233** Yellow  
**40233-5** Yellow **RETAIL**

Material: Aluminum/Acrylic  
FMVSS: A

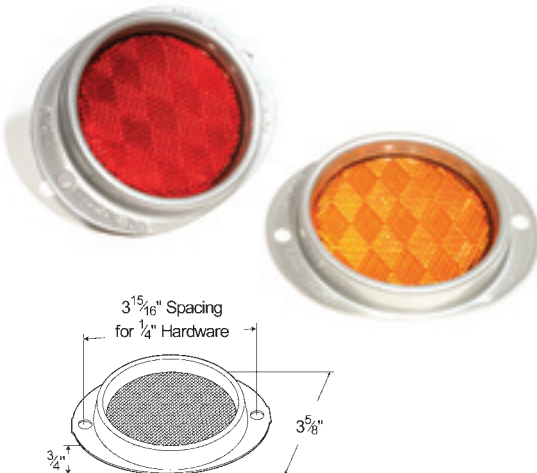

## STEEL TWO-HOLE MOUNTING REFLECTOR

Extra-deep lens recess for protection • Lens gasket cushions lens and protects prisms against dirt • Baked steel finish • 3 15/16" mounting screw hole spacing

**40192** Red, Silver Housing with Gasket  
**40193** Yellow, Silver Housing with Gasket  
**40162** Red, Green Housing with Gasket  
**40163** Yellow, Green Housing with Gasket  
**82562** Red, Desert Tan Housing with Gasket  
**82563** Yellow, Desert Tan Housing with Gasket

Material: Steel/Acrylic  
FMVSS: A  
Finish: Silver, Military Green-34094, Desert Tan-33466

## TRIANGLE WARNING KIT

Reflective up to 1/2 mile • Exceeds legal requirements • Weatherproof and impact resistant • Weighted for stability • Kit of three triangle devices in carrying case

### KITS:

**71422** Three Triangles

Material: Acrylic/ABS/Polypropylene  
FMVSS: 125, SAE: J774C-Type I

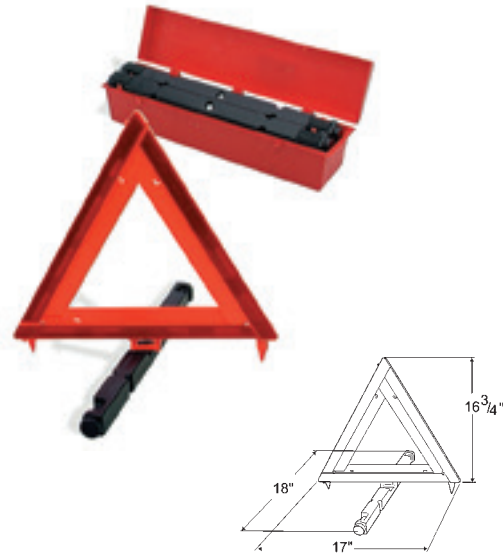

## SLOW-MOVING VEHICLE EMBLEM

13 3/4" yellow-orange center for daytime warning • Outer 1 5/8" red reflex border for nighttime warning • 6" mounting screw hole spacing

**71152** Orange & Red

Material: Acrylic/ABS  
FMVSS: SAE: J943A, ASAE: S276.3  
Bracket: 43325, 43335

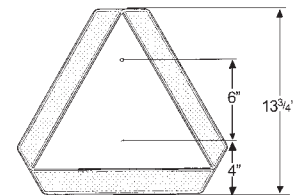

## TRAFFIC CONE

High visibility for traffic control • Fade-resistant, bright orange finish is molded of PVC to eliminate cracking and peeling

**71440** Small Cone

**71450** Large Cone

Material: PVC  
Finish: Bright Orange

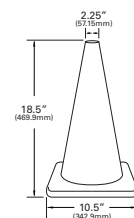
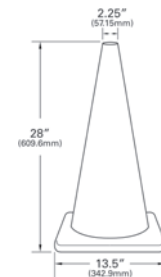



## REPLACEMENT LENSES

		Left	S/T/T	Right
<b>Chevrolet®</b>				
1999-1988	1500, 2500, 3500 Pickup (Connector Plate Housing)	85450-5		85460-5
2000-1992	Blazer (Connector Plate Housing)	85450-5		85460-5
<b>Chevrolet® / GMC®</b>				
1999-1992	Suburban/Tahoe/Yukon (Connector Plate Housing)	85450-5		85460-5
<b>Ford®</b>				
1992-Present	Ford F350-F750, Super Duty (Entire Lamp, Chassis Cab Vehicles Only)	50992		50992
1990-1977	Flareside Pickup (Lens Only)	91302		91302
1990-1977	Flareside Pickup (Entire Lamp Replacement, LED)	G5212		G5202
1979-1973	Flareside Pickup (Entire Lamp)	50972-5		50972-5
<b>Jeep®</b>				
2006-1976	CJ-5, CJ-7, Scrambler, Wrangler (Entire Lamp w/out Side Markers)	50972-5		50972-5
2006-1976	CJ-5, CJ-7, Scrambler, Wrangler (Lens Only)	91302		91302
2006-1976	CJ-5, CJ-7, Scrambler, Wrangler (Entire Lamp w/ Side Markers, LED)	G5212		G5202

## REPLACEMENT LENS ASSEMBLIES



50992



50972-5



85450-5, 85460-5



G5212, G5202

## REPLACEMENT LENSES

Lens Model Number	Fits Lamp	Lens Model Number	Fits Lamp	Lens Model Number	Fits Lamp	Lens Model Number	Fits Lamp	Lens Model Number	Fits Lamp	Lens Model Number	Fits Lamp
09561	02001-4	90172	45462	90642	51982	91502	55410	92031	77101		63391
09681	05001-5		45442		51992		55420	92032	77102	93171	64481-5
	05151	90173	45463	90652	52482		55430	92033	77103		64501-5
	05301-5		45443		52492		55440		77203	93252	45512
	05041-5	90202	45932	90742	51042		55450	92035	77105		45522
	05051-5		46712		51242-5		55460	92062	G5300	93383	76963
09781	06021-4	90203	45933		51342-5		55470	92063	G5300	93393	40063
	06001-4		46713		52002	91503	55410	92163	46802	93723	77473
	06201	90221	62011		52082		55420	92163	46803		77483
	06013-4		62021		52112		55430	92172	46862	93891	61791
09793	06021-4	90232	50630		52122		55440	92173	46863	94300	63971
	06001-4		50652	90743	52112		55450	92183	46433		63H11
	06201		50662		52122		55460		46813		63821-5
	06013-4		50852	90752	51042		55470		47183		63821
90011	62151		50852-5		51242-5	91513	55340	92193	46823		63861-5
90012	50222		50862		51342-5		55410	92382	52362		63861
	50232		50862-5		52002		55420		52372	94310	63H81
	50352		55220		52082		55430	92432	46882		63H01
	50502		55232		52112		55440		49112		63831-5
	52522		55280		52122		55450	92433	46883		63831
	55092		55290	90762	52612		55460	92453	76033		63871-5
	55132	90233	50630	90922	46282		55470	92611	61371		63871
	55202		55220		46292	91572	45262	92773	45993	94580	63571
90051	45172		55243		46892		45432	92792	52302		63671
	45173		55280	90923	46283		49072		52312		63901
90052	45012		55290		46293	91573	45263	92883	76803	94590	63591
	45172	90252	50852		46893		45433		76923		63691
	45173		50862	91042	46302	91581	60311		76933	94600	63581
90053	45013		50882	91043	46303		63051	92885	76805		63681
	45173		50892	91101	61091	91582	53000	92892	52062	99802	46332
90072	45662		50902	91112	46392		53020	92893	52023	99803	46333
	45712	90302	45022		46392-5		53052		52063	99832	78322
	47262		49002		50532		56000	92901	61511	99833	78333
	47252	90303	45023		50532-5		56020	92993	77123	99842	56072
90073	45663	90342	50532		50542	91583	53000		77703		50132
	45713		50542		50542-5		53020		77503	99843	56073
	47263	90353	76083		65230-5		53023		77613	99912	46322
	47253	90373	76203	91113	65370-5		56000		77623	99913	46323
90092	78002		76223		52442		56020		77693		
	78150	90383	76283	91122	52452	91683	46543		78853		
	78152		76163		52452	91961	46791		78863		
90093	78003		76183	91302	50902	91962	46782		78913		
	78153	90393	16063		50912		G4602	93003	77733		
	78303		16172		50942		G4602-5		77643		
90103	78003		16223		50952				77663		
90121	61081	90401	61031		50972	91963	46783		77653		
90122	46702		61861		50992		46793		77713		
	49072		61991		52602		G4603		77133		
90123	46493-5		61760		52802	91964	46792		77593		
	46703		61890		52812		46792-5	93005	77645		
90133	45333		61871		52832		46793		77655		
90152	45252		61961		52902		46793-5		77715		
	49062		61931		52912		46782		77715		
	45672	90482	55340		52972		46783		77675		
90153	45253	90483	55340		53702	91965	46792		77735		
	45673		64241		53712		46792-5		77013		
90162	45412		64251		53722		46793		77015		
	45222		64261-4		53762		46793-5		64371-5		
	49042		64271	91311	62151		46782		64541-5		
90163	45413		64281	91482	50852		46783		64551-5		
	45223		64291-4		50862	91992	46772		63451-4		
					50872	91993	46773				

## REPLACEMENT LENSES



09781



09793

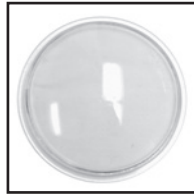

09561



09681

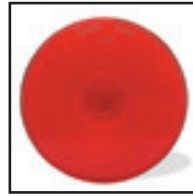

90011, 90012,  
90012-5, 90013



90051, 90052,  
90053



90062, 90063



90072, 90073



90092, 90093



90103



90121, 90122,  
90123, 90122-5,  
90123-5



90133



90152, 90153,  
90152-5, 90153-5



90162, 90163



90172, 90173



90202, 90203,  
90202-5, 90203-5



90221



90232, 90233,



90252



90373,  
91323 LEXAN



90383



90302, 90303



90342



90353



90393



90401



90481, 90482,  
90483

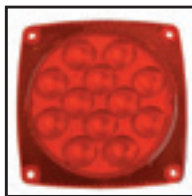

90642

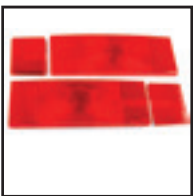

90652



90742, 90743

**REPLACEMENT LENSES**

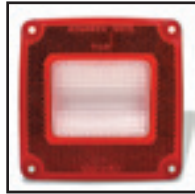

90752



90761, 90762



90922, 90923



91042, 91043



91101

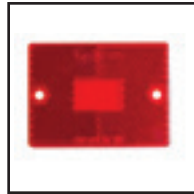

91112, 91113



91122



91302



91311



91482

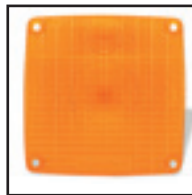

91502, 91503

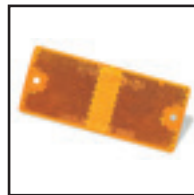

91513



91572, 91573



91581, 91582,  
91583



91683



91961, 91962, 91963,  
91964, 91965, 91962-5,  
91963-5



91992, 91993



92031, 92032,  
92033, 92035

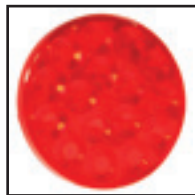

92062, 92063



92162, 92163



92172, 92173



92183



92193



92382



92432, 92433



92453

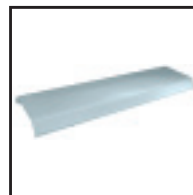

92611



92773

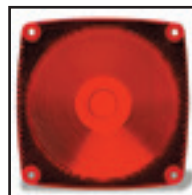

92792



92883, 92885

# Lenses

Lentilles Micas

L E N S E S

## REPLACEMENT LENSES



92892, 92893



92901



92993



93003, 93005



93013, 93015



93131



93151



93163



93171



93252



93383



93393



93723



93891



94580



94600



94590



94300



94310



99802, 99803



99832, 99833

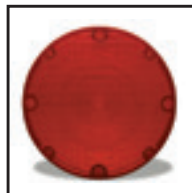

99842, 99843



99912, 99913

## LIMITED WARRANTY

Grote Industries, Inc. ("Grote") warrants its products to be free from defects in material and workmanship under normal use and service as set forth in this Limited Warranty. THIS LIMITED WARRANTY is the final, complete and exclusive expression of warranty to the purchaser and cannot be modified except in writing signed by an authorized officer of Grote.

## GENERAL ONE-YEAR LIMITED WARRANTY

Subject to the following conditions, Grote warrants to the original purchaser only (and not to anyone else) of each new product made by Grote that any part thereof which proves to be defective in material or workmanship within one year from the date of manufacture by Grote will, at Grote's option, be repaired or replaced without charge upon return to Grote of the defective product, provided any defect in the product is brought to the attention of Grote within the warranty period, who alone will be authorized to furnish or arrange for repairs or replacements within the terms of this limited warranty.

The above limited warranty does not apply, and no warranty, either expressed or implied, shall be applicable (a) to damage resulting from accident, alteration, misuse or abuse; (b) if the product is not installed, operated and maintained according to procedures recommended by Grote; (c) if the serial number, date code, or other identifying marks affixed to the product by Grote are removed, obliterated or defaced. In no case shall the warranty be extended to defects in materials, components (which includes but not limited to bulbs), or services furnished by third parties nor to the installation of the product performed by third parties, except those performed by or on behalf of Grote authorized distributors. If any repairs are made, or any other parts are replaced during the warranty period, by any distributor other than a Grote distributor, in accordance with service manuals, parts, accessories, or attachments other than authorized by Grote for use in Grote's products, the purchaser shall pay for such repairs or parts without recourse against Grote, and Grote shall be relieved of responsibility for fulfillment of the warranty with respect to parts or components of all repairs, alterations, or replacements so made.

## INSTALLATION GUIDELINES:

**Grote Systems** - Grote lamp assemblies and harness products are designed to function as a complete system; therefore, this limited warranty shall not extend to failure of any Grote products caused by the use of incompatible lamp assemblies, harness products or other components.

**Heat** - All electronic and lighting products produce heat. The installer is responsible for assurance that the application of the component will not result in contact with flammable material.

**Surface Mount** - The following procedures need to be practiced to assure proper installation: The lamp should be placed on a level unobstructed surface. Number 10 screws should be tightened to 25 in. pounds of torque. Only Grote ULTRA-BLUE-SEAL® pigtailed should interface with any Grote lamps. These guidelines will assure the products will function and last as they were designed. Deviations from these guidelines will void any warranty.

**Design Voltage and Current** - Current is provided as an approximate value and is listed for the design voltage of the lamp. The design voltage of the lamp may vary. Customers should contact Grote Industries if detailed information is required.

IN CONSIDERATION OF THE EXPRESS WARRANTY AND OTHER TERMS HEREIN CONTAINED, THE PURCHASER AGREES THAT PURCHASER'S EXCLUSIVE REMEDY AND GROTE'S SOLE LIABILITY ON ANY CLAIM, WHETHER IN TORT, CONTRACT OR WARRANTY, SHALL BE LIMITED TO, AT GROTE'S OPTION,

REPAIR OR REPLACEMENT OF A DEFECTIVE PRODUCT. NO OTHER REMEDY (INCLUDING BUT NOT LIMITED TO INCIDENTAL OR CONSEQUENTIAL DAMAGES FOR THE LOST PROFITS, LOST SALES, INJURY TO PERSON OR PROPERTY; OR ANY OTHER INCIDENTAL LOSS OR DAMAGES) SHALL BE AVAILABLE TO PURCHASER. IN NO EVENT, AND FOR NO CAUSE WHATSOEVER, INCLUDING ANY BREACH OR DEFAULT BY GROTE, SHALL GROTE HAVE ANY MONETARY LIABILITY TO PURCHASER IN EXCESS OF THE PRICE PAID BY PURCHASER FOR THE PRODUCT IN QUESTION.

THIS LIMITED WARRANTY IS EXPRESSLY IN LIEU OF ALL OTHER EXPRESSED OR IMPLIED WARRANTIES, INCLUDING THE IMPLIED WARRANTY OF MERCHANTABILITY AND THE IMPLIED WARRANTY OF FITNESS FOR A PARTICULAR PURPOSE, AND OF ALL OTHER OBLIGATIONS OR LIABILITIES ON THE PART OF GROTE. NO DEALER, DISTRIBUTOR OR OTHER REPRESENTATIVE OF THE COMPANY IS AUTHORIZED TO CHANGE THIS WARRANTY IN ANY WAY OR TO GRANT ANY OTHER WARRANTY.

Any affirmation of fact or promise made by Grote shall not be deemed to create an expressed warranty that the products shall conform to the affirmation or promise. Any description of the product is for the sole purpose of identifying such product and shall not be deemed to create an express warranty that the product shall conform to the description. Any sample or product model is for illustrative purposes only and shall not be deemed to create an express warranty that the whole of the products shall conform to the sample or model. Further, no affirmation or promise, or description, sample or model shall be deemed a part of the basis of the bargain between Grote and the purchaser.

Grote assumes no responsibility that title conveyed to the purchaser is good or the transfer of title to the products is rightful, or that the products shall be delivered free from any security interest or other lien or encumbrance of any third party, or free from any rightful claim of any third party by way of infringement or otherwise.

## NON-TRANSFERABLE

THIS WARRANTY SHALL EXTEND ONLY TO THE ORIGINAL PURCHASER AND IS NON-TRANSFERABLE.

## EXCEPTIONS

The general one-year (1) limited warranty shall apply but shall be altered as set forth below for the following products:

- (1) All Grote Sealed Lamps (12 Volt Only) shall be subject to a two-year (2) limited warranty unless otherwise stated.
  - A) Grote Economy sealed lamps shall be subject to a one-year (1) limited warranty.
- (2) Conspicuity Tape shall be subject to a five-year (5) or ten-year (10) limited warranty. Please refer to the Grote catalog and/or Grote web-site for warranty time frame by part number.
- (3) Grote LED Products are subject to the terms set forth below under "Special LED Limited Warranty"
- (4) Grote ULTRA-BLUE-SEAL® Male Pin Wire Harnesses shall be subject to a seven-year (7) limited warranty.
- (5) Grote ULTRA-BLUE-SEAL® Female Pin (Standard) Harnesses shall be subject to a five-year (5) limited warranty.
- (6) Grote makes no warranty whatsoever with respect to bulbs and fluorescent tubes in lamp assemblies.
- (7) Grote makes no warranty whatsoever with respect to any and all devices powered by common household-type batteries.

## SPECIAL LED LIMITED WARRANTY

Grote LED lamps are covered by the Grote Special LED Limited Warranty and are warranted to be free from defects in workmanship and/or material only for the specified time frames listed below. Grote will replace any Grote LED lamp to the original purchaser, if the Grote LED lamp fails due to defects in workmanship and/or materials during the warranty time frame specified below:

THE LED LIMITED WARRANTY DOES NOT APPLY TO SEVERE APPLICATIONS.

- (1) Grote LED lamps are to REMAIN INTACT, FREE FROM PHYSICAL ABUSE, SUBJECT TO PROPER INSTALLATION WITHOUT MODIFICATION AND MUST BE USED ONLY WITH GROTE APPROVED WIRING ACCESSORIES. ANY VIOLATION OF THESE CONDITIONS WILL VOID THIS LED LIMITED LAMP WARRANTY. For guidance regarding proper installation, please see above under "Surface Mount Installation Guidelines".
- (2) ANY DAMAGE DUE TO CHEMICALS OR INCOMPATIBLE CLEANERS WILL VOID THIS WARRANTY.
- (3) Grote LED lamps are designed to work in conjunction with the Grote ULTRA-BLUE SEAL® Wire Harness System including Grote factory molded pigtails for use with the Grote ULTRA-BLUE SEAL® Wire Harness System . Therefore, Grote LED lamps have a Limited Warranty based on the following criteria:

A – Grote SuperNova® high performance LED lamps are covered by a ten-year (10) Limited Warranty when installed with male pin, hard shell or patented double-seal pigtail connectors.

- 1) Grote SuperNova® high performance LED lamps are covered by a three-year (3) Limited Warranty when installed with hardwire bullet connectors.
- 2) Grote SuperNova® high performance LED lamps are covered by a two-year (2) Limited Warranty when installed with hardwire termination.

B – Grote MicroNova® high performance LED lamps are covered by a three-year (3) Limited Warranty when installed with hardwire bullet connectors.

C – Grote Hi Count® LED lamps (part numbers that begin with a G) are covered by a two-year (2) Limited Warranty.

D – Grote WhiteLight™ LED lamps are covered by a three-year (3) Limited Warranty.

E – Grote Select™ high value LED Stop/Tail/Turn and Backup lamps are covered by a two-year (2) Limited Warranty. Grote Select™ LED Flood Lamps are covered by a one-year (1) Limited Warranty.

F – Grote BriteZone™ LED lamps are covered by a two-year (2) Limited Warranty.

G – Grote Warning & Hazard LED's are covered by a two-year (2) Limited Warranty.

- 1) Any and all LED Devices powered by common household-type batteries are not covered by Grote's Limited Warranty.

H – Other Grote LED lamps for FMVSS applications excluding SuperNova®, MicroNova®, WhiteLight™ and Hi Count® are covered by a two-year (2) Limited Warranty.

I – Other Grote LED lamps (non-FMVSS) are covered by a one-year (1) Limited Warranty.

J – Grote LightForm® products are covered by a one-year (1) Limited Warranty.

LED Brand Category	Termination Style					
	Male Pin	Hard Shell	Female Pin	Hardwire w/Bullet Connectors	Hardwire	Patented Double-Seal Pigtail
Grote SuperNova®	10	10	N/A	3	2	10
Grote MicroNova®	N/A	N/A	N/A	3	N/A	N/A
Grote Hi Count®	N/A	N/A	2	N/A	2	N/A
Grote WhiteLight™	3	3	3	3	3	N/A
Grote Select™	N/A	N/A	2	N/A	1	2
Grote LightForm®	N/A	1	N/A	1	1	N/A
Grote BriteZone™	N/A	N/A	N/A	N/A	2	N/A
Grote Warning & Hazard LED's	2	N/A	N/A	2	2	N/A
Grote LED's (FMVSS)	2	N/A	2	2	2	N/A
Grote LED's (non-FMVSS)	N/A	N/A	N/A	1	1	N/A

N/A - Not Available or None

Number represents the years of warranty from manufacture date

### QUALITY SYSTEMS:

Product within the catalog may be manufactured under various quality system certifications. If a customer requires particular quality certifications on specific products, they may contact Grote Industries for detailed information.

### END USER RESPONSIBILITY:

Each user bears full responsibility for making their own determination as to the suitability of Grote materials, products, recommendations, or advice for their own particular use. Each user is ultimately responsible to identify and perform tests and analyses necessary to assure that its finished parts incorporating Grote products will be safe and suitable for use under end-user conditions. Nothing in this or any other document, nor any oral recommendation or advice, shall be deemed to alter, vary, supersede, or waive any provision of this Limited Warranty or this Disclaimer, unless any such modification is specifically agreed to in writing signed by a Grote Industries Representative.

### INTELLECTUAL PROPERTY:

No statement contained herein concerning a possible or suggested use of any material, product or design is intended, or should be construed, to grant any license under any patent or other intellectual property right of Grote Industries or any of its subsidiaries or affiliates covering such use or design, or as a recommendation for the use of such material, product or design in the infringement of any patent or other intellectual property right.

The information in this catalog is deemed correct at the time of publication and is provided in good faith. There may be inaccuracies due to legislative changes, competitive part number changes, technological advances or typographical errors. Customers should contact Grote Industries for updated information

### CONSUMER RIGHTS IN VARIOUS STATES

This warranty gives you specific legal rights, and you may have other rights that vary from state to state. Some states do not allow limitations on how long an implied warranty lasts, so the above limitations may not apply to you. Further, some states do not allow the exclusion or limitation of incidental or consequential damages so the above limitation or exclusion may not apply to you.

### TRUCKLITE-TO-GROTE INTERCHANGE

TruckLite PN	Grote Form, Fit & Function	Grote Fit & Function
41	40232	
43	40192	
45	41002	
50	43411	
52	41012	
54	41032	
172	44530	
173	44540	
182	44690	
183	44700	
262	44810	
263	44820	
264		44750
266		44730
270		44010
275		44010
276		44030
282	44710	
283	44720	
285		44891
286		44730
320		73140-5
536	82-0552	
550	82-0550	
790		43970
791		43970
792		43970
793		43970
794	49140	
797	71152	
798	71422	
801		43690
802		43970
809		43970
900		48072
901		48072
902		48072
905	48272	
910	48072	
1050		G1032
1075	G1082	
1203	46782	
1211	46792	
1213	46792	
1215	49082	
1216		49082
1222		45932
1233		45462
1259	45262	
1264	45932	
1507		46882
1520	45512	
1560	G1502	
1570		46392
1960	G1902	
2150	G2102	
2660	G4602	

TruckLite PN	Grote Form, Fit & Function	Grote Fit & Function
2701		56052
2702		53052
2750		G5300
3050	G3002	
3070		G3002 + 43149
3075	G3092	
3612		52522
3616		52522
3701		56052
3762		50662
3801		56000
3802		56000
3806		56000
3812		53000
3850		55220
3860		55280
3861		55290
3863		50630
4015		50942
4016		50952
4017		50952
4018		50942
4023		52912
4024		52912
4025		52832
4026		52822
4027		50972
4028		52602
4050		G4002
4091		52062
4093		53062
4094		52062
4095	66905	
4742		55410
4754		55450
4854		55450
4855		55460
6050		G6002
6051		G6003
6503		55982
6506		53422
7038	12201-5	
7039	12004	
7217		28293-5
7218		28293-5
7223		12263-5
7224		12263-5
7268	12322-5	
7269	12323-5	
7518	28373-5	28423-5
7519	28423-5	28842-5
7555	28473-5	12193-5
7557	28472-5	12193-5
7575		28433-5
8004		64261-4, 63451-4
8150		63861
8155		63601
8160		63651
8170		63751
8861	99912	
8909		90232
8933		90202
8938		91502
9004		90302
9005		90052
9006		91962
9007		91962
9016		91582
9021		91582
9029		90012
9040		92172
9049		91302
9057		91992
9063		90502



## TRUCKLITE-TO-GROTE INTERCHANGE

TruckLite PN	Grote Form, Fit & Function	Grote Fit & Function
9071		91302
9077		91172
9079		91502
9082		93252
9087		90132
9093		90122
9101	68130	
9102	68170	
9104	68080	
9105	68130	
9107	68110	
9162		68080
9179	43673	
9180	94110	94110
9291		64931
9341		90232
9372		92762
9944		77931
10403	67050	92920
10413		43690 67049
10704	91410	
10708	92920	
10724		43690
10728		43690
10730	43522	
10731		43690
10738		43690
15011	60280	
15012		60280
15013		60280
15040		60381
15041		60341
15053		60381
15054		60381
15055		60381
15058		60341
15059		60381
15060		60381
15061		60341
15205		60421
15208		60261
15227		60381
15404		43970
15405		43970
15406		43970
15407		43970
15408		43970
15409		43970
15412	43370	
15413		43370
15414	43380	
15415		46740
15416	46740	
15702	91380	
15727		43370
15728		43380
15729	43830	
15730		43830
15733		43370
17001		60021
17002		60021
17003		60191
17200		60191
19206	60301	
19720	43990	
19721	43850	
19723		43120
19724	43120	
19729		43782
19736		43120
19740	43990, 66202	
26330	60151	

TruckLite PN	Grote Form, Fit & Function	Grote Fit & Function
26331	60101-5	
26335	60001	
26336	60251	
26723		61931
27003		90941-5
27009	90951	
27010		63451-4, 90951
27011		90951
27012	90951	
27270	90941	
27450	90941	
30286		77193
30402		67050 92149
30404		30721 67049
30405		93760 92120 67049
30407		43690 67049
30410		43690
30700	92120	
30702		92150
30704		92150
30706		94100
30707		94100
30711		92120
30721	93750	
30722	93760	
30726		93760
30727	43690	
30728	43532	
30729		93750
33712	94350	
35740	49212-5	
40003		61431
40004	62421	
40012	62321	
40023		61431
40024	62441	
40044	62181	
40203		61051
40204	62421	
40212	62321	
40224		62421
40244	62171	
40260	62171	
40261		62171
40262	62421	
40403		67090, 91739
40700	91740	
40701		91740
40702		91740
40703		91740
40715	43642	
40719		43572
40720	43572	
40725	43655	
40742		50812
40743		50812
40746		50812
40747		50812
40756		50802
40757		50792
40850		50820
40894		40850+G4002
42722	43272	
44101		77363
44102		77362
44110		65132
44114		77352
45700	94180	
45701		43642
45720	43212	
50831	93190	
50860	87860	
50896	87250	
55554		65340-5

TruckLite PN	Grote Form, Fit & Function	Grote Fit & Function
60120		47472
60403		92420, 67089
60700	92420	
60719		92720
60720	43362	
60721		92420
60722		43952
60723		43362
60728		43952
60730		43362
60733		43952
60734		77363
70300		55220
70311		50630
80220		63821
80240		63831
80275		63821
80304	50222	
80340		62011
80342	55092	
80344	62151	
80345	62201	
80360	64931	
80361	64931	
80364	64931	
80368		64461
80373		64921
80374	64931	
80375	64931	
80378	64931	
80388		64891
80389		64891
80394		64891
80395		64891
80396		64891
80397		63821
80418		61371
80427	61161	
80438	64931	
80444		61371
80490	61031	
80491		64891
80492		64891
80493		64H01-5
80494		64891
80498		64891
80513	06021-4	
80514	06021-4	
80519	06013-4	
80520	63531	
80521	63531	
80522	06013-4	
80525		06021-4
80526		63531
80527		06013-4
80567		05001-5
80568		05001-5
80569		06013-4
80571		06013-4
80572	06013-4	
80573		06013-4
80574	06013-4	
80591	05001-5, 06013-4	
80592		06013-4
80593		06013-4, 05001-5
80594	82-0304	
80720	43262-5	
80722		43262-5
80800		63451-4
80804		63451-4
80805		63451-4
80810		63381
80820		63391
80830		63451-4

## TRUCKLITE-TO-GROTE INTERCHANGE

TruckLite PN	Grote Form, Fit & Function	Grote Fit & Function
80831		63451-4
80839		63451-4
80840		63451-4
80844		63451-4
80848		63381
80849		63391
80860		63391
80870		63381
80873		63391
80874		63381
80875		63451-4
80878		78563
80879		78563
80880		63451-4
80888		63451-4
80893		63451-4
80895		63381
80896		63391
80898		63451-4
80900		64261-4
80910		64241
80920		64251
80930		64261-4
80940		64261-4
80950		64241
80951		64251
80952		64241
80953		64251
80954		64241
80955		64251
80956		64241
80957		64251
80958		64241
80959		64251
80960		64241
80961		64251
80970		63451-4
80971		63451-4
80972		63451-4
80973		63451-4
80974		63451-4
80975		63451-4
81240		64H01-5
81245		64H01-5
81250		64H01-5
81255		64H01-5
81260		63871
81270		64H01-5
81290		64H01-5
81291		64H01-5
81295		64H01-5
81350		61491-5
81360		64H01-5
81365		64H01-5
81371		64H01-5
81374		64H01-5
81380		64E01, 64G11 64H01-5
81385		64H01-5
81390		64E11, 64G01 64H01-5
81391		64H01-5
81395		64H01-5
81500		63F21, 63F41 63F61, 63F71
81510		63F61
81520		63F61, 64H01-5
81560		63610
81701		63861
81702		83831
81704		63861
81711		63861

TruckLite PN	Grote Form, Fit & Function	Grote Fit & Function
81712		83831
81714		63871
81801		63861
81802		63H81
81804		63871
81811		63861
81812		63H81
81814		63871
91241		56073
91242		56072
91243		55993
91244		53422
91315		54342
92545		16092
92546		16093
92550		77193
92551		77192
92560		77013
92563		77013
92600		77003
92602		76983
92672		76903
92673		76903
92674		77931
92677		77931
92695		76653
92844		77931
92845		77353, 77931
92846		77931
92867		76903
92868		76651
92871		77351
92877		76651
92884		77931
92885		77353
92900	73040	
92901		73040
92902		73090
92904		73030
92905	73080	
92909		73040
92910		73040
92911		73110
92916		73130
92918		73160
92924		73090
92925	44421	
93745		66931
94706		66830
94707		66861
94718		66930
94729	66981	
94736		66931
94750		66810
94802	66811	
94850	66800	
94853		66820
94862	66930	
94882	66844	
94897	66831	
94902	67050	
94909		67050
94916		67050
94919		67050
94924	67050	
94925	67010	
94926	67000	
94932	66810	
94940	68380	
94961	67011	
94962	66812	
94964	66801	
94972	66801	
94992		67010
94993	67090	

TruckLite PN	Grote Form, Fit & Function	Grote Fit & Function
95220		92420
95306		66931
95410	66931	
96904	66201	
96919	66202	
96930	66360	
97005		66931
97050		66160
97224		64261-4
97252		77363
97283	44090	
97300	44040	
97302	44060	
97360		72110-5
97361		72100-5
97609		12020
97610		12020
97611	28162	
97612	28031	
97614	12813	
97615		12813
97618	28033	
97619	28162	
97620	28031	
97621	28663	
97623	28041	
97624	16284	
97625	16294	
97626	16304	
97627	16244	
97628		16244
97629	16202	
97630	16200	
97631	16191	
97632		16043
97633		28393
97636	16142	
97637	16141	
97644		16093
97653	12073	
97654	12072	
97655	12243-5	
97659		12193-5
97660	12111-5	
97664		28083
97665		28083
97666	22002	
97669		28453
97670		12333
97671		12331
97672		12303
97673	12301	
97674	12333	
97675		12333
97676	12331	
97678		28093-5
97681		28293
97682		28083-5
97686		12113
97687		28443
97688		28323
97694		16023
97695		16041
97718	13303	
97721		10025
97725	22233	
97726	22232	
97732	10113	
97733	11293	
97748		10623
97802	28032	
97803	16033	
97804	16032	
97805	12113-5	
97806	16091	

## TRUCKLITE-TO-GROTE INTERCHANGE

TruckLite PN	Grote Form, Fit & Function	Grote Fit & Function
97807	12071	
97808	16101	
97809	16053	
97811	16092	
97812	16023	
97815	12183	
97816	12182	
97817	12173	
97818	16102	
97819	28663	
97820	28042	
97822	16123	
97823	10173	
97826		16063
97827	16223	
97828	10173	
97829	22193	
97831	12272-5	
97835		12020
97837	16053	
97840	28461	
97843	22013	
97845	29060	
97846		28193
97847	12303	
97848		12333
97860		16023
97861	16273	
97862		12153, 28491
97863	12010	
97865	28763	
97866	16153	
97869	10623	
97872	28033	
97940	99180	
97960	43901	
98100	40641	
98101	40650	
98104	40650-5	
98105		40641-5
98107	41080	
98126	41210	
98127	41160	
98136	40650	
98137	40641	
98146	41170	
98153	41121	
98165	41133	
99172	92951	
1001AD	45023-5	
1001D	45022-5	
10028R		45072
10028Y		45073
10050R		47472
10050Y		47473
10051R		47202+47122
10051Y		47203+66840
10075R		47232+91400+66840
10075Y		47233+91400+66840
10076R		47232+91400+66850
10076Y		47233+91400+66850
10079R		47372+66840
10079Y		47373+66840
10085R		47232+91400+66850
10085Y		47233+91400+66850
10086R		47232+91400+66850

TruckLite PN	Grote Form, Fit & Function	Grote Fit & Function
10086Y		47233+91400+66850
10089R		47373+66850
10089Y		47373+66850
10090R		47232+91400+66850
10090Y		47233+91400+66850
10091R		47372+66850
10091Y		47373+66850
10092R		47232+43162+66850
10092Y		47233+43162+66850
10202C	45811	
10202R		45812
10202Y		45813
10204R		45182
10204Y		45183
10205R		45832
10205Y		45833
10208R		45832
10208Y		45833
10212Y		78343
10213Y		78343
10250R		47122
10251R		47122+43160
10251Y		47123+43160
10275R		47232
10275Y		47233
10276R	G1082	
10276Y	47223	
10279R		47372
10279Y		47373
10286R		47232
10286Y		47233
10288R		47422+66840
10288Y		47423+66840
10289R		47372+66840
10289Y		47373+66840
10375R		47232
10375Y		47233
10379R		47372
10379Y		47373
10385R		47232
10385Y		47233
10389R		47372
10389Y		47373
10391R		47232+43162
10391Y		47233+43162
1050A		G1033
10519R		45042
10519Y		45043
1051A		G1043
10520R		43670 45812 67049
10525R		45072
10525Y		45073
1052A		G1003
1070A		47372
1071A		47373
10744R	49142	
10745R		49142
1075A	G1083	
1203A	46783	
1211A	46793	
1211W	46791	
1213A	46793	
1222A		45933
1233A		45463
1259A	45263	
1264A	45933	
1312A	45333	
1320AD	46543-5	
1350A		46813
14200R	45232	

TruckLite PN	Grote Form, Fit & Function	Grote Fit & Function
14200Y	45233	
15006R	43370	
15006Y	43370	
15008R	43380	
15008Y	43380	
15033R		47082
15033Y		45083
15050R		47182
15050Y		49182
1507A	46883	
15200C	60271	
15200R	46412	
15200Y	46413	
15201R	45162	
15201Y	45163	
1520A	45513	
1520AHT	45523	
1520HT	45522	
15250R	47082	
15250Y	47083	
15506R		45082
15506Y		46413
15507R		47083
15507Y		43970
1560A	G1503	
1570A		46393
15741R		49172
15745R	49172	
15745Y	49173	
18050R	47732	
18050Y	47733	
19002R	46742	
19002Y	46743	
19006R	47092	
19006Y	47093	
19009R		46742
19009Y		46743
19031R		47092
19031Y		47093
19032R	47092	
19032Y	47093	
19200C	60301	
19200R	46742	
19200Y	46743	
19205Y	78393	
19250R	G1902	
19250Y	G1903	
19275R	47492	
19275Y	47493	
1960A	G1903	
21001R		46832
21001Y		46833
21002R	46082	
21002Y	46083	
21004C		60031
21005R		45152
21005Y		45153
21051R		47032
21051Y	47073	
21056R	47352	
21056Y	47353	
21075R	G2102-5	
21075Y	G2103-5	
21080R		47032
21080Y		47033
21200R	46832	
21200Y	46833	
21201R	46072	
21201Y	46073	
21204C		60331
21205R		45152
21205Y		45153
21210Y	78363	
21251R	47072	
21251Y	47073	

## TRUCKLITE-TO-GROTE INTERCHANGE

TruckLite PN	Grote Form, Fit & Function	Grote Fit & Function
21256R	47352	
21256Y	47353	
21271R		54002+66815
21275R	47162	
21275Y	47163	
21501R	46872	
21501Y	46873	
21506R	46832 + 66910	
21506Y	46833 + 66910	
21507R	46872 + 66910	
21507Y	46873 + 66910	
2150A	G2103	
21880R	47072	
21880Y	47073	
22002R		53062+66905
22202R		53062
22202Y		53063
25250Y		47063
25750Y	47063	
25760Y	45503	
25761Y		46813
25765Y	46913	
25766Y		46913
26250R	47262	
26250Y	47263	
26251R		47262
26251Y		47263
263-4	44860	
26311R	46282	
26311Y	46283	
26313R		46892
26313Y		46893
26315R		45172
26315Y		45173
26392C		60251
26393C		60251
26394C		60251
2660A	G4603	
2661A	G4613	
26741R	49002	
26760Y		45993
26762Y		92773
26765Y	46543	
2701A		56053
2702A		53053
27270C	90941-5	
27450C	90951-5	
29002R		46832 + 66909
29002Y		46803+66911
29002Y		46833 + 66909
29004C		60331 + 66910
29004C		60331 + 66910
29202R		45442 or 45462
29202Y		45443 or 45463
29203R	46872	
29203Y	46873	
29204C	60331	
29204C	60331	
30050R		47112
30050Y		47113
30051R		47112
30051Y		47113
30070R		47112
30070Y		47113
30071R		47112
30071Y		47113
30075R	46132 + 92120 + 67050	
30075Y	46133 + 92120 + 67050	
30080R		G3002
30080Y		G3003

TruckLite PN	Grote Form, Fit & Function	Grote Fit & Function
30085R		46132 + 92120 + 67050
30085Y		46133 + 92120 + 67050
30086Y	47113 + 92120 + 67050	
30090R	46132 + 42180 + 67050	
30090Y	46133 + 42180 + 67050	
30091R	G3002 + 43150 + 67050	
30091Y	G3003 + 43150 + 67050	
300A		77103
30200C	45821	
30200R	45822	
30200Y	45823	
30201R	47102	
30201Y	47103	
30204R	45822 + 43690	
30206R	45202	
30206Y	45203	
30221R	45562	
30221Y	45563	
30222R		45822 + 43149
30222Y		45822
30230Y		78333
30250R	47112	
30250Y	47113	
30251R		47112
30251Y		47113
30257Y	78333	
30264Y	78433	
30269Y	78433 + 43150	
30270R	47112	
30270Y	47113	
30271Y	78423	
30272R	47112 + 43150	
30272Y	47113 + 43150	
30275R		G1092
30275Y		G1093
30276R		47212
30276Y	47213	
30277R		47112 + 43151
30277Y		47113 + 43151
30279R	46142 + 67050	
30279Y	46143 + 67050	
30285Y	G3003	
30288R	G3002 + 43152 + 67050	
30288Y	G3003 + 43152 + 67050	
30289R	G3002 + 43152 + 67050	
30289Y	G3003 + 43152 + 67050	
30375Y	46133	
30379R	46132 + 43150 + 67050	
30379Y	46133 + 43150 + 67050	
30503R	45062	
30503Y	45063	
3050A	G3003	
3070A		G3003 + 43149
30740R		49142
3075A	G3093	
307A		77103
307B		77105
307R		77102
328d	73140-5	
329d	73150-5	
33050R	49342	
33050Y	49343	
33051R		49342
33051Y		49343

TruckLite PN	Grote Form, Fit & Function	Grote Fit & Function
33075R	49332	
33075Y	49333	
33080R		49332
33080Y		49333
33250R		49332
33250Y		49323, 49333
33275R		49342
33275Y		49343
35001R	65512	
35001Y	65513	
35080R	47242	
35080Y	47243	
35200R	47242	
35200Y	47243	
35880R	47242	
35880Y	47243	
36041C		60781
36042C		60791
3691W		60311
3693W		60311
3753AD		55243
3753D		55242
3754D		50642-5
3755A		55243
3756D		50642-5
3850AA		55223
40002R		52782
40002Y		52783
40006R		52770+91740+ 67000
40009R		52152+67000+ 91740
40009Y		52153+67000+ 91740
40015R		52672+67000+ 91740
40028R		53012
40028Y		53013
40029R		52692+67000
40041Y		55582
40201Y		55573
40202R		52772
40202Y		52773
40206C	61051	
40206R		52770
40209R		52152
40209Y		52153
40215R		52672
40226R		52672+92510
40229R		52691
4023Y106		52912
40241R		55572
40241Y		55573
40242R		52952
40248R		52672
4024Y106		52902
40258R		52952+92510
40259R		52952+92510
40282R		52922
40282Y		52923
4050A		G4003
4051A		G4022
4060C	62691	
4063C		62811
40898R		52952
4091A		52063
4091A		53063 + 66904
4093A		53063
4094A		52063+66905
4095A		53063+66905
41a	40233	
425WD	60631	
426W	60011	
433WD		60151
435W	60151	
43a	40193	

## TRUCKLITE-TO-GROTE INTERCHANGE

TruckLite PN	Grote Form, Fit & Function	Grote Fit & Function
44001Y		53413+67013+91740
44002R		53253+66830
44003Y		53313+91740+67002
44018Y		53413+91740+67002
44021Y		53503+66830
44022R		53272+67002
44023Y		53323+67002
44024Y		53182+67002
44026R		53182
44027Y		53513+66830
44030R		53462
44032R		53272+67002
44036R		53292+67002
44038R		53282+67002
44042C		61581
44046C		61581
44071Y		53313+67002+91740
44092R		53462
44101R		77352
44101Y		77353
44102R		77352
44102Y		77353
44103R		77352
44103Y		77353
44104R		77352
44104Y		77353
44110Y		77353
44110Y		77353
44114Y		77353
44144Y		77353
44181C		62101 + 92511 + 66861
44182C		62101 + 92512 + 66861
44201Y		53413
44202R		53312
44203Y		53313
44207C		61581
44211R		77352
44211Y		77353
44212R		77352
44212Y		77353
44213R		77352
44213Y		77363
44214R		77352
44214Y		77353
44217Y		77353
44217Y		77353
44218Y		77353
44218Y		77353
44221Y		53503
44222R		53272+67002
44223Y		53323
44224Y		53183
44226R		53182-3
44227Y		53513
44231Y		53282+67002
44237C		61141 or 61601
44248Y		77353
44248Y		77353
44249Y		77353
44249Y		77353
44253R		52092+67002
44302R		53252
44308C		61E41, 61H01
44322R		53292
44326R		53292
44328R		53282
44339C		61E01, 61G91

TruckLite PN	Grote Form, Fit & Function	Grote Fit & Function
44344C		62101 + 92511 + 66861
44345C		62101 + 92510 + 66861
44346C		62101 + 92512 + 66861
44348C		62101 + 66862 + 92511
44349C		62101 + 92510 + 66861
44438C	61171	
44439C		61G91
44871Y		53313
44877Y		53323
44878Y		53183
44881Y		53413
44882R		53212
44887Y		53503
44888Y		53513
44982R		53252
44983R		53292
44986R		53292
44988R		53282
44991C		62101 + 92510
44992C		62791
45001Y		52233+94180+67090
45002R		52203+94180+67090
45002Y		52203+94180+67090
45051R		G4502+94180+67000
45051Y		G4503+94180+67000
45201Y		52233
45202R		52203
45202Y		52203
45251R		G4502
45251Y		G4503
45a	41003	
49002R		53112
49003C	62121	
49202R		53112
49203C		62121 + 91740 + 67012
5050DK		65320-5, 65880-5
5051DK		65330-5
52a	41013	
54a	41033	
60001R		55792
60001Y		55773+67000+91740
60002R		52572
60002Y		52573
60004C	62251	
60015R		52512+67000+91740
60015Y		52253
60050R		53122
60052R		53592+66830
60056R		53622+66830
60072Y		53593+66830
60075Y		53123
60083R		53092
60083Y		53093
60085R		53122
60115Y		52323+66830+92420
60117Y		52383+66830
60120R		77363
60120Y		77363
60122R		77362
60122Y		77363
60124R		77362
60124R		77362
60124Y		77363

TruckLite PN	Grote Form, Fit & Function	Grote Fit & Function
60126R		77362
60126Y		77363
60201R		55572
60201Y		55573
60202R		52892
60202Y		52893-5
60204C	62231	
60215R		52512
60215Y		52193
60250R		53962
60252R		53592
60253R		52072
60255Y		52073
60256R		53622
60264R		52072
60272Y		53593
60275Y		53963
60276Y		53623
60283R		52182
60283Y		52183
60290Y		G4003
60315Y		52323
60317Y		52383
60360R		77362
60360Y		77363
60362R		77362
60362Y		77363
60364R		77362
60364Y		77363
60366R		77362
60366Y		77363
6050A		G6003
6051A		G6013
6058		54752, 54762, 54722
6060C	62751	
60872Y		53593
60885R		53962
60891Y		53963
610W		63211
612W		64891
613W		63231
620W		64101
620W4		64921
627WD		63111
628WD		63121
629WD		63111
630W		64931
630W4		64101
631W		64931
632W		64411
633W		64991
637W		63241
6503A		55993
6600A		77733
6600B		77635
6600MA		76663
6600R		77612
6600W		77611
6601A		77673
6601B		77735
6601R		77732
6601W		77671
6601WA		76663
66050R		53962+66830+92420
66052R		53592+66830
66056R		53622+66830
66205C		62051
66206C		62051 + 43222
66250R		53962
66252R		53592
66256R		53622

### TRUCKLITE-TO-GROTE INTERCHANGE

TruckLite PN	Grote Form, Fit & Function	Grote Fit & Function
6660PS		77931
66882R		53592
66885R		53962
6810A		76673
6810B		76665
6810MA		76673
6810W		76661
6822A		76463
6823A		76463
69002Y	52553	
69003C	62241	
69202Y	52533	
69203C	62241	
70310R		50642
70330R		55242
70330Y		55243
7044D	12014-5	
7044DB	12014	
7048D	12164-5	
7048DB	12164	
80162C		61861, 61F51
80164C		61861
80166C		61861
80255C	61F61	
80302R		50222
80302Y		50223
80322R		90013+50223
80324R		50532
80334R		50232
80335R		52522
80336R		52612
80339R		50502
80423C	60311	
81300R		55092
81300Y		90013+55092
81301R		55612
81301Y		55612+90763
81312Y		55450+91503
81335C		64M11-5
8370A		77931
8370B		77931
8370R		77931
8370W		77931
84206C		61G01
84216C		61E81, 61F01, 61G81
8861A	99913	
8933A		90203
8938A		91503
8939A		91513
8977A		90133
9004A		90303
9004W		90301
9005A		90053
9005W		90051
9006A		91963
9007A		91963
9007B		91965
9007G		91964
9007W		91961
9016A		91583
9016W		91581
9021A		91583
9021W		92581
9029A		90013
9029W		90011
90325Y		53883
9040A		92173
9057A		91993
9063A		91503
9074A		91513
9077A		91173
9078A		91503

TruckLite PN	Grote Form, Fit & Function	Grote Fit & Function
9079A		91503
9080A		91513
9082A		93253
9087A		90133
9093A		90123
9093W		90121
91315R		54342
91315Y		54343
92513C		77811
92513Y		77813
92522Y	76703	
92524Y		76703
92525Y	76713	
92530C		77321
92530Y		77323
92531Y		77323
92534C		77101
92534Y		77103
92550Y		77353
92551Y		77363
92552Y		77353
92554Y		77013
92564C		76661
92564Y		76663
92565B		77735
92565C		77671
92565R		77732
92565Y		77671
92566Y		77673
92568B		77735
92568C		77671
92568R		77732
92568Y		77673
92569Y		77671
92600Y		76463
92602B	76035	
92602R	76032	
92602Y	76033	
92642Y		76983
92644Y		76993
92645Y		76980
92646Y		76993
92695R		77462
92695Y		77463
92696R		77462
92696Y		77463
92860Y		77633
92861Y		76663
92862Y		76663
92862Y		77633
92863Y		77123
92865Y		77813
92866Y		77153
92868Y		78473
92869Y		78473
92870B		77465
92870C		77461
92870R		77462
92870Y		77463
92871B		76655
92871C		76651
92871Y		76653
92872B		76655
92872Y		76653
92WD		62021
9341A		90233
9341B		90235
9372A		92763
9380SW	61161	
9380W		61161
98006r	40152	
98006y	40153	
98031r	41042	
98031y	41043	
98154r	41122	

TruckLite PN	Grote Form, Fit & Function	Grote Fit & Function
98175r	41142	
98175y	41143	
98176r	41152	
98176y	41153	
99007C	90761	
99007R		90762
99007Y		90763
99008C	91311	
99008R		90012
99008Y	90013	
99009R		90232
99009Y		90233
99039Y	90303	
99041R	90152	
99041Y	90153	
99066Y		92773
99090R		90232
99090Y		90233
99095C		90221
99167Y	90103	
99168R	99842	
99168Y	99843	
99169R	99832	
99169Y	99833	
99170R	99802	
99170Y	99803	
99171R	99912	
99171Y	99913	

### PETERSON-TO-GROTE INTERCHANGE

Peterson PN	Grote Form, Fit & Function	Grote Fit & Function
45		43424
46		43901
294	G6151	
335		50630
337		53220
367	61871	
400		60001
415	G2271	
416	G2111	
435	60151	
449		71422
459		71152
500		48272
554		44810
557		44820
561		82-2150
570		44530
571		44540
572		44891
573		44690
574		44700
576		44710
577		44720
595		18103-5
598		18302-5
605		28032
608		12182
609		12071
615		16244
616		16092
654		28032
780		73080
781		73080
782		73030
784		73030
785		73080
810		28323-5
821		28093-5
830		12243-5
832		12113-5
833		12263-5

### PETERSON-TO-GROTE INTERCHANGE

Peterson PN	Grote Form, Fit & Function	Grote Fit & Function
835		12263-5
836		12263-5
845	G5202	
2593		42180
2594		42180
4222		G6012
4223		G6013
4224		G4002
4469		65513
4470		65512
5000		44030
5100		44010
5124		44010
5404		81-1020
100-15A		90163
100-15R		90162
104-3R	49142	
107-15A		92433
107-15R		92432
107-3R		49112
107WA	46883	
107WR	46882	
108-15A		90203
108-15R		90202
108WA	46713	
108WR	46712	
110-15A		90303
110-15R		90302
117A		45993
118-15A	91683	
119-15A	90053	
119-15R	90052	
119A		45173
119R		45172
120-49	68380	
1200A		47913
1200R		47912
123A	46283	
123R	46282	
124-15A	90923	
124-15R	90922	
124A	46893	
124R	46892	
127-18	93402	
127-181	93400	
1274R		71152
130-25A		91043
130-25R		91042
134-15A		90123
134-15R		90122
135A	45263	
135R	45262	
136-15A	90153	
136-15R	90152	
136-3R	49062	
136A	45253	
136R	45252	
138-15A		91963
138-15R		91962
138A	46793	
138R	46792	
142-09	93750	
142-18	91410	
142-18K	94000	
142-49	67050	67001
142A	45813	
142KA	45043	45813 + 91400 + 67049
142KR	45042	45812 + 91400 + 67049
142R	45812	
143-092		43512
143-18	91410	

Peterson PN	Grote Form, Fit & Function	Grote Fit & Function
143-18K	94010	
143A	45833	
143R	45832	
144-18	92920	
145A	47013	
145R	47012	
146-09	93760	
146-092		43532
146-18	92120	
146-181	92120	
146-182	92150	
146-18K	94190	
146A	45823	
146R	45822	
150-09		94233
150-091	43380	42131
150-092		43970
150-095		43970, 94233
150-10	94233	
150-13		94233
150-14		43960
150-141		43962
150-3R	49172	
150-49		66932
150A	46413	
150C	60261	
150R	46412	
152-09		94233
152-091		94233
152-10		94233
152-49	67315	67400
153-09		94233
153-49	67001	66981
153A	47083	
153C-142		60671 + 43969
153C-143		600671 + 94232
153C-BT2	60671	
153R	47082	
154-09K	43850	
154-10K		43850, 43783 + 66980
154-11K		43850
154-49		67120, 99501
154A	46743	
154C	60291	
154KA	45093	
154KR	45092	
154R	46742	
155A		46833
155R		46832
160-09		43120
160-49		66910, 66930
160-491	66930	66910
160-492		66911
160-493		66932
161A		47093
161KA	65203	47093 + 66982 + 43779
161R		47092
162-49	67001	
162-493		66851
162A	47123	
162R	47122	
163A		G1033
163FA		G1033 + 42169
163FR		G1032 + 42169
163KA		G1033 + 91400 + 67000
163KR		G1032 + 91400 + 670000
163R		G1032
164A	47113	
164R	47112	
165-10		43690
165A		G3003

Peterson PN	Grote Form, Fit & Function	Grote Fit & Function
165R		G3002
166A		G3093
166R		G3092
168A		45003-5
168R		45002-5
172A		47123
172R		47122
173A		G1003
173R		G1002
174A		47113
174R		47112
176-10		42110
176-11		42292
176-12		42282
176-14		42302
176-16		42312
176-496		67120, 99501
176A-BT2		49333
176BKKA		49333 + 42109
176BKR		49332 + 42109
176KA	49333	
176KR	49322	
176R-BT2		49332
187A	47163	
187R	47162	
188A		G2103
188R		G2102
192-492		66826
2636A		46413 + 91380 + 67049
2636R		46412 + 91380 + 67049
2637A	45093	
2637R	45092	
298C	G6121	
313-2RA		55280
313AA		55220
318L		01-5616-70 + 01-5618-70
318L-P		01-5616-70 + 01-5618-70
318R		01-5616-70 + 01-5618-70
318R-P		01-5616-70 + 01-5618-70
319AA		56150-5, 56160-5
319R		01-5618-70, 56170-5, 56180-5
325-2		55410, 55470
337-2		53220
344-49		66861
344A		55470
350A-P		54183, 66815
350AF		54203
352A		52193
354A-AMP		54193
354AF-AMP		54213
393A		53133
394C	60361	
410-21		99595
411-07	68170	
413-07		68130
414-15C	91311	
415K	62221	
416K		62111 + 92420 + 67013
417-1		43572
417-2		43642
417-48		66862
417-481		66860
417-49	66861	
417-491	66860	66860
417-491MP		67006
417-493		67006

### PETERSON-TO-GROTE INTERCHANGE

Peterson PN	Grote Form, Fit & Function	Grote Fit & Function
417C		62691
417C-5P		62101
417KR-5		53532 + 91739
417R-3P		53532
417R-5	53532	
417TA-5		54363
417TA-5P		52163
418C-P		62781
418R-3P		54572 + 66861
418R-5		53182
420C-5P		62561 + 66842
420CR-5		G6012
420KR-5		53962 + 92420 + 66829
420R-3P		54142 + 66860
420R-5		53962
420R-5P		53962 + 66829
421-09		43362
421-18	92420	92720
421-49	67014	67014
421-491	67090	66843
421-491Y		66810
421A		54183
421KA		53093
423C-5P		62561 + 43222 + 66842
423R-5		53622
423R-5P		53622 + 66830
424-09		43572, 92512
426-10		43655
426-18	91740	67150
426A		52923
426KA		52923, 91740+67090
431-49	67010	67011
431-491	67000	66825
436-01	93610	
440-15		92792
450KA		52203, 94180+66825
4523-49		66870
465-1		41160
465-4K		40650-5
465K		40650-5
510-9		43112
5406P		82-1011
5406S		82-1016
5407P		82-2149
55-15A	91113	
55-15R		91112
55-15R	91112	
551-41		82-2161
608X		12293
608XO		12173
610X		28493
616W		16091
654X		28033
657C		28373-5
658X		12272-5
667X		16093
668X		12153
670X		28443
671X		28443
672X		28493
701C		90941-5
702C + 703C		90951-5
717A		55982
717A-PKD		55982
717R	55983	
786-102		73160
786-97		73220
817C-3		62101
817KCR-3		01-5325-83 + 67006

Peterson PN	Grote Form, Fit & Function	Grote Fit & Function
817KR-3		53552 + 91740 + 67005
817KTA-3		53553, 66815
817R-2		53552
817R-3		53552
817TA-2		54363
817TA-3		53553, 66861
818C-3		62791
818KR-3		53292 + 91740 + 67006
818R-2		53292 + 67006
818R-3		53292 + 67006
818TA-2		54633
818TA-3		54633, 66815
820R-2		53962 + 67006
820R-3		54142
820R-7		54722, 54752, 54762, 54722
821R-3		G6002
822R-3		G6002 + 43222
823R-2		54132 + 43222
824R-3		G4002 + 92512
826R-3		G4002
845L	G5212	
850A-1		G4503
850A-1P		G4503, 66825
850R-1		G4502 + 67000
850R-1P		G4502 + 67000
880K-7		54672, 54682, 54702
882K-7		55162
883K-7		55202
904-MV		64H01-5
912-MV		64E01, 64E11, 64G01, 64G11
917-MV		63F21, 63F41, 63F61, 63F71
B107-15A		92433
B107-15R		92432
B1200-09X		93453
B127-18		94180
B134-15A		90123
B134-15R		90122
B138-15A		91963
B138-15B	91965	
B138-15C	91961	
B138-15R		91962
B142-18		91410
B142-49	67050	67001
B142-50		67001
B142-51		67001
B143-17	92070	
B143-18	91400	94010
B144-18	92070	
B146-09	93760	
B146-093	93760	
B146-18	92120	94100
B146-181		92120
B146-182	92150	
B146-184	92120	
B146-49		66932
B150-095		43970-3, 94233
B150-097		94233, 42162
B150-14	43960	
B150-141	43962	
B150-141B		43262
B150-142		43962
B150-143		43962
B150-18		91380
B150-181		91380
B150-491		67120
B152-49		66981, 67001-3, 67400
B153-492		66981
B153-493		66982
B153-494		66986

Peterson PN	Grote Form, Fit & Function	Grote Fit & Function
B154-092		43230
B154-11		43780
B154-11K		43780
B160-49		66930
B160-491		66930
B162-49		67001
B165-10		43690
B167-09		43780
B167-49		43780, 66981
B167-491		43780
B167-492		66801
B168-09	94233	43780
B168-092	94233	43120
B168-092B		43120
B168-093		43780
B168-10	94233	43673
B168-181		43120
B177-18	60-1084-03	
B192-492		66826, 66862
B2412		66932
B388-09X		93453
B411-07		68170
B413-07		68130
B417-49		66861
B417-491	66860	
B417-496		66860
B418-10		92513
B421-18	92420	
B421-19		67014
B421-49		67014
B421-491	67090	
B423-11	42153	42153
B426-18	91740	
B431-491	67000	
B45		43424
B450-18	94180	
B46		43901
B460A		40193
B460R		40192
B474A		40073
B474R		40072
B476A		40153
B476R		40152
B477A		40093
B477R		40092
B479A		41043
B479R		41042
B481A		40073
B481R		40072
B484A		40303
B484R		40302
B485A		40303
B485R		40302
B489A		40303
B489R		40302
B492A		40133
B492R		40132
B5425Y		68420
B5500A		82-1029
B5500B		82-1029
B570		44540
B7005S	43153	
B7007S	43823	
B7009S	43253	
B7011S	43723	
B817-48		68580
B850-18	94180, 94180-3	
M102A	45413-3	
M102R	45412-3	
M104-3R		49142
M104A	45413-3	
M104R	45412-3	
M106A	45933-3	
M106R	45932-3	
M107-3R	49112	



### PETERSON-TO-GROTE INTERCHANGE

Peterson PN	Grote Form, Fit & Function	Grote Fit & Function
M107WA	46883-3	
M107WR	46882-3	
M108WA	46713-3	
M108WR	46712-3	
M109A		45333
M110A	45023-3	
M110C	45021-5	
M110R	45022-3	
M112A	46393	
M114A	49683-5	
M114R	46982-5	
M118A	46543	
M119A	45173	
M119R	45172	
M120A		99913
M120R		99912
M122A	46893	
M122R	46892	
M122XA	46893	
M122XR	46892	
M124A	46893	
M124R	46892	
M125A		47053
M125R		47052
M126A	47053	
M126C		47051
M126R	47052	
M127A	45233	
M127R	45232	
M129A		47503
M129R		47502
M130A	46303-3	
M130R	46302-3	
M135A	45263-3	
M135R	45262-3	
M136A	45253-3	
M136R	45252-3	
M137A		47253-3
M138C	46791	
M146C	45821	
M150C		60261
M150W	60271	
M153C-BT2	60671-3	
M154C	60291-3	
M171C	49341-3	
M171R-BT		49323
M171A-BT +176-10		49413
M2875A-P		53963
M2875AF-P		53263
M294		G6151
M298C		G6121
M305A		53063
M343A		54833
M351A		54183
M351AF		54203
M352A		52193
M352KA		52253
M355A		54193
M355AF		54213
M359-3		61E81, 61F01, 61G01, 61G81
M360	61261	
M360-BT2	61261	
M361		61171
M365		61F61
M367	61871-3	
M368		61F51
M393C	62291	
M394C	60361-3	
M400		60001-3
M411C		62151
M411SC	62151	

Peterson PN	Grote Form, Fit & Function	Grote Fit & Function
M415	62271-3	
M416		62111
M417C-1		62691
M417C-5		62101
M417C-5AMP		62010
M417C-5P		62101
M417TA		54643
M417TA-2P		54363, 66861
M417TA-5AMP		54363
M417TA-5P		52163
M418C-P		62781, 66842
M418TA-2P		54633, 66861
M418TA-5		54633
M418TA-5P		54633
M420C-5		62561 + 66842
M420C-5AMP		62561 + 67006
M420C-5P		62561 + 66831
M420C-5PKD		62561 + 67006
M420TA-2AMP		53963, 66815
M420TA-2P		G4503
M420TA-5		54143
M420VC-1P		62751
M423A-4		53963
M423C-5AMP		62561 + 43222 + 67006
M423C-5P		62561 + 43222 + 66831
M423TA-2AMP		53623, 66815
M423TA-2P		53623, 94180
M423VC-1P		62751 + 43222
M423W-4		61G31
M4260A		53533
M4260AF		53533
M431C	62271	
M431KC	62221	
M434		61501
M435		60151
M436B		60081
M436B-P		60081
M450A		52203
M817TA-2		54363
M817TA-2C		54633
M818TA-2		54633
M818TA-2C		54633
M829C-7		61E01, 61E41, 61G91, 61H01
M840		51962
M840L		51972
PM-ECK-T		99170
PMV0002-T		82-6554
PMV0099PT		99580
PMV0300T		83-6510
PMV0840PT	82-9543	
PMV0905PT	82-2161	
PMV0906PT	82-2167	
PMV0950PT	82-2166	
PMV0961PT	82-2165	
PMV0963PT	82-2209	
PMV0967PT	82-2165	
PMV0969PT	82-2209	
PMV1100KT	84-2190	
PMV1200KT	84-2390	
PMV1200PT	84-2390	
PMV1268KT	84-2400	
PMV1300KT	84-2190	
PMV1300PT	84-2190	
PMV1544KT	84-2704	
PMV1545KT	84-2702	
PMV1546KT	84-2702	
PMV1560KT	84-2383	
PMV1560PT	84-2383	
PMV1560QT	84-2383	
PMV1575PT		84-9613
PMV1700KT	84-2180	
PMV1705KT	84-2104	
PMV1725KT	84-2334	

Peterson PN	Grote Form, Fit & Function	Grote Fit & Function
PMV1749KT	84-2188	
PMV1755KT	84-2187	
PMV1800QT	84-2380	
PMV1805QT	84-2304	
PMV1806QT	84-2212	
PMV1808QT	84-2340	
PMV1825KT	84-2334	
PMV1855QT	84-2387	
PMV1856QT	84-2391	
PMV1858QT	84-2394	
PMV1864KT	84-2391	
PMV1865QT	84-2387	
PMV1900QT	84-2580	
PMV1905QT	84-2504	
PMV1908KT	84-2540	
PMV1909QT	84-2507	
PMV1913QT	84-2509	
PMV1955QT	84-2587	
PMV1956QT	84-2591	
PMV2250PT	84-2150	
PMV2260PT	84-2350	
PMV2270PT	84-2550	
PMV3157QT	84-2902	
PMV4008KT	84-3015	
PMV4138KT	82-9512	
PMV4238KT	82-9516	
PMV4239KT	82-9430	
PMV4339KT	82-9431	
PMV4439KT	82-9433	
PMV4539KT	82-9435	
PMV5140PT	83-6999	
PMV5141PT	83-7000	
PMV5142PT	83-7001	
PMV5143PT	83-7002	
PMV5503PT		82-2150
PMV5509PT		82-2151
PMV5510PT		82-2116
PMV5511PT		82-2116
PMV5512PT		82-2152
PMV5522PT		82-0600
PMV5530PT		82-1901
PMV5536PT		82-1905
PMV5537PT		82-1908
PMV5540PT		82-0219
PMV5543PT		82-2127
PMV5544PT		82-2127
PMV5546PT		82-2118
PMV5560PT		82-1909
PMV5561PT		82-1912
PMV5562PT		82-1910
PMV5563PT		82-1911
PMV5570PT		82-2106
PMV5571PT		82-1909
PMV5572PT		82-2127
PMV5576PT		82-2110
PMV5577PT		82-2111
PMV5579PT		82-0600
PMV5580PT		82-1901
PMV5583PT		82-1903
PMV5584PT		82-2130
PMV5587PT		82-2132
PMV7064PT		83-6000
PMV7066PT		83-6006
PMV7067PT		83-6020
PMV7074PT		84-6001
PMV7076PT		84-6007
PMV7077PT		84-6021
PMV7120QT		84-7003
PMV81101PT	89-5000	
PMV81103PT	89-5002	
PMV81121PT	89-6000	
PMV81123PT	89-6002	
PMV81141PT	89-7000	
PMV81142PT	89-7011	
PMV81143PT	89-7002	

### PETERSON-TO-GROTE INTERCHANGE

Peterson PN	Grote Form, Fit & Function	Grote Fit & Function
PMV81145PT	89-7010	
PMV81147PT	89-7007	
PMV81161PT	89-8000	
PMV81162PT	89-8011	
PMV81163PT	89-8002	
PMV81164PT	89-8006	
PMV81165PT	89-8010	
PMV81166PT	89-8001	
PMV81181PT	89-9000	
PMV81183PT	89-9002	
PMV81187PT	89-9007	
PMV8221PT	84-5012	
V106-09		43673
V114A		46393-5
V126A		47053
V126C	47051	
V153KC-MV		60671 + 43969
V171C		49341
V25900-09		43272
V294		G6151
V298C		G6121
V306A		53133
V313-2RA		55280
V313AA		55220, 55223
V313R		50652
V335-2		50630
V361		61171
V366		61861
V369S		60591
V379S		61171
V417KTA		54643, 66815
V417KTA (+66815), M417TA		54643
V418KTA		54633, 66815
V428		50872-5
V428-09		43022
V434	61501-5	
V440		52302-5
V440L		52312-5
V472A		40233
V472R		40232
V475A		40063
V475R		40062
V480A		41033
V480R		41032
V483A		40303
V483R		40302
V487A		40133
V487R		40132
V490A		40053
V490R		40052
V500		48272
V520-10		68460-5
V520-40		44840-5
V5325		68540
V5400A		82-1031
V5401	82-1030	
V5402	82-1029	
V5404		82-1021
V5406-09		63942
V5413		82-2147
V5414		82-2146
V5415		82-2148
V5416		82-2146
V5417		82-2149
V5418		82-2142
V5425Y		68420
V5500A		82-1029
V5500B		82-1029
V560		82-2383
V570		44530

Peterson PN	Grote Form, Fit & Function	Grote Fit & Function
V582-2		64371-5, 64631-5
V599		12312
V600		12201-5
V600B-2		12201-5
V602		12164
V603		12204, 12004-5
V603B		12004
V603L		12014
V604		12312-5
V7004		43153
V7005	43153	
V7007	43163	
V7008		92513
V7009	92513	
V7009S	43253	
V7010		42153
V7011	42153	
V7011S	43723	
V780		73080
V781		73080
V783		73080
V940		65880-5

### PRIMATRONICS-TO-GROTE INTERCHANGE

Primatronics PN	Grote Form, Fit & Function	Grote Fit & Function
PT1000A	45813	
PT1000A-ABS	78343	
PT1000BK	43512	
PT1000G	91410	
PT1000GK	94010	
PT1000R	45812	
PT1000R-Kit	45042	
PT1000W	45811	
PT1001BK	42180	
PT1002BK		43690
PT1002G	91400	
PT1003BK		42180+67049
PT1004G	91410	
PT100A-Kit	45043	
PT1050R	49142	
PT1100A	45833	
PT1100R	45832	
PT1300A	45333	
PT1300R	45332	
PT1500A	46413	
PT1500BK		42131
PT1500L	60261	
PT1500R	46412	
PT1500W	60271	
PT1550R	49172	
PT1900A	46743	
PT1900BK	43850	
PT1900L	60291	
PT1900R	46742	
PT1900W	60301	
PT2100A	46083	
PT2100R	46082	
PT2101A	46803	
PT2101R	46802	
PT2102A	46873	
PT2102R	46872	
PT2110C	60331	
PT2200A	53063	
PT2200R	53062	
PT2601A	45263	
PT2601R	45262	
PT2602A	46793	
PT2602R	46792	
PT2603A	45933	

Primatronics PN	Grote Form, Fit & Function	Grote Fit & Function
PT2603R	45932	
PT2605A	46893	
PT2605R	46892	
PT2610A		45233
PT2610R		45232
PT2615A	46783	
PT2615R	46782	
PT2630A	45253	
PT2630R	45252	
PT2640A	46883	
PT2640R	46882	
PT2650A	46893-5	
PT2650R	46892-5	
PT2660R	49112	
PT2700L	60151	
PT2701L	42162	
PT2702L	43960	
PT2703L	60460	
PT2704L	60101	
PT3000A	45823	
PT3000A-AB S	78333	
PT3000A-Kit	45063	
PT3000AF	45563	
PT3000AS		45813+42179
PT3000BK	43532	
PT3000G	92120	
PT3000GK	94100	
PT3000R	45822	
PT3000R-Kit	45062	
PT3000RF	45562	
PT3000RS		45812+42179
PT3000W	45821	
PT3300A	47103	
PT3300R	47102	
PT4000A	52923	
PT4000BK	43572	
PT4000G	91740	
PT4000MA	53103	
PT4000MR	53102	
PT4000R	52922	
PT4000R-Kit	53012	
PT4000RF	53612	
PT4000TK	68730-5	
PT4000W	62271	
PT4002G	91950	
PT4100R	52672	
PT4200BK	51090	
PT4200L	51032	
PT4200R	51022	
PT4200U	51052	
PT4212RF	50232	
PT4212RF-LN	90012	
PT4500A	52203	
PT4500BK	43212	
PT4500G	94180	
PT4500R	52202	
PT4706P	66860	
PT4707P	68580	
PT4902P		67050
PT4924P	67050	
PT4925P	67010	
PT4926P	67000	
PT4992P	67014	
PT4993P	67090	
PT4999P	67010	
PT5001A		77103
PT5001A		77473
PT5001A-FT		92980
PT5001A-LN		92033
PT5001A-LN		93723
PT5001MA		77203
PT5001MA-LN		92033
PT5005A	77013	
PT5005A-FT	92960	
PT5005A-LN	93013	

**PRIMATRONICS-TO-GROTE INTERCHANGE**

Primatronics PN	Grote Form, Fit & Function	Grote Fit & Function
PT5110		73040
PT5152A	76803	
PT5152A-LN	92883	
PT5175		73250
PT5199		73030
PT5215MA		76803+43239
PT5315A		76923
PT5315A-FT	90900	
PT5315MA	76933	
PT5412		44810
PT5413		44820
PT5453		44530
PT5454		44540
PT5469		44690
PT5471		44710
PT5481		44720
PT6000A	52183	
PT6000BK	43362	
PT6000G	92420	
PT6000R	52182	
PT6000R-Kit	53092	
PT6000W	62521	
PT6002G	92720	
PT6106P	67013	
PT6107P	67002	
PT6500A	52193	
PT8005	61821	
PT8010	91302	
PT8020	52442	
PT8020K	65240-5	
PT8021	52452	
PT8428	50872	
PT8428S	50892	
PT8428W	50882	
PT8620	53000	
PT9805A	40053	
PT9805R	40052	
PT9806A	40153	
PT9806R	40152	
PT9807A	40093	
PT9807R	40092	
PT9808A	40073	
PT9808R	40072	
PT9832A	41033	
PT9832R	41032	
PTL1004A		G1033
PTL1004R		G1032
PTL1013A		G1033
PTL1013R		G1032
PTL1108A	G1003	
PTL1108R	G1002	
PTL1313A		G1083
PTL1313R		G1082
PTL1503A	G1503	
PTL1503R	G1502	
PTL1508W	60421	
PTL1550R	49182	
PTL1912A	G1903	
PTL1912R	G1902	
PTL1912W	60301	
PTL2002C		G6151
PTL3004A		G3003
PTL3004R		G3002
PTL3009A	G3003	
PTL3009R	G3002	
PTL3309A	G3093	
PTL3309R	G3092	
PTL3507A		47243
PTL3507R		47242
PTL3606A		47243
PTL3606R		47242
PTL4010A		G4003

Primatronics PN	Grote Form, Fit & Function	Grote Fit & Function
PTL4010R		G4002
PTL4018A		G4003
PTL4018R		G4002
PTL4019W		62691
PTL4040A		G4003
PTL4040AF		G4003+92511
PTL4040R		G4002
PTL4040RF		G4002+92511
PTL4040W		62691
PTL4048A		G4003
PTL4048R		G4002
PTL5005A	77443	
PTL5020		63611
PTL5021	64931	
PTL5023	63221-5	
PTL5024	63231-5	
PTL5030		63G11
PTL5040		63G01
PTL5313A		G4603
PTL5313R		G4602
PTL5505A		45583
PTL5915A		47253
PTL6010A		G6003
PTL6010R		G6002
PTL6027W		62751
PTL6056A	G6003	
PTL6056R	G6002	
PTL8000		G5082
PTL8001		G5092
PTL8020		53662
PTL8020K		65230-5
PTL8021		53672
PTL8620		G5300
PTM0105	12164	
PTM09109	12312-5	
PTM9102	12201-5	
PTM9103	12004	
PTM9104	12014	
PTM9205FB	28152	
PTM9205K	28033	
PTM9205WK	28031	
PTM9206	28663	
PTM9206B		12052+11302
PTM9206BK		28042
PTM9206K	28043	
PTM9206WK	28041	
PTM9209	16033	
PTM9209B	16032	
PTM9209H		12283+11302
PTM9210	12010	
PTM9217		12293
PTM9217B		12182+11302
PTM9217H		12283+11302
PTM9219		12173+ 11302
PTM9219B		12172+11302
PTM9219H		12283+11302
PTM9219LED-L		12143
PTM9219LED-R		12133
PTM9248		28763
PTM9300A	16244	
PTM9310		16023
PTM9310H	16053	
PTM9310HL	16173	
PTM9320	16123	
PTM9320CV	16043	
PTM9320H-L	16223	
PTM9330	16273	
PTM9330B	16142	
PTM9340	16023	
PTM9340H		16053
PTM9340HL		16223
PTM9350	16093	
PTM9350B	16092	
PTM9350W	16091	
PTM9360B	16102	

PTM9360W	16101	
PTM9370	16284	
PTM9370H		16294, 16304
PTM9420		28453
PTM9460	28093-5	
PTM9706	28323-5	
PTM9710S	22013	
PTM9712	10173	
PTM9714	11303	
PTM9716	11133	
PTM9717	10073	
PTM9718	10173	
PTM9720	10623	
PTM9724		10013
PTM9726		10025
PTM9730		10045
PTM9800	22193	
PTM9809	28443	
PTM9810	28493	
PTM9830	12153	
PTM9840	10433	
PTM9900	29060	

**MAXXIMA-TO-GROTE INTERCHANGE**

Maxxima PN	Grote Form, Fit & Function	Grote Fit & Function
M09100R	G3002	
M09100WCL		60561
M09100Y	G3003	
M09105R	G3092	
M09105Y	G3093	
M09250R-X	G3092-3	
M09250Y-X	G3093-3	
M09300R		49332
M09300R-X		49332-3
M09300R-XBC		49332-3
M09300RAS		49362
M09300WCL		49341
M09300Y		49333
M09300Y, M09320Y-X		49323
M09300Y-X		49333-3
M09300YAT		49323
M09320R-X		49322-3
M09320Y-X		49323-3
M09370BCL		77935 & 97942
M09370R		77932
M09370RCL		77932 & 97941
M09370WCL		77931 & 97941
M09370WCL-NS		60651
M09370Y		77933 & 97942
M09370YCL		77933 & 97942
M09410R		49322
M09410WCL		49341
M09410Y		49323
M11201R	G1082	
M11201Y	G1082	
M11256R	G1092	
M11256Y	G1093	
M11260R-X	G1002-3	
M11260Y-X	G1003-3	
M11300R	G1032	
M11300RCL	G1042	
M11300Y	G1033	
M11300YCL	G1043	
M11303R		49162
M11350R-X		G1092
M11350RCL-X	G1042	
M11350Y-X		G1093
M11350YCL-X	G1043	
M16280ABS		78423
M16280R		G1092
M16280R-X		G1092
M16280RCL		G1002

### MAXXIMA-TO-GROTE INTERCHANGE

Maxxima PN	Grote Form, Fit & Function	Grote Fit & Function
M16280Y		G1093
M16280Y-X		G1092-3
M16280YCL		G1003
M16800R		G1082
M16800Y		G1083
M20311R	G5052	
M20311Y	G5053	
M20320R	G1502	
M20320Y	G1503	
M20321R		G1502 & 43979
M20321Y		G1503 & 43979
M20323R		49182
M20325		94233
M20327		43980
M20328		43980
M20332R	45662	
M20332Y	45663	
M20340R		47242
M20340Y		47243
M20343R		49122
M20350R	G1902	
M20350Y	G1903	
M20350YCL	G1913	
M20355		43850
M20356		43850
M20361R		47062
M20361Y		47063
M20378Y		78473
M20391R	G2102	
M20391R-X	G2102-3	
M20391Y	G2103	
M20391Y-X	G2103-3	
M20395R		46832
M20395Y		46833
M23015R		G4602
M23015Y		G4603
M23015YCL		G4613
M34260R		G3002
M34260R-X		G3002-3
M34260Y		G3003
M34260Y-X		G3003
M34600R		G3092
M34600Y		G3092
M42100R		G4002
M42100Y		G4003
M42120R		G4002 & 92511
M42201R		G4502
M42201Y		G4503
M42213R		G4502
M42213Y		G4503
M42220	G5092	
M42320R		G4002
M42322R		G4002
M42322R-X		G4002-3
M42322RCL		G4022
M42322Y		G4003
M42323R		G4002 & 92511
M42323RCL		G4022 & 92511
M42324		62691
M42324-X		62691-3
M42339Y		G4003
M42341Y		56150-5
M42344R		54362
M42344R-X		54362-3
M42346R		54342
M42346R-X		54342-3
M42347		62691
M42347-X		62691-3
M42348		62101
M42348-X		62101-3
M42354		54602 & 67002

Maxxima PN	Grote Form, Fit & Function	Grote Fit & Function
M42354		62811
M42354R		54602
M42354R-X		54602-3
M42354Y-X		54603 & 67006
M42354Y-X		54573
M42355R		54342
M42355R-X		54342-3
M42500R		54342
M42500Y		54343
M42701BCL		77355
M42701R		77352
M42701WCL		77351
M42701Y		77353
M42705Y	77443	
M43253		43253
M43253CH		43253
M43900	67150	
M49700	94180	
M50100-B	94010	
M50100-X	94010-3	
M50102-X	92070-3	
M50103		43163
M50300-B	92120	
M50300-X	92120-3	
M50310	43673	
M50312		43230
M50400-B	91740	
M50400-X	91740-3	
M50600-B	92420	
M50600-X	92420	
M50605		43223
M50607		92420
M50900	67090	
M50900-100	67090-3	
M50900-X	67090	
M50904		66831
M50908		66861
M50909		44070
M50910		99630
M50911	67000	
M50950	67001	
M50950-X	67001-3	
M50950A-100		68551
M50951		67001
M50951A-100		68551
M50953		66862
M56100R		G4002
M63100R		G6002
M63100Y		G6003
M63201BCL		77365
M63201R		77362
M63201WCL		77361
M63201Y		77363
M63253	43223	
M63253BLK	43222	
M63253CH	43723	
M63254	43723	
M63320		62751 & 42151
M63320R		G6002 & 42151
M63320RCL		G6012 & 42151
M63320Y		G6003 & 42151
M63321R-X		G6002 & 42151
M63322R		G6001
M63322R		54722, 54752, 54762
M63322R-X		G6002 & 42152
M63322RCL		G6003-3 & 42152-3
M63322Y		G6002-3 & 42152-3
M63322YCL		G6013 & 42151
M63323R		G6002 & 43221
M63323Y		G6003 & 43221
M63323YCL		G6013 & 43221
M63324		62751 & 92419
M63324-X		62751-3 & 92420-3

Maxxima PN	Grote Form, Fit & Function	Grote Fit & Function
M63339Y		G6003
M63339YCL		G6013
M63340YCL		G6013
M63346R		G6002
M63346R-X		G6002-3
M63347		62751
M63347-X		62751-3
M63352R-X		G6002
M63420R		G6002
M63420Y		G6003
M63450R		G6002
M63450Y		G6003
M84408		61291
M84409		61291
M84410		61881
M84415		61611
M84419-B		61G81
M84420-B		60581
M84422-B		61281
M84423-A		61E81, 61E91, 61F01, 61F11, 61G81
M84427		61931
M84427-A		61F51
M844281		61E81
M84429		61281, 61G01
M84433		61411
M84435		61391
M84436		61E01, 61E41, 61G91, 61H01
M84440		61F61
M85416R		55162, 55172, 55202
M85615R		54672, 54682, 54702
M90061R		53422
M90081Y		55982
MEG-1	99170	
MHL-07HILO		90941-5
MHL-5X7HILO		90951-5
MWL-01B		63861
MWL-01HP		63861
MWL-01LS		63861
MWL-04		63611
MWL-05SP		63611
MWL-07SP		63611
MWL-10SP		63981-5
MWL-11HL		63981-5 & 64930
MWL-12		63981-5
MWL-16		63981, 63F21, 63F41, 63F61, 63F71
MWL-19		63861
MWL-20		64H01-5
MWL-20FB		64H01-5
MWL-20LS		64H01-5
MWL-21		63611
MWL-22		63611
MWL-25SP		64E01, 64E11, 64G01, 64G11

## OPTRONICS-TO-GROTE INTERCHANGE

Optronics PN	Grote Form, Fit & Function	Grote Fit & Function
212767	66200	
00212135P	45853	
00212207B	45793	
00212209B	45792	
00212211B	66200	
00212211P	66200	
00212212B	66200	
00212217B	93473	
00212217B	93473	
00212217P	93473	
00212220P	45793	
00212222P	93473	
00212226P	66200	
00212231B	45763	
00212231P	45763	
00212233B	45762	
00212233P	45762	
00212235P	45773	
00212237P	45772	
00212251B	45783	
00212251P	45783	
00212257P	45792	
00212307B	45623	
00212315B	45643	
00212316B	66200	
00212316P	66200	
00212317B	93453	
00212317P	93453	
00212331B	45583	
00212331P	45583	
00212333B	45572	
00212333P	45572	
00212338P	47772	
00212342B	45593	
00212342P	45593	
00212345P	45603	
00212351B	45613	
00212351P	45613	
00212353B		45572
00212353P		45572
00212355P	45623	
00212362B	45663	
00212362P	45663	
00212365P	45643	
00212704P	47913	
00212705P	47912	
00212706P	47923	
00212707P	47922	
A111GLPBP		42162
A11AB	92433	
A11AB	92433	
A11ABP	92433	
A11ABP	92433	
A11GLPB		42162
A11RB	92432	
A11RB	92432	
A11RBP	92432	
A24RB	90232	
A24RBP	90232	
A2RB	91122	
A2RBP	91122	
A31AB		90203
A31ABP		60203
A31RB		90202
A31RBP		90202
A33GB	94180	
A33GB	94180	
A33GBP	94180	
A38AB	90203	
A38ABP	90203	
A38RB	90202	
A38RBP	90202	

Optronics PN	Grote Form, Fit & Function	Grote Fit & Function
A40RB	90012	
A40RBP	90012	
A40SRB	99595	
A40SRBP	99595	
A42AB	91963	
A42ABP	91963	
A42RB	91962	
A42RBP	91962	
A45BB	92512	
A45BBP	92512	
A45CB	67010	
A45CB	67010	
A45CBP	67010	
A45CBP	67010	
A45GB	91740	
A45GB	91740	
A45GBP	91740	
A45GBP	91740	
A45PB	67000	
A45PBP	67000	
A45PMB	66861	
A45PMBP	66861	
A45PS	67000-5	
A45SB	43253	
A45SBP	43253	
A46PB	67050	
A46PBP	67050	
A46PS	67050-5	
A47PB	67090	
A47PBP	67090	
A47PS	67090-5	
A49PB	67014	
A49PB	67014	
A49PBP	67014	
A49PBP	67014	
A54GB	92120	
A54GBP	92120	
A54GK	94100	
A54GKP	94100	
A55GB	91410	
A55GBP	91410	
A56GB	92070	
A56GBP	92070	
A57GB	91400	
A57GBP	91400	
A57GK	94010	
A57GKP	94010	
A58GB	91880	
A60RB	91302	
A60RBP	91302	
A66PB	43850	
A66PBP	43850	
A68AB	90153	
A68ABP	90153	
A68P		66981
A68RB	90152	
A68RBP	90152	
A70GB	92420	
A70GBP	92420	
A75TB	82-2148	
A75TBP	82-2148	
A78CB		42153
A7WCB	82-1056	
A7WCBP	82-1056	
A81AB	90923	
A81ABP	90923	
A81RB	90922	
A81RBP	90922	
A8R		92792
A8RB	92792	
A8RB	92792	
A8RB	92792	
A8RBP	92792	
A8RBP	92792	
A91AB	46413	

Optronics PN	Grote Form, Fit & Function	Grote Fit & Function
A91ABP	46413	
A91B	46413	
A91GB	91380	
A91GB	91380	
A91GBP	91380	
A91GBP	91380	
A91LW		67120
A91LWP		67120
A91OB	94233	
A91OBP	92433	
A91PB	46413	
A91RB	46412	
A91RB	46412	
A91RBP	46412	
A91RBP	46412	
A93PB	69710	
A93PBP	69710	
A9R		91112
A9RB	91112	
A9RBP	91112	
A9TB	91112	
AL12GLPB	43962	
AL12GLPBP	43962	
AL45PWTB	66860	
AL45PWTB	66860	
AL45PWTBP	66860	
AL46AB	91963	
AL46RB	91962	
AL90AS		G1903-5
AL90RB		47082
AL90RBP		47082
AL90RS		G1902-5
AL91RB		47082
AL91RBP		47082
AR16RB		90562
AR17RB		90562
BK42CB	43673	
BK42CBP	43673	
BK45BB	43572	
BK45BBP	43572	
BK53BB		93760
BK53BBP		93760
BK557GB	42180	
BK557GBP	42180	
BK55BB	43512	
BK55BBP	43512	
BK57BB		93750
BK57BBP		93750
BK66DB		43230
BK66DBP		43230
BK70BB	43363	
BK70BBP	43363	
BU31CB	62291	
BU31CBP	62291	
BU33CB	62381	
BU33CBP	62381	
BU44CB	62221	
BU44CBP	62221	
BU45CB	62271	
BU45CBP	62271	
BU70CB	62521	
BU70CBP	62521	
BUL10CB		62751
BUL10CBP		62751
BUL11CB		62691
BUL11CBX		62691
BUL11CBXP		62691
BUL11CKB		62691+67090+91740
BUL11CKBP		62691+67090+91740
BUL11CMB		62101
BUL11CMBP		62101
BUL13CB		64971
BUL13CBP		64971
BUL16CBP		62691

## OPTRONICS-TO-GROTE INTERCHANGE

Optronics PN	Grote Form, Fit & Function	Grote Fit & Function
BUL22CB		62751
BUL22CBP		62751
BUL23CB		62691
BUL23CBP		62691
BUL43CB		64971
BUL43CBP		64971
BUL52CB		62751
BUL52CBP		62751
BUL53CB		62691
BUL53CBP		62691
BUL53CKB		62691+67090 +91740
BUL53CKBP		62691+67090 +91740
BUL69CB		60581
BUL72CB		61G31
BUL72CBGK		61G31+92420
BUL72CBGKP		61G31+92420
BUL72CBP		61G31
CB11AS	46543-5	
CB11WAB		46543
CB11WABP		46543
CB20AB	46323	
CB20ABP	46323	
CB22AB	46322	
CB22ABP	46322	
CBL22AB	G5053	
CBL22ABP	G5053	
CBL22RB		G5052
DH55	43901	
DH55P	43901	
IL21CB	61491-5	
IL21CBP	61491-5	
IL31CS	61091	
IL41CB	60311	
IL41CBP	60311	
IL91CB		61821
IL91CBP		61821
ILL08COB	61291	
ILL08COBP	61291	
ILL08CPG		61291
ILL10CCB	61261	
ILL10CCBP	61261	
ILL28CMB	61H91	
ILL28CMBP	61H91	
ILL28CMPG		61H91
ILL31CB		61871
ILL35CB		61871
LP11CB	60101	
LP11CBP	60101	
LP11CS	60101-5	
LP21CB	60151	
LP21CBP	60151	
LP21CS	60151-5	
LP25SB	43962	
LP25SBP	43960	
LP25SBP	43962	
LP25SBP	43960	
LP25SGB	43960	
LP25SGBP	43960	
LP26SKB	60460	
LP26SKBP	60460	
LP31CB	61501	
LP31CBP	61501	
LP31CS	61501-5	
LP56CB	60001	
LP56CBP	60001	
LP5SB		43272
LP5SBP		43022
LP5SBP		43272
LP5SBP		43022
LP65CB	60291	
LP65CBP	60291	

Optronics PN	Grote Form, Fit & Function	Grote Fit & Function
LP71CB	60251	
LP71CBP	60251	
LP91CB	60261	
LP91CBP	60261	
LPL12CB		60671
LPL26SKB		60681
LPL31CB	G6151	
LPL31CBP	G6151	
LPL31CEZB		G6151
LPL31CEZBP		G6151
MC11AB		46883
MC11ABP		46883
MC11RB		46882
MC11RBP		46882
MC21AS	45023-5	
MC21RS	45022-5	
MC22AB	45023	
MC22ABP	45023	
MC22RB	45022	
MC22RBP	45022	
MC25AB	47103	
MC25ABP	47103	
MC25RB	47102	
MC25RBP	47102	
MC27AB	45323	
MC27ABP	45323	
MC27RB	45322	
MC27RBP	45322	
MC31AB		45933
MC31ABP		45933
MC31RB		45932
MC31RBP		45932
MC35AB	46393	
MC35ABP	46393	
MC36AB	46983-5	
MC36ABP	46983-5	
MC36RB	46982-5	
MC36RBP	46982-5	
MC37AB	46983-5	
MC37ABP	46983-5	
MC38AB	45933	
MC38ABP	45933	
MC38RB	45932	
MC38RBP	45932	
MC42AB	46793	
MC42ABP	46793	
MC42AS	91963-5	
MC42RB	46792	
MC42RBP	46792	
MC42RS	91962-5	
MC52RB	45822	
MC52RBP	45822	
MC53AB	45823	
MC53ABP	45823	
MC53ABSB	78333	
MC53ABSBP	78333	
MC55AB	45813	
MC55ABKP	45043	
MC55ABP	45813	
MC55RB	45812	
MC55RBKP	45042	
MC55RBP	45812	
MC57AB	45833	
MC57ABP	45833	
MC57RB	45832	
MC57RBP	45832	
MC58AS	45413	
MC58RS	45412	
MC65AB	46743	
MC65ABP	46743	
MC65ARBP	46740	
MC65RB	46742	
MC65RBP	46742	
MC67AB		45093
MC67ABP		45093

Optronics PN	Grote Form, Fit & Function	Grote Fit & Function
MC67RB		45092
MC67RBP		45092
MC68AB	45253	
MC68ABP	45253	
MC68AS	45253-5	
MC68RB	45252	
MC68RBP	45252	
MC68RS	45253-5	
MC71AS		47053
MC71RS		47052
MC77RB		49062
MC77RBP		49062
MC81AB	46283	
MC81ABP	46283	
MC81RB	46282	
MC81RBP	46282	
MC82AB	45173	
MC82ABP	45173	
MC82RB	45172	
MC82RBP	45172	
MC90AS	46413-5	
MC90RS	46412-5	
MC92ABP	49173	
MC93AB	49173	
MC93RB	49172	
MC93RBP	49172	
MC99RB	49112	
MC99RBP	49112	
MC99RK	49112-5	
MCL11AKAB	49333	
MCL11AKABP	49333	
MCL11AKB	49333	
MCL11AKBP	49333	
MCL11RB	49332	
MCL11RBP	49332	
MCL11RKB12		49332
MCL11RKBP	49332	
MCL12RB	49332	
MCL12RBP	49332	
MCL12RKB	49332	
MCL12RKBP	49332	
MCL12RKPG	49332	
MCL21AB	G3093	
MCL21ABP	G3093	
MCL21RB	G3092	
MCL21RBP	G3092	
MCL23AB	G1083	
MCL23ABP	G1083	
MCL23RB	G1082	
MCL23RBP	G1082	
MCL45AB	G4603	
MCL45ABP	G4603	
MCL45RB	G4602	
MCL45RBP	G4602	
MCL46ABP		46143
MCL50AB		G3003
MCL50ABP		G3003
MCL50RB		G3002
MCL50RBP		G3002
MCL51AB		G1033
MCL51ABP		G1033
MCL51RB		G1032
MCL51RBP		G1032
MCL527AB		G1033
MCL527AS		G1033-5
MCL527RB		G1032
MCL527RBP		G1032
MCL527RS		G1032-5
MCL54AB		46133
MCL54ABP		46133
MCL54RB		46132
MCL54RBP		46132
MCL55AB		G3003
MCL55ABP		G3003

## OPTRONICS-TO-GROTE INTERCHANGE

Optronics PN	Grote Form, Fit & Function	Grote Fit & Function
MCL55AKB		G3003+67050+92120
MCL55FRB	43532	
MCL55RB		G3002
MCL55RBP		G3002
MCL55RKB		G3002+67050+92120
MCL56AB		G3003
MCL56ABP		G3003
MCL56AS		G3003-5
MCL56RB		G3002
MCL56RBP		G3002
MCL56RS		G3002-5
MCL57AB		G1033
MCL57ABP		G1033
MCL57ABP		G1033
MCL57RB		G1032
MCL57RBP		G1032
MCL57RCB		G1042
MCL57RCBP		G1042
MCL58AB		46143
MCL58RB		46142
MCL58RBP		46142
MCL59AB	G1003	
MCL59ABP	G1003	
MCL59RB	G1002	
MCL59RBP	G1002	
MCL61AB		G1903
MCL61ABP		G1903
MCL61AS		G1903-5
MCL61RB		G1902
MCL61RBP		G1902
MCL61RS		G1902-5
MCL63AB		G1903
MCL63ABP		G1903
MCL63CAB		G1913
MCL63CABP		G1913
MCL63RB		G1902
MCL63RBP		G1902
MCL65AB		G1903
MCL65ABP		G1903
MCL65CAB		G1913
MCL65CABP		G1913
MCL65RB		G1902
MCL65RBP		G1902
MCL66AB		47243
MCL66ABP		47243
MCL66APG		47243
MCL66RB		47242
MCL66RBP		47242
MCL67RB		G1902+43790
MCL67RBP		G1902+43790
MCL70RB		49192
MCL70RBP		49142
MCL75AB		G1903
MCL75ABP		G1903
MCL76AB		G2103
MCL76ABP		G2103
MCL76RB		G2102
MCL76RBP		G2102
MCL83RB		49182
MCL83RBP		49182
MCL84RB		49182
MCL84RBP		49182
MCL90AS		G1503-5
MCL90RS		G1502-5
MCL93RB		49182
MCL93RBP		49182
MCLLRKB	49332	
NC65ARB	46740	
RB10A		76033
RB10R		76032

Optronics PN	Grote Form, Fit & Function	Grote Fit & Function
RB15RBP	40132	
RE10AB	40303	
RE10ABP	40303	
RE10AK	40133-5	
RE10RB	40302	
RE10RBP	40302	
RE11AB	41033	
RE11ABP	41033	
RE11RB	41032	
RE11RBP	41032	
RE12AK		41033-5
RE12ARK		
RE12RK		41032-5
RE15AB	40133	
RE15ABP	40133	
RE15AK		40133-5
RE15RB	40132	
RE15RK		40132-5
RE18T		40650-5
RE21AB	40053	
RE21ABP	40053	
RE21AS	40053-5	
RE21RB	40052	
RE21RBP	40052	
RE21RS	40052-5	
RE31AS	40233-5	
RE31RS	40232-5	
RE35AB	41013	
RE35ABP	41013	
RE35RB	41012	
RE35RBP	41012	
RE37AB	41003	
RE37ABP	41003	
RE37RB	41002	
RE37RBP	41002	
RE418T		40650-5
RT150WBD	40641	
RT150Y2DB	41133	
RT150Y2DBP	41133	
RTR03150711CB		41160
RTR1015066CB		41050
RTR10150711CB	40650	
RTR10150WB		40641
RTR15066B	41050	
RTR15066BP	41050	
RTR150711B	41160	
RTR150711BP	41160	
RVPL1C	61641	
RVPL1CP	61461	
RVSL21	61793	
RVSL21P	61793	
RVSL31	61791	
RVSL31P	61791	
ST16RB	52482	
ST16RBP	52482	
ST17RB	52492	
ST17RBP	52492	
ST201RS		50872-5
ST25RB	50862	
ST25RBP	50862	
ST2RB	52442	
ST2RBP	52442	
ST31RB	53132	
ST31RBP	53132	
ST33AB	52203	
ST33ABP	52203	
ST33RB	52202	
ST33RBP	52202	
ST3RB	52452	
ST40RB	50232	
ST40RBP	50232	
ST40RS	50232-5	
ST42RB	50852	
ST42RBP	50852	
ST44AB		52923+91740+67090

Optronics PN	Grote Form, Fit & Function	Grote Fit & Function
ST44RB	53012	
ST44RBP	53012	
ST45AB	52923	
ST45ABP	52923	
ST45B	52922	
ST45RBP	52922	
ST45RGB	53102	
ST45RGBP	53102	
ST45RK	53012-5	
ST45RS	52922-5	
ST46RB	52672	
ST46RBP	52672	
ST46RKB	52682	
ST46RKBP	52682	
ST4RB	51932	
ST4RBP	51932	
ST51RS	50630-5	
ST52AAP	55223	
ST52RA	55220-5	
ST52RB	50630	
ST52RBP	50630	
ST56RS	53812	
ST57AB	52193	
ST57ABP	52193	
ST57RS	53822	
ST5RB	51942	
ST5RBP	51942	
ST70AB	52183	
ST70ABP	52183	
ST70RB	52182	
ST70RBP	52182	
ST70RS	52182-5	
ST74AB	53093	
ST74ABP	53093	
ST74RB	53092	
ST74RBP	53092	
ST77AB	52253	
ST77ABP	52253	
ST7RB	53672	
ST7RBP	53672	
ST8RB	52302	
ST8RB	53662	
ST8RBP	52302	
ST8RBP	53662	
ST8RS	50302-5	
ST9RB	52312	
ST9RBP	52312	
ST9RS	50312-5	
STL12RB		54172
STL12RBP		54172
STL12RMB		54142
STL13K		54342+67090+91740
STL13RB		54342
STL13RS		G4002-5
STL22AB		G6003
STL22ABP		G6003
STL22RB		G6002
STL22RBP		G6002
STL22RCBP		G6012
STL23AB		G4003
STL23ABP		G4003
STL23RB		G4002
STL23RBP		G4002
STL28RB		51982
STL28RBP		51982
STL33RB	G4502	
STL33RBP	G4502	
STL34RB		52202+94180+97090
STL35AB	G4503	
STL35ABP	G4503	
STL35RB		G4502
STL35RBP		G4502
STL43AB		G4003
STL43ABP		G4003

## OPTRONICS-TO-GROTE INTERCHANGE

Optronics PN	Grote Form, Fit & Function	Grote Fit & Function
STL43RB		G4002
STL43RBP		G4012
STL43RKB		G4012
STL52ARB	G5300	
STL52ARBP	G5300	
STL53ARDB	G5530	
STL53ARDBP	G5530	
STL53ARPB	G5540	
STL53ARBPB	G5540	
STL53RCB		G4022
STL543AB		G4003
STL543ABP		G4003
STL543RB		G4002
STL543RBP		G4002
STL55AB		G4003
STL55ABP		G4003
STL55RB		G4002
STL55RBP		G4002
STL572AB	G6003	
STL572ABP	G6003	
STL572RB	G6002	
STL572RBP	G6002	
STL60RB	G5082	
STL60RLB	G5092	
STL68RB		54682
STL6RS	51982-5	
STL6RS	51992-5	
STL70AB	G6003	
STL70ABP	G6003	
STL70RB	G6002	
STL70RBP	G6002	
STL72AB		G6003

Optronics PN	Grote Form, Fit & Function	Grote Fit & Function
STL72ABP		G6003
STL72RB		G6002
STL72RBP		G6002
STL72RS		G6002-5
STL74RBK		G6002+67090 +92420
STL74RBKP		G6002+67090 +92420
STL79RB	53582	
STL82RCB		G6012
STL82RCBP		G6012
STL8RB	51982	
STL8RBP	51982	
STL90AB	55993	
STL90ABP	55993	
STL90RB	53422	
STL90RBP	53422	
STL9RB	51992	
STL9RBP	51992	
TL10CB	64931	
TL10CBP	64931	
TL10CS	64931-5	
TL15RK		65300-5
TL27BK	65370-5	
TL29BK		65370-5
TL35FS	63111-5	
TL46FS	64891	
TL46TS	63231-5	
TL5RK	65230-5	
TL6K	65440-5	
TL9RK		65230-5
TLL22RK		G6002+67090 +92420
TLL29RK	65330-5	
TLL44FB		63821
TLL44FBP		63821

Optronics PN	Grote Form, Fit & Function	Grote Fit & Function
TLL44FS		63821-5
TLL45FB		63821
TLL45FBP		63821
TLL46CFB		63E21
TLL46CFBP		63E21
TLL46TB		63E21
TLL46TBP		63E21
TLL48FB		63E21
TLL48FBP		63E21
TLL50FS		63E21
TLL52FB		64H01-5
TLL52FBP		64H01-5
TLL52FS		64H01-5
TLL52FWB		64H01-5
TLL52FWBP		64H01-5
TLL54TB		63H31
TLL54TBP		63H31
TLL9RK	65320-5	
UCL11CKB		60721
UCL11CKBP		60721
UCL50CB		60561
UCL50CBP		60561
UCL55CB		60561
UCL55CBP		60561
UCL65CB	60411	
UCL65CBP	60411	
UL53CB	45821	
UL53CBP	45821	
UL95CB	60271	
UL95CBP	60271	



## Wire Sizes

No matter what the variety, it's critical to choose the correct wire size for the application. The key information required is the length of wire needed, often referred to as the length of run, and the current load that the conductor is expected to carry in use. Knowing the "length and load" characteristics will take the guesswork out of the choice.

Voltage drop, caused by current draw, is the primary consideration when selecting the proper conductor size. Every conductor has a certain amount of resistance per foot. The longer the distance, the greater the resistance in the circuit. The greater the resistance, the higher the voltage drop caused by the same current. This relationship is defined by ohms law (Voltage = Current X Resistance). As distance from the power source

increases, there is less voltage available to "push" the current through the wire. Thus causes the current to drop. There is also heat buildup as the resistance increases, which also lessens the amount of current flow.

In low voltage systems, such as vehicles, even a small drop in voltage can have a serious effect on the amount of light a lamp puts out. But there's a simple solution. As you get further away from the power source, make the conductor larger. A larger conductor means less resistance.

Using the "Wire Size Chart", first find the load in amps on the left-hand edge of the chart. Then find the length of run across the top of the chart. Read down that column until it intersects with the amp load line. The point at which they cross indicates the correct wire size for the job.

Wire Size Chart											
12V (AMP)	6V (AMP)	Length of Wire (most distant light)									
		10'	20'	30'	40'	50'	60'	70'	80'	90'	100'
Load in Amps	Load in Amps	Wire Gauge	Wire Gauge	Wire Gauge	Wire Gauge	Wire Gauge	Wire Gauge	Wire Gauge	Wire Gauge	Wire Gauge	Wire Gauge
1	0.5	18	18	18	18	18	18	18	18	18	18
1.5	0.75	18	18	18	18	18	18	18	18	18	18
2	1	18	18	18	18	18	18	18	16	16	16
3	1.5	18	18	18	18	18	16	16	16	14	14
4	2	18	18	18	16	16	16	14	14	14	12
5	2.5	18	18	18	16	14	14	14	12	12	12
6	3	18	18	16	16	14	14	12	12	12	10
7	3.5	18	18	16	14	14	12	12	12	12	10
8	4	18	16	16	14	12	12	12	10	10	10
10	5	18	16	14	12	12	12	10	10	10	10
11	5.5	18	16	14	12	12	10	10	10	10	8
12	6	18	16	14	12	12	10	10	10	8	8
15	7.5	18	14	12	12	10	10	10	8	8	8
18	9	16	14	12	10	10	8	8	8	8	8
20	10	16	12	12	10	10	8	8	8	8	6

- A) DETERMINE THE TOTAL WIRE LENGTH FROM THE POWER SOURCE TO THE MOST DISTANT POINT IN THE CIRCUIT.  
 B) DETERMINE THE TOTAL ELECTRICAL LOAD ON THE CIRCUIT.  
 C) FIND THE LOAD ALONG ONE EDGE OF THE CHART (6V OR 12V) DEPENDING ON THE VEHICLE VOLTAGE IN QUESTION, TAKING THE NEXT HIGHER LOAD IF THE INDICATED LOAD FALLS BETWEEN TWO POINTS ON THE CHART.  
 D) FIND THE CABLE LENGTH REQUIRED ON THE TOP OF THE CHART, TAKING THE NEXT HIGHER LENGTH (IF EXACT LENGTH IS NOT CITED).  
 E) AT THE INTERSECTION OF THE LENGTH AND LOAD COLUMN, READ THE MINIMUM SIZE WIRE REQUIRED FOR THAT PARTICULAR CIRCUIT.

### Wire Gauges

Conductors may be single strand or a group of strands. Stranded conductors are preferred in heavier gauges because they are more flexible and easier to work with than a comparable single strand conductor.

Comparing stranded cable sizes is simple. Stranded cable is compared using a numerical system. For example, 18/24 indicates that the conductor consists of 18 strands of 24-gauge wire. Similarly 12/12 refers to 12 strands of 12-gauge wire.

Gauge refers to the size of the conductor in a wire. The higher the gauge number, the smaller the wire. For example, an 18-gauge wire is smaller than a 12-gauge wire. And a 4-gauge wire has more than twice the diameter of a 10-gauge wire.

When the wire size gets larger, the number reaches #0 gauge or 1/0 (one aught). Additional zeros refer to larger sizes. The next larger size above 1/0 is #00 or 2/0 (two aught).

The capacity of a wire reflects the ability it has to carry electrical current. For example, over a distance of 50 feet, a 12-gauge wire can safely carry 10 amps. Over the same distance a 16-gauge wire can carry 3 amps. Choosing the size wire is made easier using a wire size chart.

Just remember the thicker the wire, the smaller the amperage loss.

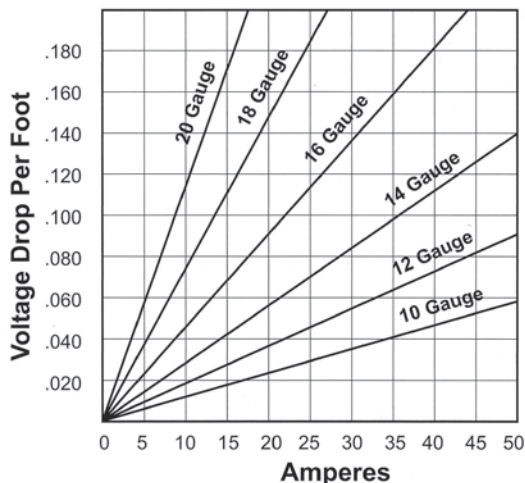

### Wire Gauge Chart

GAUGE	S.W.G.	A.W.G. (inches)	A.W.G. (mm)	Actual Size (A.W.G.)
00	0.348	0.368	9,266	●
0	0.324	0.325	8,252	●
1	0.300	0.289	7,348	●
2	0.276	0.258	6,543	●
3	0.252	0.229	5,827	●
4	0.232	0.204	5,189	●
5	0.212	0.182	4,621	●
6	0.192	0.162	4,115	●
7	0.176	0.144	3,665	●
8	0.160	0.129	3,264	●
9	0.144	0.114	2,906	●
10	0.128	0.102	2,588	●
11	0.116	0.091	2,304	●
12	0.104	0.081	2,052	●
13	0.092	0.072	1,829	●
14	0.080	0.064	1,628	●
15	0.072	0.057	1,450	●
16	0.064	0.051	1,291	●
17	0.056	0.045	1,150	●
18	0.048	0.040	1,024	●
19	0.040	0.036	0,912	●
20	0.036	0.032	0,813	●
21	0.032	0.029	0,724	●
22	0.028	0.025	0,643	●

A.W.G. = American Wire Gauge  
 S.W.G. = Imperial Standard Wire Gauge  
 (British legal standard)

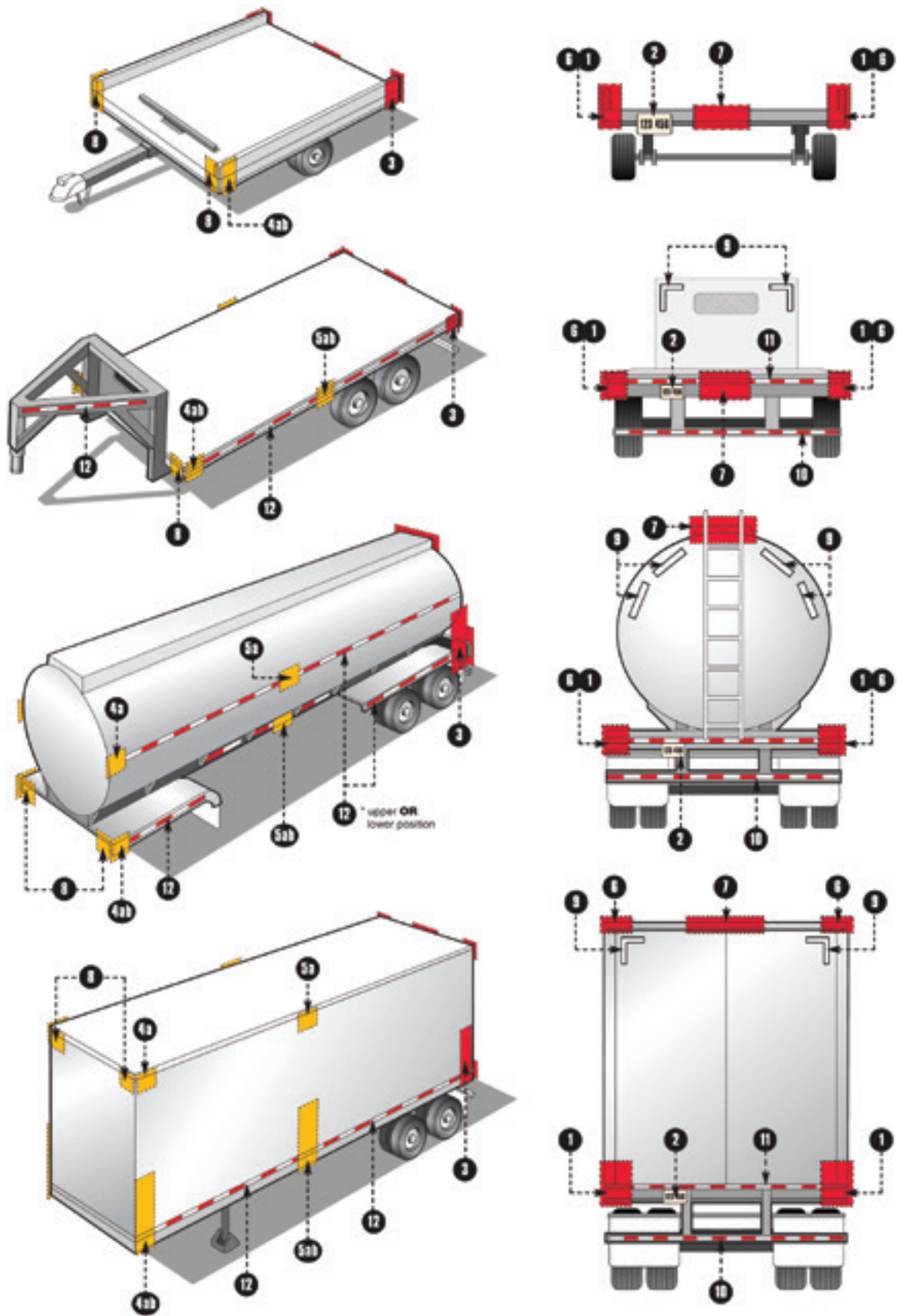

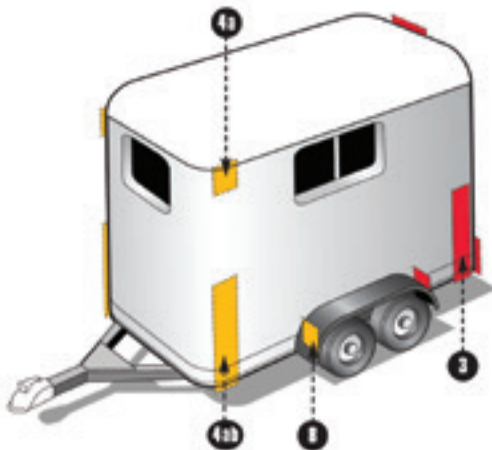
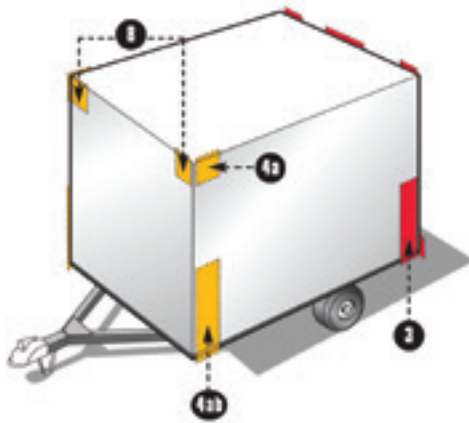
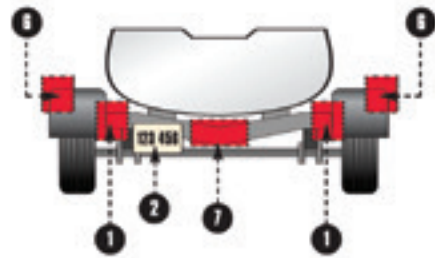
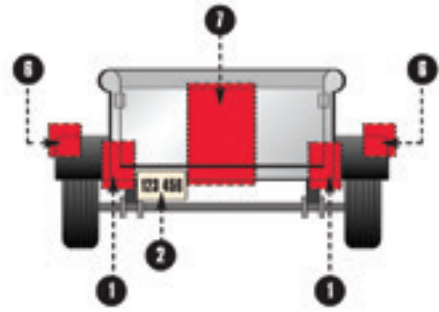
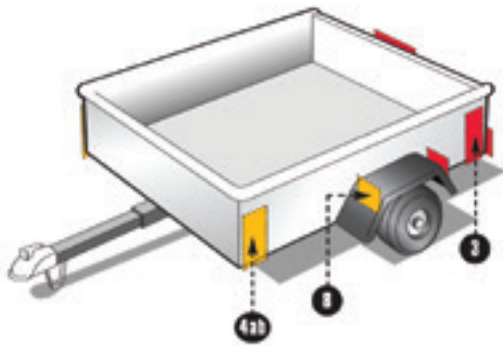

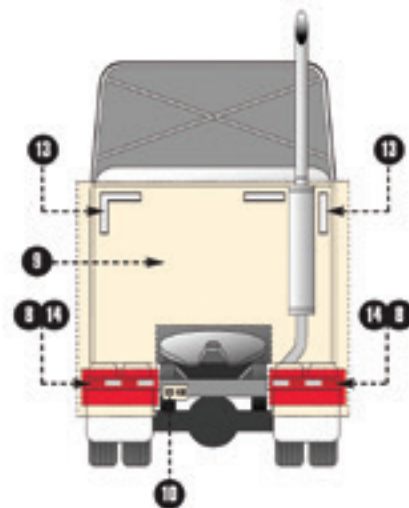
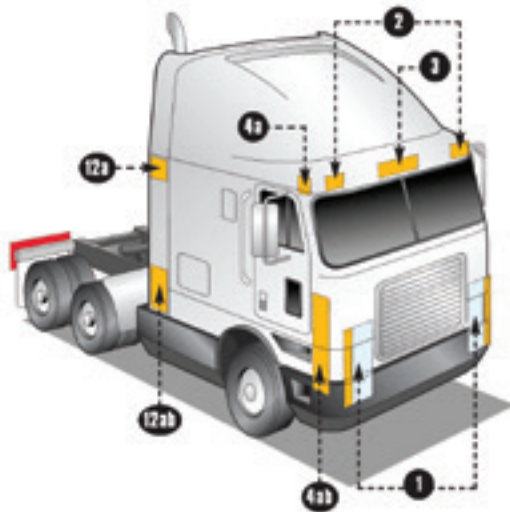
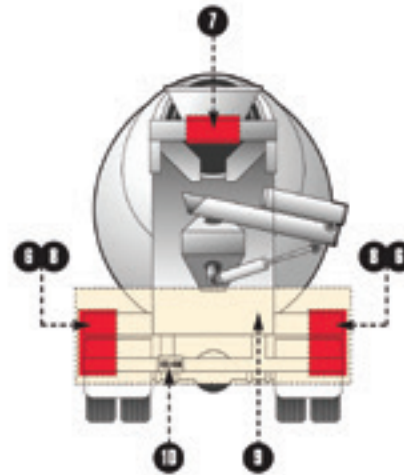
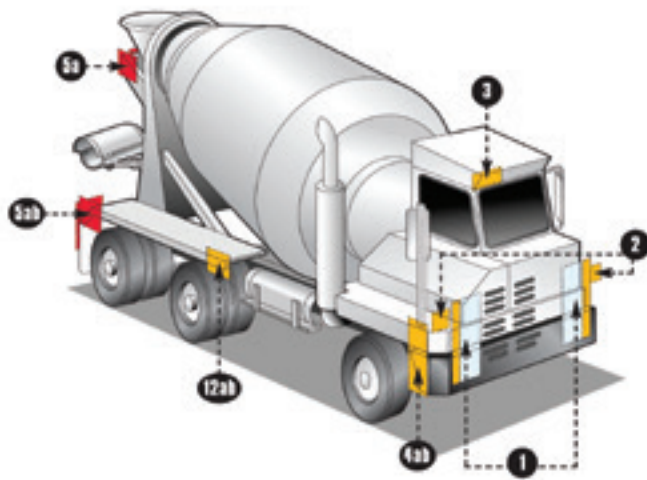
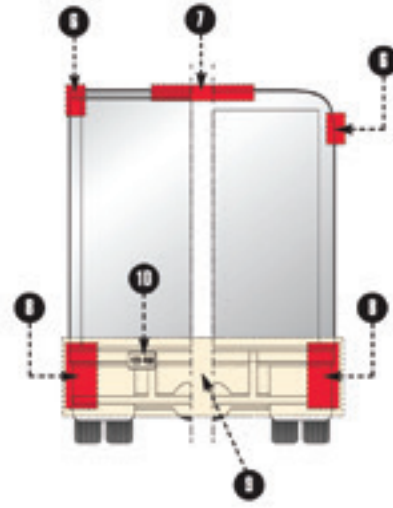
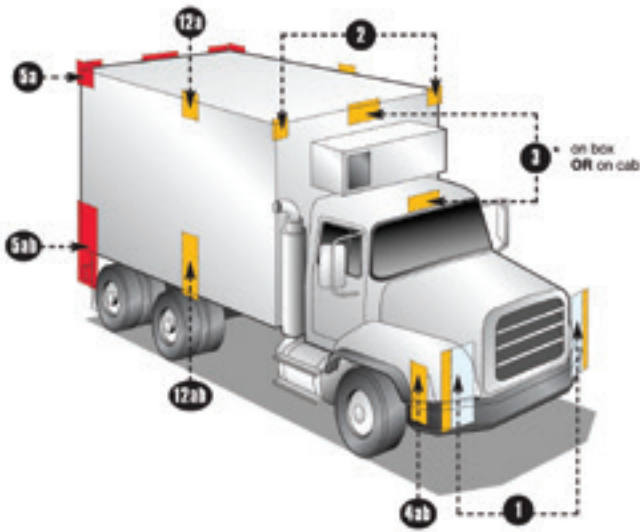

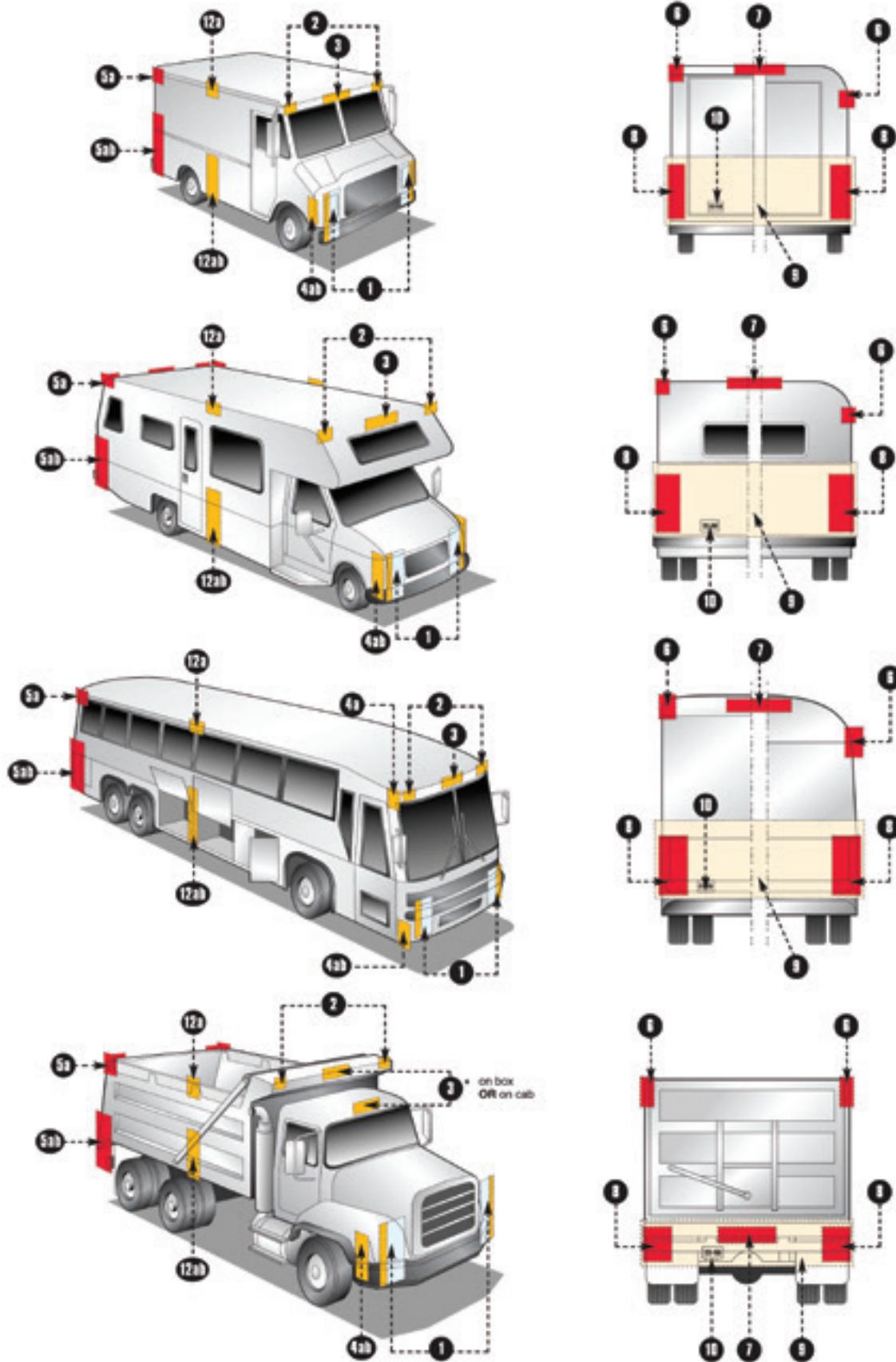

# 9 Common Causes of Failure



## VIBRATION

Broken lamp filaments are one of the most common problems caused by vibration, but they also can lead to the abrasion of mating surfaces, which cause connectors and splices to fail.

To minimize vibration problems, make certain that all wires and connectors are secured appropriately. Always secure the wiring as it exits the connector. Use cushioned mountings for lamps in applications where vibration is excessive.

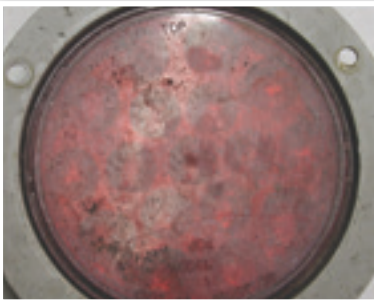

## MOISTURE AND CORROSION

Condensed water droplets inside a lens or corrosion around a lamp socket are sure signs that moisture has penetrated the system.

Water can enter the system through ineffective wire seals, unprotected splices, unsealed crimps and connectors and non-mating seals.

When making repairs, don't replace a sealed system with unsealed components. Make certain that connector seals are in place and undamaged. Inspect them carefully for cuts, tears and punctures.

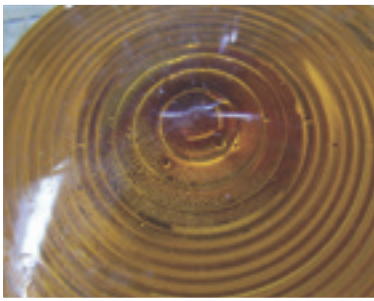

## CHEMICAL DAMAGE

Continuous exposure to many of the common chemicals found in and around trucks can cause plastics to swell, crack, soften or otherwise become degraded. Diesel fuel and hot engine oil are the main culprits.

To minimize the effects of chemicals, inspect the wiring for signs of degradation. If it is occurring in an area that is generally free of contamination, check for leaky hoses, gaskets or fittings and repair if damaged or leaking.

To avoid damage from chemicals, don't run wiring in areas where the chance for continuous exposure is likely, such as under fuel lines and filters.



## ABRASION

Abrasion occurs when wires or wire wraps are allowed to run against frame members or other abrasive surfaces. Once the insulation is worn away, bare conductors may contact a ground surface and create a grounded circuit. Or, it could cause wear to the point of fracture resulting in an open circuit.

Using the proper routing and coverings will help to prevent wear areas and abrasive damage.

Worn coverings such as loom, convoluted tubing or spiral wrap should be replaced if they are no longer providing sufficient protection for the wires inside.

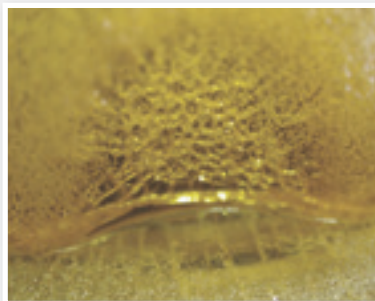
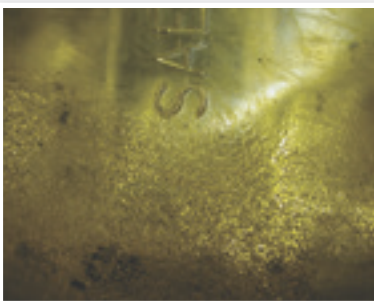

## EXTREME TEMP

A variety of conditions lead to extreme temperature build-up that can damage lighting and wiring. These include leaving a trailer's tail lights on when the trailer is backed up to a dock and airflow around the lights is prohibited.

When lights have been damaged from heat buildup, the lenses are often bubbled and misshapen. Where extreme temperatures can't be avoided, special heat-resistant wires and materials should be used.

# in Truck Wiring and Lighting

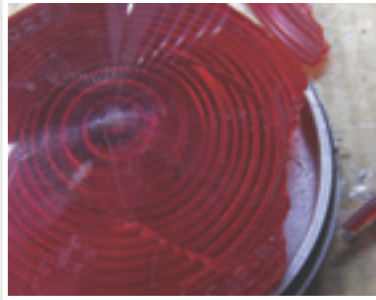
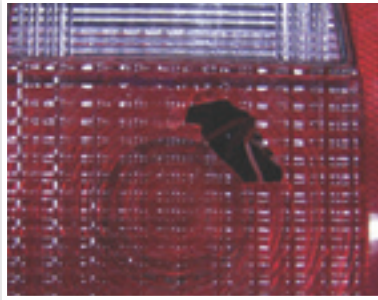

## IMPACT

Lighting and wiring must be protected from the impact of rocks, gravel and other road debris. A major impact can cause enough damage to require extensive repairs. Smaller, more frequent impacts over time may deliver equally extensive damage. Damage from impacts can cause problems although the wires are contained in a loom or other covering. During inspection, always check for damage from impacts and replace any wiring or lights that appear to be damaged. Make certain that the replacement parts are equivalent to or better than the original.



## FLEXING

Wiring in a truck often must make sharp turns around corners, as well as subjected to constant flexing where doors or hoods are opened and closed repeatedly.

To prevent wire damage from repeated flexing, avoid tight radius turns. Make sure that the wire is not snagged or stressed at its maximum extension. Also, make certain that the wire moves smoothly through its flexing cycle and doesn't rub or scrape against adjacent components.



## TENSILE LOADS

Wiring should not be considered an appropriate load-bearing component. It's easy to exceed the designed load limit by inadvertently installing wires under tension or snagging a section of wire on one of the moving parts. Using a wire bundle as a handhold or step can destroy the integrity of the conductor and its connections. So can the weight of accumulated ice, snow, mud and other materials.

Each of these points must be considered carefully when routing wires in a wiring harness.



## GRIT AND SAND

Accumulation of abrasive materials can lead to damage, especially when combined with vibration. If gritty materials enter connections, they can accelerate the wear on contact points causing interruption of the circuit and failure of devices. Sand and grit also can attract and hold moisture, creating conditions conducive to corrosion. In some cases, sand and grit may work their way inside protective coverings and abrade the insulation of wires running through them if there is relative motion between the covering and the wire.

One of the ways of reducing sand and grit buildup is to eliminate abrasive materials in the areas where wiring is present. Another way is to seal openings on protective coverings to keep gritty materials from entering.





## A family's multi-generational commitment to the vehicle and transportation lighting industry.



**William D. Grote, Founder  
Grote Industries 1901**

can't help but see the past, present and future of the lighting industry in a different context from those who simply find themselves working in the lighting business.

Grote Industries is a family-owned business, just like many of the distributors, fleets, and OEMs we serve. Like a number of our customers, we're proud of our family's multi-generational commitment to the transportation industry that reaches back more than a century. We're thankful for the visionary legacy of our predecessors and because of it, we

Founded on the principles of solid customer relationships, continuous innovation and exceptional product performance, Grote is committed to propelling itself and its industry, forward, with inventive products and challenging ideas.

As a corporation, our family's culture extends to our entire organization, around the globe and particularly to our customer-facing staff. Grote is not sales oriented, we're not engineering oriented – we're relationship oriented and we're working hard every day to uphold our reputation and continue to earn your trust.

The Grote family has played a prominent role in shaping the vehicle lighting industry. We are deeply and personally engaged today, as we will be in the future, to make the kind of brave choices and bold decisions that will help move the vehicle lighting industry ahead and into an even brighter tomorrow.

