

2014 Spring Collection



#1 IN THE WORLD

JORGE LORENZO
2010 & 2012 MOTOGP CHAMPION



CONTENTS

■ FULL FACE HELMET

RPHA 10 /4-9

FG-17 /10-11

IS-17 /12-13

CL-17 /14-17

CS-R2 /18-19

CL-Y /20-21



■ MODULAR HELMET

RPHA MAX /22

SY-MAX III /23

IS-MAX BT /24

CL-MAX II /25



■ OPEN FACE HELMET

FG-JET /26

CL-JET /26

IS-CRUISER /27

IS-2 /27

IS-33 /28

CL-33 /28

CS-2N /29

CS-5N /29



■ OFF ROAD HELMET

RPHA X /30-33

FG-X /34-37

CL-X6 /38

CS-MX /39

CL-XY /40-41



THE ALL OUT PERFORMANCE RPHA 10

- 1** Advanced P.I.M. (Premium Integrated Matrix) Construction
- 2** Optically-Superior Pinlock®-included 2D Flat-Racing Shield
- 3** Our Innovative Center One-touch open/Close Locking System
- 4** Max Airflow Front Vents

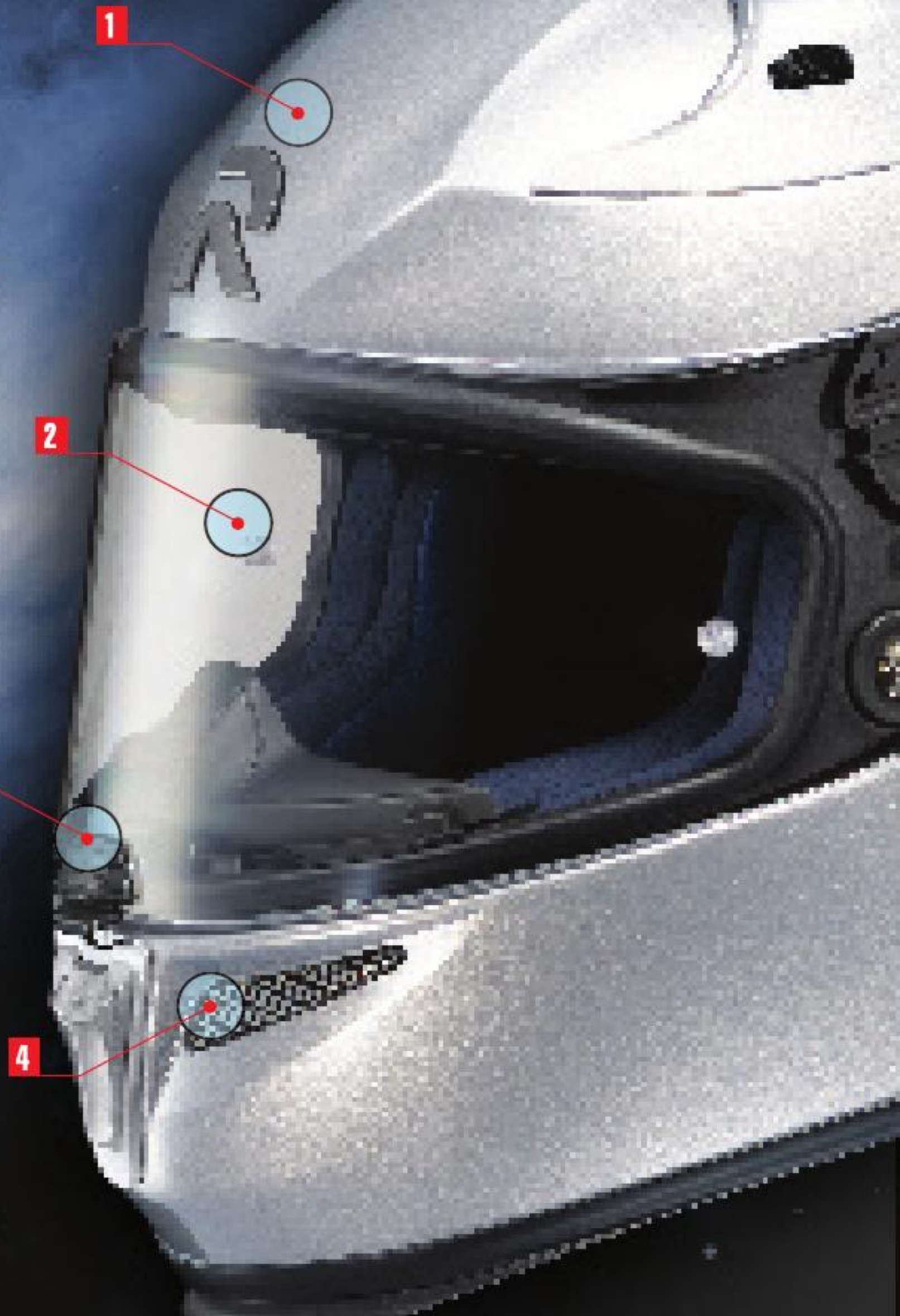

RPHA 10 JORGE LORENZO GRAFFITI



MC-2



Jorge Lorenzo "Graffiti"

Jorge Lorenzo draws attention wherever he goes; that is just a fact of life for the defending MotoGP World Champion. Earlier this season, Jorge and HJC Helmets found themselves with even more eyes on us than normal.

For Round 6 of the 2013 MotoGP season, Jorge and HJC partnered up with Spanish artist Anna Vives to design a one off helmet to benefit Anna's charity. Anna has become a famous artist in Spain recently, Jorge had this to say immediately following his win with the helmet, "The girl who designed my helmet, Anna Vives, is famous in Spain; she is a symbol that people with Down syndrome are capable of a lot more than some people think. I think it was very original and colourful so I was very proud and happy to have her on the podium to share the win with me."

The helmet that Jorge used en route to his victory recently sold for over 35,000 dollars which was donated to Anna's charity, and as a result HJC will begin selling limited edition replicas in October 2013. Proceeds from each sale will be donated to the charity.



RPHA 10 JORGE LORENZO REPLICA



RPHA 10 BEN SPIES REPLICA III



RPHA 10 CAGE

- **Max Air-flow Top Vent:** Variable air flow is adjusted by glove-friendly dials on each intake vent.
- **Advanced P.I.M. (Premium Integrated Matrix) Construction:** A matrix of Carbon Fiber, Aramid, Fiberglass and Organic Non-Woven Fabric create a remarkably strong yet extremely lightweight shell designed for superior fit and comfort using advanced CAD technology.
- **RapidFire™II Shield Replacement System:** Simple and secure shield ratchet system provides ultra-quick, tool-less removal and installation for efficient operation.
- **Optically-superior Pinlock®-prepared 2D Flat-Racing Shield:** Pinlock® fog-resistant lens included.
- **Our innovative Center one-touch open/close locking system:** is designed for an extremely secure seal.
- **"ACS" Advanced Channeling Ventilation System:** Full front to back airflow flushes heat and humidity up and out. Countless hours of development and testing conducted inside of our advanced wind tunnel have resulted in absolute smooth air flow both inside and outside. The reward is low wind resistance and maximum ventilation.
- **SilverCool Plus™ Interior:** Premium soft feel with Ginkgo Extract, moisture-wicking and odor-free interior with advanced silver anti-bacterial fabric. Crown and cheek pads are fully removable and washable.
- **Breath Guard and Chin Curtain Included**
- **SNELL/DOT Approved**
- **Sizes: XS-XXL**



◀ ALSO AVAILABLE IN SOLID COLORS ▶



RPHA 10 BUZZSAW



MC-1



MC-7



MC-10



RPHA 10 HALCYON



MC-1



RPHA 10 ZAPPY



RPHA 10 COMBUST

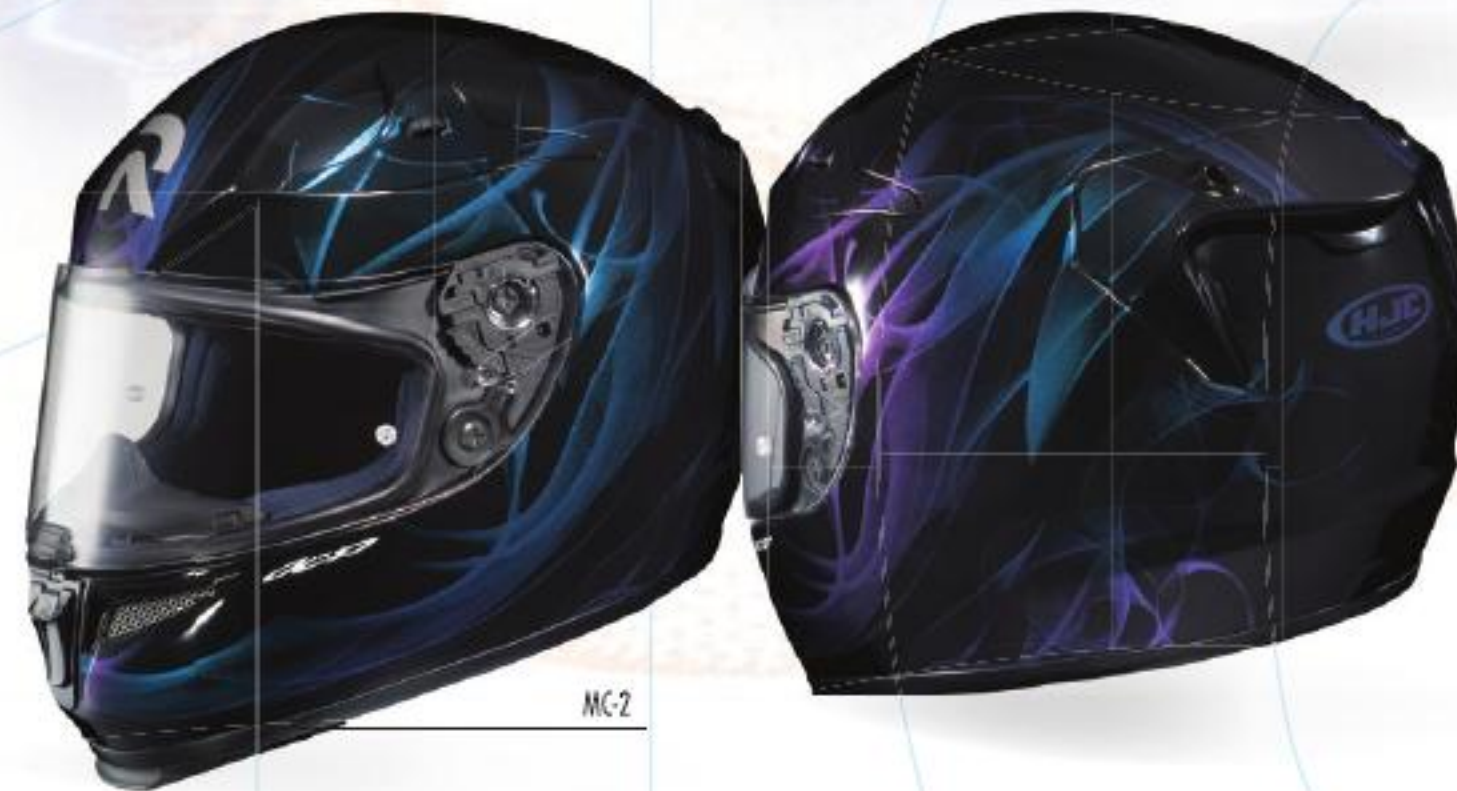

HJC'S NEW LINE 'FG-17'

The race-ready helmet with exceptionally compact shape

**NEW
GRAPHIC**

- 1** Advanced Fiberglass Composite Shell
- 2** All Sizes of Cheek Pads are Interchangeable in All Helmet Sizes
- 3** "ACS" Advanced Channeling Ventilation System
- 4** Rapidfire II Shield Replacement System

FG-17 MAMBA



◀ ALSO AVAILABLE IN SOLID COLORS ▶

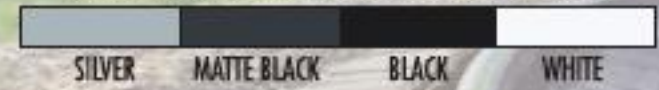

FG-17 BANSHEE



- The race-ready helmet tested at Wind Tunnel Laboratory.
- **Advanced Fiberglass Composite Shell:** Lightweight, superior fit and comfort using advanced CAD technology.
- For more comfortable fit, FG-17 comes in 3 different shells: 1st shell for XS-S sizing, 2nd for M-L sizing and 3rd for XL-3XL sizing.
- **SilverCool™ Interior:** Moisture-wicking and odor-free liners with advanced anti-bacterial fabric. Crown and cheek pads are fully removable and washable.
- **Optically-superior Pinlock®-prepared Faceshield:** New 3D design provides 95% UV protection, anti-scratch coating and is prepared for the ultimate anti-fog Pinlock insert.
- All sizes of cheek pads are interchangeable in all helmet sizes
- **RapidFire™ II Shield Replacement System:** Quick, secure, tool-less removal and installation.
- "ACS" Advanced Channeling Ventilation System: Full front to back airflow flushes heat and humidity up and out.
- SNELL/DOT Approved
- SIZE: XS-2XL

FG-17 FORCE



IS-17 GENESIS

IS-17

HJC'S NEWEST FULL FACE HELMET
WITH AN INTERNAL SUNSHIELD



**NEW
GRAPHIC**

IS-17 INTAKE

- **Advanced Polycarbonate Composite Shell:** Lightweight, superior fit and comfort using advanced CAD technology.
- **One-touch Integrated Sunshield:** 3-stage adjustable sunshield deploys quickly and easily.
- **Optically-superior Pinlock®-prepared Faceshield:** New 3D design provides 98% UV protection, anti-scratch coating and is prepared for the ultimate anti-fog Pinlock insert.
- **D-Ring with Retention Strap:** Quick-release and adjustable.
- **SuperCool® Moisture-wicking Interior:** Anti-bacterial, removable and washable.
- **Glasses Groove can accommodate riders who wear glasses.**
- **RapidFire™II shield replacement system:** Simple and secure shield ratchet system provides ultra-quick, tool less removal and installation for efficient operation.
- **SIZE: XS~2XL (All Size DOT Approved)**



◀ ALSO AVAILABLE IN SOLID COLORS ▶

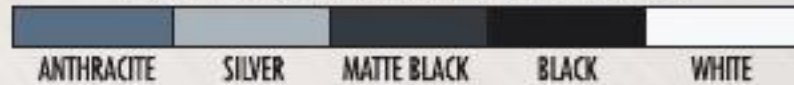

CL-17 MISSION



"ACS" ADVANCED CHANNELING VENTILATION SYSTEM:

Full front to back airflow flushes heat and humidity up and out.



ADVANCED POLYCARBONATE COMPOSITE SHELL:

Lightweight, superior fit and comfort using advanced CAD technology.



SUPERCOOL® INTERIOR:

Crown and cheek pads are removable and washable. Cheek pads are compatible within all sizes.



RAPIDFIRE™ SHIELD REPLACEMENT SYSTEM:

Quick, secure, tool-less removal and installation.



OPTICALLY SUPERIOR PINLOCK® READY FACESHIELD:

New 3D design provides 95% UV protection, an anti-scratch coating and is prepared for the ultimate anti-fog Pinlock insert.



AGGRESSIVE YET REFINED SHELL DESIGN

Eyeglasses/Sunglasses friendly EPS groove. Sizes are available from XS-5XL.



MC-1F



MC-4F



MC-5F

CL-17 REDLINE



- Advanced Polycarbonate Composite Shell: Lightweight, superior fit and comfort using advanced CAD technology.
- Optically Superior Pinlock® ready Faceshield: New 3D design provides 95% UV protection, an anti-scratch coating and is prepared for the ultimate anti-fog Pinlock insert. *Pinlock insert sold separately.
- RapidFire™ Shield Replacement System: Quick, secure, tool-less removal and installation.
- "ACS" Advanced Channeling Ventilation System: Full front to back airflow flushes heat and humidity up and out.
- SuperCool® Interior: Crown and cheek pads are removable and washable.
- SNELL/DOT Approved
- SIZES: XS-5XL (CL-17 Plus: 3XL-5XL DOT only)

◀ ALSO AVAILABLE IN SOLID COLORS ▶

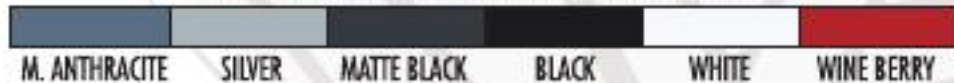

CL-17 MYSTIC



CL-17 VICTORY



MC-1

MC-3

MC-7

- Advanced Polycarbonate Composite Shell: Lightweight, superior fit and comfort using advanced CAD technology.
- Optically Superior Pinlock® ready Faceshield: New 3D design provides 95% UV protection, an anti-scratch coating and is prepared for the ultimate anti-fog Pinlock insert. *Pinlock insert sold separately.
- RapidFire™ Shield Replacement System: Quick, secure, tool-less removal and installation.
- "ACS" Advanced Channeling Ventilation System: Full front to back airflow flushes heat and humidity up and out.
- SuperCool® Interior: Crown and cheek pads are removable and washable.
- SNELL/DOT Approved
- SIZES: XS-5XL (CL-17 Plus: 3XL-5XL DOT only)

◀ ALSO AVAILABLE IN SOLID COLORS ▶



CS-R2 INJECTOR

- **Advanced Polycarbonate Composite Shell:** Light weight, superior fit and comfort using advanced CAD technology.
- **RapidFire™ Shield Replacement System:** Quick, secure, tool-less removal and installation.
- **Optically Superior Faceshield:** 95% UV protection.
- **Advanced Ventilation System:** Adjustable forehead and chin vents, and two rear exhaust vents.
- **Plush, Nylex® Interior:** Crown and cheek pads are removable and washable.
- **DOT Approved**
- **SIZES: XS-XXL**



MC-1

MC-2



MC-3

MC-5

◀ ALSO AVAILABLE IN SOLID COLORS ▶



SILVER

BLACK

WINE BERRY

CANDY RED

WHITE



MC-8

CS-R2 SAWTOOTH



MC-5



CL-Y REDLINE YOUTH

- **True Youth Size Polycarbonate Shell:** Lightweight, superior fit and comfort using advanced CAD technology.
- **Integrated Ventilation System:** Provides cooling airflow.
- **Plush, Nylex® Interior:** Washable and Removable.
- **Large Eye Port Design:** For maximum visibility.
- **Flush-mounted Shield/Ratchet System:** Simple and easy to use.
- **DOT Approved**
- **Sizes: Youth S/M/L**



CL-Y RAZZ YOUTH



◀ ALSO AVAILABLE IN SOLID COLORS ▶

BLACK MATTE BLACK WHITE

RPHA MAX ALIGN

- **Advanced P.I.M. (Premium Integrated Matrix) Construction:** A matrix of Carbon Fiber, Aramid, Fiberglass and Organic Non-Woven Fabric create a remarkably strong yet extremely lightweight shell designed for superior fit and comfort using advanced CAD technology.
- **Optimal Shell Sizing:** Three shell sizes (XS-S, M-L and XL-XXL) provide riders with proportional sizing.
- **One-Touch Integrated Sunshield:** Smoke-tinted Sunshield deploys quickly and easily adjusts to any of three positions via a handy sliding lever.
- **Extremely Quiet:** Developed in HJC's wind tunnel laboratory at high speeds to mitigate wind noise levels; only 84dB at 100 kph/62.5 mph.
- **Sport Helmet Design:** Extremely compact and aerodynamic design gives the RPHA Max the look of a full-face sportbike helmet.
- **3D Anti Scratch Shield and Pinlock 100% Max Vision Included.**
- **Innovative Center One-Touch Locking System:** Easy open/close action with an extremely secure seal.
- **RapidFire™II Shield Replacement System:** Simple and secure shield ratchet system provides ultra-quick, tool-less removal and installation for efficient operation.
- **Cool4ever™ Interior:** Lightweight, moisture-wicking, odor-free and anti-bacterial interior.
- **Self-Cooling Interior:** Innovative, new fabric features self-cooling proper ties that cools down faster than other fabrics.
- DOT Approved
- Sizes: XS-XXL
- 5-Year Limited Warranty



White

Pearl White

Matte Black

Black

Silver

MC-10

SY-MAX III SOLID

- **Advanced Fiberglass Shell with Adjustable Polycarbonate Chin bar:** Lightweight system, superior fit and comfort using advanced CAD technology.
- **One-touch Integrated Sunshield:** Three positions for sunshield sliding lever which is adjustable, smoke tinted Sunshield deploys quickly and easily. (U.S. PAT.#7,540,033)
- **Optically superior Pinlock®-prepared Faceshield:** New 3D design, an anti-scratch coating and is prepared for the ultimate anti-fog Pinlock insert.
- **Single-button Chinbar/Faceshield Release:** Open with one hand even with gloves on.
- **SilverCool™ Interior:** Moisture-wicking and odor-free interior with advanced silver anti-bacterial fabric. Crown and cheek pads are removable and washable.
- **Ready for Bluetooth communication:** Built in recesses for the ChatterBox™ and speakers.
- DOT Approved
- Sizes: XS-XXL



IS-MAX BT SPRINT

- **Ready for Bluetooth communication:** Built in recesses for the ChatterBox™ XBi2-H and speakers.
- **Advanced Polycarbonate Composite Shell with Adjustable Polycarbonate Chinbar:** Lightweight, superior fit and comfort using advanced CAD technology.
- **One-touch Integrated SunShield:** Smoke-tinted 3-stage adjustable SunShield deploys quickly and easily (U.S. PAT.#7,540,033).
- **Single-button Chinbar/Faceshield Release:** Opens with one hand even with gloves on.
- **Optically-superior Pinlock®-prepared Faceshield:** New 3D design provides 95% UV protection and is ready for the ultimate anti-fog Pinlock insert.
- **QuickSlide Shield Replacement System:** Quick, secure, tool-less removal and installation.
- **"ACS" Advanced Channeling Ventilation System:** Full front to back airflow flushes heat and humidity up and out.
- **SilverCool™ Interior:** Moisture-wicking and odor-free interior with advanced silver anti-bacterial fabric. Crown and cheek pads are removable and washable.
- **DOT Approved**
- **SIZES: XS-XXXL**



MC-5

MC-10

◀ ALSO AVAILABLE IN SOLID COLORS ▶



CL-MAX II ATOMIC

SIZES UP TO 5XL

- **Ready for Bluetooth communication:** Built in recesses for the ChatterBox™ XBi2-H and speakers.
- **Advanced Polycarbonate Composite Shell with Adjustable Polycarbonate Chinbar:** Lightweight, superior fit and comfort using advanced CAD technology.
- **Single-button Chinbar/Faceshield Release:** Opens with one hand even with gloves on.
- **Optically Superior Faceshield:** 95% UV protection.
- **QuickSlide™ Shield Replacement System (HJ-17 Shield):** Quick, secure, tool-less removal and installation.
- **"ACS" Advanced Channeling Ventilation System:** Full front to back airflow flushes heat and humidity up and out.
- **Bioceramic Nylex® Moisture-wicking Interior:** Anti-bacterial, removable and washable.
- DOT Approved
- Sizes: XS-XXXXXL



◀ ALSO AVAILABLE IN SOLID COLORS ▶



FG-JET SOLID

- Cutting edge open face design with inner sunshield.
- **Advanced Fiberglass Composite Shell:** Lightweight, Superior fit and comfort using advanced CAD technology.
- **For more comfortable fit, FG-JET comes in 3 different shells:** 1st shell: XS-S sizing, 2nd: M-L and 3rd: XL-2XL.
- **UV-Treated Faceshield**
- **SilverCool™ Interior:** Moisture-wicking and odor-free liners with advanced silver anti-bacterial fabric. Crown and cheek pads are fully removable and washable.
- **QuickSlide™ Shield Replacement System:** Quick, secure, tool-less removal and installation.
- **3D Anti-Scratch clear shield**
- **"ACS" Advanced Channeling Ventilation System:** Full front to back airflow flushes heat and humidity up and out.
- **All sizes of cheek pads are interchangeable in all helmet sizes**
- **One-touch Integrated Sunshield:** Three positions for sunshield sliding lever which is adjustable. Smoke tinted Sunshield deploys quickly and easily.
- **SIZE: XS-2XL**
- **DOT Approved**



CL-JET SOLID

- **Advanced Polycarbonate Composite Shell:** Lightweight, superior fit and comfort using advanced CAD technology.
- **UV-treated Flip-up Faceshield (HJ-17J)**
- **Quick Slide Shield Replacement System:** Quick, secure, tool-less removal and installation.
- **"ACS" Advanced Channeling ventilation System:** Our unique ACS ventilation is designed to take the cool air and flush out heat and humidity.
- **Nylex® Interior:** Plush, moisture wicking material with crown and cheek pads removable and washable.
- **Cheek pads are compatible within all sizes.**
- **DOT Approved**
- **Size: XS ~ 2XL**



IS-CRUISER SOLID

- **Advanced Polycarbonate Composite Shell:** Lightweight, superior fit and comfort using advanced CAD technology.
- **Intergrated Sunshield** Smoke-tinted shield deploys easy to slide up or down.
- **Nylex® Interior:** Plush, moisture wicking material with removable and washable liner.
- **DOT Approved**
- **Size : XS ~ 2XL**



Black



Matte Black



IS-2 BLOSSOM

- **Advanced Polycarbonate Composite Shell:** Lightweight, superior fit and comfort using advanced CAD technology.
- **Integrated SunShield:** Smoke-tinted shield deploys easily when needed.
- **SilverCool™ Interior:** Moisture-wicking and odor-free interior with advanced silver anti-bacterial fabric. Comfortable, removable and washable.
- **DOT Approved**
- **SIZES: XS-XXL**



MC-8



MC-5



◀ ALSO AVAILABLE IN SOLID COLORS ▶

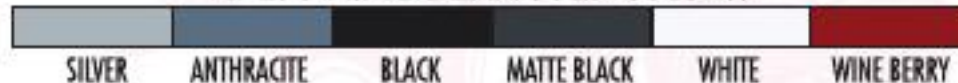

IS-33 SOLID

- **Advanced Polycarbonate Composite Shell:** Lightweight, superior fit and comfort using advanced CAD technology.
- **One-touch Integrated Sunshield:** Smoke-tinted 3-stage adjustable SunShield deploys quickly and easily (U.S. PAT.#7,540,033).
- **UV-treated Flip-up Faceshield:** Opens easily.
- **QuickSlide Shield Replacement System:** Quick, secure, tool-less removal and installation.
- **"ACS" Advanced Channeling Ventilation System:** Full front to back airflow flushes heat and humidity up and out.
- **SilverCool™ Interior:** Moisture-wicking and odor-free interior with advanced silver anti-bacterial fabric. Crown and cheek pads are removable and washable.
- DOT Approved
- SIZES: XS-XXL

◀ ALSO AVAILABLE IN SOLID COLORS ▶



Wine Berry



Silver

CL-33 SOLID

- **Advanced Polycarbonate Composite Shell:** Lightweight, superior fit and comfort using advanced CAD technology.
- **Flip-up 3D Faceshield:** UV treated and hard coated, featuring tool-less ratchet mechanism.
- **Multi-stage Vent System:** 4 forward intake vents.
- **Nylex® Interior:** For added comfort.
- DOT Approved
- SIZES: XXS-XXL

◀ ALSO AVAILABLE IN SOLID COLORS ▶

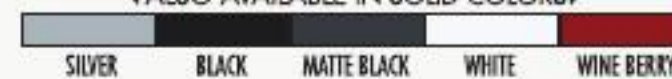

CS-2N RAZOR

- **Thermoplastic Alloy Shell:** Lightweight, superior fit and comfort using advanced CAD technology.
- **Nyllex® Interior:** For added comfort.
- **Two forehead Vents:** Delivers cooling air.
- **Aerodynamic Visor:** Low-profile design.
- **Removable Neck Curtain:** Easy to remove.
- **DOT Approved**
- **SIZES: XS-XXL**

◀ ALSO AVAILABLE IN SOLID COLORS ▶



MC-5F



*Rear View



MC-5



CS-5N SOLID

- **Thermoplastic Alloy Shell:** Lightweight, superior fit and comfort using advanced CAD technology.
- **Nyllex® Interior:** For added comfort.
- **Two Adjustable Forehead Vents:** Delivers cooling air.
- **Aerodynamic Visor:** Low-profile design.
- **DOT Approved**
- **SIZES: XXS-XXL**

◀ ALSO AVAILABLE IN SOLID COLORS ▶

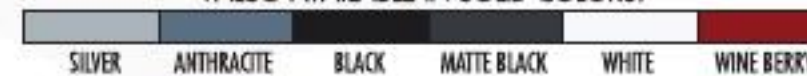

RPHA X NATE ADAMS REPLICA

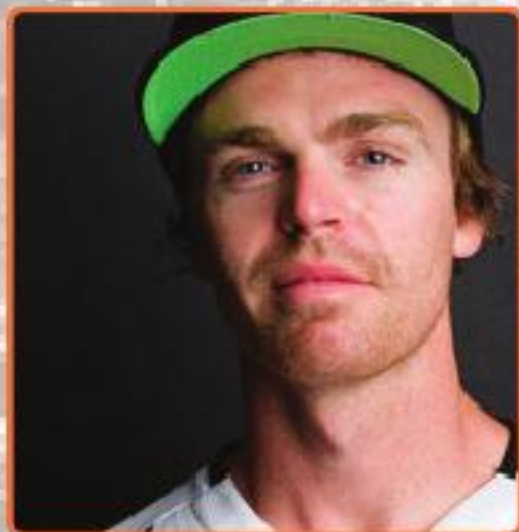

"I love it. From the moment I put on my new HJC RPHA X helmet I knew it was good and I wanted to go ride in it. It has a complete coverage and snug fit to my dome, no loose spots, no wiggling of the helmet while riding, no dirt getting in through the sides of my goggles due to helmet movement, none of that. This is a great helmet!" — **Nate Adams**



RPHA X AIRAID



MC-1



- **Advanced P.I.M. (Premium Integrated Matrix) Construction:**
A matrix of Carbon Fiber, Aramid, Fiberglass and Organic Non-Woven Fabric create a remarkably strong yet extremely lightweight shell designed for superior fit and comfort using advanced CAD technology.
- **For the perfect and compact dimensions, RPHA X comes in 3 different shells:** 1st shell: XS-S, 2nd: M-L and 3rd: XL-2XL.
- **"ACS" Advanced Channeling Ventilation System:** Full front to back airflow flushes heat and humidity up and out.
- **Large Eye Port:** For maximum visibility and superior goggle fit.
- **COOL4EVER™ interior:** Lightweight, moisture wicking, odor free and anti bacterial, premium soft feel with Ginkgo extract. Innovative new fabric offers self-cooling proper ties. It cools down faster than other major fabrics. Extremely important for long hot rides. Crown and cheek pads are removable and washable.
- **SNELL/DOT Approved**
- **Sizes:** XS-XXL
- **5-YEAR Limited Warranty**

RPHA X FACTOR

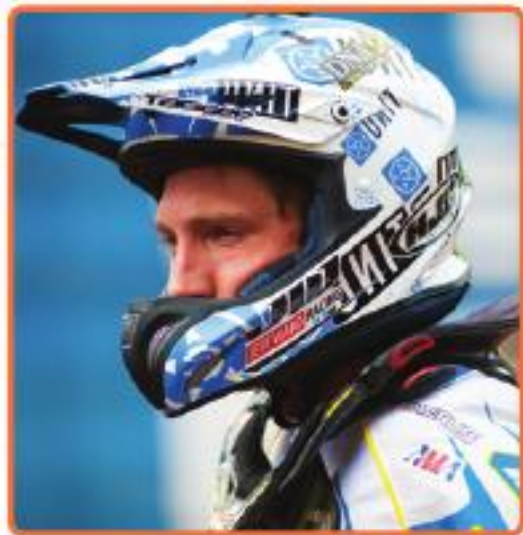

"The first thing I noticed was how light it was. That was really important. Then I put the helmet on, and noticed how good the fit was. I gave HJC some input before the helmet was finalized, but honestly there wasn't much to change. It was already really good. The padding, the liner, the venting—it's really good." - Kyle Chisholm



RPHA X TEMPEST



MC-2



MC-4



MC-5



MC-7



◀ ALSO AVAILABLE IN SOLID COLORS ▶

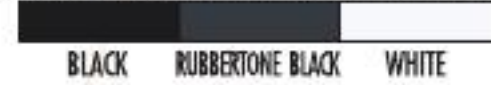

ALL NEW FG-X

ADVANCED FIBERGLASS KEVLAR REINFORCED SHELL:

LIGHTWEIGHT, SUPERIOR FIT AND COMFORT USING ADVANCED CAD TECHNOLOGY.



BLACK

WHITE

"ACS" ADVANCED CHANNELING VENTILATION SYSTEM:

FULL FRONT TO BACK AIRFLOW FLUSHES HEAT AND HUMIDITY UP AND OUT.

SILVERCOOL™ INTERIOR :

CUSTOMIZED INTERIOR IN TWO COLORS (SILVER & RED)
REMOVABLE, MOISTURE-WICKING AND ODOR-FREE INTERIOR WITH
ADVANCED ANTI-BACTERIAL FABRIC.

LARGE EYE PORT :

FOR MAXIMUM VISIBILITY AND SUPERIOR GOGGLE FIT.

MATTE
BLACK

FG-X HAMMER

- **Advanced Fiberglass Composite Shell:** Lightweight, superior fit and comfort using advanced CAD technology.
- **SilverCool™ Interior:** Removable, moisture-wicking and odor-free interior with advanced silver anti-bacterial fabric.
- **Large Eye Port:** for maximum visibility and superior goggle fit.
- **"ACS" Advanced Channeling Ventilation System:** Full front to back airflow flushes heat and humidity up and out.
- **Aggressive and attractive design.**
- **D-Ring with Retention Strap:** Quick-release and adjustable.
- **Size: XS~2XL(All Size SNELL/DOT Approved)**



FG-X TALON



MC-1



MC-2



MC-4



MC-5



MC-6



◀ ALSO AVAILABLE IN SOLID COLORS ▶

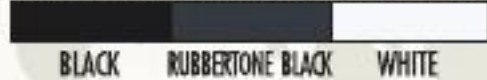

BLACK RUBBERTONE BLACK WHITE

FG-X DRIVEN



MC-10



CL-X6 FULCRUM

- **Advanced Polycarbonate Composite Shell:** Revolutionary design with unique visor. Lightweight, superior fit and comfort using advanced CAD technology.
- **"ACS" Advanced Channeling Ventilation System:** Full front to back airflow flushes heat and humidity up and out.
- **SpeedCool™ Interior:** Removable, washable, moisture-wicking and odor-free with anti-bacterial fabric.
- **Large Eye Port:** For maximum visibility and superior goggle fit.
- **SNELL/DOT Approved**
- **SIZES: XS-XXXL (XXXL DOT Only)**



◀ ALSO AVAILABLE IN SOLID COLORS ▶

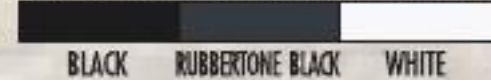

CS-MX SHATTERED

- **Polycarbonate Composite Shell:** Lightweight, superior fit and comfort using advanced CAD technology.
- **"ACS" Advanced Channeling Ventilation System:** Full front to back airflow flushes heat and humidity up and out.
- **Plush, Nylex® Interior:** Comfortable, removable, and washable.
- **Large Eye Port and Maximum Range**
- **Adjustable Visor:** For maximum visibility and superior goggle fit.
- **DOT Approved**
- **SIZES: XS-XXL**



◀ ALSO AVAILABLE IN SOLID COLORS ▶

RUBBERTONE BLACK

CL-XY FULCRUM YOUTH

- **Polycarbonate Composite Shell:** Lightweight, superior fit and comfort using advanced CAD technology.
- **Advanced Ventilation System:** Full front to back airflow flushes heat and humidity up and out.
- **Plush, Nylex® Interior:** Comfortable, removable, and washable.
- **Large Eye Port and Maximum Range Adjustable Visor:** For maximum visibility and superior goggle fit.
- **DOT Approved**
- **SIZES:** Youth S, Youth M, Youth L



MC-1



MC-2



MC-6



MC-5



MC-8

◀ ALSO AVAILABLE IN SOLID COLORS ▶



BLACK RUBBERTONE BLACK WHITE



CL-XY WHIRL YOUTH



MC-1



MC-2



MC-5



MC-28

PINLOCK SHIELDS & INSERTS



OPTIONAL SHIELDS



SHIELDS TYPE	HELMET MODEL
HJ-03	CL-12Y, CL-14Y, CS-12Y, CS-Y
HJ-05	AC-10, CL-12, CL-Y, CS-12, SY-MAX
HJ-07	AC-11, CL-14, CL-MAX
HJ-09	AC-12, CL-15, CL-16, CL-SP, CS-R1, CS-R2, FS-10, FS-15, IS-16, CL-17, CL-17 PLUS
HJ-11	AC-3, CL-33
HJ-12	FS-3
HJ-17	CL-MAX II, IS-MAX BT, SY-MAX III
HJ-20	RPHA 10
HJ-20M	FG-17, IS-17
HJ-17R	FG-JET, IS-33, CL-JET
HJ-S2	SY-MAX II
HJ-25	RPHA MAX

SUNSHIELD OPERATION

There are three positions for the sun shield sliding lever.

Stage 1-Standard position: works best for leaned forward riding position-(sportbikes) and when more nose clearance is desired.

Stage 2-Lower position: works best for more upright riding position (cruisers and touring bikes).

Stage 3-Lowest position: Used primarily for sun shield removal and replacement. Release button must be held down to get to Stage 3.

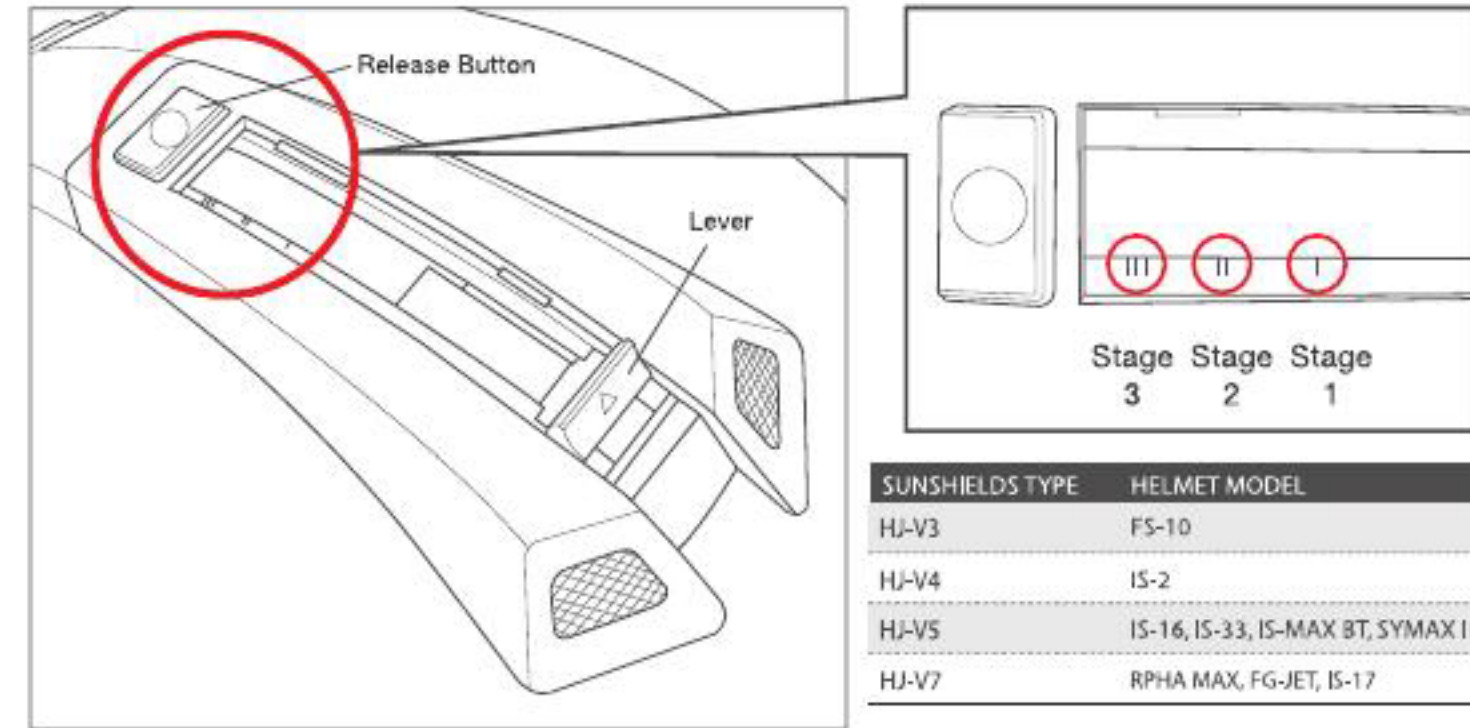

OPTIONAL TINTED SHIELDS ARE AVAILABLE



TEAR-OFF SHIELDS



❑ SIZING CHART (*Reference Only)

(Helmet Size Convention Chart)

SIZE	CENTIMETER	HAT SIZE	INCH
2XS	51-52	6 ³ / ₈ - 6 ¹ / ₂	20 - 20 ¹ / ₂
XS	53-54	6 ⁵ / ₈ - 6 ³ / ₄	20 ⁷ / ₈ - 21 ¹ / ₄
SM	55-56	6 ⁷ / ₈ - 7	21 ⁵ / ₈ - 22
MD	57-58	7 ¹ / ₈ - 7 ¹ / ₄	22 ¹ / ₂ - 22 ⁷ / ₈
LG	59-60	7 ³ / ₈ - 7 ¹ / ₂	23 ¹ / ₄ - 23 ⁵ / ₈
XL	61-62	7 ⁵ / ₈ - 7 ³ / ₄	24 - 24 ³ / ₈
2XL	63-64	7 ⁷ / ₈ - 8	24 ³ / ₄ - 25 ¹ / ₄
3XL	65-66	8 ¹ / ₈ - 8 ¹ / ₄	25 ⁵ / ₈ - 26
4XL	67-68	8 ³ / ₈ - 8 ¹ / ₂	26 ³ / ₈ - 26 ³ / ₄
5XL	69-70	8 ³ / ₄ - 8 ³ / ₄	27 ¹ / ₄ - 27 ⁵ / ₈

(RPHA SERIES, FG-17, FG-JET)

SIZE	CENTIMETER	HAT SIZE	INCH
XS	54-55	6 ³ / ₄ - 6 ⁷ / ₈	21 ¹ / ₄ - 21 ⁵ / ₈
SM	55-56	6 ⁷ / ₈ - 7	21 ⁵ / ₈ - 22
MD	57-58	7 ¹ / ₈ - 7 ¹ / ₄	22 ¹ / ₂ - 22 ⁷ / ₈
LG	58-59	7 ¹ / ₄ - 7 ³ / ₈	22 ⁷ / ₈ - 23 ¹ / ₄
XL	60-61	7 ¹ / ₂ - 7 ⁵ / ₈	23 ⁵ / ₈ - 24
2XL	62-63	7 ³ / ₄ - 7 ⁷ / ₈	24 ³ / ₈ - 24 ³ / ₄
3XL	64-65	8 - 8 ¹ / ₈	25 ¹ / ₄ - 25 ⁵ / ₈

(CL-17 & CL-17 PLUS)

SIZE	CENTIMETER	HAT SIZE	INCH
XS	54-55	6 ³ / ₄ - 6 ⁷ / ₈	21 ¹ / ₄ - 21 ⁵ / ₈
SM	56-57	7 - 7 ¹ / ₈	22 - 22 ¹ / ₂
MD	58-59	7 ¹ / ₄ - 7 ³ / ₈	22 ⁷ / ₈ - 23 ¹ / ₄
LG	60-61	7 ¹ / ₂ - 7 ⁵ / ₈	23 ⁵ / ₈ - 24
XL	62-63	7 ³ / ₄ - 7 ⁷ / ₈	24 ³ / ₈ - 24 ³ / ₄
2XL	63-64	8 - 8 ¹ / ₈	25 ¹ / ₄ - 25 ⁵ / ₈
3XL	65-66	8 ¹ / ₈ - 8 ¹ / ₄	25 ⁵ / ₈ - 26
4XL	67-68	8 ³ / ₈ - 8 ¹ / ₂	26 ³ / ₈ - 26 ³ / ₄
5XL	69-70	8 ³ / ₄ - 8 ³ / ₄	27 ¹ / ₄ - 27 ⁵ / ₈

(Youth Size)

SIZE	CENTIMETER	HAT SIZE	INCH
YOUTH S	49-50	6 ¹ / ₈ - 6 ¹ / ₄	19 ¹ / ₄ - 19 ³ / ₄
YOUTH M	51-52	6 ³ / ₈ - 6 ¹ / ₂	20 - 20 ¹ / ₂
YOUTH L	53-54	6 ⁵ / ₈ - 6 ³ / ₄	20 ⁷ / ₈ - 21 ¹ / ₄
YOUTH S/M	49-50	6 ¹ / ₈ - 6 ¹ / ₄	19 ¹ / ₄ - 19 ³ / ₄
YOUTH L/XL	51-52	6 ³ / ₈ - 6 ¹ / ₂	20 - 20 ¹ / ₂

❑ SELECTING THE RIGHT HELMET

⚠ WARNING Never buy a used helmet or borrow someone else's helmet. Over time the protective foam in helmets will adjust to the contours of a user's head. A used or borrowed helmet may not offer as much protection as a new helmet.

⚠ WARNING Wearing the wrong size helmet can increase your risk of serious injury or death in an accident. A helmet that is too large for your head may be dislodged or knocked off in an accident. To select the right size helmet for your head, follow these instructions:

- 1. Measure your head.** Wrap a tape measure around your head about one inch (2.5 cm) above your eyebrows.
- 2. Use the sizing chart** to select the helmet size that corresponds most closely to your head measurement. If your head size falls between two helmet sizes, try on the larger helmet first and then the smaller size.
- 3. Try on the helmet** by grasping both chin straps to pull the helmet completely onto your head, ensuring that the top of your head is in contact with the top of the helmet interior.
- 4. Check for a proper fit.** To make sure your helmet is the right size, check that:
 - The helmet inner lining fits snugly around your head.
 - The top pad presses firmly on your head.
 - There is no space around your brow under the inner lining. Test this by trying to insert your fingers.

If the helmet does not fit snugly, try on a smaller size.

- 5. Check your field of vision when trying on a helmet.** Some helmets may obstruct or block your vision when looking left, right, up, or down.

⚠ WARNING Always make sure you can see well enough to safely operate your motorcycle.

- 6. Test the helmet fit** by placing your hands on each side of the helmet. While holding your head as motionless as possible, try rotating your helmet from left to right then up and down. If you can feel the helmet padding sliding on your head, it is too big, try a size smaller. You should feel the helmet move the skin on your head and face as you try to move the helmet.



- 7. Fasten the retention system (chin strap)** as tight as possible under your jaw without causing pain. There must be no slack in the strap, and the strap must be tight up against your jaw. See page 5-6.

- 8. Test the retention system (chin strap)**

- Put your hands on the back of the helmet and try to push the helmet off by rotating it forward.
- Put your hands on the front of the helmet above your forehead (or on the chin guard) and try to push the helmet off by rotating backward.



⚠ WARNING If helmet comes off, try another size or another model or brand.

Repeat steps 3 through 8 until you find a helmet that fits your head snugly and securely.

