

40
Years

JOES
RACING PRODUCTS

2019 CATALOG

SECTIONS

- POPULAR ITEMS 4
- ABOUT JOES 5
- TOOLS & SETUP 6
- STEERING 20
- A-ARMS 24
- THROTTLE & FUEL 29
- ENGINE & FITTINGS 32
- HUBS 36
- SUSPENSION & MOUNTS 41

- BODY & INTERIOR 43
- ELECTRICAL 47
- MIRRORS 49
- CAMERA MOUNTS 51
- MICRO SPRINT 52
- JR SPRINT 74
- KARTS 84
- QUARTER MIDGET 87

JOES

RACING PRODUCTS

PRODUCTS

| | | | | | |
|--|----------|--------------------------------------|-------------------|----------------------------------|----------|
| A-Arms | 24-28 | Fan Spacer | 33 | Radius Rods | 64,79 |
| Air Dryer | 17 | Filler Neck | 33 | Rotor Flange | 38-39 |
| Air Tanks | 16 | Fire Extinguisher Mounts | 45 | Seals | 37-38 |
| Aluminum Fittings | 34 | Freeze Plug Adapter | 33 | Seat Belts | 73,75 |
| AN Wrenches | 17 | Fuel Cup | 31 | SetUp Blocks | 73 |
| A-Plate Mount & Slugs | 27 | Fuel Fillers | 31,72 | Shift Boots | 44 |
| Axle, Jr Sprint | 76-79 | Fuel Filters | 31,72 | Shifter Knobs & Levers | 44-45,67 |
| Axle, Kart | 84 | Gussets | 43 | Shock Tools | 14-15 |
| Axle, Micro Sprint | 58-59 | Heel Stops | 29,66 | Sockets | 17 |
| Axle Spacers, Jr Sprint | 76-77 | Helmet Hooks | 44 | Spindle Nuts | 38,56 |
| Axle Spacers, Micro Sprint | 60-61 | Hood Support Hinges | 43 | Spoiler Supports | 43 |
| Ball Joint | 24 | Hubs | 36-40,56,58,77,84 | Spring Pre-Loader | 42 |
| Ball Joint Sockets | 17 | Jack | 19 | Stands | 12-13,73 |
| Bell Crank | 29 | Jack Stands | 12 | Steering Products | 20-23 |
| Body Braces | 44 | Jr Sprint Chassis Kits | 74 | Steering Wheels | 20-22,87 |
| Bottle Mounts | 46 | Jr Sprint Products | 74-83 | Sway Bar Mounts | 41 |
| Brake Balance Adj. | 45 | Kart Products | 84-87 | Switch Panels & Mounts | 47-48 |
| Brake Bleeder Bottle | 18 | Leg Brace | 23 | Throttle Pedals | 29,63,87 |
| Brake Pressure Tester | 14 | Micro Sprint Chassis Kits | 52-53 | Tire Gauges | 6-8 |
| Breathers & Tanks | 33-34 | Micro Sprint Products | 52-73 | Tire Inflator | 8 |
| Bump Steer Gauge | 13 | Mirrors & Brackets | 49 | Tire Roller | 11 |
| Bump Stop Shims | 15 | Motor Mount Spacers | 35 | Toe Products | 9,86 |
| Caliper Mount | 42 | Mounting Clamps | 43-44 | Toolbox Labels | 18 |
| Camera Mounts | 51 | Muffler Clamp | 73 | Tread Depth | 11 |
| Canister Mounts | 41 | Nerf Bars | 66,75 | Valve Cover Fasteners | 32 |
| Car Cover | 46 | Nitrogen Tank | 16 | Vent Parts | 33-34 |
| Carb Fasteners | 31 | Oil Filter Cutter | 18 | Weld Bungs | 34 |
| Carb Fittings & Linkage | 30-31 | Oil Filter Mount | 35 | Wheel Spacers | 40 |
| Caster Camber | 12 | Paint Marker | 11 | Wheel Stands | 13 |
| Chain Breaker | 62,81,86 | Purge Tool | 9 | Window Net Mounts | 44 |
| Coil Clamps & Clamp Reducers | 35 | Precision Air Gauge | 7 | Wing Slider | 70-71 |
| Deburring Tool | 12 | Pyrometer | 10 | Wing Tree | 70,80 |
| Distributor Hold Down | 35 | Quarter Midget Products | 87 | Wings | 70-71,80 |
| Drink Holders | 46 | Quick Release | 23 | Wheels | 69,82,86 |
| Drive Flange | 37 | Rack Spacers | 13 | Wheel Wrenches | 18,69,83 |
| Durometers | 10 | Radiator Brackets | 32 | Wrenches | 14-15,17 |
| Dust Caps | 40 | Radiator Overflow Fittings | 33 | | |
| Engine Water Fittings | 32 | Radio Boxes | 46 | | |

JOES *NEW HOT ITEMS*



See Pg. 16



See Pg. 15



See Pg. 6



See Pg. 51

JOES *POPULAR ITEMS*



See Pg. 49



See Pg. 21



See Pg. 37



See Pg. 29



See Pg. 26



See Pg. 15



30 Years of Manufacturing in the United States

**JOES RACING PRODUCTS HAS 30 YEARS OF EXPERIENCE
MANUFACTURING QUALITY RACE PARTS BUILT IN THE UNITED STATES.**

**OUR COMPANY PRIDES ITSELF IN INNOVATION AND PRODUCING
CUTTING EDGE PARTS FROM CONCEPT TO PROTOTYPE, TESTING TO FINAL PRODUCTION.**

**WE ARE IN THE BUSINESS OF MAKING YOU GO FAST,
AND TOGETHER WE WILL CONTINUE OUR WINNING TRADITION!**

SINCE 1989





ALL NEW TIRE GAUGE COLLECTION

JOES PRO TIRE GAUGE

JOES Pro Tire Gauge

Durable, dependable, accurate and easy to use. What more could you want in a Tire Pressure Gauge? JOES new Analog Pro Tire Pressure Gauges features a 2-1/2" glow in the dark face, with an internal pressure diaphragm design, that is surrounded by a steel enclosure and a rubber bumper. These features combine to create a rugged, durable and accurate gauge that will give repeatable readings in any condition. Each Pro Tire Gauges comes with a flexible 17" rubber hose, along with a swivel and an angle chuck so you can choose which chuck is best for your application. Available in 0-15, 0-30 and 0-60 PSI.

- Repeatability accuracy: Reads the same every time, certified ANSI grade B40.1.
- Durable: Built to withstand drops, features steel housing and external rubber cushion.
- High flow pressure release button: Let air out of your tires quickly.
- Swivel and angle chuck included: Choose what works best for your application.
- 2-1/2" glow in dark face: Easy to read in low light.
- Internal spike suppressor: Protects gauge for longer life and consistent accuracy.
- Rubber cover: Provides shock absorption when dropped and allows for good grip.
- 17" flexible rubber hose: Lets you get to your valve stem easily.
- Steel housing: Built to last with quality materials.
- Analog movement: No more relying on batteries.

- #32315 0-15 PSI Without Hold Valve
- #32316 0-30 PSI Without Hold Valve
- #32317 0-60 PSI Without Hold Valve
- #32325 0-15 PSI With Hold Valve
- #32326 0-30 PSI With Hold Valve
- #32327 0-60 PSI With Hold Valve



#32315
0-15 PSI

#32326
0-30 PSI

#32327
0-60 PSI



JOES Hold Fitting

The internal one way valve holds pressure in the gauge after you remove the chuck - holding the pressure until you are ready for the next tire.



**BOTH BALL
AND ANGLE CHUCK
INCLUDED
WITH ALL JOES
GAUGES!**

#32316
0-30 PSI

JOES Precision-Air Tire Gauge

One of the most important, if not the most important thing on your vehicle is your tires. The detail that goes into a set of race tires and the amount of money spent on them should be backed up with accurate pressure inside them. If you are concerned about measuring tire pressure accurately, then you need a JOES gauge that can do the job for years to come. JOES has been obsessing over every little detail of our Precision-Air Tire Gauge and has spared no expense to make sure that it has the highest quality components available. Every gauge comes certified to guarantee its accuracy and it can always be recalibrated if something should happen to it in the future.



- Measures in increments of .01 PSI.
- Memory for 8 sets of tires
- Displays 4 recorded tire pressures at a time
- Fast flow fittings for releasing air
- Shock absorbing bumper
- PSI/BAR/kPa
- Measures up to 100 PSI.
- Atmospheric and temperature compensated.
- Billet aluminum housing.
- 45 deg. High flow chuck and ball chuck included
- Includes case
- Uses 4 AAA batteries
- Backlit display
- Serviceable
- Serialized
- Made in the USA

#32311 Precision-Air Tire Gauge



JOES Digital Tire Pressure Gauge

JOES Digital Tire Pressure Gauge provides top quality at an affordable price. Nice size back lit numbers are easy to read even at night. Reads in PSI or Bar. Great accuracy is built in to this versatile gauge. Laboratory Calibration to 1% Accuracy.

#32435 0-60 PSI Digital Tire Pressure Gauge

.1 Resolution

#32436 0-150 PSI Digital Tire Pressure Gauge

.5 Resolution



#32307
5-60 PSI

#32306
3-30 PSI

#32305
0-15 PSI

JOES 2-1/2" Glow-in-the-Dark Tire Pressure Gauge

- Internal gauge damper
- 17" ultra-flexible hose with swivel chuck
- 2-1/2" Glow-in-the-Dark dial face
- Air pressure release button

2-1/2" GID Tire Pressure Gauge without hold fitting

JOES Professional Quick Fill Tire Inflator

JOES Professional Tire Inflator is designed to let you fill your tires, check pressure, and release excess pressure with one tool. You will be more efficient without having to switch between your air source and tire gauge to get the perfect pressure. The billet aluminum handle is comfortable to hold, the fast fill button and high flow bleed button, fastest on the market, is in the perfect spot for easy use. It comes with a 17" flexible hose with a 45 degree swivel chuck installed and a ball chuck for tight spots. Different gauge configurations are available depending on your application. Our 2-1/2" diameter gauges glow in the dark, are easy to read, and are accurate to ANSI grade B40.1

- #32490 Billet Quick Fill, 0-30 PSI, Dial
- #32491 Billet Quick Fill, 0-60 PSI, Dial
- #32492 Billet Quick Fill, 0-60 PSI, Digital
- #32493 Billet Quick Fill, 0-100 PSI, Precision-Air

#32491
0-60 PSI



JOES Digital Quick Fill Tire Inflator

- 60 PSI
- Digital pressure gauge
- Large back lit numbers
- 1% accuracy
- Quick Fill valve
- Chrome angle chuck installed
- Ball chuck included

- #32488 Tire Inflator Quick Fill Valve w/ 60 PSI 1% Digital Pressure Gauge
- #32489 Tire Inflator Quick Fill Valve w/ 150 PSI 1% Digital Pressure Gauge



JOES Quick Fill Tire Inflator

- 60 PSI
- Quick Fill valve
- 2.5" dial glow gauge
- Chrome angle chuck installed
- Ball chuck included

- #32484 Tire Inflator Quick Fill Valve w/ 60 PSI 2-1/2" Glow in the Dark Pressure Gauge

JOES Tire Purge Tool

The JOES Tire Purging & Set tool has been track tested by top Cup teams. These top teams clip on several JOES Purging & Set tools allowing their tire specialist to purge and adjust multiple sets of tires simultaneously. The days of standing around waiting for air to drain are over. Just clip on the JOES Tire Purging & Set tool and go. Another simple, fast and easy tool from the JOES team!

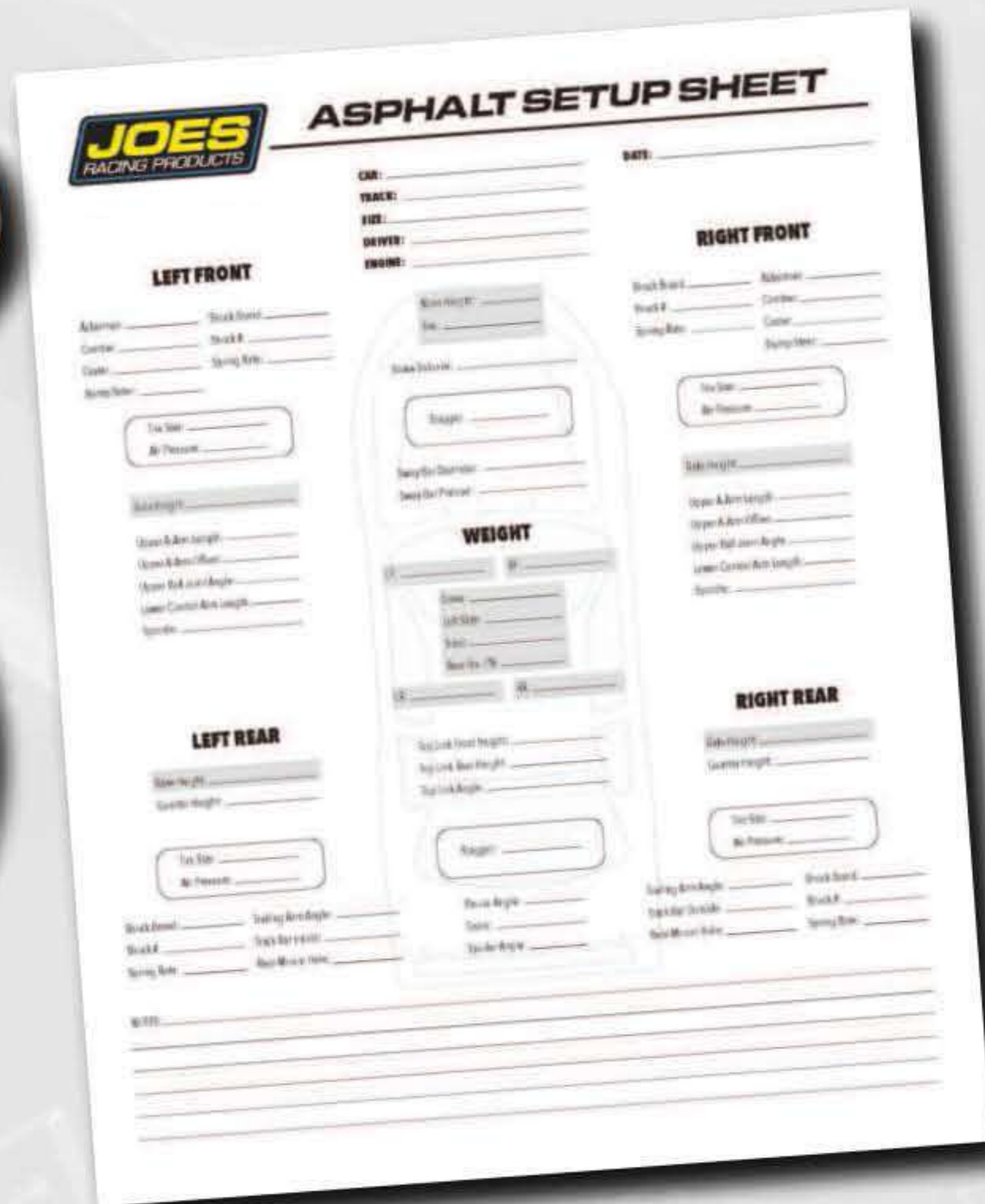

JOES Purge Tool

JOES Tire Purge & Setting Tool comes with 3 springs allowing you to set the bleed valve for nearly any type of racing. The light spring is factory installed.

- A. Light Spring Range: 2 PSI to 7 PSI
- B. Medium Spring: 14 PSI to 29 PSI
- C. Heavy Spring: 30 PSI to 68 PSI

#32125 Tire Purge Tool
[JOES Bleeder Included]

JUST CLIP ON AND GO TO THE NEXT TIRE WHILE THE PRESSURE DROPS AUTOMATICALLY.



JOES Chucks

JOES Chucks thread right on and are built with quality for a perfect seal.

- #32494 Ball Chuck
- #32495 Angle Chuck

JOES Toe Plates

Check the toe of your race car quickly and easily. Just prop a toe plate against each front tire and measure. Tape measures included.

- #32600 Toe Plates
- #32650 Replacement Toe Tape



Follow JOES on Social Media



JOES Valve Core Tool

JOES Valve Core Tool is ergonomically designed and is made out of stainless steel. This thing will last forever!

#32100 Valve Core Tool





JOES Precision Digital Durometer

JOES Digital Durometer features easy to read large numbers. Digital resolution is far superior to old dial type designs. A hold button holds your reading on the display for easy viewing. A foam lined case protects your investment. Serious racers that want to track their Durometer readings closely will enjoy the accuracy and .5 readout.

#56015 Precision Digital Durometer



JOES Dial Durometer

JOES Dial Shore A Durometer has a flat base and easy to read numbers helping you to get the best tires out of the stack. Be sure to visit our website and check out the JOES Knowledge Center for Tech that gives you the secrets for proper Durometer use.

#56020 Dial Durometer



JOES Deluxe Racing Pyrometer

The included adjustable tip probe is designed to fit the tight fender clearances on your race car. For best accuracy, work quickly and insert your probe at a consistent depth at every location.

- Max Hold feature records the highest number
- Auto Shut Off
- Rubber Boot for Protection
- User Selectable C or F

#54005 Deluxe Racing Pyrometer

#54094 Adjustable Replacement Tire Probe



JOES Digital Tread Depth Gauge

JOES Digital Tread Depth Gauge measures tire wear to 1/1000 of an inch. JOES Tread Depth Gauge gets the job done quickly and accurately at a fraction of the price. The JOES design is efficient, saving you the costs of elaborate designs that cost 10 times as much! Use the right tool and save!

#56100 Digital Tread Depth Gauge

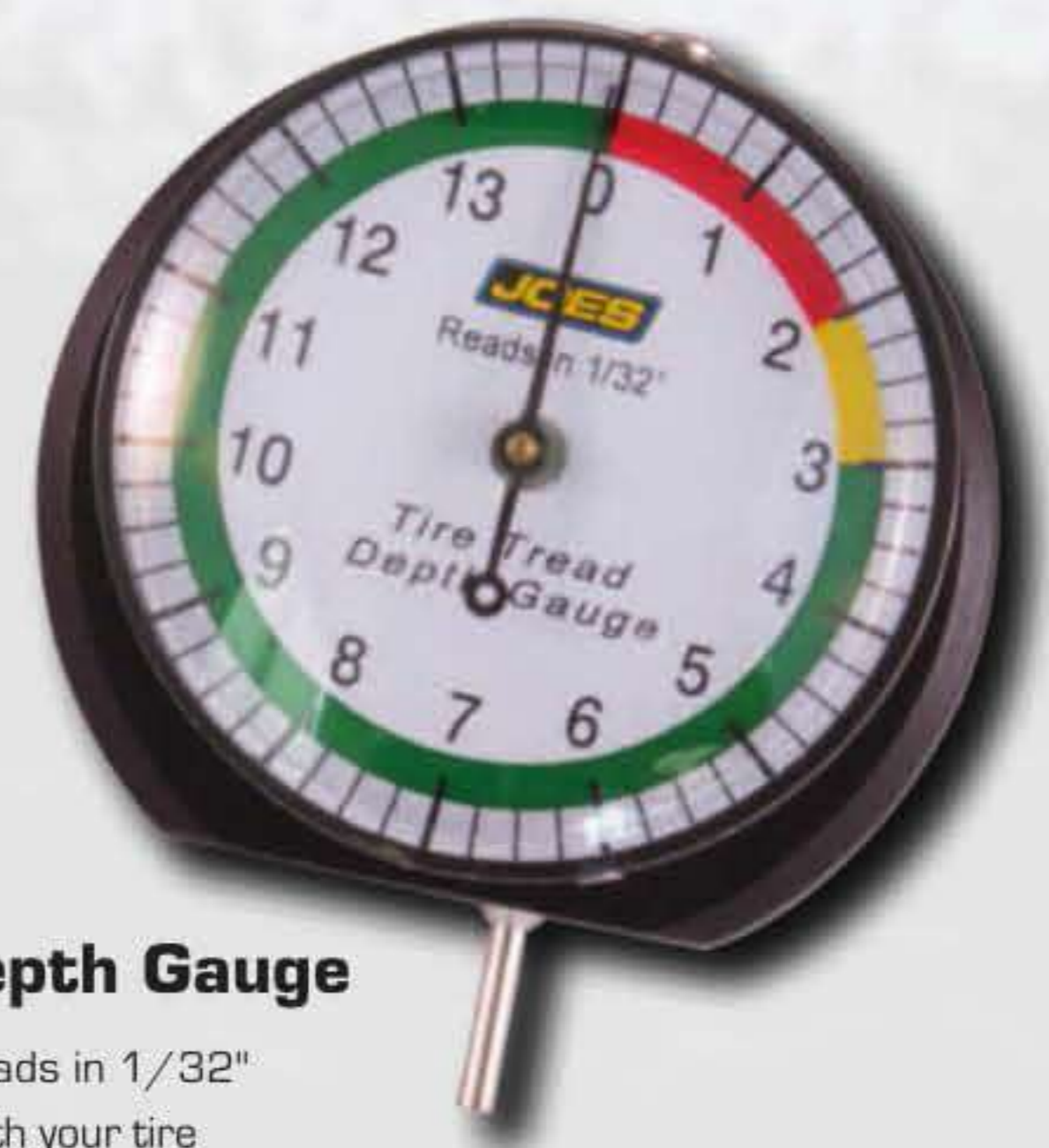

JOES Dial Tread Depth Gauge

JOES Dial Tread Depth Gauge reads in 1/32" increments. Use in conjunction with your tire pyrometer to maximize camber adjustments. Track tire wear so you can maximize performance.

#56110 Dial Tread Depth Gauge



JOES Tire Roller

Now you can check stagger, sipe, groove, inspect, and clean tires without chasing them all over the pits. You can adjust the width for different tire sizes and break it down for easy storage.

#32200 Tire Roller



JOES Tire Tape Measure

Measure your tires accurately with our 1/4" wide by 10 foot long tire tape. It won't kink like wider tapes. Make sure you always have a stagger tape on hand, buy 5 and get one free!

#32150 Tire Tape Measure

#32151 Tire Tape 6-pack



JOES Paint Marker

Works great on tires.

#32145 Paint Marker, Silver

JOES 8 Degree Caster Camber Gauge

Make sure your front-end is set accurately with a JOES Caster Camber Gauge. Our 8 degree vials give you the room so that the bubble is clear to read and won't cause errant readings due to the bubble running into the end of the vial. Expanded 8 Degree range to meet the needs of the camber settings of today. Machined from billet 6061-T6 aluminum with a magnetic adapter to attach to your hub. JOES includes a billet gauge with durable laser etched numbers that last a lifetime. JOES quality and in house manufacturing creates a superior package saving you 25.00 while giving you a visibly superior product. Our case even comes complete with a handle for easy transport and storage. Our powerful rod style magnets sit straight - Competing models use a disk that easily collect chips affecting your measurements negatively. Please compare - and you will quickly see you get more with JOES!

- #28201 Caster Camber Gauge With Wide 5, 5x5 Adapter and Case- 8 Degree
- #28203 Caster Camber Gauge With Kart 5/8"-18 Adapter and Case- 8 Degree
- #28205 Caster Camber Gauge With GM Adapter and Case- 8 Degree
- #28209 Caster Camber Gauge Without Adapter- 8 Degree
- #28210 Caster Camber Gauge With Magnetic Adapter and Case- 8 Degree
- #28010 Mag Adapter
- #28015 Wide 5 or 5x5 Adapter
- #28020 GM Adapter, 3/4"-20
- #28022 Kart 5/8"-18 Adapter
- #28025 Steel Disk For Magnetic To Dust Cap *Fits JOES 5x5"
- #28035 Ford Pinto Adapter, 3/4"-16



JOES Jack Stands

JOES aluminum jack stands are stackable and have urethane pads to help keep your car from slipping. They are light weight and stackable to save space in your trailer or the shop. 14" tall, sold in pairs.

- #55500 Stock Car Jack Stands (Pair)
- #55500-B Stock Car Jack Stands Black (Pair)

JOES Deburring Tool

Pencil style aluminum handle with pocket clip. Heavy duty blade can be used on all metals. Comes in packs of 2.

- #10010 Deburring Tool



JOES Precision Digital Billet Bump Steer Gauge

JOES Precision Billet Bump Steer Gauge has a rigid design to give you exact results every time. The digital indicator does the math for you and zeros quickly. Our billet aircraft aluminum hub plate is designed to work with most stock car hubs – one plate fits 5x5, wide 5, 5x4.5 and snap cap. Precision laser etching is used to give you accurate measurements. JOES design allows plenty of room for the jack and the roller arm is adjustable allowing the gauge to clear the hub. Breaks down for easy storage saving you room in your shop or trailer. Our digital gauge is specially made- we reversed the display for easy viewing.

#28294 Precision Digital Billet Bump Steer Gauge (4 Lug)

#28295 Precision Digital Billet Bump Steer Gauge



JOES Rack Spacers

Adjusting the bump steer in your race car sometimes requires shimming up the rack. JOES Rack Spacers eliminate the need to stack up a bunch of washers.

#14705 1/16" Spacer

#14710 1/8" Spacer

#14720 1/4" Spacer

#14730 3/8" Spacer

#14740 1/2" Spacer



JOES Turn Plates

If you think front-end alignment is important and are looking for accuracy, then you need a pair of JOES Turn Plates. Machined from 6061-T6 aluminum to exact tolerances and a total thickness of 1". Rotation angles of 30 degrees in both directions and a free-floating design makes checking alignment easy.

#31000 Turn Plates



JOES Bump Steer Shims

Precision machined spacers for use at spindle to attain proper bump steer. Includes 1 each of a 1/8", 1/4" and 3/8" spacer.

#14804 Bump Steer Shims

JOES 10" Wheel Stands

Adjust the suspension on your race car while it sits on its tires. You can string, plumb, measure angles, and make adjustments while its sitting on its springs. Made out of aluminum.

#29600 10" Wheel Stand (Qty. 4)





JOES Brake Pressure Tester Kit

Accurately measure brake bias without permanently plumbing your car for gauges. Simply screw the fitting onto your caliper bleed screw and have a helper press the brakes. Its face swivels to allow easy readings from any angle. These gauges work best in pairs, one on a front caliper and another in the rear.

#44012 Brake Pressure Tester Kit

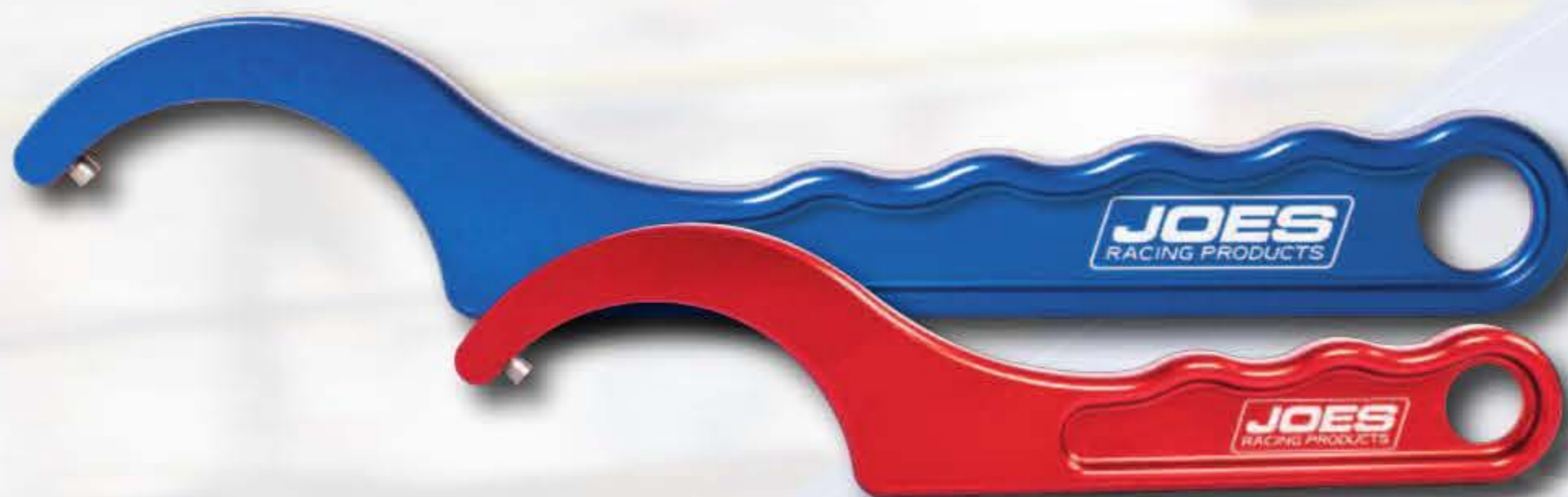

JOES Coilover Spanner Wrench

Tired of busting your knuckles adjusting coilover nuts? Get a JOES Coilover Spanner Wrench. Made from 6061 aluminum with radiused edges, anodized finish, and a replaceable 4130 steel pin. Two lengths are available, short handle for tight areas and a long handled version for more leverage. Fits shock nuts from 3" to 3-1/2" diameter.

- #33000** Coilover Spanner Wrench, Long
- #33500** Coilover Spanner Wrench, Short
- #33520** Spanner Wrench Replacement Pin

JOES Penske Shock Wrench

#19075 Penske Shock Wrench



JOES Drip Cup

Catch the oil before it runs down the side of your shock. Designed to fit shocks from 1-1/2" to 2-1/8" in diameter.

- #19300** Drip Cup
- #19301** Drip Cup Rubber Washer

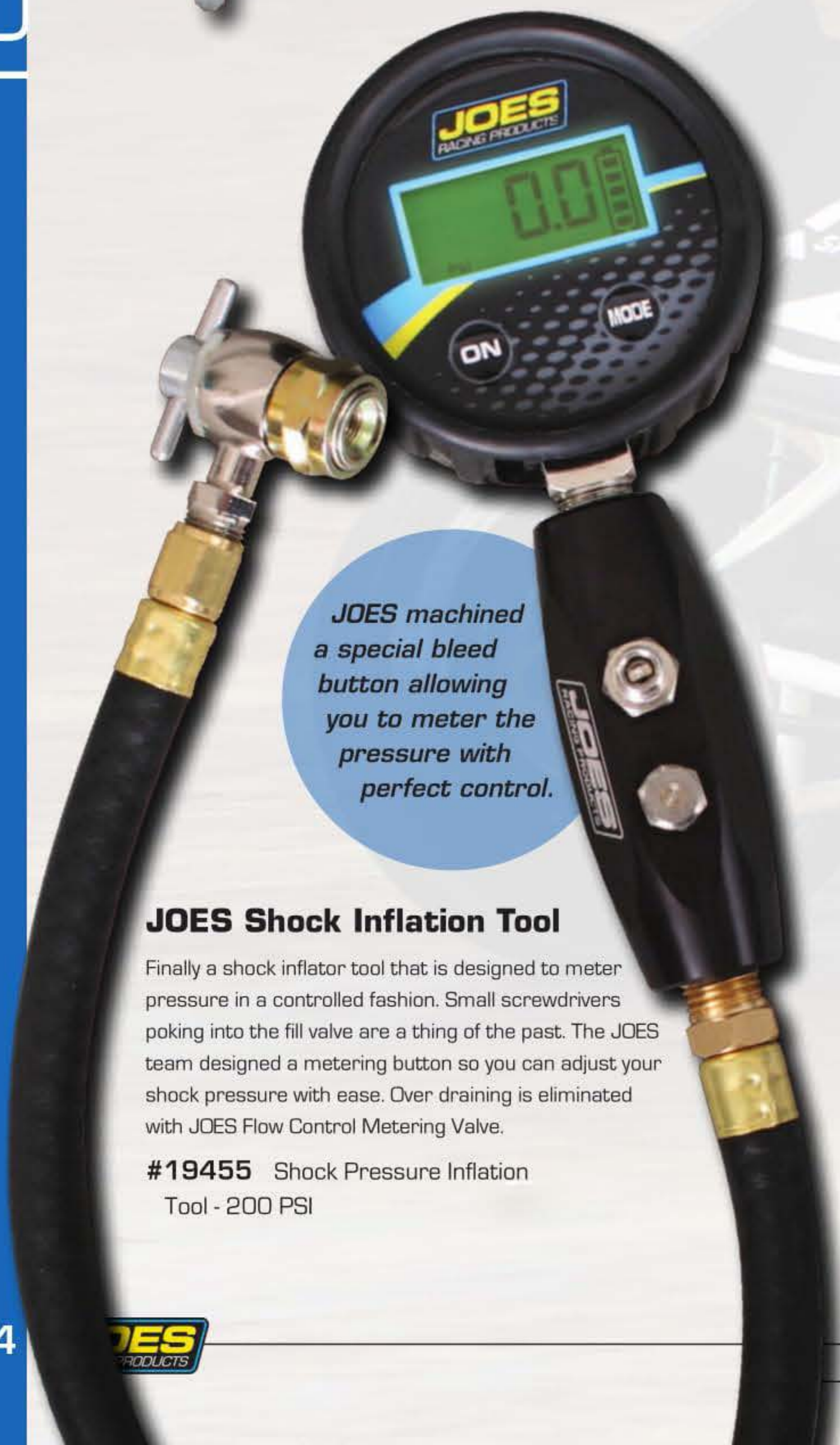

JOES machined a special bleed button allowing you to meter the pressure with perfect control.

JOES Shock Inflation Tool

Finally a shock inflator tool that is designed to meter pressure in a controlled fashion. Small screwdrivers poking into the fill valve are a thing of the past. The JOES team designed a metering button so you can adjust your shock pressure with ease. Over draining is eliminated with JOES Flow Control Metering Valve.

#19455 Shock Pressure Inflation Tool - 200 PSI



JOES Bump Stop Shim Kit

Finally a solution to easily snap your bump stop shims onto your shock shafts. The JOES crew has come up with a practical system for quick installation and removal. The JOES bump stop tool is specially shaped to work with JOES bump stop shims. A quick push and your shim snaps in place. Each shim has a hole that lines up with a pin on the removal tool for instant removal. Kit includes Case, Bump stop wrench and 4 of each shim: 1/16, 1/8, 1/4, 3/8".



- Fits 5/8" Shaft**
- #19485 Bump Stop Shim Kit 1/16, 1/8, 1/4, 3/8" (4 each)
 - #19486 Bump Stop Shim 1/16" (pack of 4)
 - #19487 Bump Stop Shim 1/8" (pack of 4)
 - #19488 Bump Stop Shim 1/4" (pack of 4)
 - #19489 Bump Stop Shim 3/8" (pack of 4)

- Fits 1/2" & 14MM Shaft**
- #19490 Bump Stop Shim Kit 1/16, 1/8, 1/4, 3/8" (4 each)
 - #19491 Bump Stop Shim 1/16" (pack of 4)
 - #19492 Bump Stop Shim 1/8" (pack of 4)
 - #19493 Bump Stop Shim 1/4" (pack of 4)
 - #19494 Bump Stop Shim 3/8" (pack of 4)
 - #19495 Bump Stop Shim Extractor Tool



NEW!



JOES Shock Workstation

JOES Shock Workstations let you hold on to your shock body and the shaft at the same time, making it a lot faster, easier, and cleaner to work on your shocks. Just put the JOES Workstation in a vise and you're ready to go, or mount it securely to a workbench or pit cart with our base. (Base sold separately)

- #19100 Single Shock Workstation
- #19200 Shock Workstation
- #19150 Single Shock Workstation Base
- #19250 Workstation Base

JOES High Pressure Nitrogen Tanks

JOES High Pressure Nitrogen Cylinder allows you to fill more tires without having to refill the tank as often. It holds 1800 PSI and you can refill it yourself from larger tanks with the included transfer hose. The regulator can be adjusted from 0 to 200 PSI and is equipped with a hose and a safety coupler that allows you to attach an air chuck or air tools for quick repairs.

- #32351 Portable Nitrogen Kit Assembly
- #32352 Bottle Bracket Assembly
- #32352-H Replacement Nitrogen Transfer Hose
- #32352-R Replacement Nitrogen Regulator
- #32352-T Replacement Nitrogen Tank, Aluminum



*Tire Gauge not included.



JOES Quick Fill Compact Aluminum Air Tank

No more waiting around for your tank to fill, we know you have more important things to do. Fill your tank in seconds, not minutes with JOES Quick Fill Aluminum Air Tanks.

- #32460 Compact Vertical Air Tank 2-1/2 gal.



ATTACH YOUR HOSE FITTING TO THE QUICK FILL VALVE TO FILL YOUR TANK FAST!

JOES DRYAIR

After more than 2 years of research and development JOES Racing Products has engineered "DRYAIR", the dryer that works for both compressed air and nitrogen. DRYAIR utilizes a specialized formula of desiccant with the drying capacity of 2-1/2 times its weight. The specialized desiccant creates more surface area effectively drying air or gas in high humidity atmosphere as well as low temperature conditions. DRYAIR is the most effective humidity control at the track or in the shop. Pair with JOES Fire Extinguisher Bracket - Panel Mount for a quick and clean wall mount, Part #12830.

- DRYAIR contains 43cu/in of desiccant.
- [2] 1/4" NPT Industrial air hose fittings.
- [2] 3/8" NPT Safety Couplers.
- Recharge kits available.

- #32120 DRYAIR
- #32121 DRYAIR Re-Charge Kit



JOES Ball Joint Sockets

Installing ball joints has never been easier. JOES Ball Joint Sockets are machined out of steel, zinc plated, and accept a 1/2" drive ratchet or breaker bar. Now you don't have to use that big old clumsy Crescent wrench.

- #40050 Upper Socket
- #40075 Lower Socket



JOES Spindle Nut Socket

Tighten and loosen your spindle nuts with a JOES Spindle Nut Socket. Fits 5x5 or wide 5 nuts and accepts a 1/2" drive ratchet. Machined from billet 6061-T6 aluminum and anodized gray. Fits 2-3/8" Hex.

- #40000 Spindle Nut Socket



JOES Standard AN Wrenches

Radiused edges, compact design, anodized finish, and quality workmanship are the reasons professional racers are choosing JOES AN Wrenches. Precision machined from 6061-T6 aluminum. Sold individual or in a set.

- #19000 AN Wrench Set #6-16
- #19006 #6 AN Wrench
- #19008 #8 AN Wrench
- #19010 #10 AN Wrench
- #19012 #12 AN Wrench
- #19016 #16 AN Wrench
- #19020 #20 AN Wrench
- #19024 #24 AN Wrench



JOES Double Ended Combo AN Wrench Set

JOES Combo Set has two sizes on each wrench to save cost and to assist you in always picking the right wrench out of the tool box. Sold individual or in a set.

- #18030 Combo Wrench Set [4] #3-20 Double Ends
- #18033 Combo Wrench #3 & #4
- #18036 Combo Wrench #6 & #8
- #18040 Combo Wrench #10 & #12
- #18046 Combo Wrench #16 & #20



JOES Double End AN Wrenches

Get to those hard to reach places with JOES Double End AN Wrenches. Designed to allow you to turn a fitting in 15-degree increments. Bright anodizing helps find the proper size wrench in a hurry. Precision machined from 6061-T6 aluminum.

- #18000 Double End AN Wrench Set #6-16
- #18001 Double End AN Wrench Set #3-20
- #18003 Double End AN Wrench #3
- #18004 Double End AN Wrench #4
- #18006 Double End AN Wrench #6
- #18008 Double End AN Wrench #8
- #18010 Double End AN Wrench #10
- #18012 Double End AN Wrench #12
- #18016 Double End AN Wrench #16
- #18020 Double End AN Wrench #20





JOES Brake Bleeder Bottle w/ Check Valve

JOES Brake Bleeder Bottle contains the mess of bleeding brakes by capturing the fluid in a 16oz. bottle. It comes with a magnetic adapter that attaches directly to your brake disc to make brake bleeding a one-man job. The one-way check valve is easy to use, just attach the bottle, open the bleed screw and pump the brakes. Each pump releases fluid out of the system and seals tight when you release the pedal. It works for the majority of brake systems without the need for an adapter.

#44010 Brake Bleeder Bottle w/Check Valve



JOES Toolbox Labels

Trying to find a tool that was put in the wrong drawer is frustrating! Save time and swear a little less by keeping your toolbox organized with JOES Toolbox Labels.

#17500 Toolbox Lables



JOES Billet Oil Filter Cutter

Inspecting your engine oil and filter can catch engine problems before it explodes. Identifying engine problems in the shop will help you win more races and save money! Fine threads ease the blade into the can for more control. One tool works perfectly for various size filters.

#21000 Oil Filter Cutter

JOES Sprint Car Wheel Wrench

New single piece design with a lower price! Our Sprint Car Wheel Wrench has a 12 point socket for maximum grip. We include a spud that can be adapted for all popular axles and with sleeve adaptors that quickly slide on the spud - one tool works for nearly every Sprint Car.

#26351 JOES Sprint Wheel Wrench



JOES Aluminum Race Jack

JOES Aluminum Race Jack was originally produced by Sierra Racing Products. In 2014 we purchased the company and have been making a great jack even better. When looking for a jack, you should consider a few important things. Will it do what you need? Is it quality workmanship? Can you buy parts for it? Can you get it serviced? JOES can do all that!

- Made from quality USA materials
- Weighs 35 pounds, with handle
- 2000 pound capacity
- Self bleeding system
- Repair and maintenance service available
- Sealed hydraulics, no vent needed
- Dirt Wings available

#55525 JOES Pro1 Race Jack

#55520 JOES Dirt Wings

**"Great Product!
I can honestly say that the
PRO1 Race Jack is the first
aluminum racing jack that
we have purchased and not had
any problems with. Finally,
a reliable jack that can
withstand the torture of
dirt late model racing.
Thanks, #teamJOES!"**

**- Jacob Magee - Dirt Late Model /
Caney, KS / 2015 Team JOES**



JOES RACING PRODUCTS
MATADOR
 STEERING WHEELS

JOES Matador Steering Wheel

When designing the Matador, we set out to build the strongest steering wheel on the market, focusing on strength and durability. We started with a flat wheel center machined from 6061-T6 Aluminum which features wider spokes for extra strength. The Matador's 1-1/4" diameter grip reduces hand fatigue while the evenly spaced finger nubs give the driver better grip for any track conditions they may face. Weighs in just under 24 oz. For added Grip, pair w/ Steering Wheel Tape #13600

Aluminum

- #13550-a 15" Flat Matador Steering Wheel, Aluminum
- #13551-a 16" Flat Matador Steering Wheel, Aluminum
- #13552-a 17" Flat Matador Steering Wheel, Aluminum

Matte Black

- #13550-b 15" Flat Matador Steering Wheel, Matte Black
- #13551-b 16" Flat Matador Steering Wheel, Matte Black
- #13552-b 17" Flat Matador Steering Wheel, Matte Black



"I've been running a Matador Steering Wheel for years and I wouldn't want anything else in my car. I love the durability of it and how it feels in my hands."

— Carson Macedo /
 World of Outlaws

JOES Lightweight Steering Wheels

Grab on to the lightest JOES aluminum Steering Wheel ever. It is drilled to reduce weight and is available with a black anodized finish or bare aluminum. Dished wheels have approximately a 2-1/2" dish. For added Grip, pair w/ Steering Wheel Tape #13600

Dished Black

- #13513-b 13" Dished Steering Wheel, Black
- #13514-b 14" Dished Steering Wheel, Black
- #13515-b 15" Dished Steering Wheel, Black
- #13516-b 16" Dished Steering Wheel, Black
- #13517-b 17" Dished Steering Wheel, Black

Dished Aluminum

- #13513-a 13" Dished Steering Wheel, Aluminum
- #13514-a 14" Dished Steering Wheel, Aluminum
- #13515-a 15" Dished Steering Wheel, Aluminum
- #13516-a 16" Dished Steering Wheel, Aluminum
- #13517-a 17" Dished Steering Wheel, Aluminum

Flat Black

- #13533-b 13" Flat Steering Wheel, Black
- #13534-b 14" Flat Steering Wheel, Black
- #13535-b 15" Flat Steering Wheel, Black
- #13536-b 16" Flat Steering Wheel, Black
- #13537-b 17" Flat Steering Wheel, Black

Flat Aluminum

- #13533-a 13" Flat Steering Wheel, Aluminum
- #13534-a 14" Flat Steering Wheel, Aluminum
- #13535-a 15" Flat Steering Wheel, Aluminum
- #13536-a 16" Flat Steering Wheel, Aluminum
- #13537-a 17" Flat Steering Wheel, Aluminum



JOES Rubber Coated Steering Wheels

JOES Rubber Coated Steering Wheels are lightweight without sacrificing durability and strength. The wheels feature a tacky rubber surface that gives the driver maximum grip and feel on any surface. Dished wheels have approximately a 2.5" dish.

- #13513-c 13" Dished Steering Wheel, Black Coated
- #13515-c 15" Dished Steering Wheel, Black Coated
- #13535-c 15" Flat Steering Wheel, Black Coated



JOES Lightweight Drag Steering Wheels

JOES Drag Steering Wheels are extremely lightweight and made from quality materials that will last a lifetime. The wheel center is made from 6061-T6, has radiused edges, and provisions for multiple buttons. They have a standard 5 bolt pattern for mounting and are anodized black. Available in 3 and 4 Spoke.

- #13450 JOES Drag Wheel, 13", Flat, 3 Spoke, Grant B.C.
- #13460 JOES Drag Wheel, 13", Flat, 4 Spoke, Grant B.C.



JOES Steering Wheel Tape

Get even more grip with our Steering Wheel Tape. Customize your wheel for maximum comfort and make sure fatigue doesn't set in.

#13600 Steering Wheel Tape



JOES Steering Wheel Hook

Hang your Steering Wheel securely and out of the way after each race with JOES Steering Wheel Hook. Made from 6061-T6 aluminum.

#10702-G 1-1/2"
#10704-G 1-3/4"



JOES Steering Wheel Spacers

Driver comfort is essential to winning races! When the steering wheel is too far away from the driver early fatigue sets in. Fix it with JOES Light Weight Steering Wheel Spacers.

- #13305 1/2" Thick Spacer
- #13310 1" Thick Spacer
- #13315 1-1/2" Thick Spacer
- #13320 2" Thick Spacer



JOES Steering Wheel Pad

Don't Bang Your Head! We hope you never crash your car hard enough to hit your head on the steering column! But just in case, think safety, get a JOES Steering Wheel Pad. It not only makes your race car safer, it looks cool too. Made with high-density foam,

#13650 Steering Wheel Pad



JOES Spoke-Up Steering Wheel Pad

JOES sets the standard in Steering Wheel Pads. The latest version is designed for steering wheels that have the center spoke pointing up.

#13651 Steering Wheel Pad - Spoke-Up



JOES Quarter Midget/ Kart Quick Disconnect

Made from 6061-T6 and fits most Quarter Midgets and kart steering columns.

- #13405 Quarter Midget/ Kart Quick Disconnect
- #13406 Quarter Midget/ Kart Quick Disconnect Shaft Coupler Only



JOES Quarter Midget Steering Wheel

JOES Quarter Midget Steering Wheel is Anodized black and Shot Peened for a texture you can hold on to. JOES machines the center section and pre-drills the mounting holes ensuring a centered wheel improving feel and chassis feedback.

#13505-B 11" Quarter Midget Steering Wheel- Black





JOES Steering Column Assembly

Adjustable from drivers compartment. Mounts to 1-3/4" tubing and accepts multiple steering columns. Made from aircraft quality aluminum.

- #13720 Steering Column Assembly w/3/4" Mis-alignment Ball
- #13725 Steering Column w/Woodward Collapsible Shaft Mount
- #13726 Steering Column w/1-1/2" I.D. Collapsible Steering Column Mount
- #13729 Steering Column Reducer Bushing 1-3/4" to 1-1/2" tube



JOES Adjustable Steering Column Leg Brace

Does your leg cramp up during the race? Add a JOES Leg Brace to our Steering Column mount and stay fresh - it bolts right on!

- #13735 Adjustable Steering Column Leg Brace



JOES Momo/Grant Steering Wheel Quick Disconnect

JOES Momo Quick Disconnect will let you remove your wheel quickly for easy access in and out of your car. The JOES adaptor is specially manufactured for Momo wheels and the tight tolerance splines make for precise steering. The adaptor is recessed leaving room for a horn button and converts your standard quick disconnect hub for a perfect fit. Fits Sparco, OMP, Nardi & Personal.

- #13411 Momo Quick Disconnect Adapter Ring (Bolt Circles: 6 x 2.913" DIA & 6 x 2.750" DIA)
- #13413 Grant Quick Disconnect Adapter Ring (Bolt Circle: 5 x 2.850")



JOES Quick Release Steering Disconnect

Made from aircraft aluminum, JOES quick releases are pin-less and spring-loaded for fast steering wheel removal. 1-3/4" bolt circle, 1-1/2" center to center.

- #13400 Quick Release 3/4" shaft
- #13401 Quick Release Shaft Coupler only 3/4" shaft
- #13402 Quick Release Assembly 5/8" shaft
- #13403 Quick Release Shaft Coupler only 5/8" shaft
- #13404 Quick Release Disconnect Hub only





JOES 10° A-Arms

Precision machine work and quality materials put JOES A-Arms in a class of their own. Available with aluminum cross shaft and 10-degree screw-in ball joint sleeve. Also available for bolt-in ball joint and slotted to accept slugs.



JOES A-Arm Slugs

Our slugs are machined out of aluminum, black anodized and laser engraved for easy identification.

- | | | | |
|--------|-------------------|--------|--------------------------|
| #15041 | A-Arm Slug, 0" | #15047 | A-Arm Slug, 3/8" |
| #15042 | A-Arm Slug, 1/16" | #15048 | A-Arm Slug, 7/16" |
| #15043 | A-Arm Slug, 1/8" | #15049 | A-Arm Slug, 1/2" |
| #15044 | A-Arm Slug, 3/16" | #15050 | A-Arm Slug Kit, 0 - 1/2" |
| #15045 | A-Arm Slug, 1/4" | #15051 | A-Arm Slug Slotted |
| #15046 | A-Arm Slug, 5/16" | | |



JOES Slotted A-Arms

JOES Slotted A-Arms have a 1" slot for caster adjustment and use an aluminum slug in one slot. You can remove and replace them without losing your setting. The Arms have a 10-degree screw-in ball joint.



STANDARD BOLT-IN

ALUMINUM SHAFT 0°

| SIZE | Part # | SIZE | Part # | SIZE | Part # |
|-------|--------|--------|--------|--------|--------|
| 7.00" | 15810 | 8.75" | 15845 | 10.50" | 15880 |
| 7.25" | 15815 | 9.00" | 15850 | 10.75" | 15885 |
| 7.50" | 15820 | 9.25" | 15855 | 11.00" | 15890 |
| 7.75" | 15825 | 9.50" | 15860 | 11.25" | 15895 |
| 8.00" | 15830 | 9.75" | 15865 | 11.50" | 15900 |
| 8.25" | 15835 | 10.00" | 15870 | 11.75" | 15905 |
| 8.50" | 15840 | 10.25" | 15875 | 12.00" | 15910 |



JOES Adjustable Upper Ball Joint

Changeable spherical style bearing. Almost no friction. Adjust roll center and camber gain.

- #14800 Upper Ball Joint, Spherical style
- #14802 Replacement Stud Only



STANDARD SCREW-IN

ALUMINUM SHAFT 10°

| SIZE | Part # | SIZE | Part # | SIZE | Part # |
|-------|--------|--------|--------|--------|--------|
| 7.00" | 15480 | 8.75" | 15515 | 10.50" | 15550 |
| 7.25" | 15485 | 9.00" | 15520 | 10.75" | 15555 |
| 7.50" | 15490 | 9.25" | 15525 | 11.00" | 15560 |
| 7.75" | 15495 | 9.50" | 15530 | 11.25" | 15565 |
| 8.00" | 15500 | 9.75" | 15535 | 11.50" | 15570 |
| 8.25" | 15505 | 10.00" | 15540 | 11.75" | 15575 |
| 8.50" | 15510 | 10.25" | 15545 | 12.00" | 15580 |



JOES Builds Custom A-Arms!

If you don't see the arm length, offset or degrees that you need just give us a call and we will custom build your A-arms [35 upcharge for custom A-Arms + 5 for powder coating. Please allow 7-10 days to ship.]

All JOES A-Arms are TIG welded and powder coated!

JOES Camaro Style A-Arms

Bone Yard A-arms are becoming harder to find so many sanctioning bodies are allowing the use of manufactured A-Arms. Go from the junk yard to the best with JOES precision Camaro A-Arms. Available in 8-1/2", 9" or 9-1/2" Length and built to fit standard screw in ball joints. Bolt Center is 7-3/4".

- #15060 8-1/2" Camaro Style A-Arm
- #15066 9" Camaro Style A-Arm
- #15070 9-1/2" Camaro Style A-Arm

- #15060 8-1/2"
- #15066 9"
- #15070 9-1/2"

All JOES A-Arms are made with .095 DGM Tubing.

7-3/4"

All JOES A-Arm tubes are CNC notched for an exact fit.

JOES Metric Clip A-Arms

Steel Shaft, 6.875" (174.63mm) spacing between holes.

6-7/8"

- #15072 8" RH A-Arm, Bolt In, Metric Clip
- #15074 8-1/2" LH A-Arm, Bolt In, Metric Clip
- #15076 9" LH A-Arm, Bolt In, Metric Clip
- #15077 9-1/2" LH A-Arm, Bolt In, Metric Clip
- #15078 10" LH A-Arm, Bolt In, Metric Clip



SLOTTED SCREW-IN

ALUMINUM SHAFT 10°

| SIZE | Part # |
|--------|----------|
| 7.00" | 15480-SL |
| 7.25" | 15485-SL |
| 7.50" | 15490-SL |
| 7.75" | 15495-SL |
| 8.00" | 15500-SL |
| 8.25" | 15505-SL |
| 8.50" | 15510-SL |
| 8.75" | 15515-SL |
| 9.00" | 15520-SL |
| 9.25" | 15525-SL |
| 9.50" | 15530-SL |
| 9.75" | 15535-SL |
| 10.00" | 15540-SL |
| 10.25" | 15545-SL |
| 10.50" | 15550-SL |
| 10.75" | 15555-SL |
| 11.00" | 15560-SL |
| 11.25" | 15565-SL |
| 11.50" | 15570-SL |
| 11.75" | 15575-SL |
| 12.00" | 15580-SL |

STEEL SHAFT 10°

| SIZE | Part # |
|--------|----------|
| 7.00" | 15680-SL |
| 7.25" | 15685-SL |
| 7.50" | 15690-SL |
| 7.75" | 15695-SL |
| 8.00" | 15700-SL |
| 8.25" | 15705-SL |
| 8.50" | 15710-SL |
| 8.75" | 15715-SL |
| 9.00" | 15720-SL |
| 9.25" | 15725-SL |
| 9.50" | 15730-SL |
| 9.75" | 15735-SL |
| 10.00" | 15740-SL |
| 10.25" | 15745-SL |
| 10.50" | 15750-SL |
| 10.75" | 15755-SL |
| 11.00" | 15760-SL |
| 11.25" | 15765-SL |
| 11.50" | 15770-SL |
| 11.75" | 15775-SL |
| 12.00" | 15780-SL |

JOES Bearing Style A-Arms

JOES Bearing Style A-Arms are the latest rage. The bolt on arm section lets you carry additional lengths for use with just one shaft. 4 sealed roller bearings eliminate nearly all resistance for rotating action that is incredibly smooth. The split design works perfectly for cars where the A-Arm needs to wrap around the frame mount. The JOES design is more rigid than competing models that flex creating unwanted variables in your suspension.



Tube Only Style A-Arms (SLBA)

Bearing Style A-Arms (SLB)

JOES Nut Plate

Holds A-Arm nuts so you only need one wrench to change shims, slugs, or A-Arms.

#14900 Nut Plate 6" spacing



BEARING STYLE SCREW-IN

| ALUMINUM SHAFT | | | |
|----------------|-----------|-----------|--------------|
| | 0° | 10° | 20° |
| SIZE | Part # | Part # | Part # |
| 7.00" | 15080-SLB | 15480-SLB | 15480-20 SLB |
| 7.25" | 15085-SLB | 15485-SLB | 15485-20 SLB |
| 7.50" | 15090-SLB | 15490-SLB | 15490-20 SLB |
| 7.75" | 15095-SLB | 15495-SLB | 15495-20 SLB |
| 8.00" | 15100-SLB | 15500-SLB | 15500-20 SLB |
| 8.25" | 15105-SLB | 15505-SLB | 15505-20 SLB |
| 8.50" | 15110-SLB | 15510-SLB | 15510-20 SLB |
| 8.75" | 15115-SLB | 15515-SLB | 15515-20 SLB |
| 9.00" | 15120-SLB | 15520-SLB | 15520-20 SLB |
| 9.25" | 15125-SLB | 15525-SLB | 15525-20 SLB |
| 9.50" | 15130-SLB | 15530-SLB | 15530-20 SLB |
| 9.75" | 15135-SLB | 15535-SLB | 15535-20 SLB |
| 10.00" | 15140-SLB | 15540-SLB | 15540-20 SLB |
| 10.25" | 15145-SLB | 15545-SLB | 15545-20 SLB |
| 10.50" | 15150-SLB | 15550-SLB | 15550-20 SLB |
| 10.75" | 15155-SLB | 15555-SLB | 15555-20 SLB |
| 11.00" | 15160-SLB | 15560-SLB | 15560-20 SLB |
| 11.25" | 15165-SLB | 15565-SLB | 15565-20 SLB |
| 11.50" | 15170-SLB | 15570-SLB | 15570-20 SLB |
| 11.75" | 15175-SLB | 15575-SLB | 15575-20 SLB |
| 12.00" | 15180-SLB | 15580-SLB | 15580-20 SLB |

| STEEL SHAFT | | | |
|-------------|-----------|-----------|--------------|
| | 0° | 10° | 20° |
| SIZE | Part # | Part # | Part # |
| 7.00" | 15280-SLB | 15680-SLB | 15680-20 SLB |
| 7.25" | 15285-SLB | 15685-SLB | 15685-20 SLB |
| 7.50" | 15290-SLB | 15690-SLB | 15690-20 SLB |
| 7.75" | 15295-SLB | 15695-SLB | 15695-20 SLB |
| 8.00" | 15300-SLB | 15700-SLB | 15700-20 SLB |
| 8.25" | 15305-SLB | 15705-SLB | 15705-20 SLB |
| 8.50" | 15310-SLB | 15710-SLB | 15710-20 SLB |
| 8.75" | 15315-SLB | 15715-SLB | 15715-20 SLB |
| 9.00" | 15320-SLB | 15720-SLB | 15720-20 SLB |
| 9.25" | 15325-SLB | 15725-SLB | 15725-20 SLB |
| 9.50" | 15330-SLB | 15730-SLB | 15730-20 SLB |
| 9.75" | 15335-SLB | 15735-SLB | 15735-20 SLB |
| 10.00" | 15340-SLB | 15740-SLB | 15740-20 SLB |
| 10.25" | 15345-SLB | 15745-SLB | 15745-20 SLB |
| 10.50" | 15350-SLB | 15750-SLB | 15750-20 SLB |
| 10.75" | 15355-SLB | 15755-SLB | 15755-20 SLB |
| 11.00" | 15360-SLB | 15760-SLB | 15760-20 SLB |
| 11.25" | 15365-SLB | 15765-SLB | 15765-20 SLB |
| 11.50" | 15370-SLB | 15770-SLB | 15770-20 SLB |
| 11.75" | 15375-SLB | 15775-SLB | 15775-20 SLB |
| 12.00" | 15380-SLB | 15780-SLB | 15780-20 SLB |

JOES A-Arm Spacers

Change camber easily with JOES A-Arm Spacers. Slotted one piece design lets you change camber without removing the A-Arm bolts.

- #14019 6" Centers, 1/16"
- #14020 6" Centers, 1/8"
- #14021 6" Centers, 3/16"
- #14022 6" Centers, 1/4"
- #14023 6" Centers, 1/2"
- #14025 6" Centers, 3/4"
- #14027 6" Centers, 1"
- #14050 A-Arm Spacer Kit 1/16"-1/2"



JOES Slug Type A-Plate

Get your race car through the corners faster by changing your front roll center. Slugs sold as a kit or separately in 1/16" or 1/8" increments.

- #14520 Slotted A-Plate
- #14530 A-Plate slug, Centered
- #14540 A-Plate slug, 1/8" Offset
- #14550 A-Plate slug, 1/4" Offset
- #14560 A-Plate slug, 3/8" Offset
- #14570 A-Plate slug, 1/2" Offset
- #14575 A-Plate slug kit,
0 - 1/2" in 1/8" Increments



JOES Tapered A-Arm Spacers

Adjust caster without putting your A-Arm in a bind. Machined out of aluminum, anodized, and laser engraved.

- #14210 6" Centers, 1/32" Taper
- #14220 6" Centers, 1/16" Taper
- #14230 6" Centers, 1/8" Taper
- #14240 6" Centers, 1/4" Taper
- #14250 A-Arm Spacer Kit, 1/32"-1/4" Taper



JOES A-Arms Are Rigorously Tested...

JOES A-Arms are designed and tested to reduce flex. We start with .095 DOM tubing and TIG weld them in house to our exacting standards. Competing models use thin tubing and standard welding. Our quality and testing ensures that we maintain tolerance at the shaft pivot for the perfect clearance and reduced friction when parts get hot. JOES A-Arms make for repeatable chassis set ups and are powder coated for durability. Other brands use paint that flakes off before you even bolt them on the car. JOES craftsman build our arms right. A quick look will show you the engineered difference between JOES A-Arms and the competition.



TUBE SECTION ONLY
SCREW-IN

| | 0° | 10° | 20° |
|--------|------------|------------|---------------|
| SIZE | Part # | Part # | Part # |
| 7.00" | 15080-SLBA | 15480-SLBA | 15480-20 SLBA |
| 7.25" | 15085-SLBA | 15485-SLBA | 15485-20 SLBA |
| 7.50" | 15090-SLBA | 15490-SLBA | 15490-20 SLBA |
| 7.75" | 15095-SLBA | 15495-SLBA | 15495-20 SLBA |
| 8.00" | 15100-SLBA | 15500-SLBA | 15500-20 SLBA |
| 8.25" | 15105-SLBA | 15505-SLBA | 15505-20 SLBA |
| 8.50" | 15110-SLBA | 15510-SLBA | 15510-20 SLBA |
| 8.75" | 15115-SLBA | 15515-SLBA | 15515-20 SLBA |
| 9.00" | 15120-SLBA | 15520-SLBA | 15520-20 SLBA |
| 9.25" | 15125-SLBA | 15525-SLBA | 15525-20 SLBA |
| 9.50" | 15130-SLBA | 15530-SLBA | 15530-20 SLBA |
| 9.75" | 15135-SLBA | 15535-SLBA | 15535-20 SLBA |
| 10.00" | 15140-SLBA | 15540-SLBA | 15540-20 SLBA |
| 10.25" | 15145-SLBA | 15545-SLBA | 15545-20 SLBA |
| 10.50" | 15150-SLBA | 15550-SLBA | 15550-20 SLBA |
| 10.75" | 15155-SLBA | 15555-SLBA | 15555-20 SLBA |
| 11.00" | 15160-SLBA | 15560-SLBA | 15560-20 SLBA |
| 11.25" | 15165-SLBA | 15565-SLBA | 15565-20 SLBA |
| 11.50" | 15170-SLBA | 15570-SLBA | 15570-20 SLBA |
| 11.75" | 15175-SLBA | 15575-SLBA | 15575-20 SLBA |
| 12.00" | 15180-SLBA | 15580-SLBA | 15580-20 SLBA |

JOES A-Arm Fixture

JOES now gives you the option to build your own custom A-Arm. Adjustable from 6-1/2" to 13" and up to 2" offset. Includes adapters to make most A-Arms. Ball Joint angle is adjustable from 0-30 degrees.

#15950 A-Arm Fixture

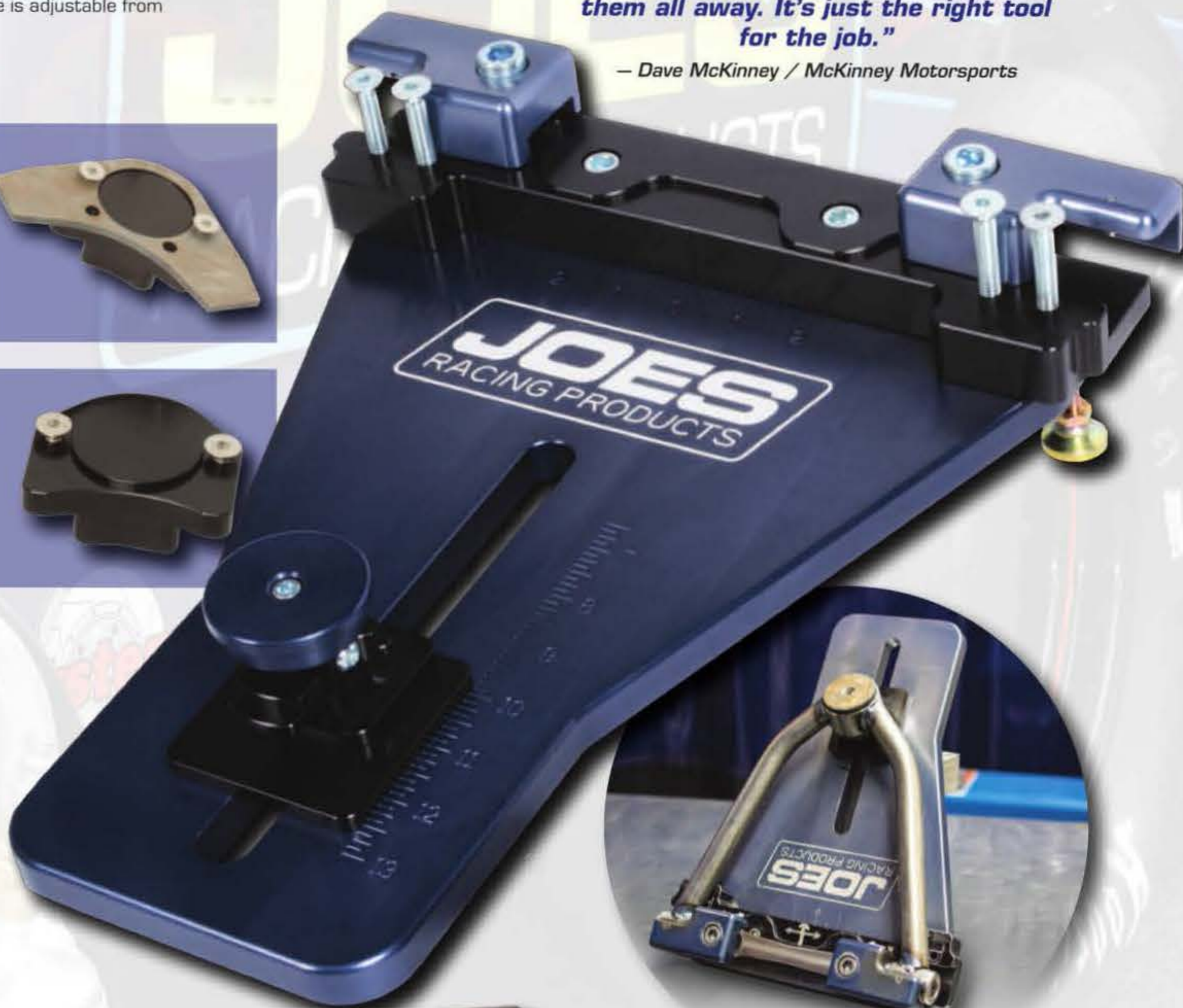

"JOES A-Arm Fixture is a well built, precision tool that is completely adjustable so I can build any arm I need. In the past I have had separate Jigs for every A-Arm, but after using the JOES Fixture, I have thrown them all away. It's just the right tool for the job."

— Dave McKinney / McKinney Motorsports



- #15023 12" A-Arm Tube
- #15024 Ball Joint Plate, Bolt-in
- #15025 Ball Joint Sleeve, Screw-in
- #15026 Bearing Style Aluminum Shaft Assembly
- #15027 Bearing Style Steel Shaft Assembly
- #15028 Tube Adapter for Bearing A-Arms
- #15030 Bushing Style Aluminum Shaft Assembly
- #15035 Bushing Style Steel Shaft Assembly
- #15039 Bushing Style Aluminum Slotted Shaft Assembly
- #15040 Bushing Style Steel Slotted Shaft Assembly



JOES Conventional Billet Throttle Pedal Assembly

JOES manufactures our Throttle Pedal Assembly for installation in any car. The billet arms are anodized and include plenty of mounting options for the perfect fit. Your throttle will be smooth as silk and multiple throttle rod holes ensure the perfect ratio. Welding required.

#33730 JOES Conventional Billet Throttle Pedal Assembly

JOES Heel Stop (Each)

JOES Heel Stop holds your foot comfortably in position keeping your driver fresh from race start to finish. The billet foot stop is specially sized to hold your heel comfortably in place.

#25836 JOES Heel Stop (Each)



JOES Holley Carburetor Fittings

Here's an idea. Move the hex down to where you can actually get a wrench on it. Made from aircraft aluminum.

#34000 7/8"-20 to #8 (Pair)

#34006 7/8"-20 to #6 (Pair)



JOES Sprint Bell Crank

JOES Sprint Car Bell Crank is made from 6061-T6 aluminum and is precision machined to be rigid and lightweight. Works on nearly all Sprint Car throttle systems and includes a black anodized finish.

#26005 Sprint Bell Crank



JOES Throttle Pedal Assembly

We designed this pedal with comfort and adjustability in mind. The linkage block acts as a side rest for your foot and can be adjusted to match the best combination for your linkage. It has a return spring and two adjustable stops, one for full throttle and one for return location.

#33600 Throttle Pedal Assembly

#33620 Throttle Pull Back

#33720 Pedal, Bell Crank & Linkage Assembly (Includes Pullback)



JOES Bell Crank Assembly

JOES Bell Crank features clamp-on arms with multiple holes to adjust your linkage for a perfect feel. The shaft and bushings are a close fit for smooth operation. Welding required.

#33700 Bell Crank

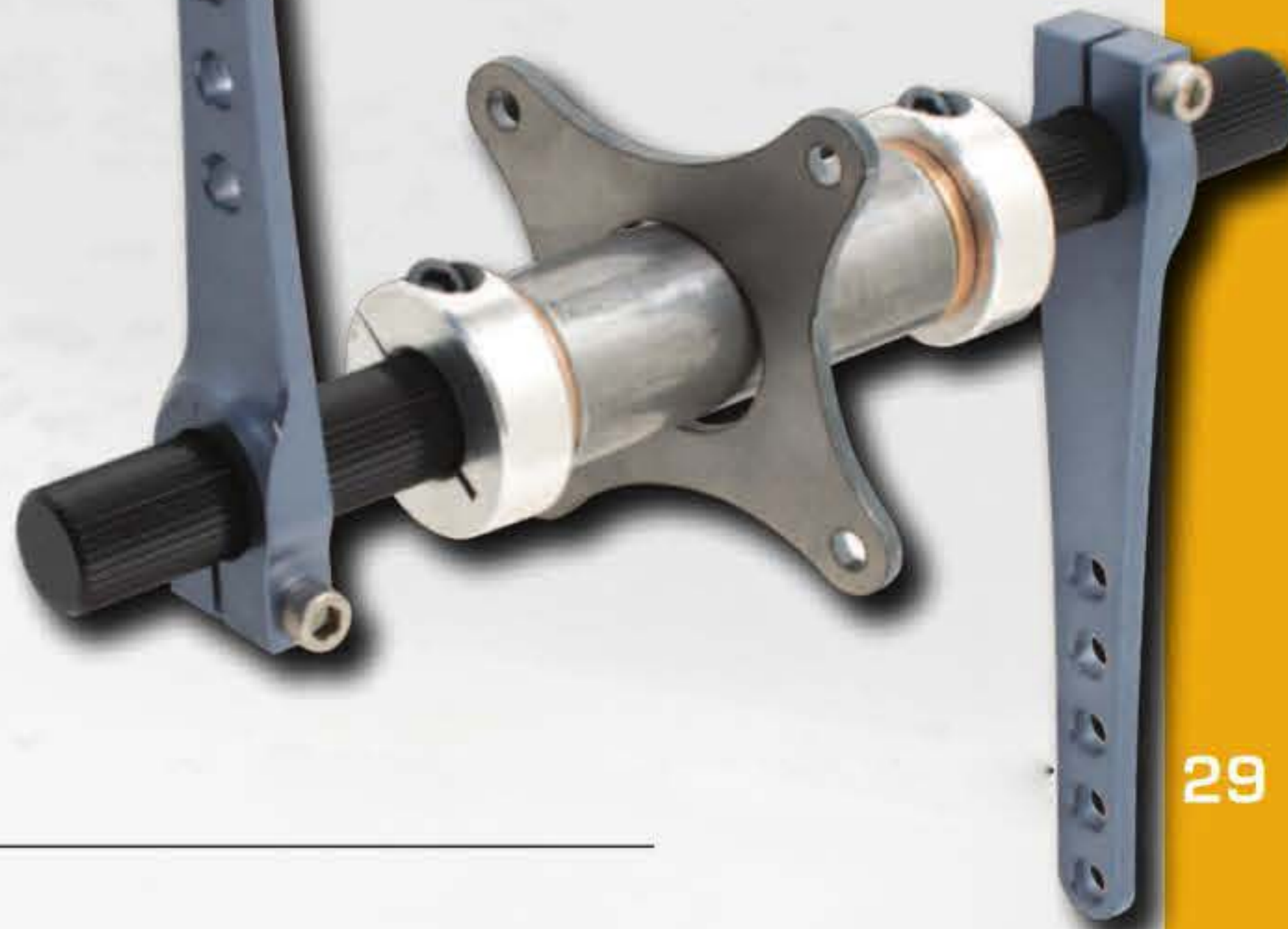



JOES Air Cleaner Nuts

No wrench needed to remove air cleaner.
O-ring base keeps dirt out.

- #34300 Air Cleaner Nut, Tall, 5/16"-18
- #34305 Air Cleaner Nut, Short, 5/16"-18
- #34310 Air Cleaner Nut, Tall, 1/4"-20
- #34315 Air Cleaner Nut, Short, 1/4"-20

JOES Air Cleaner Stud Kit

JOES Air Cleaner Stud Kit features a stainless steel threaded rod and is strong enough to handle the vibrations and the weight of the air cleaner. 2 tapered nuts improve airflow for added horsepower. The Tall Air Cleaner nut is o-ring sealed to keep dirt out of your high dollar engine.

- #34306 Air Cleaner Stud Kit, 5/16"-18
- #34316 Air Cleaner Stud Kit, 1/4"-20



JOES Throttle Return Spring Kit

JOES Throttle Return Spring Kit is designed to allow you to remove the linkage while the hardware stays attached to the carburetor saving you from losing pieces that fall in the engine or get lost during tech. The single point mounting bracket is a simple design that works in nearly every application.

- #34210 Complete Throttle Return Kit
- #34215 Throttle Return Springs (Pack of 2)
- #34220 Throttle Return Bracket Only



JOES Carburetor Bushings

Adapt the 1/2" hole in your carburetor linkage down to 1/4". Made from 6061-T6 Aluminum

- #34100 Carburetor Bushings



JOES Carburetor Linkage Assembly

Includes spring mounting hardware giving you all you need for a smooth throttle return. The JOES brand includes a threaded aluminum nut so the carb bushings and spring mount stays connected to your carburetor during removal preventing loose parts from dropping down your intake.

- #34200 Carburetor Linkage Assembly

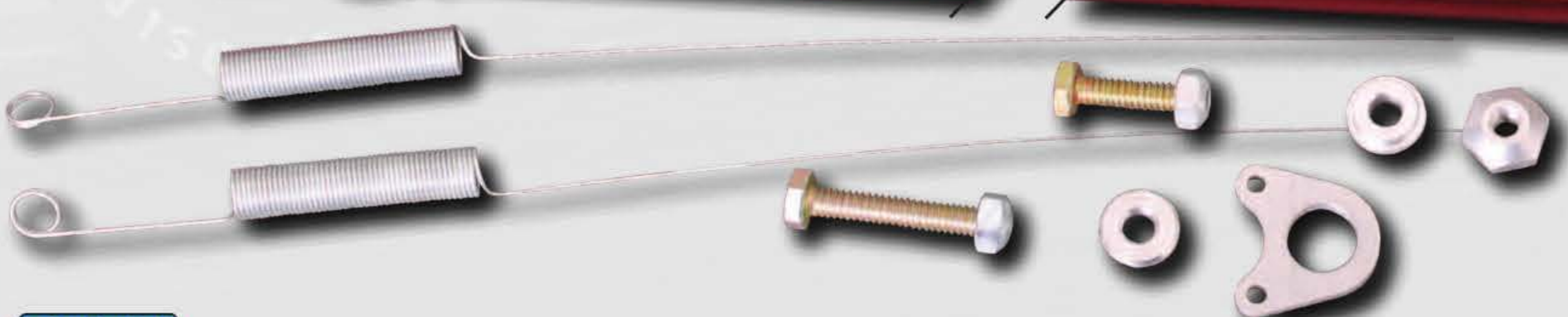
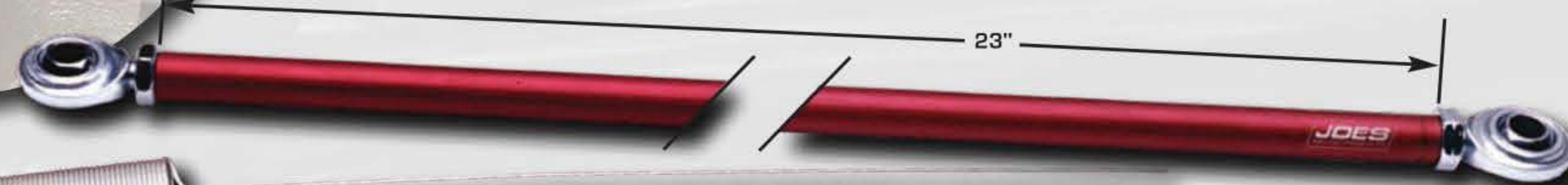



#34355 5/16"-18
Carburetor Fastener
w/ Studs - 4 Pack

JOES Carburetor Fasteners

- Eliminate dropped or lost fasteners in environments that cannot tolerate contamination by foreign objects
- No searching for the correct size socket to fit the fastener
- Access to fasteners in hard to reach areas is easy using a ratchet extension of the required length
- Spring ball of the ratchet head or extension secures the fastener to the tool
- 4 pack
- 5/16"-18 for use with no carb spacer, anodized black
- 5/16"-24 for use with 1" carb spacer, anodized red



#34357 5/16"-24
Carburetor Fastener
w/ Studs - 4 Pack



JOES Fuel Filler

JOES Fuel Filler is machined from 6061-T6 aluminum. The gasketed, thread-in cap and strong filler neck makes re-fueling safer and easier. Go radical with the exclusive Skull & Cross Bones design, the subtle Star pattern or the 5 Pocket design. 2-1/4" hose barb.

- #13200** Star Pattern
- #13201** Skull & Bones
- #13202** 5 Pocket



JOES Fuel Cup

Drain the fuel from your carburetor float bowl into a JOES Fuel Cup. After making your changes, dump the fuel back into your float bowl through the vent tube. Your motor will start right up without cranking it over to generate fuel pressure.

#34500 Fuel Cup



JOES Inline Fuel Filter

JOES Inline Fuel filters are specially designed for high flow. The 140 Micron mesh screen is optimal for keeping your fuel system free of debris while allowing ample flow. We vividly laser etch the fuel flow direction right on the housing so you are assured of a quick and correct installation every time.

- #42406** Inline Fuel Filter 140 Micron Mesh #6 AN
- #42408** Inline Fuel Filter 140 Micron Mesh #8 AN

JOES Ported Water Outlet Fitting

JOES Ported Water Outlet Fittings are compact and lightweight. They have a #16 fitting for your radiator hose and two 3/8" NPT ports for additional water lines. The base has an O-Ring for sealing to your intake manifold.

#36000 #16 Water Outlet with 3/8" NPT Ports



JOES Water Temp Plug

Plug existing gauge parts or reduces your standard gauge port to 1/8" NPT. Supplied with 1/8" NPT plug. Made out of aluminum.

#42730 Water Temp Plug



JOES Water Outlet Fittings

JOES Water Outlet Fittings are compact and lightweight. They have a #16 or #20 fitting for your radiator hose. The base has an O-Ring for sealing to your intake manifold.

#36050 #16 Water Outlet
#36060 #20 Water Outlet



JOES Thermo Spacer

Plumb additional lines to your heads for better cooling; install a water temp sending unit and your water temp gauge all in the same spacer. The base has an O-Ring for sealing to your intake manifold. Made from 6061-T6 aluminum.

#36025 1/2" NPT Ports, Gauge Port

JOES Cap & Weld Bung Assembly

JOES Caps are Lightweight, O-ring sealed, and are easy to grip. The cap is anodized while the bung is bare 6061-T6 aluminum so you can weld it to your oil, water, or fuel tank.

#37400 Cap/Weld Bung Assy.
 1-1/4" Opening
#37402 Cap/Weld Bung Assy.
 2" Opening



JOES Valve Cover Fasteners

Easily remove and replace your valve covers with our handy valve cover fasteners. The spring ball on your extension holds them so you can easily get them to the stud.

#34349 1/4"-20 Valve Cover Fastener, 8 pack
#34350 1/4"-20 Valve Cover Fastener, 4 pack
#34352 1/4"-28 Valve Cover Fastener, 4 pack



JOES Clamp On Radiator Brackets

Clamp mounts bolt right on without welding! Top clamps unbolt quickly for easy radiator removal. Easily locates radiator side to side. Multiple mounting holes make quick work out of mounting your radiator. Adjustable billet slider clamps hold radiators of any thickness securely in place. Air box can be fastened to the brackets. The JOES mounting system is the way to mount your radiator. Quickly adjusts for optimal aerodynamics. Fabricating a cobbled up mess in your shop is eliminated with the JOES flexible radiator mounting system. Billet mounts, multiple mounting holes for easy adjustment, powder coated finish for good looks. Max. height 20" & max. width 3". Specify clamp size, 1-1/4", 1-1/2", 1-3/4" and 2" available.

#36501 1-1/4" Clamp On Radiator Brackets
#36502 1-1/2" Clamp On Radiator Brackets
#36504 1-3/4" Clamp On Radiator Brackets
#36509 Replacement Radiator Core Retainer



#36509

JOES Weld-On Radiator Neck

Replacement Radiator filler neck. Thick 6061 Billet aluminum is made to hold up in racing conditions.

- #36100 Replacement Radiator neck



JOES Fan Spacers

JOES Fan Spacers are made from billet aluminum and are anodized black. Bolts are included.

- #45100 Fan Spacer, 1"
- #45101 Fan Spacer, 1-1/2"
- #45102 Fan Spacer, 2"
- #45103 Fan Spacer, 3"
- #45104 Fan Spacer, 4"
- #45105 Fan Spacer, 5"

JOES Radiator Overflow Fittings

JOES Aluminum Radiator Overflow Fitting acts as a signal to the driver indicating a possible overheating condition as the cooling system pushes out water. Fitting with threaded body and nut mounts in a body panel outside the drivers compartment and is available with a 1/4" barb or a -4AN male fitting.

- #34375 Radiator Overflow Fitting, -4AN
- #34376 Radiator Overflow Fitting, Barb



JOES Temp Tees

Want to keep an eye on engine temps? Simply install a JOES Temp Tee Fitting where you need it. The bulk head design installs in line allowing you to quickly and securely route your AN hoses in perfect fashion. Use for water or oil temp.

- #42140 Temp Tee, #10 AN
- #42141 Temp Tee, #12 AN
- #42142 Temp Tee, #16 AN

1/2" NPT



JOES Freeze Plug Adapter

Replace freeze plugs in your chevy block with our adapters and you can change the flow of water for better cooling. 1.627 +.001 -.000 Diameter

- #36200 Freeze Plug to #8 Fitting



JOES Expansion Tank

Installing a JOES expansion tank will help keep your engine cool! A 1/4" NPT fitting is welded in at the top for an air bleed line, a 1/2" pipe fitting for a line to your water pump is near the bottom, and an 1/8" fitting for water overflow is provided in the 6061-T6 billet aluminum filler cap housing. Fabricated from 5052 aluminum. LxWxH-5-1/4" x 2-3/4" x 6-1/4", 1 quart capacity.

- #45002 1-1/2" Tube Mount
- #45004 1-3/4" Tube Mount
- #45010 Sheet Metal Mount



JOES Dry Sump Breather Tank

JOES Dry Sump Breather Tank is designed to allow venting of your dry sump tank while catching any oil that blows out. It is a compact 3"x3"x6-1/2" to fit into tight places and has a 3/4" NPT fitting for your vent line. It has a drain valve so you can empty any oil that collects in the tank. Available with a JOES Clamp on the back for easy tube mounting or with a flat sheet metal mount.

- #12402 1-1/2" Tube Mount
- #12404 1-3/4" Tube Mount
- #12410 Sheet Metal Mount



JOES Vent Tank

If you're blowing oil out of your transmission or rear-end vent line, you need a JOES baffled Vent Tank. Equipped with a filter to keep dirt out of your lubricant and 1/4" NPT pipe threads or #8 AN, at the bottom for your vent line.

- #12301 Vent Tank 1-1/2" w/#8 AN
- #12302 Vent Tank 1-1/2" w/1/4" NPT
- #12303 Vent Tank 1-3/4" w/#8 AN
- #12304 Vent Tank 1-3/4" w/1/4" NPT
- #12309 Vent Tank Sheet Metal Mount w/#8 AN
- #12310 Vent Tank Sheet Metal Mount w/1/4" NPT
- #12250 Vent Clamp Replacement Filter



JOES Valve Cover Breather Kit

Let your engine breathe by welding one of these tubes to your valve cover. There are two baffles in each tube to keep oil from splashing into the filter.

- #12500 Aluminum Kit
- #12510 Valve Cover Tube Aluminum
- #12520 Filter, 1-3/8"

JOES Vent Clamp

JOES Vent Clamps mount quickly to chassis tubing with two allen screws. Each Vent Clamp is equipped with a filter to keep dirt out of your lubricant.

- #12202-G Vent Clamp, 1-1/2"
- #12204-G Vent Clamp, 1-3/4"
- #12250 Vent Clamp Replacement Filter

JOES Sprint Car Extended Port Fitting 3"x#6 AN

JOES Sprint Car Extended Port Fitting gets the #6 AN injector fitting up where you can reach it. Standard fittings are a pain to get the wrench on and the 3" extension makes hooking up fuel lines a quick and easy job.

- #42050 Sprint Car Extended Port Fitting, 3" long

JOES Ported Inlet Fitting

Designed with two 1/8" NPT ports for your valve spring oilers. They are 3-1/2" long, have a #12 fitting on one end and are 1/2" NPT on the other. Standard non-ported configurations also available.

- #42000 Ported Inlet Fitting

JOES Extended Fittings

JOES Extended Fittings are made from 6061-T6 aluminum to exact tolerances.

- #42010 Fitting, -12 x 1/2" NPT x 3" long
- #42030 Fitting, -10 x 3/8" NPT x 3" long
- #42035 Fitting, -10 x 1/2" NPT x 3" long

JOES Oil Pressure Fitting

JOES Oil Pressure Fitting is extended 2-1/4", making it easier to connect the line to your oil pressure gauge.

- #42799 Oil Pressure Fitting 1/8" NPT x #3
- #42800 Oil Pressure Fitting 1/8" NPT x #4

JOES NPT Weld Bungs

Weld into any aluminum tank or component that needs a fitting. Made from 6061-T6 aluminum.

- #37102 1/8" NPT Weld Bung
- #37104 1/4" NPT Weld Bung
- #37106 3/8" NPT Weld Bung
- #37108 1/2" NPT Weld Bung
- #37110 3/4" NPT Weld Bung
- #37112 1" NPT Weld Bung
- #37114 1-1/4" NPT Weld Bung
- #37116 1-1/2" NPT Weld Bung

JOES AN Weld Fittings

JOES Weld Fittings are made from 6061-T6 aluminum to exact tolerances.

- #37003 #3 Weld Fitting
- #37004 #4 Weld Fitting
- #37006 #6 Weld Fitting
- #37008 #8 Weld Fitting
- #37010 #10 Weld Fitting
- #37012 #12 Weld Fitting
- #37016 #16 Weld Fitting
- #37020 #20 Weld Fitting

JOES Female Weld Fittings

JOES Weld Fittings are made from 6061-T6 aluminum and accept AN or SAE O-Ring fittings.

- #37306 #6 SAE O-Ring Weld Fitting
- #37308 #8 SAE O-Ring Weld Fitting
- #37310 #10 SAE O-Ring Weld Fitting
- #37312 #12 SAE O-Ring Weld Fitting
- #37316 #16 SAE O-Ring Weld Fitting

JOES Coil Clamp

Here's a fast and easy way to mount an ignition coil. JOES Coil Clamp mounts to 1-1/2" or 1-3/4" tubing. Or for installation on any flat surface, order a JOES Coil Clamp with sheet metal mount.

- #10302-G Coil Clamp, 1-1/2"
- #10304-G Coil Clamp, 1-3/4"
- #10350-G Coil Clamp, Firewall Mount



JOES Reducer

Step down your JOES Clamp from 1-3/4" to 1-5/8", 1-1/2" or 1-1/4" with an aluminum JOES Reducer. Comes in handy when moving a Radio Box, Drink Holder, Coil Clamp, etc., to a smaller size tube.

- #13000 1-3/4" to 1-1/4"
- #13001 1-3/4" to 1-3/8"
- #13002 1-3/4" to 1-1/2"
- #13003 1-3/4" to 1-5/8"



JOES Billet Distributor Hold Down Clamp

Hold your distributor in place and make precision timing adjustments quickly. Anodized and laser etched for great looks. Includes Stainless Steel mounting hardware.

- #10550 Distributor Hold Down Clamp



JOES Motor Mount Spacers

Made from lightweight aircraft aluminum the JOES motor mount spacers are anodized and laser etched saving you from digging through the bolt bucket for those heavy steel washers. Engine installation is simplified preventing big stacks of washers from falling all over the floor. JOES motor mounts are available in 5 heights and are packaged in pairs of two for a clean look and a perfect fit in your ride.

- #10962 1/8" Motor Mount Spacer (Pair)
- #10964 1/4" Motor Mount Spacer (Pair)
- #10966 1/2" Motor Mount Spacer (Pair)
- #10968 1" Motor Mount Spacer (Pair)
- #10978 2" Motor Mount Spacer (Pair)



JOES Remote Oil Filter Mounts

Plumbing your car just got a lot easier! JOES Oil Filter Mounts are available for chevy type filters or the larger Fram HP6 type filters. The tube clamp rotates every 22-1/2 degrees so you can put it almost anywhere, or mount it to a flat panel with our sheet metal mount. There are 4 ports, two for oil lines and two for accessories like a temperature gauge and sending unit.

- #42510 Chevy Remote Oil Filter Mount, 1-1/4" Tube Clamp 1/2" NPT Ports
- #42512 Chevy Remote Oil Filter Mount, 1-1/2" Tube Clamp 1/2" NPT Ports
- #42514 Chevy Remote Oil Filter Mount, 1-3/4" Tube Clamp 1/2" NPT Ports
- #42530 Chevy Remote Oil Filter Mount, Sheet Metal Mount
- #42610 Fram HP6 or Wix Oil Filter Mount, 1-1/4" Tube Clamp #12 SAE Ports

- #42612 Fram HP6 or Wix Oil Filter Mount, 1-1/2" Tube Clamp #12 SAE Ports
- #42614 Fram HP6 or Wix Oil Filter Mount, 1-3/4" Tube Clamp #12 SAE Ports
- #42630 Fram HP6 or Wix Oil Filter Mount, Sheet Metal Mount
- #42558 Reducer Bushing 1-3/4" to 1-5/8" tube



JOES Wide 5 Accelerator Hubs

JOES Cast Wide 5 Accelerator Hubs were designed from the ground up using the latest in CAD design and the ultimate in casting technology. Stress Analysis software allowed the JOES team to simulate race conditions during the design phase. The result is the perfect balance between lightweight and strength. On track and destructive testing allowed our engineers to centralize the mass closer to the spindle and rear axle center line reducing rotational inertia for quick acceleration and faster braking.

JOES Wide 5 Cast Hubs can be installed with conventional grease or low friction oil. The rotor flange is drilled for 8 bolt rotors and is slotted to reduce weight and heat transfer into the hub. The optional T-nuts improve braking and reduce drag while extending rotor life.

JOES Cast Wide 5 Hubs use highly refined rotary degassed flux injected aluminum creating a rigid and lightweight part. In house CNC manufacturing and our quality control systems ensure that your hubs run true. Centralizing the hub mass creates a path for air to flow out of your engine compartment increasing down force while providing airflow to cool your brake components and shocks. The bare hub is ultra strong and weighs only 7.5 lbs before races and studs are installed.

JOES Wide 5 Accelerator Front Hub Kit

JOES Wide 5 Accelerator Hub Kit

Each Front Kit Includes:

- JOES Wide 5 Accelerator Hub (#25336)
- Dust Cover with Steel Insert (#25322)
- Dust Cover 5 Bolt Set (#25320)
- Spindle Nut Assembly (#25120)
- Inner and Outer Bearings
- JOES Exclusive Seal Retainer Assembly
- Seal

#25337-F Wide 5 Accelerator Floater Hub Kit, Front

#25336 Wide 5 Accelerator Hub with races, rotor flange, seal retainer and studs, Floater Style



HUBS

JOES Hub Rotor Flange

Bolt rotor directly on or use with T-nuts to float your rotor. Machined from 6061-T6.

#25361 Billet Hub Floater Rotor Flange



JOES Billet Wide 5 Dust Cover

JOES Wide 5 Dust Cover allows you to check your caster and camber quickly and accurately by sticking your magnetic gauge to it. Machined from 6061-T6 with a zinc plated steel insert.

#28500 Wide 5 Dust Cover with Steel Insert, 8-bolt
#25322 Wide 5 Dust Cover with Steel Insert, 5-bolt



JOES Wide 5 Accelerator Rear Hub Kit

Each Rear Kit Includes:

- JOES Wide 5 Accelerator Hub (#25336)
- Drive Flange (#25342)
- Drive Flange Cover (#25343)
- Drive Flange Stud Kit (#25319)
- Spindle Nut Assembly (#25120)
- Inner and Outer Bearings
- JOES Exclusive Seal Retainer Assembly
- Seal

#25337-R Wide 5 Accelerator Floater Hub Kit, Rear



JOES Wide 5 Drive Flange Cover

JOES Wide 5 Drive Flange Covers are O-ring sealed to keep out the dirt or to run oil-filled.

#25343 Wide 5 Drive Flange Cover

JOES Wide 5 Drive Flange

JOES Wide 5 Drive Flange is made from 7075-T6 Aluminum and features an O-ring to seal your hub.

#25342 Wide 5 Drive Flange

JOES Wide 5 Drive Flange Stud Kit

#25319 Wide 5 Drive Flange Stud Kit

JOES Wide 5 Hub Replacement Seals & Bearings

- #25081** Replacement Wide 5 Hub Seal
- #25091** Replacement O-Ring Wide 5 Drive Flange to Hub & Wide 5 Front Dust Cover
- #25092** Replacement JOES Seal Retainer System O-Ring
- #25093** Replacement O-Ring Wide 5 Drive Flange Cover
- #25131** Wide 5 Inner Bearing
- #25141** Wide 5 Inner Race
- #25132** Wide 5 Outer Bearing
- #25142** Wide 5 Outer Race

JOES 5x5 Billet Hubs

Now in Black with pressed in studs, secured with set screws. JOES hubs are machined from billet 6061-T6 aluminum and feature many improvements over conventional designs. The rotor flange is drilled for 8 bolt rotors and is slotted to reduce weight and heat transfer into the hub. The optional T-nuts improve braking and reduce drag while extending rotor life. The front dust cover is O-ring sealed to the hub and retained with five allen screws to eliminate cracking and leaking common with other hubs. Supplied with studs and races installed and fits popular 2" spindle pin.

JOES Wide 5x5 Billet Front Hub Kit

Each Front Kit Includes:

- Inner and Outer Bearings
- JOES 5x5 Billet Hub (#25310-B)
- JOES Exclusive Seal
- Dust Cap w/Indicators (#25026)
- Retainer Assembly
- Spindle Nut Assembly (#25120)
- Seal

#25315-BF 5x5 Billet Aluminum Hub Floater Style Kit, Front

#25310-B 5x5 Billet Aluminum Hub with races, rotor flange, seal retainer and studs, Floater Style



JOES Spindle Nut Assembly

JOES Spindle Nut Assembly stays put at any torque settings. The JOES System has multiple lock down points and the slotted retainer ensures that you can line up the spindle tab at any torque setting.

#25120 Spindle Nut Assembly



JOES 5x5 Hub Replacement Seals & Bearings

- #25080** Replacement 5x5 Hub Seal
- #25092** Replacement JOES Seal Retainer System O-Ring
- #25130** Replacement 5x5 Bearing
- #25140** Replacement 5x5 Race



JOES T-Nuts for Rotor Flange

JOES T-Nut System and Rotor Flange improve your braking efficiency. Hardened T-Nuts self center in the rotor flange. The small amount of movement allows your rotor to grow and shrink through heat expansion. As the rotor heats and cools the T-Nuts prevent heat expansion related warping resulting in a smooth and firm pedal through out the race. Pads last longer and you get more braking power. The T-Nuts and Flange isolate heat transfer to the hub and dissipate caliper heat right at the source.

#25155 T-Nuts for Rotor Flange- 8 pack

JOES Wide 5x5 Billet Rear Hub Kit

Each Rear Kit Includes:

- JOES 5x5 Billet Hub (#25310-B)
- Steel Drive Flange (#25045)
- Drive Flange Cover w/ Indicators (#25036)
- Spindle Nut Assembly (#25120)
- Inner and Outer Bearings
- JOES Exclusive Seal Retainer Assembly
- Seal

#25315-BR 5x5 Billet Aluminum Hub Floater Style Kit, Rear

#25045



#25036

#25081

#25120

#25130

JOES 5x5 hubs feature many improvements over conventional designs. The rear seal slips easily into an O-ring sealed bore and is held in place by JOES Seal Retainer System. JOES Seal Retainer System prevents the seal from slipping when the hub gets hot and allows you to reuse seals over and over, just slip expensive seals in with your fingers and lose the hammer.



JOES Hub Rotor Flange

Bolt rotor directly on or use with T-nuts to float your rotor. Machined from 6061-T6.

#25361 Billet Hub Floater Rotor Flange



Rotor Bolt Kit

#25150



#25045
Steel Drive Flange

HUBS



JOES Aluminum 5x5 Dust Cap with Indicators

JOES Aluminum 5x5 Dust Cap is designed to help locate your wheel during a pit stop. Indicators are machined into cap to help you locate the holes in your wheel with your studs. It is threaded 1/4"-20 on the end so you can attach our steel disc to it for easy caster and camber measurements. Machined out of billet 6061-T6 aluminum.

#25026 Aluminum 5x5 Dust Cap with Indicators

JOES Aluminum 5x5 Drive Flange Cover with Indicators

JOES Aluminum 5x5 Drive Flange Cover is designed to help locate your wheel during a pit stop. We machined indicators that help you line up the holes in your wheel with your studs.

#25036 Aluminum 5x5 Drive Flange Cover with Indicators



JOES Dust Cap

Machined out of 6061-T6 aluminum. Requires drilling and tapping two 8-32 holes in your hub.

#28600 Chevy Dust Cap (Each)
#28610 Ford Dust Cap (Each)



JOES Dust Cover 5 Bolt Set

Why use heavy steel hex bolts when you can use JOES lightweight aluminum dust cover bolts?

#25320 Aluminum Dust Cover 5 Bolt Set

JOES Wheel Spacers

Use JOES Wheel Spacers to push the rules right to the limit by getting your track width as wide as possible. Or maybe you just need some tire clearance for your trailing arms or tie rods. JOES Wheel Spacers are machined from 6061-T6 aluminum.

- #38120** 1/8" Universal Wheel Spacer 5x5, 4.75, 4.5
- #38121** 1/4" Universal Wheel Spacer 5x5, 4.75, 4.5
- #38125** Wide 5 Wheel Spacer 1/8"
- #38250** Wide 5 Wheel Spacer 1/4"

JOES Steel Disk

Bolt this disk to our JOES 5x5 Dust Cap so you can attach your magnetic caster camber gauge.

#28025 Steel Disk



JOES Drill & Tap Guide

JOES Drill & Tap Guide allows you to quickly and precisely tap the holes you need in stock style hubs for a perfect fit with our Chevy and Ford Dust Caps.

#28601 Chevy Cap Drill & Tap Guide



JOES Sway Bar Mount

Made from 7/8"-9 threaded stock 10" long with a 1-1/2" or 2-1/8" eyelet welded on the end. Finished with zinc plating. Two jam nuts are included.

#11905 2-1/8"



JOES Sway Bar Adjuster

Bolt on JOES sway bar adjuster on both sides for perfect alignment of big bars or standard bars. The JOES swivel eye is designed to let you drop the bar out the bottom for fast changes helping you to squeeze in set up changes with minutes to go in the last practice. The swivel makes for quick changes and keeps the bar from binding under travel and load.

#11950 Sway Bar Slider Mount Assembly, 1-1/2" I.D.

#11955 Sway Bar Slider Mount Assembly, 2-1/8" I.D.



JOES Sway Bar Bushings

Made from bearing quality plastic. Helps keep sway bars from binding.

#11915 1-1/4" I.D. x 2-1/8" O.D.

#11920 1-1/2" I.D. x 2-1/8" O.D.

#11925 1-3/4" I.D. x 2-1/8" O.D.



JOES Swivel Eye & Threaded Stem

JOES Swivel Eye unbolts so you can make quick sway bar changes. It also keeps your sway bar from binding.

#11970 Swivel Eye, 1-1/2" I.D.

#11975 Swivel Eye, 2-1/8" I.D.

#11980 Swivel Eye Only, 1-1/2" I.D.

#11985 Swivel Eye Only, 2-1/8" I.D.

#11990 Shaft, 7/8" -9, Only



JOES Quick Release Canister Mount

No more tie straps, bailing wire or bubble gum needed to hold your shock canisters or remote filters! JOES Canister Mount features a quick release nylon strap that can secure any round canister from 1-1/2" to 3" in diameter.

#19410 Canister Mount 1-1/4" clamp

#19411 Canister Mount 1-3/8" clamp

#19412 Canister Mount 1-1/2" clamp

#19414 Canister Mount 1-3/4" clamp

#19416 Canister Mount 2" clamp

#19430 Canister Panel Mount

JOES 5/8" Tie Rod Quick Adjuster

JOES Tie Rod Quick Adjuster allows you to make all your toe adjustments out at the spindle. No more fumbling around to get the inner jam nut loose. Works with any 5/8"-18 radius rod. Made of high strength steel.

#14751 5/8" Tie Rod Quick Adjuster-Steel



JOES Caliper Mount

Hang your rear calipers with a pair of lightweight JOES Caliper Mounts. Sized to mount calipers with a standard 3-1/2" bolt spacing. Available for 11-3/4" diameter rotors. Caliper Mounts take on tough brake loads thanks to 6061-T6 aluminum. Clamps securely to 3" diameter axle tubes.

#10200 Caliper Mount, 11-3/4"



JOES Rear Mount

JOES Rear Mount has been updated with a keyway to locate the mount and prevent rotation on the axle tube. The mount includes keys for both steel and aluminum axle tubes. Simply locate your rear end, slip the key in place and weld the key to the axle tube. JOES superior design allows close mounting to the wheel and tire. Axle centerline to shock mount measures 6-5/8" vertically. Shock absorbers are located by a press-in steel boss and threaded 1/2" stud. Rear Mounts clamp securely to 3" diameter axle tubes. Torque Rear Mount caps to 80 ft lbs.

#11402 JOES Rear Mount



JOES Panhard Mount

Mount your Panhard bar with a JOES Panhard Mount. Just loosen the bolts and slide JOES Panhard Mount as little or as much as you need. Choose between a 1-3/4" round, or 2" square tube mount. It's CNC machined from billet aluminum to withstand the roughest racing conditions.

#11100 Panhard Mount, 1-3/4"



JOES Rear Mount/ Caliper Mount Installation Kit

Install your Rear Mounts and Caliper Mounts easily using a JOES drill bushing, drill bit and tap.

#11475 Installation Kit



JOES 3/8"-16 Quick Change Gear Cover Nuts

Made from 7075 billet aluminum. One piece design means no washer to smash or mushroom and fall off. Cross drilled design makes it the lightest cover nut available on the market and also allows for safety wiring.

#34358 10 Pack - Quick Change Gear Cover Nuts

#34359 2 Pack - Quick Change Gear Cover Nuts



JOES 3rd Mount

Locate your car's third member securely with a pair of JOES 3rd Mounts. Made from 6061-T6 aluminum.

#12150 3rd Mount, 3 Hole (Pair)

JOES Spring Pre-Loader

There can be huge advantages to using a spring Pre-Loader on your race car. It is most commonly used on the right rear and allows you to run a soft spring but pre-load it so it has a high static load. You will get the benefits of running a heavy spring to get you into and through the center of the corner but also have the benefit of a lighter spring for more traction coming off the corner.

For example, if you have a 500lb spring in the right rear of your car and it has 500lbs of weight on it, it should be compressed 1". If it travels another inch it will have 1000lbs on it. Now if you use a JOES Spring pre-loader and compress a 125lb spring 4 inches it will have 500lbs on it. If it travels another inch it now has 625lb on it, 375lbs less than a 500lb spring. Fits all major shock brands.

- Improved friction band for advanced performance
- Anodized to prevent galling
- Coarse threads for faster, easier adjustments
- Torrington Bearing included
- Fits all major shock brands
- Now available for 3" and 5" springs

- #19500 3" Spring Pre-Loader
- #19501 Pre-Load Travel Indicator
- #19502 3" Torrington Thrust Bearing Set
- #19503 5" Torrington Thrust Bearing Set
- #19505 5" Spring Pre-Loader

Shown with #19501 Pre-Load Travel Indicator. Springs sold separately



JOES Spring Retainer Spacer Kit

Spacers keep Pre-Loader centered in Spring Cups, reducing movement or friction. Made from aluminum.

#19520 Spring Retainer Spacer Kit



JOES Fender Brace

Keep your fenders in place by supporting them with our adjustable fender brace. Choose from aluminum rods, or flexible plastic so they won't break while you're giving your competition a little lovin'. The ready made kit comes with all hardware to keep your body from flapping in the wind. Works great to Support Windows and Roofs also!

- #12050 Flexible Adj. Fender/Window/Roof Brace
- #12055 Aluminum Adj. Fender/Window/Roof Brace
- #12053 Flexible Replacement Rod



JOES Dual Fender Brace Kit

JOES Dual Fender Brace Kit includes 2 rods to give extra support to your fenders and quarters. The frame bracket is built to hold the 2 rods on the inside and brackets are included for a clean mount to your body. The dual kit is adjustable so you can adjust your fenders for aero balance.

- #12052 Flexible Adj. Fender/Window/Roof Dual Brace
- #12057 Aluminum Adj. Fender/Window/Roof Dual Brace

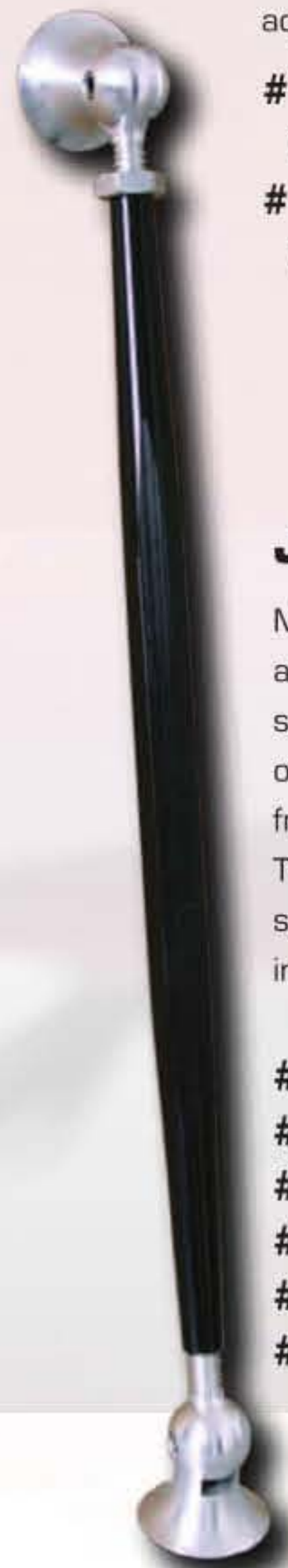

JOES Body Supports

Manufactured from aircraft aluminum, anodized and laser etched, JOES supports swivel to allow a full range of motion for use on fenders, spoilers, front splitters, windows and more. The mounting surface fans out for support and the ends are machined for improved aerodynamics.

- #12074 Billet Body Support 4"
- #12075 Billet Body Support 5"
- #12076 Billet Body Support 6"
- #12078 Billet Body Support 8"
- #12079 Billet Body Support 9"
- #12080 Support Back-up Washer (4 qty)



JOES Hood Support

Prop your hood up with super lightweight JOES Hood Supports. Made from 6061-T6 aluminum.

- #12000 Pair



JOES Gussets

Weld real safety and rigidity into your chassis with a low cost, high strength, wrap-around JOES gusset. Made from .060" mild steel sheet. Fits 1-1/2", 1-5/8" and 1-3/4" tubing and joint angles from 70 - 90 degrees.

- #10400 JOES Gusset



JOES Weld-In Chassis Bungs

JOES Weld-in Chassis Bungs are made out of 1018 steel. They work great for mounting components to tubing that need a little more strength.

- #37330 1/4"-20 Chassis Bung, 4-Pk
- #37332 5/16"-18 Chassis Bung, 4-Pk
- #37334 3/8"-16 Chassis Bung, 4-Pk
- #37336 7/16"-14 Chassis Bung, 4-Pk
- #37338 1/2"-13 Chassis Bung, 4-Pk



JOES Clamp

Best clamp on the market! Weld a JOES Clamp to any aluminum component that you want to bolt to the chassis. Tighten two allen screws and the component is mounted securely. Made from 6061-T6 aluminum.

- #10800 JOES Clamp, 1"
- #10801 JOES Clamp, 1-1/4"
- #10802 JOES Clamp, 1-1/2"
- #10803 JOES Clamp, 1-5/8"
- #10804 JOES Clamp, 1-3/4"
- #10806 JOES Clamp, 2"





JOES Window Net Mounting Kit

JOES engineers have designed a Window Net Mounting Kit that looks cool and installs quickly. The unique design disassembles which allows you to slide a new window net right on. The rods are powder coated for a finished and professional look that won't rust and the anodized handle is awesome. Competing models require you to weld after the net is installed risking damage to your safety equipment. *Window Net not included

- #12095 Window Net Mounting Kit, 18"x18" Nets
- #12096 Window Net Mounting Kit, 18"x24" Nets



JOES Shift Boot

Making adjustments to your shift linkage or taking off the shift lever for a motor or transmission change is easy with a JOES Shift Boot. Just unsnap it and you have easy access to the bolts. Made from fire retardant material with a reflective heat and oil resistant liner. Shift Boot Frame Dimensions, 7-1/2"x5-1/2".

- #16500-BK Shift Boot
- #16550 Shift Boot, Carbon-X



JOES Lightweight Shift Knob

Can't find 'em? Grind 'em! We can't guarantee that you'll find the right gear every time but at least you'll be shifting in style with a polished JOES Lightweight Shift Knob. Also reduces heat transferred from your shift lever. Made from 6061 billet aluminum.

- #16022 Shift Knob, 3/8"-16



JOES Helmet Hook

Tired of scratching up the old brain bucket by just tossing it into the race car? Hang that skid lid on a JOES Helmet Hook. Simply bolt it to a cross tube on the roll cage and you'll be hooked. Made from 6061-T6 aluminum.

- #10600-G Helmet Hook, 1"
- #10601-G Helmet Hook, 1-1/4"
- #10602-G Helmet Hook, 1-1/2"
- #10603-G Helmet Hook, 1-5/8"
- #10604-G Helmet Hook, 1-3/4"



JOES Extended Clamp

Best clamp on the market! Weld a JOES Extended Clamp to any aluminum component that you want to bolt to the chassis. Tighten two allen screws and the component is mounted securely. Made from 6061-T6 aluminum.

- #10812 Extended JOES Clamp, 1-1/2"
- #10814 Extended JOES Clamp, 1-3/4"



JOES Steering Wheel Hook

Hang your Steering Wheel securely and out of the way after each race with JOES Steering Wheel Hook. Made from 6061-T6 aluminum.

- #10702-G 1-1/2"
- #10704-G 1-3/4"



JOES Reducer

Step down your JOES Clamp from 1-3/4" to 1-5/8", 1-1/2" or 1-1/4" with an aluminum JOES Reducer. Comes in handy when moving a Radio Box, Drink Holder, Coil Clamp, etc., to a smaller size tube.

- #13000 1-3/4" to 1-1/4"
- #13001 1-3/4" to 1-3/8"
- #13002 1-3/4" to 1-1/2"
- #13003 1-3/4" to 1-5/8"





JOES Billet Brake Balance Adjuster Cable Style

We have updated our Adjuster to include a cable and sleeve that gives you more installation flexibility and will give you a more positive feel when adjusting your brake balance.

#17035 JOES Billet Brake Balance Adjuster

#17037 JOES Retro Fit Cable

JOES Shift Levers

JOES Shift Levers are lightweight but strong enough to handle some aggressive shifting. They are machined out of 6061-T6 aluminum and have a 3/8"-16 stud for your shift knob.

#16998 4" Lever-Straight

#17000 7" Lever-Straight

#17005 8" Lever-2" Left Offset

#17010 8" Lever-3" Set-back

8" Lever, 3"
Set-back

8" Lever, 2"
Left Offset

4" Straight
Lever

7" Straight
Lever



JOES Fire Extinguisher Bracket

JOES engineers have come up with the best billet fire extinguisher mounting bracket on the market. The pull pin has an oversized billet knob that is red anodized to spot quickly. The mounting housing is strong and indexes for a quick connection. Hose clamp screws are hidden in the housing for a clean appearance. Use the Panel Mount in your car, at the shop or in your trailer. Works great for small Nitrous bottles too! Roll bar mounts are available in all popular sizes.

#12821 Fire Extinguisher Bracket - 1-1/4"

#12822 Fire Extinguisher Bracket - 1-1/2"

#12823 Fire Extinguisher Bracket - 1-5/8"

#12824 Fire Extinguisher Bracket - 1-3/4"

#12826 Fire Extinguisher Bracket - 2"

#12830 Fire Extinguisher Bracket - Panel Mount



JOES Nitrous Bottle Mounts

Engineered to place your bottle at optimum angle. Multiple clamp and mount sizes ensure you get the best fit for your needs. Made from billet aluminum for a secure hold. Can be used for many different types of bottles.

Tube Clamps

- #23003 1" Tube Clamp
- #23005 1-1/4" Tube Clamp
- #23006 1-3/8" Tube Clamp
- #23007 1-1/2" Tube Clamp
- #23008 1-5/8" Tube Clamp
- #23009 1-3/4" Tube Clamp

Bottle Mounts

- #23030 2" Bottle Mount
- #23050 4" Bottle Mount
- #23065 4-3/8" Bottle Mount
- #23080 5-1/4" Bottle Mount



JOES Radio Box

JOES Radio Boxes come equipped with a swivel mount to keep your box vertical on nearly any bar. Our quality craftsmanship will protect your investment from damage and the lightweight package mounts in seconds. Measures 5"x3-3/4"x2-1/2".

- #11312 Small Radio Box, 1-1/2"
- #11314 Small Radio Box, 1-3/4"
- #11320 Panel Mount Radio Box



JOES Lightweight Car Cover

JOES Car Cover is lightweight and less bulky for easy storage. The lightweight cover installs quickly to keep the heat out on hot days and it dries in a hurry when you get caught in the rain. Heavy Denier Nylon protects your car without the need of a felt lining that can suck up water and mildew. We added a zippered opening on the windshield, rear window, and driver's window so you can drive your car through the pits or into the trailer and see where you are going. Comes with a compact storage bag that saves you precious room in your hauler. Includes grommets.

- #27500 JOES Light Weight Car Cover



JOES Drink Holder

Keep a cool drink close at hand while behind the wheel. JOES Drink Holder mounts quickly anywhere on the roll cage. Welded to the back of the aluminum housing is a JOES Clamp. Just tighten two stainless steel cap screws to mount a JOES Drink Holder in seconds.

- #12602-G Drink Bottle Holder 1-1/2"
- #12604-G Drink Bottle Holder 1-3/4"
- #12605-G Drink Bottle Holder Panel Mount
- #12610 Drink Bottle

JOES Super Drink Holder

Don't let dehydration be a factor in the outcome of your race! Drink plenty of liquid from this 1/3-gallon drink cooler. Comes with 4 feet of hose

- #12712-G Super Drink Holder, 1-1/2"
- #12714-G Super Drink Holder, 1-3/4"
- #12725 Replacement Drink Bottle
- #12755 Replacement Hose & Bite Valve Kit



JOES Weather Resistant Switch Panel Assemblies

JOES switch panels are assembled with high quality components. The 40 amp high capacity ignition switch has an aircraft style flip cover and the start button and 40 amp accessory switches have weather proof boots.

Why Choose JOES?

At JOES, we continuously strive to make race products better. Our switches and Heavy Duty Starter Buttons are treated with rubber sealant to keep detrimental water and dirt from entering your electrical products. Our shop is filled with racers and they all demand rubber sealed electrical products, if we want the added protection from dirt and moisture then we know you do too! Flip Up covers are a mandatory safety item. All of our ignition switch panels come standard with a Red Flip Up Cover. Why mess around - get all the best features and count on JOES to provide quality every time!

#46100 Panel-Flip Up/Ign./
Start Button/Accessory Switch
& Rubber Sealant



Panel Dimensions:
5" x 3-1/2"



#46105 Panel-Flip Up/Ign./
Start Button/Accessory Switch - w/Light
& Rubber Sealant

#46110 Panel-Flip
Up/Ign./ Start Button
& Rubber Sealant



Panel Dimensions:
3-3/8" x 3-1/2"



#46115 Panel-Flip Up/Ign./ Start Button -
w/Light & Rubber Sealant



Panel Dimensions:
6-5/8" x 3-1/2"



#46120 Panel-Flip Up/
Ign./ Start Button/
2 Accessory Switch
& Rubber Sealant

#46125 Panel-Flip Up/
Ign./ Start Button/2 Accessory -
w/Lights & Rubber Sealant

#46130 Panel- 4 Accessory Switch
w/Boots & Rubber Sealant



Panel Dimensions:
6-5/8" x 3-1/2"



#46135 Panel- 4 Accessory Switch w/Boots -
Lights & Rubber Sealant

JOES Battery Disconnect Switch Panel

Disconnect your battery in an emergency or use it to help prevent battery drain. Order the 4 terminal switch for cars with an alternator.

- #46200 Battery Disconnect - 2 Terminal
- #46215 Battery Disconnect - 4 Terminal

Panel Dimensions:
3-1/8" x 3-1/8"

#46215 shown



Weather Resistant On-Off Switch

40 amp high capacity ignition switch or accessory switch with weatherproof boot. We treat the back with our rubber sealant so your car starts when you need it most.

- #46102 On-Off Switch w/ Boot & Rubber Back Sealant



Flip Cover

Flip Covers verify that the switch is off, when it is down it is off. It also helps you turn your car off in an emergency and keeps it from being turned on by accident.

- #46103 Flip Cover



Weather Resistant Start Button

JOES Heavy Duty Start Button comes standard with a weather proof rubber boot on the front. We utilize heavy duty contacts and coat the back with our rubber treatment sealing out dirt and moisture. Why take a chance? Go with JOES!

- #46101 Heavy Duty Start Button w/ Rubber Boot & Rubber Back Sealant



JOES Switch Panel Bracket

Easily mount a JOES Switch Panel, battery disconnect or any other panel with a pair of our Switch Panel Brackets. They can be used to mount your panel above or below your chassis tubing.

- #46172 Switch Panel Bracket, 1-1/2" [Pair]
- #46174 Switch Panel Bracket, 1-3/4" [Pair]

JOES Switch Panel Labels

JOES Switch Panel Labels will help you organize your switches. 40 different labels are included that work with many different types of racing, and they are made from high quality vinyl.

- #17501 JOES Switch Panel Labels

JOES SWITCH LABELS

#TEAMJOES

| | | | | | |
|------------|--------|---------------|-------------|---|---------|
| ON | OFF | FAN | RADIO | ← | BRAKE L |
| ON | OFF | FAN | GAUGE PANEL | → | BRAKE R |
| ON | OFF | T. CONTROL | X-OVER | | BRAKE F |
| IGNITION | START | CRANK TRIGGER | ALTERNATOR | | A/C |
| WATER PUMP | WIPER | HIGH | LOW | | HELMET |
| FUEL PUMP | LIGHTS | WING UP | WING DOWN | | FRONT |
| | | | | | REAR |
| | | | | | NITROUS |
| | | | | | TIGHT |



JOES Wide Angle Mirrors

Easily fasten a mirror to your race car with our quality wide angle mirror kits. Brackets are billet aluminum and anodized black.

WIDE ANGLE MIRROR KIT

1-1/2" Clamp

- #11272 14" Mirror Kit w/std. Brackets
- #11272-L 14" Mirror Kit w/5" Brackets
- #11282 17" Mirror Kit w/std. Brackets
- #11282-L 17" Mirror Kit w/5" Brackets

1-3/4" Clamp

- #11274 14" Mirror Kit w/std. Brackets
- #11274-L 14" Mirror Kit w/5" Brackets
- #11284 17" Mirror Kit w/std. Brackets
- #11284-L 17" Mirror Kit w/5" Brackets

2" Clamp

- #11276 14" Mirror Kit w/std. Brackets
- #11286 17" Mirror Kit w/std. Brackets

WIDE ANGLE MIRROR ONLY

- #11279 14" Mirror Only
- #11289 17" Mirror Only

BRACKETS ONLY

1-1/2" Clamp

- #11252 Standard Bracket Only, Pair
- #11262 5" long Mirror Bracket Only, Pair

1-3/4" Clamp

- #11254 Standard Bracket Only, Pair
- #11264 5" Long Mirror Bracket Only, Pair

2" Clamp

- #11256 Standard Bracket Only, Pair
- #11266 5" Long Mirror Bracket Only, Pair



Standard Brackets

JOES Long Brackets for Wide Angle Mirrors

Easily fasten a mirror to your race car with our quality wide angle mirror kits.



5" Brackets



JOES Side View Mirror

Keep your competition in sight with our 3" diameter Side View Mirror. Mounts to your roll cage in seconds and could be your most important piece of equipment.

- #11212 3" Side Mirror, 1-1/2" Clamp
- #11214 3" Side Mirror, 1-3/4" Clamp
- #11216 3" Side Mirror, 2" Clamp



Extended Bracket Side View Mirror

JOES Extended Side View Mirror

- #11222 3" Ext. Side View Mirror, 1-1/2" Clamp
- #11224 3" Ext. Side View Mirror, 1-3/4" Clamp
- #11226 3" Ext. Side View Mirror, 2" Clamp
- #11232 Extension Bracket Only, 1-1/2" Clamp
- #11234 Extension Bracket Only, 1-3/4" Clamp
- #11236 Extension Bracket Only, 2" Clamp

DID YOU KNOW?

DID YOU KNOW ?

JRP MANUFACTURES PARTS OUTSIDE OF THE RACING INDUSTRY.

JRP HAS 21 CNC MACHINES, TURNING AND MILLING.

JRP HAS BEEN MANUFACTURING AND DISTRIBUTING PARTS SINCE 1989, 30 YEARS.

JRP HAS ROBOTIC, MIG AND TIG WELDING CAPABILITIES.

JRP DESIGNS, MANUFACTURES, PACKAGES, WAREHOUSES, AND SHIPS OUT OF ONE FACILITY.

JRP HAS OVER 40 EMPLOYEES.

JRP MANUFACTURES PARTS FOR FITNESS, AFTERMARKET AUTOMOTIVE, ENVIRONMENTAL, ARCHITECTURAL, TOOLING, MEASUREMENT INDUSTRIES AND MORE.

WE ARE CONFIDENT THAT OUR EXPERIENCED AND ENERGETIC STAFF CAN PROVIDE YOU WITH SUPERIOR RESULTS.



JOES All New GoPro Mount

JOES GoPro mounts are high quality aluminum mounts that are designed to swivel and pivot so you can aim your camera in the perfect direction. Our mounts are solid, compared to cheap plastic versions, and your videos will turn out much clearer.

NEW!

*GoPro & Case
not included.

GoPro Swivel Assembly
#60205 GoPro
Swivel Assembly

CAMERA

CAMERA

CAMERA

JOES RACING PRODUCTS

FARRELL
FRAMEWORKS



**JOES Racing Products
600 Farrell Chassis**

Winning is the ultimate goal and properly preparing to win can be the difference between first and last. At JOES, we want you to have the greatest chance of success by supplying you with the equipment and support that it takes to win races and championships. Every detail of our cars has been carefully designed for safety, ease of maintenance, and performance. We think we have an awesome car and we think you will too.



- Raised Cage with 1-3/8" Dia. .083 wall Down Tubes
- .095 Wall Front Torsion Tubes
- Industry Standard Engine Mount
- Designed for Jacobs Ladder
- Laser Cut Aluminum Body
- Wide Drivers Compartment
- Chromoly Tubing Throughout
- TIG Welded
- Top Quality Craftsmanship

**JOES Micro Sprint
Deluxe Kit**

Chassis w/ Fitted Body, Nerfs, & Bumpers

- (1) Power Steering Unit ★
- (8) Torsion Bushings
- (4) Torsion Bars
- (4) Torsion Arms and Stops
- (1) Complete Rear Axle
- (1) Jacobs Ladder
- (1) Shift Lever and Cable
- (1) Steering Rack, Shaft, & U-Joint
- (1) Brake Reservoir Kit
- (1) Throttle & Brake Pedal
- (1) Brake and Throttle Linkage Kit
- (1) Rear Brake Line Kit
- (1) Radiator w/ Cap
- (1) 20" Steel Brake Rod w/ Steel Heims
- (1) 15" Dished Steering Wheel
- (1) Billet Master Cylinder
- (1) Wilwood Caliper w/ Pads
- (1) Front Radius Rod Kit w/ Alum. Heims
- (1) Rear Radius Rod Kit w/ Alum. Heims
- (1) Bladder Fuel Cell w/ Joes Top Plate
- (1) Steel Bolt Kit
- (1) Chain Block System
- (1) Chain Tensioner

#51500-Deluxe JOES Micro Sprint Deluxe Kit

JOES Micro Sprint Pro Deluxe Kit

Chassis w/ Fitted Body, Nerfs, & Bumpers

- (1) Power Steering Unit ★
- (8) Torsion Bar Bushings
- (4) Torsion Bars
- (4) Torsion Arms w/ Rear Heims
- (4) Torsion Stops
- (4) Keizer Polished Wheels
- (4) Hoosier Tires
- (2) Nose Wing Posts and Straps
- (2) Nose Wing Post Clamps
- (2) Top Wing Roller Posts
- (1) Complete Rear Axle
- (1) Complete Front Axle
- (1) Jacobs Ladder
- (1) Shift Lever and Cable
- (1) Steering Rack, Shaft, and U-Joint
- (1) Throttle & Brake Pedal
- (1) Brake & Throttle Linkage Kit
- (1) Rear Brake Line Kit
- (1) Remote Brake Reservoir Kit
- (1) 20" Steel Brake Rod w/ Steel Heims
- (1) 15" Dished Steering Wheel
- (1) Billet Master Cylinder
- (1) Wilwood Caliper w/ Pads
- (1) Front Radius Rod Kit w/ Alum. Heims
- (1) Rear Radius Rod Kit w/ Alum. Heims
- (1) Bladder Fuel Cell w/ Joes Top Plate
- (1) Steel Bolt Kit
- (1) Chain Guide Block
- (1) Chain Tensioner
- (1) DID 520 130 Link Chain
- (1) Throttle Cable
- (1) Clutch Cable
- (1) Top Wing Tree
- (1) Electric Wing Slider
- (1) Set of Outlaw Top and Nose Wing

#51500-ProDeluxe JOES Micro Sprint Pro Deluxe Kit

**To customize your chassis order to suit your individual needs, please feel free to contact our sales department.*

**We offer Halo and Intake Protection packages. Call to learn more!*



JOES Micro Sprint Conversion Kit

Chassis w/ Fitted Body,
Nerfs & Bumpers

- (8) Torsion Bar Bushings
- (4) Torsion Stops
- (4) Torsion Arms, Front & Rear
- (1) Shift Lever
- (1) Linkage Kit
- (1) Radiator and Cap
- (1) LR Bird Cage
- (1) RR Bird Cage
- (1) Front Axle
- (1) Jacobs Ladder

#51500-Conversion JOES Micro
Sprint Conversion Kit



JOES Micro Sprint Chassis Kit

- Chassis
- Complete Body Kit
- Complete Set of Bumpers & Nerfs
- Dzus Buttons & Springs

#51500 JOES Micro Sprint
Chassis Kit

*"That car is as close
to a sprint car as it can be.
It does all the things
a 410 or 360 sprint car
does, just on a smaller scale.
It squats hard on the left
side and really drives
off the corner."*

— Gary Taylor



TeeJay Crawford Photography Photo

MICRO SPRINT



JOES Micro Sprint Carburetor Air Cleaner Kit

JOES Micro Sprint Air Cleaner Kit comes complete and ready to bolt on. Gain maximum airflow while protecting your engine from the harsh environment seen in dirt track racing in one easy bolt on kit.

#25850 Micro Sprint Carburetor Air Cleaner Kit

HONDA  YAMAHA SUZUKI

JOES Micro Sprint Carb Adapter Kits

JOES TSO Carb Adapters are precision CNC machined to help mate your carburetor to your head perfectly. JOES manufactures the billet adapters with O-rings to seal out dirt, protecting and extending the life of your engine. These adapters are required to run the 600 Restricted class at the Tulsa Shootout, but are compatible with all 600 engines.



- #25851-TSO Micro Sprint Honda Carb Adapter, 2007-2009, Complete TSO Set
- #25852-TSO Micro Sprint Yamaha Carb Adapter, 1999-Present, Complete TSO Set
- #25853-TSO Micro Sprint Suzuki Carb Adapter, 2007-2009, Complete TSO Set
- #25855 Micro Sprint Carb Adapter Boots (Set of 4)



NEW LOWER PRICE!

JOES Micro Sprint Velocity Stacks

JOES Micro Sprint Billet Velocity Stacks are precision machined for optimal airflow and performance.

- #22840 Micro Sprint Billet 5/8" Tall Velocity Stacks (set of 4)
- #22841 Micro Sprint Billet 1-3/16" Tall Velocity Stacks (set of 4)

JOES Micro Sprint R6 Carb Vents

JOES Micro Sprint Carb vents are lightweight and precision machined for easy installation. JOES microcell vent filter system is designed for optimal float bowl venting while maintaining a clean fuel system.

#25845 Micro Sprint R6 Carb Vents (Set of 2)



JOES Micro Carb Fitting

JOES Micro Carburetor fitting replaces the stock plastic fitting and has a -6 fitting for your fuel line. Built from high grade aluminum.

#25847 JOES Micro Carburetor Fitting



JOES Micro Sprint Idler Adjuster

JOES Micro Sprint Idler Adjuster allows you to fine tune the idle with just your finger tips. The lightweight CNC machined knob is anodized red, knurled for easy grip and is extended out enough in case you need to reach it from the cockpit. The JOES Idler adjuster is also equipped with a stainless steel idler screw and stainless steel spring to prevent rusting.

#25841 JOES Micro Sprint Idler Adjuster



JOES Micro Throttle/Brake Linkage kit

JOES Throttle/Brake Linkage kit has all the components necessary to easily attach your throttle cable to your pedal and your brake pedal to your master cylinder.

#25831 JOES Micro Sprint Throttle/Brake Linkage Kit



JOES Micro Sprint Billet Throttle Return Spring Kit

#25840 Micro Sprint Yamaha Carb Throttle Return Spring Kit



Micro Sprint Throttle Cable

JOES Throttle Cables are available in two lengths, 24" for inboard and 36" for outboard configurations. They have a 6mm thread on the engine side and a 8mm thread on the pedal side.

#51566 Outboard Throttle Cable
#51568 Inboard Throttle Cable



JOES Micro Sprint Sealed Bearing Front Hubs

JOES Micro Sprint Front Hubs are thick where you need it and thin where you don't for a strong yet lightweight hub package. JOES hubs are precision machined to run true and the sealed bearing design is maintenance free. Available with or without a flange so you can bolt on a rotor for a front brake.

- #25605 Micro Sprint Front Hub w/ Brake Rotor Flange
- #25610 Micro Sprint Front Hub
- #25611 Sealed Hub Replacement Bearing

#25610 Micro Sprint Hub Shown

#25605 Micro Sprint Front Hub w/ Brake Rotor Flange shown.

JOES Split Nut

Tired of using plastic nyloc nuts to hold on your Micro Sprint hubs? JOES Micro Sprint Split Nut utilizes a cinch bolt system to securely lock down your hub. Made from 6061-T6 Aluminum.

- #25601 1"-14 thread



JOES Micro Sprint Front Spindles

JOES Micro Sprint Front Spindles are machined out of 7075-T6 aluminum and are tough enough to take some serious racing abuse. They utilize bronze bushings to allow for smooth steering. Billet construction offers a durable part that bolts on the left or the right side of the axle.

- #25635 Front Spindle



JOES Micro Sprint Heat Treated King Pin

Heat treated 4340 steel allows your spindles to rotate freely even during severe conditions.

- #25644 King Pin (Qty 1)



JOES Micro Sprint Tapered Bearing Front Hubs

JOES Tapered Bearing design has the same strength as our sealed bearing hubs but the tapered bearing design spreads out the load and includes a billet cap to seal out dirt. Available with or without a flange so you can bolt on a rotor for a front brake.

- #25606 Micro Sprint Front Hub w/ Brake Rotor Flange Tapered Bearing Style
- #25609 Micro Sprint Front Hub Tapered Bearing Style
- #25612 Micro Sprint Front Hub Dust Cap
- #25616 Replacement Tapered Inner Bearing w/ seal (1)
- #25617 Replacement Tapered Outer Bearing (1)
- #25618 Replacement Tapered Bearing Race (1)

#25609 Micro Sprint Hub Shown



#25606 Micro Sprint Front Hub w/ Brake Rotor Flange shown.



Micro Sprint Torrington Thrust Bearing

Keep your Micro turning smoothly with a Torrington Thrust Bearing from JOES.

#25640 Torrington bearing



JOES Micro Sprint Front Steering Arm

JOES Micro Sprint Front Steering Arms are designed to be rigid and lightweight. Works with nearly all Micro Sprints. Anodized black with a permanent laser etched JOES logo.

#25636 Front Steering Arm



Micro Sprint Rear Brake Line Kit

- (1) 48" -2 Brake Line w/ -3 Alum. Nuts
 - (1) -3 x 1/8" NPT, 90 Deg. Adapter, Black
 - (1) -3 x 1/8" NPT, Straight Adapter, Black
- #26000** Rear Brake Line Kit



Micro Sprint Front Brake Line Kit

- (1) 16" -2 Brake Line w/ -3 Alum. Nuts
 - (1) 24" -2 Brake Line w/ -3 Alum. Nuts
 - (1) -3 Bulkhead Nut
 - (1) -3 Straight Flare Bulkhead, Black
 - (1) -3 x 1/8" NPT, 90 Deg. Adapter, Black
 - (1) -3 x 1/8" NPT, Straight Adapter, Black
- #26002** Front Brake Line Kit



JOES Micro Sprint Rotors

JOES Micro Sprint Rotors are made from 1018 steel. Drilled holes save weight without sacrificing braking. JOES rotors are designed to take the heat.

#25791 Micro Sprint Front Rotor 7" diameter

** Fits JOES brake caliper*

#25796 Micro Sprint Rear Rotor



JOES Micro Sprint Front Brake Caliper

Get through the corner quicker with superior braking power. Two 1" pistons give you the braking force needed to get you into the corner. Machined out of billet aluminum with an internal crossover. Wilwood brake pads included.

#25798 Micro Sprint Front Brake Caliper

#WIL150-4091 Replacement Wilwood Brake Pads



MICRO SPRINT

JOES Sprocket & Rotor Carriers

JOES Sprocket & Rotor Carriers are fully radiused and pocketed for maximum weight savings and strength. Precision splines keeps your JOES parts spinning true for the ultimate in performance.
1-3/4"-27 Spline.

#25675 Micro Sprint Carrier, 5/16" Bolts

#25685 Micro Sprint Carrier, 1/4" Bolts



Micro Sprint Rear Wilwood DynaPro Single LW Brake Caliper

The strong, lightweight design is perfect for your Micro Sprint rear end. They feature Quick-E-Clip pad retainers for fast pad service without caliper removal. Pads sold separately.

#WIL120-10188 Wilwood DynaPro Single LW Brake Caliper

#WIL150-12242K Replacement DynaPro Caliper Pads (BP40)

#STPGOLD#1 Replacement DynaPro Caliper Ti Pads



JOES Micro Sprint Rear Hubs

JOES Micro Sprint Rear Hubs are machined for lightweight and strength. The axle splines are precision broached helping to increase HP efficiency with a smooth transfer of power to the wheels. 1-3/4"-27 Spline.

#25615 JOES Micro Sprint Rear Hub

JOES Micro Sprint Rear Axle Nuts

Standard 1-5/8"-8 thread for most 1-3/4" axles. 2" Hex.

#25696 Micro Sprint LH Thread Rear Axle Nut

#25697 Micro Sprint RH Thread Rear Axle Nut



JOES Micro Sprint Complete Rear Axle

JOES 1-3/4" Rear Axle Kit includes all of our high end components that have been winning races for years. Everything is included, even instructions and diagrams to help you get everything lined up where it needs to be. With all the variation in motor manufacturers some additional spacers may be required to get your chain lined up perfectly. Includes:

- (1) Micro Sprint 1-7/8" Rear Axle, Black
- (2) Micro Sprint Axle Radius Spacers
- (1) Micro Sprint Brake Rotor Carrier
- (1) Micro Sprint LH Thread Rear Axle Nut
- (1) Micro Sprint RH Thread Rear Axle Nut
- (1) Micro Sprint Rear Brake Caliper Carrier [Single Bearing]
- (2) 1-3/4" Micro Sprint Splined Insert (Double Bearing)
- (1) 1-3/4" Micro Sprint Splined Insert (Single Bearing)
- (1) Micro Sprint Rear Brake Rotor, 9-1/2" Dia.
- (2) Micro Sprint Axle Spacer, 1/4"
- (2) Micro Sprint Axle Spacer, 1/2"
- (1) Micro Sprint Axle Spacer, 3/4"
- (2) Micro Sprint Axle Spacer, 1"
- (1) Micro Sprint Axle Spacer, 2-3/8"
- (1) Micro Sprint Axle Spacer, 3-1/4"
- (1) Micro Sprint Axle Spacer, 5"
- (1) Micro Sprint Axle Spacer, 7-1/8"
- (1) Micro Sprint Coned Axle Spacer, 3/4"
- (1) Micro Sprint Split Coned Axle Spacer Kit, 1-3/4" Axle
- (1) Micro Sprint LR Birdcage for 1-3/4" Axle [Double Bearing]
- (1) Micro Sprint RR Adj. Birdcage for 1-3/4" Axle [Double Bearing]
- (1) 3/8"-24 X 3/8" Eye, RH Heim Joint, Steel
- (1) 3/8"-24 RH Jam Nut, Steel

#25829 JOES Micro Sprint Complete Rear Axle

JOES Micro Sprint Rear Axle

JOES Micro Sprint Rear Axle is machined out of high strength 7075 aluminum and is extremely accurate, has 1-3/4" splines, and is 53" long. Comes with axle spacers, part #25656.

#25655-B JOES Micro Sprint Rear Axle



JOES Micro Sprint Power Steering Unit

Power steering will make a huge difference in your ability to drive fast laps from the beginning of your race to the end. We have done the research and came up with a unit that has the perfect balance between power assist and feedback. It is very simple to install and everything is included other than the bottom half of your steering column. Includes:

- Power Steering Unit
- Control Box
- Wiring Harness
- Mounting Bracket
- Steering Wheel Disconnect
- U-Joint with 3/4" I.D. Tube
- Instructions

#25978 JOES Micro Sprint Power Steering Unit



JOES Micro Sprint Front Axle

Consistency and durability is the reason for choosing the JOES Micro Front Axle. You can trust that the castor split and camber is consistent between every axle. Made out of 4130 chromoly steel.

#25650 JOES Micro Sprint Front Axle



JOES Micro Sprint Complete Front Axle

JOES Complete Front Axle includes all the high quality components you need to win races. Includes:

- (1) Micro Sprint Front Axle
- (1) Micro Sprint Front Hub w/ Rotor Flange (no rotor)
- (1) Micro Sprint Front Hub
- (2) Micro Sprint Steering Arms
- (1) Micro Sprint Tie Rod, 36" (with Heims & Spacers)
- (2) Micro Sprint Front Spindles
- (2) Micro Sprint Front Spindle Split Nuts
- (2) Micro Sprint King Pins
- (2) Micro Sprint Torrington Thrust Bearings and Washers
- (1) Micro Sprint Front Axle Bolt Kit

#25651 JOES Micro Sprint Complete Front Axle

MICRO SPRINT

JOES Micro Sprint Split Coned Spacer Kit

JOES Racing's Axle Spacer System, utilizing a Split Cone Spacer set, allows you to move the wheel in or out without searching for right size spacer. Just move spacers from one side to the other and the total spacer length automatically keeps things tight - the wheel offset is changed in seconds without the need of fumbling around finding the correct width spacer. The JOES Kit includes the following, Split Cone Set, 4 of the 1/4" & 1 of the 1/2" spacers.

- #25823 Micro 1-3/4" Sprint Split Coned Spacer Kit - Split Coned Pair, [4]- 1/4" [1]- 1/2"
- #25825 Micro Sprint 1-3/4" Split Spacer Male
- #25826 Micro Sprint 1-3/4" Split Spacer Female



JOES Micro Sprint Axle Spacers

The JOES 5" Axle Spacer is made to fit in between the JOES Single Bearing Caliper Carrier (P/N 25786) & the JOES LR Birdcage (P/N 25872). The JOES 7-1/8" Axle Spacer is made to fit in between the JOES Axle Radius Spacer (P/N 25656) & the JOES RR Birdcage (P/N 25874). This new spacer design is profiled on the inside of the tube instead of the outside to keep the weight down but also prevent the hassle of blocking your car on the edge of a radius or the need to block the rear end with two different block heights.

- #25816 Micro Sprint Spacer 1-3/4" Axle - 5"
- #25817 Micro Sprint Spacer 1-3/4" Axle - 7-1/8"

JOES Micro Sprint Rear Axle Spacer Kit

JOES Micro Sprint Rear Axle Spacer kit is designed to fit our JOES/Farrell Frameworks Chassis with a JOES 1-3/4" Rear Axle. Kit includes 10 spacers:

- [2] 1/4" • [1] 3/4" • [1] 2-3/8" • [1] 5"
- [2] 1/2" • [2] 1" • [1] 3-1/4" • [1] 7-1/8"

- #25800 Micro Sprint Rear Axle Spacer Kit

JOES Micro Sprint Caliper Carrier Spacer

Perfectly centers your Brake Rotor in your Brake Caliper for advanced brake performance.

- #25686 JOES Micro Sprint Caliper Carrier Spacer



JOES Micro Sprint Single Bearing Rear Brake Caliper Carrier

JOES Micro Sprint Brake Caliper Carrier is machined for strength while being lightweight. JOES Caliper Carrier mates with all popular caliper brands and close tolerances keep your pad wear even for efficient braking and longer lasting pads.

- #25786 Micro Sprint Rear Brake Caliper Carrier 3-1/4" Spacing



JOES Micro Sprint Rear Brake Caliper Carrier (Double Bearing)

JOES Micro Sprint Brake Dual Caliper Carriers are machined for strength while maintaining minimum weight. The dual bearing design ensures your caliper is supported for the ultimate in smooth and powerful braking. JOES Caliper Carrier mates with all popular caliper brands and close tolerances keep your pad wear even for efficient braking and longer lasting pads. 3-1/4" Mounting spread fits Wilwood Dynapro Single. 3-1/2" Mounting spread fits Wilwood GP320.

- #25788 Micro Sprint Caliper Carrier 3-1/4" Spacing (Double Bearing) for 1-3/4" Axle
- #25789 Micro Sprint Caliper Carrier 3-1/2" Spacing (Double Bearing) for 1-3/4" Axle
- #25793 Micro Sprint Caliper Carrier 3-1/4" Spacing (Double Bearing) for 2" Axle
- #25794 Micro Sprint Caliper Carrier 3-1/2" Spacing (Double Bearing) for 2" Axle

* Check out our the JOES Knowledge Center for a Tech Drawing that helps you track your rear axle spacing.



* Brake Caliper Not Included

JOES Micro Sprint Axle Spacers

JOES Micro Sprint Axle spacers come in a variety of straight spacers that are machined from billet 6061-T6 aluminum. JOES spacers slide right on your axle with precision.

- #25801 Micro Sprint Spacer 1-3/4" Axle - 1/4"
- #25802 Micro Sprint Spacer 1-3/4" Axle - 1/2"
- #25803 Micro Sprint Spacer 1-3/4" Axle - 3/4"
- #25804 Micro Sprint Spacer 1-3/4" Axle - 1"
- #25806 Micro Sprint Spacer 1-3/4" Axle - 1-1/2"
- #25808 Micro Sprint Spacer 1-3/4" Axle - 2"
- #25810 Micro Sprint Spacer 1-3/4" Axle - 2-3/8"
- #25813 Micro Sprint Spacer 1-3/4" Axle - 3-1/4"



JOES Micro Sprint Coned Axle Spacers

JOES Coned Micro Sprint Spacers are black anodized and laser etched. The cone shape gives you the clearance you need when moving your wheels in or out.

- #25818 Micro Sprint Spacer 1-3/4" Axle - 3/4" Coned
- #25820 Micro Sprint Spacer 1-3/4" Axle - 1" Coned
- #25821 Micro Sprint Spacer 1-3/4" Axle - 2" Coned



JOES Micro Sprint Axle Spacer

This spacer is designed to match up with the inside radius edges on a JOES Rear Axle.

- #25656 JOES Micro Sprint Axle Spacer [Each]



JOES Micro Sprint Left Rear Birdcage

JOES Micro Sprint LR Birdcage features the high quality that is built into every JOES product. A Zerk fitting allows you to keep up on lubrication for friction free results. We provide all top quality hardware needed so you can bolt our birdcage on right out of the package. Championship proven 5-1/2" center to center gives you the forward bite you need with maximum drive off the rear tires.

- #25872 Micro Sprint LR Double Bearing Birdcage for 1-3/4" Axle



JOES Micro Sprint Birdcage Splined Insert

JOES Micro Sprint Splined Inserts for birdcages and brake carriers are precision machined from 6061-T6 aluminum. Our top of the line equipment turns the diameters for a precision fit. Our 1-3/4" X 27 spline insert fits bearing ID 1.968 diameter. Our 2" X 31 spline insert fits bearing ID 2.165 diameter.

- #25785 1-3/4" Micro Sprint Birdcage & Double Brake Carrier Splined Insert [Double Bearing]
- #25787 1-3/4" Micro Sprint Brake Carrier Splined Insert [Single Bearing]

JOES Micro Sprint Right Rear Adjustable Birdcage

JOES Micro Sprint Adjustable RR Birdcage gives your team a whole new level of options to find the perfect balance point for maximum speed. Laser etched adjustment marks make it easy to record your settings. Dial in a small adjustment for precision settings and optimal performance. Championship proven 5-1/2" center to center gives you the forward bite you need with maximum drive off the rear tires. Additional splined insert needed for most applications.

- #25874 Micro Sprint RR Adj. [Double Bearing] Birdcage for 1-3/4" Axle



MICRO SPRINT

JOES Micro Sprint Nylon Chain Guide Block System

JOES Micro Sprint Nylon Chain Block Guide is manufactured with a lightweight and strong aluminum bracket. We use tough high quality Nylon that lasts. JOES sets the bar when it comes to quality and this bolt on piece is ready to go right out of the package. You only need one wrench to loosen the bolts and they are positioned so you can do the work with the LR Tire in place allowing you to make adjustments with the car on the ground for efficient settings. JOES makes it easy to make quick adjustments. The Nylon block splits in half so you can easily separate it from the chain.

#25869 Nylon Chain Block System



JOES Micro Sprint Chain Guide Replacement Block

JOES Micro Sprint Chain Block Replacement is made from tough Nylon. We designed the guide angle for optimal chain positioning. The JOES Replacement block bolts right on your existing JOES aluminum mounting bracket and can be installed without removing the chain.

#25870 Chain Guide Replacement Block



JOES Micro Sprint Chain Guide System

JOES Micro Sprint Chain Guide system keeps your chain in place regardless of the conditions. Sealed bearings keep things rolling and high quality springs have the perfect tension to get your horsepower to the ground smoothly.

#25875 Micro Sprint Chain Guide

#25876 Micro Sprint Chain Guide Replacement Wheels (Pair)

#25877 Micro Sprint Chain Guide Replacement Springs (Pair)



#25884

#25879

#25878

JOES Micro Sprint Case Protectors

JOES Case Protector adds beef right where it is needed to prevent damage from your chain. Save expensive repairs and serious damage to your engine with this easy to install Case Protector.

#25878 Yamaha Case Protector, 06-09 R6R

#25879 Yamaha Case Protector, 99-05 R6 & 06-Newer R6S

#25884 Honda Case Protector, 07, 08 & 09



JOES #520 Chain Breaker

JOES Chain Breaker is specially designed to adjust your chain fast. Precision machining creates a strong tool that allows you to remove and replace chain links in a hurry. We made it for any vehicle that uses #520 Chain size. The JOES tool is designed to drive the pin with control. Put away your hammer and punch and go with the tool that does the job right.

* Will not work on O-Ring Chains.

#25701 #520 Chain Breaker



D.I.D. 520 Micro Sprint Chain

High performance SDH treated pins have extreme impact strength while maintaining outstanding shock absorption. This treatment creates a chain with superior wear resistance ideal for dirt track conditions. The chain is long enough for today's car configurations.

#DID520ERT2X130 520 Micro Sprint Chain, 130 Link



JOES Micro Sprint Torsion Stops

JOES Micro Sprint Torsion Stops are designed for reduced flex. Black anodized and laser etching looks cool on any car.

Our torsion products fit the popular 7/8"-48 spline found on most micro sprints.



#25905 Micro Sprint Torsion Stops

JOES Micro Sprint Jacobs Ladder

JOES Jacobs Ladder is built strong and lightweight from 6061-T6 Aluminum. We shaved off every ounce of weight possible while maintaining strength. The main body is anodized for looks and protection. Everything you need is included right in the package.

#25955 Micro Sprint Jacobs Ladder

#25956 Micro Sprint Jacobs Ladder Straps (4 Pack)



JOES Steel Micro Sprint Jacobs Ladder

JOES Steel Micro Sprint Jacobs Ladder are built to last, with reinforced strength and durability. It features multiple holes so you can fine tune your set up for maximum corner speed. Straps and hardware included.

#25954 Micro Sprint Jacobs Ladder, Steel



JOES Micro Sprint Torsion Arms

JOES Micro Sprint 12" and 13-1/2" Torsion Arms are designed for reduced flex. Our torsion products fit the popular 7/8"-48 spline found on most Micro Sprints.

#25920 12" Torsion Arm

#25923 13-1/2" Torsion Arm

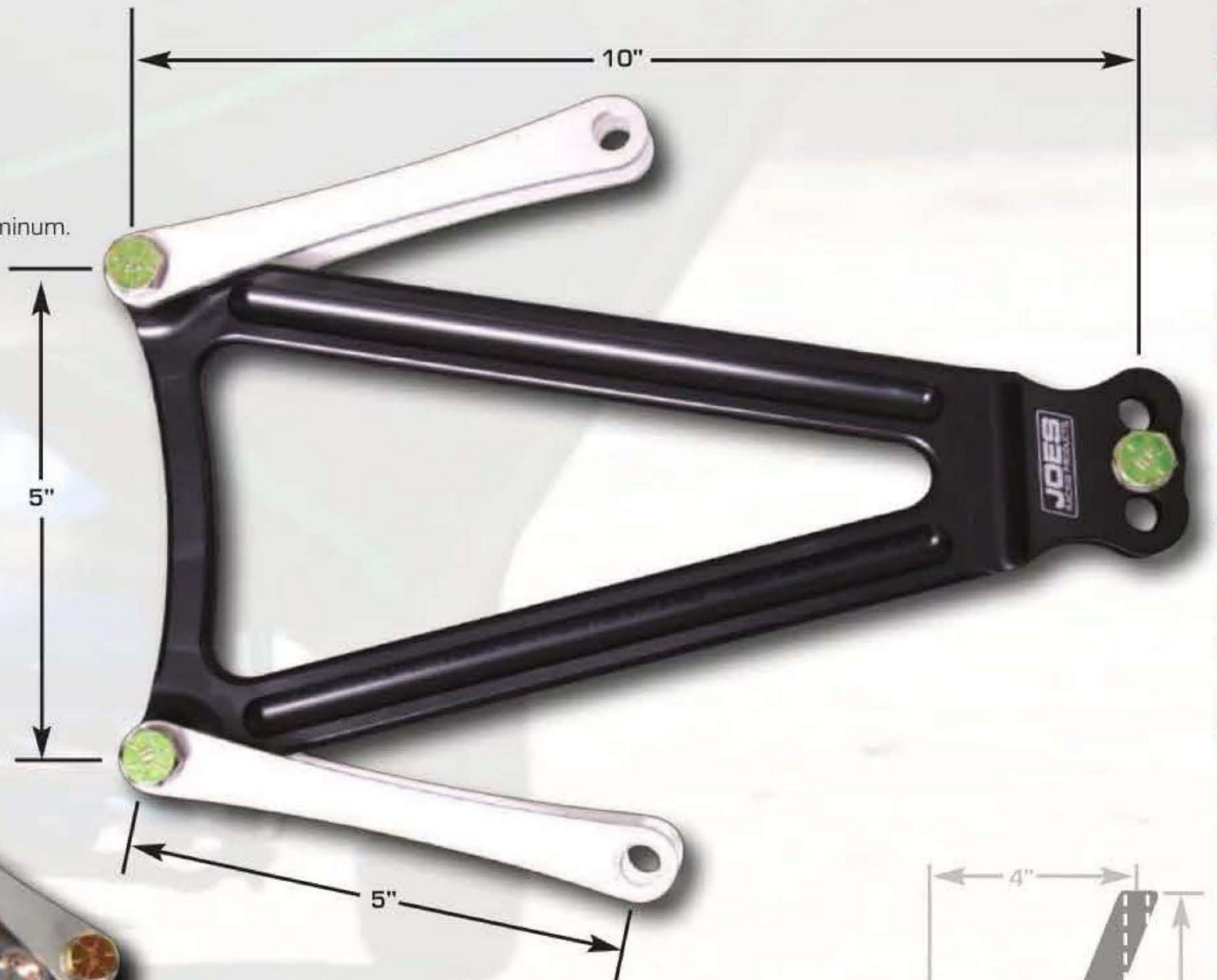

JOES Micro Sprint Right Rear Torsion Arm

JOES Micro Sprint Rear Torsion Arms are built by racers for racers. JOES spends the time to machine arms from solid billet eliminating the need for bending producing the strongest arm possible. The JOES rear arms include all hardware and a machined spud that allows your shock end to run bind free. Our torsion products fit the popular 7/8"-48 spline found on most Micro Sprints. 4" or 4-3/8" offset.

#25938 Micro Sprint Right Rear Torsion Arm 4" Offset

#25939 Micro Sprint Right Rear Torsion Arm 4-3/8" Offset



MACHINED FROM SOLID BILLET ALUMINUM! OUR COMPETITORS BEND THEM, CREATING STRESS CRACKS AND UNWANTED FLEX.



JOES Micro Sprint Left Rear Torsion Arm

JOES rear arms include all hardware and a machined spud that allows your shock end to run bind free. Our torsion products fit the popular 7/8"-48 spline found on most Micro Sprints. Length 11-1/2".

#25935 Micro Sprint Left Rear Torsion Arm Straight

#25936 Micro Sprint Left Rear Torsion Arm 1" Offset

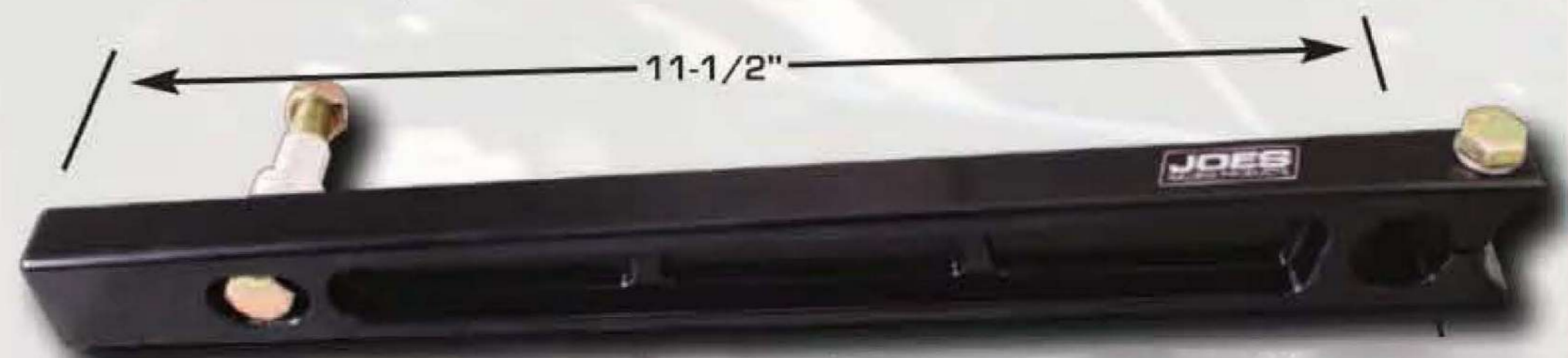

JOES Torsion Spacer & Bolt

JOES Torsion spacer and bolt are a simple way to ensure that your shock runs free under the toughest conditions.

#25942 Micro Sprint Torsion Spacer & Bolt



MICRO SPRINT

Micro Sprint Radius Rods

- 7/16"-20 left and right hand thread
- Polished High Strength Aluminum
- Swedged out of 6061-T6 Tubing

- #M&WSR757-14.5"** Radius Rod, 7/16"-20 Thread, 14-1/2" Long
- #M&WSR757-15.5"** Radius Rod, 7/16"-20 Thread, 15-1/2" Long
- #M&WSR757-20"** Radius Rod, 7/16"-20 Thread, 20" Long
- #M&WSR757-21"** Radius Rod, 7/16"-20 Thread, 21" Long
- #M&WSR757-36"** Radius Rod, 7/16"-20 Thread, 36" Long
- #25657** 7/16"-20 x 3/8" Eye, RH Heim, Alum.
- #25658** 7/16"-20 x 3/8" Eye, LH Heim, Alum.
- #25661** 7/16"-20 x 7/16" Eye, RH Heim, Alum.
- #25662** 7/16"-20 x 7/16" Eye, LH Heim, Alum.
- #27235** 7/16"-20 Jam Nut, RH, Steel, 10 Pack
- #27236** 7/16"-20 Jam Nut, LH, Steel, 10 Pack



JOES Micro Sprint Radius Rod Spacers

JOES Radius Rod Spacers will keep your Heim Joints from binding up. Available in three lengths.

- #25620** .375 x .250 Radius Rod Spacers (2)
- #25621** .375 x .500 Radius Rod Spacers (2)
- #25623** .375 x 1.000 Radius Rod Spacers (2)



JOES 7/8" Torsion Bar Bushings

JOES Torsion bar Bushings are made out of durable, lightweight bearing quality plastic that will keep your torsion bars running free. You will benefit from increased wear resistance for longer bushing life as well as less mating component wear. Sold in sets of 4.

- #25900** 1-1/4" x .083 wall, 7/8" Torsion Bar Bushings
- #25901** 1-1/4" x .095 wall, 7/8" Torsion Bar Bushings



Schroeder Torsion Bars

Schroeder 7/8" Spline Torsion Bars are made of aircraft quality high alloy steel. Only Schroeder torsion bars are machined in one continuous pass from end to end in order to prevent irregularities. They are polished, heat treated to exact specifications, then polished again to assure no surface imperfections exist which could cause a stress point or crack to originate.

- #PAC-TB-K48-525-14.5S** Torsion Bar [14.5"/Solid /.525]
- #PAC-TB-K48-550-14.5S** Torsion Bar [14.5"/Solid /.550]
- #PAC-TB-K48-575-14.5S** Torsion Bar [14.5"/Solid /.575]
- #PAC-TB-K48-600-14.5S** Torsion Bar [14.5"/Solid /.600]
- #PAC-TB-K48-625-14.5S** Torsion Bar [14.5"/Solid /.625]
- #PAC-TB-K48-650-14.5S** Torsion Bar [14.5"/Solid /.650]
- #PAC-TB-K48-700-14.5S** Torsion Bar [14.5"/Solid /.700]
- #PAC-TB-K48-700-26R** Torsion Bar [26"/Hollow /.700]
- #PAC-TB-K48-725-26R** Torsion Bar [26"/Hollow /.725]
- #PAC-TB-K48-750-26R** Torsion Bar [26"/Hollow /.750]
- #PAC-TB-K48-625-26R** Torsion Bar [26"/Hollow /.625]
- #PAC-TB-K48-650-26R** Torsion Bar [26"/Hollow /.650]
- #PAC-TB-K48-700-26R** Torsion Bar [26"/Hollow /.700]



JOES

MICRO SPRINT

Track: _____

RACING PRODUCTS

SETUP SHEET

Date: _____ Chassis: _____

Weather: _____

Start / Finish: _____

Surface: _____

Driver: _____

LEFT FRONT

Circumference: _____

Compound: _____

Pressure / Offset: _____

Block / Height: _____

Bar / Turns: _____

Shock / Pressure: _____

FRONT AXLE

Offset: _____

Lead: _____

Toe: _____

Panhard Pos: _____

RIGHT FRONT

Circumference: _____

Compound: _____

Pressure / Offset: _____

Block / Height: _____

Bar / Turns: _____

Shock / Pressure: _____

WING

Wing Position: _____

WING

Wing Angle: _____

LEFT REAR

Circumference: _____

Compound: _____

Pressure / Offset: _____

Block / Height: _____

Spacing: _____

Bar / Turns: _____

Shock / Pressure: _____

REAR

Watts Link Hole: _____

Sprocket Front / Rear: _____

Stagger: _____

RIGHT REAR

Circumference: _____

Compound: _____

Pressure / Offset: _____

Block / Height: _____

Spacing: _____

Bar / Turns: _____

Shock / Pressure: _____

NOTES: _____

Micro Sprint Steering Rack

600 Micro Sprint steering box. Frame mounted. Rack and pinion.
Size: 0.59" (15mm) -29 Spline.

#XXX600-ST-0004 Micro Sprint Steering Rack



Micro Sprint U-Joint

Micro Sprint Steering U-Joint. Steel. Complete with hardware. Precision manufactured steel U-Joint that holds up in the most extreme conditions. 15mm x 29 spline on both ends.

- Size: 0.59" (15mm) - 29 Spline
- Material: Steel
- Total weight: .85 lb

#XXX600-ST-0007 Micro Sprint U-Joint

Micro Sprint Steering Shaft

- Micro Sprint steering lower (intermediate) steering shaft. 15mm x 29 spline on both ends.
- Length: 20" (overall length)
- Spline Size: 15mm - 29
- Material: Steel
- Total weight: .85 lb

#XXX600-ST-0006 Micro Sprint Steering Shaft



JOES Micro Sprint 20" Brake Rod

The JOES Racing Brake Rod is manufactured from 4130 chromoly tube with threaded inserts welded in both ends. These lightweight brake rods are made to perform in the toughest braking conditions and handle some of the roughest tracks. JOES goes the extra mile to have the rods black E-Coated to prevent rusting on the outside as well as the inside. Brake rods measure 20" overall length with 7/16" right & left hand threads. Heims sold separately.

#25645 JOES Micro Sprint 20" Brake Rod



MCP Hi Performance Master Cylinder - Black

- 3/4" Bore Billet Aluminum, 35% more power than standard Master Cylinder
- Measures - 5" x 1" x 4-1/2" with 1-5/16" center to center bolt pattern
- Can be plumbed for dual or single brake lines

#MCP750-B MCP Hi Performance Master Cylinder



Joel/Farrell Frameworks Replacement Body Parts

- | | | | |
|-----------|-------------------------------------|-------------|--------------------------------------|
| #51600-5 | Micro Sprint Radiator Cover | #51600-60 | Micro Sprint Radiator Catch Panel |
| #51600-10 | Micro Sprint Front Floor Panel | #51600-65 | Micro Sprint Electronics Panel |
| #51600-15 | Micro Sprint Rear Floor Panel | #51600-70 | Micro Sprint Dash Panel |
| #51600-20 | Micro Sprint Left Front Side Panel | #51600-75 | Micro Sprint Inside Rear Motor Cover |
| #51600-25 | Micro Sprint Right Front Side Panel | #51600-76 | Micro Sprint Inside Motor, Leg, Pan |
| #51600-30 | Micro Sprint Right Center Side Pan | #51600-80 | Micro Sprint Hood Panel |
| #51600-35 | Micro Sprint Right Rear Bottom Pan | #51600-81 | Micro Sprint Inner Hood Panel |
| #51600-40 | Micro Sprint Left Rear Bottom Pan | #51600-85-1 | Micro Sprint Right Side Arm Gaurd |
| #51600-45 | Micro Sprint Right Side Hood Pan | #51600-86 | Micro Sprint Right Side Sail Panel |
| #51600-50 | Micro Sprint Left Side Hood Pan | #51600-90 | Micro Sprint Left Side Arm Guard |
| #51600-55 | Micro Sprint Engine Panel | #51600-91 | Micro Sprint Left Side Sail Panel |

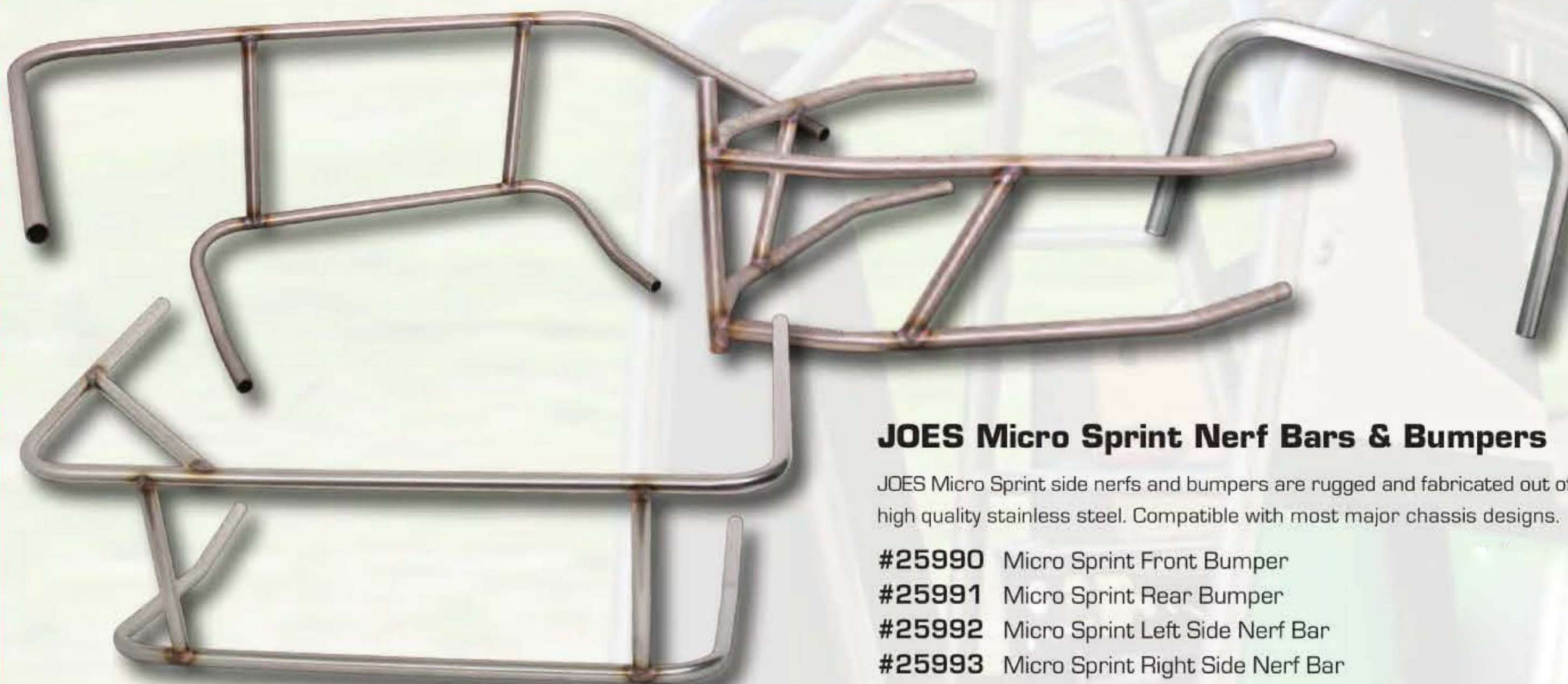

JOES Micro Sprint Nerf Bars & Bumpers

JOES Micro Sprint side nerfs and bumpers are rugged and fabricated out of high quality stainless steel. Compatible with most major chassis designs.

- #25990 Micro Sprint Front Bumper
- #25991 Micro Sprint Rear Bumper
- #25992 Micro Sprint Left Side Nerf Bar
- #25993 Micro Sprint Right Side Nerf Bar
- #25990-C Chromoly Micro Sprint Front Bumper
- #25991-C Chromoly Micro Sprint Rear Bumper
- #25992-C Chromoly Micro Sprint Left Side Bumper
- #25993-C Chromoly Micro Sprint Right Side Bumper

JOES Micro/ Kart/ Car Pedals (Pair)

JOES Micro Pedals are designed to give you maximum control. The design allows you to adjust the leverage points so that your GO foot is able to accelerate smoothly and your STOP foot can apply just the right amount of pressure to turn faster lap times. They are machined out of aircraft quality aluminum and have an anodized finish.

- #25830 Micro/Kart Pedals (Pair)



JOES Micro Sprint Heel Stop (Each)

JOES Micro Sprint Heel Stop holds your foot comfortably in position keeping your driver fresh from start to finish.

- #25836 JOES Heel Stop (Each)



JOES Micro Fuel Pump Bracket

JOES Micro Sprint Fuel Pump Bracket is designed to mount on the Torsion Tube. 5/16" threaded holes make for quick mounting of your fuel pump. We machine and anodize aluminum for a slick mount that cures the challenge of mounting the pump properly on your Micro/Mini Sprint.

#25950 JOES Torsion Tube Fuel Pump Bracket
5/16" Threaded Mount Holes



JOES Micro Sprint Shift Lever

JOES Micro Sprint Shift Lever is designed to get you into the right gear effortlessly. It is made out of 6061-T6 aluminum and includes the clutch lever.

#51550 JOES Micro Sprint Shift Lever



JOES Micro Sprint Shift Cable

6 Foot cable with 3" of throw. Works with most right hand shifter configurations.

#51560 Micro Sprint Shift Cable



Micro Sprint Clutch Cables

- Black vinyl coil-wound housing
- Meets or exceeds OEM quality
- Inner nylon sleeve for longer life and smooth operation
- Yamaha fits: 1999-2005 Yamaha R6 & 2006-2009 Yamaha R6S
- Suzuki fits: 2008-2011 Suzuki GSX-R750 & 2008-2011 Suzuki GSX-R600

#51562 Yamaha Clutch Cable

#51564 Suzuki Clutch Cable



Micro Sprint Farrell Chassis Bolt Kit

Complete bolt kit for JOES / Farrell Frameworks Chassis

#51510 Micro Sprint Farrell Chassis Bolt Kit



Farrell Chassis Dzus Kit

#51511
Dzus Kit

- #25657** 7/16"-20 x 3/8" Eye Heim Joint, Aluminum, RH
- #25658** 7/16"-20 x 3/8" Eye Heim Joint, Aluminum, LH
- #25661** 7/16"-20 x 7/16" Eye Heim Joint, Aluminum, RH
- #25662** 7/16"-20 x 7/16" Eye Heim Joint, Aluminum, LH
- #27233** 7/16"-20 x 7/16" Eye Heim Joint, Steel, RH
- #27234** 7/16"-20 x 7/16" Eye Heim Joint, Steel, LH
- #FKBJMX7** 7/16"-20 x 7/16" Eye Heim Joint, Chromoly (Rear Arm)
- #27235** 7/16"-20 Jam Nut, Steel, RH, 10 Pack
- #27236** 7/16"-20 Jam Nut, Steel, LH, 10 Pack





JOES Micro Sprint 1" Temp Gauge Fittings

Monitor your engine temp to catch problems before they damage your expensive Micro Sprint Engine. Our new temp fitting easily connects to your rubber hose water line, or your #12 AN on the other end. The threaded port fitting matches up to your standard temp sensor for a speedy installation.

- #25865 Micro Sprint Temp Gauge Fitting - 1" I.D. Rubber Hose Connection
- #25866 Micro Sprint Temp Gauge Fitting - #12 AN to 1" I.D. Rubber Hose



JOES Micro Sprint Breather Block Off Plates

JOES Block off plates are machined flat from 6061-T6 aluminum to create a perfect seal improving your engine performance.

We sell the black anodized plates in ready to use pairs.

- #25897 Micro Sprint Block Off Plates Yamaha 600R (Pair)

JOES Yamaha Oil Cap

JOES Micro Sprint Yamaha Oil Cap is CNC machined from aluminum and anodized red. 1/4" Hex for easy tightening and drilled for safety wire. O-ring sealed to keep the dirt out of your expensive engine.

- #25860 Yamaha 600R Oil Cap



JOES Suzuki Oil Cap

JOES Suzuki Oil Cap is CNC machined out of aluminum, has a 17mm hex, is drilled for safety wire and is anodized red. It is O-ring sealed to keep dirt out of your expensive engine.

- #25861 Suzuki Oil Cap

Cross Flow Radiator

Dzus-in style cross flow radiator with 2 -12AN male water fittings and a single -8 oil cooler fitting.

- #FSR78767-1 Cross Flow Radiator



JOES Micro Sprint Engine Mounts

JOES design team has built the perfect motor mount kits for your 600 Micro. All hardware is included and these billet kits are lightweight and give you everything you need for a professional installation.

- #25880 Micro Sprint Yamaha 600R Motor Mount 01-09
- #25885 Micro Sprint Honda 600RR Motor Mount 07-09
- #25888 Micro Sprint Kawasaki 600 Motor Mount (Shown) 01-06
- #25890 Micro Sprint Suzuki Motor Mount 07-09 GSXR 600

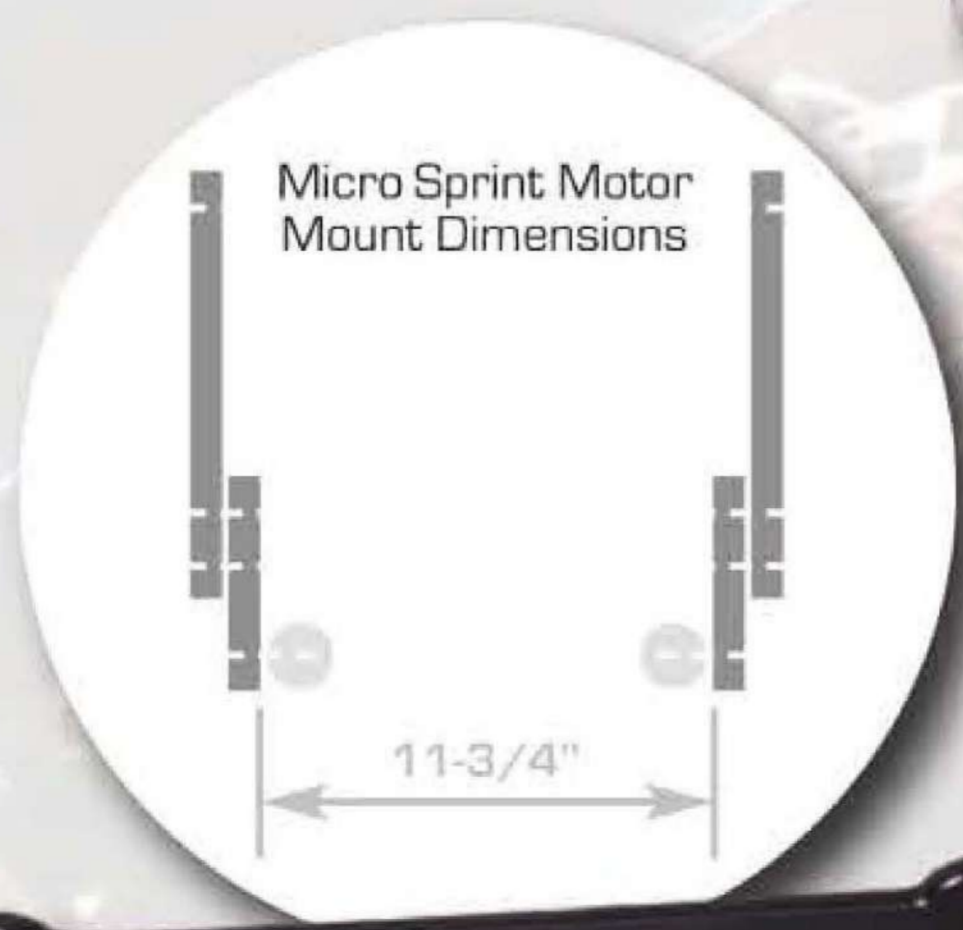

#25888 Shown Assembled



#25885 Shown

Micro Sprint Complete Rear Wheels

- Fits 1-3/4" Rear Axle
- 1-3/4"-27 Spline
- 12 Bolt Keizer Wheels
- Double wall outer rolled lip
- Polished or black finish available
- Wheels come race ready with JOES Micro Sprint Rear Hubs (#25615)

Beadlock

- #K2WDL10124BL-25615 10" diameter x 12" wide x 4" offset w/ Beadlock - Polished
 #K2WDL10124BL-BK-25615 10" diameter x 12" wide x 4" offset w/ Beadlock - Black

Non-Beadlock

- #K2WDL1083-25615 10" diameter x 8" wide x 3" offset - Polished
 #K2WDL1083-25615-BK 10" diameter x 8" wide x 3" offset - Black

Mud Covers

- #K2WDL10MC 10" Formed Mud Cover - Polished
 #K2WDL10MC-BK 10" Formed Mud Cover - Black



JOES is an official Shock Dealer for CSI, QA1 and Factory Kahne.



JOES Micro Sprint Rear Wheel Wrench

JOES Micro Sprint Wheel Wrench is precision manufactured and fits 2" Hex axle nuts. Multiple holes are drilled in the handle to hold your spare axle spacers in place. The knurled hand grip and JOES quality are built in.

#25698 JOES Micro Sprint Wheel Wrench



Micro Sprint Front Wheels

- 12 Bolt Keizer Wheels
- Double wall outer rolled lip
- 4 Pin setup
- Wheels come race ready
- Available with polished or black finish

3" Offset

- #K2WDL1073BC 10" diameter x 7" wide x 3" offset w/ Brake Bell Clearance - Polished
 #K2WDL1073BC-BK 10" diameter x 7" wide x 3" offset w/ Brake Bell Clearance - Black

4" Offset

- #K2WDL1074 10" diameter x 7" wide x 4" offset - Polished
 #K2WDL1074-BK 10" diameter x 7" wide x 4" offset - Black



MICRO SPRINT



Outlaw Wings 14 Sq. Ft. Micro Wing w/ Internal Wing Runners, Offset

Outlaw Wings produces high performance racing wings for dirt races all over the world. These lightweight aluminum wings create maximum downforce every time they hit the track. Slanted right side wing panel allows the driver a better view of the track and racing action ahead. 48" Wide x 42" Deep with Internal Wing Runners - Offset Side Boards w/ Recessed Rivets. 2" rear lips on sideboards.

- Left Side Panel - 26" x 54"
- Right Side Panel - 24" x 54"

- #OUT10006** Outlaw Top Wing
- #OUT10008** Top Wing Left Side Panel
- #OUT10009** Top Wing Right Side Panel

JOES Micro Sprint Electric Wing Slider

Moving your top wing forward or backwards makes a big difference. Our Electric Wing Slider enables you to make the adjustments from the cockpit so you can tune your car for the perfect balance. We pre-wire the switch and sealed quick connector, and include all the hardware needed for installation.

- #25983** Electric Wing Slider (Full Assembly)
- #25984** Wing Actuator Only
- #25985** Wing Actuator Mounting Spud
- #25986** Wing Actuator Replacement Gear Housing
- #46104** Standard Micro Switch



JOES Roller Wing Posts

JOES Roller Posts allow your top wing to move back and forth smoothly without binding and will put a lot less load on your wing slider. CNC aluminum top with rollers and stainless post.

- #25980** JOES Roller Top Wing Post (Each)
- #25981** Replacement Tube, Top Wing Post (Each)

JOES Micro Sprint Wing Tree

- Made from 4130 Chromoly Tubing
- E-Coated to prevent rusting
- Maximum 4" height adjustment
- Dual holes for 1/2" incremental adjustments
- Measures 23-1/4" between top wing mounting spuds
- Chassis mounting end measures 25" from outside to outside
- Supplied with 5/16" heims & an aluminum tapered spacer to fit most chassis & wings

- #25979** JOES Micro Sprint Wing Tree





JOES Micro Sprint Nose Wing Stabilizer (Pair)

Micro Sprint Nose Wing Stabilizers fit perfectly and include all hardware for easy mounting. Designed for Dzus-on body mount. Hole diameter 5/16".

#25970 Micro Sprint Nose Wing Stabilizer (Pair)

JOES Micro Sprint Nose Wing Clamp

Save yourself a headache with JOES Nose Wing Clamp! The clamp allows for wing post movement on impact reducing the need for replacement posts and other accessories.

- Strong & lightweight
- Fits 1-1/4" torsion tube
- Accepts a 3/4" post
- Includes hardware

#25969 JOES Micro Sprint Nose Wing Clamp



Outlaw Wings Micro Sprint Nose Wing

Outlaw Wings nose wings have a 30" wide by 18" long center section and are made from lightweight aluminum. These quality built wings will give you the downforce you need to keep your nose planted to the track. Rivet sideboards on and you're ready to go.

- 18"x30" • 3/4" Dish
- Mounting tabs included

#OUT10007 Micro Sprint 30" Nose Wing



JOES Micro Sprint Manual Wing Slider

- Made from 4130 Chromoly Tubing
- E-Coated to prevent rusting
- Measures 12-3/4" at lowest setting
- 6" of travel with 1/2" incremental adjustments

#25982 JOES Micro Sprint Manual Wing Slider



JOES Micro Sprint Front Wing Posts (Pair)

Micro Sprint Front Wing Posts (Pair) fit perfectly and include all hardware for easy mounting.

#25973 Micro Sprint Front Wing Posts (Pair)



JOES Micro Sprint Stabilizer Straps Shock Tower Mount (Pair)

Designed to work on chassis with the nose wing strap spud welded to the shock tower. Works with JOES/Farrell Frameworks Chassis. Includes all hardware for easy mounting. Hole diameter 1/4".

#25971 Micro Sprint Stabilizer Straps Shock Tower Mount (Pair)

MICRO SPRINT

JOES Fuel Filler Top Plate with #6 SAE Ports

- New design features 3 #6 SAE Ports
- Designed to keep dirt and water out of your fuel system
- Extra large #8 roll over valve included for efficient venting

JOES Fuel Filler Top Plate works perfect for your mini sprint, sprint car or any application where you require additional ports for fuel returns. The cap area features a raised ridge to keep dirt and water out of your fuel system. A high flow roll over vent is included. The oversize vent ensures that you meet the needs of your high fuel consumption motor without creating a vacuum in the tank. Gasket Included.

#13274 JOES Fuel Filler Top Plate with #6 SAE Ports



#13276 JOES Fuel Filler Nut Plate

#13288 JOES #8 Roll Over Vent Valve



JOES Inline Fuel Filter

JOES Inline Fuel filters are specially designed for high flow. The 140 Micron mesh screen is optimal for keeping your fuel system free of debris while promoting ample flow. We vividly laser etch the fuel flow direction right on the housing so you are assured of a quick and correct installation every time.

#42406 Inline Fuel Filter 140 Micron Mesh #6 AN

#42408 Inline Fuel Filter 140 Micron Mesh #8 AN





Saldana Fuel Cell w/ Bladder

Saldana's fuel assemblies are hand assembled from a high quality ballistic fabric and are coated with a specially formulated rubber compound. Each bladder comes with a 3 Year Manufacturer Warranty covering materials and craftsmanship.

- Ultra durable calendared 16 gallon rubber bladder
- Cross Link Polyethylene Roto molded shell
- #8 Bulkhead Fitting
- Baffle included to keep consistent fuel pressure
- Fill Plate Sold Separately

#SALPM116B-T Fuel Cell w/ Bladder
#SALPM116-T-BTM Fuel Cell w/ Bladder
 -Bottom Pickup

JOES 5-Point Seat Belt Restraints

When it comes to racing, safety comes first. JOES 5-Points Seat Belt Restraints are SFI Certified and will keep any driver safe behind the wheel. Fits all forms of racing.

#24200 5 Point Seat Belt System



JOES Micro Sprint Muffler Clamps

JOES Micro Sprint Muffler clamp keeps your muffler secure. It clamps on to your nerf bar and is adjustable for all angles. The cradle fits a 4" diameter muffler but will form easily around many sizes of mufflers. Easy to install/uninstall for use on many cars. Made from 6061-T6 aircraft aluminum. 3/4" and 7/8" nerf clamps available.

#25951 3/4" Muffler Clamp
#25952 7/8" Muffler Clamp



JOES Micro Sprint Setup Blocks

Most Micro racers set up their cars by blocking them at 1-3/4" or 2" and make changes from there. JOES Setup Blocks are a simple, compact and designed specifically for Micros.

- Simple and compact design
- Laser engraved
- Magnets to keep them from falling off your car
- Economical
- 1-3/4" or 2" heights
- Anodized bright red

#25700 Micro Sprint Setup Blocks (Pair)



JOES Sprint Stands

JOES aluminum stands are stackable and have urethane pads to help keep your car from slipping. Wide feet keep them from sinking in the dirt. They are light weight and stackable to save space in your trailer or the shop. 13" tall and 33" wide. Sold in pairs.

#55501 JOES Sprint Stands (Pair)

JOES JF1 Jr Sprint

The 2019 JOES Jr Sprint is now better than ever. We keep improving the design to make it easier to maintain and ultimately faster on the track.



- Splined rear axle that is lighter, stronger and easier to make adjustments
- Adjustable seat mount
- Taller cage for safety
- Internal runner top wing
- Integrated frame/engine mount that is lighter and stronger
- New sheet metal for more cockpit room

Complete Roller Includes:

- Chassis
- Splined Rear Axle Assy.
- Wheels and Tires
- Body Kit
- All Steering Components
- Fuel Cell
- Nerfs Bars
- Brakes
- QA1 Shocks
- Dzus Springs and Buttons
- 5 Point Seat Belt Restraints
- Springs
- Frame Engine Mount
- Pedals
- Radius Rods
- Front Axle Assy.
- Top Wing

**To get to race ready condition the following items are needed: Engine, Seat, Jack Shaft, Clutch, Pulleys and Belt, Sprockets and Chain*

#24005 JOES JF1 Jr Sprint Complete Roller

Chassis Kit Includes:

- Chassis
- Nerf Bars
- Body Kit
- Dzus Springs and Buttons

#24000 JOES JF1 Jr Sprint Chassis

JR SPRINT



JR SPRINT
JB Racing Films Photo

Jr Sprint 2 Gallon Flow Max Tank

JAZ Products 2 gallon Flow Max tank for Jr Sprints is SFI Certified. 6 Bolt Flush Mount Cap Assembly and Fast Flow Fitting sold separately. Measures 10" X 12" x 12".

- #JAZ899-202-01 2 Gallon Flow Max Tank Only
- #JAZ350-201-06 6 Bolt Flush Mount Cap Assembly
- #JAZ832-106-11 Fuel Cell Fast Flow Fitting



JOES Fiberglass Jr Sprint Tail Cone

#24170 Fiberglass Jr Sprint Tail Cone



JOES Jr Sprint Lower Tank Mount

Holds the bottom of your JAZ Fuel Tank in place. Made out of aluminum.

#24551 Jr Sprint Lower Tank Mount



JOES Jr Sprint Upper Tank Mount

Designed to mount your 2 gallon JAZ fuel tank to your Jr Sprint chassis. Made out of 6061-T6 Aluminum.

#24550 Jr Sprint Upper Tank Mount



JOES JR Sprint Nerf Bars

JOES Jr Sprint Nerfs are made from 3/4" polished stainless steel tubing. The Old Style Left Nerf is designed to fit the older Kidwell chassis. The New Style Left Nerf is designed to fit the newer JOES chassis.

- #24991 Jr Sprint Rear Bumper
- #24994 Jr Sprint Right Nerf
- #24992 Jr Sprint Left Nerf (Old Style)
- #24993 Jr Sprint Left Nerf (New Style, 2015 & Newer)



JOES Jr Sprint Front Bumper

JOES Front Bumpers are fabricated from high quality stainless steel. Bumper measures 16-1/4" between centers.

#24990 Jr Sprint Front Bumper



JOES 5-Point Seat Belt Restraints

When it comes to racing, safety comes first. JOES 5-Points Seat Belt Restraints are SFI Certified and will keep any driver safe behind the wheel. Fits all forms of racing

#24200 5 Point Seat Belt System



JOES Jr Sprint 1-1/2" Splined Rear Axle Assembly

JOES JR Sprint Splined Axle is stronger, lighter, and more adjustable compared to our previous steel axle. It is 1-1/2" diameter with 23 splines on both ends and a keyed rotor carrier. We managed to take off over 2 pounds of rotating and unsprung weight while increasing the strength at the same time by using 7075-T6 material. The splines and threaded ends let you move your wheels in and out just like they do on bigger cars. All the components needed for a complete rear axle assembly.

#24821 Jr Sprint Splined Rear Axle Assembly

#24656 Jr Sprint Splined Rear Axle Only



All components needed for a complete JOES splined rear axle assembly Includes:

[1] Jr Sprint 23 Tooth Splined Rear Axle, 1-1/2" Diameter

[2] Jr Sprint Splined Rear Hubs Diameter

[1] Jr Sprint Splined Sprocket Carrier

[1] Jr Sprint Rotor Carrier, 1-1/2"

[2] Jr Sprint Rear Axle Nuts

[1] Jr Sprint Rear Caliper Carrier, 1-1/2"

[3] Jr Sprint 1/4" Axle Spacers, 1-1/2"

[2] Jr Sprint 1/2" Axle Spacers, 1-1/2"

[1] Jr Sprint 5/8" Axle Spacer, 1-1/2"

[1] Jr Sprint 3/4" Axle Spacer, 1-1/2"

[5] Jr Sprint 1" Axle Spacers, 1-1/2"

[2] Jr Sprint 3-1/4" Axle Spacers, 1-1/2"

[2] Jr Sprint 1/2" Coned Axle Spacers, 1-1/2"

[2] Jr Sprint 1" Coned Axle Spacers, 1-1/2"

[1] Jr Sprint LR Birdcage, 1-1/2"

[1] Jr Sprint RR Birdcage, 1-1/2"

[1] Jr Sprint / Kart Rear Rotor

JOES Jr Sprint Rear Hub

JOES Splined Jr Sprint hubs fit JOES 23 tooth 1-1/2" diameter splined rear axles. They are strong, lightweight and fit wheels with a 5 on 130mm bolt circle.

#24016 Jr Sprint Rear Hub
-1-1/2" Axle



JOES Jr Sprint LR Birdcage

JOES Jr Sprint LR Birdcage is designed to fit our 1-1/2" diameter splined axle, is made from 6061-T6 aluminum and includes all the hardware needed for installation. The JOES design features a 5" roll center to give you the forward bite you need with maximum drive off the rear tires.

#24873 Jr Sprint LR Birdcage
-1-1/2" Axle



JOES Jr Sprint Sprocket Carrier

JOES Splined Jr Sprint Sprocket Carriers are splined to fit JOES 1-1/2" diameter splined rear axle. They are fully radiused and pocketed for maximum weight savings and strength. Extra long 1/4"-28 bolts are included so you can install your chain guides. Fits standard sprockets with 6 on 5-1/4" bolt circle.

#24675 Jr Sprint Sprocket Carrier
-1-1/2" Axle



JOES Jr Sprint RR Birdcage

JOES Jr Sprint RR Adjustable Birdcage is designed to fit our 1-1/2" diameter splined rear axle and is made from 6061-T6 aluminum. It uses two bearings for stability and has an adjustable Jacobs ladder mount that allows for easy adjustments to find that perfect balance. The JOES design features a 5" roll center to give you the forward bite you need with maximum drive off the rear tires. All the needed hardware is included for easy installation.

#24875 Jr Sprint RR Birdcage -1-1/2" Axle



JOES Jr Sprint Rotor Carrier

JOES Jr Sprint Rotor Carriers are made to fit JOES 1-1/2" splined rear axles. They have four 5/16"-24 threaded holes on a 3" bolt circle to mount your rotor. Bolts and 1/4" key stock are included.

#24685 Jr Sprint Rotor Carrier
-1-1/2" Axle



JOES Jr Sprint Rear Axle Nuts

JOES Jr Sprint Rear Axle Nuts are machined out of 6061-T6 aluminum to exact tolerances and black anodized for durability. 1-3/8"-8 thread with 1-5/8" hex.

#24696 Jr Sprint Rear Axle Nut-1-1/2" Axle-Left

#24697 Jr Sprint Rear Axle Nut-1-1/2" Axle-Right



JOES Jr Sprint Axle Spacers

JOES Jr Sprint Axle spacers are made from 6061-T6 aluminum and anodized black. 1-1/2" Inside diameter.

#24852 1/4"-Jr Sprint Axle Spacer

#24853 1/2"-Jr Sprint Axle Spacer

#24854 5/8"-Jr Sprint Axle Spacer

#24855 3/4"-Jr Sprint Axle Spacer

#24856 1"-Jr Sprint Axle Spacer

#24857 3-1/4"-Jr Sprint Axle Spacer

JOES Jr Sprint Jacobs Ladder

JOES Jr Sprint Jacobs Ladders are strong and lightweight. Built from 6061-T6 Aluminum. Our bolt on part includes everything you need right out of the package. Short: 8-1/2" between centers. Long: 10-1/4" between centers. Straps 4" between centers.

#24955 Jr Sprint Jacobs Ladder, Short

#24957 Jr Sprint Jacobs Ladder, Long

#24956 Jr Sprint Jacobs Ladder, Straps (4)

JOES Jr Sprint Caliper Carrier

JOES Junior Sprint Brake Caliper Carriers for JOES 1-1/2" splined rear axles are lightweight while still maintaining strength. Close tolerances keep your pad wear even for efficient braking and longer lasting pads. Fits MCP-1375 Calipers and similar with a 2-1/2" mounting spread.

#24787 Jr Sprint Caliper Carrier
-1-1/2" Axle



JOES Jr Sprint Rear 1-1/4" Axle Assembly

#24820 Jr Sprint Rear Axle Assembly

#24655 Jr Sprint Rear Axle Only

All components needed for a complete JOES rear axle assembly Includes:

- | | | |
|-------------------------------|---|-------------------------------------|
| (1) Jr Sprint Rear Axle | (1) Jr Sprint /Kart Rotor Carrier | (2) 3/4" Jr Sprint Rear Axle Spacer |
| (2) Jr Sprint Rear Hubs | (1) Jr Sprint /Kart Brake Rotor | (4) 1" Jr Sprint Rear Axle Spacer |
| (1) Jr Sprint LR Birdcage | (1) Jr Sprint Rear Axle End Caps (Pair) | (1) 3" Jr Sprint Rear Axle Spacer |
| (1) Jr Sprint RR Birdcage | (1) 1/8" Jr Sprint Rear Axle Spacer | (1) 4" Jr Sprint Rear Axle Spacer |
| (1) Jr Sprint Caliper Carrier | (5) 1/4" Jr Sprint Rear Axle Spacer | (1) Jr Sprint Rear Axle Bolt Kit |
| (1) Jr Sprint /Kart Sprocket | (4) 1/2" Jr Sprint Rear Axle Spacer | |



JOES Jr Sprint Rear Hub

JOES Jr Sprint Rear Hubs are light to reduce rotating weight yet strong enough to take some serious racing abuse. They clamp to your 1-1/4" axle and are designed to fit wheels with a 5 on 130mm bolt circle.

#24015 Jr Sprint Rear Hub

JOES Jr Sprint Caliper Carrier

JOES Jr Sprint Brake Caliper Carriers are lightweight while still maintaining strength. Close tolerances keep your pad wear even for efficient braking and longer lasting pads. 2-1/2" mounting spread. Fits MCP-1375 Calipers and similar.

#24786 Jr Sprint Caliper Carrier

JOES Jr Sprint RR Birdcage

JOES Jr Sprint RR Adjustable Birdcage is made from 6061-T6 aluminum and includes all the hardware needed to fit a 1-1/4" diameter axle. It uses two bearings for stability and has an adjustable Jacobs ladder mount to allow for easy adjustments to find that perfect balance. The JOES design features a 5" roll center to give you the forward bite you need with maximum drive off the rear tires.

#24874 Jr Sprint RR Birdcage

JOES Jr Sprint Rear Axle Spacers

JOES Jr Sprint Rear Axle Spacers are made from 6061-T6 aluminum.

- | | |
|------------------|------------------------|
| Kit Includes: | (4) 1" spacers |
| (1) 1/8" spacer | (1) 3" spacer |
| (3) 1/4" spacers | (1) 4" spacer |
| (4) 1/2" spacers | (2) Rear Axle End Caps |
| (2) 3/4" spacers | |

- #24800 Jr Sprint Rear Axle Spacer Kit
- #24801 1/8" Jr Sprint Rear Axle Spacer
- #24802 1/4" Jr Sprint Rear Axle Spacer
- #24804 1/2" Jr Sprint Rear Axle Spacer
- #24806 3/4" Jr Sprint Rear Axle Spacer
- #24808 1" Jr Sprint Rear Axle Spacer
- #24810 3" Jr Sprint Rear Axle Spacer
- #24812 4" Jr Sprint Rear Axle Spacer

JOES Jr Sprint LR Birdcage

JOES Jr Sprint LR Birdcage is made from 6061-T6 aluminum and includes all the hardware needed to fit a 1-1/4" diameter axle. The JOES design features a 5" roll center to give you the forward bite you need with maximum drive off the rear tires.

#24872 Jr Sprint LR Birdcage

JOES Jr Sprint Rear Axle End Caps

Made from 6061-T6 aluminum and fits JOES Jr Sprint rear axles.

#24815 Jr Sprint Rear Axle End Caps (Pair)

JOES Kart/Jr Sprint Rotor & Sprocket Carriers

JOES Sprocket & Rotor Carriers are fully radiused and pocketed for maximum weight savings and strength.

- #25770 Kart/Jr Sprint Brake Rotor Carrier
1-1/4" I.D. 5/16"-24 on 3" B.C.
- #25780 Kart/Jr Sprint Sprocket Carrier
1-1/4" I.D. 1/4"-28 on 5-1/4" B.C.

JOES Kart/Jr Sprint Brake Rotor

JOES Kart Rotors are made from 1018 steel. Cooling slots help to dissipate heat and the scalloped shape saves weight without sacrificing braking. Combine our rotor with the JOES rotor carrier for a lightweight package that bolts right on.

#25760 Kart/Jr Sprint Brake Rotor 1/8" x 7-1/8"

JOES Jr Sprint Steering Column Assembly

JOES Jr Sprint Steering Column is adjustable for driver comfort. The clamp block lets you move the steering wheel front to rear and also adjust the angle. Your driver will go faster if they are comfortable in the car. Assembly Includes:

- Steering Wheel Quick Disconnect
- Sliding Shaft
- Column Clamp for 1" tube
- U-joints

#24620 Jr Sprint Steering Column Assembly



Jr Sprint Steering Rack

- 12:1 ratio
- 3/8" bolts (not included)
- 1-5/16" center to center on axle mount bolt holes

#PRW924780 Jr Sprint Steering Rack

JOES Jr Sprint Steering Rack Spacer

JOES Jr Sprint Steering Rack Spacer is made from 6061-T6 aluminum and bolts directly on to JOES Jr Sprint Front Axles.

#24638 Jr Sprint Steering Rack Spacer

JOES Jr Sprint King Pin

JOES Jr Sprint King Pins are built to last. High grade alloy steel allows your spindles to rotate freely even during severe conditions.

#24644 Jr Sprint King Pin

JOES Jr Sprint Front Spindle

JOES Front Spindle is anodized black. The Billet construction offers a durable part that bolts easily to either side of your car and the bronze bushings allow for smooth steering. Add a set of JOES Jr Sprint Hubs to complete your assembly.

#24635 Jr Sprint Front Spindle

JOES Jr Sprint Steering Arm

JOES Jr Sprint Steering Arms bolt directly on to JOES Jr Sprint Front Spindles and work for either the left or the right spindle. Made from billet 6061-T6 aluminum.

#24636 Jr Sprint Steering Arm

JOES Jr Sprint Panhard Bracket

JOES Panhard Mount is lightweight but strong enough to withstand extreme racing conditions. You can quickly adjust your roll center by sliding it up or down on the frame tube. Clamps on 1" tube and accepts 3/8" heims.

#24649 Jr Sprint Panhard Bracket





JOES Jr Sprint Front Axle

Be prepared to get your car back on the track with a spare complete front axle assembly. Your day will be a lot less stressful knowing that you are prepared in case there is an incident on the track. Bare axle also available.

- #24651 Jr Sprint Front Axle Assy.
- #24650 Jr Sprint Front Axle



JOES Jr Sprint Radius Rod Mount

JOES Jr Sprint Radius Rod Mount is made from 6061-T6 aluminum and bolts directly on to your chassis. The machined slots are 1-1/2" long to make precision adjustments.

- #24652 Jr Sprint Radius Rod Mount



JOES Jr Sprint Front Hub

JOES Jr Sprint Front Hubs are thick where you need it and thin where you don't for a strong yet lightweight hub package. Sealed Bearings are maintenance free and a bearing spacer is included to allow them to move freely. Designed to fit wheels with a 5 on 130mm bolt circle. Fits 3/4" spindle.

- #24010 Jr Sprint Front Hub



JOES Jr Sprint Radius Rod Spacer

JOES Jr Sprint Radius Rod Spacers are made out of aluminum and designed for clearance with your 3/8" heim joints.

- #24653 Jr Sprint Radius Rod Spacer

Jr Sprint Radius Rods

- Threaded 3/8"-20 left hand and right hand
- Polished High Strength Aluminum
- Swedged out of 6061-T6 Tubing

- #M&W675-7" Jr Sprint Radius Rod, 7"
- #M&W675-8-1/2" Jr Sprint Radius Rod, 8-1/2"
- #M&W675-11" Jr Sprint Radius Rod, 11"
- #M&W675-15" Jr Sprint Radius Rod, 15"
- #M&W675-17-1/2" Jr Sprint Radius Rod, 17-1/2"



Jr Sprint Heim Joints

- #24657 3/8"-24 x 3/8" Eye, RH Heim, Alum.
- #24658 3/8"-24 x 3/8" Eye, LH Heim, Alum.
- #24659 3/8"-24 Jam Nut, RH, Steel, 10 Pack
- #24660 3/8"-24 Jam Nut, LH, Steel, 10 Pack



JR SPRINT

Jr Sprint Top Wing

- Designed to maximize down force and cornering speed within the rules
- Light weight but still durable

#OUT10004 Jr Sprint Top Wing - Internal Runner

#OUT10005 Jr Sprint Top Wing - Peg Leg Mounts



#OUT10004
Internal Runner



#OUT10005 Peg
Leg Mounts

JOES Jr Sprint Top Wing Posts

Made out of stainless steel with a 5/8" hole for your cross tube. The Rear posts have plenty of holes for adjustments. Sold individually.

#24979 Jr Sprint Top Wing Post, Rear

#24980 Jr Sprint Top Wing Post, Front



JOES Jr Sprint Top Wing Complete Mounting Kit

JOES Jr Sprint Top Wing Complete Kit includes everything you need to mount your Top Wing to a JOES Chassis. It is designed to allow you to move your wing front to rear 8" so you can find the perfect balance. Kit Includes:

- | | | |
|----------------------|------------------|------------------------|
| (2) Front wing Posts | (1) Right Slider | (5) 5/8" Lock Collars |
| (2) Rear wing Posts | (1) Left Slider | (2) Butterfly Brackets |
| (2) Cross Bars | (1) Adjuster Rod | |

#24982 Jr Sprint Top Wing Complete Kit



JOES Jr Sprint Top Wing Slider Kit

JOES Jr Sprint Top Wing Slider Kit is designed so that you can mount your 4 post wing and have 8" of travel front to rear.

#24981 Jr Sprint Top Wing Slider Kit



JOES Jr Sprint Top Wing Crossbars

JOES Jr Sprint Top Wing Crossbars are 20" long and made out of stainless steel so you don't have to worry about them rusting.

#24978 Jr Sprint Top Wing Crossbars

#24977 Jr Sprint 5/8" Lock Collar

#24976 Jr Sprint Top Wing Butterfly Bracket



JOES Jr Sprint Wing Tree

- Made from 4130 Chromoly Tubing
- E-Coated to prevent rusting
- Maximum 4" height adjustment
- Dual holes for 1/2" incremental adjustments
- Measures 19-1/8" between top wing mounting spuds

- Chassis mounting end measures 20-1/2" from outside to outside
- Supplied with 5/16" heims and an aluminum tapered spacer to fit most chassis & wings

#24985 Jr Sprint Wing Tree



JOES Jr Sprint Frame Engine Mount

Made from 4130 tubing and fits JOES, Kidwell, and Legacy Jr Sprint chassis.

#24880 Jr Sprint Frame Engine Mount



JOES 4-Stroke Adjustable Jack Shaft

JOES Billet Jack shaft mount is engineered to make mounting your engine a snap. Strong and easily adjustable to make for quick changes at the track or in the shop. The lightweight package comes with everything you need to bolt it right on.

#25715 Jr Sprint 4-stroke Adjustable Jack Shaft Mount



Jr Sprint Lightweight Belt Drivers

Super lightweight aluminum belt drivers, 20mm wide, for 3/4" shaft. 20 tooth front and 30 tooth rear. Machined from 7075-T6 aluminum. Anodized black.

#JPM20-20MM Jr Sprint Lightweight Front Belt Driver

#JPM30-20-MM Jr Sprint Lightweight Rear Belt Driver



JOES Jr Sprint Jack Shaft Spacer Kit

JOES Jr Sprint Jack Shaft Spacer Kit includes the following:

- (1) 1-1/4" spacer
- (2) 3/16" spacers
- (5) 1/4" spacers
- (3) end caps

#24888 Jr Sprint Jack Shaft Spacer Kit



JOES Titanium Jack Shaft

If you want the very best equipment, then you should consider our Titanium Jack Shaft. It will reduce the rotating weight of your drive train and the overall weight of your car. 3/4" diameter x 9" long. It replaces the standard shafts on our Jack Shaft Assemblies.

#25740 Titanium Shaft 3/4" Dia. x 9" long



Gates PowerGrip GT-3 Drive Belts

- Fiberglass tensile cord provides high strength, excellent flex life, and high resistance to elongation.
- Neoprene body provides protection against grime, grease, oil, and moisture.
- Nylon tooth facing provides a durable wear surface for long service life.
- 560 x 8mm x 20mm wide
- 576 x 8mm x 20mm wide
- Fits JOES Jack Shaft

#GAT560-8MGT-20 560-8M-20 PowerGrip GT3 Drive Belt

#GAT576-8MGT-20 576-8M-20 PowerGrip GT3 Drive Belt

#GAT560-8MGT-30 560-8M-30 PowerGrip GT3 Drive Belt



Chain Break

RLV #35 Chain Breaker

#RLV0765 #35 Chain Breaker



RLV Xtreme Chain

#RLV0845 RLV #35 Xtreme Chain, 106 Link

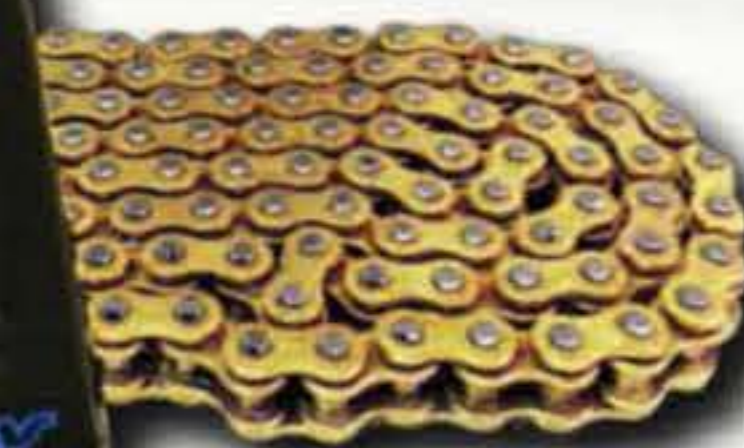

RLV World Formula Pipe and Silencer Kit

Made for a Jr Sprint Left Hand Engine. Kit Includes:

- [1] Pipe
- [1] Locking Collar
- [1] B91 Silencer
- [1] Copper Gasket

#RLV5442S-K RLV World Formula Pipe and Silencer Kit

#RLV4100 RLV B91 Exhaust Silencer

#RLV4140 RLV Locking Collar for B91 Silencer

#RLV4216 RLV Briggs Copper Exhaust Gasket

#RLV5442S RLV Jr Sprint World Formula Pipe



Jr Sprint Coil Springs

- #LANTVB-60** 10" Jr Sprint spring 60lb
- #LANTVB-75** 10" Jr Sprint spring 75lb
- #LANTVB-90** 10" Jr Sprint spring 90lb
- #LANXVB-60** 8" Jr Sprint spring 60lb
- #LANXVB-75** 8" Jr Sprint spring 75lb



CSI Deluxe Coil Over Kit

A unique two piece ride height adjuster allows you to change ride height and independently spin the locking collar for easy adjustment. Kit comes complete with ride height adjuster and spring perch. No more screws into the body! Fits CSI and Afco Shocks.

#CSI100096 CSI Deluxe Coil Over Kit



#24870 Jr Sprint Birdcage Shock Spacer



Douglas Jr Sprint Wheels

- 5 on 130 bolt pattern
- Light weight
- Made in USA
- 6061 heat treated aluminum
- Polished aluminum finish

#DWT021-16 Front Wheel - 8 X 6

#DWT021-01 Left Rear Wheel - 8 X 8

#DWT021-02 Right Rear Wheel - 8 X 9

MCP Rear Caliper with Pads

- For up to 1/4" wide discs
- Includes fittings and bleeders
- Quick adjust pad gap
- Can be shimmed for use with wider disks
- Bolt pattern 2-1/4" center to center
- Measures - 3-1/4" x 3-1/8" x 3-3/16"

#MCP1375SL MCP Rear Caliper with Pads
 #MCP1383BN Rear Brake Pads



JOES Jr Sprint Wheel Wrench

JOES Jr Sprint Wheel Wrench has a 12 point socket that fits 1-5/8" axle nuts. Multiple holes are drilled in the knurled handle to hold your spare axle spacers in place.

#24698 JR Sprint Wheel Wrench



MCP Hi Performance Master Cylinder - Black

3/4" Bore Billet Aluminum, 35% more Power than Standard Master Cylinder.

- Measures - 5" x 1" x 4-1/2" with 1-5/16" Center to Center Bolt Pattern
- Can be plumbed for dual or single brake lines.

#MCP750-B MCP Hi Performance Master Cylinder - Black



#PAN8111 Dzus Plate, 1", 10PK
 #PANA5400 Dzus Fastener, .400 Grip, 10PK
 #PANS5250 Dzus Spring, .250" Height, 1", 10PK

JOES Jr Sprint Pedal Assembly

JOES Jr Sprint Pedal Assembly has plenty of adjustment to make sure your driver is comfortable. Designed for smooth throttle and brake control.

#24831 JOES Jr Sprint Pedal Assembly

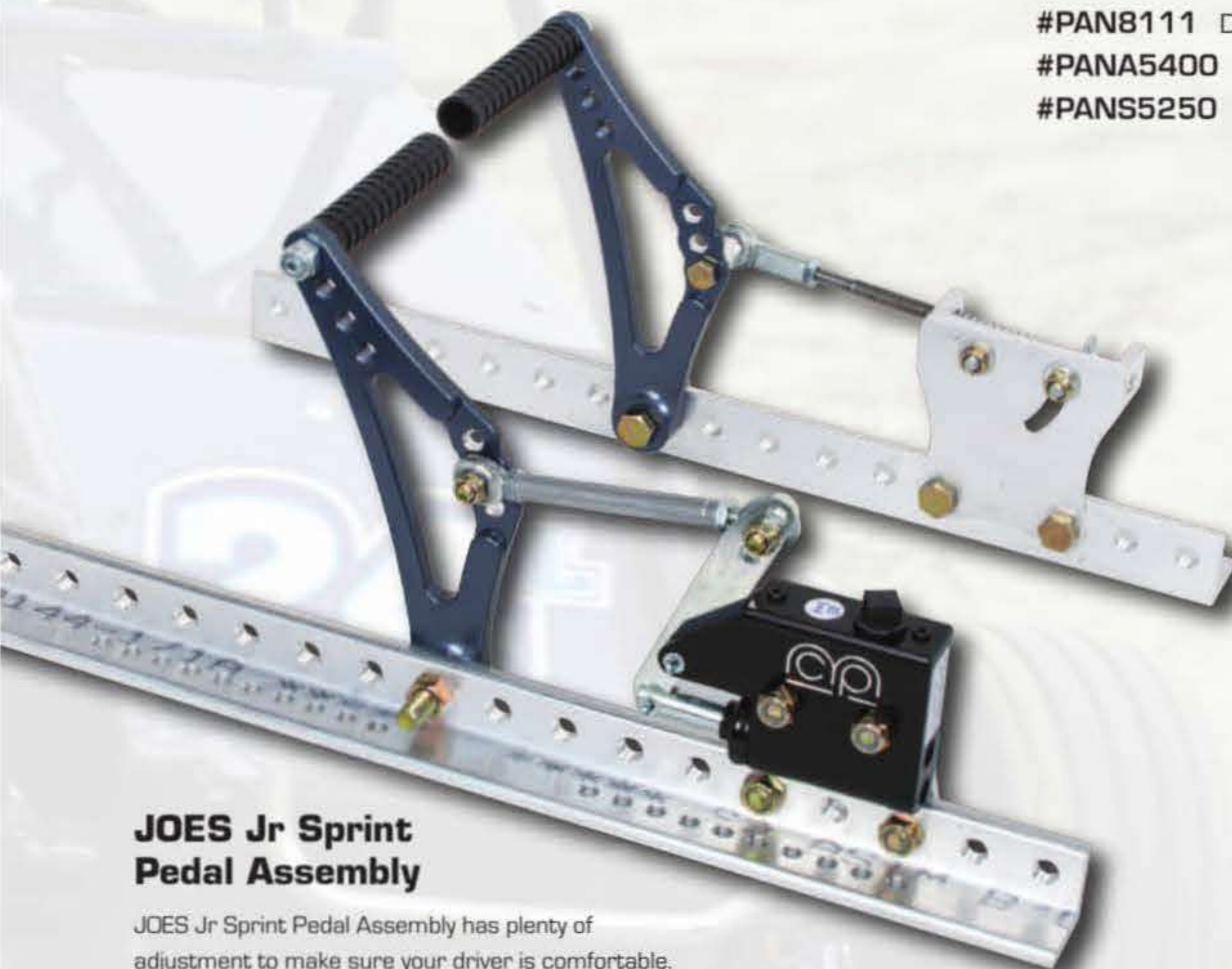

| JOES JR SPRINT BASELINE SETUP CHASSIS: JOES / KIDWELL / LEGACY | | |
|---|--|---|
| LEFT FRONT | FRONT AXLE | RIGHT FRONT |
| Clearance: 48" | Offset: Centered | Clearance: 48" |
| Compound: RD 20 | Lead: 0 | Compound: RD 20 |
| Pressure: 9 lbs. | In: 1/16 Out | Pressure: 9 lbs. |
| Wheel Width / Backspace: 6" / 3" | Rebound Pos: Level | Wheel Width / Backspace: 6" / 3" |
| Chassis Height: 2-3/4" | | Chassis Height: 2-1/8" |
| Spring: 75 | | Spring: 75 |
| Shock / Rate: CSI / 2C .5R | | Shock / Rate: CSI / 2C .5R |
| Weight: 94 | | Weight: 56 |
| RADIUS ROD POSITIONS | | RADIUS ROD POSITIONS |
| Radius Rod Slider: Bottom Hole | | Slider: 3rd From Top |
| all the way up | | Slider: 5th From Bottom |
| LEFT REAR | | RIGHT REAR |
| Clearance: 48-1/4" | | Clearance: 50-5/8" |
| Compound: RD 20 | | Compound: RD 20 |
| Pressure / Offset: 6 lbs. / 9-1/4" | | Pressure / Offset: 9 lbs. / 10" |
| Wheel Width / Backspace: 6" / 3" | | Wheel Width / Backspace: 9" / 4" |
| Chassis Height: 2-3/4" | | Chassis Height: 2-1/8" |
| Spring: 60 | | Spring: 75 |
| Shock / Rate: CSI / 1C .5R | | Shock / Rate: CSI / 3C .2R |
| Weight: 136 | | Weight: 113 |
| WING | REAR AXLE | WING |
| Wing Position: Centered Between | Wing Link Position: Centered | Wing Angle: 6" higher in rear |
| Wheels | Spindel Post / Bar: 15 / 69 | |
| | Engine Claws, Front / Rear: 20 / 30 | |
| | Bagger: 2-3/8" | |

NOTES: Weights and chassis height is with driver in car.



JOES Kart Front Hubs

JOES Kart Front Hubs feature sealed roller bearings for reduced friction. Billet 6061-T6 aluminum is precision machined and runs true for more speed. Anodized black with laser etched graphics. Fits 5/8" Spindle. Drilled and tapped 1/4"-28 and 5/16"-18 on 2.5" Bolt Circle.

#25501 Kart Front Hub



JOES Kart Front Hub Spacer Kit

Machined from 6061-T6 Aluminum. 5/8" I.D.

#25591 1/8", 1/4", 1/2" (2 each)



#25596 Hub Stud Kit
5/16"-18 X 1-1/4" (12 Pack)

#25597 Hub Stud Kit
1/4"-28 X 1-1/4" (12 Pack)



JOES Kart Rear Hubs

Use the short version or the long version to adjust your Kart for the conditions. Precision machined to roll more true than knock-offs. 1-1/4" I.D. Drilled and tapped 1/4"-28 and 5/16"-18 on 2.5" Bolt Circle.

#25560 Kart Rear Hub Short

#25580 Kart Rear Hub Long

JOES Kart/Jr Sprint Brake Rotor

JOES Kart Rotors are made from 1018 steel. Cooling slots help to dissipate heat and the scalloped shape saves weight without sacrificing braking. Combine our rotor with the JOES rotor carrier for a lightweight package that bolts right on.

#25760 Kart/Jr Sprint Brake Rotor 1/8" x 7-1/8"



JOES Kart/Jr Sprint Rotor & Sprocket Carriers

JOES Sprocket & Rotor Carriers are fully radiused and pocketed for maximum weight savings and strength.

#25770 Kart/Jr Sprint Brake Rotor Carrier
1-1/4" I.D. 5/16"-24 on 3" B.C.

#25780 Kart/Jr Sprint Sprocket Carrier
1-1/4" I.D. 1/4"-28 on 5-1/4" B.C.

JOES Kart Axle Tube

JOES Kart Axle is precision ground, 40" long and made from 1-1/4" diameter .190 wall 4130 Chromoly Tubing. It is designed for minimal rotating weight and still gets you through the toughest conditions. It has 17" long x 1/4" keyways machined on both ends to give you the adjustment you need to set your kart set up exactly the way you want.

#25755 JOES Kart Axle Tube

JOES Adjustable Jack Shaft Mount

JOES Billet Jack Shaft Mount is engineered to make mounting your engine a snap. Strong and easily adjustable to make for quick changes at the track or in the shop. JOES has engineered the mount to work with most popular Kart engines and the lightweight package comes with everything you need to bolt it right on.

#25710 Kart Universal Adjustable Jack Shaft Mount

#25715 Kart 4-stroke Adjustable Jack Shaft Mount

#25718 Kart Jack Shaft Replacement Butterfly Clamp Set



Slide Block Makes Adjustments Easy!

#25715 Shown

#25718

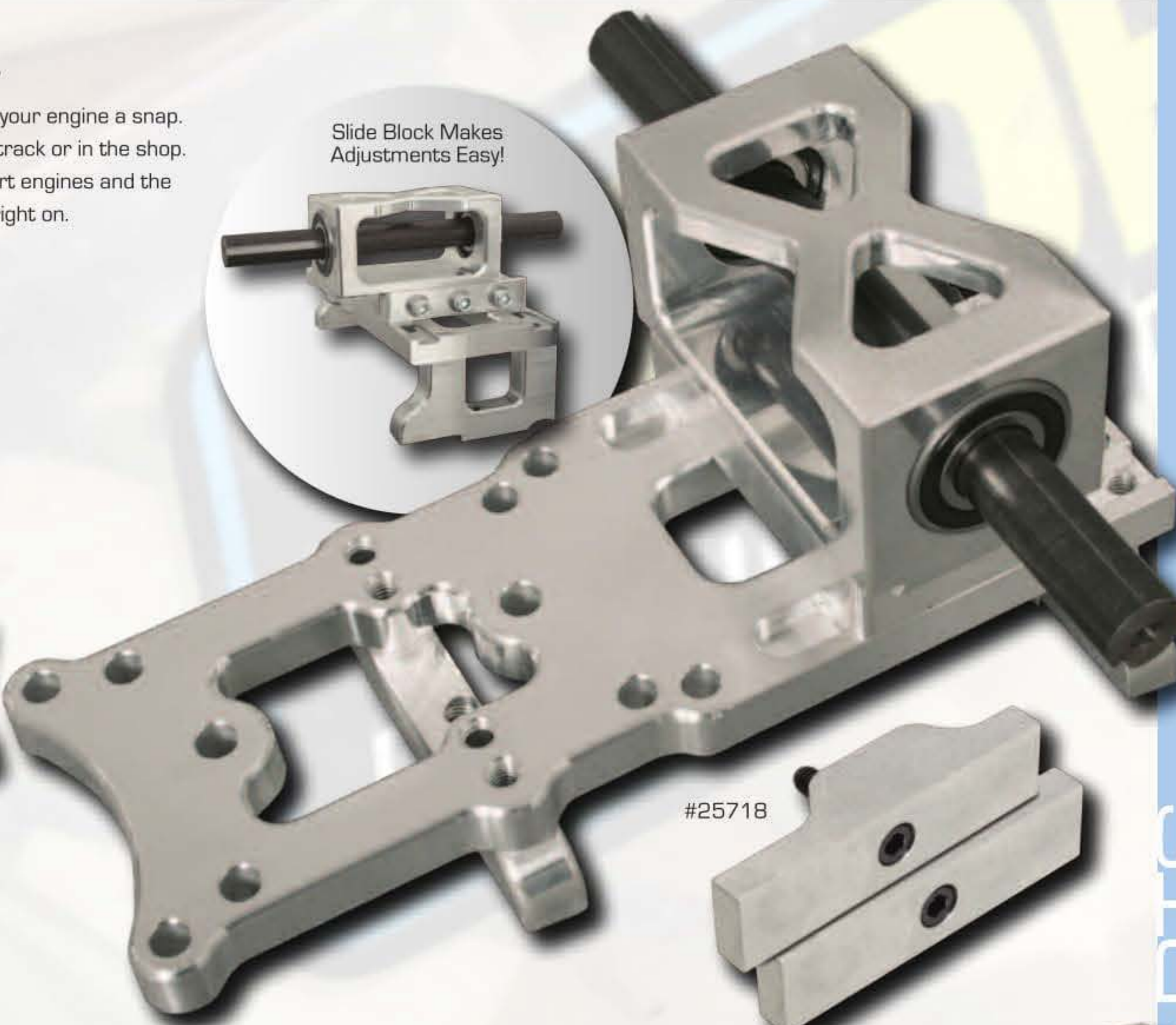

JOES Titanium Jack Shaft

If you want the very best equipment, then you should consider our Titanium Jack Shaft. It will reduce the rotating weight of your drive train and the overall weight of your kart. 3/4" diameter x 9" long. It replaces the standard shafts on our Jack Shaft Assemblies.

#25740 Titanium Shaft 3/4" Dia. x 9" Long

Birky Clutch

Birky Clutches are the most consistent clutch you will find. Once you set the RPM engagement they will consistently engage at the same RPM lap after lap, even when they get hot. They have a 50 tooth pulley built in.

#BIR10003 Birky Clutch
#BIR10004 Birky Clutch Rebuild Kit



Yamaha CRE7 Pipe

The CRE 7 Exhaust Pipe is known as the crown jewel to KT100 Go-Kart racers. Hours upon hours of dyno time were dedicated to making this the best Yamaha KT100 pipe available. It is a low to mid range pipe for small to medium size tracks. Fine tuning can be achieved by changing your flex length, but the base line is 7" to 7-3/8" from the piston to the end of the flex pipe. Uses 1-3/4" OD flex tube.

#CRE7 Yamaha CRE7 Pipe



Gates PowerGrip GT-3 Drive Belts

- Fiberglass tensile cord provides high strength, excellent flex life, and high resistance to elongation.
- Neoprene body provides protection against grime, grease, oil, and moisture.
- Nylon tooth facing provides a durable wear surface for long service life.
- 560 x 8mm x 20mm wide
- 576 x 8mm x 20mm wide

#GAT560-8MGT-20 560-8M-20 PowerGrip GT3 Drive Belt

#GAT576-8MGT-20 576-8M-20 PowerGrip GT3 Drive Belt

#GAT560-8MGT-30 560-8M-30 PowerGrip GT3 Drive Belt



KARTS

KARTS



JOES Kart Billet Caster Camber Gauge

JOES Kart Billet Camber Gauge is precision milled and has laser etched graduations for accuracy. Comes complete with a case and a 5/8"-18 adapter.

- #28203 Kart 8 Degree Caster Camber Gauge w/5/8"-18 Adapter
- #28022 Kart 5/8"-18 Adapter



JOES Kart Toe Gauge

JOES Kart Toe Gauge kit comes with everything you need to make quick work out of precisely setting the toe on your Kart. Billet construction slips on your 5/8" spindles quickly and the slots are specially designed to hold the tapes that are inside your kit. Storage box included.

- #32615 Kart Toe Gauge

Burriss Grooved Dirt Tires

- #BUR9556-TX11 11.0/5.5-6 Wide TX11
- #BUR9806-TX11 12.0/8.0-6 Wide TX11



Chain Break

RLV #35 Chain Breaker

- #RLV0765 #35 Chain Breaker



Douglas Karting Wheels

- 6" diameter X 10" wide
 - 4" Nose
 - 6" Backspace
 - 5/16"-18 on a 2.5" bolt pattern.
 - #DWT706-29B Rear Wheel
- 6" diameter X 6.5" wide
 - 2-1/2" Nose
 - 4" Backspace
 - 5/16"-18 on a 2.5" bolt pattern
 - #DWT706-03 Front Wheel

JOES Micro/Kart/Car Pedals (Pair)

JOES Micro Pedals are designed to give you maximum control. The design allows you to adjust the leverage points so that your GO foot is able to accelerate smoothly and your STOP foot can apply just the right amount of pressure to turn faster lap times. They are machined out of aircraft quality aluminum and have an anodized finish.

#25830 Micro/Kart Pedals (Pair)



JOES Kart Vent Tank

JOES Kart Vent Tank has a panel mount for quick and easy mounting on your kart. The compact tank includes a hose barb fitting and has a drain valve for removal of fluids.

#12318 JOES Kart Vent Tank



JOES Quarter Midget/Kart Quick Disconnect

Made from 6061-T6 aluminum and fits most Quarter Midgets and kart steering columns.

#13405 Quarter Midget/Kart Quick Disconnect

#13406 Quarter Midget/Kart Quick Disconnect Shaft Coupler Only



QUARTER MIDGET

JOES Spoke-Up Steering Wheel Pad

JOES sets the standard in Steering Wheel Pads. The latest version is designed for steering wheels that have the center spoke pointing up.

#13651 Steering Wheel Pad- Spoke-Up



JOES Quarter Midget Steering Wheel

JOES Quarter Midget Steering Wheel is Anodized black and Shot Peened for a texture you can hold on to. JOES machines the center section and pre-drills the mounting holes ensuring a centered wheel for improved feel and chassis feedback.

#13505-b 11" Quarter Midget Steering Wheel- Black



JOES Quarter Midget Brake Hub

JOES Quarter Midget Hubs are milled to perfection for smooth operation and longer life. Hardware, anodize and laser etching are included giving you what you need for simple installation.

#25411 Brake Hub 1-1/4" I.D.



JOES Quarter Midget Brake Rotor

JOES GM rotors are made from 1018 steel. The scalloped shape saves weight without sacrificing braking power.

#25410 Quarter Midget Brake Rotor



Check out the collection of performance fuel system parts we offer.