



KURYAKYN



*Designed
by riders
for Riders*

2019 MOTORCYCLE ACCESSORIES FOR
HARLEY-DAVIDSON®



others by accident. At Kuryakyn, ideas

of combined experience and active participat

that realize a motorcycle isn't just a means of

CHEERS to THIRTY YEARS

Design CREATORS OF DA
KURYAKYN Daring by
ORS OF DARING
nsformed
THE UNMIS
Daring by Design
CREATOR OF DARING
Be transformed
YAKYN THE UNMIS
Daring by
RING PRODUCT
Be Transformed
THE UNMIS
Daring by
RING PRODUCT
ed Daring by
MISTAKE LOG
Design



2018

1989

2019

2019



SURE, A LOT HAS CHANGED OVER THE LAST THIRTY YEARS, BUT JUST LIKE VINTAGE BIKES OF A BYGONE ERA, IT'S ALL GETTING BETTER WITH AGE.

PROGRESS ISN'T POSSIBLE WITHOUT CHANGE, AND OUR COMMITMENT TO PROGRESSION IS UNWAVERING.

WHAT STARTED IN 1989 WITH OUR ORIGINAL ISO®-GRIP AND HYPERCHARGER® AIR CLEANER HAS GROWN TO BECOME AN OUTLET FOR RIDERS OF NEARLY EVERY MAKE TO TRANSFORM THEIR RIDE INTO SOMETHING AS UNIQUELY INDIVIDUAL AS THEY ARE.

AND WE ARE NOT SLOWING DOWN. SADDLE UP FOR ONE HELL OF A RIDE AS WE CONTINUE TO BREAK GROUND TOWARD THE NEXT 30 YEARS.

JUST THE BEGINNING.



WHAT'S INSIDE

TABLE OF CONTENTS

NEW NEW IN 2018	4
KELLERMANN LIGHTING	8
XKURSION & MOMENTUM LUGGAGE	10
COLLECTIONS	12
FEATURED BIKES	14
AUDIO	27
LIGHTING	33
ACCESSORY MOUNTS	71
HANDLEBAR CONTROLS, GRIPS & MIRRORS	79
PEGS & FOOT CONTROLS	101
COVERS, TRIMS & ACCENTS	151
AIR CLEANERS & EXHAUST	235
TOURING & COMFORT	267
WINDSHIELDS & AIR MANAGEMENT	279
LUGGAGE & ORGANIZERS	285
INDEX & TERMS OF BUSINESS	317

Stay Connected

Live Chat
INSTANT ACCESS TO
CUSTOMER SERVICE REPS

Shop by Bike



Sign Up
BECOME PART OF THE KURY CREW
FOR EXCLUSIVE PERKS

NEW

PRECISION
COIL COVER

PHANTOM
MINI BOARDS

KELLERMANN ATTO

PRECISION CHIN SPOILER

HEX GRIPS & MIRRORS

RIDGEBACK
SHIFT LEVER





ROAD THUNDER
SOUND BAR PLUS

ALL NEW FOR HARLEY-DAVIDSON

COLLECTIONS

Dillinger	12
Hex	12

AUDIO & LIGHTING

Road Thunder Sound Bar Plus	28
Kellermann Custom Taillights & Turn Signals	51
L.E.D. Accent Strip Lights	68

HANDLEBAR & FOOT CONTROLS

Zombie Levers	90
Phantom Footpegs without Adapters	113
Phantom Mini Boards	113
Passenger Peg Adapters	128
Driver Peg Adapters	128
Driver Floorboard Spacers	131
Ridgeback Brake Pedal	148
Ridgeback Front Shift Arm	143
Ridgeback Shift Lever	148
Ridgeback Shift Peg	112
Ridgeback Transmission Shift Arm	143

COVERS, TRIMS & ACCENTS

Precision Chin Spoiler	179
Precision Dipstick	193
Precision Coil Cover	202
Precision Inner Primary Cover	194
Precision Lower Front Engine Cover	181
Precision Cylinder Base Cover	191
Precision Oil Line Cover	192



L.E.D. ACCENT STRIP LIGHTS



DILLINGER FOOTPEGS
& SHIFT PEG

NEW

L.E.D. SADDLEBAG HINGE ACCENTS

SADDLESHIELDS FOR SOFTAIL

XKURSION XW PORTER BAG

JACKET ROLL

NOVA SIDE MOUNT LICENSE
PLATE FRAME

MOMENTUM
DEADBEAT DUFFLE

ALL NEW FOR HARLEY-DAVIDSON



MOMENTUM ROAMER TAIL BAG



BARRIO BAG



HYPERCHARGER HORN COVER

COVERS, TRIMS & ACCENTS Continued

Precision Transmission Shroud	189
Precision Regulator Cover	177
Precision Lower Front Frame Cover	181
Speedform Saddlebag Lid Spoilers	217
Hypercharger ES Horn Cover	203
Saddlebag Scuff Protector	217
L.E.D. Saddlebag Hinge Accents	214
Nova Side Mount License Plate Frame	228

WINDSHIELDS & AIR MANAGEMENT

Saddle Shields for Sportster	282
Saddle Shields for Softail	282

LUGGAGE & ORGANIZERS

Batwing Fairing Bag	289
Barrio Bag	288
Momentum Deadbeat Duffel Bag	292
Momentum Roamer Tail Bag	308
XKursion XS Guardian Rack Bag	307
XKursion XW Porter Bag	297
Xkursion XS Steward Roll Bag	295
XKursion XS Odyssey Bag	303
Xkursion XS Depot Bag	305
XKursion XB Ambassador Tail Bag	309
Quick-Stash Magnetic Device Tank Pouch	289
Jacket Roll	312
Travel Accessory Bag	312
Removable Pouch for Momentum Luggage	313
Saddlebag Pouches	314

KURYAKYN

by Kellermann 

ATTO



MICRO S



MICRO RHOMBUS



BULLET 1000

RHOMBUS S

NEXT LEVEL LIGHTING

HIGH-PERFORMANCE TURN SIGNALS AVAILABLE IN A VARIETY OF SIZES & PROFILES. MODERN DESIGNS, PREMIUM MATERIALS, & ADVANCED L.E.D. TECHNOLOGY FOR EXTREME LIGHT OUTPUT WITH UNMATCHED LONGEVITY.

PAGES 51-58



BL 2000

#1 choice for motorcycle luggage





THERE'S SO MUCH WE LOVE ABOUT RIDING. WHAT WE DON'T LOVE IS WASTING TIME PACKING FOR THE JOURNEY. KURYAKYN LUGGAGE IS DESIGNED BY RIDERS LIKE YOU. RIDERS DRIVEN BY AN INSATIABLE LUST FOR MORE MILES. WE KNOW THAT MORE MILES MEAN MORE LIFE. THE VARIETY, CONVENIENCE AND OVERALL DESIGNS OF KURYAKYN LUGGAGE MAKE IT THE #1 CHOICE FOR WANDERLUSTS LIKE YOU.





DILLINGER

COLLECTIONS

EVERY MOTORCYCLE STARTS AS A BLANK CANVAS - YOURS FOR THE DEFINING. WE'VE DESIGNED SEVERAL COLLECTIONS THAT CAN BE USED SOLO OR IN COMBINATION WITH OTHER COLLECTIONS; ONE PIECE OR FIFTEEN! IT'S YOUR RIDE.

Make it yours.



**HEAVY
INDUSTRY**



THRESHER



RIOT



Hex



KINETIC

ZOMBIE



STREET GLIDE®

FEATURED PRODUCT

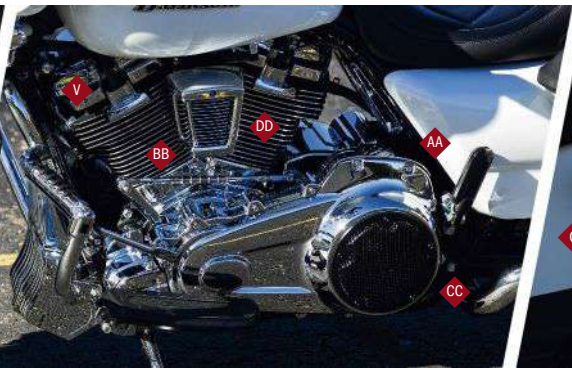



LIGHTING

A	2460	Orbit Vision 7" Headlight	34
B	5442	Front L.E.D. Turn Signal Inserts	44
NEW C	5419	L.E.D. Accent Strip Lights	68
D	5460	Rear L.E.D. Turn Signal Inserts	43

HANDLEBAR CONTROLS, GRIPS & MIRRORS

E	6123	Heavy Industry Grips	83
F	6563	Mesh Clutch Master Cylinder Cover	89
G	1816	Fairing Mounted Scythe Mirrors	98
H	5733	ISO Levers	91

PEGS & FOOT CONTROLS

I	7042	Heavy Industry Driver Floorboards	113
J	7032	Heavy Industry Footpegs	110
K	7040	Heavy Industry Brake Pedal Pad	111
L	7576	Ergo Plus Engine Guard	137

COVERS, TRIMS & ACCENTS

M	7284	Tri-Line Gauge Trim	159
N	6985	Tri-Line Ignition Switch Cover	160
O	5689	Signature Series Smooth Dash Console By Jim Nasi	167
P	7178	Flush Mount Pop-Up Gas Cap	167
Q	1229	Front Axle Nut Caps	171
R	6539	Mesh Front Caliper Cover	175
S	6417	Precision Oil Cooler Cover	177
T	6427	Precision Regulator Cover	177
U	6419	Precision Upper Frame Cover	183
V	7185	Precision Spark Plug Covers	201
W	6561	Mesh Timing Cover	187
X	6410	Precision Tappet Block Accent	188
Y	6412	Precision Transmission Shroud	189
Z	6416	Precision Starter Cover	190
AA	6413	Precision Inner Primary Cover	194
BB	6411	Precision Cylinder Base Cover	194
CC	6527	Mesh Derby Cover	197
NEW DD	7496	Hypercharger ES Horn Cover	203
EE	6510	Mesh Saddlebag Hinge Covers	215

AIR CLEANERS & EXHAUST

FF	9361	Hypercharger™ ES for Touring	237
----	------	------------------------------	-----

LUGGAGE & ORGANIZERS

GG	5261	Batwing Fairing Pouch Bag	289
----	------	---------------------------	-----



ROAD GLIDE®

FEATURED PRODUCT

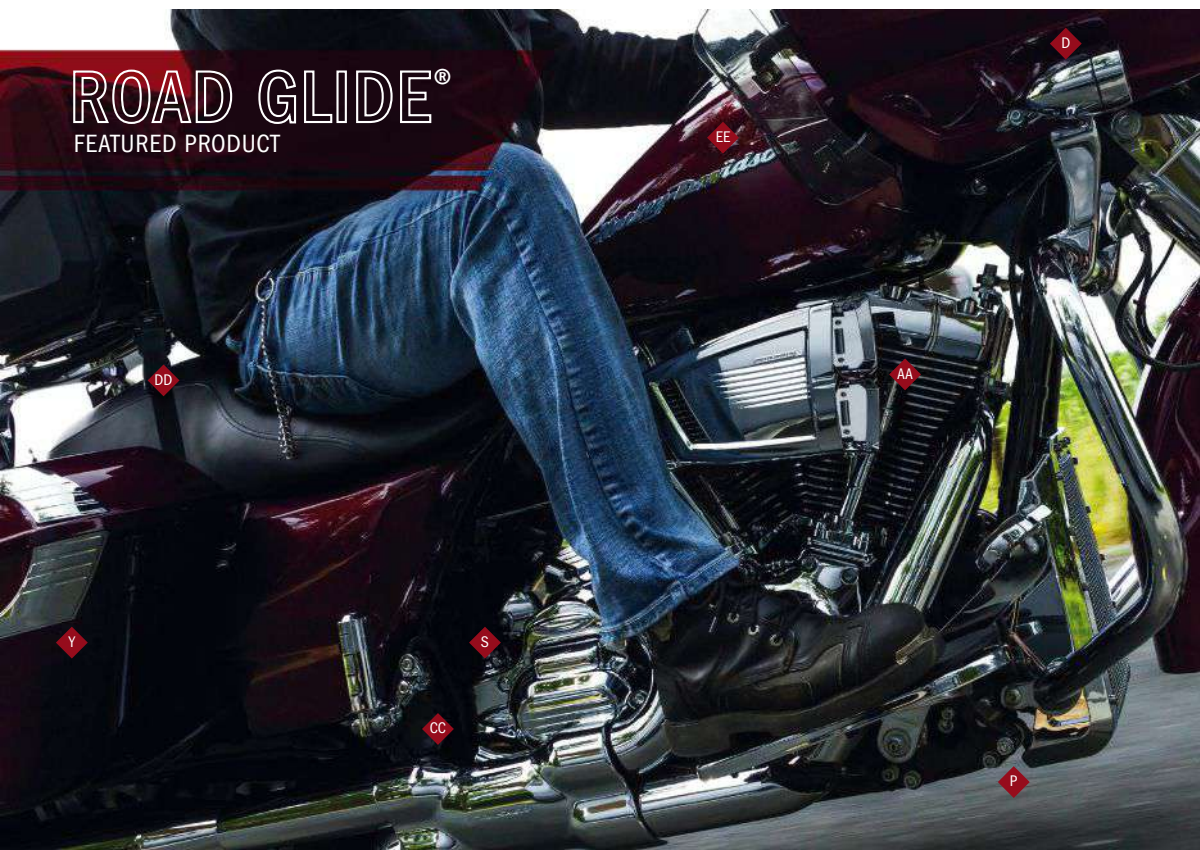



LIGHTING

A	5442	L.E.D. Front Turn Signal Inserts	44
B	6906	L.E.D. Rear Saddlebag Accents	69
C	5406	Rear Turn Signal Bar	50
D	2107	Deep Dish Bezels w/Smoke Lenses	65

HANDLEBAR CONTROLS, GRIPS & MIRRORS

E	1708	Teardrop Mirrors	97
---	------	------------------	----

PEGS & FOOT CONTROLS

F	7905	ISO® Boards	126
NEW G	9644	Ridgeback Shift Lever	148

COVERS, TRIMS & ACCENTS

H	2632	Windshield Side Trim	157
I	5715	Windshield Mounting Spikes	157
J	6913	Fairing Vent Accent	157
K	6518	Mesh Headlight Vent Accents	158
L	6926	Tri-Line Speedo/Tach Accent	161
M	7378	Tri-Line Speaker Grills	162
N	6970	Switch Panel Accent	161
O	5688	Signature Series Smooth Dash Console by Jim Nasi	167
P	6498	Mesh Airdam	179
Q	8323	Scorpion Spark Plug/Head Bolt Cover	200
R	9828	Finned Timing Cover	187
S	6950	Transmission Shroud	189
T	9748	Finned Derby Cover	198
U	6066	Finned Front Primary Accent	199
V	9231	Finned Primary Inspection Cover Accent	199
W	5687	Signature Series Horn Replacement Accent by Jim Nasi	205
X	8392	Cylinder Base Cover	196
Y	6908	Tri-Line Saddlebag Accents	217
Z	7797	Rear Fender Accents	224

AIR CLEANERS & EXHAUST

AA	9356	Hypercharger™ ES for Twin Cam	237
BB	491	Trident Slip-On Mufflers	257
CC	558	Crusher Dual Exhaust with Power Cell	260

TOURING & COMFORT

DD	1660	Multi-Purpose Backrest	269
----	------	------------------------	-----

WINDSHIELDS & AIR MANAGEMENT

EE	1244	Adjustable Fairing Air Deflectors	280
	1316	Saddle Shields (Not Shown)	282



ELECTRA GLIDE®

FEATURED PRODUCT





AUDIO & LIGHTING

A	862	Billet Antenna-Round	32
B	2461	Orbit Prism 7" L.E.D. Headlight	34
	2267	Orbit Prism 4-1/2" L.E.D. Passing Lamps (Not Shown)	34
C	7131	Sequential L.E.D. Bat Lashes	154
D	5442	L.E.D. Front Turn Signals Inserts	44

ACCESSORY MOUNTS

D	1692	Passenger Drink Holder	78
E	1699	Tech-Connect Device Mounting System	72

HANDLEBAR CONTROLS, GRIPS & MIRRORS

F	6530	Mesh Brake Master Cylinder Cover	89
NEW G	5922	Hex Grips	81
H	1843	Trigger Levers	90
NEW I	5918	Hex Mirrors	94

PEGS & FOOT CONTROLS

J	7041	Heavy Industry Floorboards	112
K	7039	Heavy Industry Brake Pedal Pad	111
L	7027	Heavy Industry Switchblades	110
M	4353	Adjustable Passenger Pegs	132
N	4526	Tour-Tech Cruise Mounts	138

COVERS, TRIMS & ACCENTS

O	5053	L.E.D. Fairing Vent Accent	153
P	1387	Smooth Windshield Trim	152
Q	7275	7" Headlight Trim Ring	156
R	7277	4-1/2" Passing Lamp Trim Rings	156
S	7284	Tri-Line Gauge Trim	159
T	7239	Tri-Line Stereo Trim	159
U	6968	Tri-Line Fuel Door	166
V	6984	Tri-Line Ignition Switch Cover	160
W	7292	L.E.D. Saddlebag Extensions	219
X	6910	Tri-Line Rear Tour-Pak Light Accent	223
Y	6911	Tri-Line Accents for Side Tour-Pak Lights	223
NEW Z	6706	Tour-Pak Lid Light	223
AA	6906	Spear L.E.D. Saddlebag Accents	220
BB	6905	Tri-Line Saddle Bag Lid Accents	219
CC	6986	Tri-Line Saddlebag Hinge Covers	214
NEW DD	5476	L.E.D. Saddlebag Hinge Accents	214

AIR CLEANERS & EXHAUST

EE	558	Crusher Dual Exhaust with Power Cell	260
----	-----	--------------------------------------	-----

TOURING & COMFORT

FF	7139	Luggage Rack	272
GG	7160	Tour-Pak Lid Grip	221

WINDSHIELDS & AIR MANAGEMENT

HH	1772	9" Dark Smoke Windshield	284
II	1247	Adjustable Fairing Air Deflectors	281

LUGGAGE & ORGANIZERS

	5261	Batwing Fairing Pouch (Not Shown)	289
JJ	5289	Saddlebag Pouches	314



ROAD KING[®]

FEATURED PRODUCT



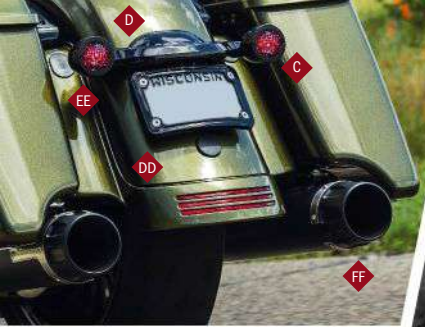

AUDIO & LIGHTING

NEW	A	2720	Road Thunder Sound Bar Plus	29
	B	2461	7" Orbit Prism L.E.D. Headlight	34
	C	6545	Mesh Turn Signal Bezels	63
	D	5407	Rear Turn Signal Bar	50

ACCESSORY MOUNTS

	E	1698	Tech-Connect Device Mounting System	73
--	---	------	-------------------------------------	----

HANDLEBAR CONTROLS, GRIPS & MIRRORS

	F	3583	Riot Grips	83
	G	1819	Trigger Levers	90
	H	1708	Teardrop Mirrors	97

PEGS & FOOT CONTROLS

	I	3595	Riot Floorboards	109
	J	3575	Riot Brake Pedal Pad	109
	K	9647	Carved Shift Linkage-Black/Raw	148
NEW	L	9679	Ridgeback Shift Lever	145
NEW	M	5803	Ridgeback Front Shift Arm Cover	143

COVERS, TRIMS & ACCENTS

	N	7143	Upper Fork Slider Accents	174
	O	7147	Lower Fork Covers	174
		6420	Precision Upper Frame Cover (Not Shown)	177
	P	6428	Precision Regulator Cover	177
	Q	6418	Precision Oil Cooler Cover	177
	R	6445	Precision Transmission Shroud	188
	S	6440	Precision Tappet Block Accent	188
	T	6446	Precision Starter Cover	190
	U	9341	Precision Throttle Servo Motor Cover	185
	V	7186	Finned Spark Plug Covers	201
	W	6443	Precision Inner Primary Cover	194
	X	7491	Hypercharger ES Horn Cover	142
	Y	9839	Finned Timing Cover	187
	Z	9749	Finned Derby Cover	198
	AA	6063	Finned Primary Accent	198
	BB	6069	Finned Front Primary Accent	199
	CC	6510	Mesh Saddlebag Hinge Covers	215
	DD	3143	Curved License Plate Frame	232
	EE	3109	Antenna Hole Filler	227

AIR CLEANERS & EXHAUST

	FF	636	4" Maverick Slip-On Mufflers	254
	GG	9361	Hypercharger ES	237



SPORTSTER®

FEATURED PRODUCT





NEW	2720	Sound Bar Plus (Not Shown)	28
A	2463	Orbit Prism 5-3/4" L.E.D. Headlight	36
NEW	B	2523 Kuryakyn By Kellermann, Atto RB	52
C	5941	Thresher Grips	81
D	1963	Phantom Mirrors	95
E	6559	Mesh Brake Master	89
NEW	F	6666 Dillinger Footpegs	106
NEW	G	6714 Dillinger Shift Peg, Silver	106
H	3572	Riot Shift Linkage, Silver	144
NEW	I	6688 Dillinger Headlight Trim Ring, 5-3/4"	155
J	6567	Mesh Manifold & Injector Cover	201
K	6529	Mesh Derby Cover	197
	6523	Mesh Timing Cover (Not Shown)	187
	6555	Mesh Front Pulley Cover (Not Shown)	192
L	7183	Spark Plug Covers	201
	3191	Nova Curved Side Mount License Plate Holder	228
	3119	Mount Clamps for Nova	229
O	9625	Crusher Revolt Air Cleaner	245
P	570	Crusher 2-into-2 Full System	261
NEW	Q	6708 Dillinger Handguards, Silver	283
NEW	R	6664 Dillinger Luggage Rack, Silver	271
NEW	S	5224 Jacket Roll	312
	5294	XKursion XT Co-Pilot Tank Bag (Not Shown)	290
	5256	XKursion XB Ambassador Tail Bag (Not Shown)	309



SOFTAIL®
FEATURED PRODUCT





A	2535	Kuryakyn By Kellermann Atto	52
NEW	B	2523 Kuryakyn By Kellermann, Atto RB	52
C	5943	Thresher Grips	81
D	1737	Heavy Industry Mirrors	95
E	5957	Thresher Footpegs	107
F	5953	Thresher Shift Peg	107
G	6549	Mesh Gas Cap	168
	6543	Mesh Front Caliper Cover (Not Shown)	175
NEW	H	6465 Precision Chin Spoiler	179
NEW	I	6467 Precision Coil Cover	202
NEW		6440 Precision Tappet Block Accent (Not Shown)	188
NEW		6451 Precision Inner Primary Cover (Not Shown)	194
NEW		6453 Precision Cylinder Base Cover (Not Shown)	194
J	7186	Finned Spark Plug Covers	201
K	9749	Finned Derby Cover	198
L	9839	Finned Timing Cover	187
M	3193	Nova Side Mount License Plate Mount	228
N	9376	Hypercharger ES	237
O	5789	Saddle Shields	282
NEW	P	5224 Jacket Roll	312
	Q	5213 Rambler Roll Bag	294

DYNA[®]

FEATURED PRODUCT



NEW	2715	Road Thunder Sound Bar (Not Shown)	28
A	2463	Orbit Prism 5-3/4" L.E.D. Headlight	36
B	2237	High-Intensity L.E.D. Bulbs, Red/Red	67
C	6545	Mesh Bezels for Bullet Style Turn Signals	63
D	5941	Thresher Grips	81
E	1737	Heavy Industry Mirrors	95
	1029	Trigger Levers (Not Shown)	90
F	3597	Riot Mini Boards	108
G	3591	Riot Shift Peg	109
	3577	Riot Brake Pedal Pad (Not Shown)	109
H	9898	Crusher Maverick Pro Air Cleaner	241
	579	Crusher TC-24D Cams (Not Shown)	265
	577	Crusher Easy Install Adjustable Pushrods (Not Shown)	266
	659	Crusher High-Performance Hydraulic Lifters (Not Shown)	266
NEW	5223	Momentum Deadbeat Duffel	292
NEW	J	5219 Barrio Bag	288



AUDIO

SPEAKERS	28
ANTENNAS	32
AUDIO COMPONENTS	32

*Charge and connect
while riding!*



NEW VERSION!

Double the power! Integrated charging & connecting capabilities!

SPEAKERS



NEW



Patent Pending Mounting Clamps



Patent Pending Mounting Clamps

ROAD THUNDER® SOUND BAR PLUS BY MTX®

The Road Thunder Sound Bar Plus features 300 watts of peak power and versatility in the form of an integrated USB charging port. An internal 4-channel amp powers two 2" x 3" full-range speakers with dual voice coils and four high-frequency 1" silk dome tweeters with N42 grade magnets for powerful distortion-free sound. Durable IP66-rated housings are weather-resistant, while built-in heat sink and self-protection circuit combat excessive heat and voltage regulation. An internal 3.0 Bluetooth receiver allows wireless connectivity to any Bluetooth-enabled smartphone or music device, and auxiliary input and output connect standard devices via 3.5 mm cable. The patent-pending universal articulating mounting clamps offer easy installation on virtually handlebar setup. Includes power, ground and ignition wire for easy disconnect.

FOR MULTI-FIT

Fits: 7/8" through 1-1/4" Bars

2719 Satin Silver (ea)

2720 Satin Black (ea)

KURYAKYN MTX ROAD THUNDER

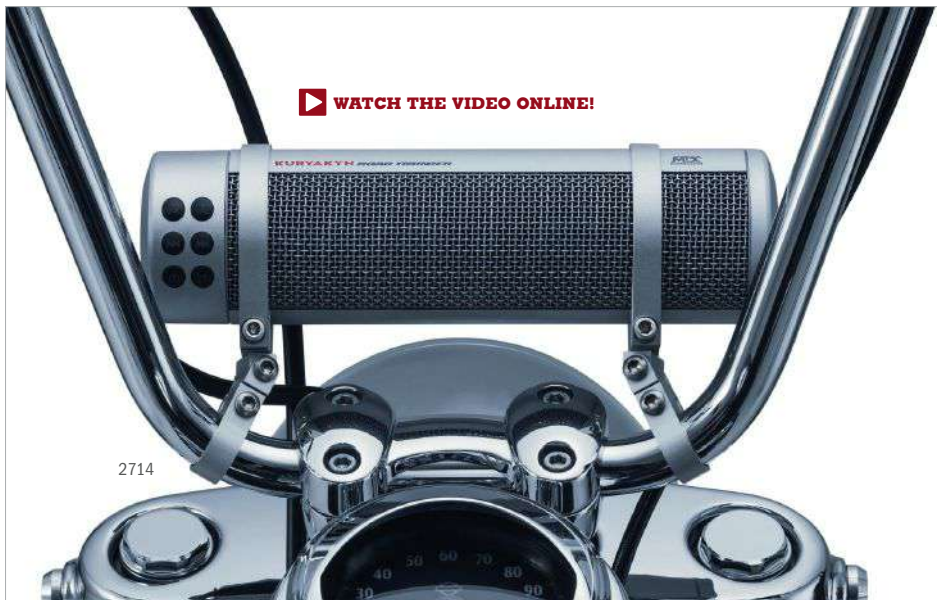

2714

▶ WATCH THE VIDEO ONLINE!



2715



2715



2714

Mounts easily & looks great on virtually any bars!

ROAD THUNDER® SOUND BAR BY MTX®

An internal amp powers two 2" x 3" full-range speakers with single voice coil and four high-frequency 1" silk dome tweeters with N35 grade magnets to pump out crystal clear tunes with 150 watts of peak power. Weather-resistant construction in accordance with IP66 rating. Universal patent pending mounting clamp fits bars from 7/8" in diameter to 1-1/4". Includes power, ground and ignition wire for easy disconnect, as well as auxiliary input for connecting devices via 3.5 mm cable. Internal Bluetooth receiver allows wireless connectivity to any Bluetooth-enabled smartphone or music device. Bracket measures 6" long x 3" in diameter.

FOR MULTI-FIT

Fits: 7/8" through 1-1/4" Bars

2714 Satin Silver (ea)

2715 Satin Black (ea)



Patent Pending Mounting Clamps



Patent Pending Mounting Clamps

KURYAKYN MTX ROAD THUNDER®

New

Collections

Featured Bikes

Audio

Lighting

Accessory Mounts

Handlebar Controls, Grips & Mirrors

Pegs & Foot Controls

Covers, Trims & Accents

Air Cleaners & Exhaust

Touring & Comfort

Windshields & Air Management

Luggage & Organizers

Index



2712



2713

*These pint-sized
speakers deliver
big sound!*



**ROAD THUNDER® SPEAKER PODS
& BLUETOOTH® AUDIO CONTROLLER BY MTX®**

Turn any smartphone or mp3 player with Bluetooth capabilities into the ultimate mobile sound system. Included are self-amplified 3" Road Thunder Speaker Pods with 100W peak power, 1" handlebar mounting clamp set, 7/8" handlebar adapter set, and the Road Thunder Bluetooth Audio Controller that lets you wirelessly connect any Bluetooth-enabled device to the powerful Road Thunder Speaker Pods. Speakers feature a low 5-amp current draw and are housed in durable high-impact ABS enclosures with 3.5 mm input port. Weather-proof design tested in accordance with IP66 rating requirements.

FOR MULTI-FIT

Fits: 7/8" & 1" Bars

2712 Chrome (set)

2713 Satin Black (set)

KURYAKYN ^{MTX} ROAD THUNDER



2716

KURYAKYN ROAD THUNDER® BLUETOOTH® AUDIO CONTROLLER BY MTX®

Turn any smartphone or mp3 player with Bluetooth capabilities into the ultimate mobile sound system. Wirelessly connects your Bluetooth-enabled device to Kuryakyn Road Thunder Speaker Pods, The Sound of Chrome speakers, or almost any other self-amplified speakers. This universal Bluetooth audio controller replaces the head unit and is easy to install. Compatible with most Bluetooth devices, including Android and iPhone. Includes two adjustable bar mount brackets for 7/8" through 1" bars and 1-1/8" through 1-1/4" bars. Durable, weather-proof design with included power, ground and output connections.

FOR MULTI-FIT

Fits: 7/8" through 1" and 1-1/8" through 1-1/4", Adjustable Mounting Brackets

2716 Satin Black (ea)



1786

**OPTIONAL & REPLACEMENT MOUNTING BRACKETS FOR THE ROAD THUNDER®
SPEAKER PODS**

Replace lost or damaged mounting adapters and clamps and continue enjoying the sound of your Kuryakyn Road Thunder Speaker Pods by MTX.

FOR MULTI-FIT

Fits: 7/8" Bars

1786 Silver (ea)



2792

Fits: 1" Bars (accepts 5/16" Mounting Hardware)

1420 Chrome (ea)

2791 Satin Black (ea)



1468

Note: Will Fit 7/8" Bars with Adapter Kit 1786

Fits: 1-1/4" Bars (accepts 5/16" Mounting Hardware)

1468 Chrome (ea)

2792 Satin Black (ea)

*Delivers pulse-pounding
crystal clear audio!*

2717



2718

ROAD THUNDER® FAIRING SPEAKER KIT BY MTX®

FOR '98-'13 ELECTRA GLIDES, STREET GLIDES & TRIKES

Includes everything you need to replace the stock fairing speakers with pulse-pounding crystal clear audio. The included 2-channel Amp cranks out 400W of potent peak power to the 120W 6.5" coaxial speakers that feature extended low frequency response for fuller sound, with high sensitivity for no distortion at higher volume levels. The included stylish steel mesh replacement speaker grills make the pair look as good as they sound. Kit includes two (2) 120W 6.5" replacement fairing speakers, 2-channel 400W peak power amp, wiring harness and speaker grills. Does not interfere with rear OEM speakers on models equipped with Tour-Pak backrest-mounted speakers. Weather-resistant amplifier is in accordance with IP66 rating.

FOR HARLEY-DAVIDSON®

Fits: '98-'13 Electra Glides (except FLHT Standard & CVO Models), '06-'13 Street Glides (except CVO Models) & '09-'13 Trikes

2717 Chrome (kit)

2718 Satin Black (kit)



2718



2717



2717

KURYAKYN MTX ROAD THUNDER

New

Collections

Featured Bikes

Audio

Lighting

Accessory Mounts

Handlebar Controls,
Grips & Mirrors

Pegs & Foot Controls

Covers, Trims
& Accents

Air Cleaners
& Exhaust

Touring & Comfort

Windshields &
Air Management

Luggage &
Organizers

Index

ANTENNAS



863



864



863



865



853



BILLET ANTENNAS

No more bent or broken antenna studs thanks to the rubber-over-molded spring base allowing the antenna to flex if bumped or hit. These 12" antennas are direct OEM replacement for AM/FM/WB signals (no CB) and install in seconds.

FOR HARLEY-DAVIDSON®

Fits: '89-'19 Electra Glides, Road Glides, Street Glides, Tour Glides & '09-'19 Trike (except Freewheeler) - AM/FM/WB Applications Only

862 Round/Grooved, Black & Raw Aluminum (ea)

863 Round/Grooved, Chrome (ea)

864 Hex/Grooved, Black & Raw Aluminum (ea)

DUAL FUNCTION FLEXIBLE ANTENNA

Provides all the range and clarity AM, FM or CB radios offer without the mile-high stock antenna. 17" long. Comes tuned so no calibration is needed.



865

FOR HARLEY-DAVIDSON®

Fits: '89-'19 Electra Glides, Road Glides, Street Glides, Tour Glides & '09-'19 Trikes (except Freewheeler) - AM/FM/WB or CB Applications

865 Dual Function Flexible Antenna (ea)

TUNE TRAPPER HIDDEN ANTENNA

These hand-tuned antennas mount behind your fairing and require no power. Your radio has all the preamp it needs built in, it's just looking for a properly tuned antenna to make it rock. Made in the U.S.A.



867

FOR HARLEY-DAVIDSON®

Fits: '96-'19 Electra Glides, Road Glides, Street Glides & Tri Glides ('14-'19 models require adapter P/N 867, sold separately)

853 Antenna (ea)

Note: Overall length is 2' with 2' cable

Fits: '14-'19 Electra Glides, Road Glides, Street Glides & Tri Glide

867 Adapter Harness (ea)



LIGHTING

HEADLIGHTS & DRIVING LIGHTS	34
PANACEA TAILLIGHT SYSTEM	40
L.E.D. CONVERSIONS & TURN SIGNALS	42
CONTROLLERS & FLASHING MODULES	46
LOAD EQUALIZERS & ADAPTERS	47
CUSTOM TAILLIGHTS & TURN SIGNALS	49
LENSES, BEZELS & BULBS	63
ACCENT LIGHTING	68

HEADLIGHTS & DRIVING LIGHTS



MUST-HAVE

Intense, uniform light output!

ORBIT PRISM & VISION 7" L.E.D. HEADLIGHT

DOT-approved L.E.D. headlamp featuring powerful high-output L.E.D.'s with integrated outer halo ring significantly enhances the rider's nighttime field of vision and all-around visibility.

FEATURES

- Raw Lumen Output: 2,600 (High); 1,350 (Low)
- Effective Lumen Output: 1,600 (High); 1000 (Low)
- Low-beam current draw: 1.5 amps
- High-beam current draw: 3.0 amps
- Color temperature: 6,000K
- Uses standard H4, 3-blade connector and includes all mounting hardware
- Durable IP67-rated aluminum housing, with UV-protected scratch-resistant polycarbonate lens
- Exceeds DOT and Transport Canada requirements

ORBIT PRISM Integrated multi-colored outer halo ring significantly enhances the rider's nighttime field of vision and all-around visibility. The included Bluetooth controller and downloadable IOS or Android app lets you customize the outer halo ring with infinite color options.

ORBIT VISION Features white halo ring - No color change functionality

FOR HARLEY-DAVIDSON®

Fits: '94-'19 Electra Glides, Road Kings, Street Glides & Trikes; '91-'17 FL Softail Models with 7" Headlights & '12-'16 Dyna Switchback. '14-'19 Electra Glides, Street Glides and Trikes require Wiring Adapter P/N 5487, sold separately. '14-'19 Road Kings require Wiring Adapter P/N 5478, sold separately.

2461 Orbit Prism 7" Headlamp with Bluetooth Controlled Multi-Colored Halo (ea)

2460 Orbit Vision 7" Headlamp with White Halo (ea)

Note: Not compatible with Kuryakyn Headlight trims for '14-later Electra Glides, Street Glides, Trikes some after market L.E.D. turn signals. L.E.D. technology draws less amperage than stock which may cause an indicator to appear. Not Compatible with High-Intensity L.E.D. Bulb P/N 2236, sold separately.

ORBIT PRISM & VISION 4 1/2" L.E.D. PASSING LAMPS

The perfect high-powered complement to our top-selling Orbit Prism 7" L.E.D. Headlamp.

FEATURES

- Raw Lumen Output: 850 (Passing Beam)
- Effective Lumen Output: 560 (Passing Beam)
- Low-beam current draw: 0.85 amps
- Color temperature rating: 6,500K
- Uses standard H11 connector
- Uniform light distribution and greater temperature stability
- Durable IP67-rated aluminum housing, with UV-protected scratch-resistant polycarbonate lens
- Exceeds applicable DOT and Transport Canada requirements
- Pigtail connector allows hardwired installation on custom applications

ORBIT PRISM Integrated multi-colored outer halo ring significantly enhances the rider's nighttime field of vision and all-around visibility. The included Bluetooth controller and downloadable IOS or Android app lets you customize the outer halo ring with infinite color options.

ORBIT VISION Features white halo ring - No color change functionality.

FOR HARLEY-DAVIDSON®

Fits: H-D Models with 4-1/2" Passing Lamps. P/N 2466 Plug-in installation on '05-'18 Models, '04-Earlier Models require Wiring Adapters P/N 5494, sold separately. '05-'17 FLSTN/I requires slight internal modification to passing lamp housing.

2467 Orbit Prism 4-1/2" Passing Lamps with Bluetooth Controlled Multi-Colored Halo (pr)

2466 Orbit Vision 4-1/2" Passing Lamps with White Halo (pr)

Note: Bluetooth controller P/N 2479 not included



2460

VISION



Crisp white halo



PRISM



Infinite halo color options!



New

Collections

Featured Bikes

Audio

Lighting

Accessory Mounts

Handlebar Controls,
Grips & Mirrors

Pegs & Foot Controls

Covers, Trims
& Accents

Air Cleaners
& Exhaust

Touring & Comfort

Windshields &
Air Management

Luggage &
Organizers

Index



Infinite color options controllable via our app!



ORBIT PRISM & VISION 5 3/4" L.E.D. HEADLIGHT

Powerful DOT-approved high-output L.E.D.'s significantly enhance the rider's nighttime field of vision and all-around visibility.

FEATURES

- Raw Lumen Output: 2,200 (High); 1,300 (Low)
- Effective Lumen Output: 1,300 (High); 860 (Low)
- Reduced low-beam current draw: 1.25 amps
- Reduced high-beam current draw: 2.0 amps
- Uses standard H4, 3-blade connector and includes all mounting hardware

- Color temperature: 6,500K
- Uniform light distribution and greater temperature stability
- Durable IP67-rated aluminum housing, with UV-protected scratch-resistant polycarbonate lens
- Exceeds applicable DOT and Transport Canada requirements

ORBIT PRISM Orbit Prism: integrated multi-colored outer halo ring significantly enhances the rider's nighttime field of vision and all-around visibility. The included Bluetooth controller and downloadable IOS or Android app lets you customize the outer halo ring with infinite color options.

ORBIT VISION Features white halo ring - No color change functionality

FOR HARLEY-DAVIDSON®

Fits: Softail: '84-'17 Softail Models with 5 3/4" Headlights Dyna: '91-'17 Dyna Models (except FLD) Sportster: '04-'19 XL Models V-Rod: '02-'11 VRSCD & VRSCDX Street: '15-'19 XG Models

2463 Orbit Prism 5-3/4" Headlamp with Bluetooth Controlled Multi-Colored Halo (ea)

2462 Orbit Vision 5-3/4" Headlamp with White Halo (ea)



STOCK



PHASE 7

PHASE 7 L.E.D. HEADLAMPS & PASSING LAMPS

Increase visibility and enhance your nighttime riding experience with these regulation-approved halogen light replacements. The advanced L.E.D. technology provides improved performance and significantly reduced draw compared to halogen products, allowing more power for other vehicle requirements and extending charging system life.

FEATURES

- Complex reflector design provides unmatched performance while providing the appearance of a traditional headlamp
- Impact-resistant polycarbonate lenses with chemical and scratch-resistant, non-yellowing coating
- Low beam current draw 1.8 amps (stock halogen is 4.9 amps)
- High beam current draw 3.6 amps (stock halogen is 5.5 amps)
- Uses standard H4, 3-blade wiring connector
- Meets applicable DOT, FMVSS or SAE requirements
- 3-year warranty on headlamp
- Made in the U.S.A.

FOR HARLEY-DAVIDSON®

Fits: '94-'19 Electra Glides, Road Kings, Street Glides & Trikes; '91-'17 FL Softail Models with 7" Headlights & '12-'16 Dyna Switchback. '14-'19 Electra Glides, Road Kings, Street Glides & Trikes require Wiring Adapter P/N 5487, sold separately. Road King models require Wiring Adapter 5478, sold separately.

2249 7" Phase 7 L.E.D. Headlamp (ea)

Fits: H-D Models with 4-1/2" Passing Lamps. Plug-in installation on '05-'19 Models, '04-Earlier Models require Wiring Adapters P/N 5494, sold separately. '05-'17 FLSTN/I requires slight internal modification to passing lamp housing.

2247 4-1/2" Phase 7 L.E.D. Passing Lamps (pr)



ALSO AVAILABLE
FRONT L.E.D. TURN SIGNALS
PG 44



ALSO AVAILABLE
ADAPTERS
PG 48



New

Collections

Featured Bikes

Audio

Lighting

Accessory Mounts

Handlebar Controls,
Grips & Mirrors

Pegs & Foot Controls

Covers, Trims
& Accents

Air Cleaners
& Exhaust

Touring & Comfort

Windshields &
Air Management

Luggage &
Organizers

Index



6917 & 7748



6917



6917

7748

L.E.D. HALO TRIM RINGS

U.S. Patents D667,989 & D668,380

Our L.E.D. Halo Trim Rings add incredible style with their grooved trim, easy installation, & low draw on your electrical system. Night or day, this product is eye catching & adds much-needed style to your lights.

FOR HARLEY-DAVIDSON™

Fits: '14-'19 Electra Glides, Street Glides & Tri Glide

6917 7", Chrome (ea)

Fits: '83-'13 Electra Glides, '06-'13 Street Glides, '94-'19 Road Kings, '09-'13 Trikes & '12-'16 Dyna Switchbacks

7785 7", Chrome (ea)

Fits: '83-'19 H-D Models with 4-1/2" Passing Lamps

7748 4-1/2", Chrome (pr)

Fits: '07-'10 FXSTC, '00-'07 FXSTD/I, '93-'06 FXSTS/I, '95-'97 FXSTSB, '97-'03 FLSTS/I, '05-'07 FLSTSC/I, '13-'14 FXSBSE, '99 FXR2/3, '99-09 XL883C, '96-'19 XL1200C & '12-'16 XL1200V

7270 5-3/4", Chrome (ea)

Note: Not compatible with Orbit Headlights P/N 2460, 2461, 2462 & 2473

ENGINE GUARD MOUNTED DRIVING LIGHTS

If you ride at night, these are a must-have. Featuring 3" DOT-approved lights and 1-1/4" clamps, they bolt on with ease. The 35-watt halogen bulbs have what it takes to penetrate the darkness. Clamp and lights rotate for limitless adjustment.

FOR MULTI-FIT

Fits: Universal Mounting for 1-1/4" Engine Guards (Requires 1-1/2" of Straight Bar)

5019 Chrome (pr)

Note: Not compatible with Fairing Lower. Necessary connectors are included to wire the lights to the existing Accessory Switch. For bikes without an Accessory Switch or if the switch is already used, we recommend one of our Wiring & Relay Kits, P/N 2202, 2203 or 2328, sold separately.



5019



5019

5019



ALSO AVAILABLE

L.E.D. UPGRADES
PG 65





5058

Don't forget to upgrade to L.E.D.

FAIRING MOUNTED DRIVING LIGHTS WITH TURN SIGNALS
FOR '14-'19 ELECTRA GLIDE & STREET GLIDE

U.S. Patent D606,215

See your ride in a whole new light with this aggressively styled halogen driving light kit that gives traditional batwing fairings an entirely new personality. Compact, stretched bezels and stylized fully adjustable brackets provide a clean, stiletto-sharp look with intense, focused illumination. The included H3 Halogen lamps offer significantly enhanced light output. Or take the brightness level up a notch with available L.E.D. lamp and turn signal upgrades (sold separately). The complete kit includes everything needed to bolt them on, with plug-&-play wiring for most applications.

FOR HARLEY-DAVIDSON™

Fits: '14-'19 Electra Glides & Street Glides

5058 Chrome (set)

5059 Gloss Black (set)

Fits: '97-'13 Electra Glides, '97-'19 Road Kings (except FLHRXS) & '06-'13 Street Glides

5005 Chrome (set)

5029 Gloss Black (set)

Note: Installation is plug-and-play on '14-later models already equipped with a passing lamp switch/wiring. For models not equipped with a passing lamp switch/wiring, there are two options: First is Kuryakyn Wiring/Relay Kit, P/N 2203, sold separately; second is H-D Auxiliary Power Switch Kit, H-D P/N 71400105, available through an authorized H-D dealership. Installation does not interfere with removal or installation of stock detachable windshield on Road King Models. This kit includes a 12-Pin Wiring Adapter that places control of the driving lights on the motorcycle's Accessory switch on '98-'13 Electra Glides and Street Glides. If you already have accessories wired to this switch, you will have to choose an alternative wiring method (sold separately). Alternatives include replacing the stock Accessory switch with a Kuryakyn Double Rocker Switch, P/N 2201, or adding a Kuryakyn Universal Driving Light Wiring Relay Kit, P/N's 2202, 2203 or 2328. If you have an empty switch location on the dash, you could purchase an OEM switch from an authorized H-D dealership.



5059



5058



5059



5029



5005



5029



5005









ALSO AVAILABLE
L.E.D. CONVERSIONS
PG 42



New
Collections
Featured Bikes
Audio
Lighting
Accessory Mounts
Handlebar Controls, Grips & Mirrors
Pegs & Foot Controls
Covers, Trims & Accents
Air Cleaners & Exhaust
Touring & Comfort
Windshields & Air Management
Luggage & Organizers
Index

PANACEA TAILLIGHT SYSTEM

COMPLETELY PLUG-&-PLAY, THIS SYSTEM ALLOWS THE STOCK REAR INCANDESCENT LIGHTING TO BE TRANSFORMED INTO A BRILLIANT MULTI-FUNCTION L.E.D. SYSTEM.

	PANACEA	STOCK
RUN	 <p>Taillight & Turn Signals Illuminate Red</p>	 <p>Only The Taillight Is Illuminated</p>
TURN	 <p>Selected Turn Signal Flashes Amber & Amber Arrow Flashes On Appropriate Side Of Taillight. Other Turn Signal Remains Illuminated Red</p>	 <p>Turn Signal Flashes Amber. Taillight Remains Illuminated</p>
BRAKE	 <p>Taillight & Turn Signals Flash Red 3 Times & Then Taillight & Turn Signals Remain Brightly Lit Until Brake Is Released. Turn Signal & Arrow Will Continue To Flash Amber During Braking Function If Turn Signal Is Activated.</p>	 <p>Only Taillight Brightens</p>

Note: Flashing Function Can Be Disabled Via The Control Module.

HOW TO ORDER:

- 1 SELECT A PANACEA TAILLIGHT FOR YOUR SPECIFIC APPLICATION
- 2 SELECT PANACEA REAR TURN SIGNAL INSERTS FOR YOUR SPECIFIC APPLICATION
- 3 SELECT L.E.D. FRONT TURN SIGNAL CONVERSIONS FOR YOUR SPECIFIC APPLICATION (OPTIONAL - PG 44)

IMPORTANT INFORMATION ABOUT PANACEA TAILLIGHTS

- 1 All wiring for trailer lights must be spliced into the wiring harness ahead of the Panacea Control Module.
- 2 If the rear of the motorcycle is equipped with any incandescent lights that were not original equipment, such lights must be spliced into the wiring harness ahead of the Panacea Control Module. Police models are often equipped with additional lights not found on their civilian counterparts. Be aware that these lights must be rewired, removed, or converted to L.E.D. prior to installing a panacea system.
- 3 The Panacea Taillight system meets FMVSS #108 when operated in "DOT mode". There is no provision in FMVSS #108 for flashing brake or amber arrows so those features are disabled when operated in "DOT mode".
- 4 Panacea Taillights can be used on '97-'01 Dynas, '96-'01 Fat Boy & FXST (except Deuce), & '99-'01 XL models, but they must be used with stock turn signals. Panacea Turn Signals are not available for these applications.

WHY USE PANACEA REAR TURN SIGNAL INSERTS?

L.E.D. Silver Bullets, stock turn signals, or other custom single filament lights can be used with the Panacea Taillight System but they will function as turn signals only. The Panacea Taillight will retain all of its functions (run, pulse brake, & amber directional arrow). To Realize the Full Benefit of Two-Color, Multi-Function Turn Signals Made Possible by the Panacea System, You Must Use Panacea Rear Turn Signal Inserts.

1 PANACEA TAILLIGHTS U.S. Patent 6,714,128
WITH LICENSE PLATE WINDOW



		RED DELUXE	SMOKE DELUXE	RED LOW PROFILE	SMOKE LOW PROFILE
TOURING	'94-'13 Electra Glides (except '05 FLHTCSE, '09 FLHT Standard), '98-'08 FLTR/I Road Glides, '11-'13 Road Glide Ultras, '94-'96 Tour Glides, '94-'13 Road Kings (except '07-'08 & '13 FLHRSE, '09-'13 FLHR)	5420	5422	5424	5426
SOFTAIL	All '94-'10 FL Softail Models (except '94-'01 FLSTF, '05-'10 FLSTN, '97-'03 FLSTS, '05-'07 FLSTSC, '10 FLSTSE), All '02-'10 FX Softail Models (except '02-'07 FXSTD, '07-'09 FXSTSSE, '08-'10 FXCW/C)	5420	5422	5424	5426
DYNA	'01 FXDX/T & All '02-'11 Dynas (except '09-'11 FXDB, '09-'10 FXDFSE, '10-'11 FXDWG)	5420	5422	5424	5426
SPORTSTER	'02-'13 XL, (except '07-'12 XL1200N, '10-'13 XL1200X, '11-'13 XL1200C, '12-'13 XL1200V, '09-'13	5420	5422	5424	5426

WITHOUT LICENSE PLATE WINDOW



		RED DELUXE	SMOKE DELUXE	SMOKE LOW PROFILE
TOURING	'06-'09 FLHX, '09 FLHT, '09 FLTR, '09-'13 FLHR, '05 FLHTCSE	5421	5423	5427

REPLACEMENT COMPONENTS

5082 Replacement Panacea Controller

** '94-'96 Requires 8-Pin Hardwire Adapter (P/N 4832) - Sold Separately
*** '04-'13 Requires 6-Pin to 8-Pin Adapter (P/N 4831) - Sold Separately

2 PANACEA REAR TURN SIGNAL INSERTS U.S. Patent 6,714,128
FLAT STYLE



		RED	SMOKE
TOURING	'94-'13 FLHTC, FLHTCU, FLHTK; '94-'09 FLHT Standard, '98-'03 FLTR, '94-'13 FLHR, '98-'13 FLHRC, '94-'96 FLTC/U, '00-'01 FLTRSE	5428	5429
SOFTAIL	'94-'10 FLSTC, '94-'96 FLSTN, '06 FLST	5428	5429

BULLET STYLE



		CHROME BEZEL RED LENS	CHROME BEZEL SMOKE LENS	GLOSS BLACK BEZEL RED LENS	GLOSS BLACK BEZEL SMOKE LENS
TOURING	'06-'09 FLHX, '04-'09 FLTR, '11-'13 FLTRU, '04-'07 FLHRS, '02-'03 FLHRSE, '04-'05 FLHTCSE, '06-'13 FLHTCUSE, '11 FLTRUSE	5430	5431	5453	5454
SOFTAIL	All '02-'10 FX Softail Models (except '02-'07 FXSTD, '07-'09 FXSTSSE, '08-'09 FXCW/C), '02-'10 FLSTF, '10 FLSTFB, '08-'10 FLSTSB	5430	5431	5453	5454
DYNA	'01 FXDX/T & all '02-'11 Dynas (except '09-'11 FXDB, '09-'10 FXDFSE, '10-'11 FXDWG)	5430	5431	5453	5454
SPORTSTER	'02-'13 XL (except '07-'12 XL1200N, '10-'13 XL1200X, '11-'13 XL1200C, '09-'13 XL883N, '12-'13 XL1200V)	5430	5431	5453	5454

New

Collections

Featured Bikes

Audio

Lighting

Accessory Mounts

Handlebar Controls, Grips & Mirrors

Pegs & Foot Controls

Covers, Trims & Accents

Air Cleaners & Exhaust

Touring & Comfort

Windshields & Air Management

Luggage & Organizers

Index

L.E.D. CONVERSION TAILLIGHTS & TURN SIGNALS

COMPLETELY PLUG-&-PLAY, THIS SYSTEM ALLOWS THE STOCK REAR INCANDESCENT LIGHTING TO BE TRANSFORMED INTO A BRILLIANT MULTI-FUNCTION L.E.D. SYSTEM.



L.E.D TAILLIGHT & REAR TURN SIGNALS



STOCK

Taillights function as run-brake just like your stock taillight. Includes connectors for '99-later & '98-earlier style taillight bases. Add Run-Turn-Brake Controller & rear L.E.D. Turn Signal Inserts for a multi-functional, super bright L.E.D. Rear Lighting Package.



RED DELUXE SMOKE DELUXE RED LOW PROFILE SMOKE LOW PROFILE

L.E.D. TAILLIGHT CONVERSIONS WITH LICENSE PLATE ILLUMINATION

TOURING	'88-'19 FLHTC/I, FLHTCU/I, FLHTK/L, '91-'08 FLHT/I, '91-'93 FLHS, '04 FLHTCSE, '06-'13 FLHTCUSE, '14-'16 FLHTKSE, '98-'08 FLTR/I, '11-'13 & '16-'19 FLTRU, '00-'01 FLTRSE, '11 & '15-'16 FLTRUSE, '94-'08 FLHR/I, '98-'13 FLHRC/I, '04-'07 FLHRS/I, '02-'03 FLHRSE, '91-'96 FLTC/U, '15-'19 FLRT (left side only)	5432	5434	5436	5438
SOFTAIL	'18-'19 FLHC/S, '18-'19 FXLR, '89-'17 FLST/I & FLSTC/I, '90-'17 FLSTF/I, '10-'16 FLSTFB, '16-'17 FLSTFBS, '08-'11 FLSTSB, '05-'06 FLSTFSE, '93-'96 FLSTN, '89-'10 FX Softail Models (except '18 FXBB, FXBR/S, FXFB/S, '00-'07 FXSTD/I, '03-'04 FXSTDSE, '07-'09 FXSTSSE, '16-'17 FXSE, '08-'10 FXCW/C)	5432	5434	5436	5438
DYNA	'91-'17 Dynas (except '09-'17 FXDB, '09-'10 FXDFSE, '10-'17 FXDWG, '12-'16 FLD, '14-'17 FXDF '16-'17 FXDLS)	5432	5434	5436	5438
SPORTSTER	'89-'19 XL (except '07-'12 XL1200N, '10-'19 XL1200X, '11-'19 XL1200C, '16-'19 XL1200CX, '12-'16 XL1200V, '09-'19 XL883N, '18-'19 XL1200NS, '18-'19 XL1200XS)	5432	5434	5436	5438

FMVSS #108 Compliant



RED DELUXE SMOKE DELUXE RED LOW PROFILE SMOKE LOW PROFILE

L.E.D. TAILLIGHT CONVERSIONS WITHOUT LICENSE PLATE ILLUMINATION

TOURING & TRIKE	'09 FLHT Standard, '05 FLHTCSE, '09 FLTR, '09-'19 FLHR (except '17-'19 FLHRXS), '06-'09 FLHX/I, '09-'19 Trikes (FLRT right side only)	5433	5435	5437	5439
DYNA	'12-'16 FLD	5433	5435	5437	5439

FMVSS #108 Compliant

TOMBSTONE TAILLIGHT CONVERSIONS

The taillights function as "run" and "brake", just like your stock taillights did. Add L.E.D. Turn Signal Conversions and a Run-Turn-Brake Controller and you'll have a multi-functional, super bright L.E.D. rear lighting package.



TAILLIGHT ONLY

Fits: '05-'10 FLSTN, '05-'07 FLSTSC, '07-'08 FLHRSE, & '02-'03 FLSTS	N/A
Fits: '05-'17 FLSTN/I Softail Deluxe, '05-'07 FLSTSC/I Springer Classic, '97-'03 FLSTS/I Heritage Springer & '07-'08 FLHRSE CVO Road King	5410

REAR L.E.D. TURN SIGNAL INSERTS

FLAT STYLE - SINGLE CIRCUIT



RED

SMOKE

TOURING	'94-'13 FLHTC/I, FLHTCU/I, FLHTK, '94-'09 FLHT/I, '98-'03 FLTR/I, '00-'01 FLTRSE, '94-'19 FLHR/I, '98-'13 FLHRC/I & '94-'96 FLTCTU/I	5444	5445
SOFTAIL	'94-'17 FLSTC/I, '06 FLST/I & '94-'96 FLSTN	5444	5445

FMVSS #108 Compliant



CHROME BEZEL RED LENS

CHROME BEZEL SMOKE LENS

GLOSS BLACK BEZEL RED LENS

GLOSS BLACK BEZEL SMOKE LENS

REAR L.E.D. TURN SIGNAL INSERTS

BULLET STYLE - SINGLE CIRCUIT

TOURING	'04-'05 FLHTCSE, '06-'13 FLHTCUSE, '14-'15 FLHTKSE, '04-'09 FLTR/I, '11-'13 FLTRU, '11 FLTRUSE, '04-'07 FLHRS/I, '02-'03 & '07-'08 FLHRSE & '06-'09 FLHX/I	5446	5447	5457	5458
SOFTAIL	'18-'19 FLHC/S, '18-'19 FLXR, '05-'17 FLSTN/I, '08-'11 FLSTSB, '02-'17 FLSTF/I, '10-'16 FLSTFB, '16-'17 FLSTFBS, '05-'06 FLSTFSE, '05-'07 FLSTSC/I, '02-'03 FLSTS/I, '00-'07 FXSTD/I, '03-'04 FXSTDSE, '02-'08 FXST/I, '02-'09 FXSTB/I, '07-'10 FXSTC, '02-'06 FXSTS/I & '07-'09 FXSTSSE (except '16-'17 FXSE)	5446	5447	5457	5458
DYNA	'01 FXDX/T & All '02-'17 Dyna Models (except '09-'17 FXDB & '10-'17 FXDWG, '16-'17 FXDLS)	5446	5447	5457	5458
SPORTSTER	'02-'19 XL Models (except '16-'19 XL1200CX '07-'12 XL1200N, '18-'19 XL1200NS, '10-'19 XL1200X, '18-'19 XL1200XS, '12-'16 XL1200V & '09-'19 XL883N)	5446	5447	5457	5458
KURYAKYN REAR TURN SIGNAL KITS	P/N's 2098, 2317 & 5405	5446	5447	5457	5458

Note: Installation on '18-later models may cause dash indicators to flash more rapidly. To simplify installation of the load equalizer on most '97-'13 models, see our Load Equalizer Adapters (P/N's 4837 & 5499 pg 47). For full multi-function performance & simplified load equalizer installation, add our Run-Turn-Brake Controller (P/N 5497 pg 46). Replacement Snap Rings For Bullet Style Turn Signals (pg 44) FMVSS #108 Compliant



CHROME BEZEL RED LENS

CHROME BEZEL SMOKE LENS

GLOSS BLACK BEZEL RED LENS

GLOSS BLACK BEZEL SMOKE LENS

REAR L.E.D. TURN SIGNAL INSERTS

BULLET STYLE - DUAL CIRCUIT

TOURING	'17-'19 FLHRXS, '10-'19 FLHX, '14-'19 FLHXS, '10-'13 & '15-'19 FLTRX/S	5448	5449	5459	5460
SOFTAIL	'18-'19 FLFB/S, '18-'19 FLFL, '18-'19 FXBB, '18-'19 FXBR/S, '18-'19 FXFB/S, '12-'17 FL, '16-'17 FLSS, '10-'12 FLSTSE, '11-'13 FXS, '13-'17 FXSB, '13-'14 FXSBSE (except '16-'17 FXSE)	5448	5449	5459	5460
DYNA	'09-'17 FXDB, '16-'17 FXDLS, '10-'17 FXDWG	5448	5449	5459	5460
SPORTSTER	'16-'19 XL1200CX, '07-'12 XL1200N, '18-'19 XL1200NS, '10-'19 XL1200X, '18-'19 XL1200XS, '12-'16 XL1200V & '09-'19 XL883N	5448	5449	5459	5460

Note: Installation on '18-later models may cause dash indicators to flash more rapidly. To simplify installation of the load equalizer on most '97-'13 models, see our Load Equalizer Adapters (P/N's 4837 & 5499 pg 47). For full multi-function performance & simplified load equalizer installation, add our Run-Turn-Brake Controller (P/N 5497 pg 46). Replacement Snap Rings For Bullet Style Turn Signals (pg 44) FMVSS #108 Compliant

New

Collections

Featured Bikes

Audio

Lighting

Accessory Mounts

Handlebar Controls, Grips & Mirrors

Pegs & Foot Controls

Covers, Trims & Accents

Air Cleaners & Exhaust

Touring & Comfort

Windshields & Air Management

Luggage & Organizers



Index



3 FRONT L.E.D. TURN SIGNAL INSERTS DUAL CIRCUIT





Amber Illumination for run and turn signal functions. Includes Load Equalizer.

3-1/4" FLAT STYLE - DUAL CIRCUIT -

		 AMBER	 SMOKE
TOURING	'94-'13 FLHTC/I, FLHTCU/I, FLHTK, '94-'09 FLHT/I, '98-'03 FLTR/I, '00-'01 FLTRSE, '94-'19 FLHR/I, '98-'13 FLHRC/I, '94-96 FLTUC/I	5440	5441
SOFTAIL	'94-'17 FLSTC/I, '94-'96 FLSTN	5440	5441

FMVSS #108 Compliant

BULLET STYLE - DUAL CIRCUIT

		 CHROME BEZEL AMBER LENS	 CHROME BEZEL SMOKE LENS	 GLOSS BLACK BEZEL AMBER LENS	 GLOSS BLACK BEZEL SMOKE LENS
TOURING & TRIKE	'04-'05 FLHTCSE, '06-'13 FLHTCUSE, '14-'19 FLHTCU, '15-'16 FLHTCUL, '14-'19 FLHTK, '15-'19 FLHTKL, '14-'15 FLHTKSE, '04-'09 FLTR/I, '10-'13, '15-'19 FLTRX, '15-'19 FLTRXS, '11-'13 FLTRU, '09 FLTRSE, '11 & '15 FLTRUSE, '12-'13 FLTRXSE, '04-'07 FLHRS/I, '02-'03 FLHRSEI, '07-'08 & '13-'14 FLHRSE, '17-'19 FLHRXS, '06-'19 FLHX/I, '14-'19 FLHXS, '10-'12, & '15 FLHXSE, '09-'19 FLHTCUTG, '15-'19 FLRT & '10-'11 FLHXXX	5442	5443	5455	5456
SOFTAIL	'18-'19 FLFB/S, '18-'19 FLHC/S, '18-'19 FLFSB, '18-'19 FLFSL, '18-'19 FXBB, '18-'19 FXBR/S, '18-'19 FXFB/S, '18-'19 FXLR/S, '12-'17 FLS, '16-'17 FLSS, '05-'06 FLSTFSE, '06 FLST/I, '05-'07 FLSTSC/I, '02-'03 FLSTS/I, '10-'12 FLSTSE, '05-'17 FLSTN, '14-'15 FLSTNSE, '08-'11 FLSTSB, '02-'17 FLSTF/I, '10-'16 FLSTFB, '16-'17 FLSTFSBS, '00-'07 FXSTD/I, '03-'04 FXSTDSE, '02-'08 FXST/I, '02-'09 FXSTB/I, '02-'06 FXSTS/I, '07-'10 FXSTC, '07-'09 FXSTSSE, '08-'11 FXCW/C, '11-'13 FXS, '13-'17 FXSB & '13-'14 FXSBSE (except '16-'17 FXSE)	5442	5443	5455	5456
DYNA	'01 FXDX/T & All '02-'17 Dyna Models	5442	5443	5455	5456
SPORTSTER	All '02-'19 XL Models	5442	5443	5455	5456
KURYAKYN DRIVING LIGHTS	Kuryakyn Driving Lights with Turn Signals, P/N's 5001, 5005, 5007, 5009, 5011 & 5029	5442	5443	5455	5456

Note: Installation on '18-later models may cause dash indicators to flash more rapidly. To simplify installation of the load equalizer on most '97-'13 models, see our Load Equalizer Adapters (P/N's 4837 & 5499 pg 47). Replacement Snap Rings For Bullet Style Turn Signals see below. FMVSS #108 Compliant

REPLACEMENT SNAP RINGS FOR BULLET STYLE TURN SIGNALS

Replace a broken L.E.D. bullet turn signal insert snap ring with the original equipment.



- 5617 Replacement Red Snap Ring for Bullet Style L.E.D. Turn Signals (ea)**
Fits: Kuryakyn P/N's 5430, 5453, 5446, 5457, 5448, 5459
- 5618 Replacement Smoke Snap Ring for Bullet Style L.E.D. Turn Signals (ea)**
Fits: Kuryakyn P/N's 5431, 5454, 5447, 5458, 5449, 5460
- 5616 Replacement Amber Snap Ring for Bullet Style L.E.D. Turn Signals (ea)**
Fits: Kuryakyn P/N's 5442 & 5455



ECE COMPLIANT L.E.D. TURN SIGNAL INSERTS

ECE compliant L.E.D. inserts available in 3-1/4" fl at or bullet styles.

3-1/4" FLAT STYLE - AMBER SINGLE CIRCUIT - FRONT OR REAR

TOURING	'94-'13 FLHTC/I, FLHTCU/I, FLHTK, '94-'09 FLHT/I, '98-'03 FLTR/I, '00-'01 FLTRSE, '94-'19 FLHR/I, '98-'13 FLHRC/I & '94-'96 FLTCTU/I	5470	5471
SOFTAIL	'94-'17 FLSTC/I, '06 FLST/I & '94-'96 FLSTN	5470	5471



AMBER

SMOKE

BULLET STYLE - AMBER SINGLE CIRCUIT - FRONT OR REAR

TOURING & TRIKE	'04-'05 FLHTCSE, '06-'13 FLHTCUSE, '14-'19 FLHTCU/L, '14-'19 FLHTK/L, '14-'15 FLHTKSE, '04-'09 FLTR/I, '10-'13 & '15-'19 FLTRX, '15-'19 FLTRXS, '11-'13, '16-'19 FLTRU, '09 FLTRSE, '11, '15 FLTRUSE, '12-'13 FLTRXSE, '04-'07 FLHRS/I, '02-'03 FLHRSEI, '07-'08 & '13-'14 FLHRSE, '17-'19 FLHRXS '06-'19 FLHX/I, '14-'19 FLHXS, '10-'12, '15 FLHXSE, '09-'19 FLHTCUTG, '15-'19 FLRT & '10-'11 FLHXXX	5472	5473	5474	5475
SOFTAIL	'18-'19 FLFB/S, '18-'19 FLHC/S, '18-'19 FLBS, '18-'19 FLSL, '18-'19 FXBB, '18-'19 FXBR/S, '18-'19 FXFB/S, '18-'19 FXLR/S, '12-'17 FLS, '16-'17 FLSS, '05-'06 FLSTFSE, '06 FLST/I, '05-'07 FLSTSC/I, '02-'03 FLSTS/I, '10-'12 FLSTSE, '05-'17 FLSTN, '14-'15 FLSTNSE, '08-'11 FLSTSB, '02-'17 FLSTF/I, '10-'16 FLSTFB, '16-'17 FLSTFBS, '00-'07 FXSTD/I, '03-'04 FXSTDSE, '02-'08 FXST/I, '02-'09 FXSTB/I, '02-'06 FXSTS/I, '07-'10 FXSTC, '07-'09 FXSTSSE, '08-'11 FXCW/C, '11-'13 FXS, '13-'17 FXSB & '13-'14 FXSBSE	5472	5473	5474	5475
DYNA	'01 FXDX/T & All '02-'17 Dyna Models	5472	5473	5474	5475
SPORTSTER	All '02-'19 XL Models	5472	5473	5474	5475



CHROME BEZEL AMBER LENS



CHROME BEZEL SMOKE LENS



GLOSS BLACK BEZEL AMBER LENS



GLOSS BLACK BEZEL SMOKE LENS

Note: Installation on '18-later models may cause dash indicators to flash more rapidly. To simplify installation of the load equalizer on most '97-'13 models, see our Load Equalizer Adapters (P/N's 4837 & 5499 pg 47).



ECE COMPLIANT L.E.D TAILLIGHT CONVERSIONS

Direct replacement for stock taillight lenses and incandescent bulbs on most '88-'19 H-D models. ECE certified, long lasting and highly visible using the latest in L.E.D. technology.

WITH LICENSE PLATE ILLUMINATION

TOURING	'88-'19 FLHTC/I, FLHTCU/I, FLHTK, '91-'08 FLHT/I, '91-'93 FLHS, '04 FLHTCSE, '06-'13 FLHTCUSE, '14-'16 FLHTKSE, '98-'08 FLTR/I, '11-'13 & '16-'19 FLTRU, '00-'01 FLTRSE, '11 & '15-'16 FLTRUSE, '94-'08 FLHR/I, '98-'13 FLHRC/I, '04-'07 FLHRS/I, '02-'03 FLHRSE, '91-'96 FLTC/U	5462	--	5466	5468
SOFTAIL	'18-'19 FLHC/S, '18-'19 FXLR, '89-'17 FLST/I & FLSTC/I, '90-'17 FLSTF/I, '10-'16 FLSTFB, '16-'17 FLSTFBS, '08-'11 FLSTSB, '05-'06 FLSTFSE, '93-'96 FLSTN, '89-'10 FX Softail Models (except '18-'19 FXBB, FXBR/S, FXFB/S, '00-'07 FXSTD/I, '03-'04 FXSTDSE, '07-'09 FXSTSSE, '16-FXSE, '08-'10 FXCW/C)	5462	--	5466	5468
DYNA	'91-'17 Dynas (except '09-'17 FXDB, '09-'10 FXDFSE, '10-'17 FXDWG, '12-'16 FLD, '14-'17 FXDF)	5462	--	5466	5468
SPORTSTER	'89-'19 XL (except '07-'12 XL1200N, '10-'19 XL1200X, '11-'19 XL1200C, '16-'19 XL1200CX, '12-'16 XL1200V, '18-'19 XL1200NS, '18-'19 XL1200XS, '09-'19 XL883N)	5462	--	5466	5468



RED DELUXE



SMOKE DELUXE



RED LOW PROFILE



SMOKE LOW PROFILE

WITHOUT LICENSE PLATE ILLUMINATION

TOURING & TRIKE	'09 FLHT Standard, '05 FLHTCSE, '09 FLTR, '09-'19 FLHR, '06-'09 FLHX/I, '09-'19 Trikes (except FLRT)	5463	5465	5467	5469
DYNA	'12-'16 FLD	5463	5465	5467	5469

New

Collections

Featured Bikes

Audio

Lighting

Accessory Mounts

Handlebar Controls, Grips & Mirrors

Pegs & Foot Controls

Covers, Trims & Accents

Air Cleaners & Exhaust

Touring & Comfort

Windshields & Air Management

Luggage & Organizers

Index

CONTROLLERS & FLASHING MODULES



REAR RUN-TURN-BRAKE CONTROLLER WITH PULSE BRAKE

Make single filament or single circuit rear turn signals function as running lights, turn signals, and brake lights! Can be used with Kuryakyn L.E.D. Silver Bullets, stock turn signals (red lenses sold separately) or any single filament light. Completely plug-&-play for most '96-newer H-D's. Compatible with '02-later H-D factory cruise control. Pulsing Brake feature can be turned on/off easily. '97-'13 Tour-Pak lighting can also be converted from stock Run-Brake to multi-function Run-Turn-Brake! One kit converts your stock taillight, turn signals and Tour-Pak lights.



FOR HARLEY-DAVIDSON®

Fits: '97-'13 Electra Glides, '98-'13 Road Glides (except '09 FLTRSE, '10-'13 FLTRX, '12-'13 FLTRXSE), '06-'09 Street Glides, '97-'13 Road Kings (except '13 FLHRSE), '96-'17 Softails (except '08-'11 FXCW/C, '10-'12 FLSTSE, '13-'14 FXSBSE, '13-'17 FXSB, '11-'13 FXS, '12-'17 FLS, '16-'17 FLSS, '14-'15 FLSTNSE, '16-'17 FXSE), '97-'17 Dynas (except '09-'17 FXDB, '10-'17 FXDWG, '16-'17 FXDLS), '99-'03 Sportsters

5497 Rear Run-Turn-Brake Controller (ea)

Note: For installation on '04-'13 Sportsters (except '07-'12 XL1200N, '10-'13 XL1200X, '12-'13 XL1200V, '10-'13 XL88N) Kuryakyn adapter, P/N 4831, is required and sold separately.

Fits: '97-'13 FLHTCU/I, '10-'13 FLHTK & '08-'09 FLHTCUSE

5490 Run-Turn-Brake Controller with Tour-Pak® Harness (ea)

Fits: '97-'13 FLHTCU/I, '10-'13 FLHTK & '08-'09 FLHTCUSE Already Equipped with a Kuryakyn Run-Turn-Brake Controller.

5489 Run-Turn-Brake Wiring Harness for Tour-Pak® (ea)

Note: 1. These are NOT the same controllers used in Kuryakyn Panacea Systems and cannot be used in conjunction with other aftermarket or accessory modules that alter the functions of the stock taillight and turn signals. If modifications have been made to your taillight and/or turn signals, the bike must be returned to stock before installation. 2. Motorcycles equipped with CAN bus electrical systems don't require a load equalizer. '97-'13 Touring, '96-'10 Softail, '97-'11 Dyna & '99-'13 Sportster equipped with factory security system and low-draw or L.E.D. turn signals also require P/N 5498.

5492



PULSATING BRAKE CONTROLLERS

Activate brake lights to flash automatically for 3 seconds and then stay on with a single squeeze of your brakes. Does not harm the life of your lights.

FOR HARLEY-DAVIDSON®

Fits: '10-'13 FLHX Street Glides & '10-'13 FLTRX Road Glide Customs

5492 Pulsating Brake Light Controller, 6-Pin (ea)

Fits: '97-'13 Electra Glides, '98-'09 Road Glides (except '09 FLTRSE), '11-'13 Road Glide Ultras, '97-'13 Road Kings, '06-'09 Street Glides, '09-'13 Tri Glide, '10-'11 Street Glide Trike, '96-'10 Softails (except '08-'10 FXCW/C & '10 FLSTSE), '97-'11 Dynas (except '09-'11 FXDB, '10-'11 FXDWG) & '99-'03 Sportsters

5493 Pulsating Brake Light Controller, 8-Pin (ea)

908



FOR MULTI-FIT

Fits: Universal for 12V Applications (Not Compatible with CAN Bus Systems)

908 Universal Pulsating Brake Light Controller (ea)

Note: Installation of this product may be in violation of FMVSS # 108. Requires Hard Wiring and is not compatible with Kuryakyn Panacea, Run-Turn-Brake Controllers or Trailer Wiring Harnesses.

LOAD EQUALIZERS & ADAPTERS

SELF-REGULATING LOAD EQUALIZER

This technologically advanced load equalizer won't overheat, even when subjected to 4-way flashers, nonstop security system flashing while trailering, or when stuck at never-ending red traffic lights. Plug-&-play when used with Kuryakyn Panacea, Run-Turn-Brake Controller, or Load Equalizer Adapters. Can also be spliced in custom applications.

FOR HARLEY-DAVIDSON®

Fits: For use on '90-'13 H-D models (except '11-'13 Softail and '12-'13 Dyna Models). Plug-and-Play installation when used with Kuryakyn Panacea Taillight, Run-Turn-Brake Controller or Load Equalizer Adapter.

5498 Self-Regulating Load Equalizer (ea)

5498



5499



LOAD EQUALIZER ADAPTERS

These handy adapters allow splice-free installation of Kuryakyn load equalizers equipped with 3-pin connectors.

FOR HARLEY-DAVIDSON®

Fits: '10-'13 FLHX Street Glides (except FLHXSE) & '10-'13 FLTRX Road Glide Customs (except FLTRXSE)

5499 Plug-In Load Equalizer Adapter, 6-Pin (ea)

4837



Fits: '97-'13 Electra Glides, '98-'13 Road Glides (except '09 FLTRSE, '10-'13 FLTRX, '12-'13 FLTRXSE), '06-'09 Street Glides, '97-'13 Road Kings (except '13 FLHRSE), '96-'10 Softails (except '08-'10 FXCW/C, '10 FLSTSE), '97-'11 Dynas (except '09-'11 FXDB, '10-'11 FXDWG), '99-'03 Sportsters

4837 Load Equalizer Adapter (ea)

LOAD EQUALIZERS

These load equalizers work great in custom applications where OEM turn signals have been removed and replaced with low-draw L.E.D. or small incandescent turn signals.

FOR MULTI-FIT

Fits: Universal 12v Applications

4807 4-Amp (ea)

4807



Fits: Universal Load Equalizer for use when stock turn signals are replaced with L.E.D. or other low-draw lights. One required for each pair of lights.

4810 2 Amp Load Equalizer (ea)

4810



ALARM COMPATIBLE LOAD EQUALIZER

When either a Panacea System or a Run-Turn-Brake Controller is installed on a late-model H-D equipped with a factory security system (TSSM) and L.E.D. or low-draw turn signals, the security remains fully functional. Our products do not disable the system in any way. If you find the illuminated security light offensive, simply plugging in this optional load equalizer will correct the situation.

FOR HARLEY-DAVIDSON®

Fits: For use on '90-'13 H-D models (except '11-'13 Softail and '12-'13 Dyna Models). Plug-and-Play installation when used with Kuryakyn Panacea Taillight, Run-Turn-Brake Controller or Load Equalizer Adapter.

4857 Alarm Compatible Load Equalizer (ea)

4857



ACCESSORY FUSED TERMINAL

An easy way to add multiple electronic accessories to your bike without stacked battery terminals. Provides 20-amp main fuse protection, one 10-amp fused connection, and two 5-amp fused connections. 3-1/2" long, 1-3/4" wide, 7/8" high.

FOR MULTI-FIT

Fits: Universal 12V Applications

2208 Fused Accessory Terminal (ea)

2208



New

Collections

Featured Bikes

Audio

Lighting

Accessory Mounts

Handlebar Controls,
Grips & Mirrors

Pegs & Foot Controls

Covers, Trims
& Accents

Air Cleaners
& Exhaust

Touring & Comfort

Windshields &
Air Management

Luggage &
Organizers

Index



5494

PASSING LAMP ADAPTERS FOR HARLEY-DAVIDSON

Allows installation of '05-later style passing lamps on '04-earlier H-D Motorcycles.

FOR HARLEY-DAVIDSON*

Fits: Allows Plug-&-Play Installation of '05-'19 Style Passing Lamps on '04-Earlier H-D Models

5494 Passing Lamp Adapters (pr)



5487

HEADLAMP ADAPTER HARNESS FOR '14-'19 H-D TOURING

Allows L.E.D. headlights with H4 style plugs to be installed

FOR HARLEY-DAVIDSON*

Fits: '14-'19 Electra Glides, '14 CVO Road King, Street Glides & Trikes

5487 Headlamp Adapter Harness for '14-'19 Touring & Trike (ea)



5478

Fits: '14-'19 Road King (except '14 FLHRSE)

5478 Headlight Adapter Harness for '14-'19 Road King (ea)

TOTAL CONTROL PASSING LAMP HARNESSES

Enables passing lamps to remain lit with high beams on.

FOR HARLEY-DAVIDSON*



5495

Fits: '96-'17 FL Softail Models with Passing Lamps & '97-'13 Road King Models with Passing Lamps

5495 Total Control Passing Lamp Harness for FLHR/FLST (ea)

Fits: '98-'13 Electra Glides & Trikes with Passing Lamps

5496 Total Control Passing Lamp Harness for Electra Glide (ea)



5496

DOUBLE ROCKER SWITCH

Incorporates two independent rockers and fits right in place of an original equipment switch. Each side of the switch operates independently and handles up to a 15-amp load. The rockers are black and match the rest of your original equipment switches perfectly.

FOR HARLEY-DAVIDSON*



2201

Fits: '96-'13 Electra Glides, Road Glides, Street Glides & Trikes

2201 Double Rocker Switch (ea)

8-PIN HARDWARE ADAPTER

This splice-in 8-pin amp connector is required to install Panacea Taillights or a Kuryakyn Run-Turn-Brake Controller.

FOR HARLEY-DAVIDSON*



4832

Fits: '91-'95 Softails, '91-'96 Dynas, '91-'96 Electra Glides, Tour Glides, Road Kings, & '91-'98 Sportsters

4832 8-Pin Hardware Adapter (ea)

6-PIN TO 8-PIN ADAPTER FOR SPORTSTER

This plug-in adapter is required for installation of Panacea Taillights or Run-Turn-Brake Controllers.

FOR HARLEY-DAVIDSON*



4831

Fits: '04-'13 XL (except '07-'12 XL1200N, '10-'13 XL1200X, '12-'13 XL1200V & '09-13 XL883N)

4831 6-Pin to 8-Pin Adapter (ea)

UNIVERSAL DRIVING LIGHT WIRING RELAY KITS

Eliminate the risk of overloading and damaging existing circuits on your bike by adding an independent fused relay circuit to power your driving lights or other accessories. Available for multiple mounting locations.

FOR MULTI-FIT

Fits: 7/8", 1", or 1-1/4" Handlebars

2202 Driving Light Wiring & Relay Kit with Handlebar Mounted Switch, Chrome (ea)

Fits: Universal 12V Applications

2328 Wiring & Relay Kit with Rocker Switch (pr)

Fits: '96-'19 H-D Models (except '15-'19 FLTRX/S, FLTRU & Street Models)

2203 Black (ea)



ROUNDIT WIRE WRAP

Add protection and looks. Though tubular in shape, it is actually a flat piece of material with a memory. A wire can be added or joined to an existing harness with no cutting or fishing necessary. Sold in 6-foot lengths.

1995 1/2" Wire Wrap (ea)

1991 3/8" Wire Wrap (ea)

1987 1/4" Wire Wrap (ea)

CUSTOM TAILLIGHTS & TURN SIGNALS

UNIVERSAL LOW-PROFILE TOMBSTONE TAILLIGHT

Thin, low-profile housing with L.E.D. run-brake function. The Tombstone Taillight with Turn Signal Mount includes a complete run-brake L.E.D. taillight, chrome base plate turn signal mount with built-in license plate light and a removable license plate bracket. The turn signal mount requires our sleek Silver Bullets (P/N 1650, sold separately).

FOR MULTI-FIT

Fits: Universal 12V Custom Applications

4990 Chrome (ea)

Fits: Universal Custom Applications (requires Turn Signals, P/N 1650, sold separately.)

4992 With Turn Signal Mount, Chrome (ea)

Fits: Kuryakyn Low-Profile Tombstone Taillight (P/N 4992) - Accepts 4"x7" Plates

9157 Chrome (ea)

Note: These taillights will not replace a stock H-D taillight on a stock H-D fender without extensive modification and fabrication. Installation of this product may be in violation of FMVSS #108.



NARROWED REAR TURN SIGNAL BAR

4-3/4" shorter than stock. Accepts stock turn signal assemblies.

FOR HARLEY-DAVIDSON

Fits: Following Models when Equipped with 3-1/4" Flat Turn Signals Housings: '91-'13 Electra Glides (except '09 FLHT Standard), '98-'03 Road Glides, '94-'13 Road Kings (except '09-'13 FLHR, '07-'08 & '13 FLHRSE), '91-'96 Tour Glides, '86-'90 & '06 FLST/I Heritage, '89-'17 FLSTC/I Heritage Classic & '93-'96 FLSTN Heritage Nostalgia/Special

2384 Chrome (ea)



New

Collections

Featured Bikes

Audio

Lighting

Accessory Mounts

Handlebar Controls, Grips & Mirrors

Pegs & Foot Controls

Covers, Trims & Accents

Air Cleaners & Exhaust

Touring & Comfort

Windshields & Air Management

Luggage & Organizers

Index



5406



5407



2098



5405



REAR TURN SIGNAL BAR FOR STREET GLIDE & ROAD GLIDE

Utilizes existing L.E.D. license plate illumination and mount, and also accepts Kuryakyn Curved License Plate Mounts (P/N 3147 or 3157). Stylized deep dish bezels with red lenses and clear incandescent bulbs provide full run-turn-brake functionality.

FOR HARLEY-DAVIDSON™

Fits: '10-'13 & '15-'19 FLTRX/S, '10-'19 FLHX/S, '17-'19 FLHRXS

5406 Chrome (ea)

5407 Gloss Black (ea)

BULLET LIGHT REAR TURN SIGNAL BAR

Relocates license plate below the taillight and features built-in illumination. Includes flat license plate support, with optional Curved License Plate frame available separately (P/N 3143 or 3162).

FOR HARLEY-DAVIDSON™

Fits: '91-'13 Electra Glides, '98-'08 Road Glides, '11-'13 Road Glide Ultra, '94-'19 Road Kings (except '17-'19 FLHRXS), '91-'96 Tour Glides & '86-'17 FLST/C/N

2098 Chrome (ea)

5405 Gloss Black (ea)

CURVED LICENSE PLATE FRAME

FOR HARLEY-DAVIDSON™

Fits: Kuryakyn Bullet Light Rear Turn Signal Bars (P/N's 2098, 5405)

3162 Chrome (ea)

3143 Gloss Black (ea)

KURYAKYN

by Kellermann 



BL1000
PAGE 56



MICRO RHOMBUS
PAGE 54



RHOMBUS S
PAGE 54



BULLET 1000
PAGE 53



ATTO DF
PAGE 52



BL2000
PAGE 56



MICRO 1000
PAGE 55



MICRO S
PAGE 55



BULLET 1000 RB
PAGE 53



ATTO
PAGE 52

Next Level Lighting

HIGH-PERFORMANCE TURN SIGNALS AVAILABLE IN A VARIETY OF SIZES & PROFILES. MODERN DESIGNS, PREMIUM MATERIALS, & ADVANCED L.E.D. TECHNOLOGY FOR EXTREME LIGHT OUTPUT WITH UNMATCHED LONGEVITY.

PRODUCTS FEATURES:

- Kellermann's HighPower L.E.D. Technology with Long Life Protection Guard® delivers maximum L.E.D. lifespan and spectacular brightness
- IC controlled (integrated circuit), 330 kHz, for max L.E.D. lifespan & brightness, with minimum power draw
- High-quality metal housing available in chrome or satin black finish
- Durable glass lens in clear or smoke (Dark) styling
- Engineered and made in Germany, includes 3-year warranty

New

Collections

Featured Bikes

Audio

Lighting

Accessory Mounts

Handlebar Controls,
Grips & Mirrors

Pegs & Foot Controls

Covers, Trims
& Accents

Air Cleaners
& Exhaust

Touring & Comfort

Windshields &
Air Management

Luggage &
Organizers

Index

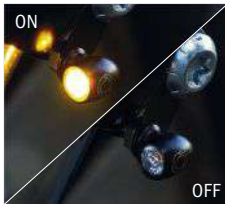

KELLERMANN ATTO COLLECTION

These pint-sized powerhouses make up for their small stature with sheer attention-grabbing brightness. Kellermann's EXtranz[®] (Extreme Optical Transparency) and HighPower L.E.D. technology with Long Life Protection Guard[®] significantly increase rider visibility on the road.

- Sold individually
- Extremely small, spectacularly bright
- 10mm Diameter x 14mm Length with 7.8mm Lens
- Universal for most 12-Volt DC applications with M5 x 0.5 x 6.5mm mounting thread

FUNCTIONALITY OPTIONS

- AMBER (front or rear applications): Amber turn signal (2-wire)
- RB (rear applications): Red run-brake, run-turn, or run-turn-brake (3-wire)
- DF (rear applications): Red run-brake and amber turn; includes heat sink, which can be replaced with P/N 2568 M8 x 40mm Threaded Stud (sold separately) (4-wire)
- WL (front applications): White running lights (2-wire)

MULTI-FIT

Fits: Universal 12V Applications.



FUNCTION: LIGHT	LENS
NEW AMBER: Amber	Clear
AMBER DARK: Amber	Smoke
NEW RB: Red/Red	Clear
NEW RB DARK: Red/Red	Smoke
NEW DF: Red/Red/Amber	Clear 2857
NEW WL: White	Clear
NEW WL DARK: White	Smoke

Note: Not DOT/FMVSS 108 Compliant. Some applications may require use of a load equalizer (sold separately).

2554



KELLERMANN BULLET 1000 COLLECTION

Patent Pending

The Kuryakyn by Kellermann Bullet 1000 Collection redefines the classic bullet-style turn signal. A clean, streamlined housing combined with modern L.E.D. innovation produces a powerful package worthy of any motorcycle. Features Kellermann's HPT™ (Homogeneous Projection Technology) for uniform, spectacularly bright light output.

- Sold individually
- HPT™: Homogeneous Projection Technology produces uniform outer ring illumination
- Universal for most 12-volt DC applications with M8 x 1.25 x 20mm mounting thread
- 2" L x 1-7/8" W x 1-1/2" H

FUNCTIONALITY OPTIONS

- **AMBER** (front or rear applications): Amber turn signal (2-wire)
- **PL** (front applications): White halo running light, amber turn signal center (3-wire)
- **DF** (rear applications): Red halo running and brake light, amber turn signal center (4-wire)
- **RB** (rear applications): Red run-brake, run-turn, or red run-turn-brake (3-wire)

MULTI-FIT

Fits: Universal 12V Applications.

FUNCTION: LIGHT	LENS	CHROME	SATIN BLACK
NEW AMBER DARK: Amber	Smoke		
PL: White/Amber	Clear		
DF: Red/Red/Amber	Clear		
NEW RB: Red/Red	Clear		

Note: Not DOT/FMVSS 108 Compliant. Some applications may require use of a load equalizer (sold separately).

KELLERMANN BULLET 1000 RB TAILLIGHT Patent Pending

Features ultra-bright red run and brake illumination and is equipped with a built-in bracket for easy mounting on virtually any rear fender. A clean, streamlined housing combined with modern L.E.D. innovation produces a powerful package worthy of any motorcycle.

- Sold individually - intended for rear fender-mounted installation
- Functionality - **RB** (rear applications): Red run-brake (3-wire)
- Built-in bracket with included drill template and hardware offer hassle-free mounting
- HPT™: Homogeneous Projection Technology produces uniform outer ring illumination
- 2" L x 1-7/8" W x 1-1/2" H

MULTI-FIT

Fits: Universal 12V Applications.

FUNCTION: LIGHT	LENS	CHROME	SATIN BLACK
RB : Red/Red	Clear	2860	2861

Note: Not DOT/FMVSS 108 Compliant. Some applications may require use of a load equalizer (sold separately).

2555



New

Collections

Featured Bikes

Audio

Lighting

Accessory Mounts

Handlebar Controls,
Grips & Mirrors

Pegs & Foot Controls

Covers, Trims
& AccentsAir Cleaners
& Exhaust

Touring & Comfort

Windshields &
Air ManagementLuggage &
Organizers

Index



KELLERMANN RHOMBUS S COLLECTION

These significantly smaller members of the micro Rhombus family pack an amazing amount of power in a scaled-down version that offers the same sleek, angular design. Features Kellermann's patented Extranz® extreme optical transparency technology.

- Sold individually, requires specific right/left side fitment
- Extranz® extreme optical transparency technology
- Universal for most 12-Volt DC applications with M5 x 0.5 x 6.5mm Mounting Thread
- 1-3/8" L x 3/8" W x 7/16" H

FUNCTIONALITY OPTIONS

- **EXTREME** (front or rear applications): Clear lens amber turn signal (2-wire)
- **AMBER** (front or rear applications): Smoke lens amber turn signal (2-wire)
- **DF** (rear applications): Red run-brake and amber turn (4-wire)

MULTI-FIT

Fits: Universal 12V Applications.

FUNCTION: LIGHT, HOUSING	LENS
EXTREME: Amber, Satin Black	Clear
AMBER DARK: Amber, Satin Black	Smoke
DF DARK: Red/Red/Amber, Satin Black	Smoke

Note: Not DOT/FMVSS 108 Compliant. Some applications may require use of a load equalizer (sold separately).



KELLERMANN MICRO RHOMBUS COLLECTION

Aggressive lines to complement virtually any ride. Kuryakyn by Kellermann micro Rhombus indicators feature durable glass lenses with sleek, angular metal housings and a flexible rubber base that absorbs impact and helps prevent vibration damage.

- Sold individually, requires specific right/left side fitment
- Flexible rubber base helps prevent prolonged vibration damage
- Universal for most 12-Volt DC applications with M8 x 1.25 x 20mm mounting thread
- 3" L x 7/8" W x 3/4" H

FUNCTIONALITY OPTIONS

- **EXTREME** (front or rear applications): Amber turn signal with clear lens (2-wire)
- **PL** (front applications): White running light converts to amber turn signal when activated (3-wire)
- **DF** (rear applications): Red run-brake and amber turn (4-wire)

MULTI-FIT

Fits: Universal 12V Applications.

FUNCTION: LIGHT	LENS
EXTREME: Amber, Chrome	Clear
EXTREME: Amber, Satin Black	Clear
PL: White/Amber, Chrome	Clear
PL: White/Amber, Satin Black	Clear
DF: Red/Red/Amber, Chrome	Clear
DF: Red/Red/Amber, Satin Black	Clear
DF DARK: Red/Red/Amber, Satin Black	Smoke

Note: Not DOT/FMVSS 108 Compliant. Some applications may require use of a load equalizer (sold separately).

NEW

2856



KELLERMANN MICRO S COLLECTION

If you're not amazed by the spectacularly bright output from the incredibly small micro S indicators, the fact that they also offer run, brake, and turn functionality will seal the deal. These scaled down versions of the popular micro 1000 series feature sleek, oval-shaped housings that deliver an ultra clean look, while their blinding brightness stops trailing motorists dead in their tracks.

- Sold individually
- Functionality - DF (rear applications): Red run-brake and amber turn (4-wire)
- Features Extran[®] Extreme Optical Transparency Technology
- Universal for most 12-volt DC applications
- Installs using M5 x 0.5 x 6.5 mm thread
- 1-7/8" L x 3/8" W x 3/8" H

FOR MULTI-FIT

Fits: Universal 12V Applications.

2856 DF DARK: Red/Red/Amber, Smoke Lens, Satin Black (ea)

Note: Not DOT/FMVSS 108 Compliant.

KELLERMANN MICRO 1000 COLLECTION

Stylish, functional and sensorially bright! The Kuryakyn by Kellermann micro 1000 Collection features streamlined oval-shaped metal housings with a flexible rubber base to absorb impact and help prevent prolonged vibration damage.

- Sold individually
- Flexible rubber base helps prevent prolonged vibration damage
- Universal for most 12-Volt DC applications with M8 x 1.25 x 20mm mounting thread
- 2-3/4" L x 5/8" W x 5/8" H

FUNCTIONALITY OPTIONS

- EXTREME (front or rear applications): Amber turn signal with clear lens (2-wire)
- PL (front applications): White running light converts to amber turn signal when activated (3-wire)
- DF (rear applications): Red run-brake and amber turn (4-wire)

MULTI-FIT

Fits: Universal 12V Applications.

FUNCTION: LIGHT	LENS
EXTREME: Amber	Clear
PL: White/Amber	Clear
DF: Red/Red/Amber	Clear
DF DARK: Red/Red/Amber	Smoke

Note: Not DOT/FMVSS 108 Compliant. Some applications may require use of a load equalizer (sold separately).

NEW

2856



2533



2537



2534



2530



2534



ALSO AVAILABLE
ADAPTERS & MOUNTS
PG 57



- New
- Collections
- Featured Bikes
- Audio
- Lighting
- Accessory Mounts
- Handlebar Controls, Grips & Mirrors
- Pegs & Foot Controls
- Covers, Trims & Accents
- Air Cleaners & Exhaust
- Touring & Comfort
- Windshields & Air Management
- Luggage & Organizers
- Index

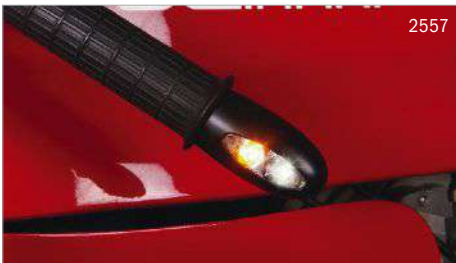

KELLERMANN BL 2000 COLLECTION

Small, but incredibly powerful, the Kuryakyn by Kellermann BL 2000 bar-end turn signal sets new standards. Visually unnoticeable when not in use, activate the indicators for a strikingly bright flashing amber L.E.D. signal that's sure to grab the attention of other motorists. The sleek metal housing with smoke-tinted glass ring is lightweight and unobtrusive, creating a clean look for virtually any handlebar setup.

- Sold individually
- Functionality: AMBER turn signal for handlebar-end applications only, 2-wire
- Signal is visible from front and rear of motorcycle, depending on handlebar width
- Includes all necessary adapters for mounting on most standard 7/8" or 1" handlebars
- Universal for most 12-Volt DC applications (may not be compatible with all heated grips, electronic throttle controls, etc.)
- Available in chrome or satin black finish

FOR MULTI-FIT

Fits: Universal 12V Applications. 7/8" or 1" Handlebars with Hollow Bar Ends.

2558 AMBER, Chrome (ea)

2559 AMBER, Satin Black (ea)

Note: Proper installation may require cutting or drilling a 5/8" hole in the end of the OEM grips. Some applications may require use of a load equalizer (sold separately).

KELLERMANN BL 1000 COLLECTION

Bar-end turn signals have never been this stylish, or functional. The Kuryakyn by Kellermann BL 1000 integrates ultra-bright white L.E.D. running lights and amber L.E.D. turn signals in a sturdy aluminum housing that also helps dampen handlebar vibration. The amber turn signal is visible from the front and rear of the motorcycle, depending on handlebar width.

- Sold individually
- Functionality - PL: (handlebar-end applications) white running light and amber turn signal (3-wire)
- Amber turn signal is visible from front and rear of motorcycle, depending on handlebar width
- Weighted housing help dampen handlebar vibration
- Includes all necessary adapters for mounting on most standard 7/8" or 1" handlebars
- Universal for most 12-Volt DC applications (may not be compatible with all heated grips, electronic throttle controls, etc.)

FOR MULTI-FIT

Fits: Universal 12V Applications. 7/8" or 1" Handlebars with Hollow Bar Ends.

2556 PL: White/Amber, Chrome (ea)

2557 PL: White/Amber, Satin Black (ea)

Note: Proper installation may require cutting or drilling a 5/8" hole in the end of the OEM grips. Some applications may require use of a load equalizer (sold separately).



2577

KELLERMANN FENDER STRUT COVER PLATES

These trick CNC-machined aluminum plates cover the holes left after removal of the stock fender strut-mounted turn signals on select Harley-Davidson models. Compatible with all Kuryakyn by Kellermann L.E.D. indicators, or any aftermarket lights with M8 mounting studs.

FOR HARLEY-DAVIDSON*

Fits: Use for Custom Applications to Replace Fender strut Mounted Turn Signals on Most '02-'19 Softail, Dyna & Sportster

2577 Chrome (pr)

2578 Gloss Black (pr)

KURYAKYN BY KELLERMANN ADAPTERS & MOUNTS

FOR ATTO, MICRO S & RHOMBUS S

Simplify the installation of Kuryakyn by Kellermann Atto, micro S or Rhombus S turn signals with an assortment of mounts designed for multiple applications.

FOR MULTI-FIT

Fits: Atto, micro S & Rhombus S. Provides M8 x 20mm Threaded Stud

2568 Black (ea)

Fits: Atto, micro S & Rhombus S. Provides M8 x 40mm Threaded Stud

2569 Black (ea)

Fits: Atto, micro S & Rhombus S. Provides M10 x 20mm Threaded Stud

2571 Black (ea)

Fits: Atto, micro S & Rhombus S. Extends Light 15mm From Mounting Surface

2572 Black (ea)

Fits: Atto, micro S & Rhombus S. Allows Mounting to License Plate Brackets; 7" (174mm) Long.

2573 Silver (ea)

Fits: Atto, micro S & Rhombus S. Allows Mounting to Mirror Studs or Lever Pins on Handlebar Controls.

2574 Silver (pr)

Fits: Atto, micro S & Rhombus S. Includes M6 x 16mm Screws for Attachment to Motorcycle

NEW 2581 Satin Black (pr)

Fits: Atto, micro S & Rhombus S. Adapter has M6 Internal Threads

NEW 2582 Satin Black (pr)



2878

Mounted: Atto Turn Signals



2878

Mounted: Atto Turn Signals



2574

Mounted: Atto Turn Signals



2568



2569



2571



2572



2573



2574



2581



2582

New

Collections

Featured Bikes

Audio

Lighting

Accessory Mounts

Handlebar Controls,
Grips & Mirrors

Pegs & Foot Controls

Covers, Trims
& Accents

Air Cleaners
& Exhaust

Touring & Comfort

Windshields &
Air Management

Luggage &
Organizers

Index



KELLERMANN ADAPTERS AND MOUNTS

FOR BULLET 1000

Allows direct replacement of stock H-D front control-mounted turn signals with Kuryakyn by Kellermann Bullet 1000 White/Amber turn signals.

FOR HARLEY-DAVIDSON®

Fits: Attaches Bullet 1000 to OEM H-D Handlebar Control Turn Signal Mount

2560 Chrome (ea)

2561 Satin Black (ea)



KELLERMANN ADAPTERS AND MOUNTS

FOR MICRO 1000 AND MICRO RHOMBUS

Optional rigid, rubber and angled mounts/adapters for use with Kuryakyn by Kellermann micro 1000 and micro Rhombus turn signals.

FOR MULTI-FIT

Fits: For Mounting micro 1000 or micro Rhombus to Angled Surfaces up to 15-degrees.

2563 Satin Black (ea)



Fits: Replaces Rubber Adapter with Rigid Adapter on micro 1000 and micro Rhombus. Provides M8 x 40mm Threaded Stud.

2564 Chrome (ea)

2565 Satin Black (ea)



Fits: Replacement Rubber Adapter for micro 1000 and micro Rhombus. Provides M8 x 20mm Threaded Stud.

2566 Black (ea)

Fits: Replacement Rubber Adapter for micro 1000 and micro Rhombus. Provides M8 x 40mm Threaded Stud.

2567 Black (ea)



TORPEDO L.E.D. LIGHTS

With their torpedo shape these ECE approved L.E.D. lights combine both style and function in one! Single-function amber versions are designed to serve as turn signal indicators up front. Multi-function versions are designed for rear use only and feature three independent red and amber circuits that allow the units to serve as run-turn-brake lights. All versions measure 70mm long x 45mm in diameter (2.75" x 1.75"), have clear lenses and utilize M10-1.5 x 25mm mounting studs to allow for easy mounting.

FOR MULTI-FIT

Fits: Universal: 12V Applications. Mounts with M10-1.5 x 25mm Mounting Stud

2509 Rear - Amber/Red Indicator Lights, Run-Turn-Brake, Matte Black (pr)

2507 Rear - Amber/Red Indicator Lights, Run-Turn-Brake, Chrome (pr)

2508 Front - Amber Indicator Lights, Turn Only, Chrome (pr)

2510 Front - Amber Indicator Lights, Turn Only, Matte Black (pr)

Note: Some applications may require use of a load equalizer (sold separately). P/N's 2507 & 2509 are not compatible with Run-Turn-Brake Controllers.

SUPER BRIGHT L.E.D. MINI BULLETS

Universal Mini Bullets can be used as marker lights or auxiliary turn signals. Their intensity greatly exceeds their small size. Unique 3/8" hollow bolt mounting hardware provides a very clean installation. When not lit, lenses appear smoked. Can also be used with our Adapter Studs (P/N 2288, 2289).

FOR MULTI-FIT

Fits: Universal: 12V Applications. Mounts with 3/8"-16 Mounting Stud

2500 Amber, Chrome (pr)

2501 Red, Chrome (pr)

2504 Amber, Gloss Black (pr)

Note: Some applications may require use of a load equalizer (sold separately).

RAZOR EYES

Good things come in small packages. These unique turn signals feature ultra bright L.E.D.'s wrapped in a 2-7/8" long by 7/8" tall chromed metal housing. Available in a single function amber for use on front or rear applications, or for the ultimate in unique rear lighting choose the Multi-Function Razor Eyes with featuring red running & brake lights with amber turn signals.

FOR MULTI-FIT

Fits: Universal: 12V Applications. Mounts with M10-1.5 x 25mm Mounting Stud

2505 Single Function Razor Eyes, Amber, Chrome (pr)

2506 Triple Function Razor Eyes, Red & Amber, Chrome (pr)

Note: Not compatible with Run-Turn-Brake controllers. Some applications may require use of a load equalizer (sold separately).

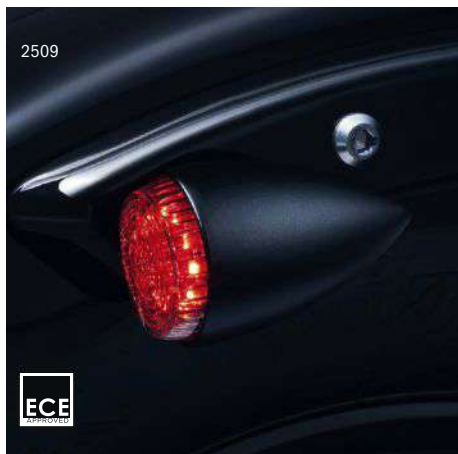

2507



2510



2504



2504



2500

2501

2505



2506



New

Collections

Featured Bikes

Audio

Lighting

Accessory Mounts

Handlebar Controls, Grips & Mirrors

Pegs & Foot Controls

Covers, Trims & Accents

Air Cleaners & Exhaust

Touring & Comfort

Windshields & Air Management

Luggage & Organizers

Index



2527



2529



5011



5032



2317



ALSO AVAILABLE
LICENSE PLATE FRAMES
PG 228



2528

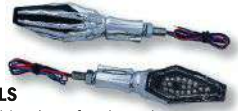

SKELETON HAND TURN SIGNALS

ECE approved for a chilling combination of style and function. Each coffin-shaped housing contains 18 individual single-function amber L.E.D.s for maximum light output.

FOR MULTI-FIT

Fits: 12V Applications. Mounts with M8-1.25 x 20mm Mounting Stud

2527 Black Stem & Black Heads, Satin Black (pr)

2528 Chrome Stem & Black Heads, Chrome & Black (pr)

2529 Black Stem & Chrome Heads, Black & Chrome (pr)

Note: Some applications may require use of a load equalizer (sold separately).

BULLET LIGHT FRONT TURN SIGNAL CONVERSION KIT

Great-looking bullet turn signals with incandescent bulbs in a 2-1/4" diameter housing with dual-circuit functionality. Mounting provides an ultra clean installation to fork, light bar or other universal applications. A perfect match to Kuryakyn Rear Bullet Lights and Light Bars for a great look front to back!

FOR MULTI-FIT

Fits: Universal Applications for Mounting with 5/16" or 3/8" Mounting Bolt, Compatible with Kuryakyn P-Clamps or Two-Piece Fork Mounts

FOR HARLEY-DAVIDSON®

Fits: '94-'13 FLHT, FLHTC, FLHTCU, FLHTK, '94-'19 FLHR & FLHRC & '96-'17 FLSTC

5011 Chrome (pr)

Note: Kit includes smoke lenses with amber incandescent bulbs.

UNIVERSAL RED SINGLE CIRCUIT TURN SIGNALS WITH SMOKED LENSES

Replace your stock rear turn signals with these perfectly sized 2-1/4" bullets. The 1" long universal mount keeps these lights tucked close to your bike for a smooth, clean look. Includes large and small rubber mount adapters for easy installation.

FOR HARLEY-DAVIDSON®

Fits: Universal Application for Mounting with a 5/16" Mounting Bolt

5032 Chrome (pr)

Note: Kit includes smoke lenses with amber incandescent bulbs.

LATE STYLE TURN SIGNAL KIT

Includes four housings with deep dish bezels, smoke lenses, and colored incandescent bulbs. Housings measure 2" diameter x 3-1/2" long.

FOR HARLEY-DAVIDSON®

Fits: '00-'07 FX Softail and Fat Boy Models, '91-'05 Dynas & '91-'08 Sportsters

2317 Chrome (set)

SILVER BULLETS WITH 3/8"-16 HOLLOW MOUNTING BOLT
Wiring exits the light through the mounting bolt. Includes clear lenses only.

FOR MULTI-FIT

Fits: Universal 12V Applications

1645 Amber, Run-Turn Dual Function, Chrome (pr)

1647 Red, Run-Turn Dual Function, Chrome (pr)

2305 Halogen, 3/8"-16 Hollow Mounting Bolt, Chrome (pr)



SMALL SILVER BULLET

LARGE SILVER BULLET

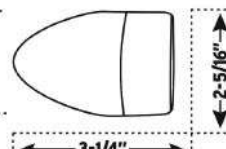
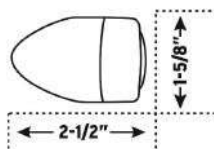

SILVER BULLETS WITH 5/16"-18 MOUNTING BOLT
Wiring exits the light through the rear of the housing. Includes clear lenses only.

FOR MULTI-FIT

Fits: Universal 12V Applications

1648 Amber, Run-Turn Dual Function, Chrome (pr)

2303 Halogen, Chrome (pr)

SMALL SILVER BULLETS

WITH SHORT FENDER STRUT MOUNTS

Red deep dish-style reflector L.E.D. Silver Bullets function as turn signals only.

FOR MULTI-FIT

Fits: Universal For Custom Turn Signal Accent Applications - Single Circuit.

FOR HARLEY-DAVIDSON®

Fits: '00-'02 Softails,'93-'05 Dyna Wide Glides, '00-'07 Deuce & Custom Applications Using Kuryakyn Low-Profile Tombstone Taillight, P/N 4992

1650 Chrome (pr)

Note: Universal For Custom Turn Signal Accent Applications - Single Circuit.

Note:

- Halogen Silver Bullets & single function Deep Dish L.E.D. Style Silver Bullets have a single power wire & ground through their mount.
- Dual function Deep Dish L.E.D. Style Silver Bullets have three wires. They cannot be used for run-brake applications because they do not change intensity.
- When installing Halogen Silver Bullets as driving lights we recommend using our Wiring & Relay kits (P/N 2328 or P/N 2202) to avoid overloading the running light circuit.
- There is no need to use a load equalizer with Halogen Silver Bullet kits.
- Installation of this product may be in violation of FMVSS #108 and are not intended to be replacements for stock turn signals.



3155

LICENSE PLATE TURN SIGNAL & MARKER LIGHT MOUNT

This kit offers stock turn signal relocation from the fender to the license plate area, or a convenient place to mount auxiliary custom lights. Includes brackets with a single 3/8" hole, perfect for mounting Silver Bullets or L.E.D. Mini Bullets.

FOR MULTI-FIT

Fits: Universal for most 4" x 7" License Plates - Accepts Most OEM Rear Turn Signals, Kuryakyn Silver Bullets, or P/N 5032 Turn Signals (3/8" Hole & Slot)

3155 Chrome (ea)

Note: Not compatible with curved license plate frames.



1650 UNLIT

1650 LIT



3155

New

Collections

Featured Bikes

Audio

Lighting

Accessory Mounts

Handlebar Controls, Grips & Mirrors

Pegs & Foot Controls

Covers, Trims & Accents

Air Cleaners & Exhaust

Touring & Comfort

Windshields & Air Management

Luggage & Organizers

Index



4017



4014



2288

2287

2389



ALSO AVAILABLE
SILVER BULLETS
PG 61



ADAPTER STUDS FOR 3/8" SILVER BULLETS

These hollow mounting studs allow 3/8"-16 Silver Bullets or Mini Bullets to be installed into 5/16"-24 or M8-1.25 threaded through-holes. These come in handy for fender strut applications. The 5/16" or M8 diameter ends should be cut to length to ensure adequate clearance.

FOR MULTI-FIT

Fits: 3/8"-16 to 5/16"-24 for Mounting Silver Bullets

2288 3/8"-16 to 5/16"-24 Adapter Studs, Chrome (pr)

Fits: 3/8"-16 to M8-1.25 for Mounting Silver Bullets

2289 Chrome (set)

P-CLAMPS

Great for mounting Silver Bullets or other lights to frame tubes or engine guards. Hinged design for easy installation. A flathead screw and the fastener used to attach the accessory aids in a very secure mount. 5/16" mounting hole.

FOR MULTI-FIT

Fits: 39mm or 41mm Tubing

4014 39mm or 41mm, Chrome (ea)

Fits: 1-1/8" or 1-1/4" Tubing

4024 1-1/8" or 1-1/4", Chrome (ea)

4023 1-1/8" or 1-1/4", Gloss Black (ea)

Fits: 1-3/8" or 1-1/2" Tubing

4019 1-3/8" or 1-1/2", Chrome (ea)

Fits: 7/8" or 1" Tubing

4018 7/8" or 1", Chrome (ea)

Fits: 1-1/2" or 1-5/8" Tubing

4017 1-1/2" or 1-5/8", Chrome (ea)

Note: Do not use for mounting footpegs.

TWO-PIECE FORK MOUNTS

Our sturdy, chrome-plated mounts are just the ticket to attach Silver Bullets (or custom lights using 5/16" mounting hardware) to fork tubes. Various sizes are offered to fit most popular models.

FOR HARLEY-DAVIDSON™

Fits: '06-'07 VRSCR Street Rod, '09-'17 VRSCF Muscle & '12-'17 VRSCDX Night Rod Special

2275 54/58mm, Chrome (pr)

Fits: '18-'19 FX Softail Models(except FXFB/S, FXDRS), '06-'17 Dyna Models (except Switchback), '02-'11 V Rod (except Models with Inverted Forks)

2287 49mm, Chrome (pr)

Fits: Universal: 41mm Fork Tubes

'93-'05 FXDWG Wide Glide Models, '84-'17 FX Softail Models (except Springer Models)

2286 41mm, Chrome (pr)

Fits: '91-'05 Dyna Models (except Wide Glide), '82-'00 FXR Models & '86-'19 XL Sportster Models (except '16-'19 XL1200X/S)

2285 39mm, Chrome (pr)

REPLACEMENT 3/8"-16 X 1-1/2" HOLLOW BOLTS

For use with Silver Bullets.

FOR MULTI-FIT

Fits: Kuryakyn Silver Bullets with 3/8"-16 Mounting Bolt

2389 Hollow Bolts, 3/8"-16 x 1-1/2", Chrome (pr)

LENSES, BEZELS & BULBS



MESH BEZELS FOR H-D BULLET STYLE TURN SIGNALS

Stainless steel mesh is durable and resists corrosion while protecting the included smoke, amber or red lenses. Socket head cap screws secure lenses and mesh inserts to aluminum bezels that snap into factory bullet turn signal housings for a rugged transformation.

FOR MULTI-FIT

Fits: Universal Turn Signal Kits (P/N 5011 & 5032) & Turn Signal Bars (P/N's 2098 & 5405)

FOR HARLEY-DAVIDSON®

Fits: '00-'19 H-D Models with Bullet Turn Signals (except Rocker, V-Rod, '16-'19 CVO & Rear '18-'19 Sport Glide), Kuryakyn Driving Lights with Turn Signals (P/N's 5001, 5005, 5007, 5009, 5029, 5058 & 5059), Universal Turn Signal Kits (P/N 5011 & 5032) & Turn Signal Bars (P/N's 2098 & 5405)

6515 Smoke, Chrome (pr)

6516 Amber, Chrome (pr)

6545 Smoke, Satin Black (pr)

6546 Amber, Satin Black (pr)

Note: Not compatible with P/N 2238 & 2239 when mounted on the front of '17-'19 FLHRXS

Fits: '00-'19 H-D Models with Bullet Turn Signals (except '18-'19 Sport Glide, Rocker, V-Rod & '16-'19 CVO), Universal Turn Signal Kit (P/N 5032) & Turn Signal Bars (P/N's 2098 & 5405)

6517 Red, Chrome (pr)

6547 Red, Satin Black (pr)

MESH BEZELS FOR H-D FLAT STYLE TURN SIGNALS

Creates a tough, industrial appearance while protecting stock flat-style turn signal lenses. Included hardware secures the corrosion-resistant stainless steel mesh inserts to aluminum bezels that cover the lenses for a hassle-free install.

FOR HARLEY-DAVIDSON®

Fits: '86-'13 Electra Glides, Road Glides, Tour Glides, '86-'19 Road Kings (except '17-'19 Road King Special) & '86-'17 Heritage Models Equipped with 3-1/4" Flat Turn Signals

6513 Chrome (pr)

6514 Satin Black (pr)

6515



6515



6545



6545

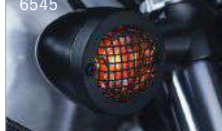

6513



6514



6513



ALSO AVAILABLE

MESH TAILLIGHT BEZEL
PG 227



New

Collections

Featured Bikes

Audio

Lighting

Accessory Mounts

Handlebar Controls,
Grips & Mirrors

Pegs & Foot Controls

Covers, Trims
& Accents

Air Cleaners
& Exhaust

Touring & Comfort

Windshields &
Air Management

Luggage &
Organizers

Index



SMOKE LENS KITS FOR TOURING OR HERITAGE

Ditch your stock lenses and show some style with the Smoke Lens Kit. Turn signal bulbs are red or amber incandescent, and fender tip bulbs are red or amber L.E.D.

FOR HARLEY-DAVIDSON™

Fits: '86-'13 Electra Glides, Road Glides, Tour Glides, Road Kings, Trikes & '86-'17 FL Softail Models with Fender Tip Lights

4824 Front Fender Tip Lens Kit, Smoke (ea)

Fits: '86-'08 Electra Glides, Road Glides, Tour Glides, Road Kings, & '86-'17 FL Softail Models with Fender Tip Lights

4823 Rear Fender Tip Lens Kit, Smoke (ea)

Fits: Following Models with 3-1/4" Flat Turn Signal Housings & Fender Tip Lights: '86-'08 Electra Glides, Road Glides, Road Kings, Tour Glides, Trikes, & '86-'17 FL Softail Models

4995 Rear Turn Signal & Fender Tip Lens Kit, Smoke (set)

Fits: Following Models with 3-1/4" Flat Turn Signal Housings & Fender Tip Lights: '86-'13 Electra Glides, Road Glides, Tour Guides, Road Kings, Trikes & '86-'17 FL Softail Models

4994 Front Turn Signal & Fender Tip Lens Kit, Smoke (set)

REPLACEMENT LENSES FOR 3-1/4" FLAT TURN SIGNALS

Replacement lenses for 3-1/4" Flat Turn Signals.

FOR HARLEY-DAVIDSON™

Fits: '86-'13 Electra Glides, Road Glides, Tour Glides, '86-'19 Road Kings (except '17-'19 Road King Special) & '86-'17 Heritage Models Equipped with 3-1/4" Flat Turn Signals

4997 Smoke (pr)

4996 Red (pr)

Note: Colored bulbs for smoke lenses must be purchased separately.

CLEAR LENSES FOR SILVER BULLETS™ diameter.

FOR MULTI-FIT

Fits: Kuryakyn Large Silver Bullet Lights

2347 2" Clear Lenses, Clear (pr)

Fits: Kuryakyn Small Silver Bullet Lights

2344 1-7/16" Clear Lenses, Clear (pr)



DEEP DISH BEZELS WITH LENSES FOR BULLET TURN SIGNALS
Snap-on installation. Retains stock bulbs and housings.

FOR HARLEY-DAVIDSON™

Fits: '00-'19 H-D Models with Bullet Turn Signals (except Rocker, V-Rod, Rocker, '18-'19 Sport Glide, & '17-'19 CVO), Kuryakyn Driving Lights with Turn Signals (P/N's 5001, 5005, 5007, 5009, 5029, 5058 & 5059), Universal Turn Signal Kits (P/N 5011 & 5032) & Turn Signal Bars (P/N's 2098 & 5405)

2109 Red Lens, Chrome (pr)

5482 Red Lens, Gloss Black (pr)

Fits: '00-'19 H-D Models with Bullet Turn Signals (except Rocker, V-Rod & '17-'19 CVO), Kuryakyn Driving Lights with Turn Signals (P/N's 5001, 5005, 5007, 5009, 5029, 5058 & 5059), Universal Turn Signal Kits (P/N 5011 & 5032) & Turn Signal Bars (P/N's 2098 & 5405)

2108 Amber Lens, Chrome (pr)

5481 Amber Lens, Gloss Black (pr)

Fits: '00-'19 H-D Models with Bullet Turn Signals (except Rocker, V-Rod, '16-'19 CVO & Rear '18-'19 Sport Glide), Kuryakyn Driving Lights with Turn Signals (P/N's 5001, 5005, 5007, 5009, 5029, 5058 & 5059), Universal Turn Signal Kits (P/N 5011 & 5032) & Turn Signal Bars (P/N's 2098 & 5405)

2107 Smoke Lens, Chrome (pr)

5480 Smoke Lens, Gloss Black (pr)

Note: Colored bulbs sold separately.



3" L.E.D. UPGRADE LAMPS FOR KURYAKYN 5000 SERIES DRIVING LIGHTS

Direct replacements for the Halogen Lamps included in our 3" driving light kits. Enjoy long life, lower operating temperatures, reduced draw, and color/brightness that closely matches our Phase 7 L.E.D. Headlamps.

FOR HARLEY-DAVIDSON™

Fits: Replaces H3 Lamp Assembly in Kuryakyn 5000 Series 3" Driving Light Kits

5035 3" L.E.D. Upgrade Lamps for Driving Lights, White (pr)

REPLACEMENT 3" HALOGEN LAMP FOR KURYAKYN 5000 SERIES DRIVING LIGHTS

Replace a damaged driving lamp with the original H3 Halogen lamp.

FOR MULTI-FIT

Fits: Direct Replacement for Kuryakyn 5000 Series Driving Lights

5083 White (ea)

Note: Includes one replacement lamp.

HALOGEN BULBS FOR SILVER BULLETS

Halogen bulbs for use with Kuryakyn Silver Bullets.

FOR MULTI-FIT

Fits: Kuryakyn Large Silver Bullet Lights

2314 Large MR16 Type - 35 Watt (ea)

2313 Large MR16 Type - 20 Watt (ea)

2312 Small MR11 Type - 35 Watt (ea)

2310 Small MR11 Type - 20 Watt (ea)

Note: 35W bulbs should be used only with clear lenses in driving light applications. Excessive heat may damage colored lens coatings.



New

Collections

Featured Bikes

Audio

Lighting

Accessory Mounts

Handlebar Controls, Grips & Mirrors

Pegs & Foot Controls

Covers, Trims & Accents

Air Cleaners & Exhaust

Touring & Comfort

Windshields & Air Management

Luggage & Organizers

Index

2225



SUPER BRIGHT L.E.D. REFLECTOR BULBS FOR SILVER BULLETS

These bulbs are the ideal way to convert Halogen style Silver Bullets or similar lights to L.E.D. Enjoy the low draw and low heat benefits of L.E.D. by simply changing bulbs.

FOR MULTI-FIT

Fits: Kuryakyn Small Silver Bullet Lights

2225 Small MR11 Type, Red (ea)

Note: A load equalizer is required for installation.

2207



SUPER WHITE 881 PASSING LAMP BULBS

30% brighter than stock. Looks great with upgraded brighter headlamps. 27W 881-style bulb is a direct replacement for '05-'17 H-D passing lamps.

FOR HARLEY-DAVIDSON*

Fits: 881 Bulb Applications - Direct Replacement for '05-'19 H-D Passing Lamps (except '18-'19 Softail)(off road use only)

2207 27 Watt (pr)

2205



SUPER WHITE H4 HEADLAMP BULB

Extend visual light range approximately 30%. Extreme white appearance, 5000K color rated. H4 Bulb with p43T base.

FOR MULTI-FIT

Fits: H4 Bulb Applications with p43T Base (off road use only)

2205 60/55 Watt (ea)

Note: Direct replacement for H-D headlights.

2229



H3 REPLACEMENT BULBS

35-watt H3 replacement bulb.

FOR MULTI-FIT

Fits: H3 Bulb Applications (off road use only)

2229 Super White H3 Bulb, 35 Watt, White (ea)

Note: Direct replacement for Kuryakyn 3" 5000 Series & Constellation Driving Lights.

4802



L.E.D. WEDGE BULB

These are a great way to reduce the load on your charging system if you've added additional lights!

FOR HARLEY-DAVIDSON*

Fits: 12v for #161 or #168 Style Push-In Bulbs

4802 L.E.D. Wedge Bulb, Red (ea)

4813



COLORED TURN SIGNAL BULBS

Direct replacements for 1156, 1157 or 3157 bulbs, these red and amber bulbs are just the ticket for bikes with clear or smoke turn signal lenses.

FOR MULTI-FIT

Fits: 1156 Single-Circuit Applications

4814 Replaces 1156 (ea)

Fits: 1157 Two-Circuit Applications

4813 Replaces 1157 (ea)

Fits: 3157 Two-Circuit Applications

4812 Replaces 3157 (ea)

4814



L.E.D. TURN SIGNAL AND TAILLIGHT BULBS

Upgrade stock turn signals or taillights from incandescent to L.E.D. in seconds. Benefits include long-lasting brightness, low current draw, vibration resistance, and attention-grabbing brightness.

FOR MULTI-FIT

Fits: 1157 Two-Circuit Applications

2883 Red (ea)

2884 Amber (ea)

2885 White (ea)

Fits: 3157 Two-Circuit Applications

2886 Red (ea)

2887 White (ea)

Fits: 1156 Single-Circuit Applications

2888 Red (ea)

2889 Amber (ea)

2890 White (ea)



HIGH-INTENSITY L.E.D. BULBS

Direct replacements with intense light output, low current draw, longer lifespan and vibration resistance. White/Amber versions offer high-intensity white running lights that convert to amber turn signals.

FOR HARLEY-DAVIDSON®

Fits: 1156 Single-Circuit Applications

2272 1156, Red (ea)

2273 1156, Amber (ea)

2274 1156, White (ea)

Note: '11-later Softail, '12-later Dyna, '14-later Sportster and Touring do not require load equalizers.

Fits: '14-'19 Touring & Trike, '11-19 Softail, '12-17 Dyna & '14-19 Sportster with 1157 Dual-Circuit Applications

2236 1157, White/Amber (ea)

Note: '11-later Softail, '12-'17 Dyna, '14-later Sportster and Touring do not require load equalizers. Not compatible with Orbit head lights, part numbers 2460, 2461, 2463, 2473 & 2478

Fits: 1157 Dual-Circuit Applications

2237 1157, Red/Red (ea)

2238 1157, Amber/Amber (ea)

2239 1157, White/White (ea)

Note: '11-later Softail, '12-'17 Dyna, '14-later Sportster and Touring do not require load equalizers.

Fits: 3157 Dual-Circuit Applications

2243 3157, Red/Red (ea)

2244 3157, White/White (ea)

Note: '11-later Softail, '12-'17 Dyna, '14-later Sportster and Touring do not require load equalizers.



New

Collections

Featured Bikes

Audio

Lighting

Accessory Mounts

Handlebar Controls, Grips & Mirrors

Pegs & Foot Controls

Covers, Trims & Accents

Air Cleaners & Exhaust

Touring & Comfort

Windshields & Air Management

Luggage & Organizers

Index

ACCENT LIGHTING

NEW



L.E.D. ACCENT STRIP LIGHTS FOR STREET GLIDE & ROAD GLIDE

Additional rear lighting is always a good thing but can add unwanted clutter to the back of the bike. These L.E.D. Accent Strip Lights provide additional ultra-bright run-turn-brake functionality in a super clean package that's virtually unnoticeable when your bike is powered off. Features chip-on-board L.E.D. technology that offers greater packing density for higher intensity output compared to standard L.E.D.'s, uniform light production and superior thermal performance (longevity).

- Sold as a pair, measures 9-1/2" long x 1" wide
- Features chip-on-board L.E.D. technology for higher intensity output than standard L.E.D.'s
- Made from durable injection-molded ABS
- Discreet mounting between the fender filler panel and saddlebags on Street Glide and Road Glides
- Installation uses automotive-grade 3M® VHB™
- Plug-&-play wiring for easy installation

FOR HARLEY-DAVIDSON®

Fits: '09 Street Glides (Can be installed on '06-'08 Models, however contour doesn't perfectly match filler panel)

5417 Black (pr)



5417



5419

Fits: '10-'13 Road Glide (except '11 FLTRU, '12-'13 FLTRXSE) & '10-'13 Street Glide (except '10-'13 FLHXSE)

5418 Black (pr)

Fits: '15-'19 Road Glides (except '16-'19 FLTRU, '15-'16 FLTRUSE & '19 FLTRXSE) & '14-'19 Street Glides (except '15-'19 FLHXSE)

5419 Black (pr)



ALSO AVAILABLE
L.E.D. REAR SADDLEBAG ACCENTS
PG 220



ALSO AVAILABLE
L.E.D. ACCENTS FOR SADDLEBAG
SUPPORTS PG 220



NEW**▶ WATCH THE VIDEO ONLINE!****L.E.D. SADDLEBAG HINGE ACCENTS FOR '14-'19 TOURING**

Reflectors are great for BMX or mountain bikes. But on a motorcycle, not so much. Ditch the factory saddlebag hinge reflectors for these ultra-bright form-fitted replacements that offer significantly increased visibility with their added run, turn and brake functionality.

- Chip-on-board L.E.D. technology provides an intense, pinpoint lighting effect
- Provides red run, red brake, and red turn functionality for increased side-view visibility
- Easy to install with included plug-&-play wiring harness
- Form fit direct replacements for the stock reflector on factory saddlebag hinge covers
- Aluminum base construction offered in chrome or satin black

FOR HARLEY-DAVIDSON™

Fits: '14-'19 Electra Glides, Road Glides, Road Kings & Street Glides

5476 Chrome (pr)

5477 Satin Black (pr)



BRAKE



TURN



OFF



5477

LIGHTED VELOCITY RING**FOR KURYAKYN, BAHN & CRUSHER AIR CLEANERS**

Fifteen bright L.E.D.s offer maximum light output from beneath any Crusher or Kuryakyn air cleaner cover. Choose Solid Color illumination, Flash Color, or cycle through all 7 color options with Auto Color. Requires Standard or Bluetooth® Lizard Lights Controller, sold separately.

FOR MULTI-FIT

Fits: Kuryakyn Hyperchargers, Mach 2, Mach 2 Co-AX, Crusher Maverick & Bahn Air Cleaners

5068 Clear (ea)

Note: Requires drilling into air cleaner backing plate to route wiring. Controller not included. Can be added to existing Lizard Light Kits or Infinity Products.

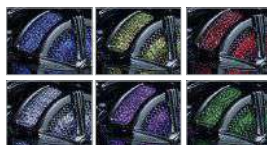
Shown with Mach 2™
PG 242

5068

New

Collections

Featured Bikes

Audio

Lighting

Accessory Mounts

Handlebar Controls,
& Grips & Mirrors

Pegs & Foot Controls

Covers, Trims
& AccentsAir Cleaners
& Exhaust

Touring & Comfort

Windshields &
Air ManagementLuggage &
Organizers

Index



ZOMBIE™ INFINITY™ HORN COVER U.S. Patent 7,029,152
Emits multi-color L.E.D.'s in steady, flashing, or continuously fading modes. Includes controller, or pair with other Infinity and Lizard Lights accessories including Bluetooth® Lizard Lights controller.

FOR HARLEY-DAVIDSON®

Fits: '92-'19 H-D Models with Stock Cowbell & Waterfall Horn Cover

7719 Chrome (ea)

BLUETOOTH CONTROLLER

FOR LIZARD LIGHT & INFINITY PRODUCTS

Cycle through the array of colors on new or existing Lizard Lights, Lighted Velocity Ring, or Infinity Covers from the convenience of your smartphone. Our downloadable app provides the ability to set Solid Color steady illumination, single-color Flash Color with variable rate, or cycle through all 7 available colors in Auto Color.

FOR MULTI-FIT

Fits: Universal 12V Applications: Kuryakyn Lizard, Super Lizard & Infinity Products

5067 Black (ea)



7719



5067



FOUR L.E.D. ACCENT LIGHTS

Use as accent lights or auxiliary turn signals. Chrome housing is 1-1/2" long, 3/4" wide, and 1/2" tall with two screw holes. Each light has two 6" wire leads that can be spliced into any 12-volt circuit.

FOR MULTI-FIT

Fits: Universal 12V Applications, Hard Wire Installation

4703 Amber (ea)

4702 Red (ea)

REAR END ACCESSORIES WITH L.E.D. ACCENTS

Looking for decorative accessories that add additional L.E.D Lighting too? Find everything from Front Fairing, Inner Dash, Tour-Pak and Saddlebag Accessories in

COVERS, TRIMS, & ACCENTS
STARTS ON PG 151





ACCESSORY MOUNTS

DEVICE MOUNTING SYSTEMS

72

DEVICE CHARGERS

76

DRINK HOLDERS

77

DEVICE MOUNTING SYSTEMS



TECH-CONNECT

DEVICE MOUNTING SYSTEMS

Easily mount and secure an iPhone®, iPod®, smartphone, GPS or small device in just seconds. An adjustable swivel head allows movement for perfect positioning and disconnecting in seconds!



*Bring your phone
on the road!*

1699

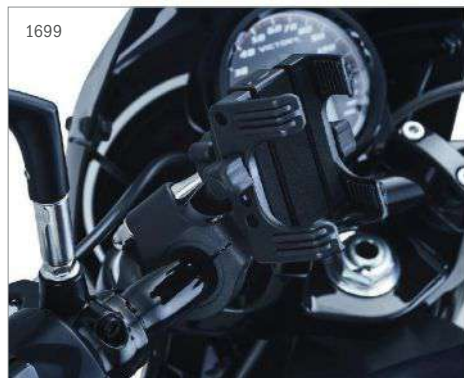

1699



TECH-CONNECT

BAR MOUNT

DEVICE MOUNTING SYSTEM

Perfect for mounting your smartphone, GPS or other small device right on your fairing for easy access.

FOR MULTI-FIT

Fits: 7/8", 1" & 1-1/4" Diameter Bars, Holds devices measuring 1-5/8" to 3-5/8" wide.

1699 Standard Cradle, Black (kit)

1699



TECH-CONNECT

CLUTCH OR BRAKE PERCH MOUNT

DEVICE MOUNTING SYSTEM

Choose between Standard Cradle and Large Cradle kits. Standard Cradle - Premium Mount comes with chrome mount.

- Standard Cradle holds devices measuring 1-5/8" to 3-5/8" wide.
- Large Cradle holds devices measuring 3-5/8" to 6" wide.

FOR HARLEY-DAVIDSON™

Fits: All '82-'19 H-D Models Clutch or Brake Perch Mounts, (except '15-'19 XG Street 500/750)

1698	Standard Cradle - Standard Mount, Black (kit)
1676	Large Cradle - Standard Mount, Black (kit)
1788	Standard Cradle - Premium Mount, Chrome (kit)

Note: Not for use with Kuryakyn Master Cylinder or Clutch Perch Covers that cover perch mounting bolts.



TECH-CONNECT

MIRROR MOUNT DEVICE MOUNTING SYSTEM

Mount your favorite device to your mirror stem in seconds. Holds devices measuring 1-5/8" to 3-5/8" wide.

FOR HARLEY-DAVIDSON™

Fits: Left Side Under Mirror Stem Mount on All Models with Cable Clutch (Except Street Rod, Street Glide or Other Models with Fairing Mounted Mirrors)

1798	Standard Cradle, Chrome & Black (ea)
------	--------------------------------------

Note: Not suggested for mirrors that mount below master cylinders.



TECH-CONNECT

FAIRING MOUNT DEVICE MOUNTING SYSTEM

Perfect for mounting your smartphone, GPS or other small device right on your fairing for easy access. An adjustable swivel head allows movement for perfect positioning and disconnects in seconds! Holds devices from 1-5/8" to 3-5/8".

FOR HARLEY-DAVIDSON™

Fits: '96-'13 Electra Glides, Street Glides & Trikes

1697	Left Side, Black (kit)
1687	Right Side, Black (kit)

Fits: '14-'19 Electra Glides, Street Glides & Tri Glides

1686	Left Side, Black (kit)
------	------------------------



New

Collections

Featured Bikes

Audio

Lighting

Accessory Mounts

Handlebar Controls, Grips & Mirrors

Pegs & Foot Controls

Covers, Trims & Accents

Air Cleaners & Exhaust

Touring & Comfort

Windshields & Air Management

Luggage & Organizers

Index

NEW

5253



5253

5253

QUICK-STASH MAGNETIC DEVICE POUCH

Keep your cell phone or GPS within eyeshot and easily accessible without the clutter of a bar-mounted device holder. Touchscreen-friendly, made from durable Tarpaulin material with sealed seams, water-resistant zippers and a high-strength magnetic attachment for maximum protection.

DIMS: 3.5" wide x 6.125" tall x 1.5" deep

- Easily attaches to steel gas tanks
- Touchscreen-friendly clear top for on-the-go convenience
- Zippered opening from the bottom keeps water out while allowing access to cords

FOR MULTI-FIT

Fits: All models with steel gas tanks

5253 Black (ea)

WATER RESISTANT DEVICE STORAGE

Constructed from water-resistant zippers and Tarpaulin material with sealed seams for maximum protection from the elements. Touchscreen-friendly without removing device from pouch, and the pivot plate mates with any standard Kuryakyn Tech-Connect kits reusing existing locking nut. Fits most standard-sized devices. Measures 3.5" wide x 6.125" tall x 1.5" deep.

FOR MULTI-FIT

Fits: Mounts to Kuryakyn Accessory and Tech Connect Accessory Mount Kits (reusing existing locking nut)

5207 Black (ea)

5207



Touchscreen friendly!

TECH-CONNECT® DEVICE HOLDERS

The most secure universal holder on the market. Dual screw clamping to quickly and securely hold your device, with integrated rubber pads to eliminate slippage.

FOR MULTI-FIT

Fits: Kuryakyn Tech-Connect Accessory Mounts

1694 Large, Holds Devices Measuring 3-5/8" to 6" wide, Black (ea)

1693 Standard, Holds Devices Measuring 1-5/8" to 3-5/8" Wide, Black (ea)

Note: Requires Accessory Mount for installation. Sold separately.



1693

1694

UNIVERSAL ACCESSORY POUCHES

Retain full use of touch-screen devices. Mounts via Tech-Connect Accessory Mounts or onto bars measuring 3/4" to 1-3/4" with included Quick Detach Rubber Strap.

FOR MULTI-FIT

Fits: 3/4" to 1-3/4" Bars & Tech-Connect Accessory Mounts

4127 Tech-Connect® Pouch, Black (ea)
Note: 5-1/2" Tall by 3-1/2" Wide

4124 Large Accessory Pouch, Black (ea)
Note: 6-3/4" Tall x 3-3/4" Wide x 3/4" Deep



4127

4124

TECH-CONNECT

HANDLEBAR ACCESSORY MOUNTS

Attach your cell phone, MP3 player and almost any portable device directly to your handlebars. Mounting plates feature standard 4-hole AMPS pattern and when not in use, a simple clamp is all that is left on your bar. Hook-&-loop straps included. Accepts most belt clips.

- Standard = Black Mount with Black Pivot Plate - 2-3/8" x 1-7/8" Mounting Plate
- Premium = Chrome Mount with Black Pivot Plate - 2-3/8" x 1-7/8" Mounting Plate
- Premium XL = Chrome Mount with Chrome Pivot Plate - 2-3/8" x 1-7/8" Mounting Plate

FOR MULTI-FIT

Fits: 1" Diameter Bars

- 1680 Premium XL, Chrome (ea)
- 1677 Premium, Black & Chrome (ea)

Note: Will Fit 7/8" Bars with Adapter Kit 1786

Fits: 1-1/4" Diameter Bars

- 1681 Premium XL, Chrome (ea)
- 1678 Premium, Black & Chrome (ea)

Fits: 7/8", 1" & 1-1/4" Diameter Bars

- 1671 Standard, Black (ea)

Note: Holds devices measuring 1-5/8" to 3-5/8" wide. Ideal for iPhones and smartphones.



TECH-CONNECT

CLUTCH OR BRAKE PERCH ACCESSORY MOUNTS

Attach your cell phone, MP3 player and almost any portable device directly to your clutch or brake perch! Mounting plates feature standard 4-hole AMPS pattern and when not in use, a simple clamp is all that is left on your bar. Hook-&-loop straps included. Accepts most belt clips.

- Standard = Black Mount with Black Pivot Plate - 2-3/8" x 1-7/8" Mounting Plate
- Premium = Chrome Mount with Black Pivot Plate - 2-3/8" x 1-7/8" Mounting Plate
- Premium XL = Chrome Mount with Chrome Pivot Plate - 2-3/8" x 1-7/8" Mounting Plate

FOR HARLEY-DAVIDSON®

Fits: All '82-'19 H-D Models Clutch or Brake Perch Mounts, (except '15-'19 XG Street 500/750)

- 1672 Standard, Black (ea)
- 1682 Premium XL, Chrome (ea)



TECH-CONNECT

FAIRING ACCESSORY MOUNTS

Mounting plates feature standard 4-hole AMPS pattern and, when not in use, a simple clamp is all that is left on your bar.

FOR HARLEY-DAVIDSON®

Fits: '96-'13 Electra Glides, Street Glides & Trikes

- 1675 Right Side, Black (ea)

New

Collections

Featured Bikes

Audio

Lighting

Accessory Mounts

Handlebar Controls, Grips & Mirrors

Pegs & Foot Controls

Covers, Trims & Accents

Air Cleaners & Exhaust

Touring & Comfort

Windshields & Air Management

Luggage & Organizers

Index

DEVICE CHARGERS



ELECTRICAL POWER POINT

Keep your cell phone, GPS, air pump or any other electrical device charged while on the road. Comes with cigarette lighter and everything you need to connect directly to your battery with an inline fuse and a quick disconnect.

FOR HARLEY-DAVIDSON®

Fits: All '82-'19 H-D Models Clutch or Brake Perch Mounts, (except '15-'19 XG Street 500/750)

1483 Electrical Power Point, Chrome (ea)

FOR MULTI-FIT

Fits: 1" Bars

1423 1" Clamp, Chrome (ea)

Note: Multi-Fit: Will Fit 7/8" Bars with Adapter Kit 1786

Fits: 1-1/4" Bars

1476 1-1/4" Clamp, Chrome (ea)



REPLACEMENT COMPONENTS FOR ELECTRICAL POWER POINT

Replace your lost or damaged clamp or cigarette element.

FOR MULTI-FIT

Fits: For use with Kuryakyn Electrical Power Points, P/N's 1476 & 1483

5619 Replacement Cigarette Element for Electrical Power Points (ea)



USB POWER SOURCE

Two USB ports (bottom = 1.0A and top = 2.1A) provide enough output for charging any modern device, including tablets. Mount anywhere you choose including inside your tour trunk, on the dash, or on your handlebars.

FOR MULTI-FIT

Fits: Universal for 12V Applications - Requires 1" x 1" Flat Surface or 1" of Straight Section on 1" Bar for Mounting (Connects Directly to Battery with In-line Fuse)

1688 Chrome (ea)

1703 Satin Black (ea)



L.E.D. BATTERY GAUGE

An array of L.E.D.'s indicate operating voltage of the bike's electrical system with simple two-wire connection.

4218



FOR MULTI-FIT

Fits: Universal Fitment for 12V Applications

4219 Chrome (ea)

4218 Black (ea)



ALSO AVAILABLE
CONTROL COVERS
PG 88



DRINK HOLDERS

MESH BASKET UNIVERSAL DRINK HOLDERS

Fingers firmly grasp onto various-sized containers to keep your drink in the mesh holder and not on you! Quick-detach thumbscrew mount leaves a simple clamp when not in use.

FOR HARLEY-DAVIDSON™

Fits: All '82-'19 H-D Models Clutch or Brake Perch Mounts, (except '15-'19 XG Street 500/750)

1462 For Perch Mount, Chrome (ea)

1738 Perch Mount, Gloss Black (ea)

FOR MULTI-FIT

Fits: 1" Bars

1422 For 1" Bars, Chrome (ea)

1729 For 1" Bars, Gloss Black (ea)

Note: Will Fit 7/8" Bars with Adapter Kit 1786

Fits: 1-1/4" Bars

1475 For 1-1/4" Bars, Chrome (ea)

BEVERAGE CARRIER UNIVERSAL DRINK HOLDERS

The quick-detach thumbscrew mount leaves a simple clamp when not in use. Drink Ring has 3" inside diameter.

FOR HARLEY-DAVIDSON™

Fits: All '82-'19 H-D Models Clutch or Brake Perch Mounts, (except '15-'19 XG Street 500/750)

1500 For Perch Mount, Chrome (ea)

Fits: Left Side Under Mirror Stem Mount on All Models with Cable Clutch (Except Street Rod, Street Glide or Other Models with Fairing Mounted Mirrors)

1790 For Mirror Mount, Chrome & Black (ea)

FOR MULTI-FIT

Fits: 1" Bars

1488 For 1" Bars, Chrome & Black (ea)

Note: Will Fit 7/8" Bars with Adapter Kit 1786

Fits: 1-1/4" Bars

1489 For 1-1/4" Bars, Chrome & Black (ea)

Note: Not suggested for mirrors that mount below master cylinders.

STAINLESS STEEL MUG DRINK HOLDERS

The 3" Chrome Ring mounts on handlebars or clutch and brake perch mounts, and the quick-detach thumbscrew leaves a simple clamp when not in use.

FOR HARLEY-DAVIDSON™

Fits: All '82-'19 H-D Models Clutch or Brake Perch Mounts, (except '15-'19 XG Street 500/750)

1463 For Perch Mount, Chrome (ea)

FOR MULTI-FIT

Fits: 1" Bars

1464 For 1" Bars, Chrome (ea)

Note: Will Fit 7/8" Bars with Adapter Kit 1786

Top
Seller



1738

1462



1422



1500



1488



1790



1464



1463



Top
Seller

New

Collections

Featured Bikes

Audio

Lighting

Accessory Mounts

Handlebar Controls,
Grips & Mirrors

Pegs & Foot Controls

Covers, Trims
& Accents

Air Cleaners
& Exhaust

Touring & Comfort

Windshields &
Air Management

Luggage &
Organizers

Index



1482



1482



1689



1692



1485



1484

PASSENGER DRINK HOLDER U.S. Patent D652,365

These non-intrusive and easy-to-reach drink holders are ready for your favorite beverage. Durable and made to last, these passenger drink holders look as good as they work.

FOR HARLEY-DAVIDSON®

Fits: '98-'13 FLHTCU/I Ultra Classic Electra Glides, '10-'13 FLHTK Electra Glide Ultra Limiteds, '11-'13 FLTRU Road Glide Ultras, '08-'13 FLHTCUSE CVO Ultra Classic Electra Glides, '11 FLTRUSE CVO Road Glide Ultras, & '09-'13 FLHTCUTG Tri Glide Ultra Classics

1482 Basket, Right Side, Chrome (ea)

1689 Basket, Left Side, Chrome (ea)

Fits: '14-'19 FLHTCU Ultra Classic Electra Glides, FLHTK Ultra Limiteds, FLHTKSE CVO Ultra Limiteds & FLHTCUTG Tri Glides, '16-'19 FLTRU Road Glide Ultras & '15-'16 FLTRUSE CVO Road Glide Ultras

1692 Basket, Right Side, Chrome (ea)

Note: P/N's 1482, 1493 & 1689 will also fit '98-'13 FLHTC if equipped with Accessory Rear Speaker Kit.

PASSENGER DRINK HOLDER

Our drink holders fasten securely and can be mounted universally on any 1/2", 5/8", or 3/4" tubing.

FOR HARLEY-DAVIDSON®

Fits: 1/2" Diameter Passenger Grab Rails on Electra Glides, Road Glides, Road Kings, Street Glide, Tour Glides & Trikes. Universal Applications on 1/2", 5/8" or 3/4" Tubing

1484 Drink Holder with Mesh Basket, Chrome & Black (ea)

1485 Drink Holder with Stainless Mug, Chrome (ea)

1472



DRINK HOLDER REPLACEMENT COMPONENTS

FOR MULTI-FIT

Fits: Kuryakyn Drink Holders P/N 1422, 1475, 1462

1429 Replacement Mesh Basket for Drink Holder, Black (ea)

1459 Beverage Carrier for 3" Diameter Ring-Style Drink Holder, Black (ea)

2792



MOUNTING HARDWARE & COMPONENTS

FOR HARLEY-DAVIDSON®

Fits: All '82-'19 H-D Models Clutch or Brake Perch Mounts, (except '15-'19 XG Street 500/750)

1472 For Clutch or Brake Perch Mount Kit, Chrome (ea)

1420



FOR MULTI-FIT

Fits: 1/2"-1-1/4" Bars (accepts 5/16" Mounting Hardware)

1468 For 1-1/4" Bars, Chrome (ea)

2792 For 1-1/4" Bars, Satin Black (ea)

1415 For 3/4", 5/8" & 1/2" Bars, Chrome (ea)

1420 For 1" Bars, Chrome (ea)

2791 For 1" Bars, Satin Black (ea)

Note: Will Fit 7/8" Bars with Adapter Kit 1786

Fits: 7/8" Bars

1786



1786 7/8" Adapter Kit, Silver (ea)



HANDLEBAR CONTROLS GRIPS & MIRRORS

GRIPS 86

GRIP ACCESSORIES 91

CONTROL COVERS 94

LEVERS 96

MIRRORS 98

GRIPS



HEAVY INDUSTRY
PAGE 83



RIOT
PAGE 82



KINETIC
PAGE 83



ISO-FLAME
PAGE 84



THRESHER
PAGE 81



ISO
PAGE 84



HEX
PAGE 81



ZOMBIE
PAGE 82

GRIPS

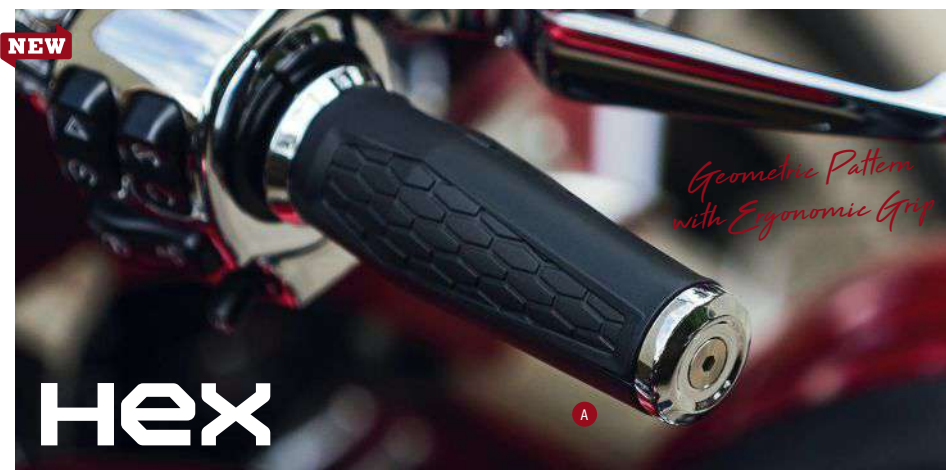

HEX GRIPS

Ergonomic design with a wide diameter for thumb, index, and middle fingers, and a tapered outer profile for ring and pinky fingers to match the natural shape of your hands. Durable EPDM rubber compound will not harden, crack or wear over time and provides an ultra soft, cushiony feel for all-day vibration dampening comfort. Constructed with aluminum collars and bar-mounted end caps that can be easily replaced with bar-end mirrors or turn signals. Glueless clutch side designs allows easy install or removal if you change handlebars.

FOR HARLEY-DAVIDSON®

See Fitment Chart Below

Hex Grips (pr)

THRESHER GRIPS

A soft shark tooth-inspired knurled rubber texture with an ergonomic profile that contours to the shape of your hands deliver unbeatable comfort and control. Premium EPDM rubber compound provides an ultra soft, cushiony feel for all-day vibration dampening. Features a “glueless” clutch grip offering easy installation or removal for handlebar swaps.

FOR HARLEY-DAVIDSON®

See Fitment Chart Below

Thresher Grips (pr)



FITMENT CHART

FITS: '96-'19 H-D MODELS WITH
DUAL CABLE THROTTLE CONTROL

FITS: '08-'19 H-D MODELS WITH
ELECTRONIC THROTTLE CONTROL

		FITS: '96-'19 H-D MODELS WITH DUAL CABLE THROTTLE CONTROL	FITS: '08-'19 H-D MODELS WITH ELECTRONIC THROTTLE CONTROL
NEW A	Hex, Chrome	5920	5922
NEW B	Hex, Satin Black	5921	5923
C	Thresher, Chrome	5940	5942
D	Thresher, Satin Black	5941	5943

Note: Kuryakyn Grips are compatible with aftermarket internal bar-style heated grips. Not compatible with OEM heated grips where heat element is in the grip.

New

Collections

Featured Bikes

Audio

Lighting

Accessory Mounts

Handlebar Controls,
Grips & Mirrors

Pegs & Foot Controls

Covers, Trim
& Accents

Air Cleaners
& Exhaust

Touring & Comfort

Windshields &
Air Management

Luggage &
Organizers

Index



RIOT GRIPS

Riot grips are all business. MX-styling with a thin profile and soft, durable knurled rubber compound together provide complete control and total comfort. Aggressive cast aluminum housings and trim rings deliver rugged style from every angle.

FOR HARLEY-DAVIDSON®

See Fitment Chart Right

Riot Grips (pr)



ZOMBIE



ALSO AVAILABLE

RIOT FOOT PEGS
PG 108



ZOMBIE™ GRIPS

U.S. Patent D560,463

Smooth chrome bodies with vibration-absorbing rubber inserts assure a comfortable and secure grip to keep control in hand. Zombie™ end caps enhance the specter of evil as the numbers of this coven of accessories continue to multiply.

FOR HARLEY-DAVIDSON®

See Fitment Chart Right

Zombie Grips (pr)

HEAVY INDUSTRY



HEAVY INDUSTRY GRIPS U.S. Patent 9,428,241
Don't be fooled by their rugged appearance. The proprietary EPDM rubber compound provides a soft, vibration-dampening feel for long-haul comfort, with tough industrial styling that hides your softer side.

FOR HARLEY-DAVIDSON™

See Fitment Chart Below

Heavy Industry Grips (pr)



ALSO AVAILABLE
HEAVY INDUSTRY SWITCHBLADES
PG 110



KINETIC™ GRIPS

U.S. Patent D725,456; D725,986 & D725,987
Featuring an aluminum body and EPDM rubber to help you ride with less fatigue and more control in a sleek, modern design.

FOR HARLEY-DAVIDSON™

See Fitment Chart Below

Kinetic Grips (pr)



FITMENT CHART		FITS: '96-'19 H-D MODELS WITH DUAL CABLE THROTTLE CONTROL	FITS: '82-'19 H-D MODELS WITH DUAL CABLE THROTTLE CONTROL	FITS: '08-'19 H-D MODELS WITH ELECTRONIC THROTTLE CONTROL
E	Riot, Silver	3580	--	3581
F	Riot, Satin Black	3582	--	3583
G	Zombie, Chrome	--	6296	6298
H	Zombie with Throttle Boss, Chrome	--	6295	6297
I	Heavy Industry, Chrome	--	6120	6122
J	Heavy Industry, Satin Black	--	6121	6123
K	Kinetic, Chrome	--	6350	6352
L	Kinetic, Gloss Black	--	6351	6353

Note: Kuryakyn Grips are compatible with aftermarket internal bar-style heated grips. Not compatible with OEM heated grips where heat element is in the grip.

New

Collections

Featured Bikes

Audio

Lighting

Accessory Mounts

Handlebar Controls,
Grips & Mirrors

Pegs & Foot Controls

Covers, Trims
& Accents

Air Cleaners
& Exhaust

Touring & Comfort

Windshields &
Air Management

Luggage &
Organizers

Index

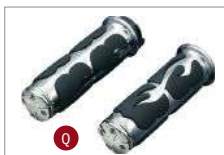

ISO®-GRIPS

Combining great style and comfort, these grips provide a soft, non-slip surface that dampens operating vibration. Recessed area between the ISO®-Pads permits air movement for added comfort in hot weather.

FOR HARLEY-DAVIDSON®

See Fitment Chart Below

ISO®-Grips (pr)

ISO®-GRIPS WITH THROTTLE BOSS

For the rider who demands the ultimate in comfort and style. Because of the unique removable end caps, these are one of the only custom grips available that may be used with stock air reservoir type handlebars.

FOR HARLEY-DAVIDSON®

See Fitment Chart Below

ISO®-Grips with Throttle Boss (pr)

ISO®-FLAME GRIPS

Featuring a unique flamed pattern in the soft and cushy raised rubber pads and finished off with a Maltese Cross emblazoned end cap and smooth trim ring for that additional bad attitude.

FOR HARLEY-DAVIDSON®

See Fitment Chart Below

ISO®-Flame Grips (pr)

TRANSFORMER™ GRIPS

U.S. Patent D631,725

Bright chrome grip bodies and sculpted end caps provide a solid feel while contrasting soft black rubber inlays absorb vibration. Interchangeable Widow, Zombie™ or Maltese Cross Emblems.

FOR HARLEY-DAVIDSON®

See Fitment Chart Below

Transformer Grips (pr)

Note: Not compatible with standard Accent Rings, Zombie or Widow Grip End Caps.

FITMENT CHART		FITS: '15-'19 H-D STREET 500 & 750	FITS: '82-'19 H-D MODELS WITH DUAL CABLE THROTTLE CONTROL	FITS: '08-'19 H-D MODELS WITH ELECTRONIC THROTTLE CONTROL
M	ISO®, Chrome	6408	6205	6227
N	ISO®, Gloss Black	6409	6320	6321
O	ISO® with Throttle Boss, Chrome	--	6212	6228
P	ISO® with Contoured Throttle Boss, Chrome	--	6342	6343
Q	ISO®-Flame, Chrome	--	6260	6269
R	Transformer, Chrome	--	6291	6293

Note: Kuryakyn Grips are compatible with aftermarket internal bar-style heated grips. Not compatible with OEM heated grips where heat element is in the grip.

GRIP ACCESSORIES

CONTOURED ISO®-THROTTLE BOSS™

Simple to install and adjustable to suit your needs. A larger surface area and pad provides even more comfort than the original design while still easing hand and forearm fatigue.

FOR MULTI-FIT

Fits: All Kuryakyn ISO®-Grips, ISO®-Flame Grips, Transformer™ Grips

6299 Right Side, Chrome (ea)

6318 Right Side, Gloss Black (ea)

6309 Left Side, Chrome (ea)



ISO

6299



ISO®-THROTTLE BOSS™

This small, adjustable paddle is positioned under the palm of the throttle hand, allowing riders to slightly relax their grip on the gas and still maintain a constant speed.

FOR MULTI-FIT

Fits: All Kuryakyn ISO®-Grips, ISO®-Flame Grips, Transformer™ Grips-Left or Right Grip

6253 Chrome (pr)

6250 Chrome (ea)

6319 Gloss Black (ea)



6250

6319



KINETIC™ THROTTLE BOSS™ U.S. Patent D707,592

Designed to relieve pressure from your palm for reduced arm and hand fatigue.

FOR MULTI-FIT

Fits: Kuryakyn Kinetic Grips, Right or Left

6354 Chrome (ea)

6355 Gloss Black (ea)



6355



6354

THROTTLE BOSSES

Allows driver to have a relaxed grip while cruising.

FOR MULTI-FIT

Fits: All Kuryakyn ISO®-Grips, ISO®-Flame Grips, & Transformer™ Grips - Left or Right Grips

6294 Transformer, Chrome (ea)

Fits: Kuryakyn Zombie™ Throttle Grip Only

6286 Zombie Throttle Boss, Chrome (ea)



6294



6286

MECHANICAL THROTTLE CRUISE ASSIST

The spring-loaded tensioner makes it easy to set without over tightening for easy throttle shutdown when needed.

FOR MULTI-FIT

Fits: For models with 1" or 7/8" handlebars with hollow bar ends, and OEM or Kuryakyn ISO®- & Transformer Style Grips

6285 Mechanical Throttle Cruise Assist, Chrome (ea)

6288 Clutch Side Matching Bar End Weight, Chrome (ea)



6285

Note: Installation may require cutting or drilling a 5/8" hole in the end of the OEM grips. Handlebars must have open ends. Not compatible with Kuryakyn Throttle Bosses. Does not fit with internally wired heated grips, models with electronic throttle or air reservoir handlebars. Requires 2-3/4" depth of open bar end.

UNIVERSAL THROTTLE BOSS™

Can be installed in seconds to provide a cushioned "platform" to rest one's palm. When not in use, it can be quickly removed without tools and stowed in a jacket pocket or tool bag. The Wide Universal Throttle Boss has a larger palm rest for added support.

FOR MULTI-FIT

Fits: Any Application with a Twist Grip Throttle

6251 Standard, Black (ea)

6315 Wide, Black (ea)



6251

New

Collections

Featured Bikes

Audio

Lighting

Accessory Mounts

Handlebar Controls,
Grips & Mirrors

Pegs & Foot Controls

Covers, Trims
& Accents

Air Cleaners
& Exhaust

Touring & Comfort

Windshields &
Air Management

Luggage &
Organizers

Index



STILETTO END CAPS

Installation is a breeze. Screws supplied for use with or without Throttle Boss.

FOR MULTI-FIT

Fits: All Kuryakyn ISO®-Grips, ISO®-Flame, Spear, Transformer & Kinetic Grips

6249 Chrome (pr)

6359 Gloss Black (pr)

Note: Kinetic™ Grips require Accent Rings, sold separately.



GRIP END CAPS

FOR MULTI-FIT

Fits: All Kuryakyn ISO®-Grips, ISO®-Flame Grips, Braided Grips, Spear Grips & Kinetic™ Grips

6245 Maltese Cross Grip End Caps, Chrome (pr)

6244 ISO®-Grip End Caps, Chrome (ea)

6243 ISO®-Grip End Caps, Chrome (pr)

Note: Kinetic™ Grips require Accent Rings, sold separately.



FIVE-SPOKE END CAPS FOR KINETIC™ GRIPS

FOR MULTI-FIT

Fits: Kuryakyn Kinetic™ Grips

6356 Chrome (pr)

6357 Gloss Black (pr)

GRIP END WEIGHTS

Install on the end of each grip to add mass and length, further reducing high-amplitude handlebar vibration.

FOR MULTI-FIT

Fits: Kuryakyn ISO®-Grips, ISO®-Flame Grips, Spear Grips & Kinetic™ Grips

6238 Chrome (pr)

6339 Gloss Black (pr)

Kinetic™ Grips require Accent Rings, sold separately.



ACCENTS FOR HEATED GRIPS

Die-cast aluminum construction.

FOR HARLEY-DAVIDSON™

Fits: '10-'19 FLHTK Electra Glide Ultra Limited or any '08-'19 Touring Model or Trike equipped with H-D P&A Black Rubber Heated Hand grips P/N 56100034

6346 Chrome (set)



GRIP ACCENT RINGS

FOR MULTI-FIT

Fits: Transformer™ Grips

6364 Smooth Accent Rings, Chrome (pr)

Fits: Kuryakyn ISO® Grips & ISO®-Flame Grips

6222 Knurled Accent Rings, Blue (pr)

6220 Knurled Accent Rings, Chrome (pr)

6226 Knurled Accent Rings, Black (pr)



GRIP GLUE

FOR MULTI-FIT

Fits: All Kuryakyn Grips

6152 Grip Glue for Kuryakyn Grips (ea)

REPLACEMENT GRIP EMBLEMS & COMPONENTS

FOR MULTI-FIT

Fits: Kuryakyn Transformer, ISO®-Grips & ISO®-Flame Grips

6289 Transformer Grip End Caps, Chrome (pr)

Fits: Zombie Clutch Grip or Throttle Grip without Throttle Boss

6281 Zombie Grip End Cap, Chrome (ea)

Fits: Zombie or Widow Grips with Throttle Boss P/N's 6270, 6275, 6295, 6297

6278 Replacement Zombie Emblems, Chrome (pr)

Fits: Zombie or Widow Grips without Throttle Boss, P/N's 6271, 6276, 6296, 6298

6279 Replacement Zombie Emblems, Chrome (pr)

Fits: Kuryakyn Transformer Grips, P/N'S 6291 & 6293

6365 Replacement Emblem Kit for Transformer™ Grips, Chrome (set)

Fits: Kuryakyn Kinetic™ Grips

6400 Kinetic Grip End Caps, Chrome (pr)

6401 Kinetic Grip End Caps, Gloss Black (pr)

Fits: Kuryakyn ISO®-Grips, ISO®-Flame Grips & Braided Grips

6219 5/8" Long Screws for ISO®-Grip End Caps, Polished (set)

6407 Standard Replacement End Cap Screws for ISO®-Grip, Chrome (set)

Note: Optional Longer Stainless Screws, P/N 6219, allow up to three additional accent rings (two if used with Throttle Boss™).

THROTTLE & IDLE CABLE COVERS

You've chromed out the rest of your controls so it's time to finish the job! Hide the often corroded or oxidized cables beneath your controls. Quick-and-easy installation requires no disassembly.

FOR HARLEY-DAVIDSON™

Fits: All '82-'13 Models with 90 Degree Cable Elbows (excludes electronic throttle applications)

2027 Chrome (set)

CLUTCH CABLE FERRULE COVER & BANJO BOLT COVER

Get rid of that rusted, oxidized clutch cable ferrule and banjo bolt.

FOR HARLEY-DAVIDSON™

Fits: All '84-'19 H-D Models with Stock Master Cylinder & Calipers (except '02-'17 V-Rod, '04-'19 XL, '08-'19 Touring & Any Models with Hydraulic Clutch)

2016 Clutch Cable Ferrule & Banjo Bolt Cover Kit, Chrome (set)

Fits: '84-'07 H-D Master Cylinders & Calipers (except '04-'07 XL) & '08-'19 Softail & '08-'17 Dyna Master Cylinders

2014 Banjo Bolt Cover, Chrome (ea)

Fits: All '84-'19 H-D Clutch Cables

2012 Clutch Cable Ferrule Cover, Chrome (ea)

Fits: Handlebar Master Cylinders on '08-'13 Electra Glides, Road Glides, Road Kings, Street Glides & Trikes

7230 Banjo Bolt Cover, Chrome (ea)

Fits: '08-'13 Electra Glides, Road Glides, Road Kings, Street Glides & Trikes

7231 Clutch Cable Ferrule & Banjo Bolt Cover Kit, Chrome (set)



6278



6278

ZOMBIE



6400



6401



2027



7231



7231



2012

New

Collections

Featured Bikes

Audio

Lighting

Accessory Mounts

Handlebar Controls,
& Mirrors

Pegs & Foot Controls

Covers, Trims
& Accents

Air Cleaners
& Exhaust

Touring & Comfort

Windshields &
Air Management

Luggage &
Organizers

Index

CONTROL COVERS



TECH TIP

No need to remove the master cylinder to install P/N's 1739-1740, 9119, or 9126

BRAKE & CLUTCH CONTROL DRESS-UP KIT

The Clutch Perch (cable style) is a complete chrome replacement unit that has been beefed up to complement the brawny look of an H-D. The Master Cylinder Cover dresses up the reservoir and covers the entire visible hand brake bracket assembly. There are even replacement chrome clamp halves and hardware accents for a 100% detailed, pure custom look.

FOR HARLEY-DAVIDSON®

Fits: '96-'14 Softails, '96-'17 Dynas & '96-'03 Sportsters equipped with Single Disc Front Brakes

9126 Chrome (set)

Fits: '96-'07 Electra Glides, Road Glides, Road Kings, Street Glides & Tour Glides; '96-'17 Dynas & '96-'03 Sportsters equipped with Dual Disc Front Brakes

9119 Chrome (set)

Fits: '08-'13 Electra Glides, Road Glides, Road Kings, Street Glides & '09-'10 Trikes without Reverse

1740 Chrome (set)

Fits: '14-'16 Electra Glides & Street Glides

1739 Chrome (set)

SWITCH HOUSINGS

Chrome versions of the OEM switch housings accept stock switches for a super clean appearance.

FOR HARLEY-DAVIDSON®

Fits: Following Models WITHOUT Cruise: '96-'13 FLHTC/I, '06-'13 FLHX/I, '10-'13 FLTRX, '96-'09 FLHT/I, '10-'11 FLHXXX

7806 Chrome (set)

Fits: '96-'13 FLHTCU/I, '10-'13 FLHTK, '98-'09 FLTR/I, '11-'13 FLTRU, '02-'13 FLHRC/I, '09-'13 FLHTCUTG

7807 Chrome (set)

Fits: '96-'13 FLHR/I Road Kings, '96-'10 Softails (except '03 FXSTDSE), '96-'11 Dynas, '96-'13 Sportsters & '02-'13 V-Rods

7808 Chrome (set)

Fits: Following Models WITH Cruise: '02-'13 FLHTC/I, '06-'13 FLHX/I, '10-'12 FLTRX, '02-'09 FLHT/I, '10-'11 FLHXXX

1742 Chrome (set)

Fits: '11-'19 Softail Models (except '11-'12 FLSTSE, '14-'15 FLSTNSE, '13-'14 FXSBSE, '16-'17 FLSTC, '16-'17 FLSTN, '16-'17 FLSS, '16-'17 FLSTFBS, '16-'17 FXDLS, '16-'17 FXSE; '18-'19 FLDE, FLHC & FLHCS), '12-'17 Dyna Models & '14-'19 Sportster Models

1747 Chrome (set)

Fits: '14-'19 Electra Glides, Road Glides, Road Kings, Street Glides & Trikes

1748 Chrome (set)

MESH

6533



6532



MESH CLUTCH MASTER CYLINDER COVER

Direct replacement for stock that provides a rugged custom appearance for the clutch master cylinder. Three-piece design integrating an aluminum outer frame and baseplate with formed steel mesh insert. Individual components disassemble easily for custom finishes. Reuses stock gasket and includes hardware.

FOR HARLEY-DAVIDSON™

Fits: '17-'19 Electra Glides, Road Glides, Road Kings, Street Glides & '19 Trike

6562 Chrome (ea)

6563 Satin Black (ea)

Fits: '14-'16 Electra Glides, Road Glides & Street Glides

6532 Chrome (ea)

6533 Satin Black (ea)

MESH BRAKE MASTER CYLINDER COVER

A direct replacement for the stock cover with rugged, industrial styling. Multi-piece design integrates an aluminum outer frame and baseplate with formed steel mesh insert for a fully custom appearance. Individual components can be easily disassembled for custom finishes. Includes hardware and reuses factory gasket.

FOR HARLEY-DAVIDSON™

Fits: '06-'17 Dyna Models; '06-'14 Softail Models; '05-'07 Electra Glide, Road Glide, Road King & Street Glide; '14-'18 Trike Clutch and Brake Master Cylinders

6534 Chrome (ea)

6535 Satin Black (ea)

Fits: '15-'19 Softail Models

6536 Chrome (ea)

6537 Satin Black (ea)

Fits: '07-'19 Sportster Models

6558 Chrome (ea)

6559 Satin Black (ea)

Fits: '08-'19 Electra Glides, Road Glides, Road Kings, Street Glides & '09-'13 & '19 Trikes

6530 Chrome (ea)

6531 Satin Black (ea)

6533



6530



6537



ALSO AVAILABLE
MESH DERBY COVERS
PG 197



ALSO AVAILABLE
MESH BEZELS
PG 63



New

Collections

Featured Bikes

Audio

Lighting

Accessory Mounts

Handlebar Controls,
Grips & Mirrors

Pegs & Foot Controls

Covers, Trims
& Accents

Air Cleaners
& Exhaust

Touring & Comfort

Windshields &
Air Management

Luggage &
Organizers

Index

LEVERS



	A		B
LEVERS U.S. Patents D432,470 & D596,091	ZOMBIE™ CHROME	ZOMBIE™ GLOSS BLACK	TRIGGER GLOSS BLACK
Fits: '17-'19 Electra Glides, Road Glides, Road Kings & Street Glides (pr)	1984	1983	1819
Fits: Following Models with Hydraulic Clutch: '14-'16 Electra Glides & Street Glides, '15-'16 Road Glides, '14 FLHRSE CVO Road Kings (pr)	1721	1722	1843
Fits: '15-'17 Softail Models (except '15 FLSTNSE, '16-'17 FLSS, FLSTFBS, FXSE) (pr)	1841	1842	1835
Fits: Following Models with Cable Operated Clutch: '96-'07 Electra Glides, Road Glides, Road Kings, Street Glides, Tour Glides; '96-'17 Dynas, '99-'00 FXR2/3/4, '96-'14 Softails & '96-'03 Sportsters (pr)	1047	1090	1029
Fits: Following Models with Cable Operated Clutch: '08-'13 Electra Glides, Road Glides, Street Glides, '08-'16 Road Kings & '09-'13 Trikes (pr)	1058	1091	1056
Fits: '04-'13 Sportsters (pr)	1060	1092	--
Fits: Following Models with Hydraulic Clutch: '99-'06 Twin Cams & '02-'05 V-Rods (pr)	--	--	--
Fits: '82-'95 H-D Models (pr)	--	--	1021
Fits: '18-'19 Softail Models (pr)	NEW 6744	NEW 6745	--
Fits: '14-'19 XL Models (pr)	--	--	--



C	D	E	F	G			
SILHOUETTE CHROME	BOSS BLADES CHROME	BOSS BLADES GLOSS BLACK	BOSS BLADES W/ ADJUSTABLE CLUTCH CHROME	NEW DILLINGER™ SILVER	NEW DILLINGER™ SATIN BLACK	ISO® CHROME	ISO® GLOSS BLACK
--	1986	1985	--	--	--	5736	5735
--	1723	1849	--	--	--	5734	5733
--	1837	1838	--	--	--	--	--
1049	1038	1847	1080	NEW 6681	NEW 6682	--	--
1055	1057	1848	--	--	--	--	--
--	--	--	1093	--	--	--	--
--	1036	--	--	--	--	--	--
--	--	--	--	--	--	--	--
--	--	--	--	--	--	--	--
--	--	--	--	NEW 6668	NEW 6669	--	--

- New
- Collections
- Featured Bikes
- Audio
- Lighting
- Accessory Mounts
- Handlebar Controls,
Grips & Mirrors**
- Pegs & Foot Controls
- Covers, Trims
& Accents
- Air Cleaners
& Exhaust
- Touring & Comfort
- Windshields &
Air Management
- Luggage &
Organizers
- Index



HEX
PAGE 94



SKELETON HAND
PAGE 98



ELLIPSE
PAGE 94



TRIDENT
PAGE 96



TEARDROP
PAGE 97

MIRRORS



HEAVY INDUSTRY
PAGE 95



ZOMBIE
PAGE 98



PHANTOM
PAGE 95



MAGNUM
PAGE 99



SCYTHE
PAGE 98

New

Collections

Featured Bikes

Audio

Lighting

Accessory Mounts

Handlebar Controls,
Grips & Mirrors

Pegs & Foot Controls

Covers, Trims
& Accents

Air Cleaners
& Exhaust

Touring & Comfort

Windshields &
Air Management

Luggage &
Organizers

Index

MIRRORS

Hex

NEW



NEW

5918



1437



HEX MIRRORS

The wide, angular mirror heads offer excellent field of vision and are accented by smooth beveled edges for a clean custom look. A machined stainless steel ball and nylon socket provide smooth pivoting for easy adjustability and secure positioning. Mirror heads measure 5-1/2" wide x 3-1/2" tall, while the position of the stems place mirrors 4-1/2" out and 3" above mounting location.

FOR MULTI-FIT

Fits: Universal; Requires Adapters for Installation

FOR HARLEY-DAVIDSON®

Fits: Direct Replacement for H-D Applications (except '04-'19 XL/XR, XG); XG Street 500/750 Require Adapters for Installation

5918 Chrome (pr)

5919 Satin Black (pr)

ELLIPSE™ MIRRORS

Available with flat or convex glass, and featuring an oversized swivel ball for superior locking ability. 5" wide x 2-3/4" tall.

FOR HARLEY-DAVIDSON®

Fits: Direct Replacement for H-D Applications (except '04-'19 XL/XR, XG) XG Street 500/750 Require Adapters for Installation

1438 Convex Glass, Chrome (pr)

1437 Flat Glass, Chrome (pr)

HEAVY INDUSTRY MIRRORS

A rugged and industrial design ideal for minimalist riders seeking gritty style paired with pure form and function. Mirror heads measure approximately 6" long x 3" wide, stems are 6" long and position mirror heads 4" above and 5-1/2" out from the mounting location. Stem and Accent Kits are sold separately to allow additional customization.

FOR HARLEY-DAVIDSON*

Fits: Direct Replacement for H-D Application (except XG Models); XG Models Require Adapters for Installation

COMPLETE MIRRORS

- 1736 Chrome (pr)
- 1737 Satin Black (pr)
- 1765 Chrome & Satin Black (pr)
- 1766 Satin Black & Chrome (pr)

STEMS AND ACCENT KITS

- 1776 Stems, Chrome (pr)
- 1777 Stems, Satin Black (pr)
- 1778 Accent Kit, Chrome (kit)
- 1779 Accent Kit, Satin Black (kit)



PHANTOM MIRRORS

Made from premium chrome-plated or black anodized forged aluminum, with a machined stainless steel ball and nylon socket that provide smooth pivoting for easy adjustability and secure positioning. Mirror heads measure 2-3/4" tall x 4-3/4" wide and utilize convex glass to provide a greater field of visibility.

FOR HARLEY-DAVIDSON*

Fits: Direct Replacement for H-D Application (except XG Models); XG Street Require Adapters for Installation

- 1962 Chrome (pr)
- 1963 Gloss Black (pr)



PHANTOM BAR END MIRRORS

An aggressive bar-end design widens rear-view visibility and incorporates convex glass for a greater field of vision. Made from premium chrome-plated or black anodized forged aluminum, with machined stainless steel ball and nylon socket that provide smooth pivoting for easy adjustability and secure positioning. Mirror heads measure 2-3/4" tall x 4-3/4" wide.

FOR MULTI-FIT

Fits: Universal: 1" or 7/8" Handlebars with Hollow Bar Ends. Requires 2-3/4" Depth x 5/8" of Open Bar End. Compatible With OEM or Kuryakyn Grips

- 1958 Chrome (pr)
- 1959 Gloss Black (pr)

Note: Installation may require cutting or drilling a 5/8" hole in the end of the grips. Not compatible with Kuryakyn Chrome style throttle bosses that screw to the end of Kuryakyn Grips, other grip end accessories/weights, Heated Grips, Air Reservoir Handlebars, or Throttle Side with Electronic Throttle.



- New
- Collections
- Featured Bikes
- Audio
- Lighting
- Accessory Mounts
- Handlebar Controls, Grips & Mirrors
- Pegs & Foot Controls
- Covers, Trims & Accents
- Air Cleaners & Exhaust
- Touring & Comfort
- Windshields & Air Management
- Luggage & Organizers
- Index



1495



6370



6370



6370



1431



1495

TRIDENT MIRRORS

Trident Mirrors lock in just where you want. The convex lens offers increased viewing with approximately 9" from mount to mirror end. Mirror head measures 4-3/4" wide x 2-1/8" tall.

FOR HARLEY-DAVIDSON*

Fits: Direct Replacement for H-D Applications (except XG Models); XG Street 500/750 Require Adapters for Installation

1495 Chrome (ea)

TRIDENT BAR END MIRROR

Just like the café racers of the 60's, bar end mirrors are back and better than ever. These are a great way to transform the look of your bars and put the mirrors in a wider, more useful position. The offset arm and swiveling head provides great adjustability. (Convex Glass) Mirror head measures 4-3/4" wide x 2-1/8" tall.

FOR MULTI-FIT

Fits: Universal: 1" or 7/8" Handlebars with Hollow Bar Ends. Requires 2-3/4" Depth x 5/8" of Open Bar End. Compatible With OEM or Kuryakyn Grips

6370 Chrome (ea)

Note: Proper installation may require cutting or drilling a 5/8" hole in the end of the OEM grips. Proper installation requires 7/8" or 1" handlebars that have open ends. Not compatible with Kuryakyn Chrome style throttle bosses that screw to the end of Kuryakyn Grips or other grip end accessories/weights. Installation may require cutting or drilling a 5/8" hole in the end of the grips. Not compatible with Kuryakyn Chrome style throttle bosses that screw to the end of Kuryakyn Grips, other grip end accessories/weights, Heated Grips, Air Reservoir Handlebars, or Throttle Side with Electronic Throttle.

TURN SIGNAL MIRRORS

Featuring super-bright L.E.D.'s that double as running lights and turn signal accents. Measuring 5" wide x 2-3/4" tall.

FOR HARLEY-DAVIDSON*

Fits: Direct Replacement for H-D Applications (except '04-'19 XL/XR, XG); XG Street 500/750, Require Adapters for Installation

1432 Convex Glass, Chrome (pr)

1431 Flat Glass, Chrome (pr)

Note: May be in violation of FMVSS #108.



ALSO AVAILABLE

ISO®-GRIPS
PG 84





1708

TEARDROP MIRRORS

The streamlined mirror heads with convex glass measure 5" wide x 2" tall, and the stems position the pivot ball 5" out and 3" above the mounting location.

FOR HARLEY-DAVIDSON®

Fits: Direct Replacement for H-D Applications (except '04-'19 XL/XR, XG); XG Street 500/750 Require Adapters for Installation

1707 Chrome (pr)

1708 Satin Black (pr)

Note: Not compatible with Kuryakyn Chrome Handlebar Control Dress-Up Kits on '04-'13 Sportsters.

FAIRING MOUNTED TEARDROP MIRRORS

Direct bolt-on replacements for Street Glides™, and comes with a drill template for installation on Electra Glides™ and Tri Glides™. Mirror heads measure 5" wide x 2" tall.

FOR HARLEY-DAVIDSON®

Fits: '14-'19 Street Glides, Electra Glides & Tri Glides

1810 Chrome (pr)

Note: Installation on Electra Glides and Tri Glides requires drilling mounting holes. Template and all hardware included.

WINDSHIELD MOUNTED MIRRORS

Clean and simple, the mount adds a classy trim to the fairing and positions the mirrors to provide excellent rearward visibility.

FOR HARLEY-DAVIDSON®

Fits: '96-'13 Electra Glides, '06-'13 Street Glides, '09-'13 Trikes & Kuryakyn AirMaster Fairings

1453 Ellipse Mirrors, Chrome (set)

1454 Mount Only - No Mirrors, Chrome (ea)



1707



1708



1810



1810



1453



1454

New
Collections
Featured Bikes
Audio
Lighting
Accessory Mounts
Handlebar Controls, Grips & Mirrors
Pegs & Foot Controls
Covers, Trims & Accents
Air Cleaners & Exhaust
Touring & Comfort
Windshields & Air Management
Luggage & Organizers
Index



1760

1448



1816



1815

Top
Seller



1759

ECE
COMPLIANT

1758



1764



1450



ZOMBIE

1450



ALSO AVAILABLE
SKELETON HAND TURN
SIGNALS PG 60



1449



SCYTHE™ MIRRORS

Slice through the wind! Select the Scythe™ mirror with classic Knife blade-style stem or Scythe II with contoured stem. Mirror head is 6" wide x 2-1/4" tall.

FOR HARLEY-DAVIDSON®

Fits: Direct Replacement for H-D Applications (except XG Models); H-D XG Street, Require Adapters for Installation

1448 Scythe II Mirrors, Chrome (pr)

1449 Scythe Mirrors, Chrome (pr)

1760 Scythe Mirrors, Gloss Black (pr)

FAIRING MOUNTED SCYTHE™ MIRRORS

A machined stainless steel ball and nylon socket provide smooth pivoting for easy adjustability and precise, firm positioning of the unique knife-shaped mirror heads that measure 6" wide x 2-1/4" tall.

FOR HARLEY-DAVIDSON®

Fits: '14-'19 Street Glides, Electra Glides & Tri Glides

1815 Chrome (pr)

1816 Gloss Black (pr)

Fits: '06-'13 Street Glides, '96-'13 Electra Glides & '09-'13 Trikes

1818 Chrome (pr)

1817 Gloss Black (pr)

Note: Installation on '96-'13 Electra Glides and '09-'13 Tri Glides requires drilling mounting holes. Template and all hardware included.

SKELETON HAND MIRRORS U.S. Patent D585,800

Now you can enlist your own creepy skeleton hand to hold your mirror head in perfect position! Mirror head is 5" wide x 3" tall. ECE compliant.

FOR HARLEY-DAVIDSON®

Fits: Direct Replacement for H-D Applications (except '04-'19 XL/XR, XG Models); XG Street 500/750 Require Adapters for Installation

1758 Black Stems & Black Heads, Black (pr)

1759 Chrome Stems & Black Heads, Chrome & Black (pr)

1764 Black Stems & Chrome Heads, Black & Chrome (pr)

ZOMBIE™ MIRRORS

Mirror head is 3" wide x 4" tall with round glass 3" in diameter.

FOR HARLEY-DAVIDSON®

Fits: Direct Replacement for H-D Applications (except XG Models); XG Street Models, Require Adapters for Installation

1450 Chrome (pr)

Available in
two head sizes



1430

MAGNUM™ MIRRORS

Featuring sturdy stems and an oversized adjuster ball. Available in two head sizes. Large Heads are 5-1/2" x 3", Small Heads are 5" x 2-5/8".

FOR HARLEY-DAVIDSON®

Fits: Direct Replacement for H-D Applications (except '04-'19 XL/XR, XG Models); XG Street 500/750 Require Adapters for Installation

1430 Large Flat Glass, Chrome (pr)

1428 Small Flat Glass, Chrome (pr)

MAGNUM™ PLUS MIRRORS

Magnum Plus Mirrors position the mirror head outward 2" farther than our Magnum Mirrors. Available with flat glass or convex glass. Large Head - 5-1/2" x 3", Small Head - 5" x 2-5/8".

FOR HARLEY-DAVIDSON®

Fits: Direct Replacement for H-D Applications (except '04-'19 XL/XR, XG Models); XG Street 500/750 Require Adapters for Installation

1412 Large Flat Glass, Chrome (ea)

1410 Small Flat Glass, Chrome (ea)

1409 Large Convex Glass, Chrome (ea)

1408 Small Convex Glass, Chrome (ea)

COVERS FOR STOCK MIRRORS

Change the look of your stock mirrors without breaking the bank. Installs in minutes using high-strength 3M VHB.

FOR HARLEY-DAVIDSON®

Fits: '03-'19 H-D Models with Original Equipment Handlebar Mounted Mirrors (except CVO/Screamin' Eagle Models)

1754 Flame Accents, Gloss Black (pr)

L.E.D. MIRROR STEM COVERS

Easily add auxiliary lighting with run-turn function to your handlebars.

FOR HARLEY-DAVIDSON®

Fits: '03-'19 H-D Original Equipment Tapered, Short- Stem Mirrors

1757 Chrome (pr)



1757



1428
Small Head
5" x 2-5/8"



1410
Small Head
5" x 2-5/8"



1412
Large Head
5-1/2" x 3"



1754



1757

New

Collections

Featured Bikes

Audio

Lighting

Accessory Mounts

Handlebar Controls,
Grips & Mirrors

Pegs & Foot Controls

Covers, Trims
& Accents

Air Cleaners
& Exhaust

Touring & Comfort

Windshields &
Air Management

Luggage &
Organizers

Index



1444



1444

MIRROR STEM EXTENDERS

Extend stock mirrors outward about 3" and slightly upward with these uniquely angled, chrome plated mirror stem extenders. Fasten to handlebars exactly like stock mirrors and reuse acorn nut or turn signal mounting swivels.

FOR HARLEY-DAVIDSON™

Fits: Stock H-D Mirrors with Round Steel Stem (except Street)

1444 Chrome (pr)



1812

MIRROR ADAPTERS

Great for mounting Kuryakyn mirrors, also universal for mounting most mirrors with tapped 5/16"-18 hole.

FOR HARLEY-DAVIDSON™

Fits: '15-'19 Street 500 & 750 (except '17-'19 Street Rod)

1812 Black (pr)

Fits: 1" Bars (accepts 5/16" Mounting Hardware)

1420 Chrome (ea)

2791 Satin Black (ea)

Note: Will Fit 7/8" Bars with Adapter Kit 1786

Fits: 1-1/4" Bars (accepts 5/16" Mounting Hardware)

1468 Chrome (ea)

Fits: 1-1/4" Bars (accepts 5/16" Mounting Hardware)

2792 Satin Black (ea)

Fits: 7/8" Bars

1786 Silver (ea)



1812



1786



1420



2791

REPLACEMENT COMPONENTS FOR MAGNUM™ & MAGNUM™ PLUS MIRRORS

FOR MULTI-FIT

MIRROR STEMS

Fits: Accepts Mirror Head with 1/4"-20 Threads

1400 Magnum™ Plus Mirror Stem, Chrome, Right or Left, Chrome (ea)

1401 Standard Magnum™ Mirror Stem, Right, Chrome (ea)

1402 Standard Magnum™ Mirror Stem, Left, Chrome (ea)

MIRROR HEADS ONLY

Fits: Replacement Mirror Head for Kuryakyn Magnum™ & Magnum™ Plus Mirrors. Universal Installation in Stems that Accept Mirrors Heads Installing with 1/4"-20 Mount Stud

1418 Large Magnum™ Mirror Head with Flat Glass, Chrome (ea)

1417 Small Magnum™ Mirror Head with Flat Glass, Chrome (ea)

1407 Large Magnum™ Mirror Head with Convex Glass, Chrome (ea)

1406 Small Magnum™ Mirror Head with Convex Glass, Chrome (ea)

REPLACEMENT COMPONENTS FOR BLIND SPOT II MIRRORS

FOR MULTI-FIT

Fits: Kuryakyn Blind Spot II Mirror, P/N 1499

1497 Replacement Stem, Right, Chrome (ea)

1498 Replacement Stem, Left, Chrome (ea)



PEGS & FOOT CONTROLS

FOOTPEGS, SHIFT PEGS & BRAKE PEDAL PADS 104

FOOTPEG & FLOORBOARD ADAPTERS 128

FOOTPEG & FLOORBOARD RELOCATORS 129

PASSENGER PEGS 132

HIGHWAY & CRUISE PEGS 135

ENGINE GUARDS 137

CLAMPS & MOUNTS 140

SHIFT LINKAGES & ARM COVERS 143

SHIFT & BRAKE LEVERS 147

FORWARD CONTROLS 150



RIOT FLOORBOARDS
PAGE 109



RIOT MINI BOARDS
PAGE 108



RIOT FOOTPEGS
PAGE 108



ISO®-WING MINI BOARDS
PAGE 124



DILLINGER FOOTPEGS
PAGE 106



HEX FOOTPEGS
PAGE 104



PHANTOM FOOTPEGS
PAGE 113



ZOMBIE FOOTPEGS
PAGE 117



PHANTOM MINI BOARDS
PAGE 113

& FLOORBOARDS

FOOTPEGS

KINETIC FOOTPEGS
PAGE 114



TRIDENT ISO®-FOOTPEGS
PAGE 118



SPEAR MINIBOARDS
PAGE 113

KINETIC MINIBOARDS
PAGE 114



THRESHER FOOTPEGS
PAGE 113



SPEAR FOOTPEGS
PAGE 113

HEAVY INDUSTRY FOOTPEGS
PAGE 110



FLAME FOOTPEGS
PAGE 121

HEAVY INDUSTRY
FLOORBOARDS PAGE 112



New

Collections

Featured Bikes

Audio

Lighting

Accessory Mounts

Handlebar Controls,
Grips & Mirrors

Pegs & Foot Controls

Covers, Trims
& Accents

Air Cleaners
& Exhaust

Touring & Comfort

Windshields &
Air Management

Luggage &
Organizers

Index

FOOTPEGS, SHIFT PEGS & BRAKE PEDAL PADS

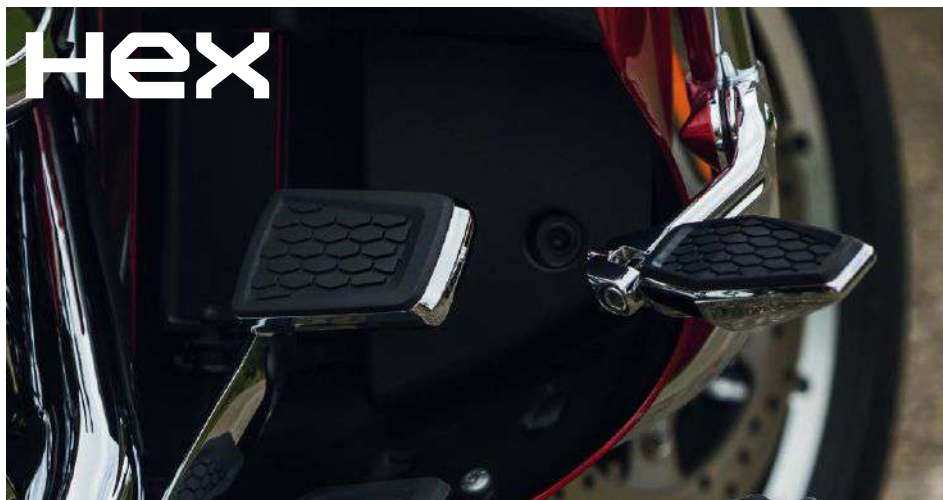

HEX PEGS

A perfect blend of form and function with heavy-duty aluminum housings highlighted by angular designs and smooth beveled edges that provide depth. Premium EPDM rubber inserts featuring a geometric "hex" pattern deliver traction, durability, and vibration-dampening comfort. Splined adapters offer precise peg angle adjustability.

FOR MULTI-FIT

See Fitment Chart Right

5904 With Male Mount Adapters, Chrome (pr)

5905 With Male Mount Adapters, Satin Black (pr)

5906 Without Adapters, Chrome (pr) *

5907 Without Adapters, Satin Black (pr) *

HEX SHIFT PEG

Aluminum construction with durable EPDM rubber pads on top and bottom that provide traction so you can confidently shift through the gears in style.

FOR HARLEY-DAVIDSON™

Fits: All H-D Shift Levers

5910 Chrome (ea)

5911 Satin Black (ea)



ALSO AVAILABLE

HEX MIRRORS
 PG 94



*Surefooted
stopping power!*

5917



HEX BRAKE PEDAL PADS

The rubber pad provides grip, vibration dampening, and features the signature geometric "Hex" pattern for added style.

FOR HARLEY-DAVIDSON®

Fits: '80-'19 Electra Glides, Road Glides, Road Kings, Street Glides, Tour Glides & Trikes; '86-'19 FL Softail Models (except '18-'19 FL5B) & '12-'16 Dyna Switchbacks

5914 Chrome (ea)

5915 Satin Black (ea)

Fits: All '84-'17 FX Softail Models, '08-'11 FXCW/C Rocker Models, '93-'17 FXDWG Dyna Wide Glide Models, '08-'17 FXDF, Dyna Fat Bob Models with Forward Controls, '15-'19 XG Street (except '17-'19 Street Rod) & All Kuryakyn Forward Controls

5916 Chrome (ea)

5917 Satin Black (ea)

HEX PASSENGER BOARD INSERTS

Direct replacements for stock passenger board pads featuring molded EPDM rubber to improve vibration dampening. Angular hexagonal design combined with smooth beveled aluminum trim adds depth and style to completely transform the look.

FOR HARLEY-DAVIDSON®

Fits: '86-19 Electra Glides, Road Glides, Road Kings, Tour Glides & Trikes with Traditional D-Shaped Passenger Boards; '86-'17 Softail or '06-'17 Dyna Models equipped with H-D Accessory Passenger Floorboard Kits Using Traditional D-Shaped Passenger Boards

5902 Chrome (pr)

5903 Satin Black (pr)



ALSO AVAILABLE
HEX GRIPS
PG 81



NEW



5914

NEW



5915

NEW



5916

NEW



5902

NEW



5903

NEW



5902

NEW



5903

FITMENT CHART

WITH MALE MOUNT ADAPTERS

FOR HARLEY-DAVIDSON®

Fits: Universal Fitment for All Kuryakyn Male Mount Footpeg Clevises, Direct Replacement for H-D Style Male Mount Footpeg Applications (except Driver/Passenger '18-'19 Softails & Driver location on '15-'19 XG, '11-'19 XL1200C Sportster Custom, '12-'16 XL1200V Sportster Seventy-Two & '10-'19 XL1200X/S Sportster Forty-Eight/Special)

WITHOUT ADAPTERS

FOR HARLEY-DAVIDSON®

Fits: OEM Stock Footpeg Mount Location, Requires Model Specific Tapered (▲) or Splined (✳) Adapters (Sold Separately) Found On Page 128-129

New

Collections

Featured Bikes

Audio

Lighting

Accessory Mounts

Handlebar Controls,
Grips & Mirrors

Pegs & Foot Controls

Covers, Trims
& Accents

Air Cleaners
& Exhaust

Touring & Comfort

Windshields &
Air Management

Luggage &
Organizers

Index

DILLINGER



NEW



6667

DILLINGER™ FOOTPEGS

Multi-piece construction with contrasting textured and smooth finishes combined with a unique pass-through design offers an aggressive look and feel. Raised features on the top surface provide traction, while the use of sturdy steel splined adapters allow precise peg angle adjustability. Cast from high-quality aluminum.

FOR MULTI-FIT

See Fitment Chart Right

6666 With Male Mount Adapters, Silver (pr)

6667 With Male Mount Adapters, Satin Black (pr)

6658 Without Adapters, Silver (pr) *

6659 Without Adapters, Satin Black (pr) *

NEW



6666

NEW



6667

DILLINGER™ SHIFT PEG

The perfect complement to our Dillinger Pegs features a rugged design so you can aggressively bang through the gears. Features include multi-piece aluminum construction with contrasting finishes and a unique pass-through design for an aggressive look and feel.

FOR HARLEY-DAVIDSON™

Fits: All H-D Shift Levers

6714 Silver (ea)

6715 Satin Black (ea)

NEW



6714

NEW



6715



ALSO AVAILABLE
 DILLINGER HANDGUARDS
 PG 283



ALSO AVAILABLE
 DILLINGER LUGGAGE RACK
 PG 271





THRESHER

THRESHER PEGS

Sleek and subtly aggressive with a unique shark tooth-inspired knurled rubber surface that delivers sharp style, excellent grip, and all-day vibration-dampening comfort. Streamlined aluminum housings wrapped in soft EPDM rubber.

FOR MULTI-FIT

See Fitment Chart Below

5952 With Male Mount Adapters, Chrome (pr)

5953 With Male Mount Adapters, Satin Black (pr)

5954 Without Adapters, Chrome (pr) *

5955 Without Adapters, Satin Black (pr) *

THRESHER SHIFT PEGS

The unique shark tooth-inspired knurled rubber surface delivers sharp style and excellent grip for a sleek, subtly aggressive look. Streamlined aluminum housings wrapped in soft EPDM rubber.

FOR HARLEY-DAVIDSON*

Fits: All H-D Shift Levers

5956 Chrome (ea)

5957 Satin Black (ea)

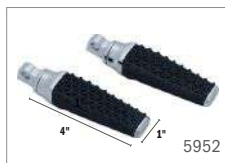



ALSO AVAILABLE
THRESHER GRIPS
PG 81



FITMENT CHART

WITH MALE MOUNT ADAPTERS

FOR HARLEY-DAVIDSON*

Fits: Universal Fitment for All Kuryakyn Male Mount Footpeg Clevises, Direct Replacement for H-D Style Male Mount Footpeg Applications (except Driver/Passenger '18-'19 Softails & Driver location on '15-'19 XG, '11-'19 XL1200C Sportster Custom, '12-'16 XL1200V Sportster Seventy-Two & '10-'19 XL1200X/S Sportster Forty-Eight/Special)

WITHOUT ADAPTERS

FOR HARLEY-DAVIDSON*

Fits: OEM Stock Footpeg Mount Location, Requires Model Specific Tapered (▲) or Splined (✱) Adapters (Sold Separately) Found On Page 128-129

New

Collections

Featured Bikes

Audio

Lighting

Accessory Mounts

Handlebar Controls, Grips & Mirrors

Pegs & Foot Controls

Covers, Trims & Accents

Air Cleaners & Exhaust

Touring & Comfort

Windshields & Air Management

Luggage & Organizers

Index



3598 & 3590

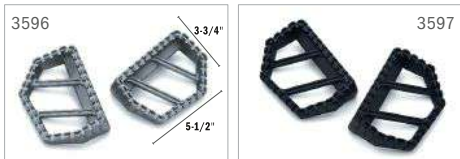

3598

RIOT FOOTPEGS

Authentic and industrial MX-styled pegs suited for aggressive riders who like to throw down on any terrain. Rugged cast aluminum construction featuring a serrated toothed top surface for no-slip traction to rip up the streets, tracks or trails. Footpegs measure 4.6" long x 1.64" wide and accept model-specific splined adapters (sold separately) for ideal angle adjustment.

FOR MULTI-FIT

See Fitment Chart Right

3599 Without Adapters, Satin Black (pr) 

3598 Without Adapters, Silver (pr) 

Note: Requires model specific adapter (sold separately).

RIOT MINI BOARDS

Ideal for hardcore riders seeking an aggressive look combined with the comfort of enhanced foot room. Accepts splined adapters to allow forward, back or center positioning at almost any angle. Tough MX styling with durable cast aluminum construction featuring a serrated toothed top surface for no-slip traction to rip up the streets, tracks or trails. Boards measure 5-1/2" long x 3-3/4" wide.

FOR MULTI-FIT

See Fitment Chart Right

3597 Without Adapters, Satin Black (pr) 

3596 Without Adapters, Silver (pr) 

Note: (except The Rider Position '15-'19 XG Street) Requires Model Specific Splined Adapter (Sold Separately)



ALSO AVAILABLE
 RIOT GRIPS
 PG 82



ALSO AVAILABLE
 RIOT SHIFT LINKAGE
 PG 144



RIOT BRAKE PEDAL PAD

MX styling with rugged construction made from durable single aluminum casting and resilient bead-blasted textured finishes. The raised-tooth top surface delivers ideal traction in any riding condition.

FOR HARLEY-DAVIDSON®

Fits: '80-'19 Electra Glides, Road Glides, Road Kings, Street Glides, Tour Glides & Trikes; '86-'17 FL Softail Models & '12-'16 Dyna Switchbacks

3574 Silver (ea)

3575 Satin Black (ea)

Fits: '84-'17 FX Softail Models (except '13-'14 FXSBSE), '08-'11 Rocker Models, '93-'17 Dyna Wide Glides, '08-'17 Dyna Fat Bobs with Forward Controls (except '09-'10 FXDFSE), '15-'19 XG Street (except '17-'19 Street Rod) & all Kuryakyn Forward Controls

3576 Silver (ea)

3577 Satin Black (ea)

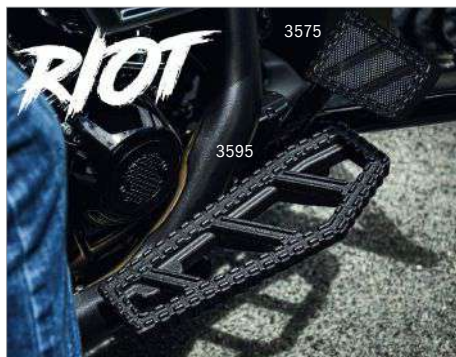

RIOT FLOORBOARDS

Rugged MX-styled direct replacements for stock H-D floorboards featuring a tapered design from front to back for aggressive cornering clearance and ample foot room. Sturdy cast aluminum construction with serrated toothed top surface for no-slip traction and control to rip up the streets. Floorboards measure 11-3/4" long x 5" wide (at widest point).

FOR HARLEY-DAVIDSON®

Fits: '83-'19 Electra Glides, Road Glides, Road Kings, Street Glides, Tour Glides; '09-'19 Trikes, '86-'17 FL Softail Models & '12-'16 Dyna Switchbacks

3595 Satin Black (pr)

3594 Silver (pr)



RIOT SHIFT PEGS

Dirt track-styled direct replacement for H-D-style shift pegs, measuring 2 1/2" long x 1 1/4" wide. Rugged cast aluminum construction with smooth bottom to prevent boot scuffing and serrated toothed top surface for no-slip traction to rip up the streets, tracks or trails.

FOR HARLEY-DAVIDSON®

Fits: All H-D Shift Levers

3590 Silver (ea)

3591 Satin Black (ea)



FITMENT CHART

WITH MALE MOUNT ADAPTERS

FOR HARLEY-DAVIDSON®

Fits: Universal Fitment for All Kuryakyn Male Mount Footpeg Clevises, Direct Replacement for H-D Style Male Mount Footpeg Applications (except Driver/Passenger '18-'19 Softails & Driver location on '15-'19 XG, '11-'19 XL1200C Sportster Custom, '12-'16 XL1200V Sportster Seventy-Two & '10-'19 XL1200X/S Sportster Forty-Eight/Special)

WITHOUT ADAPTERS

FOR HARLEY-DAVIDSON®

Fits: OEM Stock Footpeg Mount Location, Requires Model Specific Tapered (▲) or Splined (⚙) Adapters (Sold Separately) Found On Page 128-129

New

Collections

Featured Bikes

Audio

Lighting

Accessory Mounts

Handlebar Controls, Grips & Mirrors

Pegs & Foot Controls

Covers, Trims & Accents

Air Cleaners & Exhaust

Touring & Comfort

Windshields & Air Management

Luggage & Organizers

Index



HEAVY INDUSTRY



*Switchblades
work great for
Highway peg
setups!*

HEAVY INDUSTRY PEGS

Sized to offer ideal surface area for confident control, with splined adapters that allow the footpeg angle to be dialed in for optimum comfort. Premium rubber reduces harsh road vibrations and surrounds a knurled aluminum center for overall improved traction.

FOR MULTI-FIT

See Fitment Chart Below

7031 With Male Mount Adapters, Chrome (pr)

7032 With Male Mount Adapters, Satin Black (pr)

7033 Without Adapters, Chrome (pr) 🌟

7034 Without Adapters, Satin Black (pr) 🌟

HEAVY INDUSTRY SWITCHBLADES

U.S. Patent 6,893,038

Tough, stylish and versatile with flip-out heel rests for additional foot support and unrivaled long-haul comfort. Cast from quality A380 aluminum with a rugged design featuring a knurled top surface area surrounded by premium rubber for reduced vibration, solid traction and confident control.

FOR MULTI-FIT

See Fitment Chart Below

7027 With Male Mount Adapters, Chrome (pr)

7028 With Male Mount Adapters, Satin Black (pr)

7029 Without Adapters, Chrome (pr) 🌟

7030 Without Adapters, Satin Black (pr) 🌟

Complements the entire collection!



7035

HEAVY INDUSTRY SHIFT PEGS

A direct replacement for stock H-D shift pegs with rugged style and durable construction. Premium rubber frames the outer perimeter for reduced vibration and improved control, while the knurled aluminum center provides traction for your boots.

FOR HARLEY-DAVIDSON™

Fits: All H-D Shift Levers

7035 Chrome (ea)

7036 Satin Black (ea)

HEAVY INDUSTRY BRAKE PEDAL PADS

A premium rubber insert exposes socket head fasteners as it wraps around the knurled aluminum center for improved traction and a rugged, contrasting appearance.

FOR HARLEY-DAVIDSON™

Fits: All '84-'17 FX Softail Models, '08-'11 FXCW/C Rocker Models, '93-'17 FXDWG Dyna Wide Glide Models, '08-'17 FXDF, Dyna Fat Bob Models with Forward Controls, '15-'19 XG Street (except '17-'19 Street Rod) & All Kuryakyn Forward Controls

7037 Chrome (ea)

7038 Satin Black (ea)

Fits: '80-'19 Electra Glides, Road Glides, Road Kings, Street Glides, Tour Glides & Trikes; '86-'19 FL Softail Models (except '19 FL5B) & '12-'16 Dyna Switchbacks

7039 Chrome (ea)

7040 Satin Black (ea)



ALSO AVAILABLE
HEAVY INDUSTRY MIRRORS
PG 95



Floorboards
Page 112



ALSO AVAILABLE
HEAVY INDUSTRY GRIPS
PG 83



FITMENT CHART

WITH MALE MOUNT ADAPTERS

FOR HARLEY-DAVIDSON™

Fits: Universal Fitment for All Kuryakyn Male Mount Footpeg Clevises, Direct Replacement for H-D Style Male Mount Footpeg Applications (except Driver/Passenger '18-'19 Softails & Driver location on '15-'19 XG, '11-'19 XL1200C Sportster Custom, '12-'16 XL1200V Sportster Seventy-Two & '10-'19 XL1200X/S Sportster Forty-Eight/Special)

WITHOUT ADAPTERS

FOR HARLEY-DAVIDSON™

Fits: OEM Stock Footpeg Mount Location, Requires Model Specific Tapered (▲) or Splined (✳) Adapters (Sold Separately) Found On Page 128-129

New

Collections

Featured Bikes

Audio

Lighting

Accessory Mounts

Handlebar Controls,
Grips & Mirrors

Pegs & Foot Controls

Covers, Trims
& Accents

Air Cleaners
& Exhaust

Touring & Comfort

Windshields &
Air Management

Luggage &
Organizers

Index



7044

**HEAVY
INDUSTRY**



7041



7042



7041



NEW

7053



NEW

7052



ALSO AVAILABLE
RIDGEBACK SHIFT LEVER
PG 148



**HEAVY INDUSTRY
PASSENGER FLOORBOARDS**

These cast aluminum boards feature a rugged, industrial design with vibration-dampening soft rubber inserts for comfort and traction.

FOR HARLEY-DAVIDSON™

Fits: '93-'19 Electra Glides, '98-'09 Road Glides (except '00-'01 & '09 FLTRSE), '11-'13 & '16-'19 FLTRU Road Glide Ultras, '11 & '15-'16 FLTRUSE CVO Road Glide Ultras, '94-'19 Road Kings (except, '04-'07 FLHRS), '02-'03, '07-'08 & '13-'14 FLHRSE, '17-'19 FLHRXS), '93-'96 Tour Glides, '09-'19 Trikes and '86-'17 Softail & '06-'17 Dyna Models with H-D Accessory Passenger Floorboard Kits

7043 For Passenger, Chrome (pr)

7044 For Passenger, Satin Black (pr)

HEAVY INDUSTRY DRIVER FLOORBOARDS

These cast aluminum boards feature a rugged, industrial design with vibration-dampening soft rubber inserts for comfort and traction.

FOR HARLEY-DAVIDSON™

Fits: '83-'19 Electra Glides, Road Glides, Road Kings, Street Glides, Tour Glides, Trikes, '86-'17 FL Softail Models & '12-'16 Dyna Switchback

7041 For Driver, Chrome (pr)

7042 For Driver, Satin Black (pr)



LOOKS GREAT WITH
FINNED DERBY COVER
PG 198



RIDGEBACK SHIFT PEGS

All-metal construction, fully polished with raised spines for a clean but aggressive custom look. Measures 3" long x 7/8" thick.

FOR HARLEY-DAVIDSON™

Fits: All H-D Shift Levers

7052 Chrome (ea)

7053 Satin Black (ea)

FITMENT CHART

WITH MALE MOUNT ADAPTERS

FOR HARLEY-DAVIDSON™

Fits: Universal Fitment for All Kuryakyn Male Mount Footpeg Clevises, Direct Replacement for H-D Style Male Mount Footpeg Applications (except Driver/Passenger '18-'19 Softails & Driver location on '15-'19 XG, '11-'19 XL1200C Sportster Custom, '12-'16 XL1200V Sportster Seventy-Two & '10-'19 XL1200X/S Sportster Forty-Eight/Special)

WITHOUT ADAPTERS

FOR HARLEY-DAVIDSON™

Fits: OEM Stock Footpeg Mount Location, Requires Model Specific Tapered (▲) or Splined (✳) Adapters (Sold Separately) Found On Page 128-129



5760

PHANTOM FOOTPEGS

A modern, aggressive design with sharp sculpted lines combines quality aluminum with premium EPDM rubber pads to create a solid foundation for stability, traction, and comfort. Available model-specific Splined Adapters allow peg angle adjustability to dial in preferred placement.

FOR MULTI-FIT

See Fitment Chart Left

5760 Without Adapters, Chrome (pr)

5761 Without Adapters, Gloss Black (pr)



5761



PHANTOM MINI BOARDS

Features a unique pass-through design with sharp, sculpted lines, and a much larger area to rest your foot compared to standard footpegs. Constructed from quality A380 aluminum with durable EPDM rubber inserts for traction and long-haul vibration dampening comfort. Available Splined Adapters can mount in forward, middle, or rear mounting locations for a variety of placements in driver or passenger peg locations.

FOR MULTI-FIT

See Fitment Chart Left

5772 Without Adapters, Chrome (pr)

5773 Without Adapters, Gloss Black (pr)



5772



SPEAR FOOTPEGS

A flattened top surface provides ideal foot placement and support, while premium EPDM rubber offers reduced vibration for comfort on long rides. Sharp styling complements the entire Spear collection, and available model-specific splined adapters deliver precise angle adjustment.

FOR MULTI-FIT

See Fitment Chart Left

5658 Without Adapters, Chrome (pr)

5657 Without Adapters, Satin Black (pr)



5652



SPEAR MINI BOARDS

Model-specific Adapters position the boards forward, back or center at almost any angle, and proprietary EPDM premium rubber compound provides reduced vibration for long-haul comfort. The sharp traditional spear design coordinates with the entire line of Kuryakyn Spear products for Indian.

FOR MULTI-FIT

See Fitment Chart Left

5652 Without Adapters, Chrome (pr)

5653 Without Adapters, Satin Black (pr)

- New
- Collections
- Featured Bikes
- Audio
- Lighting
- Accessory Mounts
- Handlebar Controls, Grips & Mirrors
- Pegs & Foot Controls
- Covers, Trims & Accents
- Air Cleaners & Exhaust
- Touring & Comfort
- Windshields & Air Management
- Luggage & Organizers
- Index



KINETIC™ PEGS U.S. Patent D723,981

Designed to keep you moving in comfort with the perfect blend of vibration-dampening EPDM rubber and style. Available in contrasting chrome or black finishes, complete the look with our Kinetic™ Grips for all-around comfort and style.

FOR MULTI-FIT

See Fitment Chart Right

4316 With Male Mount Adapters, Chrome (pr)

4317 With Male Mount Adapters, Gloss Black (pr)

4321 Without Adapters, Gloss Black (pr) *

4320 Without Adapters, Chrome (pr) *

KINETIC™ MINI BOARDS

Great for driver or passenger, with premium EPDM rubber compound to reduce vibration! 5" long x 4" wide. Mount via splined adapters so the board can be positioned forward, back, or center at almost any angle. Also a great option for Driver Cruise Pegs!

FOR MULTI-FIT

See Fitment Chart Right

7610 With Male Mount Adapters, Chrome (pr)

7612 With Male Mount Adapters, Gloss Black (pr)

7611 Without Adapters, Chrome (pr) *

7613 Without Adapters, Gloss Black (pr) *

KINETIC™ SHIFT PEGS U.S. Patent D718,191

Kuryakyn's Kinetic™ Shift Pegs feature a modern design and help you power through the gears in comfort with the perfect blend of vibration-dampening EPDM rubber and style. Coordinate with our Kinetic™ Footpegs and Grips to complete the look. Available in Chrome or Gloss Black finishes.

FOR HARLEY-DAVIDSON®

Fits: All H-D Shift Levers

4305 Gloss Black (ea)

4304 Chrome (ea)

FITMENT CHART

WITH MALE MOUNT ADAPTERS

FOR HARLEY-DAVIDSON®

Fits: Universal Fitment for All Kuryakyn Male Mount Footpeg Clevises, Direct Replacement for H-D Style Male Mount Footpeg Applications (except Driver/Passenger '18-'19 Softails & Driver location on '15-'19 XG, '11-'19 XL1200C Sportster Custom, '12-'16 XL1200V Sportster Seventy-Two & '10-'19 XL1200X/S Sportster Forty-Eight/Special)

WITHOUT ADAPTERS

FOR HARLEY-DAVIDSON®

Fits: OEM Stock Footpeg Mount Location, Requires Model Specific Tapered (▲) or Splined (✳) Adapters (Sold Separately) Found On Page 128-129



4310

KINETIC™ BRAKE PEDAL PAD U.S. Patent D718,192 Kuryakyn's Kinetic Brake Pedal Pads are made from quality cast aluminum and feature modern styling with vibration-isolating EPDM rubber to aid rider comfort. Available in chrome or gloss black finishes, complete the look with our Kinetic Shift Pegs, Footpegs, Floorboard Inserts and Grips.

FOR HARLEY-DAVIDSON™

Fits: '80-'19 Electra Glides, Road Glides, Road Kings, Street Glides, Tour Glides & Trikes; '86-'19 FL Softail Models (except '18-'19 FLSB) & '12-'16 Dyna Switchbacks

4311 Gloss Black (ea)

4310 Chrome (ea)



4311

KINETIC



4310



4311



COMPLETE THE LOOK!

KINETIC GRIPS
PG 83



KINETIC™ FLOORBOARD INSERTS FOR DRIVER & PASSENGER Keep your feet buzz-free! Kinetic Floorboard Inserts fit right in place of stock pads for an instant upgrade in style and comfort. Complete the look with our Kinetic Shift Pegs and Brake Pedal Pad.

FOR HARLEY-DAVIDSON™

Fits: '86-'19 Electra Glides, Road Glides, Road Kings, Tour Glides & Trikes with Traditional D-Shaped Passenger Boards; '86-'17 Softail or '06-'17 Dyna Models equipped with H-D Accessory Passenger Floorboard Kits Using Traditional D-Shaped Passenger Boards

4398 For H-D D-Shaped Passenger Boards,
Chrome (pr)

Fits: '84-'19 Electra Glides (except '04-'05 FLHTCSE, '06-'13 FLHTCUSE, '14-'19 FLHTKSE), '98-'09 Road Glides (except '09 FLTRSE & '17-'19 FLTRX, FLTRXS), '11-'13 & '16-'19 Road Glide Ultras (except '11 & '15-'16 FLTRUSE), '94-'19 Road Kings (except '04-'07 FLHRS, '07-'08 & '13-'14 FLHRSE & '17-'19 FLHRXS), '84-'96 Tour Glides, '09-'19 Trikes, '86-'08 FLST/FLSTC, '90-'17 FLSTF, '93-'96 FLSTN, '97-'03 FLSTS, '05-'07 FLSTSC & '12-'16 FLD Dyna Switchback

4395 For H-D Traditional Driver Boards, Gloss
Black (pr)

Fits: '04-'05 FLHTCSE, '06-'13 FLHTCUSE, '14-'19 FLHTKSE, '09 FLTRSE, '10-'13 & '15-'19 FLTRX/S, '11 FLTRUSE, '12-'13 FLTRXSE, '06-'19 FLHX/I, '14-'19 FLHXS, '10-'12 FLHXSE, '04-'07 FLHRS/I, '07-'08 & '13-'14 FLHRSE, '17-'19 FLHRXS, '10-'12 FLSTSE, '14-'15 FLSTNSE or any H-D Model equipped with H-D SweptWing Shape Boards.

4396 For H-D SweptWing Driver Boards,
Chrome (pr)

4397 For H-D SweptWing Driver Boards,
Gloss Black (pr)



4398



4398



4395



4395



4396



4397

New

Collections

Featured Bikes

Audio

Lighting

Accessory Mounts

Handlebar Controls,
Grips & Mirrors

Pegs & Foot Controls

Covers, Trims
& Accents

Air Cleaners
& Exhaust

Touring & Comfort

Windshields &
Air Management

Luggage &
Organizers

Index

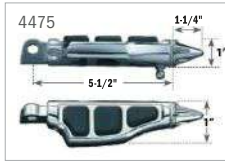

REPLACEMENT COMPONENTS
 STILETTO FOOT CONTROLS
PG 127



STILETTO PEGS

The radical Stiletto Peg is designed for those who ride on the wild side.

FOR MULTI-FIT

See Fitment Chart Right

- 4475 With Male Mount Adapters, Chrome (pr)
- 4476 Without Adapters, Chrome (pr) ▲

STILETTO STIRRUPS

Relax and kick your heels up in style. Includes Stiletto Pegs and Stirrups.

FOR MULTI-FIT

See Fitment Chart Right

- 4477 With Stirrups and Male Mount Adapters, Chrome (pr)

STILETTO SHIFT PEG

The radical Stiletto Peg is designed for those who ride on the wild side.

FOR HARLEY-DAVIDSON®

Fits: All H-D Shift Levers

- 4479 Shift Peg, Chrome (ea)

STILETTO BRAKE PEDAL PAD

Designed to compliment the Stiletto line of footpegs.

FOR HARLEY-DAVIDSON®

Fits: All '84-'17 FX Softail Models, '93-17 FXDWG, '08-17 FXDF & '15-'19 XG Street (except Street Rod)

- 4480 Chrome (ea)

DOMED END CAPS FOR STILETTO PEGS

Simple to install, and they'll give the pegs an entirely new look!

FOR MULTI-FIT

Fits: Stiletto Foot Controls

- 4484 For Stiletto Pegs, Chrome (pr)
- 4483 For Stiletto Stirrups, Chrome (pr)
- 4489 For Stiletto Brake Pedal Pad, Chrome (pr)

FITMENT CHART

WITH MALE MOUNT ADAPTERS

FOR HARLEY-DAVIDSON®

Fits: Universal Fitment for All Kuryakyn Male Mount Footpeg Clevises, Direct Replacement for H-D Style Male Mount Footpeg Applications (except Driver/Passenger '18-'19 Softails & Driver location on '15-'19 XG, '11-'19 XL1200C Sportster Custom, '12-'16 XL1200V Sportster Seventy-Two & '10-'19 XL1200X/S Sportster Forty-Eight/Special)

WITHOUT ADAPTERS

FOR HARLEY-DAVIDSON®

Fits: OEM Stock Footpeg Mount Location, Requires Model Specific Tapered (▲) or Splined (✳) Adapters (Sold Separately) Found On Page 128-129

ZOMBIE™ PEGS

All feature chrome with durable rubber pads and our ominous Zombie skull.

FOR MULTI-FIT

See Fitment Chart Left

4470 With Male Mount Adapters, Chrome (pr)

4471 Without Adapters, Chrome (pr) ▲

MINI DAGGER PEGS

Measuring 1-1/8" wide by 3-1/2" long, Mini Daggers are great for keeping cruise, driver or passenger pegs minimal.

FOR MULTI-FIT

See Fitment Chart Left

7521 With Male Mount Adapters, Chrome (pr)

7520 Without Adapters, Chrome (pr) ▲

ZOMBIE™ SHIFT PEG

FOR HARLEY-DAVIDSON™

Fits: All H-D Shift Levers

4414 Chrome (ea)

ZOMBIE™ BRAKE PEDAL PADS

Chrome with durable rubber pads

FOR HARLEY-DAVIDSON™

Fits: '80-'19 Electra Glides, Road Glides, Road Kings, Street Glides, Tour Glides & Trikes; '86-'19 FL Softail Models (except '18-'19 FL5B) & '12-'16 Dyna Switchbacks

4406 Chrome (ea)

Fits: '84-'17 FX Softail Models (except '13-'14 FXSBSE), '08-'11 Rocker Models, '93-'17 Dyna Wide Glides, '08-'17 Dyna Fat Bobs with Forward Controls (except '09-'10 FXDFSE), '15-'19 XG Street (except Street Rod) & all Kuryakyn Forward Controls

4405 Chrome (ea)

ZOMBIE™ FLOORBOARD COVERS FOR DRIVER & PASSENGER
 Easily installed in place of the stock, ribbed rubber pads.

FOR HARLEY-DAVIDSON™

Fits: Traditional Boards on '84-'19 Electra Glides (except '04-'05 FLHTCSE, '06-'13 FLHTCUSE, '14-'19 FLHTKSE), '98-'09 Road Glides (except '09 FLTRSE), '11-'13 & '16-'19 Road Glide Ultras (except '11 & '15-'16 FLTRUSE), '94-'19 Road Kings (except '04-'07 FLHRS, '07-'08, '13-'14 FLHRSE & '17-'19 FLHRXS), '84-'96 Tour Glides, '09-'19 Trikes, '86-'08 FLST/FLSTC, '90-'17 FLSTF, '93-'96 FLSTN, '97-'03 FLSTS, '05-'07 FLSTSC & '12-'16 FLD Dyna Switchback

4566 Chrome (pr)

Fits: '86-19 Electra Glides, Road Glides, Road Kings, Tour Glides & Trikes with Traditional D-Shaped Passenger Boards; '86-'17 Softail or '06-'17 Dyna Models equipped with H-D Accessory Passenger Floorboard Kits Using Traditional D-Shaped Passenger Boards

4572 Black (pr)



REPLACEMENT COMPONENTS
 ZOMBIE FOOT CONTROLS
PG 127

New

Collections

Featured Bikes

Audio

Lighting

Accessory Mounts

Handlebar Controls, Grips & Mirrors

Pegs & Foot Controls

Covers, Trims & Accents

Air Cleaners & Exhaust

Touring & Comfort

Windshields & Air Management

Luggage & Organizers

Index



Comfort & style in multiple sizes

SMALL TRIDENT ISO®-PEGS

All the features and comfort of the original ISO-Peg but with a whole new look!

FOR MULTI-FIT

See Fitment Chart Below

7590 With Male Mount Adapters, Chrome (pr)

7560 With Male Mount Adapters, Gloss Black (pr)

7595 Without Adapters, Chrome (pr) ▲

7565 Without Adapters, Gloss Black (pr) ▲



LARGE TRIDENT ISO®-PEGS

All the features and comfort of the original ISO-Peg but with a whole new look!

FOR MULTI-FIT

See Fitment Chart Below

7591 With Male Mount Adapters, Chrome (pr)

7561 With Male Mount Adapters, Gloss Black (pr)

7596 Without Adapters, Chrome (pr) ▲

7566 Without Adapters, Gloss Black (pr) ▲

DUALLY TRIDENT ISO®-PEGS

Features the same vibration-isolating technology as the rest of our classic ISO-pegs, but with an updated look!

FOR MULTI-FIT

See Fitment Chart Below

7592 With Male Mount Adapters, Chrome (pr)

7562 With Male Mount Adapters, Gloss Black (pr)

7597 Without Adapters, Chrome (pr) ▲

7567 Without Adapters, Gloss Black (pr) ▲

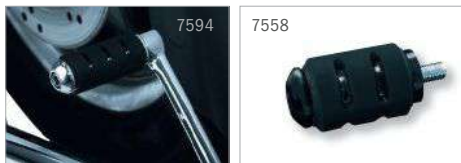

TRIDENT ISO®-SHIFT PEGS

Perfectly matches other Trident products. The Longhorn is 5/8" longer than your stock shift peg for easier shifting.

FOR HARLEY-DAVIDSON®

Fits: All H-D Shift Levers

7593 Standard, Chrome (ea)

7594 Longhorn, Chrome (ea)

7558 Standard, Gloss Black (ea)



REPLACEMENT COMPONENTS

TRIDENT, PREMIUM & WIDOW FOOT CONTROLS
PG 127

FITMENT CHART

WITH MALE MOUNT ADAPTERS

FOR HARLEY-DAVIDSON®

Fits: Universal Fitment for All Kuryakyn Male Mount Footpeg Clevises, Direct Replacement for H-D Style Male Mount Footpeg Applications (except Driver/Passenger '18-'19 Softails & Driver location on '15-'19 XG, '11-'19 XL1200C Sportster Custom, '12-'16 XL1200V Sportster Seventy-Two & '10-'19 XL1200X/S Sportster Forty-Eight/Special)

WITHOUT ADAPTERS

FOR HARLEY-DAVIDSON®

Fits: OEM Stock Footpeg Mount Location, Requires Model Specific Tapered (▲) or Splined (✳) Adapters (Sold Separately) Found On Page 128-129

PREMIUM MINI BOARDS

These compact boards combine the size and convenience of a peg with the comfort of a full-sized floorboard. 5-1/2" long x 4" wide and styled to complement our Premium and Trident lines so you can still ride in comfort without sacrificing style. Utilizing splined adapters, the boards can be positioned forward, back, or center at almost any angle. Also a great option for Driver Cruise Pegs!

FOR MULTI-FIT

See Fitment Chart Left

4392 With Male Mount Adapters, Chrome (pr)

7578 With Male Mount Adapters, Gloss Black (pr)

4393 Without Adapters, Chrome (pr) *

7579 Without Adapters, Gloss Black (pr) *

DELUXE ISO®-BRAKE PEDAL PADS

High-quality soft rubber wrapped in glistening chrome, this premium pedal looks good and is made to last. Installs easily using hidden fasteners.

FOR HARLEY-DAVIDSON®

Fits: All '84-'17 FX Softail Models, '08-'11 FXCW/C Rocker Models, '93-'17 FXDWG Dyna Wide Glide Models, '08-'17 FXDF Dyna Fat Bob Models with Forward Controls, '15-'19 XG Street Models (except '17-'19 Street Rod) & All Kuryakyn Forward Controls

7588 Chrome (ea)

'80-'19 Electra Glides, Road Glides, Road Kings, Street Glides, Tour Glides & Trikes; '86-'19 FL Softail Models (except '18-'19 FLSB) & '12-'16 Dyna Switchbacks

7589 Chrome (ea)

EXTENDED BRAKE PEDAL PADS

A complete assembly containing a brake pad with 1-1/4" extension that makes it easier to apply the rear brake.

FOR HARLEY-DAVIDSON®

Fits: '80-'19 Electra Glides, Road Glides, Road Kings, Street Glides, Tour Glides & Trikes; '86-'19 FL Softail Models (except '18-'19 FLSB) & '12-'16 Dyna Switchbacks

7587 Chrome (ea)

Note: Not compatible with fairing lowers on '04-earlier Touring Models.

PREMIUM & RIBBED FOLDING BOARDS

U.S. Patent D653,174

Style, quality, function, and adjustability at a price that can't be beat. Switching to floorboards just got easier with five thoughtfully placed splined mounts. These boards can be fine tuned just right for the rider or passenger. (4-1/2" wide x 8-1/2" long)

FOR MULTI-FIT

See Fitment Chart Left

4357 Without Adapters, Wrinkle Black (pr) *

4351 Without Adapters, Chrome (pr) *



Switch from pegs to boards in seconds!

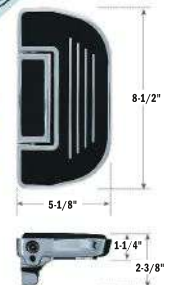

New

Collections

Featured Bikes

Audio

Lighting

Accessory Mounts

Handlebar Controls,
Grips & Mirrors

Pegs & Foot Controls

Covers, Trims
& Accents

Air Cleaners
& Exhaust

Touring & Comfort

Windshields &
Air Management

Luggage &
Organizers

Index



7553



7554



7553

7553



PREMIUM FLOORBOARD INSERTS

Our Premium Inserts for Driver Floorboards ride on rubber isolators to keep your feet buzz-free. The cushy inserts for Passenger Boards pop right in place of the stock pads. They'll look great on any bike using H-D's Traditional & D-shaped passenger boards.

FOR HARLEY-DAVIDSON®

Fits: Traditional Boards:

'84-'19 Electra Glides (except '04-'05 FLHTCSE, '06-'13 FLHTCUSE, '14-'19 FLHTKSE), '98-'09 Road Glides (except '09 FLTRSE), '11-'13 & '16-'19 Road Glide Ultras (except '11 & '15-'16 FLTRUSE), '94-'19 Road Kings (except '04-'07 FLHRS, '07-'08, '13-'14 FLHRSE & '17-'19 FLHRXS), '84-'96 Tour Glides, '09-'19 Trikes, '86-'08 FLST/FLSTC, '90-'17 FLSTF, '93-'96 FLSTN, '97-'03 FLSTS, '05-'07 FLSTSC & '12-'16 FLD Dyna Switchback

7553 Black (pr)

Fits: '86-19 Electra Glides, Road Glides, Road Kings, Tour Glides & Trikes with Traditional D-Shaped Passenger Boards; '86-'17 Softail or '06-'17 Dyna Models equipped with H-D Accessory Passenger Floorboard Kits Using Traditional D-Shaped Passenger Boards

7554 Black (pr)

 **REPLACEMENT COMPONENTS**
 TRIDENT, PREMIUM & WIDOW FOOT CONTROLS
PG 127



WIDOW

4491



4492



4491



4494



4494

WIDOW™ PEGS

Distinct and durable, these pegs are built to stun.

FOR MULTI-FIT

See Fitment Chart Below

4491 With Male Mount Adapters, Chrome (pr)

4492 Without Adapters, Chrome (pr) 

WIDOW™ SHIFT PEG

The perfect embellishment to our Widow series of products.

FOR HARLEY-DAVIDSON®

Fits: All H-D Shift Levers

4494 Chrome (ea)

FITMENT CHART



WITH MALE MOUNT ADAPTERS

FOR HARLEY-DAVIDSON®

Fits: Universal Fitment for All Kuryakyn Male Mount Footpeg Clevises, Direct Replacement for H-D Style Male Mount Footpeg Applications (except Driver/Passenger '18-'19 Softails & Driver location on '15-'19 XG, '11-'19 XL1200C Sportster Custom, '12-'16 XL1200V Sportster Seventy-Two & '10-'19 XL1200X/S Sportster Forty-Eight/Special)

WITHOUT ADAPTERS

FOR HARLEY-DAVIDSON®

Fits: OEM Stock Footpeg Mount Location, Requires Model Specific Tapered () or Splined () Adapters (Sold Separately) Found On Page 128-129

4416



FLAMIN' PEGS U.S. Patent D593,911
 Flames add class and timeless design to your bike.

FOR MULTI-FIT

See Fitment Chart Left

4416 With Male Mount Adapters, Chrome (pr)

4417 Without Adapters, Chrome (pr) ▲

FLAMIN' SWITCHBLADE PEGS

U.S. Patents D593,911 & 6,893,038
 Switch it up and extend the heel stirrup for added comfort.

FOR MULTI-FIT

See Fitment Chart Left

4411 With Male Mount Adapters, Chrome (pr)

4412 Without Adapters, Chrome (pr) ▲

FLAMIN' SHIFT PEG

Tough die-cast construction with a brilliant chrome finish.

FOR HARLEY-DAVIDSON®

Fits: All H-D Shift Levers

4418 Chrome (ea)

FLAMIN' BRAKE PEDAL PADS

Tough die-cast construction and brilliant chrome finish.

FOR HARLEY-DAVIDSON®

Fits: '80-'19 Electra Glides, Road Glides, Road Kings, Street Glides, Tour Glides & Trikes; '86-'19 FL Softail Models (except '18-'19 FL SB) & '12-'16 Dyna Switchbacks

7518 Chrome (ea)

FLAME FLOORBOARD COVERS FOR DRIVER & PASSENGER

Easily installed in place of the stock, ribbed rubber pads.

FOR HARLEY-DAVIDSON®

Fits: '86-19 Electra Glides, Road Glides, Road Kings, Tour Glides & Trikes with Traditional D-Shaped Passenger Boards; '86-'17 Softail or '06-'17 Dyna Models equipped with H-D Accessory Passenger Floorboard Kits Using Traditional D-Shaped Passenger Boards

7523 Chrome (pr)

4416



FLAME

4411



CLOSED



4411

4418



4418



7518

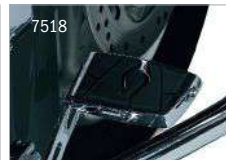

7518



7523

7523



REPLACEMENT COMPONENTS
 FLAME FOOT CONTROLS
PG 127

New

Collections

Featured Bikes

Audio

Lighting

Accessory Mounts

Handlebar Controls,
 Grips & Mirrors

Pegs & Foot Controls

Covers, Trims
 & Accents

Air Cleaners
 & Exhaust

Touring & Comfort

Windshields &
 Air Management

Luggage &
 Organizers

Index



4425



4430



4428



4430



4425



4430



4429



4426

PILOT™ PEGS

With Pilot Pegs you get the same versatility as with the ISO and Retro Pegs. Our wide variety of extensions, clamps, and accessories provide endless possibilities for peg location and application. A transforming full-coverage brake pedal pad completes the set.

FOR MULTI-FIT

See Fitment Chart Below

4425 With Male Mount Adapters, Chrome (pr)

MINI PILOT™ PEGS

The same great styling as the original Pilot Pegs in a smaller size! Perfect for providing a foot peg for the passenger while not calling attention to itself.

FOR MULTI-FIT

See Fitment Chart Below

4430 With Male Mount Adapter, Chrome (pr)

PILOT™ PEG STIRRUPS

Our superbly designed stirrup arm, with its smooth radius and built-in heel guard, prevents melting the heel of your boot on the front pipe when resting your weary ridin' feet.

FOR MULTI-FIT

See Fitment Chart Below

4428 With Stirrups and Male Mount Adapter, Chrome (pr)

PILOT™ SHIFT PEG

The Pilot Pegs' flowing teardrop profile complements the shape of components found on some of today's cutting-edge customs.

FOR HARLEY-DAVIDSON®

Fits: All H-D Shift Levers

4426 Shift Peg, Chrome (ea)

PILOT™ BRAKE PEDAL PAD

Our transforming full-coverage brake pedal pad flows with a teardrop profile while complementing the shape of components found on some of today's cutting-edge customs.

FOR HARLEY-DAVIDSON®

Fits: All '84-'17 FX Softail Models, '08-'11 FXCW/C Rocker Models, '93-'17 FXDWG Dyna Wide Glide Models, '08-'17 Dyna Fat Bob Models with Forward Controls, '15-'19 XG Street (except Street Rod) & All Kuryakyn Forward Controls

4429 Brake Pedal Pad, Chrome (ea)

FITMENT CHART

WITH MALE MOUNT ADAPTERS

FOR HARLEY-DAVIDSON®

Fits: Universal Fitment for All Kuryakyn Male Mount Footpeg Clevises, Direct Replacement for H-D Style Male Mount Footpeg Applications (except Driver/Passenger '18-'19 Softails & Driver location on '15-'19 XG, '11-'19 XL1200C Sportster Custom, '12-'16 XL1200V Sportster Seventy-Two & '10-'19 XL1200X/S Sportster Forty-Eight/Special)

WITHOUT ADAPTERS

FOR HARLEY-DAVIDSON®

Fits: OEM Stock Footpeg Mount Location, Requires Model Specific Tapered (▲) or Splined (✳) Adapters (Sold Separately) Found On Page 128-129

SMALL ISO®-PEGS

The industry's most comfortable footpegs!

FOR MULTI-FIT

See Fitment Chart Below

- 8000 With Male Mount Adapters, Chrome (pr)
- 7964 Without Adapters, Chrome (pr) ▲
- 8024 Longhorn with 1" Extension & Male Mount Adapters, Chrome (pr)

LARGE ISO®-PEGS

The industry's most comfortable footpegs!

FOR MULTI-FIT

See Fitment Chart Below

- 8002 With Male Mount Adapters, Chrome (pr)
- 7965 Without Adapters, Chrome (pr) ▲
- 8025 Longhorn with 1" Extension & Male Mount Adapters, Chrome (pr)

DUALLY ISO®-PEGS

Slightly larger footprint gives you even more added comfort!

FOR MULTI-FIT

See Fitment Chart Below

- 8028 With Male Mount Adapters, Chrome (pr)
- 7963 Without Adapters, Chrome (pr) ▲

ISO®-SWEPTWING PEGS

Simple & stylish. Add the sleek lines of the ISO-SweptWing Peg to streamline your bike & get ready for flight. Traditional ISO style blended with reduced vibration design creates a one-of-a-kind footpeg. Add them solo or coordinate them as a matched set to Kuryakyn's SwingWing Peg.

FOR MULTI-FIT

See Fitment Chart Below

- 4463 With Male Mount Adapters, Chrome (pr)
- 4464 Without Adapters, Chrome (pr) ▲

FEMALE MOUNT ISO®-PEGS FOR BULLET STYLE MOUNTS

Designed specifically for H-D applications requiring Female Mount Pegs.

FOR HARLEY-DAVIDSON®

Fits: H-D Applications Requiring Female Mount Pegs

- 8001 Small with 5/8" Female Mount Adapters, Chrome (pr)
- 8003 Large with Bullet Style Female Mount Adapters, Chrome (pr)



REPLACEMENT COMPONENTS
 ISO®-FOOT CONTROLS
PG 127



New

Collections

Featured Bikes

Audio

Lighting

Accessory Mounts

Handlebar Controls, Grips & Mirrors

Pegs & Foot Controls

Covers, Trims & Accents

Air Cleaners & Exhaust

Touring & Comfort

Windshields & Air Management

Luggage & Organizers

Index



4445
CLOSED



4445
OPEN

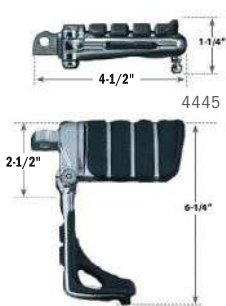

4445

ISO



4466
OPEN

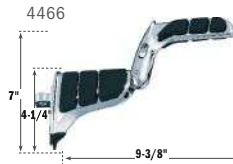

4466



4466



4450



4450



8075

8076

4028

8074



4554

4555



8075

SWITCHBLADE PEGS U.S. Patents D506,707 & 6,893,038

In their standard compact mode, they are a large-surface-area, rubber-isolated footpeg. Deploy the concealed heel rest and now you have added fatigue-fighting comfort.

FOR MULTI-FIT

See Fitment Chart Right

4445 With Male Mount Adapters, Chrome (pr)

4446 Without Adapters, Chrome (pr) ▲

SWINGWING PEGS U.S. Patent D560,562

A convenient fold-forward, comfortable cruise peg that fastens in place of your stock peg and provides a secondary fold-out peg 3" forward.

FOR MULTI-FIT

See Fitment Chart Right

4466 With Male Mount Adapters, Chrome (pr)

4467 Without Adapters, Chrome (pr) ✳

ISO®-WING MINI BOARDS

The ISO-Wing has the greatest surface area of any of our ISO offerings to date.

7563



FOR MULTI-FIT

See Fitment Chart Right

4450 With Male Mount Adapters, Chrome (pr)

7563 With Male Mount Adapters, Gloss Black (pr)

4452 Without Adapters, Chrome (pr) ▲

7568 Without Adapters, Gloss Black (pr) ▲

ISO®-PEG STIRRUPS

We added a heel rest to our popular ISO-Pegs to give you floorboard-like comfort without the added bulk.

FOR MULTI-FIT

See Fitment Chart Right

8074 Without Pegs with Male Mount Adapter, Chrome (pr)

8076 Small Pegs with Male Mount Adapter, Chrome (pr)

8075 Large Pegs with Male Mount Adapter, Chrome (pr)

8062 Dually Pegs with Male Mount Adapter, Chrome (pr)

4028 Without Pegs or Adapters Chrome (pr) ▲

ISO®-STIRRUPS FOR H-D CUSTOM PEGS

Finally, an affordable way to add the comfort of heel rests to your custom Harley-Davidson footpegs. Quick and easy to install, simply remove the male mount from the peg and replace it with the stirrup assembly.

FOR HARLEY-DAVIDSON®

See Kuryakyn for Specific H-D Compatible Part Numbers

4555 3-5/8" Shaft, Chrome (pr)

4554 1-3/4" Shaft, Chrome (pr)



STANDARD & LONGHORN ISO®-SHIFT PEGS

Standard is stock-like in size; the Longhorn has one more O-ring and is 5/8" longer (great for extended controls).

FOR HARLEY-DAVIDSON®

Fits: All H-D Shift Levers

8021 Longhorn, Chrome (ea)

8004 Standard, Chrome (ea)

ISO®-BRAKE PEDAL PAD

Designed to coordinate beautifully with our ISO-Pegs and ISO-Grips, these ISO-Brake Pedal Pads complete the look.

FOR HARLEY-DAVIDSON®

Fits: '80-'19 Electra Glides, Road Glides, Road Kings, Street Glides, Tour Glides & Trikes; '86-'19 FL Softail Models (except '18-'19 FLSB) & '12-'16 Dyna Switchbacks

8027 Standard, Chrome (ea)

4456 Longhorn, Chrome (ea)

Fits: All '84-'17 FX Softail Models, '08-'11 FXCW/C Rocker Models, '93-'17 FXDWG Dyna Wide Glide Models, '08-'17 FXDF, Dyna Fat Bob Models with Forward Controls, '15-'19 XG Street (except '17-'19 Street Rod) & All Kuryakyn Forward Controls

8029 Standard, Chrome (ea)

8044 Longhorn, Chrome (ea)

ISO® BRAKE PEDAL & COVERS

Installs directly over stock parts.

FOR HARLEY-DAVIDSON®

Fits: H-D: '99-'09 XL883C Sportster Custom, '99-'19 XL1200C Sportster Custom; '18-'19 XL1200NS Iron, '10-'19 XL1200X/S Sportster Forty-Eight, '12-'16 XL1200V Sportster Seventy-Two, '03-'08 & '10-'17 FXDWG Dyna Wide Glide, '08-'17 FXDF Fat Bob with Forward Controls, '02-'06 VRSCA V-Rod, '04-'05 VRSCB V-Rod, '07-'10 VRSCAW V-Rod, '07-'17 VRSCDX Night Rod Special, '07 VRSCX V-Rod Limited Edition, '09-'17 VRSCF V-Rod Muscle

8022 Pedal Cover, Chrome (ea)



8004



8021



8021



8027



8027



4456



8029



8044



8022



8022



MORE OPTIONS

DELUXE ISO®-BRAKE PEDAL PAD
PG 119



FITMENT CHART

WITH MALE MOUNT ADAPTERS

FOR HARLEY-DAVIDSON®

Fits: Universal Fitment for All Kuryakyn Male Mount Footpeg Clevises, Direct Replacement for H-D Style Male Mount Footpeg Applications (except Driver/Passenger '18-'19 Softails & Driver location on '15-'19 XG, '11-'19 XL1200C Sportster Custom, '12-'16 XL1200V Sportster Seventy-Two & '10-'19 XL1200X/S Sportster Forty-Eight/Special)

WITHOUT ADAPTERS

FOR HARLEY-DAVIDSON®

Fits: OEM Stock Footpeg Mount Location, Requires Model Specific Tapered (▲) or Splined (⚙) Adapters (Sold Separately) Found On Page 128-129

New

Collections

Featured Bikes

Audio

Lighting

Accessory Mounts

Handlebar Controls,
Grips & Mirrors

Pegs & Foot Controls

Covers, Trims
& Accents

Air Cleaners
& Exhaust

Touring & Comfort

Windshields &
Air Management

Luggage &
Organizers

Index



7905



7906

ISO®-BOARDS FOR DRIVER & PASSENGER

ISO-Boards are a great-looking and comfortable alternative to the lackluster original equipment floorboards. Rubber ISO-ribs run the full length of the board, providing both traction and comfort. Longer than stock for more room on long hauls.

FOR HARLEY-DAVIDSON®

Fits: '93-'19 Electra Glides, '98-'09 Road Glides (except '00-'01 & '09 FLTRSE), '11-'13 & '16-'19 FLTRU Road Glide Ultras, '11 & '15-'16 FLTRUSE CVO Road Glide Ultras, '94-'19 Road Kings (except, '04-'07 FLHRS; '02-'03, '07-'08 & '13-'14 FLHRSE, '17-'19 FLHRXS), '93-'96 Tour Glides, '09-'19 Trikes and '86-'17 Softail & '06-'17 Dyna Models with H-D Accessory Passenger Floorboard Kits

7906 For Passenger, Chrome (pr)



7902

Fits: '83-'19 Electra Glides, Road Glides, Road Kings, Street Glides, Tour Glides, Trikes, '86-'17 FL Softail Models & '12-'16 Dyna Switchback

7905 For Driver or Passenger, Chrome (pr)

Fits: '93-'19 Electra Glides, '94-'19 Road Kings (except, '04-'07 FLHRS, '02-'03, '07-'08, '13-'14 FLHRSE, '17-'19 FLHRXS), '98-'19 Road Glides (except '00-'01, '09 FLTRSE, '10-'13 FLTRX, '12-'13 & '18-'19 FLTRXSE), '93-'96 Tour Glides, '09-'19 Trikes and '86-'17 FL Softail Models & '12-'16 Dyna Switchback with H-D Accessory Passenger Floorboard Kits

7902 Combo Set, Chrome (set)



REPLACEMENT COMPONENTS

ISO-FOOT CONTROLS
PG 127



7906



7905



7916



4455

ISO®-BOARD CONVERSIONS FOR DRIVER OR PASSENGER

These kits include our finely chromed ISO-Boards and a cast bracket to connect the board to the slip-resistant splined adapter (sold separately).

FOR MULTI-FIT

Fits: See Fitment Chart Below

4455 For Passenger, Chrome (pr)

7916 For Driver or Passenger, Chrome (pr)

Note: Boards should not be installed in place of a footpeg on a peg mount secured with a single fastener and no anti-rotation mechanism. The board will apply too much force and loosen the mount from the bike. Passenger applications for Softail and Dyna requires Anti-Rotation Floorboard Mounts for installation. Installation on other models in place of a male mount footpeg requires P/N 8883. Applications for Softail & Dyna Require Anti-Rotation Mounts. Installation On Other Models In Place of a Male Mount Footpeg Requires Splined Adapter, P/N 8883

REPLACEMENT RUBBERS & RUBBER PADS

FOR MULTI-FIT

7512	Replacement Rubbers for Mini Dagger Pegs (set)
4485	Replacement Rubber Pads for Stiletto Pegs (set)
4468	Replacement Rubber Pads for SwingWing Pegs (set)
4454	Replacement Pads for ISO [®] -Wings (set)
4448	Replacement Rubber Pads for Switchblade Peg (set)
4431	Replacement Rubber Pads for Pilot™ Pegs (set)
4390	Replacement Rubber Pads for Trident Shift Peg (ea)
4391	Replacement Rubber Pads for Longhorn Trident Shift Peg (ea)
4543	Replacement Rubber Pads for ISO [®] -Boards (set)
4488	Replacement Rubber Pads for Stiletto Brake Pad (set)
4487	Replacement Rubber Pads for Stiletto Shift Peg (set)
4434	Replacement Rubber Pads for Mini Pilot™ Peg (set)
4433	Replacement Rubber Pads for Pilot™ Brake Pedal Pad (set)
4432	Replacement Rubber Pads for Pilot™ Stirrups or Shift Peg (set)
8023	Replacement Pads for Dually ISO [®] -Pegs (set)
4339	Trident Style Replacement Rubber Pads for Dually ISO [®] -Pegs (pr)
8011	Replacement Pads for ISO [®] - Shift Peg (set)
8010	Replacement Pads for Large ISO [®] -Pegs, Black (set)
4338	Trident Style Replacement Rubber Pads for Large ISO [®] -Pegs, Black (pr)
8009	Replacement Pads for Small ISO [®] -Pegs (set)
4345	Trident Style Replacement Rubber Pads for Small ISO [®] -Pegs (pr)
8082	Replacement Pads for 8027 & 8857 (set)
8083	Replacement Pads for P/N8044(set)
8081	Replacement Pads for P/N 8029 & 4025 (set)

REPLACEMENT ISO[®]-STIRRUP COMPONENTS

FOR MULTI-FIT

Fits: Kuryakyn ISO-Stirrups

8079	ISO [®] -Stirrup Mount, Male, Chrome (ea)
8078	Replacement Stirrup Arm, Right or Left, Chrome (ea)
8077	ISO [®] -Stirrup Mount, 5/8" Female, Chrome (ea)
8080	Replacement Pads for Stirrup Heel Rest, Black (pr)

REPLACEMENT COMPONENTS

FOR MULTI-FIT

1492	Zombie™ Medallions, 1" Diameter, Chrome (pr)
4490	Replacement Curb Feelers for Stiletto, Kaiser, Flamin' & Flamin' Switchblade Pegs, Chrome (pr)
4474	Replacement Curb Feelers for Widow & Zombie Pegs, Chrome (set)
4473	Replacement Skull Emblem for P/N 4470 & 4471, Chrome (ea)
4447	Replacement Curb Feelers for Switchblade Pegs (pr)
8732	Replacement Locking Pins & Screw Kit for 4467 & 4466, Chrome (kit)
8066	Ends & Bolts for Kuryakyn Large ISO-, Dually ISO-, ISO-Wing, Large Trident & Dually Trident Pegs

FOOTPEG MOUNTING HARDWARE

Grade 5 steel footpeg hardware in glistening chrome.

FOR HARLEY-DAVIDSON™

Fits: 3/8"-24 X 1-1/2" Bolts with nuts & spring washers.

7943	Chrome (pr)
------	-------------

New

Collections

Featured Bikes

Audio

Lighting

Accessory Mounts

Handlebar Controls, Grips & Mirrors

Pegs & Foot Controls

Covers, Trims & Accents

Air Cleaners & Exhaust

Touring & Comfort

Windshields & Air Management

Luggage & Organizers

Index

FOOTPEG & FLOORBOARD ADAPTERS



SPLINED ADAPTERS

Splined Adapters are required for mounting Kuryakyn pegs, mini boards and passenger boards sold without adapters to OEM locations. They allow riders to dial in their preferred foot angle via extended splines that mate with grooves on the pegs or boards for safe and secure mounting.

Fits: All Kuryakyn Pegs That Accept Splined Adapters, for Use With All Kuryakyn Highway Peg Mounts (does not fit OEM driver & passenger locations)

FOR HARLEY-DAVIDSON*

FITMENT	YEAR	CHROME		GLOSS BLACK		SATIN BLACK		SILVER	
		FRONT	REAR	FRONT	REAR	FRONT	REAR	FRONT	REAR
A Standard*	All	8881	8881	8888	8888	8898	8898	8899	8899
B Old Style Non-Pivoting**	All	8883	8883	--	--	--	--	--	--
C New Style Non-Pivoting***	All	8883	8894	--	--	--	8895	--	--
D Milwaukee-Eight® Softail****	'18-'19	8945	8923	8946	8924	--	--	--	--
E Standard - for XL1200C 1200 Custom	'11-'19	8884	8881	8886	8888	8896	8898	8897	8899
E Standard - for XL1200V Seventy-Two	'12-'16	8884	8881	8886	8888	8896	8898	8897	8899
E Standard - for XL1200X Forty-Eight	'10-'19	8884	8881	8886	8888	8896	8898	8897	8899

* Note : (except Driver & Passenger location '18-UP Softails, Driver Peg Location on '10-'19 XL1200X Forty-Eight/Special, '11-'19 XL1200C 1200 Custom , '12-'16 XL1200V Seventy-Two)

** Note : Non-Pivoting design intended for Kuryakyn floorboards P/N's 4351, 4357, 4455, 5908, 5909, 7045, 7046 & 7916 (except '18-UP Softails, '15-'16 FLHTCUL, '15-'19 FLHTKL, '16-'19 FLHX/S/SE, '16-'19 FLTRX/S '06-'17 Dyna Passenger Location & '10-'19 XL1200C,

*** Note : Non-Pivoting design intended for rear passenger mount Kuryakyn floorboards P/N's 4351, 4357, 4455, 5908, 5909, 7045, 7046 & 7916 , '15-'16 FLHTCUL, '15-'19 FLHTKL, '16-'19 FLHX/S/SE, '16-'19 FLTRX/S & '06-'17 Dyna Passenger Mounts

**** Note : '19-UP FXDRS with OEM passenger accessory peg mount from H-D





TAPERED ADAPTERS

Tapered Adapters are required for mounting Kuryakyn pegs, mini boards or passenger boards sold without adapters. The tapered male end is available in standard, serrated or adjustable stop styles, allowing infinite adjustment.

FOR HARLEY-DAVIDSON*

FITMENT	YEAR	CHROME		GLOSS BLACK	
		FRONT	REAR	FRONT	REAR
F Standard* H-D Style Male Mount Peg Applications	All	8008	8008	--	--
G Adjustable Stop* H-D Style Male Mount Application	All	8008A	8008A	--	--
H Serrated* H-D Style Male Mount Application	All	8880	8880	8890	8890
I Milwaukee-Eight® Softail**	'18-'19	8947	8925	8948	8926
J Standard - for XL1200C 1200 Custom	'11-'19	8885	8880	8887	8890
J Standard - for XL1200V Seventy-Two	'12-'16	8885	8880	8887	8890
J Standard - for XL1200X Forty-Eight	'10-'19	8885	8880	8887	8890
K Big Dog Motorcycles	'04-'10	8882	--	--	--

* Note : (except Driver & Passenger location '18-'19 Softails, Driver Peg Location on '10-'19 XL1200X Forty-Eight/Special, '11-'19 XL1200C 1200 Custom , '12-'16 XL1200V Seventy-Two)

** Note : '19-UP FXDRS with OEM passenger accessory peg mount from H-D

FEMALE PEG ADAPTERS

Female Peg Adapters for Kuryakyn pegs accepting tapered adapters.

FOR HARLEY-DAVIDSON*

Fits: Kuryakyn Pegs Accepting Tapered Adapters

8006 For Bullet Style Mounts, Chrome (pr)

8007 For 5/8" Square Mounts, Chrome (pr)



FOOTPEG & FLOORBOARD RELOCATORS

FOOTPEG & STIRRUP EXTENDERS

Protect those new boots from melting all over your front pipe. These slick extenders put another couple inches between those size 15's and your bike.

FOR MULTI-FIT

Fits: Universal Fitment for Typical Male Mount Cruise Peg Applications

8043 1-1/4", Chrome (pr)

8041 2-1/4", Chrome (pr)



MALE MOUNT FOOTPEG EXTENSIONS

Need more room? Our ISO-Peg Extensions are made of machined steel and are then chrome plated.

FOR MULTI-FIT

Fits: All Kuryakyn Pegs That Accept Tapered Adapters for Use with All Kuryakyn Highway Peg Mounts (does not fit OEM driver & passenger locations)

8064 2-1/2", Chrome (pr)

8063 1-1/2", Chrome (pr)



Note: For use as extension from Male Mount Clevis. Pegs sold separately.

New

Collections

Featured Bikes

Audio

Lighting

Accessory Mounts

Handlebar Controls, Grips & Mirrors

Pegs & Foot Controls

Covers, Trims & Accents

Air Cleaners & Exhaust

Touring & Comfort

Windshields & Air Management

Luggage & Organizers

Index



4556

ADJUSTABLE LOCKABLE OFFSETS

Adjust your pegs 2" or 4" forward, back, up or down for perfect comfort. 360° of lockable adjustability. Kuryakyn Male Mount Pegs sold separately.

FOR MULTI-FIT

Fits: H-D Style Male Mount Applications & Typical Male Mount Cruise Peg Applications

4557 4" Offsets with Male Mount Adapters, Chrome (pr)

4556 2" Offsets with Male Mount Adapters, Chrome (pr)

Note: Not recommended for use on mounts fastened to the motorcycle with only a single fastener. Leverage applied by the offset arm will cause the mount to twist and loosen from the motorcycle.

2" OFFSET FOR PASSENGER BOARD MOUNTING

Gain a new foot position - just add boards! The mounting splines lock your boards in secure & maintain the single pivot point at the board.

FOR MULTI-FIT

Fits: All Kuryakyn Floorboards for Mounting with Model Specific Splined Adapters (sold separately)

8837 Chrome (pr)

Note: Not intended for Driver Position Applications.

MALE MOUNT LOCKABLE OFFSET

Greater flexibility for a wide variety of applications without fear of slippage. Tapered end accepts Kuryakyn footpegs requiring tapered adapters (sold separately).

FOR MULTI-FIT

Fits: Kuryakyn Footpegs Using Tapered Adapters for H-D Style Male Mount Applications & Typical Male Mount Cruise Peg Applications

7937 4" Lockable Offset, Chrome (pr)

Note: Not compatible with Kuryakyn Floorboards, Liberator Pegs or SwingWing Pegs or Kinetic Pegs.

ANTI-ROTATION PASSENGER FLOORBOARD MOUNTS

Now you can add floorboards to your Softail without the chance of them rotating or coming loose down the road. Interlocking teeth make adjustments simple and precise.

FOR HARLEY-DAVIDSON®

Fits: '08-'17 FLSTC, '08-'10 FXSTC, '08-'09 FXSTB, '10 FLSTSE

4372 Black (set)

Note: Will also fit '08-'17 FLSTN, FLSTF, FLSTFB, FLSTSB & FXSTSSE if the stock exhaust & rear support bracket has been removed & replaced with a staggered dual or 2-1 system.

Fits: '07-'17 FLSTN, '08-'11 FLSTSB & '12-'17 FLS with Stock Rear Exhaust Support Bracket

4371 Black (set)

Note: If stock exhaust system & rear support bracket has been removed & replaced by a staggered dual or 2-1 system, use P/N 4372 or 4374.

Fits: '00-'07 FLSTC, '06 FLST, '00-'07 FXST & FXSTB, '07 FXSTC, '00-'06 FXSTS

4374 Black (set)



7937



8837



4371



4372



4372



4371



4330



MORE OPTIONS
PREMIUM FLOORBOARDS
PG 120



4609



FLOORBOARD RELOCATION BRACKETS

FOR DRIVER BOARDS

- Repositions driver boards out 1" and forward 1" from stock location
- Makes a noticeable difference in comfort; thighs aren't as tight against the tank, right knee is not as tight against the air cleaner, and legs get to stretch out a little bit more
- Compatible with Kuryakyn ISO-Boards as well as H-D Traditional or SweptWing shaped boards

FOR HARLEY-DAVIDSON®

Fits: '97-'16 Electra Glides (except '15-'16 FLHTKSE), Road Glides (except '15-'16 FLTRUSE), Road Kings, Street Glides (except '15-'16 FLHXSE) & '09-'13 Trikes

4588 Chrome (set)

Fits: '00-'17 FL Softail Models

7528 Chrome (set)

Fits: '17-'19 Electra Glides (except '17-'19 FLHTKSE), Road Glides (except '18-'19 FLTRXSE), Road Kings, Street Glides (except '17-'19 FLHXSE) & '17-'19 Trikes

4609 Chrome (set)

Note: Not compatible with Cruise Arm Mark III, P/N's 7914, 7915, or Standard Length Cruise Arm Mark IV, P/N 7840.

*Move your boards
 3/4" outward!*

DRIVER FLOORBOARD SPACERS

Move your stock driver boards outward 3/4".

FOR HARLEY-DAVIDSON®

Fits: '09-'19 Electra Glides, Road Glides, Road Kings, Street Glides & '09-'13 Trikes

7509 Gloss Black (set)

Fits: '92-'08 Electra Glides, Road Glides, Road Kings, Street Glides & Tour Glides

450 Gloss Black (set)

Fits: '18-'19 FL Softail Models (except Sport Glide)

7508 Gloss Black (set)

Note: Not compatible with Chrome Display Stand (H-D P/N 99002-97).



LOOKS GREAT WITH
 ISO® DRIVER BOARDS
 PG 126



4609

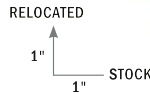

7528



4588

7508



**Top
 Seller**

7509



7508



7509



New

Collections

Featured Bikes

Audio

Lighting

Accessory Mounts

Handlebar Controls,
 Grips & Mirrors

Pegs & Foot Controls

Covers, Trims
 & Accents

Air Cleaners
 & Exhaust

Touring & Comfort

Windshields &
 Air Management

Luggage &
 Organizers

Index

PASSENGER PEGS: FIXED & ADJUSTABLE









4505, 4570, 7926, 4571

ADJUSTABLE PASSENGER PEGS

Give your passenger multiple foot placement options, much like a highway cruise peg for riders. The Adjustable Passenger Pegs bolt onto your bike's existing rear floorboard mount, retaining all functions of the stock boards with the added benefit of new higher and farther-forward riding positions. By providing relief from the fatigue caused by the limitations of stock floorboards, the Adjustable Passenger Pegs are a must-have for two-up travelers.

STANDARD APPLICATIONS

PASSENGER BOARD MOUNT TYPE	FITMENT/APPLICATION	P/N	PRICE
 H-D Stock '10-'19 Floorboard Mount	'10-'19 Electra Glides (except '10-'13 FLHTCUSE, '14-'19 FLHTKSE, '15-'19 FLHTKL, '15-'16 FLHTCUL), '11-'13 & '16-'19 Road Glide Ultras (except '11 & '15-'16 FLTRUSE), '10-'19 Road Kings (except '13-'14 FLHRSE & '17-'19 FLHRXS) & '10-'19 Trikes	4353	
 H-D Stock '10-'19 Floorboard Mount	'10-'19 Electra Glides (except '10-'13 FLHTCUSE, '14-'19 FLHTKSE, '15-'19 FLHTKL, '15-'16 FLHTCUL), '11-'13 & '16-'19 Road Glide Ultras (except '11 & '15-'16 FLTRUSE), '10-'19 Road Kings (except '13-'14 FLHRSE & '17-'19 FLHRXS) & '10-'19 Trikes	7059	
 H-D Adjustable Passenger Floorboard Mount Kit	'07-'13 FLHTCUSE, '14 FLHTKSE & '11 FLTRUSE; Stock on '07-'13 FLHTCUSE, '14 FLHTKSE & '11 FLTRUSE & sold as an accessory as H-D P/N 50768-07.	4505	
 Kuryakyn or H-D Chrome Passenger Floorboard Brackets	A chrome version of the stock '93-'06 mount sold as Kuryakyn P/N's 4569 & 4536 or H-D P/N 53070-00.	7926	
 Stock Black Floorboard Mount '07-'09	'07-'09 Electra Glides (except '07-'09 FLHTCUSE), Road Glides (except '09 FLTRSE), Road Kings (except '07 FLHRS & '07-'08 FLHRSE) & Trikes	4571	
 Stock Black Floorboard Mount '93-'06	'93-'06 Electra Glides (except '04-'05 FLHTCSE, '06 FLHTCUSE), Road Glides, Road Kings (except '04-'06 FLHRS/I) & Tour Glides	7926	

SPECIAL APPLICATIONS

If you have modified your motorcycle, the chart below will help you identify the correct product selection for trouble-free installation.

'93-'08 MODELS WITH RINEHART EXHAUST	PART NUMBERS NEEDED
'07-'08 Electra Glides, Road Glides, Road Kings	7926, 4561, & 4569
'93-'06 Electra Glides, Road Glides, Road Kings	7926 & 4537
'93-'08 Electra Glides, Road Glides, Street Glides, Tour Glides & Road Kings with Chrome or Black H-D Passenger Floorboard Support Kits (H-D P/N 52714-04)	7926, 4561, & 4569
'04-'05 FLHTCSE & '06-'08 FLHTCUSE	7926, 4561, & 4569

Top
Seller

PEGS & FOOT CONTROLS
PASSENGER PEGS: FIXED & ADJUSTABLE

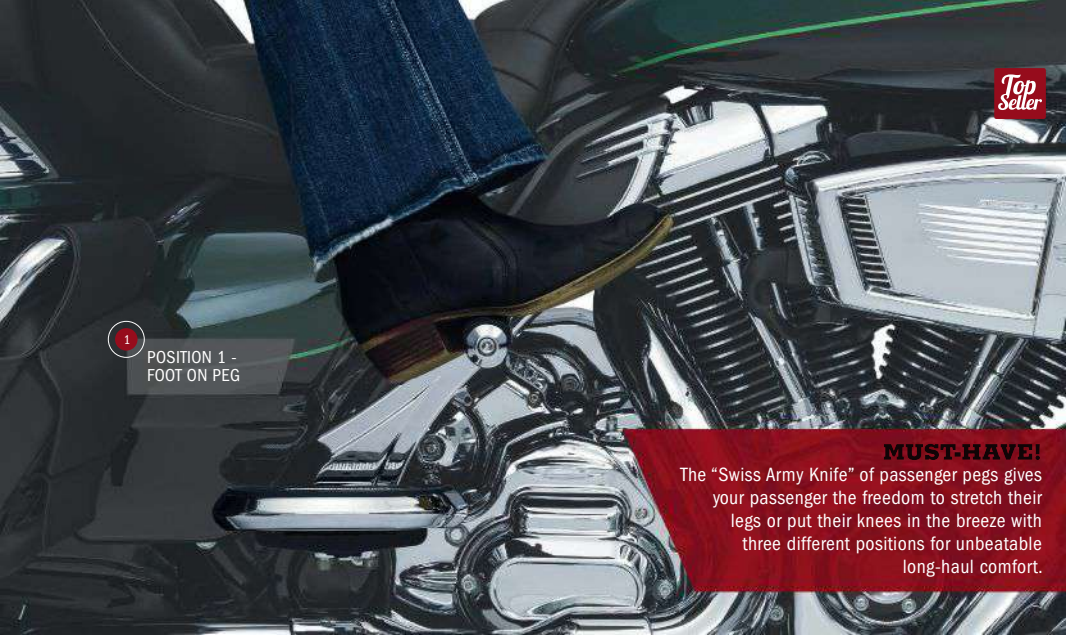

1 POSITION 1 - FOOT ON PEG

MUST-HAVE!
The "Swiss Army Knife" of passenger pegs gives your passenger the freedom to stretch their legs or put their knees in the breeze with three different positions for unbeatable long-haul comfort.



3 POSITION 3 - FOOT ON PEG



2 POSITION 2 - CALF ON PEG

PASSENGER BOARD MOUNTS FOR TOURING
Kuryakyn offers chrome standard length board mounts as well as black or chrome extended mounts for added comfort or to provide clearance when installing Adjustable Passenger Pegs with Rinehart Exhaust.

FOR HARLEY-DAVIDSON™

Fits: '93-'19 Electra Glides, Road Glides, Road Kings, Street Glides, Tour Glides & '09-'19 Trikes

4569 Standard Length Mount, Chrome (ea)

4536 Standard Length Mount, Chrome (pr)

Note: All mounts accept Kuryakyn Passenger Pegs, P/N 7926.

Fits: '93-'19 Electra Glides, Road Glides, Road Kings, Street Glides & Tour Glides

4561 Extended Length Mount, Chrome (ea)

4537 Extended Length Mount, Black (ea)

Note: All mounts accept Kuryakyn Adjustable Passenger Pegs, P/N 7926. Extended length version primarily used for additional clearance when installing Adjustable Passenger Pegs with Rinehart exhaust on '93-'08 models.

REPLACEMENT COMPONENTS
Replacement Pin, Spring and Knob kit for Kuryakyn Adjustable Passenger Pegs.

FOR HARLEY-DAVIDSON™

Fits: Kuryakyn Adjustable Passenger Pegs, P/N 4353 (Services one side.)

4368 Replacement Pin, Spring & Knob (ea)

Fits: Kuryakyn Adjustable Passenger Pegs, P/N 4353 (Services both sides.)

4367 Pivot Shaft Service Kit (ea)

Fits: Kuryakyn P/N's 4352, 4353, 4388 & 4389

4376 Replacement Tapered Peg Mount with Screw, Chrome (ea)

Fits: Kuryakyn Adjustable Passenger Pegs, P/N's 4505, 4570, 4571 & 7926

7883 Pivot Shaft Service Kit (set)

7882 Replacement Pin, Spring & Knob Kit (ea)

- New
- Collections
- Featured Bikes
- Audio
- Lighting
- Accessory Mounts
- Handlebar Controls, Grips & Mirrors
- Pegs & Foot Controls**
- Covers, Trims & Accents
- Air Cleaners & Exhaust
- Touring & Comfort
- Windshields & Air Management
- Luggage & Organizers
- Index



UNDERSEAT PEG MOUNTS

FOR SOFTAIL

These Mounts will give your passenger that “breeze past the knees” chopper-style riding position. Great for also giving small passengers rides.

FOR HARLEY-DAVIDSON®

Fits: '08-'17 Softail Models, (except '08-'09 FXCW, '08-'11 FXCWC & '13-'17 FXSB), '06-'07 FXST Softail Standard, '06-'07 FXSTB Night Train, '07 FXSTC Softail Custom, '06 FXSTS Softail Springer, '07 FLSTF Fat Boy & '06 FLSTFSE Screamin' Eagle Fat Boy

4344 Chrome (pr)

4334 Gloss Black (pr)

Fits: '86-'07 Softail Models (except '00-'07 FXSTD, '06-'07 FXST/B/C/S, '06 FLSTFSE, '07 FLSTF)

7960 Chrome (pr)

ADJUSTABLE PASSENGER PEG MOUNTS FOR TOURING

Direct replacements for stock passenger floorboards.

Accepts any H-D style male mount peg and adjusts to any of the three stock positions.

FOR HARLEY-DAVIDSON®

Fits: '93-'19 Electra Glides, Road Glides, Road Kings, Street Glides, Tour Glides & '09-'19 Trikes

7527 Chrome (pr)

RETRACTABLE PASSENGER PEGS

U.S. Patents D653,175 & 8,870,207

Designed to transform a bike equipped with uncomfortable stock rear footpegs to a comfortable two-up touring machine.

FOR HARLEY-DAVIDSON®

Fits: '10-'13 & '15-'19 FLTRX/S; '00-'01 & '09 FLTRSE; '12-'13 FLTRXSE; '04-'07 FLHRS/I; '02-'03, '07-'08 & '13-'14 FLHRSE; '06-'19 FLHX/I/S, '10-'12 & '15-'19 FLHXSE & '15-'16 FLHTCUL

4352 Chrome (pr)

Note: P/N 4352 will fit all '93-'13 Touring Models for customers wishing to remove passenger boards & convert to pegs. Will fit all '93-'19 Touring Models for customers wishing to remove passenger boards & convert to pegs.



ALSO AVAILABLE..
PREMIUM & RIBBED
FLOORBOARDS Pg 119



HIGHWAY & CRUISE PEGS

*Arms fold away discreetly
when not in use*

FLIP BLADES

These stealthy highway pegs bolt in place on the bottom of Traditional or SweptWing H-D floorboards and fold out to lock in place. The hinged design eliminates cornering touch-downs, and release lever reverts the blades to original positioning.

FOR HARLEY-DAVIDSON™

Fits: '84-'19 Electra Glide Classics and Standards (except '04-'05 FLHTCSE), '84-'96 Tour Glides, '98-'09 Road Glides (except '09 FLTRSE), '94-'19 Road Kings (except '04-'07 FLHRS, '07-'08 & '13-'14 FLHRSE), '10-'11 Street Glide Trike, '86-'08 FLST/FLSTC, '90-'16 FLSTF, '93-'96 FLSTN, '97-'03 FLSTS, '05-'07 FLSTSC, '12-'16 Dyna Switchback

7540 For Traditional Boards, Chrome (pr)

7556 For Traditional Boards, Chrome (pr)

Fits: '04-'05 FLHTCSE, '09 FLTRSE, '10-'13 & '15-'19 FLTRX/S, '12-'13 FLTRXSE, '04-'07 FLHRS/I, '07-'08 & '13-'14 FLHRSE, '06-'19 FLHX/I, '14-'19 FLHXS, '10-'12 FLHXSE, '10-'12 FLSTSE, '14-'15 FLSTNSE, '17-'19 FLHRXS or any H-D Model Equipped with H-D SweptWing Shape Boards.

7541 For SweptWing Boards, Chrome (pr)

Note: Not recommended for use with fairing lowers.

ADJUSTABLE MUSTACHE BAR

Our Mustache Bar has the ability to be adjusted to fit virtually any rider. Due to its cleverly designed clamp system, it can be moved up or down the downtubes and rotated to provide fore and aft adjustment. Accepts any typical male mount cruise pegs, sold separately.

FOR HARLEY-DAVIDSON™

Fits: '86-'17 Softail & Rocker Models

7502 Chrome (ea)

Fits: '91-'17 Dyna Models

7503 Chrome (ea)

ADJUSTABLE MUSTACHE BAR FOR SPORTSTER

These super adjustable cruise pegs for Sportsters are quick and easy to install, and provide a wide range of adjustment. They bolt securely to the welded cross brace near the bottom of the downtubes and work on models with or without forward controls. Accepts any H-D style male-mount footpegs (sold separately).

FOR HARLEY-DAVIDSON™

Fits: Late-'84-'03 Sportster Models

7869 Chrome (ea)

Fits: '04-'19 Sportster Models

7868 Chrome (ea)



New

Collections

Featured Bikes

Audio

Lighting

Accessory Mounts

Handlebar Controls,
Grips & Mirrors

Pegs & Foot Controls

Covers, Trims
& Accents

Air Cleaners
& Exhaust

Touring & Comfort

Windshields &
Air Management

Luggage &
Organizers

Index



CRUISE ARM MARK III

Simply drill mounting holes in the steel floorboard base for the adjustable mount and full-length reinforcing plate. Reinforcing plate adds stiffness to the floorboard to keep flex to a minimum. The stock rubber floorboard pads remain unaffected. The arms are fully adjustable front to back. Accepts any H-D style male mount footpeg, sold separately.

FOR HARLEY-DAVIDSON®

Fits: Required for installation of P/N 7914 on '84-'08 Electra Glides, Road Glides, Road Kings & Tour Glides

4533 Chrome (ea)

Fits: '84-19 Electra Glides (except FLHTCU, FLHTK, FLHTCSE, FLHTCUSE, FLHTKSE), '84-'91 FLTC Tour Glides, '98-'09 Road Glides (except '09 FLTRSE), '94-'19 Road Kings (except '04-'07 FLHRS, '07-'08 & '13-'14 FLHRSE '17-'19 FLHRXS), '10-'11 Street Glide Trikes; '86-'08 FLST/FLSTC, '90-'17 FLSTF, '93-'96 FLSTN, '97-'03 FLSTS & '05-'07 FLSTSC

7914 Chrome (pr)

Note: Only compatible with O.E.M. H-D floorboards. Adjustment is limited when installed on motorcycles with engine guards. '84-'08 Electra Glides, Road Glides, Road Kings & Tour Glides require Support Kit, P/N 4533, sold separately. Not compatible with fairing lowers.

CRUISE ARM MARK IV

Heavy-duty chrome arms wrap around your stock floorboards just right, so kick back and relax! No drilling required. Mounts directly to frame, not the board. Compatible with Kuryakyn ISO-Boards and all H-D footboards.

FOR HARLEY-DAVIDSON®

Fits: '00-'17 FL Softtail Models Without Engine Guards (except '05-'06 FLSTFSE)

7841 Extended Length, Chrome (set)

7840 Standard Length, Chrome (set)

Note: Adjustment of Standard Version is limited on several Models. Not compatible with oil coolers or engine guards. Accepts any H-D style Male Mount Footpeg, sold separately. Adjustment on '07-'17 models is limited. Not compatible with oil coolers.





Built in highway pegs!



7532

ERGO PLUS ENGINE GUARDS FOR TOURING MODELS

U.S. Patents D513,719; 6,969,083 & 7,073,808

This innovative design combines a stylish engine guard with built-in highway pegs. Use the highway pegs folded in or flip them out for an optional foot position! Designed with an ergonomic pull back, your feet will feel secure with less outward leg pressure no matter what position you have them in. Bolts directly to existing mounts on your frame for quick and easy installation.

FOR HARLEY-DAVIDSON*

Fits: '97-'19 Electra Glides, Road Kings & Street Glides

7532 Chrome (ea)

7576 Black (ea)



7576

ERGO PLUS ENGINE GUARD FOR SOFTTAIL MODELS

U.S. Patents D513,719; 6,969,083 & 7,073,808

This innovative design combines a stylish engine guard with built-in highway pegs. Use the highway pegs folded in or flip them out for an optional foot position! Designed with an ergonomic pull back, your feet will feel secure with less outward leg pressure no matter what position you have them in. Bolts directly to existing mounts on your frame for quick and easy installation.

FOR HARLEY-DAVIDSON*

Fits: '00-'17 FL Softail Models

7529 Chrome (ea)

7577 Black (ea)



7529



7577

7529

Note: Includes shortened replacement brake pedal.

New

Collections

Featured Bikes

Audio

Lighting

Accessory Mounts

Handlebar Controls,
Grips & Mirrors

Pegs & Foot Controls

Covers, Trims
& Accents

Air Cleaners
& Exhaust

Touring & Comfort

Windshields &
Air Management

Luggage &
Organizers

Index

HIGHWAY & CRUISE PEGS



7583

Made Especially for Bikes with Lower!



4528



4523



4522



7585



7582



7993

4436

7999

7998

TOUR-TECH™ CRUISE MOUNTS FOR 1-1/4" ENGINE GUARDS
Short Arm Mounts place the peg 4" back from the bar for taller riders, while the Long Arms are 6" back for shorter riders. The arm and footpeg may be further adjusted along a vertical or horizontal arc. A unique clevis permits angle adjustment of the footpeg. The heavy-duty Quick Clamp and sturdy offset arm ensures that the footpegs will clear fairing lowers and will stay where you put them.

FOR MULTI-FIT

Long Arm For Short Riders: Mounts 6" Back From Bar
Fits: 1-1/4" Engine Guards or Tubing

7586 Trident Dually ISO-Pegs, Chrome (pr)

7584 Trident Dually ISO-Pegs, Gloss Black (pr)

4529 Dually ISO-Pegs, Chrome (pr)

4528 ISO-Wing Pegs, Chrome (pr)

7582 Premium Mini Boards, Chrome (pr)

7598 Premium Mini Boards, Gloss Black (pr)

4526 Mounts Only, Chrome (pr)

7575 Mounts Only, Gloss Black (pr)

Short Arm Or Tall Riders: Mounts 4" Back From Bar
Fits: 1-1/4" Engine Guards or Tubing

7585 Trident Dually ISO-Pegs, Chrome (pr)

7583 Trident Dually ISO-Pegs, Gloss Black (pr)

4523 Dually ISO-Pegs, Chrome (pr)

4522 ISO-Wing Pegs, Chrome (pr)

7580 Premium Mini Boards, Chrome (pr)

7581 Premium Mini Boards, Gloss Black (pr)

4520 Mounts Only, Chrome (pr)

7574 Mounts Only, Gloss Black (pr)

Note: Made especially for bikes with fairing lowers.

OFFSET HIGHWAY PEGS

The clamp can be positioned forward or back, and the arm offers full 360-degree rotation for tall, short, or in-between riders! If your engine guard is angled in such a way that the peg will not be level once installed, find our Right Angle Mounts or Male Adapters with Adjustable Stop. (Peg mounts perpendicular to engine guard.)

FOR MULTI-FIT

Fits: 1" Engine Guards or Tubing

4438 Pilot Pegs, Chrome (pr)

7976 Dually ISO-Pegs, Chrome (pr)

Fits: 1-1/4" Engine Guards or Tubing

4436 Pilot Pegs, Chrome (pr)

7999 Large ISO-Pegs, Chrome (pr)

7998 Small ISO-Pegs, Chrome (pr)

7993 Dually ISO-Pegs, Chrome (pr)



7599

LONGHORN OFFSET HIGHWAY PEGS

The 3-1/4" arm provides up to 6-1/2" of adjustment and features an innovative secure locking device. Available in 1-1/2" or 1-1/4" diameter clamps and includes footpegs.

FOR MULTI-FIT

Fits: 1-1/2" Engine Guards or Tubing

4574 Dually ISO-Pegs, Chrome (pr)

Fits: 1-1/4" Engine Guards or Tubing

4575 Dually ISO-Pegs, Chrome (pr)

4616 SweptWing Pegs, Chrome (pr)

7555 Trident Dually ISO-Pegs, Chrome (pr)

7599 Trident Dually ISO-Pegs, Gloss Black (pr)

Fits: 1" Engine Guards or Tubing

7980 Dually ISO-Pegs, Chrome (pr)

ENGINE GUARD OR FRAME MOUNT FOOTPEGS

U.S. Patents D506,707 & 6,893,038

With the trusted Magnum Quick Clamp, install on any round tubing (frames or engine guards). Keep in mind that the footpeg itself will end up perpendicular to the bar to which it is mounted.

FOR MULTI-FIT

Fits: 1" Engine Guards or Tubing

4510 Dually ISO-Pegs, Chrome (pr)

8031 Large ISO-Pegs, Chrome (pr)

8030 Small ISO-Pegs, Chrome (pr)

Fits: 1-1/4" Engine Guards or Tubing

4451 ISO-Wing Pegs, Chrome (pr)

4443 Switchblade Pegs, Chrome (pr)

4435 Pilot Pegs, Chrome (pr)

7992 Dually ISO-Pegs, Chrome (pr)

8033 Large ISO-Pegs, Chrome (pr)

8032 Small ISO-Pegs, Chrome (pr)

8071 Large ISO-Pegs with ISO-Stirrups, Chrome

Note: If your engine guard is angled in such a way so that the peg will not be level once installed, see our Right Angle Mounts or P/N 8008A.

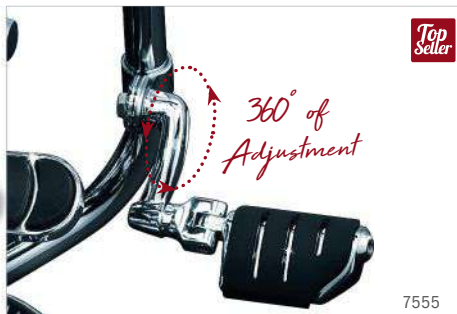

7555



4575



4616



4451



4443

7992

8032

8033

4451

4435



8071



8033

New

Collections

Featured Bikes

Audio

Lighting

Accessory Mounts

Handlebar Controls, Grips & Mirrors

Pegs & Foot Controls

Covers, Trims & Accents

Air Cleaners & Exhaust

Touring & Comfort

Windshields & Air Management

Luggage & Organizers

Index

CLAMPS & MOUNTS



4501

X-TENSION CRUISE PEG MOUNTS

Measuring 4-1/2" long with a 1-1/4" offset, the rider may now increase or decrease the reach to the highway peg. The X-Tension mounts with Magnum Quick Clamps and will accept any typical male mount cruise peg applications.

FOR MULTI-FIT

Fits: Universal Applications with 1-1/4" Tubing

4501 Dually ISO®-Pegs, Chrome (pr)

Fits: Mounts with a 1/2"-13 Bolt. May be Used with OEM Highway Peg Mounts, Some Forward Control Plates or with Magnum Quick Clamps

4515 Mounts Only, Chrome (pr)

Note: Not suggested for use with full size engine guards. (Requires 1-1/4" of available round space on both front frame tubes)

RIGHT ANGLE CRUISE MOUNTS & PEGS

Allows you to position the peg horizontally regardless of the orientation of the engine guard or frame tube.

FOR MULTI-FIT

Fits: Universal Applications, Requires Magnum Quick Clamps & Male Mount Cruise Pegs, Sold Separately.

4511 Short Mounts Only, 3-3/4", Chrome (pr)

4503 Long Mounts Only, 4-1/2", Chrome (pr)

Fits: Universal Applications, Requires Magnum Quick Clamp, Sold Separately

7539 Long Mounts, Longhorn ISO-Pegs, Chrome (pr)

Fits: 1" Engine Guard or Tubing

4509 Long Mounts, Dually ISO-Pegs, Chrome (pr)

4507 Long Mounts, Small ISO-Pegs, Chrome (pr)

Fits: 1-1/4" Engine Guards or Tubing

4517 Short Mounts, Small ISO-Pegs, Chrome (pr)

4514 Short Mounts, Dually ISO-Pegs, Chrome (pr)

Fits: Universal Applications for 1-1/2" Tubing

7559 Long Mounts - Trident ISO-Pegs, Chrome (pr)

PEG MOUNTS WITH MAGNUM QUICK CLAMPS

This setup allows the use of any Kuryakyn cruise peg-style male mount or H-D style male-mount pegs with our innovative Magnum Quick Clamps and Clevises for engine guard applications.

FOR MULTI-FIT

Fits: 1-1/2" Engine Guards or Tubing

4573 Chrome (pr)

Fits: 1-1/4" Engine Guards or Tubing

7944 Chrome (pr)

7572 Gloss Black (pr)

Note: Requires male mount pegs, sold separately.



4515



4501



7539



4514



7539



4514



4511

4503



4517



7944



7572

BRUTE HIGHWAY PEG MOUNTS

The slim design and smooth contours make a great fit for any motorcycle with 1-1/4" engine guards, including Touring models with fairing lowers. The fasteners securing the clamps to the engine guard face inward, providing a clean look not found in other designs.

FOR MULTI-FIT

Fits: 1-1/4" Engine Guards or Tubing

7617 Chrome (pr)

7616 Gloss Black (pr)



TECH TIP

Check bolts/hardware for all newly installed items after the first 100-200 miles for tightness and secure fitment

PEG MOUNTS & MOUNTING CLEVISES

All footpeg mounting clevises and footpeg mounts listed perform a similar function. Your decision will be determined by the length required and the style you prefer.

FOR MULTI-FIT

Fits: Universal Applications, Requires Magnum Quick Clamps & Male Mount Pegs, Sold Separately

8016 Longhorn Offset Peg Mounts, Chrome (pr)

Fits: Kuryakyn Offset, Longhorn Offset & Underseat Mount for Softail

4568 Serrated Replacement Clevis with Hardware, Chrome (ea)

Fits: 3/8"-16 Mounting Bolt (Included). Accepts Any H-D Style Male Mount Peg

8087 3-1/2" Peg Mounts with 3/8"-16 Mount Bolts, Chrome (pr)

Fits: Universal for 1/2" Bolt Through 1/2" Hole Mounting for Typical Male Mount Cruise Peg Applications, Accepts Any H-D Style Male Mount Peg

8015 Peg Mount Clevises with 1/2"-20 Mount Bolts, Chrome (pr)

Fits: Mounts with 1/2"-13 Bolt (Included). Accepts Any H-D Style Male Mount Peg.

7996 Offset Peg Mounts with 1/2"-13 Mounting Bolt, Chrome (pr)

8088 3-1/2" Peg Mounts with 1/2"-13 Mount Bolts, Chrome (pr)

8061 Short Magnum Peg Mounts with 1/2"-13 Mounting Bolts, Chrome (pr)

7573 Short Magnum Peg Mounts with 1/2"-13 Mounting Bolts, Gloss Black (pr)

Note: To measure your tube size tighten an adjustable wrench around the tube. Remove the wrench & measure the opening. Mounting Cruise Pegs off frame tubes requires 1-1/2" of straight unobstructed tubing for clamping at equal height on both sides & approximately 3/8" of clearance around tube.



7617



7616



7617



8016

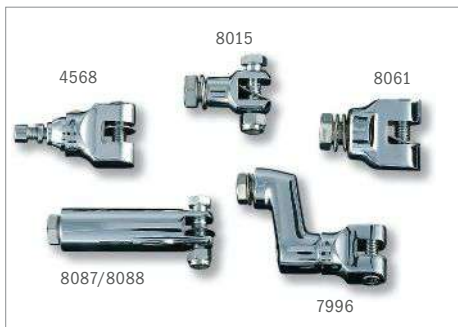

4568

8015

8061

8087/8088

7996



7573



8016

New

Collections

Featured Bikes

Audio

Lighting

Accessory Mounts

Handlebar Controls, Grips & Mirrors

Pegs & Foot Controls

Covers, Trims & Accents

Air Cleaners & Exhaust

Touring & Comfort

Windshields & Air Management

Luggage & Organizers

Index



TUBE DIAMETER FITMENT CHART

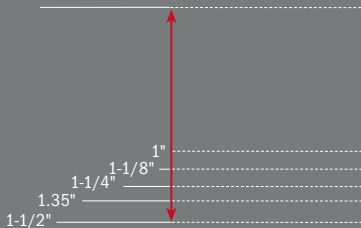

Note: To measure your tube size tighten an adjustable wrench around the tube. Remove the wrench & measure the opening. Mounting Cruise Pegs off frame tubes requires 1-1/2" of straight unobstructed tubing for clamping at equal height on both sides & approximately 3/8" of clearance around tube.

LONGHORN OFFSET PEG MOUNTS

WITH MAGNUM QUICK CLAMPS

With 360 degrees of adjustment, the 3-1/4" radius offers up to a 6-1/2" range of positioning. The pegs stay tucked in toward centerline of the bike for maximum comfort.

FOR MULTI-FIT

Fits: 1" Engine Guards or Tubing

7985 Chrome (set)

Fits: 1-1/2" Engine Guards or Tubing

4577 Chrome (pr)

Fits: 1-1/4" Engine Guards or Tubing

7986 Chrome (set)

7571 Gloss Black (set)

Note: Requires male mount footpegs (sold separately).

MAGNUM™ QUICK CLAMPS

Stainless steel construction for superior strength, and hinged construction for fast, simple installation. Accepts a 1/2" clamp bolt.

FOR MULTI-FIT

Fits: 1" Engine Guards or Tubing

1002 1", Chrome (pr)

7940 1", Chrome (ea)

Fits: 1-1/8" Engine Guards or Tubing

7941 1-1/8", Chrome (ea)

Fits: 1-1/4" Engine Guards or Tubing

1000 1-1/4", Chrome (pr)

8073 1-1/4", Chrome (ea)

1003 1-1/4", Gloss Black (ea)

Fits: 1.35" Engine Guards or Tubing

7942 1.35", Chrome (ea)

Fits: 1-1/2" Engine Guards or Tubing

1001 1-1/2", Chrome (pr)



REPLACEMENT SCREWS & D-WASHERS

FOR MULTI-FIT

Fits: Replacement D-Washers

4508 D-Washers (pr)

Fits: Replaces Peg Fastener On Kuryakyn Magnum Footpeg Mounts

4538 Replacement Clevis Screws with D-Washers, Chrome (set)



KOOL KAPS BOLT COVERS

FOR MULTI-FIT

Fits: Kuryakyn Magnum Footpeg Mounts or 1/2" Hex Head Bolt (Uses 3/4" Wrench)

2451 1/2" Hex Head Bolt, Chrome (pr)

Note: * Requires a small amount of silicone. Found at local hardware store.

SHIFT LINKAGES & SHIFT ARM COVERS

RIDGEBACK FRONT SHIFT ARM

Precision-broached splines and investment cast steel construction deliver strength, beauty, and secure fitment. Contrasting textured and polished surfaces provide a unique custom look.

FOR HARLEY-DAVIDSON™

Fits: '17-'19 Electra Glides, Road Glides, Road Kings, Street Glides & Trikes

5802 Chrome (ea)

5803 Satin Black (ea)



RIDGEBACK TRANSMISSION SHIFT ARM

This direct replacement shift arm made from investment cast steel delivers strength, beauty, and a unique custom look. Features contrasting textured and polished surfaces, with precision-broached splines for solid and secure fitment.

FOR HARLEY-DAVIDSON™

Fits: '17-'19 Electra Glides, Road Glides, Road Kings, Street Glides, Trikes & '18-'19 Softails

5800 Chrome (ea)

5801 Satin Black (ea)



ALSO AVAILABLE

RIDGEBACK SHIFT & BRAKE LEVERS
PG 148



FLAME™ SHIFT ARM COVER

Light up your shift arm with this easy-to-install cover.

FOR HARLEY-DAVIDSON™

Fits: '82-'16 Electra Glides, Road Glides, Road Kings, Street Glides, Tour Glides & '09-'16 Trikes

1059 Chrome (ea)

Fits: All '07-'17 Softail Models

1082 Chrome (ea)



ZOMBIE™ SHIFT ARM COVER

FOR HARLEY-DAVIDSON™

Fits: '82-'16 Electra Glides, Road Glides, Road Kings, Street Glides, Tour Glides & '09-'16 Trikes

1054 Chrome (ea)

Fits: All '07-'17 Softail Models

1081 Chrome (ea)

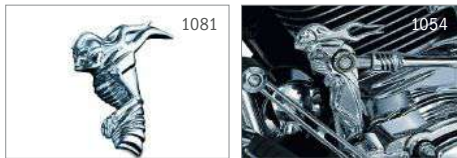

TRANSMISSION SHIFT ARM COVER

FOR HARLEY-DAVIDSON™

Fits: '01-'16 Electra Glides, Road Glides, Road Kings, Street Glides; '09-'16 Trikes, '01-'17 Softails & '01-'17 Dynas

1068 Chrome (ea)



UNIVERSAL JOINTS

FOR HARLEY-DAVIDSON™

Fits: 5/16"-24 R.H. Female Threads

9058 Ball Joint Style, Chrome (ea)

9056 Barrel Style, Chrome (ea)

9046 Ball Joint Style with Short Stud, Chrome (ea)



New

Collections

Featured Bikes

Audio

Lighting

Accessory Mounts

Handlebar Controls,
Grips & Mirrors

Pegs & Foot Controls

Covers, Trims
& Accents

Air Cleaners
& Exhaust

Touring & Comfort

Windshields &
Air Management

Luggage &
Organizers

Index



3572



3573

RIOT SHIFT LINKAGE

Aggressively designed direct replacement made from high-quality aluminum with premium steel heim joints for smooth shifting, and custom jam nuts to conceal exposed threads.

FOR HARLEY-DAVIDSON®

Fits: '04-'19 Sportster Models equipped with standard forward controls

3572 Silver (ea)

3573 Satin Black (ea)



3571

RIOT SHIFT LINKAGE

Aggressively designed direct replacement made from high-quality aluminum with premium steel heim joints for smooth shifting, and custom jam nuts to conceal exposed threads.

FOR HARLEY-DAVIDSON®

Fits: '06-'17 Dyna Models equipped with Mid Controls

3570 Silver (ea)

3571 Satin Black (ea)



3570



1072



COMPLETE THE LOOK!

RIOT FOOTPEGS
PG 108



1072



1075

FLAME™ SHIFT LINKAGE

The unique flames are three dimensional, not stamped or laser cut. Top quality ball joints are used for smooth action & long life.

FOR HARLEY-DAVIDSON®

Fits: '80-'19 Electra Glides, Road Glides, Road Kings, Street Glides & Tour Glides; '09-'19 Trikes & '86-'19 Softail Models (except '19 FXBB, FXLR & '97-'99 FLSTS)

1072 Chrome (ea)

Note: Can also be used on '93-'12 Dyna Models with forward controls, and Dyna Switchback, if Shift Linkage Extension Kit (P/N 1067) is added - sold separately. Can also be used on '93-'17 Dyna models with forward controls if Shift Linkage Extension Kit, P/N 1067 is added, sold separately.

ZOMBIE™ SHIFT LINKAGE

Our chrome steel linkage is a complete replacement for your dull stock shifter rod.

FOR HARLEY-DAVIDSON®

Fits: '80-'19 Electra Glides, Road Glides, Road Kings, Street Glides & Tour Glides; '09-'19 Trikes & '86-'19 Softail Models (except '19 FXBB, FXLR & '97-'99 FLSTS)

1075 Chrome (ea)

Note: Not compatible with Kuryakyn Inner Primary Covers on '07-'12 Softails or Touring Models. Can also be used on '93-'17 Dyna models with forward controls if Shift Linkage Extension Kit, P/N 1067 is added, sold separately.



1075



9679

CARVED SHIFT LINKAGES

Premium CNC-machined aluminum with detailed grooves and contours serve up a stunning upgrade versus the round stock unit. Custom jam nuts add distinctive style and cover exposed threads, while high-quality ball joints deliver smooth operation.

FOR HARLEY-DAVIDSON™

Fits: '80-'19 Electra Glides, Road Glides, Road Kings, Street Glides & Tour Glides; '09-'19 Trikes & '86-'19 Softail Models (except '97-'99 FLSTS, '18-'19 FXLR & FXBB)

9677 Chrome (ea)

9678 Gloss Black (ea)

9679 Black & Raw Aluminum (ea)

Note: Can also be used on '93-'17 Dyna models with forward controls if Shift Linkage Extension Kit, P/N 1067 is added, sold separately.

GROOVED SHIFT LINKAGES

Stylish grooved design precision machined from quality aluminum with fine attention to detail. Includes premium stainless steel ball joints for smooth shifting, and custom jam nuts to conceal exposed threads for a clean appearance.

FOR HARLEY-DAVIDSON™

Fits: '80-'19 Electra Glides, Road Glides, Road Kings, Street Glides & Tour Glides; '09-'19 Trikes & '86-'19 Softail Models (except '97-'99 FLSTS, FLXR & FXBB)

9674 Chrome (ea)

9675 Gloss Black (ea)

9676 Black & Raw Aluminum (ea)

Note: Can also be used on '93-'17 Dyna models with forward controls if Shift Linkage Extension Kit, P/N 1067 is added, sold separately.

CUSTOM EXTRUDED SHIFT LINKAGE

Massive bold look. Personalize with the included red, blue & chrome lock nuts.

FOR HARLEY-DAVIDSON™

Fits: '80-'19 Electra Glides, Road Glides, Street Glides, Tour Glides, Road Kings & Trikes; '86-'19 Softail Models (except '97-'99 FLSTS, '18-'19 FXBB & FXLR); '93-'05 Dyna Wide Glides

9059 Chrome (ea)

Fits: Custom Applications - Adjusts from 15" to 15-1/2"

1063 Chrome (ea)



9677



9678



9679



9674



9674



9675



9676



FINNED DERBY COVER
PG 198



9059

Includes red, blue & chrome lock nuts



New

Collections

Featured Bikes

Audio

Lighting

Accessory Mounts

Handlebar Controls,
Grips & Mirrors

Pegs & Foot Controls

Covers, Trims
& Accents

Air Cleaners
& Exhaust

Touring & Comfort

Windshields &
Air Management

Luggage &
Organizers

Index



ALSO AVAILABLE
GIRDER BRAKE PEDAL
PG 148



GIRDER SHIFT LINKAGE

Shift with style! Machined from billet aluminum and then chrome plated with care, our Girder Shift Linkage is a beautiful addition to your bike. Innovative design looks great by itself or with our Girder Shift Lever where applicable.

FOR HARLEY-DAVIDSON*

Fits: '80-'19 Electra Glides, Road Glides, Road Kings, Street Glides, Tour Glides & Trikes; '86-'19 Softail Models (except '97-'99 FLSTS, '18-'19 FXBB & FXLR); '93-'02 Dyna Wide Glides

9054 Chrome (ea)

SHIFT LINKAGE

Beautiful chrome-plating, high-quality ball joints, & streamlined jam nuts make this shift linkage a great linkage a great value for anyone looking to replace their stock shift linkage.

FOR HARLEY-DAVIDSON*

Fits: '80-'19 Electra Glides, Road Glides, Road Kings, Street Glides & Tour Glides; '09-'19 Trikes & '86-'19 Softail Models (except '18-'19 FXBB, FXLR & '97-'99 FLSTS)

1077 Chrome (ea)

Note: Can also be used on '93-'17 Dyna models with forward controls if Shift Linkage Extension Kit, P/N 1067 is added, sold separately.

SERPENT™ SHIFT LINKAGE & EMBLEMS

Featuring a unique rustic and antique pewter finish that combines a snake, bones and barbed wire for a wicked theme. Included is a sinister skull emblem.

FOR HARLEY-DAVIDSON*

Fits: '80-'19 Electra Glides, Road Glides, Road Kings, Street Glides & Tour Glides; '09-'19 Trikes & '86-'19 Softail Models (except '18-'19 FXBB, FXLR & '97-'99 FLSTS)

1079 Serpent Shift Linkage, Pewter (ea)

Fits: Universal applications with 1" diameter flat surface, Serpent Shift Linkage (P/N 1079)

1083 Wild Boar Emblem, Pewter (ea)

1084 Dollar Sign Bling Emblem, Pewter (ea)



SHIFTER SPLINE COVER

Removing the heel shift lever is an easy task, but it leaves the unsightly shifter spline exposed. Our slick little chrome cover solves that problem quickly and inexpensively.

FOR HARLEY-DAVIDSON*

Fits: All H-D Shifter Shafts

9072 Chrome (ea)



SHIFT LINKAGE EXTENSION KIT

The kit includes 1-1/2" and 2-1/2" extension adapters, which can be used independently or threaded together for up to 4" of extension.

FOR HARLEY-DAVIDSON*

Fits: Can be used to extend any shift linkage with 5/16"-24 right-hand threaded ends.

1067 Chrome (kit)

SHIFT & BRAKE LEVERS

PRECISION™ HEEL SHIFT ELIMINATOR

Maintains a clean appearance and prevents premature wear to the shift shaft if you decide to ditch the heel shift lever. Aluminum construction styled to match the entire Precision line of accessories for Milwaukee-Eight®.

FOR HARLEY-DAVIDSON™

Fits: '80-'19 Electra Glides, Road Glides, Road Kings, Street Glides & Trikes

6434 Chrome (ea)

6433 Gloss Black (ea)

HEEL SHIFT LEVER ELIMINATOR

Quickly and easily remove the heel shift lever on Dressers, Road Kings, or any FL Softail Models. Unique design keeps the shift shaft in perfect alignment to avoid premature shaft wear, a problem common to similar products. The Delrin® lining eliminates rattles and keeps your bike shifting as smoothly as ever.

FOR HARLEY-DAVIDSON™

Fits: '80-'19 Electra Glides, Road Glides, Road Kings, Street Glides, Tour Glides & Trikes

1045 Chrome (ea)

Fits: All '86-'17 FL Softail Models

1046 Chrome (ea)

EXTENDED GIRDER SHIFT LEVER

Gain additional room on the floorboard. 1-3/4" longer than stock. Works as both front or rear on floorboard-equipped Harleys. The perfect complement to our Extended Girder Brake Pedal.

FOR HARLEY-DAVIDSON™

Fits: Heel or Toe on '83-'19 Electra Glides, '98-'19 Road Glides (except '16-'19, FLTRU & '15-'16 FLTRUSE), '94-'19 Road Kings, '06-'19 Street Glides (except '15-'19 FLHXSE), '83-'96 Tour Glides, '09-'19 Tri Glides, '15-'19 Freewheelers & all '86-'19 FL Softail Models

1026 Chrome (ea)

Note: Not for Use in the Toe Position on '14-'19 Twin Cooled Models with Fairing Lowers

LIBERATOR™ SHIFT LEVER

Accepts any Kuryakyn or H-D shift peg (sold separately).

FOR HARLEY-DAVIDSON™

Fits: '83-'19 Electra Glides, Road Glides, Road Kings, Street Glides, Tour Glides, '09-'19 Trikes & '86-'19 FL Softail Models

1066 Chrome (ea)

SLOTTED SHIFT LEVER

Accepts any Kuryakyn or H-D shift peg (sold separately).

FOR HARLEY-DAVIDSON™

Fits: '83-'19 Electra Glides, Road Glides, Road Kings, Street Glides, Tour Glides, '09-'19 Trikes & '86-'19 FL Softail Models

1065 Chrome (ea)



6433

MUST-HAVE



6434



6433



COMPLETE THE LOOK
PRECISION LOWER FRONT
FRAME COVER **PG 181**



1045



1046



1026



1066



1066



1065



1065

New

Collections

Featured Bikes

Audio

Lighting

Accessory Mounts

Handlebar Controls,
Grips & Mirrors

Pegs & Foot Controls

Covers, Trims
& Accents

Air Cleaners
& Exhaust

Touring & Comfort

Windshields &
Air Management

Luggage &
Organizers

Index



RIDGEBACK SHIFT LEVER

FOR TOURING, TRIKE & FL SOFTAIL

Direct replacement for the OEM shift lever featuring durable forged steel construction, elegant styling with its sculpted spine, plus textured and polished surfaces for a unique contrasting effect. Includes matching shift peg.

FOR HARLEY-DAVIDSON®

Fits: '83-'19 Electra Glides, Road Glides, Road Kings, Street Glides, Tour Glides, '09-'19 Trikes & '86-'19 FL Softail Models

9644 Chrome (ea)

9647 Satin Black (ea)

RIDGEBACK BRAKE PEDAL

FOR '14-'19 TOURING & TRIKE MODELS

Made from forged steel to deliver strength, beauty, and a unique custom look. Extended design repositions the brake pedal at a lower and flatter angle for easier rider operation. Brass bushings with a grease zerk (fitting) offer smooth operation and long life. Includes matching brake peg made from A380 aluminum, which can be replaced with any H-D style shift peg.

FOR HARLEY-DAVIDSON®

Fits: Following Models Without Fairing Lower: '14-'19 Electra Glides, Road Glides, Road Kings, Street Glides & Trikes

9698 Chrome (ea)

9699 Satin Black (ea)

Note: Not compatible with Kuryakyn Ergo Guards.

GIRDER EXTENDED BRAKE PEDALS

Girder Extended Brake Pedals for models without fairing lowers are noticeably longer than stock, with a pad angle set lower and flatter for more comfortable rider operation. Girder Brake Pedals for models with fairing lowers are the same length as stock to avoid interference, but also feature a more neutral pad location for better positioning, making it easier for the operator to engage. Made from quality steel, bronze pivot bushings with grease fitting ensure smooth operation and long life. Accepts stock or aftermarket brake pads designed for the stock pedal.

FOR HARLEY-DAVIDSON®

Fits: Following Models Without Fairing Lower: '14-'19 Electra Glides, Road Glides, Road Kings, Street Glides & Trikes

9642 Without Fairing Lower, Chrome (ea)

9643 Without Fairing Lower, Gloss Black (ea)

Note: Not compatible with Kuryakyn Ergo Guards.

Fits: Following Models With Fairing Lower: '14-'19 Electra Glides, Road Glides, Road Kings, Street Glides & Trikes

9648 With Fairing Lower, Chrome (ea)

9649 With Fairing Lower, Gloss Black (ea)



EXTENDED BRAKE PEDALS

FOR '14-'19 TOURING AND TRIKE MODELS

Extended Brake Pedals for models without fairing lowers are noticeably longer than stock, with a pad angle set lower and flatter for more comfortable rider operation. Extended Brake Pedals for models with fairing lowers are the same length as stock to avoid interference, but also feature a more neutral pad location for better positioning, making it easier for the operator to engage. Made from quality steel, bronze pivot bushings with grease fitting ensure smooth operation and long life. Accepts stock or aftermarket brake pads designed for the stock pedal.

FOR HARLEY-DAVIDSON®

Fits: Following Models Without Fairing Lower: '14-'19 Electra Glides, Road Glides, Road Kings, Street Glides & Trikes

9670 Chrome (ea)

9671 Gloss Black (ea)

Note: Not compatible with Kuryakyn Ergo Guards.

Fits: Following Models With Fairing Lower: '14-'19 Electra Glides, Road Glides, Road Kings, Street Glides & Trikes

9672 Chrome (ea)

9673 Gloss Black (ea)

EXTENDED BRAKE PEDALS

FOR '97-'13 TOURING & '87-'17 FL SOFTAIL

Lever relocate the brake pedal pad while flattening the angle of the pad, resulting in easier and more natural braking. Amount of extension varies depending on application. All levers are beautifully polished and chrome-plated and feature a bronze bushing with a grease fitting for smooth operation and long life.

FOR HARLEY-DAVIDSON®

Fits: '97-'07 Electra Glides, Road Glides, Road Kings & Street Glides; '87-'17 FL Softail Models

1027 Chrome Girder, Chrome (ea)

9061 Chrome (ea)

Fits: '08-'13 Electra Glides, Road Glides, Road Kings, Street Glides & '09-'13 Trikes

1071 Chrome Girder, Chrome (ea)

Note: On '02-'13 Touring and FL Softail Models our Extended Brake Pedals provide just slightly more extension than stock but the brake pedal pad is lower & flatter, making the transition from board to brake more natural. On '02-'07 Models our extended Brake Pedals provide slightly more extension than stock but the Brake Pedal Pad is lower & flatter, making the transition from board to brake more neutral.



COMPLETE THE UPGRADE..

DELUXE ISO™-BRAKE
PEDAL PAD **PG 119**



New

Collections

Featured Bikes

Audio

Lighting

Accessory Mounts

Handlebar Controls,
Grips & Mirrors

Pegs & Foot Controls

Covers, Trims
& Accents

Air Cleaners
& Exhaust

Touring & Comfort

Windshields &
Air Management

Luggage &
Organizers

Index

FORWARD CONTROLS



9064



9062



9062

FORWARD CONTROLS

Flush, countersunk fasteners used for a clean, uncluttered appearance. All ball joints, linkages and visible hardware are chrome finished. Igus shifter bearings provide smooth, maintenance-free operation. Footpegs not included.

FOR HARLEY-DAVIDSON®

Fits: '91-'17 Dyna Models (except '12-'16 FLD Dyna Switchback)

9064 Extended forward Controls, Chrome (ea)

9063 Standard forward Controls, Chrome (ea)

Note: Not compatible with most engine guards or with stock exhaust on '08-'16 FXDF, '09-'10 FXDFSE, '10-'16 FXDWG or '14-'16 FXDL. As a guideline, we suggest the Standard Controls, P/N 9063, for riders with a 33" or shorter inseam.

3" EXTENSION KIT

Move your stock forward controls a full 3" forward. The set includes extension plates, countersunk trim plates, linkages, and all hardware. All chrome components. Only basic hand tools are needed to complete this easy installation.

FOR HARLEY-DAVIDSON®

Fits: '93-'02 FXDWG and any Dyna Models using H-D Forward Controls (P/N 49080-93A)

9062 Chrome (set)

Fits: '03-'08 FXDWG & Any Dyna Models Using H-D Forward Controls (P/N 49080-03 or 49080-06)

9049 Chrome (set)

Note: Also compatible with '08-'17 FXDF, '09-'10 FXDFSE or '10-'17 FXDWG if stock exhaust has been removed & replaced with a staggered dual system.



COVERS TRIMS & ACCENTS

OUTER FAIRING	152
INNER FAIRING	159
TANK & DASH	166
FRONT END	171
ENGINE	177
HORN COVERS & HORNS	203
FASTENER COVERS	206
FRAME	208
REAR END	213
LICENSE PLATE FRAMES & MOUNTS	228
FLAGS	234

OUTER FAIRING



ALSO AVAILABLE..
GRAPHIC WINDSHIELDS
PG 284



SMOOTH WINDSHIELD TRIM

Beautifully finished and easy to install.

FOR HARLEY-DAVIDSON™

Fits: '96-'13 Electra Glides, '06-'13 Street Glides, '09-'13 Trikes & Kuryakyn AirMaster Fairings

1310 Chrome (ea)

1318 Gloss Black (ea)

Fits: '14-'19 Electra Glides, Street Glides & Tri Glide

1389 Gloss Black (ea)

1387 Chrome (ea)

TRI-LINE WINDSHIELD TRIM

Simple installation with the included polished hardware.

FOR HARLEY-DAVIDSON™

Fits: '14-'19 Electra Glides, Street Glides & Trikes

2631 Chrome (ea)

ZOMBIE™ WINDSHIELD TRIM

Includes two windshield mounting spikes.

FOR HARLEY-DAVIDSON™

Fits: '96-'13 Electra Glides, '06-'13 Street Glides, '09-'13 Trikes & Kuryakyn AirMaster Fairings

1198 Zombie™, Chrome (ea)

Fits: Kuryakyn Zombie Windshield Trim, P/N 1198

1189 Replacement Emblem, Chrome (ea)

DECORATIVE WINDSHIELD SCREWS

Direct replacements for the stock bolts featuring durable cast aluminum accents and steel fasteners.

FOR HARLEY-DAVIDSON™

Fits: '96-'13 Electra Glides, Street Glides & Trikes. Universal 5/16"-18 x 5/8" Applications

5717 Chrome (set)

5718 Gloss Black (set)

Fits: '14-'19 Electra Glides, Street Glides & Trikes

5719 Chrome (set)

5720 Gloss Black (set)

WINDSHIELD MOUNTING SPIKES

Can be used with or without most windshield trims.

FOR HARLEY-DAVIDSON™

Fits: '96-'13 Electra Glides, Street Glides & Trikes. Universal 1/4"-20 x 5/8" Applications

1369 Chrome (set)

5712 Gloss Black (set)

Fits: '14-'19 Electra Glides, Street Glides & Tri Glides

5713 Chrome (set)

5714 Gloss Black (set)



6511

MESH

MESH FAIRING INTAKE VENT ACCENT

Replaces stock intake vent bezel for a fully integrated appearance. Aluminum outer frame secures stainless steel mesh insert via exposed socket head cap screws for a tough, industrial look. Disassembles easily to custom-paint individual components.

FOR HARLEY-DAVIDSON®

Fits: '14-'19 Electra Glides, Street Glides & Tri Glides

6511 Chrome (ea)

6512 Satin Black (ea)

Note: Does not fit CVO models or color matched Slipstream vent trim for Batwing fairings.



ALSO AVAILABLE..
MESH TIMING COVER
PG 187

**L.E.D. FAIRING VENT ACCENT FOR '14-'19 TOURING & TRIKE**

Add a chrome or gloss black accent with a hint of sharp white L.E.D. lighting to the fairing vent on your H-D touring bike. Plug-and-play installation.

FOR HARLEY-DAVIDSON®

Fits: '14-'19 Electra Glides, Street Glides & Tri Glide

5053 Chrome (ea)

5056 Gloss Black (ea)

Note: Does not fit CVO models or color matched Slipstream vent trim for Batwing fairings.

FAIRING VENT ACCENT U.S. Patent D772,107

A clean and simple solution to update the look of the boring black vent.

FOR HARLEY-DAVIDSON®

Fits: '14-'19 Electra Glides, Street Glides & Tri Glides

6901 Chrome (ea)

6912 Gloss Black (ea)

Note: Does not fit CVO models or color matched Slipstream vent trim for Batwing fairings.



6512



5053



5053



5056



6912



6912



6901

New

Collections

Featured Bikes

Audio

Lighting

Accessory Mounts

Handlebar Controls,
Grips & Mirrors

Pegs & Foot Controls

Covers, Trims
& AccentsAir Cleaners
& Exhaust

Touring & Comfort

Windshields &
Air ManagementLuggage &
Organizers

Index



7131



SEQUENTIAL RUN-TURN L.E.D. BAT LASHES

Tried-and-true style plus increased visibility now offered with integrated sequential turn signals. Auxilliary run-turn functionality featuring white L.E.D. running lights and amber L.E.D. turn signals that light up individually for consistent directional illumination. Durable injection-molded ABS with ultra-bright L.E.D.'s for longer life, low current draw and a look unlike any other.

FOR HARLEY-DAVIDSON®

Fits: '14-'19 Electra Glides, Street Glides & Tri Glide

7131 Chrome (pr)

Note: Requires drilling to route wiring.

7753



L.E.D. BAT LASHES

Enhance batwing fairing contours while increasing nighttime visibility. The sleek ABS housings provide full-time L.E.D. functionality for unrivaled style and low current draw.

FOR HARLEY-DAVIDSON®

Fits: '96-'13 Electra Glides, Street Glides & Trikes

7753 Chrome (pr)

Note: Requires drilling to route wiring.

6904



7753



Fits: '14-'19 Electra Glides, Street Glides & Tri Glide

6904 Chrome (pr)

Note: Requires drilling to route wiring.



6708
PAGE 283

DILLINGER™ HEADLIGHT TRIM RING

FOR 5-3/4" HEADLIGHTS

Ditch the boring stock 5-3/4" trim ring with this aggressively styled direct replacement and you've got a killer new look in minutes. Aluminum construction with a grilled design that can be run horizontally or vertically depending on your style preference.

FOR HARLEY-DAVIDSON®

Fits: '11-'13 FXS, '08-'11 FLSTSB, '99-'06 FXST/I, '99-'09 FXSTB/I, '94-'99 FXSTC, '13-'17 FXSB, '16-'17 FXSE, '94-'17 Dyna Models (except '08-'17 FXDF, '09-'10 FXDFSE, '12-'16 FLD), '94 FXLR, '04-'08 XL883, '05-'19 XL883L, '09-'19 XL883N, '06-'08 XL883R, '04-'08 XL1200R, '07 XL50, '07-'11 XL1200L, '07-'12 XL1200N, '14-'17 XL1200T, '16-'19 XL1200CX & '10-'19 XL1200X/S

6687 Silver (ea)

6688 Satin Black (ea)



L.E.D. HALO TRIM RINGS U.S. Patents D667,989 & D668,380 Night or day, add incredible style with our L.E.D. grooved trims that are easy to install and feature low draw on your electrical system.

FOR HARLEY-DAVIDSON®

Fits: '14-'19 Electra Glides, Street Glides & Tri Glide

6917 7", Chrome (ea)

Fits: '83-'13 Electra Glides, '06-'13 Street Glides, '94-'19 Road Kings, '09-'13 Trikes & '12-'16 Dyna Switchbacks

7785 7", Chrome (ea)

Fits: '83-'19 H-D Models with 4-1/2" Passing Lamps

7748 4-1/2", Chrome (pr)

Fits: '07-'10 FXSTC, '00-'07 FXSTD/I, '93-'06 FXSTS/I, '95-'97 FXSTSB, '97-'03 FLSTS/I, '05-'07 FLSTSC/I, '13-'14 FXSBSE, '99 FXR2/3, '99-09 XL883C, '96-'19 XL1200C & '12-'16 XL1200V

7270 5-3/4", Chrome (ea)



Note: Not compatible with Orbit Headlights P/N 5460 & 2461

- New
- Collections
- Featured Bikes
- Audio
- Lighting
- Accessory Mounts
- Handlebar Controls, Grips & Mirrors
- Pegs & Foot Controls
- Covers, Trims & Accents
- Air Cleaners & Exhaust
- Touring & Comfort
- Windshields & Air Management
- Luggage & Organizers
- Index



6915 & 7277



7275 & 7277

HEADLIGHT TRIM RINGS U.S. Patent D667,989
Add incredible style with these easy-to-install grooved trim rings. Available in Chrome or Gloss Black.

FOR HARLEY-DAVIDSON®

Fits: '83-'13 Electra Glides, '06-'13 Street Glides, '94-'19 Road Kings, '09-'13 Trikes & '12-'16 Dyna Switchbacks

7275 7", Chrome (ea)

7276 7", Gloss Black (ea)

Fits: '83-'19 H-D Models with 4 1/2" Passing Lamps

7277 4-1/2", Chrome (pr)

Fits: '14-'19 Electra Glides, Street Glides & Tri Glide

6915 7", Chrome (ea)

6916 7", Gloss Black (ea)



6916



7277

HEADLIGHT VISOR FOR 7" HEADLIGHT

Fastens securely to your existing headlight for easy installation.

FOR MULTI-FIT

Fits: Universal: 7" Headlights with Retainer Ring

FOR HARLEY-DAVIDSON®

Fits: H-D Models with 7" Headlights (except '14-'19 Electra Glides, Street Glides & Trikes)

2182 Chrome (ea)



2182



2182

Note: Not compatible with H-D® Accessory Trim Rings.

BAT BROW

Add a little edginess to your batwing fairing with this easy-to-install accent.

FOR HARLEY-DAVIDSON®

Fits: '96-'13 Electra Glides, Street Glides & Trikes

7796 Chrome (ea)



6902



6902

Fits: '14-'19 Electra Glides, Street Glides & Tri Glide

6902 Chrome (ea)



7796



7796

TRI-LINE FAIRING ACCENTS FOR '14-'19 TOURING & TRIKE
Sleek, streamlined, and designed to complement the traditional batwing shape with their unique Tri-Line feature. Easy installation with high-strength adhesive.

FOR HARLEY-DAVIDSON®

Fits: '14-'19 Electra Glides, Street Glides & Tri Glides

6903 Chrome (pr)

6972 Gloss Black (pr)

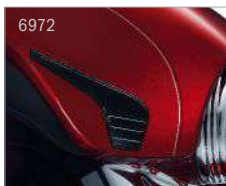

6972



6903

2635

**WINDSHIELD TRIMS** FOR '15-'19 ROAD GLIDE

Choose the Side Trims only, or complete the look with the Center Trim for full coverage. Made from lightweight injection-molded ABS, installation of the Gloss Black Trim pieces reuses OEM hardware while the Chrome versions come with stainless steel replacement screws.

FOR HARLEY-DAVIDSON™

Fits: '15-'19 Road Glides

2632 Side Trims, Chrome (set)

2633 Side Trims, Gloss Black (set)

2634 Center Trim, Chrome (ea)

2635 Center Trim, Gloss Black (ea)

FAIRING VENT ACCENT FOR '15-'19 ROAD GLIDE

A hassle-free solution to adding distinct style to the center scoop area of the fairing vent below the windshield. Injection-molded ABS that easily installs via high-strength 3M® VHB™ adhesive without removal of the windshield.

FOR HARLEY-DAVIDSON™

Fits: '15-'19 Road Glides

6913 Chrome (ea)

6914 Gloss Black (ea)

DECORATIVE WINDSHIELD SCREWS

Change the look and attitude of your fairing with these direct replacements for the stock bolts featuring durable cast aluminum accents and steel fasteners.

FOR HARLEY-DAVIDSON™

Fits: '15-'19 FLTRX & FLTRXS Road Glides

5721 Chrome (set)

5722 Gloss Black (set)

WINDSHIELD MOUNTING SPIKES

Direct replacement windshield mounting screws with a little more style. Batwing applications can be used with or without most windshield trims, Road Glide applications not compatible with stock FLTRU or Kuryakyn Windshield Trims.

FOR HARLEY-DAVIDSON™

Fits: '15-'19 FLTRX & FLTRXS Road Glides

5715 Chrome (set)

5716 Gloss Black (set)

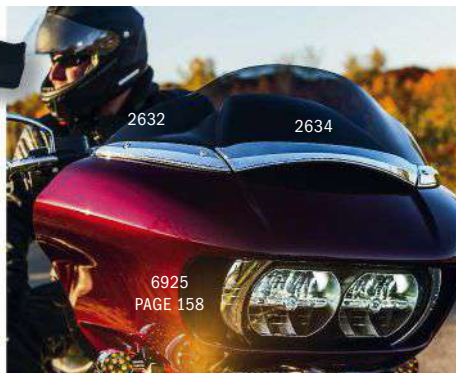

ALSO AVAILABLE..
GRAPHIC WINDSHIELDS
PG 284



New

Collections

Featured Bikes

Audio

Lighting

Accessory Mounts

Handlebar Controls,
Grips & Mirrors

Pegs & Foot Controls

Covers, Trims
& AccentsAir Cleaners
& Exhaust

Touring & Comfort

Windshields &
Air ManagementLuggage &
Organizers

Index



2632
pg 157

6913
pg 157

6518



6519



6518

MESH HEADLIGHT VENT ACCENTS FOR ROAD GLIDE

A rugged and industrial grilled design delivers an aggressive styling enhancement. Aluminum outer frame with formed steel mesh panel provides sharp contrasting elements and impactful visual appeal.

FOR HARLEY-DAVIDSON®

Fits: '15-'19 Road Glides

6518 Chrome (pr)

6519 Satin Black (pr)



6519



6925

TRI-LINE HEADLIGHT VENT ACCENTS

FOR '15-'19 ROAD GLIDE

A simple upgrade to the headlight housing and vent area on redesigned Road Glide™ fairings using 3M® VHB™ adhesive. Installation does not require or impede removal of the outer fairing.

FOR HARLEY-DAVIDSON®

Fits: '15-'19 Road Glides

6925 Chrome (pr)



6925

WINDSHIELD TRIMS FOR ROAD GLIDE

Make a clean transition. This handsome three-piece trim set provides a smooth, flowing bridge from the fairing to the windshield.

FOR HARLEY-DAVIDSON®

Fits: '98-'13 Road Glides ('09-'13 CVO Models Require H-D 58705-98D Molding, Sold Separately)



1370



1309

1370 Chrome (ea)

1309 Gloss Black (ea)

INNER FAIRING



TRI-LINE

7285

7299

7278
PAGE 160

TRI-LINE GAUGE TRIM U.S. Patent D777,061
Transform your stock gauges and inner fairing into a show piece all their own. One piece design surrounds all four gauges and features easy installation using high-strength adhesive. A clean one-piece design and easy installation make this a must-have upgrade to your inner fairing.

FOR HARLEY-DAVIDSON™

Fits: '14-'19 Electra Glides, Street Glides & Tri Glide

7284 Chrome (ea)

7285 Gloss Black (ea)

TRI-LINE STEREO TRIMS & ACCENTS

FOR '14-'19 TOURING & TRIKE

U.S. Patents D772,759, U.S. Patents D772,759 & D772670
These stylish trims work with either the 4.3 or 6.5GT Boom! Infotainment System. Choose from Stereo Trims only or the Deluxe Kits that also cover the adjacent media door and side panel.

FOR HARLEY-DAVIDSON™

Fits: '14-'19 Electra Glides, Street Glides & Tri Glide

7240 Deluxe Tri-Line Stereo Trim Kit for Boom! Box 6.5GT, Chrome (kit)

7299 Deluxe Tri-Line Stereo Trim Kit for Boom! Box 6.5GT, Gloss Black (kit)

7239 Stereo Trim Only, Chrome (ea)

7291 Stereo Trim Only, Gloss Black (ea)



7284

7240

7284



7240

7299

7239

7291



ALSO AVAILABLE
TRI-LINE FUEL DOOR
PG 166



COVERS, TRIMS & ACCENTS
INNER FAIRING

New

Collections

Featured Bikes

Audio

Lighting

Accessory Mounts

Handlebar Controls,
Grips & Mirrors

Pegs & Foot Controls

Covers, Trims
& Accents

Air Cleaners
& Exhaust

Touring & Comfort

Windshields &
Air Management

Luggage &
Organizers

Index



SWITCH PANEL ACCENT FOR '14-'19 TOURING & TRIKE
Transform the OEM switch panel with this stylish accent that features simple installation requiring no tools or disassembly.

FOR HARLEY-DAVIDSON™

Fits: '14-'19 Electra Glides, Street Glides & Tri Glides

7283 Chrome (ea)

7278 Gloss Black (ea)

TRI-LINE IGNITION SWITCH COVER

Carry the clean, custom Tri-Line theme to the lower inner fairing with this quality die-cast aluminum cover that does not require removal of the stock switch for installation.

FOR HARLEY-DAVIDSON™

Fits: '14-'19 Electra Glides (except '14-'19 FLHTKSE), Road Glides (except '15-'18 FLTRUSE, '18-'19 FLTRXSE), Street Glides (except '15-'19 FLHXSE) & '14-'19 Tri Glides

6984 Chrome (ea)

6985 Gloss Black (ea)

TRI-LINE INNER FAIRING COVER PLATES

Attaches to Batwing fairings with high-strength 3M® VHB™ adhesive.

FOR HARLEY-DAVIDSON™

Fits: '14-'19 Electra Glides, Street Glides & Tri Glides

6978 Chrome (pr)

6979 Gloss Black (pr)

SPEAKER GRILLS FOR '14-'19 TOURING & TRIKE

With these trick, easy-to-install grills, your speakers will look as good as they sound!

FOR HARLEY-DAVIDSON™

Fits: '14-'19 Electra Glides (except '14-'19 FLHTKSE), '14-'19 Street Glides (except '18-'19 FLHXS, '15-'18 FLHXSE) & '14-'19 Tri Glide Ultra

7373 Zombie™ Speaker Grill, Chrome (pr)

7374 Flame Speaker Grill, Chrome (pr)

7375 Vortex Speaker Grill, Chrome (pr)

7377 Corona Speaker Grill, Chrome (pr)

Note: Can be installed on rear speakers with addition of P/N 7376, sold separately.

REAR SPEAKER ACCENTS

Replaces stock rear speaker rings and mesh grills. Required to install matching Speaker Grills to your rear speakers.

FOR HARLEY-DAVIDSON™

Fits: '14-'19 Electra Glides (except '14-'19 FLHTKSE), '16-'19 Road Glide Ultra (except '15-'16 FLTRUSE), '14-'19 Tri Glide Ultra

7376 Chrome (pr)



TRI-LINE



TRI-LINE SPEED & TACH ACCENTS

This two-piece accent provides an easy and effective way to instantly customize the speedo and tach cluster for Road Glides. Made from injection-molded ABS, installs using high-strength adhesive.

FOR HARLEY-DAVIDSON™

Fits: '15-'19 Road Glides

6926 Chrome (ea)

6928 Gloss Black (ea)

TRI-LINE FUEL & VOLTAGE GAUGE BEZELS

Gracefully fill the recessed areas surrounding the battery voltage and fuel gauges with styling to match the full lineup of Tri-Line accessories. Hassle-free installation will revamp your Road Glide cockpit in minutes.

FOR HARLEY-DAVIDSON™

Fits: '15-'19 Road Glides

6922 Chrome (pr)

6927 Gloss Black (pr)

TRI-LINE STEREO TRIMS

Choose between the outer trim only for both stereo options, or choose the outer frame and faceplate that fills the dead space left between the stereo control panel on 4.3-inch systems.

FOR HARLEY-DAVIDSON™

Fits: '15-'19 Road Glides

6964 Stereo Trim Only, Chrome (ea)

6965 Stereo Trim Only, Gloss Black (ea)

Fits: '15-'19 Road Glides with Boom! Box 4.3 Stereo

6966 For Road Glide with Boom! Box 4.3, Chrome (kit)

6967 For Road Glide with Boom! Box 4.3, Gloss Black (kit)

SWITCH PANEL ACCENT

Made from injection-molded ABS that is durable, lightweight and easy to install via high-strength 3M® VHB™ adhesive.

FOR HARLEY-DAVIDSON™

Fits: '15-'19 Road Glides

6970 Chrome (ea)

6971 Gloss Black (ea)



COMPLETE THE LOOK!
TRI-LINE SPEAKER GRILLS
PG 162



New

Collections

Featured Bikes

Audio

Lighting

Accessory Mounts

Handlebar Controls,
Grips & Mirrors

Pegs & Foot Controls

Covers, Trims
& Accents

Air Cleaners
& Exhaust

Touring & Comfort

Windshields &
Air Management

Luggage &
Organizers

Index



TRI-LINE SPEAKER GRILLS

Compatible with Harley's standard and Boom! audio speakers, the clean outer frame with satin black aluminum mesh screen offers a drastic improvement in appearance versus the stock plastic honeycomb grills. Installation is a snap.

FOR HARLEY-DAVIDSON®

Fits: '15-'19 Road Glides (except '18-'19 FLTRXS)

7378 Chrome (pr)

7379 Gloss Black (pr)

Note: Compatible with standard and Boom! Audio Stage I Speakers (stock on CVO models). Not compatible with Boom! Audio Stage II Speakers.



TRI-LINE SPEAKER ACCENTS FOR '15-'19 ROAD GLIDE

Add a clean, custom Tri-Line enhancement for an effortless upgrade around stock Road Glide speaker grills with easy application using high-strength 3M® VHB™ adhesive.

FOR HARLEY-DAVIDSON®

Fits: '15-'19 Road Glides

7385 Chrome (pr)

7386 Gloss Black (pr)

TRI-LINE GLOVE BOX ACCENTS FOR '15-'19 ROAD GLIDE

This four-piece kit (two per door) adds sleek styling to match the rest of the Tri-Line accessories for a cohesive theme throughout. Made from lightweight and durable injection-molded ABS, installation via high-strength adhesive does not require removal of the glove box doors.

FOR HARLEY-DAVIDSON®

Fits: '15-'19 Road Glides

6924 Chrome (pr)

6919 Gloss Black (pr)



TRI-LINE TOP DASH ACCENT

This contoured accent hugs the center of the upper dash just behind the windscreen to drastically enhance the dull black panel and vent. Features the Tri-Line collection's signature clean styling for a streamlined custom appearance, constructed from durable injection-molded ABS.

FOR HARLEY-DAVIDSON®

Fits: '15-'19 Road Glides

6962 Chrome (ea)

6963 Gloss Black (ea)



GLOVE BOX ACCENTS FOR ROAD GLIDE

This striking chrome trim provides a finger catch to make opening the doors a snap - even with gloves on!

FOR HARLEY-DAVIDSON®

Fits: '98-'13 Road Glides

3769 Chrome (pr)

INNER FAIRING DRESS-UP PACKAGE

We've taken our three most popular items and packaged them in one kit. This easy-to-install kit contains: Speedo & Tach Brow, Switch Panel Accent and Stereo Accent.

FOR HARLEY-DAVIDSON®

Fits: '96-'13 Electra Glides (except '07-'13 FLHTCUSE), '06-'13 Street Glides & '09-'13 Trikes

7229 Chrome (kit)



7229

SPEEDO & TACH BROW

Chrome-plated ABS elegantly accents the speedo and tach gauge cluster.

FOR HARLEY-DAVIDSON®

Fits: '96-'13 Electra Glides (except '07-'13 FLHTCUSE), Street Glides & Trikes

7746 Chrome (ea)



7229

STEREO ACCENT

Made from lightweight ABS. No tools or disassembly required for installation.

FOR HARLEY-DAVIDSON®

Fits: '96-'13 Electra Glides, '06-'13 Street Glides & '09-'13 Trikes

3765 Chrome (ea)

*Top Selling Items
in one Kit!*

SWITCH PANEL ACCENT U.S. Patent D629,337

Transform the OEM switch panel with this stylish accent that features simple installation with high-strength adhesive.

FOR HARLEY-DAVIDSON®

Fits: '96-'13 Electra Glides, '06-'13 Street Glides & '09-'13 Trikes

3783 Chrome (ea)



7746



7746

ROCKER SWITCH COVER KITS

Brushed stainless for a unique custom look. Quick installation with no disassembly required.

FOR HARLEY-DAVIDSON®

Fits: '96-'13 FLHTCU/I, '10-'13 FLHTK, '06 FLHTCUSE, '98-'09 FLTR/I, '11-'13 FLTRU, '00-'01 & '09 FLTRSE & '09-'13 FLHTCUTG

7232 Brushed Stainless (set)

Fits: '06-'13 FLHX/I, '10-'12 FLHXSE, '10-'11 FLHXXX & '10-'13 FLTRX

7233 Brushed Stainless (set)

Fits: '96-'09 FLHT/I, '96-'13 FLHTC/I & '04-'05 FLHTCSE

7234 Brushed Stainless (set)



3765

3783



LOOKS GREAT WITH
SPEAKER ACCENTS
PG 165



3765

3783

7232

New

Collections

Featured Bikes

Audio

Lighting

Accessory Mounts

Handlebar Controls,
Grips & Mirrors

Pegs & Foot Controls

Covers, Trims
& AccentsAir Cleaners
& Exhaust

Touring & Comfort

Windshields &
Air ManagementLuggage &
Organizers

Index



L.E.D. SPEEDO & TACH BEZELS

Bathe your speedo and tach in blue light with these L.E.D. Speedo and Tach Bezels. The radial design adds a stunning visual appearance unlike anything you've seen before.

FOR HARLEY-DAVIDSON*

Fits: '00-'13 Electra Glides, '06-'13 Street Glides & '09-'13 Trikes

7288 Gloss Black (pr)

7289 Chrome (pr)

L.E.D. SPEAKER BEZELS FOR TOURING & TRIKE

Take your inner dash to the next level! These are a great match to the L.E.D. Speedo & Tach Bezels. Featuring state-of-the-art blue illumination in a striking radial design.

FOR HARLEY-DAVIDSON*

Fits: '96-'13 Electra Glides, Street Glides & Trikes

7287 Chrome (pr)

7286 Gloss Black (pr)

DELUXE GAUGE BEZELS

Dress-up your gauges with these chrome bezels featuring interchangeable black, red, and blue accents.

FOR HARLEY-DAVIDSON*

Fits: '00-'13 Electra Glide, Road Glide, Street Glide & Trike Speedometers and Tachometers

3781 Large, Chrome (pr)

Fits: '86-'13 Electra Glide, Road Glide, Street Glide & Trike Voltmeter, Oil Pressure, Air Temp & Fuel Gauges

3782 Small, Chrome (pr)

ALSO AVAILABLE
L.E.D. BAT LASHES
PG 154





3753

SPEAKER GRILLS

FOR '96-'13 TOURING & TRIKE

With these trick, easy-to-install grills, your speakers will look as good as they sound! Available in multiple designs to suit your individual personality.

FOR HARLEY-DAVIDSON®

Fits: '96-'13 Electra Glides (except '12-'13 FLHTCUSE), '06-'13 Street Glides (except '11-'12 FLHXSE) & '09-'13 Trikes

- 3787 Zombie, Chrome (pr)
- 3788 Flame, Chrome (pr)
- 3753 Firefighter, Chrome (pr)

Note: When combined with P/N 3792, will fit rear speakers on '98-'13 FLHTCU, FLHTK, '08-'11 FLHTCUSE, '09-'13 FLTCUTG & '11-'13 FLTRU. Single Grills available, see Medallions listed with Mach 2 Air Cleaners.

REAR SPEAKER ACCENTS FOR '98-'13 TOURING & TRIKE

Look great by themselves but are also required to install matching Speaker Grills to your rear speakers. Installs over stock black rear speaker rings. Includes polished stainless hardware.

FOR HARLEY-DAVIDSON®

Fits: '98-'13 FLHTCU/I, '10-'13 FLHTK, '08-'11 FLHTCUSE, '11-'13 FLTRU & '09-'13 FLHTCUTG.

- 3792 Chrome (pr)

RUN-TURN EDGE ACCENTS FOR BATWING FAIRING

A nice subtle touch of chrome with additional lighting to create a unique look.

FOR HARLEY-DAVIDSON®

Fits: '96-'13 Electra Glides, Street Glides & Trikes

- 7266 Chrome (pr)

INNER FAIRING COVER PLATES

Cover the mounting holes left by stock inner fairing-mounted mirrors.

FOR HARLEY-DAVIDSON®

Fits: '06-'13 Street Glides & '10-'11 Street Glide Trikes

- 3767 Chrome (pr)
- 7210 Gloss Black (pr)

INNER FAIRING COVERS

Is your inner fairing dull or sun-faded? Here's a simple fix to make this area better than new.

FOR HARLEY-DAVIDSON®

Fits: '96-'13 Electra Glides & '09-'13 FLHTCUTG Tri Glide Ultra Classics

- 7267 Gloss Black (pr)



3788



3787



3753



3792



3792 & 3787



7266



7210

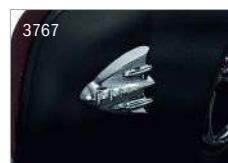

3767



7267



7267

New

Collections

Featured Bikes

Audio

Lighting

Accessory Mounts

Handlebar Controls,
Grips & Mirrors

Pegs & Foot Controls

Covers, Trims
& Accents

Air Cleaners
& Exhaust

Touring & Comfort

Windshields &
Air Management

Luggage &
Organizers

Index

TANK & DASH

**MESH FUEL DOOR**

A radical direct replacement that accepts the stock lock or push-button latch. Aluminum outer frame and baseplate with steel mesh insert creates a unique three-piece design to custom paint individual components.

FOR HARLEY-DAVIDSON*

Fits: '08-'19 Electra Glides, Road Glides (except '12-'13 & '18-'19 FLTRXSE), Street Glides (except '11-'12, '15-'19 FLHXSE) & '09-'19 Tri Glides

6982 Chrome (ea)

6983 Satin Black (ea)

TRI-LINE FUEL DOOR

Drastic styling improvement over the stock fuel door to coordinate with the entire Tri-Line family of products. Made from high-quality A380 aluminum, this direct replacement fuel door installs with simple hand tools reusing the factory hardware, lock and latch mechanisms.

FOR HARLEY-DAVIDSON*

Fits: '08-'19 Electra Glides, Road Glides (except '12-'13 & '18-'19 FLTRXSE), Street Glides (except '11-'12, '15-'19 FLHXSE) & '09-'19 Tri Glides

6968 Chrome (ea)

6969 Gloss Black (ea)

PUSH BUTTON FUEL DOOR LATCH

Direct replacement for stock key-lock fuel door latch.

FOR HARLEY-DAVIDSON*

'92-'19 Electra Glides, Road Glides (except '12-'13 & '19 FLTRXSE), Street Glides (except '11-'12 & '15-'19 FLHXSE), Tour Glides & '09-'19 Tri Glides (except '15-'19 FLRT)

1467 Chrome (ea)

7428 Gloss Black (ea)

**DASH PANEL INSERT**

Transform the look of your dash from stock to custom quickly and easily.

FOR HARLEY-DAVIDSON*

Fits: '00-'08 FLSTC/I, '06 FLST/I, '05-'17 FLSTN/I, '00-'17 FLSTF/I, '10-'17 FLSTFB, '16-'17 FLSTFBS, '05-'07 FLSTSC/I, '00-'03 FLSTS/I, '07-'10 FXSTC, '00-'08 FXST/I, '00-'09 FXSTB/I, '00-'06 FXSTS/I & '93-'03 FXDWG

1522 Chrome (ea)

**SPEEDOMETER VISORS**

Easily affixes to the speedometer to reduce glare.

FOR HARLEY-DAVIDSON*

Fits: '98-'13 Road Glide Models, '04-'10 XL883C, '04-'19 XL1200C, '13-'17 XL1200CA, '13 XL1200CA-ANV, '13-'17 XL1200CB, '11-'17 XL1200CP, '06-'11 XL1200L, '04-'09 XL1200R, '14-'17 XL1200T, '12-'16 XL1200V & '06 XL50 Sportster Models.

4015 Chrome (ea)



Fits: '68-'19 H-D Models with 5" Tank-Mounted Speedometer (except CVO, and '08-up FLHR/C/XS)

112 Chrome (ea)

SIGNATURE SERIES SMOOTH DASH CONSOLE BY JIM NASI

Die-cast aluminum construction with a unique, smooth design that flows with the tank's contours for a custom look without having to go the stretched tank route. Direct replacement for the factory dash panel and uses existing mounts. Gloss black finish can be easily prepped to paint-match custom color themes.

FOR HARLEY-DAVIDSON™

Fits: Following Models with Center Fill Tank and without CB port: '08-'19 Electra Glides, Road Glides, Street Glides & Street Glide Trikes

5688 Chrome (ea)

5689 Gloss Black (ea)

Note: Will fit '08-'19 Ultra, Limited & Tri Glide Models if CB port is relocated or removed

FLUSH MOUNT POP-UP GAS CAP

Clean low-profile billet aluminum design ideal for those who like a tank with a sleek, uncluttered appearance. Just push in the cap and rotate it a 1/4 turn left to pop it, or right to lock it. Knurled surface on the outer ring offers grip for easy opening and closing.

FOR HARLEY-DAVIDSON™

Fits: '96-'19 H-D Screw-Type Tanks - R.H. Thread - Vented

7178 Chrome (ea)

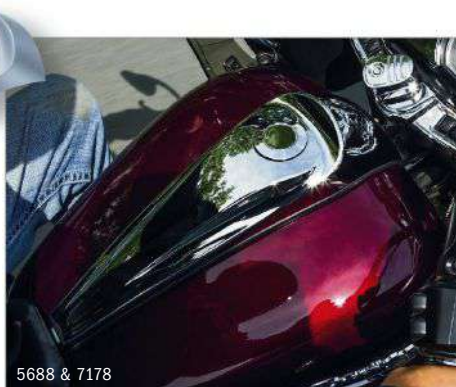
**SCULPTED DASH INSERTS**

The polished and sand-casted finish provides a contrasting textured appearance. Durable, injection-molded ABS direct replacement for the stock dash insert.

FOR HARLEY-DAVIDSON™

Fits: '08-'19 FLHX, '14-'19 FLHXS, '10-'13 & '15-'19 FLTRX, '15-'19 FLTRXS

6990 Chrome (ea)

6991 Chrome & Black (ea)

Fits: '08-'19 FLHTCU/L, '11-'19 FLHTK/L, '11-'13 & '16-'19 FLTRU, '11 & '15-'16 FLTRUSE, & '09-'19 FLHTCUTG

6988 Chrome (ea)

6989 Chrome & Black (ea)

**SCULPTED IGNITION SWITCH COVERS**

Made from high-quality A380 cast aluminum. Installs easily over the stock ignition switch via 3M™ VHB™ adhesive with no disassembly required.

FOR HARLEY-DAVIDSON™

Fits: '14-'19 Electra Glides (except '14-'19 FLHTKSE), Road Glides (except '15-'18 FLTRUSE, '18-'19 FLTRXSE), Street Glides (except '15-'19 FLHXSE) & '14-'19 Tri Glides

6992 Chrome (ea)

6993 Chrome & Black (ea)

Fits: '07-'13 Electra Glides, Road Glides, Street Glides & '09-'13 Trikes

6994 Chrome (ea)

6995 Chrome & Black (ea)



New

Collections

Featured Bikes

Audio

Lighting

Accessory Mounts

Handlebar Controls,
Grips & Mirrors

Pegs & Foot Controls

Covers, Trims
& AccentsAir Cleaners
& Exhaust

Touring & Comfort

Windshields &
Air ManagementLuggage &
Organizers

Index



MESH DASH INSERTS

A rugged new look that transforms the dash console. Aluminum outer frame and baseplate with steel mesh insert creates a unique three-piece design to custom paint individual components.

FOR HARLEY-DAVIDSON®

Fits: '08-'19 FLHX, '14-'19 FLHXS, '10-'13 & '15-'19 FLTRX, '15-'19 FLTRXS

6505 Chrome (ea)

6506 Satin Black (ea)

Fits: '08-'19 FLHTCU/L, '11-'19 FLHTK/L, '11-'13 & '16-'19 FLTRU, '11 & '15-'16 FLTRUSE, & '09-'19 FLHTCUTG

6507 Chrome (ea)

6508 Satin Black (ea)

MESH GAS CAP

This low-profile vented cap gives the tank some attitude. Grooves around the perimeter offer easy removal and installation. Aluminum outer frame and baseplate with steel mesh insert creates a unique three-piece design to custom paint individual components.

FOR HARLEY-DAVIDSON®

Fits: '82-'19 H-D Screw-Type Tanks - R.H. Thread - Vented

6548 Chrome (ea)

6549 Satin Black (ea)

MESH L.E.D. FUEL & BATTERY GAUGE

U.S. Patent 7,652,563

A must-have match to the Mesh Gas Cap. Plug-&-play direct replacement for the stock fuel gauge with L.E.D. fuel level and battery voltage indicators. Low profile three-piece design disassembles easily to custom-paint individual components.

FOR HARLEY-DAVIDSON®

Fits: Replaces Stock Tank Mounted (not center console mounted) Fuel Gauge on '94-'19 Road Kings, '00-'17 Softails, '91-'17 Dynas, '15-'19 Freewheeler & '88-'94 FXR Models

6550 Chrome (ea)

6551 Satin Black (ea)



ALSO AVAILABLE..
MESH FUEL DOOR
PG 166



7382



7384



ALLEY CAT GAS CAP

This 3" diameter vented gas cap is a direct replacement for the lifeless OEM fuel cap with styling to match the top-selling Kuryakyn Alley Cat Air Cleaners.

FOR HARLEY-DAVIDSON™

Fits: '82-'19 H-D Screw-Type Tanks - R.H. Thread - Vented

7382 Chrome (ea)

7384 Gloss Black (ea)

ALLEY CAT L.E.D. FUEL & BATTERY GAUGE

U.S. Patent 7,652,563

Easily monitor battery voltage and fuel levels with the illuminated multi-colored L.E.D.'s that produce a highly visible display.

FOR HARLEY-DAVIDSON™

Fits: Replaces Stock Tank Mounted (not center console mounted) Fuel Gauge on '94-'19 Road Kings, '00-'17 Softails, '91-'17 Dynas, '15-'19 Freewheeler & '88-'94 FXR Models

7381 Chrome (ea)

7383 Gloss Black (ea)



COMPLETE THE LOOK!
ALLEY CAT AIR CLEANER
PG 243



DECO GAS CAP

This sleek and stylish design looks great with almost any paint scheme. Our matching Fuel & Battery Gauge completes the transformation.

FOR HARLEY-DAVIDSON™

Fits: '82-'19 H-D Screw-Type Tanks - R.H. Thread - Vented

7280 Chrome (ea)

DECO L.E.D. FUEL & BATTERY GAUGE

U.S. Patent 7,652,563

The sparkling L.E.D.'s let you easily judge your fuel and battery levels out of the corner of your eye. A perfect match to our stunning Deco Gas Cap.

FOR HARLEY-DAVIDSON™

Fits: Replaces Stock Tank Mounted (not center console mounted) Fuel Gauge on '94-'19 Road Kings, '00-'17 Softails, '91-'17 Dynas, '15-'19 Freewheeler & '88-'94 FXR Models

7281 Chrome (ea)



- New
- Collections
- Featured Bikes
- Audio
- Lighting
- Accessory Mounts
- Handlebar Controls, Grips & Mirrors
- Pegs & Foot Controls
- Covers, Trims & Accents
- Air Cleaners & Exhaust
- Touring & Comfort
- Windshields & Air Management
- Luggage & Organizers
- Index



7282

INFORMER L.E.D. FUEL & BATTERY GAUGE

U.S. Patent 7,652,563

A sleek, low-profile fuel gauge with color-coded L.E.D.'s to indicate fuel and battery voltage levels. Plus our patented design allows the rider to select the fuel level at which the red "empty" L.E.D. illuminates.

FOR HARLEY-DAVIDSON™

Fits: Replaces Stock Tank Mounted (not center console mounted) Fuel Gauge on '94-'19 Road Kings, '00-'17 Softails, '91-'17 Dynas, '15-'19 Freewheeler & '88-'94 FXR Models

7282 Chrome (ea)



7282



8309

FLUSH MOUNT GAS CAP

Sleek and streamlined with a keyed entry system that prevents tampering or theft, and the built-in trim ring protects the painted surface around the filler opening from dings and gas stains.

FOR HARLEY-DAVIDSON™

Fits: '82-'99 H-D Screw-Type Tanks - L.H. Thread

8310 Non-Vented, Chrome (ea)

Fits: '82-'19 H-D Screw-Type Tanks - R.H. Thread

8309 Vented, Chrome (ea)



7358

ZOMBIE™

ZOMBIE™ GAS CAP

Extend the Zombie™ theme to your tank with this direct replacement vented gas cap for OEM Harley-Davidson screw-type tanks.

FOR HARLEY-DAVIDSON™

Fits: '82-'19 H-D Screw-Type Tanks - R.H. Thread - Vented

7358 Chrome (ea)



7357

ZOMBIE™ L.E.D. FUEL & BATTERY GAUGE

U.S. Patent 7,652,563

A menacing display of easy-to-read L.E.D.'s to help keep an eye on fuel and battery voltage levels. Made from quality die-cast aluminum with hassle-free plug-&-play installation.

FOR HARLEY-DAVIDSON™

Fits: Replaces Stock Tank Mounted (not center console mounted) Fuel Gauge on '94-'19 Road Kings, '00-'17 Softails, '91-'17 Dynas, '15-'19 Freewheeler & '88-'94 FXR Models

7357 Chrome (ea)



7357



7358

STOCK-STYLE REPLACEMENT GAS CAP

Our chrome-plated gas caps are a fraction of the cost of stainless steel caps.

FOR HARLEY-DAVIDSON™

Fits: '96-'19 H-D Screw-Type Tanks - R.H. Thread - Vented

8669 Chrome (ea)



COMPLETE THE LOOK!
ZOMBIE HORN COVER
PG 204



FRONT END



	A	B	C	D	E	F	G	H
	SATIN BLACK	CHROME	PEAKED	ROMAN	GROOVED	POINTED SPUN BLADE	ZOMBIE SPUN BLADE	TWISTED
AXLE CAPS								
Fits: '84-'06 Softails (except Deuce & Springer), '80-'99 Electra Glides, Road Glides, Tour Glides & Road Kings, '91-'03 Dynas with 39mm forks, '93-'05 FXDWG, '88-'07 Sportsters, '88-'00 FXRs, '80-'86 FXWG	N/A	1201	1224*	1225*	1226*	1232	1235	1217
Fits: '00-'07 Electra Glides, Road Glides, Street Glides & Road Kings, '04-'07 Dyna (except '04-'05 FXDWG & '07 FXDSE)	N/A	1213	1224*	1225*	1226*	1233	1236	1218
'07-'17 Softails (except Deuce, Springer, Rocker & Breakout Models), '08-'19 Electra Glides, Road Glides, Road Kings & Street Glides, '08-'17 Dynas (except '08 FXDSE), '08-'19 Sportsters (except '16-'19 XL1200X/S, XL1200CX), '02-'11 V-Rod (except VRSCR & VRSCF), '15-'19 Streets	1229	1214	1224*	1225*	1226*	1234	1237	1219

*Also fits '09-'19 Trikes

- New
- Collections
- Featured Bikes
- Audio
- Lighting
- Accessory Mounts
- Handlebar Controls, Grips & Mirrors
- Pegs & Foot Controls
- Covers, Trims & Accents
- Air Cleaners & Exhaust
- Touring & Comfort
- Windshields & Air Management
- Luggage & Organizers
- Index



9022

FENDER ORNAMENTS

Choose to fly with the Eagle or ride with the Wild Boar, both feature illuminated eyes!

FOR MULTI-FIT

Fits: Universal, 12V Applications

9026 Eagle, Chrome (ea)

9022 Wild Boar, Chrome (ea)

Note: Requires drilling fender and hard-wiring the lighted eyes.



9026

DECO EAGLE FRONT FENDER ORNAMENT

Let your style soar with this lightweight, chrome-plated ABS accent.

FOR HARLEY-DAVIDSON®

Fits: Universal: Front Fenders with approximately 15-1/4" radius; Typical Fitments Include: Late Model Touring Models & Softails

7333 Chrome (ea)



7333

FRONT FENDER ORNAMENTS

Measures 1-1/4" wide x 8" long, with simple installation using high-strength adhesive.

FOR HARLEY-DAVIDSON®

Fits: Universal: Front Fenders with approximately 15-1/4" radius; Typical Fitments Include: Late Model Touring Models & Softails

7332 Chrome (ea)



7332

TRICEPTOR FENDER ACCENT

Quickly cover unsightly chips. Simple installation using high-strength 3M® VHB™.

FOR HARLEY-DAVIDSON®

Fits: Universal for 4" or wider style fenders

7340 Chrome (ea)

Note: Does not fit fenders with flat center width



7340

FENDER TIPS

Simple installation requires no drilling and can be done without any tools.

FOR HARLEY-DAVIDSON®

Fits: '90-'06 Fat Boy Rear Fenders (except '06 FLSTFSE) (ea)

9015 Rear Fender Tip, Chrome (ea)

Fits: All '90-'17 FLSTF/B Fat Boy Front Fenders (Trailing Edge)

9014 Front Fender Tip, Chrome (ea)

Fits: '90-'17 FLSTF/B Fat Boy Front Fenders (Leading Edge)

9013 Front Fender Tip, Chrome (ea)

Fits: Leading Edge of Most Narrow H-D Front Fenders on FXST, XL, Dyna & FXR Models

9012 Front Fender Tip, Chrome (ea)

Fits: '07-'17 FLSTF, '10-'16 FLSTFB, '16-'17 FLSTFBS & '06 FLSTFSE

7787 Rear Fender Tip, Chrome (ea)



9015



9014

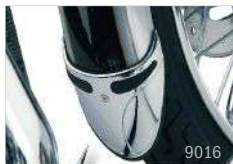

9012

FENDER EXTENSION FOR NARROW FRONT FENDERS

Enjoy a dryer ride, a cleaner engine and even sparkle! A molded-in contour hugs the stock H-D narrow fender tightly for a clean look.

FOR HARLEY-DAVIDSON®

Fits: Most Narrow H-D Front Fenders on FXST, XL, Dyna & FXR Models

9016 Chrome (ea)



9016

FRONT FENDER SIDE TRIM

Installation is quick and easy, getting you back on the road in no time.

FOR HARLEY-DAVIDSON®

Fits: '04-'05 FLHTCSE, '06-'13 FLHTCUSE, '14-'19 FLHTKSE, '98-'13 & '15-'19 Road Glides, '04-'07 FLHRS/I Road King Customs; '02-'03, '08 & '13-'14 FLHRSE, '17-'19 FLHRXS, '06-'19 Street Glides, '10-'11 FLHXXX Street Glide Trikes & '12-'16 Dyna Switchbacks

7786 Chrome (pr)



8642

7786

FENDER ACCENTS

The clean, unadorned fenders on the Road Glide, Road King Custom, Street Glide and many CVO Screamin' Eagle Touring Models look sharp, but could use a little flash. Our classy fender tips are the perfect chrome complement.

FOR HARLEY-DAVIDSON®

Fits: '04-'05 FLHTCSE, '06-'13 FLHTCUSE, '14-'19 FLHTKSE, '98-'13 & '15-'19 Road Glides, '04-'07 FLHRS/I Road King Customs; '02-'03, '08 & '13-'14 FLHRSE, '17-'19 FLHRXS, '06-'19 Street Glides, '10-'11 FLHXXX Street Glide Trikes & '12-'16 Dyna Switchbacks

8642 Leading Edge, Chrome (ea)



7786

8643



Fits: '04-'05 FLHTCSE, '06-'13 FLHTCUSE, '14-'19 FLHTKSE, '98-'13 & '15-'19 Road Glides, '04-'07 FLHRS/I Road King Customs; '02-'03, '08 & '13-'14 FLHRSE, '06-'19 Street Glides & '10-'11 FLHXXX Street Glide Trikes

8643 Trailing Edge, Chrome (ea)

Note: Leading edge refers to the front edge of the front fender. "Trailing" edge refers to the rear edge of the front fender.



8606

ZOMBIE

FENDER TIP LENS GRILLS

This unique design embeds custom emblems in a bold chrome grill. Includes both front and rear lens grills.

FOR HARLEY-DAVIDSON®

Fits: Front & Rear Fender Tip Lights on '80-'08 Electra Glides, Road Kings, Tour Glides & '86-'17 FL Softail Models

8606 Chrome (pr)



7795

FRONT LENS GRILL WITH EMBLEMS

Sometimes less is more. Our lens cover maximizes the light's impact with fine illuminated slots and interchangeable theme emblems.

FOR HARLEY-DAVIDSON®

Fits: Front Fender Tip Lights on '80-'13 Electra Glides, Road Kings, Tour Glides, Trikes & '86-'17 FL Softail Models with Front Fender Tip Lights

7795 Chrome (ea)



8606

7795



COMPLETE THE LOOK!
FLAME FOOT CONTROLS
PG 121



New

Collections

Featured Bikes

Audio

Lighting

Accessory Mounts

Handlebar Controls,
Grips & Mirrors

Pegs & Foot Controls

Covers, Trims
& AccentsAir Cleaners
& Exhaust

Touring & Comfort

Windshields &
Air ManagementLuggage &
Organizers

Index



7142



7143

UPPER FORK SLIDER ACCENTS

An easy and stylish solution to adding a custom appearance to the upper fork legs without disassembly. Constructed from durable aluminum that installs directly over the factory fork sliders.

FOR HARLEY-DAVIDSON®

Fits: '14-'19 Electra Glides, Road Glides, Road Kings, Street Glides & Trikes

7142 Chrome (pr)

7143 Gloss Black (pr)

LOWER FORK COVERS

Give the lower forks an entirely new custom look at a fraction of the cost for complete replacements. Lower Fork Covers feature durable aluminum construction and easy bolt-on installation. Combine with Upper Fork Slider Accents to completely revamp the front end in no time.

FOR HARLEY-DAVIDSON®

Fits: '14-'19 Electra Glides, Road Glides, Road Kings & Street Glides

7148 Chrome (pr)

7147 Gloss Black (pr)

Note: Not compatible with caliper covers



8635



8635



7211

UPPER FORK SLIDER COVERS

Install in only minutes over the stock covers - no need to disassemble the front end.

FOR HARLEY-DAVIDSON®

Fits: '96-'13 Electra Glides, Road Glides, Street Glides & Trikes (except all CVO/Screamin' Eagle Models)

8635 Chrome (pr)

7211 Gloss Black (pr)

LOWER LEG DEFLECTOR SHIELDS

Protect those legs and keep them looking good! These irresistible chrome accents not only look good but also protect your factory lower fork legs from the notorious "sandblasting" caused by road debris. Installation is effortless with no tools required.

FOR HARLEY-DAVIDSON®

Fits: '00-'13 Electra Glides, Road Glides, Road Kings, Street Glides & Trikes

7768 Chrome (pr)

7209 Gloss Black (pr)



7209



7768



7209

Fits: '86-'17 FL Softail Models (except FLSTSB, FLSTS, FLSTSC); '91-'10 FXST, FXSTB, FXSTC; '93-'05 FXDWG, & '06-'17 Dynas (except '07-'08 FXDSE, '08-'17 FXDF, '09-'10 FXDFSE & '12-'16 FLD)

7765 Chrome (pr)

Note: Kit does not include Fender Mount Boss Covers.

Fits: '86-'17 FL Softail Models (except FLSTSB, FLSTS & FLSTSC), '91-'10 FXST, FXSTB & FXSTC, '93-'05 FXDWG

7212 Chrome (pr)

6539

**MESH FRONT CALIPER COVERS**

Unique multi-piece construction features a rugged and industrial design with the ability to add a custom finish on each individual component. Bolts on in minutes and maintains full braking functionality.

FOR HARLEY-DAVIDSON™

Fits: '08-'19 Electra Glides, Road Glides, Road Kings, Street Glides; '09-'13 Trikes & '06-'11 V-Rods (except '06-'07 VRSCR Street Rod & '09-'11 VRSCF V-Rod Muscle)

6538 Chrome (pr)

6539 Satin Black (pr)

Fits: '08-'17 Dyna (except FXDF & '14-'17 FXDL) & '08-'14 Softail Models (except Springer) with Single Front Disc

6540 Chrome (ea)

6541 Satin Black (ea)

Fits: '15-'19 Softail Models with Single Front Disc (except '18-'19 FXBB, FLFB/S, FXLR, FXBR/S)

6542 Chrome (ea)

6543 Satin Black (ea)

CALIPER COVERS FOR BREMBO CALIPERS

Bolt-on chrome caliper covers. Works on ABS-equipped bikes.

FOR HARLEY-DAVIDSON™

Fits: '08-'19 Electra Glides, Road Glides, Road Kings, Street Glides; '09-'13 Trikes & '06-'11 V-Rods (except '06-'07 VRSCR Street Rod & '09-'11 VRSCF V-Rod Muscle)

7789 Chrome (pr)

FULL COVERAGE CALIPER COVERS

These unique accents cover the entire profile of the brake caliper while deviating from the standard round-style caliper insert.

FOR HARLEY-DAVIDSON™

Fits: All '84-'99 H-D Models, '00-'06 FXSTS/I, '00-'03 FLSTS/I, '05-'07 FLTSC/I & '08-'11 FLSTSB

1291 Chrome (ea)

BRAKE BLEEDER SCREW & BANJO BOLT COVERS

These little jewels transform the unfinished bleeder screws and banjo bolts on stock calipers into glistening chrome.

FOR HARLEY-DAVIDSON™

Fits: Bleeder Screws on '84-'17 stock H-D calipers (except '08-'17 Touring & Trike)

2013 Bleeder Screw Cover, Chrome (pr)

Fits: '84-'07 H-D Master Cylinders & Calipers (except '04-'07 XL) & '08-'19 Softail & '08-'17 Dyna Master Cylinders

2014 Banjo Bolt Cover, Chrome (ea)

6541



6540



6538



6543



6542



COMPLETE THE LOOK!
MESH REAR CALIPER COVER
PG 213



7768



7789

1225
PG 171

1291



1291



2014



2013



New

Collections

Featured Bikes

Audio

Lighting

Accessory Mounts

Handlebar Controls,
Grips & Mirrors

Pegs & Foot Controls

Covers, Trims
& AccentsAir Cleaners
& Exhaust

Touring & Comfort

Windshields &
Air ManagementLuggage &
Organizers

Index



CUSTOM TIE-DOWN BRACKETS

Bolts directly to the sides of the front fork to provide a secure, easily accessible point to attach tie-down straps.

FOR HARLEY-DAVIDSON®

Fits: '83-'13 Electra Glides (except CVO Models) & '94-'19 Road Kings

928 Teardrop, Chrome (pr)

Fits: '86-'90 & '06 FLST/I Heritage Softail, '89-'17 FLSTC/I Heritage Softail Classic, '90-'17 FLSTF/I Fat Boy, '10-'16 FLSTFB Fat Boy Lo, '05-'17 FLSTN/I Softail Deluxe, '12-'17 FLS Softail Slim, '16-'17 Softail Slim S, '93-'94 FLSTN Heritage Softail Nostalgia & '95-'96 FLSTN Heritage Softail Special

926 Teardrop, Chrome (pr)

Fits: '06-'13 FLHX, '04-'05 FLHTCSE, '06-'13 FLHTCUSE, '10-'12 FLHXSE

924 Teardrop, Chrome (pr)

Note: Also fits '83-'13 Electra Glide or Road King models equipped with Kuryakyn 5005 or 5029 Driving Lights.

Fits: '14-'19 Electra Glides & Street Glides

949 Teardrop, Chrome (pr)

FORK BRACE FOR WIDE GLIDE® FRONT ENDS

By reducing fork flex, one can enjoy more aggressive, controlled cornering, smoother ride, and straighter, more predictable hard stopping. All while looking fantastic on your bike!

FOR HARLEY-DAVIDSON®

Fits: '91-'99 & '07-'10 FXSTC Softail Customs, '99-'08 FXST/I Softail Standards, '99-'09 FXSTB/I Night Trains & '93-'05 FXDWG/I Dyna Wide Glides

8620 Chrome (ea)

FORK SKINS FOR SPORTSTERS

Revamp your XL's front-end at a fraction of the cost! Only a few wrenches and about 20 minutes is needed to transform the ordinary to the spectacular with Kuryakyn's Chrome or Gloss Black Fork Skins.

FOR HARLEY-DAVIDSON®

Fits: '04-'17 Sportster Models with Single Disc Front End (except '11-'17 XL883L, '09-'17 XL883N, '11-'17 XL1200C, '16-'17 XL1200CX, '08-'12 XL1200N, '14-'17 XL1200T, '10-'17 XL1200X)

7202 Chrome (set)

7227 Black & Chrome (set)

ENGINE

6419

**PRECISION™ UPPER FRAME COVER**

Hides the engine mount bracket for a simple but effective aesthetic upgrade that adds a custom look to the upper frame area above the regulator.

FOR HARLEY-DAVIDSON™

Fits: Following Models Equipped with Factory Oil Coolers: '17-'19 Electra Glides, Road Glides, Road Kings, Street Glides & Freewheeler

6419 Chrome (ea)

6420 Gloss Black (ea)

Note: Not compatible with Twin Cooled models

PRECISION™ REGULATOR COVER

Conceal the factory regulator with this finely sculpted aluminum cover that's sure to stand out. Easy bolt-on installation using included hardware.

FOR HARLEY-DAVIDSON™

Fits: '17-'19 Electra Glides, Road Glides, Road Kings, Street Glides & Trikes

6427 Chrome (ea)

6428 Gloss Black (ea)

PRECISION™ OIL COOLER COVER

Fit to exacting standards to conceal the oil cooler and hoses without restricting all-important airflow. Durable injection-molded ABS construction with easy installation.

FOR HARLEY-DAVIDSON™

Fits: Stock Oil Cooler on '17-'19 Electra Glides, Road Glides, Road Kings & Street Glides

6417 Chrome (ea)

6418 Gloss Black (ea)

PRECISION™ COOLANT PUMP COVER

This direct replacement made from durable injection-molded ABS delivers a significant style upgrade over stock for a clean, custom look while fully concealing the coolant pump and lines.

FOR HARLEY-DAVIDSON™

Fits: Stock Coolant Pump on '17-'19 Twin Cooled Electra Glide Ultra Limited, Road Glide Ultra & Tri Glides

6414 Chrome (ea)

6421 Gloss Black (ea)



6428



6417

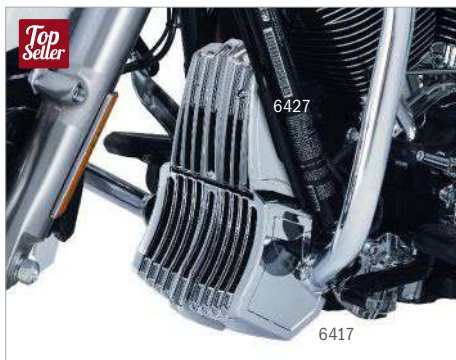

6421



6414

**COMPLETE THE LOOK!**

PRECISION LOWER FRONT
ENGINE COVER **PG 181**



New

Collections

Featured Bikes

Audio

Lighting

Accessory Mounts

Handlebar Controls,
Grips & Mirrors

Pegs & Foot Controls

Covers, Trims
& AccentsAir Cleaners
& Exhaust

Touring & Comfort

Windshields &
Air ManagementLuggage &
Organizers

Index



RADIATOR GRILLS

FOR TWIN COOLED MODELS

Deliver a classy chrome upgrade to fairing lowers on Twin-Cooled High Output Twin Cams with these lightweight chrome-plated ABS Radiator Grills.

FOR HARLEY-DAVIDSON®

Fits: '14-'19 FLHTK, '15-'19 FLHTKL, '14-'19 FLHTKSE, '16-'19 FLTRU, '15-'16 FLTRUSE, '15-'17 FLHXSE & '14-'19 FLHTCUTG

7681 Chrome & Black (pr)



COOLANT PUMP COVER

Hides the unsightly voltage regulator.

FOR HARLEY-DAVIDSON®

Fits: Stock Coolant Pump on '14-'16 Twin Cooled Electra Glide Ultra Limited, Road Glide Ultra, (except CVO Touring Models) & Tri Glides

7677 Chrome (ea)



OIL COOLER COVER FOR '11-'16 TOURING MODELS

Offers a custom look treatment to help hide the oil lines.

FOR HARLEY-DAVIDSON®

Fits: Stock Oil Cooler on '11-'16 Electra Glides (except '14-'16 FLHTK, FLHTKL, FLHTKSE), Road Glides (except '15-'16 FLTRUSE), Road Kings, Street Glides (except '15-'16 FLHXSE), '11-'13 Trikes & '15-'16 Freewheeler

7784 Chrome (ea)

7690 Gloss Black (ea)



ENGINE GUARD MOUNT TAB COVERS

Cover those rust-prone engine guard welds.

FOR HARLEY-DAVIDSON®

Fits: Stock Engine Guards on all '97-'13 Electra Glides, Road Glides, Street Glides, Road Kings & Trikes

7778 Chrome (pr)



6465

PRECISION CHIN SPOILER FOR '18-'19 SOFTAIL

This trick spoiler covers the area between the frame and downtubes, as well as the horn, regulator cover, and oil cooler for a clean custom look. Made from durable and lightweight ABS, the one-piece bolt-on design installs with ease and features a slotted design that maintains all-important airflow to the oil cooler.

FOR HARLEY-DAVIDSON®

Fits: '18-'19 Softail Models

6464 Chrome (ea)

6465 Gloss Black (ea)



LOOKS GREAT WITH
PRECISION TAPPET BLOCK
ACCENT **PG 188**



REGULATOR COVER FOR SOFTAIL MODELS

Add some style to your voltage regulator with deep fins and brilliant chrome! The smooth finish is much easier to keep clean, and liberal venting helps keep its cool. Installation is simple, requiring only two bolts.

FOR HARLEY-DAVIDSON®

Fits: '01-'17 Softail Models

7839 Chrome (ea)

MESH AIRDAM FOR '14-'16 TOURING MODELS

Give the lower frame and dull factory oil cooler a completely custom look. Made from lightweight, durable ABS combined with steel screen and mounting brackets. Bolt-on installation with easy removal for cleaning.

FOR HARLEY-DAVIDSON®

Fits: '14-'16 Electra Glides, Road Glides, Road Kings & Street Glides

6498 Chrome (ea)

6499 Satin Black (ea)

Note: Does not fit water cooled models or models with fairing lowers.



6464



NEW
6465



7839



7839



MESH

6499



6498

New

Collections

Featured Bikes

Audio

Lighting

Accessory Mounts

Handlebar Controls,
Grips & Mirrors

Pegs & Foot Controls

Covers, Trims
& Accents

Air Cleaners
& Exhaust

Touring & Comfort

Windshields &
Air Management

Luggage &
Organizers

Index



1547

REGULATOR COVER FOR TOURING MODELS

Two-piece design uses a stamped steel base and a chrome composite top. Open and well-vented design keeps your regulator running cool. Two functional and decoratively shaped chrome fasteners add the finishing touch.

FOR HARLEY-DAVIDSON™

Fits: '97-'11 Electra Glides, '98-'11 Road Glides, '06-'11 Street Glides & '97-'11 Road Kings Without Oil Coolers

1547 Chrome (ea)

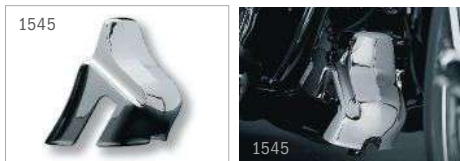

1545

1545

FRONT MOTOR MOUNT COVER

Easy 2-bolt installation.

FOR HARLEY-DAVIDSON™

Fits: '91-'05 Dyna Models

1545 Chrome (ea)



3563

UNIVERSAL RIOT HEAT SHIELDS

Aggressively designed clamp-on heat shield made from high-quality aluminum helps prevent leg or boot contact with hot exhaust. Measures 6" long, includes hose clamps for easy installation and a wide range of fitment.

FOR MULTI-FIT

Fits: Universal fit for exhaust systems measuring 1-1/2" to 2" O.D.

3562 Silver (ea)

3563 Satin Black (ea)

Note: Requires a 6" section of straight tube for installation



3562

3563

BRIDGE THE GAP HEAT SHIELD U.S. Patent D523,787

Quick and easy to install, this piece bridges the ugly gap left between the stock heat shields.

FOR HARLEY-DAVIDSON™

Fits: '93-'08 Electra Glides, Road Glides, Tour Glides, Street Glides & Road Kings with stock head pipes & heat shields

9196 Chrome (ea)



9196 BEFORE

9196 AFTER

FLOORBOARD EXHAUST BOOT GUARDS U.S. Patent D618,597

Protect your boots from your exhaust pipe. Easy to install.

FOR HARLEY-DAVIDSON™

Fits: '84-'19 Electra Glides (except '04-'05 FLHTCSE & '06-'13 FLHTCUSE, '14-'19 FLHTKSE), '98-'09 Road Glides (except '09 FLTRSE), '11-'13 & '16-'19 Road Glide Ultras (except '11 FLTRUSE), '94-'19 Road Kings (except '04-'07 FLHRS, '07-'08, '13-'14 FLHRSE & '17-'19 FLHRXS), '84-'96 Tour Glides, '09-'19 Trikes, '86-'08 FLST/FLSTC, '90-'17 FLSTF, '93-'96 FLSTN, '97-'03 FLSTS, '05-'07 FLSTSC & '12-'16 FLD Dyna Switchback

7544 Right Side, Chrome (ea)



7544

KICKSTAND SPRING

Chrome-plated O.E.M.-style kickstand components for late-model Big Twins.

FOR HARLEY-DAVIDSON™

Fits: '91-'06 Touring Models, '85-'06 Softail Models, '91-'94 FXR Models & '91-'06 Sportster Models

7110 Chrome (ea)



PRECISION™ LOWER FRONT ENGINE COVER

Sculpted to conceal the lower portion of the frame, kickstand assembly, front engine stabilizer, floorboard mount and wiring leading to the voltage regulator. Bolt-on design constructed from quality cast aluminum.

FOR HARLEY-DAVIDSON™

Fits: '17-'19 Electra Glides, Road Kings, Road Glides & Street Glides

6423 Chrome (ea)

6424 Gloss Black (ea)

Fits: '18-'19 Softail Models

NEW 6454 Chrome (ea)

NEW 6455 Gloss Black (ea)

LOWER FRONT FRAME COVER

Cover the kickstand assembly, front engine stabilizer and floorboard mount.

FOR HARLEY-DAVIDSON™

Fits: '91-'16 Electra Glides, Road Kings, Road Glides, Street Glides, Tour Glides & '09-'13 Trikes

7772 Chrome (ea)

Fits: 91-'08 Touring Models Without Fairing Lower Or Oil Coolers

7897 Chrome (ea)

OIL PRESSURE SENDER COVER

The simple addition of this finely sculpted chrome accessory adds life to the dull cast finish surrounding it.

FOR HARLEY-DAVIDSON™

Fits: '07-'11 Electra Glides, Road Glides, Road Kings & Street Glides; '00-'17 Softails (except '13-'17 FXSB, FXSBSE, FLSS, FLSTFBS, FLSTNSE) & '06-'17 Dynas

8655 Chrome (ea)

Note: Not compatible with oil coolers.

REAR MASTER CYLINDER COVERS

Super clean and covers everything - even the small related components. Simple installation using only two fasteners.

FOR HARLEY-DAVIDSON™

Fits: '99-'07 Electra Glides, Road Glides, Road Kings & Street Glides; '09-'13 H-D Trikes; '00-'17 Softail Models

9128 Chrome (ea)

Fits: All '08-'19 Electra Glide Standard, Electra Glide Classic, Road Glides (except FLTRU & FLTRUSE), Road Kings (except '13-'14 FLHRSE) & Street Glides (except '11-'12, '15-'19 FLHXSE)

8653 Chrome (ea)

Note: Does not fit '09-'19 models with fairing lowers.

Fits: '09-'19 FLHTCU, '09-'13 FLHTCUSE, '10-'19 FLHTK, '14-'15 FLHTKSE, '11 & '16-'19 FLTRU, '11 & '15-'16 FLTRUSE, '15-'19 FLTRX, '13-'14 FLHRSE, & '11-'12 & '15-'19 FLHXSE

7769 Chrome (ea)

Note: Also fits other '09-'19 Touring models equipped with fairing lowers.



New

Collections

Featured Bikes

Audio

Lighting

Accessory Mounts

Handlebar Controls, Grips & Mirrors

Pegs & Foot Controls

Covers, Trims & Accents

Air Cleaners & Exhaust

Touring & Comfort

Windshields & Air Management

Luggage & Organizers

Index



8697



7259



2017



8407



6060



6061



6061



8697

FRONT UPPER STABILIZER LINK COVER

Simple installation requires no tools.

FOR HARLEY-DAVIDSON™

Fits: '08-'16 Electra Glides, Road Glides, Road Kings, Street Glides & Trikes

8697 Chrome (ea)

CLUTCH CABLE ADJUSTER COVER

This glistening chrome cover replaces the stock rubber adjuster cover.

FOR HARLEY-DAVIDSON™

Fits: '87-'19 H-D Models with Stock Clutch Cables (except '18-'19 Softails)

7259 Chrome (ea)

Fits: All '87-'19 Models with Stock Clutch Cables (except '18-'19 Softail) & Most Steel Braided Cables 0.355" In Diameter

2017 Chrome (ea)

SCARAB™ AIR CLEANER COVER

Kuryakyn comes slammin' home with an affordable upgrade to the stock oval Twin Cam air cleaner cover. The Scarab™ Air Cleaner Cover adds a custom touch with racy contours and chrome grilled openings for additional airflow.

FOR HARLEY-DAVIDSON™

Fits: '02-'13 Electra Glides, Road Glides, Road Kings, Street Glides & Trikes (except Carbureted California Models), '01-'15 Softail Models (except '08-'11 FLSTSB, '11-'13 FXS, '12-'15 FLS & Carbureted California Models) & '04-'07 EFI Dyna Models

8407 Chrome (ea)

Note: Not Available in the State of California

FINNED AIR CLEANER ACCENT

Add a subtle touch of classic custom style to the stock air cleaner cover. Made from quality A380 aluminum, with a reusable backer for easy installation and removal for filter maintenance

FOR HARLEY-DAVIDSON™

Fits: '17-'19 Electra Glides, Road Glides, Road Kings, Street Glides & Trikes (except CVO models)

6060 Chrome (ea)

6061 Satin Black & Machined (ea)

**LOOKS GREAT WITH**FINNED TIMING COVER
PG 187

8414

**QUANTUM AIR CLEANER COVER**

Offering radical styling and larger intake openings, the Quantum is a direct replacement for the stock H-D air cleaner cover. Quick and easy to install reusing stock mounting screw.

FOR HARLEY-DAVIDSON™

Fits: '14-'16 Electra Glides (except '14-'16 FLHTKSE), '15-'16 Road Glides (except '15-'16 FLTRUSE), '14-'16 Road Kings (except '14 FLHRSE), '14-'16 Street Glides (except '15-'16 FLHXSE) & '14-'16 Trikes; '16-'17 Softails (except FLSS & FLSTFBS)

8417 Chrome (ea)

8414 Gloss Black (ea)

Note: Fits with Stock back plate & filter, Screamin' Eagle Stage 1 back plate & filter or Kuryakyn Street Sleeper III.

ALLEY CAT AIR CLEANER COVER

Made to fit the Street Sleeper II and III as well as many other aftermarket high-flow air cleaners, this cover features a unique chrome mesh insert and "knock-off" styled end cap for that retro look on your modern motorcycle.

FOR HARLEY-DAVIDSON™

Fits: Screamin' Eagle Stage 1 Air Cleaner kits for '99-'16 Touring, '00-'17 Softail, '99-'07 Dyna; Kuryakyn Street Sleeper II and III, & All Arlen Ness Stage 1 Big Sucker Kits.

9439 Chrome (ea)

9438 Gloss Black (ea)

Note: Not compatible with Ness Stage II Big Sucker or the original Kuryakyn Street Sleeper. Not Available in the State of California

SPEEDFORM AIR CLEANER COVER

Speed-inspired design with fast lines and a smooth, aerodynamic look makes this direct replacement for the stock cover an easy and affordable upgrade. Outer badge adds a contrasting finish effect and conceals the mounting bolt for a clean hardware-free appearance.

FOR HARLEY-DAVIDSON™

Fits: '17-'19 Electra Glides, Road Glides, Road Kings, Street Glides & Trikes (except CVO models)

9964 Chrome (ea)

9965 Satin Black (ea)



LOOKS GREAT WITH
SPEEDFORM SADDLEBAG
EXTENSIONS **PG 219**



8417



9438

9438



9439



9964



9965



9965



New

Collections

Featured Bikes

Audio

Lighting

Accessory Mounts

Handlebar Controls,
Grips & Mirrors

Pegs & Foot Controls

Covers, Trims
& AccentsAir Cleaners
& Exhaust

Touring & Comfort

Windshields &
Air ManagementLuggage &
Organizers

Index



COMPLETE THE LOOK!
VELOCIRAPTOR® AIR CLEANER
PG 244



7244

THROTTLE SERVO MOTOR COVER

Cover up the throttle servo motor cover on your fly-by-wire bike with this simple piece.

FOR HARLEY-DAVIDSON®

Fits: For use with Screamin' Eagle Stage One or Heavy Breather Air Cleaner on '08-'16 Electra Glides, Road Glides, Road Kings & Street Glides & Trikes; '16-'17 Softail, '11-'12 FLSTSE, '13-'14 FXSBSE & '14-'15 FLSTNSE

8657 Chrome (ea)

7244 Gloss Black (ea)

Fits: For use with Kuryakyn Air Cleaners on '08-'16 Electra Glides, Road Glides, Road Kings & Street Glides & Trikes; '16-'17 Softails, '11-'12 FLSTSE, '13-'14 FXSBSE & '14-'15 FLSTNSE

8659 Chrome (ea)

7245 Gloss Black (ea)

THROTTLE BODY SUPPORT BRACKET COVER

Cover the stock black throttle body support bracket with this unique chrome cover.

FOR HARLEY-DAVIDSON®

Fits: Following Models Equipped with Kuryakyn Air Cleaners: '08-'16 Electra Glides (except '11-'13 FLHTCUSE & '14-'16 FLHTKSE), '08-'16 Road Glides (except '09 FLTRSE, '11 & '15-'16 FLTRUSE, '12-'13 FLTRXSE), '08-'16 Street Glides (except '10, '12 & '15-'16 FLHXSE), '08-'16 Road Kings (except '13-'14 FLHRSE), '09-'16 Trikes & '16-'17 Softails (except '16-'17 FLSTFBS & FLSS)

8658 Chrome (ea)

BREATHER BOLT COVERS FOR TWIN CAM

Cover those unsightly zinc-plated Twin Cam breather bolts. Simply press-on and tighten the set screw.

FOR HARLEY-DAVIDSON®

Fits: '99-'17 Twin Cams & '07-'19 Sportster Models with Kuryakyn Air Cleaners

7791 Chrome (pr)

THROTTLE BODY COVER

Dress up one of the most noticeable areas on the Twin Cam motor.

FOR HARLEY-DAVIDSON®

Fits: Compatible with Kuryakyn Air Cleaners (except Hyperchargers & Twin Velocity/Plus), Ness Big Sucker I & II, H-D Screamin' Eagle Stage 1 & Heavy Breather on '02-'07 EFI Touring Models, '01-'15 EFI Softail Models (except '11-'12 FLSTSE, '13-'14 FXSBSE, '14-'15 FLSTNSE) & '04-'17 EFI Dyna Models (except '16-'17 FXDLS)

7247 Chrome (ea)



PRECISION™ THROTTLE SERVO MOTOR COVER

Minimalist styling that gracefully conceals the exposed throttle servo motor and wiring. Durable cast aluminum construction with a tapered stepped design that's form-fitted and hugs tight to the throttle body.

FOR HARLEY-DAVIDSON™

Fits: For use with Kuryakyn Air Cleaners on '17-19 Electra Glides, Road Glides, Road Kings, Street Glides & Trikes, '18-'19 Softails

9340 Chrome (ea)

9341 Satin Black (ea)

Fits: For use with Screamin' Eagle Heavy Breather Air Cleaner on '17-'19 Electra Glides, Road Glides, Road Kings, Street Glides, Trikes & '18-'19 Softails

9342 Chrome (ea)

9343 Satin Black (ea)

BANTAM THROTTLE SERVO MOTOR COVER

Slim, minimalist design with grooved accents and a contoured scoop that covers the throttle servo motor and wiring for a tight, clean appearance. Works with all Kuryakyn and Crusher air cleaners, and most aftermarket air cleaners including H-D Heavy Breathers and Screamin' Eagle Stage 1 kits.

FOR HARLEY-DAVIDSON™

Fits: '08-'16 Electra Glides, Road Glides, Road Kings, Street Glides & Trikes; '16-'17 Softails, '11-'12 FLSTSE, '13-'14 FXSBSE & '14-'15 FLSTNSE

9845 Chrome (ea)

9846 Satin Black (ea)

SIGNATURE SERIES FINNED EFI COVER BY JIM NASI

Chrome-pated aluminum fins with a durable black ABS base that can be custom-painted to match color. Available for both round-style and 90-degree elbow air cleaners to conceal exposed throttle servo motor and wiring.

FOR HARLEY-DAVIDSON™

Fits: Following Models with Offset or 90 Degree Air Cleaners; '08-'16 Electra Glides, Road Glides, Road Kings, Street Glides & Trikes; '16-'17 Softails, '16-'17 FXDLS, '11-'12 FLSTSE, '13-'14 FXSBSE & '14-'15 FLSTNSE

5685 Black & Chrome (ea)

Fits: Following Models with Round Air Cleaners; '08-'16 Electra Glides, Road Glides, Road Kings & Street Glides & Trikes; '16-'17 Softails, '16-'17 FXDLS, '11-'12 FLSTSE, '13-'14 FXSBSE & '14-'15 FLSTNSE

5686 Black & Chrome (ea)

Note: Not Compatible with Street Sleeper III, Maverick Pro & Screamin' Eagle Stage I

The Kuryakyn Signature Series showcases original designs from minds of true masters of the trade. Jim Nasi is a true pioneer of one-off custom motorcycles and components. A brand built on original designs, demanding quality and a passion for creativity; for over two decades Jim Nasi Customs has established a reputation for awe-inspiring concepts, intelligent engineering and clean, unfiltered style.

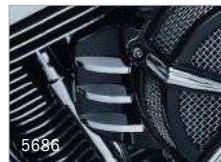

Signature
SERIES

New

Collections

Featured Bikes

Audio

Lighting

Accessory Mounts

Handlebar Controls,
Grips & Mirrors

Pegs & Foot Controls

Covers, Trims
& AccentsAir Cleaners
& Exhaust

Touring & Comfort

Windshields &
Air ManagementLuggage &
Organizers

Index

PRECISION ENGINE ACCENTS

MODERN, MUSCULAR AND POWERFUL DESIGNS THAT DELIVER A TRULY DEFINED APPEARANCE.

NOW FOR MILWAUKEE-EIGHT TOURING & SOFTAIL



DESCRIPTION	PAGE	DESCRIPTION	PAGE
A Lower Front Engine Cover	181	K Upper Frame Cover	177
B Throttle Servo Motor Cover	185	L Regulator Cover	177
C Tappet Block Accent	188	M Oil Cooler Cover	177
D Transmission Top Cover	188	Coolant Pump Cover	177
E Transmission Shroud	189	Chin Spoiler (Softail Only)	179
F Starter Cover	190	O Spark Plug Wire Cover	191
G Dipstick	193	Oil Line Cover (Softail Only)	192
H Inner Primary Cover	194	P Spark Plug Covers	201
I Cylinder Base Cover	194	Coil Cover (Softail Only)	202
J Heel Shift Eliminator	147		

6561



MESH

6560

MESH TIMING COVER

Dynamic bolt-on replacement for stock timing cover
Three-piece design provides a dimensional appearance.
A380 aluminum baseplate and outer frame secure
stainless mesh insert upon installation with included
hardware. Disassembles easily to custom-paint individual
components and match any color theme.

FOR HARLEY-DAVIDSON®

Fits: '17-'19 Electra Glides, Road Glides, Road Kings, Street
Glides & Trikes; '18-'19 Softails

6560 Chrome (ea)

6561 Satin Black (ea)

Fits: All '99-'17 Twin Cam Models

6520 Chrome (ea)

6521 Satin Black (ea)

Fits: '04-'19 Sportsters

6522 Chrome (ea)

6523 Satin Black (ea)



6521



6520



6522



6523

FINNED TIMING COVER

Direct replacement for stock made from quality aluminum
and featuring a classic finned design for a cool retro vibe.
Styled to complement the entire line of Kuryakyn finned
accents and covers.

FOR HARLEY-DAVIDSON®

Fits: '17-'19 Milwaukee-Eight® Engines

9838 Chrome (ea)

9839 Satin Black & Machined (ea)

Fits: All '99-'17 Twin Cam Models

9828 Chrome (ea)

9829 Satin Black & Machined (ea)



9839

Finned



9829



9838

FINNED TRANSMISSION COVER ACCENTS FOR TWIN CAM

An easy, effective and affordable solution to revamp the
transmission cover for a custom appearance. Cast from
durable A380 aluminum shaped to fit perfectly in the
recessed area utilizing high-strength 3M® VHB™ adhesive.

FOR HARLEY-DAVIDSON®

Fits: '11-'16 Touring & Trike models with 103CI Twin Cam
(except '11-'16 FLHR & FLHRC)

9261 Chrome (ea)

9263 Satin Black & Machined (ea)



9261



9263

New

Collections

Featured Bikes

Audio

Lighting

Accessory Mounts

Handlebar Controls,
Grips & Mirrors

Pegs & Foot Controls

Covers, Trims
& AccentsAir Cleaners
& Exhaust

Touring & Comfort

Windshields &
Air ManagementLuggage &
Organizers

Index

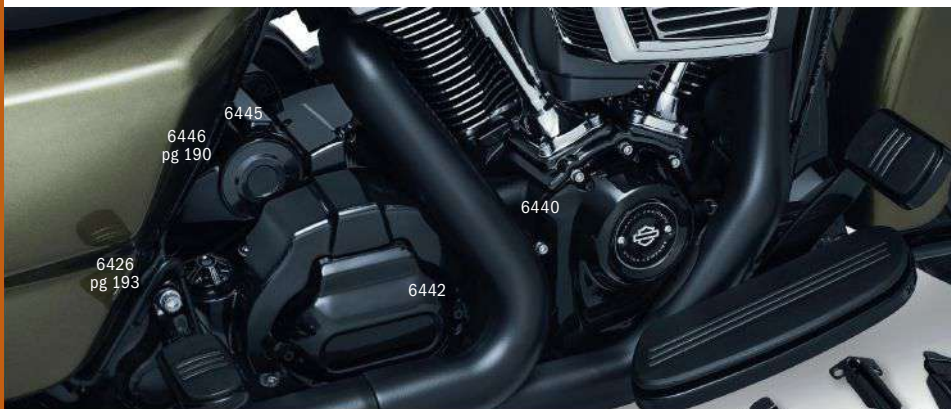

6440



PRECISION™ TAPPET BLOCK ACCENT

One-piece detailed design crafted from premium aluminum that's precisely formed to fill the wrinkle black portions of the tappet block.

FOR HARLEY-DAVIDSON™

Fits: '17-'19 Electra Glides, Road Glides, Road Kings, Street Glides & Trikes; '18-'19 Softail Models

6410 Chrome (ea)

6440 Gloss Black (ea)

TAPPET BLOCK ACCENT U.S. Patent D588,049

Add some chrome to the area around your stock tappet blocks with this simple-to-install cover.

FOR HARLEY-DAVIDSON™

Fits: All '99-'17 Twin Cam Engines

8389 Chrome (ea)

TAPPET BLOCK COVERS

Transform your stock cast aluminum or wrinkle black finish to glistening chrome.

FOR HARLEY-DAVIDSON™

Fits: '91-'03 Sportster Models

8124 Chrome (pr)

Fits: '84-'99 Evo Big Twins

8123 Chrome (set)

PRECISION™ TRANSMISSION TOP COVER

Bolts directly onto the stock cover for a form-fitted custom transformation. Crafted from premium aluminum, with included hardware for easy installation.

FOR HARLEY-DAVIDSON™

Fits: '17-'19 Electra Glides, Road Glides, Road Kings, Street Glides & Trikes

6415 Chrome (ea)

6445 Gloss Black (ea)



6456

PRECISION™ TRANSMISSION SHROUD

Single-piece, bolt-on design cast from quality aluminum and form-fitted to seamlessly cover the outer transmission casing for a complete transformation.

FOR HARLEY-DAVIDSON™

Fits: '17-'19 Electra Glides, Road Glides, Road Kings, Street Glides & Trikes

6412 Chrome (ea)

6442 Gloss Black (ea)

Fits: '18-'19 Softail Models (except FLFB/S, FXBR/S & FXDRS)

NEW 6456 Chrome (ea)

NEW 6457 Gloss Black (ea)

TRANSMISSION SHROUDS U.S. Patent D587,632

Transform the right side of your Twin Cam engine with these easy-to-install, luxurious covers.

FOR HARLEY-DAVIDSON™

Fits: '09-'16 Electra Glides, Road Glides, Road Kings, Street Glides & Trikes

6950 Chrome (ea)

Note: Will also fit '09-'16 Touring Models with Crusher or V&H True Dual Head Pipes where the rear head pipe is routed in the same manner as the stock rear head pipe. Front shroud not used with OEM Head Pipes.

Fits: '07-'08 Electra Glides, Road Glides, Road Kings & Street Glides with True Dual Head Pipes

7877 Chrome (set)

Fits: '07-'08 Electra Glides, Road Glides, Road Kings & Street Glides with Stock Head Pipes

7876 Chrome (set)

Fits: '02-'06 Electra Glides, Road Glides, Road Kings & Street Glides

8201 Chrome (ea)

Fits: '99-'01 Road Kings & '00-'01 Electra Glides

8209 Chrome (ea)

Fits: '07-'17 Softail Models

7878 Chrome (ea)

Fits: '00-'06 Softail Models

8205 Chrome (ea)

Fits: '99-'05 Dyna Models

8208 Chrome (ea)



NEW

6456 6460 pg 192



NEW

6457 6461 pg 192 6463 pg 193 6440 pg 188



6412



6412



7876



6950



7877



7877



8201



8201



7878



7878

New

Collections

Featured Bikes

Audio

Lighting

Accessory Mounts

Handlebar Controls, Grips & Mirrors

Pegs & Foot Controls

Covers, Trims & Accents

Air Cleaners & Exhaust

Touring & Comfort

Windshields & Air Management

Luggage & Organizers

Index



PRECISION™ STARTER COVER

Form-fitted one-piece aluminum construction developed with precise accuracy to cover the starter mechanism, mounting surface and solenoid.

FOR HARLEY-DAVIDSON®

Fits: '17-'19 Electra Glides, Road Glides, Road Kings, Street Glides & Trikes

6416 Chrome (ea)

6446 Gloss Black (ea)

Note: Not compatible with CoolFlow Fan



STARTER COVER

U.S. Patent D596,537, U.S. Patent D595,191

A simple way to cover your bike's starter in chrome.

FOR HARLEY-DAVIDSON®

Fits: '07-'16 Electra Glides (except '07-'13 FLHTCUSE, '14-'16 FLHTKSE), '07-'16 Road Glides (except '09 FLTRSE, '11 & '15-'16 FLTRUSE, '12-'13 FLTRXSE), '07-'16 Street Glides (except '10-'12 & '15-'16 FLHXSE), '07-'16 Road Kings (except '07-'08 & '13-'14 FLHRSE) & '09-'16 Trikes

7847 Chrome (ea)



Fits: '99-'06 Electra Glides (except '04-'05 FLHTCSE & '06 FLHTCUSE), '99-'06 Road Glides, '06 Street Glides, & '99-'06 Road Kings (except '03 FLHRSE)

7846 Chrome (ea)

STARTER MOUNT COVER

Dress up your starter mount with this easy-to-install die-cast chrome cover.

FOR HARLEY-DAVIDSON®

Fits: '09-'16 Electra Glides, Road Glides, Road Kings, Street Glides & Trikes

7779 Chrome (ea)

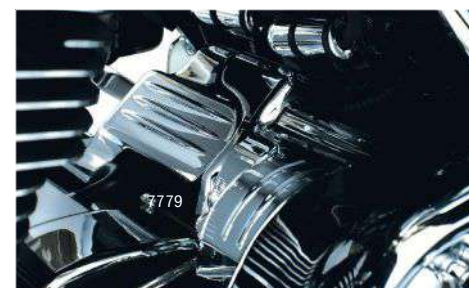

Note: Will also fit '07-'08 Models if equipped with a 2-1 or staggered dual exhaust. Compatible with One-Piece Inner Primary Cover, P/N 7780. Not compatible with Two-Piece Inner Primary Cover, P/N 8397.



9267

9264

FINNED STARTER END ACCENT

The clean, finned design echoes classic custom culture to completely alter the boring wrinkle black starter case. Cast aluminum construction with hassle-free installation.

FOR HARLEY-DAVIDSON™

Fits: '17-'19 Electra Glides, Road Glides, Road Kings, Street Glides & Trikes

9264 Chrome (ea)

9265 Satin Black & Machined (ea)

FINNED STARTER END COVER

Direct bolt-on replacement for the plain stock Twin Cam starter end cover with classic finned styling, cast from quality A380 aluminum.

FOR HARLEY-DAVIDSON™

Fits: All '99-'17 Twin Cam Models

9266 Chrome (ea)

9267 Satin Black & Machined (ea)

PRECISION™ SPARK PLUG WIRE COVER

Clean up the coil area on the Milwaukee-Eight by concealing unsightly spark plug wires. Bolt-on design constructed from durable injection-molded ABS.

FOR HARLEY-DAVIDSON™

Fits: '17-'19 Electra Glides, Road Glides, Road Kings & Street Glides

6430 Chrome (ea)

6431 Gloss Black (ea)

Note: Requires the removal of OEM air deflectors.

REAR CYLINDER BASE COVER

Clean up the space between your rear cylinder and transmission top cover with this simple-to-install cover.

FOR HARLEY-DAVIDSON™

Fits: '09-'16 Electra Glides, Road Glides, Road Kings, Street Glides & Trikes

8694 Chrome (ea)

Fits: '02-'06 Electra Glides, Road Glides, Street Glides & Road Kings

8274 Chrome (ea)



9265



9266



6430



6431



6430



8694



8694



8674

New

Collections

Featured Bikes

Audio

Lighting

Accessory Mounts

Handlebar Controls,
Grips & Mirrors

Pegs & Foot Controls

Covers, Trims
& Accents

Air Cleaners
& Exhaust

Touring & Comfort

Windshields &
Air Management

Luggage &
Organizers

Index



6460



6461



6554



6555



8264



7203



8395



8136



8136

PRECISION™ OIL LINE COVER FOR SOFTAIL

This bolt-on cover made from quality aluminum adds a polished, sculpted appearance while concealing the oil lines in the area between the cam cover and side of the transmission cover.

FOR HARLEY-DAVIDSON™

Fits: '18-'19 Softail Models

6460 Chrome (ea)

6461 Gloss Black (ea)

MESH FRONT PULLEY COVER FOR SPORTSTER

Aggressively styled replacement for the front pulley and belt cover with custom mesh design for a semi-exposed effect. Rugged, mechanical appearance featuring a durable aluminum frame and stainless steel mesh insert to protect the front pulley and belt. Includes hardware for installation.

FOR HARLEY-DAVIDSON™

Fits: '04-'19 XL Models

6554 Chrome (ea)

6555 Satin Black (ea)

OIL FILLER SPOUT COVER

Chrome-plated die-cast construction with easy installation.

FOR HARLEY-DAVIDSON™

Fits: '93-'06 Electra Glides (except '04-'05 FLHTCSE & '06 FLHTCUSE), Road Glides, Road Kings (except '03 FLHRSE), Street Glides & Tour Glides

8264 Chrome (ea)

OIL LINE COVER FOR SOFTAIL

Easy to install with a single polished, stainless band clamp.

FOR HARLEY-DAVIDSON™

Fits: All '00-'17 Softails (except FXCW/C, FXSB, FXSBSE)

7203 Chrome (ea)

DELUXE OIL LINE NACELLE

Installs easily and is the perfect complement to our Transmission Shroud and Tappet Block Accent.

FOR HARLEY-DAVIDSON™

Fits: All '07-'17 Softail Models

8395 Chrome (ea)

Fits: All '00-'06 Softail Models (ea)

8204 Chrome (ea)

OIL SENDER SWITCH COVER

This rubber-lined, easily-installed, die-cast cover is a must (shown with sending unit, not included).

FOR HARLEY-DAVIDSON™

Fits: All '84-'99 Evo Big Twins except Models Equipped with Large 2-Terminal Sending Units

8136 Chrome (set)



PRECISION™ DIPSTICK

Swap the black plastic dipstick with a chrome-plated or gloss black aluminum replacement featuring stylish grooved indents.

FOR HARLEY-DAVIDSON™

Fits: '17-'19 Electra Glides, Road Glides, Road Kings, Street Glides & Trikes

6425 Chrome (ea)

6426 Gloss Black (ea)

Fits: '18-'19 Softail Models

NEW 6462 Chrome (ea)

NEW 6463 Gloss Black (ea)

EASY TURN DIPSTICK CAP

Utilizing the internals of the stock dipstick, this easy-turn cap replaces the top portion to make checking oil levels quick and simple.

FOR HARLEY-DAVIDSON™

Fits: '07-'16 Electra Glides, Road Glides, Street Glides, Road Kings; '09-'16 Trikes, '06-'17 Dyna Models, '08-'11 Rocker/C, '13-'16 FXSB, '13-'14 FXSBSE & '16-'17 FXSE

1007 Chrome (ea)

ZOMBIE™ OIL FILLER CAP U.S. Patent D545,746

Whether you're into Zombies or not - your bike cries out for this part to perk up that dull oil filler cap. This chrome-plated, die-cast cap is easy to install and makes checking your oil a breeze!

FOR HARLEY-DAVIDSON™

Fits: '93-'06 Electra Glides, Road Glides, Street Glides, Tour Glides, Road Kings & '99-'05 Dynas

1052 Chrome (ea)

SOLENOID COVER

Keep your stock dome-shaped starter motor cover and add this trick little Solenoid Cover.

FOR HARLEY-DAVIDSON™

Fits: '90-'06 Big Twin Starters, '91-'19 XL1200 & '95-'19 XL883

9050 Chrome (ea)

FROG MOUTH™ NEUTRAL SWITCH COVER

Conceal both the switch body and the stock rubber insulators! Installation is a breeze.

FOR HARLEY-DAVIDSON™

Fits: All '98-'05 Dynas, All '98-'16 Electra Glides, Road Glides, Road Kings, Street Glides & Trikes

2025 Chrome (ea)



New

Collections

Featured Bikes

Audio

Lighting

Accessory Mounts

Handlebar Controls, Grips & Mirrors

Pegs & Foot Controls

Covers, Trims & Accents

Air Cleaners & Exhaust

Touring & Comfort

Windshields & Air Management

Luggage & Organizers

Index



7185
Page 201

NEW
6450

6454
Page 181



6413

PRECISION™ INNER PRIMARY COVER

Covers the wrinkle black inner primary with a smooth, contoured design that seamlessly complements the factory outer cover.

FOR HARLEY-DAVIDSON™

Fits: '17-'19 Electra Glides, Road Glides, Road Kings, Street Glides & Trikes

6413 Chrome (ea)

6443 Gloss Black (ea)

Note: Not compatible with 1045 Heel Shift Eliminator

Fits: '18-'19 Softail Models

NEW 6450 Chrome (ea)

NEW 6451 Gloss Black (ea)

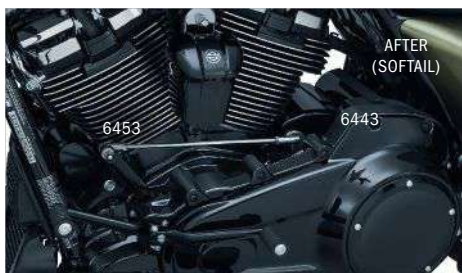

PRECISION™ CYLINDER BASE COVER

A sculpted design provides dimensional depth and forms to the cylinder base for a smooth transition to the engine case. Made from quality aluminum.

FOR HARLEY-DAVIDSON™

Fits: '17-'19 Electra Glides, Road Glides, Road Kings, Street Glides & Trikes

6411 Chrome (ea)

6441 Gloss Black (ea)

Fits: '18-'19 Softail Models

NEW 6452 Chrome (ea)

NEW 6453 Gloss Black (ea)



6451



6411



6453



Top
Seller

INNER PRIMARY COVERS U.S. Patent D581,322

Go for the smooth look, transforming your bike from dull to daring in minutes.

FOR HARLEY-DAVIDSON®

Fits: '09-'16 Electra Glides, Road Glides, Road Kings, Street Glides & Trikes

7780 Chrome (ea)

Note: Will also fit '07-'08 Touring models if the stock exhaust has been removed and replaced with a 2 into 1 or Staggered Dual system.

Fits: '07-'08 Electra Glides, Road Glides, Street Glides & Road Kings

8397 Chrome (ea)

Fits: '90-'06 Electra Glides, Road Glides, Street Glides & Road Kings

8294 Chrome (ea)

Fits: '07-'17 Softails (except '08-'11 FXCW/C, '13-'17 FXSB, '13-'14 FXSBSE)

8398 Chrome (ea)

Note: Rear section cannot be installed on '07 FLSTC/I.

Fits: '00-'06 Softail Models

8291 Chrome (ea)

Fits: '89-'99 Softail Models (except '97-'99 FLSTS)

8299 Chrome (ea)

Fits: '12-'17 FLD, '06-'08 & '10-'17 FXDWG & '08-'17 FXDF with forward controls

8399 Chrome (ea)

Note: Can also be used on any '06-'17 Dyna converted to forward controls.



8398



7780



8294



8291



8397



8299



LOOKS GREAT WITH
HYPERCHARGER HORN COVER
PG 203



New

Collections

Featured Bikes

Audio

Lighting

Accessory Mounts

Handlebar Controls,
Grips & Mirrors

Pegs & Foot Controls

Covers, Trims
& Accents

Air Cleaners
& Exhaust

Touring & Comfort

Windshields &
Air Management

Luggage &
Organizers

Index



8370



8392



8143



8141

8140



8393



8370



8295

**INNER PRIMARY COVER EXTENSIONS
FRONT AND REAR**

If you're using a 2-1 or staggered performance exhaust with our 8294 Inner Primary Cover, our rear extension (P/N 8295) covers the area where the crossover pipe had been. Our Front Extension (P/N 8370) picks up right where our 8294 Inner Primary Cover left off to cover the shift pivot area & grease fitting.

FOR HARLEY-DAVIDSON®

Fits: '90-'06 Electra Glides, Road Glides, Street Glides, and Road Kings equipped with Inner Primary Cover P/N 8294

8370 Chrome (ea)

Fits: '90-'06 Electra Glides, Road Glides, Street Glides, and Road Kings equipped with Inner Primary Cover P/N 8294 & 2-1 EXHAUST

8295 Chrome (ea)

CYLINDER BASE COVERS

Beautifully highlight the transition from cylinder to engine case. The perfect complement to Kuryakyn Inner Primary Covers (sold separately).

FOR HARLEY-DAVIDSON®

Fits: '07-'16 Electra Glides, Road Glides, Road Kings, Street Glides, Trikes & '06-'17 Dyna Models

8392 Chrome (ea)

Fits: '84-'99 H-D Evo Big Twins with Forward Controls or Floorboards

8140 Chrome (ea)

Fits: '07-'17 Softail Models

8393 Chrome (ea)

Fits: '00-'06 Softails, '99-'06 Electra Glides, Road Glides, Road Kings & Street Glides, '99-'05 FXDWG & any '99-'05 Dyna Models Converted to Forward Controls

8143 Chrome (ea)

Fits: All '91-'03 Sportster Models

8141 Chrome (ea)



LOOKS GREAT WITH
CARVED SHIFT LINKAGES **PG 146**





MESH

New

Collections

Featured Bikes

MESH DERBY COVER

Heavy-duty bolt-on replacement derby covers. Unique three-piece design features an aluminum outer frame and baseplate, with formed steel insert secured with included hardware upon installation. Individual components can be custom-painted to match any color theme.

FOR HARLEY-DAVIDSON®

Fits: '15 FLHTCUL & FLHTKL, '16-'19 Electra Glides Road Glides, Road Kings, Street Glides & Trikes

6526 Chrome (ea)

6527 Satin Black (ea)

Fits: '99-'17 Dyna & '99-'18 Softail Models (except '18-'19 FL5B) & '99-'15 Touring & Trike (except '15 FLHTCUL & '15 FLHTKL)

6524 Chrome (ea)

6525 Satin Black (ea)

Fits: '04-'19 XL Models

6528 Chrome (ea)

6529 Satin Black (ea)

Note: Installation requires purchase of separate Harley-Davidson Gasket, H-D P/N 25416-99C



ALSO AVAILABLE
MESH TIMING COVER
PG 187

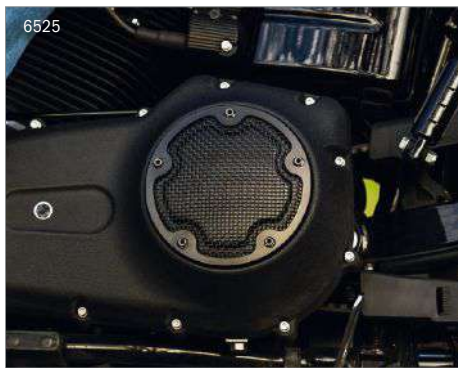

Audio

Lighting

Accessory Mounts

Handlebar Controls,
Grips & Mirrors

Pegs & Foot Controls

**Covers, Trims
& Accents**

Air Cleaners
& Exhaust

Touring & Comfort

Windshields &
Air Management

Luggage &
Organizers

Index



Finned



9768



9749



6062



6063

FINNED DERBY COVERS

Direct replacement for stock made from quality aluminum and featuring a classic finned design for a cool retro vibe. Includes hardware for easy installation.

FOR HARLEY-DAVIDSON®

Fits: '15 FLHTCUL & FLHTKL & All '16-'19 Electra Glides, Road Glides, Road Kings, Street Glides & Trikes

9768 Chrome (ea)

9769 Satin Black & Machined (ea)

Fits: '99-'17 Dyna & '99-'18 Softail Models (except '18 FL5B) & '99-'15 Touring & Trike (except '15 FLHTCUL & '15 FLHTKL)

9748 Chrome (ea)

9749 Satin Black & Machined (ea)

Note: Installation requires purchase of separate Harley-Davidson Gasket (H-D p/n varies by model/year)

FINNED PRIMARY ACCENT

An easy, effective and affordable way to add classic finned styling to the outer primary. A380 aluminum shaped to fit perfectly in the recessed area via high-temp and high-strength 3M® VHB™ adhesive.

FOR HARLEY-DAVIDSON®

Fits: '17-'19 Electra Glides, Road Glides, Road Kings, Street Glides & Trikes

6062 Chrome (ea)

6063 Satin Black & Machined (ea)



LOOKS GREAT WITH
FINNED SPARK PLUG COVERS
PG 201



**FINNED FRONT PRIMARY ACCENT**

A simple, effective and affordable solution to adding classic finned styling to the outer primary. Cast from durable A380 aluminum, installs easily using high-strength and high-temp 3M® VHB™.

FOR HARLEY-DAVIDSON®

Fits: '17-'19 Electra Glides, Road Glides, Road Kings, Street Glides & Trikes

6068 Chrome (ea)

6069 Satin Black & Machined (ea)

Fits: '99-'16 Electra Glides, Road Glides, Road Kings, Street Glides & Trikes

6066 Chrome (ea)

6067 Satin Black & Machined (ea)

Fits: '07-'17 Twin Cam Softail & Dyna

6064 Chrome (ea)

6065 Satin Black & Machined (ea)

Note: Not comparable with heel shifters.

FINNED PRIMARY INSPECTION COVER ACCENTS

An easy, effective and affordable way to add classic finned styling to the outer primary. A380 aluminum shaped to fit perfectly in the recessed area via high-temp and high-strength 3M® VHB™ adhesive.

FOR HARLEY-DAVIDSON®

Fits: '07-'16 Touring & Trike

9231 Chrome (ea)

9233 Satin Black & Machined (ea)

Fits: '07-'17 Softail & '07-'17 Dyna Models with Factory Forward Controls

9234 Chrome (ea)

9236 Satin Black & Machined (ea)



LOOKS GREAT WITH
HEAVY INDUSTRY FOOT
CONTROLS **PG 110**



New

Collections

Featured Bikes

Audio

Lighting

Accessory Mounts

Handlebar Controls,
Grips & Mirrors

Pegs & Foot Controls

Covers, Trims
& AccentsAir Cleaners
& Exhaust

Touring & Comfort

Windshields &
Air ManagementLuggage &
Organizers

Index



8372



8107



8106



8323



8323



8315



7260



7243



8144

ROCKER BOX BOLT COVERS

The final touch that makes the difference. Simple push-on installation.

FOR HARLEY-DAVIDSON®

Fits: All '99-'17 Twin Cam Engines & '17-'19 Milwaukee-Eight Engines

8372 Peaked - Set of 4, Chrome (set)

8693 Peaked - Set of 6, Chrome (set)

8144 Stiletto - Set of 4, Chrome (set)

HEAD BOLT COVERS

A quick and easy way to dress up the dull look of your Head bolts. These Head bolt Covers hide the whole bolt head for a much cleaner look!

FOR HARLEY-DAVIDSON®

Fits: All '87-'19 H-D Evolution and Twin Cam Engines

8107 Stiletto, Chrome (set)

8106 Peaked, Chrome (set)

SCORPION SPARK PLUG/HEAD BOLT COVERS

Add a classy touch to your engine. Held in position with set screws, ensuring rattle-free performance.

FOR HARLEY-DAVIDSON®

Fits: All '99-'17 Twin Cam Engines

8323 Chrome (pr)

Fits: H-D Evolution Big Twins & '86-'03 XL (Does not fit Screamin' Eagle Evolution heads) (pr)

8315 Chrome (set)

SLOTTED HEAD BOLT COVERS

Featuring a stepped and slotted design to complement the engine. The chrome version also features faceted edges to catch and reflect light for an incredible shine.

FOR HARLEY-DAVIDSON®

Fits: '99-'16 Electra Glides, Road Glides, Road Kings, Street Glides & '09-'16 Trikes

7260 Chrome (pr)

7243 Gloss Black (pr)



LOOKS GREAT WITH
MAVERICK HORN COVER
PG 203



7186



FINNED SPARK PLUG COVERS

Investment cast aluminum with wrinkle-black finish and machined outer edges to match the cylinder heads while filling the gap for a clean appearance.

FOR HARLEY-DAVIDSON™

Fits: '17-'19 Electra Glides, Road Glides, Road Kings, Street Glides & Trikes; '18-'19 Softail Models

7186 Wrinkle Black (pr)

PRECISION™ SPARK PLUG COVERS

Pure perfection when it comes to filling the void around the base of the plugs, head bolts, and surrounding area. Features a stunning stepped design cast from quality aluminum.

FOR HARLEY-DAVIDSON™

Fits: '17-'19 Electra Glides, Road Glides, Road Kings, Street Glides & Trikes; '18-'19 Softail Models

7185 Chrome (pr)

6444 Gloss Black (pr)

SPARK PLUG COVERS FOR SPORTSTER

Prevent road grime from collecting at the base of your plugs and get a clean custom look in the process. Cast from quality aluminum available with black or machined outer edges to match the cylinder heads for a fully finned appearance.

FOR HARLEY-DAVIDSON™

Fits: '04-'19 XL Models

7184 Satin Black & Raw Aluminum (pr)

7183 Wrinkle Black (pr)

MESH MANIFOLD & INJECTOR COVER FOR SPORTSTER

This cover fills the gap between the upper cylinders, concealing the unfinished manifold and zinc-plated injector retaining bracket for a unique, rugged look. Constructed from a die-cast aluminum frame, stainless steel mesh, and sturdy steel back plate. Mounts to threaded holes in the heads with included steel bracket and hardware.

FOR HARLEY-DAVIDSON™

Fits: '07-'19 XL Models (except '07 XL50, '07-'19 XL1200C, '12-'16 XL1200V & '14-'17 XL1200T)

6566 Chrome (ea)

6567 Satin Black (ea)



ALSO AVAILABLE
MESH FRONT PULLEY COVER
PG 192



BEFORE

7186
AFTER

6444



7185



7185



7183

6567



6566



7184



BEFORE



6566 - AFTER

New

Collections

Featured Bikes

Audio

Lighting

Accessory Mounts

Handlebar Controls,
Grips & Mirrors

Pegs & Foot Controls

Covers, Trims
& AccentsAir Cleaners
& Exhaust

Touring & Comfort

Windshields &
Air ManagementLuggage &
Organizers

Index

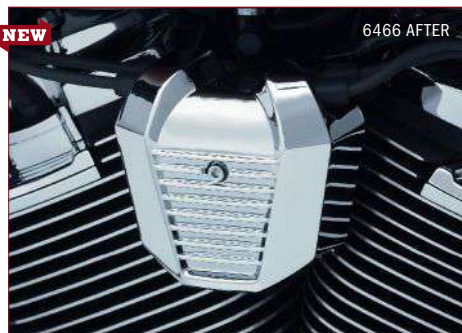

NEW

6467



PRECISION™ COIL COVER FOR '18-'19 SOFTAIL

Give the coil and plug wires an entirely new, custom look with this trick cover designed to match our entire Precision line for Milwaukee-Eight Softails. Constructed from high-quality aluminum, the sculpted design features raised fins that provide depth.

FOR HARLEY-DAVIDSON™

Fits: '18-'19 Softail Models

6466 Chrome (ea)

6467 Gloss Black (ea)



LINEAR FUEL LINE FITTING COVERS

Sleek and streamlined to provide full coverage for the visible portion of the fuel line for a clean look. Aluminum construction with tool-less installation.

FOR HARLEY-DAVIDSON™

Fits: '02-'19 Fuel Injected Electra Glides, Road Glides, Road Kings, Street Glides & Trikes, '01-'17 Fuel Injected Softails, '04-'17 Fuel Injected Dynas & '07-'19 Sportsters

9854 Chrome (ea)

9855 Satin Black (ea)

9856 Gloss Black (ea)



FUEL LINE FITTING COVER

Cover up the plumbing on your fuel-injected bike with this two-piece streamlined beauty.

FOR HARLEY-DAVIDSON™

Fits: '02-'19 Fuel Injected Electra Glides, Road Glides, Road Kings, Street Glides & Trikes, '01-'17 Fuel Injected Softails, '04-'17 Fuel Injected Dynas & 14-'19 Sportsters

1521 Chrome (ea)

MARQUIS CHOKE KNOB

U.S. Patent 5,836,214

Easier to locate and get a hold of, our choke knob cover installs neatly over the stock black plastic unit.

FOR HARLEY-DAVIDSON™

Fits: All '88-'06 XL Models & '90-'06 Big Twin with Stock Carburetors

2009 Chrome (ea)



HORN COVERS & HORNS



HYPERCHARGER™ ES HORN COVER

Looks great on its own, and also serves as the perfect counterpart to the Kuryakyn Hypercharger ES Air Cleaner. Features an aggressive finned design made from quality A380 aluminum. Modular construction allows for easy application of custom finishes to color-match other accessories or paint.

FOR HARLEY-DAVIDSON™

Fits: '95-'19 H-D Models with Stock Cowbell & Waterfall Horn Cover

7496 Chrome (ea)

7491 Satin Black (ea)

MAVERICK HORN COVER

Ditch the stock "cowbell" or "waterfall" horn cover for this direct replacement featuring an aggressive yet clean beveled design styled after Crusher Maverick air cleaners and exhaust. Made from high-quality cast aluminum, includes hardware for easy bolt-on installation.

FOR HARLEY-DAVIDSON™

Fits: '95-'19 H-D Models with Stock Cowbell & Waterfall Horn Cover

7474 Chrome (ea)

7478 Satin Black (ea)

MACH 2™ HORN COVER

Die-cast cover with mesh insert. Perfect match to Mach 2 or Alley Cat Air Cleaners.

FOR HARLEY-DAVIDSON™

Fits: '95-'19 H-D Models with Stock Cowbell & Waterfall Horn Cover

7296 Chrome with Black Mesh (ea)

7297 Gloss Black with Chrome Mesh (ea)

7295 Chrome with Chrome Mesh (ea)



New

Collections

Featured Bikes

Audio

Lighting

Accessory Mounts

Handlebar Controls,
Grips & Mirrors

Pegs & Foot Controls

Covers, Trims
& Accents

Air Cleaners
& Exhaust

Touring & Comfort

Windshields &
Air Management

Luggage &
Organizers

Index

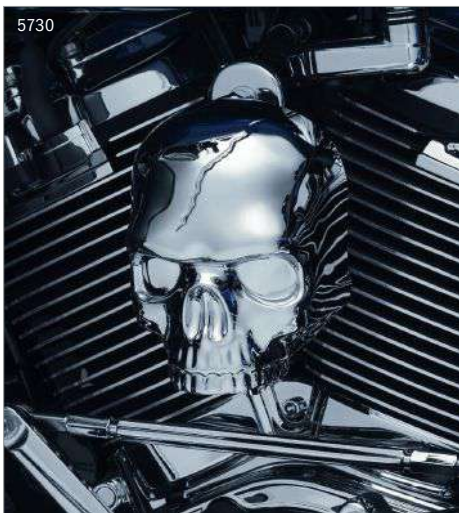

5730

5731



SKULL HORN COVER

FOR WATERFALL STYLE HORN COVERS

Converts the shape and style of the stock "waterfall"-style horn cover with the perfect amount of sinister attitude. Durable ABS construction, installs easily using high-strength 3M® VHB™.

FOR HARLEY-DAVIDSON®

Fits: '17-'19 H-D Models with Stock Waterfall Style Horn Cover

5730 Chrome (ea)

5731 Gloss Black (ea)



7718

7741



SKULL HORN COVER

The stock cowbell horn cover is a great look for ol' Bessie, but on your bike it lacks attitude. Here's a better idea; stick our wicked Skull Horn Cover onto your stock cowbell and transform bovine to bad in an instant!

FOR HARLEY-DAVIDSON®

Fits: '92-'19 H-D Models with Stock Cowbell Horn Cover

7718 Chrome (ea)

7741 Black Chrome (ea)



7714

FLAME™ HORN COVER

ABS construction. Fastens to stock cowbell cover with 3M® VHB™.

FOR HARLEY-DAVIDSON®

Fits: '92-'19 H-D Models with Stock Cowbell Horn Cover

7714 Chrome (ea)

FLAME™ HORN COVER WITH WOLO® ELECTRIC HORNS

Kit combines Wolo's 225-2T High-Low Tone electric horns (115 decibel 510/420 Hz) with our Flame Horn Cover and complete mount and wiring kit. Bolts on in place of your stock cowbell and wiring is plug-&-play to ensure a low-stress install.

FOR HARLEY-DAVIDSON®

Fits: '92-'19 H-D Models with Stock Cowbell & Waterfall Horn Cover

7298 Chrome (kit)



7298



8128

7204



V-SHIELD HORN COVER

The V-Shield Horn Cover provides a sharp, classy appearance that accentuates the lines of Harley's 45-degree V-Twins.

FOR HARLEY-DAVIDSON®

Fits: '92-'19 H-D Models with Stock Cowbell & Waterfall Horn Cover

8128 Chrome (ea)

7204 Gloss Black (ea)

KRUSADER HORN COVER

Liberate your bike from the basic factory cowbell horn cover and replace it with the sharp lines of the aggressive Krusader Horn Cover. Choose between two configurations: Chrome or Gloss Black, with included chrome or gloss black mesh inserts for a unified or contrasting appearance.

FOR HARLEY-DAVIDSON™

Fits: '95-'19 H-D Models with Stock Cowbell & Waterfall Horn Cover

7396 Chrome (ea)

7397 Gloss Black (ea)

**SIGNATURE SERIES HORN REPLACEMENT ACCENT BY JIM NASI**

Flows with the angle of the cylinder heads for clean custom style in place of factory "cowbell" covers. Durable ABS construction with signature stainless steel Jim Nasi "N" logo. Gloss black finish can be prepped to paint-match color themes. Includes steel mounting bracket and reuses factory engine mount bolts.

FOR HARLEY-DAVIDSON™

Fits: '08-'16 Electra Glides, Road Glides, Road Kings, Street Glides & Trikes

5687 Chrome (kit)

5695 Gloss Black (kit)

5859 Horn Relocation Kit, Black (kit)

Note: Requires relocation of factory horn.



The Kuryakyn Signature Series showcases original designs from minds of true masters of the trade. Jim Nasi is a true pioneer of one-off custom motorcycles and components. A brand built on original designs, demanding quality and a passion for creativity; for over two decades Jim Nasi Customs has established a reputation for awe-inspiring concepts, intelligent engineering and clean, unfiltered style.

Signature
SERIES

WOLO BAD BOY AIR HORN KITS FOR H-D MODELS

The latest in air horn technology, Wolo's Bad Boy Air Horn produces a powerful 118 decibel - 530/680 Hz dual-tone air horn sound that is drastically louder than the factory horn. The one-piece design requires no hoses and the heavy-duty, maintenance-free compressor will provide years of dependable service. Deluxe and Super Deluxe Kits include a sturdy bracket and plug-&-play wiring harness so you can mount the Bad Boy in place of the stock H-D horn without any fabrication and plug it in without having to piece together your own wiring to install the relay. The Super Deluxe Kit also includes a chrome horn cover.

FOR HARLEY-DAVIDSON™

Fits: '95-'19 H-D Models with Stock Cowbell & Waterfall Horn Cover

7742 Deluxe Kit, Chrome (ea)

7743 Super Deluxe Kit, Chrome (kit)

Fits: Wolo Bad Boy Air Horn Kuryakyn P/N 7742 & Wolo Bad Boy Air Horn Models 419 & 519

7732 Cover for Wolo Bad Boy Horn, Chrome (ea)

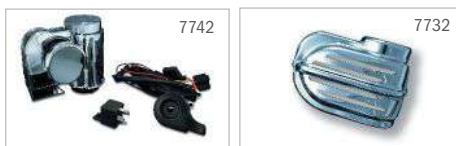

New

Collections

Featured Bikes

Audio

Lighting

Accessory Mounts

Handlebar Controls,
Grips & Mirrors

Pegs & Foot Controls

Covers, Trims
& AccentsAir Cleaners
& Exhaust

Touring & Comfort

Windshields &
Air ManagementLuggage &
Organizers

Index

FASTENER COVERS



KOOL KAPS BOLT COVERS 10 PACK

Easily installs over the head of existing bolts for a smooth, finished appearance.

FOR HARLEY-DAVIDSON®

Fits: 1/4" Hex Head Bolt (Uses 7/16" Wrench)

2442 Chrome (kit)

Fits: 1/4" Socket Head Bolt (Uses 3/16" Allen Wrench)

2440 Chrome (kit)

2454 Gloss Black (kit)

Fits: 5/16" Socket Head Bolt (Uses 1/4" Allen Wrench)

2441 Chrome (kit)

2457 Gloss Black (kit)

Fits: 5/16" Button - Socket Head Bolt (Uses 1/4" Allen Wrench)

2443 Chrome (kit)

Fits: 5/16" Hex Head Bolt (Uses 1/2" Wrench)

2446 Chrome (kit)

2456 Gloss Black (kit)

Fits: 5/16" Torx Head Bolt (Uses T40 Torx Wrench)

2444 Chrome (kit)

Fits: 3/8" Hex Head Bolt or Torx Head Bolt (Uses 9/16" Wrench or T30 Torx)

2449 Chrome (kit)

2458 Gloss Black (kit)

Fits: 3/8" Socket Head Bolt (Uses 5/16" Allen Wrench)

2445 Chrome (kit)

2455 Gloss Black (kit)

Fits: 1/2" Hex Head Bolt (Uses 3/4" Wrench)

2447 Chrome (kit)

2459 Gloss Black (kit)

Fits: 7/16" Hex Head Bolt (Uses 5/8" Wrench)

2448 Chrome (kit)

Note: Requires a small amount of silicone. Found at local hardware store.

KOOL KAPS BOLT COVERS ENGINE KIT

FOR HARLEY-DAVIDSON™

Fits: '17-'19 Electra Glides, Road Glides, Road Kings, Street Glides, Trikes & '18-'19 Softails

2464 Chrome (kit)

2465 Gloss Black (kit)

Fits: Evolution and Twin Cam Engines (kit)

2450 Chrome (kit)

2452 Gloss Black (kit)

Note: Requires a small amount of silicone. Found at local hardware store.



KOOL KAPS BOLT COVERS 2 PACK

FOR HARLEY-DAVIDSON™

Fits: Kuryakyn Magnum Footpeg Mounts or 1/2" Hex Head Bolt (Uses 3/4" Wrench)

2451 Chrome (pr)

Note: Requires a small amount of silicone. Found at local hardware store.

HOLLOW POINT SLEEVE & HOT SPOT KIT

Works and looks great on all motor bolts using a 1/4" Socket Head Cap Screw.

FOR HARLEY-DAVIDSON™

Fits: 1/4" Socket Head Screws

7771 Chrome (set)

HOT SPOTS™ CUSTOM END PLUGS FOR ALLEN HEAD BOLTS

Give your Allen head that smooth look and protect from rust damage with Hot Spots Custom End Plugs.

FOR HARLEY-DAVIDSON™

Fits: 3/8" Allen Bolts - Set of 6

8120 For 3/8" Allen Bolts, Chrome (set)

Fits: 5/16" Allen Bolts - Set of 7

8117 For 5/16" Allen Bolts, Chrome (set)

Fits: 1/4" Allen Bolts - Set of 10

8114 For 1/4" Allen Bolts, Chrome (set)

ZOMBIE MEDALLIONS

FOR MULTI-FIT

Fits: Universal Applications, Requires Flat Surface Area

1492 1" Diameter, Chrome (pr)

1491 2" Diameter, Chrome (pr)



ALSO AVAILABLE
PRECISION TAPPET BLOCK
ACCENT **PG 188**



2465



2450



7771



7771



2451



Before

After



8781



1491

1492

New

Collections

Featured Bikes

Audio

Lighting

Accessory Mounts

Handlebar Controls, Grips & Mirrors

Pegs & Foot Controls

Covers, Trims & Accents

Air Cleaners & Exhaust

Touring & Comfort

Windshields & Air Management

Luggage & Organizers

Index

FRAME

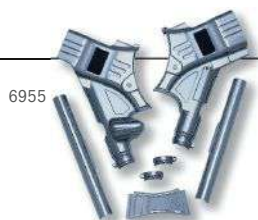
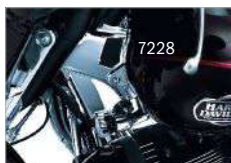
**DELUXE NECK COVERS**

U.S. Patents D591,207 & 7,762,586, U.S. Patent D635,061
Just the right touch of edge and functionality. Hide those welds and wires in one quick and easy step. Kuryakyn Neck Cover Kits customize the frame's steering neck and down tubes with easily installed chrome covers. Downtube Crossbrace Cover included in Part Numbers 7832, 7228 and 6955.

FOR HARLEY-DAVIDSON®

Fits: '14-'19 Electra Glides, Road Glides, Road Kings & Street Glides

6955 Chrome (set)

Fits: '09-'13 Electra Glides, Road Glides, Road Kings & Street Glides

7832 Chrome (pr)

Fits: '09-'13 Tri Glide Ultra Classic & '10-'11 Street Glide Trikes

7228 Chrome (set)

Fits: '95-'07 Electra Glides, Road Glides, Road Kings, Street Glides & Tour Glides

7866 Chrome (pr)

Fits: '95-'05 Electra Glides, Road Glides, Tour Glides & Road Kings

8146 Chrome (set)

**NECK COVERS FOR SOFTAIL**

Masking the roughly finished forged frame neck on a Twin Cam Softail is now as easy as two screws and a few minutes of your time. We've designed a smooth and cleanly contoured set of stamped steel neck covers to work on Softail Models equipped with fork tins. These beautifully chromed covers mask the wiring, giving your bike's neck a finished appearance.

FOR HARLEY-DAVIDSON®

Fits: '07-'17 FLSTC, FLSTF, FLSTFB, FLSTN & FLS

7833 Chrome (set)

Fits: '00-'06 FLST, FLSTC, FLSTF & FLSTN

8163 Chrome (set)

Note: These covers do not fit FLSTs, FLSTSC, or FLSTSB Models.

6997

**MID-FRAME COVERS**

FOR TOURING U.S. Patent D518,760

Create a smooth, sharp look by concealing unsightly frame welds with this chrome-plated stamped steel cover.

FOR HARLEY-DAVIDSON™

Fits: '14-'19 Electra Glides, Road Glides, Road Kings, Street Glide & Trikes

6997 Chrome (set)



Fits: '09-'13 Electra Glides, Road Glides, Road Kings, Street Glides & Trikes

8609 Chrome (set)



Fits: '97-'07 Electra Glides, Road Glides, Road Kings & Street Glides

8239 Chrome (kit)

SWINGARM ACCENTS FOR TOURING

Add a glint of chrome to your swingarm without the need for tools.

FOR HARLEY-DAVIDSON™

Fits: '09-'19 Electra Glides, Road Glides, Road Kings & Street Glides

8696 Chrome (ea)

**DOWN TUBE COVERS** FOR SOFTAIL

Snap-on installation makes this an easy way to add some chrome to the front frame downtubes.

FOR HARLEY-DAVIDSON™

Fits: '07-'17 Softail Models (except FXCW/C, FXSB, FXSBSE)

7863 Chrome (set)



Fits: '00-'06 Softail Models

7853 Chrome (set)

**DOWNTUBE CROSSBRACE COVER**

Covers the front and back of the downtube crossbrace.

FOR HARLEY-DAVIDSON™

Fits: '99-'13 Electra Glides, Road Glides, Street Glides, Road Kings, & Trikes

7774 Chrome (ea)

**ACCENTS FOR H-D MID-FRAME AIR DEFLECTORS**

Add some visual appeal to the mid-frame heat deflectors for an easy custom look.

FOR HARLEY-DAVIDSON™

Fits: '09-'19 FLHTCU/L, '09-'13 FLHTCUSE, '10-'19 FLHTK/L, '14-'19 FLHTKSE, '11-'13 & '16-'19 FLTRU, '11 & '15-'16 FLTRUSE, '09-'19 Trikes and any '09-'19 Touring Models Equipped with H-D Mid-Frame Air Deflectors (H-D P/N 58002-09)

8674 Chrome (pr)

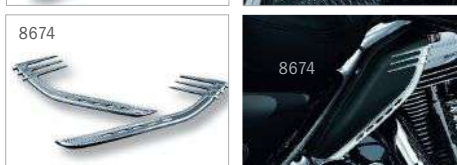

New

Collections

Featured Bikes

Audio

Lighting

Accessory Mounts

Handlebar Controls,
Grips & Mirrors

Pegs & Foot Controls

Covers, Trims
& AccentsAir Cleaners
& Exhaust

Touring & Comfort

Windshields &
Air ManagementLuggage &
Organizers

Index



9396



PASSENGER BOARD BLOCK OFF PLATES FOR TOURING & TRIKES

If you're a solo rider, these are a must to cover the bolt holes left behind when removing the passenger boards. Constructed from lightweight and durable A380 aluminum.

FOR HARLEY-DAVIDSON®

Fits: '93-'19 Electra Glides, Road Glides, Road Kings, Street Glides, Tour Glides & Trikes

9396 Chrome (pr)

9397 Black (pr)



ALSO AVAILABLE
HEX PASSENGER BOARDS
PG 105



PASSENGER FLOORBOARD COVERS

Made from quality A380 aluminum, these install directly over the stock D-shaped passenger boards.

FOR HARLEY-DAVIDSON®

Fits: '86-'19 Electra Glides, Road Glides, Road Kings, Tour Glides & Trikes with Traditional D-Shaped Passenger Boards; '86-'17 Softail or '06-'17 Dyna Models equipped with H-D Accessory Passenger Floorboard Kits Using Traditional D-Shaped Passenger Boards

8876 Finned Covers, Chrome (pr)

8877 Finned Covers, Satin Black (pr)

4563 Flamed Covers, Chrome (pr)

PASSENGER BOARD MOUNT ACCENTS

Chrome cover for the stock passenger board mounts.

FOR HARLEY-DAVIDSON®

Fits: '93-'09 Electra Glides, Road Glides, Tour Glides, Road Kings & Trikes with Stock Passenger Floorboard Mounts (except '04-'05 FLHTCSE & '06-'09 FLHTCUSE)

7776 Chrome (pr)

Fits: Stock Passenger Floorboard Mounts on '10-'19 Electra Glides (except '10-'13 FLHTCUSE, '14-'19 FLHTKSE), Road Glide Ultras (except '11 & '15-'16 FLTRUSE), Road Kings (except '13-'14 FLHRSE & '17-'19 FLHRXS) & Trikes

7777 Chrome (pr)

RIGHT REAR LOWER FRAME COVER U.S. Patent D594,791
Covers the exposed frame tubes and rear rubber swingarm bushing.

FOR HARLEY-DAVIDSON®

Fits: '07-'08 Electra Glides, Road Glides, Road Kings & Street Glides

7829 Chrome (ea)



BOOMERANG FRAME COVERS

Install in minutes and change the look of your bike dramatically!

FOR HARLEY-DAVIDSON™

Fits: '08-'17 FLSTC Heritage Classic, FXST Softail Standard, FXSTC Softail Custom, FLSTSE CVO Softail Convertible, FXSB Breakout, FXSBSE CVO Breakout, FXSE Pro street Breakout

7773 Chrome (pr)

Fits: All '00-'07 FXST (except Deuce) & all '00-'07 FLST (except Fat Boy & Deluxe)

7851 Chrome (pr)

Fits: '86-'99 FXST Models & FLST Models without Shotgun Exhaust (pr)

8188 Chrome (pr)

Note: If you have a '00-'07 Fat Boy or '05-'07 Deluxe & have removed the O.E. rear exhaust support bracket, you should use P/N 7851. Exhaust support brackets will directly affect which covers to order. Please read the applications & notes carefully before ordering. Not compatible with H-D passenger floorboards. Will also fit '08-'17 FLSTF, FLSTFB, FLSTN, FXS & FLS if the stock exhaust has been removed & replaced by a staggered dual or 2 into 1 system.

LOWER BELT GUARD ACCENT

A great opportunity to add another gleaming chrome accent without the hassle of removing the stock guard.

FOR HARLEY-DAVIDSON™

Fits: All '00-'17 Softail Models (except FXCW/C, FXSB & FXSBSE)

8677 Chrome (ea)



New

Collections

Featured Bikes

Audio

Lighting

Accessory Mounts

Handlebar Controls,
Grips & Mirrors

Pegs & Foot Controls

Covers, Trims
& Accents

Air Cleaners
& Exhaust

Touring & Comfort

Windshields &
Air Management

Luggage &
Organizers

Index



8256



SWINGARM COVERS FOR SOFTAIL

Offered with L.E.D. single-function auxiliary lights, unlit or tube covers only.

FOR HARLEY-DAVIDSON®

Fits: '08-'17 FLSTC Heritage Softail Classic, FLSTSE Softail Convertible, FXST Softail Standard, FXSTB Night Train and FXSTC Softail Custom

7815 Unlit, Chrome (set)

Note: Will fit FLSTF; FLSTFB, FLS, FXS and FLSTN if stock exhaust has been removed and replaced with a staggered dual or 2 into 1 system.

Fits: '86-'99 Softail Models

8288 Unlit, Chrome (set)

8222 L.E.D., Chrome (set)

Fits: '00-'07 Softail models (Except '00-'07 FXSTD Deuce, '07 FLSTF Fat Boy, '06-'07 FXST/C Softail Standard, FXSTB Night Train & FXSTS Softail Springer.)

8256 Unlit, Chrome (set)

SWINGARM TUBE COVERS FOR SOFTAIL

Intended for riders that already have Kuryakyn Phantom Covers or similar style axle covers.

FOR HARLEY-DAVIDSON®

Fits: All '08-'17 Softails (except FXCW/C, FXSB & FXSBSE)

7818 Swingarm Tube Covers, Chrome (set)

Fits: '00-'07 Softail (Except '00-'07 FXSTD Deuce)

8108 Swingarm Tube Covers, Chrome (set)

Fits: '86-'99 Softail

8228 Swingarm Tube Covers, Chrome (set)

LOWER FRAME COVER FOR SOFTAIL

Easy and neat, this cover installs right below our Boomerang Frame Cover on the left side of your bike.

FOR HARLEY-DAVIDSON®

Fits: '97-'07 Softail Models without cross-over exhaust

8253 Chrome (ea)

SWINGARM PIVOT COVERS

Quickly and easily cover the ends of the swingarm pivot shaft on your Twin Cam Softail with these chrome-plated covers.

FOR HARLEY-DAVIDSON®

Fits: All '08-'17 Softail Models (except '08-'11 FXCW/C, '13-'17 FXSB, '13-'14 FXSBSE)

7258 Chrome (pr)

Fits: All '00-'07 Softail Models (except '05-'07 FLSTN, '07 FLSTF & '07 FXSTD)

7849 Chrome (set)

REAR END

6552



MESH REAR CALIPER COVER

FOR DYNA & SOFTAIL

Transform stock rear calipers without the added cost of complete replacements. Unique multi-piece construction features a rugged and industrial design with the ability to add custom finishes on each individual component. Bolts on in minutes and maintains full braking functionality.

FOR HARLEY-DAVIDSON®

Fits: '08-'17 Dyna & Softail Models

6552 Chrome (ea)

6553 Satin Black (ea)



6553

MESH



ALSO AVAILABLE

MESH FRONT CALIPER COVER
PG 175



REAR AXLE COVERS FOR SOFTAIL

Constructed from die-cast aluminum with sharp lines and industrial styling for full coverage of the rear axle, nut and axle adjuster mechanism.

FOR HARLEY-DAVIDSON®

Fits: '08-'17 FLSTC Heritage Softail Classic, FLTSE Softail Convertible, FXST Softail Standard, FXSTB Night Train and FXSTC Softail Custom

7486 Chrome (pr)

7487 Black & Brushed Aluminum (pr)

Note: Will fit FLSTF, FLSTFB, FLS, FXS and FLSTN if stock exhaust has been removed and replaced with a staggered dual or 2 into 1 system.



7487

7486



7487



PHANTOM COVERS FOR SOFTAILS

Simple install with great results!

FOR HARLEY-DAVIDSON®

Fits: All '86-'07 Softail Models (except '00-'07 FLSTF, FXSTD, '05-'07 FLSTN, '06-'07 FXST, FXSTB, FXSTC & FXSTS)

8200 Phantom Covers, Chrome (pr)

Note: Will fit Fat Boy and Deluxe if stock exhaust has been removed and replaced with a staggered dual or 2-1 system. Will fit '00-'06 FLSTF, '00-'07 FXSTD, or '05-'07 FLSTN if stock exhaust has been removed and replaced by a staggered dual or 2-1 system. Not compatible with rear facing axle adjusters found on some '86-'87 Softails.

Fits: All '86-'07 Softails Models (except '00-'07 FLSTF, FXSTD, '05-'07 FLSTN, '06-'07 FXST, FXSTB, FXSTC & FXSTS)

8202 Phantom Covers, Gloss Black (pr)

Note: Will fit Fat Boy and Deluxe if stock exhaust has been removed and replaced with a staggered dual or 2-1 system.

Fits: All '86-'07 Softails Models

8220 L.E.D. Phantom Covers, Chrome (set)

Note: Will fit Fat Boy and Deluxe if stock exhaust has been removed and replaced with a staggered dual or 2-1 system.

8200



8200



8202



New

Collections

Featured Bikes

Audio

Lighting

Accessory Mounts

Handlebar Controls,
Grips & Mirrors

Pegs & Foot Controls

Covers, Trims
& Accents

Air Cleaners
& Exhaust

Touring & Comfort

Windshields &
Air Management

Luggage &
Organizers

Index

NEW

NEW

TURN

NEW

BRAKE

NEW

OFF

NEW

5477

TRI-LINE

6986

6987

6987

1595

1599

L.E.D. SADDLEBAG HINGE ACCENTS FOR '14-'19 TOURING

Chip-on-board L.E.D. technology provides higher intensity output than standard L.E.D.'s, uniform light production, and superior thermal performance (longevity). Replaces stock saddlebag hinge reflectors for significantly enhanced visibility thanks to additional run, turn and brake functionality. Aluminum base construction with an included wiring harness for easy plug-&-play installation.

FOR HARLEY-DAVIDSON®

Fits: '14-'19 Electra Glides, Road Glides, Road Kings & Street Glides

5476 Chrome (pr)

5477 Satin Black (pr)



ALSO AVAILABLE
L.E.D. SADDLEBAG
EXTENSIONS **PG 219**



TRI-LINE SADDLEBAG HINGE COVERS

The perfect addition to the complete lineup of Tri-Line accessories for H-D Touring. Elegant Tri-Line styling replaces the factory hinge and reflector, reusing stock hardware and lock assemblies for a hassle-free installation. Made from high-quality cast aluminum.

FOR HARLEY-DAVIDSON®

Fits: '14-'19 Electra Glides, Road Glides, Road Kings & Street Glides

6986 Chrome (pr)

6987 Gloss Black (pr)

SADDLEBAG LATCH COVERS

The subtle grooved design adds an uncomplicated detail or add to your custom theme with the classic flame version supplied with Maltese Cross, Zombie, & Widow emblems. Stock lock mechanisms are re-used.

FOR HARLEY-DAVIDSON®

Fits: '93-'13 Electra Glides, Road Glides, Road Kings, Street Glides & Tour Glides with Hard Saddlebags

1599 Grooved, Chrome (pr)

1595 Flame, Chrome (pr)



MESH SADDLEBAG HINGE COVERS

Bolt-on replacements for the stock hinge covers with rugged, industrial styling. Accepts factory lock mechanisms. Aluminum outer frame and baseplate with steel mesh insert creates a unique three-piece design for custom-painting individual components.

FOR HARLEY-DAVIDSON™

Fits: '14-'19 Electra Glides, Road Glides, Road Kings & Street Glides

6509 Chrome (pr)

6510 Satin Black (pr)



ALSO AVAILABLE

MESH GAS CAP & L.E.D.
BATTERY GAUGE **PG 168**



QUICK DRAW SADDLEBAG LATCH HANDLES

A stylish direct replacement for the factory saddlebag lid handle offering improved ergonomics and easy operation. Made from quality A380 aluminum with integrated EPDM rubber for sure-fingered grip.

FOR HARLEY-DAVIDSON™

Fits: '14-'19 Electra Glides, Road Glides, Road Kings & Street Glides (except FLHXSE & FLTRXSE)

5192 Chrome (pr)

5193 Gloss Black (pr)

ZOMBIE™ SADDLEBAG LATCH HANDLES

A sleek direct replacement for the factory saddlebag lid handle offering improved ergonomics and sinister styling. Made from quality A380 aluminum.

FOR HARLEY-DAVIDSON™

Fits: '14-'19 Electra Glides, Road Glides, Road Kings & Street Glides (except FLHXSE & FLTRXSE)

5190 Chrome (pr)

5191 Gloss Black (pr)



ALSO AVAILABLE

ZOMBIE HORN COVER
PG 204



6509



6510

MESH



5193



5192



5192



5190

ZOMBIE



5191



5191

New

Collections

Featured Bikes

Audio

Lighting

Accessory Mounts

Handlebar Controls,
Grips & Mirrors

Pegs & Foot Controls

Covers, Trims
& Accents

Air Cleaners
& Exhaust

Touring & Comfort

Windshields &
Air Management

Luggage &
Organizers

Index



6891

SADDLEBAG FILLER PANELS

FOR '14-'16 ELECTRA GLIDE & ROAD KING
Elegantly fill the wide-open gap and exposed hardware in the rear saddlebag support for a smooth-flowing clean, custom appearance. Injection-molded ABS with secure installation using a metal bracket that can be easily removed for service work.

FOR HARLEY-DAVIDSON®

Fits: '14-'16 FLHTCU/L, FLHTK/U, FLHTKSE, FLTRU, FLTRUSE & FLHR

6980 Chrome (pr)

6981 Gloss Black (pr)

Note: CVO models require removal of factory saddlebag support filler strips.



SADDLEBAG FILLER PANELS

Fill the void between fender and saddlebag.

FOR HARLEY-DAVIDSON®

Fits: '95-'08 Electra Glide Standards, Road Glides & Road Kings with or without H-D Detachable Docking Hardware Kits (53803-06 & 53804-06)

1192 Chrome (set)

MUFFLER BRACKET COVERS

Chrome-plated stamped steel.

FOR HARLEY-DAVIDSON®

Fits: 4" Diameter Round Mufflers on '95-'19 Electra Glides, Road Glides (except '10 FLTRX), Road Kings, Street Glides (except '10 FLHX) & Tour Glides

7365 Chrome (pr)

7367 Satin Black (pr)



ALSO AVAILABLE
BILLET ANTENNA
PG 32



SPEEDFORM SADDLEBAG LID SPOILERS

FOR '14-'19 TOURING MODELS

Perfect for riders looking for an easy way to add custom styling to the stock saddlebag lids. Made from lightweight and durable ABS with easy installation using automotive-grade 3M™ VHB™.

FOR HARLEY-DAVIDSON™

Fits: '14-'19 Electra Glides, Road Glides, Road Kings & Street Glides

7066 Chrome (ea)

7067 Gloss Black (pr)



SADDLEBAG SCUFF PROTECTORS FOR '14-'19 TOURING

Cover existing scuffs or guard against future dings from boots and road debris. Durable ABS construction with EPDM rubber inlays for unique contrasting style.

FOR HARLEY-DAVIDSON™

Fits: '14-'19 Electra Glides, Road Glides (except '18-'19 FLTRXSE), Road Kings & Street Glides (except '15-'19 FLHXSE) does not fit with Boom Audio Speaker Lids

6824 Chrome (pr)

6825 Gloss Black (pr)



TRI-LINE SADDLEBAG ACCENTS

Add distinctive style to your saddlebags and Tour-Pak. The transformation takes minutes using high-strength adhesive.

FOR HARLEY-DAVIDSON™

Fits: '14-'19 Electra Glides, Road Glides, Road Kings & Street Glides

6905 Lid Accents, Chrome (pr)

6973 Lid Accents, Gloss Black (pr)

6908 Side Accents, Chrome (pr)

6974 Side Accents, Gloss Black (pr)



New

Collections

Featured Bikes

Audio

Lighting

Accessory Mounts

Handlebar Controls,
Grips & Mirrors

Pegs & Foot Controls

Covers, Trims
& Accents

Air Cleaners
& Exhaust

Touring & Comfort

Windshields &
Air Management

Luggage &
Organizers

Index



*Designed with
rider individuality
in mind*

7764



7764

SLOTTED SADDLEBAG LID ACCENTS

Can be positioned according to the rider's preference, centered or off center on top of the bag. Made from high quality chrome-plated aluminum and installs in seconds with no drilling required.

FOR HARLEY-DAVIDSON®

Fits: Hard Saddlebags on '93-'13 Electra Glides, Road Glides (except '13 FLTRXSE), Road Kings (except '13 FLHRSE), Street Glides (except '12 FLHXSE) & Tour Glides

7764 Slotted, Chrome (pr)

7764



SADDLEBAG LID ACCENTS

These chrome accents really highlight the tasteful look of the H-D saddlebag lids.

FOR HARLEY-DAVIDSON®

Fits: Hard Saddlebags on '93-'13 Electra Glides, Road Glides (except '13 FLTRXSE), Road Kings (except '13 FLHRSE), Street Glides (except '12 FLHXSE) & Tour Glides

8646 Chrome (pr)



8646

8645

SIDE COVER & SADDLEBAG ACCENTS

Intended for use without saddlebag rails, they'll add a classic, personal touch to your H-D Touring bike. Easily installs with high-strength adhesive.

FOR HARLEY-DAVIDSON®

Fits: Hard Saddlebags and Side Covers on '93-'08 Electra Glides, Road Glides, Road Kings, Street Glides & Tour Glides with Hard Saddlebags

8645 Chrome (set)

8646



8645



ALSO AVAILABLE..
SADDLEBAG LATCH COVERS
PG 214





SPEEDFORM SADDLEBAG EXTENSIONS

Get that custom stretched bag look at a fraction of the cost for complete replacements. Extends bags 4" and features removable cutouts for single, dual or side-output exhaust systems, as well as bolt-on steel scrape protectors so you can confidently carve through the corners.

FOR HARLEY-DAVIDSON®

Fits: '14-'19 Electra Glides (except '14-'19 FLHTKSE), Road Glides (except '15-'19 FLTRUSE, FLTRXSE & '18-'19 FLTRXS), Road Kings (except '14 FLHRSE, '17-'19 FLHRXS) & Street Glides (except '15-'19 FLHXSE, '17-'19 FLHXS)

7190 Chrome (pr)

7191 Gloss Black (pr)



L.E.D. SADDLEBAG EXTENSIONS FOR TOURING

These extensions bolt on securely and feature plug-&-play wiring for installation ease. 14-later applications provide run, turn and rake functionality ('14-later Road King models only support run and turn functions). '93-'13 version provides run and turn functionality for all applications. The inward curved bottom edge offers unique styling while also reducing cornering interference often seen with other saddlebag extensions.

FOR HARLEY-DAVIDSON®

Fits: '14-'19 Electra Glides (except '14-'19 FLHTKSE), Road Glides (except '15-'19 FLTRUSE, FLTRXSE & '17-'19 FLTRXS), Road Kings (except '14 FLHRSE, '17-'19 FLHRXS) & Street Glides (except '15-'19 FLHXSE, '17-'19 FLHXS)

7292 Chrome (pr)

7293 Gloss Black (pr)



Fits: '93-'13 Electra Glides, '98-'13 Road Glides (except '09 FLTRSE & '12-'13 FLTRXSE), 94-'13 Road Kings with Hard Saddlebags (except '13 FLHRSE), '06-'13 Street Glides (except '10-'12 FLHXSE) & '93-'96 Tour Glides

7272 Chrome (pr)

7273 Gloss Black (pr)

- New
- Collections
- Featured Bikes
- Audio
- Lighting
- Accessory Mounts
- Handlebar Controls, Grips & Mirrors
- Pegs & Foot Controls
- Covers, Trims & Accents**
- Air Cleaners & Exhaust
- Touring & Comfort
- Windshields & Air Management
- Luggage & Organizers
- Index

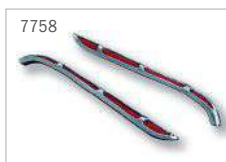

5054

L.E.D. INSERTS FOR SADDLEBAG SUPPORTS

Specifically designed to fill the rear-facing opening, these L.E.D. inserts will provide additional run, turn and brake lighting with easy-to-install plug-&-play wiring. '14-later FLHTKSE CVO Ultra Limited, FLTRUSE CVO Road Glide Ultra & Road King models only support run and turn functions.

FOR HARLEY-DAVIDSON®

Fits: '14-'19 FLHTCU/L Electra Glide Ultra Classic/Low, FLHTK/L Ultra Limited/Low, FLHTKSE CVO Ultra Limited, FLTRU Road Glide Ultra, FLTRUSE CVO Road Glide Ultra & FLHR Road King (except '17-'19 FLHRXS)

5054 Chrome (pr)

5055 Gloss Black (pr)

Note: CVO models require removal of factory saddlebag support filler strips.

L.E.D. REAR SADDLEBAG ACCENTS

Simple installation with plug-&-play wiring.

FOR HARLEY-DAVIDSON®

Fits: '93-'13 Electra Glides without Saddlebag Rails, '98-'13 Road Glides, '94-'13 Road Kings with Hard Saddlebags & '06-'13 Street Glides

7262 Wedge, Chrome (pr)

7263 Wedge, Gloss Black (pr)

Fits: '93-'19 Electra Glides without Saddlebag Rails, '98-'19 Road Glides, '94-'19 Road Kings with Hard Saddlebags & '06-'19 Street Glides

6906 Spear, Chrome (pr)

6907 Spear, Gloss Black (pr)

Note: '93-'96 Models, '10-'12 FLHXSE, '12-'13 FLTRXSE, & '13 FLRHSSE require lights be hard-wired to motorcycle. Drilling holes required for installation.

REAR FENDER STRIP LIGHTS

Add additional run-brake L.E.D. lighting to your rear end! The gently curved chrome housings sit perfectly in the contour of the rear fender skirt, but also look great on most any full-length fender.

FOR HARLEY-DAVIDSON®

Fits: '97-'13 H-D Touring & '96-'13 FL Softail Models with Full Length Rear Fenders. Universal Applications: Lights are 12" Long and Can Be Installed on Most Motorcycles with Flat-sided Full-length Fenders.

7758 Chrome (pr)

7744 Gloss Black (pr)

Note: Plug-&-play wiring harnesses included for '97-'13 Touring (including '10-'13 FLHX & FLTRX) and '96-'13 Softail. Installation on earlier or later models requires splicing wiring connectors.



7163

TOUR-PAK® LID GRIP

Protect paint and prevent wear and tear with this sleek and unobtrusive finger-hold that provides a convenient lifting point to grasp when opening Tour-Pak lids.

FOR HARLEY-DAVIDSON®

Fits: '06-'13 Touring & Trike with King or Ultra Tour-Paks

7160 Chrome (ea)

7161 Gloss Black (ea)

Fits: '14-'19 FLHTCU/L, FLHTK/L, FLHTKSE, FLTRU, '15-'16 FLTRUSE, '14-'19 FLHTCUTG and any '14-'19 Touring Models Equipped with H-D Accessory Tour-Pak

7162 Chrome (ea)

7163 Gloss Black (ea)

TRI-LINE TOUR-PAK® ACCENTS

Add distinctive style to your saddlebags and Tour-Pak. The transformation takes minutes using high-strength adhesive.

FOR HARLEY-DAVIDSON®

Fits: '14-'19 Electra Glides, '15-'19 Road Glide Ultras & '14-'19 Tri Glides

6909 Chrome (pr)

6975 Gloss Black (pr)

LID ACCENTS FOR SADDLEBAGS & TOUR-PAK®

Installs easily with high-strength adhesive.

FOR HARLEY-DAVIDSON®

Fits: Tour-Pak Lids on '80-'13 Touring Models Equipped with King, Ultra, Razor or Chopped Tour-Paks & Hard Saddlebag Lids on '93-'13 Electra Glides, Road Glides, Road Kings, Street Glides & Tour Glides

8647 Chrome (pr)

HINGE COVERS FOR '89-'13 H-D TOUR-PAK®

U.S. Patent D627,690

Installs quickly and securely over the tired-looking OEM stainless pieces. You'll be amazed at the life these give to any paint job.

FOR HARLEY-DAVIDSON®

Fits: '89-'13 Electra Glides, Tour Glides, Tri Glides, or Any Touring Model Equipped with a King, Ultra, Razor or Chopped Tour-Pak

8648 Chrome (pr)



7162



7162



7160



7161



6909



6975



6909



8647

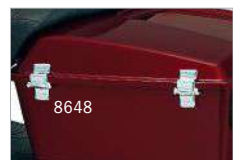

8648

New

Collections

Featured Bikes

Audio

Lighting

Accessory Mounts

Handlebar Controls,
Grips & Mirrors

Pegs & Foot Controls

Covers, Trims
& Accents

Air Cleaners
& Exhaust

Touring & Comfort

Windshields &
Air Management

Luggage &
Organizers

Index



COMPLETE THE LOOK!

SPEAKER GRILLS
PG 160 & 165

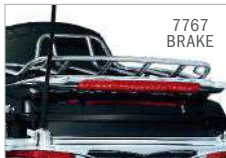

REAR SPEAKER ACCENTS FOR '98-'13 TOURING & TRIKE
Look great by themselves but are also required to install matching Speaker Grills to your rear speakers. Installs over stock black rear speaker rings. Includes polished stainless hardware.

FOR HARLEY-DAVIDSON®

Fits: '98-'13 FLHTCU/I, '10-'13 FLHTK, '08-'11 FLHTCUSE, '11-'13 FLTRU & '09-'13 FLHTCUTG.

3792 Chrome (pr)

REAR SPEAKER ACCENTS FOR '14-'19 TOURING & TRI GLIDE
Look great by themselves, but are also required to install matching Speaker Grills to your rear speakers. Replaces stock black rear speaker rings and mesh grills.

FOR HARLEY-DAVIDSON®

Fits: '14-'19 Electra Glides (except '14-'19 FLHTKSE), '16-'19 Road Glide Ultra (except '16 FLTRUSE), '14-'19 Tri Glide Ultra

7376 Chrome (pr)

COLOSSUS REAR TRIM FOR TOUR-PAK®

U.S. Patent D630,136

This trim is applied right over the stock Tour-Pak light bar, adding an element of surprise to the back of your ride.

FOR HARLEY-DAVIDSON®

Fits: '93-'13 FLHTCU, '10-'13 FLHTK, '08-'09 FLHTCUSE, '93-'96 FLTCU & '09-'13 FLHTCUTG

8666 Chrome (ea)

L.E.D. RUN-TURN-BRAKE SPOILER

Lighting features include red turn lights, bright red brake lights, and outer-third flash amber lights when the turn signals are activated. Mounts to most H-D Tour-Paks and can be used with or without luggage racks.

FOR HARLEY-DAVIDSON®

Fits: '93-'13 Touring and Trike Models with King, Chopped or Razor-Pak Tour Paks

7767 Chrome (ea)



Perfect match
to manufacturer's
Tour-Pak Light!

COVERS, TRIMS & ACCENTS
REAR END

TOUR-PAK® LID LIGHT

Additional rear lighting is always a good thing, and our Tour-Pak Lid Light delivers a triple dose of run-turn-brake functionality to significantly enhance rider visibility for trailing motorists. Fits inconspicuously in the recessed space on top of the lid and features a durable ABS housing with high-intensity red L.E.D.'s for ultra-bright performance.

FOR HARLEY-DAVIDSON®

Fits: '14-'19 Electra Glides, Road Glides, Tri Glides with Tour-Paks, '14-'19 King & Chopped Accessory Tour-Paks

- 6706 Chrome (ea)
- 6707 Satin Black (ea)



6706

TRI-LINE ACCENT FOR REAR TOUR-PAK® LIGHT

This three-piece chrome-plated ABS accent adds sleek Tri-Line styling to the stock rear light housing found on Tour-Paks. Hassle-free installation utilizing high-strength 3M® VHB™ adhesive.

FOR HARLEY-DAVIDSON®

Fits: '14-'19 FLHTCU Electra Glide Ultra Classic, '15-'19 FLHTCUL Electra Glide Ultra Classic Low, '14-'19 FLHTK Ultra Limited, '15-'19 FLHTKU Ultra Limited Low, '14-'19 FLHTKSE CVO Limited, '16-'19 FLTRU, '15-'17 FLTRUSE & '14-'19 FLHTCUTG Tri Glide Ultra

- 6910 Chrome (ea)



6910

6911

TRI-LINE

TRI-LINE ACCENTS FOR SIDE TOUR-PAK® LIGHTS

Extend the Tri-Line theme to the lower lights found on the sides of Harley Tour-Paks with this sleek accent that features cutouts so light output is not diminished. Hassle-free installation utilizes high-strength 3M VHB adhesive.

FOR HARLEY-DAVIDSON®

Fits: '14-'19 FLHTCU Electra Glide Ultra Classic, '15-'16 FLHTCUL Electra Glide Ultra Classic Low, '14-'19 FLHTK Ultra Limited, '15-'19 FLHTKL Ultra Limited Low, '14-'19 FLHTKSE CVO Limited, '16-'19 FLTRU, '15-'17 FLTRUSE & '14-'19 FLHTCUTG Tri Glide Ultra

- 6911 Chrome (pr)



Before



6910



6910



6911

Note: Does Not Fit with Tour-Pak & Saddlebag lighting kits

- New
- Collections
- Featured Bikes
- Audio
- Lighting
- Accessory Mounts
- Handlebar Controls, Grips & Mirrors
- Pegs & Foot Controls
- Covers, Trims & Accents
- Air Cleaners & Exhaust
- Touring & Comfort
- Windshields & Air Management
- Luggage & Organizers
- Index



7797



TURN SIGNAL BAR FILLER PANEL U.S. Patent D647,433
Gain additional run-brake lighting to the rear of your ride if you choose from the two lit options. Installation is hassle-free with no tools required.

FOR HARLEY-DAVIDSON®

Fits: '10-'19 FLHX Street Glides, '14-'19 FLHXS Street Glide Specials, '10-'13 & '15-'19 FLTRX Road Glide Customs & '17-'19 Road Glide Specials

3156 Unlit, Chrome (ea)

Fits: '10-'13 FLHX Street Glides & '10-'13 FLTRX Road Glide Customs

3154 L.E.D., Red (ea)

3153 L.E.D., Smoke (ea)

REAR FENDER & SADDLEBAG ACCENTS

Define the bottom edge of your fender and saddlebags with these easy-to-install accents.

FOR HARLEY-DAVIDSON®

Fits: '93-'13 Electra Glides, Road Glides (except '09 FLTRSE, '12-'13 FLTRXSE), Road Kings (except '98-'13 FLHRC/I, '04-'07 FLHRX/I, '07-'08 & '13 FLHRSE), Street Glides (except '10-'12 FLHXSE) & Tour Glides

8641 Chrome (pr)

Fits: '04-'08 Road Glides, '04-'07 Road King Customs, '02-'03 FLHRSE, '04-'05 FLHTCSE, '06-'08 FLHTCUSE (ea)

8640 Chrome (ea)

REAR FENDER ACCENTS FOR FLHX, FLTRX & FLHRXS

Made from a flexible, yet durable, ABS, these new accents offer a great way to make your bike as individual as you are.

FOR HARLEY-DAVIDSON®

Fits: '06-'19 FLHX/I Street Glides, '14-'19 FLHXS Street Glide Specials, '10-'13 & '15-'19 FLTRX Road Glide Customs, Road Glide Specials & '17-'19 FLHRXS Road King Specials

7797 Chrome (set)



LOOKS GREAT WITH
CURVED LICENSE PLATE
MOUNT PG 230



7215

**TRUNK LATCH ACCENT** FOR TRIKES

Lightweight, yet durable, chrome-plated ABS installs in just minutes.

FOR HARLEY-DAVIDSON™

Fits: '09-'19 FLHTCUTG Tri Glide Ultra Classic & '10-'11 FLHXXX Street Glide Trike

7215 Chrome (ea)



7215

SIDE BODY ACCENTS FOR TRIKES

Designed to compliment both the trunk and the wheel arch, these Side Body Accents are easy to install using high-strength 3M™ VHB™.

FOR HARLEY-DAVIDSON™

Fits: '11-'19 FLHTCUTG Tri Glide Ultra Classics & '11 FLHXXX Street Glide Trikes

7274 Chrome (pr)

7274



7217

**REAR FENDER ACCENTS FRONT EDGE** FOR TRIKES

Add some chrome and protect the edge of your Trike's fenders with these stylized accents. Mounting to the front leading edge of the rear fenders, these chrome plated ABS accents are just what you need to dress up a very noticeable area.

FOR HARLEY-DAVIDSON™

Fits: '09-'19 FLHTCUTG Tri Glide Ultra Classic & '10-'11 FLHXXX Street Glide Trikes

7217 Leading Edge Rear Fender Accents,
Chrome (pr)

7274

REAR FENDER FLARES FOR TRIKES

Much more than just chrome edging, these two-piece fender flares add three-dimensional depth to an otherwise bland wheel opening on stock H-D Trikes. With unique lines and a brilliant chrome finish, these rear fender flares are sure to turn heads. Installation is quick and easy using 3M™ VHB™.

FOR HARLEY-DAVIDSON™

Fits: '09-'19 FLHTCUTG Tri Glide Ultra Classic & '10-'11 FLHXXX Street Glide Trikes

7214 Rear Fender Flares, Chrome (pr)

7214



7216



7217

7216

7214

TOP FENDER ACCENTS FOR TRIKES

Enhance the look and add some character to the top side of your trikes rear fenders with these unique and noticeable accents. Made from lightweight, durable ABS and chrome plated for an unmistakable look.

FOR HARLEY-DAVIDSON™

Fits: '09-'19 FLHTCUTG Tri Glide Ultra Classic & '10-'11 FLHXXX Street Glide Trikes

7216 Top Fender Accents, Chrome (pr)



ALSO AVAILABLE..
LICENSE PLACE FRAME
FOR TRIKES PG 232



New

Collections

Featured Bikes

Audio

Lighting

Accessory Mounts

Handlebar Controls,
Grips & Mirrors

Pegs & Foot Controls

Covers, Trims
& AccentsAir Cleaners
& Exhaust

Touring & Comfort

Windshields &
Air ManagementLuggage &
Organizers

Index



REAR LIGHT BARS FOR TRIKES

Elegant light bars provide auxiliary run, turn and brake functionality and connect with plug-&-play wiring adapters.

FOR HARLEY-DAVIDSON®

Fits: '09-'19 FLHTCUTG Tri Glide Ultra Classic & '10-'11 FLHXXX Street Glide Trike

6976 Chrome (pr)



REAR BUMPER ACCENTS FOR TRIKES

Cover the exposed welds on your tubing while adding a hint of dimensional chrome.

FOR HARLEY-DAVIDSON®

Fits: H-D Bumper (Trunk Guard) P/N's 83825-09 & 83825-09A installed on '09-'19 FLHTCUTG Tri Glide Ultra Classics or '10-'11 FLHXXX Street Glide Trikes

7223 Chrome (pr)



MUD FLAPS

Reduce road spray from the rear tires and add style to your trike with these great-looking mud flaps. Made from durable, yet flexible, rubber contrasting with chrome trim to match the lines of the rear fenders. Secure, bolt-on design installs quick to get you on the road in no time.

FOR HARLEY-DAVIDSON®

Fits: '11-'19 FLHTCUTG Tri Glide Ultra Classic & '11 FLHXXX Street Glide Trikes

7220 Chrome (pr)



KNOCK-OFF CENTER CAPS FOR TRIKES

Get the vintage race car look with these decorative, chrome-plated ABS center caps. They install easily over a stock center cap, with no need to remove the wheels for installation, and can be easily disassembled and reassembled if the wheel needs to be removed for service.

FOR HARLEY-DAVIDSON®

Fits: '09-'19 FLHTCUTG Tri Glide Ultra Classics & '10-'11 FLHXXX Street Glide Trikes

1243 Chrome (pr)

MULTI-CONNECTOR FOR KURYAKYN REAR L.E.D. ACCENTS

Eliminate the need for multiple 8-pin or 6-pin wiring adapters when installing more than one like-functioning Kuryakyn rear auxiliary lighting product. Compatible with auxiliary Run-Brake lighting products.

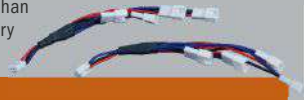

FOR HARLEY-DAVIDSON®

Fits: Compatible with Kuryakyn auxiliary Run-Brake lighting products P/N's 1564, 3145, 5051, 7262, 7263, 7744, 7751, 7755, 7756, 7757, 7758 or auxiliary Run-Turn lighting products P/N's 7265, 7268, 7272, 7273.

5491 Multi-Connector Adapter (pr)

ANTENNA HOLE ACCENT/FILLER

Our injection-molded ABS Antenna Hole Accents and Fillers replace the stock rubber unit with easy snap-in installation.

FOR HARLEY-DAVIDSON™

Fits: '06-'19 Street Glide & '10-'19 Road Glide (Except CVO Models)

3106 Accent, Chrome (ea)

3108 Accent, Gloss Black (ea)

Fits: '06-'19 Street Glide '10-'19 Road Glide, '17-'19 Road King Special (Except CVO Models)

3107 Filler, Chrome (ea)

3109 Filler, Gloss Black (ea)

MESH BEZEL FOR H-D TAILLIGHT

Installs easily over the stock taillight lens and turns boring into badass in minutes. Made from aluminum and stainless steel wire mesh that's highly durable and resists corrosion. Includes hardware for easy installation.

FOR HARLEY-DAVIDSON™

Fits: '73-'19 H-D Models with Conventional Fender Mounted Taillights (except '11-'18 XL1200C)

6564 Chrome (ea)

6565 Satin Black (ea)

TAILLIGHT COVERS U.S. Patent D632,815

These stylish covers do wonders for your dull taillight.

FOR HARLEY-DAVIDSON™

Fits: '73-'19 H-D Models with Conventional Fender Mounted Taillights (Does Not Fit Models with Bobbed Rear Fenders, Models with Tombstone Taillights, Deuce, V-Rod, or '11-'19 XL1200C)

8130 With Slots, Chrome (ea)

9008 Without Slots, Chrome (ea)

9009 Zombie™ Taillight Cover, Chrome (ea)

9020 Widow™ Taillight Cover, Chrome (ea)

9024 Zombie™ Taillight Cover, Black (ea)

SEAT RELEASE

Combo Kit includes tang cover and both 1/4"-20 and 1/4"-28 threaded screws. Installation on '99-newer bikes requires removal of stock captured thumb screw.

FOR HARLEY-DAVIDSON™

Fits: All H-D Models with 1/4"-20 Seat Mount Screws

9038 1/4" - 20 Knurled Screw Only, Chrome (ea)

Fits: All H-D Models with 1/4"-20 or 1/4"-28 Seat Mount Screws

9035 Seat Screw & Beauty Cap Combo, Chrome (ea)

SPEED TAB

The spring-loaded latch nestles in a housing that covers the seat's mounting tab.

FOR HARLEY-DAVIDSON™

Fits: All H-D Models with 1/4"-20 or 1/4"-28 Seat Mount Screws

9037 Chrome (ea)



New

Collections

Featured Bikes

Audio

Lighting

Accessory Mounts

Handlebar Controls,
Grips & Mirrors

Pegs & Foot Controls

Covers, Trims
& AccentsAir Cleaners
& Exhaust

Touring & Comfort

Windshields &
Air ManagementLuggage &
Organizers

Index

LICENSE PLATE FRAMES & MOUNTS



3191

HOW TO ORDER:

- 1 Select a horizontal or vertical License Plate Holder
- 2 Select a model-specific Mount Clamp on pg 235



3191



3193



3192



3190

1 NOVA CURVED SIDE MOUNT LICENSE PLATE HOLDER

A seamless design with no visible fasteners combined with wraparound DOT compliant L.E.D.'s make this one of the cleanest and most functional side-mount license plate holders available. Offered in horizontal and vertical styles.

FOR MULTI-FIT

Fits: Requires Kuryakyn Model Specific Mounting Clamp (Sold Separately, page 235)

3190 Vertical Mount, Chrome (ea)

3191 Vertical Mount, Gloss Black (ea)

3192 Horizontal Mount, Chrome (ea)

3193 Horizontal Mount, Gloss Black (ea)

Note: L.E.D. License plate illumination is DOT L11 Compliant.



9253

1 CURVED SIDE MOUNT LICENSE PLATE HOLDERS

Sized to fit 4" x 7" plates only. All versions are lighted to illuminate the license plate. Choose a License Holder and Mount Clamp, both required for installation.

FOR MULTI-FIT

Fits: Requires Kuryakyn Model Specific Mounting Clamp (Sold Separately, page 235)

3125 Horizontal Mount, Gloss Black (ea)

9251 Lighted Vertical Mount, Chrome (ea)

9253 Horizontal Mount, Chrome (ea)

9252 Lighted Vertical Mount with Taillight, Chrome (ea)



3125



9252

Note: Not intended for use with saddlebags. Please check local laws regarding side mount license plates before ordering. L.E.D. License plate illumination is DOT L11 Compliant.

1 NOVA SIDE MOUNT LICENSE PLATE FRAME
FOR '18-'19 SOFTAIL

Clean styling with no visible hardware, fasteners or license plate mounting holes. Made from durable A380 aluminum alloy and mounts horizontally or vertically directly to the stock pivot mechanism for easy installation (plate illumination is not DOT-compliant when mounted vertically).

FOR HARLEY-DAVIDSON™

Fits: '18-'19 Breakout, Fat Bob, Fat Boy, Slim & Street Bob

3141 Chrome (ea)

3142 Gloss Black (ea)

2 MOUNT CLAMPS FOR SIDE MOUNT LICENSE PLATE HOLDERS

Aluminum swingarm mounts required to install Kuryakyn side mount license plate holders.

FOR HARLEY-DAVIDSON™

Fits: '18-'19 Softail Models (except FXDRS) & Custom Applications on Motorcycles with 1-1/4" Diameter Swingarms

3175 Chrome (ea)

3121 Gloss Black (ea)

Fits: '86-'17 Softails (except '08-'11 FXCW/C, '09 FXSTSSSE, '13-'17 FXSB, '13-'14 FXSBSE & '16-'17 FXSE) without Kuryakyn Swingarm Covers. Universal for 1-1/8" Round Bars

3183 Chrome (ea)

3116 Gloss Black (ea)

Fits: '86-'17 Softails (except '08-'11 FXCW/C, '09 FXSTSSSE, '13-'17 FXSB, '13-'14 FXSBSE & '16-'17 FXSE) with Kuryakyn Swingarm Covers or 1-3/16" Tubing

3184 Chrome (ea)

Fits: '08-'11 FXCW/C Rocker, '09 FXSTSSSE Screamin' Eagle Springer Softail, '13-'14 FXSBSE CVO Breakout, '13-'17 FXSB Breakouts & '16-'17 FXSE Pro Street Breakout

3188 Chrome (ea)

3117 Gloss Black (ea)

Fits: '91-'05 Dyna Models

3185 Chrome (ea)

Fits: '06-'17 Dyna Models

3187 Chrome (ea)

3118 Gloss Black (ea)

Fits: '86-'19 XL Models

3186 Chrome (ea)

3119 Gloss Black (ea)

Fits: '15-'19 Street 500 & 750 Models

3194 Chrome (ea)

3195 Gloss Black (ea)



LOOKS GREAT WITH..
KELLERMANN LIGHTING
PG 52

New

Collections

Featured Bikes

Audio

Lighting

Accessory Mounts

Handlebar Controls, Grips & Mirrors

Pegs & Foot Controls

Covers, Trims & Accents

Air Cleaners & Exhaust

Touring & Comfort

Windshields & Air Management

Luggage & Organizers

Index



ALSO AVAILABLE..
 REAR TURN SIGNAL
 LIGHT BAR PG 50



CURVED LICENSE PLATE MOUNT

Rid yourself of the stock black bracket and the flat look with this bolt-on, gracefully curved license plate mount. No drilling, and no need for a new license plate light. Just bolt it on and go!

FOR HARLEY-DAVIDSON™

Fits: '10-'19 Street Glides (except '10-'12 & '15-'19 FLHXSE), '10-'13 & '15-'19 Road Glides (except '11-'13 & '16-'19 FLTRU, '12-'13 & '18-'19 FLTRXSE, '11 & '15-'16 FLTRUSE) & '17-'19 FLHRXS Road King Special

3157 Chrome (ea)

3147 Black (ea)

Fits: '06-'09 FLHX/I Street Glides, '09 FLTR Road Glides, '09 FLHT Electra Glide Standards, '09-'18 FLHR Road King (except '17-'18 FLHRXS), '07-'08 FLHRSE Screamin' Eagle Road Kings, '05 FLHTCSE Screamin' Eagle Electra Glide & '12-'16 FLD Dyna Switchback

3163 Chrome (ea)

3149 Black (ea)

CURVED LAYDOWN LICENSE PLATE MOUNT

FOR SOFTAIL WITH TOMBSTONE TAILLIGHT

A slightly swept mounting position blends in instead of sticking out. Fully compatible with stock Softail Deluxe luggage racks.

FOR HARLEY-DAVIDSON™

Fits: '05-'17 FLSTN/I Softail Deluxe, '05-'07 FLTSC/I Softail Springer Classic & '98-'03 FLSTS Heritage Springer

3181 Chrome (ea)

CURVED LICENSE PLATE FRAMES FOR CVO ROAD GLIDES, STREET GLIDES, & ROAD KINGS

We've come up with two bolt-on, plug-&-play solutions to rid your CVO fender of the black plastic stock license plate mount! Purchase our Chrome Mounting Back-plate (P/N 3146) and then add the clean, simple Curved L.E.D. Lighted Frame (P/N 3144).

FOR HARLEY-DAVIDSON™

Fits: '09 FLTRSE CVO Road Glides, '10-'12 & '15-'19 FLHXSE CVO Street Glides, '12-'13 & '18-'19 FLTRXSE CVO Road Glide Customs & '13 FLHRSE CVO Road Kings

3144 Curved License Plate Frame with L.E.D. License Plate Light, Chrome (ea)

3146 Mounting Backplate, Chrome (ea)

Note: P/N 3146 is required for installation of P/N's 3144 or 3145

CURVED LAYDOWN LICENSE PLATE MOUNT WITH FRAME

The curved frame meets the backing plate cleanly for a finished and completely custom look. Accepts 4" x 7" plates.

FOR HARLEY-DAVIDSON®

Fits: Any H-D® Model with Standard 3-Bolt Mounted License Plate Bracket & Universal for Custom Applications

9171 Chrome (ea)

3148 Gloss Black (ea)



3148



L.E.D. LIGHTED CURVED LAYDOWN LICENSE PLATE MOUNT WITH FRAME

A great alternative to your stock license plate mount, with ball-milled frame design and illumination that meets DOT L11 standards.

FOR HARLEY-DAVIDSON®

Fits: Any H-D® Model with Standard 3-Bolt Mounted License Plate Bracket & Universal for Custom Applications

3138 Chrome (ea)

L.E.D. LAYDOWN CURVED LICENSE PLATE

This curved plate frame features L.E.D. edge lighting and an 8-degree mounting angle that flows with the lines on your bike's rear fender. (DOT L11 Compliant Lighting.)

FOR MULTI-FIT

Fits: Universal Flat Plate Mount, Widest Mounting Slot is 5" Wide for 4" x 7" Plate

7688 Chrome (ea)

7678 Satin Black (ea)



3138

CURVED TIP-BACK LICENSE PLATE FRAME

Featuring an 8-degree angle and a curved frame, this chrome beauty holds a 4" x 7" plate and bolts directly to your stock OEM license plate mount.

FOR MULTI-FIT

Fits: Universal: Bolts Directly to Flat Stock OEM License Plate Mount, Widest Mounting Slot is 5" Wide.

9198 Chrome (ea)



7678



7688

L.E.D. LIGHTED CURVED LICENSE PLATE MOUNT WITH FRAME

Chrome backing plate and outer frame with built-in L.E.D.'s to illuminate the license plate. It's a great way to relocate a license plate below the taillight! (DOT L11 compliant.)

FOR MULTI-FIT

Fits: Universal for Custom Applications, Typically Requires Drilling Holes for Installation, fits 4" x 7" Plate

9255 Chrome (ea)

Note: Installation requires drilling mounting holes.



9198



7678



9255



TECH TIP

When test fitting products, use blue painter's tape over areas you don't want to scratch

- New
- Collections
- Featured Bikes
- Audio
- Lighting
- Accessory Mounts
- Handlebar Controls, Grips & Mirrors
- Pegs & Foot Controls
- Covers, Trims & Accents
- Air Cleaners & Exhaust
- Touring & Comfort
- Windshields & Air Management
- Luggage & Organizers
- Index



5148

LICENSE PLATE FRAME FOR HD TRIKES

Complements factory trunk styling cues to offer full coverage of the license plate, utilizing factory plate illumination. Durable aluminum construction with foam backing to prevent scratches.

FOR HARLEY-DAVIDSON*

Fits: '11-'19 FLHTCUTG Tri Glide Ultra Classics & '10-'11 FLHXX Street Glide Trikes

5148 Chrome (ea)

5149 Gloss Black (ea)



5148



5149

UNIVERSAL LAYDOWN LICENSE HOLDER

Kit includes rubber wedge so you have an option as to how far the plate lays down.

FOR HARLEY-DAVIDSON*

Fits: Any H-D Model with Standard 3-Bolt Mounted License Plate Bracket or Custom Applications may Require Drilling Mounting Holes.

9165 Chrome (ea)

Note: License plate frame not included. Universal applications may require drilling holes in fender.



9165

LIGHTED LICENSE PLATE FRAME

Incorporates two high-intensity light bulbs that are wired separately. Wire one to your brake and tail lamp circuits, or together for an extra bright stop or running light. Includes integrated white light for plate illumination.

FOR MULTI-FIT

Fits: Universal Fitment, 4" x 7" License Plates

9167 Chrome (ea)

Note: Not intended to replace O.E.M. brake or taillight.



9167



113

LAY DOWN LICENSE PLATE HOLDER

FOR ROAD KINGS & ROAD GLIDE

This license plate bracket lays down to complement the lines of the fender rather than standing up like a billboard. Mounts in the same location as the stock piece. Easy to install.

FOR HARLEY-DAVIDSON*

Fits: '97-'08 FLHT Electra Glide Standard, '98-'08 Road Glides & '97-'08 Road Kings (except '07-'08 FLHRSE)

113 Chrome (ea)

CURVED LICENSE PLATE FRAME FOR KURYAKYN BULLET

LIGHT REAR TURN SIGNAL BAR

A classy, bolt-on upgrade for our Bullet Light Rear Turn Signal Bar.

FOR HARLEY-DAVIDSON*

Fits: Kuryakyn Bullet Light Rear Turn Signal Bars (P/N's 2098, 5405)

3162 Chrome (ea)

Fits: Kuryakyn Bullet Light Rear Turn Signal Bars (P/N's 2098, 5405)

3143 Gloss Black (ea)



3143



REQUIRED FOR INSTALL
BULLET LIGHT REAR TURN
SIGNAL BAR PG 48



BALL-MILLED LICENSE PLATE FRAMES

This great looking frame is finished in glistening chrome & has ball-milled accents. Sized to fit 4" x 7" plates and includes chrome hardware.

FOR MULTI-FIT

Fits: 4" x 7" License Plates

9163 Chrome (ea)

**LICENSE FRAME & BACK PLATE SET**

Dress up your license plate when using the stock bracket.

FOR MULTI-FIT

Fits: 4" x 7" License Plates

9166 Chrome (set)



Note: Acorn nuts not included.

LICENSE PLATE HELMET LOCK WITH MOUNT

The simple mounting plate easily bolts to the back of almost any motorcycle.

FOR MULTI-FIT

Fits: Universal Fitment for Most Flat License Plate Brackets.

4248 Black (ea)



Note: Mounting holes intended for standard 4" x 7" license plate. Will not install with Curved License Plate Frames or Swept/Lone Eagle License Plate Frames.

UNIVERSAL HELMET LOCK

Don't let anyone walk off with your helmet! Lock it right to your bike!

FOR MULTI-FIT

Fits: Universal Fitment for 7/8" to 1-1/2" Diameter Tubing

4232 For 1-1/4" to 1-1/2" Diameter Tubing, Chrome (ea)

4220 For 7/8" to 1-1/4" Diameter Tubing, Chrome (ea)



Note: Installs with standard tools. Works best mounted on a 2-1/4" long section of straight tube.

L.E.D. LICENSE PLATE BOLT ILLUMINATORS

Each License Plate Illuminator has two L.E.D.'s. The white L.E.D. lights up the license plate, and the rear-facing red L.E.D. can function as an auxiliary running light, turn signal, or brake light for added visibility. The 1/4"-20 mounting stud makes it simple to bolt them on

FOR MULTI-FIT

Fits: Universal 12V Applications

9398 Chrome (pr)



Note: License plate bolt lights have a 1/4"-20 Mounting Stud. Not compatible with Curved License Plate Frames.

L.E.D. LICENSE PLATE BOLT LIGHTS

Light up your license plate whether it's in the stock location or custom-mounted with these white L.E.D. bolt lights.

FOR MULTI-FIT

Fits: Universal 12V Applications

9199 Chrome (pr)



Note: 1/4"-20 Mounting Stud. Chrome Frame sold separately (P/N 9163). Not intended for use with Kuryakyn Curved Frames.

LICENSE PLATE MOUNTING HOLE COVERS

If you have relocated your license plate below the taillight, here's how to cover the exposed holes left in the fender.

FOR HARLEY-DAVIDSON®

Fits: All H-D Models with Standard 3-Bolt Fender Mounted License Plate Bracket

3159 Tribal, Chrome (ea)

3158 Zombie, Chrome (ea)



New

Collections

Featured Bikes

Audio

Lighting

Accessory Mounts

Handlebar Controls,
Grips & Mirrors

Pegs & Foot Controls

Covers, Trims
& AccentsAir Cleaners
& Exhaust

Touring & Comfort

Windshields &
Air ManagementLuggage &
Organizers

Index

Note: Also covers the fourth hole found on some Dyna and Sportster Models

FLAGS



4254

VERTICAL MOUNT FLAGS

Mount straight, securely, and with dignity. 1/2" version fits most luggage racks or any 1/2" tubing, including front fender rails. 3/4" version fits saddlebag rails or any 3/4" tubing. American Flag is 6" x 11" and POW/MIA Flag is 6" x 9".

FOR MULTI-FIT

Fits: Universal - Mounts to 1/2" Tubing

4254 Chrome (ea)



4255

Fits: Universal - Mounts to 3/4" Tubing

4255 Chrome (ea)



4259

FLAG WITH MOUNT FOR LUGGAGE RACK

Reinforced ratcheting system allows you to adjust the angle of the staff without tools. Includes 4" x 9" American flag.

FOR MULTI-FIT

Fits: Universal - Mounts to 1/2" Tubing

4259 Chrome (ea)



4208

ANTENNA MOUNT FLAG

Includes both American Flag and a plain, customizable white flag. Flags measure 6" x 8".

FOR MULTI-FIT

Fits: Universal for O.E.M. Antennas

4217 Chrome (set)



4208

SIDE MOUNT FLAG KIT BY FINE ART TRANSFORMATIONS

Machined from aluminum, the sturdy mount is easy to install. A single bolt tightens the two clamp halves around the chrome saddlebag guard that comes standard on the FLHTC and FLHTCU. Includes 12" and 18" staffs, American (9"x18"), P.O.W. (9"x14") and Crossbones (9"x14") flags.

FOR HARLEY-DAVIDSON®

Fits: '83-'13 FLHTC/I Electra Glide Classics & FLHTCU/I Ultra Classic Electra Glides

4208 Chrome (ea)



4217

THEMED & REPLACEMENT FLAGS FOR FLAG HOLDERS

Show your individuality or replace a worn flag. For use with Kuryakyn flag mounts.

FOR MULTI-FIT

Fits: Replacement for Kuryakyn Flag Mounts P/N's 4254 & 4255

4262 American Flag, 6" x 11" (ea)

4263 P.O.W. Flag, 6" x 9" (ea)



4272

Fits: Replacement for Kuryakyn Flag Mounts P/N 4208, 4233, 4253, 4259, & 4260

4264 American Flag, 4" x 9" (ea)

4271 Canadian Flag, 4" x 9" (ea)

4272 Don't Tread On Me Flag, 4" x 9" (ea)

4273 Pirate Flag, 4" x 9" (ea)

4274 Blank Flag, 4" x 9" (ea)



4271



4274

Fits: Replacement for Kuryakyn Flag Mounts P/N 4208

4265 American Flag, 9" x 18" (ea)



AIR CLEANERS & EXHAUST

AIR CLEANERS	236
EXHAUST	254
FUEL MANAGEMENT	264
ENGINE COMPONENTS	265

ELECTRONIC RPM-BASED BUTTERFLY ENGAGEMENT
DELIVERS CALCULATED MOVEMENT TO ELIMINATE
VACUUM-OPERATED FLUTTERING.



9361 & 9369



A



B



C



Modern updates in styling & performance!

9353

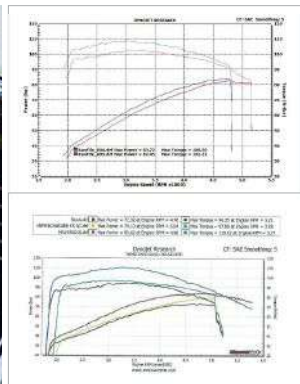

HYPERCHARGER ES

REINVENTING A REVOLUTION

AIR CLEANERS

HYPERCHARGER™ ES AIR CLEANER U.S. Patent 6,374,815 and other Patents Pending

Modern updates in styling and performance for a timeless classic. An integrated electronic servo motor delivers precise RPM-based butterfly engagement. The all-new custom Kuryakyn-designed high-flow K&N filter delivers approximately 10% more airflow than previous models for improved CFM rating, and a new internal "stinger" design on the end cap maximizes airflow to the throttle body.

- High-quality A380 aluminum housings in three finish options
- Ergonomic forward-facing design with "ram air" styled inlets
- Modular design for easy customization with accessory faceplates
- All-new Kuryakyn-designed high-flow K&N filter with larger surface area offers approximately 10% more airflow
- New filter with integrated "stinger" design maximizes airflow to the throttle body

FOR HARLEY-DAVIDSON™

FITMENT	A	B	C
	CHROME	BLACK	CHROME & BLACK
'17-'19 Electra Glides, Road Glides, Road Kings, Street Glides & Trikes	9359	9360	9361
'18-'19 Softail Models	9375	9376	9377
'08-'16 Electra Glides, Road Glides, Road Kings, Street Glides & Trikes; '16-'17 Softails, '16-'17 FXDLS, '11-'12 FLSTSE, '13-'14 FXSBSE & '14-'15 FLSTNSE	9356	9357	9358
'01-'17 Twin Cam with Delphi EFI (except '08-'16 Touring/Trike, '16-'17 Softail, '16-'17 FXDLS, '11-'12 FLSTSE, '13-'14 FXSBSE, '14-'15 FLSTNSE)	9353	9354	9355
'07-'19 XL Models	9350	9351	9352

Note: Not Available in the State of California.



CLASSIC FACEPLATES FOR HYPERCHARGER™ ES

Patent Pending

Give your Hypercharger ES an all-new look quickly and easily with this interchangeable faceplate. Features a clean retro finned design made from quality A380 aluminum offered in three finish options.

FOR HARLEY-DAVIDSON™

Fits: All Hypercharger ES Models

9362	Chrome (kit)
9363	Satin Black (kit)
9369	Satin Black & Machined (kit)



New

Collections

Featured Bikes

Audio

Lighting

Accessory Mounts

Handlebar Controls, Grips & Mirrors

Pegs & Foot Controls

Covers, Trims & Accents

Air Cleaners & Exhaust

Touring & Comfort

Windshields & Air Management

Luggage & Organizers

Index



HYPERCHARGER™

Kuryakyn offers a select number of complete Hypercharger kits assembled with a Blood Groove-style trap door. Blood Groove Trap Doors offer a styling alternative to standard Hypercharger air cleaner trap doors.

- Multiple color upgrades & configurations
- Vacuum-operated butterflies for precise airflow and old-school hotrod styling
- Lifetime Kuryakyn-designed K&N filter element



LOOKS GREAT WITH...
CLEAR TRAP DOORS
PG 248



FOR HARLEY-DAVIDSON*

	A	B	C	D
	STANDARD HYPER	BLOOD GROOVE HYPER	BLOOD GROOVE HYPER	BLOOD GROOVE HYPER
FITMENT	CHROME	CHROME	GLOSS BLACK	WRINKLE BLACK WITH CHROME BUTTERFLIES
'91-'06 XL with CV Carb	8469	9995	9989	--
'07-'19 XL Models	9326	9873	9874	--
'93-'99 Evolution Big Twin with CV Carb	8464	9990	9988	9981
'99-'01 Twin Cam Touring with EFI*	9774	9983	--	--
'01-'05 Twin Cam with Delphi EFI	9763	9998	9994	9979
'99-'17 Twin Cam with CV Carb or Delphi EFI (except '08-'16 Touring/Trike, '16-'17 Softail, '16-'17 FXDLS, '11-'12 FLSTSE, '13-'14 FXSBSE, '14-'15 FLSTNSE)	9754	9992	9987	9980
'08-'16 Electra Glides, Road Glides, Road Kings, Street Glides & Trikes; '16-'17 Softails, '16-'17 FXDLS, '11-'12 FLSTSE, '13-'14 FXSBSE & '14-'15 FLSTNSE**	9767	9970	9971	9973
Complete Air Cleaner Assembly (Bolt Pattern for CV Carb/Cable Throttle Delphi). Use with Adapters, Brackets, or Mounting Kits for Custom Applications.***	8446	9982	--	--

*Requires drilling a hole in manifold to supply a vacuum source.

**Note: '11-'13 FLHTCUSE, '14-'16 FLHTKSE, '09 FLTRSE, '11, '15-'16 FLTRUSE, '12-'13 FLTRXSE, '13-'14 FLHRSE, '10-'12, '15-'16 FLHXSE, '11-'12 FLSTSE, '13-'14 FXSBSE & '14-'15 FLSTNSE also require Throttle Body Support Bracket, P/N 9929, sold separately.

*** Note: Will Bolt directly to stock 40mm or Screamin' Eagle 44mm CV carbs or cable operated Delphi throttle bodies. Can be installed on Mikuni HSR42/45/48, S&S E or G Shorty, or other aftermarket carbs by using adapters, sold separately.

Note: Not Available in the State of California. Don't see your application? More options available online.



PRO-R HYPERCHARGER™

- Enlarged opening with vacuum-operated butterflies for almost-unrestricted airflow
- Scoop on the outer cover directs air into a high-flow washable K&N filter
- Airflow is smooth and precise, delivering maximum power
- Comes with all mounting hardware and crankcase breather kits

PRO-SERIES HYPERCHARGER™

- Housing is 1/2" wider than standard Hypercharger
- Smooth, one-piece outer cover
- Vacuum-operated butterflies for precise airflow and hotrod styling
- Utilizes washable K&N filter element



FOR HARLEY-DAVIDSON®

FITMENT	A	B
	PRO-R HYPER CHROME	PRO-SERIES HYPER CHROME
'91-'06 XL with CV Carb	9320	9300
'07-'19 XL Models	9328	9327
'93-'99 Evolution Big Twin with CV Carb	9321	9301
'99-'01 Twin Cam Touring with EFI*	--	9307
'01-'05 Twin Cam with Delphi EFI	9323	9311
'99-'06 Twin Cam with CV Carb & '06-'17 with Delphi EFI (except '08-'16 Touring/Trike, '16-'17 Softail, '16-'17 FXDLS, '11-'12 FLSTSE, '13-'14 FXSBSE & '14-'15 FLSTNSE)	9322	9302
'08-'16 Electra Glides, Road Glides, Road Kings, Street Glides & Trikes; '16-'17 Softail, '16-'17 FXDLS, '11-'12 FLSTSE, '13-'14 FXSBSE & '14-'15 FLSTNSE**	9325	9315
Complete Air Cleaner Assembly (Bolt Pattern for CV Carb/Cable Throttle Delphi). Use with Adapters, Brackets, or Mounting Kits for Custom Applications.	9324	9306

*Requires drilling a hole in manifold to supply a vacuum source.

**Note: '11-'13 FLHTCUSE, '14-'16 FLHTKSE, '09 FLTRSE, '11 & '15-'16 FLTRUSE, '12-'13 FLTRXSE, '13-'14 FLHRSE, '10-'12 & '15-'16 FLHXSE, '11-'12 FLSTSE, '13-'14 FXSBSE & '14-'15 FLSTNSE also require Throttle Body Support Bracket, P/N 9929, sold separately.

Note: Not Available in the State of California.

- New
- Collections
- Featured Bikes
- Audio
- Lighting
- Accessory Mounts
- Handlebar Controls, Grips & Mirrors
- Pegs & Foot Controls
- Covers, Trims & Accents
- Air Cleaners & Exhaust
- Touring & Comfort
- Windshields & Air Management
- Luggage & Organizers
- Index

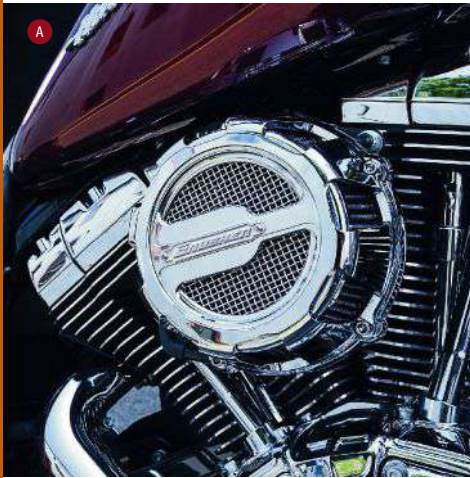

CRUSHER

MAVERICK AIR CLEANER

We've taken the skillful styling found on Maverick Series exhaust components and created a heavy-breathing monster of an intake unit in the form of the Maverick Air Cleaner. Available in Chrome or Black with embossed stainless steel badge featuring the Crusher word mark, the Maverick Air Cleaner can support engine builds in excess of 150 hp, features a Kuryakyn-designed K&N filter element, and a high-flow curved entry to the throttle body for optimum performance.

FOR HARLEY-DAVIDSON®

FITMENT	A	B
	CHROME	SATIN BLACK
'91-'06 XL Models with CV Carb (ea)	9887	9882
'07-'19 XL Models	9888	9883
'93-'99 Evolution Big Twin with CV Carb	9892	9891
'99-'17 Twin Cam with CV Carb or Delphi EFI (except '08-'16 Touring/ Trike, '16-'17 Softail, '16-'17 FXDLS, '11-'12 FLSTSE, '13-'14 FXSBSE, '14-'15 FLSTNSE)	9889	9884
'08-'16 Electra Glides, Road Glides, Road Kings, Street Glides & Trikes; '16-'17 Softails, '16-'17 FXDLS, '11-'12 FLSTSE, '13-'14 FXSBSE, '14-'15 FLSTNSE Note: '11-'13 FLHTCUSE, '14-'16 FLHTKSE, '09 FLTRSE, '11 & '15-'16 FLTRUSE, '12-'15 FLTRXSE, '13-'14 FLHRSE, '10-'16 FLHXSE, '11-'12 FLSTSE, '13-'14 FXSBSE & '14-'15 FLSTNSE also require Throttle Body Support Bracket, P/N 9929, sold separately.	9890	9885
Complete Air Cleaner Assembly (Bolt Pattern for CV Carb/Delphi) - Use with Adapters, Brackets, or Mounting Kits for Custom Applications (ea) Note: Will Bolt directly to stock 40mm or Screamin' Eagle 44mm CV carbs or Delphi throttle bodies. Can be installed on Mikuni HSR42/45/48, S&S E or G Shorty, or other aftermarket carbs by using adapters, sold separately.	9886	9881

Note: Not Available in the State of California.

ECE COMPLIANT CRUSHER® MAVERICK AIR CLEANER

FOR HARLEY-DAVIDSON®

FITMENT	CHROME	SATIN BLACK
	'07-'16 XL1200 Models	9654
'07-'16 XL883 Models	9387	9388



Unique shape & features!

CRUSHER

MAVERICK PRO AIR CLEANER U.S. Patent 6,374,815

The premium forged and machined aluminum cover features an aggressive slotted appearance available in three finish options. A unique integrated crankcase breather design eliminates the need for additional hoses or fittings, and the kit includes a washable and reusable high-flow K&N filter element. A slim design maintains ample legroom, and airflow to the throttle body is maximized thanks to the high-flow radiused inlet on the backing plate.

FOR HARLEY-DAVIDSON®

FITMENT	A	B	C
	SATIN BLACK/ MACHINED	CHROME	SATIN BLACK
'17-'19 Electra Glides, Road Glides, Road Kings, Street Glides, Trikes & '18-'19 Softails. Note: 114 & 117 Engines Require Support Bracket P/N 9379, Sold Separately	9937	9935	9936
'99-'17 Twin Cam with CV Carb or Delphi EFI (except '08-'16 Touring/Trike, '16-'17 Softail, '16-'17 FXDLS, '11-'12 FLSTSE, '13-'14 FXSBSE, '14-'15 FLSTNSE)	9898	9897	9896
'08-'16 Electra Glides, Road Glides, Road Kings, Street Glides & Trikes; '16-'17 Softails, '16-'17 FXDLS, '11-'12 FLSTSE, '13-'14 FXSBSE & '14-'15 FLSTNSE	9895	9894	9893

Note: Not Available in the State of California.

New

Collections

Featured Bikes

Audio

Lighting

Accessory Mounts

Handlebar Controls,
Grips & Mirrors

Pegs & Foot Controls

Covers, Trims
& Accents

Air Cleaners
& Exhaust

Touring & Comfort

Windshields &
Air Management

Luggage &
Organizers

Index



MACH 2™

The Mach 2™ can support engine builds well over 140hp, is available in multiple finish options and styles, and includes a Kuryakyn-designed high-flow filter that's washable and reusable. ECE-compliant versions include an internal baffle to meet all ECE street-legal requirements.



FOR HARLEY-DAVIDSON®

	A	B	C	D	E	F
	MACH 2™ CHROME	MACH 2™ BLACK & CHROME	MACH 2™ BLACK	ZOMBIE™ CHROME	CO-AX CHROME	CO-AX BLACK
'91-'06 XL with CV Carb	9453	9533	9551	--	9567	9573
'07-'19 XL Models	9871	9549	9555	--	9568	9574
'93-'99 Evolution Big Twin with CV Carb	9454	9534	9552	--	9569	9575
'99-'17 Twin Cam with CV Carb or Delphi EFI (except '08-'16 Touring/Trike, '16-'17 Softail, '16-'17 FXDLS, '11-'12 FLTSTSE, '13-'14 FXSBSE & '14-'15 FLSTNSE)	9455	9535	9553	9458	9570	9576
'08-'16 Electra Glides, Road Glides, Road Kings, Street Glides & Trikes; '16-'17 Softails, '16-'17 FXDLS, '11-'12 FLTSTSE, '13-'14 FXSBSE & '14-'15 FLSTNSE*	9456	9536	9554	9459	9571	9577
Complete Air Cleaner Assembly (Bolt Pattern for CV Carb/Delphi). Use with Adapters, Brackets, or Mounting Kits for Custom Applications.**	9451	9514	9550	--	9566	9572

*Note: '11-'13 FLHTCUSE, '14-'16 FLHTKSE, '09 FLTRSE, '11 & '15-'16 FLTRUSE, '12-'13 FLTRXSE, '13-'14 FLHRSE, '10-'12 & '15-'16 FLHXSE, '11-'12 FLSTSE, '13-'14 FXSBSE & '14-'15 FLSTNSE also require Throttle Body Support Bracket, P/N 9929, sold separately.

**Note: Will Bolt directly to stock 40mm or Screamin' Eagle 44mm CV carbs or Delphi throttle bodies. Can be installed on Mikuni HSR42/45/48, S&S E or G Shorty, or other aftermarket carbs by using adapters, sold separately.

Note: Not Available in the State of California.

ECE COMPLIANT MACH 2™ AIR CLEANER KTS

FOR HARLEY-DAVIDSON®

	A	B	C	E	F
	ECE CHROME	ECE BLACK & CHROME	ECE BLACK	ECE CO-AX CHROME	ECE CO-AX BLACK
'07-'16 XL1200 Models	9658	9659	9660	9665	9666
'07-'16 XL883 Models	9389	9390	9391	9392	9393

Note: Not Available in the State of California.

Accessorize your Mach 2 - page 248



Supports builds in excess of 150 HP!

ALLEY CAT AIR CLEANER

This cat is sure to make your motor purr! We've combined our super high-flowing Kuryakyn-designed K&N filter with our sleek Alley Cat Cover into one easy-to-install kit! Airflow to support even the largest of engine builds.

- Can support engine builds in excess of 150HP
- Lifetime Kuryakyn-designed K&N filter element
- High-flow parabolic curve entry to throttle body



FOR HARLEY-DAVIDSON*

FITMENT	A	B
	CHROME	BLACK & CHROME
'99-'17 Twin Cam with CV Carb or Delphi EFI (except '08-'16 Touring/Trike, '16-'17 Softail, '16-'17 FXDLS, '11-'12 FLSTSE, '13-'14 FXSBSE & '14-'15 FLSTNSE)	9515	9517
'08-'16 Electra Glides, Road Glides, Road Kings, Street Glides & Trikes; '16-'17 Softails, '16-'17 FXDLS, '11-'12 FLSTSE, '13-'14 FXSBSE & '14-'15 FLSTNSE*	9508	9516

*Note: '11-'13 FLHTCUSE, '14-'16 FLHTKSE, '09 FLTRSE, '11 & '15-'16 FLTRUSE, '12-'13 FLTRXSE, '13-'14 FLHRSE, '10-'12 & '15-'16 FLHXSE, '11-'12 FLSTSE, '13-'14 FXSBSE & '14-'15 FLSTNSE also require Throttle Body Support Bracket, P/N 9929, sold separately. Note: Not Available in the State of California.



ALSO AVAILABLE..

- ALLEY CAT AIR CLEANER COVER **PG 183**
- ALLEY CAT L.E.D. FUEL & BATTERY GAUGE **PG 169**
- REPLACEMENT FILTERS **PG 251**



New

Collections

Featured Bikes

Audio

Lighting

Accessory Mounts

Handlebar Controls, Grips & Mirrors

Pegs & Foot Controls

Covers, Trims & Accents

Air Cleaners & Exhaust

Touring & Comfort

Windshields & Air Management

Luggage & Organizers

Index



CRUSHER

VELOCIRAPTOR® AIR CLEANER

Unlike most velocity stacks on the market, the Velociraptor breathes well and filters the air with its K&N washable element. The Super Ring insert covers up the mounting bolts, delivering smooth airflow into your motor.

FOR HARLEY-DAVIDSON®

FITMENT	A	B
	CHROME	BLACK
'91-'06 XL with CV Carb	9510	9876
'07-'19 XL Models	9872	9877
'93-'99 Evolution Big Twin w/ CV Carb	9511	9878
'99-'17 Twin Cam with CV Carb or Delphi EFI (except '08-'16 Touring/Trike, '16-'17 Softail, '16-'17 FXDLS, '11-'12 FLSTSE, '13-'14 FXSBSE & '14-'15 FLSTNSE)	9512	9879
'08-'16 Electra Glides, Road Glides, Road Kings, Street Glides & Trikes; '16-'17 Softails, '16-'17 FXDLS, '11-'12 FLSTSE, '13-'14 FXSBSE & '14-'15 FLSTNSE*	9513	9880
'15-'19 Street 500 & 750 (except '17-'19 Street Rod)	9370	9371
Complete Air Cleaner Assembly (Bolt Pattern for CV Carb/Cable Throttle Delphi). Use with Adapters, Brackets, or Mounting Kits for Custom Applications.	9870	9875

*Note: '11-'13 FLHTCUSE, '14-'16 FLHTKSE, '09 FLTRSE, '11 & '15-'16 FLTRUSE, '12-'13 FLTRXSE, '13-'14 FLHRSE, '10-'12 & '15-'16 FLHXSE, '11-'12 FLSTSE, '13-'14 FXSBSE & '14-'15 FLSTNSE also require Throttle Body Support Bracket, P/N 9929, sold separately.

Note: Not Available in the State of California.



CRUSHER

REVOLT AIR CLEANER

Rise up in rebellion with a new revolution of high-performance air cleaners that make a defiant statement. The Revolt's aggressive velocity stack styling incorporates a stainless steel mesh insert and Crusher-designed high-flow K&N washable/reusable filter to eliminate debris from entering the throttle body. Housings are cast from quality A380 aluminum, and the included super ring insert covers the back plate mounting bolts to deliver smooth, precise airflow to the motor.



FOR HARLEY-DAVIDSON®

FITMENT	A	B
	CHROME	SATIN BLACK
'91-'06 XL with CV Carb	9613	9624
'07-'19 XL Models	9614	9625
'93-'99 Evolution Big Twin with CV Carb	9615	9626
'99-'17 Twin Cam with CV Carb or Delphi EFI (except '08-'16 Touring/Trike, '16-'17 Softail, '11-'12 FLSTSE, '13-'14 FXSBSE & '14-'15 FLSTNSE, '16-'17 Dyna FXDLS)	9616	9627
'08-'16 Electra Glides, Road Glides, Road Kings, Street Glides & Trikes; '16-'17 Softails, '16-'17 FXDLS, '11-'12 FLSTSE, '13-'14 FXSBSE & '14-'15 FLSTNSE*	9617	9628
Complete Air Cleaner Assembly (Bolt Pattern for CV Carb/Delphi). Use with Adapters, Brackets, or Mounting Kits for Custom Applications.**	9618	9629

*Note: '11-'13 FLHTCUSE, '14-'16 FLHTKSE, '09 FLTRSE, '11 & '15-'16 FLTRUSE, '12-'13 FLTRXSE, '13-'14 FLHRSE, '10-'12 & '15-'16 FLHXSE, '11-'12 FLSTSE, '13-'14 FXSBSE & '14-'15 FLSTNSE also require Throttle Body Support Bracket, P/N 9929, sold separately.

**Note: Will Bolt directly to stock 40mm or Screamin' Eagle 44mm CV carbs or Delphi throttle bodies. Can be installed on Mikuni HSR42/45/48, S&S E or G Shorty, or other aftermarket carbs by using adapters, sold separately.

Note: Not Available in the State of California.

New

Collections

Featured Bikes

Audio

Lighting

Accessory Mounts

Handlebar Controls, Grips & Mirrors

Pegs & Foot Controls

Covers, Trims & Accents

Air Cleaners & Exhaust

Touring & Comfort

Windshields & Air Management

Luggage & Organizers

Index



*Re-uses stock
air cleaner cover!*



CRUSHER

CRUSHER® STREET SLEEPER® III AIR CLEANER

U.S. Patent 6,374,815

This unit includes a high-flow K&N® washable and reusable filter element. Integrated crankcase breathers eliminate the need for external hoses and fittings for a clean appearance. The high-flow filter element is compatible with factory Harley-Davidson® oval and round Touring air cleaner covers to maintain a stock appearance, as well as the Kuryakyn Alley Cat or Quantum air cleaner covers, and Crusher Maverick or Crusader air cleaner trims (all sold separately). Front-end and outer perimeter breathing provide a significant boost in airflow versus stock. Stock H-D air cleaner cover not included.

FOR HARLEY-DAVIDSON®

Fits: '99-'17 Twin Cam with CV Carb or Delphi EFI (except '08-'16 Touring/Trike, '16-'17 Softail, '16-'17 FXDLS, '11-'12 FLSTSE, '13-'14 FXSBSE, '14-'15 FLSTNSE)

9605 Satin Black (kit)

Note: Not Available in the State of California.

Fits: '08-'16 Electra Glides, Road Glides, Road Kings, Street Glides; Trikes, '16-'17 Softail, '16-'17 FXDLS, '11-'12 FLSTSE, '13-'14 FXSBSE, '14-'15 FLSTNSE

9606 Satin Black (kit)

Note: Not Available in the State of California.



9241



9240

CRUSHER

CRUSHER® CRUSADER AIR CLEANER TRIM

A clean design with laser-cut openings around the outer perimeter of the aluminum cover that are enhanced by contrasting brushed stainless steel accents and center ring. Includes removable backplate and hardware for installation on both standard and end-breathing filters.

FOR HARLEY-DAVIDSON™

Fits: Screamin' Eagle Stage 1 Air Cleaner kits for '99-'16 Touring, '00-'17 Softail, '99-'07 Dyna; All Street Sleeper II, Street Sleeper III, S&S Stealth & Arlen Ness Stage 1 Big Sucker Kits

9240 Chrome (ea)

9241 Satin Black (ea)



9241



9239



9238

CRUSHER

CRUSHER® MAVERICK AIR CLEANER TRIM

An aggressive beveled design on the outer perimeter is enhanced by a stainless steel mesh insert and brushed stainless steel badge that conceals the center mounting bolt for a clean, hardware-free appearance. Compatible with the following aftermarket air cleaner kits: Crusher Street Sleeper III, Arlen Ness Stage I Big Sucker, H-D Screamin' Eagle Stage 1, and S&S Stealth.

FOR HARLEY-DAVIDSON™

Fits: Screamin' Eagle Stage 1 Air Cleaner kits for '99-'16 Touring, '00-'17 Softail, '99-'07 Dyna; All Street Sleeper II, Street Sleeper III, S&S Stealth & Arlen Ness Stage 1 Big Sucker Kits

9238 Chrome (kit)

9239 Satin Black (kit)



9238

New

Collections

Featured Bikes

Audio

Lighting

Accessory Mounts

Handlebar Controls,
Grips & Mirrors

Pegs & Foot Controls

Covers, Trims
& Accents

Air Cleaners
& Exhaust

Touring & Comfort

Windshields &
Air Management

Luggage &
Organizers

Index

8746



8747



CLEAR TRAP DOOR

Give your classic Standard or Blood Groove Hypercharger Air Cleaner an entirely new look with this direct replacement for the original trap door that provides an inside look at the inner workings of the air cleaner and throttle body.

FOR MULTI-FIT

Fits: Kuryakyn Standard & Blood Groove Hypercharger Air Cleaners

8746 Chrome (ea)

8747 Gloss Black (ea)

8475



8476

TRAP DOORS FOR STANDARD HYPERCHARGER

Plated or powder-coated colored Trap Doors give your Hypercharger a new look in minutes!

FOR MULTI-FIT

Fits: Standard Hypercharger Air Cleaners

8482 Chrome (ea)

BLOOD GROOVE TRAP DOORS

A quick and classy alternative to the standard Trap Door. Five minutes and you have a whole new look.

FOR MULTI-FIT

Fits: Kuryakyn Standard Hypercharger Air Cleaners

8476 Chrome (ea)

8475 Gloss Black (ea)



8498



8498

STINGER TRAP DOOR FOR HYPERCHARGER

This is an incredibly cost-effective way to increase airflow in any standard Hypercharger. Easy four-bolt replacement of any standard trap door. Sit down, shut-up, and hang on!

FOR MULTI-FIT

Fits: Kuryakyn Standard Hypercharger Air Cleaners

8498 Chrome (ea)



8488

BUTTERFLIES FOR STANDARD HYPERCHARGER

Replacement butterflies for all Standard or Blood Groove Hyperchargers.

FOR MULTI-FIT

Fits: Standard Hypercharger Air Cleaners

8488 Chrome (pr)

3797



ACCESSORIES FOR MACH 2™

FOR HARLEY-DAVIDSON®

Fits: Kuryakyn Hi-Five Mach 2 Air Cleaners & Universal Applications

3797 Zombie™ Medallion, Chrome (ea)

3764 Deco Medallion, Chrome (ea)

Note: Requires a 4-1/2" diameter flat surface

FOR MULTI-FIT

Fits: Kuryakyn Mach 2 or Mach 2 Co-Ax Air Cleaners

9547 Co-Ax Update Kit, Chrome (ea)

9548 Co-Ax Update Kit, Gloss Black (ea)

3764



9548



PRE-FILTERS FOR KURYAKYN AIR CLEANERS

Keep bugs, dirt, wash water, or torrential downpour out of your air cleaner. Made exclusively for us in the U.S.A. by Outerwears. Water repellent, UV resistant and filters debris down to .005".

FOR MULTI-FIT

Fits: Kuryakyn Air Cleaners

- 8443 Pre-Filter for Hypercharger™ (ea)
- 9335 Pre-Filter for Pro-R Hypercharger™ (ea)
- 9559 Pre-Filter for Mach 2™ & Alley Cat Air Cleaners(ea)
- 9373 Prefilter for Hypercharger™ ES (ea)
- 9899 Pre-Filter for Maverick Pro Air Cleaners (ea)



8443



9559

BLUEGRASS BREATHER KITS

The banjo fittings and chrome tubes route the vented gasses upward so gravity can keep any expelled oil droplets in the engine. The vent line can be run up and out, or the optional catch tank is available for those who would rather vent to a closed container.

FOR HARLEY-DAVIDSON™

Fits: '93-'99 Evo Big Twin with Mikuni HSR series carb, '91-'19 XL Models

- 9930 Chrome (ea)

Fits: '93-'99 Evo Big Twin (Most Carbs except Mikuni HSR), '99-'06 Twin Cam with Stock & Most Carbs, '01-'16 Twin Cam with Delphi EFI (except '08-'16 Touring/Trike & '16-'17 Softail, '11-'12 FLSTSE, '13-'14 FXSBSE & '14-'15 FLSTNSE, Dyna '16 FXDLS)

- 9932 Chrome (ea)

Fits: 1/2" Crankcase Vent Hose - Includes 5/16"-18 x 1" Mount Bolt

- 9931 Chrome (ea)

Note: Not Available in the State of California.



9931



9932



9930

AIR CLEANER SPACERS

Make more room between your air cleaner and the engine or fuel tank. Compatible with any CV bolt pattern (late inlet) air cleaner.

FOR HARLEY-DAVIDSON™

Fits: Bolt Pattern for CV Carb/Cable Throttle Delphi

- 8564 1/4" CV Bolt Pattern Spacer, Raw (ea)
- 8512 5/8" CV Bolt Pattern Spacer, Raw (ea)
- 8510 7/8" CV Bolt Pattern Spacer, Raw (set)



8510

8564

8512

CARB INLET GASKETS

Replacement gaskets for late- and early-model Harley-Davidson carburetors.

FOR HARLEY-DAVIDSON™

Fits: H-D/Keihin 40mm & 44mm CV, Delphi EFI (except '08-'18 Touring/Trike, '16-'18 Softail, '11-'12 FLSTSE, '13-'14 FXSBSE, '14-'15 FLSTNSE)

- 9902 Carb Inlet Gasket, Late Inlet (ea)

Fits: Keihin 38mm Butterfly, Bendix, Zenith, Tillotson Carburetors

- 9901 Carb Inlet Gasket, Early Inlet (ea)



9902



9901

- New
- Collections
- Featured Bikes
- Audio
- Lighting
- Accessory Mounts
- Handlebar Controls, Grips & Mirrors
- Pegs & Foot Controls
- Covers, Trims & Accents
- Air Cleaners & Exhaust**
- Touring & Comfort
- Windshields & Air Management
- Luggage & Organizers
- Index

9920



CRANKCASE BREATHER KIT FOR TWIN CAM & EVO

Included with our Hypercharger Kits for Twin Cam models, this breather kit installs between the air cleaner and the carb support bracket. The stock breather bolts and vent hoses are reused.

FOR HARLEY-DAVIDSON*

Fits: '93-'07 Touring (except '95-'01 EFI), '93-'15 Softails (except '11-'12 FLSTSE, '13-'14 FXSBSE & '14-'15 FLSTNSE), '93-'17 Dynas (except '16-'17 FXDLS), '93-'94 & '99-'00 FXR & '91-'06 XL

8999



9920 Crankcase Breather Kit for '93-'17 Twin Cam, Raw (ea)

Note: '93-'99 Evolution Big Twin & '91-'06 XL require separate purchase of 1/2"-13 Breather Bolts, P/N 9927.

Fits: '07-'19 XL Models

9928 Crankcase Breather Kit for '07-'19 Sportster, Raw (ea)

9975



Fits: '99-'01 TWIN CAM WITH MAGNETI-MARELLI EFI

9921 Crankcase Breather Kit for '99-'01 EFI Twin Cam, Raw (ea)

REPLACEMENT COMPONENTS FOR CRANKCASE BREATHER KIT FOR EVO

Replacement components for the Crankcase Breather Kit for Evo engines.

FOR HARLEY-DAVIDSON*

9977



Fits: Replacement for Kuryakyn Crankcase Breather, P/N 8518

2000 Replacement 1" Breather Bolts (pr)

8999 Replacement Rubber Boot & Hose Kit (kit)

9900 Replacement Rubber Boots (pr)

BREATHER COMPONENTS FOR TWIN CAM

FOR HARLEY-DAVIDSON*

8525



Fits: '99-'17 Twin Cams

9977 Formed Breather Hoses (pr)

9976 1/2" longer Breather Bolt for Twin Cam 1-3/4" (pr)

9975 1-1/4" Breather Bolt for Twin Cam (pr)

8553



Fits: '93-'99 Evolution Big Twin, '91-'19 XL

9927 1/2"-13 x 1" Breather Bolt for Twin Cam Style (pr)

CARBURETOR ADAPTERS

Adapters and enrichers for Mikuni HSR42/45/48, HS40, and S&S E or G carbs.

FOR HARLEY-DAVIDSON*

8519



Fits: Mikuni HSR42/45/48

8553 Raw (ea)

Fits: S&S E or G Carburetors

8525 Raw (ea)

8519 Enrichener for S&S E or G (ea)

AIR CLEANER COMPONENTS

FOR HARLEY-DAVIDSON®

9612	Replacement K&N Air Filter for Maverick Pro (ea)
9509	Replacement K&N Air Filter for Velociraptor & Revolt (ea)
9469	Replacement K&N Filter for Mach 2, Street Sleeper II, Street Sleeper III, Crusher Maverick, Alley Cat & Skull Air Cleaners (ea)
9367	Replacement K&N Air Filter for Hypercharger ES (Twin Cam) (ea)
9368	Replacement Servo Motor for Hypercharger ES (ea)
9372	Replacement K&N Air Filter for Hypercharger ES (Milwaukee-Eight) (ea)
9334	Case Screws for Pro-Series & Pro-R Hyperchargers (set)
8554	Vacuum Pod Rebuild Kit for Pro-Series or Pro-R Hypercharger (ea)
9330	Chrome Butterflies for Pro-R/Pro-Series Hyperchargers (pr)
9493	Replacement K&N Filter for Pro-Series & Pro-R Hyperchargers (ea)
9590	Chrome Pro-R Hypercharger Front Half (ea)
9319	Replacement Cage/Foam Filter Assembly for Pro-R Hypercharger (ea)
9333	Pro-R Butterfly Shaft Caps with Screws, Washers, Bearings, & Spring (set)
9538	Chrome Pro Series Hypercharger Front Half (ea)
9332	Pro-Series Butterfly Shaft Caps with Screws, Washers, Bearings, & Spring (set)

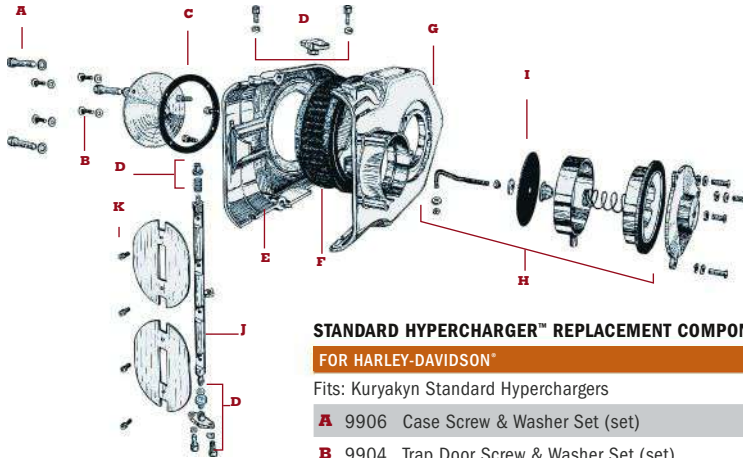

STANDARD HYPERCHARGER™ REPLACEMENT COMPONENTS

FOR HARLEY-DAVIDSON®

Fits: Kuryakyn Standard Hyperchargers

A	9906 Case Screw & Washer Set (set)
B	9904 Trap Door Screw & Washer Set (set)
C	9903 Standard Trap Door Gasket (ea)
D	9913 Butterfly Shaft Caps for Hypercharger (set)
E	9910 Chrome Hypercharger Front Half (ea)
F	8513 K&N Filter Element (ea)
G	9911 Chrome Hypercharger Back Half, Early Inlet (ea)
G	9912 Chrome Hypercharger Back Half, Late Inlet (ea)
H	8580 Vacuum Pod Rebuild Kit for Hypercharger (set)
I	8581 Diaphragm Only for Hypercharger (ea)
J	8599 Butterfly Shaft for Hypercharger (set)
K	9905 Butterfly Screw Set (set)

Disclaimer: The California Air Resources Board (CARB) does not permit the use of aftermarket emission-related parts(s) that alter the performance of OEM emission-related devices unless CARB has issued an Executive Order, other than on racing vehicles on closed courses. Check your local laws and manufacturer's information.

New

Collections

Featured Bikes

Audio

Lighting

Accessory Mounts

Handlebar Controls, Grips & Mirrors

Pegs & Foot Controls

Covers, Trims & Accents

Air Cleaners & Exhaust

Touring & Comfort

Windshields & Air Management

Luggage & Organizers

Index

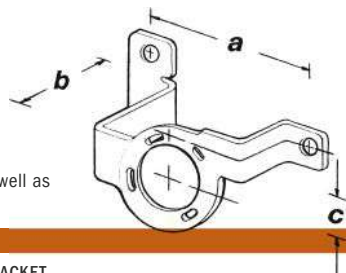

CARBURETOR SUPPORT BRACKETS

Carburetor supports brackets for Evo Sportster and Big Twin models, as well as Twin Cams and Milwaukee-Eight Touring models.

FOR HARLEY-DAVIDSON*

P/N	MODEL #	FITMENT	CARB INLET	HEAD ATTACHMENT BOLT SIZE	BRACKET USE REDUCTION WASHERS?	DIMENSIONS (ABOVE)		
						A	B	C
MILWAUKEE-EIGHT*								
9379		Required for installation of Kuryakyn air cleaners on '17-'19 Touring & Softail Models with 114 & 117 engines	N/A	3/8"	N/A	N/A	N/A	N/A
TWIN CAM								
8332		'92-'17 Evolution Big Twin or Twin Cam with CV or Mikuni HSR42/45/48 or Delphi EFI (except '08-'16 Touring/ Trike, '16-'17 Softail, '11-'12 FLSTSE, '13-'14 FXSBSE, '14-'15 FLSTNSE '16-'17 FXSE, Dyna, '16-'17 FXDLS)	Late	1/2"	No	5-15/16"	1-3/8"	1-5/16"
8327	MF5	'99-'01 Touring with Magneti-Marelli EFI	F.I. Oval	3/8"	No	5-15/16"	1-1/4"	2-1/2"
9929		'08-'16 Electra Glides, Road Glides, Road Kings & Street Glides, '16-'17 Softails, '09-'16 Trikes, '11-'12 FLSTSE, '13-'14 FXSBSE & '14-'15 FLSTNSE	N/A	3/8"	No	N/A	N/A	N/A
EVOLUTION BIG TWIN MODELS								
8344	MB 2	'90-'91 with CV; '84-'91 with Mikuni, Rev Tech, S.E.	Late	5/16"	Yes	5-15/16"	1-7/16"	1-5/16"
8332		'92-'99 with CV, Mikuni, S.E.	Late	1/2"	No	5-15/16"	1-3/8"	1-5/16"
8346	MB 3	'84-'89 with 38mm Butterfly S&S B	Early	5/16"	Yes	5-15/16"	1-7/16"	1-5/16"
8587	MB 9	'84-'99 with S&S E or G	Late	5/16" or 1/2"	Yes	5-15/16"	2-1/16"	1-5/16"
EVOLUTION SPORTSTER MODELS								
8349	XL-6	'88-'06 with CV Mikuni, Rev Tech, S.E.	Late	1/2"	Yes	5-3/16"	1-3/16"	1-1/8"

1/2"-13 AIR CLEANER MOUNTING BOLTS

Use these 1/2"-13 button head screws to secure the carburetor support bracket to the cylinder heads on '92 Evolution Big Twins when installing Kuryakyn or other custom air cleaners.

2004	1/2"-13 X 1" Air Cleaner Mounting Bolts (pr)
------	--

COMPLETE MOUNTING KITS FOR AIR CLEANERS

These mounting kits include everything necessary to install a Hypercharger, Pro-Hyper or Pro-R.



FOR HARLEY-DAVIDSON*

Fits: '93-'99 Evolution Big Twin with CV Carburetor, for use with Screamin' Eagle Crankcase Breather

8342 Chrome (ea)

Fits: '88-'90 XL with CV Carburetor

8340 Chrome (ea)

Fits: '91-'06 XL with CV Carburetor, Includes Kuryakyn Crankcase Breather.

8341 Chrome (ea)

Fits: '88-'90 XL with CV Carburetor

8339 Chrome (ea)

Fits: '88-'90 XL with CV Carburetor

8338 Chrome (ea)

Fits: '92 Evolution Big Twin with CV Carburetor

8337 Chrome (ea)

Fits: '90-'91 Evolution Big Twin with CV Carburetor

8336 Chrome (ea)

Fits: '84-'89 Evolution Big Twin with 38mm Keihin Butterfly or S&S B Carburetors

8335 Chrome (ea)

Fits: Pre-Evo Big Twin or XL with Stock Carb

8333 Chrome (ea)

Fits: '01-'05 Twin Cam with Delphi EFI

9924 Chrome (ea)

Fits: '99-'06 Twin Cam with CV Carburetor

9919 Chrome (set)

Fits: '06-'17 Twin Cam with Delphi EFI (except '08-'16 Touring/Trike, '16-'17 Softail, '11-'12 FLSTSE, '13-'14 FXSBSE & '14-'15 FLSTNSE, '16-'17 Dyna FXDLS)

9926 Chrome (ea)

Fits: '07-'19 XL Models

9329 Chrome (kit)

Fits: '08-'16 Touring/Trike, '16-'17 Softail, '11-'12 FLSTSE & '13-'14 FXSBSE & '14-'15 FLSTNSE

9978 Hyper AC Mounting Kit 2008-2017 With Electronic Throttle, Chrome (kit)

Note: '11-'13 FLHTCUSE, '14-'16 FLHTKSE, '09 FLTRSE, '11 & '15-'16 FLTRUSE, '12-'15 FLTRXSE, '10-'16 FLHXSE, '13-'14 FLHRSE, '11-'12 FLSTSE, '14-'15 FLSTNSE & '13-'14 FXSBSE also require Throttle Body Support Bracket, P/N 9929, sold separately.

New

Collections

Featured Bikes

Audio

Lighting

Accessory Mounts

Handlebar Controls,
Grips & Mirrors

Pegs & Foot Controls

Covers, Trims
& Accents

Air Cleaners
& Exhaust

Touring & Comfort

Windshields &
Air Management

Luggage &
Organizers

Index

EXHAUST



563



564



563

CRUSHER

CRUSHER® MAVERICK 4" SLIP-ONS FOR TOURING & TRIKE

Command authority. A deep, low roar you'll love at wide-open throttle with lower decibel levels at cruising speeds. Precision-machined billet aluminum tips. High-flow louvered baffles are maintenance-free and never need repacking. Optional Sound Reduction Baffles available if you're more of a quiet type.

- 4" diameter
- Chrome or matte black high-temp ceramic
- CNC-machined billet end caps with black high-temp ceramic coating
- Brushed stainless steel banding featuring the Crusher emblem
- Made in the U.S.A.

FOR HARLEY-DAVIDSON®

Fits: '95-'16 Electra Glides, Road Glides, Road Kings, Street Glides, Tour Glides & '09-'19 Trikes (except FLRT)

563 Chrome (pr)

564 Matte Black (pr)

Fits: '17-'19 Electra Glides, Road Glides, Road Kings & Street Glides

635 Chrome (pr)

636 Matte Black (pr)

Note: Installation on '10 FLHX or FLTRX requires conversion to True Dual or Crusher Dual head pipes and Muffler Support & Grommet, P/N 560, sold separately.



626

CRUSHER

CRUSHER® MARKSMAN™ 4" SLIP-ONS

Tactfully designed with the precision of a deadeye. Visible stainless steel inserts covertly expose laser-cut Crusher emblems spanning the top perimeter of the tips. High-flow baffles with shallow-cut louvers create less turbulence inside the mufflers for improved performance throughout the RPM range. An aggressive bark at full throttle eases into a deep, low rumble at cruising speeds. Made in the U.S.A. high-temp black ceramic-coated steel.

- 4" Muffler diameter
- High-flow louvered baffle design with no packing to blow out over time
- Aggressive exhaust tone when accelerating, with a low, deep rumble at cruising speed
- Made in the U.S.A.



FOR HARLEY-DAVIDSON®

Fits: '95-'16 Electra Glides, Road Glides, Road Kings, Street Glides, Tour Glides & '09-'19 Trikes (except FLRT)

626 Marksman, Matte Black (pr)

Note: Installation on '10 FLHX or FLTRX requires conversion to True Dual or Crusher Dual head pipes and Muffler Support & Grommet, P/N 560, sold separately.



LOOKS GREAT WITH
MAVERICK PRO AIR CLEANER
PG 241



LOOKS GREAT WITH
CRUSADER AIR CLEANER TRIM
PG 247



New

Collections

Featured Bikes

Audio

Lighting

Accessory Mounts

Handlebar Controls,
Grips & Mirrors

Pegs & Foot Controls

Covers, Trims
& Accents

**Air Cleaners
& Exhaust**

Touring & Comfort

Windshields &
Air Management

Luggage &
Organizers

Index



627



628



627



628

CRUSHER

CRUSHER® CRUSADER 4" SLIP-ONS FOR TOURING & TRIKE

Sleek tips feature a laser-engraved Crusher emblem above the opening, with laser-cut accents on the outer perimeter enhanced by a visible stainless steel insert. High-flow baffles with shallow-cut louvers create less turbulence inside the mufflers. The result is improved performance throughout the RPM range and a commanding exhaust tone at wide-open throttle. Made in the U.S.A. from premium chrome-plated or high-temp black ceramic-coated steel.

- 4" Muffler Diameter
- Brushed stainless steel band for added styling
- High-flow louvered baffle design with no packing to blow out over time
- Made in the U.S.A.

FOR HARLEY-DAVIDSON®

Fits: '95-'16 Electra Glides, Road Glides, Road Kings, Street Glides, Tour Glides & '09-'19 Trikes (except FLRT)

627 Crusader, Chrome (pr)

628 Crusader, Matte Black (pr)

Note: Installation on '10 FLHX or FLTRX requires conversion to True Dual or Crusher Dual head pipes and Muffler Support & Grommet, P/N 560, sold separately.



CRUSHER

CRUSHER® TRIDENT SLIP-ONS FOR TOURING & TRIKE

Big, bold, and 100% badass. Intimidation starts with beefy chrome and black tips that demand notice. Featuring high-performance perforated core baffles with stainless steel packing for added longevity. Mellow slip-ons feature the same sophisticated styling and performance as the full sound with a toned-down growl that won't rattle the neighbors.

FOR HARLEY-DAVIDSON®

Fits: '95-'16 Electra Glides, Road Glides, Road Kings, Street Glides, Tour Glides & '09-'19 Trikes (except FLRT)

491 Chrome (pr)

Note: In California, in order to meet Air Resources Board emissions requirements, certain aftermarket part applications have been identified as replacements, and others have received ARB Executive Orders. All other emissions related aftermarket parts are for competition use only. A list of replacement parts and EO parts, and corresponding fitment is provided. Kuryakyn makes no warranty regarding discoloration of chrome exhaust products. Discoloration is a result of heat & is not a manufacturing defect. Installation on '10 FLHX or FLTRX requires conversion to True Dual or Crusher Dual head pipes and Muffler Support & Grommet, P/N 560, sold separately. Ground clearance is reduced when installed on Trikes.

New

Collections

Featured Bikes

Audio

Lighting

Accessory Mounts

Handlebar Controls,
Grips & Mirrors

Pegs & Foot Controls

Covers, Trims
& Accents

Air Cleaners
& Exhaust

Touring & Comfort

Windshields &
Air Management

Luggage &
Organizers

Index



CRUSHER® MAVERICK 2.5" SLIP-ONS FOR DYNA, SOFTAIL & SPORTSTER

Featuring precision-machined billet aluminum tips with high-temp black ceramic coating. Maintenance-free high-flow louvered baffles that never need repacking, with optional Sound Reduction Baffles (sold separately) if you want to keep the peace with your neighbors.

- 2.5" diameter with signature Maverick styling
- CNC-Machined billet end caps with high-temp black ceramic coating
- Brushed stainless steel banding featuring embossed Crusher emblem
- Chrome or matte black ceramic
- Made in the U.S.A. from premium chrome-plated or high-temp black ceramic-coated steel

FOR HARLEY-DAVIDSON®

Fits: '07-'17 FLSTC Heritage Classic, '10-'12 FLSTSE CVO Softail Convertible, '07-'08 FXST Standard, '07-'09 FXSTB Night Train, '07-'10 FXSTC Softail Custom, '13-'17 FXSB Breakout, '08-'11 FXCW/C, '09 FXSTSSE CVO Softail Springer, '13-'14 FXSBSE CVO Breakout, '16-'17 FXSE CVO Pro Street Breakout

606 Maverick, Chrome (pr)

Fits: '07-'17 FLSTF Fat Boy, '10-'16 FLSTFB Fat Boy Lo & '07 FXSTD Deuce

607 Maverick, Chrome (pr)

Fits: '07-'17 FLSTN Softail Deluxe, '08-'11 FLSTSB Softail Cross Bones, '12-'17 FLS Softail Slim & '16-'17 FLSS Softail Slim S

609 Maverick, Chrome (pr)

610 Maverick, Black (pr)

Fits: '91-'17 Dyna Models (except '08-'17 FXDF, '09-'10 FXDFSE, '10-'17 FXDWG, '14-'17 FXDL, '12-'16 FLD, '16-'17 FXDLS)

611 Maverick, Chrome (pr)

612 Maverick, Black (pr)

Fits: '08-'17 FXDF Fat Bob, '09-'10 FXDFSE CVO Fat Bob, '16-'17 FXDLS Dyna Low Rider S & '10-'17 FXDWG Dyna Wide Glide

613 Maverick, Chrome (pr)

614 Maverick, Black (pr)

Fits: '04-'13 XL Models

615 Maverick, Chrome (pr)

616 Maverick, Black (pr)

Fits: '14-'19 XL Models

617 Maverick, Chrome (pr)

Note: Not available for sale in the state of California



CRUSHER

CRUSHER® TRUE DUAL HEAD PIPES FOR TOURING & TRIKE

The total package. Revitalize your engine and heavy-hand the throttle. Bottomless growl with trusted results. Each cylinder breathes through its own header and muffler for enriched airflow and unmatched power. Includes all heat shields and mounting hardware necessary for installation.

FOR HARLEY-DAVIDSON®

Fits: '95-'08 Electra Glides, Road Glides, Road Kings, Street Glides & Tour Glides

513 Chrome (kit)

Fits: '09-'16 Electra Glides, Road Glides, Road Kings, Street Glides & Trikes (Except '15 & '16 CVO Models)

516 Chrome (kit)

543 Matte Black (kit)

Note: Emissions Notice: For optimum performance, Kuryakyn recommends also adding one of our high-flow Air Cleaners and a fuel-injection tuning device such as the Vance & Hines Fuelpak or Master Tune Kit from TTS. Kuryakyn makes no warranty regarding discoloration of chrome exhaust products. Discoloration is a result of heat and is not a manufacturing defect. '09-'16 Trikes require Exhaust Adapter Kit, P/N 561, sold separately.

New

Collections

Featured Bikes

Audio

Lighting

Accessory Mounts

Handlebar Controls,
Grips & Mirrors

Pegs & Foot Controls

Covers, Trims
& Accents

Air Cleaners
& Exhaust

Touring & Comfort

Windshields &
Air Management

Luggage &
Organizers

Index



CRUSHER

CRUSHER® DUAL EXHAUST WITH POWER CELL FOR TOURING & TRIKE

Confidence delivered. Our best-performing head pipes with integrated Power Cell crossover enhance performance. Get 2-into-1 results masked by the Smooth Power Cell Heat Shield that lends a flawless flow to your ride. Includes all heat shields and mounting hardware necessary for installation.

FOR HARLEY-DAVIDSON®

Fits: '09-'16 Electra Glides, Road Glides, Road Kings, Street Glides & Trikes

558 Chrome (set)

Note: Not available in the State of California. '09-'16 Trikes require Exhaust Adapter Kit, P/N 561, sold separately.





CRUSHER® POWER CELL STAGGERED DUAL EXHAUST

Keep the wicked looks of staggered duals with a system that executes like a 2-into-1. Tuned performance and deep, powerful exhaust notes. Optional mellow baffles diminish sound, not performance. Includes full heat shields with billet end caps.

FOR HARLEY-DAVIDSON®

Fits: '06-'17 Dyna Models (except '14-'17 FXDL)

562 Chrome (set)

Note: See Emissions Notice



CRUSHER® MAVERICK 2-INTO-2 FULL SYSTEMS FOR DYNA, SOFTAIL & SPORTSTER

Renegade styling for bold bikers. Embossed stainless steel bands and signature precision-machined billet aluminum tips. Deep reverberation, solid power gains and incomparable looks. The Maverick is a must-have for your Dyna, Softail or Sporty. Made in the U.S.A. from premium chrome-plated or black ceramic-coated steel.

FOR HARLEY-DAVIDSON®

Fits: '86-'17 Softail Models (except '08-'11 FXCW/C, '13-'17 FXSB, '13-'14 FXSBSE)

565 Chrome (set)

566 Matte Black (set)

Fits: '06-'17 Dyna Models (except '12-'16 FLD & '14-'17 FXDL)

567 Chrome (set)

Fits: '04-'19 XL Models

569 Chrome (set)

570 Matte Black (set)

- New
- Collections
- Featured Bikes
- Audio
- Lighting
- Accessory Mounts
- Handlebar Controls, Grips & Mirrors
- Pegs & Foot Controls
- Covers, Trims & Accents
- Air Cleaners & Exhaust
- Touring & Comfort
- Windshields & Air Management
- Luggage & Organizers
- Index

482



CRUSHER® COMETIC® EXHAUST PORT GASKETS

We have worked with Cometic to develop a gasket that won't squeeze out into the exhaust port and restrict flow. Mesh type gaskets are notorious for obstructing the exhaust port. Don't let a cheap gasket rob you of hard-earned horsepower!

FOR HARLEY-DAVIDSON®

Fits: All Milwaukee-Eight, Twin Cam, Evo Big Twin & XL Sportster Engines

482 Cometic Exhaust Port Gaskets (pr)

509



EXHAUST BRACKETS & COMPONENTS FOR CRUSHER® EXHAUST

Additional brackets, gaskets and components for installation of Crusher exhaust products.

FOR HARLEY-DAVIDSON®

Fits: '95-'16 Electra Glides, Road Glides, Road Kings, Street Glides, Tour Glides & Trikes (Mounts 1 Muffler)

560 Muffler Support Bracket & Rubber Grommet, Chrome (kit)

540



Fits: Required to Install Crusher Head Pipes, P/N's 516, 543 or 558 on '09-'16 H-D Trikes

561 Trike Exhaust Adapter Kit for '09-'16, Chrome (kit)

Fits: 18mm O2 Sensor Bungs

509 18mm O2 Sensor Bung Plugs, Raw (kit)

Fits: 12mm O2 Sensor Bungs

540 12mm O2 Sensor Bung Plugs, Raw (kit)

9155



TORQUE CONES

Here's an inexpensive way to get back some of that lost horsepower and gas mileage without affecting the sound.

FOR HARLEY-DAVIDSON®

Fits: Most 1-3/4" O.D. Twin Cam, Evolution Big Twin and XL Exhaust Systems

9155 Raw (pr)

495



Note: Not Available in the State of California

CRUSHER® MUFFLER COMPONENTS

Replacement components for Crusher mufflers.

FOR HARLEY-DAVIDSON®

Fits: Crusher Mufflers with Trident Tip Only, P/N's 491 & 505

492 Replacement Trident Tip for Crusher Muffler, Chrome (ea)

557



Fits: All Kuryakyn Crusher Mufflers for Touring & Trike

495 Heat Shields for Crusher Mufflers, Chrome (pr)

SMOOTH POWER CELL HEAT SHIELD

A clean and simple styled chrome heat shield for those who desire that understated look.

FOR HARLEY-DAVIDSON®

Fits: All Crusher Power Cell Exhaust Systems

557 Chrome (ea)

583



SLOTTED POWER CELL HEAT SHIELD

Chrome or Black and Chrome replacement heat shields provide a radical look for your Power Cell exhaust system.

FOR HARLEY-DAVIDSON®

Fits: All Crusher Power Cell Exhaust Systems

515 Chrome (ea)

583 Black & Chrome (ea)

COMPONENTS & SERVICE KITS FOR MAVERICK TOURING SLIP-ONS

Replacement components for Crusher Maverick 4" Touring Slip-Ons. The sound reduction baffles will provide a quieter sound from your Maverick Slip-Ons while retaining the original style and performance.

FOR HARLEY-DAVIDSON®

Fits: Crusher Maverick 4" Slip-On Mufflers

589 Replacement Tip for Maverick 4" Touring Slip-Ons, Black (ea)

Fits: Left Side Crusher Maverick 4" Touring Slip-On

584 Brushed Stainless (ea)

Fits: Right Side Crusher Maverick 4" Touring Slip-On

585 Brushed Stainless (ea)

Fits: Crusher Maverick 4" Touring Slip-On Mufflers, P/N's 563 & 564 Only

582 Sound Reduction Baffles for Maverick 4" Touring Slip-Ons (pr)

Note: Includes replacement screws.

Fits: All Crusher Maverick Slip-Ons and Complete Systems

581 Replacement Stainless Screws for Maverick Exhaust, 16 pack, Brushed Stainless (set)

COMPONENTS & SERVICE KITS FOR MARKSMAN™ & CRUSADER TOURING SLIP-ONS

Sound Reduction Baffles provide a toned-down exhaust note without sacrificing performance. Replacement tips for Crusader and Marksman Slip-Ons reuse original hardware.

FOR HARLEY-DAVIDSON®

Fits: Crusher Marksman 4" Touring Mufflers

629 Replacement Tip for Marksman™ 4" Touring Mufflers, Chrome (ea)

630 Replacement Tip for Marksman™ 4" Touring Mufflers, Matte Black (ea)

Fits: Crusher Crusader 4" Touring Mufflers

631 Replacement Black Tip for Crusader 4" Touring Mufflers, Matte Black (ea)

Fits: Part #'s 625, 626, 627, & 628

632 Sound Reduction Baffles for Marksman™ & Crusader 4" Touring Slip-Ons (pr)

REPLACEMENT COMPONENTS FOR MAVERICK 2-2 & 2.5" SLIP-ONS

Replacement components for Maverick 2-2 Full Systems and 2.5" Slip-On mufflers.

FOR HARLEY-DAVIDSON®

Fits: Maverick 2-Into-2 Full Systems & 2-1/2" Slip-Ons

587 Replacement Tip for Maverick 2-Into-2 full Systems, Black (ea)

586 Replacement 2-1/2" Band with Hardware for Maverick Exhaust, Brushed Stainless (ea)

Fits: Crusher Maverick 2-Into-2 Systems and 2-1/2" Slip-On's

590 Sound Reduction Baffles for Maverick 2-Into-2 Systems & Slip-Ons (pr)

Fits: All Crusher Maverick Slip-Ons and Complete Systems

581 Replacement Stainless Screws for Maverick Exhaust, 16 pack, Brushed Stainless (set)

MELLOW BAFFLES FOR CRUSHER®

Standard baffles too loud? Replace them with these Mellow Baffles and keep the neighbors happy.

FOR HARLEY-DAVIDSON®

Fits: All Crusher Power Cell Staggered Duals for Softail & Dyna

544 Mellow Baffles for Crusher Power Cell Exhaust, Silver (pr)

New

Collections

Featured Bikes

Audio

Lighting

Accessory Mounts

Handlebar Controls,
Grips & Mirrors

Pegs & Foot Controls

Covers, Trims
& Accents

Air Cleaners
& Exhaust

Touring & Comfort

Windshields &
Air Management

Luggage &
Organizers

Index

FUEL MANAGEMENT



VANCE & HINES FUELPAK FP3

Connecting wirelessly by Bluetooth to iPhone or Android smartphones, Fuelpak FP3 uses Flash technology to recalibrate engine parameters and mapping for exhaust systems and other performance upgrades. With the Fuelpak FP3 module plugged-in, Live Sensor Data can be viewed through the smartphone to display speed, RPM, cylinder head temperature, voltage, gear selection and other vital information. (Part Number 233 excludes fuel economy/average fuel economy, gear and odometer functions)

FOR HARLEY-DAVIDSON®

Fits: '14-'19 Electra Glides, Road Glides, Road Kings & Street Glides, '14-'19 Trikes; '11-'19 Softails (except '11-'13 CVO Models), '12-'17 Dynas, '14-'19 Sportsters & '14-'19 Streets

230 Vance & Hines Fuelpak FP3 CANbus, 6-Pin (ea)

Fits: '07-'13 Electra Glides, Road Glides, Road Kings, Street Glides & Trikes, '07-'10 Softails, '07-'11 Dynas & '07-'13 Sportsters

233 Vance & Hines Fuelpak FP3 J1850, 4-Pin (ea)

Note: Not Available in the State of California

Online tutorials!



9225

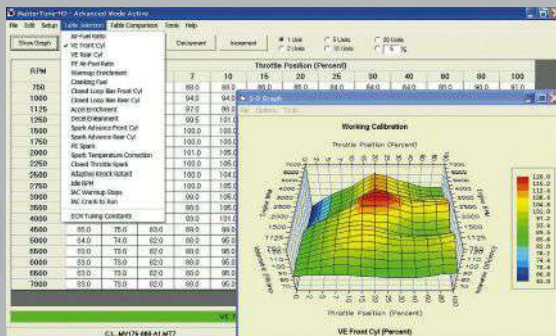

TTS MASTERTUNE

The most powerful tuning tool available for your motorcycle's ECM, bar none! This one tool contains three powerful programs including Mastertune tuning software, Data Master data acquisition and VTune, a self-tuning software solution. Mastertune has over 20 tables and parameters to optimize your ECM including air-fuel mixture and timing. (Some early year bikes may have fewer tables). Not compatible with Apple/Mac.

FOR HARLEY-DAVIDSON®

Fits: '01-'19 H-D Models with Delphi EFI

9225 TTS MasterTune Single Bike Kit, Blue (kit)

9226 TTS MasterTune Dual Bike Kit, Blue (kit)

Fits: For use with TTS MasterTune on '02-'13 Electra Glides, Road Glides, Road Kings & Street Glides; '09-'13 Trikes, '01-'10 Softails, '04-'11 Dynas & '07-'13 Sportsters

9228 MasterTune USB Cable Kit, 4-Pin for J1850 Delphi (kit)

Fits: For use with TTS MasterTune on '14-'19 Electra Glides, Road Glides, Road Kings, Street Glides, Trikes, Sportsters & Street Models, '11-'19 Softails, '12-'17 Dynas & '15-'19 Streets

9229 MasterTune USB Cable Kit, 6-Pin for CANbus (ea)

Note: The TTS MasterTune does NOT include link cables for tuning. If you install the TTS MasterTune yourself you will need to purchase the appropriate USB Cable Kit for your application. Not compatible with Apple/Mac. Not Available in the State of California

ENGINE COMPONENTS

CRUSHER® TC-23D BOLT-IN CAMS FOR TWIN CAM

Monster torque cams for 96's and 103's. These cams are easy on the valve train and they can be used with stock pushrods and valve springs.



580

FOR HARLEY-DAVIDSON®

Fits: '06 Dyna Models & All '07-'17 Twin Cams

580 Crusher TC-23D Bolt-in Cams (set)

Note: Not Available in the State of California

GRIND	LIFT (INCHES)	LIFT @ TDC (INCHES)	OPENING (DEGREES)	CLOSING (DEGREES)	DURATION (DEGREES)	LOBE CENTER (DEGREES)
Intake	.548	.153	13	29	222	98
Exhaust	.548	.163	43	15	238	104

CRUSHER® TC-24D BOLT-IN CAMS FOR TWIN CAM

Most cams trade low-end power and torque for upper horsepower or top-end performance for low-end torque. Crusher Cams are finessed to give wide usable power-bands with strong low end, big torque, high horsepower and extended RPM ranges. Low noise and long valve train life are also features built into these cams. Adjustable pushrods are required, but no head work, valve springs or piston clearancing is necessary.



579

FOR HARLEY-DAVIDSON®

Fits: '06 Dyna Models & All '07-'17 Twin Cams

579 Crusher TC-24D Bolt-In Cams (set)

Note: Not Available in the State of California

GRIND	LIFT (INCHES)	LIFT @ TDC (INCHES)	OPENING (DEGREES)	CLOSING (DEGREES)	DURATION (DEGREES)	LOBE CENTER (DEGREES)
Intake	.575	.190	20	42	242	101
Exhaust	.547	.150	46	14	240	106

CRUSHER® TC-25D BOLT-IN CAMS FOR TWIN CAM

Great bolt-in low-mid range torque cam for the Twin Cam 110. These cams won't beat up your valve train and can be used with the stock pushrods and valve springs.



578

FOR HARLEY-DAVIDSON®

Fits: '06 Dyna Models & All '07-'17 Twin Cams

578 Crusher TC-25D Bolt-in Cams (set)

Note: Not Available in the State of California

GRIND	LIFT (INCHES)	LIFT @ TDC (INCHES)	OPENING (DEGREES)	CLOSING (DEGREES)	DURATION (DEGREES)	LOBE CENTER (DEGREES)
Intake	.560	.184	18	38	236	100
Exhaust	.560	.153	46	14	240	106

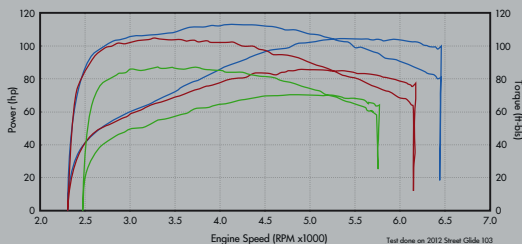

- Crusher Exhaust, A/C Tuner & TC-24D Cams 104 HP & 112 FT. LB OF TORQUE
- Crusher Exhaust, A/C & Tuner 85 HP & 103 FT. LB OF TORQUE
- Stock 69 HP & 86 FT. LB OF TORQUE

Testing Done On '12 Street Glide 103" Motor With No Other Modifications Other Than Listed Above

New

Collections

Featured Bikes

Audio

Lighting

Accessory Mounts

Handlebar Controls, Grips & Mirrors

Pegs & Foot Controls

Covers, Trims & Accents

Air Cleaners & Exhaust

Touring & Comfort

Windshields & Air Management

Luggage & Organizers

Index

577



CRUSHER® EASY INSTALL ADJUSTABLE PUSHRODS

Crusher Easy Install Adjustable Push Rods make cam swaps a breeze. Just cut out your stock push rods, no need to remove the fuel tank or rocker boxes. The Crusher push rods work with stock push rod tubes and are made from high strength chrome moly steel.

FOR HARLEY-DAVIDSON®

Fits: All '99-'17 Twin Cams

577 Crusher Easy Install Adjustable Pushrods (set)

659



CRUSHER® HIGH PERFORMANCE HYDRAULIC LIFTERS FOR TWIN CAM

Crusher High Performance Hydraulic lifters are a direct replacement for stock lifters in the '99-'16 Twin Cams. Tight tolerances and precision ground lifter bodies make these a must for doing complete builds or cam swaps.

FOR HARLEY-DAVIDSON®

Fits: All '99-'17 Twin Cams & '00-'19 XL

659 Crusher High Performance Hydraulic Lifters (set)



CRUSHER® LION LOGO T-SHIRT

Made from 100% cotton, let your support for Crusher roar with this stylish T-Shirt that sports the Crusher and lion logos.

115178 Small, Grey (ea)

115179 Medium, Grey (ea)

115180 Large, Grey (ea)

115183 3X-Large, Grey (ea)

CRUSHER® "C" LOGO T-SHIRT

Made from 100% cotton, show your support for Crusher Performance with the signature Crusher "C" logo T-Shirt.

115172 Small, Black (ea)

115173 Medium, Black (ea)

115174 Large, Black (ea)

115177 3X-Large, Black (ea)



TOURING & COMFORT

BACKRESTS 268

LUGGAGE RACKS 271

PASSENGER ARMRESTS 273

RELOCATORS FOR TOUR-PAK 274

TRAILER HITCHES & WIRING 277

BACKRESTS



1606

**TRANSFORMER™ BACKREST
WITH FOLD-DOWN LUGGAGE RACK**

U.S. Patents 6,966,471 & 8,459,517

Simply fold down the inconspicuous luggage rack right out of the backrest when you need it, and stow it away securely with the integrated thumb nut when you don't. Mounts directly to the required Kuryakyn quick-detach Side Plates for Transformer Backrest, sold separately.

FOR MULTI-FIT

Fits: Requires Kuryakyn Motorcycle Specific Side Plates for Transformer Backrest, Sold Separately Below

1606 Chrome (ea)

Note: Kuryakyn Quick Release Side Plates are compatible with H-D Detachable Docking Kits if the bike is already so equipped. P/N 1634 is compatible with H-D Docking Kit 54030-09. P/N 1636 is compatible with H-D Docking Kit 53803-06. P/N 1638 is compatible with H-D Docking Kit 53544-04 or 53529-04. P/Ns 1640, 1641, & 1644 are compatible with Docking Kits 53824-00, 53932-03, 53821-00, 53930-03, 53822-22, 53931-03, 53009-03, or 53075-03.

QUICK RELEASE SIDES PLATES & QUICK RELEASE ATTACHMENT KITS FOR TRANSFORMER BACKREST U.S. Patent 8,267,613

TOURING APPLICATIONS	QUICK RELEASE SIDE PLATES	QUICK RELEASE ATTACHMENT KITS
Fits: '09-'13 Electra Glide Standards, Road Glides, Street Glides, & Road Kings	1634	1635
Fits: '94-'08 Electra Glide Standards, Road Glides, Street Glides, & Road Kings	1636	1637
SPORTSTER APPLICATIONS	QUICK RELEASE SIDE PLATES	QUICK RELEASE ATTACHMENT KITS
Fits: All '04-'19 Sportsters ¹	1638	1639
SOFTAIL APPLICATIONS	QUICK RELEASE SIDE PLATES	QUICK RELEASE ATTACHMENT KITS
Fits: '00-'17 FLSTC Heritage Classic with Stock Saddlebags	--	1642
Fits: '00-'17 FLSTC Heritage Classic with H-D Hard Saddlebags (90224-00)	1640	1642
Fits: '00-'03 FLSTS Heritage Springer with Stock Saddlebags	--	1642
Fits: '05-'17 FLSTN Deluxe with or without H-D P&A Saddlebags or Hard Saddlebags (90725-00)	1640	1642
Fits: '05-'07 FLSTSC Springer Classic with or without H-D P&A Saddlebags (except Heritage Bags)	1640	1642
Fits: '05-'07 FLSTSC Springer Classic with H-D Hard Saddlebags (90224-00 or 90225-00)	1640	1642
Fits: '05-'07 FLSTSC Springer Classic with Heritage Saddlebags	--	1642
Fits: '06 FLST Heritage with or without H-D P&A Saddlebags (except Heritage Bags)	1640	1642
Fits: '06 FLST Heritage with H-D Hard Saddlebags (90224-00)	1640	1642
Fits: '06 FLST Heritage with Heritage Saddlebags	--	1642
Fits: '00-'05 FXST, FXSTB, FXSTS, '00-'06 FLSTF with or without H-D P&A Saddlebags	1640	1642
Fits: '00-'05 FXST, FXSTB, FXSTS, '00-'06 FLSTF with H-D Hard Saddlebags (90225-00, or 90715-00)	1640	1642

1. Sportster Models equipped with H-D hard saddlebags (91412-0x) must purchase hardware kit 91405-04 from an authorized H-D dealer.

MULTI-PURPOSE DRIVER & PASSENGER BACKREST

U.S. Patent 8,905,474

Introducing the first truly multipurpose backrest and luggage rack system, available only from Kuryakyn. Once installed, no tools are needed for adjustments, making the switch from rider to passenger backrest a snap. Full adjustability will help you enjoy those longer rides, and with the incorporated luggage rack, carrying all your stuff just got a whole lot easier.

- Sturdy aluminum main frame, steel folding luggage rack with rubber inserts and comfortably padded backrest.
- Backrest pad is fully adjustable via stainless sliding rods with push-button locks and knurled threaded knobs.

FOR MULTI-FIT

Fits: Various Applications - Requires Model Specific Mounting Brackets, Sold Separately Below

1660 Chrome (ea)

1661 Black & Chrome (ea)

Note: Backrest & Mount Plates sold separately.

QUICK RELEASE ATTACHMENT KIT FOR '14-'19 TOURING

Durable stamped steel mount and hardware kit designed for quick-detatch functionality of the Kuryakyn Multi-Purpose Driver & Passenger Backrest.

FOR HARLEY-DAVIDSON*

Fits: '14-'19 Road Glides (except FLTRU, FLTRUSE), Road Kings & Street Glides

7093 Mount, Chrome (pr)

7098 Attachment Point Kit, Chrome (kit)

Note: Quick release mounts and attachment kits are sold separately. Compatible with H-D Docking Kit 52300353.

FIXED MOUNTS FOR MULTI-PURPOSE DRIVER & PASSENGER BACKREST

Review chart below carefully & order the correct mount for your application. Backrest & Fixed Mounts are sold separately.

TOURING APPLICATIONS	FIXED MOUNT
Fits: '14-'19 Road Glides, Road Kings & Street Glides	1662
Fits: '09-'13 Electra Glide Standards, Road Glides, Road Kings & Street Glides, LOW mount	1665**
Fits: '09-'13 Electra Glide Standards, Road Glides, Road Kings & Street Glides, TALL mount	1666**
Fits: '97-'08 Electra Glide Standards, Road Glides, Road Kings & Street Glides, LOW mount	1663*
Fits: '97-'08 Electra Glide Standards, Road Glides, Road Kings & Street Glides, TALL mount	1664*
SOFTAIL APPLICATIONS	FIXED MOUNT
Fits: '03-'17 FLSTC/I Heritage Classic, '06 FLST/I Heritage, '05-'07 FLSTSC/I Heritage Springer Classic, '07-'17 FLSTN Softail Deluxe & '03 FLSTS/I Heritage Springer	1667
Fits: '05-'06 FLST, FLSTN, '00-'06 FLSTF, '00-'05 FXST, FXSTB & FXSTS	7096
DYNA APPLICATIONS	FIXED MOUNT
Fits: '06-17 Dyna Models (except FLD, FXDWG, FXDF & FXDFSE/2)	7095
SPORTSTER APPLICATIONS	FIXED MOUNT
Fits: '04-'19 XL Models (except XL1200T & XL1200CX)	7097

*For Use with Low-Profile Seats 6" Thick or Less Measured at the Front of the Passenger Seat

**Compatible with stock seats on '09 FLHT, '11-'13 FLHR & '11-'13 FLHX



New

Collections

Featured Bikes

Audio

Lighting

Accessory Mounts

Handlebar Controls, Grips & Mirrors

Pegs & Foot Controls

Covers, Trims & Accents

Air Cleaners & Exhaust

Touring & Comfort

Windshields & Air Management

Luggage & Organizers

Index



1670

1670



1670

**PLUG-IN DRIVER BACKREST
FOR TOURING**

Multiple adjustments and easy installation make this a must-have touring accessory.

FOR HARLEY-DAVIDSON®

Fits: One-Piece Slotted Seats on '97-'19 Electra Glides, Road Glides, Road Kings & Street Glides

1670 Chrome (kit)



8987

DRIVER BACKREST FOR SOFTAIL

The Driver Backrest for Softails can add miles of comfort to a day's travel. The rider enjoys a reach to the controls tailored to their stature, as well as backrest angle and height adjustments. For passenger convenience, pad assembly folds forward for easy seating. Quick-detach mechanism permits fast installation and removal of hoop and pad assembly.

FOR HARLEY-DAVIDSON®

Fits: '06 FLST/I Heritage, '06-'17 FLSTC/I Heritage Classic, '06-'17 FLSTN/I Softail Deluxe, '06-'07 FLSTSC/I Springer Classic, and All '93-'05 Softails (except '00-'05 FXSTD/I, '03-'04 FXSTDSE, '05 FLSTFSE)

8987 Chrome (ea)



8998
8980
1605

PLUG & PLAY SISSY BAR & BACKREST PAD

U.S. Patents 5,984,331

Bolts to the rear fender underneath the passenger seat and accepts our low, custom Sissy Bar (P/N 8980) and Backrest Pad (P/N 1605), both sold separately, for passenger comfort and convenience. The backrest and pad measures 6-1/2" wide x 9-1/2" tall from the rear fender.

FOR HARLEY-DAVIDSON®

Fits: H-D Models with 130mm, 140mm, or 150mm Rear Tires (Softail, Dyna, Sportster, FXR)

8998 Plug & Play Mount for H-D Models,
Chrome (ea)

Fits: Plug-N-Play Sissy Bar Mount, P/N 8998

8980 Sissy Bar for Plug & Play, Chrome (ea)

Fits: Kuryakyn Sissy Bar, P/N 8980

1605 Backrest Pad for Plug & Play Sissy Bar,
Black (ea)



**ALSO AVAILABLE
DRINK HOLDERS
PG 77**



LUGGAGE RACKS



DILLINGER™ LUGGAGE RACK FOR SPORTSTER

Make a statement to your fellow riders and prove that luggage racks don't have to be run-of-the-mill. Features a unique and aggressive design that's capable of handling virtually any sized luggage. Designed with ridges and a slight rise at the tail to keep the load from sliding when strapped down. Made from durable stamped steel, includes all mounting brackets and hardware for a clean install between the fender and struts.

FOR HARLEY-DAVIDSON™

Fits: '04-'19 XL Models (except Roadster)

6664 Silver (ea)

6665 Satin Black (ea)



TOUR-PAK® LID GRIP

Protect paint and prevent wear and tear with this sleek and unobtrusive finger-hold that provides a convenient lifting point to grasp when opening Tour-Pak lids.

FOR HARLEY-DAVIDSON™

Fits: '06-'13 Touring & Trike with King or Ultra Tour-Paks

7160 Chrome (ea)

7161 Gloss Black (ea)

Fits: '14-'19 FLHTCU/L, FLHTK/L, FLHTKSE, FLTRU, '15-'16 FLTRUSE, '14-'19 FLHTCUTG and any '14-'19 Touring Models Equipped with H-D Accessory Tour-Pak

7162 Chrome (ea)

7163 Gloss Black (ea)



7161



7163



New

Collections

Featured Bikes

Audio

Lighting

Accessory Mounts

Handlebar Controls,
Grips & Mirrors

Pegs & Foot Controls

Covers, Trims
& Accents

Air Cleaners
& Exhaust

Touring & Comfort

Windshields &
Air Management

Luggage &
Organizers

Index



7137



7137

LUGGAGE RACK FOR H-D TOUR-PAK*

Designed to compliment the classic lines of your H-D Tour-Pak. Measuring 20" x 12", this deep cradle design handles sleeping bags, tents, jackets or rack bags with ease. Tie-down points at each corner make securing your load a snap. Constructed of tubular steel.

FOR HARLEY-DAVIDSON*

Fits: '80-'19 H-D Touring & Trike Models with King, Ultra, Chopped or Razor Tour-Paks

7139 Chrome (ea)

7137 Gloss Black (ea)



7139

Top Seller

LUGGAGE RACK RELOCATION KIT FOR H-D TOUR-PAK

Your luggage rack will be raised 1/2" and can be positioned 1/2" forward or 1/2" backward from its current location. Allows for the use of Kuryakyn L.E.D. Run-Turn-Brake Spoiler (P/N 7767) on '10-'13 Electra Glide Ultra Limited Models when mounted in the forward position.

FOR HARLEY-DAVIDSON*

Fits: Luggage Racks with 1/2" diameter legs using 1/4"-20 mounting screws - This includes Kuryakyn Luggage Rack (P/N 7139) & stock rack on '10-'19 Ultra Limited

7138 Chrome (kit)



7138



7138



7159

MULTI-RACK ADJUSTABLE TRUNK LUGGAGE RACK

Features adjustable mounting stand-offs to fit virtually any trunk lid whether flat or curved, a 1/2" tubular design to accommodate flag holders, and built-in corner loops to help keep luggage secure. Includes mounting extensions for trunk lids with a downward rear swoop or spoiler and measures 21" wide x 12" long.

FOR MULTI-FIT

Fits: Flat, Curved, & Slanted Tour Trunks with a rigid top utilizing adjustable mounting posts - Requires 6" Long x 13" Wide mounting area

FOR HARLEY-DAVIDSON*

Fits: All H-D Touring & Trike Models with King, Ultra, Chopped or Razor Tour-Paks

7159 Chrome (ea)

7149 Gloss Black (ea)



7149

Note: Requires drilling four holes in trunk lid for installation.

PASSENGER ARMRESTS



8955

PASSENGER ARMRESTS FOR '14-'19 TOURING & TRI GLIDE

Patent Pending

Armrests can be adjusted vertically and rotated out of the way when mounting and dismounting, or remove them with a simple push of a button. Mounting bracket conveniently mounts between the Tour-Pak and speaker housing. Includes one cup holder installed on the right side - supplied cup holder can be moved to left side or a second cup holder can be added (P/N 8954), sold separately.

FOR HARLEY-DAVIDSON™

Fits: '14-'19 Electra Glides, Road Glide Ultra & Tri Glides

8955 Passenger Armrests, Chrome (pr)

Fits: Kuryakyn Passenger Armrests, P/N 8953 & 8955

8954 Cup Holder Kit, Black (ea)



8955



8955



8958

STEALTH PASSENGER ARMRESTS FOR TOURING & TRIKE

U.S. Patent D724,499 & Patent Pending

Ultimate comfort and convenience in a compact, sturdy package! Support brackets are nearly invisible and fastened between Tour-Pak lid and pad. Each arm has two mounting locations, and pivot has an adjustable stop for fine-tuning pad position. Padded over-molded arm folds back out of the way.

FOR HARLEY-DAVIDSON™

Fits: '97-'13 Electra Glides (except '10-'13 FLHTCUSE), Road Glides (except '11 FLTRUSE), Road Kings, Street Glides, Tour Glides & Trikes Equipped with King or Ultra Tour Pak

8958 Chrome (set)



8958



8958

New

Collections

Featured Bikes

Audio

Lighting

Accessory Mounts

Handlebar Controls,
Grips & Mirrors

Pegs & Foot Controls

Covers, Trims
& Accents

Air Cleaners
& Exhaust

Touring & Comfort

Windshields &
Air Management

Luggage &
Organizers

Index



PASSENGER ARMRESTS FOR TRI GLIDE

U.S. Patents D526,952 & 7,114,774

Our Passenger Armrests are designed specifically for H-D Trikes. The unique design of the mounting plates allows you to permanently relocate your Tour-Pak 1" to 2" back, or 1" forward of the stock location. The swing-away design does not interfere with the passenger mounting or dismounting the bike. A built-in cup holder keeps a cold (or warm) drink at their fingertips and includes a foam can cooler.

FOR HARLEY-DAVIDSON®

Fits: '09-'13 FLHTCUTG Tri Glide Ultra Classic

8959 Chrome (set)

QUICK DETACH PASSENGER ARMRESTS

U.S. Patents D526,952; D652,356; 7,114,774 & 9,056,569

These passenger armrests come on and off in minutes with no tools and feature pivot joints with variable tension adjusters for the ultimate fit. Compatible with Kuryakyn Quick Adjust Tour-Pak Relocator (P/N 8973).

FOR HARLEY-DAVIDSON®

Fits: '98-'13 Electra Glides, Road Glides, Road Kings or Street Glides Equipped with Rigid Mounted or Detachable King or Ultra Tour-Paks

8979 Chrome (set)

Note: Not compatible with chopped or leather covered Tour-Paks or H-D's original detachable Tour-Pak Rack (P/N 53107-96), which is a welded, tubular design.

PASSENGER GRAB RAILS FOR TOURING

Beautifully chromed and padded, these passenger grab rails provide a place to "hold on" and a feeling of control.

FOR HARLEY-DAVIDSON®

Fits: '99-'13 Electra Glides, Road Glides, Road Kings, Street Glides & '09-'19 Trikes (except Freewheeler)

1609 Chrome (ea)

RELOCATORS FOR TOUR-PAK®



RELOCATOR KIT FOR DETACHABLE TOUR-PAK®

H-D's Detachable Tour-Pak provides three positions: Full Forward, 1" Back and 2" Back. Our Relocator Kit shifts this range of adjustment back an additional 2", allowing you to select a position 2" back, 3" back, or 4" back from the original full forward position.

FOR HARLEY-DAVIDSON®

Fits: '97-'08 Road King, FLHT, FLHX, and FLTR Models equipped with H-D Two-Up or Solo Detachable Tour-Pak Racks (H-D P/Ns 53276-04 or 53260-02) and King or Chopped Tour-Paks

8986 Chrome (ea)

Note: Not compatible with H-D's original Detachable Tour-Pak Rack design (H-D P/N 53107-96). This style of rack has a tubular frame topped with a flat plate.

Top
Seller

TOURING & COMFORT
RELOCATORS FOR TOUR-PAK

*Adjusts 1" forward
and 3" back!*



8731

ADJUSTABLE TOUR-PAK® RELOCATOR

Adjust the Tour-Pak from 1" forward to 3" back from the stock position with a tool-free slider and latch system. Features interlocking aluminum support plates, chrome locking levers, a chrome rear accent panel and an extended-length vinyl pad/wiring cover for the front of the Tour-Pak.

FOR HARLEY-DAVIDSON®

Fits: '14-'19 Electra Glides, Road Glides, Road Kings & Street Glides Equipped with Rigid Mounted or Detachable King, Ultra or Chopped Tour-Paks

8731 Chrome (kit)

Note: Not compatible with H-D Passenger Armrests, H-D P/N 52400073

FILLER PAD FOR TOUR-PAK RELOCATOR

Fill the gap between your seat and Tour-Pak when using Kuryakyn's Fixed Tour-Pak Relocator, P/N 8956.

FOR HARLEY-DAVIDSON®

Fits: '97-'13 Electra Glides, Road Glides, Road Kings & Street Glides equipped with Kuryakyn's Tour-Pak Relocators

5201 Black (ea)

Fits: '14-'19 Electra Glides, Road Glides, Road Kings, Street Glides & Trikes Equipped with Rigid Mounted or Detachable King, Ultra or Chopped Tour-Paks

8742 Black (ea)



8731

Includes pad!

8731



BEFORE



5201



5201



8742

New

Collections

Featured Bikes

Audio

Lighting

Accessory Mounts

Handlebar Controls,
Grips & Mirrors

Pegs & Foot Controls

Covers, Trims
& Accents

Air Cleaners
& Exhaust

Touring & Comfort

Windshields &
Air Management

Luggage &
Organizers

Index



8956

*Adjusts
1, 2 or 3\"/>*

**Top
Seller**

RELOCATOR KITS FOR TOURING & TRIKE TOUR-PAKS

This handy kit moves the Tour-Pak® back 1", 2" or 3" to provide more room for your passenger.

FOR HARLEY-DAVIDSON®

Fits: '09-'13 Electra Glides, Road Glides, Road Kings, Street Glides & Trikes Equipped with Rigid Mounted or Detachable King, Ultra or Chopped Tour-Paks

8957 Black (ea)

Fits: '14-'19 Electra Glides, Road Glides, Road Kings, Street Glides & Trikes Equipped with Rigid Mounted or Detachable King, Ultra or Chopped Tour-Paks

8956 Black (ea)



8956



8957

QUICK ADJUST TOUR-PAK® RELOCATOR

FOR '97-'13 TOURING MODELS

U.S. Patent 8,887,974

The Quick Adjust Tour-Pak Relocator offers a full 4 inches of adjustability. Adjustments can be made without tools 1" forward to 3" back from the stock position, giving you and your passenger the ultimate in comfort and convenience.

FOR HARLEY-DAVIDSON®

Fits: Late '00-'13 Electra Glides, Road Glides, Road Kings & Street Glides (including '09-'13 CVO Models) with Rigid Mounted Tour-Pak and '97-'13 Electra Glides, Road Glides, Road Kings & Street Glides with H-D Two-Up or Solo Detachable Tour-Pak Racks (P/Ns 53276-04, 53260-02, 53276-09A, 53260-09A, 53246-09A) & King, Chopped or Razor-Pak Tour-Pak

8973 Chrome (ea)

Note: Not compatible with amplifiers found stock on '08-earlier Screamin' Eagle Models or included in H-D's "Enhanced Sound System" or Boom! Audio™ products for '08-earlier models. Not compatible with leather covered Tour-Paks. Will fit '98-'00 Touring Models with rigid mounted Tour-Pak if the stock support tube has been replaced with the '00-'08 support.

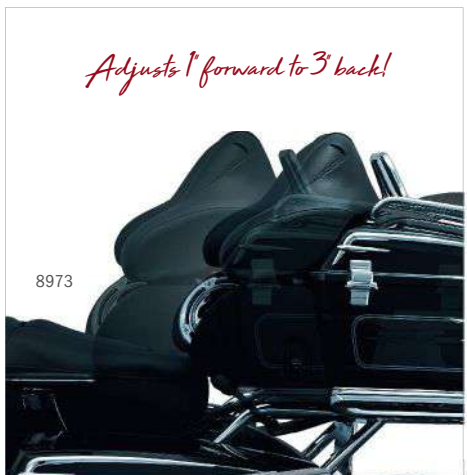

Adjusts 1\"/>

8973

REPLACEMENT COMPONENTS FOR QUICK ADJUST TOUR-PAK® RELOCATOR

FOR HARLEY-DAVIDSON®

Fits: Kuryakyn Quick Adjust Tour-Pak Relocator, P/N 8973

8964 Cam Lever, Chrome (ea)



8973

RELOCATOR KIT FOR '98-'08 TOURING TOUR-PAK

U.S. Patent 6,817,501

This handy kit moves the Tour-Pak back 2" to provide more room for your passenger. The added space makes things much more comfortable for the passenger and makes climbing on and off much easier, especially if the bike is equipped with a driver backrest.

FOR HARLEY-DAVIDSON®

Fits: '98-'08 Electra Glides Equipped with Rigid Mounted H-D Tour-Pak

1559 Chrome (ea)



BEFORE

AFTER
1559

TRAILER HITCHES & WIRING

RECEIVER HITCH FOR '14-'19 TOURING MODELS

Sturdy forged and welded steel receiver hitch featuring a unique dual receiver design where the ball mount assembly engages the hitch frame vertically on both sides for optimum structural support. Includes 1-7/8" ball, and the mount can be installed in either of two positions depending on fender configuration. Black powder-coated mounting brackets and chrome-plated ball mount, with simple bolt-on installation using hand tools.

FOR HARLEY-DAVIDSON™

Fits: '14-'19 Electra Glides, Road Glides (except '18-'19 FLTRXSE), Road Kings & Street Glides (except '18-'19 FLHXSE); Will not fit with accessory Saddlebag Guard Rails P/N 90200561

7657 Black & Chrome (ea)



7657

TRAILER HITCHES

Our hitches are designed for superior strength and rigidity, while allowing bolt-on installation using a few common hand tools. Once installed, these beauties look right at home. Add the appropriate Trailer Wiring Harness and Trailer Receptacle Kit for a truly custom appearance. Trailer Hitch kits include all mounting hardware and a 1-7/8" ball.

FOR HARLEY-DAVIDSON™

Fits: '09-'13 Electra Glides, Road Glides (except '09 FLTRSE, '12-'13 FLTRXSE), Road Kings (except '13 FLHRSE) & Street Glides (except '10-'12 FLHXSE)

7652 Trailer Hitch for '09-'13 Touring (ea)



7657

7652

Fits: All '80-'08 Electra Glides, Road Glides, Road Kings (except '07-'08 FLHRSE) & Tour Glides

9181 Chrome (ea)

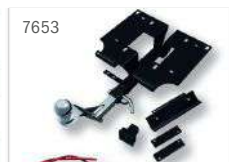

7653

Fits: '09-'19 FLHTCUTG Tri Glide Ultra Classic & '10-'11 FLHXXX Street Glide Trike

7653 Receiver Hitch for Trike (ea)

TRAILER WIRING & RELAY HARNESSES

Safely and effectively apply the load from your trailer lighting to the battery and not to the rest of the bike's electrical system.

- Eliminate overloading stock lighting or accessory circuits
- Utilizes inputs from the motorcycle to direct power from the battery to the appropriate trailer lighting circuit
- 5 Wire Plus 1 or 4 Wire Plus 1: Standard 5-wire output (run, brake, left turn, right turn, ground) or standard 4-wire output (run, left turn/brake, right turn/brake, ground) plus a bonus wire that can be connected as needed to provide fused 12v power to the trailer for compartment lights or keyless entry systems that are wired independently of the trailers essential lighting
- 4-Wire Kits include flat-4 connector, 5-Wire kits do not include Receptacle Kits because the style of receptacle required varies by trailer manufacturer.



FOR HARLEY-DAVIDSON™

Fits: '14-'19 Electra Glides, Road Glides, Street Glides (except '14-'15 FLHTKSE, '15 FLTRUSE) & Road King Special

2595 With 5-Wire Trailer (ea)

2596 With 4-Wire Trailer (ea)

Fits: '14-'19 Road Kings, (except '17-'19 FLHRXS), Police Models, '14-'15 FLHTKSE, '15 FLTRUSE

2597 With 5-Wire Trailer (ea)

2598 With 4-Wire Trailer (ea)

Fits: '14-'19 Trikes

2599 With 4-Wire Trailer (ea)

New

Collections

Featured Bikes

Audio

Lighting

Accessory Mounts

Handlebar Controls,
Grips & Mirrors

Pegs & Foot Controls

Covers, Trims
& AccentsAir Cleaners
& Exhaust

Touring & Comfort

Windshields &
Air ManagementLuggage &
Organizers

Index

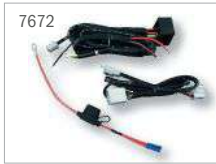

7672

TRAILER WIRING HARNESES

Safely and effectively apply the load from your trailer lighting to the battery and not to the rest of the bike's electrical system. Eliminate blown fuses caused by overloading stock lighting or accessory circuits. Our relay harness utilizes inputs from the motorcycle to direct power from the battery to the appropriate trailer lighting circuit.

- 5 Wire Plus 1: Our kits provide standard 5-wire output (run, brake, left turn, right turn, ground) plus a bonus wire that can be connected as needed to provide fused 12V power to the trailer for compartment lights or keyless entry systems that are wired independently of the trailers essential lighting.
- 5 to 4 Wire Converter: Plugs in and allows our Wiring and Relay Kits to power trailers requiring a 4-wire harness (run, left turn/brake, right turn/brake, ground). The bonus wire is still available to provide fused 12V power to the trailer for compartment lights or keyless entry systems that are wired independently of the trailers essential lighting. Includes 4-pin flat vehicle connector.

FOR HARLEY-DAVIDSON*

Fits: '97-'13 Electra Glides, '98-'13 Road Glides (except '09 FLTRSE, '10-'13 FLTRX & '12-'13 FLTRXSE), '97-'13 Road Kings (except '13 FLHRSE), '06-'09 Street Glides, '09-'13 Trikes, '96-'10 Softails (except 08-'10 FXCW/C & '10 FLSTSE), '97-'11 Dynas (except '10-'11 FXDWG)

7672 Plug & Play Trailer Wiring & Relay Harness, H-D (ea)



7671

FOR MULTI-FIT

Fits: Universal 12V Applications on Motorcycles with Separate Taillight and Turn Signals

7671 Universal Trailer Wiring & Relay Kit (ea)



7675

7675 5 to 4 Wire Converter for Kuryakyn Trailer Wiring Harness (ea)



9183

TRAILER RECEPTACLE KITS

Available in different styles depending on your application. Includes 5-Pin round receptacle.

FOR HARLEY-DAVIDSON*

Fits: Kuryakyn Trailer Hitches P/N's 7652, 7653 & Universal Applications

7659 5-Pin Receptacle Kit (ea)



7659

FOR MULTI-FIT

Fits: Universal Applications: Mounts Under Trailer Hitch Ball

9183 Trailer Hitch Receptacle, Chrome (ea)

Note: Not for use with Kuryakyn Hitch Rack, P/N 7643.

TRAILER HITCH BALL COVER

This shining chrome trailer hitch ball cover fits all 1-7/8" and 2" balls. It includes a foam lining to ensure a good fit.

FOR MULTI-FIT

Fits: 1-7/8" & 2" Trailer Hitch Balls (Includes foam lining)

7658 Chrome (ea)



7658

TRAILER HITCH RACK

Bring a fully loaded cooler or those extra items with you that just don't seem to fit in your trunk. Simply install the mounting plate beneath your trailer hitch ball & this rack quickly attaches or detaches in seconds. Rack is 18" x 12" x 1-1/2".

FOR MULTI-FIT

Fits: Kuryakyn Trailer Hitches & Universal Applications: Mounts Under Hitch Ball & Requires a Flat/Unrestricted Area 5" Wide x 2-1/2" Long & Ball Stud Able to Accept a 1/4" Spacer

7643 Black (ea)



7643

Note: This product is not intended to be used while pulling a trailer. Suggested weight limit is 35 lbs. for appropriate handling & cornering. Will not install with Trailer Hitch Receptacle, P/N 9183.



WIND & AIR MANAGEMENT

AIR & HEAT DEFLECTORS

280

WINDSHIELDS

284

AIR & HEAT DEFLECTORS



Direct airflow just where you need it!

1244

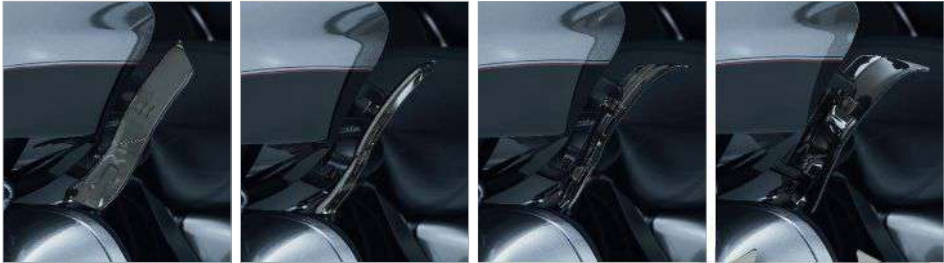

ADJUSTABLE FAIRING AIR DEFLECTORS FOR '15-'19 ROAD GLIDE

Adjustable deflectors are easy to operate, locking securely in four positions to direct airflow just how you want it. Durable shatterproof polycarbonate with a stylish dark smoke tint and satin black mounting brackets.

FOR HARLEY-DAVIDSON*

Fits: '15-'19 Road Glides (except '19 FLTRXSE)

1244 Dark Smoke (pr)



ALSO AVAILABLE
L.E.D. TURN SIGNAL
CONVERSIONS
PG 44



ALSO AVAILABLE..
MOMENTUM LUGGAGE
PG 286





1247

MUST-HAVE

ADJUSTABLE FAIRING AIR DEFLECTORS

FOR '14-'19 TOURING MODELS

Open the vents to channel air into the cockpit on hot days, or close them up to block the breeze in cool weather. The adjustable polycarbonate deflectors feature a stylish smoke finish and are easy to operate, locking securely in four positions to direct airflow just how you want it. Mounts to existing holes in the fairing, no modifications needed.

FOR HARLEY-DAVIDSON™

Fits: '14-'19 Electra Glides, Street Glides & Tri Glides

1246 Chrome (pr)

1247 Satin Black (pr)



DRAGON WING™ VARIABLE AIR DEFLECTORS

Guide airflow around the fairing for reduced turbulence during cool weather, or open them for a refreshing breeze on those scorching hot days.

FOR HARLEY-DAVIDSON™

Fits: '96-'13 Electra Glides, Street Glides, Trikes & Kuryakyn AirMaster Fairing

1117 Reflective Smoke (pr)

1108 Dark Smoke (pr)

Note: Fitment on Kuryakyn AirMaster fairing requires spacer kit that is provided with fairing.

REPLACEMENT THUMB TABS FOR DRAGON WINGS

FOR HARLEY-DAVIDSON™

Fits: Kuryakyn Dragon Wings (P/N's 1108 & 1117)

1119 Dark Smoke (pr)



New

Collections

Featured Bikes

Audio

Lighting

Accessory Mounts

Handlebar Controls,
Grips & Mirrors

Pegs & Foot Controls

Covers, Trims
& Accents

Air Cleaners
& Exhaust

Touring & Comfort

Windshields &
Air Management

Luggage &
Organizers

Index



MUST-HAVE

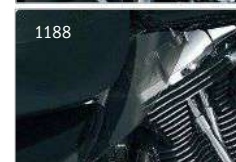
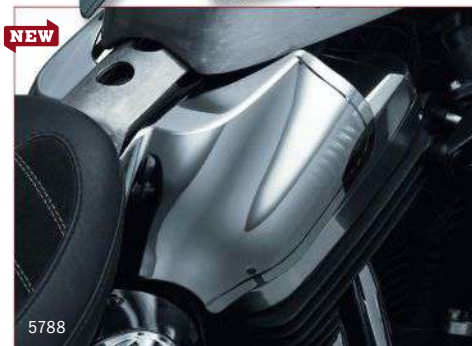

SADDLE SHIELDS HEAT DEFLECTORS FOR H-D MODELS

U.S. Patent 6,854,542

Our frame-mounted, reflective smoke polycarbonate shields are perfectly positioned to dissipate and redirect heat away from you and your thighs.

FOR HARLEY-DAVIDSON®

Fits: '09-'19 Electra Glides, Road Glides, Road Kings, Street Glides & Trikes

1316 Reflective Smoke (pr)

Fits: '08 Electra Glides, Road Glides, Road Kings & Street Glides

1196 Reflective Smoke (pr)

Fits: '97-'07 Electra Glides, Road Glides, Road Kings & Street Glides

1188 Reflective Smoke (pr)

Fits: '18-'19 Softail Models (except FXDRS)

NEW 5789 Reflective Smoke (pr)

Fits: '00-'17 Softail Models (except '00-'07 FXSTD/I, '03-'04 FXSTDSE, '08-'11 FXCW/C, '13-'17 FXSB, '13-'14 FXSBSE)

1186 Reflective Smoke (pr)

Fits: '14-'19 Sportster Models With Peanut Style Tanks

NEW 5788 Reflective Smoke (set)

Fits: '99-'17 Dyna Models

1317 Reflective Smoke (pr)

REPLACEMENT MOUNTING KITS FOR SADDLE SHIELDS

FOR HARLEY-DAVIDSON®

Fits: Kuryakyn Part Numbers 1196 & 1197

1313 Replacement Mounting Kit (ea)

Fits: Kuryakyn Part Numbers 1187 & 1188

1314 Replacement Mounting Kit (ea)



6708

6787
pg 161

DILLINGER

DILLINGER™ HANDGUARDS

Whether riding hard on the streets and trails, or banging bars on the tracks, these handguards add aggressive styling while blocking wind and protecting your hands from rocks and other debris. Easy bolt-on design mounts directly to the mirror location reusing existing mirror-stem bolts. Modular construction from durable A380 aluminum and ABS.



FOR HARLEY-DAVIDSON™

Fits: '04-'19 Sportster Models

- 6708 Silver (pr)
- 6709 Satin Black (pr)

ALSO AVAILABLE
DILLINGER FOOTPEGS
PG 106

ALSO AVAILABLE
DILLINGER LUGGAGE RACK
PG 271

LOWER TRIPLE TREE WIND DEFLECTOR

This wind deflector is a great way to redirect the air coming from between the front forks and fender to reduce upward airflow between the tank and fairing.

FOR HARLEY-DAVIDSON™

Fits: '80-'13 Electra Glides, Road Glides (except '11 FLTRUSE, '12-'13 FLTRU, '12-'13 FLTRXSE), Road Kings, Street Glides & Tour Glides

- 1100 Chrome (ea)

Fits: '14-'19 Electra Glides, Road Glides, Road Kings & Street Glides

- 1804 Chrome (ea)
- 1805 Satin Black (ea)



1100

New

Collections

Featured Bikes

Audio

Lighting

Accessory Mounts

Handlebar Controls, Grips & Mirrors

Pegs & Foot Controls

Covers, Trims & Accents

Air Cleaners & Exhaust

Touring & Comfort

Windshields & Air Management

Luggage & Organizers

Index

AIR & HEAT DEFLECTORS

FLAME

1821



1277



ZOMBIE

1271



1278



Available in 3 different heights!

1772



1771



1773



AIRMASTER® GRAPHIC WINDSHIELDS

Airmaster graphic windshields are 10.5" tall and manufactured from premium hard-coated polycarbonate that will not crack or shatter upon impact. Graphics are screen printed behind a light smoke material with proprietary inks, making the images unbelievably sharp and durable.

FOR HARLEY-DAVIDSON®

Fits: '98-'13 Road Glides

1820 Catacomb (ea)

1821 Flame (ea)

1822 Zombie (ea)

Fits: '96-'13 Electra Glides, Street Glides, Trikes & Kuryakyn Airmaster Fairing

1271 Zombie (ea)

1272 Flame (ea)

1273 Catacomb (ea)

Fits: '14-'19 Electra Glides, Street Glide & Tri Glide

1277 Flame (ea)

1278 Catacomb (ea)

Note: Bottom portion of Catacomb and Zombie windshields are opaque. Flame windshield is fully opaque. Take into account that you must maintain a clear line of sight over the windshield. The windshield should not obstruct your vision in any way.

AIRMASTER® DARK SMOKE WINDSHIELDS

Manufactured from premium quality, optically clear, hard-coated polycarbonate. Unlike acrylic, polycarbonate will not crack or shatter upon impact.

FOR HARLEY-DAVIDSON®

Fits: '96-'13 Electra Glides, Street Glides, Trikes & Kuryakyn Airmaster Fairing

1773 5" (ea)

1774 7" (ea)

1775 9" (ea)

Fits: '14-'19 Electra Glides, Street Glides, Tri Glide Ultras

1770 5" (ea)

1771 7" (ea)

1772 9" (ea)



LUGGAGE & ORGANIZERS

FRONT END & FAIRING BAGS 288

TANK BAGS & BACKPACKS 290

SEAT, TRUNK & RACK BAGS 292

TAIL BAGS 308

SADDLEBAGS 310

ORGANIZERS, LINERS & ACCESSORIES 312

#1 choice for motorcycle luggage

OFFERING YOU A VARIETY OF SILHOUETTES, FEATURES AND CONVENIENCES, CHOOSE BETWEEN OUR TWO LUGGAGE COLLECTIONS FOR THE BAGS THAT BEST SUIT YOUR NEEDS AND STYLE.



ARMED FOR ADVENTURE

Value driven gear with all the versatility and toughness required for hardcore riders always on the hustle. Momentum luggage is designed to keep you moving with convenient mounting options and practical storage capabilities to handle all your riding needs.

- A** Versatile Sissybar Strap
- B** External, adjustable bungee storage system
- C** Riveted dual swing, fully welded D-rings
- D** Molle webbing for a variety of attachments
- E** Low-profile carrying handles for easy transport off the bike



BOTTLE STORAGE



RAIN COVER INCLUDED



GLOVE FRIENDLY ZIPPERS

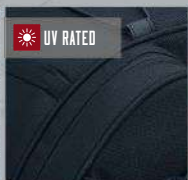

UV RATED



MEDIA STORAGE



DESIGNED FOR THE MODERN MOTORCYCLIST

DESIGNED TO CARRY EVERYTHING YOU NEED – AND LOOK GREAT IN THE PROCESS. PREMIUM CONSTRUCTION UTILIZING ADVANCED MATERIALS FOR STRENGTH, SHAPE RETENTION, AND UNMISTAKABLE STYLE.

- A** Large Access Points
- B** Exterior Coat/Bedroll Flap with Adjustable Custom G-Hooks
- C** Anti-Scratch Coated, Dual Swing, Fully Welded D-Rings
- D** Laser Cut, Low-Profile Molle Fields for a Variety of Attachments.
- E** Bright, Contrasting Interior Lining
- Easy To Use, Sissybar Strap for a Variety of Mounting Solutions
- Riveted Tie-Down Points
- Ergonomic Carrying Handle

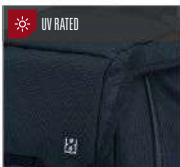

FRONT END & FAIRING BAGS



5219



BARRIO BAG

Whether strapped to your bike's handlebars, forks, windshield brackets or sissy bar, the Barrio Bag is your go-to stash pouch for everything from PBR tallboys to tools. Flexible hook-&-loop straps coupled with multiple MOLLE attachment points accommodate virtually any setup you can think of.

DIMS: 7" wide x 4" deep x 9" tall (fully expanded)

CUBIC INCHES: 266

LITERS: approx 4.5 liters

FEATURES

- Durable UV-rated, weather-resistant 1200 denier textile material
- Roll top design with high-strength hook and loop closure for storage versatility & water resistance
- Fully adjustable convenient speed-buckle clasps
- Safe & secure storage for wallets, sunglasses, phones, road sodas, tools, & more
- Convenient external bottle pocket with MOLLE modular attachment
- Front & side quick-stash pockets

FOR MULTI-FIT

Fits: Adjustable straps for multi-purpose mounting

5219 Barrio Bag (ea)

5219

*Multiple
Mounting
Options*



5219

5219



4129



SINGLE POCKET WINDSHIELD BAG FOR SMARTPHONES

Mount your smartphone within view and add useful storage! Touch screen functions remain while your device sits snug and secure. Specially designed ports keep your device connected and charged. Simple Installation.

DIMS: 13.5" wide x 6.25" deep x 7.25" tall

CUBIC INCHES: 280

FOR HARLEY-DAVIDSON®

Fits: '96-'13 Electra Glides, Street Glides & Trikes

4129 Single Pocket Windshield Bag (ea)

Note: Does not work on AirMaster Fairing or Sportech Detachable Fairing. Does not work with Kuryakyn Inner Fairing Accent (P/N 3766) or H-D Fairing Dash Pad (P/N 58262-05).



5261



BATWING FAIRING POUCH BAG

Keep the small essential items at your fingertips with this structurally formed fairing bag that hugs the contours of the Batwing fairing and windscreen. Specifically designed for maximum storage with full access to the vent open/close button to allow uninterrupted airflow.

- Premium formed vinyl construction retains its shape
- Heavy-duty magnetic closures ensure secure storage and easy access
- Internal zippered storage in the main compartment to secure loose items
- Clean lines and a compact design to maximize storage for cell phones, wallets, sunglasses and more

FOR HARLEY-DAVIDSON™

Fits: '14-'19 Electra Glides, Street Glides & Tri Glides

5261 Batwing Fairing Pouch Bag (ea)

Note: Not compatible with contoured windshields

Fits: '06-'13 Electra Glides, Street Glides & Trikes, Kuryakyn AirMaster Fairing & Sportech Detachable Fairing-Plus

NEW 5212 Batwing Fairing Pouch Bag (ea)

Note: Not compatible with contoured windshields

QUICK-STASH MAGNETIC DEVICE POUCH

Touchscreen-friendly, made from durable Tarpaulin material with sealed seams, water-resistant zippers and a high-strength magnetic attachment for maximum protection.

DIMS: 3.5" wide x 6.125" tall x 1.5" deep

- Touchscreen-friendly clear top for on-the-go convenience
- Zippered opening from the bottom keeps water out while allowing access to cords

FOR MULTI-FIT

Fits: All models with steel gas tanks

5253 Quick-Stash Magnetic Device Pouch (ea)

5261



NEW

5212



5212



NEW

5253



New

Collections

Featured Bikes

Audio

Lighting

Accessory Mounts

Handlebar Controls, Grips & Mirrors

Pegs & Foot Controls

Covers, Trims & Accents

Air Cleaners & Exhaust

Touring & Comfort

Windshields & Air Management

Luggage & Organizers

Index

TANK BAGS & BACKPACKS



TOUCH SCREEN COMPATIBLE



ELECTRONICS POCKET

SUNGLASS TRAY



SUN SHADE



XKURSION® XT CO-PILOT TANK BAG

The convenience of a do-it-all tank bag with updated features for 21st-century riders. Low-profile design with a clear weather-resistant display screen for GPS, tablets or maps, and plenty of storage to easily stow and access the essentials.

DIMS: 8.5" wide x 11.25" deep x 4" tall

CUBIC INCHES: 382

LITERS: 6.25

FEATURES

- Convenient tablet/GPS storage for all your mobile needs, fitting up to a 12" device
- Clear, touchscreen-compatible outer panel for easy device operation without removal
- Low profile silhouette works with most tank styles and maintains gauge visibility
- Thermoformed sunglass tray for secure storage
- Non-slip/scratch base with quick magnetic tank mounting, plus additional strap kit for non-magnetic tanks
- Detaches from mounting base and integrated carrying handle offers easy transport off the bike
- Audio jacks and outlets for headphones or device charging
- Removable sun shade helps prevent device overheating from sun exposure
- Laser-cut low-profile MOLLE for modular attachment options
- Includes rain cover with waterproof clear screen for viewing GPS or tablet

FOR MULTI-FIT

Fits: Mounts to Magnetic and Non-Magnetic Gas Tanks

5294 XKursion XT Co-Pilot Tank Bag (ea)



ADJUSTABLE G-HOOK



MEDIA STORAGE

BOTTLE POCKET

TSA FRIENDLY



XKURSION® XB DISPATCH BACKPACK

Comfort, style and versatility all in one mobile office backpack capable of going anywhere you do. TSA-friendly for simplified travel, with quick-release straps that make putting it on or taking it off a breeze.

DIMS: 12" wide x 8.5" deep x 18" tall

CUBIC INCHES: 1,836

LITERS: 30

FEATURES

- TSA-friendly device storage compartment that fits up to 15" laptops or tablets
- Adjustable ergonomic quick-release strap design
- Maximum comfort and support with shoulder, sternum and removable waist straps
- Channeled padded back panel for enhanced airflow and reduced heat
- Built-in coat flap with adjustable G-Hook for external storage
- Zippered side bottle pockets for easy rider access
- External quick-access storage pockets
- Heavy-duty welded D-rings and included mounting straps for easy bike mounting
- Laser-cut low-profile MOLLE for modular attachment options

FOR MULTI-FIT

Fits: Backpack with optional mounting to passenger seat (with or without sissy bar) or luggage rack

5292 XKursion XB Dispatch Backpack (ea)

Note: If installing to passenger seat or luggage rack fitment requires four-point mounting



REMOVABLE WAIST STRAP

New

Collections

Featured Bikes

Audio

Lighting

Accessory Mounts

Handlebar Controls, Grips & Mirrors

Pegs & Foot Controls

Covers, Trims & Accents

Air Cleaners & Exhaust

Touring & Comfort

Windshields & Air Management

Luggage & Organizers

Index

SEAT, TRUNK & RACK BAGS



Top Roll Design for Expanded Storage



MOMENTUM DEADBEAT DUFFLE

Unlike most deadbeats, the Momentum Deadbeat Duffel puts in work. The “baby brother” of our popular Freeloader Duffel is ideal for minimalists who want a bag capable of holding all the essentials without all the bulk. Strap it down in seconds, and sling it over your shoulder when the ridin’s done.

DIMS: 10” Diameter x 14.5” Tall (18” when expanded)

CUBIC INCHES: 1,414

LITERS: 23

FEATURES

- UV-rated weather-resistant 1200 denier textile material with removable rain cover
- Quick-mount sissy bar strap for safe & secure mounting in seconds
- External adjustable bungee storage for coat, bedroll or other items
- MOLLE modular attachment points
- Low-profile carrying handle & removable shoulder strap for off-the-bike convenience
- Roll top design with high-strength hook and loop closure for storage versatility & water resistance
- Fully adjustable convenient speed-buckle clasps
- Side zippered quick-stash pockets
- Heavy-duty welded D-Rings & full mounting strap kit for bikes without sissy bars



FOR MULTI-FIT

Fits: Passenger Seat (With or Without Sissy Bar) or Luggage Rack

5223 Momentum Deadbeat Duffel (ea)

Note: Installation requires four-point mounting



BOTTLE POCKET WITH MOLLE MODULAR ATTACHMENT



MOMENTUM FREELOADER DUFFEL

Rugged, utilitarian styling designed by riders for riders, the Freeloader Duffel gives new meaning to the term “stow-n-go!” Experience no fuss thanks to a clever quick-mount strap design that easily secures to almost any sissy bar or backrest. The wide-open main storage compartment with top-roll design offers complete versatility in carrying capacity plus security for all your cargo.

DIMS: 12” diameter x 18” tall (21” tall when expanded)
CUBIC INCHES: 2,036 (2,375 expanded)
LITERS: 33 (39 expanded)

FEATURES

- UV-rated weather-resistant 1200 denier textile material with removable rain cover
- Quick-mount sissy bar strap design gets you on the road in record timing
- External adjustable bungee storage system for coat, bedroll or other items
- Low-profile carrying handle and removable shoulder strap for carrying convenience off the bike
- Separate bottom compartment for quick access to included rain cover and other items
- Convenient external bottle pocket with MOLLE modular attachment
- Easy-access quick-stash pockets for smaller items
- Multiple D-Rings for easy and secure mounting options if using without sissy bar or backrest

FOR MULTI-FIT

Fits: Passenger Seat (With or Without Sissy Bar) or Luggage Rack

5282 Momentum Freeloader Duffel (ea)

Note: Installation requires four-point mounting

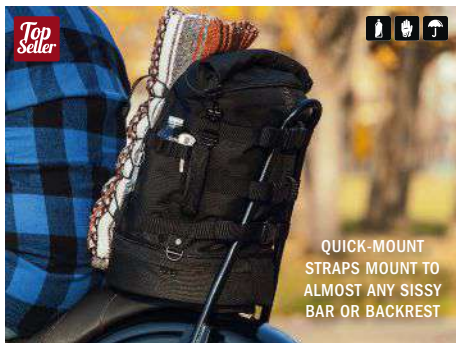

QUICK-MOUNT STRAPS MOUNT TO ALMOST ANY SISSY BAR OR BACKREST



SEPARATE BOTTOM COMPARTMENT



Top-Roll Design for Expanded Storage



New

Collections

Featured Bikes

Audio

Lighting

Accessory Mounts

Handlebar Controls, Grips & Mirrors

Pegs & Foot Controls

Covers, Trims & Accents

Air Cleaners & Exhaust

Touring & Comfort

Windshields & Air Management

Luggage & Organizers

Index



Easy mounting & side entry access



SIDE ENTRY FOR QUICK ACCESS ON THE ROAD



EXTERNAL BUNGEE STORAGE



WORKS GREAT WITH..

Combine the Rambler with the Outrider Saddlebags for a convenient travel set!
PG 310



MOMENTUM RAMBLER ROLL BAG

Versatile and convenient mounting options make the Rambler ideal for day-trippers needing minimal storage, or long-haul tourers looking for an easy way to securely strap additional luggage to existing gear.

DIMS: 15.5" wide x 9" tall x 9.25" deep

CUBIC INCHES: 1,290

LITERS: 21

FEATURES

- UV-rated, weather-resistant 1200 denier textile construction with removable rain cover
- Bottom-mounted tie-down loops for easy mounting on luggage racks or Momentum Drifter (P/N 5283), Road Warrior (P/N 5284) and Vagabond (P/N 5285) bags, all sold separately
- Convenient side entry doors to easily access items while mounted
- Front stash pocket for easy access to small items
- Quick-mount sissy bar strap design for secure mounting in seconds
- External adjustable bungee storage system for coat, bedroll or other items
- Integrated MOLLE modular attachment points
- Low-profile carrying handle plus removable shoulder strap for easy portability off the bike
- Rigid structure retains its shape whether loaded or empty
- Multiple D-Rings for additional easy and secure mounting options
- Includes full mounting strap kit

FOR MULTI-FIT

Fits: Universal mounting to Passenger Seat, Luggage Racks, or Other Momentum Luggage Bags

5213 Momentum Rambler Roll Bag (ea)

Note: Installation requires four-point mounting

NEW



BUILT-IN COAT FLAP

ADDITIONAL STORAGE POUCH

DUAL SIDE ACCESS ENTRY

WIDE OPENING FOR EASY LOAD/UNLOADING



XKURSION® XS STEWARD ROLL BAG

This is not your ordinary run-of-the-mill roll bag. Kuryakyn designers have taken the classic roll bag blueprint to a whole 'nother level with best-in-class materials and a 21st-century design that meets the needs of 21st-century riders. Whether strapped to your trunk, luggage rack, sissy bar or passenger seat, the Steward protects your precious cargo and gets the job done.

DIMS: 20" wide x 11.5" deep x 11.5" tall
CUBIC INCHES: 2,700
LITERS: 44

FEATURES

- Convenient dual side access entry with wide opening for easy loading/unloading
- Built-in coat flap with adjustable G-Hook for quick and easy external storage
- Plush lined storage pocket on coat flap for cell phones, sunglasses or other items
- Laser-cut low-profile MOLLE modular attachment options
- Integrated heavy-duty welded D-Rings, sissy bar and mounting straps to mount to additional bags, luggage racks or passenger seats

FOR MULTI-FIT

Fits: Passenger Seat (With or Without Sissy Bar) or Luggage Rack

5221 XKursion XS Steward Roll Bag (ea)

Note: Installation requires four-point mounting



MULTIPLE ACCESS POINTS



SISSY BAR STRAP



New

Collections

Featured Bikes

Audio

Lighting

Accessory Mounts

Handlebar Controls, Grips & Mirrors

Pegs & Foot Controls

Covers, Trims & Accents

Air Cleaners & Exhaust

Touring & Comfort

Windshields & Air Management

Luggage & Organizers

Index



IDEAL SIZE FOR EVERY DAY COMMUTERS OR MINIMALIST RIDERS

BUILT-IN COAT FLAP

MEDIA STORAGE



XKURSION® XS CUBE

Compact, versatile and ideal for everyday commuters, day-trippers or minimalist weekend wanderers. Removable base pad provides a contoured recessed bottom for a wide variety of fitment on virtually any passenger seats or luggage racks.

DIMS: 16" wide x 11" deep x 11.5" tall

CUBIC INCHES: 2,024

LITERS: 33

FEATURES

- Removable base pad provides multiple mounting options on a variety of bikes
- Main compartment large enough to store a full-face helmet plus other small items
- Top and side zippered openings for multiple access points to main storage
- Built-in coat flap with adjustable G-Hook for quick and easy external storage
- Padded device storage for up to a 12" tablet and two other small devices
- Integrated heavy-duty welded D-rings, sissy bar, and mounting straps to mount to additional bags, luggage racks or passenger seats
- Laser-cut low-profile MOLLE for modular attachment options
- Multiple quick-access stash pockets for the small essentials



SISSY BAR STRAP

COMBINE WITH XB FASTLANE SADDLEBAGS FOR A PERFECT TRAVELING DUO!



REMOVABLE BASE PAD

FOR MULTI-FIT

Fits: Passenger Seat (With or Without Sissy Bar)
or Luggage Rack

5295 XKursion XS CUBE (ea)

Note: Installation requires four-point mounting

NEW



DESIGNED TO FIT PERFECTLY INTO A TOUR-PAK



TRAVEL/AIRPORT FRIENDLY WHEELS



XKURSION® XW PORTER BAG

Whether cruising the highways or flying the friendly skies, the XKursion XW Porter is ideal for hardcore travelers who want a go-anywhere piece of luggage designed with functionality and versatility in mind. This mobile office-ready bag has a compact thermoformed structure and shape that makes it perfect for storing on top of or inside tour trunks, on passenger seats or any standard luggage rack.

DIMS: 12" wide x 10" deep x 18" tall
CUBIC INCHES: 2,160
LITERS: 35

FEATURES

- Thermoformed front panel and rigid structure for maximum support and security
- Two separate storage compartments offer packing versatility and organization
- Telescopic handle and smooth-rolling wheels for easy transport off the bike
- Mobile office-ready with padded storage pockets for up to a 15" laptop and 12" tablet
- Multiple internal mesh pockets to keep smaller items organized and easily accessible
- Laser-cut low-profile MOLLE for modular attachment options
- Secure mounting with a multitude of integrated heavy-duty welded D-Rings and mounting strap kit



THERMOFORMED



MEDIA STORAGE

TWO SEPARATE STORAGE COMPARTMENTS

TELESCOPIC HANDLE

FOR MULTI-FIT

Fits: Passenger Seat (With or Without Sissy Bar) or Luggage Rack

FOR HARLEY-DAVIDSON®

Fits: Inside Tour Trunk, On Passenger Seat (With or Without Sissy Bar) or Luggage Rack

5216 XKursion XW Porter Bag (ea)

Note: Installation requires four-point mounting



LUGGAGE & ORGANIZERS
SEAT, TRUNK & RACK BAGS

New

Collections

Featured Bikes

Audio

Lighting

Accessory Mounts

Handlebar Controls, Grips & Mirrors

Pegs & Foot Controls

Covers, Trims & Accents

Air Cleaners & Exhaust

Touring & Comfort

Windshields & Air Management

Luggage & Organizers

Index



Sized to mount virtually anywhere!



HASSLE-FREE MOUNTING!



SIDE ENTRY FOR QUICK ACCESS ON THE ROAD



MOMENTUM DRIFTER BAG

The Drifter is your go-to travel companion for wherever you roam and whatever you ride. The utilitarian design features a rigid structure that offers a variety of convenient mounting options on passenger seats, sissy bars, or tour trunk luggage racks.

DIMS: 18.5" wide x 11.5" tall x 12" deep

CUBIC INCHES: 2553

LITERS: 42

FEATURES

- UV-rated, weather-resistant 1200 denier textile construction
- Ideal size/shape for tour trunks with luggage racks, passenger seats or sissy bars with or without luggage racks
- Quick-mount sissy bar strap design for secure mounting in seconds
- Easily mounts to Kuryakyn Momentum Road Warrior (P/N 5284), Vagabond (P/N 5285) or other luggage (all sold separately)
- Dual side entry doors offer easy access to main storage compartment
- External adjustable bungee storage system for coats, bedrolls or other items
- Seven external quick stash pockets, including two bottle pockets
- Integrated MOLLE modular attachment points
- Rigid structure retains its shape whether empty or loaded
- Tethered rain cover with designated storage pocket
- Low-profile carrying handles plus removable shoulder strap for easy portability off the bike
- Includes full mounting strap kit



WORKS GREAT WITH..

Combine the Drifter with the Rambler for a setup that will keep you on the road for miles & miles!
PG 294



FOR MULTI-FIT

Fits: Passenger Seat (With or Without Sissy Bar) or Luggage Rack

5283 Momentum Drifter Bag (ea)

Note: Installation requires four-point mounting



"The safest motorcycle pet carrier on the market. Hands Down."



Top Seller

LUGGAGE & ORGANIZERS
SEAT, TRUNK & RACK BAGS

GRAND PET PALACE

Take your favorite four-legged family member on the road trip of a lifetime with the safest and most versatile motorcycle pet carrier available. Updated styling, amenities, plus plenty of ventilation and internal space for your fur baby make the Grand Pet Palace the ultimate home away from home for your pet.

DIMS: 18.5" wide x 13" deep x 14" tall;
interior capacity: 18" wide x 12.5" deep x 12" tall
INTERNAL CUBIC INCHES: 2,700
INTERNAL LITERS: 44

FEATURES

- Sissy bar strap, multiple D-rings and adjustable straps offer easy, secure mounting options
- Easy-clean removable foam cushion offers a comfortable ride for your furry friend
- Pet amenities include internal adjustable leash, two dishes, and removable stash pouch
- Side-mounted handles plus removable carrying strap offer easy portability
- Bottle pocket with MOLLE modular attachment points
- Internal frame and rigid bottom provides support and protection
- Top window opens allowing pet to pop its head out
- Four mesh windows for viewing and maximum ventilation
- UV-rated weather-resistant 1200 denier textile material with removable rain cover

FOR MULTI-FIT

Fits: Passenger Seat (With or Without Sissy Bar) or Luggage Rack

5288 Grand Pet Palace (ea)

Note: Installation requires four-point mounting



4 MESH WINDOWS FOR MAXIMUM VENTILATION!



A home away from-home!



EASY MOUNT SYSTEM

New

Collections

Featured Bikes

Audio

Lighting

Accessory Mounts

Handlebar Controls, Grips & Mirrors

Pegs & Foot Controls

Covers, Trims & Accents

Air Cleaners & Exhaust

Touring & Comfort

Windshields & Air Management

Luggage & Organizers

Index



QUICK STASH TOP COMPARTMENT



QUICK-MOUNT
SISSY BAR STRAP DESIGN



PADDED MEDIA STORAGE



*Versatile storage
with easy access!*



MOMENTUM VAGABOND BAG

Utilitarian by nature, with enough internal storage capacity to carry everything required for weekend road trips or interstate adventures. Two separate packing compartments offer easy access to cargo while on the road without disrupting the contents of your bag.

DIMS: 18" wide x 12" deep x 15.5" tall

CUBIC INCHES: 2,820

LITERS: 46

FEATURES

- Two separate storage compartments (top and bottom) to easily access items while on the road
- Internal zippered mesh pockets keep smaller items organized
- Made from UV-rated, weather-resistant 1200 denier textile material
- Durable structure maintains shape even when empty
- Padded media storage pocket for up to 13" laptops or tablets
- Quick-mount sissy bar strap design, plus full mounting strap kit for a variety of easy, secure mounting options
- Two bottle pockets and two external stash pockets for smaller items
- External bungee storage system for coats, bedrolls or other items
- Integrated MOLLE modular attachment options
- Removable shoulder strap plus low-profile carrying handles for easy transport off the bike
- Multiple heavy-duty D-Rings for secure mounting
- Includes tethered rain cover

FOR MULTI-FIT

Fits: Passenger Seat (With or Without Sissy Bar)
or Luggage Rack

5285 Momentum Vagabond Bag (ea)

Note: Installation requires four-point mounting

BOTTLE POCKET



ADJUSTABLE SHELF



PACKING CUBES



XKURSION® XW ARSENAL BAG

Think of the XW Arsenal as motorcycle luggage that meets the demands of everyday life. Carry-on friendly with telescopic handle and smooth-rolling wheels, making this it the ideal go-to travel companion whether cruising on your bike or rushing through the airport.

DIMS: 14" wide x 9" deep x 22" tall

CUBIC INCHES: 2,772

LITERS: 45

FEATURES

- Ideal size for airplane carry-on luggage, with telescopic handle and wheels for easy transport off the bike
- Adjustable shelf and multiple packing cubes for personalized interior organization options to suit your travel needs
- Wraparound zipper entry to main storage allows access to the top or bottom of the bag without unpacking
- Mobile office-ready with padded storage pockets for up to 15" laptops or tablets
- Secure mounting with a multitude of integrated heavy-duty welded D-rings, sissy bar strap and mounting strap kit
- Laser-cut low-profile MOLLE for modular attachment options
- Low-profile wheels and rubberized feet to protect your bike when mounted
- Multiple easy-access stash pockets for small items, with rear window pocket for easy identification



MEDIA STORAGE



TELESCOPIC HANDLE



SISSY BAR STRAP

FOR MULTI-FIT

Fits: Passenger Seat (With or Without Sissy Bar) or Luggage Rack

5296 XKursion XW Arsenal Bag (ea)

Note: Installation requires four-point mounting

New

Collections

Featured Bikes

Audio

Lighting

Accessory Mounts

Handlebar Controls, Grips & Mirrors

Pegs & Foot Controls

Covers, Trims & Accents

Air Cleaners & Exhaust

Touring & Comfort

Windshields & Air Management

Luggage & Organizers

Index



SIDE SWING DOOR FOR EASY ACCESS TO ELECTRONICS & GEAR WHILE MOUNTED.



Built for long-haul convenience!



WIDE CENTER HATCH DOOR FOR CONVENIENT CARGO ACCESS



QUICK-MOUNT
SISSY BAR STRAP DESIGN



MOMENTUM ROAD WARRIOR BAG

Customizable storage options meet the demands of any rider. With eight external stash pockets, two bottle pockets, and three separate zippered openings to the main compartment, this bag is the epitome of convenience.

DIMS: 19" wide x 12" deep x 16" tall

CUBIC INCHES: 3,648

LITERS: 60

FEATURES

- Made from UV-rated, weather-resistant 1200 denier textile material
- Durable structure maintains shape even when empty
- Wide center hatch opening with zippered side swing access doors for convenient cargo access
- Customized versatility with eight external stash pockets and two bottle pockets
- Padded media storage pocket for up to 15" laptops or tablets
- Internal zippered mesh pocket on the center hatch keeps smaller items organized
- External bungee storage system for coats, bedrolls or other items
- Quick-mount sissy bar strap design, plus full mounting strap kit for a variety of mounting options
- Multiple heavy-duty D-Rings for secure mounting options
- Integrated MOLLE modular attachment options
- Includes removable shoulder strap and low-profile carrying handles for easy transport off the bike
- Includes tethered rain cover for added protection from the elements

FOR MULTI-FIT

Fits: Passenger Seat (With or Without Sissy Bar) or Luggage Rack

5284 Momentum Road Warrior Bag (ea)

Note: Installation requires four-point mounting

LARGE BOTTLE POCKET



MEDIA STORAGE



WIDE FRONT HATCH - FULL ACCESS



NEW

MULTIPLE STASH POCKETS

XKURSION® XS ODYSSEY BAG

Saddle up for an epic adventure with this do-it-all bag designed to keep you well-equipped for weeks on the road. The XKursion XS Odyssey features a massive easy-to-access main compartment, versatile and safe electronic device storage along with a variety of separate stash pockets. The contoured bottom allows secure mounting on a variety of passenger seats or luggage racks.

DIMS: 16" wide x 10" deep x 20" tall
CUBIC INCHES: 3,200
LITERS: 52

FEATURES

- Wide front hatch for easy access to the main storage
- Formed bottom for secure mounting on a variety of luggage rack styles or passenger seats
- High-strength hook-&-loop sissy bar strap for easy mounting to passenger backrests or sissy bars
- Media storage for up to 15" laptops and 12" tablets
- Front cell phone or media device pocket with a built-in port to accommodate charging cords
- Built-in external coat flap with adjustable G-Hooks for coats, blankets or other items
- External bottle pockets and quick-access stash pockets to keep smaller items organized
- Laser-cut low-profile MOLLE for modular attachment options
- Integrated heavy-duty welded D-Rings and included mounting strap kit



MOUNT TO SEAT OR LUGGAGE RACK



SISSY BAR STRAP

DEVICE POCKET WITH PORT



WIDE FRONT HATCH - MEDIUM ACCESS

FOR MULTI-FIT

Fits: Passenger Seat (With or Without Sissy Bar) or Luggage Rack

5222 XKursion XS Odyssey Bag (ea)

Note: Installation requires four-point mounting

New

Collections

Featured Bikes

Audio

Lighting

Accessory Mounts

Handlebar Controls, Grips & Mirrors

Pegs & Foot Controls

Covers, Trims & Accents

Air Cleaners & Exhaust

Touring & Comfort

Windshields & Air Management

Luggage & Organizers

Index



PADDED FRONT DOUBLES AS A RIDER BACKREST!



Sits Right Behind the Driver!

PADDED MEDIA STORAGE



MOMENTUM WANDERER BAG TOURING SEAT BAG

Set your sights on the ultimate solo touring adventure. Fits like a glove on the passenger seat of most bikes with tour trunks, and the cavernous main compartment offers organized packing options with its unique integrated mesh dividers. What's more, this do-it-all bag doubles as a backrest, allowing riders to kick back in the saddle while racking up the miles.

DIMS: 22" wide x 12" deep x 18.5" tall

CUBIC INCHES: 3,700

LITERS: 60

FEATURES

- Made from UV-rated, weather-resistant 1200 denier textile material
- Ideal for the passenger seat of a touring bike with trunk
- Padded face/front for additional back support for the rider
- Adjustable internal mesh dividers partition the internal compartment, creating three separate storage spaces
- Three external quick-stash pockets, including forward-facing bottle pocket
- Padded media storage for up to a 15" laptop or tablet
- Durable structure holds shape even when empty
- Included shoulder strap and low-profile carrying handles offer easy portability off the bike
- Multiple heavy-duty D-Rings offer secure mounting options
- Includes rain cover for added protection from the elements

FOR HARLEY-DAVIDSON®

Fits: Mounts on Backseat of a Touring Bike Equipped with a Tour-Pak

5286 Momentum Wanderer Bag (ea)

Note: Mounts with or without stock Tour-Pak speakers

NEW

BOTTLE POCKET



5 STASH POCKETS

INTERNAL POWER PORT

MEDIA STORAGE



HATCH-STYLE OPENING FOR MAX ACCESS



XKURSION® XS DEPOT BAG TOURING SEAT/RACK BAG

If you're a wandering nomad looking for one bag capable of carrying anything and everything you need for weeks on the road, the XKursion XS Depot is for you. The largest bag in the XKursion lineup boasts class-leading storage capacity and a host of rider-friendly features designed to make life on the road feel like living at home. A variety of convenient and secure mounting options lets you load it up and hit the highway worry-free.

DIMS: 19" wide x 21" tall x 12" deep

CUBIC INCHES: 4,788

LITERS: 78

FEATURES

- Rigid thermoformed structure to retain shape and provide security for any size load
- Hatch-style main opening for convenient access to the cavernous main storage compartment
- Built-in coat flap with adjustable G-Hooks for secure external storage
- Adjustable high-strength hook-&-loop sissy bar strap plus full strap kit for a variety of secure mounting options
- Padded media storage for up to 17" laptops
- Additional 12" padded media storage with integrated port to access wireless chargers
- Five external quick-stash pockets including two bottle pockets
- Laser-cut MOLLE modular attachment points on both sides
- Heavy-duty welded D-rings and included strap kit for easy mounting

FOR MULTI-FIT

Fits: Passenger Seat (With or Without Sissy Bar) or Luggage Rack

5252 XKursion XS Depot Bag (ea)

Note: Installation requires four-point mounting



THE LARGEST BAG IN OUR LUGGAGE LINEUP!



BUILT-IN COAT FLAP

SISSY BAR STRAP



New

Collections

Featured Bikes

Audio

Lighting

Accessory Mounts

Handlebar Controls, Grips & Mirrors

Pegs & Foot Controls

Covers, Trims & Accents

Air Cleaners & Exhaust

Touring & Comfort

Windshields & Air Management

Luggage & Organizers

Index



The most versatile trunk rack bag!



BOTTLE POCKET



EXTERNAL BUNGEE STORAGE



RAIN COVER INCLUDED



EASY MOUNT SYSTEM

MOMENTUM HITCHHIKER TRUNK RACK BAG

Hands down the most versatile trunk rack bag in the business, with easy, secure mounting on virtually any tour trunk-mounted luggage rack. Features a wide main zippered opening for easy access, external pockets with MOLLE modular attachment options, and an external bungee storage system.

DIMS: 23" wide x 14" deep x 9" tall

CUBIC INCHES: 1,677

LITERS: 27

FEATURES

- UV-rated and weather-resistant 1200 denier textile material
- Rider/passenger-facing bottle pockets with MOLLE modular attachment options
- External bungee storage system for bedrolls, coats or other items
- Integrated elastic shock cords and hook-&-loop fasteners for quick and easy mounting
- Includes tethered rain cover with designated pocket for storage
- Maintains shape when empty and conveniently folds up to stash away in trunks or saddlebags when not in use

FOR MULTI-FIT

Fits: Attaches to Kuryakyn, H-D & Most Trunk Mounted Luggage Racks

5281 Momentum Hitchhiker Bag (ea)

Note: Not suggested for triangle Victory Luggage racks.

NEW

SPECIALLY DESIGNED TO FIT ON TRUNK-MOUNTED LUGGAGE RACKS



CARRYING HANDLES

RIGID STRUCTURE - RETAINS SHAPE PACKED OR EMPTY



LUGGAGE & ORGANIZERS
SEAT, TRUNK & RACK BAGS

XKURSION® XS GUARDIAN RACK BAG

Specifically designed to securely mount on most trunk-mounted luggage racks to keep your cargo organized and your ride looking good. The rigid structure retains its shape whether fully loaded or empty, and its outstanding storage capacity can handle everything from helmets to weeks' worth of clothing to ensure you've got everything needed on that next road trip.

DIMS: 26" wide x 12" deep x 11" tall

CUBIC INCHES: 2,940

LITERS: 48

FEATURES

- Rigid structure holds up to the most demanding use
- Semi-detachable carrying handle in designated pocket, plus side-mounted handles for easy transport off the bike
- Built-in coat flap with plush lined pocket and adjustable G-Hook for quick and easy external storage
- Interior zippered mesh pocket to keep main storage compartment organized
- Thermoformed quick-stash zippered side pockets and front pocket with mesh partition to stow and easily access small items
- Integrated media pocket with power port to connect devices to power chargers
- Tethered lid offers convenient loading/unloading
- Heavy-duty over-molded and welded D-rings and included strap kit for easy mounting



COAT FLAP



MESH COMPARTMENTS

LID TETHER

INTERNAL POWER PORT

FOR MULTI-FIT

Fits: Luggage Rack or Passenger Seat

5251 Xkursion XS Guardian Bag (ea)

Note: Installation requires four-point mounting



ALSO AVAILABLE
TIE DOWN ANCHORS
PG 316



New

Collections

Featured Bikes

Audio

Lighting

Accessory Mounts

Handlebar Controls,
Grips & Mirrors

Pegs & Foot Controls

Covers, Trims
& Accents

Air Cleaners
& Exhaust

Touring & Comfort

Windshields &
Air Management

Luggage &
Organizers

Index

TAIL BAGS

NEW



NEW

5214



MOMENTUM ROAMER TAIL BAG

If you're a solo-riding commuter or weekend wanderer who wants stylish storage that gets the job done, then the Momentum Roamer is for you. The Roamer delivers ample storage for a tail bag, yet conforms to the rear fender or passenger seat for a clean, sleek, and sporty setup.

DIMS: 17.5" wide x 15" deep x 8" tall

CUBIC INCHES: 1,860

LITERS: 30.5

FEATURES

- Durable UV-rated, weather resistant 1200 denier textile material with removable rain cover
- External adjustable bungee storage for coat, bedroll or other items
- Low-profile carrying handle & removable shoulder strap for off-the-bike convenience
- Multiple welded D-Rings & included strap kit for secure mounting
- Integrated MOLLE modular attachment points
- External quick-stash pockets & bottle pockets
- Includes optional clear protective film for fender/paint protection

5214



5214



FOR MULTI-FIT

Fits: Rear fender, rear seat or luggage rack

5214 Momentum Roamer Bag (ea)

Note: Installation requires four-point mounting



TETHERED RAIN COVER



ALSO AVAILABLE

JACKET ROLL
PG 312



NEW



BUILT-IN COAT FLAP

EXTERNAL COMPARTMENTS

INTERNAL POWER PORT



MESH COMPARTMENTS

LID TETHER



XKURSION® XB AMBASSADOR TAIL BAG

A do-it-all tail bag that delivers versatility, style, and convenience on or off the bike. The ultimate commuter bag for everyday riding or short overnight getaways features a contoured bottom for a perfect fit on rear fenders or passenger seats, and includes a handy integrated shoulder strap for easy transport when you arrive at your destination.

DIMS: 15" wide x 15" deep x 9.5" tall
CUBIC INCHES: 1,530
LITERS: 25

FEATURES

- Contoured and thermoformed bottom for strength, structure, and secure mounting
- Integrated fixed shoulder strap stows away discreetly when not in use
- Shoulder strap and wide grab handle offer easy transport off the bike
- Side-mounted quick stash pockets for keeping smaller items organized
- Built-in coat flap with adjustable G-Hook for quick and easy external storage
- Includes optional clear protective film for fender/paint protection



CONTOURED BOTTOM FOR
SECURE MOUNTING



CONVENIENT
TRANSPORT HANDLE

FOR MULTI-FIT

Fits: Tail Section, Passenger Seat (With or Without Sissy Bar) or Luggage Rack

5256 Xkursion XB Ambassador Bag (ea)

Note: Installation requires four-point mounting



ALSO AVAILABLE
QUICK-STASH MAGNETIC
DEVICE POUCH **PG 313**



SHOULDER STRAP

New

Collections

Featured Bikes

Audio

Lighting

Accessory Mounts

Handlebar Controls,
Grips & Mirrors

Pegs & Foot Controls

Covers, Trims
& Accents

Air Cleaners
& Exhaust

Touring & Comfort

Windshields &
Air Management

Luggage &
Organizers

Index

SADDLEBAGS



*Throw-over convenience
for almost any ride!*



MOMENTUM OUTRIDER THROW-OVER SADDLEBAGS

Rugged, purely utilitarian and loaded with ideal storage capabilities for virtually any bike or rider. A fully adjustable mounting belt offers throw-over convenience for easy installation and removal without requiring hardware or support brackets.

DIMS: 18" wide x 8" deep (10" expanded) x 11" tall (each bag)

CUBIC INCHES: 1,584 per bag, Expanded: 1,980 per bag

LITERS: 26 per bag (32 expanded)

FEATURES

- UV-rated weather-resistant 1200 denier textile material with removable rain covers
- No saddlebag supports or mounting brackets required
- Fully adjustable mounting belt to fit almost any motorcycle
- Angled design accommodates most stock fender-mounted turn signals
- Mounts on top or under passenger seat with slant forward or backward
- Anti-scratch backs and heat resistant bottoms
- Includes mounting strap kit for extra security
- Forward-facing quick-stash pockets for smaller items or bottle storage
- 2" expansion panel with capacity to fit a half helmet
- Internal adjustable divider for organization



*Ideal for commuters &
weekend warriors!*



FULL STRAP KIT FOR
ADDED SECURITY



WORKS GREAT WITH..

Combine with Outrider Saddlebags with the Rambler for a setup that will keep you on the road for miles & miles! **PG 294**



FOR MULTI-FIT

Fits: Fits Over or Under Passenger Seat

5209 Momentum Outrider Saddlebags (set)

Note: Applications with larger turn signals mounted to fender struts may limit the number of mounting options. Depending on the specific mounting, these bags may limit access to passenger foot pegs. Allow 4" clearance from exhaust pipe.



CARRYING HANDLE

ADJUSTABLE G-HOOK STRAPS

MEDIA STORAGE

BOTTLE POCKET



XKURSION® XB FAST LANE SADDLEBAGS

Enjoy all the extra storage space saddlebags provide, with the added benefits of updated styling and throw-over convenience to eliminate the need for hardware or bulky mounting brackets. Adjustable seat strap offers a custom fit either on top or under the passenger seat on virtually any motorcycle.

DIMS: 16" wide x 9.5" deep (11.5" expanded) x 11" tall (each bag)

CUBIC INCHES: 1,672 in each bag (2,024 expanded)
LITERS: 27 in each bag (33 expanded)

FEATURES

- Integrated media storage for up to a 12" device
- Premium adjustable G-Hook straps for external storage
- 2" expansion options offers enough storage to fit a full-face helmet
- Forward-facing bottle pocket for easy access, with laser-cut low-profile MOLLE modular attachment options
- Designed with anti-scratch back side and heat-resistant bottom
- Clamshell opening with interior mesh fence and side gussets to protect/retain gear when accessing main storage
- Includes optional mounting strap kit for extra security
- Top carrying handle and included shoulder strap offer convenient and easy transport off the bike
- Heavy-duty welded D-rings and included straps for easy mounting



THROW-OVER DESIGN MAKES THEM MOUNTABLE ON NEARLY ANY BIKE MODEL!



RAIN COVERS INCLUDED

FOR MULTI-FIT

Fits: Fits Over or Under Passenger Seat

5293 XKursion XB Fast Lane Saddlebags (set)

Note: Allow 4" clearance from exhaust pipe.

New

Collections

Featured Bikes

Audio

Lighting

Accessory Mounts

Handlebar Controls, Grips & Mirrors

Pegs & Foot Controls

Covers, Trims & Accents

Air Cleaners & Exhaust

Touring & Comfort

Windshields & Air Management

Luggage & Organizers

Index

ORGANIZERS, LINERS & ACCESSORIES



NEW

5224



NEW

5224



NEW

5224



NEW

5224

JACKET ROLL

Designed for the true minimalists who want a convenient storage option to keep jackets, extra layers, bedrolls, or blankets handy and securely stowed away.

- Dims: 16.5" wide x 12" long x 1" deep (rolls up to 12" long x 3" wide)
- Made from durable UV-rated, weather-resistant 1200 denier textile
- Adjustable buckle snap straps for convenient mounting on virtually any handlebar or sissy bar setup
- Loaded with MOLLE modular attachment points
- Folds up for easy storage when not in use

FOR MULTI-FIT

Fits: Adjustable straps for multi-purpose mounting

5224 Jacket Roll (ea)

Note: Adjustable straps for multi-purpose mounting



NEW

5259

TRAVEL ACCESSORY BAG

Whether used as a tool roll or Dopp kit, this is a convenient option to carry those ride essentials. Rolls up for easy storage and features MOLLE loops for external integration with other Kuryakyn luggage to free up all-important packing space.

- Dims: 10" wide x 7" tall x 4" deep
- Made from weather-resistant and UV-tested 1200 denier textile
- Includes three internal pockets: 1 low-profile mesh pocket, 1 clear spill-resistant pocket, and 1 general purpose pocket
- Easily attaches to any Kuryakyn luggage equipped with MOLLE modular attachment points



NEW

5259



NEW

5259

FOR MULTI-FIT

Fits: Fits inside of Kuryakyn luggage

5259 Travel Accessory Bag (ea)

Note: Fits inside of Kuryakyn luggage



NEW

5253

QUICK-STASH MAGNETIC DEVICE POUCH

Keep your cell phone or GPS within eyeshot and easily accessible without the clutter of a bar-mounted device holder. Touchscreen-friendly, made from durable Tarpaulin material with sealed seams, water-resistant zippers and a high-strength magnetic attachment for maximum protection.

- Dims: 3.5" wide x 6.125" tall x 1.5" deep
- Easily attaches to steel gas tanks
- Touchscreen-friendly clear top for on-the-go convenience
- Zippered opening from the bottom keeps water out while allowing access to cords

FOR MULTI-FIT

Fits: Fits models with magnetic gas tanks

5253 Quick-Stash Magnetic Device Pouch (ea)

LUGGAGE REMOVABLE BACKREST PAD

Mounts to Kuryakyn XKursion or Momentum seat/rack bags and features an ergonomic design to keep you rollin' in comfort. Premium UV-tested vinyl construction with padded foam core for shape retention and comfort. The hook-&-loop attachments offer a variety of mounting options on luggage or sissy bars.

FOR MULTI-FIT

Fits: Compatible With Most Kuryakyn Momentum and XKursion Luggage

5299 Removable Backrest Pad (ea)

REMOVABLE POUCH FOR MOMENTUM LUGGAGE

The ultimate add-on for Kuryakyn luggage is great for small items like tools, keys, power cords, flashlights, extra spark plugs; you name it. Attaches to any Kuryakyn luggage equipped with MOLLE via integrated snap straps.

- Dims: 7.5" wide x 2" deep x 5.5" tall
- Cubic Inches: 82
- Made from weather-resistant, UV-tested 1200 denier textile
- Interior MOLLE loops and mesh pocket keep contents securely in place

FOR MULTI-FIT

Fits: Snap straps for multi-purpose mounting to MOLLE loops on Kuryakyn & Momentum luggage

5264 Pouch for Momentum Luggage (ea)



NEW

5253



Instant backrest!



NEW

5299



NEW

5299



NEW

5264



NEW

5264



NEW

5264



5264

New

Collections

Featured Bikes

Audio

Lighting

Accessory Mounts

Handlebar Controls, Grips & Mirrors

Pegs & Foot Controls

Covers, Trims & Accents

Air Cleaners & Exhaust

Touring & Comfort

Windshields & Air Management

Luggage & Organizers

Index



5289



5287

MUST-HAVE



5287



5202

*Holds up to a
12-pack of bottles or
18-pack of cans!*



5202

5289



**H-D TOURING
SADDLEBAG POUCHES**

Convenient external storage for quick access to cell phones, wallets, firearms or other small items. Features include premium UV-rated rigid vinyl construction, a large main compartment with interior mesh pocket and heavy-duty magnetic closures, and a smaller external expandable pocket with high-strength Velcro closure. Main storage compartment measures 6" wide x 9" tall x 3" deep.

FOR HARLEY-DAVIDSON®

Fits: Fits '93-later Touring models equipped with Saddlebag Guards

5289 Saddlebag Pouches (pr)

Note: Does not fit with saddlebag guard rails

5287



INTERNAL SADDLEBAG ORGANIZERS

No more fumbling through that abyss of a saddlebag to find whatever inevitably ends up at the bottom. Keep small items secure and easily accessible with included zippered pocket, expandable pocket, MOLLE attachment points and slip pockets for maps or phones. Mounts to the inner front panel in seconds using high-strength 3M® VHB™.

FOR HARLEY-DAVIDSON®

Fits: HD Touring with OEM Hard Saddlebags

5287 Internal Saddlebag Organizers (pr)

SADDLEBAG COOLER

Keep your favorite fluids or snacks frosty and at the ready on those hot summer rides. Easily holds up to a 12-pack of bottles or 18-pack of cans plus ice, and the sealed interior lining means moisture stays inside the cooler instead of your saddlebag.

- Dims: 17.5" long x 6" wide x 9" tall
- Made from durable 1200 denier polyester with a sealed TPU-coated nylon liner with high-density insulation
- Sized to fit virtually any OEM saddlebag
- Included bottle opener never leaves you hanging
- Wide zippered opening and side-mounted carrying handles for easy access
- Includes removable/adjustable shoulder strap
- Sold individually

FOR HARLEY-DAVIDSON®

Fits: '80-'19 Touring Models with OEM Hard Saddlebags & Leather Road King Saddlebags

5202 Saddlebag Cooler (ea)

Mounts right to Stock Door!

FAIRING LOWER DOOR POCKETS

Sold in pairs, these handy pouches mount directly over the factory lower fairing panels, providing a convenient storage option to keep smaller items at your fingertips. Premium formed vinyl construction retains its shape and is also UV tested. Heavy-duty magnetic closures and interior mesh wall ensure secure storage and easy access.

FOR HARLEY-DAVIDSON™

Fits: '14-'19 FLHTK/L/SE, '16-'19 FLTRU, '15-'16 FLTRUSE, '14-'19 FLHTCUTG, & '15-'17 FLHXSE

5208 Fairing Lower Door Pockets (pr)



ALSO AVAILABLE..

BATWING FAIRING POUCH
PG 289



REMOVABLE SADDLEBAG LINERS

Handles plus a shoulder strap makes unloading and carrying luggage quick and easy.

- Dims: 23" slanted tip to tail, 10" tall x 6" wide

FOR HARLEY-DAVIDSON™

Fits: '80-'19 Touring Models with OEM Hard Saddlebags & Leather Road King Saddlebags

4170 Removable Saddlebag Liners (pr)



LID ORGANIZER BAG FOR H-D TOUR-PAK™

A variety of padded and see-through mesh compartments offer protection and easy accessibility for frequently used items. Quick-disconnect hook-&-loop and handles make it easily portable.

FOR HARLEY-DAVIDSON™

Fits: H-D King, Ultra, or Chopped Tour-Paks (Does Not Fit Leather Tour-Paks)

4134 Lid Organizer Bag (ea)



REMOVABLE TOUR-TRUNK LINER

Handles plus a shoulder strap makes unloading and carrying luggage quick and easy.

- Tour Trunk Liner Dims: 21" wide x 15" deep x 8" tall

FOR HARLEY-DAVIDSON™

Fits: '80-'19 Models Equipped with King or Ultra Tour-Pak

4177 Tour-Trunk Liner (ea)

New

Collections

Featured Bikes

Audio

Lighting

Accessory Mounts

Handlebar Controls,
Grips & Mirrors

Pegs & Foot Controls

Covers, Trims
& Accents

Air Cleaners
& Exhaust

Touring & Comfort

Windshields &
Air Management

Luggage &
Organizers

Index



5071



REAR TIE-DOWN ANCHORS

A simple and unobtrusive attachment point for securing mounting straps. Durable steel construction with a slim design that mounts discreetly to the rear fender strut.

FOR HARLEY-DAVIDSON*

Fits: '14-'19 Road Glides (except FLTRU, FLTRUSE), Road Kings & Street Glides, '04-'19 Sportsters (except XL1200T)

5072 Gloss Black (pr)

5071 Silver (pr)



SEAT BOLT TIE-DOWN ANCHOR

This discreet multi-fit bracket provides a quick and easy attachment point for securing luggage straps utilizing the seat bolt location. Features sturdy stainless steel construction.

FOR HARLEY-DAVIDSON*

Fits: H-D Model Cruisers and Touring without Tour-Paks (except Freewheeler)

5073 Chrome (ea)

5074 Gloss Black (ea)



TIE-DOWN BRACKET/CABLE GUIDE

These handy brackets quickly and cleanly provide anchor points for securing luggage or other items to your motorcycle. Mounting hole accepts up to a 3/8" (or M10) screw.

FOR MULTI-FIT

Fits: Universal Applications as a Tie Down Bracket.

4179 Chrome (pr)

Note: Replaces H-D P/N 38623-68 as a Cable Guide.



PREMIUM LUGGAGE STRAP KIT

Works with all Kuryakyn and XKursion luggage. Includes (4) double snap hook straps, (2) single snap hook straps with pull-through loop, (2) hook-and-loop straps, and (2) hook-and-loop snap straps.

FOR MULTI-FIT

Fits: Universal for Kuryakyn and select XKursion luggage (p/n's 5292, 5293, 5294, 5295, & 5296)

5163 Premium Luggage Strap Kit (kit)



REPLACEMENT LUGGAGE STRAPS

Replace lost or damaged Kuryakyn luggage straps.

FOR MULTI-FIT

Fits: Universal for Kuryakyn and XKursion luggage.

5297 Replacement Loop Luggage Mounting Strap, Black (ea)

5215 Replacement Double Snap Hook Luggage Mounting Strap, Black, Black (ea)

5217 Replacement Luggage Shoulder Strap, Black (ea)

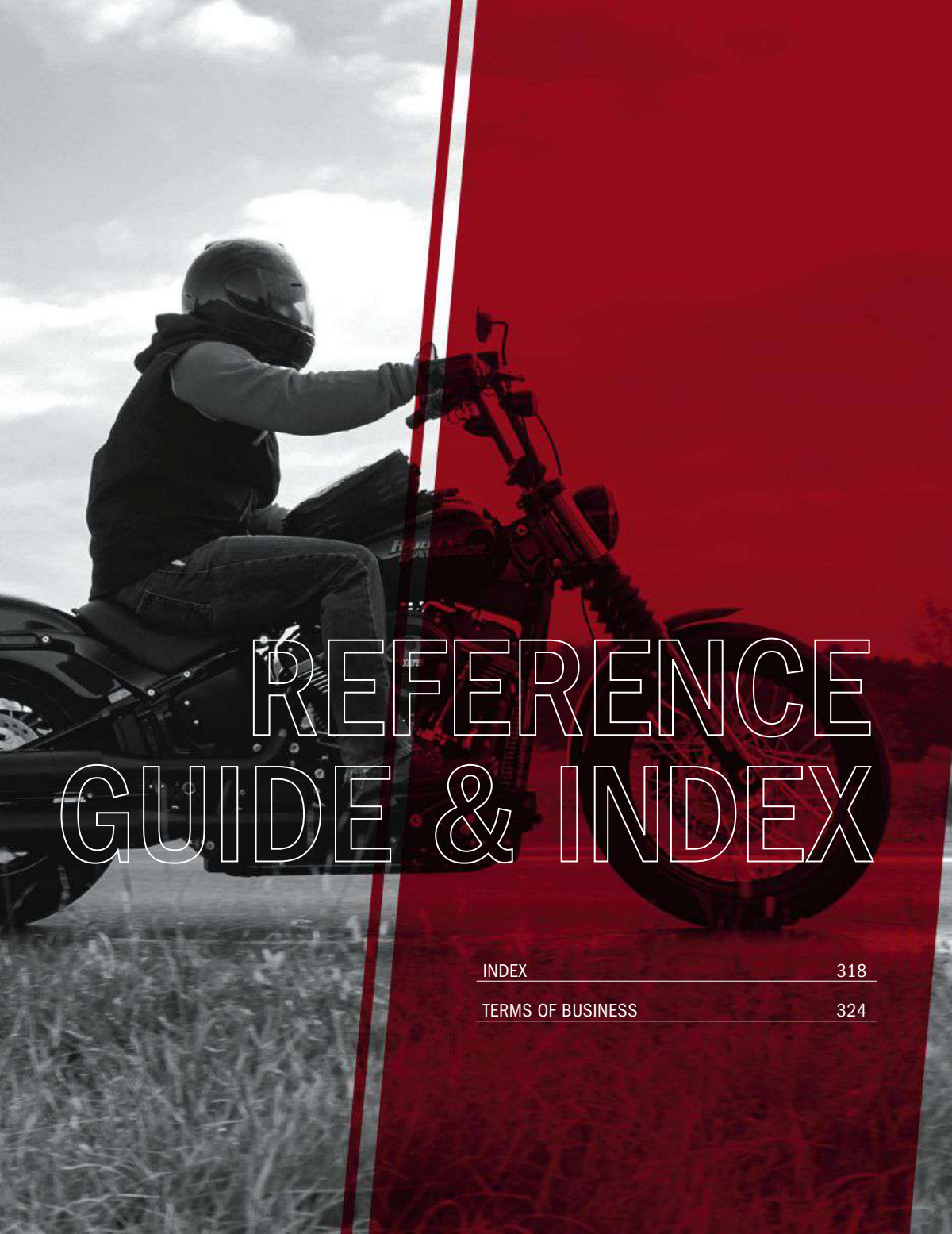

REFERENCE GUIDE & INDEX

INDEX 318

TERMS OF BUSINESS 324



ALL **NEW** PRODUCTS ARE HIGHLIGHTED IN **RED!**

A	
Accent Lighting	26
Accessory Charger	64
Accessory Mounts	72-75
Accessory Switches	48-59
Adapters	
Adapter Studs	62
Footpeg	128
Accessory / Mirror	30, 78, 100
Lighting Mount	48-58, 60, 62
Load Equalizer	47
Wiring Harnesses	48-49
Adjustable Passenger Pegs	132
Adjustable Passenger Peg Mounts	134
Air Cleaner Accessories	248, 250-251
Air Cleaner Adapters/ Mount Kits	250, 252-253
Air Cleaner Covers (Pre-Filters)	249
Air Cleaners	236-247
Air Deflectors	280-281
Alley Cat	
Air Cleaner	243
Air Cleaner Cover	183
Gas Cap	169
L.E.D Fuel & Battery Gauge	169
American Flags	234
Antenna Hole / Accent Filler	227
Antennas	32
Anti-Rotation Floorboard Mounts	130
Armrests	273-274
Audio	28-32
Axle Caps/ Covers	171
B	
Backrest Mounts	268-269
Bad Boy Air Horns, Wolo	205
Baffles, Quiet	263
Ball Joints, Shifter	143
Banjo Bolt Covers	87
Bat Lashes	154
Battery Gauge	76
Bleeder Screw Covers	172

Blood Groove Hypercharger™	238
Bluegrass Breather Kits	249
Bluetooth Audio Controller	30
Bluetooth Controller Lizard® Lights / Infinity	70
Bluetooth Speakers	28-30
Board Extenders	131
Boards, Driver & Passenger	102-125
Bolt Covers	206-207
Boomerang Frame Covers	211
Boss Blades	91
Brake & Clutch Control Dress-up Kit	88
Brake & Clutch Levers	90-91
Brake Arms, Extended	148-149
Brake Bleeder Screw Cover	175
Brake Caliper Covers	175
Brake Master Cylinder Covers, Front & Rear	88
Brake or Clutch Accessory Mount Kit	72-75
Brake Pedal Arm	148-149
Brake Pedal Pad / Cover	104-125
Brake Pedal Pads, Extended	119, 125
Breather Bolt Covers	184
Breather Bolts	249
Brute Highway Peg Mounts	141
Bulbs	65-67
Bullet Lights	60
Butterflies for Hypercharger™	248
C	
Cable Covers	87
Caliper Covers	175
Cams	265
Carburetor Adapter & Support Brackets	250, 252
Cell Phone Mounts & Holders	72-75
Chargers	76
Choke Knob Cover	202
Chrome Nut/Bolt Cover	206-207
Cigarette Lighter	76
Clamps	142
Clevises	141

Clutch & Brake Levers	90-91
Clutch Cable Adjuster Cover	182
Clutch Cable Ferrule Covers	87
Coil Cover	202
Colossus Rear Trim	222
Control Covers	88
Coolant Pump Cover	177-178
Crankcase Breather Kits	249-250
Cruise Arm Mark III & IV	136
Cruise Assists	85
Cruise Pegs & Mounts	135-136
Crusher™	
Air Cleaners	240-241, 244-247
Cams	265
Exhaust	254-260
Lifters	266
Pushrods	266
True Dual Head Pipes	259-260
Cup Holders	77-78
Curved License Plate Frames	228-231
Curved Side Mount License Plate Mounts	228, 230-231
Cylinder Base Covers	194, 196
D	
D-Washers	142
Dash Panel Inserts	166-167
Deco Gas Cap & Gauge	169
Deep Dish Bezels	65
Deflectors, Heat	282
Dillinger	
Footpegs	106
Levers	91
Luggage Rack	271
Handguards	283
Headlight Trim Ring	155
Shift pegs	106
Dipsticks & Accents	193
Downtube Covers	209
Dragon Wings	281
Drink Holders, Driver	77
Drink Holders, Passenger	78
Driver Backrests	269
Driver Floorboard	109, 112, 126
Driving Lights	38-39

INDEX E - H

E		Horn Cover	204	Handlebar Device Holders & Mounts	72-75
EFI Tuners	264	Shift Arm Cover	143	Handlebar Electrical Power Point	76
Electrical Power Point	76	Shift Linkage	144	Handlebar Master Cylinder Cover	88
End Caps for Grips	76-77	Shift Peg	121	Handlebar Speakers	28-30
Engine Guard Mounted Lights	38	Flash Brake Controllers, Pulsating	46	Head Bolt Covers	200
Engine Guard Tab Covers	178	Flip Blades	135	Headlight Adapter Harness	48
Engine Guards (Ergo™)	137	Floorboard Covers	102-121	Headlight Bulbs	66
Engine Performance Parts	265-266	Floorboard Inserts	102-126	Headlight (L.E.D.)	34-37
Engine Stabilizer Link	182	Floorboard Spacers/Extenders	131	Headlight Trim Rings	38-155
Ergo™ Guards	137	Floorboards	102-126	Headlight Visor	156
Exhaust Port Gaskets	262	Flush Mount Gas Caps	167,170	Heavy Industry	
Exhaust Systems	254-261	Fog Lights (Passing Lamps)	34,39	Accent kit	95
Exhaust Tips	254-261	Footpeg Adapters	128	Brake Pedal Pad	111
Extended Brake Pedal	148-149	Footpeg Extensions	129	Floorboards	113
Extended Forward Controls	150	Footpeg Mounting Hardware	141-142	Footpegs	110
Extensions- Footrests	129	Footpeg Mounts/Clamps	141-142	Grips	83
F		Footpegs	102-125	Mirrors / Stems	95
Fairing Accents, Inner	156-165	Footrest Extensions & Relocators	129	Shift & Brake Pegs	111
Fairing Accents, Outer	152-158	Fork Braces	176	Switchblades	111
Fairing Lower Door Pocket	315	Fork Clamps	62	Heat Deflectors	282
Fairing Mounted Bag	288-289	Fork Covers- Lower	174	Heat Shields (Exhaust)	180
Fairing Mounted Driving Lights	39	Fork Skin Covers	176	Heel Shift Eliminator	147
Fairing Vent Accent	153,157	Fork Slider Covers	174	Heel Shift Lever	370
Fender Accents	172-173	Forward Control Extensions	150	Heel rests (Stirrups)	124
Fender Extensions	172	Forward Controls	150	Helmet Lock	233
Fender Light Strips-Rear	68,220	FP3 Tuner	264	Heim Joints, Shifter	143
Fender Tip Lens Grills	173	Frame Covers	211-212	Hex	
Fender Tip Lenses	64	Front Motor Mount Cover	180	Brake Pedal Pad	104
Fender Tips	172-173	Fuel Door Push Button	166	Floorboard Inserts	105
Filler Panel, Turn Signal Bar	224	Fuel Injection Tuning	264	Footpegs	104
Filler Panels, Saddlebag	216	Fuel Line Fitting Cover	202	Grips	81
Finned		Fuel/Battery Gauge (L.E.D.)	168-170	Mirrors	94
Air Cleaner Accent	182	Fuelpak, Tuner	264	Shift Pegs	104
Derby Cover	198	G		High-Intensity L.E.D. Bulbs	67
Front Primary Accent	198	Gadget Holders	72-75	Highway Bars, Mustache	135
Primary Accents	198	Gas Caps	167-170	Highway Boards	102-125
Spark Plug Covers	201	Gauge Bezels	161-164	Highway Pegs	102-125
Spark Plug Wire Cover	191	GPS Mounts & Holders	72-75	Hitches	277
Starter End Accent	191	Grab Rails, Passenger	274	Horn Covers	203-205
Starter End Cover	191	Grip End Weights	86	Horns	205
Timing Cover	187	Grips & Grip Accessories	80-87	Hot Spots/Hot Sleeves/Kool Kaps	207
Transmission Cover Accents	187	H		Hub Cover (for Trike)	226
Flags / Mounts	234	Halo Headlight Trim Ring	38,155	Hypercharger™ Air Cleaners	238-239
Flame™/Flamin'		Halogen Bulbs	65-66	Adapters	250
Brake Pedal Pad	121	Handlebar Accessory Mounting Systems	72-75	Brackets/Components	250-251
Covers		Handlebar Clamps/Mounts	78	Mount Kits	253
Floorboard Covers	121	Handlebar Control Covers	88	Trap Doors/Butterflies	248
Footpegs	121			Hypercharger ES	236-237
Grips	84				

New

Collections

Featured Bikes

Audio

Lighting

Accessory Mounts

Handlebar Controls, Grips & Mirrors

Pegs & Foot Controls

Covers, Trims & Accents

Air Cleaners & Exhaust

Touring & Comfort

Windshields & Air Management

Luggage & Organizers

Index

INDEX I - M

I	
Ignition Switch Cover	167
Informer L.E.D. Fuel & Battery Gauge	170
Inner Fairing Accents	165
Inner Fairing Cover Plate, Mirror Hole	165
Inner Primary Covers	195
Intakes, Air	236-247
iPhone Mounts	72-75
ISO® Products	
Boards	126
Brake Pedal Pads	125
Dually Trident Pegs	118
Grips	84
Levers	91
Pegs	123
Shift & Brake Pegs	125
Throttle Boss	85

J	
Jim Nasi Signature Series	
Dash Console	167
E.F.I. Cover	185
Horn Covers	205

K	
Kellermann Lighting & Accessories	51-58
Kinetic™	
Brake Pedal Pad	115
Floorboard Inserts	115
Footpegs	114
Grips	83
Mini Boards	114
Shift & Brake Pegs	114
Throttle Boss	85
Kool Kaps, Fastener Covers	206-207
Krusader Horn Cover	205

L	
L.E.D. Bat Lashes	154
L.E.D. Battery Gauge	76
L.E.D. Bulbs	66-67
L.E.D. Bullet Lights	59
L.E.D. Conversion for H-D Tombstone Taillight	42
L.E.D. Fairing Vent Accent	153
L.E.D. Fuel/Battery Gauge	168-170
L.E.D. Halo Trim Rings	38,155
L.E.D. Headlights	34-37
L.E.D. High-Intensity Bulbs	67
L.E.D. Inserts For Saddlebag Supports	220
L.E.D. License Plate Bolt Lights	233

L.E.D. Mini Bullets	56
L.E.D. Mirror Stem Covers	99
L.E.D. Passing Lamps, Fog	34,37-39
L.E.D. Rear Fender Tip	64
L.E.D. Reflector Bulbs	66
L.E.D. Saddlebag Extensions	219
L.E.D. Saddlebag Hinge Accents	69,214
L.E.D. Speaker Bezels / Grills	164
L.E.D. Speedo & Tach Bezels	164
L.E.D. Taillights	42,44,52-55
L.E.D. Torpedo Lights	59
L.E.D. Turn Signals	52-56,59-61
L.E.D. Turn Signal Inserts	41,43-45
L.E.D. Upgrade Lamps For 5000 Series	65
L.E.D. Vertical Light Strips	68,220
Late Style Turn Signal Kit	60
Lenses	63-65
Levers	90-91
License Plate Frame	228-233
License Plate Hardware Kits	229-233
License Plate Helmet Lock	233
License Plate Mounting Hole Covers	233
License Plate Mounts	228-233
Lid Organizers	315
Light Bars, Rear	49-50
Lighted Lower Saddlebag Accents	220,224
Lighted Phantom Covers	213
Lighted Swingarm Covers	212
Lighted Velocity Ring	69
Liners, Saddlebag	315
Load Equalizer Adapter	47
Load Equalizers	47
Lockable Offsets	130
Longhorn Offset Highway Pegs	139
Lower Front Frame Cover	212
Lower Leg Accents/Covers	174
Lower Leg Deflector Shields	174
Lower Saddlebag Accents, Lighted	220,224
Lower Triple Tree Wind Deflector	283
Luggage	285-316
Accessory Bag	312

Backrest Pad, Removable	313
Device Pouch, Magnetic	74, 313
Fairing Lower Door Pocket	315
Internal Saddlebag Organizer	314
Jacket Roll	312
Lid Organizers	315
Luggage Strap	316
Pouch, Removable	313
Passenger Pouches	313
Roll Bags	294-295
Saddlebag Cooler	314
Saddlebag Liners	315
Saddlebags	310-311
Saddlebag Pouches	314
Seat, Trunk & Rack Bags	292-311
Sissy Bar Bags	288
Strap Kit	316
Tank Bags	290,309
Windshield Bags	288-289
Luggage Rack Relocation Kit	272
Luggage Racks	271-272

M	
Mach 2™ Air Cleaner	242
Magnetic Device Tank Pouch	74,313
Magnum Mirrors	99
Magnum™ Quick Clamps	142
Master Cylinder Covers, Front	88
Master Cylinder Covers, Rear	88
MasterTune Kits	264
Maverick Air Cleaners	240-241
Maverick Exhaust	254-259
Maverick Horn Cover	203
Medallions	207
Mesh	
Airdam	179
Bezels	63
Brake Master Cylinder Cover	89
Clutch Master Cylinder Cover	89
Dash Inserts	168
Derby Cover	197-198
Fairing Vent Accent	153
Front Caliper Covers	175
Front Pulley Cover	192
Fuel Door	166
Gas Cap	169

INDEX M - Q

Headlight Vent Accent	158
L.E.D. Fuel & Battery Gauge	168
Manifold & Injector Cover	201
Rear Caliper Cover	213
Saddlebag Hinge Covers	215
Taillight Bezel	227
Timing Cover	187
Mid-Frame Covers	209
Mini Bullets (L.E.D)	59
Mini Dagger	117
Mirror Adapters	100
Mirror Covers	99
Mirror Extensions	100
Mirrors	92-99
Momentum Luggage	288-313
Barrio bag	288
Deadbeat Duffie	292
Drifter Bag	298
Freeloader Duffie	293
Grand Pet Palace	299
Hitchhiker Trunk Rack	306
Pouch, Removable	313
Rambler Roll Bag	294
Road Warrior Bag	302
Roamer Tail Bag	308
Outrider Throw-Over Saddlebags	310
Vagabond Bag	300
Wanderer Touring Seat Bag	304
Mud Flaps	226
Muffler Bracket Cover	216
Mufflers	
Quiet Baffles	263
Replacement Tips	263
Multi-Purpose Driver & Passenger Backrest	269
Mustache Highway Bars	135
N	
Neck Covers	208
Neutral Switch Covers, Chrome	193
O	
Offset Highway Pegs	138
Offset Mounts	130
Oil Cooler Cover	178
Oil Dipsticks	193
Oil Filler Caps/Cap Accents	193
Oil Filler Spout Cover	192
Oil Line Covers	192
Oil Line Nacelle	192

Oil Pressure Sender Covers	181
Oil Sender Switch Cover	192
Orbit 7" L.E.D. Headlight Prism	34
Orbit 5 3/4" L.E.D. Headlight Prism	36
Orbit 4 1/2" L.E.D. Passing Lamps Prism	34
Orbit 4 1/2" L.E.D. Passing Lamps Vision	34
Organizers, Lid	315
P	
P-Clamps	62
Panacea Adapters	48
Panacea Controller	41
Panacea Taillight Systems	40-41
Panacea Turn Signals	41
Passenger Armrests	273-274
Passenger Backrests	268-269
Passenger Board Covers	102-126
Passenger Board Inserts	102-126
Passenger Board Mounts	133
Passenger Boards	102-126
Passenger Board Mount Accents	210
Passenger Drink Holder	78
Passenger Grab Rails	274
Passenger Pegs & Mounts	102-125
Passing Lamp Harnesses	48-49
Passing Lamps	34
Peg Adapters	128-129
Peg Mounts	140-141
Pegs	
Dillinger	106
Flame™/Flamin'	121
Heavy Industry	110
Hex	104
ISO®	123
ISO Wing	124
Kinetic™	114
Mini Dagger	117
Pilot™	122
Phantom	113
Riot	108
Stiletto™	116
Spear	113
SweptWing	123
Swingwing	124
Switchblade	124
Thresher	107

Trident	118
Widow™	120
Zombie™	117
Pet Palace	299
Phantom	
Bar End Mirrors	95
Axel Cover	213
Footpegs	113
Mini Boards	113
Mirrors	95
Phase 7	37
Phone Charger	76
Phone Mount	72-75
Plug-N-Play Sissy Bar Mount	270
Pop Up Gas Cap	167
Power Point Charger	76
Power Source	76
Pre-Filters	249
Precision	
Chin Spoiler	179
Coolant Pump Cover	177
Cylinder Base Cover	194
Dipstick	193
Heel Shift Eliminator	147
Inner Primary Cover	194
Lower Front Engine Cover	181
Oil Cooler Cover	177
Oil Line Cover	192
Regulator Cover	177
Spark Plug Covers	201
Spark Plug Wire Cover	191
Starter Cover	190
Tappet Block Accent	188
Throttle Servo Motor Cover	185
Transmission Shroud	189
Transmission Top Cover	188
Upper Frame Cover	187
Premium	
Brake Pedal Pad Cover	119
Floorboard Inserts	120
Floorboards	119
Mini Boards	119
Primary Accents	196,198-199
Pro-R & Pro-Series Hyper-charger™	239
Pulsating Brake Modules	46
Push-Button Fuel Door	166
Q	
Quantum Air Cleaner Cover	183
Quick Clamps	142

New

Collections

Featured Bikes

Audio

Lighting

Accessory Mounts

Handlebar Controls, Grips & Mirrors

Pegs & Foot Controls

Covers, Trims & Accents

Air Cleaners & Exhaust

Touring & Comfort

Windshields & Air Management

Luggage & Organizers

Index

INDEX Q - T

Quick Draw Saddlebag Levers	115	Road Thunder Sound Bar Plus	28	Speaker Accents	160, 165, 222
Quick Release Backrests	268	Road Thunder Speaker Pods	30	Speaker Bezels	160, 162, 165
R					
Racks, Luggage	271-272	Rocker Box Bolt Covers	200	Speaker Grills	160,165
Radio Trim	159-163	Rocker Switch Cover Kits	163	Speakers	28-31
Radiator Grills	178	Roundit Wire Wrap	49	Speedform	
Razor Eyes Turn Signals	59	Run-Turn-Brake Controllers	46	Air Cleaner Cover	183
Rear Axle Covers	213	S			
Rear Cylinder Base Covers	191	Saddle Shields	282	Saddlebag Lid Spoilers	217
Rear Fender Accents	224	Saddlebag Accents	220	Saddlebag Scuff Protectors	217
Rear Fender Strip Lights	68,220	Saddlebag Extensions	219	Speedo/Tach Bezels	164
Rear Master Cylinder Covers	181	Saddlebag Filler Panel Inserts (L.E.D.)	230	Spear	
Rear Shift Lever Eliminator	147	Saddlebag Filler Panels	216	Footpegs	113
Rear Speaker Accents	160,165	Saddlebag Hinge Accent (L.E.D.)	69	Mini Boards	113
Rear Tie Down Anchors	316	Saddlebag Latch Covers	214	Speedometer Trim/Visors	161-166
Rear Turn Signal Bars/Brackets	49-50	Saddlebag Latch Handle	215	Splined Peg/Floorboard Adapters	128
Receptacle Kits	278	Saddlebag Latches Covers	214-215	Spoilers	217,222
Regulator Covers	179-180	Saddlebag Lid Accent Covers	218	Spot Lamps & Driving Lights	38-39
Relay Kits	82	Saddlebag Liners	315	Starter Cover	190
Relocation Brackets for Driver Boards	131	Saddlebag Scuff Protectors	217	Starter Mount Cover	190
Relocator Kit for Tour-Pak & Trunks	274-276	Saddlebag Top Trim	217-218	Stereo Trim	159, 161, 153
Replacement K&N Air Filters	251	Screw Head Covers	206-207	Stiletto™	
Replacement Rubbers	127	Scythe Mirrors	98	Brake Pedal Pad	116
Reservoir Covers	88	Seat Screws	227	Footpegs	116
Retractable Passenger Pegs	134	Servo Covers	184	Shift peg	116
Revolt Air Cleaner	245	Shift Arm Accents/Covers	143	Stirrups	116
Ridgeback		Shift Lovers	147-148	Stinger Trap Door (Hyper)	248
Brake Pedal	148	Shift Linkages	144-146	Stirrups (Heelrest)	124
Front Shift Arm	143	Shift Pegs	102-125	Straps, Luggage	316
Shift Levers	148	Shift Spline Cover	146	Strut Lights	52-61
Shift pegs	112	Shifter Ball Joints	143	Support Bracket Intake	250-251
Transmission Shift Arm	143	Shifter Heim Joints	143	Sweptwing Peg	123
Right Angle Peg Mounts	140	Shifter Rods	144-146	Swingarm Accents	209
Riot		Shirts	266	Swingarm Covers	212
Brake Pedal Pad	109	Signature Series, Jim Nasi		Swingarm Pivot Covers	212
Floorboards	109	Dash Console	167	Switch (Double Rocker)	48
Footpegs	108	E.F.I. Cover	185	Switchblade Peg	124
Grips	83	Horn Cover	205	Switch Housings	88
Heat Shields	180	Silver Bullet Lights	61	Switch Panel Accent	160-161,163
Mini Boards	108	Silver Bullet Mounts & Components	62	T	
Shift Linkage	144	Sissy Bars/Mounts	268-270	Taillight Bulbs	65-67
Shift & Brake Pegs	109	Skeleton Hand Mirrors	98	Taillight Visors/ Covers	227
Road Thunder Bluetooth Controller	30	Skeleton Hand Turn Signals	60	Taillights	41-42,45,49
Road Thunder Fairing Speakers	31	Smoke Lenses	63-65	Tapered Peg Adapters	129
Road Thunder Sound Bar	29	Solenoid Cover	193	Tappet Block Accents/ Covers	188
		Spark Plug Covers	200-201	Teardrop Mirrors	97
				Tech-Connect®	72-75
				Build-Your-Own	74-75

INDEX T -Z

Complete Kits	72-73	Fuel Door	168	Windshields	284
Thresher		Gauge Trim	159	Wire Wrap/Loom (Round-It)	49
Footpegs	107	Glove Box Accents	162	Wiring Harness	
Grips	81	Headlight Vent Accents	158	Accessory	48-49
Shift & Brake Pegs	107	Ignition Switch Cover	160	Driving Lights	49
Throttle Assist	85	Inner Fairing Cover	160	Trailer	277-278
Throttle Body Cover	184	Plates		Wolo Bad Boy Air Horn Kit	205
Throttle Body Support Bracket Cover	184	Rear Tour-Pak Light Accent	223		
Throttle Boss	85	Saddlebag Accents	217	X	
Throttle Cable Covers	87	Saddlebag Hinge Covers	214	XKursion Luggage	290-311
Throttle Rocker	85	Side Tour-Pak Accents	223	Ambassador Tail Bag	309
Throttle Servo Motor Cover	184-185	Speedo & Tach Accents	161	Arsenal Bag XW	301
Tie Down Brackets	176	Speaker Accents	162	Co-Pilot Tank Bag XT	290
Timing Covers	187	Speaker Grills	162	Cube XS	296
Tombstone Taillights	49	Stereo Trim	159,163	Depot Bag XS	305
Torpedo Lights	59	Top Dash Accent	162	Dispatch Bag XB	291
Torque Cones	262	Tour-Pak Accents	223	Fast Lane Saddlebags	311
Tour-Pak Accents	221	Windshield Trim	152	XB	
Tour-Pak Lid Grip	221,271	Trunk Relocator	274-276	Guardian Rack Bag XS	307
Tour-Pak Lid Light	223	TTS MasterTune	264	Jacket Roll	312
Tour-Pak Liners	315	Tune Trapper® & Adapter	32	Odyssey Bag XS	303
Tour-Pak Relocator	274-276	Turn Signal Bar Filler Panel	224	Porter Bag XW	297
Tour-Pak Spoiler	222	Turn Signals	51-61	Steward Roll Bag XS	295
Tour-Tech™ Cruise Pegs & Mounts	138	Two-Piece Fork Mounts	62	X-Tension Cruise Peg Mounts	140
Tour Trunk Accent	221				
Trailer Ball Cover	278	U		Z	
Trailer Hitch Rack	278	Underseat Peg Mounts	134	Zombie™	
Trailer Hitches	277	Universal Drink Holders	77	Brake Pedal Pads	117
Trailer Wiring Harness	277-278	Universal Helmet Lock	233	Floorboard Covers	117
Transformer™ Backrest	268	Universal Joints for shift linkage	143	Floorboard Inserts	117
Transformer Grips	84	Upper Fork Slider Covers / Shrouds	174	Footpegs	117
Transmission Shrouds	189	USB Power Source	76	Gas Cap	170
Trap Doors for Hyper-charger™	248			Grips	83
Travel Bags & Accessories	286-315	Velociraptor Air Cleaner	244	Horn Cover	70
Travel Mug	78	Velocity Ring	69	L.E.D. Fuel & Battery Gauge	170
Trigger Levers	90	Vent Accents	152-153,158	Levers	90
Trike Accessories		Visors, Headlight	156	Medallions	207
Center Caps	226	Visors, Taillight	227	Mirrors	98
Latch Accent	225	Volt Meter	76	Oil Filler Cap	193
License Plate Frame	231-233			Saddlebag Latch Handle	115
Mud Flaps	226	W		Shift Arm Cover	143
Rear Fender Accents	225	Widow™		Shift Linkage	144
Rear Fender Flares	225	Footpegs	120	Shift Peg	117
Rear Lighting	226	Shift Peg	120	Taillight Cover	227
Top Fender Accent	225	Taillight Cover	233	Windshield Trim	152
Trailer Hitch	277	Wind Deflectors	280-283		
Tri-Fin Primary Cover Cap	378	Windshield Bags	288-289		
Tri-Line		Windshield Mounted Mirrors	97		
Fuel & Voltage Gauge Bezels	161	Windshield Trim	152,157-158		

New

Collections

Featured Bikes

Audio

Lighting

Accessory Mounts

Handlebar Controls, Grips & Mirrors

Pegs & Foot Controls

Covers, Trims & Accents

Air Cleaners & Exhaust

Touring & Comfort

Windshields & Air Management

Luggage & Organizers

Index