

MSD CATALOG 2015
EFI / IGNITIONS / COILS / DISTRIBUTORS / TIMING CONTROLS / SPARK PLUGS & WIRES / STARTERS / ALTERNATORS / RPM CONTROLS



MSD[®]

DRIVING INNOVATION

2015 CATALOG

EFI IGNITIONS COILS DISTRIBUTORS TIMING CONTROLS SPARK PLUGS SPARK PLUG WIRES STARTERS ALTERNATORS RPM CONTROLS



WELCOME TO MSD



Racers never stop experimenting as they search for every way to wring out more power or handling performance to gain an edge over the competition. The team at MSD is no different as we strive to deliver the products you need to meet your performance goals. We continue to innovate and invent components and technology that deliver performance and reliability with products that are easy to use and install.

Over the course of 40-plus years, MSD Performance has been driving the development of innovative components that helped shape the way our cars race and perform. From super speedways to road courses, land speed racing to top fuel dragsters, and of course your traditional hot rod, MSD has provided the components to fire nearly anything in motorsports.

Early on, MSD focused squarely on ignition systems with revolutionary products like the multiple sparking CD ignition, timing and rev controls, billet aluminum distributors and the Pro-Mag, an incredible breakthrough in power and endurance.

Today MSD is developing electronics for your entire powertrain. The Atomic EFI systems for the LS engine platform and throttle body are now complemented with a transmission controller. Our DynaForce Starters and Alternators ensure that your engine cranks over to fire up and the Alternators keep it charged. Together with our sister company, Racepak, we are developing wiring and instrumentation solutions to give you advanced control over your electronics.

MSD is poised to deliver components that work and communicate together to provide performance and value. Imagine a complete vehicle management system that will reduce wiring, cut sensor duplication and provide a single source for programming. The Atomic Fuel Injection, rotating electronics and Racepak instrumentation are just the beginning. Wait till you see what's coming next.





Introduction..... 2-7
 Contents3
 New for 20154-5
 Information, Specs and Catalog Symbols .6-7



Applications 8-17
 Muscle Car / Street Rod8-9
 Drag Race10-11
 Circle Track / Road / Offroad12-13
 Late Model14-15
 Truck16
 Marine.....17



Atomic® EFI & TCM.....18-31
 Atomic Intro18
 Atomic TBI.....20-23
 Atomic LS.....24-29
 Atomic Trans Controller30-31



DynaForce® 32-35
 Starters and Alternators32-35



Spark Plugs 36-39
Ignitions 40-63
 Info and Specs.....40-42
 6-Series43-48
 Track and Marine Ignitions.....49-50
 Programmable Midget Ignition.....51
 7-Series, Drag Racing.....52-53
 7AL-3 and MSD 854
 Programmable Digital 755
 Power Grid™ Ignition.....56-59
 Pro Mag Overview.....60
 Distributorless Ignitions61-63



Late Model Controllers. .64-66
 GLS Controllers and Harnesses.....64
 Ford 6-Mod Ignition Controller65
 6-HEMI® Ignition Controller66



Late Model Coils67-71
 Performance LS Coils68-70
 Performance Ford® Coils71-72
 Performance Chrysler® Coils.....73



Coils.....74-79
 Blaster™ Performance Coils.....75-76
 Replacement Coils77
 HVC & HVC II Coils.....78-79

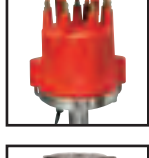

Distributors 80-124
 Introduction80-81
 Distributor Quick Reference82-83
 Chevrolet HEI85-84
 Ford® Distributors.....95-102
 Chrysler® Distributors103-105
 AMC®, Buick®, Oldsmobile®, Pontiac®.106-109
 Cadillac®, VW® Distributors.....110
 Dual Pickup Distributors.....111-112
 Crank Trigger Distributors.....113-114
 Front Drive Distributors, Oil Pump Drives....115
 Distributor Caps and Rotors.....116-122
 Distributor Gears123
 Distributor Accessories124



Crank Trigger Kits..... 125-126
Timing/RPM Controls ...127-138
 Timing Controls127-129
 Boost Controls.....130
 RPM Controllers and Accessories.....131-134
 Shift Lights and Accessories137
 Fuel Pump Booster.....138



Spark Plug Wires 139-154
 Street Fire® Spark Plug Wires.....141
 Universal Sets and Boot Key142-143
 Race Tailored and Custom Sets144-148
 Boots, Terminals, Accessories149-154



Street Fire®155-161
 Ford, Chrysler and GM LS Coils.....156-158
 CDI Ignitions158
 Cap, Rotors and Distributors159-160
 Wires.....161



Marine 162-164
 Marine Ignition.....162
 Marine Distributors163-164



Accessories 165-155
 Wire Connectors165
 Wiring Harnesses and Switches166
 Accessories167
 Tach Adapters168-169
 Tools and Testers170-171



Promo 173-168
 Banners and Decals.....173
 Literature.....174
 P.O.P and Apparel175-176



MSD Group and Brands.. 177-178
 Racepak, Powerteq

Part Number Index179



NEW FOR 2015



Accessories
Specialty
Items
Promo
Marine
Street Fire
Spark Plug
Wires
Timing/RPM
Controls
Crank
Triggers
Distributors
Coils
Late Model
Ignitions
Spark Plugs
Starters/
Alternators
Atomic EFI



Spark Plugs

Fire up your engine with MSD from start to finish! Our new performance spark plugs deliver the final step in the ignition process with outstanding results. These spark plugs incorporate an Iridium-tipped center electrode, cutting edge ceramic, Copper-cored Yttrium ground electrode, and several other features that result in superior durability and consistent performance. Spark plugs are available for a variety of applications from modern muscle cars and trucks to sport compact 4-cylinders and traditional hot rod V8 engines. See pages 36-39 for more information.

order a complete
Application Guide,
PN 9730

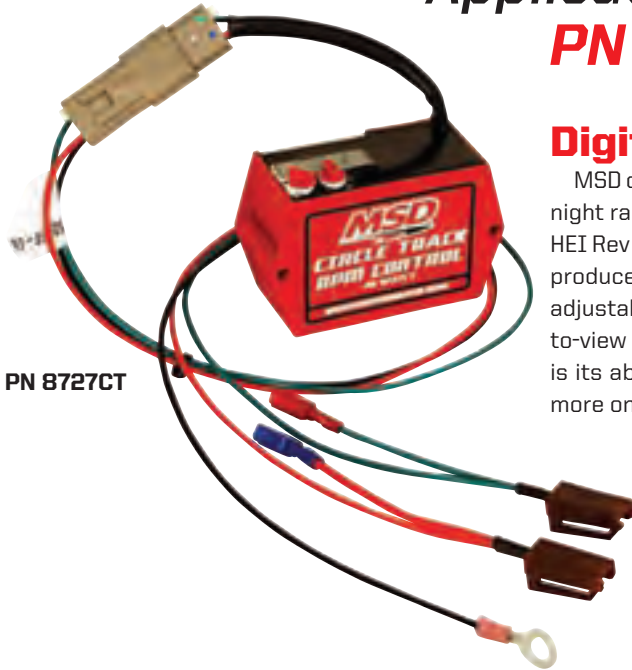
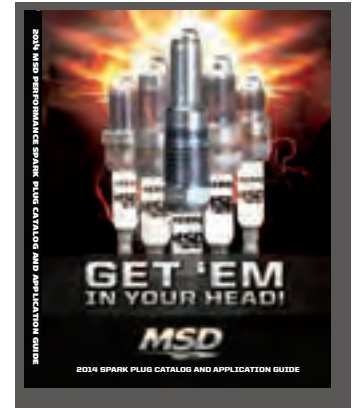

PN 8727CT

Digital Soft-Touch HEI Rev Limiter

MSD designed this new Digital Rev Limiter with the input of Saturday night racers and sanctioning bodies! The new MSD Digital Soft-Touch HEI Rev Limiter is designed to plug into nearly any HEI distributor and produces an accurate, smooth rev limiting action. The rpm limit is adjustable from 3,000 - 9,000 rpm via two rotary dials with an easy-to-view LED to display the value. A unique feature of the this Limiter is its ability to record the highest rpm reached during a race. Learn more on page 134.

Power Grid 3-Stage Delay Timer

This component plugs inline to the communication network of the Power Grid and provides you the ability to activate up to three individual outputs based on time. When the clutch/transbrake is released, the timings begins will trigger a relay to activate a shifter, nitrous solenoid or whatever other device you need. For Power Grid details, flip ahead to pages 56-59.



PN 7760



NEW FOR 2015

A Taste of Nostalgia - Y-Block and 392 Hemi Distributors

It's cool to see classic old engines powering hot rods as they add a touch of nostalgia both visually and their unique exhaust tone. To keep these classics hitting on all cylinders, MSD now offers a Pro-Billet Distributor for the 392 Hemi and the Ford Y-Block. Check out pages 102 and 103 for details.

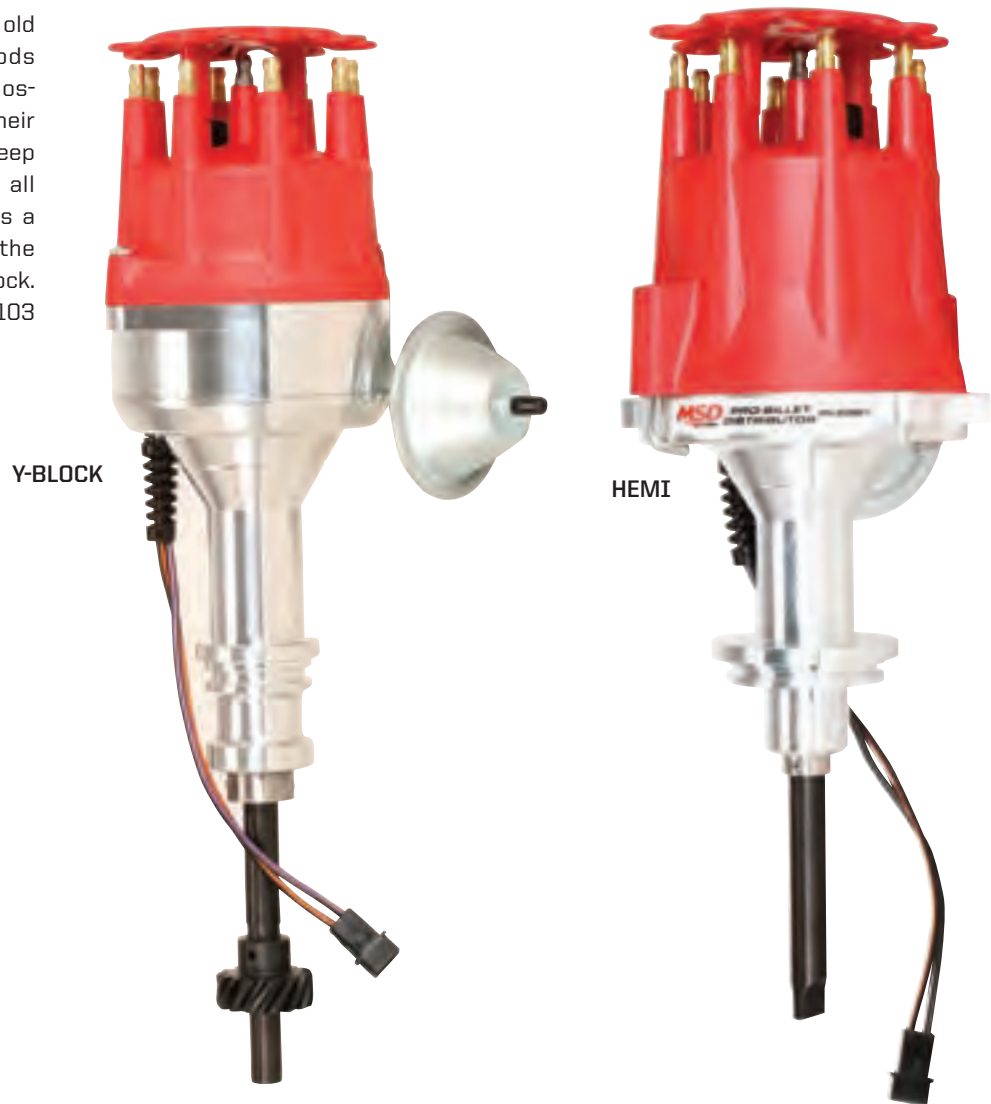

Y-BLOCK

HEMI

Street Fire® Coils for Late Model Muscle Cars

We're excited to expand our value based ignition line, Street Fire, to include coil upgrades for the GM LS platform, Ford Coyote and Chrysler Hemi engines. These coils are based on OEM installation with factory style connectors yet deliver improved spark energy across the full rpm range to improve performance of your modern muscle car. See more Street Fire products on pages 155-161.



Atomic EFI
Starters/
Alternators
Spark Plugs
Ignitions
Late Model
Coils
Distributors
Crank
Timing/RPM
Controls
Spark Plug
Wires
Street Fire
Marine
Accessories
Specialty
Items
Promo



CATALOG SYMBOLS



Selected Products Receive California ARB Executive Orders

Performance aftermarket parts sold in the U.S. are subject to laws that govern which parts can be legally sold, distributed and installed on street driven vehicles with emission controls. It is our responsibility at MSD to comply with these laws and to notify you of which MSD products have received California Air Resources Board (CARB) Executive Order numbers. As of this writing, the EPA accepts a CARB exemption as reasonable basis for meeting the requirements of Memorandum 1A in the Federal Clean Air Act of 1990. Consequently, MSD parts with E.O. Numbers are legal for sale, distribution and installation in all states. Below is a brief description of the types of products we offer and how to identify which parts are legal for emission controlled vehicles.

MSD products with a CARB Executive Order Number next to the part number indicates that the product has been assigned an E.O. number and is legal to sell, distribute and install on emissions controlled, street driven vehicles in all 50 states. To identify which MSD products have an E.O. number, look for the E.O. stamp (shown) next to the product. Most exempted MSD products can be installed on emission controlled vehicles through 2003. MSD has several products that are exempt for vehicles equipped with OBD II which are shown with an OBD II Legal symbol.



LS Coils



Atomic EFI is Carb Approved!

The Atomic TBI fuel injection system, PN 2900 and PN 2910, now carry an Executive Order Number making the system legal to install on 1987 and older GM vehicles in California! The Atomic TBI system received E.O. Number D-722 which permits the system to be installed in place of the factory carburetor on 1987 and older GM passenger cars and trucks originally powered by a V8 engine.



For Racing and Off-Road Use Only*

Many MSD products are intended for use on racing vehicles only and will never be used for street or highway applications in any state. These products can be identified by the asterisk (*) next to the part number which means these parts are not legal for sale or use on pollution controlled vehicles.

Legal To Sell, Distribute And Install - E.O. Not Applicable

All other products listed in this catalog, which do not have any callout next to the part number, indicates that these parts do not require an Executive Order Number and are legal to sell, distribute and install on all vehicles. This includes plug wires, caps, rotors and other components, including MSD Coils.

Application Icons

MSD offers a variety of ignition controls, coils and distributors that are designed for various applications. In many cases, there is considerable overlap in what a product is used for. For instance, the 6AL Ignition is right at home on the street or on a Saturday night special dirt track car!

To help identify what specific products are designed for, we've designed several icons that are used throughout the catalog.



Street

From daily drivers to weekend cruisers, these parts are made to be driven. Note that this **does not** mean that the product is legal to install in California or states that enforce CARB approval.



Track and Offroad

For parts designed to handle the rigors of the banked oval, road course and off-road.



Strip

Designed for race vehicles covering the quarter mile or longer.



Marine

These parts are specifically designed for marine use.

Atomic EFI
Starters/ Alternators
Spark Plugs
Ignitions
Late Model
Coils
Distributors
Crank Triggers
Timing/RPM Controls
Spark Plug Wires
Street Fire
Marine
Accessories
Specialty Items
Promo



WHAT MSD CAN DO FOR YOU

Who needs an MSD ignition?

Factory ignition systems and their components are designed to be inexpensive to produce while providing adequate performance, at best. For the majority of drivers, 'adequate' is tolerable, which leaves a lot of room for improvements. For anyone looking to improve their car's performance or driveability, an MSD should be at the top of their list of upgrades.

An MSD Ignition uses capacitive discharge (CD) technology to produce a very high primary voltage. This high voltage is always present regardless if you're at an idle or racing down a straight away at 10,000 rpm. By introducing a powerful spark to the air/fuel mixture, the variability between cycle-to-cycle combustion events is reduced. Among the beneficial effects of this reduced variability are a smoother idle and an improvement in overall engine performance. There are numerous variables than can affect the variability of combustion events, such as: fuel octane, fuel quality, condition of the spark plugs and wires, driving habits, atmospheric conditions, and design of the overall engine package (intake manifold, cylinder heads, cam, exhaust, etc.).

When you consider all of these variables, it is easy to see that achieving complete combustion of the air/fuel mixture every time is unlikely. When you have a high energy spark from an MSD, you can be assured that the fuel mixture is going to be fully combusted to generate the most performance possible.



Classic, race or late model, MSD has the performance your engine needs.



Which MSD is Right for Me?

You'll notice that MSD offers quite a few different ignitions, coils and distributors. Our components fit a wide range of vehicles over a broad range of years, makes and models. Because our parts are so universal, it makes it very difficult to pin point exact applications, such as for a specific year, make or model.

Do you have a street rod that you drive to different shows and events? How about a muscle car that sees double duty at the bracket races? Or do you have an off-road truck that gets beat around the desert at high rpm for hundreds of miles? Drag car? Land speed racer? Road course? Dirt Track? You get the picture.



- Atomic EFI
- Starters/
- Alternators/
- Spark Plugs
- Ignitions
- Late Model
- Coils
- Distributors
- Crank
- Triggers
- Timing/RPM
- Controls
- Spark Plug
- Wires
- Street Fire
- Marine
- Accessories
- Specialty
- Items
- Promo



STREET ROD & MUSCLE CARS



Accessories
Specialty
Items

Promo

Marine

Street Fire

Spark Plug
Wires

Timing/RPM
Controls

Crank
Triggers

Distributors

Coils

Late Model
Ignitions

Spark Plugs

Starters/
Alternators

Atomic EFI



Street Rods Muscle Cars and Classics

Many people think of MSD as ignition parts for race cars. Well of course that's true, but we also offer a long line of products for street rods and muscle cars. Ignition upgrades are an important piece of overall drivability from starting to top end!

MSD offers Ready-to-Run Distributors for popular V8 engines, including cool vintage powerplants such as Ford FE, early Hemis, Chevy 348/409 and even Buick Nailheads. A CD Ignition such as a Digital 6AL will bring a big block to life - and can even be used with a factory distributor.

There are plenty of combinations for different engines and applications. Check out a few examples.



MSD now offers an incredible electronic fuel delivery system, the Atomic EFI.

This system bolts in place of standard square-bore carburetors and in place of stock GM fuel rails on LS engines. These systems deliver modern drivability benefits to classic hot rods and muscle cars.

Don't let wiring or programming intimidate you - the Atomic EFI is a self learning system that is almost too simple to install. Check out pages 18-29 to see how easy fuel injection can be.

LEVEL 1

The MSD Ready-to-Run Distributor line is the perfect for street rods and muscle cars. The distributor features a high output ignition module and simple three wire installation. This keeps the engine compartment looking clean and helps retain the original appearance on muscle cars.

Ready-To-Run Distributor

Models available for most V8 engines, see the distributor chart starting on page 82.

- Maintenance-free magnetic pickup
- High output ignition module
- Easy three wire installation
- Built-in rev limiter

Blaster 2 Coil

Available in red or chrome, the Blaster 2 Coil will produce a high output spark for your engine every time. Check out page 75.

8.5mm Super Conductor Wires

Wires are the arteries of your ignition system! MSD's low resistance 8.5mm wires are available in red or black in a variety of custom fit or universal sets. See page 139 for more wire information.

DynaForce™ Starters

Check out the line of DynaForce Starters to get your rod cranked up and running. See page 32-35.



STREET RODS & MUSCLE CARS

LEVEL 2



Packing a little more power in your street car? Maybe a vintage set of carbs or a thumping cam? Stepping up to a multiple sparking, CD ignition is the best bet.

MSD Digital 6A or 6AL Ignition

An MSD 6A Ignition will improve the overall performance of your engine thanks to its high output capacitive discharge sparks. Below 3,000 rpm the ignition delivers multiple sparks that will clean up the idle, improve starting and throttle response. Step up to the 6AL to have an engine saving rev limiter.

Pro-Billet™ Distributor

An MSD 6A can be used with your stock distributor, but chances are that the unit is more than a little worn out. A Pro-Billet Distributor will provide accurate trigger signals with a mechanical advance you can adjust to your application.

Blaster™ 2 Coil and 8.5mm Wires

A red or chrome Blaster 2 Coil will make sure you get the most spark possible. See page 75. See page 139 for 8.5mm wires.

Atomic® EFI

Enjoy the driveability benefits of fuel injection with the Atomic EFI System. Easy to install and set up - learn more on pages 18-27.

LEVEL 3



For the ultimate machine the MSD Programmable 6AL-2 gives you the features you need to control your boost or nitrous fed engine.

MSD Programmable 6AL-2 Ignition, PN 6530

The MSD Programmable 6AL-2 is perfect for weekend bracket racers. High output, without the high cost plus the ignition provides programmable control to meet your engines needs. See page 48 for details.

Blaster HVC Coil, PN 8252

The Blaster HVC Coil is the best choice for high powered street engines. These coils are designed to maximize the energy output of an MSD Ignition Control plus they run cooler at sustained high rpm and can handle the kick of nitrous or boost. See page 78.

8.5mm Super Conductor Wires

Available in custom fit sets for LS and first gen HEMIs. If you care to remote mount the LS coils, check the universal sets; PN 32079 and PN 32073 on page 142.

Atomic EFI
Starters/
Alternators
Spark Plugs
Ignitions
Late Model
Coils
Distributors
Crank
Triggers
Timing/RPM
Controls
Spark Plug
Wires
Street Fire
Marine
Accessories
Specialty
Items
Promo



DRAG RACING



Atomic EFI
Starters/
Alternators
Spark Plugs
Ignitions
Late Model
Coils
Distributors
Crank
Triggers
Timing/RPM
Controls
Spark Plug
Wires
Street Fire
Marine
Accessories
Specialty
Items
Promo



Drag Racing

Street/Strip. Strip/Street. Or just Strip. MSD has you covered.

From bracket racing to 6-second turbo outlaw cars, MSD offers an ignition that is right for you. Not only do we have the ignition, but we have coils, timing controls crank triggers and wires designed specifically to help you get the most out of your drag car!

LEVEL 1



For entry level bracket racing, and even for cars that see double duty on the street and the strip, the 6AL-2 is perfect. The higher output CD sparks will burn high octane fuels and produce full output sparks through redline rpm. Be sure to wrap up the complete system with a Pro-Billet Distributor, Blaster HVC Coil and 8.5mm Wires.

MSD 6AL-2 Ignition, PN 6421

The MSD 6AL-2 is perfect for weekend bracket racers. High output, without the high cost plus the ignition provides a built-in 2-Step Rev Control so you can set a starting line rpm limit. See page 47 for details.

Pro-Billet™ Distributor

As rpm climbs, so does the importance of accurate trigger signals. A Pro-Billet Distributor ensures precise signals through the use of a magnetic pickup. Also, the ball bearing guide keeps the shaft steady at rpm to improve spark delivery. Check out pages 90-91 for your engine.

Blaster™ HVC II Coil, PN 8253

The big blue Blaster HVC, PN 8253, is ideal to deliver the most voltage and current possible with the 6AL-2 Ignition. Page 78.

DynaForce™ Starter

Check out the line of DynaForce Starters to get your racecar cranked up. See page 32-35.

LEVEL 2



Packing a little more power with higher compression, better heads, solid cam and a tunnel ram? It's time to step up to a 7AL-2 Ignition for the increased output and performance.

MSD 7AL-2 Plus Ignition

The 7AL-2 set the bar in drag racing for high output ignitions and it is still a great choice. Higher compression and rpm are no problem for this ignition, plus you get the benefit of a built-in 2-Step Rev Control. One rpm limit for the starting line, and the other for overrev protection.

Pro-Billet™ Distributor

As rpm climbs, so does the importance of accurate trigger signals. A Pro-Billet Distributor ensures precise signals through the use of a magnetic pickup. Also, the ball bearing guide keeps the shaft steady at rpm to improve spark delivery. Check out pages 90-91.

Pro Power™ HVC II Coil, PN 8261

There are several drag race coils available from MSD, but the Pro Power HVC II fits every application using a 7-Series Ignition. Stout spark packed with voltage and energy. Page 79.

8.5mm Super Conductor Wires

Finish off your new ignition with a set of the Super Conductors! Available in red or black in a variety of custom fit or universal sets. See page 139 for more wire information.

LEVEL 3



When you step up the power level, the need for adjustments and advanced ignition tuning are required. The Power Grid Ignition System delivers. At this point it's also recommended to mount a crank trigger for absolutely accurate trigger signals.

Power Grid™

The Power Grid Ignition Control delivers incredible power with incredible tuning capabilities. MSD's View Software lets you map and program timing curves for every gear, rev limits and much more. Be sure to check out pages 56-59 for more information on the Power Grid Ignition System.

Flying Magnet Crank Trigger Kit

There is no better place to trigger the ignition than at the crank. MSD's Crank Trigger Kits are the most accurate available and rely on special rare earth magnets to trigger the ignition. See page 125.

Pro Power™ HVC II Coil, PN 8261

The Pro Power HVC II is ideal for the Programmable 7 Ignitions. Page 79.

DynaForce™ Starter

The best ignition won't do you much good if your starter won't crank your engine. MSD's DynaForce Starters will roll your engine over every time. See pages 32-33.



DIRT & TRACK IGNITIONS

Promo
Accessories
Specialty
Items
Marine
Street Fire
Spark Plug
Wires
Timing/RPM
Controls
Crank
Triggers
Distributors
Coils
Late Model
Ignitions
Spark Plugs
Starters/
Alternators
Atomic EFI



Circle Track & Off-Road Racing

Circle track, road course and off-road races can be some of the most severe and abusive environments in the world where electronics are expected to live. Extreme use, dirt, grime, shock, vibration, and much more can take their toll on any part. At MSD we have gone above and beyond the normal protection standards to make parts that are specifically made to handle all the battering.

From circling a dirt track, to trophy trucks, to NASCAR, and everything in between, these ignition products will keep you in the race from green to checkered.

LEVEL 1

Saturday night dirt track action! Local dirt tracks are fun whether you're strapped in the car or sitting in the stands. One of the most popular distributors used on these cars is the tried and true Chevrolet HEI. These distributors are a favorite due to their internal coil and one wire installation. Some classes even mandate them. Fortunately, MSD has the weekend warrior covered.

HEAT HEI Module
The highest output HEI module available! Over 7.5 amps are driven into the coil for full power through 9,000 rpm. Plus a built-in rev limiter - See page 86.

Ultimate HEI Kit, PN 8501
This kit has everything you need to update your HEI. It includes the high output HEAT Module, the matched HEI Coil, MSD molded Cap and rotor, plus the coil cover/wire retainer.

Pro-Billet™ HEI Distributor, PN 8365
Drop in a complete Pro-Billet HEI! See page 85.

8.5mm Super Conductor Plug Wires
Dirt track racing is tough on plug wires! MSD's Super Conductor wires feature the strongest crimps and durable sleeves to perform in the harsh conditions. See page 139 for more wire information.





DIRT & TRACK IGNITIONS

Atomic EFI
Starters/
Alternators
Spark Plugs
Ignitions
Late Model
Coils
Distributors
Crank
Triggers
Timing/RPM
Controls
Spark Plug
Wires
Street Fire
Marine
Accessories
Specialty
Items
Promo

LEVEL 2



Throwing a rooster of dirt or rubbing paint in the corners, racing puts a serious amount of abuse on the ignition. Be ready with MSD!

Extreme Duty 6ALN Ignition, PN 6430

Extreme racing conditions call for an extreme ignition. The 6ALN is designed to put up with the abuse of offroad and other racing. Sealed, locking connectors are supplied and the electrical circuits are encased in a vibration-proof compound. A built-in rev limiter will save the engine when you're in the air. See page 49.

Pro-Billet™ Distributor

A Pro-Billet Distributor ensures precise signals through the use of a magnetic pickup. MSD also offers distributors with dual pickups so a complete redundant system can be installed. See page 111.

Blaster™ HVC II Coil, PN 8253

There are a couple coil choices for this level such as the High Vibration Blaster, PN 8222, and the Blaster HVC II. The big blue coil delivers a snap of high voltage backed by the current to ensure combustion. See page 78.

DynaForce™ Starters

Check out the line of DynaForce Starters to get your vehicle cranked up. See page 32-35.

LEVEL 3



When you reach the speedways or open road course, your engine demands the best spark and the most accurate distributor. MSD has thousands of miles of proven performance on speedways around the country and have developed specific professional racing components to fit these requirements.

6 HVC Ignition Control

Designed specifically for high rpm and long endurance, the 6 HVC is the only choice. Advanced components produce incredible voltage and energy while running cool. See page 50.

HVC Coil, PN 8250

Designed specifically for the 6 HVC Ignition. Heavy duty mounts and secure terminal connections exceed the demand. See page 78.

Pro-Billet™ Distributor

A Pro-Billet Distributor ensures precise signals through the use of a magnetic pickup. MSD also offers distributors with dual pickups so a complete redundant system can be installed. See page 111.

8.5mm Super Conductor Plug Wires

Finish off your new ignition with a set of the Super Conductors! Available in red or black in a variety of custom fit or universal sets. See page 139 for more wire information.



LATE MODELS

Promo
 Accessories
 Speciality
 Items
 Marine
 Street Fire
 Spark Plug
 Wires
 Timing/RPM
 Controls
 Crank
 Triggers
 Distributors
 Coils
 Late Model
 Ignitions
 Spark Plugs
 Starters/
 Alternators
 Atomic EFI



Late Model

Today's new muscle cars are getting more high-tech, and giving better performance all the time. MSD is following suit offering new products for late model applications that help take your new ride to the next level. We offer a series of products for each new motor including a Ford Mod Motor, the GM LS series, and the Chrysler HEMI. We make sure that no matter where you put your muscle car brand loyalty you can have a full MSD ignition to fire the engine.

FORD

When Ford moved to the 4.6L Modular Motor in 1996, it left a lot of die hard 5.0L enthusiasts scratching their head. It didn't take long for those enthusiasts and the performance aftermarket industry to dig in and start making power with the OHC engines. In fact, the new 5.0L generation has just begun and MSD is working on ignition products for the 2014 engine platform.

Blaster™ Coil-on-Plugs

MSD's replacement coils for the Mod Motors are designed with improved materials and product increased high rpm operation and are great for forced induction systems. See pages 70-71.

'99-'04 SOHC 4.6L	PN 82428
'05-'09 SOHC 4.6L	PN 82438
'99-'04 DOHC 4.6L	PN 82448
2011-On Coyote 5.0L	PN 82488

6-Mod Controller

Program the timing and rpm limits of your Mod Motor through a PC! Map a timing curve or a boost retard chart while setting a launch rpm limit or even a nitrous retard. If you're going the retro route with a carburetor, the 6-Mod will power the system! See page 65.

2-Step Launch Control, PN 8734

Plug this compact device into the factory connectors of your Mod Motor and you'll be able to activate a lower rpm limit to use on the starting line. The limit is adjusted with rotary dials and will hold the engine at a steady rpm to help improve your holeshots and ET. See page 132.

CHEVY



The LS engine platform is already hot, but MSD can fan the fire with increased spark power and advanced ignition controls.

Performance LS Coils

Upgrade from the factory coil packs with MSD performance! Our coils create increased energy and deliver multiple sparks at lower rpm to ensure combustion. Three models are available in sets of eight. See page 68-69.

- LS1/LS6 - PN 82858
- LQ9 - PN 82868
- LS2/LS7 - PN 82878

6LS Ignition Control

The 6LS Controllers allow you to set a different timing curve, program a boost retard timing map, set a 2-Step rev limit and even retard the timing for a shot of nitrous. The Controllers can be used with either factory EFI (harness accessories required) or will control the entire ignition if you choose the old school route of a carburetor. See page 64.

2-Step Launch Control, PN 8733

Improve your car's consistency off the line with the 2-Step Launch Control! This compact rpm limiter plugs directly into the factory connectors and allows you to set a low rpm limit in 100 rpm increments. See page 132.

8.5mm Super Conductor Plug Wires

Sure the wires are only 10" long on LS engines, but the 8.5mm MSD wire still has a lot lower resistance than the factory wires. We also offer universal sets that will help if you decide to move the coils from the valve covers.

CHRYSLER



Few engine names perk the ears of car guys like the word 'Hemi'. When Chrysler launched the late model Hemi, fans came out in droves. Today you'll find these engines being retrofitted into muscle cars and on the race track. MSD can help light them up!

Late Model Blaster™ Coils

Fire up your new Hemi with a set of MSD's Blaster Coils. The coils are a direct replacement and accept factory connectors, but are spec'd out with superior materials and winding ratios to improve the output. See page 72-73.

- Early Model, '03-'05, PN 82568
- Later Model, '06-'14, PN 82558

6-HEMI® Controller, PN 6013

Take control of your Hemi's timing and rpm with the 6-HEMI Controller. For factory EFI or carbureted engines, this controller puts performance at your fingertips with advanced PC programming! See page 66.

8.5mm Super Conductor Plug Wires

MSD also offers a set of wires for the early Hemi design. The low resistance ensures the most spark delivery!

- '03-'05 5.7L Hemi, Red, PN 32039
- '03-'05 5.7L Hemi, Black, PN 32033



Atomic EFI
Starters/Alternators
Spark Plugs
Ignitions
Late Model
Coils
Distributors
Crank Triggers
Timing/RPM Controls
Spark Plug Wires
Street Fire
Marine
Accessories
Specialty Items
Promo

If you have a late model truck and needs a little extra oomph MSD has just what you need. We make coil sets for each of the biggest sellers from the Big Three. We know that trucks can live a hard life and MSD keeps the Fire to Drive in your truck whether you're on the work site, commuting, or towing a boat.

GM



GM trucks using the LS engine platform are used for towing and racing. Either way, MSD has them covered.

Performance LS Coils

Upgrade from the factory coil packs with MSD performance! Our coils create increased energy and deliver multiple sparks at lower rpm to ensure combustion. Three models are available in sets of eight. See page 68-69.



8.5mm Super Conductor Plug Wires

Sure the wires are only 10" long on LS engines, but the 8.5mm MSD wire still has a lot lower resistance than the factory wires. Or, we offer universal sets that will help if you decide to move the coils from the valve covers. See page 139.

FORD



When Ford moved to the 5.4L Modular Motor it didn't take long for truck enthusiasts to start looking for performance goodies to install. MSD has answered with upgraded coils and controls.

Blaster™ Coil-on-Plugs

MSD's replacement coils for the Mod Motors are designed with improved materials and product increased high rpm operation and are great for forced induction systems. See page 70-71.



6-Mod Controller

Program the timing and rpm limits of your Mod Motor through a PC! Map a timing curve or a boost retard chart while setting a launch rpm limit or even a nitrous retard. If you're going the retro route with a carburetor, the 6-Mod will power the system! See page 65.

DODGE



Dodge trucks need a Hemi. It's the only way to go. Torque and power define the Hemi, just like high output sparks define MSD.

Late Model Blaster™ Coils

Fire up your new Hemi with a set of MSD's Blaster Coils. The coils are a direct replacement and accept factory connectors, but are spec'd out with superior materials and winding ratios to improve the output. See page 72-73.



8.5mm Super Conductor Plug Wires

MSD also offers a set of wires for the early Hemi design. The low resistance ensures the most spark delivery! See page 139.

We dare to put fire on water! MSD makes a full line of products that are specifically made for marine applications. Each of these products are designed to handle harsh, wet conditions, and most importantly they are UL certified. The UL certification shows their dependability and can help with insuring private boats. Check out the suggestions below to find what's right to fire your boat.

STAGE 1



The MSD Ready-to-Run Distributor line is ideal for cruisers. The distributor features a high output ignition module and simple three wire installation. A heavy duty gear is installed, the cap bolts securely to the billet base and flame arrestor holes are machined into the base. See page 158.



High Vibration Blaster™ Coil, PN 8222

The High Vibration Blaster Coil is the best choice for marine use. The windings are encased in epoxy for vibration resistance. Check out page 75.

8.5mm Super Conductor Plug Wires

Wires are the arteries of your ignition system! MSD's low resistance 8.5mm wires are available in red or black in a variety of custom fit or universal sets. See page 139 for more wire information.

STAGE 2



Packing a little more power in your boat? Stepping up to a multiple sparking, CD ignition is the best choice.



MSD 6M2-L Ignition

The 6M2-L Ignition will improve the overall performance of your engine thanks to its high output capacitive discharge sparks. See page 162.

Pro-Billet™ Distributor

Pro-Billet Distributor will provide accurate trigger signals with a mechanical advance you can adjust to your application. See page 163-164.

High Vibration Blaster Coil, PN 8222

The High Vibration Blaster Coil is the best choice for marine use. The windings are encased in epoxy for vibration resistance. Check out page 75.

STAGE 3



Drag boats are easy for MSD! There's no better than the 7AL-2 Ignition, a crank trigger, Pro-Billet Distributors and a set of 8.5mm wires to ensure the best performance from your race boat!

7AL-2 Plus Ignition, PN 7222

Higher compression and rpm are no problem for this ignition, plus you get the benefit of a built-in 2-Step Rev Control. See page 53.

Pro Power™ HVC II Coil, PN 8261

Stout spark packed with voltage and energy. See page 79.

Flying Magnet Crank Trigger Kits

There is no better place to trigger the ignition than at the crankshaft. MSD's Crank Trigger Kits are the most accurate available and rely on special rare earth magnets to trigger the ignition. See page 125.

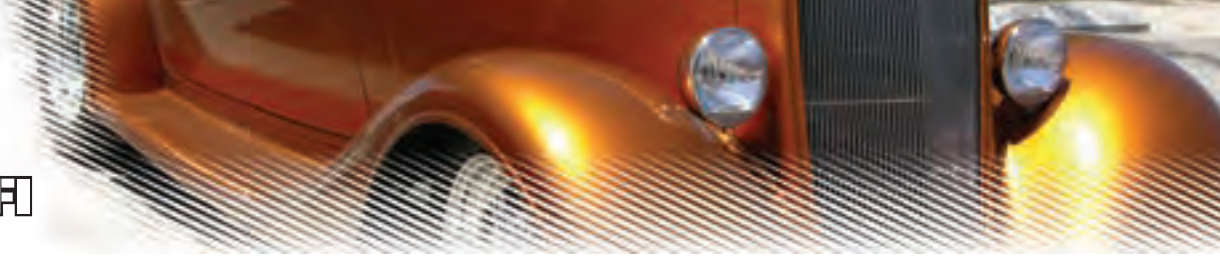

Atomic® EFI

MSD's Atomic EFI systems were designed with two goals in mind - simplify the installation and improve overall performance. Simplicity was achieved with less wiring and fewer connections to ease the installation process as well as programming the system through a compact handheld monitor. Performance is served from idle to full throttle blasts with crisp throttle response and comprehensive driveability improvements.

MSD offers two Atomic EFI systems, a Throttle Body system designed to replace a carburetor and the Atomic LS, for the popular Gen III/IV GM powerplant. Both systems are based on self-learning EFI technology to deliver incredible performance and reliability along with MSD's promise of simplified installation and initial setup.



See Pages 19-23 for TBI information and applications.

See Pages 24-29 for Atomic LS information and applications.



- Less Wiring, Fewer Connections
- Self-Learning technology
- Simple to setup - no laptop required
- Capable of running with boost or nitrous
- Ignition timing control
- Improved overall driveability including idle, throttle response, starting and cruising



Less Wiring - More Performance

Today, there is no reason your muscle car or hot rod shouldn't start, idle and cruise down the road as smoothly as a newer car. When it comes to the installation and initial setup, the Atomic Throttle Body Injection system is the easiest way to convert your classic car to EFI. As far as performance, the advanced self-learning technology of the Atomic is constantly monitoring and analyzing the engine's operating conditions ensuring that you receive the best possible driveability.

With the ECU and built-in sensors integrated into the throttle body, the Atomic has fewer wiring connections than any other system, plus there is no bulky ECU to mount. This design makes the conversion to EFI much easier to install and program while keeping things clean under the hood.



- **Less wiring and fewer connections for the easiest installation**
- **Integrated sensors reduce the number of connections**
- **Mounts in place of standard square bore carburetors**
- **Self-learning technology keeps the engine performing smooth through any condition**
- **Supplied with wide-band O2 and coolant temp sensors for easy installation**
- **Controls the activation of two cooling fans**
- **Supports nitrous and boosted applications**

The Atomic EFI provides the performance and driveability benefits that you expect from fuel injection. Quick starts, smooth idle and great throttle response just to name a few. Combine the fact that the Atomic will support ignition timing through the ECU and you have a win-win combination. Initial timing is handled through a compact handheld monitor where you simply answer a few car-guy questions about your engine and you're off and running! This monitor can be removed from the car after it's running, or left in place so you can monitor engine parameters in real-time.

The Atomic TBI system will turn the car you love into the car you love to drive.



- Atomic EFI
- Starters/Alternators
- Spark Plugs
- Ignitions
- Late Model
- Coils
- Distributors
- Crank Triggers
- Timing/RPM Controls
- Spark Plug Wires
- Street Fire
- Marine
- Accessories/Specialty Items
- Promo



ATOMIC® EFI



The crown jewel of the Atomic EFI system is of course the throttle body itself. Our engineers have countless hours in designing the throttle body with great performance and appearance. The compact design is similar in size to a carburetor, yet contains an Electronic Control Unit, four injectors, the Idle Air Control motor, TPS, MAP, Intake Air Temperature (IAT) sensor, and more. It's easy to overlook all of the details so let's have a closer look -

Atomic EFI
Starters/Alternators
Spark Plugs
Ignitions
Late Model
Coils
Distributors
Crank Triggers
Timing/RPM Controls
Spark Plug Wires
Street Fire
Marine
Accessories
Specialty Items
Promo

Internal Fuel Rail

By integrating the fuel rail we were able to remove fitting connections to reduce the areas that a leak could develop (not to mention the enhanced appearance).

Mount and Blades

The Atomic throttle body will bolt in place of a standard square bore carburetor and accepts most common throttle and kick down linkages. The throttle bores are 1.75" diameter and each blade is supported with precision roller bearings for smooth pedal operation.

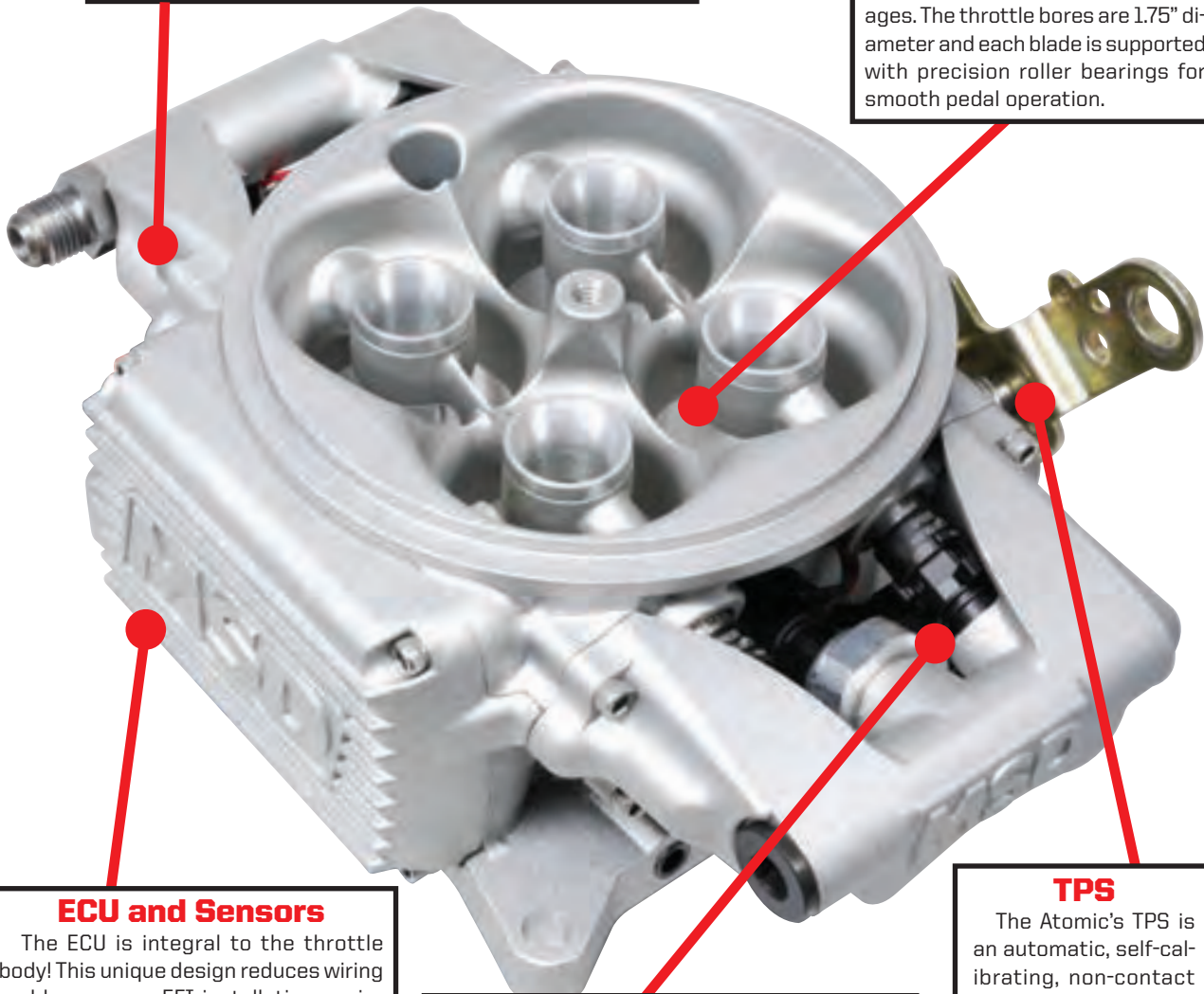

ECU and Sensors

The ECU is integral to the throttle body! This unique design reduces wiring and keeps your EFI installation easier than ever. The TPS, MAP, IAT and fuel pressure sensors are all incorporated into the ECU saving you wiring and connections. In fact, the only sensors you need to connect are the coolant temp and the wide-band oxygen sensors.

Injectors

Fuel delivery is provided by four precision 80-pound injectors. These injectors feature a stainless steel ball and seat metering method for maximum internal sealing. For a secure mount the injectors are sealed between the housing and the cast fuel rails.

TPS

The Atomic's TPS is an automatic, self-calibrating, non-contact sensor. That means you don't have to worry about configuring it during set up. Also, with no contact, there is nothing to wear out or replace.



Power Module

This compact device handles the high power systems such as the electric fans and the fuel pump control. It simply plugs into the throttle body via MSD's CAN-Bus network with a single connection. It supplies power to the fuel pump so you don't need to run an external relay. Also, it has two activation wires so you can set temperature settings for dual electric cooling fans.

The Handheld Monitor and the throttle body both plug into the Power Module through single connectors to tie the entire system together.



Handheld Monitor

The Atomic's handheld monitor gives you access to the Atomic EFI setup for your application! This monitor, combined with the self-learning technology from the internal ECU, eliminate the need for a laptop. Simply push the joystick left, right, up, and down to move through the options. Within minutes the setup will be complete! Plus, the handheld will act as a dash to display all that is happening in your new Atomic injected engine such as coolant temp, TPS, air/fuel ratio, rpm, IAC count, injector cycle and much more.



Capabilities and Features of the Atomic® TBI

CARB Approved: The Atomic TBI, PN 2900 and PN 2910, have been issued an Executive Order Number, D-722, from the California Air Resource Board (CARB). This means it is legal to install the Atomic TBI system on '87 and older GM passenger vehicles that were originally equipped with a V8 engine and carburetor.

Rev Limit: You can easily adjust and set a fuel based rev limit with the Atomic to protect your engine from the chance of overrev damage caused by driveline failure or a missed shift.

Power: The Atomic TBI is designed to support up to 625 horsepower when used with the specified high horsepower fuel pump. The Master Kit is supplied with the standard pump that will support 525 horsepower.

Timing Control: The Atomic system does more than just control fuel. When paired with an ignition control like the MSD 6A, the Atomic unit can control your engine's spark timing. The handheld gives three simple options to set the timing including the total, initial and rate of advance. It's like the springs and bushings on a distributor, but with digital control!

Nitrous Compatible: For nitrous fans, a wet system (one that supplies its own fuel to compensate for nitrous) can be run with the Atomic TBI! From the Atomic handheld monitor you'll be able to program a target air/fuel ratio that will be used when the nitrous is activated. There is also a setting that will retard the timing during nitrous activation.

Got Boost?: For boosted applications, whether it be a blow through or draw through, the Atomic can handle it. The throttle body incorporates a 2-bar MAP sensor and can manage up to 14-psi of boost. There is a value for a target air/fuel ratio during boost on the Handheld Monitor as well as a timing retard that is based off the desired amount of retard per pound of boost.



ATOMIC® EFI



Atomic Throttle Body Kits



PN 2900



PN 2910

Atomic TBI Master Kit - PN 2900

The Master Kit includes every component you need to complete an EFI conversion, including: Throttle Body, Power Module, Wide Band O2 Sensor, Handheld Monitor, harnesses and the Returnless Fuel Pump Kit which includes the pump (good to 525hp), filters, brackets, high pressure hose and clamps.

Atomic TBI Basic Kit - PN 2910

This kit is the right choice if your vehicle is already fit with a high pressure electric fuel pump, regulator and return line. The Basic Kit provides; the Throttle Body, Power Module, Wide-Band O2 Sensor, harnesses and the Handheld Programmer.



CARB APPROVED! The MSD Atomic TBI EFI system, PN 2900 and PN 2910, have been issued Executive Order Number, D-722, which permits the installation on 1987 and older GM passenger cars and pickups with a V8 engine and originally equipped with a carburetor.



PN 2920

Fuel Pump Kits

Standard Fuel Pump Kit - PN 2920

For engines up to 525hp, the standard Fuel Package includes all of the parts needed to upgrade a vehicle's fuel system to Atomic standards. Parts included: Fuel Pump, Pre-Filter, Post-Filter, 15 ft. 3/8" Fuel Line, Mounting Hardware

High Horsepower Fuel Kit - PN 2921

The Fuel Upgrade is a replacement fuel pump for vehicles making between 525-650hp. Parts included: Fuel Pump, Pre-Filter, Post-Filter, 15 ft. 3/8" Fuel Line, Mounting Hardware

Fuel Return Kit - PN 2922

If you plan to run a return line with your Atomic EFI system, this kit provides a regulator, 15 ft. of 3/8" line and the fittings to assemble.



PN 2921



PN 2922



PN 2925

Replacement Pumps

Standard Atomic Fuel Pump 525HP - PN 2925

High Horsepower Fuel Pump, 625HP - PN 2926

Atomic EFI
Starters/Alternators
Spark Plugs
Ignitions
Late Model
Coils
Distributors
Crank Triggers
Timing/RPM Controls
Spark Plug Wires
Street Fire
Marine
Accessories
Specialty Items
Promo



ATOMIC® TBI SUPPORT COMPONENTS

Atomic® TBI Throttle Position Output Module - PN 2939

In some applications such as with an electronic overdrive transmission, a Throttle Position Sensor signal is required. The compact TPS Module, PN 2939, plugs in-line to the Atomic TBI EFI system and delivers a universal 5-volt output signal that is required for electronic transmission controllers and other accessories.



Extension Harness, for the throttle body or the Monitor:

2-Foot - PN 7782

4-Foot - PN 7784

TBI, Throttle Body Unit Only - PN 2905

TBI, ECU Only - PN 2906

TBI, Power Module Only - PN 2911

TBI, Hand Held Monitor Only - PN 2912

TBI, Idle Air Control Motor - PN 2937

TBI, Map Sensor Assembly - PN 2933

TBI, Sensor Coolant Temp - PN 2934

Fuel Pressure Regulator - PN 2938

Pre-Fuel Filter - PN 2923

Post-Fuel Filter - PN 2924

3/8" Fuel Hose 15Ft. - PN 2927

Clamp Kit 35/64"-21/32" Dia, Qty 10 - PN 2928

TBI, Fuel Pressure Sensor - PN 2929



PN 2937



PN 2933

PN 2934



PN 2938



PN 2923



PN 2924



PN 2927



PN 2928
Set of 10



PN 2929



PN 2930



PN 2931



PN 2932



PN 2935



O2 Sensor Wideband - PN 2930

O2 Sensor Bung & Plug Only - PN 2931

Injector 80 Pound-per-Hour, Single - PN 2932

-6AN Fitting 90°, Socketless Black - PN 2935

-6AN Fitting Straight Socketless Black - PN 2936

PN 2936



Atomic EFI
Starters/
Alternators
Spark Plugs
Ignitions
Late Model
Coils
Distributors
Crank
Triggers
Timing/RPM
Controls
Spark Plug
Wires
Street Fire
Marine
Accessories
Specialty
Items
Promo

MSD

ATOMIC® LS EFI

Atomic EFI
Starters/
Alternators
Spark Plugs
Ignitions
Late Model
Coils
Distributors
Crank
Triggers
Timing/RPM
Controls
Spark Plug
Wires
Street Fire
Marine
Accessories
Specialty
Items
Promo

ATOMIC® EFI LS

The GM LS-based engine has been embraced by hot rodders, muscle car fans and racers alike. The lightweight and compact engine produces plenty of power and fits easily in many engine compartments. However, trying to retrofit the factory EFI system into a street rod or muscle car creates a number of challenges from wiring to programming.

Intimidating electronics and bulky wiring harnesses can quickly clutter the engine compartment and hurt the aesthetics of any hot rod. The massive factory ECU is not only a hassle to mount, but the sheer amount of wiring that goes along with it is simply overwhelming. MSD's Atomic LS EFI systems are designed to eliminate the intimidation and clutter when installing aftermarket EFI on an LS engine.

By integrating the ECU onto the fuel rails MSD has eliminated the bulky ECU and tangled mess of a wiring harness. The self-tuning technology of the Atomic system allows the average do-it-yourself hot rodder to easily wrap up an LS engine transplant. Initial setup is a breeze with the supplied handheld monitor and by simply answering a few car guy questions during the initial setup, your Atomic LS'd project will be ready to drive.



**Clean Installation
Less Wiring
No PC Required**



**PATENT
PENDING**

- Electronics are integrated with the fuel rails to significantly reduce the amount of underhood wiring
- No PC necessary while self-learning technology eases the initial setup
- Improves the aesthetics of the engine bay with less wiring and NO ECU to mount
- Supports up to 1,000 horsepower
- Kits available for most popular LS engine swaps
- Recognizes 24- or 58-tooth crank trigger wheels
- Supports boost and nitrous



ATOMIC® LS EFI

Integrated Components and Wiring

MSD is breaking new ground in electronic fuel injection with the next generation of Atomic EFI - the all new Atomic LS system. Where the Atomic TBI consolidated electronics and sensors into the throttle body itself, the LS platform incorporates the electronics into the fuel rails of the system! There's no bulky ECU to mount and; therefore, no wires to route to and from - it's all on the engine, hidden in plain sight.

There's no need for a PC, complicated software or tuning experience. Simply bolt it on, plug it in, answer a few car-guy questions using the supplied handheld controller and start the engine. The Atomic LS will begin learning and tuning your LS engine as soon as you fire it up. Advanced adjustments can be made to air/fuel targets, pump squirt, ignition timing and much more. The self tuning Atomic LS system will give you the performance and driveability you expect from your LS engine.

MSD has a variety of advanced programming features that are simple to navigate using the handheld programmer. These unique features allow you to get the most performance and benefits from your new Atomic EFI system.



Atomic EFI

Starters/
Alternators

Spark Plugs

Ignitions

Late Model

Coils

Distributors

Crank
Triggers

Timing/RPM
Controls

Spark Plug
Wires

Street Fire

Marine

Accessories
Specialty
Items

Promo



- Adjustable temperature outputs to activate two cooling fans
- Advance or retard the ignition timing up to 10°
- Select a rev limit through fuel or ignition cut-off
- Compatible with OE Variable Valve Timing (VVT) cam control



ATOMIC® LS EFI



Atomic EFI

Starters/
Alternators

Spark Plugs

Ignitions

Late Model

Coils

Distributors

Crank
Triggers

Timing/RPM
Controls

Spark Plug
Wires

Street Fire

Marine

Accessories
Specialty
Items

Promo

The Atomic LS EFI system is a completely unique design that puts the EFI electronics right onto the fuel rails. This concept reduces the sheer amount of wiring required to control an LS engine. Each smart rail has the wiring and connectors required for each bank which saves time and effort when it comes to installation.

Fuel Rails

The foundation for the integrated fuel/electronic rails is a CNC machined aluminum fuel rail assembly. The inside diameter of the rails is equivalent to a -8AN line to provide plenty of fuel to feed engines up to 1000 horsepower. This includes engines with nitrous or forced induction as well.

Fuel/ECU Rails

The heart of the electronics are hidden in plain sight! The Atomic LS reduces wiring by integrating the Electronic Control Unit within the fuel rails! Advanced electronic control assemblies are mounted on each assembly and communicate through MSD's proprietary, patent-pending CAN-Bus technology.



Injectors

There are several Atomic LS fuel/ECU rails available, depending on your application. Each model is designed to operate with a specific engine/intake manifold such as an LQ9 truck intake, an LS2 or an LS7 platform. To learn more about a kit for your engine

Connectors

Having the ECU built into the fuel rails cuts down on miles of wiring. Each bank of the Atomic LS has only the connectors needed on each side of the engine. For instance, the coolant temperature connector is always on the driver's bank while the crankshaft position sensor is always on the passenger side. All sensors are wired with factory connectors to ease installation concerns.

Crank Sensor Connector

The crank sensor circuit of the Atomic LS will recognize whether your engine is a 24-tooth or 58-tooth trigger wheel so there is one less programming step for you! Other steps are taken care of when you select the actual engine configuration being used.



ATOMIC® LS EFI

Power Module and Handheld Monitor

The LS platform incorporates a Power Module, a compact component that is responsible for communication from the fuel rails to the fuel pump, fans, WBO2 as well as other inputs for nitrous, AC Kick-up or the 2-step launch control rev limit. There is a main connector, a power connector as well as the Handheld Monitor connection.

Don't fret about programming your Atomic EFI system as everything can be set right from the supplied Handheld Monitor. From the main menu you simply select from a few target settings, values and what engine you're working with. Scroll up and down through a few easy



parameters and your engine will be running in to no time. The Handheld can be unplugged and stowed away, or leave it connected to view a list of items in real time as the engine runs! No PC, no software and no experience necessary. It's just that easy.

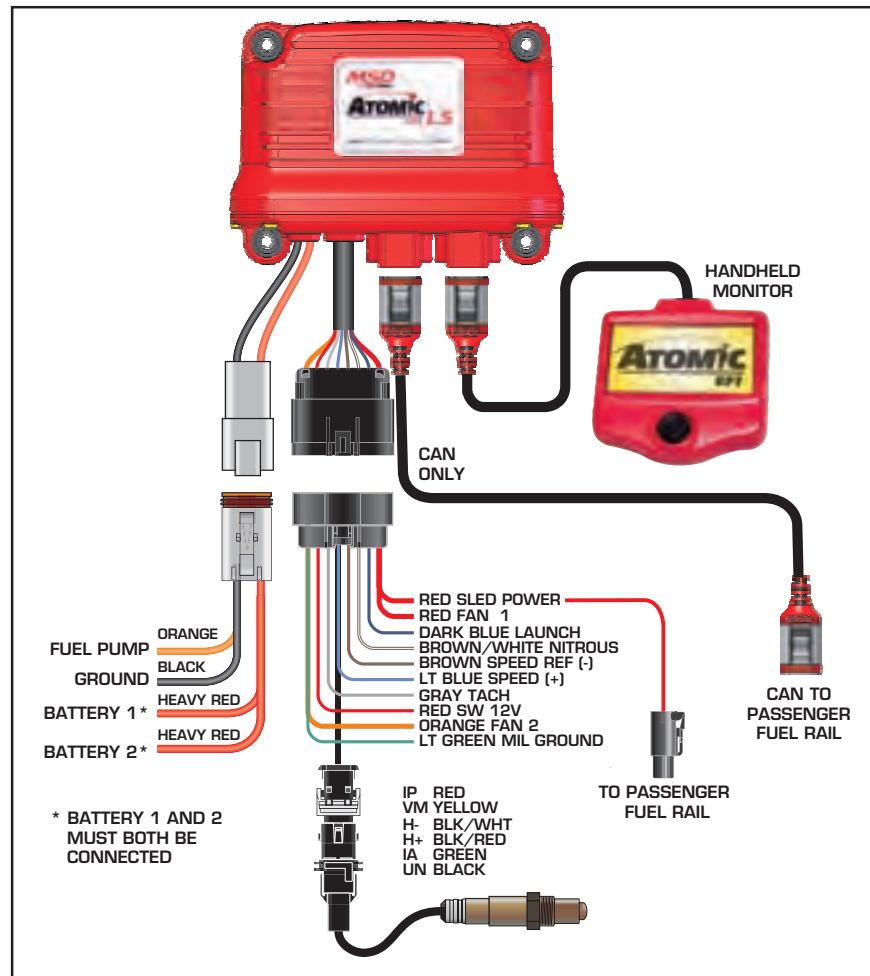

This diagram shows the Power Module Wiring.

- Atomic EFI
- Starters/ Alternators
- Spark Plugs
- Ignitions
- Late Model
- Coils
- Distributors
- Crank Triggers
- Timing/RPM Controls
- Spark Plug Wires
- Street Fire
- Marine
- Accessories
- Specialty Items
- Promo



ATOMIC® LS EFI

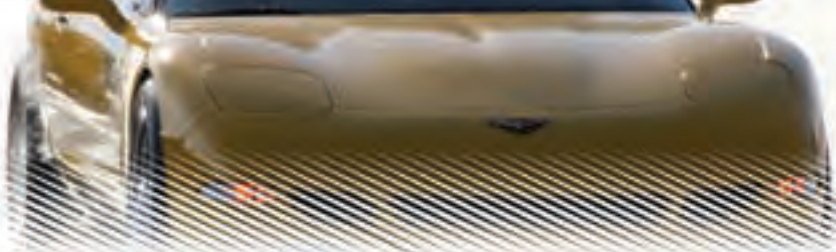

ATOMIC® LS Systems and Components

**PATENT
PENDING**

PN 2950



NOTE: Fuel pump, hoses and injectors are NOT supplied.

LS Master Kits

MSD's goal is make our Atomic EFI the simple solution for your LS EFI install. Each Atomic Master Kit is supplied with the Integrated Fuel Rails, brackets and hardware, Power Module, Handheld Monitor, WBO2 Sensor Kit, Crossover fuel line, injector retainers, and harnesses. Four different Master Kits are available for your crate or donor engine:

LS2/LS3 Kit - PN 2950*

LS7 Kit - PN 2960*

LS Truck Engine Kits

Early Model, with 3-bolt throttle body - **PN 2957***

Later Model, with 4-bolt throttle body - **PN 2958***

LS1 Install Kit

If you're working with an LS1/LS6 engine and intake combination, different fuel rail brackets and injector connectors will be required to install the PN 2950 Master Kit. This install kit will provide the proper brackets and injector connectors.

Installation Kits:

LS1/LS6 Intake Systems - PN 2955

Must be used with Master Kit, PN 2950.

PN 2957



PN 2955



*Not legal for use or sale on pollution controlled vehicles.

Atomic EFI

Starters/
Alternators

Spark Plugs

Ignitions

Late Model

Coils

Distributors

Crank
Triggers

Timing/RPM
Controls

Spark Plug
Wires

Street Fire

Marine

Accessories
Specialty
Items

Promo



ATOMIC® LS EFI

Atomic® LS Support Parts and Accessories

Throttle Body

When you run an LS engine, performance begins with the introduction of air into the intake manifold. MSD's new 90mm LS Throttle Body answers the need for a high quality throttle body with a mechanical throttle mechanism that bolts to most factory and aftermarket intakes.

MSD went through the time and expense to develop a cast throttle body assembly in order to achieve a unique parabolic bore form. This design helps deliver excellent drivability characteristics during part throttle that typical billet straight bore throttles just can't deliver. We incorporated factory style bearings and seals on the throttle blade to achieve a very robust design that can withstand temperature swings seen by street.



PN 2940

Atomic LS Throttle Body - PN 2940*

TPS / IAC Kit for LS Throttle Body - PN 2942

Atomic® LS Accessory Coil and Fuel Rail Covers

The Atomic LS is the best way to get your engine running and these Covers will help make the engine look as good as it runs! These extruded aluminum coil covers are completely integrated with the Atomic LS, providing a clean way to hide the LS coils while enhancing the look of the LS engine. Covers are available in red, black and unfinished aluminum that can be customized to fit the look of your engine compartment.



Coil Cover Kits:

LS 2/3/7

Red Finish - PN 2970

Black Finish - PN 2971

Un-Finished - PN 2972

LS 1/6

Red Finish - PN 29701

Black Finish - PN 29711

Un-Finished - PN 29721

Fuel Rail Covers:

Black Finish - PN 2974

Un-Finished - PN 2975



PN 2975

Support Components:

Wide Band O2 Sensor - PN 2930

O2 Sensor Bung and Plug - PN 2931

Fuel Pressure Regulator - PN 2938



PN 2930



PN 2938



PN 2931

Atomic EFI
Starters/
Alternators
Spark Plugs
Ignitions
Late Model
Coils
Distributors
Crank
Triggers
Timing/RPM
Controls
Spark Plug
Wires
Street Fire
Marine
Accessories
Specialty
Items
Promo



ATOMIC® TRANSMISSION CONTROLLER



Atomic EFI
Starters/
Alternators
Spark Plugs
Ignitions
Late Model
Coils
Distributors
Crank
Triggers
Timing/RPM
Controls
Spark Plug
Wires
Street Fire
Marine
Accessories
Specialty
Items
Promo



Easily modify the operating parameters of your GM or Ford 4-speed automatic transmission

- *Adjust shift points*
- *Adjust torque converter clutch behavior*
- *Select different levels of shift firmness*
- *Select between auto-shift mode and manual-shift mode*
- *Activate Dyno Mode to deliver repeatable chassis dyno results*

Atomic® Transmission Controller

There is no reason to settle on just three gears or the kickdown linkage of an automatic transmission with the number of electronically controlled four speed automatics that are available these days. MSD will take the mystery out of setting up or programming an automatic trans with the Atomic Transmission Controller.

The Atomic Trans Control Module (TCM) is based off the popular Atomic EFI series with the same goal of making installation and setup simple. The TCM, PN 2760, is complemented with a Harness Kit to match your application. Harness Kits are available for most GM and Ford four speed automatics (see page 31).

Once connected, you'll be able to easily modify the operating parameters of your transmission such as the shift points, torque converter clutch behavior, shift firmness and more!

- **Adjust the operating parameters of later model electronically controlled 4-speed overdrive transmissions**
- **Simple to configure with the supplied Handheld Monitor - no PC required***
- **OEM style connectors allow direct plug-in to popular GM and Ford transmissions**
- **Adjust shift points, shift firmness, torque converter clutch behavior, and more**
- **Monitor the operation of your transmission in real-time**
- **Dual calibration modes to accommodate different driving conditions**



ATOMIC® TRANSMISSION CONTROLLER



The Atomic Transmission Controller is easy to connect with OEM style connectors.

Atomic Transmission Controller - PN 2760*

Includes the Controller, Handheld Monitor and Auxiliary Harness. Designed to control Late Model GM/Ford 4 speed transmissions. Transmission Harness sold separately. Requires a Throttle Position Sensors that output a 0 to +5 VDC signal (not supplied).

Trans Controller Harness

A harness must be purchased separately to connect the Atomic TCU to your specific transmission. MSD offers the following:

GM

4L60-85E, 1993-up or **4L70**, 2006-2008 - **PN 2770**

4L70 (2009-up) - **PN 2771**

Ford

AODE/4R70W, 1998-up - **PN 2772**

AODE/4R70W, 1992-1997 - **PN 2773**

4R100, 1998-up - **PN 2774**

E40D, 1995-1997 - **PN 2775**

E40D, 1989-1994 - **PN 2776**

Atomic® TBI Throttle Position Output

Module - PN 2939

The Atomic Transmission Controllers require a throttle position signal. MSD offers this new component that plugs in-line to the Atomic TBI EFI system and delivers a universal 5-volt output signal. This means you do not need to install an external TPS sensor and wiring on the throttle linkage!



PARAMETER ADJUSTMENT

The Atomic TCM allows simple parameter adjustment using the supplied Handheld Monitor. That's right - no need to worry about a PC and complicated software. The Handheld connects to the Atomic TCM and can be left in place as a dash board to monitor the transmission in real-time, or disconnected once the configuration is complete.

Once installed and connected, you need only specify a few basic parameters that are listed in the Initial Setup menu. First and foremost, select the type of transmission you are using (such as a GM 4L60E or Ford 4R70W). All supported transmission types are listed in the menu to make this step easier. Other required fields under Initial Setup include the number of engine cylinders, rear end gear ratio (and transfer case ratio, if applicable), and tire height.

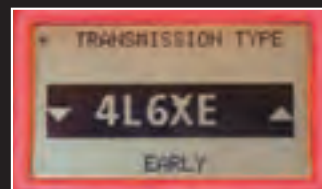
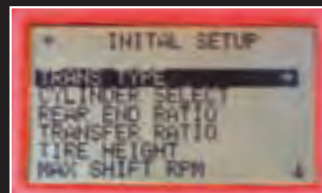

Once the Initial Setup has been completed, you can start and drive the vehicle while taking advantage of the Advanced Setup menu items to dial-in the transmission to your liking. From the Advanced Setup menu, you can control shift points and characteristics like shift feel and torque converter clutch operation. There are also options allowing adjustment of the desired Wide Open Throttle (WOT) shifting, Vehicle Speed Sensor configuration, and more. You can feel the results in real-time as a passenger manipulates the parameters and monitors real-time operational data on the Handheld Monitor! Data available for viewing includes engine speed, vehicle speed, throttle position, transmission fluid temperature, shifter position, commanded gear, and more!

Atomic EFI

Starters/ Alternators

Spark Plugs

Ignitions

Late Model

Coils

Distributors

Crank Triggers

Timing/RPM Controls

Spark Plug Wires

Street Fire

Marine

Accessories Specialty Items

Promo



DYNAFORCE® STARTERS

MSD Quality and Performance Right from the Start

You may have all the spark energy you need, but if your starter won't spin the engine, you're not going anywhere. MSD's DynaForce Starters will crank your engine over to get it fired up every time! Our Dynaforce Starters are designed to crank the highest compression engines on a hot day in Death Valley. Not that too many cars are sitting in Death Valley, but it's good to know that you have the oomph to make it happen.

MSD DynaForce Starters are made to crank. A 3.4 horse motor spins a reduction set of gears with a 4.4:1 ratio to deliver incredible torque. The armature is supported by ball bearings and we plate the internal contacts and disc to reduce arcing while improving continuity.

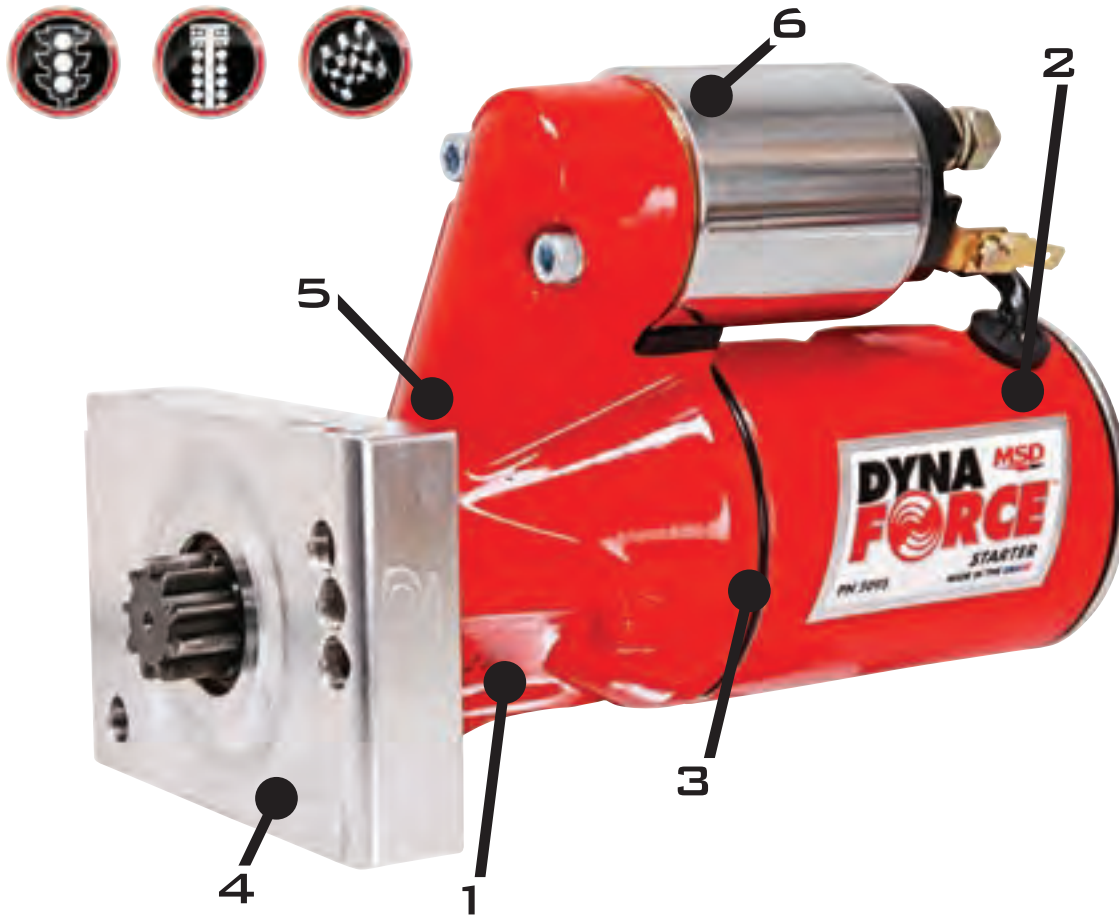

- 1** Gear reduction of 4.4:1 improves torque to easily spin engines up to 18:1 compression
- 2** 3.4 horsepower motor provides power for high compression engines
- 3** Ball bearing supported armature and pinion gear
- 4** Billet aluminum mount can be clocked to assist in mounting issues
- 5** Red powder coat for long lasting protection
- 6** Nickel plated, heavy duty solenoid with plated contacts for endurance

Atomic EFI

Starters/
Alternators

Spark Plugs

Ignitions

Late Model

Coils

Distributors

Crank
Triggers

Timing/RPM
Controls

Spark Plug
Wires

Street Fire

Marine

Accessories
Specialty
Items

Promo



MSD

DYNAFORCE® STARTERS

DynaForce® Starters



Chevy V8, 153 and 168 Tooth Flywheels, Straight Mount - **PN 5095**
 Chevy V8 168 Tooth, Staggered Mount - **PN 50951**



Ford Small Block, 289-351w - **PN 5090**
 Ford Small Block, V8, 3/8th Depth - **PN 50901**
 Ford Big Block, 351m, 400, 429 - **PN 5092**



GM LS-Series (LS1-LS7) Engines - **PN 5096**



Jeep In-line 232, 258, 4.0L **PN 5094**



Ford FE 390, 427, 428 **PN 5093**



Chrysler 318-440 - **PN 50981**



Pontiac/Olds 326, 455 **PN 5097**



Chrysler, 318-440 Engines - **PN 5098**
 The Chrysler Starter is a compact replacement for everything from Small Blocks to 440 engines.

SERVICE PARTS

- Solenoid
- GM LS, PN 5096 PN 5086
- Other models..... PN 5087
- Gear Clutch Assembly
- For PN 5090, PN 5095 and PN 5096 PN 5089



PN 5086



PN 5087



PN 5089

NOT FOR USE ON HIGH SPEED MODELS

Atomic EFI
 Starters/Alternators
 Spark Plugs
 Ignitions
 Late Model
 Coils
 Distributors
 Crank Triggers
 Timing/RPM Controls
 Spark Plug Wires
 Street Fire
 Marine
 Accessories/Specialty Items
 Promo



DYNAFORCE® STARTERS



High Speed DynaForce® Starters

Anyone who struggles to start their Chevy race engine reliably because the starter can't keep up needs to check out the new High Speed DynaForce Starter. This starter was designed for race engines using magnetos that require higher cranking speed. The 25% extra speed makes it so that even the most stubborn of motors will start. The extreme durability built into these starters ensures they can handle the teams that use them.



- 3.73:1 gear reduction delivers up to 25% more cranking rpm
- Heavy duty high temp solenoid for 12-16 volt systems
- Plated disc and contacts reduce arcing and increase continuity
- Billet aluminum adjustable mounting block
- Easily spins engines up to 18:1 compression



Ford 289, 302, 351W - **PN 50902**
Ford BB 351M, 400, 429 - **PN 50922**



Chevy 10 Pitch/139 Tooth
PN 50953

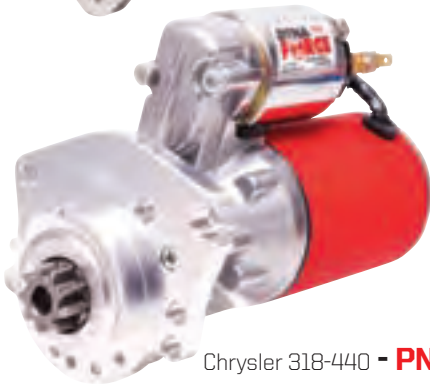

Chrysler 318-440 - **PN 50982**



Chevy 153/168 Tooth - **PN 50952**
Perfect for applications with magnetos that require 250+ rpm to start.



The DynaForce mounting block can be positioned in different locations to help clear suspension parts, the oil pan and exhaust systems.

Atomic EFI

Starters/
Alternators

Spark Plugs

Ignitions

Late Model

Coils

Distributors

Crank
Triggers

Timing/RPM
Controls

Spark Plug
Wires

Street Fire

Marine

Accessories
Specialty
Items

Promo



DYNAFORCE® ALTERNATORS

Atomic EFI
Starters/
Alternators
Spark Plugs
Ignitions
Late Model
Coils
Distributors
Crank
Triggers
Timing/RPM
Controls
Spark Plug
Wires
Street Fire
Marine
Accessories
Specialty
Items
Promo

DynaForce® 120 Amp and 160 Amp Alternators

Whether you need a high output alternator to power your muscle car, street rod or touring machine, MSD has you covered with the DynaForce Alternator. Not only are they designed for extreme output at higher rpm, but MSD balances the current output to keep your electronic components up to speed during idle and lower rpm operation as well.

Both the 120 and 160 Amp Alternators feature one-wire installation to keep things clean, easy and effective. The charge post of the alternators is moved to the side of the housing to allow for improved clearance to the block, plus a pulley baffle is included to ensure there is never any fan-to-belt issues (common at high rpm on lesser alternators). The housings are available in two finishes including a show quality chrome or black for subtle appearance.



PN 5361



PN 5322

DynaForce Alternators:

120 Amp

Black - **PN 5321**
Chrome - **PN 5322**

160 Amp

Black - **PN 5361**
Chrome - **PN 5362**



- Designed for maximum output from idle to high rpm
- Stator and rotor are electrically balanced for optimum performance
- Dual plane balanced rotor assembly delivers high rpm precision and reliability
- Hand assembled in the USA and NEVER rebuilt or refurbished units
- Every unit is delivered with a proof of performance
- Blue-printed assembly process ensures superior operation and longevity
- One wire installation with added fan baffle for belt protection

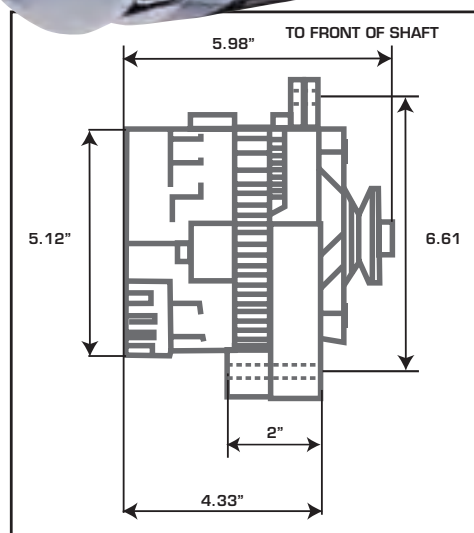

The 120 and 160 Amp DynaForce Alternators are designed with straight mounts. These mounting tabs fit many GM bracket systems from the mid '60s to the mid '80s.



SPARK PLUGS



MSD Iridium Spark Plugs



With over four decades of experience in engineering and manufacturing high output ignition systems, MSD Performance is excited to present our new High Performance Iridium spark plugs! Whether you're on the street, trail or track, MSD has a performance plug that will fire up your engine.

MSD's spark plugs are engineered to improve the efficiency of the combustion process to create the most power possible combined with increased durability. The center tip of the plug is made from iridium to promote the best spark and increase resilience. A proprietary ceramic material enhances the dielectric strength of the plug housing forcing the spark, even under extreme cylinder pressures, to jump across the plug gap to the ground electrode. This electrode is machined to expose more spark to the incoming gases to promote the most effective combustion event possible.



- Proprietary plug design inside and out
- Designed for use on street vehicles that utilize high output ignition systems
- Machined electrode increases exposure to the flame to improve combustion
- MSD's proprietary ceramic formula provides the highest dielectric strength
- Yttrium ground electrode reduces the chance of pre-ignition
- Iridium tip improves cold starts
- Designed to outlast other performance plugs
- All spark plugs tested prior to packaging and shipping
- Shorty-style plugs for applications where space is limited

Atomic EFI
Starters/Alternators
Spark Plugs
Ignitions
Late Model
Coils
Distributors
Crank Triggers
Timing/RPM Controls
Spark Plug Wires
Street Fire
Marine
Accessories
Specialty Items
Promo



SPARK PLUGS

MSD Iridium Spark Plugs

What makes MSD's Iridium plugs a cut above the competition? Only MSD could create a spark plug for street cars that was designed with race winning experience of firing 330 mph top fuel cars, the endurance of 500 mile stock car racing and the brutal expectations of off-road racing, our new spark plugs are designed to perform from the inside out.

Order a complete application guide, PN 9730.

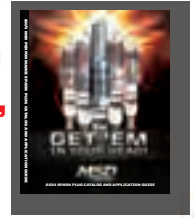

Fixed terminal nut for solid connection.

Proprietary ceramic improves dielectric strength, eliminating failure with high output ignitions.

Low resistance seal suppresses EMI (electro magnetic interference)

Zinc-Nickel Chromated shell resists corrosion and seizure.

Copper core center electrode reduces operating temperature promoting long life and reducing the possibility of detonation.

Yttrium Ground electrode with center copper core reduces temperature and increases mileage intervals.

The space between the center electrode and insulated tip enables a fast evaporation of fuel preventing formation of soft combustible deposits on the insulator tip.

Iridium contact on the center electrode insures long life with high output ignitions.

Center cut ground electrode ensures un-shrouded spark for improved combustion.

- Atomic EFI
- Starters/Alternators
- Spark Plugs
- Ignitions
- Late Model
- Coils
- Distributors
- Crank Triggers
- Timing/RPM Controls
- Spark Plug Wires
- Street Fire
- Marine
- Accessories
- Specialty Items
- Promo



SPARK PLUGS



- Atomic EFI
- Starters/Alternators
- Spark Plugs
- Ignitions
- Late Model
- Coils
- Distributors
- Crank Triggers
- Timing/RPM Controls
- Spark Plug Wires
- Street Fire
- Marine
- Accessories/Specialty Items
- Promo

MUSCLE CARS



With today's fuel blends, vintage muscle cars need as much spark as possible and MSD's plugs are designed to keep the fire burning. The iridium tip will assist in cold starts while the yttrium enhanced ground strap helps reduce the chances of pre-ignition. From the high revving 289 to a ground pounding 454, MSD spark plugs have you covered.

MODERN MUSCLE



Whoever laments for the 'good old days' obviously hasn't been behind the wheel of a new Mustang, Camaro or Challenger. Today's muscle cars make great power and there is more left on the table. A set of MSD spark plugs will help you pull more power out of your modern muscle car especially in concert with other performance upgrades such as intake systems, free-flowing exhaust, nitrous boost and more.

TRUCKS and SUVs



Today's trucks and SUVs have to be ready for a long haul, trail run or pulling a loaded trailer. MSD's spark plugs are designed to outlast and out-fire the competition with a proprietary ceramic blend for increased spark isolation and an iridium tip for the best spark transfer to the combustion chamber.

SPORT COMPACT



High revving 4- and 6-cylinder engines require a superior spark to achieve the performance you expect, especially when coupled with forced induction systems. Boosted or not, the unique form of MSD's electrode ensures that the spark is exposed directly to the fuel mixture entering the cylinder to improve the combustion process and performance.



SPARK PLUGS



MSD Spark Plugs

MSD offers a long list of spark plug applications ranging from AMC to VWs, listings below are only a handful of listings to give you an idea on the range of our iridium spark plugs. For more infor-

For applications,
go to
MSDInYourHead.com
or
order a complete
Application Guide,
PN 9730

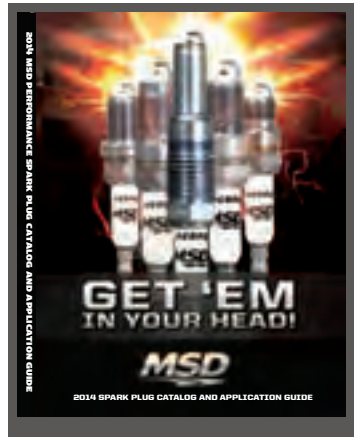

Modern Muscle

- Ford Mustang, 5.0L
- Ford Mustang, 4.6L
- Dodge Challenger, 5.7L
- Dodge Charger, 5.7L
- Chevy Camaro, 6.2L
- Chevy Camaro, 5.7L
- Pontiac G8, 6.0L

Muscle Cars and Hot Rods

- AMC Rebel, 360 cid
- Buick Wildcat, 401 cid
- Chevy C10, 350 cid
- Chevy Chevelle, 454 cid
- Dodge Dart, 318 cid
- Ford Mustang, 289 cid
- Pontiac Firebird, 326 cid
- Plymouth Roadrunner, 383 cid

Late Model Trucks

- Ford F-150 EcoBoost
- Ford Expedition, 5.4L
- Chevy Silverado 2500 HD, 6.0L
- Chevy Tahoe, 5.3L
- Dodge Ram, 5.7L
- Dodge Ram 1500, 3.7L

Sport Compact

- Audi A6, 4.2L
- Acura NSX, 3.0L
- Infiniti FX45, 4.5L
- Toyota Corolla, 1.8L



- Atomic EFI
- Starters/Alternators
- Spark Plugs
- Ignitions
- Late Model
- Coils
- Distributors
- Crank Triggers
- Timing/RPM Controls
- Spark Plug Wires
- Street Fire
- Marine
- Accessories
- Specialty Items
- Promo



6-SERIES IGNITIONS

Promo
Accessories
Specialty
Items
Marine
Street Fire
Spark Plug
Wires
Timing/RPM
Controls
Crank
Triggers
Distributors
Coils
Late Model
Ignitions
Spark Plugs
Starters/
Alternators
Atomic EFI



PN 6425



PN 6530



BENEFITS AND RESULTS

- Quick Starts
- Increased Power
- Smooth Idle
- Crisp Throttle Response
- Reduced Spark Plug Fouling

The MSD 6-Series Advantage

MSD was the first company to develop and offer the multiple sparking, capacitive discharge ignition for engines. The line of MSD 6-Series Ignitions are the most popular aftermarket ignitions in the world due to our race-proven performance on the track and our reliability on the street!

Most of the 6-Series Ignition Controls share similar output characteristics when it comes to spark energy, voltage and the spark series. The main difference is the addition of a built-in rev control such as the 6AL or the boost timing control in the 6 BTM. The increased voltage that the MSD puts across the plug gap will improve the driveability and performance of everyday drivers to Saturday night racers!

All of the MSD 6 Ignitions can be installed on 4, 6 or 8-cylinder engines equipped with a 12 volt, negative ground electrical system and a distributor. They can be triggered by points, electronic amplifiers, magnetic pickups and even other aftermarket distributors.

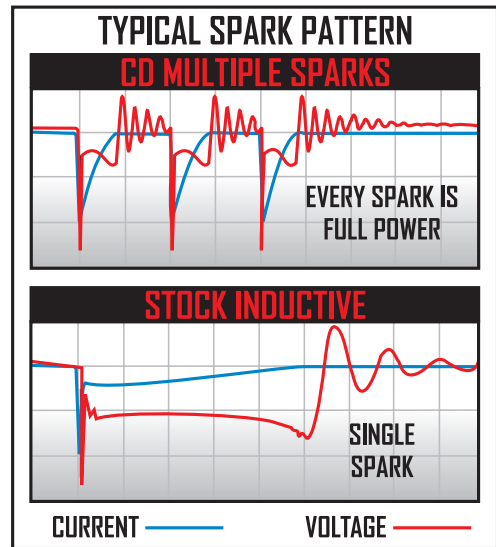

MSD's multiple sparks are shown at the top. This series of sparks ensures combustion to improve power.

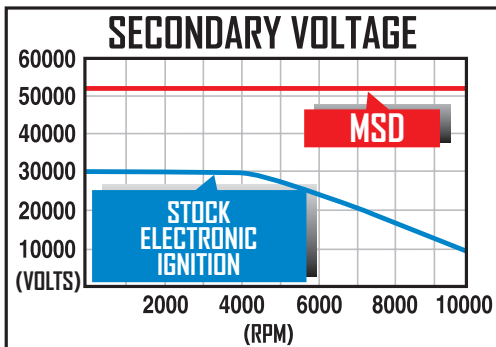

MSD's proven Capacitive Discharge technology delivers high primary voltage at any rpm!

Capacitive Discharge

An MSD Ignition uses capacitive discharge (CD) technology to produce a very high primary voltage. This high voltage is always present regardless if you're at an idle or racing down a straight away at 10,000 rpm.

A special transformer instantly steps up the supply voltage from the battery then stores this high voltage in a large capacitor. When the ignition is triggered the capacitor releases all of this voltage to the coil so the primary voltage is at full power at any rpm. These high powered sparks ensure complete combustion of the fuel mixture at racing rpm which in turn produces more power!



6-SERIES IGNITIONS

Multiple Sparks

All of the MSD 6-Series Ignitions produce multiple sparks up to at least 3,000 rpm. This series of sparks, whether there are two or six, will always last for 20° of crankshaft rotation. Also, each spark is at full voltage. This powerful series will improve the starting ability, idle quality and throttle response. If you have a multiple carb set up that is a little off at idle or an engine that burns a little oil, the MSD's spark series will help prevent the cylinders loading up.

At higher rpm there isn't enough time to fire the plug more than once during the combustion stroke so there is only a single, full power spark. Thanks to MSD's CD technology, this spark is always at full power even through 10,000+ rpm so you know the fuel mixture is being burned efficiently, creating maximum power!

Wiring

The primary wiring used on an MSD has a special tinned conductor that meets MIL-86A specifications. This allows for superior crimps and prevents corrosion. The jacket is resistant to high temperatures, abrasion and underhood chemicals.

Soft Touch Rev Control

MSD first developed the adjustable rev control and we have since incorporated it into most of our ignition controls. Our Soft Touch circuitry produces an accurate and smooth limit without loading up the cylinders or excessive backfires. Even if your car is a mild street machine, a rev limiter can save you from expensive engine damage due to driveline failure or a missed shift.

Add-Ons

Another great thing about the MSD Ignition line is that most all of our accessories can be added to your existing Ignition Control. You can run an MSD Ignition with your stock distributor, then upgrade to a Pro-Billet model or even a crank trigger. You don't have to buy everything at once or spend money on features that you will never use.

For instance, if you choose an MSD Digital 6AL then decide to add a nitrous system, you can easily install an MSD Timing Retard accessory. MSD has a variety of different timing controls, but the point is that you don't have to pay for features that you won't use when you select an MSD Ignition!

MSD Ignitions install easily to a variety of applications. This diagram shows the wiring with a points distributor.

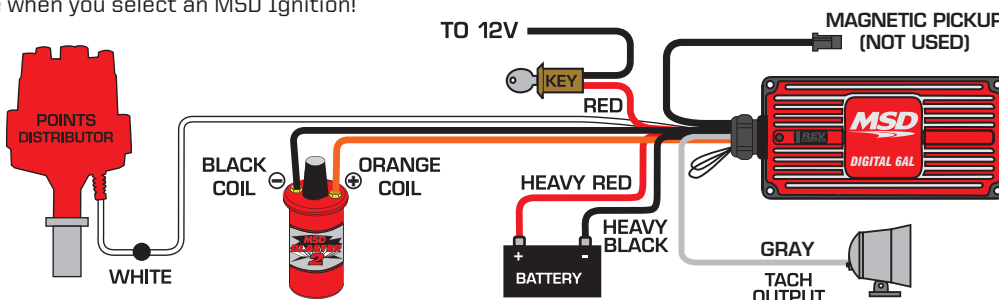

COMMON QUESTIONS the 6A and 6AL Ignition Control?

The only difference is the addition of a rev limiter. The 6A, 6AL and 6 BTM ignitions all share the same CD, multiple sparking circuitry and output power. The units also have the same wiring but with a couple different features such as the rev limiter or boost retard circuit.

Do the 6-Series operate on distributorless engines?

No, or you would need one ignition per coil pack! To meet these needs, MSD engineers developed our multi-channel Stacker or DIS Ignition Controls. These Ignitions are capable of firing two to four coil packs or coil per cylinder and feature our proven multiple spark design along with other built-in features.

Do I need to replace my points?

No. Actually, adding an MSD 6-Series Ignition will increase the life of your original breaker points. With an MSD installed the current across the points gap decreases significantly and the gap is not imperative to performance. Of course, it is important to have a distributor that is not worn out and an accurate mechanical advance aids performance.

Will I need a Tach Adapter?

In most cases, a Tach Adapter is not necessary. Most quality aftermarket tachs will have no problem reading the MSD's tach signal. Some factory tachs, such as Fords, may need an Adapter and most import cars will need one to run.

Which coil is right for my application?

Coil selection depends on your performance goals. You can use your stock coil with an MSD, but an MSD Blaster Coil will ensure that you get the most output power available. MSD offers a variety of performance and racing coils and there is more information starting on page 50.

What's the best spark plug gap for my application?

The spark plug is the point in the ignition system where electrical energy is converted into heat, consequently, the larger the gap the greater the amount of heat available to light the air/fuel mixture. As a starting point, follow the engine builder or manufacturer's recommendation for the plug gap. With that, you can experiment with increasing the gap by .005" - .010" until the best performance is found.

Atomic EFI
Starter/Alternators
Spark Plugs
Ignitions
Late Model
Coils
Distributors
Crank Triggers
Timing/RPM Controls
Spark Plug Wires
Street Fire
Marine
Accessories
Specialty Items
Promo



INFORMATION & SPECIFICATIONS

Atomic EFI
 Starters/ Alternators
 Spark Plugs
 Ignitions
 Late Model
 Coils
 Distributors
 Crank Triggers
 Timing/RPM Controls
 Spark Plug Wires
 Street Fire
 Marine
 Accessories Specialty Items
 Promo

Operating Voltage: This is the amount of supply voltage required from the battery to operate the MSD Ignition at full output power. An MSD CD Ignition is designed to produce full output power (470-630 volts) with a supply voltage of 10-18 volts. The MSD will still operate below 10 volts, but the output voltage will be lower. An MSD will also accept a momentary 24 volts such as during a jump start.

Operating Current: This is the current, or amperes, required to operate the MSD Ignition. This is shown with the rpm of the engine because more current is required as rpm increases.

Spark Energy: This is a measure of how much "heat" is produced across the spark plug gap to initiate the combustion process of the air/fuel mixture. Spark energy is a product of voltage, current and time with the result being measured in millijoules. The specification shown with MSD CD ignitions is the amount of energy stored in the capacitor which is all delivered to the coil for every firing.

Primary Voltage Output: This is the maximum amount of voltage that is delivered to the primary terminals of the ignition coil. With a CD ignition this voltage is very high because the MSD steps up and stores this voltage with its transformer and capacitor. DO NOT attempt to check for voltage on the coil terminals with a test light.

Secondary Voltage Output: This is the potential maximum voltage that the ignition and coil can generate. It is the most common specification used and also the most exaggerated. Your engine will not typically require the maximum voltage given, though the ignition and coil are capable of reaching this level. This measurement is affected by the specifications of the coil such as its construction, turns ratio, insulation as well as the type of coil used. MSD lists which coil was used to determine this specification.

RPM: This is the highest rpm rating that the MSD will operate at full output power. This number is always listed for V8 engines. The rpm rating is higher as the number of cylinders decrease.

Spark Duration: The spark duration shown is how long the series of multiple sparks lasts in crankshaft degrees. It is listed this way because the number of sparks that occur decreases as rpm increases. When operating with a supply voltage of 14 volts, a general rule is one spark per millisecond.

Ignition Specification Chart

MSD uses standard measuring methods as set by the Society of Automotive Engineers (SAE) and information from the California Air Resources Board (CARB) to test our ignitions. Note that we list the coils used with each listing of specifications. The ignition coil plays a major role in determining several specifications such as secondary voltage, current and spark energy and selecting the proper coil for your application is important. When comparing other ignition systems always be sure to examine the coil used during the tests.

Ignition	Operating Voltage	Operating Current AMP per RPM	RPM w/ 14.4v	Spark Series Duration	Spark Energy Millijoules	Output Primary (Into Coil)	Voltage Secondary (Coil Output)	Weight	Size L x W x H	Coil Used
6ALN 6 BTM 6M-2L	12-18 Volt DC	1A/1,000 rpm	15,000	20°	105-115 mJ	460-480V	45,000V	6ALN - 5 lbs. 6 BTM - 3 lbs. 6M-2 - 3.5 lbs.	8" x 4" x 2.25" 8" x 4" x 2.25" 8" x 3.5" x 2.25"	PN 8202, PN 8207 PN 8252, PN 8253
Digital 6A, 6AL		0.7A/1,000 rpm	12,500	20°	135 mJ	535V	48,000V	3 lbs. PN 8252	7" x 4" x 2"	PN 8202, PN 8207 PN 8252, PN 8253
Digital-6 Plus		0.7A/1,000 rpm	12,500	20°	135 mJ	535V	48,000V	2.856 lbs.	8.5" x 4.5" x 2.2"	PN 8202, PN 8207 PN 8252, PN 8253
6 HVC Professional Racing Ign.		0.7A/1,000 rpm	15,000	20°	150 mJ	550V	40,000V	3.75 lbs.	8" x 3.5" x 2.25"	PN 8250
DIS-2 Plus DIS-4 Plus		0.7A/1,000 rpm	14,000 14,000	20°	105-115 mJ	460-480V	45,000V	3 lbs. 3 lbs.	9.5" x 4.5" x 2.2"	Stock type coil
DIS-2 HO DIS-4 HO		0.8A/1,000 rpm	14,000	20°	170 mJ	470V	43,000V	3 lbs.	9.5" x 4.5" x 2.2"	PN8323
Midget System		1A/1,000 rpm	15,000	20°	190 mJ	500V	45,000V	4.5 lbs.	9.5" x 4.5" x 2.2"	PN 8240
7AL-2 Plus		1A/1,000 rpm	14,000	20°	160 mJ	570V	47,000V	4.75 lbs.	8" x 3.75" x 5.75"	PN 8201, PN 8251 PN 8261
7AL-3		1A/1,000 rpm	14,000	20°	160 mJ	570V	50,000V	4.4 lbs.	8" x 3.75" x 5.75"	PN 8201, PN 8251 PN 8261
Digital-7 Plus Programmable Digital-7-Series		1.1A/1,000 rpm	12,500	21°	190 mJ	530	45,000V	3 lbs.	9.5" x 4.5" x 2.2"	PN 8201, PN 8251 PN 8261
Power Grid-7		1.3A/1,000 rpm	15,000	20°	200-220 mJ	545-570	50,000 V+	2.9 lbs.	7.5"x5"x2.25"	PN 8261
MSD 8-Plus		3A/1,000 rpm	15,000	20°	315-330 mJ	360-580V	50,000V + Single Coil	5 lbs.	8" x 3.75" x 5.75"	PN 8261



6-SERIES APPLICATIONS

Atomic EFI
Starters/
Alternators
Spark Plugs
Ignitions
Late Model
Coils
Distributors
Crank
Triggers
Timing/RPM
Controls
Spark Plug
Wires
Street Fire
Marine
Accessories
Specialty
Items
Promo

Selecting an Ignition

Choosing an MSD ignition may seem confusing, but making the right choice really comes down to what you plan to do with your vehicle. The following suggestions will help you choose the right ignition for your application.

All MSD 6-Series Ignitions:

- Deliver full power capacitive discharge multiple sparks
- Trigger from distributors with breaker points, amplifiers or magnetic pickups
- Accept an MSD Timing Accessory
- Full one year warranty

Digital 6A

This is the base model multiple sparking, capacitive discharge (CD) ignition control. If you're simply looking for a hotter spark for improved driveability, this is the model for you. Remember though, there is not a rev limiter, nor can one be added. See page 44.



Digital 6AL

If you are planning on spirited driving, grabbing gears or some form of racing, the adjustable rev control of the Digital 6AL or 6BTM Ignitions is a wise choice. Also, you can add a 2-Step Module Selector for launch rpm limit if you choose. See page 44.



Digital 6AL-2-Series Ignitions

The Digital 6AL-2 Ignition Control is ideal for the street and strip and features a built-in 2-Step rev control. The next step is the Programmable 6AL-2 which gives you PC programming for the street! Check out pages 47-48 for more information on this exciting ignition.



Extreme Duty 6ALN Ignition

For severe duty applications such as off-road truck racing or saturday night dirt tracks, the 6ALN is the best choice. Sealed locking connectors and epoxy for vibration resistance create an ignition ready to take on the rigors of hard-core racing. See page 49.



Marine

This ignition is fit with sealed Weathertight connectors. All of the power and multiple sparks of an MSD, plus a rev limiter for Marine applications. See page 49 and 162.



Professional Racing Ignitions

Just like the name implies, this ignition is designed for professional long duration, high-rpm racing. It features NASCAR mandated harnesses, a clear baseplate and vibration dampening silicone. This ignition uses a special Coil (PN 8250) and produces higher spark energy and voltage. See page 50.





6A & 6AL IGNITIONS



Promo
Accessories
Specialty
Items
Marine
Street Fire
Spark Plug
Wires
Timing/RPM
Controls
Crank
Triggers
Distributors
Coils
Late Model
Ignitions
Spark Plugs
Starters/
Alternators
Atomic EFI



PN 6425

The Next Generation 6AL Ignition Control

The MSD 6AL Ignition Control set the standards that other ignitions strive to reach. In fact, you'll find ignitions from other companies that carry the 6AL name (and in some cases, the same part number). MSD raised the bar even higher with the revised Digital 6AL Ignition Control!

The wiring of the Digital 6AL and 6A is routed out one end of the unit through a sealed and locking connector. This eases installation and keeps your wiring looking neat and clean. The rev limiter of the 6AL is located right on top of the housing for easy access to the two rotary dials to set the limit in 100 rpm increments.

Inside the Digital 6AL you'll find a microprocessor that monitors and controls every firing and rev limit. The circuits are updated with efficient components that help the ignition produce more power while drawing less current! In fact, the Digital 6AL and 6A deliver over 530 volts to the coil with up to 135mJ of spark energy for every firing! Increased output combined with MSD's proven multiple spark series is a win-win situation!

The Digital 6A and 6AL are supplied with the wiring harness and the components you'll need for installation. The 6AL is also supplied with vibration mounts. Both ignitions are compatible on 4, 6 or 8-cylinder engines with 12-volt, negative ground electrical systems. They'll accept trigger inputs from breaker points, amplifiers and magnetic pickups.

- Higher output with 530 primary volts and 135mJ of spark energy
- Efficient components use less current to produce more power
- Set an rpm limit on the 6AL with two rotary dials in 100 rpm increments
- Same bolt pattern as the original 6AL with a lower profile housing
- Built-in LED for system checks
- All wires exit through a locked, sealed connector
- Compatible for 4, 6 or 8-cylinder engines



Digital 6A™ Ignition Control, no rev limiter - PN 6201

Note that the mounting points of the Digital 6A are slightly wider than the original PN 6200 model.

Digital 6AL™ Ignition Control, with Soft Touch Rev Control - PN 6425



6A & 6AL IGNITIONS



PN 6201

6A AND 6AL OPERATING SPECIFICATIONS

SPARK ENERGY:	135-145 mJ Per Spark
PRIMARY VOLTAGE:	520-540 Volts
SECONDARY VOLTAGE:	45,000 Volts
SPARK SERIES DURATION:	20° Crankshaft Rotation
RPM RANGE:	0-15,000 RPM with 14.4 Volts
VOLTAGE REQUIRED:	12-15 Volts, 7 Volt Start
CURRENT DRAW:	.7 Amp per 1,000 RPM
WEIGHT & SIZE:	1.7 lbs., 8"L x 4"W x 1.825"H

These products are Legal to sell, distribute or install on non-OBD II vehicles in California according to Executive Order E.O. D-40-43; legal in all 50 states.



If you want to add a 2-Step Rev Control to the new Digital 6AL, see page 132 for a new Digital 2-Step rev control.



PN 8732

SEALED AND LOCKED CONNECTOR



The Digital 6A and 6AL Ignitions incorporate a secure and sealed connector for all of the wiring. This design routes the wiring out of one side of the ignition making wiring your engine easier and looks great.

SOFT TOUCH REV CONTROL



Rotary dials are easy to access right on top of the 6AL! You can dial-in a rev limit to protect your engine from overrev damage caused by a missed gear or driveline failure.

WIRING

The Digital 6AL and 6A easily connect to 4, 6 or 8-cylinder engines with a 12 volt, negative ground electrical system. The MSD will accept trigger signals from a points or amplifier distributor as well as a magnetic pickup.

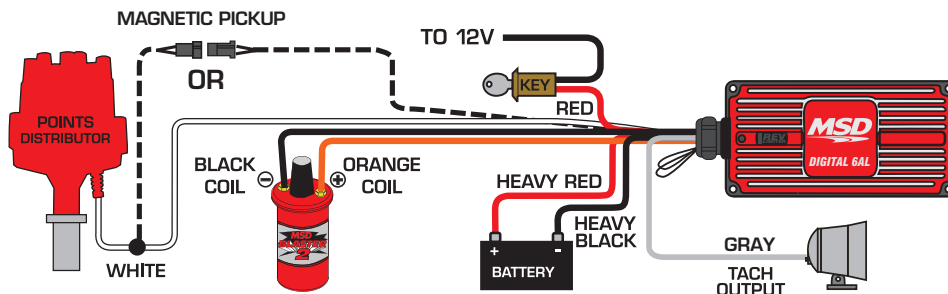

Atomic EFI
Starters/ Alternators
Spark Plugs
Ignitions
Late Model
Coils
Distributors
Crank Triggers
Timing/RPM Controls
Spark Plug Wires
Street Fire
Marine
Accessories
Specialty Items
Promo



6 BTM & HARNESSSES

Accessories
Specialty
Items
Promo
Marine
Street Fire
Spark Plug
Wires
Timing/RPM
Controls
Crank
Triggers
Distributors
Coils
Late Model
Ignitions
Spark Plugs
Starters/
Alternators
Atomic EFI



PN 6462

6 BTM™ Ignition Control

The 6 BTM is ideal for engines with a turbo or supercharger. Not only will the engine benefit from MSD's full power CD sparks, but there is also an adjustable boost/timing retard circuit to prevent detonation.

When your turbo or blower forces the air/fuel mixture into the engine, the cylinder pressure inside the combustion chamber increases. The result is a great increase in power but this can also lead to detonation that can result in severe engine damage. The 6 BTM lets you dial away detonation by retarding the timing in relation to the boost pressure.

A dash mounted control knob lets you adjust the amount of timing retard. It can be adjusted from 0° per pound of boost to 3° per pound (up to 15°).

The 6 BTM also shares the Soft Touch Rev Control for overrev protection. The BTM is supplied with rubber shock mounts and rpm modules for 3,000, 6,000, 7,000 and 8,000 rpm.



OPERATING SPECIFICATIONS

SPARK ENERGY:	105-115 mJ Per Spark
PRIMARY VOLTAGE:	450-480 Volts
SECONDARY VOLTAGE:	45,000 Volts
SPARK SERIES DURATION:	20° Crankshaft Rotation
RPM RANGE:	15,000 RPM with 14.4 Volts
VOLTAGE REQUIRED:	12-18 Volts, Negative Ground
CURRENT DRAW:	1 Amp per 1,000 RPM
WEIGHT & SIZE:	3 lbs., 8"L x 4"W x 2.25"H

Tested with Blaster Coil
These products are Legal to sell, distribute or install on non-OBD II vehicles in California according to Executive Order E.O. D-40-28; legal in all 50 states.

6 BTM Ignition Control, 4, 6 (even-fire only) and 8-Cylinder - PN 6462

NOTE: For a PC-adjustable boost/timing map, see the Programmable 6AL-2 on page 44.

Wiring Harnesses

MSD Ignition Controls are easy to install, but we also offer several direct plug-in Harnesses for late model vehicles! The Harnesses plug directly into your factory coil and harness then four color coded wires plug into the corresponding wires of the MSD.

- MSD to Ford TFI Harness - PN 8874
- MSD to GM Dual Connector Coil - PN 8876
- MSD to GM '96-On Single Connector Coil - PN 8877
- MSD to '90-'97 Dodge Ram 5.2/5.9L - PN 8889
- MSD to '98-'03 Dodge/Chrysler - PN 8884



PN 8874

MSD to GM HEI (internal coil) without Vacuum Advance - PN 8875

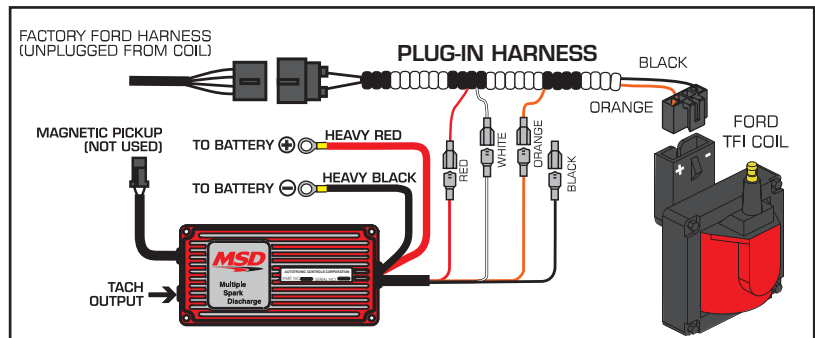



DIGITAL 6-SERIES

Digital 6AL-2™

Inside the new cast aluminum housing you'll find an advanced micro-controller that manages the timing and rpm of the ignition. The spark output of the new box has been turned up to 535 volts of primary voltage with spark energy reaching up to 135 millijoules! The multiple sparks of the 6AL-2 burn in the cylinder for 20° of crankshaft rotation to ensure complete combustion.

There are two rev limiters; one for high end overrev protection and another you can activate off a clutch or transbrake to set a launch limit. This feature will help your car blast off the starting line! Adjustments are made via four rotary dials for 100 rpm increment control!

This capacitive discharge ignition will easily connect to nearly any 12 volt negative ground distributor system, even Hall-effect pickups. The ignition is supplied with wiring and vibration mounts for a complete installation. It's even compatible with 4, 6 and 8-cylinder engines.



PN 6421



Digital 6AL-2 Ignition Control - PN 6421*

- Accurate digital circuits and control
- Built-in 2-Step Rev Control - with rotary dials
- Accepts Hall-effect, points and mag pickup triggers

OPERATING SPECIFICATIONS

SPARK ENERGY:	135 mJ Per Spark
PRIMARY VOLTAGE:	535 Volts
SECONDARY VOLTAGE:	45,000 Volts
SPARK SERIES DURATION:	20° Crankshaft Rotation
RPM RANGE:	12,000 RPM with 14.4 Volts
VOLTAGE REQUIRED:	12-18 Volts, Negative Ground
CURRENT DRAW:	.7 Amp per 1,000 RPM
WEIGHT & SIZE PN 6421:	3 lbs., 7"L x 4"W x 2"H
PN 6520:	3.7 lbs., 8.5"L x 4.5"W x 2.2"H

Tested with Blaster HVC II Coil, PN 8252
The PN 6520 is legal to sell, distribute or install on non-OBD II vehicles in California according to Executive Order E.O. D-40-31; legal in all 50 states.
PN 6421 CARB Approval Pending

Digital-6 Plus™

The MSD Digital-6 Plus Ignition Control combines terrific power, digital accuracy and great accessories making it ideal for street/strip applications.

For nitrous equipped cars, the Digital-6 Plus offers a step retard that will retard the timing when the N2O is activated. There is also a 2-step rev limiter for holeshot consistency and overrev protection. Accepts points, amplifiers and mag pickups on 4, 6 or 8-cylinder engines.

MSD Digital-6 Plus Ignition Control, 4, 6 and 8-cylinder engines - PN 6520

- Built-in Drag Race features
- Single stage retard
- 2-Step rev control
- Start Retard



PN 6520



Atomic EFI
Starters/ Alternators
Spark Plugs
Ignitions
Late Model
Coils
Distributors
Crank Triggers
Timing/RPM Controls
Spark Plug Wires
Street Fire
Marine
Accessories
Specialty Items
Promo



PROGRAMMABLE 6AL-2



Programmable 6AL-2™

The Programmable 6AL-2 Ignition provides street and performance cars to take advantage of tuning-in an ignition curve or boost timing map from a PC. Also, using MSD's Pro-Data+ software will provide simple adjustments to a 2-Step Rev Limiter, step retard and more!

The Programmable 6AL-2 shares the same advanced features of the new 6AL-2 with 535 primary volts and spark energy reaching 135 mJ! Vibration mounts, wiring and a PC cable are supplied.

Programmable 6AL-2 - PN 6530*

PRO-DATA+ SOFTWARE



OPERATING SPECIFICATIONS

SPARK ENERGY:	135 mJ Per Spark
PRIMARY VOLTAGE:	535 Volts
SECONDARY VOLTAGE:	45,000 Volts
SPARK SERIES DURATION:	20° Crankshaft Rotation
RPM RANGE:	12,500 RPM with 14.4 Volts
VOLTAGE REQUIRED:	12-18 Volts, Negative Ground
CURRENT DRAW:	.7 Amp per 1,000 RPM
WEIGHT & SIZE PN 6200:	3 lbs., 7"L x 4"W x 2"H

Tested with Blaster HVC II Coil, PN 8253

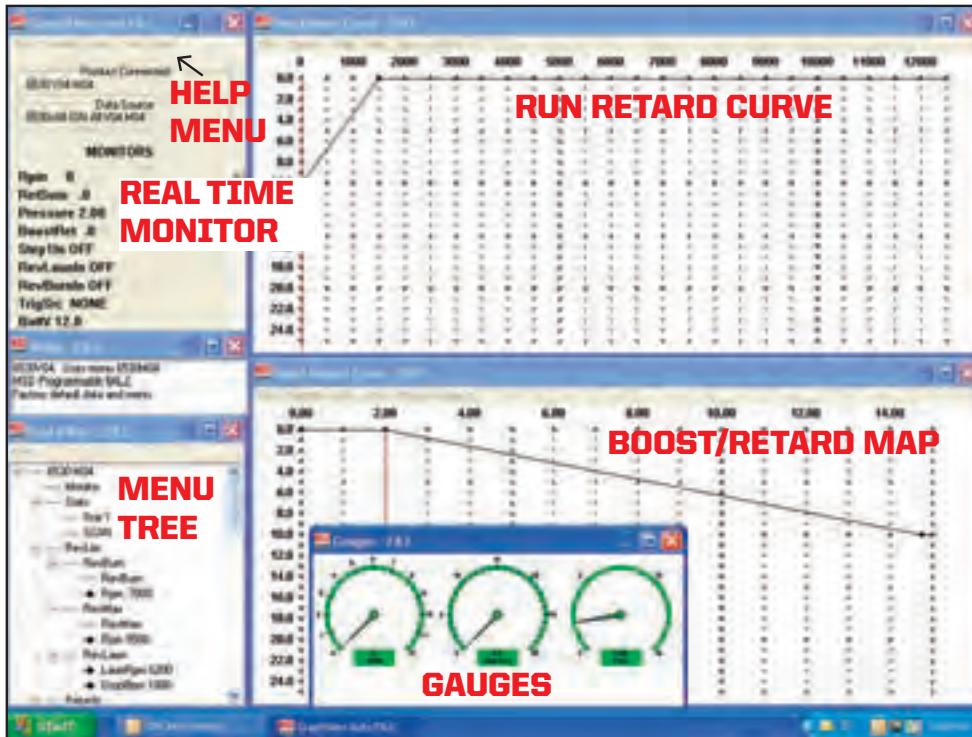

HELP MENU

REAL TIME MONITOR

RUN RETARD CURVE

BOOST/RETARD MAP

MENU TREE

GAUGES

The Programmable 6AL-2 lets you lock out the distributor and program a timing curve via a PC. You'll also be able to set a 2-Step Rev Limiter, a retard for use with nitrous and even a boost timing curve for forced induction engines!

Promo
Accessories
Specialty
Items
Marine
Street Fire
Spark Plug
Wires
Timing/RPM
Controls
Crank
Triggers
Distributors
Coils
Late Model
Ignitions
Spark Plugs
Starters/
Alternators
Atomic EFI



TRACK & MARINE IGNITIONS

Atomic EFI
Starters/
Alternators/
Spark Plugs
Ignitions
Late Model
Coils
Distributors
Crank
Triggers
Timing/RPM
Controls
Spark Plug
Wires
Street Fire
Marine
Accessories
Specialty
Items
Promo

Extreme Duty 6ALN™ Ignition Control

Every MSD Ignition is designed for performance use but the Extreme Duty 6ALN is ready to take on nearly any harsh performance environment!

Originally designed with NASCAR in mind, the 6ALN is equipped with the mandatory 6-Pin Weathertight connector to meet NASCAR's ignition wiring rule, 20-6.1. This special connector provides a tight, positive locking connection with individual seals to keep dirt and moisture away from each connection. All of the MSD's primary wiring meets MIL-86A specifications with special tinned conductors for superior crimps. Inside the strong cast aluminum housing, the multiple sparking CD circuits are encased in a clear two part silicone elastomer for the ultimate in vibration protection. A special clear base plate is also installed for easy tech inspection.

The 6ALN has a built-in Rev Control. These rev controls are adjustable with plug-in modules and will save your engine from over-rev damage caused by missed shifts or driveline failure.

MSD 6ALN, 4, 6 (Even-Fire)
& 8-cyl. - PN 6430*

NOTE: The 6ALN is supplied with a 3000, 6000, 7000 and 8000 rpm module.

The 6ALN is fit with locking and sealed Weathertight connectors making it ready for racing or for the trails.



PN 6430



OPERATING SPECIFICATIONS

SPARK ENERGY:	105-115 mJ Per Spark
PRIMARY VOLTAGE:	460-480 Volts
SECONDARY VOLTAGE:	45,000 Volts
SPARK SERIES DURATION:	20° Crankshaft Rotation
RPM RANGE:	15,000 RPM with 14.4 Volts
VOLTAGE REQUIRED:	12-18 Volts, Negative Ground
CURRENT DRAW:	1 Amp per 1,000 RPM
WEIGHT & SIZE PN 6430:	5.1 lbs., 8"L x 4"W x 2.25"H

Tested with Blaster Coil

MSD 6M-2 L™ Marine Ignition Control

The MSD 6M-2L Ignition Control is designed for performance marine applications where a high energy and reliable ignition is a necessity. MSD offers the 6M-2L and Pro-Billet distributors that are U.L. approved for marine use. See pages 157-159 for more information on marine products.

MSD 6M-2L Marine Ignition, with
Rev Limiter - **PN 6560**

PN 6560



Thoroughly tested by Underwriter's Laboratory and certified to meet or exceed safety standards for marine ignitions as specified by the U.S. Coast Guard.





CIRCLE TRACK & PROFESSIONAL RACING



Atomic EFI
Starters/Alternators
Spark Plugs
Ignitions
Late Model
Coils
Distributors
Crank Triggers
Timing/RPM Controls
Spark Plug Wires
Street Fire
Marine
Accessories
Specialty Items
Promo

MSD 6 HVC™-Series Ignitions

PN 6631



OPERATING SPECIFICATIONS

SPARK ENERGY:	150 mJ Per Spark
PRIMARY VOLTAGE:	550 Volts
SECONDARY VOLTAGE:	40,000 Volts
SPARK SERIES DURATION:	20° Crankshaft Rotation
RPM RANGE:	15,000 RPM with 14.4 Volts
VOLTAGE REQUIRED:	12-18 Volts, Negative Ground
CURRENT DRAW:	.7 Amp per 1,000 RPM
WEIGHT & SIZE:	5.1 lbs., 8"L x 4"W x 2.25"H

Tested with 6 HVC Coil.



The 6 HVC-L Ignition features a built-in rev limiter.

Professional race teams have been relying on the power and endurance of our 6 HVC Ignition Control and will be excited to see the addition of a rev limiter! The 6 HVC-L Ignition has a built-in rev limiter that will save the engine from over-rev damaged caused by spins, missed shifts or driver misfortune. This means there is no need to mount an external rev control (i.e., less wiring and reduced weight)!

The advanced component design and circuitry of the 6 HVC Ignitions produce incredible voltage with high current output. Internally there is an efficient heat sync, solid component mounting and it's all encased in a clear epoxy. The rpm limit is adjustable with plug-in modules and the wiring is routed into NASCAR approved Deutsch style MSD connectors.

6 HVC-L Ignition Controls

Fast Rev Limiter, Deutsch Connectors - **PN 6631***

Soft Touch Rev Limiter, Deutsch Connectors - **PN 6632***

PN 8250



MSD HVC™ Coil

The HVC Coil is designed exclusively for the HVC Professional Racing Ignition Control. The E-Core design of the HVC Coil is more efficient in producing more output with less loss.

COIL SPECIFICATIONS

TURNS RATIO:	100:1
PRIMARY RESISTANCE:	.07 Ohms
SECONDARY RESISTANCE:	360 Ohms
INDUCTANCE:	3mH

MSD 6 HVC Coil (Must be used with MSD 6 HVC Ignition) - **PN 8250***

Automatic Coil Selector

Running redundant ignition systems gives you piece of mind during long races, but how do you swap the coil wire to the backup ignition? The MSD Automatic Coil Selector solves this problem.

The Coil Selector has two posts that connect to the high voltage coil towers of the ignition coils while a third post connects to the distributor cap. When a racer switches from their primary ignition to the backup ignition, the Coil Selector automatically switches to the backup coil.

Automatic Coil Selector - **PN 8210**

NOTE: Not for use with MSD 7, 8 or 10-Series Ignitions.



PN 8210

Tach Splitter

If you are running a dual ignition system, this little device will allow the tachometer to operate with both ignitions. Simply install the Splitter between the tach outputs and the Tachometer. Female faston connectors match common racing connections.



PN 8911

Dual Ignition Tach Splitter - **PN 8911**

*Not legal for use or sale on pollution controlled vehicles.



MSD

MIDGET IGNITIONS



PROGRAM FEATURES:

- Plot two timing curves ranging from 800-15,000 rpm in 0.1° increments
- Select a rev limit from 2,000-15,000 rpm in 100 rpm increments
- A battery monitor circuit shows real time battery voltage and a low voltage time percentage
- Switch between two timing curves as track conditions change during a race

Programmable Midget Ignition

The Programmable Midget Ignition is a complete electronic distributorless system consisting of a powerful capacitive discharge Ignition Control, a four tower high output coil pack and uses two non-magnetic pickups with a trigger wheel as a crank trigger source. This takes all of the mechanical variables out of the picture to produce exact ignition timing!

Adding to the accuracy and high output of this ignition system, is the advantage of being able to precisely program the timing throughout the engine's entire rpm range. By using the optional Hand Held Programmer, PN 7550, or MSD's Pro-Data+ software package on a Windows based PC, racers can program two different timing curves down to .1° per 100 rpm increments! Other features of the Programmable Midget Ignition include a rev limiter to protect the engine from over-rev damage, a start retard and a circuit that monitors the battery supply voltage.

The Midget Ignition produces full power capacitive discharge sparks at any rpm so you can be assured of complete combustion. To control this power and the programs, a microcontroller analyzes the various inputs and is capable of extremely quick compensations to maintain exact timing and rpm.

The Midget Ignition is supplied with the Ignition Control, two Non-Magnetic Pickups, Trigger Magnet, On/Off Switch and Software.

MSD Programmable Midget Ignition - PN 6214*

Midget Coil Pack - PN 8240*

NOTE: Coil Pack PN 8240, must be purchased separately. Crank Trigger Wheel must be fabricated for each application.

US
 PATENT NOS.
 6196208
 6304814
 6741925

8.5mm Universal Wire Set for Midgets

MSD offers a universal set of 8.5mm Super Conductor plug wires for the Midget racers. These 50 ohms per foot resistance wires are supplied with the coil side's special locking terminal and boot crimped to the wires. The spark plug side boots and terminals are supplied loose so the wires can be routed and crimped for each application. A special Mini-Stripper-Crimper tool is also supplied.

Midget Universal 8.5mm Wire Set - PN 31689

Atomic EFI
 Starters/
 Alternators
 Spark Plugs
 Ignitions
 Late Model
 Coils
 Distributors
 Crank
 Triggers
 Timing/RPM
 Controls
 Spark Plug
 Wires
 Street Fire
 Marine
 Accessories
 Specialty
 Items
 Promo



DRAG RACING



Atomic EFI
Starters/ Alternators
Spark Plugs
Ignitions
Late Model
Coils
Distributors
Crank Triggers
Timing/RPM Controls
Spark Plug Wires
Street Fire
Marine
Accessories
Specialty Items
Promo



PN 7222



PN 7330



PN 7720



PN 7730



PN 7805

Selecting a Race Ignition

MSD offers a variety of racing and performance ignition controls for a variety of engine applications. The following ignitions are generally used in drag racing, pulling and similar applications. The following suggestions will help you choose the right ignition for your application.

7AL-2™ PN 7222

The 7AL-2 has been a staple in the drag race community for years. It has now been redesigned with a 40% increase in spark energy! It also features a popular 2-Step Rev Control, LEDs for troubleshooting and convenient terminal strips for easy wiring. See page 53.

7AL-3™ PN 7330

Need a start retard? How about three rev limits? Running multiple nitrous stages? If you answered yes to any of these, the MSD 7AL-3 could be the ignition for you. It has these features and an RPM Activated Switch and has been completely updated from the inside out. See page 54.

Power Grid™ Ignition System

The Power Grid Ignition System is the next evolution of our Programmable Series Ignition Controls. It features an all new software system with USB interface and operates on a CAN-Bus harness system which reduces the amount of wiring and simplifies the addition of accessory modules. A high output CD ignition was developed to square off with high compression, nitrous and boost pressures. Check the Grid out in detail on pages 56-59.

MSD 8™ PN 7805

The MSD 8 is a favorite of tractor pullers thanks to its high spark energy and spark duration. Our powerful MSD 8 is a single unit that works on a single or dual plug system. See page 54.



MSD 7-SERIES IGNITION

MSD 7AL-2™ Plus Ignition

You'll recognize the 7AL-2 Plus Ignition Control, as its predecessor is the most popular ignition control used in drag racing. The "Plus" model updates the original 7AL-2 with improved internal components plus our engineers added a 2-Step Rev Control and a useful diagnostic LED.

Racers will be happy to see that the updated components up the voltage output and spark energy! Over 40% more spark energy in fact!

Visually, you'll notice the two terminal strips that allow for easier wiring in your race car. The LED over the power connections will come in handy for troubleshooting as it flashes only when the coil fires. That way you know that the coil, the trigger source and ignition are all functioning properly. The mounting pattern is the same as the 7AL-2 and is supplied with vibration mounts and a few rpm modules.

NOTE: MSD 7-Series Ignitions are not compatible with distributorless systems.



MSD 7AL-2 Plus Ignition Control - PN 7222*



- Built-in 2-Step Rev Control
- Operates on 4, 6 or 8-cylinder engines
- Troubleshooting LED for spark output diagnostics
- High output energy and spark profile

OPERATING SPECIFICATIONS

SPARK ENERGY:	160 Millijoules/Spark
PRIMARY VOLTAGE:	570 Volts
SECONDARY VOLTAGE:	47,000 Volts
SPARK SERIES DURATION:	20° Crankshaft Rotation
RPM RANGE:	14,000 RPM with 14.4 Volts
VOLTAGE REQUIRED:	12-18 Volts, Negative Ground
CURRENT DRAW:	6 Amps at 6,000 RPM
WEIGHT & SIZE:	4.85 lbs., 8.25"L x 3.75"W x 5.75"H

Tested with Pro Power Coil, PN 8201



Atomic EFI
 Starters/ Alternators
 Spark Plugs
 Ignitions
 Late Model
 Coils
 Distributors
 Crank Triggers
 Timing/RPM Controls
 Spark Plug Wires
 Street Fire
 Marine
 Accessories Specialty Items
 Promo



7AL-3 & MSD 8



MSD 7AL-3™ Ignition

For racers that want adjustments at their fingertips, the 7AL-3 is the right choice. The 7AL-3 packs high voltage with four step retards, three rev limits and an rpm switch.

All of the features are adjusted using plug-in modules including the 3-Step Rev Control and Multi-Step Retard. The Rev Control gives you the ability to set one rev limit for the burnout, another for the staging rpm limit and a third for use top end engine protection in the event of driveline failure. For nitrous fans, there are four separate stages that can be activated independently yet add up together. Plus there's an RPM Activated Switch for precise control over a circuit.

Something new is that the start retard is now adjustable with plug-in modules giving you better control over the amount of retard pulled out during cranking.

The unit is supplied with a variety of rpm and timing modules. It has a footprint that fits into the red 7AL-3's mount.

MSD 7AL-3 Ignition Control, V8 /6/4 - PN 7330*

NOTE: MSD 7-Series Ignitions are not compatible with distributorless systems.

OPERATING SPECIFICATIONS

SPARK ENERGY:	160 Millijoules/Spark
PRIMARY VOLTAGE:	570 Volts
SECONDARY VOLTAGE:	50,000 Volts
SPARK SERIES DURATION:	20° Crankshaft Rotation
RPM RANGE:	14,000 RPM with 14.4 Volts
VOLTAGE REQUIRED:	12-18 Volts, Negative Ground
CURRENT DRAW:	6 Amps at 6,000 RPM 12 Amps at 12,000 RPM
WEIGHT & SIZE:	4.75 lbs., 8"L x 3.75"W x 5.75"H

Tested with Pro Power Coil, PN 8201

- 3-Step Rev Limiter
- 4-Stage Multi-Step Retard
- RPM Activated Switch
- Adjustable Start Retard



FOR MORE INFORMATION ON:

- Recommended Coils, see page..... 74
- Flying Magnet Crank Trigger Kits, see page... 125
- RPM Module Kits, see page 137

MSD 8-Plus™ Ignition Control

There has always been a niche group of hardcore racers and pullers that run nothing but the MSD 8 Ignition Series. If you liked it then, you're going to like it even better now!

The MSD 8-Plus Ignition produces the same extreme output of the original 8-Series, yet is now in a smaller housing with improved efficiency and internal components. One distinct change is now a built-in 2-Step Rev Control. Now you can switch between two rev limits without extra wiring or housings.

For those that are looking for a dual fire MSD 8, the new 8-Plus is all you need. Our engineers were able to deliver an ignition that is capable of firing two coils at once for those extreme racers using dual plug race setups.

MSD 8-Plus Ignition Control - PN 7805*

OPERATING SPECIFICATIONS

SPARK ENERGY:	315-345 Millijoules/Spark
PRIMARY VOLTAGE:	580 Volts
SECONDARY VOLTAGE:	50,000 Volts
SPARK SERIES DURATION:	20° Crankshaft Rotation
RPM RANGE:	15,000 RPM with 14.4 Volts
VOLTAGE REQUIRED:	12-18 Volts, Negative Ground
CURRENT DRAW:	36 Amps at 12,000 RPM
WEIGHT & SIZE:	4.85 lbs., 8.25"L x 3.75"W x 5.75"H

Tested with Pro Power Coil, PN 8201

- Extreme spark output
- Built-in 2-Step Rev Control
- Compatible for 4, 6 and 8-cylinders
- Single or dual coil output



Atomic EFI
Starters/Alternators
Spark Plugs
Ignitions
Late Model
Coils
Distributors
Crank Triggers
Timing/RPM Controls
Spark Plug Wires
Street Fire
Marine
Accessories
Specialty Items
Promo

*Not legal for use or sale on pollution controlled vehicles.



PROGRAMMABLE DIGITAL-7

Programmable Digital-7 Plus™

This ignition set the standard for programmable ignition controls and opened the doors to advanced laptop tuning for extreme powered nitrous and boosted cars. The Programmable 7 Plus provides racers with the ability to set a timing curve for every gear, ramp step retards on and off, activate shift lights or solenoids and even record ignition data for review in the pits.

Programmable Digital-7 Plus - PN 7531* Replacement Harness - PN 8855

NOTES: *Illegal for use in NHRA classes except Pro Mod. The Programmable-7 Series of ignition controls has been updated with the Power Grid Ignition System. For more information, see pages 56-59.*



OPERATING SPECIFICATIONS

SPARK ENERGY:	190 Millijoules/Spark
PRIMARY VOLTAGE:	535 Volts
SECONDARY VOLTAGE:	40,000 Volts
SPARK SERIES DURATION:	20° Crankshaft Rotation
RPM RANGE:	12,500 RPM with 14.4 Volts
VOLTAGE REQUIRED:	12-18 Volts, Negative Ground
CURRENT DRAW:	1.1 Amp per 1,000 RPM
WEIGHT AND SIZE:	3 lbs., 9.5"L x 4.5"W x 2.2"H

Tested with Pro Power HVC Coil, PN 8251
The MSD Pro Power HVC Coil, PN 8251 or PN 8261, are the recommended coils.



US
PATENT
PENDING

- Map a complete timing curve for every gear
- Acquire ignition data after a run including two seconds prior to launch
- Select a slew rate rpm limiter value in rpm/seconds
- Program an rpm limit that is ramped in during the launch
- Program your engine's firing order for ease of setting the cylinder-to-cylinder timing
- Output to activate a device through rpm, time or pressure inputs

Programmable 7 Plus Accessories Manual Launch Control - PN 7551*

This handy device lets you change the launch rpm setting instantly at the turn of a dial.

Adjustable Intensity Shift Light - PN 7542

This compact shift light delivers a bright flash to alert you to shift. Best of all, it plugs directly into the PN 7531 ignition and lets you easily adjust the intensity of the light as drag day shifts into drag night.

Inductive Pickup - PN 7555

This pickup simply slides over the number one spark plug wire allowing you to sync the PN 7531 ignition with the firing order of the engine allowing for cylinder to cylinder timing control.



PN 7551



PN 7542



PN 7555

Atomic EFI
Starters/
Alternators/
Spark Plugs
Ignitions
Late Model
Coils
Distributors
Crank
Triggers
Timing/RPM
Controls
Spark Plug
Wires
Street Fire
Marine
Accessories
Specialty
Items
Promo



POWER GRID™ IGNITION SYSTEMS



Atomic EFI
Starters/
Alternators
Spark Plugs
Ignitions
Late Model
Coils
Distributors
Crank
Triggers
Timing/RPM
Controls
Spark Plug
Wires
Street Fire
Marine
Accessories
Specialty
Items
Promo



PN 7730



PN 7720

OPERATING SPECIFICATIONS

SPARK ENERGY:	200-220 mJ/Spark
PRIMARY VOLTAGE:	545-570 Volts
SECONDARY VOLTAGE:	50,000 Volts plus
SPARK SERIES DURATION:	20° Crankshaft Rotation
RPM RANGE:	15,000 RPM with 14.4 Volts
VOLTAGE REQUIRED:	12-18 Volts, Negative Ground
CURRENT DRAW:	1.3 Amp per 1,000 RPM
WEIGHT & SIZE:	2.9 lbs., 7.5"L x 5"W x 2.25"H



Power Grid Programming Features:

- USB connection for ease of programming
- Timing based on engine rpm, gear value and time
- Advanced individual cylinder timing based on gear or time
- Five retard stages for nitrous
- Five steps of rpm limits for burnout, spool, launch, overrev and safety
- Output switch set on rpm or time
- Shift light settings for each gear
- Ignition data acquisition records multiple runs



The Controller is designed to mount on top of the Ignition housing. This keeps wiring and required space at a minimum.



The Controller features a single wiring harness routed through a durable, locking connector. Next to it is a sealed cover that protects the micro-SD card and the USB connection. That's right - the Power Grid uses a USB connection for easier connections. The grid will power up through the USB, eliminating ignition to be on to program.



POWER GRID™ IGNITION SYSTEM

The Power Grid Ignition System is the next evolution of our Programmable 7-Series Ignition Controls. The Grid incorporates an efficient 32 bit microcontroller and an all new software program, called MSD View, and is USB compatible. The Windows based software is designed with tabs to help racers easily select different programming windows and parameters. Also, the data acquisition files of the ignition are now captured on a micro SD card for ease of storage and reviewing.

The Power Grid Ignition incorporates CAN-Bus technology which reduces the amount of wiring and simplifies the addition of accessory modules. The CAN-Bus is a common harness that accessory controls are connected to and easily brought into the programming library of the View Software. With this technology, racers can connect the Power Grid system directly into their Racepak Data Recorder and other Racepak products.

The Power Grid Controller is the brains behind the entire system and **can be used with any MSD Ignition or the Pro Mag** to provide advance ignition tuning capabilities. While it is compatible with all MSD boxes, the new Power Grid System Controller has been specially designed to mount to the Power Grid-7 box. Also, this new Ignition packs higher output than the current programmable units!



PN 7730

**Power Grid Ignition System™
Controller - PN 7730*
Ignition - PN 7720***

**Replacement Harness for PN 7730 - PN 7780*
CAN-Bus Extension Harnesses:
2 feet - PN 7782*
4 feet - PN 7784*
6 feet - PN 7786***

**Harness Adapter, PN 7730 to
Digital-7 Programmable - PN 7789***

Inductive Spark Plug Wire Sync Kit

This pickup simply installs on the number one spark plug wire. Much like a timing light pickup, it senses the spark and relays this information through a fiber optic cable to the Controller. By using a fiber optic cable, there is absolutely no chance of EMI or interference.

Inductive Spark Plug Wire Pickup - PN 7555



PN 7555

- Atomic EFI
- Starters/Alternators
- Spark Plugs
- Ignitions
- Late Model
- Coils
- Distributors
- Crank Triggers
- Timing/RPM Controls
- Spark Plug Wires
- Street Fire
- Marine
- Accessories
- Specialty Items
- Promo



POWER GRID™ IGNITION SYSTEM

Atomc EFI
Starters/
Alternators
Spark Plugs
Ignitions
Late Model
Coils
Distributors
Crank
Triggers
Timing/RPM
Controls
Spark Plug
Wires
Street Fire
Marine
Accessories
Specialty
Items
Promo

The Power Grid System consists of a central Controller, and an Ignition. The Controller is the brains of the system, while the Ignition is a high output CD ignition (or use your existing MSD ignition). To add accessories, such as a Boost Retard Module, or a Manual Launch Shift Light Control, simply plug the new Module into the CAN-Bus bridge connector and that's it! Also, notice the separate connector that plugs directly into a RacePak Data System. The Power Grid is designed to share its ignition information to Racepak's data!

WIRING OVERVIEW

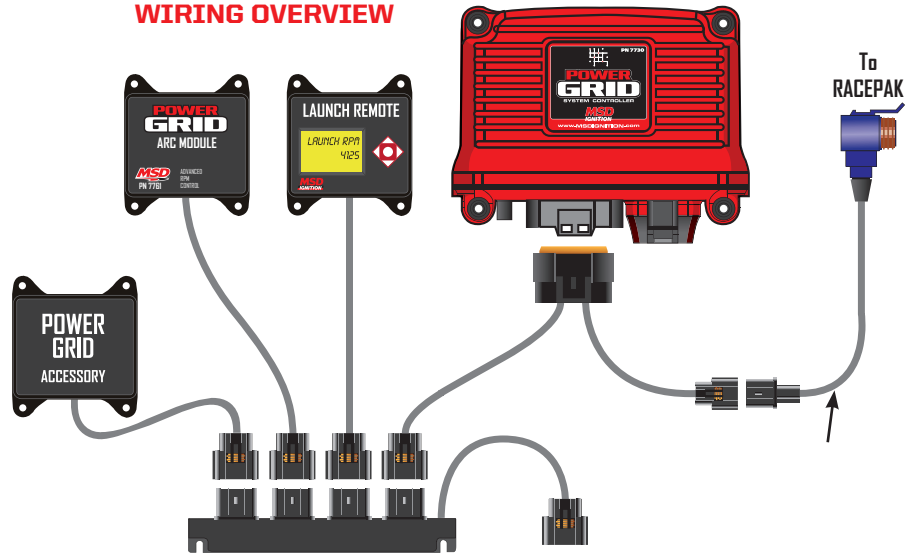

PN 7740

4-Connector Hub - PN 7740*

This hub allows you to expand the Power Grid system with up to four accessory modules.



PN 7751

CAN-Bus Termination Cap - PN 7741*

Loose your cap? Here's the one you need.

Manual Launch Control - PN 7751*

Change the launch rpm limit (2-Step) on the fly to adjust for changing track conditions.

NEW!

Programmable 3 Stage Delay Timer - PN 7760*

This timer will activate up to three individual outputs based on time. Outputs can trigger a relay to activate a shifter, nitrous, etc. When the clutch/transbrake is released the Power Grid will start the timers through the CAN Connection.



PN 7760

ARC Module - PN 7761*

MSD's ARC Module (Advancer RPM Control), PN 7761 is the easiest way keep traction while going down the track. The ARC module plugs directly into the Power Grid via the CAN bus and is programmable with MSD View software. The ARC module is capable of controlling the rate of engine acceleration as well as ignition timing in order to keep the tire hooked. Users have the option to control these parameters based on engine RPM, drive shaft RPM or both. The Power Grid data acquisition will record drive shaft RPM, ARC active, rev limiter & ignition timing (when ARC is active). This is key when running a small tire car or trying to get down a bad track. A driveshaft curve from a previous run can be imported into the ARC from MSD Re-View or Racepak. This makes setting up the ARC module a breeze.



PN 7761



POWER GRID™ IGNITION SYSTEM

Boost Retard Control

This Power Grid module does exactly as its names suggests; retards the ignition timing in relation to boost pressure. The software provides a timing map that allows you to program a timing curve based on the built-in 3-BAR sensor. It also has an output wire that can be used to activate another device based on boost pressure, as well as an overboost shut-down feature that will shut the ignition off if boost exceeds the overboost target.



PN 7762

Boost Retard Control - PN 7762*

Boost Controllers

MSD Boost Controllers are the most accurate and easy to use controllers on the market. Both controllers plug directly into the Power Grid via the CAN bus which allows user to make adjustments through MSD View software. MSD Boost controllers feature two boost curves that can be toggled on the fly, a user adjustable boost vs. timing retard curve, pressure switch and an over boost shutdown to protect the engine. The Power Grid data acquisition will record manifold and wastegate pressure as well as solenoid operation. The MSD Boost Controller, PN 7763 has two built-in 4-Bar (43.5 psi) sensors. High boost application will require, PN 77631 which uses a pair of external 6-Bar (75 psi) sensors. The 77631 is equipped with a "quick spool" feature which allows the customer to increase launch RPM or retard timing in order to help spool at the starting line.



PN 7763



PN 77631

4-BAR, up to 43.5 PSI - PN 7763*

6-BAR, up to 75 PSI - PN 77631*

Power Module

The Power Module has four high solid state switches that can be configured independently or in conjunction by Time, RPM and temperature switching On /OFF as well as by percentage for NOS systems. Each channel is capable of handling 20 amps of current without the use of a relay. It can be used to activate a fan, fuel pump, a NOS system, Throttle stop, the possibilities are endless. When connected to the Power Grid it will data log all the functions including Time from Launch, time or rpm of activation and deactivation.

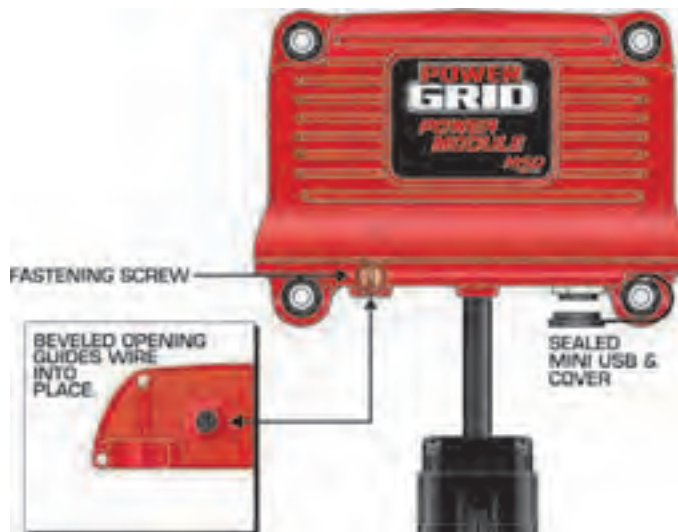

Power Module - PN 7764*

Atomic EFI

Starters/
Alternators

Spark Plugs

Ignitions

Late Model

Coils

Distributors

Crank
Triggers

Timing/RPM
Controls

Spark Plug
Wires

Street Fire

Marine

Accessories
Specialty
Items

Promo



Atomic EFI
Starters/Alternators
Spark Plugs
Ignitions
Late Model
Coils
Distributors
Crank Triggers
Timing/RPM Controls
Spark Plug Wires
Street Fire
Marine
Accessories
Specialty Items
Promo

MAINTENANCE-FREE

- No Points to Adjust
- No Batteries to Replace
- Magnets Never Require Recharging

The MSD Pro Mags are known for their incredible power and superior reliability! There are no magnetos that can come close to the performance of the Pro Mag. Three series of Pro Mags are offered: the Pro Mag 12 for gas and alcohol engines, the 20 Amp for blown alcohol and the 44 Amp version for nitro gulping, ground pounding applications. The Pro Mags burn more fuel, hold the timing solid and are always consistent in their power, leaving more time to tune other aspects of the car.



12LT

Now in Black!

Pro Mag® 12LT

Designed with sprint cars in mind, the Pro Mag 12LT offers light weight and incredible power. The compact housing also sits an inch lower for improved clearance of the fuel injection plus features a band clamp mount for easier timing adjustments.

The Electronic Points Box is the brain of the Pro Mag 12. It controls the spark duration and the unique full-power firing sequence of the Pro Mag 12. The energy from the generator is controlled with field effect transistor (FET) technology which is far superior to mags still using points as a trigger source.

Each Pro Mag 12LT is supplied with a bronze gear, band clamp, cap and rotor. Available for Chevrolet, Ford 351W and Band Clamp Mounts.

20 AMP Generators

The increased output of the 20 Amp Pro Mag was born of racers being racers; always asking for more power. This stemmed from drag racers that were using a 12 Amp system, but just didn't require a 44 Amp system. The engineers at MSD found that with a few changes to the internals the generator would deliver the increased current through the same Electronic Points Box, PN 8106.

The 20 Amp magneto is a favorite in alcohol slurping engines such sportsman dragsters and Quick-8 racers. There are three different generators available, a band clamp design in both CW and CCW rotation, plus a model built on a Chevy distributor base. All three require the PN 8106 Electronic Points Box. The band clamp versions are equipped with a large Ford style cap while the Chevy version uses a 4-inch cap and both are topped with heavy duty retainers.

Pro Mag® 44

The Pro Mag 44 is the king of all magnetos. With no points to replace, no magnets to recharge and by producing an amazing 44 amps of primary current, it's no wonder that the 44 is the only choice in nitro-gulping top fuel racing!

The 44 requires an external Electronic Points Box to manage the primary current through the accurate triggering of the magnetic pickup. A special coil is required to handle this hit of current and pumps it up to 50,000 volts with over 1 Amp of energy firing across the plug gap. For racers with serious boost pressures and fuel, the Pro Mag 44 is the only way to go.



DISTRIBUTORLESS IGNITIONS

What is Distributorless?

Late-model vehicles have incorporated ignition systems that have not used a distributor for quite a few years. Reaching back to the mid '80s, some vehicles, such as Buick's turbo V-6 models used a coil pack with six secondary terminals. This technology continued to be used on more cars and trucks rolling off the assembly line. These systems use some form of a crank sensor that produces a trigger signal to the ECU which triggers the correct channel of the ignition.

In recent years, distributorless technology has evolved into coil-per-cylinder and coil-on-plug systems that have an individual coil for each cylinder. These coils receive voltage and energy through a driver that is triggered by the ECU. These drivers are sometimes incorporated into the ECU, and other times in the coils themselves (such as the GM LS). The following info will help you get an idea of which ignition is right for your application.

MSD DIS Ignition Controls

These DIS Ignition Controls provide MSD's proven CD multiple sparks that will ignite performance into street/strip cars. The DIS-2 is designed for 4-cylinder engines with two coil packs, the DIS-4 can be used on 6 or 8-cylinder engines with coil packs (and on some 4-cylinder coil-per-cylinder systems). Both Ignitions have been updated with rotary dials to adjust its two rev limiters and step retard. See page 62.



High Performance Coil Packs

When it comes to modern muscle car and truck performance, one of the best upgrades is with a set of MSD high output coils. We now offer three different series of coils for most domestic late model trucks and cars; Street Fire, Blaster and Pro Power Coils. Street Fire Coils are designed as an economical upgrade, Blaster Coils are the next step with improved performance and the Pro Power Coils are designed to deliver the most spark energy possible from cranking to redline rpm. See more on the line of MSD Coil packs on pages 67-73.



Ignition Controllers for the Detroit-Three

The Detroit-Three have been distributorless for over a decade! MSD now offers an ignition controller for each; the GM LS engines, the Ford Modulares and the new Dodge Hemi. These Controllers will connect to the factory sensors (with the accessory EFI Harnesses) and allow the user to alter the timing curve, set a launch rpm limit, program a step retard or even map a timing curve based on boost pressure. They'll also drive the coil packs when an old-school carburetor is added to the mix! Check out pages 64-66.



6-Mod



6LS

- Atomic EFI
- Starters/ Alternators
- Spark Plugs
- Ignitions
- Late Model
- Coils
- Distributors
- Crank Triggers
- Timing/RPM Controls
- Spark Plug Wires
- Street Fire
- Marine
- Accessories
- Specialty Items
- Promo



DISTRIBUTORLESS IGNITIONS

Atomic EFI
Starters/Alternators
Spark Plugs
Ignitions
Late Model
Coils
Distributors
Crank Triggers
Timing/RPM Controls
Spark Plug Wires
Street Fire
Marine
Accessories
Specialty Items
Promo



PN 62152



OPERATING SPECIFICATIONS

SPARK ENERGY:	105-115 Millijoules/Spark
PRIMARY VOLTAGE:	460-480 Volts
SECONDARY VOLTAGE:	40,000 Volts
SPARK SERIES DURATION:	20° Crankshaft Rotation
RPM RANGE:	14,000 RPM with 14.4 Volts
VOLTAGE REQUIRED:	10-18 Volts, Negative Ground
CURRENT DRAW DIS-2:	3.5 Amps at 10,000 RPM
CURRENT DRAW DIS-4:	6.6 Amps at 10,000 RPM
WEIGHT & SIZE:	4.5 lbs., 9.5"L x 4.5"W x 2.2"H

This product is Legal to sell, distribute or install on non-OBD II vehicles in California according to Executive Order E.O. D-40-31; legal in all 50 states.

DIS-4 Plus Ignition Control

The mid 1980s were the beginning of the end for distributors in regard to new cars. The Buick Grand Nationals started using coil pack technology while many other GM vehicles were using dual tower coil packs sometimes known as Waste Spark systems. When Ford moved to the 4.6L Modular engine in the '96 Mustang, there were two coil packs with four towers each set up as a Waste Spark. Other common applications came from Mitsubishi and eventually Chrysler systems.

MSD's DIS-4 Ignition Control is designed for engines with coil pack, waste spark ignition systems and is capable of firing up to four coil packs (or even four individual coils). Each Control delivers full power Capacitive Discharge sparks from idle through racing rpm. Below 3,000 rpm there is a series of multiple sparks that last for up to 20° of crankshaft rotation to improve idle, starting and throttle response.

The adjustable features of the DIS Ignition includes an over-rev limiter and the holeshot rev limit. Also, there is a step retard that can be wired directly to a nitrous system or switch for activation! These are adjustable with rotary dials.

MSD DIS-4 Plus (For use on 6 or 8-cylinder engines with two, three or four coil packs.) - **PN 62152**

BUILT-IN FEATURES:

- 2-Step Rev Control
- Step Retard
- LED Monitor
- Features are adjustable with rotary switches



Higher Output Race-only DIS-4 Plus Ignition Control

For full bred drag race engines running high boost pressures from turbos, blowers or nitrous we offer a Higher Output version of the DIS Ignition Control. The DIS-4 Plus HO Ignition produces an incredible 170 millijoules of spark energy with 470 primary volts. This increased output will light up fuel mixtures even under extreme cylinder pressures.



PN 62153



DIS-4 Plus HO, 2, 3 or 4-Coil Packs - **PN 62153***

OPERATING SPECIFICATIONS

SPARK ENERGY:	170 Millijoules/Spark
PRIMARY VOLTAGE:	470 Volts
SECONDARY VOLTAGE:	43,000 Volts (stock coil)
SPARK SERIES DURATION:	20° Crankshaft Rotation
RPM RANGE:	14,000 RPM with 14.4 Volts
VOLTAGE REQUIRED:	10-18 Volts, Negative Ground
CURRENT DRAW DIS-4:	10 Amps at 10,000 RPM
WEIGHT & SIZE:	3 lbs., 9.5"L x 4.5"W x 2.2"H



DISTRIBUTORLESS ACCESSORIES

Atomic EFI
Starters/
Alternators/
Spark Plugs
Ignitions
Late Model
Coils
Distributors
Crank
Triggers
Timing/RPM
Controls
Spark Plug
Wires
Street Fire
Marine
Accessories
Specialty
Items
Promo

Blaster™ Single Tower Coil

For performance applications with multi-channel coil drivers this Single Tower Blaster Coil is a great choice. The Coil will also top off your MSD DIS-HO Ignition system when it is set up for a coil-per-cylinder ignition system. The coil's low resistance and quick rise time make it ideal for high revving, multi-coil performance systems.

Blaster Single Tower Coil PN 8232*

COIL SPECIFICATIONS

URNS RATIO:	85:1
PRIMARY RESISTANCE:	.09 ohms
SECONDARY RESISTANCE:	988 ohms
INDUCTANCE:	3.7 mH
MAXIMUM VOLTAGE:	43,000 V
PEAK CURRENT:	800 mA
SPARK DURATION:	125 uS

Tested with CPC Ignition at plug gap



Coil Interface Module

This module goes between the factory GM ignition module and coils. It has color coded wires that connect to the DIS wiring and are molded using Dupont Rynite for its high dielectric strength and connect directly to the factory terminals.

GM Coil Interface Module - PN 8870

NOTE: Coil sold separately.



DIS-4 Harnesses

MSD DIS-4 to Dual Ford Coil Packs - PN 88812

This harness provides a splice-free installation of a DIS-4 to Dual Ford Coil Packs ('96-'98).

Dual DIS-4 on Ford '99-'09 Mod Motor Harness - PN 88813

This harness provides a plug-in installation of two DIS-4 ignition controls to Ford V8 Mod Motors from '99-'09.



Ford Coil-on-Plug Ignition Adapter - PN 89121

Required when installing two DIS-4 ignitions on a '99-'09 Mod Motor.

Dual Coil Ignitor

This device will help you remove the weak OEM pencil oil in favor of a higher output Blaster SS or HVC coil. A DIS-series ignition control must be used.

DIS Dual Coil Ignitor, 2-Channel - PN 6302





6LS CONTROLLERS

Atomic EFI
Starters/Alternators
Spark Plugs
Ignitions
Late Model
Coils
Distributors
Crank Triggers
Timing/RPM Controls
Spark Plug Wires
Street Fire
Marine
Accessories
Specialty Items
Promo

MSD 6LS and 6LS-2 Ignition Controllers



PN 6012

QUICK ID
LS2/LS7 - Cam Sensor in front. Gray Crank Sensor.
LS1/LS6 - Cam Sensor in rear. Black Crank Sensor.

- *Runs a carbureted LS engine without complicated EFI hardware*
- *Map a timing curve using Pro-Data+ software*
- *Programmable 2-Step Rev Limiter, vacuum advance curve and step retard*
- *Direct plug-in to factory components*
- *Programmable via a PC through MSD's Pro-Data+ software*

While it may seem blasphemous to some, putting a carburetor on a GM Gen-III V-8 is a great option for those wanting the advantages of the aluminum small block without the headaches of wiring a modern EFI system. The controllers allow you to map a timing advance curve with MSD's easy-to-use Pro-Data+ software. Other programmable features include a 2-Step Rev Limiter, a vacuum advance curve for cruising economy and even a step retard in case you want to add a little nitrous to the mix.

The 6LS is designed for LS1/LS6 type engines with a 24-tooth wheel, which can be identified by its black harness connector.

The 6LS-2 is designed specifically for the LS2/LS7 and its 58-tooth wheel, which can be easily recognized by its gray harness connector. Both of these compact ignition controllers fit with matching factory connectors for a direct installation. Only a handful of connections are required; the coils, crank sensor, MAP sensor and the cam sensor. You'll have your carb'ed LSX running in no time!



US PATENT PENDING

MSD 6LS Ignition Controller, for LS1/LS6 (24-tooth crank trigger) Engines - PN 6010*

6LS-2 Ignition Controller for LS2/LS7 (58-tooth crank trigger) Engines - PN 6012*



EFI Harnesses

These harnesses allow you to easily connect the 6LS or 6LS-2 to a factory EFI system to take advantage of timing adjustments and settings!

6LS to EFI Harness, LS1/LS6 - PN 8886

6LS-2 to EFI Harness, LS2/LS7 - PN 88862



FORD® MODULAR PERFORMANCE

Ford® Modular Ignition Controller

New technology to go old school! When you retro-fit a Ford 4.6L or 5.4L (SOHC/DOHC) with a carbureted intake manifold, you'll need this new Controller to handle the ignition chores.

The Controller plugs into the coil packs and sensors of the engine for a direct installation. From a PC, using our Pro-Data+ software, you can program a custom timing curve, a step retard, 2-Step Rev Limiter and even a vacuum advance. A great system for street rods and retro muscle cars.



PN 6011

Ignition Controller for Carbureted Ford Modular Engines 4.6/5.4L - PN 6011*



- *Fire the coils and control the timing on Ford Modular engines with carburetors*
- *Map a timing curve and vacuum advance to meet your vehicle's needs*
- *Program two rev limits and set a step retard for nitrous use*
- *Connects directly to the coils, crank, cam and MAP sensors for an easy installation*

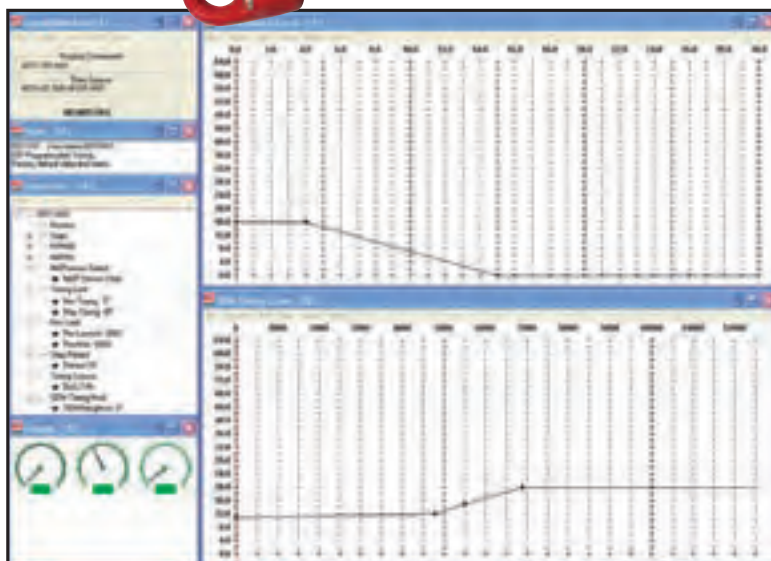

6-Mod Controller Harness for EFI

The 6-Mod Ignition Controller was originally developed for Mod Motors that were fed through a carburetor rather than an electronic fuel injection system. However, with the useful options that the 6-Mod provides, such as two rev limits, a step retard and easy control over the timing, the EFI guys wanted a way to take advantage of the adjustment. The answer lies in this new Harness Kit.

This Harness provides a splice-free installation of the MSD 6-Mod Controller to factory equipped EFI vehicles making installation a snap. All of the connectors plug directly to the factory units so there is no cutting or splicing of your factory wires. The compact "tach adapters" ensure that the ECU and the 6-Mod receive the correct signals required to keep both systems operating as designed.

Once installed, the 6-Mod allows users to advance or retard the factory's timing curve, program a step retard for use with nitrous systems or even map out a timing curve through a laptop by using MSD's Pro-Data+ software.



PN 88814

6-Mod Harness for EFI - PN 88814

Atomic EFI
Starters/Alternators
Spark Plugs
Ignitions
Late Model
Coils
Distributors
Crank Triggers
Timing/RPM Controls
Spark Plug Wires
Street Fire
Marine
Accessories
Specialty Items
Promo



LATE MODEL HEMI® PERFORMANCE



PN 6013



6-Hemi Ignition Controller

Hemi fans old and new will be excited to see that the 6-Hemi Controller will connect to factory EFI fueled Hemis or will drive the coil packs of a carbureted retro-fit engine! The Controller plugs into each coil pack along with the crank and cam sensors to provide you the ability to modify the timing curve, set a 2-Step Rev Limit, nitrous retard or even a boost/timing map! The 6-Hemi Controller is designed to operate with both styled coil packs that are offered on the new engines. A wiring harness for each application is sold separately.

6-Hemi Ignition Controller - PN 6013*

- *Fire the coils and control the timing on Hemis retro-fit with a carburetor or factory EFI*
- *Program two rev limits and a step retard*
- *Connects directly to the coils, crank, cam and MAP sensors for easy installation*



6-Hemi Harnesses

Chrysler used two different coil packs on the late model Hemi engines. For connections on a carbureted engine a Harness will be required. For EFI engines, the Harness and an Adapter will be required.

Harness:

'03-'05 - **PN 88863**

'06-'08 - **PN 88864**

Adapter for Factory EFI:

'03-'05 - **PN 88815**

'06-'08 - **PN 88816**

8.5mm Super Conductor Wire for '03-'05 Hemi's

MSD offers a set of low resistance 8.5mm wires, PN 32039 and PN 32033.



Hemi® is a registered trademark of Chrysler LLC.

Atomic EFI
Starters/Alternators
Spark Plugs
Ignitions
Late Model
Coils
Distributors
Crank Triggers
Timing/RPM Controls
Spark Plug Wires
Street Fire
Marine
Accessories
Specialty Items
Promo



LATE MODEL COILS

There is no denying that today's modern muscle cars deliver incredible power with outstanding driveability. The LS, Coyote and modern HEMI all make incredible power yet idle smooth, knock down great mileage and don't seem to leak like their ancestor designs. Better yet, is that there is power to be had in these engines with a few easy bolt-on parts - such as the coil packs.

MSD offers three different series of coil packs for your late model muscle car and truck. There is our value based Street Fire brand, an entry level MSD Blaster Coil and a high output Pro Power line with the highest output available. Each coil is series has been tested and designed by MSD to improve spark energy and improve efficiency of the coil for overall performance improvements. When you're adding other upgrades such as a cold air intake system, programming tweaks or a better flowing exhaust, the increased spark output will help tie the performance benefits together.

Fire up your late model muscle car with MSD and Street Fire Coils!



NEW!

PN 5508



PN 5515



PN 5516



BLASTER™



PN 8262

PN 8248



PN 8255



PRO POWER™

PN 8285



**MSD Pro Power™
Ford and Hemi
Coils
Coming Soon!**

Atomic EFI
Starter/Alternators
Spark Plugs
Ignitions
Late Model
Coils
Distributors
Crank Triggers
Timing/RPM Controls
Spark Plug Wires
Street Fire
Marine
Accessories
Specialty Items
Promo





PRO POWER™ LS COILS



MSD Pro Power™ Coil Kits

MSD's engineering team have been working diligently the past year to improve our Multiple Spark Coils for the GM LS-engine platform. The new coils fit in place of the OEM coils yet are capable of delivering higher spark energy to the plugs, topped with multiple sparks at idle rpm.

Increased spark energy and voltage, along with multiple spark capabilities, help improve the combustion process of the fuel mixture to create an efficient burn. This results in improved throttle response, smooth idle and quick starts, plus increased high rpm performance!

There are three types of housings for the MSD Coils. Check your application for the visual match.



PN 8285



PN 8286



PN 8287



The Pro Power LS coils deliver up to three times the current of the stock coils.

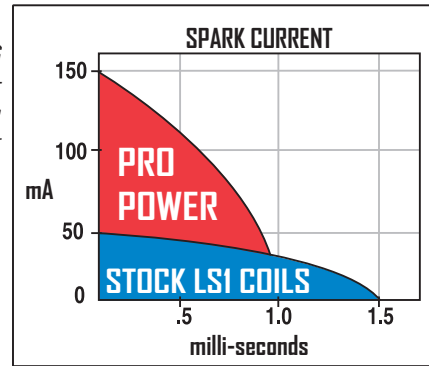

COIL SPECIFICATIONS

	PN8285/8286	PN 8287
URNS RATIO:	52:1	52:1
PRIMARY RESISTANCE:	.57 ohms	.49 ohms
SECONDARY RESISTANCE:	3.1K ohms	2.3K ohms
INDUCTANCE:	5.8 mH	3 mH
MAXIMUM VOLTAGE:	44,000 Volts	44,000 Volts
PEAK CURRENT:	150 mA	210 mA
SPARK DURATION:	1200 uS	900 uS

These products are legal to sell, distribute or install on vehicles (up through 2008) in California according to Executive Order E.O. D-40-41; legal in all 50 states.

'98-'06 LS1/6
'99-'07 Truck Series
'05-'13 LS2/3/4/7/9

Individual
PN 8285
PN 8286
PN 8287

8-Pack
PN 82858
PN 82868
PN 82878

Coil Bracket
PN 8215
PN 8216

Identifying your coils

GM used a variety of coils on these engines, so the best way to identify the coil you need is through visual comparison. The chart below shows a picture of the OE coils and with the recommended Pro Power and Blaster coil part numbers to help ensure you select the proper coil for your application.

NOTE: The 8th digit in the VIN is the engine code.

Pro Power PN 82858 replaces:
'98-'04 GM Car w/VIN G/S
'98-'06 Trucks w/VIN E and D
Connector and plug wire on same side.



Blaster, PN 82628

Pro Power PN 82868 replaces:
'99-'07 GM Truck 4.8L, 5.3L, 6.0L
'03-'07 Hummer 6.0L
VIN Z, N, T, V, U, B and P
Connectors on opposite ends.



Blaster, PN 82638

Pro Power PN 82878 replaces:
'05-'13 Cars 5.3L, 6.0L, 7.0L, 8.1L
w/VIN M and C
'05-'13 Trucks 5.3L, 6.0L
w/VIN G, T, U and H



Blaster, PN 82658

'99-'09 GM 4.8L, 5.3L, 6.0L, 8.1L
'03-'07 Hummer 6.0L
VIN Z, N, T, V, U and B
Connectors on opposite ends.



Blaster, PN 82648

Atomic EFI
Starters/Alternators
Spark Plugs
Ignitions
Late Model
Coils
Distributors
Crank Triggers
Timing/RPM Controls
Spark Plug Wires
Street Fire
Marine
Accessories
Specialty Items
Promo



BLASTER™ LS COILS

Looking to replace your worn out LS coils with a more efficient upgrade? The new MSD Blaster LS Coil line is ideal for your modern GM muscle car or truck. The coils are designed as a bolt-in replacement yet have been thoroughly tested and detailed by our experienced engineering team. The improved efficiency of these Blaster Coils will give your LS the ignition boost you're looking for.

NEW!

GM LS Platform

- '98-'06 LS1/6
- '05-'13 LS2/3/4/7/9
- '99-'07 Truck Series
- '99-'09 Truck Series

CARB approval pending

Individual 8-Pack

- PN 8262 PN 82628
- PN 8265 PN 82658
- PN 8263 PN 82638
- PN 8264 PN 82648

PN 8265



PN 8264



PN 8262



PN PN 8263



Power Upgrade Harness - PN 88867

We've learned that some of the OEM wiring that powers the coils may not be up to snuff when it comes to increasing performance and coil output. This direct plug-in harness allows you to provide a reliable path for the increased voltage and current that your coils need. (Recommended for use with MSD Pro Power Coils and can even be used with OE coils.)

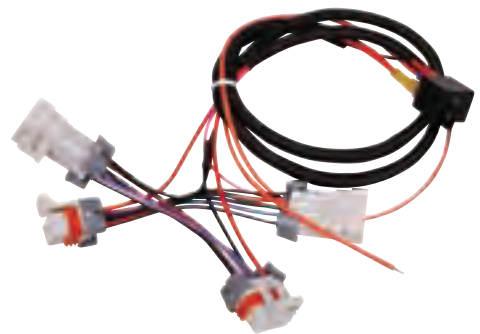

Coil Brackets

LS Engines are outstanding when it comes to performance, however their aesthetics leave a lot to be desired. Specifically when it comes to the coils and their factory stamped brackets. MSD offers two brackets for use on LS engines that will help clean up the coil installation.

These new brackets are made from cast aluminum with a machined finish to deliver strength and great looks. The brackets are supplied with all new mounting hardware and accept either OEM or MSD style coils!



- LS 1/LS6 OE, Pro Power, MSD or Street Fire Coils - PN 8215
- LS 2/LS7 OE, Pro Power, MSD or Street Fire Coils - PN 8216

Atomic EFI
 Starters/
 Alternators
 Spark Plugs
 Ignitions
 Late Model
 Coils
 Distributors
 Crank
 Triggers
 Timing/RPM
 Controls
 Spark Plug
 Wires
 Street Fire
 Marine
 Accessories
 Specialty
 Items
 Promo



STREET FIRE® LS COILS



Looking for an effective performance upgrade for your daily driver? The Street Fire line of performance LS Coils are the answer! MSD engineers spec'd the internal components of these coils to deliver increased spark energy over the entire rpm range of the engine. The coils bolt in place of the factory units and accept OEM connections for a simple installation.



GM LS Platform

- '98-'06 LS1/6
- '05-'13 LS2/3/4/7/9
- '99-'07 Truck Series
- '99-'09 Truck Series

Carb approval pending

Individual	8-Pack
PN 5508	PN 55088
PN 5511	PN 55118
PN 5509	PN 55098
PN 5510	PN 55108



PN 5508

NEW!



PN 5511



PN 5510



PN 5509

Identifying your coils

GM used a variety of coils on these engines, so the best way to identify the coil you need is through visual comparison. The chart below shows the OE coils and the Street Fire part numbers to help ensure you select the proper coil for your application.

NOTE: The 8th digit in the VIN is the engine code.

Street Fire®, PN 55088 replaces: '98-'04 GM Car w/VIN G/S '98-'06 Trucks w/VIN E and D Connector and plug wire on same side.	Street Fire®, PN 55098 replaces: '99-'07 GM Truck 4.8L, 5.3L, 6.0L '03-'07 Hummer 6.0L VIN Z, N, T, V, U, B and P Connectors on opposite ends.	Street Fire®, PN 55118 replaces: '05-'13 Cars 5.3L, 6.0L, 7.0L, 8.1L w/VIN M and C '05-'13 Trucks 5.3L, 6.0L w/VIN G, T, U and H	Street Fire®, PN 55108, replaces: '99-'09 GM 4.8L, 5.3L, 6.0L, 8.1L '03-'07 Hummer 6.0L VIN Z, N, T, V, U and B Connectors on opposite ends.
--	---	---	---



Promo
Accessories
Specialty
Items
Marine
Street Fire
Spark Plug
Wires
Timing/RPM
Controls
Crank
Triggers
Distributors
Coils
Late Model
Ignitions
Spark Plugs
Starters/
Alternators
Atomic EFI



BLASTER™ FORD® COILS

Ford Blaster™ Coil-on-Plug

The improved spark energy and voltage of MSD's Coils have made them a favorite for performance enthusiasts. Whether firing a restored BOSS 429 or a Saturday night circle tracker, MSD Coils always get the job done. MSD is excited to offer coils for late model Ford engines with the same performance and reliability.

MSD offers high output coils for a variety of late model Modular Motors as well as the Coyote. The housing and installation are the same as the factory, but that's where the similarity ends. Inside the MSD red housing, engineers spec'd better material to assemble the primary and secondary windings. Together, this combines a coil that produces higher voltage and spark energy!

- Improved high rpm operation
- Direct bolt-in to factory connectors

Ford Coil-on-Plug

'11-'14, 5.0L, 4-Valve,
'98-'14, 4.6/5.4L, 2-Valve
'04-'08, 4.6/5.4L, 3-Valve
'99-'14, 4.6/5.4L, 4-Valve

Individual

PN 8248
PN 8242
PN 8243
PN 8244

8-Pack

PN 82488
PN 82428
PN 82438
PN 82448



These products are legal to sell, distribute or install on vehicles in California according to Executive Order E.O. D-40-42; legal in all 50 states.



Blaster™ Coyote Coil-on-Plug

The Ford 5.0L Coyote engine is hot, but MSD now offers a coil that will make it even hotter! MSD developed a replacement coil that incorporates improved windings and material to increase the output of the coil. Also, when other modifications are being added, you can rely on the Blaster Coil to recover quicker through high rpm with a powerful spark to promote combustion.



Atomic EFI
Starter/Alternators
Spark Plugs
Ignitions
Late Model
Coils
Distributors
Crank Triggers
Timing/RPM Controls
Spark Plug Wires
Street Fire
Marine
Accessories
Specialty Items
Promo



STREET FIRE® FORD® COILS



Ford moved to coil-on-plug technology in the mid '90s and have never looked back. To help keep the spark energy at a higher level in your Mod Motor or new Coyote, we offer a series of Street Fire coils to replace the weak factory units. Each Street Fire Coil is designed to improve the spark energy and efficiency of the coil to ensure full power at the plug gap to improve the overall performance of your Ford.



Ford Application

	Single	Set of 8
'98-'14, 4.6L/5.4L 2-Valve	PN 5512	PN 55128
'04-'08, 4.6L/5.4L 3-Valve	PN 5513	PN 55138
'99-'14, 4.6L/5.4L 4-Valve	PN 5514	PN 55148
'11-'14, 5.0L 4-Valve	PN 5515	PN 55158

NEW!



Atomic EFI
Starters/Alternators
Spark Plugs
Ignitions
Late Model
Coils
Distributors
Crank Triggers
Timing/RPM Controls
Spark Plug Wires
Street Fire
Marine
Accessories
Specialty Items
Promo



LATE MODEL HEMI® COILS

Blaster Hemi® Coil-on-Plug

Fire up your late model Hemi with a set of MSD's Blaster Coils. The Coils are a direct bolt-in and are spec'd with superior materials and winding ratios to improve the output of the coil while retaining the factory fit.

Blaster Hemi® Coils
5.7L Hemi, '03-'05
5.7/6.1L Hemi, '05-'14

<i>Individual</i>	<i>8-Packs</i>
PN 8256	PN 82568
PN 8255	PN 82558

- Improved high rpm operation
- Patented winding design and materials
- Direct bolt-in to factory connectors



These products are legal to sell, distribute or install on vehicles in California according to Executive Order E.O. D-40-42; legal in all 50 states.



If you have a high mile HEMI and are looking to breathe some life back into the motor, the increased spark energy of the Street Fire coils are a great starting point. Any engine will perk up when the spark is stepped up across the plug gap and Street Fire coils will deliver! Two models are available to fit the range of late model Hemi engines.

Chrysler Application

'03-'05 5.7L Hemi
 '05-'14 5.7L/6.1L Hemi

Single	Set of 8
PN 5517	PN 55178
PN 5516	PN 55168

Carb approval pending



PN 8256



PN 8255



PN 5516



PN 5517

Atomic EFI
 Starters/
 Alternators
 Spark Plugs
 Ignitions
 Late Model
 Coils
 Distributors
 Crank
 Triggers
 Timing/RPM
 Controls
 Spark Plug
 Wires
 Street Fire
 Marine
 Accessories
 Specialty
 Items
 Promo



PERFORMANCE COIL INFO



Like our ignition controls, MSD offers a variety of performance coils designed for a number of different applications. From OEM replacement models, to Blaster 2 kits to improve spark output on stock systems and up to the HVC II Coil, MSD has a coil for most everything!

MSD hand assembles several of our high output racing coils completely in-house. This gives our engineers much more control over the output, quality and ultimately, the performance that you receive from your ignition system. The HVC II Coils (see page 78) are completely built in-house

and incorporate state-of-the-art Rynite molded bobbins and special wiring for windings. This advanced technology may be over the top for many applications, but the information gained from these race coils is useful in developing all of our coils and products.

The chart below will give you a good starting point in choosing the right coil for your ignition system. If you have any questions regarding coil selection, please contact our Customer Support Department at (915) 855-7123.

		COILS									
		Blaster 2, 3-Series	Blaster SS PN 8207	HEI Coil PN 8225	Blaster GM Ford and OEM Coils	Blaster HVC PN 8252	Pro Power PN 8201	Pro Power HVC, PN 8251	Blaster HVCII PN 8253	HVC II PN 8261	HVC Coil PN 8250
IGNITION	Factory Points* or Electronic Ignition	✓	✓	✓	✓						
	MSD HEI Module, PN 83647	✓+	✓+	✓							
	MSD 6A, 6AL, 6ALN, 6AL-2, 6 BTM	✓	✓	✓	✓	✓			✓		
	Digital 6AL-2 Digital-6 Plus, Programmable 6AL-2	✓	✓	✓	✓	✓			✓		
	6 HVC Professional Racing Ignitions										✓
	MSD 7AL-2 Plus, 7AL-3	✓	✓			✓	✓	✓		✓	
	Digital-7-Series					✓	✓			✓	
	Power Grid							✓		✓	
	MSD 8						✓	✓		✓	

* Points require a ballast resistor, supplied with PN 8200 and PN 8203.

+ When used with modified cover, PN 8401. See page 121.

Atomic EFI
Starters/Alternators
Spark Plugs
Ignitions
Late Model
Coils
Distributors
Crank Triggers
Timing/RPM Controls
Spark Plug Wires
Street Fire
Marine
Accessories
Specialty Items
Promo



BLASTER™ PERFORMANCE COILS

If you are looking to upgrade your stock coil or want to complement the performance of your MSD 6-Series Ignition, our Blaster Coils are the right choice.

COIL SPECIFICATIONS

URNS RATIO:	100:1
PRIMARY RESISTANCE:	.7 ohms
SECONDARY RESISTANCE:	4.5K ohms
	PN 8200, 10K
INDUCTANCE:	8 mH
MAXIMUM VOLTAGE:	45,000 Volts
PEAK CURRENT:	140 mA
SPARK DURATION:	350 uS

Tested with 6AL Ignition at plug gap

These products are OBD II Legal to sell, distribute or install on 2003 or older vehicles in California According to Executive Order E.O. D-40-37; legal in all 50 states.

For MSD Ignition Applications

The following Blaster Coils share the same special windings and high voltage output as the other Blaster 2 coils, but do not include a ballast resistor. When you are using an MSD Ignition Control, the Ignition is responsible for delivering the voltage to the coil so a ballast resistor is not necessary.

Blaster 2, Red - PN 8202

Blaster 3 - PN 8223

The Blaster 3 Coil features an extra tall tower design to improve the coil wire attachment and spark isolation. Supplied with a 90° terminal and boot.

Blaster 2F - PN 8205

This coil features the same "horseshoe" connector that the stock Ford Duraspark Ignitions have so there is no need to cut the wires!

High Vibration Blaster™

In applications such as off-road, marine or other harsh conditions, the MSD Blaster High Vibration Coil is the best choice.

The sturdy metal housing of the High Vibration Coil is completely potted with a premium grade epoxy to completely encase the coil's primary and secondary windings. This protects the coil's internal components from high and low frequency vibrations that are commonly experienced in racing.

High Vibration Blaster - PN 8222

Blaster™ Coils for Points, Electronic or MSD Ignitions

With a stock points style ignition, a ballast resistor must be placed in-line with the positive terminal of the coil. The following Blaster Coils are supplied with a 0.8 ohm ballast resistor plus a terminal and boot to fit most applications. Mallory Unilite applications also require the ballast resistor.

Blaster 2 Kit, Chrome - PN 8200

Blaster 2 Kit, Red - PN 8203

Coil Bracket

The MSD Coil Bracket offers easy, universal mounting for standard size ignition coils up to 2.25" in diameter. The Bracket uses a bolt and nut combination instead of the easily stripped self-tapping screw common on other brands brackets. Not compatible with HVC Series.

Coil Bracket, Universal - PN 8213

Coil Bracket, GM Vertical Style - PN 82131



PN 8202



PN 8223



PN 8205



(Ballast Resistor PN 8214)



PN 8200



PN 8213



Atomic EFI
Starters/ Alternators
Spark Plugs
Ignitions
Late Model
Coils
Distributors
Crank Triggers
Timing/RPM Controls
Spark Plug Wires
Street Fire
Marine
Accessories
Specialty Items
Promo

NOTE: The ballast is not necessary if an MSD 6 or 7-series Ignition Control is being used with the points distributor.



BLASTER™ PERFORMANCE COILS



Atomic EI
Starters/
Alternators
Spark Plugs
Ignitions
Late Model
Coils
Distributors
Crank
Triggers
Timing/RPM
Controls
Spark Plug
Wires
Street Fire
Marine
Accessories
Specialty
Items
Promo



PN 8207

Blaster SS™ Coil

Don't let the compact size of the Blaster SS Coil fool you, because it is packed with performance! The efficient E-core windings are designed to produce high amounts of current without sacrificing the voltage output. In fact, when used with an MSD 6-Series Ignition, the Blaster SS produces 300 milliamps with a maximum voltage output of 40,000 volts!

The secondary windings are wound on a segmented bobbin which reduces the chance of voltage breakdown between the primary and secondary windings. For more protection, these windings are encased in a polyurethane compound for complete protection against vibration.

COIL SPECIFICATIONS

Turns Ratio:	70:1
Primary Resistance:	.355 ohms
Secondary Resistance:	4.4K ohms
Inductance:	6.9 mH
Maximum Voltage:	40,000 Volts
Peak Current:	300 mA
Spark Duration:	220 uS

Tested with 6AL Ignition at plug gap

ALL



The Blaster SS features brass terminals and a sturdy Rynite housing. It is supplied with a 90° boot, terminal and vibration mounts. A great addition to CD Ignitions and some stock applications.

Blaster SS Coil - PN 8207



PN 8225

HEI Coil

HEI owners now have a choice to replace their stock coil with the MSD High Energy Unitized Coil for GM HEI Distributors. This coil is a direct replacement of the stock coil and offers increased spark energy when used with the MSD HEI Module, PN 83647.

COIL SPECIFICATIONS

Turns Ratio:	70:1
Primary Resistance:	.31 ohms
Secondary Resistance:	9.2K ohms
Inductance:	3.5 mH
Maximum Voltage:	42,000 Volts
Peak Current:	200 mA
Spark Duration:	200 uS

Tested with 6AL Ignition at plug gap

The coil features special low inductance, high temperature windings which charge faster to give you increased spark energy at higher rpm. The premium epoxy filled construction is designed to withstand harsh race applications as well as the wear and tear that daily usage dishes out, and still deliver more spark energy to the spark plugs.

HEI Coil - PN 8225



PN 8226

Blaster™ TFI and GM Coil

Top off your Ford or GM Ignition system with these great new replacement coils. The Blaster TFI and GM Coils have MSD performance in factory style housings!

MSD designed these Coils by combining our Blaster Coil experience with E-core coil efficiency. Each coil has a unique turns ratio plus there is lower primary resistance than the stock coil. This all amounts to a bolt-in replacement coil that produces more output voltage. The Coils will work with stock ignition systems as well as MSD equipped cars and trucks.

Installation Tip: If you plan to install an MSD Ignition with your Blaster TFI Coil, use a PN 8874 Harness for a direct plug-in installation. For the Blaster GM Coil, use a PN 8876 Harness. See page 46.

COIL SPECIFICATIONS PN 8226 AND PN 8227

Turns Ratio:	100:1
Primary Resistance:	.68 ohms
Secondary Resistance:	4.8K ohms
Inductance:	5.6 mH
Maximum Voltage:	44,000 Volts
Peak Current:	220 mA
Spark Duration:	300 uS

Tested with 6AL Ignition at plug gap

Blaster GM Dual Connector Coil - PN 8226

Blaster Ford TFI Coil - PN 8227



PN 8227



REPLACEMENT COILS

When it comes to late model performance parts, nothing beats bolt-on and direct connection components. These new bolt-in coils are designed with improved materials and windings to produce a stronger output.

These products are legal to sell, distribute or install on 2003 or older vehicles in California according to Executive Order E.O. D-40-37; legal in all 50 states.



PN 8224



GM DIS 2-Tower Coil Pack - PN 8224

Used on GM vehicles from the mid 1980s to late 1990s. **Installation Tip:** If you plan to install an MSD DIS Ignition, use Interface Modules, PN 8870. See page 58.

COIL SPECIFICATIONS

TURNS RATIO:	80:1
PRIMARY RESISTANCE:	.35 ohms
SECONDARY RESISTANCE:	7.8K ohms
INDUCTANCE:	4.2 mH
MAXIMUM VOLTAGE:	40,000 Volts

PN 8231



GM Single Connector Coil - PN 8231

Used on 1996-1999 GM vehicles. **Installation Tip:** If you plan to install an MSD Ignition with this coil, use a PN 8877 Harness for a direct plug-in installation. See page 46.

COIL SPECIFICATIONS

TURNS RATIO:	80:1
PRIMARY RESISTANCE:	.5 ohms
SECONDARY RESISTANCE:	6.5K ohms
INDUCTANCE:	3.9 mH
MAXIMUM VOLTAGE:	40,000 Volts

Late Model Dodge, 2-Pin

Connector - PN 8228

MSD offers direct plug-in Dodge Harnesses for MSD 6 installations, see page 42.

COIL SPECIFICATIONS

TURNS RATIO:	70:1
PRIMARY RESISTANCE:	1.2 ohms
SECONDARY RESISTANCE:	13.7K ohms
INDUCTANCE:	3.9 mH
MAXIMUM VOLTAGE:	40,000 Volts

PN 8228



Ford Coil Pack, 4-Tower - PN 8241

For 1995-1998 4.6L, DOHC/SOHC.

COIL SPECIFICATIONS

TURNS RATIO:	83:1
PRIMARY RESISTANCE:	.53 ohms
SECONDARY RESISTANCE:	13.7K ohms
INDUCTANCE:	3.9 mH
MAXIMUM VOLTAGE:	40,000 Volts

PN 8241



Mitsubishi/Neon/Talon/Mini

MSD offers this 4-tower coil as replacements for a variety of years ranging from 1994-2003 on vehicles including Mitsubishi, Neons and others.

Flat Terminals - PN 8239

NOTE: Some OE coils use round terminals. The MSD coil features flat terminals. Contact MSD Customer Service for the connector to convert round terminals to flat.



PN 8239

COIL SPECIFICATIONS

TURNS RATIO:	77:1
PRIMARY RESISTANCE:	.051 ohms
SECONDARY RESISTANCE:	12K ohms
INDUCTANCE:	7 mH
MAXIMUM VOLTAGE:	36,000 Volts

PN 8239



Atomic EFI
Starters/
Alternators/
Spark Plugs
Ignitions
Late Model
Coils
Distributors
Crank
Triggers
Timing/RPM
Controls
Spark Plug
Wires
Street Fire
Marine
Accessories
Specialty
Items
Promo



HVC & HVC II COILS



High Voltage/High Current Performance Coils

Coils have always had to compromise voltage output against current output. More voltage increases the initial ionization of the spark plug gap, but lowers the amount of current, or heat, that follows across the plug gap. When a coil is designed to produce more current, the voltage output generally suffers which taxes the ease of ionizing the gap. The MSD HVC Coils are designed to produce maximum voltage and energy!

To accomplish this combination of high voltage and current MSD uses an E-core winding design. This is a very efficient design where less loss occurs during the transfer of electricity due to the closed core of the coil.

Another benefit is that the coils run extremely cool, even at high racing rpm, thanks to the efficient design and huge laminations.

COIL SPECIFICATIONS

	PN 8252	PN 8253	PN 8250
URNS RATIO:	100:1	85:1	100:1
PRIMARY RESISTANCE:	.02 ohms	.16 ohms	.07 ohms
SECONDARY RESISTANCE:	138K ohms	630 ohms	360 ohms
INDUCTANCE:	7 mH	3.5 mH	3 mH
MAXIMUM VOLTAGE:	42,000 V	44,000 V	34,000 V
PEAK CURRENT:	300 mA	450 mA	600 mA
SPARK DURATION:	200 uS	450 uS	200 uS
ALL HVC COILS WEIGH:	3.75 Lbs. fully assembled		

PN 8252 Tested with 6AL Ignition at plug gap
PN 8253 Tested with Digital 6 Plus Ignition at plug gap
The PN 8250 coil must be used with the PN 6631 Ignition Control.

Blaster HVC™ Coil

The Blaster HVC is designed for high rpm, long duration applications such as road course and circle track racing using an MSD 6-Series Ignition.

Blaster HVC, for 6-Series Ignitions - PN 8252



This product is legal to sell, distribute or install on vehicles in California according to Executive Order E.O. D-40-37; legal in all 50 states.

PN 8252

Blaster HVC II™

The Blaster HVC coil utilizes an iron U-Core design with a segmented bobbin for improved voltage distribution. The bobbin is molded from a special Dupont Rynite material and wound specifically to produce the most current possible with incredible voltage and lightning quick rise time.

The blue housing is also molded from high dielectric Rynite material. The brass primary terminals are spaced far apart and the secondary tower is well protected for increased spark isolation. The housing is completely potted with an epoxy compound for vibration resistance and installs with sturdy vibration mounts.

Blaster HVC II Coil, for 6-Series Ignition Controls - PN 8253*

PN 8253

MSD 6 HVC™ Coil

The HVC Coil is designed exclusively for the HVC Professional Racing Ignition Controls PN 6631. See page 50.

MSD 6 HVC Coil, for 6 HVC Ignitions - PN 8250*



PN 8250

Atomic EFI
Starters/Alternators
Spark Plugs
Ignitions
Late Model
Coils
Distributors
Crank Triggers
Timing/RPM Controls
Spark Plug Wires
Street Fire
Marine
Accessories
Specialty Items
Promo





HVC & HVC II COILS

Pro Power HVC™ Coil

The Pro Power HVC Coil is designed for racing applications with an MSD 7 or 8-Series Ignition Control.

Pro Power HVC, for 7/8-Series Ignitions - **PN 8251***

- *Coil technology produces incredible voltage and high current*
- *Efficient windings and material produce incredible voltage, lightning quick rise time and lengthy duration*
- *Windings are completely potted with a fracture resistant compound for vibration resistance*

COIL SPECIFICATIONS

URNS RATIO:	85:1
PRIMARY RESISTANCE:	.04 ohms
SECONDARY RESISTANCE:	86 ohms
INDUCTANCE:	1 mH
MAXIMUM VOLTAGE:	45,000 V
PEAK CURRENT:	1.1 Amp
SPARK DURATION:	150 uS
WEIGHT:	3.75 lbs.

Tested with 7AL-2 Ignition at plug gap



PN 8251



Pro Power HVC II™ Coil

The Pro Power HVC II Coil is also completely built in-house so our engineers have exclusive control over their performance and quality. The Coil utilizes an iron U-Core design with a segmented bobbin for improved voltage distribution. The bobbin is molded from a Dupont Rynite material which has incredible dielectric capabilities at high temperatures. MSD also incorporated a cutting edge winding material that has an improved insulation and is also capable of enduring extreme voltages. Together, these materials create a durable coil with incredible voltage capabilities, lightning quick rise time and lengthy spark duration.

The housing features wide spaced brass primary terminals and a well protected secondary tower for increased spark isolation. The housing is completely potted with an epoxy compound for vibration resistance and installs with sturdy vibration mounts. For use with MSD 7 and 8-Series Ignitions.

COIL SPECIFICATIONS

URNS RATIO:	70:1
PRIMARY RESISTANCE:	.016 ohms
SECONDARY RESISTANCE:	30 ohms
INDUCTANCE:	.250 mH
MAXIMUM VOLTAGE:	45,000 V
PEAK CURRENT:	2 Amps
SPARK DURATION:	150 uS
WEIGHT:	3.75 lbs.

Tested with PN 7530T at plug gap



PN 8261



HVC Pro Power II Coil, for 7/8-Series Ignition Controls - **PN 8261***

MSD Pro Power™ Coil

The MSD Pro Power Coil is a great choice for short duration applications such as drag racing. The special windings of the Pro Power Coil have extremely low resistance to produce the highest voltage possible with plenty of spark energy when used with an MSD 7 or 8-Series Ignition Control.

The coil wire tower rises tall above the primary terminals and uses a spark plug style terminal for a firm connection to the coil wire. The housing is molded from a high dielectric polyester material and a Ciba Arathane compound adds vibration protection to the coil windings. Vibration mounts are also supplied.

COIL SPECIFICATIONS

URNS RATIO:	100:1
PRIMARY RESISTANCE:	.03 ohms
SECONDARY RESISTANCE:	240 ohms
INDUCTANCE:	1 mH
MAXIMUM VOLTAGE:	43,000 V
PEAK CURRENT:	800 mA
SPARK DURATION:	180 uS

Tested with 7AL-2 Ignition at plug gap



PN 8201



Pro Power Coil, for MSD 7AL and 8-Series Ignitions only - **PN 8201***

Atomic EFI
Starters/
Alternators/
Spark Plugs
Ignitions
Late Model
Coils
Distributors
Crank
Triggers
Timing/RPM
Controls
Spark Plug
Wires
Street Fire
Marine
Accessories
Specialty
Items
Promo



PRO-BILLET™ DISTRIBUTORS



Promo
Accessories
Specialty
Items
Marine
Street Fire
Spark Plug
Wires
Timing/RPM
Controls
Crank
Triggers
Distributors
Coils
Late Model
Ignitions
Spark Plugs
Starters/
Alternators
Atomic EFI

As with the multiple spark, CD ignition, MSD was the first to introduce a distributor housing machined from a billet of 6061-T6 aluminum. MSD Pro-Billet Distributors are the finest performance and racing distributors available. Every feature has been engineered to endure the rigors of high performance and racing engines. Whether you race stock cars, dragsters, boats or trucks, MSD has a distributor to put you in the winner's circle. MSD uses state-of-the-art, Computer Numerical Controlled (CNC) mills and lathes to machine each housing. After a long series of precise cuts and movements, the billet is formed into a flawless distributor housing that is accurate to within 0.001". The flex-free housings are lightweight, have no porosity or weak areas and look great on polished, show-quality engines. Whether you race stock cars, dragsters, boats or trucks, MSD has a distributor to put you in the winner's circle.

1 MSD's race-proven adjustable mechanical advance features a chromoly plate and weights that are "fine blanked" for precision and balance. The weight pins are staked and TIG-welded, while nylon bushings ensure smooth movement of the weights. The entire assembly also receives a QPQ coating to reduce friction and eliminate corrosion. Three sets of advance springs and six stop bushings are supplied to dial-in a curve to match your application.



2 All of the MSD Distributors, except crank trigger models, use a high-output magnetic pickup to trigger the ignition system. This triggering method is extremely accurate and reliable at any engine rpm. The stationary pickup is mounted to the base of the distributor and creates an ignition signal as the shaft mounted reluctor passes by. This reluctor is precision manufactured and is bright zinc plated for corrosion resistance.



3 The top of the polished steel shaft is guided by a sealed ball bearing while an extra long, sintered steel bushing is used at the bottom of the distributor (some models use a lower bearing). This assembly will deliver accurate sparks for the life of your distributor, even in a 10,000 rpm race environment.



4 MSD's Pro-Billet Distributors offer incredible strength and stability. Each housing is CNC-machined from a billet of 6061-T6 aluminum resulting in a precise housing with no porosity or weak areas.



5 Most Pro-Billet Distributors are topped off with MSD's own cap and rotor. Molded from Dupont Rynite material, the cap and rotor offer high dielectric properties and improved strength. Also, most models are supplied with a retainer to secure the wires.

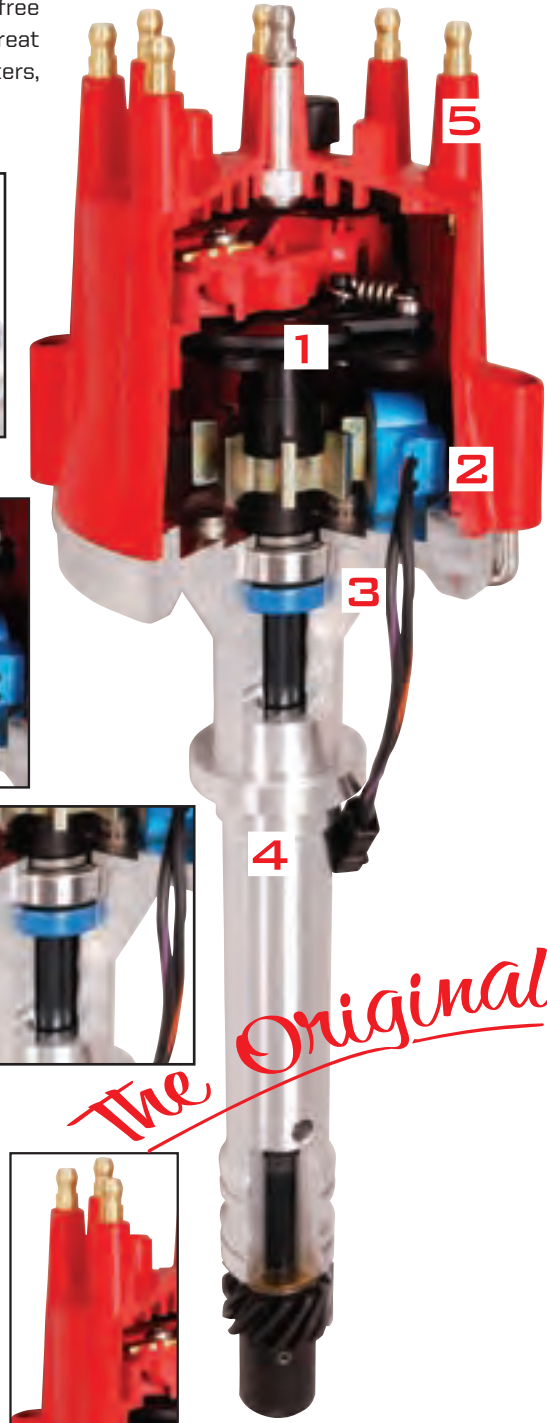

NOTE: Most MSD Distributors must be used with an MSD Ignition Control. The Ready-to-Run models and the D.E. style distributors do not require an MSD Ignition.



ADJUSTABLE MECHANICAL ADVANCE

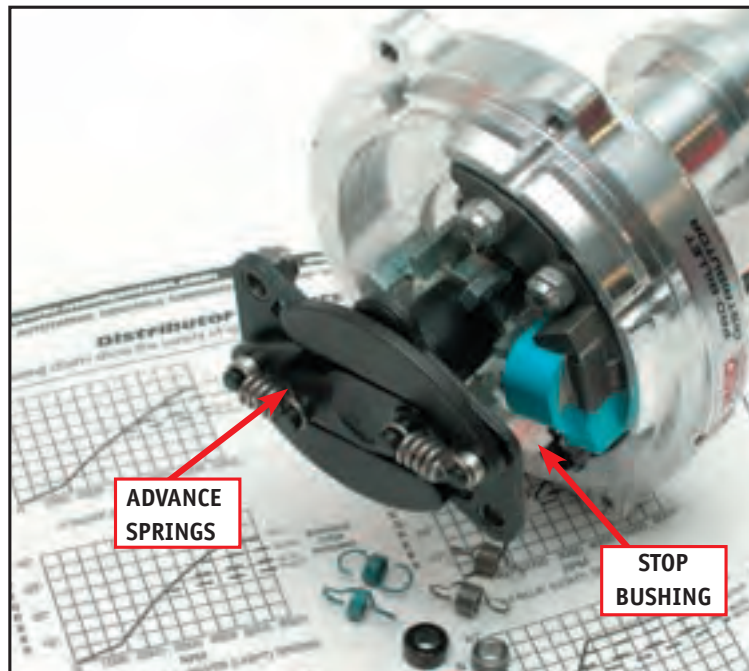
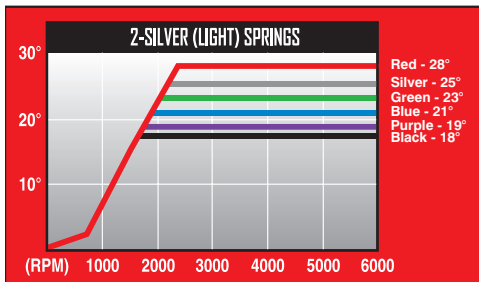
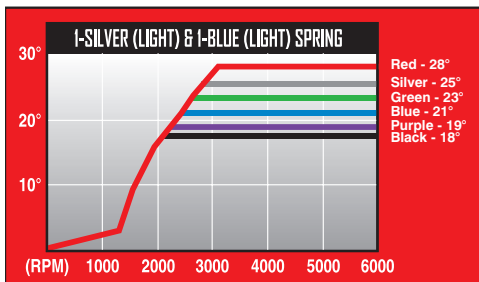
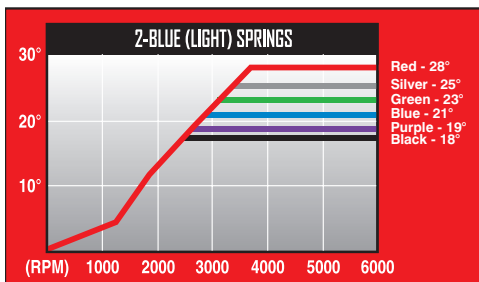
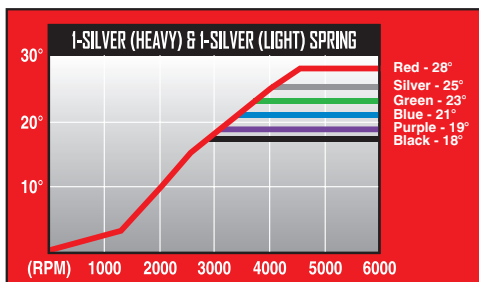
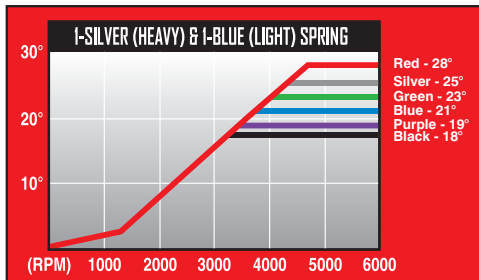
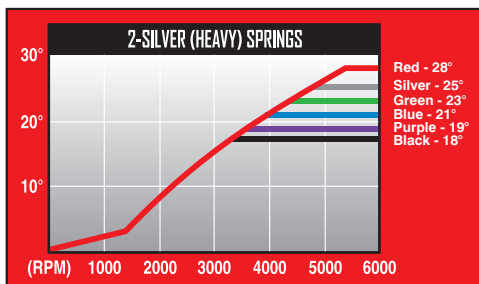

The advance assembly is mounted on top of every MSD distributor. Each model is supplied with different advance springs and stop bushings so you can easily tune in a timing curve to match your engine and application.

One of the most important features of the MSD Pro-Billet Distributors is the adjustable mechanical advance assembly. The mechanical advance, sometimes referred to as centrifugal advance, allows you to accurately and easily modify the advance curve to match your specific application. MSD engineers have spent many hours at the dyno controls and in our labs perfecting this great distributor feature.

The advance plate and weights are made from chromoly steel through a "fine blank" process. This produces precise and well balanced components. The weight pins are staked into this plate and TIG-welded in place for extra strength. The entire assembly then receives a QPQ plating for corrosion resistance. Nylon pads are positioned under the chromoly weights to ensure smooth movement as the weights move outward advancing the timing as rpm increases. This assembly is mounted on top of the distributor shaft on all of our distributors to ease adjustments.

A variety of timing curves can be achieved simply by changing the advance springs and stop bushing. The stop bushing determines the amount of mechanical advance that can be achieved. Each distributor is equipped from the factory with the blue (21°) bushing installed with five other bushings included; Red allows 28°, Silver 25°, Green 23°, Purple 19° and Black for 18°.

The springs determine the rate, or how fast the advance occurs. Each distributor comes with two heavy silver springs installed which give the curve the slowest advance rate. There are also two sets of springs with different tensions included; blue and light silver, which can be mixed and matched to achieve a variety of advance rates. The charts to the left illustrate the variety of ignition timing curves you can achieve by simply changing the springs and stop bushing.

These charts show the variety of mechanical, or centrifugal, advance curves you can achieve with MSD's Pro-Billet Distributors.

- Atomic EFI
- Starters/ Alternators
- Spark Plugs
- Ignitions
- Late Model
- Coils
- Distributors
- Crank Triggers
- Timing/RPM Controls
- Spark Plug Wires
- Street Fire
- Marine
- Accessories Specialty Items
- Promo



DISTRIBUTOR QUICK REFERENCE CHART

Atomic EFI
 Starters/ Alternators
 Spark Plugs
 Ignitions
 Late Model
 Coils
 Distributors
 Crank Triggers
 Timing/RPM Controls
 Spark Plug Wires
 Street Fire
 Marine
 Accessories Specialty Items
 Promo

PN	Description	Page	Cylinders	Requires	Requires MSD Ignition Control	Built-in Ignition Module	Mechanical Advance	Vacuum Advance	Locked Out Timing	Gear Material	Crank Trigger Required	Special Notes
AMC												
8516	Jeep 6-cyl. 232-258, 4.0L	106	6	✓		✓	✓			Iron		
8519	Pro-Billet, 290, 304, 343, 360, 390, 401, ci	106	8	✓		✓	✓			Iron		
8523	Ready-to-Run, 290, 304, 343, 360, 390, 401 ci	106	8		✓	✓	✓			Iron		Built-in Rev Limiter
BUICK												
8548	Pro-Billet, 215, 300, 340, 350 ci	107	8	✓		✓				Iron		
8517	Pro-Billet, 400, 430, 455 ci	107	8	✓		✓				Iron		
8552	Ready-to-Run, 400, 430, 455 ci	107	8		✓	✓	✓			Iron		
8524	Ready-to-Run, Nailhead, 322, 364, 401, 425	107	8		✓	✓	✓			Iron		Built-in Rev Limiter
CADILLAC												
8363	Pro-Billet, 368, 425, 472, 500 ci	110	8	✓		✓	✓			Iron		
CHRYSLER												
8534	Billet, 273, 318, 360 ci	103	8	✓		✓				N/A		
83891	Pro-Billet, 392 Hemi®	103	8	✓		✓	✓			N/A		
8545	Pro-Billet, 383, 400 ci	103	8	✓		✓				N/A		
8546	Pro-Billet 426, 440 ci	103	8	✓		✓				N/A		
8388	Ready-to-Run, 273, 318, 360 ci	104	8		✓	✓	✓			N/A		Built-in Rev Limiter
8504	E-Curve, Ready-to-Run, 273, 318, 360 ci	105	8		✓	✓	✓			N/A		Electronic Advance
8391	Ready-to-Run, Early Hemi, 331, 354 ci	105	8		✓	✓	✓			N/A		Built-in Rev Limiter
8389	Ready-to-Run, Early Hemi, 392 ci	105	8		✓	✓	✓			N/A		Built-in Rev Limiter
8386	Ready-to-Run, 383-400 ci	104	8		✓	✓	✓			N/A		Built-in Rev Limiter
8387	Ready-to-Run, 440, 426 ci	104	8		✓	✓	✓			N/A		Built-in Rev Limiter
CHEVROLET												
8515	Pro-Billet, 194, 230, 250, 292 ci	93	6	✓		✓	✓			Iron		
8366	Pro-Billet, EFI, 5.0L, 5.7L	89	8		✓			✓		Iron		OEM Replacement
85551	Pro-Billet, Standard	87	8	✓		✓				Iron		
85561	Pro-Billet, Slip Collar	92	8	✓		✓				Iron		Adjustable Height
8361	Pro-Billet, Street	87	8	✓		✓	✓			Iron		
84891	Pro-Billet, Flat-Top	90	8	✓		✓	✓			Iron		Crab Cap
8570	Pro-Billet, Small Diameter	91	8	✓		✓				Iron		Adjustable Height
85501	Pro-Billet, Locked Out	91	8	✓				✓		Bronze		Adjustable Height
8572	Pro-Billet, Mechanical Tach Drive	92	8	✓		✓	✓			Iron		with Mechanical Tach Drive
8360	Ready-to-Run, Pro-Billet	88	8		✓	✓	✓			Iron		Built-in Rev Limiter
8393	Ready-to-Run, Pro-Billet, 348, 409 ci	93	8		✓	✓	✓			Iron		Built-in Rev Limiter
8394	E-Curve, Ready-to-Run	89	8		✓		✓			Iron		Electronic Advance
8381	Pro-Billet, LT-1 '93-'94, 5.7L	90	8		✓					N/A		Adjustable Advance
83811	Pro-Billet, LT-1 '95-'97, 5.7L	90	8		✓					N/A		Adjustable Advance
8365	Pro-Billet HEI, with Digital Module and Coil	85	8		✓	✓	✓			Iron		4-pin MSD HEI Module
8547	Billet, Extra Tall Deck	92	8	✓		✓				Iron		Adjustable Height
84697	Billet, Crank Trigger, Low-Profile	113	8	✓				✓		Bronze	✓	Large Cap
8558	Billet, Crank Trigger, Tall Block	113	8	✓				✓		Bronze	✓	Adjustable Height
8486	Billet, Crank Trigger, Crab Cap	114	8	✓				✓		Bronze	✓	Adjustable Height
8489	Billet, Crank Trigger, Crab Cap, Tall Block	114	8	✓				✓		Bronze	✓	Adjustable Height, Extra Tall
8712	Pro-Billet Front Mount, LS Engines	115	8	✓				✓		N/A	✓	Requires Cam Belt Drive
8520	Pro-Billet Front Mount, Big Block	115	8	✓				✓		N/A	✓	Requires Cam Belt Drive
8510	Pro-Billet Front Mount, Small Block	115	8	✓				✓		N/A	✓	Requires Cam Belt Drive
8356	Pro-Billet Dual Pickup	111	8	✓		✓				Iron		Dual Pickups
8362	Street-Fire HEI	160	8		✓	✓	✓			Cast		4-Pin HEI, cast housing
2340	Cam Sync, Billet, Low-Profile, Non-Magnetic Cam Sync	113	8	✓				✓		Bronze	✓	Large Cap
2345	Cam Sync, Pro-Billet, Non-Magnetic Cam Sync	94	8	✓				✓		Iron		Standard Cap, Adjustable Rotor
23451	Cam Sync, Pro-Billet, Large Cap Hall-Effect Cam Sync	94	8	✓				✓		Iron		Large Cap, Hall-Effect Cam Sync
8366	Marine, Pro-Billet, EFI, 5.0L, 5.7L	89,158	8		✓			✓		Iron		for factory EFI, UL Approved
8560	Marine, Pro-Billet	158	8	✓		✓				Iron		UL Approved
83606	Marine, Ready-to-Run, Pro-Billet	159	8		✓	✓				Iron		UL Approved



DISTRIBUTOR QUICK REFERENCE CHART

PN	Description	Page	Cylinders	Requires MSD Ignition Control			Vacuum Advance	Locked Out Timing	Gear Material	Crank Trigger Required	Special Notes
				Built-in Ignition Module	Mechanical Advance						
FORD											
8473	Billet, 2.3L	97	4	✓	✓				Iron		
8580	Billet, 351C, 351M, 400, 429, 460 ci	96	8	✓	✓				Iron		
8598	Billet, with Steel Gear, 289, 302 ci	96	8	✓	✓				Steel		for Roller Hydraulic Cams
8582	Billet, 289, 302 ci	96	8	✓	✓				Iron		
8584	Billet, 351W ci	96	8	✓	✓				Iron		
85805	Billet, 351W ci, for Edelbrock Victor Jr. Intake	96	8	✓	✓				Iron		clears Edel Vic Jr. intake
85840	Billet, with steel gear, 351W ci	96	8	✓	✓				Steel		
8579	Pro-Billet, Small Diameter, 289, 302 ci	97	8	✓	✓				Iron		Small Diameter Cap
8577	Pro-Billet, Small Diameter, 351C, 351M, 400, 429, 460 ci	97	8	✓	✓				Iron		Small Diameter Cap
8578	Pro-Billet, Small Diameter, 351W ci	97	8	✓	✓				Iron		Small Diameter Cap
8477	Pro-Billet, Small Diameter, 351C, 351M, 400, 429, 460 ci	97	8	✓	✓	✓			Iron		Small Diameter Cap
8478	Pro-Billet, Small Diameter, 351W ci	97	8	✓	✓	✓			Iron		Small Diameter Cap
8479	Pro-Billet, Small Diameter, 289, 302 ci	97	8	✓	✓	✓			Iron		Small Diameter Cap
8594	Pro-Billet, FE, 332, 352, 360, 406, 410, 427, 428 ci	101	8	✓	✓				Iron		
83831	Pro-Billet, Y-Block, 329, 372, 292, 312 ci	93	8	✓	✓	✓			Iron		
8382	Pro-Billet Dual Pickup, 289, 302	111	8	✓	✓				Iron		Dual Pickups
8384	Pro-Billet Dual Pickup, 351W	111	8	✓	✓				Iron		Dual Pickups
8503	E-Curve, Ready-to-Run, 289, 302 ci	99	8		✓	✓			Iron		Electronic Advance
8352	Ready-to-Run, 289, 302 ci	98	8		✓	✓	✓		Iron		Built-in Rev Limiter
83521	Ready-to-Run, 289, 302 ci	98	8		✓	✓	✓		Steel		for Roller Hydraulic Cams
8350	Ready-to-Run, 351C, 351M, 400, 429, 460 ci	98	8		✓	✓	✓		Iron		Built-in Rev Limiter
83501	Ready-to-Run, 351C, 351M, 400, 429, 460 ci	98	8		✓	✓	✓		Steel		for Roller Hydraulic Cams
8354	Ready-to-Run, 351W ci	98	8		✓	✓	✓		Iron		Built-in Rev Limiter
83541	Ready-to-Run, 351W ci	98	8		✓	✓	✓		Steel		for Roller Hydraulic Cams
8595	Ready-to-Run, FE, 332, 352, 360, 406, 410, 427, 428 ci	101	8		✓	✓	✓		Iron		Built-in Rev Limiter
8573	Ready-to-Run, Flathead, '49-'53	102	8		✓	✓	✓		Iron		Adjustable Height
8383	Ready-to-Run, Y-Block, 239, 272, 292, 312 ci	102	8		✓	✓	✓		Iron		OEM Replacement
8456	TFI, '86-'93 with Module, 302 ci	95	8		✓		✓		Steel		OEM Replacement
8455	TFI, '94-'95, no Module, 302 ci	95	8		✓		✓		Steel		OEM Replacement
8453	TFI, '86-'93 with Module, 351W ci	95	8		✓		✓		Iron		OEM Replacement
8451	TFI, '94-'95, no Module, 351W ci	95	8		✓		✓		Steel		OEM Replacement
8452	TFI, '86-'93 with Module, 351W ci	95	8		✓		✓		Steel		OEM Replacement
8378	Billet, Crank Trigger, 351W ci	114	8	✓			✓		Bronze	✓	Low-Profile
8569	Billet, Crank Trigger, 351C, 351M, 400, 429, 460 ci	114	8	✓			✓		Bronze	✓	for Sheet Metal Intakes
2358	Cam Sync, Pro-Billet, Non-Magnetic Cam Sync	100	8	✓			✓		Steel		Adjustable Rotor
2359	Cam Sync, Pro-Billet, Non-Magnetic Cam Sync	100	8	✓			✓		Iron		Adjustable Rotor
2360	Cam Sync, Pro-Billet, Non-Magnetic Cam Sync	100	8	✓			✓		Bronze		Adjustable Rotor
2362	Cam Sync, Pro-Billet, Non-Magnetic Cam Sync	100	8	✓			✓		Steel		Adjustable Rotor
83506	Marine, Ready-to-Run, 351C, 351M, 400, 429, 460 ci	159	8		✓	✓			Iron		UL Approved
OLDSMOBILE											
8566	Pro-Billet, 260, 307, 330, 350, 400, 403, 425, 455 ci	108	8	✓		✓			Iron		
8529	Ready-to-Run, 260, 307, 330, 350, 400, 403, 425, 455 ci	108	8		✓	✓	✓		Iron		Built-in Rev Limiter
PONTIAC											
8563	Pro-Billet, 326, 350, 389, 400, 421, 428, 455 ci	109	8	✓		✓			Iron		
8528	Ready-to-Run, 326, 350, 389, 400, 421, 428, 455 ci	109	8		✓	✓	✓		Iron		Built-in Rev Limiter
VW											
8485	Billet, Type 1	110	4	✓		✓			N/A		



Atomic EFI
 Starters/
 Alternators/
 Spark Plugs
 Ignitions
 Late Model
 Coils
 Distributors
 Crank
 Triggers
 Timing/RPM
 Controls
 Spark Plug
 Wires
 Street Fire
 Marine
 Accessories
 Specialty
 Items
 Promo



DISTRIBUTOR INFO



Promo
Accessories
Marine
Street Fire
Spark Plug Wires
Timing/RPM Controls
Crank Triggers
Distributors
Coils
Late Model Ignitions
Spark Plugs
Starters/Alternators
Atomic EFI

PRO-BILLET

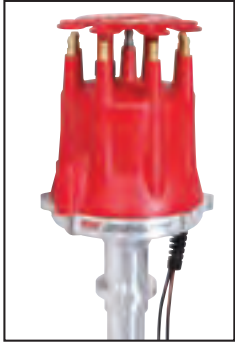

MSD introduced the first aftermarket distributor crafted from a billet of 6061-T6 aluminum. These Pro-Billet Distributors are now available for most popular domestic V8s and several other popular engines.

You'll notice that there are several versions of distributors available. There are similarities across the distributor line, such as the upper ball bearing and seal design to guide the QPQ coated shaft or the non-magnetic pickup, but there are several lines available that fit different applications.

Pro-Billet™

This pretty well covers all of our distributors, however this is our traditional distributor. This is our most popular distributor and they require an MSD Ignition Control such as a 6AL or 7AL-2 Ignition

Control. The distributor has a 2-pin connector that plugs directly into an MSD Ignition.

These distributors are available from AMC to the famous W-Chevy motor. They're built for everything, from powerful street cars to racers. Some have vacuum advance while others



Standard Pro-Billet Distributors use a 2-pin connector that plugs into an MSD Ignition Control. Ready-to-Run models are equipped with a 3-pin Weathertight connector.

READY-TO-RUN



may be locked out. The important thing to note is that an MSD Ignition Control is required and are identified by the 2-pin connector.

Ready-to-Run™

MSD offers a line of distributors called Ready-to-Run. The biggest visual difference is that the distributor has a 3-pin Weathertight connector. These distributors have a built-in ignition module, so an MSD Ignition Control is not required. They're simple to drop in and connect with three wires (power, coil negative and ground) making them favorites for street rods and muscle cars. They also have a gray tach output wire to trigger a tach or even an aftermarket EFI system, such as the Atomic EFI (pages 20-23). Plus, there is now an adjustable rev limiter!

Crank Trigger Distributors

Like the name implies, these Pro-Billet Distributors will require a crank trigger to fire the ignition. These distributors do only that, distribute the spark. There is no trigger mechanism and no advance. They are meant as high performance, racing distributors. They are easy to identify with the lack of wiring and their lower stance.

CRANK TRIGGER



OEM Upgrade

MSD also offers several distributors that are Pro-Billet designs, yet they're suitable as performance replacements for OEM models. Examples include the popular Ford TFI used in

OEM UPGRADE



Fox bodied Mustangs. These distributors feature increased strength and support, yet incorporate the factory style module, pickup and connectors for a drop-in replacement.

STREET FIRE



Street Fire Distributors

MSD offers a high quality, value based line of distributors called Street Fire. Street Fire distributors are new distributors based around a cast aluminum housing and built to deliver performance at a value based price. For more information on Street Fire Distributors, see pages 158-159.



CHEVROLET® HEI



PN 8365

The Chevrolet HEI Distributor is a favorite for muscle cars, street rods and even circle track racers. The integrated coil keeps underhood wiring clean, and for race cars, the idea of running one wire to the distributor keeps things simple. However, when it comes to performance, the stock HEI falls short.

MSD answers the need for a strong, accurate and high performance HEI with our Pro-Billet HEI. The distributor is supplied with our Digital HEI Module and Coil so there is plenty of spark energy combined with improved dwell and timing control.

Tig welded on top of the distributor shaft is MSD's adjustable centrifugal advance assembly. Three sets of springs and four stop bushings let you dial in up to 24 different timing curves to match your driving needs. Plus, there's a vacuum advance for those concerned with economy.

All of this is assembled around a precision and great looking CNC-machined housing. The distributor is supplied with MSD's cap, rotor and coil cover and heavy duty gear so it is ready to install in your engine!

NOTE: The PN 8365 is designed to replace GM HEI Distributors that use a 4-Pin ignition module.

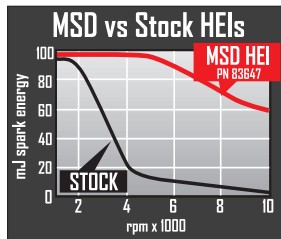

MSD Pro-Billet Chevrolet HEI - PN 8365 MSD HEI Coil - PN 8225

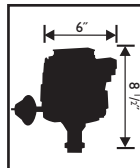

PN 8365 REPLACEMENT PARTS

Red Cap:	Rotor:	Gear:	Bronze Gear:
PN 84111	PN 84101	PN 8531	PN 8471

For more distributor accessories see pages 116-124. These products are legal to sell, distribute or install on vehicles in California according to Executive Order E.O. D-40-39 and D-40-37; legal in all 50 states.

Atomic EFI
Starters/
Alternators/
Spark Plugs
Ignitions
Late Model
Coils



Crank
Triggers

Timing/RPM
Controls

Spark Plug
Wires

Street Fire

Marine

Accessories
Specialty
Items

Promo



PN 8362

Street Fire® HEI Distributor

MSD offers an all HEI Distributor for the value conscious enthusiast called Street Fire. This all new distributor is spec'd by MSD engineers and is built around a new cast aluminum housing and includes a powerful ignition module, coil and high quality cap and rotor.

One of the most important tuning features of a distributor is the centrifugal advance. The Street Fire HEI Distributor features an advance assembly that features welded weight pins and coated weights to ensure smooth movement and accurate timing.

Street Fire HEI, Chevy V8 - PN 8362

CARB Approval Pending



For more information on the Street Fire HEI and other high quality ignition components at a great value, see pages 155-161.

Street Fire HEI Advance Kit - PN 8428

See page 160 for more information.



HEI PERFORMANCE



Promo
Accessories
Specialty
Items
Marine
Street Fire
Spark Plug
Wires
Timing/RPM
Controls
Crank
Triggers
Distributors
Coils
Late Model
Ignitions
Spark Plugs
Starters/
Alternators
Atomic EFI

HEAT Digital HEI Module and Coil

MSD's HEAT Digital HEI Module and performance coil will fire up your stock HEI Distributor. The Module is a direct plug-in for the 4-pin HEI module and will produce up to 8.5 amps of current. This increased energy will continue through racing rpm reaching 9,000 rpm!

The HEI Module is extremely accurate in its delivery of this energy resulting in more accurate ignition timing. Another unique feature is an adjustable rev limiter. You can dial in an engine saving rev limit ranging from 5,000-10,000 rpm.

To get the most performance out of the HEI Module, MSD offers a performance Coil as well. This Coil drops right in place of the original, and fits under the stock cover.



- Digitally controlled module for accurate timing
- High drive currents to the coil for a powerful spark
- Adjustable rev limiter for overrev protection
- Module and Coil fit in a stock HEI distributor

Heat Digital HEI Module - PN 83647

Ultimate HEI Kit

Update your stock 4-pin HEI distributor with MSD performance. This kit includes the MSD HEAT Module, Coil, MSD Heavy Duty Cap, Rotor and Coil Cover.



Ultimate HEI Kit - PN 8501



These products are legal to sell, distribute or install on vehicles in California according to Executive Order E.O. D-40-36; legal in all 50 states.

MSD Super HEI Kit

The MSD Super HEI Kit is one of MSD's solutions to the GM HEI's common problem of power loss and lack of response above 4,500 rpm. The kit allows you to remove or bypass the low-powered HEI module and coil and replace them with the MSD Digital 6AL Ignition Control and the Blaster 2 high output coil. The result is more power, increased rpm range, easier starting, plus better mileage and performance.

The Kit includes the new MSD Digital 6AL Ignition, Blaster SS Coil, coil wire and HEI dust cover. The 6AL has a Soft Touch Rev Control to protect your engine from over-rev damage.



Super HEI Kit II, with MSD Digital 6AL - PN 85001

CARB Approval Pending



CHEVY DISTRIBUTORS

Pro-Billet™ Chevy V8

This is our most popular performance distributor! The housing is machined from a billet of 6061-T6 aluminum on a state-of-the-art CNC-machine producing exact tolerances.

For high rpm stability, a .500" steel shaft is supported by a sealed ball bearing and a long sintered bushing. This shaft also receives a QPQ coating for friction reduction and resistance to corrosion. A precision machined reluctor is attached to the shaft which triggers the magnetic pickup mounted in the housing.

This high output magnetic pickup is the most accurate way to trigger your ignition. Plus, with no moving parts to wear or adjust, the pickup is maintenance-free! Just above the pickup is MSD's adjustable mechanical advance assembly. Different springs and stop bushings are supplied so you can tune an advance curve to match your application.

NOTE: Must be used with an MSD 6, 7 or 8-Series Ignition.

Chevy V8 - PN 85551*

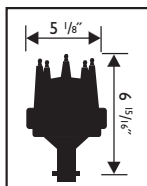

PN 85551 REPLACEMENT PARTS

Red Cap:	Black Cap:	Rotor:	Gear:	Bronze Gear:
PN 8433	PN 84333	PN 8467	PN 8531	PN 8471

For more distributor accessories see pages 116-124.

Street Pro-Billet™ V8

The Street Pro-Billet is a popular route for people looking for proven race performance for their street cars. A vacuum advance canister provides economy and the proven MSD mechanical advance gives you the opportunity to dial-in a timing curve to fit your needs.

Inside, an oversized steel shaft is QPQ-coated for low friction and rides in a sealed ball bearing at the top of the distributor with an extra-long sintered bushing at the bottom. This combination keeps the shaft steady creating accurate spark delivery at any rpm.

The Street Pro-Billet relies on a magnetic pickup to trigger the MSD Ignition Control which delivers the powerful sparks to the coil. This pickup is extremely accurate and never needs adjusting.

NOTE: Must be used with an MSD 6, 7 or 8-Series Ignition.

Chevy V8 - PN 8361

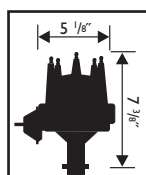

PN 8361 REPLACEMENT PARTS

Red Cap:	Black Cap:	Rotor:	Gear:	Bronze Gear:
PN 8433	PN 84333	PN 8467	PN 8531	PN 8471

For more distributor accessories see pages 116-124.

This product is legal to sell, distribute or install on vehicles in California according to Executive Order E.O. D-40-39; legal in all 50 states.



Atomic EFI
Starters/Alternators
Spark Plugs
Ignitions
Late Model
Coils
Distributors
Crank Triggers
Timing/RPM Controls
Spark Plug Wires
Street Fire
Marine
Accessories
Specialty Items
Promo



CHEVY® DISTRIBUTORS



Atomic EFI
Starters/Alternators
Spark Plugs
Ignitions
Late Model
Coils
Distributors
Crank Triggers
Timing/RPM Controls
Spark Plug Wires
Street Fire
Marine
Accessories
Specialty Items
Promo



Separate Tach circuit is ideal to trigger the Atomic® EFI System.

Pro-Billet™ Ready-To-Run

The Pro-Billet Ready-to-Run distributor is the perfect upgrade for outdated points distributors or bulky HEIs. Simply install the distributor in the engine, connect three wires, the coil and fire it up!

A maintenance-free magnetic pickup accurately triggers the module. The increased output of the amplifier easily outperforms stock ignitions and will smooth out the engine's idle, improve starting and provide a much higher rpm range.

The Ready-to-Run features MSD's adjustable mechanical advance which allows you to custom tailor an ignition curve to match your engine's needs. There is also a vacuum advance canister to help improve economy. Plus, there is an easy-to-adjust rev limiter! For positive street performance, the Ready-to-Run is the best choice.

Ready-to-Run Chevy V8 - PN 8360

PN 8360 REPLACEMENT PARTS

Red Cap:	Black Cap:	Rotor:	Gear:	Bronze Gear:	Harness:
PN 8433	PN 84333	PN 8467	PN 8531	PN 8471	PN 88621

For more distributor accessories see pages 116-124.

This product is legal to sell, distribute or install on vehicles in California according to Executive Order E.O. D-40-39; legal in all 50 states.

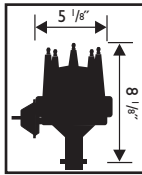

Chevy Crate Ignition Kits

These kits make it easy to add MSD performance to your new crate engine.

Two kits are available; one with our Pro-Billet HEI (PN 8365) for applications that have enough room to take advantage of an internal coil and large cap. If you need something smaller, the other kit is supplied with our Ready-to-Run (PN 8360) Distributor along with a powerful Blaster SS Coil.

Both kits are complemented with a set of 8.5mm Super Conductor Wires, Pro-Clamp separators and even a Billet Hold-Down Clamp!

Chevy Crate Engine Ignition Kits: Ready-to-Run Distributor Kit - PN 84741 HEI Distributor Kit - PN 84742

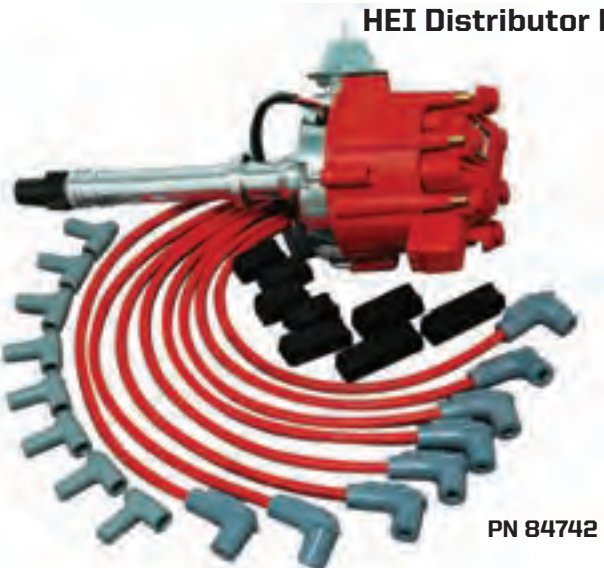

PN 84742

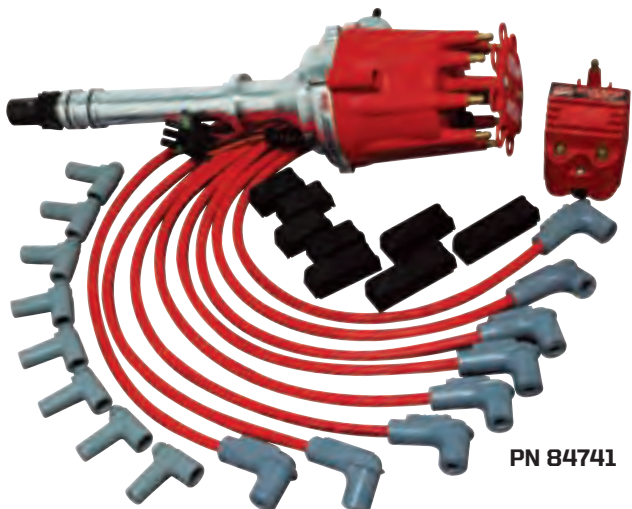

PN 84741



CHEVY® DISTRIBUTORS

Digital E-Curve™ Chevy

The Digital E-Curve Distributor will drop right in your engine, easily connect to the coil and fire up! There are no external controls or boxes to mount and connect, and you can set a timing curve with the twist of a rotary dial!

That's right, no more springs or stop bushings to change. An advanced digital module lets you select from nearly 100 different advance curves, including a vacuum advance! Simply remove the cap and rotor to access the rotary dials and select a curve to match your application. You can also set an rpm limit that will protect your engine from over-rev damage caused by a missed shift or driveline failure. This limit is adjustable from 5,000-10,000 rpm.

E-Curve Chevy V8 - PN 8394

- Digitally controlled stand-alone distributor with adjustable electronic advance
- High output ignition module produces a powerful spark for improved performance
- Simple three wire connection and you're ready-to-run
- Dial-in a rev limit to protect your engine from over-rev damage



PN 8394



CARB Approval Pending

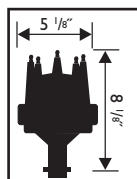

PN 8394 REPLACEMENT PARTS

Red Cap:	Black Cap:	Rotor:	Gear:	Bronze Gear:	Harness:
PN 8433	PN 84333	PN 8467	PN 8531	PN 8471	PN 88621

See page 99 for sample Timing Curves.

Pro-Billet™ EFI

GM late-model performance enthusiasts will be happy to see this Pro-Billet Distributor. The distributor, PN 8366, is a drop-in replacement for GM V8s using the small cap distributor with a dual connector coil found in cars from 1987-1993 and trucks from 1987-1995.

The entire housing is CNC-machined to exact tolerances for incredible strength (not to mention cool looks). Inside, a polished steel shaft receives guidance from a sealed ball bearing and an extra-long sintered bushing adds stability. This 0.500" shaft also receives a QPQ coating for increased friction reduction and corrosion resistance.

An OEM based ignition module is supplied with the distributor so your factory wiring will plug directly in. For late model engine swaps or bolt-on strength, this distributor is the answer.

Late Model GM, V8 - PN 8366

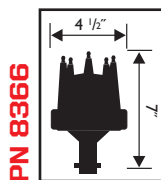

PN 8366

REPLACEMENT PARTS

	Cap/Rotor Kit:	Gear:	Bronze Gear:	Module:
V6	PN 8430	PN 8531	PN 8471	PN 84665
V8	PN 8406	PN 8531	PN 8471	PN 84665

For more distributor accessories see pages 116-124.
Note: These are OEM replacement distributors and are legal to install in all states.



PN 8366



Street Fire EFI Models

If you're looking for an all new distributor, but already know that your engine just doesn't require the best performance of a Pro-Billet model, our Street Fire line may be just what you need!

The Street Fire EFI Distributor is an all new distributor that has been spec'd by our engineering team. An all new cast aluminum housing features a long sintered bushing for long life. An OEM style module is included along with a high quality gear and cap with brass terminals. For more info, see pages 159.

Street Fire EFI Distributor, V8 - PN 5591

Street Fire Vortech, V8 - PN 5592

Atomic EFI
Starters/ Alternators
Spark Plugs
Ignitions
Late Model
Coils
Distributors
Crank Triggers
Timing/RPM Controls
Spark Plug Wires
Street Fire
Marine
Accessories Specialty Items
Promo



CHEVY® DISTRIBUTORS



Atomic EFI
Starters/Alternators
Spark Plugs
Ignitions
Late Model
Coils
Distributors
Crank Triggers
Timing/RPM Controls
Spark Plug Wires
Street Fire
Marine
Accessories
Specialty Items
Promo



PN 8381

Pro-Billet™ LT 1

- Advanced optical encoder trigger design for accuracy and reliability
- Easily adjust the timing up to +/-6°
- Improved housing design and extra bolt eliminates leaks
- Large ball bearing stabilizes timing through 10,000 rpm
- Rotor drive design is positively indexed and cannot slip

Leave it to MSD to build an all-out performance distributor to replace the OEM GM LT1 Optispark! We machine an entire billet block of aluminum down into a precise housing that fits in place of the factory piece. Then, we fill it with a reliable new pickup assembly, a trick timing adjustment mechanism and top it off with an all new MSD distributor cap!

The pickup is an advanced optical encoder, a different style of optical pickup than the OEM. This improved pickup has proven to be very reliable and stable through extreme rpm and conditions. The rotor is bolted to a drive assembly that is indexed to the shaft and is stabilized through the use of a large ball bearing assembly.

Once installed, you have the ability to adjust the ignition timing - the only distributor that offers timing adjustability! An adjustment screw allows the timing to be tweaked up to +/-6°.

The distributor is supplied complete with our heavy duty LT1 Cap, Rotor and the components required for installation.

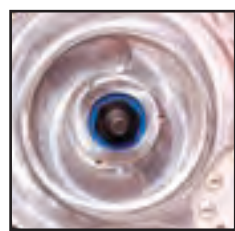

PN 8381 - Spline Drive



PN 83811 - Pin Drive



MSD evaluated the shortcomings of the OEM optical trigger and incorporated our own trigger wheel and digital encoder. This trigger process is much more reliable and accurate through high rpm.

Pro-Billet LT1 Distributors:

'94-'96 Late Model - **PN 83811***

'92-'94 Early Model, supplied with fresh air hoses - **PN 8381***



PN 84891

Flat-Top Pro-Billet™

Having a huge huffer mounted on top of your engine is cool, but can lead to limited choices for a distributor. We decided to morph our Crab Cap crank trigger distributor with a standard Chevy model to come up with the Flat-Top!

This distributor sits low in the engine block, then is topped with our special Crab Cap that positions the spark plug terminals horizontally to give you plenty of clearance.

For trigger accuracy, a maintenance-free magnetic pickup is used. This pickup plugs directly into an MSD Ignition Control. The Flat-Top Distributor is supplied with our Dupont, Rynite molded distributor cap and rotor along with a heavy duty gear for long life in your engine.

- Crab cap will clear low cowls, exotic intakes and air cleaners
- Mechanical advance is easy to adjust for your engine
- Maintenance-free magnetic pickup provides accurate trigger signals

NOTE: Must be used with an MSD 6, 7 or 8-Series Ignition.

Flat-Top Chevy V8 - PN 84891*

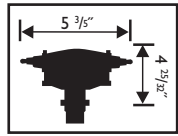

PN 84891 REPLACEMENT PARTS

Red Cap:	Rotor:	Gear:	Bronze Gear:
PN 8541	PN 84673	PN 8531	PN 8471

For more distributor accessories see pages 116-124.



CHEVY® DISTRIBUTORS

Pro-Billet™ Small Diameter

This Distributor was designed for racers and street rodders that have space limitations due to firewall interference, blowers or oversized intake manifolds such as tunnel rams. The distributor is 3/8" narrower and almost 1" shorter than a standard distributor.

Proven performance features include a high output magnetic pickup and precision machined reluctor for accurate ignition triggering. A fully adjustable mechanical advance allows you to tailor the advance curve to your specific application. Topping it all off is our own small diameter cap. This is molded out of durable Rynite® material and comes with an optional wire retainer.

NOTE: Must be used with an MSD 6, 7 or 8-Series Ignition.

Small Diameter Chevy - PN 8570*

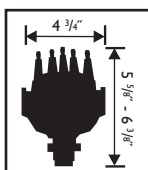

PN 8570 REPLACEMENT PARTS

Red Cap:	Black Cap:	Rotor:	Gear:	Bronze Gear:
PN 8431	PN 84313	PN 8467	PN 8531	PN 8471

For more distributor accessories see pages 116-124.

SLIP COLLAR BENEFITS



The adjustable slip collar allows you to compensate for machining of the engine block, intake manifold or heads. The adjustable collar will ensure that you obtain the correct gear mesh as well as the oil pump to distributor shaft overlap. Once adjusted, the slip collar locks securely in place around the distributor housing.

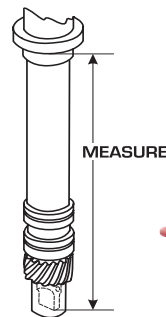
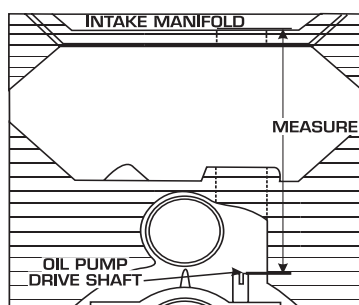

Pro-Billet™ Locked-Out

This strong, billet aluminum distributor is set up for engines that run locked-out timing or an MSD Timing Computer. With no advance assembly, the rotor plate is welded directly to the oversized shaft. A sealed ball bearing guides the top of the shaft while an extra long sintered bushing stabilizes the lower portion.

Trigger signals are produced via a high-output magnetic pickup. This pickup is extremely accurate and never requires adjustment. Since this distributor is designed primarily for race engines, an oversized (+.006") bronze gear is installed along with an adjustable slip collar for modified blocks, heads or intake manifolds.

NOTE: Must be used with an MSD 6, 7 or 8-Series Ignition.

Pro-Billet w/Locked-Out Timing, Chevy V8 - PN 85501*

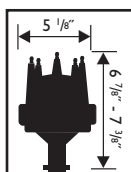

PN 85501 REPLACEMENT PARTS

Red Cap:	Black Cap:	Rotor:	Gear:	Bronze Gear:
PN 8433	PN 84333	PN 8467	PN 8531	PN 8472

For more distributor accessories see pages 116-124.



Atomic EFI
 Starters/ Alternators
 Spark Plugs
 Ignitions
 Late Model
 Coils
 Distributors
 Crank Triggers
 Timing/RPM Controls
 Spark Plug Wires
 Street Fire
 Marine
 Accessories
 Specialty Items
 Promo



CHEVY® DISTRIBUTORS



Accessories
Specialty
Items
Promo
Marine
Street Fire
Spark Plug
Wires
Timing/RPM
Controls
Crank
Triggers
Distributors
Coils
Late Model
Ignitions
Spark Plugs
Starters/
Alternators
Atomic EFI



PN 85561

Pro-Billets with Slip Collar

If you have a slightly taller block or have decked the heads, the distance between the distributor mounting pad and the cam gear/oil pump drive may be different. MSD offers these Distributor with an adjustable slip collar with 1.5" of adjustment so you can be sure the distributor is installed correctly.

The distributor shares the same features of the standard Pro-Billet Chevrolet model including a ball bearing guide, long sintered lower bushing and an oil seal. To trigger the MSD Ignition a maintenance-free magnetic pickup is secured in the billet base of the distributor. Just above this pickup assembly is an adjustable mechanical advance assembly.

NOTE: Must be used with an MSD 6, 7 or 8-Series Ignition.

Slip Collar Chevy - PN 85561* Extra Tall Slip Collar Chevy - PN 8547*

Designed for racing blocks with maximum increased deck height such as Alan Root, Merlin and Rocket Blocks. Nearly three inches of adjustment.

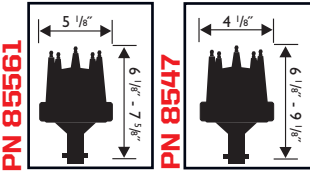

REPLACEMENT PARTS

Red Cap:	Black Cap:	Rotor:	Gear:	Bronze Gear:
PN 8433	PN 84333	PN 8467	PN 8531	PN 8472

For more distributor accessories see pages 116-124.



Corvette Pro-Billet™ Tach Drive

Corvette owners can now replace their worn out Magna-Pulse distributors with this precision Pro-Billet Tach Drive Distributor. Advantages such as an accurate magnetic pickup, oversized shaft, vacuum advance and a billet aluminum housing are just a few of the MSD advantages.

Inside the billet housing, a sealed ball bearing and long sintered bushing guide a 0.500" steel shaft for high rpm accuracy. A special reluctor is mounted to this shaft and is responsible for triggering the magnetic pickup.

An adjustable mechanical advance assembly allows you to get the most performance out of your Vette's engine by custom tailoring a timing curve to fit your application.

The tach drive assembly is compact to clear the firewall and linkage. It can be repositioned easily to fit different applications plus has a grease fitting for lubrication. Also, a stock points style cap can be used to keep that factory appearance.

NOTE: Must be used with an MSD 6, 7 or 8-Series Ignition.

Corvette, with Mechanical Tach Drive, '63-'74 Applications - PN 8572

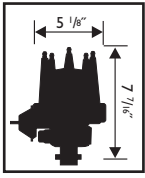

PN 8572 REPLACEMENT PARTS

Red Cap:	Black Cap:	Rotor:	Gear:	Bronze Gear:
PN 8433	PN 84333	PN 8467	PN 8531	PN 8471

For more distributor accessories see pages 116-124.
This product is legal to sell, distribute or install on vehicles in California according to Executive Order E.O. D-40-39; legal in all 50 states.



CHEVY® DISTRIBUTORS

Atomic EFI
Starters/
Alternators
Spark Plugs
Ignitions
Late Model
Coils
Distributors
Crank
Triggers
Timing/RPM
Controls
Spark Plug
Wires
Street Fire
Marine
Accessories
Specialty
Items
Promo

Ready-to-Run™ 348/409

If you're a 348/409 fan, you'll be excited to learn that you can get a high performance distributor for your classic Chevy engine!

This distributor is Ready-to-Run meaning that you simply need to install it in the engine and connect three wires to fire up the engine. No external ignition controls are required with this distributor because it has a powerful module built into the housing. This module produces a stout inductive spark that will improve the overall driveability and performance of your classic Chevy.

Just above the maintenance-free magnetic pickup there is a chromoly mechanical advance assembly that provides smooth advance of the timing and is easy to adjust. There is also a vacuum canister for cruisers. If you're concerned about looking stock, the distributor accepts a stock-style points distributor cap.

- An ideal distributor for restored 409s or for nostalgia racers
- Maintenance-free magnetic pickup never requires adjusting
- Built-in ignition module delivers a powerful spark
- Simple and clean three wire installation
- Built-in adjustable rev limiter

BUILT-IN REV LIMITER



Ready-to-Run Chevy 348/409 - PN 8393

CARB Approval Pending

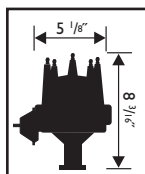

PN 8393 REPLACEMENT PARTS

Red Cap:	Black Cap:	Rotor:	Gear:	Bronze Gear:	Harness:
PN 8433	PN 84333	PN 8467	PN 8531	PN 8471	PN 88621

For more distributor accessories see pages 116-124.

Pro-Billet™ 6-Cylinder

Starting on the inside, a 0.500" oversized steel shaft spins in a sealed ball bearing and sintered bushing for long endurance and accurate spark delivery throughout the entire rpm range. Mounted on top of the shaft is an easy-to-adjust chromoly mechanical advance assembly. Different advance springs and stop bushings are supplied so you can choose from a variety of curves.

A maintenance-free magnetic pick-up provides accurate trigger signals to your MSD Ignition Control. A precision-manufactured reluctor that is connected to the shaft is responsible for triggering the pick-up. The distributor is topped off with a high quality MSD red cap and Race Rotor.

Pro-Billets:

90° V6, Even-Fire, 4.3L - PN 8597*

Inline-6, 194, 230, 250, 292 - PN 8515

NOTE: Must be used with an MSD 6, 7 or 8-Series Ignition.

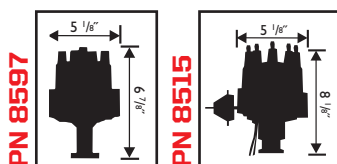

REPLACEMENT PARTS

Cap:	Rotor:	4.3L Gear:
PN 8014	PN 8467	PN 8531

For more distributor accessories see pages 116-124. This product is legal to sell, distribute or install on vehicles in California according to Executive Order E.O. D-40-39; legal in all 50 states.



PN 8515





EFI CAM SYNC DISTRIBUTORS

Atomic EFI
Starters/Alternators
Spark Plugs
Ignitions
Late Model
Coils
Distributors
Crank Triggers
Timing/RPM Controls
Spark Plug Wires
Street Fire
Marine
Accessories
Specialty Items
Promo



PN 2345



Adjustable Cam Sync Distributors

Some aftermarket EFI management systems fire the fuel injectors in the same order as the engine's firing order. These are called synchronization systems and are found in most high performance applications. These systems require a sync signal to know when the number one cylinder is firing.

These MSD Distributors feature an adjustable cam sync pickup so you can set it to your ECU's requirements (up to 60° BTDC). Two models are offered; one with a non-magnetic sync pickup and a new version with a Hall-effect switch. Each model is equipped with a slip collar, iron gear and an adjustable rotor to help set phasing!

- Chevy V8, Magnetic Sync - PN 2345***
- Chevy V8, Hall-Effect Sync - PN 2357***

NOTE: Must be used with an MSD 6, 7 or 8-Series Ignition.

- Chevy V8, Large Cap, Hall-Effect Sync - PN 23451***

REPLACEMENT PARTS

	Red Cap:	Black Cap:	Rotor:	Iron Gear:	Bronze Gear:	Pickup:
PN 2345 and PN 2357	PN 8431	PN 84313	PN 84211	PN 8531	PN 8471	PN 2346 or PN 2348
PN 23451	PN 8408	PN 84083	PN 8421	PN 8531	PN 8471	PN 2348

For more distributor accessories see pages 116-124.

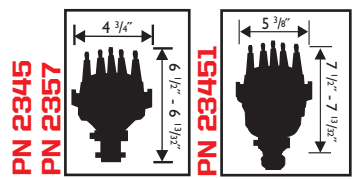

PN 23451



Hall-Effect Pickup with LED

Hall-Effect Pickup with LED Cam Sync Distributor - PN 2348

Available separately and can replace the non-magnetic pickup of the PN 2345 and PN 2340 distributors.



Universal Cam-Sync Pickup

This Universal Cam-Sync pickup Kit is supplied with a non-magnetic pickup and a magnet that you install to any part that operates at cam-shaft speed. When the magnet passes the pickup, a signal is created to alert the ECU of the position and firing order of the engine. Matching connectors are supplied and the magnet measures .250" x .200". You will need to fabricate a bracket assembly and install the magnet.

Universal Cam-Sync Pickup Kit - PN 2346





FORD[®] DISTRIBUTORS

Pro-Billet™ EFI Fords

When you start making serious power with your EFI Ford, the stock distributor shaft is one of the weak links of the engine. These Pro-Billet models answer the need for an affordable replacement in a strong and great looking package.

Each distributor starts as a solid billet that is secured into a state-of-the-art Computer Numerical Control (CNC) machine where it is transformed into a precision housing.

Inside each housing there is a sealed ball bearing at the top of the shaft. This design is responsible for accurately guiding the oversized polished steel shaft throughout the entire rpm range of your engine. The shaft is also QPQ-coated for friction reduction and corrosion resistance.

The Pro-Billet Distributors use a stock-style trigger pickup to accept factory connectors. For installation, you simply remove the stock distributor and bolt the Pro-Billet MSD in place! Each model is supplied with a high-quality cap with brass terminals for full spark delivery, heavy-duty rotor and a special gear to work with the factory camshafts.

5.0L EFI Pro-Billet Distributors:

1986 - 1993 - **PN 8456**

1994 - 1995 - **PN 8455**

5.8L EFI Pro-Billet Distributors:

w/Module, non-roller cam - **PN 8453**

w/Module, steel gear for factory roller-cam - **PN 8452**

for remote Modules, steel gear for factory roller-cam - **PN 8451**



PN 8456

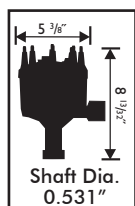

REPLACEMENT PARTS

Red Cap:	Black Cap:	Rotor:	Gear:	Bronze Gear:	Module:	Black Spacer:
PN 8408	PN 84083	PN 8070	PN 85834	PN 8585	PN 83648	PN 8120
(with Roller Cam)						

For more distributor accessories see pages 116-124.

Note: These are OEM replacement distributors and are legal to install in all 50 states.



Street Fire[®] 5.0L TFI Distributor

Looking for a performance replacement for your stock/mild 5.0L? Our Street Fire line of distributors are manufactured with all new materials to MSD specifications.

The Street Fire TFI Distributor features an OEM replacement module and accepts the factory connector. A high quality gear is compatible with hydraulic roller camshafts and a new cap and rotor are supplied. See page 159 for more information.

Street Fire 5.0L TFI Distributor - PN 5594

CARB Approval Pending



PN 8451

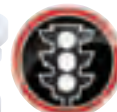

Atomic EFI
 Starters/ Alternators
 Spark Plugs
 Ignitions
 Late Model
 Coils
 Distributors
 Crank Triggers
 Timing/RPM Controls
 Spark Plug Wires
 Street Fire
 Marine
 Accessories Specialty Items
 Promo



FORD® DISTRIBUTORS

Promo
Accessories
Specialty
Items
Marine
Street Fire
Spark Plug
Wires
Timing/RPM
Controls
Crank
Triggers
Distributors
Coils
Late Model
Ignitions
Spark Plugs
Starters/
Alternators
Atomic EFI



PN 8580

Billet Ford

For Ford enthusiasts that are serious about performance! Just under the brass terminals of the MSD cap and rotor is an easy-to-adjust mechanical advance assembly. The assembly is fine blanked from chromoly steel, TIG-welded for strength plus receives a QPQ coating. The precision weights glide on nylon bushings for smooth advancement and different springs and stop bushings are supplied so a variety of advance curves can be tuned.

The steel shaft that spins the advance and reluctor receives a friction reducing coating plus is guided by a sealed ball bearing and long sintered bushing. This combination provides stable timing signals and spark delivery at any rpm. Triggering chores are handled by MSD's race proven, maintenance-free magnetic pickup.

NOTE: Must be used with an MSD 6, 7 or 8-Series Ignition.

NOTE: PN 8580 will not clear some factory-style Shaker Hood Scoops.



These Ford Distributors use a maintenance-free magnetic pickup and an adjustable advance assembly.

Ford Billet Distributors:

351C, 351M, 400, 429, 460 - PN 8580*

289, 302 - PN 8582*

351W - PN 8584*

Special Ford Applications:

289, 302 with Steel Gear for Hydraulic Roller Cams - **PN 8598***

351W for use with Edelbrock Victor Jr. Intake Manifold - **PN 85805***

351W with steel gear for hydraulic roller cams - **PN 85840***

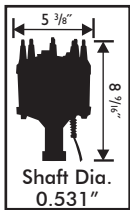

351W

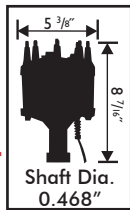

289/302

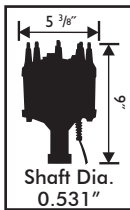

460

REPLACEMENT PARTS

Red Cap:	Black Cap:	Rotor:	Gear:	Bronze Gear:	Black Spacer:
PN 8408	PN 84083	PN 8423	PN 85812 (351C-460)	PN 8581	PN 8446
			PN 85832 (289-302)	PN 8583	
			PN 85852 (351W)	PN 8585	

For more distributor accessories see pages 116-124.

NOTE: Will not fit XD and later Australian 351 Cleveland engines.



TECH TIP

Ford used a variety camshaft designs which affect the choice of distributor gear. Here is a quick guide to ensure you have the right gear for your cam.

Hydraulic Cams - Cast Iron Gear

Hydraulic Roller Cams - Steel Gear (including '85 - '95 Mustangs)

Billet Roller Cams - Bronze Gear



FORD® DISTRIBUTORS

Pro-Billet™ Small Diameter Ford

MSD engineers fit all of their high performance distributor experience into a special compact housing designed to be less obtrusive for Ford engines.

The diameter of the special cap and housing are 5/8" smaller than stock Ford distributors providing extra room in front of the engine. The new MSD cap features spark plug style terminals and is firmly screwed down to the housing.

The distributor relies on MSD's race proven magnetic pickup and precision reluctor to deliver accurate trigger signals to the MSD Ignition throughout high rpm. The reluctor assembly is turned by a hardened steel shaft which rides in a sealed ball bearing for high rpm stability and endurance.

Mounted to the top of this shaft is a fully adjustable mechanical advance assembly. The rate at which the chromoly assembly advances the timing is easily controlled by changing the supplied advance springs and stop bushing for total advance.

NOTE: Must be used with an MSD 6, 7 or 8-Series Ignition.

Ford Small Diameter Distributors:

351C - 460 - PN 8577*

351W - PN 8578*

289, 302 - PN 8579*

With Vacuum Advance:

351C - 460 - PN 8477

351W - PN 8478

289, 302 - PN 8479

Billet 2.3L Ford

This distributor features an aluminum housing that is CNC-machined for closer tolerances than any conventional cast distributor. Plus you get an adjustable mechanical advance which can be easily tailored to any engine by changing the stop bushing and advance springs.

Triggering the MSD Ignition system is the same high-output magnetic pickup that is used in our racing distributors. This pickup produces an extremely accurate trigger signal and is maintenance-free.

2.3L Ford - PN 8473*

NOTE: Must be used with an MSD 6, 7 or 8-Series Ignition.

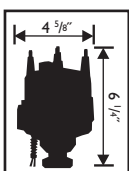

PN 8473 REPLACEMENT PARTS

Gray Cap:	Rotor:
PN 8434	PN 8470

For more distributor accessories see pages 116-124.

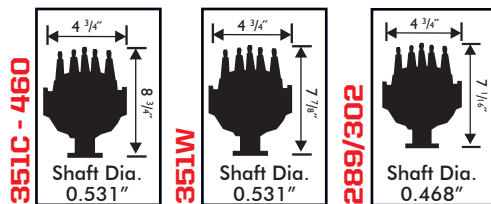

REPLACEMENT PARTS

Red Cap:	Black Cap:	Rotor:	Gear:	Bronze Gear:
PN 8431	PN 84313	PN 8467	PN 85812 (351C-460) PN 85832 (289-302) PN 85852 (351W)	PN 8581 PN 8583 PN 8585

For more distributor accessories see pages 116-124.

NOTE: Will not fit XD and later Australian 351 Cleveland engines.



Atomic EFI
Starters/ Alternators
Spark Plugs
Ignitions
Late Model
Coils
Distributors
Crank Triggers
Timing/RPM Controls
Spark Plug Wires
Street Fire
Marine
Accessories Specialty Items
Promo



FORD® DISTRIBUTORS



Atomic EFI
Starters/
Alternators
Spark Plugs
Ignitions
Late Model
Coils
Distributors
Crank
Triggers
Timing/RPM
Controls
Spark Plug
Wires
Street Fire
Marine
Accessories
Specialty
Items
Promo



PN 8352

Separate Tach circuit is ideal to trigger the Atomic® EFI System.

Ready-to-Run Pro-Billet™ Fords

MSD's Ready-to-Run Ford Distributors are the perfect upgrade for bulky DuraSpark systems or ancient breaker point models. These distributors come complete and ready-to-run. All you need to do is drop it in the engine, connect three wires and fire the engine. Each distributor features an ignition module that produces a powerful inductive spark to improve combustion of the fuel mixture resulting in quick starts, smooth idle and increased performance.

The billet aluminum housings of these distributors are 5/8" smaller in diameter to accommodate induction setups and tight engine compartments. A maintenance-free magnetic pickup is responsible for triggering the high voltage sparks while a sealed ball bearing guides an oversized shaft.

Beneath the bolt down cap and MSD race rotor you'll find MSD's accurate mechanical advance assembly. Different advance springs and stop bushings are supplied so you can easily tune a curve to match your needs. Plus, there is a vacuum advance canister to increase economy on long drives. For protection, there is also an easy-to-set rev limiter!

Ready-to-Run Ford Distributors:

	Iron Gear	Steel Gear	
289, 302 -	PN 8352	PN 83521	CARB
351W -	PN 8354	PN 83541	Approval
351C - 460 -	PN 8350	PN 83501	Pending



REPLACEMENT PARTS

Red Cap:	Black Cap:	Rotor:	Iron Gear:	Steel Gear:	Harness:
PN 8431	PN 84313	PN 8467	PN 85812 (351C-460)	PN 85832 (289-302)	PN 85833
			PN 85852 (351W)	PN 85834	PN 88621

For more distributor accessories see pages 116-124.

These products are legal to sell, distribute or install on vehicles in California according to Executive Order E.O. D-40-39; legal in all 50 states.

NOTE: Will not fit XD and later Australian 351 Cleveland engines.

Ford Crate Ignition Kits

These kits are supplied with everything you need for your ignition including a Ready-to-Run Distributor, Blaster SS Coil, 8.5mm Spark Plug Wires with separators and even a billet hold-down clamp. The Ready-to-Run distributor is a great choice for your engine.

They feature a high output module that produces a vigorous jolt across the plug gap and the installation is simple with just three wires to connect!

The Blaster SS Coil is a compact and efficient coil that is easy to mount and the system is complemented with MSD's red 8.5mm Super Conductor wires. The wires are supplied as a universal fit, with our straight/multi-angle boots and terminals on the spark plug side and after you route them and cut to length, you simply install the distributor side terminal and boot. Our Pro-Clamp separators keep the wires neat and secure and we even supply a Pro-Billet Hold-Down Clamp for the distributor.

Ford Crate Ignition Kits:

(supplied with steel gear for compatibility with hydraulic roller cams)

289, 302 - PN 84745
351W - PN 84746

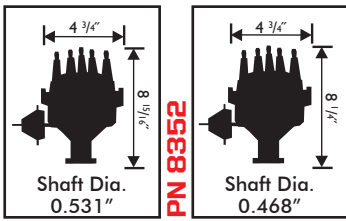



FORD® DISTRIBUTORS

Digital E-Curve™ Pro-Billet™

The E-Curve Distributor will drop right in your Ford 289/302 and fire up its performance.

The E-Curve Distributor features a digital control module that manages the timing curve replacing the centrifugal advance springs and weights. This module lets you select from nearly 100 different advance curves, including a vacuum advance by turning two rotary dials! You can also set an rpm limit that will protect your engine from over-rev damage caused by a missed shift or driveline failure.

These distributors are also fit with a high-output ignition module so there is no need to run an external ignition box. This combination makes these distributors ideal for restored muscle cars and street rods to keep a stock or clean appearance under the hood.

Digital E-Curve Distributor Ford 289/302 - PN 8503

CARB Approval
Pending

- Digitally controlled, stand-alone distributor
- Adjustable electronic advance with vacuum advance
- Select up to 100 different curves through two rotary dials
- High output ignition module for a powerful spark
- Set a rev limit to protect your engine from over-rev damage
- Simple three wire connection and you're ready-to-run

PN 8503 REPLACEMENT PARTS

Red Cap:	Black Cap:	Rotor:	Gear:	Bronze Gear:	Harness:
PN 8433	PN 84333	PN 8467	PN 85832	PN 8583	PN 88621

For more distributor accessories see pages 116-124.

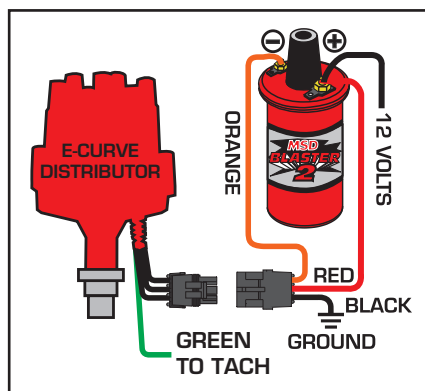
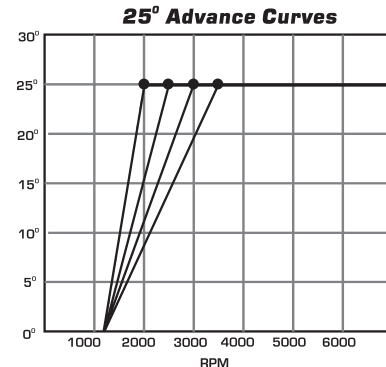
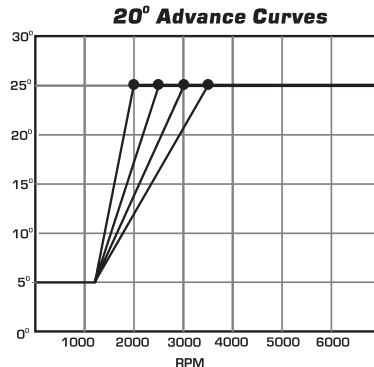
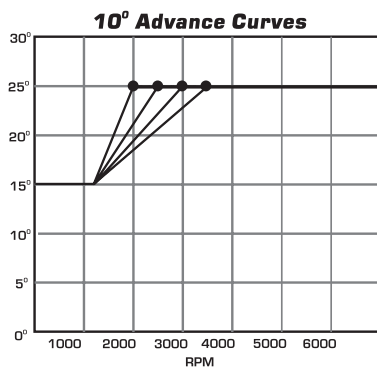
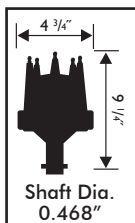

See how easy it is to install an MSD E-Curve Distributor. Three wires plus a tach wire. The timing charts above show just a sample of the timing curves available.

TECH TIP

When setting up your E-Curve, and even a basic distributor, you need to consider the Total timing and the desired Initial timing.

Initial Timing: The timing at idle, with no mechanical or vacuum advance present.

Total Timing: The highest point the timing will reach Before Top Dead Center. This setting includes the mechanical advance. (Rev the engine until the timing stops moving. That is Total Timing.)

NOTE: On E-Curves, you'll position the distributor at Total timing, and work back to an initial timing setting.

Atomic EFI
 Starters/Alternators
 Spark Plugs
 Ignitions
 Late Model
 Coils
 Distributors
 Crank Triggers
 Timing/RPM Controls
 Spark Plug Wires
 Street Fire
 Marine
 Accessories/Specialty Items
 Promo



FORD® CAM SYNC DISTRIBUTORS

Pro-Billet™ Cam Sync Distributors for Ford

If you plan on using an aftermarket EFI system that fires sequentially, you'll need to provide the ECU with a cam synchronization signal. The ECU requires to know when cylinder number one is firing (or preparing to fire) so it knows the sequence of the injectors coming next.

These two new Pro-Billet Distributors from MSD feature an adjustable cam sync pickup as well as a magnetic pickup inside the distributor to trigger the ignition control. The Hall-effect sync pickup is adjustable up to 60° BTDC to meet the needs of most aftermarket ECUs and even is crimped with a 2-pin Weathertight connector.

Each distributor is CNC-machined from billet aluminum creating a strong foundation. The caps are MSD designed and molded from Dupont® Rynite™ material for great strength and resistance to spark scatter. A great new feature is the two piece adjustable rotor that is supplied. This assists in setting up the proper rotor phasing for accurate timing and spark control.



PN 2358

Pro-Billet Cam Sync Distributors for Ford:

289, 302, Steel gear - **PN 2358***

Iron gear - **PN 2359***

Bronze gear - **PN 2360***

351W, Steel gear - **PN 2362***

NOTE: Must be used with an MSD 6, 7 or 8-Series Ignition.

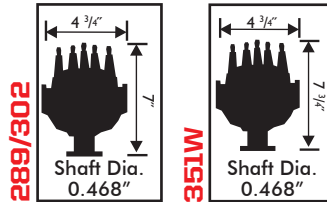

REPLACEMENT PARTS

	Black Cap:	Red Cap:	Rotor:	Iron Gear:	Bronze Gear:	Steel Gear:	Pickup:
PN 2358 / PN 2359 / PN 2360:	PN 84313	PN 8431	PN 84211	PN 85833	PN 8583	PN 85834	PN 2384
PN 2362:	PN 84313	PN 8431	PN 84211	PN 85852	PN 8585	PN 85813	PN 2384

For more distributor accessories see pages 116-124.

TECH TIP

Many aftermarket EFI systems require a cam sync signal to tell the ECU when the number one cylinder is firing. This is need on sequential EFI systems.

MSD's Cam Sync Distributors have two pick-ups; one to trigger the ignition control, just like our standard ignitions, and another external magnetic pickup that produces one pulse per revolution of the distributor (engine). This pickup can also be 'phased' BTDC depending on the ECU.



Each Cam Sync Distributor is topped with MSD's adjustable two piece rotor to provide rotor phasing adjustments.



MSD's Hall-effect pickup features an LED that assists in setting up the rotor phasing.

Atomic EFI
Starters/Alternators
Spark Plugs
Ignitions
Late Model
Coils
Distributors
Crank Triggers
Timing/RPM Controls
Spark Plug Wires
Street Fire
Marine
Accessories
Specialty Items
Promo



FORD® FE DISTRIBUTORS

Ready-to-Run FE

The Pro-Billet Ready-to-Run Distributor is the answer to weak breaker points or rebuilt aftermarket models.

Inside the billet housing there is a high-output ignition module. When the maintenance-free magnetic pickup signals the module to fire, up to 7.5 amps is sent to the coil where a powerful spark is created. This improved spark output results in quick starts, snappy throttle response and terrific driveability.

The distributor is equipped with a vacuum advance canister for cruising economy. Plus, there is a mechanical advance assembly that is mounted on top of the distributor shaft making it easy to adjust the advance to meet your needs.

Another great feature of the Ready-to-Run Distributor is their simple installation! All you need to do is connect three wires and you'll be cruising!

Ford FE Pro-Billet Ready-to-Run, 332, 352, 360, 390, 406, 410, 427, 428 - PN 8595



PN 8595

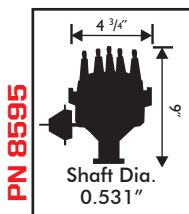

PN 8595

REPLACEMENT PARTS

Red Cap:	Black Cap:	Rotor:	Gear:	Bronze Gear:
PN 8431	PN 84313	PN 8467		
PN 8431	PN 84313	PN 8467	PN 85812	PN 8581

For more distributor accessories see pages 116-124. These products are legal to sell, distribute or install on vehicles in California according to Executive Order E.O. D-40-39; legal in all 50 states.

Pro-Billet™ Ford FE

Racers and nostalgic Ford enthusiasts using the famous Ford FE engine now have access to a distributor that is truly equal to the performance level of their engine.

A magnetic pickup triggers your MSD Ignition Control accurately at any rpm. Above this pickup the mechanical advance assembly is positioned so it can be adjusted without disassembling the distributor. In addition, the specially ground advance cam is tig-welded to the 9/16" hardened shaft and the weight pins are staked and TIG-welded to the advance plate.

NOTE: Must be used with an MSD 6, 7 or 8-Series Ignition.

Ford FE, 332, 352, 360, 390, 406, 410, 427, 428 - PN 8594*

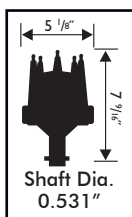

PN 8594 REPLACEMENT PARTS

Red Cap:	Black Cap:	Rotor:	Gear:	Bronze Gear:
PN 8433	PN 84333	PN 8467	PN 85812	PN 8581

For more distributor accessories see pages 116-124.



PN 8594



Atomic EFI
 Starters/ Alternators
 Spark Plugs
 Ignitions
 Late Model
 Coils
 Distributors
 Crank Triggers
 Timing/RPM Controls
 Spark Plug Wires
 Street Fire
 Marine
 Accessories/ Specialty Items
 Promo



FORD® VINTAGE DISTRIBUTORS

Atomic EFI
Starters/Alternators
Spark Plugs
Ignitions
Late Model
Coils
Distributors
Crank Triggers
Timing/RPM Controls
Spark Plug Wires
Street Fire
Marine
Accessories
Specialty Items
Promo



PN 8573

Ready-to-Run™ 8-BA Flathead and Y-Block

These distributors are built around a CNC-machined billet aluminum housing and features a maintenance-free magnetic pickup so there are no points to worry about. A precision reluctor is mounted to a QPQ-coated steel shaft which is guided by a sealed ball bearing for accurate timing signals throughout the entire rpm range.

The distributors also offer an easy-to-adjust mechanical advance assembly. Chromoly weights move smoothly on nylon pads and different advance springs and stop bushings are supplied so you can custom tailor a timing curve to match your engine's requirements.

The best thing about this distributor is that it features an ignition module that is built into the billet aluminum housing. This distributor drops in the engine and connects with only three wires!



The 8-BA Flathead Distributors are supplied with a special die to help set up the hold down clamp.

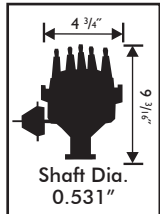

PN 8383

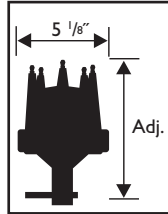

PN 8573

Vintage Ford Ready-to-Run Distributors: Flathead, '49-'53 - PN 8573* Y-Block, '239, '272, '292, '312 - PN 8383

(may hit firewall seam on '57-'59 full size cars)

REPLACEMENT PARTS

Red Cap:	Black Cap:	Rotor:	Harness:
PN 8433	PN 84333	PN 8467	PN 88621

For more distributor accessories see pages 116-124.

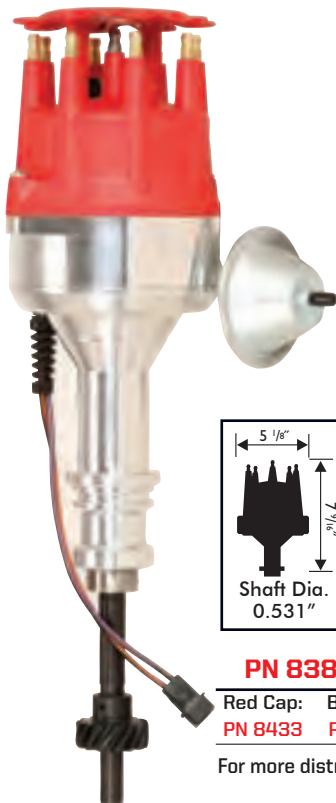

Pro-Billet Y-Block

The Ford Y-Block holds a special place in Ford's history books and with blue oval enthusiasts. To ensure precise spark delivery and control, MSD offers a Pro-Billet Distributor for most Y-Blocks.

Rather than ancient breaker points, this distributor uses a maintenance-free non-magnetic pickup to trigger the ignition control. Atop the distributor shaft is our proven centrifugal advance that allows you to alter the rate and amount of mechanical advance which is a very important tuning step with a Y-Block.

This distributor requires an MSD Ignition Control such as a 6A or 7-series ignition which will provide plenty of energy and multiple sparks to make your vintage Ford purr.

Pro-Billet Y-Block, '239, '272, '292, '312 - PN 83831

(may hit firewall seam on '57-'59 full size cars)

NOTE: Must be used with an MSD 6, 7 or 8-Series Ignition.

CARB Approval Pending.

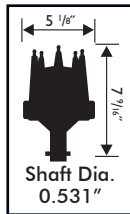

PN 83831 REPLACEMENT PARTS

Red Cap:	Black Cap:	Rotor:	Bronze Gear:
PN 8433	PN 84333	PN 8467	PN 8581

For more distributor accessories see pages 116-124.

TECH TIP

MECHANICAL TIMING

Centrifugal force of the spinning distributor pushes the advance weights to advance the ignition timing. Two things to consider:

- The advance rate is controlled by the tension of the springs.
- The amount of advance is controlled by the stop bushing.



CHRYSLER® DISTRIBUTORS

Billet Chrysler Small Block and 392 Hemi®

Get your Mopar fired up with billet accuracy and performance. Remove the MSD cap and Race Rotor and you'll find easy access to the adjustable mechanical advance assembly for easy adjustments. This advance is designed for accuracy and strength with TIG-welded weight pins, nylon pads for smooth movement of the weights and a QPQ coating for friction reduction. Different advance springs and stop bushings are supplied so you can custom tailor a timing curve to fit your Chrysler's needs.

Supporting the advance assembly is a hardened, polished steel shaft. Two ball bearing guides are used to support the shaft producing incredible stability. Precision paddles of a zinc-plated reluctor pass a maintenance-free magnetic pickup creating a trigger signal that tells the MSD to fire.

NOTE: Must be used with an MSD 6, 7 or 8-Series Ignition.

Chrysler Billet, 273, 318, 340, 360 - PN 8534*

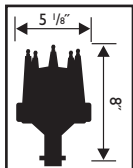

PN 8534, PN 83891 REPLACEMENT PARTS

Red Cap: PN 8433	Black Cap: PN 84333	Rotor: PN 8467
---------------------	------------------------	-------------------

For more distributor accessories see pages 116-124.



PN 8534

Pro-Billet™, 392 Hemi - PN 83891* *NEW!*

Precision timing and control for your vintge 392 Hemi®.

Pro-Billet™ Small Diameter Chrysler

Since many Chrysler enthusiasts use the B1 head or aftermarket valve covers, these Pro-Billet Chrysler distributors have been designed with a small diameter housing. This allows the distributors to fit tight block and head combinations.

**Chrysler Pro-Billet:
383, 400 - PN 8545*
440, 426 - PN 8546***

NOTE: Must be used with an MSD 6, 7 or 8-Series Ignition.

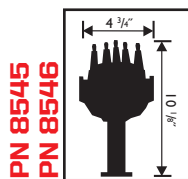

PN 8545
PN 8546

REPLACEMENT PARTS

Red Cap: PN 8431	Black Cap: PN 84313	Rotor: PN 8467
---------------------	------------------------	-------------------

For more distributor accessories see pages 116-124.



PN 8545

TECH TIP

MAGNETIC PICKUP POLARITY

If you ever change the connectors on an MSD distributor, keep in mind that the colors DO NOT correspond.

MSD Wire	Distributor Wire
Violet+	Orange/Black +
Green -	Violet/Black -

Never connect Violet to Violet/Black - the timing will be way off at higher rpm!

Atomic EFI
Starters/
Alternators
Spark Plugs
Ignitions
Late Model
Coils
Distributors
Crank
Triggers
Timing/RPM
Controls
Spark Plug
Wires
Street Fire
Marine
Accessories
Specialty
Items
Promo



CHRYSLER® DISTRIBUTORS



Ready-To-Run™ Chrysler

MSD's Ready-to-Run Pro-Billet distributors for Chrysler engines are the perfect upgrade from breaker points or weak electronic ignitions.

These distributors feature a maintenance-free magnetic pickup that accurately triggers the built-in powerful ignition module. This module produces a high-output spark which improves combustion in the cylinder, resulting in quick starts, a smooth idle and great performance.

Just beneath the race rotor is a mechanical advance assembly so a timing curve can easily be tailored to match your application. The QPQ-coated shaft is guided by a sealed ball bearing assembly for stability and endurance while a vacuum advance canister helps increase economy on those long cruises.

The Ready-to-Run distributors are also a breeze to install. Simply drop it in the engine and connect three wires and you're ready-to-run to your favorite cruise! The front engine mount models are designed in a special small diameter housing to clear aftermarket heads and valve covers.



PN 8388

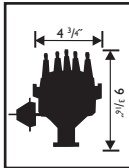

Ready-to-Run Chrysler Distributors:

273, 318, 340, 360 - PN 8388

383, 400 - PN 8386

426, 440 - PN 8387

PN 8388 REPLACEMENT PARTS

Red Cap:	Black Cap:	Rotor:	Harness:
PN 8433	PN 84333	PN 8467	PN 88621

For more distributor accessories see pages 116-124. This product is legal to sell, distribute or install on non-OBD II vehicles in California according to Executive Order E.O. D-40-39; legal in all 50 states.

REPLACEMENT PARTS

Red Cap:	Black Cap:	Rotor:	Harness:
PN 8431	PN 84313	PN 8467	PN 88621

For more distributor accessories see pages 116-124. These products are legal to sell, distribute or install on non-OBD II vehicles in California according to Executive Order E.O. D-40-39; legal in all 50 states.

PN 8386
PN 8387

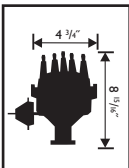

PN 8386

TECH TIP

MSD Ready-to-Run Distributors have a separate Gray wire that provides a clean tach signal. This wire also allows you to program an engine saving rev limit. To program the rev limit, run the engine to half the desired rpm limit and tap the Gray wire to ground. This will set the rev limiter and will be confirmed by the tachometer every time you turn the key on.

Atomic EFI
Starters/Alternators
Spark Plugs
Ignitions
Late Model
Coils
Distributors
Crank Triggers
Timing/RPM Controls
Spark Plug Wires
Street Fire
Marine
Accessories
Specialty Items
Promo



CHRYSLER® DISTRIBUTORS

Digital E-Curve® Chrysler

The Digital E-Curve Distributor will drop right in your engine, easily connect to the coil and fire up! There are no external controls or boxes to mount and connect, and you can set a timing curve with the twist of a rotary dial!

That's right, no more springs or stop bushings to change. A new digital module lets you select from nearly 100 different advance curves, including a vacuum advance! Simply remove the cap and rotor to access the rotary dials and select a curve to match your application. You can also set an rpm limit that will protect your engine from over-rev damage caused by a missed shift or driveline failure. This limit is adjustable from 5,000-10,000 rpm.

These adjustments are possible due to an advanced digitally-controlled ignition module. Not only does the module offer these adjustable options, it also produces a hardy jolt of energy to the coil to produce a powerful spark to fire up your engine's performance. Also, a magnetic pickup is used for reliable and accurate trigger signals throughout the entire rpm range of your engine.

The E-Curve Distributor is topped with MSD's Rynite molded cap and rotor and is supplied with a heavy-duty gear and a matching 3-Pin Weathertight wiring harness.

E-Curve, 318, 340, 360 - PN 8504

CARB Approval Pending

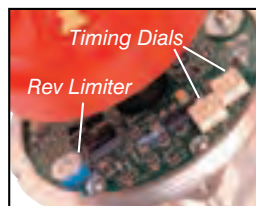

Timing curve and the rev limit adjustments are made with the rotary dials beneath the rotor. See page 99 for timing curve samples.



PN 8504

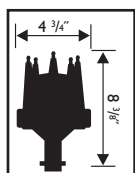

PN 8504 REPLACEMENT PARTS

Red Cap:	Black Cap:	Rotor:	Harness:
PN 8433	PN 84333	PN 8467	PN 88621

For more distributor accessories see pages 116-124.



Pro-Billet™ Early Hemi®

Street rods look great with matching era power plants and the early Hemi engines are a great fit! More rodders are turning to these engines and MSD is excited to offer these Ready-to-Run Distributors to bring their ignitions up to date!

Ready-to-Run Early Hemi:

331, 354 - PN 8391

392 - PN 8389

PN 8391
PN 8389

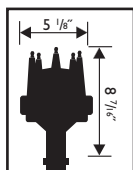

REPLACEMENT PARTS

Red Cap:	Black Cap:	Rotor:	Harness:
PN 8433	PN 84333	PN 8467	PN 88621

For more distributor accessories see pages 116-124. These products are legal to sell, distribute or install on non-OBD II vehicles in California according to Executive Order E.O. D-40-39; legal in all 50 states.

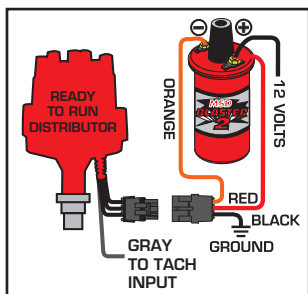

The Ready-to-Run distributor earns its name with simple wiring. One wire to 12 volts, one to coil negative and another to ground. That's it! A matching harness with a 3-pin Weathertight connector is supplied.



PN 8391



Atomic EFI
Starters/ Alternators/
Spark Plugs
Ignitions
Late Model
Coils
Distributors
Crank Triggers
Timing/RPM Controls
Spark Plug Wires
Street Fire
Marine
Accessories
Specialty Items
Promo



AMC® DISTRIBUTORS



Atomic EFI
Starters/Alternators
Spark Plugs
Ignitions
Late Model
Coils
Distributors
Crank Triggers
Timing/RPM Controls
Spark Plug Wires
Street Fire
Marine
Accessories
Specialty Items
Promo



PN 8523

Ready-To-Run™ Pro-Billet™ V8

Finally an answer for your AMC's worn out breaker points distributor! This Ready-to-Run Pro-Billet Distributor has a built-in inductive module that produces up to 7.5 amps to create a high voltage spark at the plug. This spark improves combustion of the fuel mixture resulting in quick starts, a smooth idle and great performance

Since this distributor has its own ignition module there is no need to run an MSD Ignition Control. Installation of the distributor is simple with only three wires to connect with the supplied Weathertight harness.

Under the MSD cap there is a mechanical advance assembly that can easily be tuned to your engine's specifications. Different advance springs and stop bushings are supplied, giving you 24 curves to choose from. The Ready-to-Run AMC Distributor also has a vacuum advance canister and is supplied with everything you need for installation!

290, 304, 343, 360, 390, 401 - PN 8523

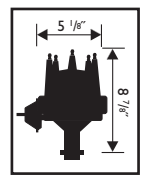

PN 8523 REPLACEMENT PARTS

Red Cap:	Black Cap:	Rotor:	Gear:	Bronze Gear:	Harness:
PN 8433	PN 84333	PN 8467	PN 8005	PN 8006	PN 88621

For more distributor accessories see pages 116-124.
This product is legal to sell, distribute or install on vehicles in California according to Executive Order E.O. D-40-39; legal in all 50 states.



PN 8516

Pro-Billet™ AMC

There is a big following of AMC enthusiasts that are cruising a 401 equipped Javelin or trail blazing in a rock crawling Jeep with an inline 6-cylinder! MSD offers two Pro-Billet Distributors to deliver accurate trigger signals and are maintenance-free!

Under the brass terminal cap of each distributor is MSD's race proven magnetic pickup. This pickup never requires adjustment and simply plugs right into an MSD Ignition Control. Just above it and under our strong race rotor is an adjustable mechanical advance assembly. The chromoly weights of this assembly slide on nylon bushings producing smooth movement of the timing. You can easily adjust the curve to match your engine's requirements with the supplied springs and stop bushings.

Each precision CNC-machined billet aluminum housing features a sealed ball-bearing and long sintered bushing for stability at any rpm and increased endurance. An oversized steel shaft receives a QPQ coating to reduce friction and prevent corrosion.

Both distributors are supplied with a high quality cap, rotor and gear. There is even a vacuum advance canister for street cruising economy!

NOTE: Must be used with an MSD 6, 7 or 8-Series Ignition.

290, 304, 343, 360, 390, 401 - PN 8519
Jeep I-6, 232, 258 - PN 8516

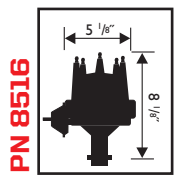

PN 8516

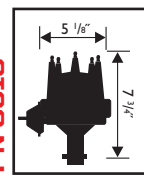

PN 8519

REPLACEMENT PARTS

Red Cap:	Black Cap:	Rotor:
PN 8433(V8)	PN 84333	PN 8467
PN 8014 (6-cyl.)		PN 8467

For more distributor accessories see pages 116-124.
These products are legal to sell, distribute or install on vehicles in California according to Executive Order E.O. D-40-39; legal in all 50 states.



BUICK[®] DISTRIBUTORS

Ready-To-Run™ Buick and Nailhead

If you're looking for a performance distributor for your Buick or Nailhead your search is over!

MSD's Ready-to-Run Distributor incorporates a magnetic pickup that never wears out! Plus, the distributor has a built in ignition module so there is no need to mount an external MSD Ignition Control. Not only do you get the benefits of electronic triggering, but your engine will awaken with the powerful sparks from the ignition module. This module delivers up to 7.5 amps to the coil creating a stout inductive spark. This improves combustion of the fuel mixture resulting in quick starts, a smooth idle and great performance!

Another advantage of an MSD Distributor is the accurate and adjustable mechanical advance assembly. The advance curve is easy to adjust with different advance springs and stop bushings which are included. To top it off there is a vacuum advance canister and MSD's strong cap and wire retainer.

The Ready-to-Run Distributor comes with a matching 3-pin harness making installation simple. All that it takes is routing two wires to the coil and one to ground!

400, 430, 455 - PN 8552

Ready-to-Run Nailhead, 322, 364, 401, 425 - PN 8524

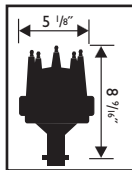

READY-TO-RUN REPLACEMENT PARTS

Red Cap: PN 8433	Black Cap: PN 84333	Rotor: PN 8467	Harness: PN 88621
---------------------	------------------------	-------------------	----------------------

For more distributor accessories see pages 116-124.
This product is legal to sell, distribute or install on vehicles in California according to Executive Order E.O. D-40-39; legal in all 50 states.



PN 8552

Pro-Billet™ Buick

This distributor uses a high-output magnetic trigger to fire an MSD Ignition Control. Accurate trigger signals and spark delivery are the responsibility of the QPQ-coated steel shaft. A sealed ball bearing and long sintered bushing hold this shaft stable at any rpm.

An adjustable mechanical advance mechanism is mounted on top of the shaft. Nylon pads ensure smooth movement of the fine balanced weights for accurate timing advancement. A variety of advance stop bushings and springs are supplied so you can dial-in a custom curve.

NOTE: Must be used with an MSD 6, 7 or 8-Series Ignition.

400, 430, 455 - PN 8517*

215, 300, 340, 350 - PN 8548*

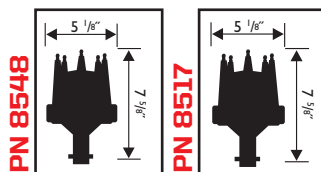

REPLACEMENT PARTS

Red Cap: PN 8433	Black Cap: PN 84333	Rotor: PN 8467
---------------------	------------------------	-------------------

For more distributor accessories see pages 116-124.



PN 8517

Atomic EFI
Starters/ Alternators
Spark Plugs
Ignitions
Late Model
Coils
Distributors
Crank Triggers
Timing/RPM Controls
Spark Plug Wires
Street Fire
Marine
Accessories Specialty Items
Promo



OLDSMOBILE® DISTRIBUTORS

Atomic EFI

Starters/
Alternators

Spark Plugs

Ignitions

Late Model

Coils

Distributors

Crank
Triggers

Timing/RPM
Controls

Spark Plug
Wires

Street Fire

Marine

Accessories
Specialty
Items

Promo



Pro-Billet™ Oldsmobile

Sharing the CNC-machining techniques with the rest of the MSD Distributor line, the Olds housing is machined from high quality 6061-T6 aluminum. Adding to this strength are two sealed ball bearings that guide the 0.500" shaft accurately through 10,000+ rpm.

TIG-welded on top of the polished steel shaft is MSD's adjustable mechanical advance assembly. To accurately trigger the ignition, a high-output magnetic pickup is bolted to the base. This trigger pickup produces a precise trigger signal. An MSD red cap with brass terminals and Race Rotor are supplied.

NOTE: Must be used with an MSD 6, 7 or 8-Series Ignition.

Oldsmobile V8, 260, 307, 330, 350, 400, 403, 425, 455 - PN 8566*

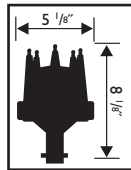

PN 8566 REPLACEMENT PARTS

Red Cap:	Black Cap:	Rotor:
PN 8433	PN 84333	PN 8467

For more distributor accessories see pages 116-124.

GM HEI

If you're looking to upgrade your Olds HEI Distributor, see pages 86 for MSD's Ultimate HEI kit and more!



Ready-To-Run™ Oldsmobile

Diehard Oldsmobile enthusiasts have been asking about a Ready-to-Run Distributor and here it is! Ready-to-Run means just that, drop it in the engine, connect three wires and fire up your Olds.

Inside the billet aluminum housing there is a high-output inductive ignition module that lights the spark. This module now has a built-in rev limiter to protect your Olds from overrev damage. A polished steel shaft spins in the center of this module and is guided by a sealed ball bearing for great stability.

Another great benefit of the MSD Ready-to-Run distributor is the mechanical advance. The weights and assembly are fine-blanked from chromoly for absolute precision resulting in smooth timing changes. You can set up a timing curve to match your engine's specifications easily with the supplied advance springs and bushings plus there is a vacuum advance for economy.

The Distributor is supplied with the MSD Cap, Race Rotor, wire retainer and gear.

Ready-to-Run, 260, 307, 330, 350, 400, 403, 425, 455 - PN 8529

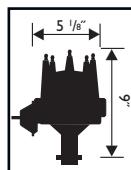

PN 8529 REPLACEMENT PARTS

Red Cap:	Black Cap:	Rotor:	Harness:
PN 8433	PN 84333	PN 8467	PN 88621

For more distributor accessories see pages 116-124.

This product is legal to sell, distribute or install on vehicles in California according to Executive Order E.O. D-40-39; legal in all 50 states.





PONTIAC® DISTRIBUTORS

Pro-Billet™ Pontiac

MSD's Pro-Billet Pontiac Distributor is ready for engines built for either street performance or hard core racing applications.

Special features include a fully adjustable mechanical advance assembly. For all-out racing, the advance mechanism can also easily be locked-out.

For stable timing, a high-output magnetic trigger pickup is used to supply the ignition with a trigger signal. Additional stability is achieved via the 0.500" hardened distributor shaft that is supported by sealed ball bearings.

NOTE: Must be used with an MSD 6, 7 or 8-Series Ignition.

Pontiac V8, 326, 350, 389, 400, 421, 428, 455 - PN 8563*

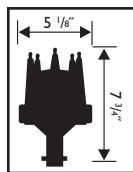

PN 8563 REPLACEMENT PARTS

Red Cap:	Black Cap:	Rotor:	Bronze Gear:
PN 8433	PN 84333	PN 8467	PN 85631

For more distributor accessories see pages 116-124.



Ready-to-Run™ Pontiac

Do yourself and your Poncho a favor and replace your points distributor with a Ready-to-Run model. You'll never have to adjust or replace the points again and your car will run better thanks to the hot MSD sparks.

Inside the CNC-machined billet housing there is an ignition module that produces a much hotter spark which will improve the performance of your engine. Also, since timing advance is important to Pontiac engines, the mechanical advance can easily be adjusted with the supplied advance springs and stop bushings. Plus, there's a vacuum advance canister to help economy at moderate cruise speeds.

For protection, there is an adjustable rev limiter built into the ignition module. Triggering the module is the responsibility of a magnetic pickup that will never wear or require adjusting. The Ready-to-Run distributor is easy to wire with only three wires! If you're determined to keep your engine looking stock, you could even remove the high quality MSD cap and clip a stock unit in place!

Ready-to-Run Pontiac, 326, 350, 389, 400, 421, 428, 455 - PN 8528

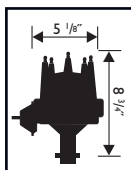

PN 8528 REPLACEMENT PARTS

Red Cap:	Black Cap:	Rotor:	Harness:
PN 8433	PN 84333	PN 8467	PN 88621

For more distributor accessories see pages 116-124.

This product is legal to sell, distribute or install on vehicles in California according to Executive Order E.O. D-40-39; legal in all 50 states.



Atomic EFI
 Starters/
 Alternators
 Spark Plugs
 Ignitions
 Late Model
 Coils
 Distributors
 Crank
 Triggers
 Timing/RPM
 Controls
 Spark Plug
 Wires
 Street Fire
 Marine
 Accessories
 Specialty
 Items
 Promo



CADILLAC® & VW® DISTRIBUTORS



Atomic EFI
Starters/Alternators
Spark Plugs
Ignitions
Late Model
Coils
Distributors
Crank Triggers
Timing/RPM Controls
Spark Plug Wires
Street Fire
Marine
Accessories
Specialty Items
Promo



Pro-Billet™ Cadillac

Cadillac cruisers will be excited about this new Pro-Billet distributor for the 368, 425, 472 and 500 cubic inch engines.

The Distributor begins life as a billet of 6061-T6 aluminum before being CNC-machined to precise dimensions. The sturdy, flex-free housing is fitted with a sealed ball-bearing and long sintered bushing for high-rpm accuracy.

MSD's race proven magnetic pickup supplies a trigger signal that is accurate to within one degree at any rpm. Mounted above this pickup is an adjustable mechanical advance and is supplied with different springs and stop bushings for a number of curves. For street cruising economy, as if there's any such thing in a Caddy, there is a vacuum advance canister.

NOTE: Must be used with an MSD 6, 7 or 8-Series Ignition.

Cadillac V8, 368, 425, 472, 500 - PN 8363

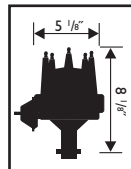

PN 8363 REPLACEMENT PARTS

Red Cap: PN 8433	Black Cap: PN 84333	Rotor: PN 8467
---------------------	------------------------	-------------------

For more distributor accessories see pages 116-124. This product is legal to sell, distribute or install on vehicles in California according to Executive Order E.O. D-40-39; legal in all 50 states.

Billet VW Type I

Using technology gained from building distributors for off-road and NASCAR racers, MSD offers this Billet Distributor for the popular Type I engine.

A maintenance-free magnetic pickup is responsible for triggering the MSD Ignition. This pickup is accurate to within 1° at any rpm so you won't have to worry about points float or "burbles" at top end speeds. The pickup is triggered by a precision reluctor that is attached to a hardened steel shaft. For increased stability, a sealed ball bearing is used to guide the shaft. Since every engine application is different, the MSD Billet distributor features an easy-to-adjust mechanical advance assembly. By simply changing the advance springs and stop bushing you can tune in 24 different advance curves.

NOTE: Must be used with an MSD 6 or 7-Series Ignition.

NOTE: Different style spark plug terminals and boots are required or use MSD's custom sets, PN 31939.

VW Type I, Air Cooled - PN 8485*

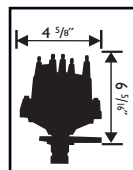

PN 8485 REPLACEMENT PARTS

Gray Cap: PN 8434	Rotor: PN 8470
----------------------	-------------------

For more distributor accessories see pages 116-124.





DUAL PICKUP DISTRIBUTORS

Dual Pickup Pro-Billet™ Chevy

The Chevrolet housing has several racing features that racers will appreciate. At the base of the CNC-machined housing there are two O-ring grooves. These seals prevent oil in the lifter gallery from leaking through the oil passage. If the engine deck, heads or intake have been modified, there is an adjustable slip collar which allows you to set the correct installation depth.

A fine-blanked advance cam is TIG-welded on top of the 0.500" QPQ-coated shaft. Added to the advance plate are chromoly weight pins which are staked and TIG-welded in place. The advance weights are specially coated to reduce friction and nylon pads are mounted on the advance plate to allow the weights to react quickly to rpm changes. This style advance assembly is fully adjustable or can easily be locked out.

NOTE: Must be used with an MSD 6, 7 or 8-Series Ignition.

Dual Pickup Pro-Billet Distributor, Chevy V8 - PN 8356*

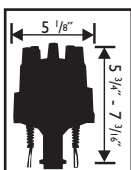

PN 8356 REPLACEMENT PARTS

Red Cap:	Black Cap:	Rotor:	Gear:	Bronze Gear:
PN 8433	PN 84333	PN 8467	PN 8531	PN 8471

For more distributor accessories see pages 116-124.

PN 8356



Dual Pickup Pro-Billet™ Fords

For demanding Ford racing applications, MSD's Pro-Billet Dual Pickup Distributors are the answer. Each distributor features a billet housing that is machined from 6061-T6 aluminum using computer controlled CNC-machining technology.

Additional features include a fully adjustable mechanical advance consisting of a hardened advance cam, chromoly weights and weight pins that are TIG-welded to the advance plate. The advance assembly can also be locked-out with no welding.

Two high output magnetic trigger pickups are bolted to the billet base of the distributor so you can have a secondary ignition trigger source for a backup ignition and coil.

NOTE: Must be used with an MSD 6, 7 or 8-Series Ignition.

Ford Dual Pickup Distributors:

V8, 289, 302 - PN 8382*

V8, 351W - PN 8384*

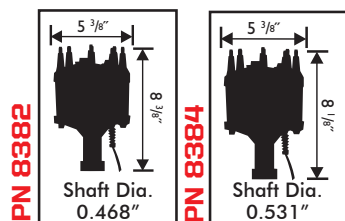

PN 8382

PN 8384

REPLACEMENT PARTS

Red Cap:	Black Cap:	Rotor:	Gear:	Bronze Gear:
PN 8408	PN 84083	PN 8423	PN 85812 (351C-460)	PN 8581
			PN 85832 (289-302)	PN 8583
			PN 85852 (351W)	PK 8585

For more distributor accessories see pages 116-124.

PN 8382



- Atomic EFI
- Starters/ Alternators
- Spark Plugs
- Ignitions
- Late Model
- Coils
- Distributors
- Crank Triggers
- Timing/RPM Controls
- Spark Plug Wires
- Street Fire
- Marine
- Accessories
- Specialty Items
- Promo



HVC RACING DISTRIBUTORS

MSD HVC™ Professional Racing Distributors

Through our close relationships with top racing teams, our engineers were able to develop a distributor that will accurately trigger a racing ignition through miles of 9,000 +rpm. Inside, there are two magnetic pickups that can be switched for redundant systems. These pickups are stacked so any individual cylinder timing will not be affected between pickups. Also, the secondary pickup is adjustable +/-8° so teams can easily tune to their needs.

The timing is locked out on these distributors and for stability there is a 1.58" diameter precision ball bearing which also holds the endplay at zero. Engine pressures are sealed off through a double seal assembly and the large Dupont Rynite injection molded distributor cap is securely bolted to the billet base.

The HVC Distributors are supplied with a cap and rotor. Also, a gear is not installed and must be purchased separately.

Pro-Billet HVC Distributors: Chevrolet SB2 - PN 83941*

Toyota - PN 83944*

NOTE: The HVC Distributors are not supplied with a gear. See page 123 for gears.

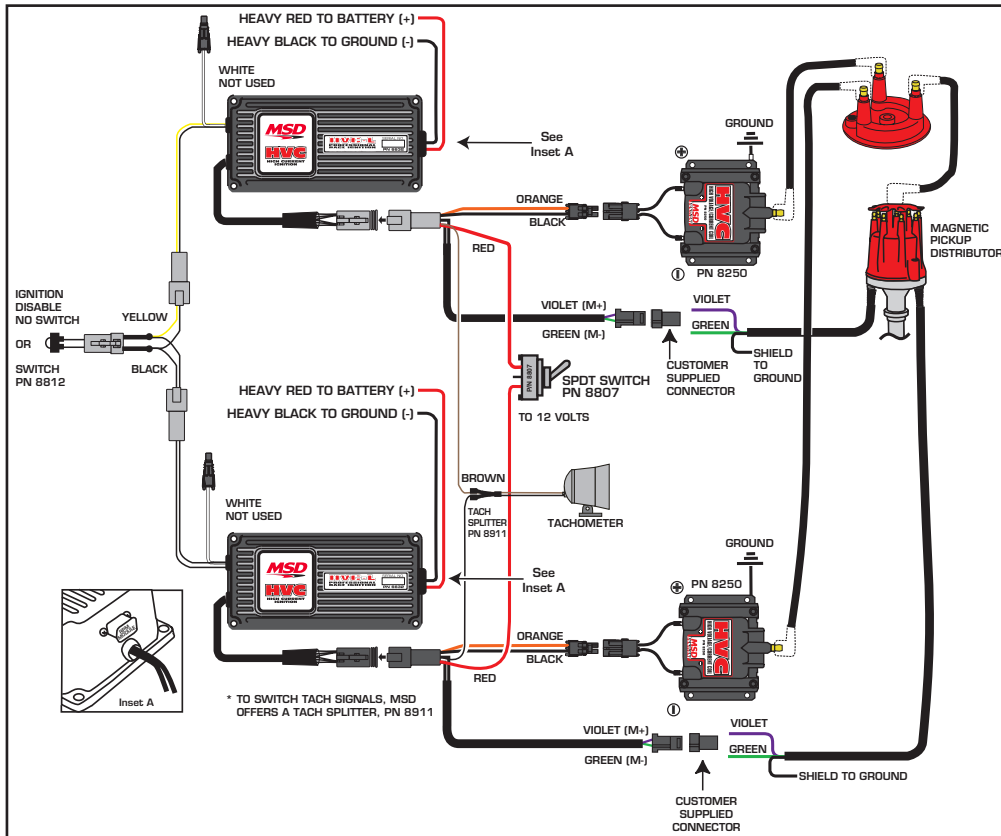

This diagram shows a professional racing system with dual HVC-L ignitions, coils and distributor.

HVC Accessories

The HVC Distributors incorporate a magnetic pickup for the most accurate signal possible. Two pickups are stacked atop each other so if a driver switches to the secondary ignition any custom firing or timing will be unaffected.

The secondary pickup is also adjustable +/-8° for increased tuning.

HVC Distributor Support Pieces :

Rotor - PN 8484

Replacement Base, includes both pickups - PN 83565

*Not legal for use or sale on pollution controlled vehicles.

Atomic EFI
Starters/ Alternators
Spark Plugs
Ignitions
Late Model
Coils
Distributors
Crank Triggers
Timing/RPM Controls
Spark Plug Wires
Street Fire
Marine
Accessories
Specialty Items
Promo



CRANK TRIGGER DISTRIBUTORS

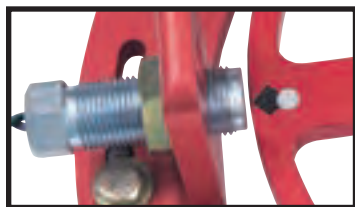

Crank Trigger distributors have no magnetic pickup or advance assemblies. And must be used with a Crank Trigger Kit, see page 133.

The MSD Billet Crank Trigger distributors are designed for racing engines that use a crankshaft-triggered ignition. Since most race engines use custom tunnel rams or blowers that limit the space for a distributor, these Crank Trigger distributors are designed to fit in tight quarters and still accurately deliver the sparks.



PN 84697



SLIP COLLAR
PN 8558 ONLY.

Chevy V8 Low-Profile

The unique design of these distributors fit tight intake systems while still transferring the high voltage of the MSD racing ignition to the spark plugs.

The high voltage carrying capabilities are the result of several features which have been designed into these low-profile distributors. This includes a large diameter cap with wide spaced terminals and an injection molded Rynite rotor with thick vanes to stir up the air inside the cap. The high dielectric Rynite base also prevents arcing to the billet housing.

NOTE: Must be used with an MSD 6, 7 or 8-Series Ignition and Crank Trigger (page 125).

Billet Crank Trigger Distributors:

Standard Chevy V8 - PN 84697*

Tall Block Chevy V8 with slip collar - PN 8558*

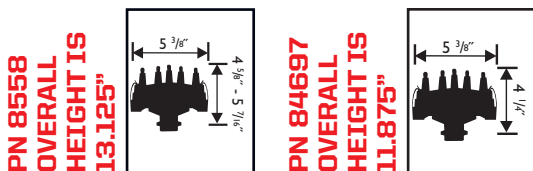

REPLACEMENT PARTS

Red Cap:	Black Cap:	Rotor:	Bronze Gear:
PN 8408	PN 84083	PN 8457	PN 8471

For more distributor accessories see pages 116-124.

EFI Sync Distributor

If your EFI system has limited space in the back of the engine due to the intake combination or firewall, this low-profile distributor is for you!

The sync pickup of this distributor is fixed at 45° BTDC on the number one cylinder. This magnetic pickup signal will reliably alert your ECU as to when the number one cylinder is preparing to fire.

The distributor uses a wide, Ford-style cap to improve voltage distribution and to reduce the chances of ionization and spark scatter. A 0.500" polished steel shaft is responsible for spinning the rotor and is guided by a sealed ball bearing guide and bushing. The distributor is ready to drop in your race engine from the bronze gear to the brass terminals of the cap.

Sync Signal Billet Distributor, Chevy V8 - PN 2340*

NOTE: Must be used with an MSD 6, 7 or 8-Series Ignition and Crank Trigger (page 125).

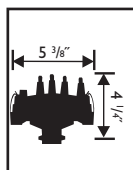

PN 2340 REPLACEMENT PARTS

Red Cap:	Black Cap:	Rotor:	Bronze Gear:	Iron Gear:	Pickup:
PN 8408	PN 84083	PN 8457	PN 8471	PN 8531	PN 2346

For more distributor accessories see pages 116-124.



PN 2340



Atomic EFI
Starters/
Alternators
Spark Plugs
Ignitions
Late Model
Coils

Distributors

Crank
Triggers

Timing/RPM
Controls

Spark Plug
Wires

Street Fire

Marine

Accessories
Specialty
Items

Promo



CRANK TRIGGER DISTRIBUTORS

Atomic EFI
Starters/Alternators
Spark Plugs
Ignitions
Late Model
Coils
Distributors
Crank Triggers
Timing/RPM Controls
Spark Plug Wires
Street Fire
Marine
Accessories
Specialty Items
Promo



PN 8489

Chevy Crab Cap Distributors

The MSD Crab Cap distributors are built specifically for racing engines with almost no room for a distributor due to tunnel rams or blowers. The distributor is equipped with a special low-profile crab style distributor cap to allow it to fit in extremely tight areas.

The housing features two optional O-rings at the bottom that improve oil control by preventing oil pressure loss. Also, a small oil bleed hole located in the base sprays oil on the distributor and camshaft gears to prevent excessive wear. Since this is a racing distributor, there is an adjustable slip collar to make up for engines that have had the distance between the mounting surface and the gear modified.

Crowning this distributor is MSD's own Crab Cap! This cap incorporates spark plug style terminals for a better connection and grip to the plug wires.

Billet Crab Cap Distributor, Chevy V8 - PN 8489*

The super tall crab cap model has all of the same features, plus is taller to fit special racing blocks such as the Allen Root or Rocket blocks.

Billet Super Tall Block Crab Cap Distributor, Chevy V8 - PN 8486*

NOTE: Must be used with an MSD 6, 7 or 8-Series Ignition and Crank Trigger (page 125).

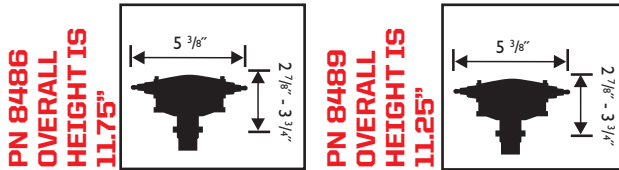

REPLACEMENT PARTS

Red Cap:	Rotor:	Bronze Gear:
PN 8541	PN 8567	PN 8471

For more distributor accessories see pages 116-124.

Ford Crank Trigger

Blue oval racers will be happy to see these Crank Trigger distributors. The housing of these three distributors are standard-height Ford distributors so they will work with cast intake manifolds.

These distributors have a low-profile cap assembly to clear busy intake set-ups and are topped with MSD's new Rynite-molded Ford-style cap and wire retainer. The low design is accomplished because the only thing under the cap is a rotor! These distributors don't have an advance assembly or pickup so they must be used with a crank trigger. Each distributor is supplied with a bronze gear.

Ford Crank Trigger Distributor, 351W - PN 8378*

NOTE: Must be used with an MSD 6, 7 or 8-Series Ignition and Crank Trigger (page 125).



PN 8378

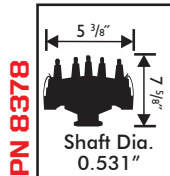

REPLACEMENT PARTS

Red Cap:	Black Cap:	Rotor:	Bronze Gear:
PN 8408	PN 84083	PN 8457	PN 8581 (351C-460) PN 8583 (289-302) PN 8585 (351W)

For more distributor accessories see pages 116-124.

Ford Sheet Metal Intake, 351C-460 - PN 8569*

NOTE: Will not fit XD and later Australian 351 Cleveland engines.

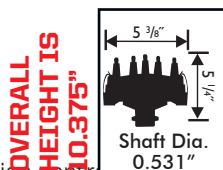

PN 8569 REPLACEMENT PARTS

Red Cap:	Black Cap:	Rotor:	Bronze Gear:
PN 8408	PN 84083	PN 8457	PN 8581

For more distributor accessories see pages 116-124.

*Not legal for use or sale on pollution controlled vehicles.

*Not legal for use or sale on pollution controlled vehicles.



FRONT DRIVE DISTRIBUTORS & OIL PUMP DRIVE

MSD's Pro-Billet Front Drive distributor is the solution for race engines that don't have room for a standard distributor due to firewall clearance or intake combinations.

The MSD Front Drive distributor is belt-driven from a pulley installed on the camshaft. For increased strength and durability a 9mm belt is used which is wider than any other drive assembly. The distributor head is CNC-machined from a billet of aluminum and is secured to a strong precision bracket. This system is an extremely accurate way to distribute the spark energy from your MSD Ignition!

We revised the front drive with our standard Ford-style cap and rotor. This creates a downsized package for an easier fit in tight engine compartments. The Front Drive distributor is supplied with mounting bolts, cam pulley and drive belt.

NOTE: Must be used with a Jesel or Comp Cams Camshaft Belt Drive Kit and an MSD Flying Magnet Crank Trigger, see page 125.

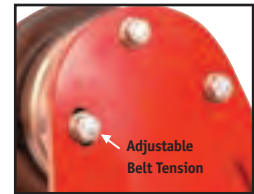

The MSD Front Drive Distributors are the only models available with an adjustment for belt tension.

PN 8510



REPLACEMENT PARTS

Red Cap:	Black Cap:	Rotor:	Belts:
PN 8408	PN 84083	PN 8457	Standard: PN 8722
			-.119 Center Distance: PN 8724

For more distributor accessories see pages 116-124.

Pro-Billet Front Drive Distributors:

Chevy Small Block - PN 8510*

Chevy Big Block - PN 8520*

(Will not fit raised cam big blocks such as Merlin, Donovan or Dart blocks or Gen V or Gen VI.)

LS Series Engines - PN 8712*

NOTE: Trigger your MSD with the LSX Trigger Converter shown on page 132.

- Band clamp mount allows easy rotor phasing adjustment
- The only front drive distributor with adjustable belt tension
- The MSD Cap and Rotor are injection molded from strong DuPont Rynite™ material
- Billet aluminum bracket and lower housing for strength
- Supplied with cam gear, hardware and extra wide 9mm belt



Pro-Billet™ Oil Pump Drive

Our Chevrolet Front Drive distributors brought the need for a distributor plug. This billet plug is designed for wet sump systems and features a slip collar to ensure correct installation depth.

Wet Sump Oil Drive - PN 8513*



PN 8513

Atomic EFI
 Starters/ Alternators/
 Spark Plugs
 Ignitions
 Late Model
 Coils
 Distributors
 Crank Triggers
 Timing/RPM Controls
 Spark Plug Wires
 Street Fire
 Marine
 Accessories Specialty Items
 Promo



MSD DISTRIBUTOR CAPS AND ROTORS



Atomic EFI
Starters/Alternators
Spark Plugs
Ignitions
Late Model
Coils
Distributors
Crank Triggers
Timing/RPM Controls
Spark Plug Wires
Street Fire
Marine
Accessories
Specialty Items
Promo

MSD Caps

MSD molds our most popular V8 distributor caps in-house. These caps are injection molded from DuPont® Rynite material and feature spark plug-style terminals. These terminals offer improved locking connections and the Rynite material is extremely strong with excellent dielectric properties. Plus, most caps have an optional wire retainer that is supplied with these caps to lock the wires in place.



MSD GM Points Style Cap

Red - **PN 8433**

Black - **PN 84333**

If you are upgrading from a points socket style cap you will need to change your boots and terminals. MSD offers a set of nine as PN 8849.



MSD Ford Style and Cap-A-Dapt

Red - **PN 8408**

Black - **PN 84083**

The Ford-style cap has a provision for the coil wire to be routed in separately!



MSD Small Diameter Distributor Cap

Red - **PN 8431**

Black - **PN 84313**

MSD Small Diameter Marine Cap - **PN 84316**



PN 8541

Crab Cap Distributor

PN 8541

(Crank Trigger distributor, use rotor PN 8567, Flat Top and Flathead distributors, use rotor PN 84673)



PN 8565

GM Marine V8, Bolt Down Style - **PN 8565**

(use rotor PN 8467)



PN 8014

GM/MSD 6-cylinder Cap - **PN 8014**

(use rotor PN 8467)

Rotors

Racing Rotor, for MSD and GM Distributors with 'Points' Caps - **PN 8467**

NOTE: Will not fit Flathead or Flat-Top distributors, use rotor PN 84673.



PN 8467



PN 8423

MSD Ford Distributors and Cap-A-Dapts **PN 8441, PN 8445 - PN 8423**

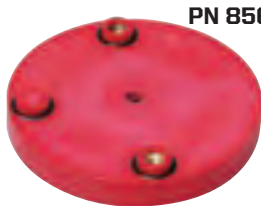

PN 8568

Rotor Base for Crab Cap Distributor - **PN 8568**



PN 84211

Adjustable Race Rotor **PN 84211**

(Allows you to adjust rotor phasing, see page 120).



PN 8457 (includes base)

Rotor and Base for Low-Profile Distributor **PN 8457**



Replacement Rotors

MSD Distributor Rotors are molded from high quality, voltage insulating material to resist carbon tracking while ensuring that the ignition spark reaches the spark plug terminals. For optimum voltage carrying capabilities the rotor tips are made from low resistance brass for maximum voltage transfer.

Rotors:

VW, PN 8485, and Ford 2.3L,
PN 8473, Distributors only - PN 8470
GM and MSD HEI, OE - PN 8410

GM & MSD Small Cap EFI
(PN 8366 and PN 8367) - PN 8427
Ford & MSD 5.0L Late Model - PN 8070
Ford Large Cap, Duraspark - PN 8407



PN 8470

(For Distributors PN 8485 and PN 8473 only.)



PN 8410



PN 8070



PN 8427



PN 8407

MSD Timing Tapes

Accurate ignition timing is one of the most vital adjustments you can make to your engine. Proper timing can mean the difference between winning and losing a race or even blowing an engine (as a worst case scenario). Recognizing the importance of the timing, MSD offers these Timing Tapes.

The MSD Timing Tape comes with eight different tapes to fit common balancers ranging from 5.25" to 8" in diameter. The tapes are marked off in one degree increments from 10° ATDC to 62° BTDC and are printed on a tough, chemical resistant material.

Not only do the MSD Timing Tapes help you get an exact timing setting, they allow you to see exactly where the Total timing is set. Remember, the Total timing is just as critical as the initial timing and the MSD Timing Tape will help you ensure that it is set accurately.

MSD Timing Tapes - PN 8985

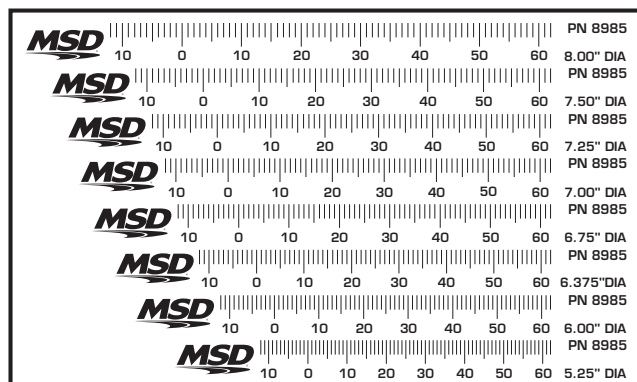

MSD Timing tapes will help you set your timing exactly where you want it!



Atomic EFI
 Starters/ Alternators
 Spark Plugs
 Ignitions
 Late Model
 Coils
 Distributors
 Crank Triggers
 Timing/RPM Controls
 Spark Plug Wires
 Street Fire
 Marine
 Accessories Specialty Items
 Promo



CAP & ROTOR KITS



Cap and Rotor Kits

The cap and rotor of any ignition system must be considered maintenance items. Just as you change the oil and filter of your car, you should always replace the cap and rotor as a set. To make things easy, we now offer these cap and rotor replacement kits.



PN 8406

GM V8 EFI, External Coil - PN 8406

GM V6 EFI, 4.3L - PN 8430

GM V8 HEI, Internal Coil, OE - PN 8416

MSD/GM Points Style Socket Cap - PN 8442

Ford V8 TFI - PN 8482

Ford V8 Duraspark - PN 8450

Ford V8 Duraspark with Spacer - PN 8414

MSD Extreme HEI, Internal Coil - PN 84023

MSD Cap (PN 8433) and Race Rotor - PN 84335

Small Diameter MSD Cap (PN 8431) and Race Rotor - PN 84315

Large Cap Ford (PN 8408) and MSD Rotor - PN 84085



PN 8430



PN 8416



PN 8442



PN 8482



PN 8450



PN 8414



PN 84023



PN 84335



PN 84315



PN 84085

Atomic EFI

Starters/
Alternators

Spark Plugs

Ignitions

Late Model

Coils

Distributors

Crank
Triggers

Timing/RPM
Controls

Spark Plug
Wires

Street Fire

Marine

Accessories
Specialty
Items

Promo



LTI & HEI CAPS

MSD GM LT1 Distributor Cap/Rotor

Finally a high quality Cap and Rotor for the front mount LT1 distributor! LT1 fans have been searching for a cap that could deliver the performance of the LT1 and MSD is happy to bring it to them.

Remember, changing the cap and rotor on this engine is no walk in the park. So when you do it, you want to make sure to install the best parts possible and the MSD Cap and Rotor deliver.

The all-new cap housing is injection molded from a special DuPont material that provides extreme strength and high dielectric properties resulting in less chance of breakdown causing a misfire. The terminal paths are encased in a durable epoxy compound for even more protection. The rotor is also an all-new molded piece with a brass/stainless rotor tip design.

Two models are available to cover all your LT1 needs!

LT1 Distributor Cap and Rotor Kit : '93-'94, with Fresh Air Vacuum Kit - PN 8481
'94-'97 - PN 84811



PN 8481

Be sure to see the Pro-Billet LT1 Distributor on page 90.

MSD Vortech Cap & Rotor Kit

The late '90's GM used a funky looking cap and rotor, commonly referred to as the Vortech distributor. These caps offer a corrected position of the terminals to ease the routing of the wires.

MSD offers a heavy duty version of this cap and rotor. The new pieces are molded from a more durable material for improved spark isolation. Brass terminals top it off.

MSD Vortech Cap and Rotor - PN 8017



PN 8017

See page 159 for a new distributor!

MSD Heavy Duty HEI Parts

MSD tooled up to produce the strongest HEI Cap available. The Cap and Rotor will fit our HEI Pro-Billet Distributor, PN 8365, plus will work on most stock applications.

V8 HEI Cap - PN 84111

Rotor - PN 84101

Coil Cover - PN 84022

Low Resistance Rotor Bushing - PN 8412



PN 84111



PN 84101



PN 84022



PN 8412

Atomic EFI
Starters/
Alternators
Spark Plugs
Ignitions
Late Model
Coils

Distributors

Crank
Triggers
Timing/RPM
Controls
Spark Plug
Wires

Street Fire
Marine

Accessories
Specialty
Items

Promo



CAP-A-DAPTS AND ADJUSTABLE ROTORS



Atomic EFI
Starters/Alternators
Spark Plugs
Ignitions
Late Model
Coils
Distributors
Crank Triggers
Timing/RPM Controls
Spark Plug Wires
Street Fire
Marine
Accessories
Specialty Items
Promo



PN 8445



PN 8441



PN 8420



PN 84211

MSD Cap-A-Dapts™

The MSD Cap-A-Dapt adapts a large, Ford style cap onto your MSD distributor. This large cap spaces the spark plug terminals farther apart which lessens the chances of cross-fire and ionization occurring. Spark plug style terminals are used on the cap for tight connections that will not vibrate loose.

The rotor is injection molded out of Rynite® for incredible strength and resistance to spark. Thick vanes are incorporated to stir up the air in the cap for even more ionization prevention. Three Cap-A-Dapts are available; two with a fixed rotor and another with an adjustable, two-piece rotor.

The two-piece rotor allows you to adjust the rotor tip to cap terminal alignment so you can adjust the rotor phasing. All of the MSD Distributors are phased at the factory, but if you are running a Multi-Step Retard or Timing Controller, having the ability to adjust the rotor phasing is beneficial.

The Cap-A-Dapts will install on most MSD Pro-Billet Distributors (except the Ford FE, PN 8594). Both kits are supplied with a high quality cap with brass terminals, rotor and cap spacer.

Cap-A-Dapt, Fixed Rotor - PN 8445

Cap-A-Dapt, Small Diameter Distributors - PN 8441

Cap-A-Dapt, with Adjustable Rotor - PN 8420

Cap-A-Dapt Spacers:

Large Caps & Fords - PN 8446

Ford TFI - PN 8120

REPLACEMENT PARTS

Red Cap:	Black Cap:	Fixed Dist. Rotor:	Adjustable Rotor:	Cap Spacer:
PN 8408	PN 84083	PN 8423	PN 8421	PN 8446
				(Except PN 8441)

ADJUSTABLE ROTOR

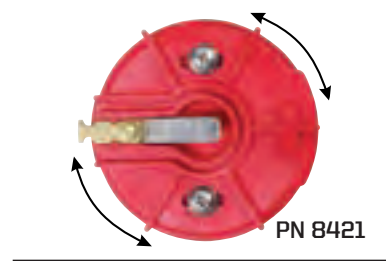

Adjustable Race Rotor

When you install EFI on your engine, most systems will require the ignition timing to be advanced for the ECU. This can cause issues with rotor phasing, but the new Adjustable Rotor remedies this issue! The Rotor is based on MSD's popular PN 8467 Race Rotor so it will install on most any MSD distributor with a PN 8433 or PN 8431 cap. The rotor offers up to 20° of advance or retard and is easy to set up with accurate one degree detent adjustments.

Adjustable Race Rotor - PN 84211

(for use in place of Race Rotor PN 8467)



Compare the diameter of the new Pro-Cap and rotor with that of a Ford style distributor cap. The entire Pro-Cap is molded from Dupont® Rynite™ and can handle over 40,000 volts!

The Pro-Cap has a big five inch diameter with two full inches between each terminal! This ensures accurate spark delivery and far less chance of spark scatter inside the cap. The entire assembly is injection molded from Dupont® Rynite™ material for incredible strength and high dielectric properties.

The Rotor features a deep skirt and thick vanes to stir up the air to prevent ionization and the rotor screws are even overmolded with Rynite for increased spark isolation. The extra thick rotor tip can easily handle high heat and is indexed and firmly secured with two screws. The Pro-Cap is crowned with a screw-down retainer to keep all of the plug wires firmly attached to each terminal.

REPLACEMENT PARTS

	Retainer:	Cap:	Rotor:	Rotor Terminal Kit:
RED	PN 7409	PN 7408	PN 7424	PN 7411
BLACK	PN 74093	PN 74083		

Pro-Cap for most MSD Pro-Billet distributors
PN 7445

Rotor Kit

The directional rotor tip is designed to handle large amounts of retard in high voltage applications.

Pro-Cap Rotor Rebuild Kit - PN 7411



Stock Style Cap and Rotor for GM HEI Distributors

Stock Style Cap, Spring Clips - PN 8411

Stock Style Cap, Bolt-Down - PN 84115

Replacement Rotor - PN 8410

Stock Coil Cover - PN 8402

Modified Coil Cover - PN 8401

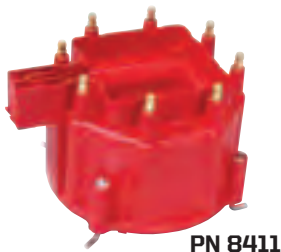

Distributor Caps

All MSD Extra Duty Distributor caps are designed with performance in mind and are molded from high quality, voltage insulating material and use low resistance terminals.



- Atomic EFI
- Starters/ Alternators
- Spark Plugs
- Ignitions
- Late Model
- Coils
- Distributors
- Crank Triggers
- Timing/RPM Controls
- Spark Plug Wires
- Street Fire
- Marine
- Accessories
- Specialty Items
- Promo



HONDA POWER CAPS



Atomic EFI
Starters/Alternators
Spark Plugs
Ignitions
Late Model
Coils
Distributors
Crank Triggers
Timing/RPM Controls
Spark Plug Wires
Street Fire
Marine
Accessories
Specialty Items
Promo



Extreme Honda Power Caps



Extreme Honda Rotor



Honda Power Caps & Rotor Kits

Extreme Honda Power Caps

One of the best upgrades you can make with a Honda engine is to bypass the weak internal coil. These new caps allow you to take advantage of an external coil and ensure all of the new high voltage reaches the plugs.

The caps are injection molded from DuPont Rynite material producing a strong cap with high dielectric properties. While we were at it, our engineers incorporated brass spark plug style terminals to the cap for a better connection to the plug wire terminal. Refer to chart below for applications.

Extreme Honda Rotor

All new Rynite injected rotors for MSD's Honda/Acura caps! These rotors feature an all new injection molded design with a brass terminal for improved transfer of the high voltage. Refer to chart below for applications.

Honda Power Cap & Rotor Kits

MSD's Honda and Acura Modified Distributor Kits are specially constructed to allow the use of a powerful external Blaster Series Coil.

Each cap is specially fitted with an MSD Power Tower to accept the high voltage of an MSD Blaster series coil. The spark plug socket features brass terminals for improved conductivity. A low resistance 8.5mm Super Conductor coil wire and crimp tool are supplied so you can custom fit the wire to your application. A new rotor is also supplied to finish off the new kit!

YEAR	MODEL	ENGINE	NOTES	CAP/ROTOR KIT	RED POWER CAP	EXTREME
ACURA						
'88-'91	Integra	1.6L/1.8L	w/Tec Dist.	PN 82903		
'92-'93	Integra (All)	1.7L/1.8L	w/Tec Dist.	PN 82923	PN 82921	PN 82922
'94-'01	Integra GS, LS, RS	1.8L	w/Tec Dist.	PN 82923	PN 82921	PN 82922
'94-'01	Integra GS-R/Type-R	1.8L	w/Tec Dist.	PN 82933		
HONDA						
'90-'91	Accord	2.2L	w/Tec Dist.	PN 82923	PN 82921	PN 82922
'98-'02	Accord DX (Only)	2.3L	w/Tec Dist.	PN 82923	PN 82921	PN 82922
'88-'91	Civic/CRX	1.5L/1.6L	w/Tec Dist.	PN 82903		
'93-'97	Civic Del Sol	1.5L/1.6L	w/Tec Dist.	PN 82923	PN 82921	PN 82922
'92-'00	Civic/Si (Exc. '96-'00 HX)	1.5L/1.6L	w/Tec Dist.	PN 82923	PN 82921	PN 82922
'97-'01	CRV	2.0L	w/Tec Dist.	PN 82923	PN 82921	PN 82922
'92-'01	Prelude	2.2L/2.3L	w/Tec Dist.	PN 82923	PN 82921	PN 82922



DISTRIBUTOR GEARS

A distributor's performance is only as good as its drive gear. MSD has put a great deal of effort into researching and testing a variety of metallurgical compositions, heat treating and coatings to provide you with a durable, accurate and strong distributor gear.

MSD engineers have built test fixtures and spent hundreds of hours testing and evaluating the metallurgy of our gears. The result is a special iron alloy gear that is treated to a low-friction coating process. To you this means long life, an easy break-in period and reliable performance!

MSD IRON GEARS FEATURE:

- Increased outer hardened layer thickness (RC 55-60)
- Micro polished surface for smooth contact
- Proprietary formula for ductile iron
- Melonite QPQ coating reduces friction and initial wear
- Interstitial carbide concentration improves wear resistance and running properties

These two gears were run at 7,200 rpm with an oil pressure of 85 psi. The MSD gear on the left ran for 12 hours and shows only a slight chaffing on the teeth. The other gear lasted only four minutes and is destroyed.



Iron Gears

Chevy, .500" ID - **PN 8531**

Chevy, Melonized, Marine Applications, .500" ID - **PN 8561**

Ford 351W, .531" ID - **PN 85852**

Ford 289, 302, .468" ID - **PN 85832**

Ford 351C, 351M, 400, 429, 460, FE, .531" ID - **PN 85812**

Distributor Gear, AMC - **PN 8005**

Cam Gear, AMC - **PN 8007**

Ford Gears

Some Ford engines were equipped with distributor gears made of different materials, due to the camshaft used. When the most common engine, the 302, was equipped with EFI in the mid '80s it also used a hydraulic roller camshaft, which required a steel gear. MSD offers several replacements.

Steel Gear, Ford 289/302, replacement for carbureted Ford distributors with 0.468" ID and MSD PN 8582, PN 8579, PN 8479, PN 8352, and PN 8503 - **PN 85833**

Steel Gear, Factory EFI 5.0L, replacement for PN 8455 and PN 8456 also for MSD 351W distributors with 0.531" ID - **PN 85834**

Steel Gear, 351C-460 w/Hydraulic Roller Cam - **PN 85813**

Bronze Gears

MSD Bronze Distributor gears are machined from quality AMPCO 45 aluminum bronze containing 5% nickel. This special combination creates high-strength gear teeth that are less prone to wear even with high-volume oil pumps.

Bronze Gears:

Chevy, .500" ID - **PN 8471**

Chevy, +0.006" ID - **PN 8472**

Pontiac V8, .500" ID - **PN 85631**

Ford 289, 302, .468" ID - **PN 8583**

Ford 351C, 351M, 400, 429, 460, FE, .530" ID - **PN 8581**

Ford 351W, .530" ID - **PN 8585**

AMC V8 - **PN 8006**



NOTE: Some Ford Gears do not have roll pin holes.



Atomic EFI
 Starters/
 Alternators/
 Spark Plugs
 Ignitions
 Late Model
 Coils
 Distributors
 Crank
 Triggers
 Timing/RPM
 Controls
 Spark Plug
 Wires
 Street Fire
 Marine
 Accessories
 Specialty
 Items
 Promo



DISTRIBUTOR ACCESSORIES

Promo
Accessories
Specialty
Items
Marine
Street Fire
Spark Plug
Wires
Timing/RPM
Controls
Crank
Triggers
Distributors
Coils
Late Model
Ignitions
Spark Plugs
Alternators
Starters/
Atomic EFI

Vacuum Advance

This is the replacement canister for MSD distributors equipped with vacuum advance (except the PN 8365 and PN 8362 HEI Distributors).

Vacuum Advance Mechanism - PN 8463



Vacuum Advance Lockout

This bracket allows you to easily remove the vacuum advance from MSD distributors that are CW rotation (except PN 8365 and PN 8362).

Vacuum Advance Lockout - PN 8468



HEI Vacuum Advance Stop Plate

This little plate allows you to limit the amount of vacuum advance on your Pro-Billet HEI, PN 8365, and Street Fire HEI, PN 8362.



HEI Vacuum Advance Stop Plate - PN 84281

Magnetic Pickup

The MSD Magnetic Pickup replacement is the same high output assembly that is currently found in all MSD Distributors. It is supplied with the two pin connector installed.



NOTE: Not for use as a replacement on OEM Distributors.

Magnetic Pickup Assembly, All MSD Billet and Pro-Billet Distributors - PN 84661

Low Resistance HEI Bushing

The carbon rotor button in a stock HEI distributor cap has very high resistance. When the high voltage of an MSD 7-Series Ignition is added, this resistance builds up heat and can actually melt the distributor cap. The solution to this problem is the use of the MSD Low Resistance HEI Bushing which will pass the secondary voltage from the distributor cap to the rotor without excessive heat buildup.

Low Resistance HEI Bushing - PN 8412



Ford TFI Replacement Module

A direct replacement for MSD Ford TFI Distributors, PN 8456, PN 8453 and PN 8452. Also fits OE TFI distributors.

Ford TFI Module, for PN 8456, PN 8453 and PN 8452 - PN 83648



Advance Kits

The MSD Distributor Advance Kits are the same kits that come with your MSD Distributor. The kit contains an assortment of springs and advance limit bushings.



Advance Kit, All MSD Distributors - PN 8464 Weight Kit - PN 8628

Distributor Clamps

MSD's Billet Distributor Hold Down Clamps are strong enough to keep the timing locked in place whether you are using an MSD Billet Distributor or Pro Mag. The MSD Hold Down Clamp is CNC-machined from steel and fits all MSD Pro-Billet Chevrolet distributors and the Pro Mags. Each clamp includes the mounting stud, lock washer and nut.



MSD Billet Hold Down Clamps: Chevrolet - PN 8110 Ford - PN 8010

Tach Drive Adapter

The standard tach drive for MSD Tach Drive Distributors is a 3/16" tang drive cable. In most cases this type of drive will work, but for those who require the 0.104" square drive (Corvette style), MSD offers a Tang to Square Drive Adapter to fit all MSD Tach Drive Distributor assemblies.



Tach Drive Adapter, Tang to Square Drive - PN 8491

NOTE: This is included with each MSD Tach Drive Distributor.

DISTRIBUTOR SERVICE ITEMS

The following service items for MSD distributors are available direct from the factory by special order. Contact the Customer Support Department at (915) 855-7123 for pricing and availability on these items.

- Advance Weight Kit, MSD Pro-Billet Distributors, PN 8628
- O-Ring Kit, Billet Chevy Distributors, PN 8494
- Adjustable Collar, All Slip Collar Distributors, PN 8539
- Screw kit for bolt down caps
- Distributor reluctors
- Spiral roll pins used on distributor gears
- Weight plate assemblies
- Standard rotation tach drive gears
- Keyed Reluctor +/- 10°, PN 8627



FLYING MAGNET CRANK TRIGGERS



Strong rare earth magnets used in the trigger wheel are riveted in place.

FLYING MAGNET DESIGN PREVENTS FALSE TRIGGERS

The Flying Magnet Crank Trigger is named for the four magnets that are embedded in the aluminum wheel. As the engine is rotating, these magnets move past the stationary non-magnetic pickup, creating the trigger signal for the ignition. This design eliminates false triggering because only the moving magnets can trigger the pickup and ignition control.



For a long time, racers have known that one of the best things to do to an engine to improve its performance is to stabilize the ignition timing. The MSD Flying Magnet Crank Trigger system does exactly that by using four magnets embedded in an aluminum wheel. Although similar in appearance to other crank triggers, the MSD Flying Magnet design works on a different principle.

Most crank triggers have a wheel, with steel studs sticking out, bolted to the harmonic balancer. As the crankshaft turns, the studs pass by a stationary magnetic pickup, triggering the ignition. This pickup can be triggered by other bolts, debris or even vibrations which will cause a loss of power or engine damage. The MSD Flying Magnet Crank Trigger uses four magnets secured in the aluminum trigger wheel that pass by a stationary non-magnetic pickup to trigger the ignition. This "flying magnet" design produces accurate trigger signals and the non-magnetic pickup cannot be false triggered.

Each Flying Magnet Crank Trigger includes a two-piece mounting bracket for the non-magnetic pickup that in most cases will work on either the passenger side or driver's side of the engine (the SB Chrysler and SB Ford brackets mount on only one side). The CNC-machined aluminum bracket securely holds the pickup in place and is slotted to provide a wide range of timing adjustment. Spacers are included so you can mount the bracket on engines with standard motor mounts or engines with a .25" motor plate. These systems will trigger MSD 6, 7 and 8-Series Ignitions and all MSD Timing Accessories.

Flying Magnet™ Crank Trigger Kits

Chevy

Small Block

6.25" Balancer - PN 8600*

7" Balancer - PN 8610*

Wheel only - PN 8611*

8" Balancer - PN 8615*

Big Block

8" Balancer - PN 8620*

Wheel only - PN 8621*

Chrysler

SB, 7.25" Balancer - PN 8633*

BB, 7.25" Balancer - PN 8636*

The MSD Flying Magnet Crank Trigger kits are supplied complete with CNC-machined brackets, spacers and hardware.

Ford

SB, 289, 302, 351W, 6.562" Balancer - PN 8640*

BB, (except Cleveland block), 7.25" Balancer - PN 8644*

Pontiac V8

7" Balancer - PN 8650*

TECH TIP

A few things to consider with your Flying Magnet Crank Trigger Kit:

- The arrow on the wheel MUST face out!
- Air gap between the wheel and the pickup should be 0.030" - 0.060"
- The resistance across the pickup wires should be

Atomic EFI
 Starters/
 Alternators
 Spark Plugs
 Ignitions
 Late Model
 Coils
 Distributors
 Crank
 Triggers
 Timing/RPM
 Controls
 Spark Plug
 Wires
 Street Fire
 Marine
 Accessories
 Specialty
 Items
 Promo



CRANK TRIGGERS & PICKUPS

Accessories
Specialty
Items
Promo
Marine
Street Fire
Spark Plug
Wires
Timing/RPM
Controls
Crank
Triggers
Distributors
Coils
Late Model
Ignitions
Spark Plugs
Starters/
Alternators
Atomic EFI

Non-Magnetic Pickup

MSD's Non-Magnetic Pickups are engineered for extreme applications. In fact, this Pickup was designed and tested on 300+ mph top fuel dragsters! To live up to MSD's demanding expectations in these extreme applications, we took it upon ourselves to design and build the Pickups in-house. This way we can control every aspect of their assembly and quality.

Each Pickup is hand wound on a special bobbin and terminated to our tinned conductor, teflon jacketed wiring. These wires are also routed through a strain relief for protection. This assembly is then installed into the precision housing and is potted with a fracture resistant epoxy compound. To ensure that the windings are entirely encased in epoxy, the Pickups undergo a vacuum procedure to remove any air inside the housing.

All of these procedures are necessary to produce the strongest, most reliable non-magnetic Pickup available.



PN 8276

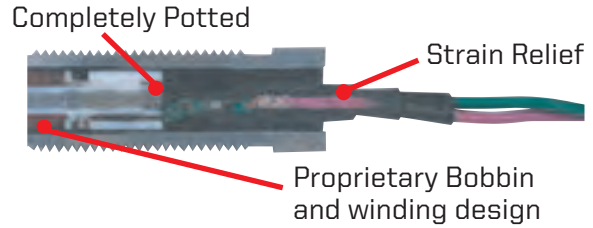

Non-Magnetic Pickup for MSD Flying Magnet Crank Trigger Kits

(3/4" X 16 X 2.25") - **PN 8276**



PN 8509

Magnetic Signal Stabilizer

The stabilizer converts the signal from a magnetic pickup to a square wave trigger signal for the MSD Ignition Control.

Magnetic Signal Stabilizer - PN 8509



PN 2346

Universal Cam-Sync Pickup

This Universal Cam-Sync pickup Kit is supplied with a non-magnetic pickup and a magnet that you install to any part that operates at camshaft speed. When the magnet passes the pickup, a signal is created to alert the ECU of the position and firing order of the engine. Matching connectors are supplied and the magnet measures .250" x .200". You will need to fabricate a bracket assembly and install the magnet.

Universal Cam-Sync Pickup Kit - PN 2346

TECH TIP

Crank Trigger Distributors do not have a magnetic pickup or mechanical advance. That's why they're so low profile! You'll need a Flying Magnet Crank Trigger Kit (see page 125) to trigger the ignition and if you need a timing curve or step retard a timing accessory will be required.

Magnetic Pickup

This is a replacement pickup for older style crank trigger systems that require a magnetic pickup. This pickup is magnetic and must be used with a trigger wheel equipped with steel studs to create a signal. The pickup is .75" x 16" x 2.25".

Magnetic Pickup (for old style crank triggers only) - **PN 8505**



ELECTRONIC TIMING CONTROLS

Starter Saver with Signal Stabilizer

When you install a crank trigger system, having locked out timing may put a strain on the starter and flywheel. This compact controller provides a retard that automatically retards the timing during cranking to ease the pressure.

The MSD Starter Saver measures only 1.5" X 3.5" X 2" and wires into your ignition system with only four wires. It can be programmed to retard the timing 10° or 20° during cranking only. The retard is activated when the engine begins cranking and is deactivated once the engine reaches over 800 rpm. (If the engine rpm drops below 500 rpm it will activate again.)

The Starter Saver receives the trigger signal through an MSD crank trigger pickup or the distributor's magnetic pickup. This Control has a very accurate pickup compensation circuit resulting in rock steady timing throughout the entire rpm range of your engine. There is also an LED that illuminates with each trigger signal to confirm operation and the circuitry is completely potted in a polyurethane compound for extreme vibration resistance.

Starter Saver with Signal Stabilizer - PN 8984*

NOTE: The Starter Saver can only be used on V8 applications using an MSD magnetic pickup distributor or crank trigger.

Start and Step Retard Control

If you run locked-out timing on your street/strip car and the engine cranks slowly due to advanced timing or high compression, the new MSD Start and Step Retard Control is what you need!

This digitally controlled accessory allows you to select a 5°, 10°, 15° or 20° of retard while the engine is cranking. By pulling the timing back during cranking the pressure being applied to the starter, flywheel and the rotating assembly of the engine is lessened so the engine will start easier. Once the engine starts or when the key is released the timing returns to the set mechanical amount.

The Start and Step also features a single stage of retard making it ideal for nitrous engines. This retard can easily be activated when the nitrous is turned on, or add a switch for a high speed retard. You can simply dial in 1°-15° with the rotary dial for quick adjustments.

The Start and Step will easily connect to magnetic pickups and has a points input as well, plus it can work on 4, 6 or 8-cylinder engines.

Start and Step Retard Control - PN 8987*



PN 8984



PN 8987



TECH TIP

MSD IGNITION COIL WIRING

The orange and black wires of an MSD Ignition are the only two wires that connect to the coil. Also, the coil + terminal will NOT show 12 volts with the key on. Since the MSD is a Capacitive Discharge ignition, the voltage is stored in a capacitor inside the ignition. When running, the coil + terminal receives just under 500 volts! Don't get zapped and don't zap your test light!

- Atomic EFI
- Starters/ Alternators
- Spark Plugs
- Ignitions
- Late Model
- Coils
- Distributors
- Crank Triggers
- Timing/RPM Controls
- Spark Plug Wires
- Street Fire
- Marine
- Accessories Specialty Items
- Promo



ELECTRONIC TIMING CONTROLS



Atomic EFI
Starters/Alternators
Spark Plugs
Ignitions
Late Model
Coils
Distributors
Crank Triggers
Timing/RPM Controls
Spark Plug Wires
Street Fire
Marine
Accessories
Specialty Items
Promo

- Four stages of retard
- Magnetic pickup compensation circuit
- Adjustable start retard



PN 8975

Digital Multi-Retard

The Digital Multi-Retard provides four different stages of retard along with an adjustable start retard feature - all of this with no modules!

There are four separate retard stages that can be activated independently or together for a total sum of retards. Each stage is adjustable from 0°-9° and a maximum of 20° of retard can be pulled out. On top of these great features, there is also an optional start retard circuit that can be programmed to retard the timing 5°, 10°, 15° or 20° during cranking. The Digital Multi-Retard can be used on 4, 6 or 8-cylinder engines and must be used with an MSD Ignition Control.

Digital Multi-Retard - PN 8975*



PN 8970

Three Stage Retard Control

The Three Stage Retard Control allows you to retard your ignition timing in three different stages. When activated together, the retard amounts are cumulative so you get the total of the three. For example, if you pull 2°, then 4° on the second stage and another 2° at top end, the total retard is 8° (2+4+2=8).

In addition to the individual retard stages, the Three Stage Retard Control has an optional start retard function that retards the timing 10° or 25° while cranking the engine.

The Three Stage Retard Control connects easily to your MSD Ignition Control and can be triggered from points, electronic ignitions, crank triggers or magnetic pickup distributors. It is supplied with 2°, 3° and 4° modules and must be used with an MSD 6, 7, 8 or 10-Series Ignition.

Three Stage Retard Control - PN 8970*

APPLICATION WITH MULTIPLE STAGE NITROUS

Drag racers using multiple stage nitrous systems on their engines can connect the Three Stage Retard Control directly to their nitrous system simply by tapping into the 12 volt solenoid wires. When installed this way, every time a nitrous stage is activated, a different retard module will be activated.

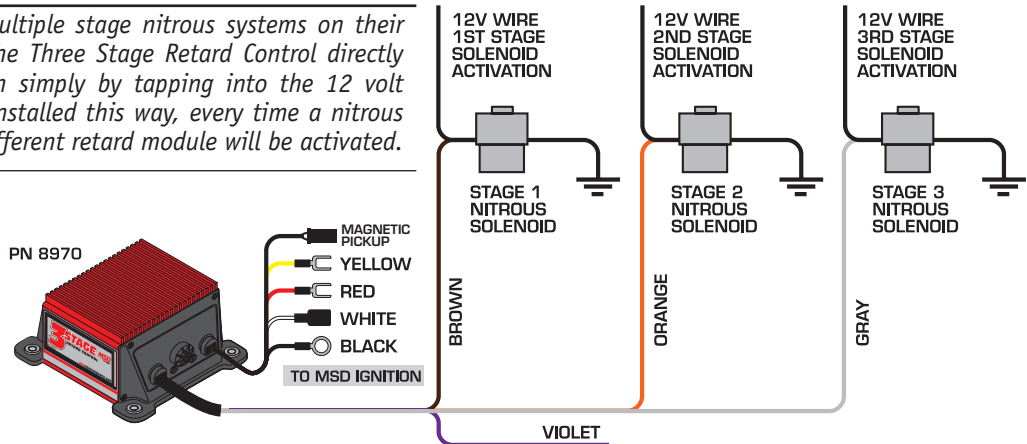



ELECTRONIC TIMING CONTROLS

Adjustable Timing Control

The MSD Adjustable Timing Control puts you in control of your ignition timing from the driver's seat! A dash-mounted control knob allows you to adjust the ignition timing to compensate for changes in altitude, low octane gas, or heavy loads. For cars driven every day but raced occasionally on the weekends, this control is perfect. Increased fuel mileage and performance are just some of the benefits as the ignition timing can be advanced or retarded to prevent engine detonation.

The control knob mounts to the dash board for easy and accurate timing adjustments up to 15°. The Control can be used on 4, 6 and 8-cylinder engines and must be used with an MSD Ignition Control.



PN 8680

Adjustable Timing Control - PN 8680

- Easily connects to your MSD Ignition
- Adjust the timing 15° from the driver's seat!

This product is legal to sell, distribute or install on vehicles in California according to Executive Order E.O. D-40-28; legal in all 50 states.

Retard Module Selector

The Retard Module Selector allows you to select between 12 retard amounts with the turn of a dial. The Selectors plug into the retard module receptacle of any MSD Timing Control.

Retard Module Selector, 0°-11° - PN 8676

Retard Module Selector, 0°/10°-20° - PN 8678



PN 8676

Retard Modules

MSD Retard Module Kits give you a full selection of retard modules to be used with your timing controls.

Retard Module Kits:

11°, 12°, 13°, 14°, 15° - **PN 8774**

16°, 17°, 18°, 19°, 20° - **PN 8775**

5°, 6°, 7°, 8°, 9°, 10° - **PN 8776**

1°, 2°, 3°, 4°, 5° - **PN 8777**

Zero Degree Module - PN 8773



Module Holders

The MSD Module Holders are exactly what you need to keep track of your MSD RPM or Retard Modules.

Flexible Module Holder - PN 87551

Atomic EFI
 Starters/ Alternators
 Spark Plugs
 Ignitions
 Late Model
 Coils
 Distributors
 Crank Triggers
 Timing/RPM Controls
 Spark Plug Wires
 Street Fire
 Marine
 Accessories
 Specialty Items
 Promo



BOOST CONTROLS



Boost Timing Master for MSD Ignitions

The Boost Timing Masters allow you to adjust the amount of ignition retard from 1° per pound of boost to 3° per pound via a control knob that you mount on the dashboard. This way you can make adjustments on the fly to prevent detonation as fuel quality or altitude and air quality changes up to a maximum of 15° retard. You can also set a boost pressure point to start the retard. There is a boost pressure port to connect to your manifold and the BTM wires easily to the MSD Ignition Control.

NOTE: This unit must be used with an MSD 6, 7 or 8-Series Ignition.

BTM for MSD Ignitions - PN 8762



These products are legal to sell, distribute or install on non-OBD II vehicles in California according to Executive Order E.O. D-40-28; legal in all 50 states.

The shaded area of this chart shows the adjustability of the timing in relation to boost pressure.



PN 8762

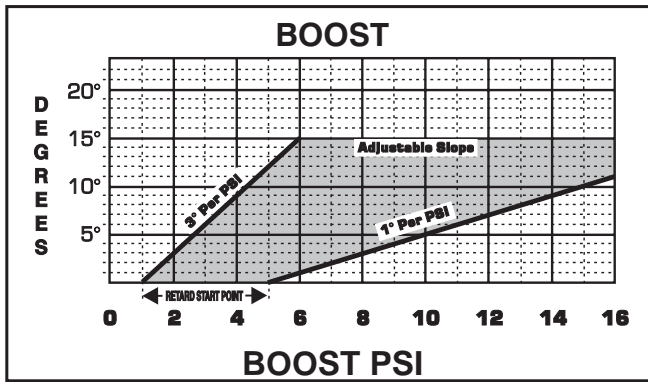

Manifold Absolute Pressure Sensors

The pressure inside the intake manifold is an extremely important input to the ECU. This Sensor will respond to changes in manifold pressures and relay the information to the ECU in the form of a voltage signal ranging from about 1 volt to 5 volts. Several different versions are available for normally-aspirated and engines with blowers.

Stock Style MSD Controllers

MAP Sensor, 2-Bar for blown/turbo

Applications up to 20 lbs of boost **PN 2312 PN 23121**

MAP Sensor, 3-Bar for blown/turbo

Applications up to 30 lbs of boost **PN 2313 PN 23131**



PN 23131

PN 23121

TECH TIP

PRESSURE

MSD registers PSIA, which is Absolute Pressure. Many gauges only read boost pressure, and quantify it as PSIG (gauge).

When powered, the MSD boost map will show absolute atmospheric pressure with a red line on the map. Note that any readings to the right of that line will be boost pressure. Values to the left will be in vacuum.

For example, MSD is based at 4,000-feet so our PSIA is 12.8 while at sea level, it is 14.7. You must take this measurement into consideration when setting a boost/retard ratio - and it changes with the weather!

Atomic EFI
Starters/Alternators
Spark Plugs
Ignitions
Late Model
Coils
Distributors
Crank Triggers
Timing/RPM Controls
Spark Plug Wires
Street Fire
Marine
Accessories
Specialty Items
Promo



RPM CONTROLLERS

2-Step Rev Control for the Digital 6AL

Since the Digital 6AL Ignition uses rotary dials to adjust the rev limiter, our engineers were tasked with developing a 2-Step Rev Control that could be added to give racers the ability to switch to a low rpm limit to use on the starting line.

The new 2-Step is also digitally controlled and connects to the Digital 6AL's gray tach output wire. There are two easy to read rotary dials that let you set the launch rpm in 100 rpm increments. There is an activation wire that connects to the transbrake, a clutch switch or to the line-lock to activate the low rpm limit. When that switch is released, the low rpm limit is turned off and the car launches hard!

2-Step Rev Control, for the Digital 6AL (PN 6425) only - **PN 8732**

PN 8732



2 and 3-Step Module Selectors™

The MSD Module Selectors allow you to choose two or three different rpm limits that can be activated at different times. With this ability, the possibilities are endless.

As an example, we'll use a drag car with a 3-Step Module Selector plugged into the rpm socket of a 7AL-2 Ignition. The different rpm modules are activated when 12 volts are applied to a corresponding wire. By connecting one wire to the line-lock circuit, one module will be activated during the burnout. This helps keep tire temperatures consistent. When the line-lock button is released, the limit turns off. When you're on the starting line, you can activate the second limit through the clutch or trans switch. This provides a steady and consistent rpm for firm holeshots every time. When no modules are selected, the remaining high limit is active to protect the engine in the event of driveline failure. The 2-Step works the same, but only with two different limits.

The Module Selectors can also be used with an MSD Timing Control. By plugging the Selector into a retard module socket, you can activate different retard amounts at select times. This is a great feature for engines being upgraded to a multi-stage nitrous system. With the addition of an RPM Activated Switch, you can use the 2-Step to activate a shift light at different rpm.

The Module Selectors must be used with an MSD Soft Touch Rev Control or a Timing Controller with a high-speed retard module. No rpm or retard modules are supplied.

2-Step Module Selector - PN 8739

3-Step Module Selector - PN 8737

*See page 137
for RPM module kits!*

PN 8739



PN 8737



Launch Control Module Selector

To help drag racers achieve even more consistency, our engineers have incorporated an adjustable low rpm stage into a 3-Step Module Selector! This allows you to make adjustments in 100 rpm increments from the driver's seat!

The Launch Control Module features a shielded harness for increased protection against EMI so it can be mounted within easy reach of the driver. This way, as track conditions change while you're waiting in the staging lanes, you can easily compensate the launch rpm.

The Launch Control also features two other rpm limits; one for top end over-rev protection and another to use during the burnout to achieve consistent tire temperatures. These limits are adjustable with MSD's plug-in modules. No rpm modules are supplied.

PN 8735



Atomic EFI
Starters/
Alternators
Spark Plugs
Ignitions
Late Model
Coils
Distributors
Crank
Triggers
Timing/RPM
Controls
Spark Plug
Wires
Street Fire
Marine
Accessories
Specialty
Items
Promo



LATE MODEL RPM CONTROLLERS



Accessories
Specialty
Items
Promo
Marine
Street Fire
Spark Plug
Wires
Timing/RPM
Controls
Crank
Triggers
Distributors
Coils
Late Model
Ignitions
Spark Plugs
Starters/
Alternators
Atomic EFI

2-Step for Ford Mod Motors

This 2-Step connects right to your late model Ford to produce consistent launches and quicker 60-foot times by setting an rpm limit to stage with. When activated, the rpm will be held at a steady rpm and once the green light comes on, release the clutch and take off - but be sure to hold on! The rpm is adjusted with two built-in rotary dials ranging from 1,800-9,900 rpm in 100 rpm increments. A handy LED shows when the launch rev limit is active.

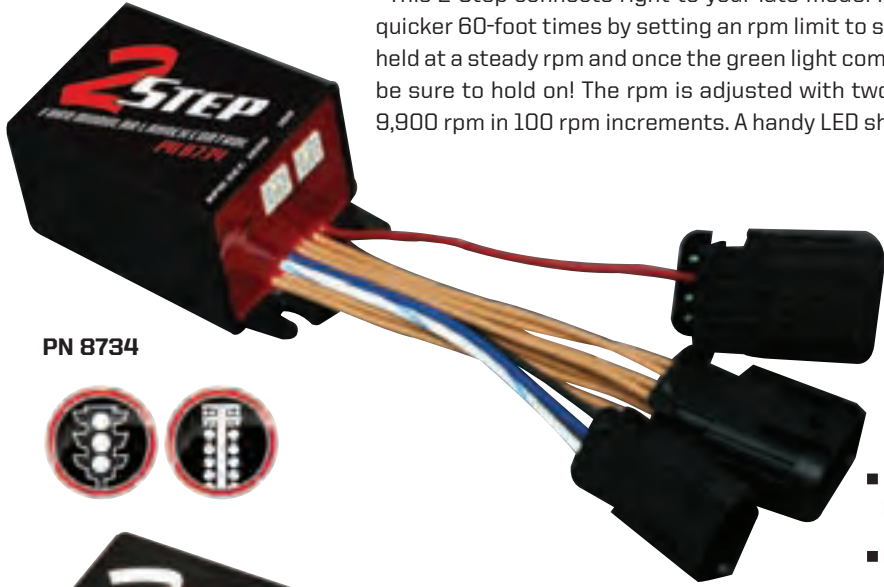

PN 8734



**2-Step, Ford 4.6L
Mod Motors - PN 8734***

**2-Step, Coyote
5.0L - PN 8731***

NOTE: For use on Coil-on-Plug systems only.

- Easily set a launch rpm for consistent holeshots
- Connects to the factory coils for easy installation
- The best way to launch hard

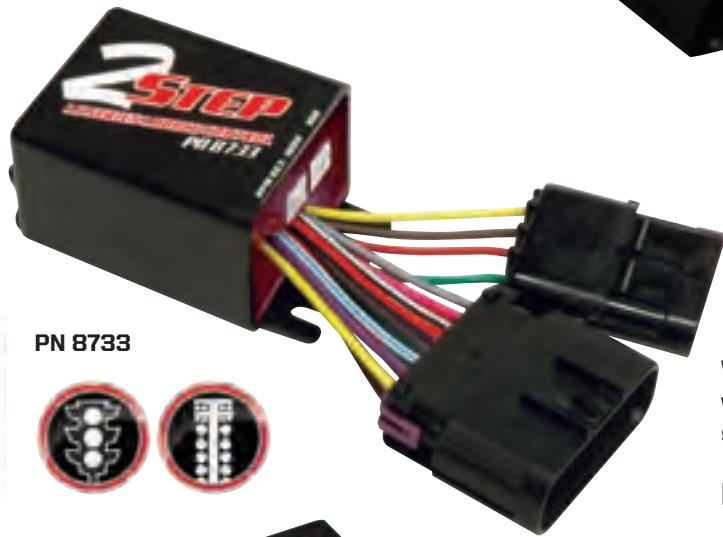

PN 8733



LS 2-Step Launch Control

GM performance fans will be geeked to learn about this direct plug-in 2-Step Launch Control! The unit is easy to connect with factory style connectors and lets the users set an rpm limit to activate from the holeshot! When you're staged, you can hold the pedal to the floor while the rpm stays at a consistent level producing consistent holeshots.

LS 2-Step Launch Control - PN 8733*



PN 6301

LSx Trigger Converter

The GM LS-Series engines are being built for a lot of different performance and racing applications. You can see good ol' hot rodder ingenuity taking place as racers are running carburetors and even using distributors on these engines!

This device plugs into the factory crank sensor of an LS1/LS2 engine and converts the factory trigger signal into a 12 volt square wave signal to trigger an MSD Ignition Control such as a 6 or 7-Series Ignition control. For racers that are incorporating a front mount distributor to their LS engines, this means you don't need to run an external crank trigger.

LSx Trigger Converter - PN 6301*

NOTE: A distributor is required, such as MSD's Front Mount race distributor, PN 8712, on page 115.

- Trigger an MSD 6 or 7-Series Ignition on your LS engine
- Converts the factory crank sensor signal to a 12 volt square wave



RPM ACCESSORIES

RPM Activated Switches

These RPM Activated Switches will perform a variety of different functions from turning on a bulb or solenoid to activating an MSD Timing Control at a desired rpm.

The RPM Activated Switch, PN 8950, has two activation wires; one to ground a circuit and the other to open a circuit. Simply plug in an rpm module and wire the Switch to the circuit you want to activate. When the engine rpm reaches that amount, the circuit is activated and will remain on until the rpm falls below that amount.

The RPM Window Switch, PN 8956, has two rpm adjustments; one to activate a circuit, while the other deactivates the same circuit. This Switch will supply then remove ground to a circuit. This is a great feature to deactivate nitrous before the engine's rev limit is reached.

Both Switches can be used with stock inductive ignitions or an MSD Ignition and can handle up to 1.5 amps. No rpm modules are supplied so they must be ordered from the selection of modules shown on page 133. For use on 4, 6, or 8-cylinder engines.

NOTE: To activate circuits that require over 1.5 amps, see the MSD Relays on page 136.

RPM Activated Switch - PN 8950 RPM Activated Window Switch - PN 8956

FOR MORE INFORMATION ON:

A full selection of RPM Module Kits or Selectors, see page 137

Digital RPM Window Switch

Are you looking for an RPM Switch that will turn a circuit on, then off at a different rpm? How about one for your late model coil-per-cylinder ignition system? Or, something for your car with dual coil packs? Maybe one for a Viper or even a Harley Davidson? Look no further, our new Digital RPM Window Switch will do it all!

This Switch will accept an input rpm signal from a coil negative terminal (for stock ignitions), a tach output from an ignition control, an ECU tach output or even a 5 volt tach signal. Another great feature is that no rpm modules are needed! The rpm activation points are programmed by simply scrolling through the LED display to your desired rpm amounts.

The switch has two outputs; one Normally Open, the other is Normally Closed. It can be programmed from 200 rpm to 15,000 rpm in 100 rpm increments. It can be used with an input voltage of 9-18 volts.

Programmable Shifter Controller

This Programmable Shifter Controller allows you to program different rpm points to trigger the shift solenoids. Any transmission configuration may be used up to a six speed transmission. Programming the rpm and options of the Shift Controller can be done with MSD's Hand Held Monitor, PN 7550, or with the MSD Pro-Data+ Software on a Windows based PC.

Programmable Shifter Controller PN 75591



PN 8950



PN 8956



PN 8969

Digital RPM Window Switch - PN 8969



PN 75591

- Atomic EFI
- Starters/ Alternators
- Spark Plugs
- Ignitions
- Late Model
- Coils
- Distributors
- Crank Triggers
- Timing/RPM Controls
- Spark Plug Wires
- Street Fire
- Marine
- Accessories
- Specialty Items
- Promo



REV LIMITERS

Atomic EFI
Starters/Alternators
Spark Plugs
Ignitions
Late Model
Coils
Distributors
Crank Triggers
Timing/RPM Controls
Spark Plug Wires
Street Fire
Marine
Accessories
Specialty Items
Promo



NEW!

Circle Track Digital Soft-Touch HEI Rev Limiter

In an attempt to keep costs down and racing close, many dirt track racing sanctioning bodies across the country institute a mandatory rpm limit in several classes. MSD has been in close contact with many tracks over the years and thanks to their input, as well as that of the racers, we are excited to introduce an rpm limiter designed for the Saturday night racer!

The new MSD Digital Soft-Touch HEI Rev Limiter is designed to plug into nearly any HEI distributor and produces an accurate, smooth rev limiting action. The rpm limit is adjustable from 3,000 - 9,900 rpm via two rotary dials with an easy-to-view LED to display the value. A unique feature of this Limiter is its ability to record the highest rpm reached during a race. This is useful information for the race team, as well as tech officials. Also, if the Limiter loses any connection or is manipulated during a race a fault code will be displayed.

The Limiter is encased in epoxy for protection against the abuse of dirt track racing. For use with GM style HEI distributors on V8 engines only.

Circle Track Digital Soft-Touch HEI Rev Limiter - PN 8727CT*

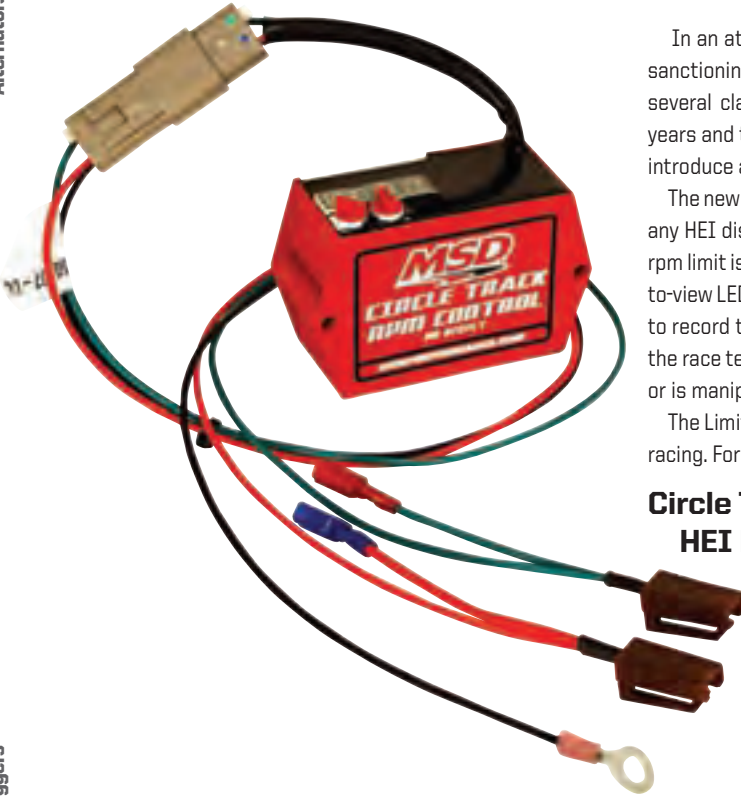

PN 8728



This product is legal to sell, distribute or install on non-OBD II vehicles in California according to Executive Order E.O. D-40-29; legal in all 50 states.

Soft Touch Rev Control™

For points and OEM Ignition systems.

The Soft Touch Rev Control, PN 8728, is designed to be used on standard points ignition or inductive ignition systems. This means that the PN 8728 can be installed on engines with a GM HEI Ignition, Ford or Chrysler electronic ignition or any standard breaker points systems (non-CD ignitions).

The Soft Touch Rev Control is adjusted with plug-in modules and is supplied with 6,000, 7,000 and 8,000 rpm modules. When the engine reaches your set rpm, the Soft Touch circuitry kicks in and drops the spark to certain cylinders. This limiter produces very accurate and smooth, backfire-free rev limits.

Can be used on 4, 6 or 8-cylinder engines with inductive ignitions.

NOTE: Not for use with CD Ignitions.

Soft Touch Rev Control, Non CD Ignitions - PN 8728

*Not legal for use or sale on pollution controlled vehicles.



MSD SHIFT LIGHTS

Digital Shift Light

The most universal and easy to use shift light available! Our new compact Digital Shift Light can be installed on everything from 1-cylinder points-triggered engines to Modular Ford engines with coil-on-plug technology.

The tiny digital controller inside the compact housing gives you the ability to program the rpm activation points through the easy-to-view LED panel and two programming buttons. When the engine reaches the activation rpm, the six red LEDs illuminate brightly to alert your senses into throwing the shifter at the exact rpm. The DSL can be installed on 1-cylinder engines up through 12-cylinders on stock ignitions or high-powered aftermarket systems.

NOTE: Supplied with the new GMR Pickup (see previous page.) This makes installation even easier on diesels, points, coil-on-plug and most any other application!

Digital Shift Light, Sync Shift - PN 8963
Digital Shift Light, Single RPM Point - PN 89631



PN 89631

- Installs with distributors, coil packs or coil-on-plug systems ranging from single to 12-cylinders
- Programmable from 100-15,900 rpm down to 10 rpm increments
- Six bright LEDs are easy to view in daylight and can be dimmed at night
- Supplied with an easy to install GMR Pickup!

Adjustable Intensity LED Shift Light

Racers speak and MSD listens. Pro Stock drivers were looking for a simple and small shift light that they could easily control the intensity of the LED. Easy enough. Here's the solution that plugs directly into our Programmable 7-Series Ignitions.

Adjustable Intensity LED Shift Light - PN 7542



PN 7542

MSD Shift Light

The MSD Shift Light will turn on to "remind" you to shift when the engine reaches your specified rpm. You select the rpm using the same plug-in modules that are used with your MSD Soft Touch Rev Control. The Shift Light features a bright cluster of LEDs making it easily visible, even in bright daylight. The light will also turn on for a moment when the ignition switch is first turned on to inform you that the light is functioning properly.

The Shift Light will work on 2, 4, 6 or 8-cylinder engines and will plug directly into the tach output on MSD 6, 7, 8 and 10-Series Ignitions or can be connected to the negative coil terminal when used with points or inductive-type ignitions. The MSD Shift Light is 4.5"L x 3.5"H with a 1.5" diameter lens. No rpm modules are supplied (see page 137 for kits).

Shift Light - PN 8952



PN 8952

Atomic EFI
Starters/Alternators
Spark Plugs
Ignitions
Late Model
Coils
Distributors
Crank Triggers
Timing/RPM Controls
Spark Plug Wires
Street Fire
Marine
Accessories
Specialty Items
Promo



ACCESSORIES



Tach Signal GMR Pickup

Just think of things you can easily accomplish with our GMR Pickup! This little device simply attaches, with no splicing or cutting, to a current carrying wire and turns that information into a 12 volt rpm signal. This signal can be used to activate a shift light, rpm activation switch or a tachometer.

One example is to connect the GMR, which stands for Giant Magnetoresistive, to a diesel injector current wire. This will produce a signal that can be used to trigger a tachometer or a shift light! Another example is on a late-model engine equipped with a coil-on-plug ignition system. One of the coil's primary current wires is simply routed into the Pickup clip and GMR converts this pulsing into a 12 volt signal for a shift light!

- Clip to a coil pack's voltage wire to produce a common 12 volt signal for a tach, shift light or rpm device
- Connect to a diesel injector wire to provide an easy tach installation
- Operates with 5-24 volt input for universal applications

GMR Pickup - PN 8918



PN 8918

MSD High Current Relays

MSD's High Current Relays are what you need to activate accessories that draw high current. These Relays are very reliable due to the fully automated manufacturing process and sophisticated coil winding procedure.

The SPST High Current Relay is rated at 30 amps with an input voltage of 12 volts DC. The relay is ideal for use with the MSD RPM Activated Switch when 12 volts are responsible for activating a high current device such as a nitrous solenoid.

The DPDT relay is also rated at 30 amps with a 12 volt input voltage. This Relay is the best choice when 12 volts are required to activate multiple high current devices at the same time such as multiple stage nitrous solenoids.

Single-Pole Double-Throw 30 Amp/12 VDC - PN 8961

Double-Pole Double-Throw 30 Amp/12 VDC - PN 8960

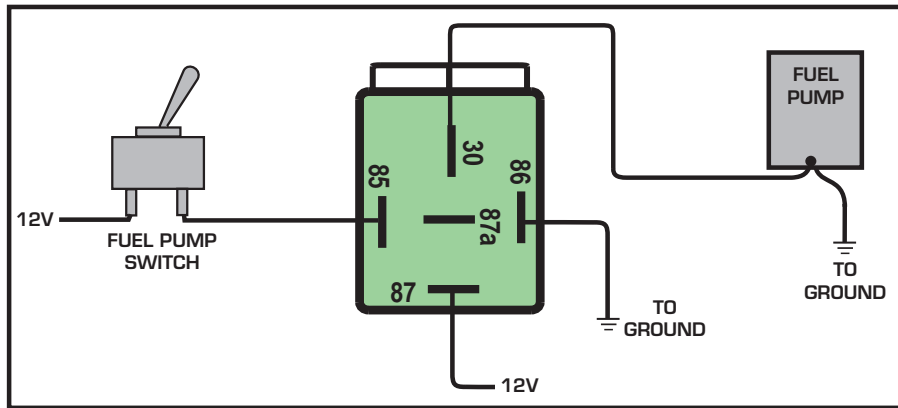

One of the most common uses of a relay is to provide a high current source for an electric fuel pump. MSD's relays will handle up to 30 amps with a 12 volt source.

TECH TIP

IGNITION ON, IGNITION OFF

When installing your MSD Ignition, take the time to check the connection to the small red wire of the unit. This wire requires 12 volts to turn on the ignition. Make sure that when the key is off, there is no voltage present. Also, make sure that when the key is on, and when the engine is cranking, that 12 volts are present.



PN 8960



PN 8961

Atomic EFI
Starters/Alternators
Spark Plugs
Ignitions
Late Model
Coils
Distributors
Crank Triggers
Timing/RPM Controls
Spark Plug Wires
Street Fire
Marine
Accessories
Specialty Items
Promo



RPM ACCESSORIES

RPM Module Kits

RPM Module Kits include five modules in 200 rpm increments. Each kit is within a 1,000 rpm range. For example, the PN 8745 is supplied with: 5,000, 5,200, 5,400, 5,600, 5,800 modules.

EVEN INCREMENTS

3,000-3,800:	PN 8743
4,000-4,800:	PN 8744
5,000-5,800:	PN 8745
6,000-6,800:	PN 8746
7,000-7,800:	PN 8747
8,000-8,800:	PN 8748
9,000-9,800:	PN 8749
10,000-10,800:	PN 8750
11,000-11,800:	PN 8751

ODD INCREMENTS

3,100-3,900:	PN 87431
4,100-4,900:	PN 87441
5,100-5,900:	PN 87451
6,100-6,900:	PN 87461
7,100-7,900:	PN 87471
8,100-8,900:	PN 87481
9,100-9,900:	PN 87491

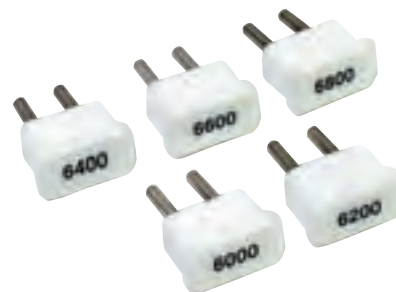

These products are legal to sell, distribute or install on non-OBD II vehicles in California according to Executive Order E.O. D-40-29; legal in all 50 states.

MSD Adjustable Low RPM Module

With this module, the user can dial-in any rpm between 1,000 and 3,000 rpm by simply turning a potentiometer. Ideal for vehicles with automatic transmissions that are using the MSD 2-Step Module Selector to leave the starting line below 3,000 rpm.

Adjustable Module, 1,000-3,000 RPM - PN 8677



Module Holder

The MSD Module Holder is exactly what you need to keep track of your MSD RPM or Retard Modules.

Flexible Module Holder - PN 87551

RPM Module Selectors

The RPM Module Selector plugs directly into the rpm module socket on all MSD Soft Touch Rev Controls and accessories that use plug-in modules. The user can then select between twelve different rpm limits by simply turning the knob. Six models are available to cover a range from 3,000 rpm to 12,800 rpm in 200 rpm increments.

Module Selector, 3,000-5,200 - PN 8670*

Module Selector, 4,600-6,800 - PN 8671*

Module Selector, 6,000-8,200 - PN 8672*

Module Selector, 7,600-9,800 - PN 8673*

Module Selector, 9,000-11,200 - PN 8674*

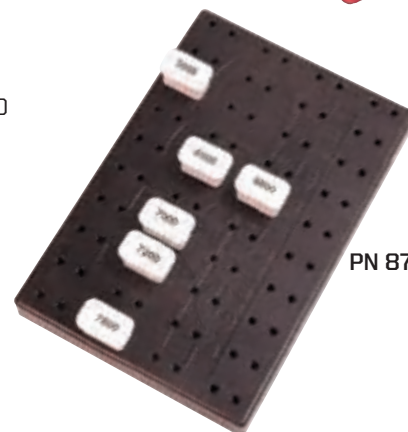

TECH TIP

All MSD race modules (color coded White) and RPM Module Selectors will work with any of the MSD products listed below:

RPM MODULES

MSD 6AL, 6 BTM:	PN 6420/6462
MSD 7AL-2 PLUS, 7AL-3:	PN 7222/7230
SOFT TOUCH REV CONTROL:	PN 8728
3-STEP MODULE SELECTOR:	PN 8737
2-STEP MODULE SELECTOR:	PN 8739
LAUNCH CONTROL MODULE SELECTOR:	PN 8735
RPM ACTIVATED SWITCHES:	PN 8950, 8956
SHIFT LIGHT:	PN 8952

Atomic EFI
Starters/
Alternators
Spark Plugs
Ignitions
Late Model
Coils
Distributors
Crank
Triggers
Timing/RPM
Controls
Spark Plug
Wires
Street Fire
Marine
Accessories
Specialty
Items
Promo



FUEL DELIVERY



Atomic EFI
Starters/Alternators
Spark Plugs
Ignitions
Late Model
Coils
Distributors
Crank Triggers
Timing/RPM Controls
Spark Plug Wires
Street Fire
Marine
Accessories
Specialty Items
Promo

- Maintains fuel volume in relation to boost pressure by stepping up the supply voltage to the electric fuel pump
- Voltage output is adjustable up to 22 volts at 15 psi of boost
- For use with stock electric fuel pumps or secondary booster pumps



PN 2351

Programmable Fuel Pump Voltage Booster

The updated Fuel Pump Booster is an easy way to maintain the proper fuel pressure on your car after adding a power adder such as a turbo or supercharger. The Booster allows you to make your boost adjustments through a PC for improved control and accuracy.

The Booster ensures that the engine receives the fuel it needs to make up for the increase in air being pumped into the intake manifold. It will increase the voltage to the factory fuel pump in proportion to manifold boost pressure in order to maintain the proper fuel delivery. The amount of increase is adjustable from a range of an additional 1.5 -22 volts and up to 30 psi which can all be set and adjusted from your PC with MSD's easy to use Windows based software. The MSD Booster will wire to the factory fuel pump relay or with a secondary booster pump.

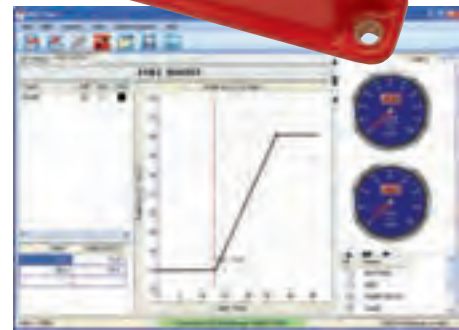

MSD's View software is windows based and allows you to easily program the voltage to the pump based on boost.

Programmable Fuel Pump Voltage Booster - PN 2351

NOTE: The Fuel Pump Booster cannot be used on fuel systems without a return line (pulse-modulated pumps).

43gph@40psi



PN 2225 162L/hr

High Pressure Electric Fuel Pump

Multiport EFI systems require a stable fuel supply to maintain best performance throughout the engine's rpm range. This high-pressure and high-flow Fuel Pump features a roller vane pump mechanism which is extremely resistant to clogging and jamming. The pump mounts in-line (outside of the fuel tank) with two supplied cushioned clamps for a quick and sturdy installation. The nipple inlet is 3/8" with a 5/16" outlet. The wire terminals feature brass studs for secure connections. Made in the USA, the pump is ideal for use as a "booster" for nitrous oxide applications, or as a stand-alone pump for multiport EFI systems on engines up to approximately 500 HP. Capable of 43 gph at 40 psi at 5.4 amps.

High Pressure Electric Fuel Pump - PN 2225*

NOTE: Do not attempt to change fittings.

Boost Adjustable Regulator

Maintaining accurate fuel system pressure on any multiport EFI system is crucial to performance. MSD's Adjustable Fuel Pressure Regulators allow you to fine tune the fuel pressure to meet the demands of your engine and injection system.

Both Regulators are adjustable from 36-45 psi with a flow rate of 9.2-10.5 gal/hr. The inlet and outlet is 5/16" and a jam nut is supplied for special threads on the bottom to ease mounting to a bracket.

This Regulator is designed for turbo or supercharged engines. As boost pressure increases, more fuel is required by the engine. This regulator features a boost reference circuit that adds more fuel in proportion to boost pressure.

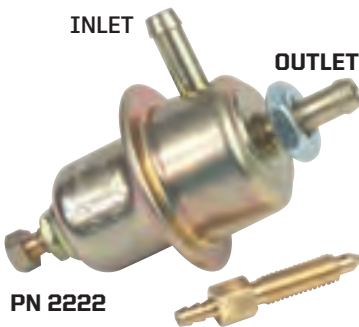

PN 2222

Boost/Fuel Pressure Regulator - PN 2222*



SPARK PLUG WIRES

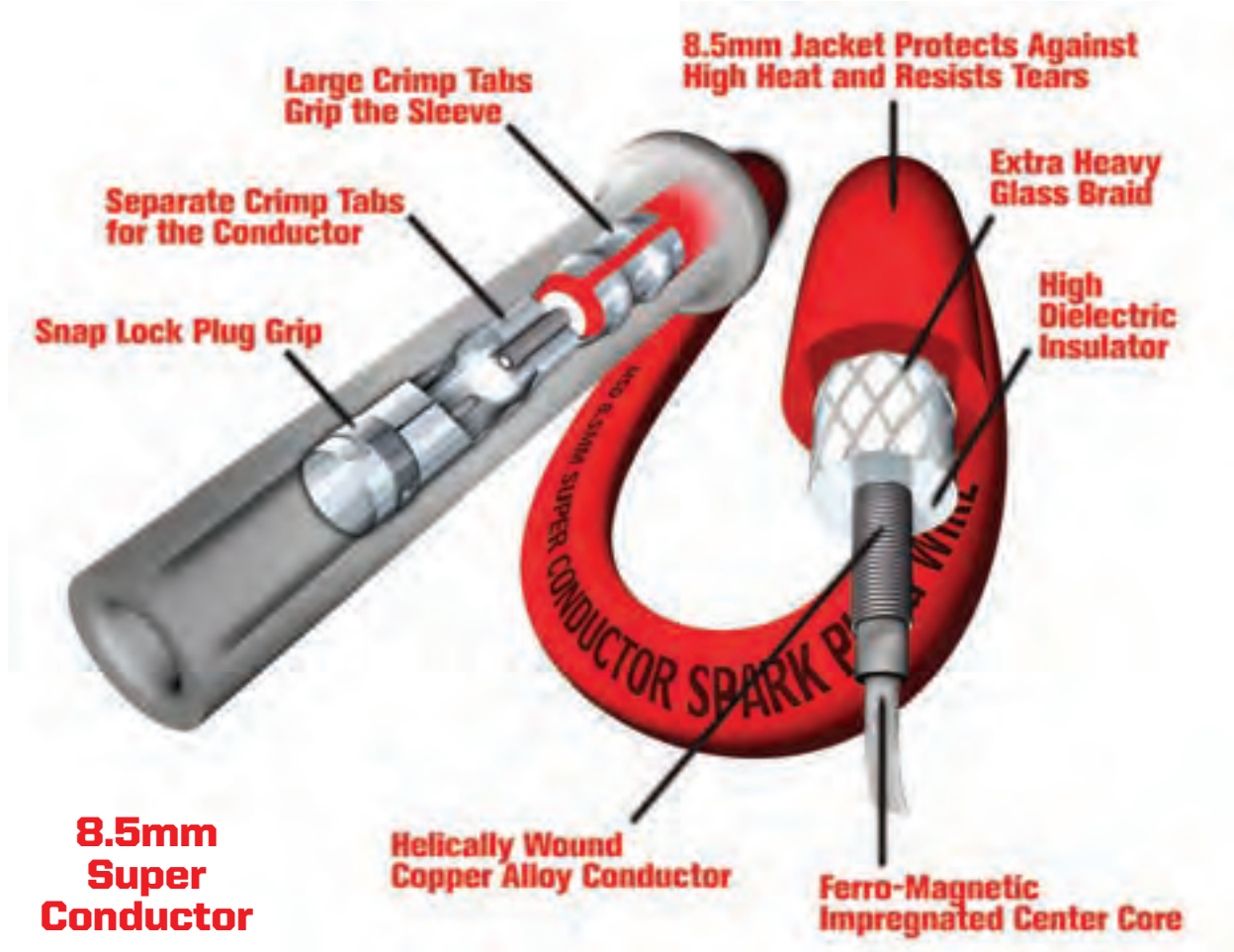

8.5mm Super Conductor

Spark plug wires are one of the most important pieces of the ignition system. You can have the best ignition control and coil possible (and with MSD, you will), but if the plug wires aren't up to snuff, all the energy will just be wasted.

Not only do plug wires need to carry extremely high voltages, but they have to do it in a harsh environment. Wires must be able to handle extreme heat, abrasion, and even getting whipped around from racing speeds. Also, the crimps and connections must be secure and live up to being pulled off in the pits during tune-up sessions.

MSD offers two types of spark plug wires; Street Fire and the 8.5mm Super Conductor. Street Fire plug wires are designed to provide great performance at a budget price. The wires have lower resistance and a durable silicone sleeve and are ideal for street cars and cruiser. The 8.5mm Super Conductor wire is engineered to deliver the most spark possible and features the lowest resistance with high EMI suppression. This wire also features extreme high temp sleeving and boots plus MSD's strong Dual Crimp terminals.

DUAL CRIMP™ TERMINALS

The MSD's 8.5mm spark plug terminals feature "Dual Crimp" terminals. As the name implies, the terminals feature two crimps; one for the sleeve of the wire and another separate crimp to grasp the conductor.

By having separate crimps, the conductor doesn't need to be bent 180° and get squeezed between the terminal and sleeve. This individual conductor crimp produces a more secure crimp and there is less chance of spark arcing to the engine block or exhaust manifold through the boot!

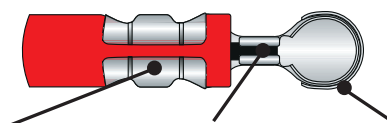

Large crimp tabs grasp the Super Conductor sleeve.

Separate crimp tabs firmly grip the conductor.

Stainless steel "Click-Lock" tab will not vibrate off.

Atomic EFI
Starters/Alternators
Spark Plugs
Ignitions
Late Model
Coils
Distributors
Crank Triggers
Timing/RPM Controls
Spark Plug Wires
Street Fire
Marine
Accessories
Specialty Items
Promo



SPARK PLUG WIRES

MSD 8.5mm Super Conductor®

The MSD 8.5mm Super Conductor is the ultimate performance wire! Its extremely low-resistance combined with the ability to suppress Electro Magnetic Interference is a combination that defies the common laws of physics.

Less resistance means more energy is going to make it to the spark plug to ignite the air/fuel mixture. The Super Conductor uses a copper alloy conductor resulting in less than 50 ohms per foot of wire! This ensures that the most energy possible makes it to the spark plug. By helically winding the conductor around a special core, we are able to produce a highly effective choke to keep the EMI inside the wire and away from other electronics.

This combination is encased in a heavy duty sleeve that will withstand abrasion and high temperatures. Cap off each end with our Dual Crimp Terminals and you have the best wire available!

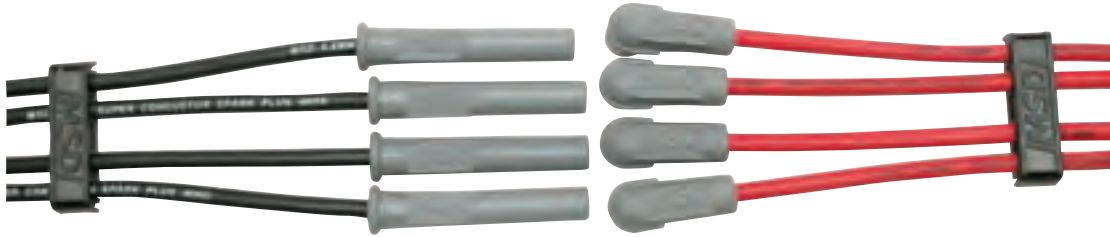
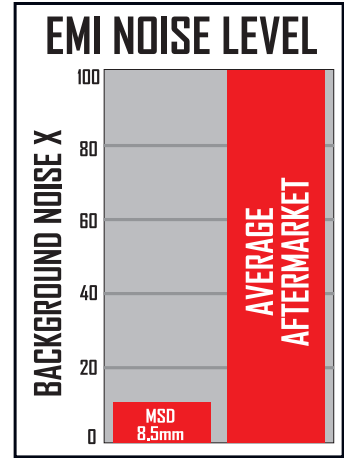

- Copper alloy conductor has a resistance value of less than 50 ohms per foot for superior spark
- Ferro-magnetic impregnated core creates an effective EMI choke
- Forty feet of conductor is wound into a single foot of wire for high EMI suppression
- Conductor core features Dupont Kevlar material for increased tensile strength
- Durable outer sleeve is a proprietary compound for resistance to high heat or abrasion



Street Fire® Wire

Street Fire plug wires are also designed with lower resistance to ensure the spark reaches the plugs for thousands of cruising miles. This 8mm wire features a helically wound conductor encased in a silicone sleeve for resistance to heat and the harsh underhood environment. High quality terminals are used to grip the wire and lock onto the spark plug terminal. Excellent performance at an incredible price.



Be sure to check out our Street Fire Spark Plug Wires - see more on page 161.

Promo
Accessories
Specialty
Items
Marine
Street Fire
Spark Plug
Wires
Timing/RPM
Controls
Crank
Triggers
Distributors
Coils
Late Model
Ignitions
Spark Plugs
Starters/
Alternators
Atomic EFI



STREET FIRE® SPARK PLUG WIRES



Spark Plug Wires

Street Fire plug wires deliver quality performance at a budget price. For more information and applications, see page 161.

Atomic EFI
Starters/Alternators
Spark Plugs
Ignitions
Late Model
Coils
Distributors
Crank Triggers
Timing/RPM Controls
Spark Plug Wires
Street Fire
Marine
Accessories
Specialty Items
Promo

Cyl.	Description	Year	Style	PN	1-cyl.	2-cyl.	3-cyl.	4-cyl.	5-cyl.	6-cyl.	7-cyl.	8-cyl.	Coil Wire
CHEVROLET/GMC													
8	Caprice, Impala SS LT1 and V8	1994-1996	LT1	5576	16" B, I	15" B, K	21" B, I	19" B, K	24" B, I	22" B, K	35" B, I	31" B, K	13" B, I
8	Camaro, LT1	1993-1997	LT1	5575	16" B, I	18" B, I	18" B, I	22" B, I	24" B, I	28" B, I	36" B, I	32" B, I	10" B, I 10" I, K
8	LS1 Vette, Camaro	1997-on	LS1	5572	8" A, N	8" A, N	8" A, N	8" A, N	8" A, N	8" A, N	8" A, N	8" A, N	
8	LS1 Truck	1999-on	LS1	5574	12" A, N	12" A, N	12" A, N	12" A, N	12" A, N	12" A, N	12" A, N	12" A, N	
6	Vortech, 4.3L	1996-2002		5577	29" A, I	24" B, I	24" B, I	23" A, I	24" B, I	22" B, I			16" K, K
8	307, 327, 350, Cars/Trucks (with wires over valve covers)	1971-1974	Socket	5565	38" B, C	38" B, C	34" B, C	34" B, C	27" B, C			25" B, C	12" C, F
8	267, 305, 350, 400, Cars/Trucks (with wires over valve covers)	1975-1982	w/HEI	5554	34" B, D	38" B, D	34" B, D	27" B, D	27" B, D	24" B, D	24" B, D	24" B, D	
8	All 350 Corvette (with long wires below exhaust manifold)	1975-1982	w/HEI	5566	54" B, D	54" B, D		28" B, D	28" B, D	22" B, D	22" B, D	25" B, D	
8	All 454 Chevy, GMC, Car/Trucks	1974-1976	w/HEI	5560	22" A, D			27" A, D	32" A, D	25" A, D	38" A, D	40" A, D	
8	All 366, 426, 454, Cars/Trucks	1977-1987	w/HEI	5561	39" A, D	39" A, D	37" A, D	28" A, D	28" A, D	29" A, D	27" A, D	29" A, D	
8	All 366, 396, 427, 454, Car/Trucks	1969-1974	w/HEI	5562	39" A, C	39" A, C	36" A, C	36" A, C	29" A, C	28" A, C	27" A, C	27" A, C	18" C, F
8	Chevy Corvette 350 TPI	1975-1987	w/HEI	5562	45" B, D	41" B, D	41" B, D	33" B, D	28" B, D	28" B, D	26" B, D	26" B, D	
8	Truck 305, 350	1985-1995	w/HEI	5562	38" B, G	36" B, G	37" B, G	31" B, G	29" B, G	28" B, G	28" B, G	27" B, G	9" D, G
8	Chevy Truck 3600 (with internal or external manifold)	1978-1989	w/HEI	5569	39" A, D	43" A, D	38" A, D	27" A, D	27" A, D	31" A, D	25" A, D	32" A, D	9" D, D
8	GM Pickup Vortech 350 5.7 L	1996-2000		5573	28" B, I	26" B, I	28" B, I	26" B, I	23" B, I	20" B, I	21" B, I	18" B, I	13" I, I
CHRYSLER													
8	318, 340, 360, Cars and Trucks Stock Distributors	1973-on	Socket	5533	30" A, E	29" A, E	32" A, E	23" A, E	29" A, E	30" A, E	21" A, E	21" A, E	15" F, E
8	Dodge Ram, 318, 360	1994-2001		5532	31" A, D	32" A, D	28" A, D	30" A, D	20" A, D	26" A, D	21" A, D	21" A, D	38" B, D
8	302 (5.0L) Car/Trucks, Mustang, Thunderbird, LTD, Granada	1977-1993	w/HEI	5541	24" A, R	23" A, R	37" A, R	31" A, R	25" A, R	37" A, R	28" A, R	34" A, R	26"-B, R 25"-F, R
8	(5.0L) Mustang	1994-1995	w/HEI	5544	19" A, R	21" A, R	20" A, R	27" A, R	23" A, R	23" A, R	28" A, R	27" A, R	8" B, R
8	350, 360 (5.0L) Cars/Trucks, Mustang, Thunderbird, Granada	1977-1993	w/HEI	5541	24" A, R	23" A, R	37" A, R	31" A, R	25" A, R	37" A, R	28" A, R	34" A, R	26"-B, R 25"-F, R
8	350, 360 (5.0L) Car	1965-1976	Socket	5542	30" A, C	35" A, C	35" A, C	33" A, C	32" A, C	35" A, C	33" A, C	33" A, C	16" C, F

See Boot Key on page 143.

*Factory Style Boot. Not listed.



UNIVERSAL PLUG WIRE SETS



Atomic EFI
Starters/Alternators
Spark Plugs
Ignitions
Late Model
Coils
Distributors
Crank Triggers
Timing/RPM Controls
Spark Plug Wires
Street Fire
Marine
Accessories
Specialty Items
Promo

Routing spark plug wires is an art form. It takes patience and time to route your wires away from the headers, through separators and to the distributor cap. Some wire sets fit perfect, but a lot of people want to build their own so they can route them exactly how they see fit.

Our Universal spark plug wire sets come with the spark plug terminal and boot installed with the other end open. Distributor cap boots and terminals are included so you can cut the wire to the desired length, then install the terminal with the supplied Mini-Stripper-Crimper. It's a little more work, but in the end it will be worth it!

PART NUMBER KEY	
Black Wire Part Numbers end with a 3	
Red Wire Part Numbers end with a 9	

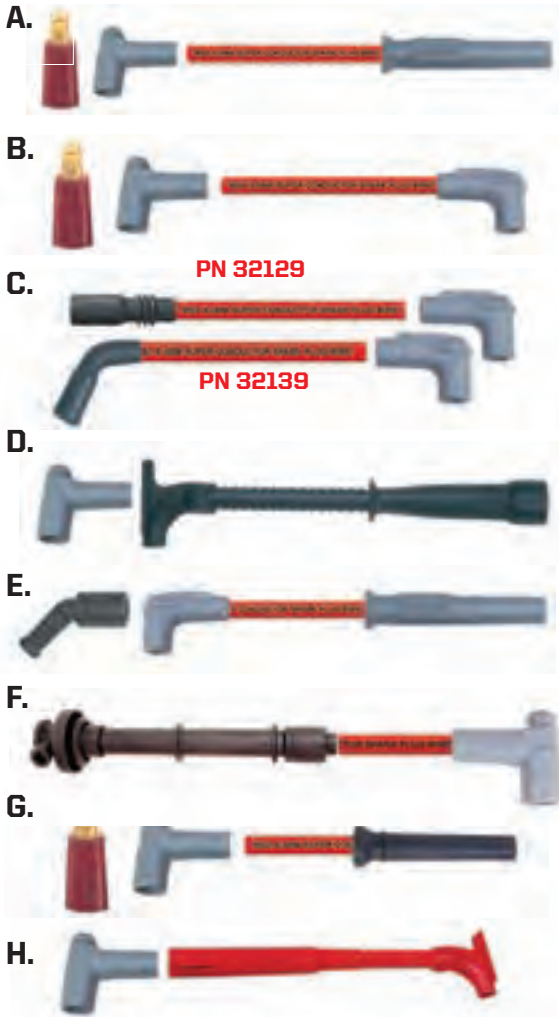

A. For engines with late-model type (HEI “spark plug top”) distributor caps. Multi-angle boots and terminals installed on one end. 90° distributor boots and terminals included.

8-cylinder Engine - PN 31183, PN 31189
Street Fire - PN 5550

B. For engines with late-model type (HEI “spark plug top”) distributor caps (Ford Duraspark or MSD Cap-A-Dapt). 90° spark plug boots installed with 90° distributor boots and terminals included.

8-cylinder Engine - PN 31223, PN 31229
Street Fire, PN 5552

C. For late model GM LT1 Engines, this set comes with the LT1 Boots and Terminals installed and 90° spark plug boots and terminals loose.

8-cylinder, Straight LT1 Boot - PN 32129
8-cylinder, 90° LT1 Boot - PN 32139

D. For Chrysler based Hemi engines, this kit is supplied with MSD's Hemi tubes and HEI style boots and terminals for the distributor cap.

8-Hemi Single plug set, Red Tubes - PN 31529
8-Hemi Single plug set, Black with Black tubes - PN 31523
16-Hemi Dual plug set - PN 31559

E. For GM Gen-III engines such as the LS1 or LS6, these wires are perfect when you relocate the coils. Both 90° and MA boots supplied.

LS Engines, 45” long - PN 32073, PN 32079
F. For Ford fans, these wires are designed for Ford Modular engines.

Ford Modular, 4.6/5.4L DOHC - PN 31889
G. Designed for the Chevy Pro Stock head, these 8.5mm wires incorporate a special boot for the spark plug. Ninety degree boots and terminals are supplied to be installed on the distributor side.

Chevrolet Pro Stock Head - PN 30839
H. The new Ford and Chrysler Hemi style cylinder heads being used in Pro Stock racing features a long, skinny tunnel to access the spark plug. MSD's new injection molded tubes are designed specifically for these hard to reach plugs.

Ford and Chrysler Hemi Pro Stock Head - PN 31539

TECH TIP

CHECKING RESISTANCE

MSD's 8.5mm Super Conductor wires use a special copper alloy conductor that has less than 50 ohms per foot of resistance. That ensures the most spark possible makes it to the plugs.

To test your plug wires, simply connect each end to an ohm meter. For a 4-foot wire, it should measure 200 ohms.

$$4' \times 50 \text{ ohms} = 200 \text{ ohms}$$

NOTE: Universal sets, except PN 31179 and PN 31159, come with: two 56” wires, two 50” wires, two 42” wires and three 32” wires.



8.5mm SPARK PLUG WIRES

Two-in-One Universal Wire Sets

To cover all your bases, these wire sets are supplied with both the boot and terminals that fit older, socket style distributor caps, as well as the ones for spark plug-style terminals.

A. Set includes terminals for engines with early type (socket) and late type (HEI "spark plug top") distributor caps. Multi-angle boots and terminals factory installed on one end.

4-cylinder Engine - PN 31159

6-cylinder Engine - PN 31179

8-cylinder Engine - PN 31193, PN 31199

Supplied with two 56", two 50", two 48" and three 32" wires.

Street Fire - PN 5552

B. Set includes terminals for engines with early type (socket) and late type (HEI "spark plug top") distributor caps. 90° boots and terminals factory installed on one end.

8-cylinder Engine - PN 31233, PN 31239

Street Fire - PN 5553

NOTE: Universal sets, except PN 31179 and PN 31159, come with: two 56" wires, two 50" wires, two 42" wires and three 32" wires.

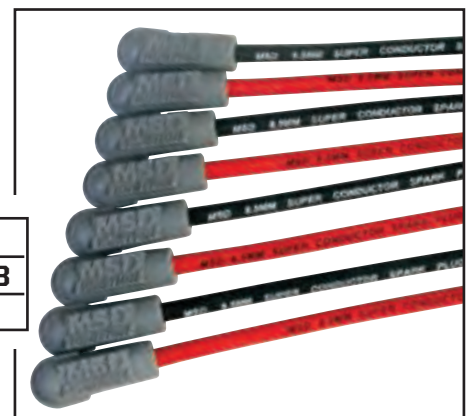

PART NUMBER KEY	
Black Wire Part Numbers	end with a 3
Red Wire Part Numbers	end with a 9

Boot Key

The wire sets listed on the following pages are ready to install. Letters are used to describe which boot is installed.

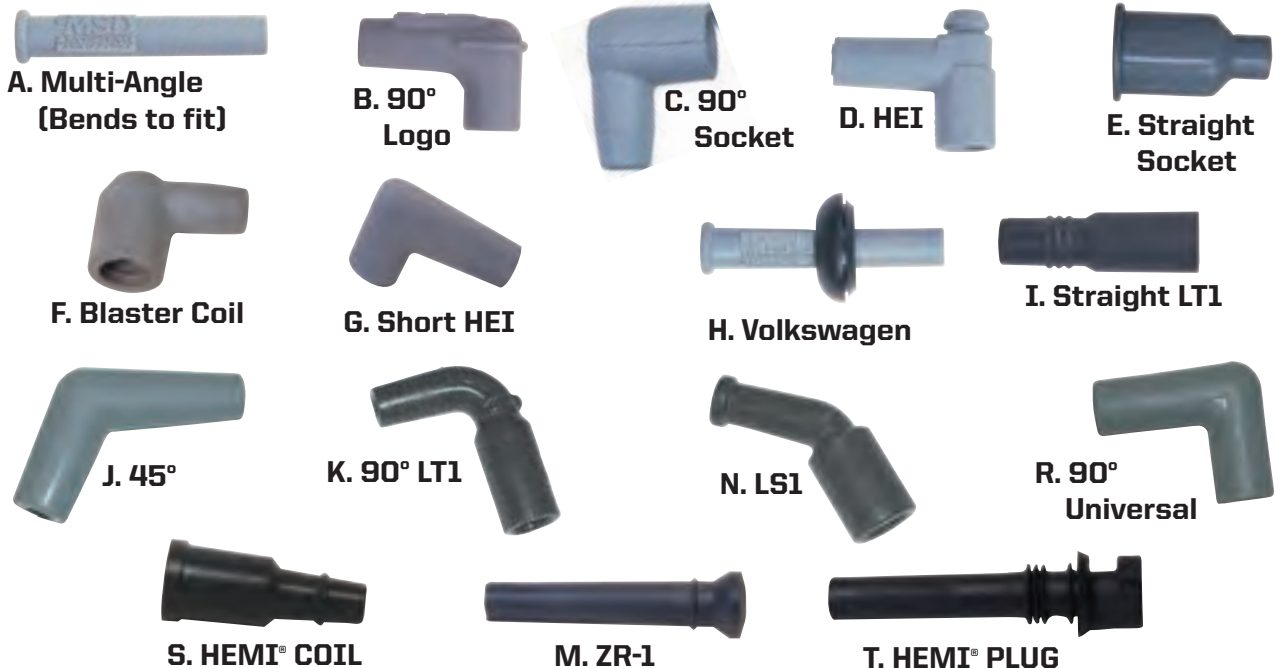

Atomic EFI
Starters/Alternators
Spark Plugs
Ignitions
Late Model
Coils
Distributors
Crank Triggers
Timing/RPM Controls
Street Fire
Marine
Accessories
Specialty Items
Promo





RACE TAILORED 8.5mm SETS

Race Tailored Wire Sets

The MSD Race Tailored 8.5mm Super Conductor Wire Sets are designed specifically to fit race engines equipped with headers or an MSD Distributor.

PART NUMBER KEY

Black Wire Part Numbers end with a **3**

Red Wire Part Numbers end with a **9**

Wire Length and Boot Description by Cylinder

Cyl.	Description	Style	PN	1-cyl.	2-cyl.	3-cyl.	4-cyl.	5-cyl.	6-cyl.	7-cyl.	8-cyl.	Coil Wire
CHEVY												
8	All SB Chevy w/Low-Profile Distributor, PN 84697, 84997, 8558 (wires below header/exhaust manifold)	90°	31243 31249	39" B, D	36" B, D	33" B, D	30" B, D	24" B, D	25" B, D	25" B, D	18" B, B	24" B, D
8	All BB Chevy w/Low-Profile Distributor PN 84697, 84997, 8558 (wires below header/exhaust manifold)	90°	31293 31299	37" B, D	40" B, D	33" B, D	33" B, D	28" B, D	27" B, D	23" B, D	25" B, D	38" B, D
8	All SB Chevy w/new Crab Cap PN 8541 with HEI terminals (wires below header/exhaust manifold)	HEI	30479	38" B, G	40" B, G	32" B, G	29" B, G	24" B, G	25" B, G	20" B, G	18" B, G	24" B, G
8	All BB Chevy w/new Crab Cap PN 8541 with HEI terminals (wires below header/exhaust manifold)	HEI	30829	39" B, G	40" B, G	36" B, G	30" B, G	24" B, G	29" B, G	20" B, G	20" B, G	32" B, G
8	All SB Chevy w/Socket Distributor Cap (wires below header/exhaust manifold)	Socket	31593 31599	37" B, C	39" B, C	35" B, C	32" B, C	33" B, C	29" B, C	27" B, C	28" B, C	12" C, F
8	All SB Chevy w/HEI style Distributor Cap (wires below header/exhaust manifold)	HEI	35599 35593	37" B, D	39" B, D	35" B, D	32" B, D	33" B, D	29" B, D	27" B, D	28" B, D	12" D, F
8	All BB Chevy w/Socket Distributor Cap (wires below header/exhaust manifold)	Socket	31603 31609	42" B, C	42" B, C	34" B, C	34" B, C	28" B, C	31" B, C	24" B, C	24" B, C	24" C, F
8	All BB Chevy w/HEI style Distributor Cap (wires below header/exhaust manifold)	HEI	35609 35603	42" B, D	41" B, D	34" B, D	34" B, D	28" B, D	31" B, D	24" B, D	23" B, D	24" D, F
VOLKSWAGEN												
4	Volkswagen Wire Set for VW Billet Distributor, PN 8485	90°	31939	32" D, H	32" D, H	23" D, H	23" D, H					16" D, F

See Boot Key on page 143.

*Factory Style Boot. Not listed.

Professional Racing Boots

These spark plug boots are designed for extreme racing applications. Using a proprietary blend of materials, the boots can handle much higher temperatures over an increased amount of time. Three designs are available.

- Designed exclusively for extreme duty racing
- Proprietary rubber compound has a higher devulcanizing rating
- Composition absorbs less infrared radiation



90° Pro Temp Boots
 2 per Card - **PN 3325**
 Pack of 8 - **PN 8852**

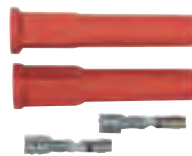

Straight Boots
 2 per Card - **PN 3327**
 Pack of 8 - **PN 8854**

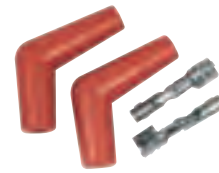

115° Pro Race Boots
 2 per Card - **PN 3326**
 Pack of 8 - **PN 8853**

Atomic EFI
 Starters/Alternators
 Spark Plugs
 Ignitions
 Late Model
 Coils
 Distributors
 Crank Triggers
 Timing/RPM Controls
 Spark Plug Wires
 Street Fire
 Marine
 Accessories
 Specialty Items
 Promo

CUSTOM FIT 3.5mm WIRE SETS

Wire Length and Boot Description by Cylinder

PART NUMBER KEY

Black Wire Part Numbers end with a **3**

Red Wire Part Numbers end with a **9**

Cyl.	Description	Year	Style	PN	1-cyl.	2-cyl.	3-cyl.	4-cyl.	5-cyl.	6-cyl.	7-cyl.	8-cyl.	Coil Wire
AMC													
8	V8 AMC		Socket	31859	26" A, C	26" A, C	28" A, C	28" A, C	32" A, C	32" A, C	34" A, C	38" A, C	24" B, C, F
8	V8 AMC		HEI	35859	26" A, D	26" A, D	28" A, D	28" A, D	32" A, D	32" A, D	34" A, D	38" A, D	24" D, F
BUICK													
6	Buick Grand National, 3.8L Turbo, Distributorless	All	w/HEI	31869	30" A, D	23" A, D	24" A, D	24" A, D	23" A, D	27" A, D			
8	All 265, 301, 307, 350, 403, Riviera, Electra, LeSabre	1975-1987	w/HEI	31363 31369	22" A, D	22" A, D	36" A, D	27" A, D	32" A, D	25" A, D	38" A, D	40" A, D	
8	All 267, 305(5.0L), 350, Century Regal, Electra	1977-1986	w/HEI	31409	41" A, D	45" B, D	45" A, D	41" A, D	37" A, D	37" A, D	22" B, D	29" A, D	
CADILLAC													
8	All 350, 350R	1975-1980	w/HEI	31363 31369	22" A, D	22" A, D	36" A, D	27" A, D	32" A, D	25" A, D	38" A, D	40" A, D	
CHEVROLET/GMC													
8	Caprice, Impala SS LT1 and V8	1994-1996	LT1	32153 32159	16" B, I	15" B, K	21" B, I	19" B, K	24" B, I	22" B, K	35" B, I	31" B, K	13" B, I
8	Camaro, LT1	1993-1997	LT1	32143 32149	16" B, I	18" B, I	18" B, I	22" B, I	24" B, I	28" B, I	36" B, I	32" B, I	10" B, I 10" I, K
8	Corvette, LT1	1992-1996		32173 32179	24" B, I	24" B, I	25" B, I	26" B, I	32" B, I	35" A, I	34" B, I	35" A, I	16"-I, K 16" B, I
8	LS1 Vette, Camaro	1997-on	LS1	32813 32819	8" A, N	8" A, N	8" A, N	8" A, N	8" A, N	8" A, N	8" A, N	8" A, N	
8	LS1 Truck	1999-on	LS1	32823 32829	12" A, N	12" A, N	12" A, N	12" A, N	12" A, N	12" A, N	12" A, N	12" A, N	
6	GM Full Size Truck, 4.3L, non-Vortech	1992-1997	w/HEI	31649	36" A, G	33" B, G	26" B, G	28" B, G	27" B, G	27" A, G			12" B, G
6	Vortech, 4.3L	1996-2002		32839	29" A, I	24" B, I	24" B, I	23" A, I	24" B, I	22" B, I			16" K, K
8	307, 327, 350, Cars/Trucks (with wires over valve covers)	1971-1974	Socket	31653 31659	38" B, C	38" B, C	34" B, C	34" B, C	27" B, C	28" B, C	27" B, C	25" B, C	12" C, F
8	307, 327, 350, Cars/Trucks (with wires over valve covers)	1971-1974	w/HEI	35653 35659	38" B, D	38" B, D	34" B, D	34" B, D	27" B, D	28" B, D	27" B, D	25" B, D	12" D, F
8	267, 305, 350, 400, Cars/Trucks (with wires over valve covers)	1975-1982	w/HEI	31353 31359	34" B, D	38" B, D	34" B, D	27" B, D	24" B, D	27" B, D	24" B, D	24" B, D	
8	All 350 Corvette (with long wires below exhaust manifold)	1975-1982	w/HEI	31763 31769	54" B, D	54" B, D	47" B, D	44" B, D	28" B, D	28" B, D	22" B, D	25" B, D	
8	All 267, 305, 350, Car/Trucks Blazer, Camaro, Malibu	1978-1982	w/HEI	31409	41" A, D	45" B, D	45" A, D	41" A, D	37" A, D	37" A, D	22" B, D	29" A, D	
8	All 454 Chevy, GMC, Car/Trucks	1974-1976	w/HEI	31363 31369	22" A, D	22" A, D	36" A, D	27" A, D	32" A, D	25" A, D	38" A, D	40" A, D	
8	All 366, 426, 454, Cars/Trucks	1977-1987	w/HEI	31773 31779	31" A, D	39" A, D	37" A, D	28" A, D	28" A, D	29" A, D	27" A, D	29" A, D	
8	All 366, 396, 427, 454, Car/Trucks	1969-1974	Socket	31373 31379	39" A, C	39" A, C	36" A, C	36" A, C	29" A, C	28" A, C	27" A, C	29" A, C	18" C, F
8	All 366, 396, 427, 454, Car/Trucks	1969-1974	w/HEI	35379	39" A, D	39" A, D	36" A, D	36" A, D	29" A, D	28" A, D	27" A, D	29" A, D	18" D, F
8	Chevy Corvette 350 TPI	1984-1991	w/HEI	31459	45" B, D	41" B, D	41" B, D	33" B, D	26" B, D	28" A, D	26" B, D	26" B, D	

See Boot Key on page 143.

*Factory Style Boot. Not listed.

Atomic EFI
Starter/Alternators
Spark Plugs
Ignitions
Late Model
Coils
Distributors
Crank Triggers
Timing/RPM Controls
Spark Plug Wires
Street Fire
Marine
Accessories
Specialty Items
Promo



CUSTOM FIT 8.5mm WIRE SETS

PART NUMBER KEY

Black Wire Part Numbers end with a **3**

Red Wire Part Numbers end with a **9**

Cyl.	Description	Year	Style	PN	1-cyl.	2-cyl.	3-cyl.	4-cyl.	5-cyl.	6-cyl.	7-cyl.	8-cyl.	Coil Wire
CHEVROLET/GMC (CONTINUED)													
8	Truck 305, 350	1985-1995	w/HEI	31413 31419	38" B, G	36" B, G	37" B, G	31" B, G	29" B, G	28" B, G	28" B, G	27" B, G	9" D, G
8	Chevy Truck 366, 454(7.4L), with internal or external coil	1978-1989	w/HEI	31803 31809	A, D	A, D	A, D	A, D	A, D	A, D	A, D	A, D	9" D, D
8	Chevy Caprice, Camaro, Monte Carlo	1988 on	w/HEI	31833	31" B, G	33" B, G	30" B, G	29" B, G	35" B, G	26" B, G	22" B, G	25" B, G	9" D, G
8	Truck, 454	1996-2000		32109	34" A, I	36" A, I	30" A, I	33" A, I	25" A, I	30" A, I	22" A, I	25" A, I	12" I, I
8	Truck, 8.1L	2001-2005		39849	13" A, N	13" A, N	13" A, N	13" A, N	13" A, N	13" A, N	13" A, N	13" A, N	
8	GM Pickup, Vortech 350 5.7 L	1996-2000		32163 32169	28" B, I	26" B, I	28" B, I	26" B, I	23" B, I	20" B, I	21" B, I	18" B, I	13" I, I
8	Chevy Big Block Truck	1990-1995	HEI	32119	37" B, A	41" B, A	35" B, A	31" B, A	29" B, A	28" B, A	28" B, A	26" B, A	12" B, G
8	Camaro, Firebird 3.8L V6	1996-1999	w/HEI	32799	22" B, B	40" B, B	28" B, B	36" B, B	32" B, B	32" B, B			
6	Camaro/Firebird 3.8L	2000-2002		32089	22" A, B	25" A, B	28" A, B	30" A, B	34" A, B	38" A, B			
6	3.1L Lumina, Malibu, 3.4L Monte Carlo, Venture, Impala	2000-2005		32559	24" A, B	36" A, B	25" A, B	33" A, B	26" A, B	36" A, B			
CHRYSLER													
6	Jeep Cherokee, Wrangler 4.0L	1991-1998	90°	32239	10" A, D	17" A, D	15" A, D	16" A, D	14" A, D	11" A, D			9" B, D
8	Dodge Dakota, 5.9L/5.2L	1999-2002		32979	31" A, R	29" A, R	20" A, R	20" A, R	33" A, R	33" A, R	24" A, R	21" A, R	38" R, R
8	318, 340, 360, Cars and Trucks Stock Distributors	1973-on	Socket	31309	30" A, E	29" A, E	32" A, E	23" A, E	29" A, E	30" A, E	21" A, E	21" A, E	15" F, E
8	318, 340, 360, Cars and Trucks MSD Distributors, PN 8534, PN 8388		HEI	32749	30" A, D	29" A, D	32" A, D	23" A, D	29" A, D	30" A, D	21" A, D	21" A, D	15" D, F
8	383, 400, 440, Cars and Trucks, MSD Distributors, PN 8386, PN 8546, PN 8545		HEI	32733 32739	29" A, D	24" A, D	36" A, D	51" A, D	43" A, D	44" A, D	55" A, D	55" A, D	18" D, F
8	Dodge Ram, 318, 360	1994-2000		32183 32189	31" A, D	32" A, D	28" A, D	30" A, D	20" A, D	26" A, D	21" A, D	21" A, D	38" B, D
8	Dodge, 5.7L Hemi	2003-2005		32033 32039	37" S, T	35" S, T	35" S, T	37" S, T	35" S, T	37" S, T	37" S, T	35" S, T	
FORD (Focus see page 142)													
4	Ford 2300			31259	32" A, B	32" A, B	32" A, B	29" A, B					16" B, R
8	302 (5.0L) Car/Trucks, Mustang, Thunderbird, LTD, Granada	1977-1993	w/HEI	31323 31329	24" A, R	23" A, R	37" A, R	31" A, R	25" A, R	37" A, R	28" A, R	34" A, R	26"-B, R 25"-F, R
8	(5.0L) Mustang	1994-1995	w/HEI	32203 32209	19" A, R	21" A, R	20" A, R	27" A, R	23" A, R	23" A, R	28" A, R	27" A, R	8" B, R
8	255, 351W (5.8L) Cars/Trucks, Mustang, Thunderbird, Granada	1977-1993	w/HEI	31323 31329	24" A, R	23" A, R	37" A, R	31" A, R	25" A, R	37" A, R	28" A, R	34" A, R	26"-B, R 25"-F, R
8	351M, 400, Cars/Trucks, LTD, LTD II, Thunderbird	1975-1979	w/HEI	31339	30" A, R	30" A, R	30" A, R	32" A, R	31" A, R	40" A, R	30" A, R	30" A, R	14" F, R

Atomic EFI
 Starters/Alternators
 Spark Plugs
 Ignitions
 Late Model
 Coils
 Distributors
 Crank Triggers
 Timing/RPM Controls
 Spark Plug Wires
 Street Fire
 Marine
 Accessories
 Specialty Items
 Promo



CUSTOM FIT 3.5mm WIRE SETS

PART NUMBER KEY

Black Wire Part Numbers end with a **3**

Red Wire Part Numbers end with a **9**

Cyl.	Description	Year	Style	PN	1-cyl.	2-cyl.	3-cyl.	4-cyl.	5-cyl.	6-cyl.	7-cyl.	8-cyl.	Coil Wire
FORD (CONTINUED)													
8	302cid Cars, Light Trucks w/ HEI Cap	1970-1976	HEI	35399	31" A, D	30" A, D	30" A, D	28" A, D	32" A, D	36" A, D	26" A, D	28" A, D	15" D, F
8	351C, 351W, 352, 390, 400, 429, 460 Car	1965-1976	Socket	31383 31389	30" A, C	35" A, C	35" A, C	33" A, C	32" A, C	35" A, C	33" A, C	33" A, C	16" C, F
8	351C, 351W, 352, 390, 400, 429, 460 Car w/ HEI Cap	1965-1976	HEI	35383 35389	29" A, D	35" A, D	35" A, D	33" A, D	32" A, D	32" A, D	33" A, D	33" A, D	16" D, F
6	3.8L Mustang	1994-1998	90°	32289	15" *, A	20" *, A	26" *, A	27" *, A	36" *, A	37" *, A			
6	3.8L Mustang	2001-2004		32889	48" *, J	42" *, J	38" *, J	15" *, J	14" *, J	14" *, J			
6	3.8L Mustang	1999-2000	90°	32999	48" J, *	46" J, *	42" J, *	20" J, *	15" J, *	17" J, *			
8	4.6L Cobra DOHC	1996-1998	90°	32219	28" *, *	36" *, *	30" *, *	46" *, *	39" *, *	39" *, *	29" *, *	35" *, *	
BUICK													
6	3.1L Century, Regal	2000-2005		32559	24" A, B	36" A, B	25" A, B	33" A, B	26" A, B	36" A, B			
OLDSMOBILE													
8	All 260, 307, 350, 403, 455, Cutlass Delta, Toronado	1974-1983	w/HEI	31363 31369	22" A, D	22" A, D	36" A, D	27" A, D	32" A, D	25" A, D	38" A, D	40" A, D	
8	All 267, 305, (5.0L), Except 1976-1979 Omega	1978-1986	w/HEI	31409	40" A, D	44" B, D	44" A, D	40" A, D	36" A, D	36" A, D	22" B, D	28" A, D	
6	3.4L Alero, Silhouette	2000-2004		32559	24" A, B	36" A, B	25" A, B	33" A, B	26" A, B	36" A, B			
PONTIAC													
8	All 260, 265, 301, 350 w/out Turbo Firebird, Grand-Am, Lemans	1975-1992	w/HEI	31363 31369	22" A, D	22" A, D	36" A, D	27" A, D	32" A, D	25" A, D	38" A, D	40" A, D	
8	All 267, 305 (5.0L), Firebird, Grand-Am, Grand Prix, Lemans	1981-on	w/HEI	31409	40" A, D	44" B, D	44" A, D	40" A, D	36" A, D	36" A, D	22" B, D	28" A, D	
6	Pontiac Grand Prix 3.8L Supercharged	1997-2000		32789	13" A, B	42" A, B	20" A, B	40" A, B	24" A, B	44" A, B			
6	3.1L Grand-Am, Grand Prix ('00-'03), Transport	2000-2004		32559	24" A, B	36" A, B	25" A, B	33" A, B	26" A, B	36" A, B			
6	Grand Prix GT	1997-on		32789	13" A, B	42" A, B	20" A, B	40" A, B	24" A, B	44" A, B			
8	LS1 GTO	2004-2006	LS1	32813 32819	8" A, N	8" A, N	8" A, N	8" A, N	8" A, N	8" A, N	8" A, N	8" A, N	

See Boot Key on page 143.

*Factory Style Boot. Not listed.



Atomic EFI
Starter's/
Alternators
Spark Plugs
Ignitions
Late Model
Coils
Distributors
Crank
Triggers
Timing/RPM
Controls
Spark Plug
Wires
Street Fire
Marine
Accessories
Specialty
Items
Promo



SPORT COMPACT 8.5^{mm} WIRE SETS

8.5mm Super Conductor[®] for Sport Compact

These sets are specifically designed for sport compact engines.

VEHICLE	YEAR	DESC.	ENGINE	RED	BLACK	EXTREME WIRE SET
ACURA						
Integra LS, RS, GS	'90-'01	DOHC 16V	1.8L 1834cc			
Integra GS-R	'92-'93	DOHC 16V VTEC	1.7L 1678cc			
Integra GS-R	'92-'95	DOHC 16V VTEC	1.8L 1834cc			
Integra GS-R, Type R	'96-'01	DOHC 16V VTEC	1.8L 1834cc		PN 32343	
BMW						
Mini Cooper	'90-'00		1.6L	PN 32879		
DODGE/CHRYSLER						
Cirrus, Sebring	'95-'98	DOHC 16V	2.0/2.4L	PN 32279		
Cirrus, Sebring	'97-'00	SOHC 16V	2.0L	PN 32729		
Avenger, Caravan, Stratus	'95-'98	DOHC 16V	2.0/2.4L	PN 32279		
Avenger, Caravan, Stratus	'97-'00	SOHC 16V	2.0L	PN 32729		
Neon SRT-4, PT Cruiser	'03-'05	4-Cyl. Turbo	2.4L	PN 32689		
PT Cruiser	'03-'05	4-Cyl.	2.4L	PN 32689		
FORD						
Focus, with MSD Coil, PN 8241	'99-'04	4V	2.0L	PN 32939		
ZX-2	'98-'04		2.0L	PN 32939		
HONDA						
Civic HX, Coupe 2DR	'96-'00	SOHC 16V VTEC-E	1.6L 1590cc			PN 35359*
Civic Si Hatchback 3DR	'92-'95	SOHC 16V VTEC	1.6L 1590cc			PN 35359*
Civic Si	'99-'00	DOHC 16V VTEC	1.6L 1590cc		PN 32343	
Civic VX Hatchback	'92-'95	SOHC 16V VTEC-E	1.5L 1493cc			PN 35359*
Civic Del Sol VTEC	'94-'97	DOHC 16V VTEC	1.6L 1590cc		PN 32343	
Civic Del Sol S	'93-'95	SOHC 16V	1.6L 1590cc			
Civic Del Sol S, Coupe 2DR	'96-'97	SOHC 16V	1.6L 1590cc			PN 35359*
Civic Del Sol Si, Coupe 2DR	'93-'97	SOHC 16V VTEC	1.6L 1590cc			PN 35359*
EAGLE						
Talon	'95-'99	DOHC 16V	2.0L	PN 32279		
Talon	'97-'00	SOHC 16V	2.0L	PN 32729		
Talon, Turbo	'95-'99	DOHC Turbo	2.0L			
MAZDA						
Miata			1.6/1.8L	PN 32599		
MITSUBISHI						
Eclipse	'95-'99	DOHC 16V	2.0L	PN 32279		
Diamante/GT3000	'92-'96	TURBO V6	3.0L	PN 32709		
PLYMOUTH						
Neon, Voyager	'95-'98	DOHC 16V	2.0/2.4L	PN 32279		
Neon, Voyager	'97-'00	SOHC 16V	2.0L	PN 32729		
TOYOTA						
Toyota Trucks	'79-'92			PN 31949		

* Supplied with female 90° terminals and boots installed.

Atomic EFI
 Starters/Alternators
 Spark Plugs
 Ignitions
 Late Model
 Coils
 Distributors
 Crank Triggers
 Timing/RPM Controls
 Spark Plug Wires
 Street Fire
 Marine
 Accessories
 Specialty Items
 Promo



Replacement Boots and Terminals

MSD boots are designed with longevity in mind. Each boot provides excellent heat resistance as well as maximum protection against spark loss.

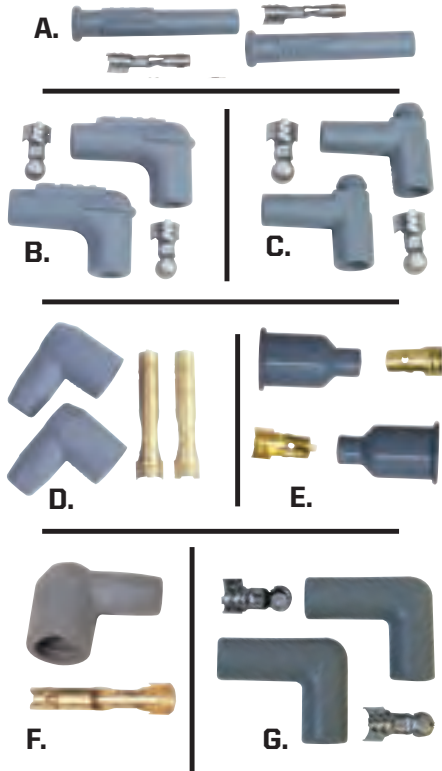

- A. Multi-Angle** Boots and Terminals, 2/Card - **PN 3301**
- B. 90° MSD** Boots and Terminals, 2/Card - **PN 3311**
- C. HEI Style 90°** Boots and Terminals, 2/Card - **PN 3320**
- D. 90° Socket** Boots and Terminals, 2/Card - **PN 3321**
- E. Straight Socket** Boots and Terminals, 2/Card - **PN 3322**
- F. Blaster 2 Coil** Boot and Terminal, 1/Card - **PN 3331**
- G. 90° Non-Logo** Boots and Terminals, 2/Card - **PN 3323**
- H. LT1 Straight** Boots and Terminals, 2/Card - **PN 3302**
- I. LT1 90°** Boots and Terminals, 2/Card - **PN 3303**
- J. LS1 45°** Boots and Terminals, 2/Card - **PN 3304**

Boot and Terminal Sets

If you're making a custom set of spark plug wires these sets are for you. Each set is supplied with nine high-temperature boots and their matching terminal.



- K. 90° Socket** Boots and Brass Terminals - **PN 8851**
- L. 90° MSD** Boots and Dual Crimp Terminals - **PN 8850**
- M. 90°** Boots and Dual Crimp Terminals - **PN 8847**
- N. HEI** Boots for Retainers and Dual Crimp Terminal - **PN 8849**
- O. Short 90°** Boots and Dual Crimp Terminals - **PN 8848**





PLUG WIRE ACCESSORIES



Atomic EFI
Starters/Alternators
Spark Plugs
Ignitions
Late Model
Coils
Distributors
Crank Triggers
Timing/RPM Controls
Spark Plug Wires
Street Fire
Marine
Accessories
Specialty Items
Promo



Replacement Spark Plug Wires

The MSD Universal Replacement wire is 48" long and has a multi-angle terminal and boot on one end with a 90° HEI style terminal on the other side. A 90° socket terminal and boot is also supplied with a Mini-Stripper-Crimper so the wire can be custom tailored to your application.

8.5mm Super Conductor Wire, Red - PN 34069
8.5mm Super Conductor Wire, Black - PN 34063



Coil Wire Replacement

This Super Conductor Coil Wire is 18" long.

Coil Wire Replacement

HEI boots, Red - PN 84039
HEI boots, Black - PN 84033
Blaster Socket boot, Red - PN 84049

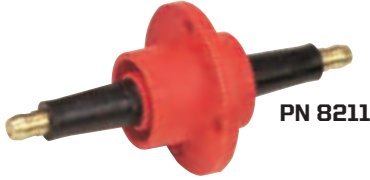

PN 8211

Firewall Feed-Thru

To prevent voltage leaks in passenger compartment mounted coil installations, MSD designed the Firewall Feed-Thru.

Molded from Rynite® and nylon, the Firewall Feed-Thru provides 1/2" of insulation to ensure that the coil's spark reaches the distributor.

Firewall Feed-Thru, Red/Black - PN 8211



PN 3475

Hemi Tubes

MSD's Hemi Tubes are molded from Rynite for incredible strength and high spark isolation properties. For easy assembly and disassembly we incorporated a new twist-lock cap at the base. The tubes meet NHRA's requirements. The Tubes are available in a set of 16 with eight red and eight black.

MSD Hemi Tubes, Set of 16 - PN 3475



PN 3476

Pro Stock Hemi Tubes

Ford and Chrysler Hemi Pro Stock heads have a long, skinny tube machined in the head to access the spark plug. This created a challenge to install spark plug wires. MSD answers with an injection molded spark plug wire boot that reaches down to securely connect the wire to the spark plug. The set of eight includes the tubes and components to assemble the wire.

MSD Pro Stock Hemi Tubes,

Set of 8 - **PN 3476**



BULK WIRE & TERMINALS



Bulk Wire

MSD offers both the Heli-Core and 8.5mm Super Conductor Wire in bulk. Sets are sold in 6', 25', 100' and 300' lengths.

LENGTH	8.5MM RED	8.5MM BLACK
6 feet	PN 34039	PN 34033
25 feet	PN 34019	PN 34013
100 feet	PN 34049	PN 34043
300 feet	PN 34059	PN 34053



Bulk Boots and Terminals

You can now get MSD Boots and Terminals in bulk sets of 100.

100 TERMINALS

- A. Multi-Angle Dual Crimp Terminals - **PN 34605**
- B. 90° Plug Style Dual Crimp Terminal - **PN 34615**
- C. 90° Socket Cap Terminals - **PN 34635**

100 BOOTS

- D. Multi-Angle - **PN 34565**
- E. 90° Spark Plug Style - **PN 34515**
- F. 90° Socket Cap - **PN 34525**
- G. HEI Style w/Nipple - **PN 34555**
- H. 90° Non-Logo Boot, Quantity 50 - **PN 34575**



TECH TIP

GROUNDS

Nothing is more aggravating than an intermittent electrical issue. We've found many ignition issues directly related to faulty grounds. A few tips:

- Have a ground wire from the engine running to the chassis.
- For trunk mounted batteries, route a ground wire (at least 10-gauge) directly to the engine.
- When using MSD 7, 8, or Pro Mag ignition, ground the heads together and connect them to the common chassis ground point.

Atomic EFI
 Starters/
 Alternators
 Spark Plugs
 Ignitions
 Late Model
 Coils
 Distributors
 Crank
 Triggers
 Timing/RPM
 Controls
 Spark Plug
 Wires
 Street Fire
 Marine
 Accessories
 Specialty
 Items
 Promo



ACCESSORIES & TOOLS



Atomic EFI
Starters/Alternators
Spark Plugs
Ignitions
Late Model
Coils
Distributors
Crank Triggers
Timing/RPM Controls
Spark Plug Wires
Street Fire
Marine
Accessories
Specialty Items
Promo

Plug wire dies included!



PN 35051



**AMP Pin
PN 3506**



**AMP Lug
PN 3507**



**8.5mm Plug Wire
PN 3508**



**Weathertight
PN 3509**



**Deutsch
PN 3510**

Pro-Crimp Tool™

If you make numbers of plug wires or do a lot of custom wiring, the Pro-Crimp Tool is a must for your toolbox. The Pro-Crimp features interchangeable jaws allowing for a variety of different style crimps with one heavy-duty tool.

The Pro-Crimp features a hardened steel frame with comfortable molded hand grips. The slick ratchet action provides secure, factory quality crimps every time. The Tool is supplied with precision crimping/stripping jaws for MSD's spark plug wire terminals.

Pro-Crimp Tool - PN 35051

TECH TIP

CRIMP IT TWICE

MSD uses special Dual Crimp Terminals on the multi-angle and the 90° HEI/spark plug terminals. These terminals have two sets of crimp tabs; one to grip the wire sleeve and another to secure the conductor. This produces the strongest crimp possible!

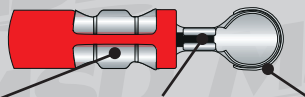

Large crimp tabs grasp the Super Conductor sleeve.	Separate crimp tabs firmly grip the conductor.	Stainless steel "Click-Lock" tab will not vibrate off.
--	--	--

Pro-Crimp Dies

These dies are for use with Pro-Crimp Tool, PN 35051.

- Amp Pin Terminal Dies - PN 3506**
- Amp Lug Terminal Dies - PN 3507**
- Plug Wire Terminal Dies - PN 3508**
- Weathertight Terminal Dies - PN 3509**
- Deutsch Terminal Dies - PN 3510**

Mini-Stripper Crimper

This special tool is an inexpensive way to make a set of custom plug wires. It provides a "die" to strip either 8mm Heli-Core or 8.5mm Super Conductor Wire, then can be used in a vise to provide a solid terminal crimp to the wire.



Mini-Stripper-Crimper - PN 3503



PLUG WIRE ACCESSORIES

Pro-Clamp™ Separators

The Pro-Clamp will keep the plug wires in a tidy order and away from engine heat sources. Each Separator features secure grooves for each wire and a top bracket snaps in place to sandwich the wires in place. Each base has a hole for a retaining screw if desired and a tab that will help hold it in position.

The kit is supplied with two 4-wire assemblies, two 3-wire assemblies and four 2-wire assemblies.



PN 8843

Pro-Clamp Separators - PN 8843

- No tools needed to open
- Wires stay in place when cover is removed
- Stand alone or can be bolted down

Wire Separators

Not only do separators have to keep spark plug wires away from engine heat sources, they also have to keep the plug wires far enough apart to prevent inductive crossfire and actual spark loss. MSD Wire Separators will clean up your wire installation and last the duration of your vehicle.

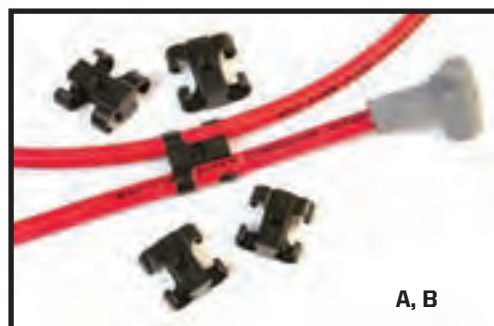

A, B

A. Dual Plug Wire Separators, 8-8.5mm Wires,

Set of 16 - **PN 8841**

B. Dual Plug Wire Separators, Wires w/Sleeve,

Set of 16 - **PN 8842**

Shrink Sleeve with Numbers

This Sleeving simply slides over the spark plug boot or other connection and will shrink tightly around it for a secure connection. Best of all, these sleeves have the cylinder numbers on them so each wire is clearly marked preventing any confusion during thrashes in the pits.



PN 3415

Numbered Shrink Sleeve - PN 3415

Cylinder Markers

These great little markers will save you time and ensure that the plug wires are always in the right place. They will withstand high underhood temperatures and are available in two sizes. The Markers are also supplied on a trick tool that makes installation effortless.

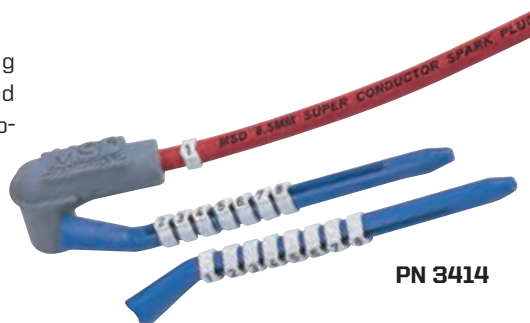

PN 3414

Cylinder Markers, 8.5mm Wire - PN 3414

Atomic EFI
 Starters/Alternators
 Spark Plugs
 Ignitions
 Late Model
 Coils
 Distributors
 Crank Triggers
 Timing/RPM Controls
 Spark Plug Wires
 Street Fire
 Marine
 Accessories/Specialty Items
 Promo



PLUG WIRE ACCESSORIES



Atomic EFI
Starters/Alternators
Spark Plugs
Ignitions
Late Model
Coils
Distributors
Crank Triggers
Timing/RPM Controls
Spark Plug Wires
Street Fire
Marine
Accessories
Specialty Items
Promo



PN 3411

Pro-Heat Guard™

This tough sleeving is made up of a thick glass woven core that resists temperatures up to 1,000°F. Silicone rubber coating surrounds the core adding protection against abrasion and heat. The sleeving has a 3/8" inner diameter so it easily slides over most spark plug wires.

Pro-Heat Guard Roll of 25 feet - **PN 3411**



PN 3412

Pro-Boot Guard™

MSD's Pro-Boot Guard is designed to protect spark plug boots from excessive heat. The slide-on sleeve features a fiberglass woven inner sleeve which is then coated with a specially compounded silicone rubber. This combination produces a thick sleeve that can withstand extreme temperatures. Slides over most plug boots.

Pro-Boot Guard Roll of 6 feet - **PN 3412**

Shrink Sleeving

MSD Shrink Sleeving can be used to protect connections throughout the vehicle as well as spark plug wires. Simply install the Shrink Sleeving over the connection and apply heat. The sleeving will shrink tightly around the wire and protect it. MSD Shrink Sleeving will not split and is designed to withstand high underhood temperatures.

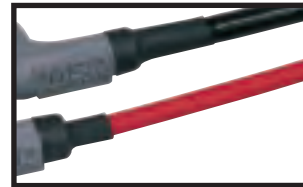

PN 3407

Shrink Sleeving for Pro-Heat Guard Set of 18 - **PN 3407**

Spark Guard™

MSD's Spark Guard is a dielectric grease that solves many common ignition troubles. It stops voltage leaks, eases boot removal, prevents moisture buildup inside the spark plug wire boots, and even helps protect against radio noise (EMI). It also simplifies the installation of MSD Universal Spark Plug Wire Sets. Spark Guard will not dry up or harden so it will retain its spark isolating capabilities indefinitely.



Spark Guard
PN 8804



⚡ TECH TIP ⚡

SOFTWARE COMPATIBILITY

MSD's Pro-Data+ v3.19 is compatible with Windows XP, Windows Vista, and Windows 7 (32-bit & 64-bit).
The MSD View is currently compatible with Windows XP, Windows Vista, and Windows 7 (32-bit only).



MSD
STREET FIRE®

Street Fire is an extension brand from MSD that delivers quality at a budget price. All of the Street Fire components are spec'd by MSD engineers and designed to provide performance for the price. The quality of each part is backed up with a one year warranty!

ST
STREET FIRE

- Quality components at a value price - with confidence
- All new components spec'd by MSD engineers
- One year warranty on all Street Fire products

Atomic EFI
 Starters/
 Alternators
 Spark Plugs
 Ignitions
 Late Model
 Coils
 Distributors
 Crank
 Triggers
 Timing/RPM
 Controls
 Spark Plug
 Wires
 Street Fire
 Marine
 Accessories
 Specialty
 Items
 Promo

DISTRIBUTORS



CDI IGNITION





COILS





WIRES



An **MSD** Brand



STREET FIRE[®] FORD & CHRYSLER COILS



Promo
Accessories
Specialty
Items
Marine
Street Fire
Spark Plug
Wires
Timing/RPM
Controls
Crank
Triggers
Distributors
Coils
Late Model
Ignitions
Spark Plugs
Starters/
Alternators
Atomic EFI



Late model truck and modern muscle car enthusiasts will be excited to see the new Street Fire coil offerings for their vehicles! Street Fire coils are based on the OEM form but have been engineered with performance improvements in mind! The internal windings and materials are optimized to boost the spark output and efficiency of the coil resulting in increased performance for your engine.



Ford Application

- '98-'14 4.6L/5.4L 2-Valve
- '04-'98 4.6L/5.4L 3-Valve
- '99-'14 4.6L/5.4L 4-Valve
- '11-'14 5.0L 4-Valve

	Single	Set of 8
'98-'14 4.6L/5.4L 2-Valve	PN 5512	PN 55128
'04-'98 4.6L/5.4L 3-Valve	PN 5513	PN 55138
'99-'14 4.6L/5.4L 4-Valve	PN 5514	PN 55148
'11-'14 5.0L 4-Valve	PN 5515	PN 55158

Chrysler Application

- '05-'14 5.7L/6.1L Hemi
 - '03-'05 5.7L Hemi
- Carb approval pending*

'05-'14 5.7L/6.1L Hemi	PN 5516	PN 55168
'03-'05 5.7L Hemi	PN 5517	PN 55178





STREET FIRE® GM LS COILS

NEW!

GM LS Platform

- '98-'06 LS1/6
- '05-'13 LS2/3/4/7/9
- '99-'07 Truck Series
- '99-'09 Truck Series

Carb approval pending

Single Set of 8

- PN 5508 PN 55088
- PN 5511 PN 55118
- PN 5509 PN 55098
- PN 5510 PN 55108



PN 5508



PN 5510



PN 5509



PN 5511



Atomic EFI
 Starters/
 Alternators
 Spark Plugs
 Ignitions
 Late Model
 Coils
 Distributors
 Crank
 Triggers
 Timing/RPM
 Controls
 Spark Plug
 Wires
 Street Fire
 Marine
 Accessories
 Specialty
 Items
 Promo



STREET FIRE®



Atomic EFI
Starters/Alternators
Spark Plugs
Ignitions
Late Model
Coils
Distributors
Crank Triggers
Timing/RPM Controls
Spark Plug Wires
Street Fire
Marine
Accessories
Specialty Items
Promo

Street Fire® CDI

The Street Fire Capacitive Discharge Ignition is perfect for performance enthusiasts with a tight budget. The ignition offers capacitive discharge technology and will fire a series of multiple sparks that last for 20° of crankshaft rotation when the engine is running at lower rpm. This ensures combustion of the air/fuel mixture and produces great throttle response and smooth idle.

The CDI is built around a durable cast aluminum housing and easily connects to points, amplifiers and magnetic pickup distributors. An adjustable rev limiter will protect the engine in the event of driveline failure. This rpm is adjustable with rotary dials in 100 rpm increments. If you have a 4, 6 or 8-cylinder engine, the Street Fire CDI will connect and fire it up!



Street Fire CDI Ignition - PN 5520



OPERATING SPECIFICATIONS STREET FIRE CDI

SPARK ENERGY:	95 mJ Per Spark
PRIMARY VOLTAGE:	435 Volts
SECONDARY VOLTAGE:	43,000 Volts
SPARK SERIES DURATION:	20° Crankshaft Rotation
RPM RANGE:	15,000 RPM with 14.4 Volts
VOLTAGE REQUIRED:	10-18 Volts, Negative Ground
CURRENT DRAW:	.7 Amp per 1,000 RPM
WEIGHT & SIZE:	1.5 lbs., 6"L x 3.5"W x 1.75"H

Tested with Blaster Coil

This product is legal to sell, distribute or install on vehicles in California according to Executive Order E.O. D-40-43; legal in all 50 states.

- Capacitive discharge technology
- Multiple sparks improve starting and idle
- Full power output at high rpm
- Easily connects to points, amplifiers and magnetic pickup distributors
- Adjustable rev limiter for overrev protection

Street Fire® Coils

We're excited to introduce several new coils to the Street Fire line. These coils mount directly in place of factory style versions and accept the OEM connectors as well. Performance output is improved thanks to a careful selection of better materials and efficient winding ratios.

- Ford TFI Coil - PN 5527**
- GM Dual Connector Coil - PN 5526**
- Canister Coil - PN 5524**
- Internal HEI Coil - PN 5525**

- Ford 6-Tower Coil Pack, '94-'00 - PN 5528**
- Ford 6-Tower Coil Pack, '01-'04 - PN 5529**



PN 5527



PN 5526



PN 5524



PN 5525



PN 5528



PN 5529



These products are legal to sell, distribute or install on vehicles in California according to Executive Order E.O. D-40-42; legal in all 50 states.

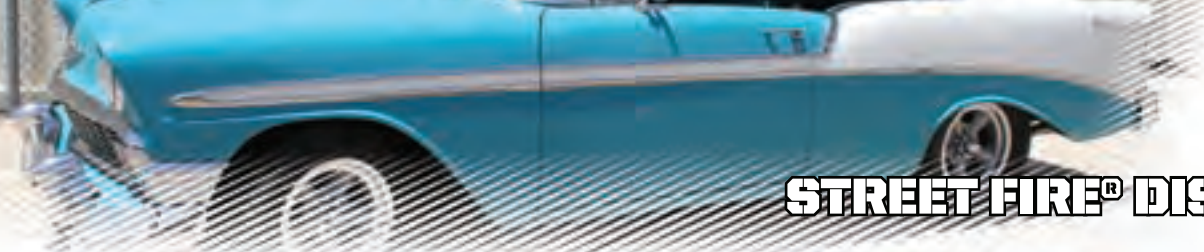

STREET FIRE® DISTRIBUTORS

Cap and Rotor Kits

Street Fire is making ignition maintenance easy for you! The cap, rotor and even plug wires all need to be considered as maintenance items. These new Cap and Rotor kits are designed to deliver quality at a value price and are supplied with brass terminals and a heavy duty rotor.

GM Points Style with

- V8 Socket Cap - **PN 5500**
- GM HEI, V8 Internal Coil - **PN 5501**
- GM External Coil, V8 EFI - **PN 5502**
- GM External Coil, V6 EFI - **PN 5503**

- Ford V8 Socket Cap - **PN 5506**
- Ford Duraspark V8 - **PN 5504**
- Ford/MSD TFI V8 - **PN 5505**



Street Fire GM EFI Distributors

These Street Fire Distributors are ready to drop in to your V8 engine to replace the worn OEM piece. A factory style ignition module is included along with a durable new cap and rotor. The cast housing features a long sintered bushing to add stability and timing accuracy to the ignition.

Street Fire GM EFI Distributor - PN 5591

GM used this distributor when trucks first moved to EFI back in 1988! It was carried over into cars and was used through the mid 1990s and the introduction of the Vortech engine and LS Series blocks. Also, many aftermarket EFI systems require this style distributor and module.

Street Fire GM Vortech Distributor - PN 5592

GM moved to this distributor in the late 1990s and only used them for a few years. The unique flat cap design acts as a 'correct-a-cap' meaning that the even number spark plug wires are all on the passenger side while the odd numbers are all on the driver's side.

Street Fire Ford TFI

One of the most popular Ford distributors in use is the TFI version used in the 5.0L Mustangs from '86-'94. Since these cars are getting up there in miles and years, Street Fire offers a great OEM upgrade and an even better price.

As with all of the Street Fire Distributors, each one is spec'd by MSD engineers. The Ford TFI is supplied with the correct TFI ignition module and accepts the factory style connector. Of course a new cap and rotor are supplied to top the system off, as well as a fresh gear for durability.



Atomic EFI
Starter/Alternators
Spark Plugs
Ignitions
Late Model
Coils
Distributors
Crank Triggers
Timing/RPM Controls
Spark Plug Wires
Street Fire
Marine
Accessories
Specialty Items
Promo

CARB Approval Pending



STREET FIRE® DISTRIBUTOR



Atomic EFI
Starters/Alternators
Spark Plugs
Ignitions
Late Model
Coils
Distributors
Crank Triggers
Timing/RPM Controls
Spark Plug Wires
Street Fire
Marine
Accessories
Specialty Items
Promo



CARB Approval Pending

Street Fire® HEI Distributor

For value conscious enthusiasts, the Street Fire HEI is a great choice! We know the importance of a centrifugal advance in a distributor so our engineers made sure that the Street Fire received an advance assembly with coated weights and welded weight pins (not just pressed in like other models). Another area that you cannot afford to scrimp on is with a distributor gear. The Street Fire is fit with the same gear that is used on our Pro-Billet models. The metallurgy of this gear has been refined for years to perform through the harshest conditions.

Inside, the ignition module and coil work together to produce a stout spark to light the fuel mixture for great performance. The high voltage is transferred through a new rotor to the brass terminals of the distributor cap and out to the plugs. The Street Fire Distributor is the first product to come from our new value branded ignition line.

Street Fire HEI Distributor - PN 8362

- The components, including the coil, spec'd by MSD engineers
- Heavy duty distributor gear for durability
- Welded weight pins and heavy duty construction
- Vacuum advance for economy

PN 8362 REPLACEMENT PARTS

Cap/Rotor Kit:	Module:	Coil:
PN 5501	PN 5596	PN 5525

The Street Fire HEI Distributor is not intended for extreme rpm or racing applications. In these applications, the MSD Ignition Pro-Billet HEI Distributor, PN 8365, is required.



One of the best parts of the Street Fire Distributor is the heavy duty MSD gear!

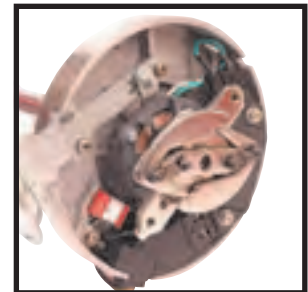

The Street Fire HEI is supplied with the module and coil. The HEI features all brand new parts!

HEI Vacuum Advance Stop Plate

This little plate allows you to limit the amount of vacuum advance on your Pro-Billet HEI, PN 8365, and Street Fire HEI, PN 8362.

HEI Vacuum Advance Stop Plate - PN 84281



PN 84281



PN 8428

Street Fire HEI Advance Kit

This kit will help you achieve the solid ignition timing you need! The Kit comes with new advance weights, springs to set the rate of advance and new bushings. This is designed for the Street Fire HEI and stock style HEI Distributors. (Not for use with MSD's PN 8365 Pro-Billet HEI.)

HEI Advance Kit - PN 8428



STREET FIRE® WIRES



Street Fire® Wires

The Street Fire Spark Plug Wires feature a low resistance conductor that's wrapped in a sleek and durable black sleeve. The terminals are covered in black boots that protect the conductor from engine heat to ensure spark delivery.

- Helically wound conductor suppresses electro magnetic interference and radio noise
- Kevlar core combination for great strength and durability
- Heavy duty terminals for secure connection
- 8mm silicone and synthetic jacket resists heat and abrasion
- 500 Ohms per foot resistance for improved spark delivery and power
- Silicone boots protect against high exhaust temps

CHEVY

- PN 5554 .. Small Block Chevy, 350 HEI
- PN 5560 .. Chevy 454, '74-'76 HEI
- PN 5561 .. Chevy 366-454, Socket
- PN 5562 .. Chevy Truck 305-350, '85-On
- PN 5563 .. '84-'91, Corvette, 350TPI
- PN 5564 .. SBC, Socket Cap, under Manif.
- PN 5565 .. SBC, Socket Dist. Cap over VC
- PN 5566 .. '75-'82, Corvette 305-350 HEI
- PN 5567 .. Chevy 454, '75-On HEI
- PN 5569 .. Chevy 454, '88-On
- PN 5570 .. Chevy Caprice/Camaro, '88-On
- PN 5572 .. GM F-Body, Corvette, LS-Series, '97-On
- PN 5573 .. GM Truck, Tahoe, Suburban, Vortech V8, '96-'97
- PN 5574 .. GM Truck, LS, LQ-Series, '99-'05
- PN 5575 .. GM F-Body, LT1, '93-'96
- PN 5576 .. Chevy Caprice, Impala, LT1, '94-'96
- PN 5577... GM, Vortec V6, 4.3L, '96-'04

DODGE/CHRYSLER

- PN 5530 .. '73-On, 318-360, Socket
- PN 5531 .. '73-On, 383-440, Socket
- PN 5532 .. Dodge Ram, '94-'97, 318-360

FORD

- PN 5540 .. Ford 351W, 400, 460, '77-On HEI
- PN 5541 .. Ford 302, 351W, HEI
- PN 5542 .. Ford 351C-460, Socket
- PN 5543 .. Ford 289-302, Socket
- PN 5544 .. Mustang 5.0L, '94-On

PONTIAC

- PN 5539 .. Pontiac Grand Prix GTP V6, '97-On

UNIVERSAL

These kits are supplied only with the spark plug boot installed. This way you can route the wires exactly as you'd like for a custom fit. Terminals and boots are supplied for the distributor side that you install with a special tool that is also supplied. All kits are for 8-cylinder.

- PN 5550 .. Multi-Angle Plug, HEI Cap
- PN 5551 and PN 8804 ... Multi-Angle, Socket/HEI
- PN 5552 .. 90°, Plug/90° Plug
- PN 5553 .. 90°, Socket/HEI Cap

Atomic EFI
 Starters/
 Alternators
 Spark Plugs
 Ignitions
 Late Model
 Coils
 Distributors
 Crank
 Triggers
 Timing/RPM
 Controls
 Spark Plug
 Wires
 Street Fire
 Marine
 Accessories
 Specialty
 Items
 Promo





MARINE IGNITION SYSTEMS

MSD 6M-2L™ Marine Ignition with Rev Limiter

The MSD 6M-2L Ignition Control is designed for performance marine applications where a high energy and reliable ignition is a necessity. The capacitive discharge (CD) design of the MSD produces full power sparks throughout your boat's entire rpm range. Below 3,000 rpm, a series of multiple sparks burn in the cylinder for 20° of crankshaft rotation ensuring complete combustion. Together, these sparks produce easier starting, great throttle response, more power and reduced plug fouling during idling.

Weathertight connectors securely lock together to provide reliable connections that are unaffected

by water, oil, gasoline and most other chemicals associated with boats. The 6M-2L's electrical circuitry from marine conditions, the entire unit is potted with a polyurethane compound. This material prevents the electrical components from coming into contact with water or other chemicals.

The 6M-2L also features a built-in Soft Touch Rev Control that will save your engine from overrev damage. The rpm limit is set with sealed rpm modules (see below).

The 6M-2L can be triggered by either a magnetic pickup (distributor or crank trigger), amplifier or by a breaker point distributor. The cable harness has the proper connector so you can plug the 6M-2L into one of the Pro-Billet MSD Marine distributors.

6M-2L Marine Ignition

w/Rev Limiter - **PN 6560**

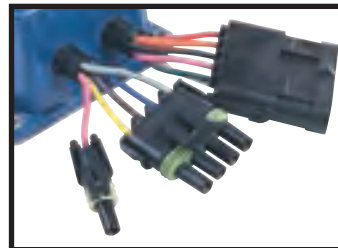

Weathertight connectors are used on all MSD marine ignition parts.



6M-2L BUILT-IN ADJUSTABLE REV LIMITER

OPERATING SPECIFICATIONS

SPARK ENERGY:	105-115 mJ Per Spark
PRIMARY VOLTAGE:	460-480 Volts
SECONDARY VOLTAGE:	45,000 Volts
SPARK SERIES DURATION:	20° Crankshaft Rotation
RPM RANGE:	15,000 RPM with 14.4 Volts
VOLTAGE REQUIRED:	12-18 Volts, Negative Ground
CURRENT DRAW:	1 Amp per 1,000 RPM
WEIGHT & SIZE:	3.5 lbs., 8"L x 3.5"W x 2.25"H

Tested with Blaster Coil



The 6M-2L is thoroughly tested by Underwriter's Laboratory and certified to meet or exceed safety standards for marine ignitions as set out by the U.S. Coast Guard.

Additional RPM Module Kits

Each RPM Module Kit provides five modules within a range of 1,000 rpm. Example: PN 87456 Module Kit includes a 5,000, 5,200, 5,400, 5,600 and 5,800 rpm module.

NOTE: These modules can only be used with 6M-2L.

Module Kits

5,000 RPM Series - PN 87456

6,000 RPM Series - PN 87466



Atomic EFI
Starters/Alternators
Spark Plugs
Ignitions
Late Model
Coils
Distributors
Crank Triggers
Timing/RPM Controls
Spark Plug Wires
Street Fire
Marine
Accessories
Specialty Items
Promo



READY-TO-RUN MARINE DISTRIBUTORS

Marine Ready-to-Run™

MSD's Ready-to-Run Marine distributors are the perfect upgrade for boats that are relying on worn-out breaker points or weak ignition systems. These new distributors feature a powerful ignition module built into the billet aluminum housing. This module produces a stout inductive spark that will improve combustion of the fuel mixture for better driveability.

Beneath the durable bolt-down, injection-molded cap, a maintenance-free magnetic pickup produces accurate trigger signals while an oversized shaft is guided by a sealed ball bearing. An easy-to-adjust mechanical advance allows you to custom tailor a timing curve to match your application.

The Ready-to-Run distributors are a breeze to install. Simply drop it in the engine and connect three wires and you're ready-to-run across the lake! Supplied with a cap, rotor, gear and Weathertight wiring harness.

- Only three wires to connect for a simple installation
- High output ignition module produces quick starts, smooth idle and improved mid range performance
- Accurate and maintenance-free magnetic pickup never needs adjustment
- Easily adjust the mechanical advance with the supplied springs and stop bushings to fit your boat's needs



PN 83606

Ready-to-Run Marine Distributors

Chevrolet V8 - **PN 83606**

Ford 351C-460 - **PN 83506**

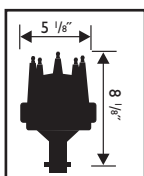

PN 83606 REPLACEMENT PARTS

Red Cap:	Rotor:	Gear:
PN 8565	PN 8467	PN 8531

For more distributor accessories see pages 116-124.

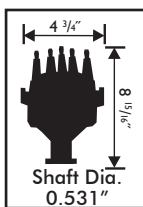

PN 83506 REPLACEMENT PARTS

Red Cap:	Black Cap:	Rotor:	Iron Gear:
PN 8431	PN 84313	PN 8467	PN 85812

For more distributor accessories see pages 116-124.



All of our marine distributors are equipped with flame arrestor holes machined into their billet aluminum housings.



PN 83506

MARINE



Atomic EFI
 Starters/
 Alternators/
 Spark Plugs
 Ignitions
 Late Model
 Coils
 Distributors
 Crank
 Triggers
 Timing/RPM
 Controls
 Spark Plug
 Wires
 Street Fire
 Marine
 Accessories
 Specialty
 Items
 Promo



MARINE DISTRIBUTORS

Promo
Accessories
Specialty
Items
Marine
Street Fire
Spark Plug
Wires
Timing/RPM
Controls
Crank
Triggers
Distributors
Coils
Late Model
Ignitions
Spark Plugs
Starters/
Alternators
Atomic EFI



PN 8366



PN 8560

Pro-Billet™ Marine Distributors

Marine environments place rigorous demands on every component of the ignition system, especially the distributor. The combination of water spray, salt exposure, full throttle acceleration and harsh vibrations all take their toll.

The MSD Pro-Billet distributor is the strongest and most accurate distributor you can put in your boat. The housing is CNC-machined from a billet of 6061-T6 aluminum creating a housing with no porosity. Internally, a QPQ coated shaft is guided by a sealed ball bearing and an extra long sintered bushing for high-speed stability.

Each distributor uses MSD's race-proven magnetic pickup to trigger the ignition control. Mounted just above the pickup is a mechanical advance assembly that is easy to adjust so you can dial-in an ignition curve to match your boat's application (except PN 8366).

For marine use, the distributor cap is bolted to the aluminum base. There are two flame arrester holes with brass screens machined into the base of the distributor to prevent ignition of gas fumes that may build up in the engine compartment. A special Weathertight connector is supplied to provide a positive-lock and water resistant connection.

The Marine Pro-Billet distributors have been tested by Underwriter's Laboratory and are certified to meet or exceed safety standards for marine ignition systems as set by the U.S. Coast Guard.

Late Model GM, EFI V8 - PN 8366
Marine Pro-Billet, V8 Chevy - PN 8560+
+Must be used with an MSD 6M-2L Ignition Control.

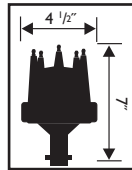

PN 8366 REPLACEMENT PARTS

Cap and Rotor Kit:	Gear:
PN 8406	PN 8531

For more distributor accessories see pages 116-124.

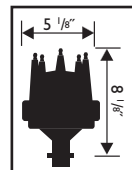

PN 8560 REPLACEMENT PARTS

Red Cap:	Rotor:	Gear:
PN 8565	PN 8467	PN 8531

For more distributor accessories see pages 116-124.

TECH TIP

PLUG WIRES

MSD distributors are topped with our own special molded distributor cap with male, spark plug style terminals. If you're changing from the older caps with socket style terminals you'll need to change the boots and terminals of the plug wires. MSD offers a kit online as PN 8849.



WIRE CONNECTORS

Deutsch Connectors

There is absolutely no excuse for losing a race due to a poor wiring connection. MSD's Deutsch Connectors are sealed and lock together making them perfect for harsh racing applications.

The compact housing of the connectors are molded from a durable plastic material that will not harden or crack. Each housing is indexed to prevent any chance of mismatching the ends plus they have a molded channel to secure another connector for a tidy appearance.

The terminals grip to the wire with strong crimp tabs then lock into position inside the housing. The connections are protected with thick seals that will keep water, mud and debris away from the contacts. These terminals can handle more current than conventional connectors and do not require special tools. Supplied with terminals, seals and housings.

- 2-Pin Connector, 16 gauge - PN 8183**
- 4-Pin Connector, 16 gauge - PN 8181**
- 6-Pin Connector, 16 gauge - PN 8180**
- 8-Pin Connector, 16 gauge - PN 8185**
- 12-Pin Connector, 16 gauge - PN 8186**
- 2-Pin Connector, 12-14 gauge - PN 8184**
- 4-Pin Connector, 12-14 gauge - PN 8187**

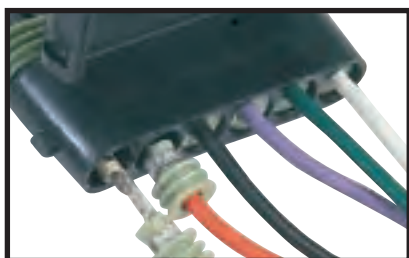

See page 152 for Crimp Tools.

Weathertight Sealed Connectors

If you need electrical connectors that are unaffected by water, chemicals, vibration, temperature or dirt, and that will not come apart accidentally, then you need MSD Weathertight Connectors.

The Weathertight connectors are molded from a special nylon material to withstand temperatures from -40° to +257°F and are indexed to prevent mismatching. Positive locks let you know when the connectors are completely joined by producing an audible CLICK. No click means no connection.

For maximum electrical isolation, each terminal has its own tower so there is no chance of shorting between the wires. Each terminal tower utilizes self-lubricating silicone seals for protection against water, dust, oil, and other engine compartment fluids.

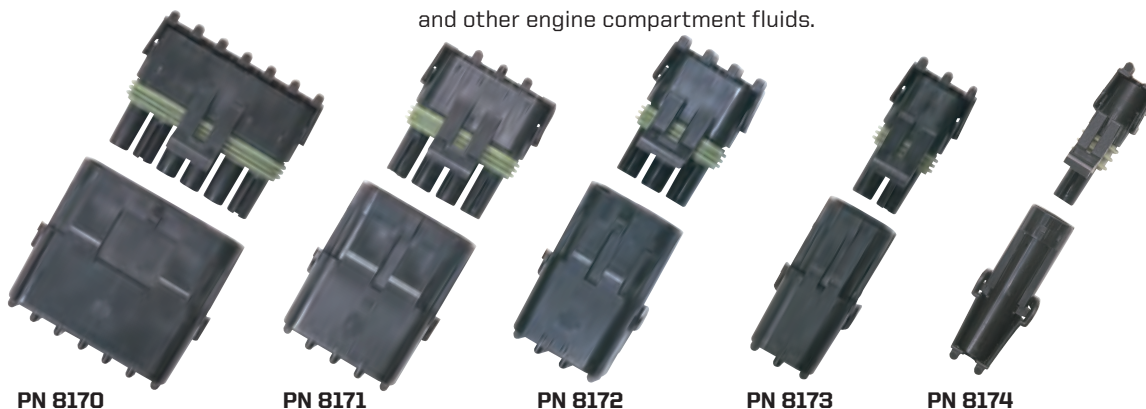

CONNECTORS

Male Tower/Female Shroud with Pins and Seals

CONNECTOR	INDIVIDUAL
6-Pin	PN 8170
4-Pin	PN 8171
3-Pin	PN 8172
2-Pin.....	PN 8173
1-Pin.....	PN 8174

Pin Extraction Tool - PN 8193

This Tool allows you to remove the terminal from the Weathertight connector if you need to make repairs or change your wiring.



- 10 Male Pins and Seals - PN 8190**
- 10 Female Pins and Seals - PN 8191**

Atomic EFI
 Starters/ Alternators/
 Spark Plugs
 Ignitions
 Late Model
 Coils
 Distributors
 Crank Triggers
 Timing/RPM Controls
 Spark Plug Wires
 Street Fire
 Marine
 Accessories Specialty Items
 Promo



SWITCHES & HARNESSES



Atomic EFI
Starters/Alternators
Spark Plugs
Ignitions
Late Model
Coils
Distributors
Crank Triggers
Timing/RPM Controls
Spark Plug Wires
Street Fire
Marine
Accessories
Specialty Items
Promo

PN 8812



Alternate Action Switch

This switch is designed to be used as an auxiliary ignition On/Off button. It can be mounted to the steering wheel within easy reach of the driver and can be used in a Normally Open or Normally Closed position. Assembled and constructed for harsh racing conditions.

Alternate Action Switch - **PN 8812**

PN 8862

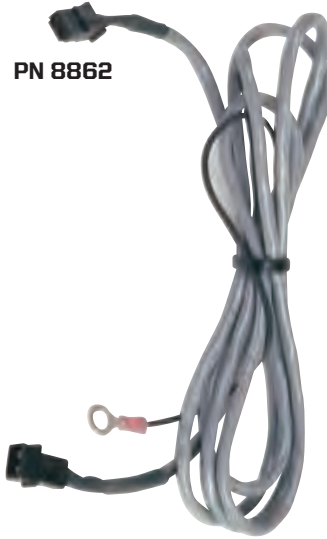

Shielded Mag Cable

This Shielded Magnetic pickup Cable will help protect the trigger signal from the distributor or crank trigger pickup from Electro Magnetic Interference (EMI). The pickup wires are wound together and routed through a special aluminum skinned sleeve that connects to ground. This provides a ground shield around the trigger wires. The Harness is six feet long and is equipped with matching 2-Pin connectors. Recommended with MSD Digital Ignitions and aftermarket EFI racing systems.

Shielded Magnetic Pick-Up Cable, 6' - **PN 8862**

PN 8860



Replacement Cables

When the time comes to replace the mag pickup harness, those worn out or burned cables, MSD offers a complete selection of cables to fit your needs. Use these harnesses to connect your MSD to your distributor, MSD 7-Series Ignition, PN 8860 or the MSD Marine, PN 64601.

6' Cable Harness, 2 Wire Magnetic Trigger - PN 8860
6M-2L Marine Harness - PN 64601

Harnesses and Adapters

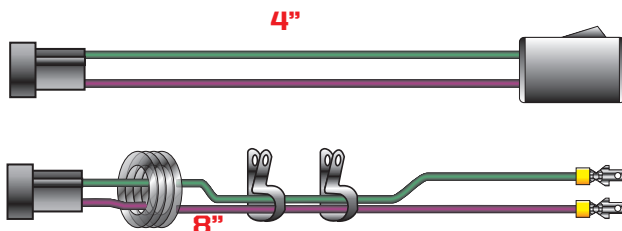

This adapter cable allows you to plug your MSD 6 or 7-Series Ignition or Timing Accessory directly into a Ford Duraspark Connector. **PN 8869**

The MSD GM HEI Module Bypass Cable Assembly allows you to plug an MSD 6 or 7-Series Ignition or Timing Accessory directly into the magnetic trigger inside a GM HEI distributor. **PN 8861**



Noise Filter

If you experience radio noise after installing the MSD Ignition, you may need to install an MSD Noise Filter. Electro Magnetic Interference (EMI) is occasionally generated from the MSD power cables and can be easily eliminated by installing the Noise Filter on the heavy power supply wires coming from the MSD. When the MSD draws current, it will draw through the Noise Filter instead of directly from the battery, so all other accessories that operate off 12 volts, like the radio, fuel pump, or the engine computer, will be unaffected by the MSD.

The Noise Filter will also prevent damage to the MSD during jump-starts and will keep a vehicle's 12 volt line "clean" by removing any voltage and current surges that could interfere with the operation of some MSD accessories such as the Soft Touch Rev Control or the 2-Step Module Selector. It is recommended that the Noise Filter be used on installations with the MSD 7 and 8-Series Ignitions to prevent this interference.

MSD Noise Filter w/Cover, 26 kufd - PN 8830



Two Pin Connector

MSD's Two Pin Connector Kit replaces damaged connectors or aids in custom wiring. This is the same connector used on MSD's magnetic pickup harnesses. Each kit comes with two connectors and four pins.

MSD Two Pin Connector - PN 8824

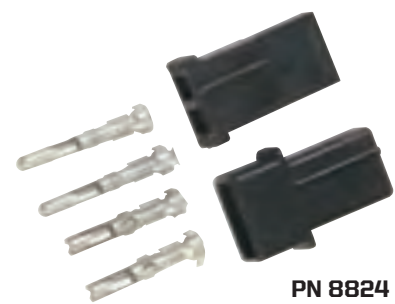

Vibration Mounts

In many performance applications such as off-road, drag race, marine and oval track racing, strong vibration forces can be transmitted through the chassis to the MSD unit. To protect the MSD from excessive vibration, we recommend the use of these vibration mounts. MSD offers three types of vibration mounts, one for the MSD 5 and 6 Ignitions, one for the MSD 7, 8 and 10-Series, and one for the Pro Power Coil.

Vibration Mounts, 7AL-2, 7AL-3, 8 and 10 -Series,

1" x .75", 4/Card - **PN 8800**

Vibration Mounts, 5 and 6, SCI, Digital 7-Series,

.75" x .63", 4/Card - **PN 8823**

Vibration Mounts, Pro Power Coil, .44" x .50", 3/Card - PN 8825

Vibration Mounts, Blaster SS Coil, .44" x .50", 3/Card - PN 8839



Ballast Resistor

For use with an MSD Blaster Coil when connected to a stock points ignition system.

0.8 ohm Ballast Resistor - PN 8214

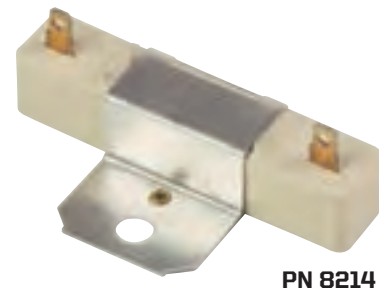

Atomic EFI
Starters/
Alternators
Spark Plugs
Ignitions
Late Model
Coils
Distributors
Crank
Triggers
Timing/RPM
Controls
Spark Plug
Wires
Street Fire
Marine
Accessories
Specialty
Items
Promo





TACH ADAPTERS



Atomic EFI
Starters/Alternators
Spark Plugs
Ignitions
Late Model
Coils
Distributors
Crank Triggers
Timing/RPM Controls
Spark Plug Wires
Street Fire
Marine
Accessories
Specialty Items
Promo

Tachometer/Fuel Injection Adapters

If your tachometer, fuel injection, fuel pump relay or even aftermarket water injection does not work properly after installing an MSD Ignition, you may need an MSD Tach Adapter. There are basically two types of tachometers: voltage-triggered and current-triggered. Voltage-triggered tachs are the most common and most aftermarket tachs, fuel injection systems, fuel pump relays and water injection systems are voltage triggered.

On stock systems that use voltage-triggered tach/fuel injection systems, the tach or fuel injector control picks up an rpm signal from the negative coil (-) terminal. With the MSD installed, the coil (-) terminal can no longer be used as a trigger signal for tachometers. The MSD is equipped with a tach output terminal which you should try connecting your tach's trigger wire to first. In most instances, this will trigger the tach/fuel injection. If not, an MSD Tach Adapter may be necessary.

The second type of tachs are current-triggered tachs. These are usually factory installed and wired in-line with the positive side of the coil (+). They are triggered by the amount of current that is passed through them. These tachs will require a PN 8920 Tach Adapter or Ballast Resistor.

ORIGINAL WIRING: CURRENT TRIGGER

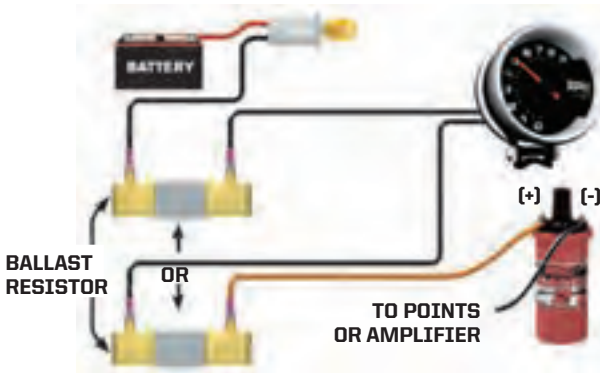

Current-Triggered Tachs

If you are using a current-triggered tach and use the White wire to trigger the MSD unit, you can use a Chrysler Dual Ballast Resistor (used on 1973-1976 vehicles), available at your local auto parts store. If using the magnetic pickup wire (Green and Violet wires) to trigger the MSD, you need a PN 8920 Adapter.

Voltage-Triggered Tachs

If you are using a voltage-triggered tach and using the White wire to trigger the MSD Ignition Unit, you need a PN 8910 Tach Adapter. If using the Magnetic pickup (Green and Violet wires) to trigger the MSD, you need a PN 8920 Adapter.

USING A CHRYSLER DUAL BALLAST RESISTOR

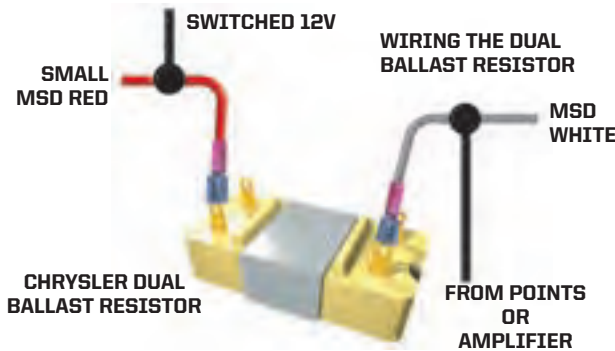

GM Tachometer

GM vehicles have an in-line filter that should be bypassed if the factory tachometer drops back to zero as the engine rpm increases. The drawings below show what the filter might look like. For correct operation, disconnect both wires from the filter and leave them disconnected. Connect the wire going to the tachometer to the MSD Ignition unit tach output terminal.



ORIGINAL WIRING: VOLTAGE TRIGGERED

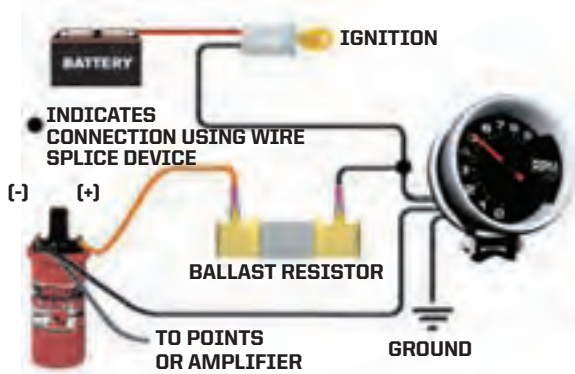

TECH TIP
WHY DO I NEED A TACH ADAPTER?
 Some tachometers or factory EFI systems require a kick-back signal that the ECU or tach use. This is especially prevalent in imports and some late models. This signal is no longer available with an MSD Ignition and in these cases, a Tach Adapter is required. See page 169 for more info.



TACH ADAPTERS

Trigger Source: Points Or Amplifier (Factory Ignition Module)

If you are triggering an MSD 6 or 7-Series Ignition with its white wire or points terminal, you will need the PN 8910 Tach Adapter. The PN 8910 will correct the operation of most voltage-triggered tachometers or fuel injection systems that do not work directly off the tach output terminal of the MSD Ignition Unit.

Tach Adapter - PN 8910

For use on non-current limiting ignitions, originally equipped with a ballast resistor.

Tach Adapter - PN 8910-EIS

Designed for current-limiting ignition systems (non-ballast resistor systems).

NOTE: For applications using an MSD DIS Ignition see page 63.

Trigger Source: Magnetic Pickup

If you are using the magnetic pickup input (green and violet wires) to trigger your MSD Ignition, you will need the PN 8920 Tach Adapter. The PN 8920 will correct the operation of most voltage-triggered tachometers that do not work directly off the tach output terminal of the MSD control. This Adapter should also be used on current-triggered tachs (hooked in series with the ignition switch).

Tach/Fuel Adapter, Magnetic Trigger Installations or Current Triggered Tachometers - PN 8920



PN 8910



PN 8920

Aftermarket Tachometer	White Wire Trigger	Magnetic Trigger Connector
AUTOGAGE.....	8910.....	8920
AUTOMETER.....	NONE.....	NONE
FORD MOTORSPORTS.....	NONE.....	NONE
MALLORY.....	NONE.....	NONE
STEWART.....	8910.....	8920
S.W. & BI TORX.....	NONE.....	NONE
SUN.....	8910.....	8920
VDO.....	NONE.....	NONE
AMC (JEEP).....	8910.....	8920
CHRYSLER.....	8910.....	8920
FORD.....	8910.....	8920
GENERAL MOTORS.....	Bypass In-line Filter.....	.Bypass In-line Filter
IMPORTS.....	.8910/8910-EIS.....	8920

Distributorless Tach Driver

Ever wonder how you can install an aftermarket tachometer on a vehicle with no distributor and multiple coil packs? MSD has the answer with the Distributorless Tach Driver!

The compact Tach Driver measures only 1.5" x 3.5" x 2" and is potted with a polyurethane compound for vibration and water protection so it can easily be mounted under the hood. It wires inline on the coils' 12 volt supply wire where it senses the current going through this wire and converts this information into a 12 volt output signal that most aftermarket tachometers use as a trigger signal. It can be used on 4, 6 or 8-cylinder engines.

NOTE: Not for use on odd-fire engines.

Distributorless Tach Driver - PN 8913



PN 8913

US PATENT PENDING

Atomic EFI
Starters/ Alternators
Spark Plugs
Ignitions
Late Model
Coils
Distributors
Crank Triggers
Timing/RPM Controls
Spark Plug Wires
Street Fire
Marine
Accessories
Specialty Items
Promo





IGNITION TOOLS



Atomic EFI
Starters/Alternators
Spark Plugs
Ignitions
Late Model
Coils
Distributors
Crank Triggers
Timing/RPM Controls
Spark Plug Wires
Street Fire
Marine
Accessories
Specialty Items
Promo

PN 8992



PN 89921

NOTE: The PN 8992 supersedes the chrome PN 8990 light.

MSD Timing Light

This MSD Timing Light is perfect for working in a garage, outside in the sun, or anywhere else you need to check your timing. The light provides stable, reliable signals from 0 to 10,000 rpm so that you can be sure of your tune all the way through red-line. With a patented flash, we make it easy to see your timing scale by being up to three times brighter than standard timing lights.

This rugged timing light is built to work in the toughest of environments. The MSD Timing Light's heavy duty resin casing is strong, easy to clean, and resistant to corrosives and most other chemicals that could get on it while you work. This light is built to protect itself from the abuse that occurs to tools.

The MSD Light uses a metal inductive pickup that will not melt if accidentally touched against hot components like an exhaust manifold. A 6-foot leads provide plenty of reach from the battery to most timing indicators. The battery clamps are color-coded, insulated, and have a strong spring to ensure a tight, safe connection.

**MSD Timing Light, Inductive - PN 8992
Replacement Harness - PN 89921**

Self-Powered Timing Light

An accurate timing light is extremely important to the performance of your engine. MSD's Self-Powered Timing Light is a tool every performance tuner should have.

A great feature of the Self-Powered Timing Light is that it does not require 12 volts. This means less wires are hanging over the engine compartment and makes for quick, easy checks. For power, the Light uses six AAA batteries.

The lightweight assembly is injection molded for great durability and produces an intense strobe that is easy to view through 5,000 rpm. The inductive pickup is detachable for easy storage.

**Self-Powered Timing Light - PN 8991
Harness - PN 89911**



PN 8991

**Great for Sprint Cars
and Street Rods with
NO Battery Access!**

MSD Timing Tapes

Accurate ignition timing is one of the most vital adjustments you can make to your engine. Proper timing can mean the difference between winning and losing a race or even blowing an engine (as a worst case scenario). Recognizing the importance of the timing, MSD offers these Timing Tapes.

The MSD Timing Tape comes with eight different tapes to fit common balancers ranging from 5.25" to 8" in diameter. The tapes are marked off in one degree increments from 14° ATDC to 64° BTDC and are printed on a tough, chemical resistant material.

Not only do the MSD Timing Tapes help you get an exact timing setting, they allow you to see exactly where the total timing is set. Remember, the total timing is just as critical as the initial timing and the MSD Timing Tape will help you ensure that it is set accurately.

MSD Timing Tapes - PN 8985

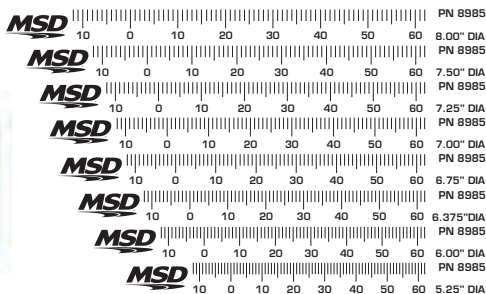

MSD Timing tapes will help you set your timing exactly where you want it!



IGNITION TESTERS

Atomic EFI
Starters/ Alternators
Spark Plugs
Ignitions
Late Model
Coils
Distributors
Crank Triggers
Timing/RPM Controls
Spark Plug Wires
Street Fire
Marine
Accessories
Specialty Items
Promo

If a race engine hesitates or bumbles on the track, the first thing that is suspected is the ignition system. MSD offers an ignition tester to assist racers when troubleshooting in the pits.

The tester allows you to check the operation of the ignition control and coil without removing them from the car! You can also confirm rev limits, shift points, tachometer accuracy and more by varying the rpm with the two control knobs. Every racer's toolbox should have an MSD Ignition Tester!

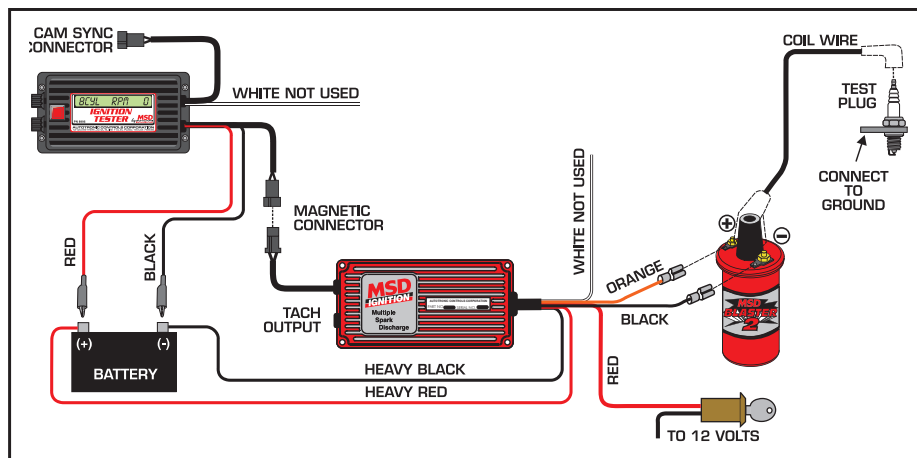

PN 8998



EASILY CHECK AND TEST:

- Operation of the Ignition and Coil
- Rev Limits and Shift Lights
- RPM Switch Operation
- Tachometer Accuracy

MSD Single Channel Digital Ignition Tester

This Tester will check the operation of all of MSD's single-channel CD Ignition controls. Once the ignition tests good, you can continue troubleshooting and find the culprit.

The Tester produces a simulated trigger signal that fires the ignition just as if the engine was running. A special, load-producing clip-on spark plug is included to connect to the coil wire. If the spark is unable to jump the gap of the tester, there is an ignition problem and you can track it down.

For racers with our Digital Programmable 7 Ignition controls that are using a non-magnetic pickup as sync signal for individual cylinder management, the Tester has a circuit to check its operation too.

The Tester has an LCD display that clearly shows the simulated rpm. This also allows you to test the accuracy of any rpm limits, rpm-activated switches, shift light operation and your tachometer. The Tester operates on 4, 6 or 8-cylinder engines and will simulate up to 16,000 rpm.

MSD Single Channel Digital Ignition Tester PN 8998

TECH TIP

SERIAL PORT TO USB CONNECTIONS

The Programmable Series of ignitions that use the Pro-Data+ software require a serial port connection. If your PC only has a USB, you'll need an adapter. MSD recommends IOGEAR GUC232A.



SERIAL PORT

USB CONNECTION



SPECIALTY ITEMS



Atomic EFI
Starters/Alternators
Spark Plugs
Ignitions
Late Model
Coils
Distributors
Crank Triggers
Timing/RPM Controls
Spark Plug Wires
Street Fire
Marine
Accessories
Specialty Items
Promo

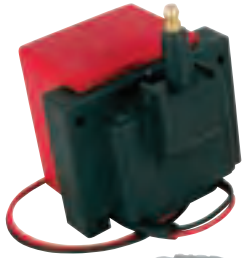

PN 5801

Continuous Fire Ignitor

MSD developed this device to fire generators and similar engines that run continuously at a steady rpm but there are many other uses as well. The compact unit features a built in coil with a molded in 22" 8.5mm Super Conductor spark plug wire so there is no concern for the connection at the coil. The unit is completely potted and encased in a sturdy epoxy compound for protection against harsh environments. Once 12 volts and ground are applied to the only two wires of the unit, a high voltage spark is fired! The rpm on a V8 engine is rated at approximately 1,200 rpm.

Continuous Fire Ignitor - PN 5801



PN 4376

Heavy Gauge Quick Disconnect

Need a heavy duty connector? MSD offers this new connector designed for extreme size circuits using up to 6-gauge wiring. The connector can handle up to 50 amps and features low resistance tin plated copper contacts that lock together to ensure a solid connection that will not come apart. The connectors are molded in a single pieces and feature stainless steel springs to hold the contacts in place. The Heavy Gauge Connectors are ideal for electric fans, fuel pump wiring or high current solenoids.

Heavy Gauge Quick Disconnect - PN 4376



PN 4390

Heavy Duty Relay

Need a relay that can handle serious current? The new MSD Heavy Duty Relay will support up to 65 amps which is perfect for high performance nitrous solenoids or fuel pumps. It is constructed to lock out moisture and can live in racing and underhood environments thanks to the stainless steel mount. The large copper terminals assure solid contact with the terminals for a worry-free connection.

Heavy Duty Relay - PN 4390



PN 8812

Universal Push Button Switch

This switch is designed to be used as an auxiliary ignition On/Off button. It can be mounted to the steering wheel within easy reach of the driver and can be used in a Normally Open or Normally Closed position. Assembled and constructed for harsh racing conditions.

Push Button Switch, Alt Action - PN 8812



MSD

PROMOTIONAL ITEMS

MSD Decals



9" x 3.5" - **PN 9310**



9" x 4" - **PN 9290**



9" x 4" - **PN 9294**
6" x 2.75" - **PN 9295**



9" x 3.5" - **PN 9300**
7.5" x 3.5" - **PN 9299**
24" x 12" - **PN 9302**
Multi-Size - **PN 9303**
5.5" x 2.25" - **PN 9306**



9" x 4" - **PN 9292**



9" x 4" - **PN 9293**



9" x 4" - **PN 9291**



9" x 4" - **PN 9296**



9" x 4" - **PN 9309**



Spark Plug

Floor Decal 22"x36", approx. - **PN 9740**
Window Cling 22"x36", approx. - **PN 9741**
Window Cling 6"x12", approx. - **PN 9742**

MSD Banner

Let customers know you carry MSD Ignition products by displaying our giant 3' x 5' banner inside your store, at the races or during your cruise night. The MSD Banner will give your store that "speed shop" look and will bring attention to the MSD line of products with the red and black MSD logo. There's also a smaller banner available!

MSD Banner, 3' x 5' - **PN 9420**
Mini MSD Banner, 1' 11" x 2' 11" - **PN 9421**
MSD Atomic Banner, 3' x 5' - **PN 9424**

MSD 2015 Catalog CD

This CD is full of text and product photos and will come in handy to help our dealers when doing catalog ads and websites. PC and Mac Compatible.

MSD Catalog CD - **PN 9606**



Also Available in Print!
MSD Catalog - **PN 9600**

Atomic EFI
Starters/
Alternators
Spark Plugs
Ignitions
Late Model
Coils
Distributors
Crank
Triggers
Timing/RPM
Controls
Spark Plug
Wires
Street Fire
Marine
Accessories
Specialty
Items





TECHNICAL INFO



Atomic EFI
Starters/
Alternators
Spark Plugs
Ignitions
Late Model
Coils
Distributors
Crank
Triggers
Timing/RPM
Controls
Spark Plug
Wires
Street Fire
Marine
Accessories
Specialty
Items
Promo



MSD Wiring, Build Book and Application Guide

MSD Wiring Diagrams and Tech Notes Book - PN 9615

Wiring CD - PN 9607

No race garage or trailer should be without this MSD bible. This comprehensive book covers current MSD components and shows you how to install them to a variety of different engines and ignition systems. There are pages of technical information including specifications, coil applications, wiring tips and troubleshooting. Countermeasures will find this book extremely helpful when customers are searching for an ignition system or asking tough technical questions.

How to Build High Performance Ignition Systems PN 9630

There are many things to consider when you're looking to upgrade your ignition system and plenty of different ignition systems to consider as well. "How to Build High Performance Ignition Systems" from CarTech Publishing is loaded with answers. The tome is full of theory, installation examples and information about different systems, distributors and coils so you can select the right parts for your engine. Give it a read!

Spark Plug Application Guide - PN 9730

Tech Bulletins

The importance of rotor phasing and how to check it.

Rotor Phasing - FRM 32121

Radio and Electronic Noise - FRM 29515

How to recognize and prevent frustrating radio and engine electronic noise.

Top Ten Ignition Questions - FRM 29233

Complete answers to our most asked questions.

Magnetic Pickup Tips - FRM 29562

Suggestions to help you get the most from your magnetic pickup.

Catalogs and Brochures

MSD also offers a variety of products for specialty markets and has brochures to supply more information to each market.

MSD Mini Catalog - PN 9610

This pocket sized catalog gives customers a look at a variety of MSD's product line.

MSD your late model Mustang - FRM 31570

DynaForce Alternators and Starters Brochure - FRM 32511

Atomic Brochure - FRM 32369

LS Product Brochure - FRM 32387

Apparel Brochure - FRM 32485

Check out our latest offering in hats, shirts and jackets!

8.5mm Super Conductor Wire Brochure - FRM 31839

This full-color brochure covers most of the 8.5mm applications and shows all of the performance features of this great plug wire.

MSD Pro Mag Catalog - FRM 32609

This catalog is full of race winning MSD Pro Mag information including parts, technical information and specifications.

Atomic Frequently Asked Questions - FRM 32580

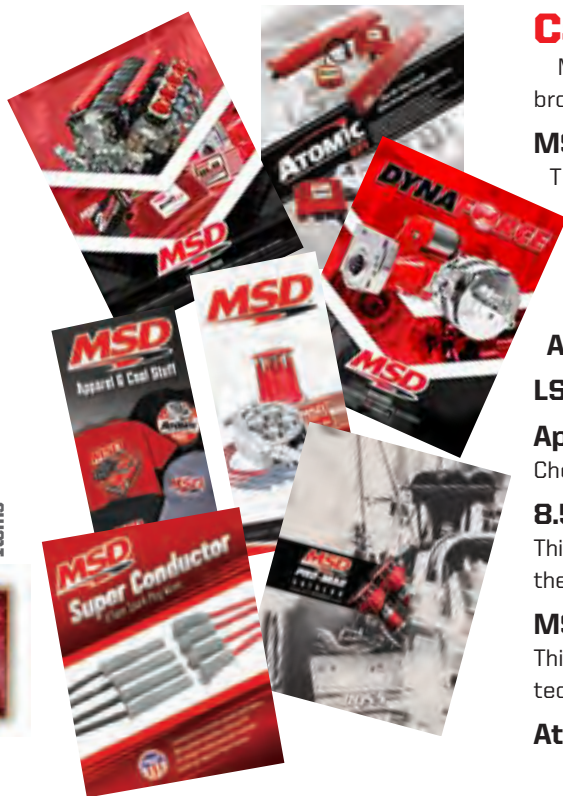



P.O.P. & APPAREL

Atomic EFI
Starters/
Alternators
Spark Plugs
Ignitions
Late Model
Coils
Distributors
Crank
Triggers
Timing/RPM
Controls
Spark Plug
Wires
Street Fire
Marine
Accessories
Specialty
Items

Empty Box Plan-O-Gram

One of the best ways to boost your MSD product sales is to maximize the amount of exposure your customer receives from MSD products. With the MSD Plan-O-Gram Display you can do just that by putting MSD Packaging directly in front of your customers! The MSD Plan-O-Gram will generate sales for you and is available to MSD dealers at no cost. The Plan-O-Gram is supplied with empty boxes for MSD Ignition Controls, Spark Plug Wire, Billet Distributor, carded coil and accessories plus a 8" x 2' header card. It measures approximately 2' x 4' and comes with information cards.



MSD Plan-O-Gram, 2' x 4' - PN 94441

MSD Caps

A cap with the MSD logo displayed prominently on the front is just what you need to stay cool and look sharp at those hot races. Comes with a sewn-in adjustable strap so that one size fits all.



MSD BASEBALL CAPS:

Gray Adjustable Hat - PN 9519

Black Flexfit - PN 95191

MSD Beanie

Keep your noggin warm on those cool nights at the races with an MSD Beanie!

Black Beanie - PN 93541



MSD Apron

Ideal for working on your engine or to protect your clothes while barbecuing after a successful day at the races. A special blend of cotton/polyester with duracote finish makes this apron super durable. MSD logo displayed proudly on the front. One size fits all.



MSD Apron Red - PN 9328

MSD 6AL Key Chain

You would think this miniature MSD 6AL would run a model plane engine, but instead it will hold your keys. Supplies are limited and when they're gone, they're gone!

Key Chain - PN 9390



MSD Patch

The MSD Patch is deal for firesuits, jackets, hats of all types and other sportswear, the MSD Patch can easily be sewn onto all types of materials, and is completely washable. The revised patch is embroidered in bright red, black and white and measures 2" x 4.5"



MSD Patch, 2" x 4.5" - PN 93121

MSD Shop Jacket and Shirt



The hip length zipper front jacket has an MSD patch on chest and back, a button down collar, ribbed cuffs and a zippered pocket in the lining. The button down shirt has an MSD patch on chest and back and two button up pockets on the front.

SHOP JACKET

- BLACK
- Small - **PN 9364**
- Medium - **PN 93641**
- Large - **PN 93642**
- X-Large - **PN 93643**
- XX-Large - **PN 93644**

SHOP SHIRT

- BLACK
- Small - **PN 9535**
- Medium - **PN 95351**
- Large - **PN 95352**
- X-Large - **PN 95353**
- XX-Large - **PN 95354**





T-Shirts

Let everyone know that you use the best ignition components available with these high quality, 100% cotton pre-shrunk MSD T-shirts.



- A. OFF-ROAD, BLACK**
 Medium - PN 95113
 Large - PN 95123
 X-Large - PN 95133
 XX-Large - PN 95143
- B. SPRINT CAR, GRAY**
 Medium - PN 95114
 Large - PN 95124
 X-Large - PN 95134
 XX-Large - PN 95144
- C. MSD ATOMIC, BLACK**
 Medium - PN 95115
 Large - PN 95125
 X-Large - PN 95135
 XX-Large - PN 95145
- D. STREET RACER, BLACK**
 Medium - PN 95116
 Large - PN 95126
 X-Large - PN 95136
 XX-Large - PN 95146
- E. PRO MAG, BLACK**
 Medium - PN 95117
 Large - PN 95127
 X-Large - PN 95137
 XX-Large - PN 95147

COMING SOON
SPARK PLUG, BLACK
 Medium - PN 95118
 Large - PN 95128
 X-Large - PN 95138
 XX-Large - PN 95148

MSD Polo Shirts



The polo shirts are 100% polyester with coolplus wicking.

- F. POLO SHIRT, RED**
 Medium - PN 95111
 Large - PN 95121
 X-Large - PN 95131
 XX-Large - PN 95141
- G. POLO SHIRT, GRAY**
 Medium - PN 95112
 Large - PN 95122
 X-Large - PN 95132
 XX-Large - PN 95142

MSD Long Sleeve and Sweatshirt



The long sleeve t-shirt is 100% cotton. The sweatshirt is 80% cotton and 20% polyester.

- H. LONG SLEEVE T-SHIRT, BLACK**
 Large - PN 9375
 X-Large - PN 9376
- I. SWEATSHIRT, BLACK**
 Large - PN 9385
 X-Large - PN 9386
 XX-Large - PN 9387

Accessories
 Specialty Items
 Marine
 Street Fire
 Spark Plug Wires
 Timing/RPM Controls
 Crank Triggers
 Distributors
 Coils
 Late Model
 Ignitions
 Spark Plugs
 Starters/Alternators
 Atomic EFI

Promo



MSD
MSD BRAND

Racepak
An MSD Brand

AN **MSD** BRAND

Racepak Atomic UDX Street Dash

Our sister company, Racepak, is the hands-down leader in drag race data acquisition systems. To complement their data recorder line, they also offer a number of incredible dashboards. We put our heads together and came up with a digital dash made for the street that connects directly into the Atomic Throttle Body EFI system. The Atomic UDX Street Dash will save you time, wiring and expense by sharing the data within the Atomic system. Better yet, all of the Atomic's data is relayed to the UDX through a single cable connection! The dash will display; coolant temp, fuel pressure, intake air temp, manifold absolute pressure, rpm and the air/fuel ratio. Since this is a street dash, Racepak added a speedometer/odometer, warning lights for oil psi and water temp, high beam indicator, turn signals and even a parking brake lamp!



Racepak Atomic UDX Street Dash - PN 250-DS-UDXEFIAT IQ3 Display Dash

The IQ3 Display Dash can be utilized with any of Racepak's V-Net data loggers, providing a compact, fully programmable LCD digital dash for use in a variety of motorsports.

Progressive shift lights, eight warning lights and all inputs are easily programmable through the DatalinkII software supplied with each data logger.

In addition, the IQ3 dash can be utilized as a standalone display dash, independent of a Racepak V-Net data logger, through the use of optional sensors off of the V-Net port, located on the rear of the dash.



SmartWire

Solving the wiring complexity of the modern race car, the Racepak SmartWire is a fully programmable power control module. While traditional wiring provides control of vehicle electronic components through the routing of wiring to single or multiple fuses, relay and circuit breaker panels, the Racepak Smartwire functions as a central "command center" for all vehicle wiring.

Based on Racepak's exclusive single cable V-Net technology, the Racepak SmartWire module is the electronic "starting point", with a direct main power connection from the vehicle battery to the module. Each input/output is then user defined, both in function, power requirements and current exceeding limits via a USB connection to the user's PC. The design of the module functions to both reduce overall installation weight / clutter, while providing a quicker reacting electronic system, through the solid state switching design.

The V-Net compatibility insures a seamless integration with existing Racepak data logger or displayed equipped vehicles, while also providing a future upgrade path for additional inputs, control modules and instrumentation, when utilized as a standalone power control module.



Atomic EFI
Starters/
Alternators
Spark Plugs
Ignitions
Late Model
Coils
Distributors
Crank
Triggers
Timing/RPM
Controls
Spark Plug
Wires
Street Fire
Marine
Accessories
Specialty
Items
Promo