

CATALOGUE 2019



THE GENUINE DEFINITION OF WINNING!



PROIX
RACING PARTS

DIRTBIKE | STREETBIKE | ALLTERRAIN | WATERCRAFT | SNOWMOBILE | 50CC & MOPED

PISTON PINS (O.E.M. Replacement Pins)



ProX Racing Parts offers a wide range of piston pins in many sizes and specifications. We offer straight wall and tapered wall pistons pins. Our chromed pistons pins are specially designed for the application. Every ProX piston pin is machined precisely and treated to get the best hardness and properties to stand the extreme conditions where it is used for.

Size (mm)	Part No.	Size (mm)	Part No.	Size (mm)	Part No.
10 x 33.00	04.1033	16 x 41.40	04.1641.4	19 x 50.30	04.1950.3
12 x 30.50	04.1230.5	16 x 41.50	04.1641.5	19 x 50.40	04.1950.4
12 x 31.50	04.1231.5	16 x 41.60	04.1641.6	19 x 50.50	04.1950.5
12 x 33.00	04.1233	16 x 41.90	04.1641.9	20 x 45.00	04.2045
12 x 33.90	04.1233.9	16 x 44.40	04.1644.4	20 x 47.60	04.2047.6
12 x 36.40	04.1236.4	16 x 44.50	04.1644.5	20 x 50.45	04.2050.5
12 x 39.00	04.1239	16 x 45.00	04.1645	20 x 50.90	04.2050.9
12 x 39.60	04.1239.6	16 x 46.50	04.1646.5	20 x 55.50	04.2055.5
12 x 40.00	04.1240	16 x 46.90	04.1646.9	20 x 55.80	04.2055.8
13 x 30.50	04.1330.5	16 x 47.00	04.1647	20 x 57.50	04.2057.5
13 x 38.50	04.1338.5	16 x 48.00	04.1648	20 x 58.40	04.2058.4
14 x 33.00	04.1433	16 x 53.00	04.1653	20 x 60.40	04.2060.5
14 x 36.50	04.1336.5	16 x 54.00	04.1654	20 x 65.75	04.2065.8
14 x 38.50	04.1438.5	16 x 57.00	04.1657	20 x 69.00	04.2069
14 x 39.00	04.1439	16 x 59.00	04.1659	21 x 50.90	04.2150.9
14 x 39.50	04.1439.5	17 x 43.00	04.1743	21 x 51.00	04.2151
14 x 40.90	04.1440.9	17 x 55.00	04.1755	21 x 63.50	04.2163.5
14 x 41.00	04.1441	18 x 43.90	04.1844	21 x 65.00	04.2165
14 x 45.00	04.1445	18 x 44.45	04.1844.4	21 x 65.00	04.2165T
14 x 46.00	04.1446	18 x 46.90	04.1846.9	22 x 50.80	04.2250.8
14 x 47.50	04.1447.5	18 x 49.90	04.1850	22 x 50.90	04.2250.9
15 x 41.00	04.1541	18 x 50.40	04.1850.4	22 x 51.00	04.2251
15 x 43.80	04.1543.8	18 x 52.70	04.1852.7	22 x 68.00	04.2268
15 x 45.00	04.1545	18 x 53.30	04.1853.3	22 x 69.90	04.2269.9
15 x 45.80	04.1545.8	18 x 53.40	04.1853.4	22 x 70.00	04.2270
15 x 46.70	04.1546.7	18 x 55.00	04.1855	22 x 72.00	04.2272
15 x 46.90	04.1546.9	18 x 56.00	04.1856	23 x 57.20	04.2357.2
15 x 47.00	04.1547	18 x 56.90	04.1856.9	23 x 63.50	04.2363.5
15 x 50.00	04.1550	18 x 57.00	04.1857	24 x 57.10	04.2457.1
16 x 37.90	04.1637.9	18 x 58.00	04.1858	24 x 63.50	04.2463.5
16 x 40.00	04.1639.9	18 x 59.00	04.1859	24 x 69.00	04.2469
16 x 40.90	04.1640.9	19 x 47.50	04.1947.5	24 x 69.00	04.2469

PISTON CLIPS (O.E.M. Replacement Clips)



ProX Racing Parts offers a wide range of clips for many piston diameters in different styles depending on the application:

- C-style
- G-style

Piston clips are not just a circled wire. They avoid the pin to move in the piston bosses. Do not underestimate the forces on the pin during operation.

Size (mm)	Remarks	Part No.	Size (mm)	Remarks	Part No.
10 x 0.9	C-Type	05.1009	19 x 1.2	C-Type	05.1912
10 x 1.0	C-Type	05.1010	20 x 1.0	C-Type	05.2010
10 x 1.0	G-Type	05.1010G	20 x 1.2	C-Type	05.2012
12 x 1.0	C-Type	05.1210C	20 x 1.3	C-Type	05.2013
12 x 1.0	G-Type	05.1210G	20 x 1.4	C-Type	05.2014
13 x 1.0	C-Type	05.1310	20 x 1.5	C-Type	05.2015
14 x 1.0	C-Type	05.1410C	21 x 1.2	C-Type	05.2112
14 x 1.0	G-Type	05.1410G	21 x 1.4	C-Type	05.2114
14 x 1.0	Rotax	05.1410R	21 x 1.5	C-Type	05.2115
14 x 1.2	C-Type	05.1412	21 x 1.6	C-Type	05.2116
15 x 1.0	C-Type	05.1510	22 x 1.2	C-Type	05.2212
16 x 1.0	C-Type	05.1610	22 x 1.4	C-Type	05.2214
16 x 1.2	C-Type	05.1612C	22 x 1.5	C-Type	05.2215
16 x 1.2	G-Type	05.1612G	22 x 1.6	C-Type	05.2216
17 x 1.0	C-Type	05.1710	23 x 1.2	C-Type	05.2312
17 x 1.2	C-Type	05.1712C	23 x 1.8	C-Type	05.2318
18 x 1.0	C-Type	05.1810	24 x 1.2	C-Type	05.2412
18 x 1.2	C-Type	05.1812	24 x 1.4	C-Type	05.2414
18 x 1.4	C-Type	05.1814	24 x 1.4	C-Type	05.2414
18 x 1.5	C-Type	05.1815			
19 x 1.0	C-Type	05.1910			

PISTON PIN BEARINGS (O.E.M. Replacement Bearings)



ProX offers a complete line of piston pin bearings for the Dirtbike, ATV, PWC and 50cc/scooter segment. The pistons pin bearings are manufactured by the leading Japanese OEM factories. All pistons pin bearings are designed and developed to OEM specifications and are a direct and cost efficient OEM replacement. Full line of piston pin bearings for Dirtbike, ATV, PWC and 50cc/scooter available from ready stock.

ProX Piston Pin Bearing features

- Manufactured by leading Japanese OEM factories.
- Designed to exact OEM specifications to be a direct and cost efficient OEM replacement.
- Complete line for Dirtbike, ATV, PWC and 50cc/scooter available from stock.

Size (mm)	Rollers	Part No.	Size (mm)	Rollers	Part No.	Size (mm)	Rollers	Part No.
10 x 14 x 12	9 pcs	21.1000	15 x 19 x 20	14 pcs	21.4214	18 x 23 x 22.8	13 pcs.	21.5598
12 x 15 x 14.3	13 pcs	21.7012	15 x 20 x 18	12 pcs	21.2217	19 x 24 x 25	13 pcs	21.4408
12 x 15 x 14.7	13 pcs	21.6011	16 x 20 x 17.7	14 pcs	21.3349	20 x 24 x 22.8	16 pcs.	21.5503
12 x 15 x 16	13 pcs	21.2001	16 x 20 x 19.5	13 pcs	21.2250	20 x 24 x 23	16 pcs	21.5510
12 x 16 x 15	10 pcs	21.4100	16 x 20 x 20	14 pcs	21.2202	20 x 25 x 21.8	16 pcs.	21.2798
12 x 16 x 16	10 pcs	21.3001	16 x 20 x 21.8	14 pcs.	21.5695	20 x 25 x 22	16 pcs	21.5507
12 x 16 x 16	11 pcs	21.2018	16 x 20 x 22	12 pcs	21.2012	20 x 25 x 22.8	15 pcs.	21.5700
12 x 17 x 14	10 pcs	21.1003	16 x 20 x 23	12 pcs	21.4504	20 x 25 x 23.8	15 pcs.	21.2697
12 x 17 x 15	10 pcs	21.2103	16 x 21 x 17.5	12 pcs	21.2014	20 x 25 x 24	15 pcs	21.2510
14 x 18 x 16	12 pcs	21.1111	16 x 21 x 19	12 pcs	21.4204	20 x 25 x 25	16 pcs	21.4510
14 x 18 x 16	12 pcs	21.3103	16 x 21 x 19.5	12 pcs	21.2011	20 x 25 x 29	15 pcs	21.1404
14 x 18 x 17	12 pcs	21.4103	16 x 21 x 22	12 pcs	21.2020	21 x 25 x 24	16 pcs	21.5515
14 x 18 x 18	12 pcs	21.1205	16 x 22 x 19.7	16 pcs	21.6320	20 x 25 x 23.8	13 pcs.	21.5698
14 x 18 x 20	11 pcs	21.3202	18 x 22 x 22	15 pcs	21.1303	21 x 27 x 24.8	14 pcs.	21.5808
14 x 19 x 17	11 pcs	21.1103	18 x 22 x 22	15 pcs	21.2309	22 x 27 x 23	17 pcs	21.2518
14 x 19 x 17	11 pcs	21.3205	18 x 22 x 22.8	15 pcs.	21.5400	22 x 27 x 23.8	17 pcs.	21.5807
15 x 19 x 16.7	13 pcs	21.1206	18 x 22 x 23	14 pcs	21.1316	22 x 27 x 24.8	17 pcs.	21.5801
15 x 19 x 17.2	14 pcs	21.1211	18 x 22 x 24	14 pcs	21.4305	22 x 27 x 25	16 pcs	21.4512
15 x 19 x 17	14 pcs	21.2221	18 x 23 x 21.8	13 pcs.	21.5696	24 x 29 x 23.8	18 pcs.	21.5802
15 x 19 x 20	14 pcs	21.3206	18 x 23 x 22	14 pcs	21.3303			

THRUSTWASHERS (O.E.M. Replacement Washers)



ProX OEM style washers increases oil retention and reduces friction between rod, washer and crank web.

Size (mm)	Remarks	Part No.	Size (mm)	Remarks	Part No.
16 x 29 x 1.0	Copper	03W.16291.0	26 x 42 x 1.5	Silver	03W.26421.5
18 x 31 x 1.0	Silver	03W.18311.0	27 x 45 x 1.5	Silver	03W.27451.5
18 x 33 x 1.0	Silver	03W.18331.0	28 x 45 x 1.0	Silver	03W.28451.0
20 x 33 x 1.0	Silver	03W.20331.0	30 x 46 x 1.0	Silver	03W.30461.0
20 x 34 x 1.5	Silver	03W.20341.5	30 x 48 x 0.5	Copper	03W.30480.5
22 x 35 x 0.5	Copper	03W.22350.5	30 x 50 x 1.0	Silver	03W.30501.0
22 x 35 x 1.0	Silver	03W.22351.0	32 x 50 x 1.0	Copper	03W.32501.0
22 x 35 x 1.5	Silver	03W.22351.5	33 x 53 x 1.0	Silver	03W.33531.0
22 x 37 x 1.0	Silver	03W.22371.0	34 x 53 x 1.0	Silver	03W.34531.0
24 x 40 x 1.5	Silver	03W.24401.5	34 x 54 x 0.5	Copper	03W.34540.5
24 x 41 x 1.0	Silver	03W.24411.0	35 x 55 x 1.0	Copper	03W.35551.0
25 x 40 x 1.0	Silver	03W.25401.0	38 x 57 x 1.0	Copper	03W.38571.0
25 x 42 x 1.0	Silver	03W.25421.0	40 x 60 x 1.0	Copper	03W.40601.0

BIG END PINS

(O.E.M. Replacement Pins)

Our chromed crank pins are specially designed for the application. Every ProX crank pin is machined precisely and treated to get the best hardness and properties to stand the extreme conditions where it is used for. Our 4 stroke crank pins have precision located oil canals to maximize oiling under extreme conditions.



Size (mm)	Remarks	Part No.
16 x 40.00	Solid	06.1640
18 x 42.00	Hollow	06.1842
18 x 43.30	Hollow	06.1843.3
18 x 43.50	Solid	06.1843.5
18 x 54.30	-	06.1854.3
18 x 56.00	Solid	06.1856
19 x 50.00	-	06.1950
20 x 45.00	Hollow	06.2045
20 x 45.90	Hollow	06.2045.9
20 x 46.00	Hollow	06.2046
20 x 49.00	-	06.2049
22 x 45.90	Hollow	06.2245.9
22 x 46.00	Hollow	06.2246
22 x 47.00	Hollow	06.2247
22 x 51.00	Hollow	06.2251
22 x 53.00	Hollow	06.2253H
22 x 54.00	Caps	06.2254
22 x 54.50	Solid	06.2254.5
22 x 55.00	Hollow	06.2255
22 x 56.50	Hollow	06.2256.5
24 x 58.00	Hollow	06.2458
24 x 58.50	Hollow	06.2458.5
24 x 59.00	Caps	06.2459
24 x 59.10	Hollow	06.2459.1
24 x 59.30	Hollow / Caps	06.2459.3
24 x 59.60	Caps	06.2459.6
25 x 50.00	Hollow / Caps	06.2550
25 x 59.60	Caps	06.2559.6
25 x 60.50	Solid	06.2560.5
26 x 43.50	Solid / Lub. Hole	06.2643.5
26 x 53.00	Solid	06.2653
26 x 55.00	Solid	06.2655
26 x 58.00	Hollow	06.2658
26 x 67.65	Hollow	06.2668
27 x 68.30	Solid	06.2768.3
28 x 42.50	Hollow / 1 Cap	06.2842.5
28 x 55.00	Solid	06.2855
28 x 57.00	Solid	06.2857
30 x 53.00	Hollow / Caps	06.3053
30 x 53.60	Hollow / Caps	06.3053.6
30 x 54.80	Hollow / 1 Cap	06.3054.8
30 x 54.80	Hollow / 1 Cap	06.3054.8-1
30 x 55.00	Hollow / Caps	06.3055
30 x 55.90	Hollow / Caps	06.3055.9
30 x 56.00	Hollow / Caps	06.3056
30 x 56.50	Hollow / Caps	06.3056.5
32 x 54.80	Hollow / Caps	06.3254.8
32 x 56.00	Hollow / Caps	06.3256
32 x 59.90	Hollow / Caps	06.3259.9
32 x 64.60	Hollow / Caps	06.3264.6
32 x 67.80	Hollow / 1 Cap	06.3267.8
33 x 60.80	Hollow / Caps	06.3360.8
34 x 58.30	Hollow / Caps	06.3458.3
34 x 59.90	Hollow / Caps	06.3459.9
34 x 60.00	Solid	06.3460
34 x 60.80	Hollow / 1 Cap	06.3460.8
34 x 60.90	Hollow / Caps	06.3460.9
34 x 61.00	Hollow / Caps	06.3461
34 x 62.00	-	06.3462
34 x 64.90	-	06.3464.9
34 x 66.00	Hollow / Caps	06.3466
35 x 62.70	-	06.3562.7
35 x 63.90	-	06.3563.9
35 x 64.70	Hollow / 1 Cap	06.3564.7
35 x 67.00	Hollow / Caps	06.3567
36 x 62.80	Hollow / 1 Cap	06.3662.8
36 x 71.00	-	06.3671

Size (mm)	Remarks	Part No.
37 x 73.80	Hollow / 1 Cap	06.3773.8-2
38 x 65.00	Hollow / Caps	06.3865
40 x 65.00	Hollow / 1 Cap	06.4065
40 x 73.80	Hollow / 1 Cap	06.4073.8

BIG END BEARINGS

(O.E.M. Replacement Bearings)

The ProX big-end bearings are manufactured by leading OEM factories in Japan such as IKO and NTN. The bearings are made of the finest materials and designs based on the latest technology in the industry. A large selection of M-cage bearings as well as Flat-cage bearings depending on each type of engine performance and rpm.



Size (mm)	Rollers	Remarks	Part No.
18 x 24 x 14	13 pcs	Silver / M-Cage	22.182414
18 x 24 x 14	15 pcs	Silver / Flat Cage	22.182414F
18 x 24 x 15	15 pcs	Silver / Flat Cage	22.182415F
20 x 26 x 14	16 pcs	Silver / Flat Cage	22.202614F
20 x 26 x 15	14 pcs	Silver / M-Cage	22.202615
20 x 26 x 15	16 pcs	Silver / Flat Cage	22.202615F
20 x 29 x 14	12 pcs	Silver / M-Cage	22.202714
20 x 27 x 14	14 pcs	Silver / Flat Cage	22.202714F
22 x 28 x 16	14 pcs	Silver / M-Cage	22.222816
22 x 28 x 16	18 pcs	Silver / Flat Cage	22.222816F
22 x 29 x 14	16 pcs	Silver / Flat Cage	22.222914F
22 x 29 x 16	14 pcs	Silver / M-Cage	22.222916
22 x 29 x 16	15 pcs	Silver / Flat Cage	22.222916F
22 x 29 x 17	14 pcs	Silver / M-Cage	22.222917
22 x 29 x 17	16 pcs	Silver / Flat Cage	22.222917F
24 x 30 x 17	17 pcs	Silver / M-Cage	22.243017
24 x 30 x 17	19 pcs	Silver / Flat Cage	22.243017F
24 x 30 x 20	19 pcs	Silver / Flat Cage	22.243020F
24 x 31 x 16	-	Silver / Flat Cage	22.243116F
24 x 31 x 17	15 pcs	Silver / M-Cage	22.243117
24 x 31 x 17	16 pcs	Silver / Flat Cage	22.243117F
24 x 32 x 20	12 pcs	Silver / M-Cage	22.243220
24 x 32 x 20	16 pcs	Silver / Flat Cage	22.243220F
25 x 31 x 20	15 pcs	Silver / M-Cage	22.253120
25 x 32 x 16	17 pcs	Silver / Flat Cage	22.253216F
25 x 32 x 16.5	17 pcs	Silver / Flat Cage	22.253216.5F
25 x 32 x 20	16 pcs	Silver / M-Cage	22.253220
26 x 33 x 18	16 pcs	Silver / M-Cage	22.263318
26 x 33 x 22	15 pcs	Silver / Flat Cage	22.263322F
26 x 34 x 20	14 pcs	Silver / M-Cage	22.263420
26 x 35 x 20	14 pcs	Silver / Flat Cage	22.263520F
27 x 34 x 21	16 pcs	Silver / M-Cage	22.273421
28 x 35 x 18	17 pcs	Silver / M-Cage	22.283518
28 x 36 x 20	15 pcs	Silver / M-Cage	22.283620
30 x 38 x 16	17 pcs	Silver / M-Cage	22.303816
30 x 38 x 18	17 pcs	Copper / M-Cage	22.303818C
30 x 38 x 18	19 pcs	Silver / Flat	22.303818F
30 x 38 x 18	19 pcs	Silver / Flat	22.303818F-1
30 x 38 x 18	17 pcs	Silver / M-Cage	22.303818S
30 x 38 x 19	20 pcs	Silver / Flat	22.303819F
30 x 38 x 20	19 pcs	Silver / Flat Cage	22.303820F
32 x 40 x 18	20 pcs	Silver / Flat	22.324018F
32 x 40 x 20	18 pcs	Silver / M-Cage	22.324020
32 x 40 x 20	20 pcs	Silver / Flat Cage	22.324020F
33 x 41 x 20	20 pcs	Silver / Flat Cage	22.334120F
34 x 42 x 20	21 pcs	Silver / Flat Cage	22.344220F
34 x 42 x 21	21 pcs	Silver / Flat Cage	22.344221F
34 x 43 x 20	16 pcs	Silver / M-Cage	22.344320
35 x 42 x 20	21 pcs	Silver / Flat Cage	22.354220F
35 x 43 x 20	22 pcs	Silver / Flat-Cage	22.354320F
35 x 43 x 22	19 pcs	Silver / Flat-Cage	22.354322F
36 x 45 x 23	20 pcs	Silver / Flat-Cage	22.364523F
36 x 45 x 23	18 pcs	Silver / Flat-Cage	22.364523F-1
37 x 45 x 22	22 pcs	Copper / Flat-Cage	22.374522F
38 x 50 x 23	17 pcs	Silver / Flat Cage	22.385023F
40 x 50 x 22	21 pcs	Silver / Flat Cage	22.405022F
40 x 50 x 23	19 pcs	Silver / Flat Cage	22.405023F

BALL BEARINGS (O.E.M. Replacement Bearings)

ProX stocks a wide variety of high quality ball and roller bearings. It does not matter if you need Crankshaft Bearings, Steering Bearings, Swingarm Bearings or Wheel Bearings, ProX has them all. And of course in the best quality available. At ProX you will only find the top quality brands like KOYO, NTN, SKF, HIC, MBS, etc. This will enable you to rebuild your specific assembly to, reliable and as new specifications.



Size (mm)	Remarks	Part No.
8 x 22 x 7	2 side sealed	23.608-2RS
10 x 22 x 6	C3	23.6900C3
10 x 35 x 11	2 side sealed	23.6300-2RS
10 x 39 x 9	2 side sealed	23.6200-2RS
12 x 28 x 7	C3	23.16001
12 x 28 x 8	C3	23.6001C3
12 x 28 x 8	2 side sealed	23.6001-2RS
12 x 32 x 10	2 side sealed	23.6201-2RS
12 x 37 x 12	2 side sealed	23.6301-2RS
15 x 32 x 9	2 side sealed	23.6002-2RS
15 x 35 x 11	C3	23.6202C3
15 x 35 x 11	2 side sealed	23.6202-2RS
15 x 42 x 13	2 side sealed	23.6302-2RS
17 x 35 x 10	C3	23.6003C3
17 x 35 x 10	2 side sealed	23.6003-2RS
17 x 40 x 12	C3	23.6203C3
17 x 40 x 12	2 side sealed	23.6203-2RS
17 x 47 x 14	C3	23.6303C3
17 x 47 x 14	2 side sealed	23.6303-2RS
20 x 37 x 9	2 side sealed	23.6904-2RS
20 x 42 x 12	2 side sealed	23.6004-2RS
20 x 47 x 12	-	23.SCO4A34
20 x 47 x 14	C3	23.6204C3
20 x 47 x 14	C4	23.6204C4
20 x 47 x 14	2 side sealed	23.6204-2RS
20 x 47 x 14	Grooved, with ring	23.6204NR
20 x 47 x 14	Coated Cage	23.83299SH
20 x 52 x 15	C3	23.6304C3
20 x 52 x 15	C4	23.6304C4
20 x 52 x 15	2 side sealed	23.6304-2RS
20 x 52 x 15	-	23.6304JR2
20 x 52 x 15	Coated Cage	23.6304SH
22 x 39 x 9	2 side sealed	23.6922-2RS
22 x 44 x 12	2 side sealed	23.6022-2RS
22 x 50 x 14	C3	23.6222C3
22 x 50 x 14	C4	23.6222C4
22 x 50 x 14	2 side sealed	23.6222-2RS
22 x 52 x 15	-	23.6304/22
22 x 56 x 16	C3	23.6322C3
22 x 56 x 16	C4	23.6322C4
22 x 56 x 16	C4, Coated Cage	23.6322SH2-9TC4
25 x 42 x 9	2 side sealed	23.6905-2RS
25 x 47 x 12	2 side sealed	23.6005-2RS
25 x 52 x 15	C3	23.6205C3
25 x 52 x 15	C4	23.6205C4
25 x 52 x 15	1 side sealed	23.6205-RS
25 x 52 x 15	2 side sealed	23.6205-2RS
25 x 52 x 15	Grooved, with ring	23.6205NR
25 x 52 x 15	Roller Bearing	23.NJ205
25 x 55 x 15	-	23.83A915
25 x 55 x 15	With pin	23.83A916C
25 x 55 x 18	Grooved, with pin	23.83B051D
25 x 56 x 16	-	23.SXO4B10
25 x 62 x 16	Grooved, with ring & pin	23.6305RI
25 x 62 x 17	C3	23.6305C3
25 x 62 x 17	2 side sealed	23.6305-2RS
25 x 62 x 17	Grooved, with ring	23.6305NR
25 x 62 x 17	-	23.6305JR2
25 x 62 x 17	Grooved, with pin	23.83406
25 x 62 x 17	Pinned	23.83464A
28 x 58 x 16	C3	23.6228C3
28 x 68 x 18	C3	23.6328C3
28 x 68 x 18	C4	23.6328C4
28 x 68 x 18	-	23.830048-4
28 x 72 x 18	-	23.6328/72C4
28 x 72 x 18	-	23.SCO6C50C4
30 x 47 x 9	2 side sealed	23.6906-2RS
30 x 62 x 16	C3	23.6206C3
30 x 62 x 16	C4	23.6206C4

Size (mm)	Remarks	Part No.
30 x 62 x 16	Grooved, with ring	23.6206NR
30 x 62 x 16	Grooved, with ring	23.6206NRC4
30 x 62 x 16	Pinned	23.6206PC3
30 x 62 x 16	-	23.6206RSI
30 x 62 x 16	-	23.830046-14
30 x 62 x 16	Roller Bearing	23.NJ206
30 x 62 x 16	Roller Bearing	23.NJ206ECP-1
30 x 62 x 16	Grooved, Roller Bearing	23.NJ206ECP-2
30 x 62 x 16	Grooved, Roller Bearing	23.NJ206ECP-3
30 x 62 x 16	-	23.TMB206
30 x 62 x 20	-	23.62206
30 x 63 x 16	-	23.830046-20
30 x 64 x 16	-	23.830046-1
30 x 72 x 16	-	23.SX06C62
30 x 72 x 16	-	23.SX06C62V1
30 x 72 x 18	-	23.6306R/3
30 x 72 x 19	C3	23.6306C3
30 x 72 x 19	Grooved, with ring	23.6306NR
30 x 72 x 19	Pinned	23.6306PC3
30 x 72 x 19	-	23.6306YA1C4
30 x 72 x 19	-	23.83C072C
30 x 72 x 19	-	23.SX06C42
30 x 72 x 19	-	23.SX06D11
30 x 72 x 19	Roller Bearing	23.NJ306C3
30 x 72 x 19	-	23.TMB306
30 x 76 x 17.5	-	23.SC0692C3
30 x 76 x 19	Grooved	23.SX06C84
30 x 76 x 19	Grooved	23.SX06C84CS
32 x 65 x 17	C3	23.6232C3
32 x 65 x 17	-	23.6232X2
32 x 72 x 30	With pinholes	23.83B207
32 x 75 x 19.9	-	23.6332R
32 x 75 x 20	-	23.830053-4
35 x 62 x 14	-	23.6007-2RS
35 x 72 x 17	C3	23.6207C3
35 x 72 x 17	C4	23.6207C4
35 x 72 x 17	Grooved, with ring	23.6207NR
35 x 72 x 17	Grooved, with ring & pin	23.6207NRLT
35 x 72 x 17	Pinned	23.6207PC4
35 x 72 x 17	With pinhole	23.6207YR9
35 x 72 x 17	With pin	23.6207-26JR
35 x 72 x 17	With pin	23.83A844A
35 x 72 x 17	Roller Bearing	23.NJ207ECS
35 x 72 x 17	Roller Bearing	23.NJ207ECP-1
35 x 72 x 17	Grooved	23.SX07E39
35 x 72 x 27	With pinhole & pin	23.5207-1LT
35 x 80 x 18	With pin	23.6307/18
35 x 80 x 18.5	-	23.SC07A08
35 x 80 x 21	-	23.6307
35 x 80 x 21	C3	23.6307C3
35 x 80 x 21	Grooved, with ring	23.6307NR
35 x 80 x 21	With pin	23.83A948
35 x 80 x 21	Grooved, with pinhole	23.83B727
35 x 80 x 31	Roller Bearing	23.2307W11
35 x 80 x 35	Pinned	23.5307
36 x 76 x 17.5	-	23.SC0775CS
39 x 58 x 16	Roller Bearing	23.8ENK/16
39 x 60 x 16	Roller Bearing	23.8ENK/60
39 x 65 x 18	Roller Bearing	23.8ENK
40 x 76 x 17.5	-	23.DG407618
40 x 80 x 18	C3	23.6208C3

CRANKSHAFT OILSEALS (O.E.M. Oilseals)



ProX offers a wide range of crankshaft oil seals for the MX, ATV and PWC segment. The major part of the crankshaft oil seals are manufactured by the OEM factories in Japan. Premium base materials are made to OEM specs and tolerances for steady and guaranteed quality and superior durability! The ProX crankshaft oilseals are assembled in sets to be the easy and cost efficient OEM replacement for each application in the MX, ATV or PWC segment.

Size (mm)	Part No.
15 x 24 x 7	41.6-076000
15 x 24 x 7	41.6-152472
17 x 28 x 7	41.8-95017
17 x 35 x 7	41.2-17067
17 x 35 x 7	41.6-077000
18 x 30 x 6	41.3-18006
18 x 30 x 7	41.3-18007
20 x 32 x 7	41.1-166004
20 x 35 x 6	41.6-076100
20 x 35 x 8	41.1-444005
20 x 37 x 6	41.3-20051
20 x 37 x 7	41.1-KZ3861
20 x 40 x 7	41.2-20485
20 x 40 x 7	41.4-1052
20 x 40 x 7	41.4-1188
20 x 40 x 7	41.6-59977
20 x 40 x 8	41.2-20447
20 x 40 x 9	41.4-1300
22 x 38 x 7	41.2-22419
22 x 40 x 7	41.2-22363
22 x 40 x 8	41.1-GC4711
23 x 57 x 7	41.2-23174
25 x 35 x 7	41.6-253570
25 x 37 x 6	41.3-25083
25 x 37 x 6	41.3-25099
25 x 38 x 7	41.3-25082
25 x 40 x 6	41.4-1365
25 x 40 x 7	41.4-1250
25 x 40 x 8	41.2-25098
25 x 40 x 8	41.2-25125
25 x 40 x 8	41.2-25258
25 x 40 x 10	41.2-25108
25 x 42 x 6	41.2-25M50
25 x 44 x 8	41.3-25012
25 x 44 x 8	41.2-25331
25 x 45 x 7	41.4-1051
25 x 48 x 8	41.2-25M35
25 x 62 x 6	41.5-831355
26 x 35 x 6	41.6-263561
27.8 x 55 x 10	41.2-28004
28 x 38 x 7	41.7-230425
28 x 38 x 9	41.3-28025
28 x 40 x 8	41.2-28011
28 x 40 x 8	41.3-28007
28 x 45 x 8	41.1-444003
28 x 50 x 8	41.1-HA2771
28 x 52 x 8	41.3-28024
28 x 56 x 8	41.1-KE6831
29 x 47 x 8	41.3-29002
30 x 40 x 6	41.3-30069
30 x 40 x 7	41.3-30061
30 x 40 x 7	41.4-0030
30 x 42 x 6	41.6-304261
30 x 44 x 8	41.2-30008
30 x 45 x 8	41.1-KS6004

Size (mm)	Part No.
30 x 47 x 6	41.6-304760
30 x 47 x 7	41.6-304772
30 x 50 x 7	41.4-057
30 x 55 x 10	41.2-30150
30 x 62 x 6	41.5-831990
30 x 62 x 7	41.5-830748
30 x 62 x 9	41.4-3006
30 x 62 x 10	41.4-507
30 x 72 x 6	41.4-3706
30 x 72 x 7	41.6-0041
30 x 72 x 10	41.4-3704
30 x 72 x 10	41.4-3705
31 x 45 x 7	41.1-K95A21
32 x 40 x 5	41.6-92896
32 x 44 x 8	41.2-32099
32 x 44 x 8	41.2-32171
32 x 44 x 8	41.2-32183
32 x 44 x 9	41.4-1301
32 x 47 x 6	41.3-32037
32 x 48 x 7.5	41.1-KSE671
32 x 48 x 10	41.2-32M01
33 x 72 x 8.5	41.5-931711
34 x 45 x 6.5	41.6-324564
34 x 79 x 2	41.5-931450
34.5 x 90 x 5	41.2-36M61
34.5 x 90 x 5	41.2-36M62
35 x 42 x 4	41.6-354240
35 x 47 x 7	41.6-354774
35 x 51 x 8	41.2-35M03
35 x 68 x 8	41.2-35M57
35 x 72 x 7	41.5-831952
35 x 80 x 6	41.4-3716
35 x 80 x 6	41.6-0043
35 x 80 x 8	41.4-3715
35 x 80 x 8	41.6-0042
36 x 52 x 8	41.3-36004
36 x 52 x 8	41.3-36007
36 x 55 x 10	41.2-36182
36 x 80 x 8	41.2-36M33
36 x 80 x 8	41.2-36M46
38 x 52 x 7	41.1-1MEB671
38 x 52 x 7	41.6-385273
38 x 52 x 8	41.3-38018
38 x 58 x 11	41.1-KA4004
39 x 53 x 7	41.1-MKEA01
39 x 56 x 7	41.1-2MEB671
39 x 56 x 7.5	41.1-2K95A21
39 x 56 x 7.5	41.1-MEY671
40 x 55 x 6	41.6-405560
40 x 55 x 6	41.6-405561
40 x 55 x 10	41.2-40091
40 x 62 x 10	41.2-40077
40 x 72 x 10	41.5-830638
40 x 80 x 7	41.8-931280
45 x 87 x 6	41.5-931750

CRANKSHAFT OILSEAL SETS

Set Part No.	Seal No.1	Qty.	Seal No.2	Qty.	Seal No.3	Qty.	Seal No.4	Qty.
42.1100	41.1-166004	1	41.1KE6831	1	-	-	-	-
42.1103	41.1-166004	1	41.1-GC4711	1	-	-	-	-
42.1200	41.1-444003	1	41.1-444005	1	-	-	-	-
42.1202	41.1-444005	1	41.1-KS6004	1	-	-	-	-
42.1206	41.1-166004	1	41.1-KS6004	1	-	-	-	-
42.1207	41.1-KSE671	1	41.1-1MEB671	1	-	-	-	-
42.1301	41.1-444003	1	41.1-KA4004	1	-	-	-	-
42.1304	41.1-166004	1	41.1-KA4004	1	-	-	-	-
42.1312	41.1-KZ3861	1	41.1-KA4004	1	-	-	-	-

Set Part No.	Seal No.1	Qty.	Seal No.2	Qty.	Seal No.3	Qty.	Seal No.4	Qty.
42.1348	41.1-K95A21	1	41.1-2K95A21	1	-	-	-	-
42.1365	41.1-HA2771	1	41.1-KA4004	1	-	-	-	-
42.1402	41.1-1MEB671	1	41.1-2MEB671	1	-	-	-	-
42.1405	41.1-1MEB671	1	41.1-MEY671	1	-	-	-	-
42.1417	41.1-MKEA01	1	41.1-1MEB671	1	-	-	-	-
42.2005	41.2-17067	1	41.2-23174	1	-	-	-	-
42.2008	41.2-25098	1	41.2-32183	1	-	-	-	-
42.2018	41.2-20485	1	41.2-20485	1	-	-	-	-
42.2020	41.2-25108	1	41.2-40077	1	-	-	-	-
42.2102	41.2-20447	1	41.2-28011	1	-	-	-	-
42.2200	41.2-25125	1	41.2-28011	1	-	-	-	-
42.2201	41.2-25258	1	41.2-28011	1	-	-	-	-
42.2206	41.2-22363	1	41.2-32099	1	-	-	-	-
42.2218	41.2-22363	1	41.2-32183	1	-	-	-	-
42.2221	41.2-30008	1	41.2-20485	1	-	-	-	-
42.2225	41.2-22419	1	41.2-20485	1	-	-	-	-
42.2280	41.2-25331	1	41.2-32099	1	-	-	-	-
42.2281	41.2-25331	1	41.2-32171	1	-	-	-	-
42.2285	41.2-25012	1	41.2-32099	1	-	-	-	-
42.2300	41.2-30150	1	41.2-40091	1	-	-	-	-
42.2308	41.2-22363	1	41.2-40091	1	-	-	-	-
42.2318	41.2-22363	1	41.2-36182	1	-	-	-	-
42.2319	41.2-20485	1	41.2-36182	1	-	-	-	-
42.2321	41.2-28004	1	41.2-20485	1	-	-	-	-
42.2500	41.2-25M35	1	-	1	41.2-25M50	1	-	-
42.2510	41.2-32M01	1	41.2-36M33	1	41.2-36M46	1	-	-
42.2518	41.2-35M03	1	41.2-36M61	1	41.2-36M62	1	-	-
42.2520	41.2-35M57	1	41.2-36M61	1	41.2-36M62	1	-	-
42.3109	41.3-30061	1	41.3-18006	1	-	-	-	-
42.3206	41.3-28007	1	41.3-18006	1	-	-	-	-
42.3219	41.3-30061	1	41.3-18007	1	-	-	-	-
42.3314	41.3-38018	1	41.3-20051	1	-	-	-	-
42.3316	41.3-38018	1	41.3-25083	1	-	-	-	-
42.3320	41.3-25099	1	41.3-38018	1	-	-	-	-
42.3323	41.3-25099	1	41.3-28024	1	-	-	-	-
42.3325	41.3-25099	1	41.3-28025	1	-	-	-	-
42.3340	41.3-30061	1	41.3-30069	1	-	-	-	-
42.3350	41.3-36004	1	41.3-25082	1	-	-	-	-
42.3410	41.3-30061	1	41.3-32037	1	-	-	-	-
42.4100	41.4-1250	1	41.4-1250	1	-	-	-	-
42.4105	41.4-1188	1	41.4-1188	1	-	-	-	-
42.4205	41.4-1052	1	41.4-1052	1	-	-	-	-
42.4208	41.4-1300	1	41.4-1301	1	-	-	-	-
42.4288	41.4-1365	1	41.4-1365	1	-	-	-	-
42.4300	41.4-1051	1	41.4-1052	1	-	-	-	-
42.4350	41.4-1047	1	41.4-1051	1	-	-	-	-
42.4403	41.4-057	1	41.4-057	1	-	-	-	-
42.4505	41.4-3706	1	41.4-3705	1	41.4-3705	1	-	-
42.4519	41.4-3705	1	41.4-3715	1	41.4-3716	1	-	-
42.4607	41.4-1051	1	41.4-1051	1	-	-	-	-
42.5506	41.5-831952	1	41.5-830748	1	41.5-831990	1	41.5-831355	1
42.5507	41.5-831952	1	41.5-830748	1	41.5-831990	1	41.5-831990	1
42.5510	41.5-931450	1	41.5-931450	1	41.5-830748	1	41.5-830638	1
42.5515	41.6-0042	1	41.6-0042	1	41.5-931711	1	41.5-931750	1
42.6009	41.6-253570	1	41.6-152472	1	-	-	-	-
42.6011	41.6-076000	1	41.6-077000	1	-	-	-	-
42.6013	41.6-152472	1	41.6-263561	1	-	-	-	-
42.6017	41.6-076100	1	41.6-076100	1	-	-	-	-
42.6029	41.6-076100	1	41.6-304772	1	-	-	-	-
42.6103	41.6-076100	1	41.6-304261	1	-	-	-	-
42.6202	41.6-92896	1	41.6-59977	1	-	-	-	-
42.6218	41.6-324564	1	41.6-253570	1	-	-	-	-
42.6320	41.6-253570	1	41.6-385273	1	-	-	-	-
42.6320	41.6-385273	1	41.6-253570	1	-	-	-	-
42.6326	41.6-354240	1	41.6-304772	1	-	-	-	-
42.6336	41.6-405561	1	41.6-304760	1	-	-	-	-
42.6351	41.6-405560	1	41.6-304772	1	-	-	-	-
42.6427	41.6-405560	1	41.6-405560	1	-	-	-	-
42.6432	41.6-354774	1	41.6-354774	1	-	-	-	-
42.6680	41.6-0041	1	41.6-0042	1	41.6-0043	1	-	-
42.6698	41.6-304772	1	41.6-304772	1	-	-	-	-
42.7202	41.7-230425	1	41.7-230425	1	-	-	-	-

CAM CHAINS

ProX is offering a wide range of camchains for the MX, ATV and Roadbike market. For the supply of the camchains ProX has a successful cooperation with Borg Warner in Japan. Borg Warner is a big name in the industry and is known as one of the main suppliers to many OEM companies worldwide. The quality is proven and the range of products is very wide. Since the cooperation between ProX and Borg Warner the product program has increased significantly and a complete line of camchains for MX, ATV and Roadbikes is available from ready stock.

ProX Camchain features

- Manufactured in Japan by Borg Warner.
- Designed to OEM specifications.
- Strong M-type chain which has special heat treated pin plus advanced pin and link connection for maximum performance and durability.



Part No.	Chain Type	Remarks
31.1223	92RH2005-100M	BORG WARNER - MADE IN JAPAN
31.1227	92RH2015-96M	BORG WARNER - MADE IN JAPAN
31.1323	92RH2005-104M	BORG WARNER - MADE IN JAPAN
31.1331	92RH2010-126M	BORG WARNER - MADE IN JAPAN
31.1335	92RH2015-104M	BORG WARNER - MADE IN JAPAN
31.1340	92RH2015-106M	BORG WARNER - MADE IN JAPAN
31.1348	96RH2015-116M	BORG WARNER - MADE IN JAPAN
31.1384	82RH2015-102M	BORG WARNER - MADE IN JAPAN
31.1393	82RH2010-110M	BORG WARNER - MADE IN JAPAN
31.1396	82RH2010-102M	BORG WARNER - MADE IN JAPAN
31.1403	92RH2015-112M	BORG WARNER - MADE IN JAPAN
31.1409	96RH2015-108M	BORG WARNER - MADE IN JAPAN
31.1417	96RH2015-110M	BORG WARNER - MADE IN JAPAN
31.1419	96RH2015-112M	BORG WARNER - MADE IN JAPAN
31.1480	92RH2015-52M	BORG WARNER - MADE IN JAPAN
31.1485	92RH2015-56M	BORG WARNER - MADE IN JAPAN
31.1487	92RH2010-60M	BORG WARNER - MADE IN JAPAN
31.1493	92RH2015-114M	BORG WARNER - MADE IN JAPAN
31.1496	82RH2010-112M	BORG WARNER - MADE IN JAPAN
31.1655	82RH2010-118M	BORG WARNER - MADE IN JAPAN
31.1661	92RH2010-122M	BORG WARNER - MADE IN JAPAN
31.1683	82RH2015-118M	BORG WARNER - MADE IN JAPAN
31.1691	92RH2015-116M	BORG WARNER - MADE IN JAPAN
31.1900	92RH2015-124M	BORG WARNER - MADE IN JAPAN
31.1993	92RH2015-126M	BORG WARNER - MADE IN JAPAN
31.1997	92RH2015-130M	BORG WARNER - MADE IN JAPAN
31.2301	92RH2010-132M	BORG WARNER - MADE IN JAPAN
31.2398	82RH2005-94M	BORG WARNER - MADE IN JAPAN
31.2402	92RH2010-114M	BORG WARNER - MADE IN JAPAN
31.2404	92RH2005-110M	BORG WARNER - MADE IN JAPAN
31.2414	98XRH2010-144M	BORG WARNER - MADE IN JAPAN
31.2419	92RH2010-120M	BORG WARNER - MADE IN JAPAN
31.2423	98XRH2010-118M	BORG WARNER - MADE IN JAPAN
31.2429	98XRH2010-120M	BORG WARNER - MADE IN JAPAN
31.2432	92RH2010-116M	BORG WARNER - MADE IN JAPAN
31.2487	BF05M-90L	TSUBAKI - MADE IN JAPAN
31.2661	82RH2015-126M	BORG WARNER - MADE IN JAPAN
31.2669	92RH2015-120M	BORG WARNER - MADE IN JAPAN
31.2706	98XRH2010-126M	BORG WARNER - MADE IN JAPAN

Part No.	Chain Type	Remarks
31.2891	82RH2015-138M	BORG WARNER - MADE IN JAPAN
31.2904	98XRH2020-122M	BORG WARNER - MADE IN JAPAN
31.2986	219FTSS DHA 118LE	DID - MADE IN JAPAN
31.3390	82RH2010-108M	BORG WARNER - MADE IN JAPAN
31.3403	82RH2010-128M	BORG WARNER - MADE IN JAPAN
31.3407	82RH2010-124M	BORG WARNER - MADE IN JAPAN
31.3603	82RH2010-136M	BORG WARNER - MADE IN JAPAN
31.3607	82RH2015-120M	BORG WARNER - MADE IN JAPAN
31.3695	82RH2015-144M	BORG WARNER - MADE IN JAPAN
31.3796	82RH2015-128M	BORG WARNER - MADE IN JAPAN
31.3901	82RH2015-130M	BORG WARNER - MADE IN JAPAN
31.3987	82RH2015-142M	BORG WARNER - MADE IN JAPAN
31.3996	82RH2015-150M	BORG WARNER - MADE IN JAPAN
31.3997	92RH2015-92M	BORG WARNER - MADE IN JAPAN
31.3999	82RH2015-136M	BORG WARNER - MADE IN JAPAN
31.4347	98XRH2005-116	BORG WARNER - MADE IN JAPAN
31.4393	92RH2010-128M	BORG WARNER - MADE IN JAPAN
31.4406	98XRH2010-124M	BORG WARNER - MADE IN JAPAN
31.4409	98XRH2010-122M	BORG WARNER - MADE IN JAPAN
31.4663	98XRH2010-116M	BORG WARNER - MADE IN JAPAN
31.4907	98XRH2015-138M	BORG WARNER - MADE IN JAPAN
31.4994	92RH2015-134M	BORG WARNER - MADE IN JAPAN
31.6301	92RH2010-118M	BORG WARNER - MADE IN JAPAN
31.6307	92RH2015-118M	BORG WARNER - MADE IN JAPAN
31.6328	92RH2015-108M	BORG WARNER - MADE IN JAPAN
31.6351	98XRH2015-112M	BORG WARNER - MADE IN JAPAN
31.6356	T106ER-110N2	BORG WARNER - MADE IN JAPAN
31.6403	92RH2010-124M	BORG WARNER - MADE IN JAPAN
31.6427	98XRH2015-80M	BORG WARNER - MADE IN JAPAN
31.6428	92RH2015-110M	BORG WARNER - MADE IN JAPAN
31.6502	92RH2010-130M	BORG WARNER - MADE IN JAPAN
31.6508	92RH2015-114M	BORG WARNER - MADE IN JAPAN
31.6508	92RH2015-114M	BORG WARNER - MADE IN JAPAN
31.6508	92RH2015-114M	BORG WARNER - MADE IN JAPAN
31.6502	92RH2010-130M	BORG WARNER - MADE IN JAPAN
31.6508	92RH2015-114M	BORG WARNER - MADE IN JAPAN
31.6508	92RH2015-114M	BORG WARNER - MADE IN JAPAN
31.6502	92RH2015-110M	BORG WARNER - MADE IN JAPAN
31.6502	92RH2010-130M	BORG WARNER - MADE IN JAPAN
31.6508	92RH2015-114M	BORG WARNER - MADE IN JAPAN



ENGINE VALVES (O.E.M. Replacement & High Performance Valves)

ProX offers a complete range of high quality Titanium Valves for MX and ATV segment. The ProX Titanium Valves are forged in one piece for extra strength. The use of a special Ti3Al material in combination with a CrN coating will give the valves better material properties under high temperatures offering greater durability over the OEM Titanium Valves.



Titanium Valve Features

- Forged in one piece for extra strength.
- Use of special Ti3Al for better material properties under high temperatures.
- CrN coating for extra hardness and less friction between valves and guides.
- Greater durability than OEM Titanium Valves.
- Full range of products for MX and ATV available from stock.

Next to the Titanium valves ProX also offers a complete line of steel valves. The ProX steel valves are manufactured of premium grade steel to exact OEM specifications and tolerances. The ProX steel valves are made by the leading OEM factories in Japan and are a direct and cost-efficient OEM replacement. ProX steel valves can be used in combination with all the OEM valve train components like valve springs, guides, bases and retainers.

A complete line of steel valves is available for Dirtbike and ATV.

Steel Valve Features

- Manufactured by the leading OEM factories in Japan.
- Made to exact OEM specs and tolerances.
- The steel valves are a direct and cost efficient OEM replacement.
- Complete range for Dirtbike and ATV available from ready stock.

Valve Installation
Instructions on page 418

Part No.	OEM Reference	Material	Head (mm)	Length (mm)	Stem (mm)
28.1040-1	14721-GK4-601	Steel	16.00	68.60	5.00
28.1040-2	14711-GK4-013	Steel	19.00	69.00	5.00
28.1070-1	14721-GF6-000	Steel	20.00	65.40	5.00
28.2200-1	5HP-12121-00	Steel	22.00	63.60	5.00
28.1227-1	14721-KSE-670	Steel	22.50	79.90	4.50
28.1070-2	14711-GN5-713	Steel	23.00	65.90	5.00
28.2401-2	5NL-12111-10	Titanium	23.00	78.55	4.00
28.2401-3	5NL-12112-10	Titanium	23.00	80.05	4.00
28.2924-2	5VY-12111-00	Titanium	23.50	87.30	4.00
28.2924-3	5VY-12112-00	Titanium	23.50	88.45	4.00
28.1356-1	14721-KCZ-000	Steel	23.50	95.65	5.00
28.2401-1	5NL-12121-10	Titanium	24.50	77.85	4.50
28.4334-1	12005-0002	Titanium	25.00	79.10	4.50
28.4347-1	12005-0761	Titanium	25.00	80.40	4.50
28.3337-1	12912-10H00	Titanium	25.00	80.60	4.50
28.2414-1	1SM-12121-00	Titanium	25.00	82.40	4.50
28.1340-1	14721-KRN-A40	Steel	25.00	84.20	4.50
28.2924-1	5VY-12121-00	Titanium	25.00	87.60	4.50
28.1381-1	14721-437-000	Steel	25.00	91.50	5.50
28.2200-2	5HP-12111-01	Steel	26.00	64.40	5.00
28.1227-2	14711-KSE-670	Steel	26.00	78.00	4.50
28.3337.OS1-1	-	Titanium	26.00	80.60	4.50
28.1338-1	14721-KRN-A10	Steel	26.00	82.00	4.50
28.1334-1	14721-KRN-670	Steel	26.00	82.10	5.00
28.1226-1	14721-KRM-840	Steel	26.00	82.40	5.00
28.6333-1	777.36.031.000	Titanium	26.50	98.30	5.00
28.6326-1	770.36.031.000	Titanium	26.60	92.90	5.00
28.2423-2	5TA-12111-00	Titanium	27.00	76.30	4.50
28.2423-3	5TA-12112-00	Titanium	27.00	77.20	4.50
28.2418-2	5BE-12111-10	Steel	27.00	83.25	4.50
28.2420-2	5JG-12111-00	Titanium	27.00	83.25	4.50
28.2418-3	5BE-12112-10	Steel	27.00	84.35	4.50
28.2420-3	5JG-12112-00	Titanium	27.00	84.35	4.50
28.1323-1	14721-KBB-900	Steel	27.00	89.20	5.50
28.2423-1	5TA-12121-00	Titanium	28.00	75.08	5.00
28.2418-1	5BE-12121-10	Steel	28.00	82.00	5.00
28.2420-1	5JG-12121-00	Titanium	28.00	82.00	5.00
28.1358-2	14711-KPF-900	Steel	28.00	83.50	5.00
28.6425-1	8000 A4161	Titanium	28.50	90.55	5.00
28.2396-1	5HO-12121-00	Steel	28.50	92.55	6.00
28.1356-2	14711-KCZ-000	Steel	28.50	96.60	5.00
28.3406-1	12912-45G00	Titanium	29.00	81.00	5.50
28.3405-1	12912-35G00	Titanium	29.00	81.30	5.00
28.3407-1	12912-35G20	Titanium	29.00	81.30	5.50
28.3402-1	12912-29F00	Steel	29.00	81.35	5.00
28.1495-1	14721-KCY-670	Steel	29.00	101.30	5.50
28.6351-1	772.36.031.100	Titanium	29.10	89.10	5.50
28.1409-1	14721-MEN-A30	Steel	30.00	80.55	5.00
28.1226-2	14711-KRM-840	Steel	30.00	83.45	5.00
28.1407-1	14721-MEN-A00	Steel	30.00	84.30	5.00

PISTON PARTS
 CRANKSHAFT PARTS
 VALVE TRAIN PARTS
 CLUTCH PARTS
 GASKETS
 DRIVE TRAIN PARTS
 BRAKE PARTS
 SUSPENSION PARTS
 WHEEL & STEERING PARTS
 FUEL & AIR PARTS
 DIMENSIONS

PISTON PARTS
 CRANKSHAFT PARTS
 VALVE TRAIN PARTS
 CLUTCH PARTS
 GASKETS
 DRIVE TRAIN PARTS
 BRAKE PARTS
 SUSPENSION PARTS
 WHEEL & STEERING PARTS
 FUEL & AIR PARTS
 DIMENSIONS

ENGINE VALVES (O.E.M. Replacement & High Performance Valves)

Part No.	OEM Reference	Material	Head (mm)	Length (mm)	Stem (mm)
28.2440-1	33D-12121-00	Titanium	30.00	85.95	5.50
28.1381-2	14711-437-000	Steel	30.00	92.05	5.50
28.6423-1	594.36.031.000	Titanium	30.00	97.00	6.00
28.6520-1	590.36.031.000	Steel	30.00	97.05	6.00
28.2661-2	5KM-12111-00	Steel	30.00	100.55	6.00
28.2444-1	1SL-12121-00	Titanium	30.50	85.80	5.50
28.1340-2	14711-KRN-A40	Titanium	30.50	89.15	5.00
28.6326-2	770.36.030.000	Titanium	30.90	99.40	5.00
28.4409-1	12005-0049	Titanium	31.00	76.95	5.50
28.4334-2	12004-0002	Titanium	31.00	79.00	4.50
28.4339-2	12004-0033	Titanium	31.00	79.20	4.50
28.3337-2	12911-10H00	Titanium	31.00	80.35	4.50
28.3340-2	12911-49H00	Titanium	31.00	80.35	4.50
28.3408-1	12912-28H00	Titanium	31.00	80.80	5.50
28.4406-1	12005-0036	Titanium	31.00	82.00	5.50
28.2419-2	B7B-12111-00	Titanium	31.00	82.95	5.00
28.1334-2	14711-KRN-670	Titanium	31.00	83.35	5.00
28.2414-2	1SM-12111-00	Titanium	31.00	83.60	5.00
28.1402-1	14721-MEB-670	Steel	31.00	84.25	5.00
28.4347-2	12004-0741	Titanium	31.00	88.25	4.50
28.5594-1	420254682	Steel	31.00	90.60	6.00
28.1654-1	14721-MAN-620	Steel	31.00	104.15	6.50
28.1323-2	14711-KBB-900	Steel	31.40	89.70	5.50
28.6427-1	773.36.031.200	Titanium	31.70	89.60	6.00
28.4334.OS1-2	-	Titanium	32.00	79.00	4.50
28.4339.OS1-2	-	Titanium	32.00	79.20	4.50
28.2600-1	1VJ-12121-00	Steel	32.00	91.80	7.00
28.2661-1	3YF-12121-00	Steel	32.00	92.70	6.00
28.2706-1	5VK-12121-00	Steel	32.00	96.25	6.00
28.6333-2	777.36.030.000	Titanium	32.50	95.90	5.00
28.4419-1	12005-0780	Titanium	33.00	78.65	5.50
28.1348-2	14711-K95-A20	Titanium	33.00	88.00	5.00
28.6425-2	8000 A4631	Titanium	33.00	100.50	5.50
28.1495-2	14711-KCY-670	Steel	33.00	102.80	5.50
28.6419-1	795.36.031.000	Titanium	33.10	82.65	6.00
28.6428-1	780.36.031.000	Steel	33.10	92.25	5.00
28.6433-1	789.36.031.000	Titanium	33.10	92.95	6.00
28.2396-2	5HO-12111-00	Steel	34.00	93.80	6.00
28.2487-1	1UY-12121-01	Steel	34.00	100.50	7.00
28.8905-1	211.1.055.1A	Titanium	34.00	103.20	6.00
28.1405-2	14711-MEY-670	Titanium	35.00	84.60	5.50
28.6423-2	594.36.030.000	Titanium	35.00	97.00	6.00
28.6520-2	590.36.030.000	Steel	35.00	97.00	6.00
28.4409-2	12004-0034	Titanium	36.00	78.20	5.50
28.1409-2	14711-MEN-A30	Titanium	36.00	78.65	5.00
28.3408-2	12911-28H00	Titanium	36.00	81.90	5.50
28.3406-2	12911-45G00	Titanium	36.00	82.00	5.50
28.3405-2	12911-35GU0	Titanium	36.00	82.40	5.00
28.3407-2	12911-35G20	Titanium	36.00	82.40	5.50
28.3402-2	12911-29F00	Steel	36.00	82.50	5.00
28.4406-2	12004-0018	Titanium	36.00	83.30	5.50
28.2440-2	33D-12111-00	Titanium	36.00	83.80	5.50
28.1402-2	14711-MEB-670	Titanium	36.00	84.60	5.50
28.1654-2	14711-MG3-000	Steel	36.00	105.75	6.50
28.6351-2	772.36.030.000	Titanium	36.10	87.20	5.50
28.2444-2	1SL-12111-00	Titanium	37.00	83.75	5.50
28.2600-2	1VJ-12111-00	Steel	37.00	97.20	7.00
28.1417-2	14711-MKE-A01	Titanium	38.00	78.80	5.00
28.5594-2	420254293	Steel	38.00	90.30	6.00
28.2706-2	5VK-12111-00	Steel	38.00	102.30	6.00
28.6428-2	780.36.030.000	Titanium	39.90	92.85	6.00
28.6433-2	789.36.030.000	Titanium	39.90	93.50	6.00
28.6419-2	795.36.030.000	Titanium	40.00	83.70	6.00
28.4419-2	12004-0760	Titanium	40.00	85.05	5.50
28.2487-2	1UY-12111-01	Steel	40.00	102.60	7.00
28.6427-2	773.36.030.200	Titanium	40.30	88.00	6.00

Valve Installation
Instructions on page 418

VALVE SHIMS

ProX valve shims are made of premium materials. Specific heat-treatment will ensure hardness of the shims to offer maximum durability and less wear. Next to the specific heat-treatment the shims are precision machined to match exact size.



The ProX valve shims are available in complete assortment boxes as well as refill kits. Complete assortment boxes contain a full line of 7.48, 8.90, 9.48 or 10.00 mm shims in thicknesses from 1.20 mm. upto 3.50 mm. with 3 items each size. Refill kits are available for each individual size and are packed per 5 pcs. ProX valve shims are the cost efficient and easy replacement for the expensive OEM shims!

ProX Valve Shims features

- Specific heat-treatment ensuring hardness to offer maximum durability and less wear.
- Precision machined to match exact size.
- Available in complete assortment box as well as individual refill kit for all dimensions.
- Cost efficient and easy replacement for expensive OEM shims.
- Will fit wide variety of Dirt Bikes, Road Bikes and ATV's.

7,48 mm

Model DIRT	Part No.
ProX Valve Shim Assortment 250cc - 7.48 from 1.20 to 3.50 mm.	29.VSA748
ProX Valve Shim Assortment 250cc - 7.48 from 1.225 to 3.475 mm.	29.VSA748-2
ProX Valve Shim Refill Kit 7.48 x 1.20 mm. (5 pcs.)	29.748120
ProX Valve Shim Refill Kit 7.48 x 1.225 mm. (5 pcs.)	29.748122.5
ProX Valve Shim Refill Kit 7.48 x 1.25 mm. (5 pcs.)	29.748125
ProX Valve Shim Refill Kit 7.48 x 1.275 mm. (5 pcs.)	29.748127.5
ProX Valve Shim Refill Kit 7.48 x 1.30 mm. (5 pcs.)	29.748130
ProX Valve Shim Refill Kit 7.48 x 1.325 mm. (5 pcs.)	29.748132.5
ProX Valve Shim Refill Kit 7.48 x 1.35 mm. (5 pcs.)	29.748135
ProX Valve Shim Refill Kit 7.48 x 1.375 mm. (5 pcs.)	29.748137.5
ProX Valve Shim Refill Kit 7.48 x 1.40 mm. (5 pcs.)	29.748140
ProX Valve Shim Refill Kit 7.48 x 1.425 mm. (5 pcs.)	29.748142.5
ProX Valve Shim Refill Kit 7.48 x 1.45 mm. (5 pcs.)	29.748145
ProX Valve Shim Refill Kit 7.48 x 1.475 mm. (5 pcs.)	29.748147.5
ProX Valve Shim Refill Kit 7.48 x 1.50 mm. (5 pcs.)	29.748150
ProX Valve Shim Refill Kit 7.48 x 1.525 mm. (5 pcs.)	29.748152.5
ProX Valve Shim Refill Kit 7.48 x 1.55 mm. (5 pcs.)	29.748155
ProX Valve Shim Refill Kit 7.48 x 1.575 mm. (5 pcs.)	29.748157.5
ProX Valve Shim Refill Kit 7.48 x 1.60 mm. (5 pcs.)	29.748160
ProX Valve Shim Refill Kit 7.48 x 1.625 mm. (5 pcs.)	29.748162.5
ProX Valve Shim Refill Kit 7.48 x 1.65 mm. (5 pcs.)	29.748165
ProX Valve Shim Refill Kit 7.48 x 1.675 mm. (5 pcs.)	29.748167.5
ProX Valve Shim Refill Kit 7.48 x 1.70 mm. (5 pcs.)	29.748170
ProX Valve Shim Refill Kit 7.48 x 1.725 mm. (5 pcs.)	29.748172.5
ProX Valve Shim Refill Kit 7.48 x 1.75 mm. (5 pcs.)	29.748175
ProX Valve Shim Refill Kit 7.48 x 1.775 mm. (5 pcs.)	29.748177.5
ProX Valve Shim Refill Kit 7.48 x 1.80 mm. (5 pcs.)	29.748180
ProX Valve Shim Refill Kit 7.48 x 1.825 mm. (5 pcs.)	29.748182.5
ProX Valve Shim Refill Kit 7.48 x 1.85 mm. (5 pcs.)	29.748185
ProX Valve Shim Refill Kit 7.48 x 1.875 mm. (5 pcs.)	29.748187.5
ProX Valve Shim Refill Kit 7.48 x 1.90 mm. (5 pcs.)	29.748190
ProX Valve Shim Refill Kit 7.48 x 1.925 mm. (5 pcs.)	29.748192.5
ProX Valve Shim Refill Kit 7.48 x 1.95 mm. (5 pcs.)	29.748195
ProX Valve Shim Refill Kit 7.48 x 1.975 mm. (5 pcs.)	29.748197.5
ProX Valve Shim Refill Kit 7.48 x 2.00 mm. (5 pcs.)	29.748200
ProX Valve Shim Refill Kit 7.48 x 2.025 mm. (5 pcs.)	29.748202.5
ProX Valve Shim Refill Kit 7.48 x 2.05 mm. (5 pcs.)	29.748205
ProX Valve Shim Refill Kit 7.48 x 2.075 mm. (5 pcs.)	29.748207.5
ProX Valve Shim Refill Kit 7.48 x 2.10 mm. (5 pcs.)	29.748210
ProX Valve Shim Refill Kit 7.48 x 2.125 mm. (5 pcs.)	29.748212.5
ProX Valve Shim Refill Kit 7.48 x 2.15 mm. (5 pcs.)	29.748215
ProX Valve Shim Refill Kit 7.48 x 2.175 mm. (5 pcs.)	29.748217.5
ProX Valve Shim Refill Kit 7.48 x 2.20 mm. (5 pcs.)	29.748220
ProX Valve Shim Refill Kit 7.48 x 2.225 mm. (5 pcs.)	29.748222.5
ProX Valve Shim Refill Kit 7.48 x 2.25 mm. (5 pcs.)	29.748225
ProX Valve Shim Refill Kit 7.48 x 2.275 mm. (5 pcs.)	29.748227.5
ProX Valve Shim Refill Kit 7.48 x 2.30 mm. (5 pcs.)	29.748230
ProX Valve Shim Refill Kit 7.48 x 2.325 mm. (5 pcs.)	29.748232.5

7,48 mm continued..

Model DIRT	Part No.
ProX Valve Shim Refill Kit 7.48 x 2.35 mm. (5 pcs.)	29.748235
ProX Valve Shim Refill Kit 7.48 x 2.375 mm. (5 pcs.)	29.748237.5
ProX Valve Shim Refill Kit 7.48 x 2.40 mm. (5 pcs.)	29.748240
ProX Valve Shim Refill Kit 7.48 x 2.425 mm. (5 pcs.)	29.748242.5
ProX Valve Shim Refill Kit 7.48 x 2.45 mm. (5 pcs.)	29.748245
ProX Valve Shim Refill Kit 7.48 x 2.475 mm. (5 pcs.)	29.748247.5
ProX Valve Shim Refill Kit 7.48 x 2.50 mm. (5 pcs.)	29.748250
ProX Valve Shim Refill Kit 7.48 x 2.525 mm. (5 pcs.)	29.748252.5
ProX Valve Shim Refill Kit 7.48 x 2.55 mm. (5 pcs.)	29.748255
ProX Valve Shim Refill Kit 7.48 x 2.575 mm. (5 pcs.)	29.748257.5
ProX Valve Shim Refill Kit 7.48 x 2.60 mm. (5 pcs.)	29.748260
ProX Valve Shim Refill Kit 7.48 x 2.625 mm. (5 pcs.)	29.748262.5
ProX Valve Shim Refill Kit 7.48 x 2.65 mm. (5 pcs.)	29.748265
ProX Valve Shim Refill Kit 7.48 x 2.675 mm. (5 pcs.)	29.748267.5
ProX Valve Shim Refill Kit 7.48 x 2.70 mm. (5 pcs.)	29.748270
ProX Valve Shim Refill Kit 7.48 x 2.725 mm. (5 pcs.)	29.748272.5
ProX Valve Shim Refill Kit 7.48 x 2.75 mm. (5 pcs.)	29.748275
ProX Valve Shim Refill Kit 7.48 x 2.775 mm. (5 pcs.)	29.748277.5
ProX Valve Shim Refill Kit 7.48 x 2.80 mm. (5 pcs.)	29.748280
ProX Valve Shim Refill Kit 7.48 x 2.825 mm. (5 pcs.)	29.748282.5
ProX Valve Shim Refill Kit 7.48 x 2.85 mm. (5 pcs.)	29.748285
ProX Valve Shim Refill Kit 7.48 x 2.875 mm. (5 pcs.)	29.748287.5
ProX Valve Shim Refill Kit 7.48 x 2.90 mm. (5 pcs.)	29.748290
ProX Valve Shim Refill Kit 7.48 x 2.925 mm. (5 pcs.)	29.748292.5
ProX Valve Shim Refill Kit 7.48 x 2.95 mm. (5 pcs.)	29.748295
ProX Valve Shim Refill Kit 7.48 x 2.975 mm. (5 pcs.)	29.748297.5
ProX Valve Shim Refill Kit 7.48 x 3.00 mm. (5 pcs.)	29.748300
ProX Valve Shim Refill Kit 7.48 x 3.025 mm. (5 pcs.)	29.748302.5
ProX Valve Shim Refill Kit 7.48 x 3.05 mm. (5 pcs.)	29.748305
ProX Valve Shim Refill Kit 7.48 x 3.075 mm. (5 pcs.)	29.748307.5
ProX Valve Shim Refill Kit 7.48 x 3.10 mm. (5 pcs.)	29.748310
ProX Valve Shim Refill Kit 7.48 x 3.125 mm. (5 pcs.)	29.748312.5
ProX Valve Shim Refill Kit 7.48 x 3.15 mm. (5 pcs.)	29.748315
ProX Valve Shim Refill Kit 7.48 x 3.175 mm. (5 pcs.)	29.748317.5
ProX Valve Shim Refill Kit 7.48 x 3.20 mm. (5 pcs.)	29.748320
ProX Valve Shim Refill Kit 7.48 x 3.225 mm. (5 pcs.)	29.748322.5
ProX Valve Shim Refill Kit 7.48 x 3.25 mm. (5 pcs.)	29.748325
ProX Valve Shim Refill Kit 7.48 x 3.275 mm. (5 pcs.)	29.748327.5
ProX Valve Shim Refill Kit 7.48 x 3.30 mm. (5 pcs.)	29.748330
ProX Valve Shim Refill Kit 7.48 x 3.325 mm. (5 pcs.)	29.748332.5
ProX Valve Shim Refill Kit 7.48 x 3.35 mm. (5 pcs.)	29.748335
ProX Valve Shim Refill Kit 7.48 x 3.375 mm. (5 pcs.)	29.748337.5
ProX Valve Shim Refill Kit 7.48 x 3.40 mm. (5 pcs.)	29.748340
ProX Valve Shim Refill Kit 7.48 x 3.425 mm. (5 pcs.)	29.748342.5
ProX Valve Shim Refill Kit 7.48 x 3.45 mm. (5 pcs.)	29.748345
ProX Valve Shim Refill Kit 7.48 x 3.475 mm. (5 pcs.)	29.748347.5
ProX Valve Shim Refill Kit 7.48 x 3.50 mm. (5 pcs.)	29.748350

VALVE SHIMS continued..

8,90 mm

Model DIRT	Part No.
ProX Valve Shim Assortment KTM - 8.90 from 1.72 to 2.60 mm.	29.VSA890
ProX Valve Shim Assortment KTM - 8.90 from 1.74 to 2.58 mm.	29.VSA890-2
ProX Valve Shim Refill Kit 8.90 x 1.72 mm. (5 pcs.)	29.890172
ProX Valve Shim Refill Kit 8.90 x 1.74 mm. (5 pcs.)	29.890174
ProX Valve Shim Refill Kit 8.90 x 1.76 mm. (5 pcs.)	29.890176
ProX Valve Shim Refill Kit 8.90 x 1.78 mm. (5 pcs.)	29.890178
ProX Valve Shim Refill Kit 8.90 x 1.80 mm. (5 pcs.)	29.890180
ProX Valve Shim Refill Kit 8.90 x 1.82 mm. (5 pcs.)	29.890182
ProX Valve Shim Refill Kit 8.90 x 1.84 mm. (5 pcs.)	29.890184
ProX Valve Shim Refill Kit 8.90 x 1.86 mm. (5 pcs.)	29.890186
ProX Valve Shim Refill Kit 8.90 x 1.88 mm. (5 pcs.)	29.890188
ProX Valve Shim Refill Kit 8.90 x 1.90 mm. (5 pcs.)	29.890190
ProX Valve Shim Refill Kit 8.90 x 1.92 mm. (5 pcs.)	29.890192
ProX Valve Shim Refill Kit 8.90 x 1.94 mm. (5 pcs.)	29.890194
ProX Valve Shim Refill Kit 8.90 x 1.96 mm. (5 pcs.)	29.890196
ProX Valve Shim Refill Kit 8.90 x 1.98 mm. (5 pcs.)	29.890198
ProX Valve Shim Refill Kit 8.90 x 2.00 mm. (5 pcs.)	29.890200
ProX Valve Shim Refill Kit 8.90 x 2.02 mm. (5 pcs.)	29.890202
ProX Valve Shim Refill Kit 8.90 x 2.04 mm. (5 pcs.)	29.890204
ProX Valve Shim Refill Kit 8.90 x 2.06 mm. (5 pcs.)	29.890206
ProX Valve Shim Refill Kit 8.90 x 2.08 mm. (5 pcs.)	29.890208
ProX Valve Shim Refill Kit 8.90 x 2.10 mm. (5 pcs.)	29.890210
ProX Valve Shim Refill Kit 8.90 x 2.12 mm. (5 pcs.)	29.890212
ProX Valve Shim Refill Kit 8.90 x 2.14 mm. (5 pcs.)	29.890214

9,48 mm

Model DIRT	Part No.
ProX Valve Shim Assortment 450cc - 9.48 from 1.20 to 3.50 mm.	29.VSA948
ProX Valve Shim Assortment 450cc - 9.48 from 1.225 to 3.475 mm.	29.VSA948-2
ProX Valve Shim Refill Kit 9.48 x 1.20 mm. (5 pcs.)	29.948120
ProX Valve Shim Refill Kit 9.48 x 1.225 mm. (5 pcs.)	29.948122.5
ProX Valve Shim Refill Kit 9.48 x 1.25 mm. (5 pcs.)	29.948125
ProX Valve Shim Refill Kit 9.48 x 1.275 mm. (5 pcs.)	29.948127.5
ProX Valve Shim Refill Kit 9.48 x 1.30 mm. (5 pcs.)	29.948130
ProX Valve Shim Refill Kit 9.48 x 1.325 mm. (5 pcs.)	29.948132.5
ProX Valve Shim Refill Kit 9.48 x 1.35 mm. (5 pcs.)	29.948135
ProX Valve Shim Refill Kit 9.48 x 1.375 mm. (5 pcs.)	29.948137.5
ProX Valve Shim Refill Kit 9.48 x 1.40 mm. (5 pcs.)	29.948140
ProX Valve Shim Refill Kit 9.48 x 1.425 mm. (5 pcs.)	29.948142.5
ProX Valve Shim Refill Kit 9.48 x 1.45 mm. (5 pcs.)	29.948145
ProX Valve Shim Refill Kit 9.48 x 1.475 mm. (5 pcs.)	29.948147.5
ProX Valve Shim Refill Kit 9.48 x 1.50 mm. (5 pcs.)	29.948150
ProX Valve Shim Refill Kit 9.48 x 1.525 mm. (5 pcs.)	29.948152.5
ProX Valve Shim Refill Kit 9.48 x 1.55 mm. (5 pcs.)	29.948155
ProX Valve Shim Refill Kit 9.48 x 1.575 mm. (5 pcs.)	29.948157.5
ProX Valve Shim Refill Kit 9.48 x 1.60 mm. (5 pcs.)	29.948160
ProX Valve Shim Refill Kit 9.48 x 1.625 mm. (5 pcs.)	29.948162.5
ProX Valve Shim Refill Kit 9.48 x 1.65 mm. (5 pcs.)	29.948165
ProX Valve Shim Refill Kit 9.48 x 1.675 mm. (5 pcs.)	29.948167.5
ProX Valve Shim Refill Kit 9.48 x 1.70 mm. (5 pcs.)	29.948170
ProX Valve Shim Refill Kit 9.48 x 1.725 mm. (5 pcs.)	29.948172.5
ProX Valve Shim Refill Kit 9.48 x 1.75 mm. (5 pcs.)	29.948175
ProX Valve Shim Refill Kit 9.48 x 1.775 mm. (5 pcs.)	29.948177.5
ProX Valve Shim Refill Kit 9.48 x 1.80 mm. (5 pcs.)	29.948180
ProX Valve Shim Refill Kit 9.48 x 1.825 mm. (5 pcs.)	29.948182.5
ProX Valve Shim Refill Kit 9.48 x 1.85 mm. (5 pcs.)	29.948185
ProX Valve Shim Refill Kit 9.48 x 1.875 mm. (5 pcs.)	29.948187.5
ProX Valve Shim Refill Kit 9.48 x 1.90 mm. (5 pcs.)	29.948190
ProX Valve Shim Refill Kit 9.48 x 1.925 mm. (5 pcs.)	29.948192.5
ProX Valve Shim Refill Kit 9.48 x 1.95 mm. (5 pcs.)	29.948195
ProX Valve Shim Refill Kit 9.48 x 1.975 mm. (5 pcs.)	29.948197.5
ProX Valve Shim Refill Kit 9.48 x 2.00 mm. (5 pcs.)	29.948200
ProX Valve Shim Refill Kit 9.48 x 2.025 mm. (5 pcs.)	29.948202.5
ProX Valve Shim Refill Kit 9.48 x 2.05 mm. (5 pcs.)	29.948205
ProX Valve Shim Refill Kit 9.48 x 2.075 mm. (5 pcs.)	29.948207.5
ProX Valve Shim Refill Kit 9.48 x 2.10 mm. (5 pcs.)	29.948210
ProX Valve Shim Refill Kit 9.48 x 2.125 mm. (5 pcs.)	29.948212.5
ProX Valve Shim Refill Kit 9.48 x 2.15 mm. (5 pcs.)	29.948215
ProX Valve Shim Refill Kit 9.48 x 2.175 mm. (5 pcs.)	29.948217.5
ProX Valve Shim Refill Kit 9.48 x 2.20 mm. (5 pcs.)	29.948220
ProX Valve Shim Refill Kit 9.48 x 2.225 mm. (5 pcs.)	29.948222.5
ProX Valve Shim Refill Kit 9.48 x 2.25 mm. (5 pcs.)	29.948225
ProX Valve Shim Refill Kit 9.48 x 2.275 mm. (5 pcs.)	29.948227.5
ProX Valve Shim Refill Kit 9.48 x 2.30 mm. (5 pcs.)	29.948230
ProX Valve Shim Refill Kit 9.48 x 2.325 mm. (5 pcs.)	29.948232.5

8,90 mm continued..

Model DIRT	Part No.
ProX Valve Shim Refill Kit 8.90 x 2.16 mm. (5 pcs.)	29.890216
ProX Valve Shim Refill Kit 8.90 x 2.18 mm. (5 pcs.)	29.890218
ProX Valve Shim Refill Kit 8.90 x 2.20 mm. (5 pcs.)	29.890220
ProX Valve Shim Refill Kit 8.90 x 2.22 mm. (5 pcs.)	29.890222
ProX Valve Shim Refill Kit 8.90 x 2.24 mm. (5 pcs.)	29.890224
ProX Valve Shim Refill Kit 8.90 x 2.26 mm. (5 pcs.)	29.890226
ProX Valve Shim Refill Kit 8.90 x 2.28 mm. (5 pcs.)	29.890228
ProX Valve Shim Refill Kit 8.90 x 2.30 mm. (5 pcs.)	29.890230
ProX Valve Shim Refill Kit 8.90 x 2.32 mm. (5 pcs.)	29.890232
ProX Valve Shim Refill Kit 8.90 x 2.34 mm. (5 pcs.)	29.890234
ProX Valve Shim Refill Kit 8.90 x 2.36 mm. (5 pcs.)	29.890236
ProX Valve Shim Refill Kit 8.90 x 2.38 mm. (5 pcs.)	29.890238
ProX Valve Shim Refill Kit 8.90 x 2.40 mm. (5 pcs.)	29.890240
ProX Valve Shim Refill Kit 8.90 x 2.42 mm. (5 pcs.)	29.890242
ProX Valve Shim Refill Kit 8.90 x 2.44 mm. (5 pcs.)	29.890244
ProX Valve Shim Refill Kit 8.90 x 2.46 mm. (5 pcs.)	29.890246
ProX Valve Shim Refill Kit 8.90 x 2.48 mm. (5 pcs.)	29.890248
ProX Valve Shim Refill Kit 8.90 x 2.50 mm. (5 pcs.)	29.890250
ProX Valve Shim Refill Kit 8.90 x 2.52 mm. (5 pcs.)	29.890252
ProX Valve Shim Refill Kit 8.90 x 2.54 mm. (5 pcs.)	29.890254
ProX Valve Shim Refill Kit 8.90 x 2.56 mm. (5 pcs.)	29.890256
ProX Valve Shim Refill Kit 8.90 x 2.58 mm. (5 pcs.)	29.890258
ProX Valve Shim Refill Kit 8.90 x 2.60 mm. (5 pcs.)	29.890260

9,48 mm continued..

Model DIRT	Part No.
ProX Valve Shim Refill Kit 9.48 x 2.35 mm. (5 pcs.)	29.948235
ProX Valve Shim Refill Kit 9.48 x 2.375 mm. (5 pcs.)	29.948237.5
ProX Valve Shim Refill Kit 9.48 x 2.40 mm. (5 pcs.)	29.948240
ProX Valve Shim Refill Kit 9.48 x 2.425 mm. (5 pcs.)	29.948242.5
ProX Valve Shim Refill Kit 9.48 x 2.45 mm. (5 pcs.)	29.948245
ProX Valve Shim Refill Kit 9.48 x 2.475 mm. (5 pcs.)	29.948247.5
ProX Valve Shim Refill Kit 9.48 x 2.50 mm. (5 pcs.)	29.948250
ProX Valve Shim Refill Kit 9.48 x 2.525 mm. (5 pcs.)	29.948252.5
ProX Valve Shim Refill Kit 9.48 x 2.55 mm. (5 pcs.)	29.948255
ProX Valve Shim Refill Kit 9.48 x 2.575 mm. (5 pcs.)	29.948257.5
ProX Valve Shim Refill Kit 9.48 x 2.60 mm. (5 pcs.)	29.948260
ProX Valve Shim Refill Kit 9.48 x 2.625 mm. (5 pcs.)	29.948262.5
ProX Valve Shim Refill Kit 9.48 x 2.65 mm. (5 pcs.)	29.948265
ProX Valve Shim Refill Kit 9.48 x 2.675 mm. (5 pcs.)	29.948267.5
ProX Valve Shim Refill Kit 9.48 x 2.70 mm. (5 pcs.)	29.948270
ProX Valve Shim Refill Kit 9.48 x 2.725 mm. (5 pcs.)	29.948272.5
ProX Valve Shim Refill Kit 9.48 x 2.75 mm. (5 pcs.)	29.948275
ProX Valve Shim Refill Kit 9.48 x 2.775 mm. (5 pcs.)	29.948277.5
ProX Valve Shim Refill Kit 9.48 x 2.80 mm. (5 pcs.)	29.948280
ProX Valve Shim Refill Kit 9.48 x 2.825 mm. (5 pcs.)	29.948282.5
ProX Valve Shim Refill Kit 9.48 x 2.85 mm. (5 pcs.)	29.948285
ProX Valve Shim Refill Kit 9.48 x 2.875 mm. (5 pcs.)	29.948287.5
ProX Valve Shim Refill Kit 9.48 x 2.90 mm. (5 pcs.)	29.948290
ProX Valve Shim Refill Kit 9.48 x 2.925 mm. (5 pcs.)	29.948292.5
ProX Valve Shim Refill Kit 9.48 x 2.95 mm. (5 pcs.)	29.948295
ProX Valve Shim Refill Kit 9.48 x 2.975 mm. (5 pcs.)	29.948297.5
ProX Valve Shim Refill Kit 9.48 x 3.00 mm. (5 pcs.)	29.948300
ProX Valve Shim Refill Kit 9.48 x 3.025 mm. (5 pcs.)	29.948302.5
ProX Valve Shim Refill Kit 9.48 x 3.05 mm. (5 pcs.)	29.948305
ProX Valve Shim Refill Kit 9.48 x 3.075 mm. (5 pcs.)	29.948307.5
ProX Valve Shim Refill Kit 9.48 x 3.10 mm. (5 pcs.)	29.948310
ProX Valve Shim Refill Kit 9.48 x 3.125 mm. (5 pcs.)	29.948312.5
ProX Valve Shim Refill Kit 9.48 x 3.15 mm. (5 pcs.)	29.948315
ProX Valve Shim Refill Kit 9.48 x 3.175 mm. (5 pcs.)	29.948317.5
ProX Valve Shim Refill Kit 9.48 x 3.20 mm. (5 pcs.)	29.948320
ProX Valve Shim Refill Kit 9.48 x 3.225 mm. (5 pcs.)	29.948322.5
ProX Valve Shim Refill Kit 9.48 x 3.25 mm. (5 pcs.)	29.948325
ProX Valve Shim Refill Kit 9.48 x 3.275 mm. (5 pcs.)	29.948327.5
ProX Valve Shim Refill Kit 9.48 x 3.30 mm. (5 pcs.)	29.948330
ProX Valve Shim Refill Kit 9.48 x 3.325 mm. (5 pcs.)	29.948332.5
ProX Valve Shim Refill Kit 9.48 x 3.35 mm. (5 pcs.)	29.948335
ProX Valve Shim Refill Kit 9.48 x 3.375 mm. (5 pcs.)	29.948337.5
ProX Valve Shim Refill Kit 9.48 x 3.40 mm. (5 pcs.)	29.948340
ProX Valve Shim Refill Kit 9.48 x 3.425 mm. (5 pcs.)	29.948342.5
ProX Valve Shim Refill Kit 9.48 x 3.45 mm. (5 pcs.)	29.948345
ProX Valve Shim Refill Kit 9.48 x 3.475 mm. (5 pcs.)	29.948347.5
ProX Valve Shim Refill Kit 9.48 x 3.50 mm. (5 pcs.)	29.948350

10,00 mm

Model DIRT	Part No.
ProX Valve Shim Assortment KTM - 10.00 from 1.85 to 3.20 mm.	29.VSA1000
ProX Valve Shim Assortment KTM - 10.00 from 1.875 to 3.175 mm.	29.VSA1000-2
ProX Valve Shim Refill Kit 10.00 x 1.85 mm. (5 pcs.)	29.100185
ProX Valve Shim Refill Kit 10.00 x 1.875 mm. (5 pcs.)	29.100187.5
ProX Valve Shim Refill Kit 10.00 x 1.90 mm. (5 pcs.)	29.100190
ProX Valve Shim Refill Kit 10.00 x 1.925 mm. (5 pcs.)	29.100192.5
ProX Valve Shim Refill Kit 10.00 x 1.95 mm. (5 pcs.)	29.100195
ProX Valve Shim Refill Kit 10.00 x 1.975 mm. (5 pcs.)	29.100197.5
ProX Valve Shim Refill Kit 10.00 x 2.00 mm. (5 pcs.)	29.100200
ProX Valve Shim Refill Kit 10.00 x 2.025 mm. (5 pcs.)	29.100202.5
ProX Valve Shim Refill Kit 10.00 x 2.05 mm. (5 pcs.)	29.100205
ProX Valve Shim Refill Kit 10.00 x 2.075 mm. (5 pcs.)	29.100207.5
ProX Valve Shim Refill Kit 10.00 x 2.10 mm. (5 pcs.)	29.100210
ProX Valve Shim Refill Kit 10.00 x 2.125 mm. (5 pcs.)	29.100212.5
ProX Valve Shim Refill Kit 10.00 x 2.15 mm. (5 pcs.)	29.100215
ProX Valve Shim Refill Kit 10.00 x 2.175 mm. (5 pcs.)	29.100217.5
ProX Valve Shim Refill Kit 10.00 x 2.20 mm. (5 pcs.)	29.100220
ProX Valve Shim Refill Kit 10.00 x 2.225 mm. (5 pcs.)	29.100222.5
ProX Valve Shim Refill Kit 10.00 x 2.25 mm. (5 pcs.)	29.100225
ProX Valve Shim Refill Kit 10.00 x 2.275 mm. (5 pcs.)	29.100227.5
ProX Valve Shim Refill Kit 10.00 x 2.30 mm. (5 pcs.)	29.100230
ProX Valve Shim Refill Kit 10.00 x 2.325 mm. (5 pcs.)	29.100232.5
ProX Valve Shim Refill Kit 10.00 x 2.35 mm. (5 pcs.)	29.100235
ProX Valve Shim Refill Kit 10.00 x 2.375 mm. (5 pcs.)	29.100237.5
ProX Valve Shim Refill Kit 10.00 x 2.40 mm. (5 pcs.)	29.100240
ProX Valve Shim Refill Kit 10.00 x 2.425 mm. (5 pcs.)	29.100242.5
ProX Valve Shim Refill Kit 10.00 x 2.45 mm. (5 pcs.)	29.100245
ProX Valve Shim Refill Kit 10.00 x 2.475 mm. (5 pcs.)	29.100247.5
ProX Valve Shim Refill Kit 10.00 x 2.50 mm. (5 pcs.)	29.100250

10,00 mm continued..

Model DIRT	Part No.
ProX Valve Shim Refill Kit 10.00 x 2.525 mm. (5 pcs.)	29.100252.5
ProX Valve Shim Refill Kit 10.00 x 2.55 mm. (5 pcs.)	29.100255
ProX Valve Shim Refill Kit 10.00 x 2.575 mm. (5 pcs.)	29.100257.5
ProX Valve Shim Refill Kit 10.00 x 2.60 mm. (5 pcs.)	29.100260
ProX Valve Shim Refill Kit 10.00 x 2.625 mm. (5 pcs.)	29.100262.5
ProX Valve Shim Refill Kit 10.00 x 2.65 mm. (5 pcs.)	29.100265
ProX Valve Shim Refill Kit 10.00 x 2.675 mm. (5 pcs.)	29.100267.5
ProX Valve Shim Refill Kit 10.00 x 2.70 mm. (5 pcs.)	29.100270
ProX Valve Shim Refill Kit 10.00 x 2.725 mm. (5 pcs.)	29.100272.5
ProX Valve Shim Refill Kit 10.00 x 2.75 mm. (5 pcs.)	29.100275
ProX Valve Shim Refill Kit 10.00 x 2.775 mm. (5 pcs.)	29.100277.5
ProX Valve Shim Refill Kit 10.00 x 2.80 mm. (5 pcs.)	29.100280
ProX Valve Shim Refill Kit 10.00 x 2.825 mm. (5 pcs.)	29.100282.5
ProX Valve Shim Refill Kit 10.00 x 2.85 mm. (5 pcs.)	29.100285
ProX Valve Shim Refill Kit 10.00 x 2.875 mm. (5 pcs.)	29.100287.5
ProX Valve Shim Refill Kit 10.00 x 2.90 mm. (5 pcs.)	29.100290
ProX Valve Shim Refill Kit 10.00 x 2.925 mm. (5 pcs.)	29.100292.5
ProX Valve Shim Refill Kit 10.00 x 2.95 mm. (5 pcs.)	29.100295
ProX Valve Shim Refill Kit 10.00 x 2.975 mm. (5 pcs.)	29.100297.5
ProX Valve Shim Refill Kit 10.00 x 3.00 mm. (5 pcs.)	29.100300
ProX Valve Shim Refill Kit 10.00 x 3.025 mm. (5 pcs.)	29.100302.5
ProX Valve Shim Refill Kit 10.00 x 3.05 mm. (5 pcs.)	29.100305
ProX Valve Shim Refill Kit 10.00 x 3.075 mm. (5 pcs.)	29.100307.5
ProX Valve Shim Refill Kit 10.00 x 3.10 mm. (5 pcs.)	29.100310
ProX Valve Shim Refill Kit 10.00 x 3.125 mm. (5 pcs.)	29.100312.5
ProX Valve Shim Refill Kit 10.00 x 3.15 mm. (5 pcs.)	29.100315
ProX Valve Shim Refill Kit 10.00 x 3.175 mm. (5 pcs.)	29.100317.5
ProX Valve Shim Refill Kit 10.00 x 3.20 mm. (5 pcs.)	29.100320

VALVE STEM SEALS

ProX offers a wide range of valve stem seals for the MX, Dirtbike, Roadbike and ATV segment. The seals are manufactured by the leading OEM factories in Japan such as NOK and ARS.

The seals are all manufactured from premium grade materials and are made to OEM specs and tolerances, offering low friction in combination with superior seal for excellent durability.

ProX Valve Stem Seal features

- Manufactured by the leading OEM factories in Japan such as NOK and ARS.
- High quality base materials made to OEM specifications and tolerances for guaranteed quality and superior durability.
- Wide range of valve stem seals for MX, Dirtbike, Roadbike and ATV available.

Part No.	O.E.M. Reference	Brand
35.VS001	12208-413-003	ARS
35.VS002	12208-ML0-721	ARS
35.VS003	12209-GB4-681	NOK
35.VS004	12209-GB4-682	ARS
35.VS005	12209-MN1-671	NOK
35.VS006	12209-413-003	ARS
35.VS008	12209-K77-013	ARS
35.VS010	5VL-E2119-00	-
35.VS011	4TV-12119-00	ARS
35.VS012	4SV-12119-00	ARS
35.VS013	33M-12119-00	ARS
35.VS014	51Y-12119-00	ARS
35.VS015	5H0-12119-00	ARS
35.VS016	1J7-12119-01	ARS
35.VS017	M01-12129-00	ARS
35.VS018	09289-04002	ARS
35.VS019	09289-05011	KOYO
35.VS020	09289-05015	ARS
35.VS021	92049-1349	NOK
35.VS022	92049-1062	ARS
35.VS024	92049-1218	ARS
35.VS026	590.36.027.000	ARS
35.VS027	4TE-12119-00	-
35.VS028	770.36.027.000	-
35.VS029	772.36.027.000	-



Valve Installation Instructions

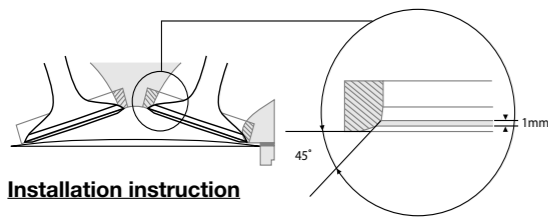

ProX Titanium Engine Valves are manufactured to the highest quality standards and specifications. By using the latest state of the art Titanium material and coating, the valves have improved properties over the original item. We would like to support you to achieve maximum durability. Titanium is a very exotic material which requires you to work after following installation instructions.

Installation instruction

- Do not touch the valve surface with your bare hands, use gloves or pre lube the valve with engine oil, these precautionary measures will reduce the risk of corroding the coating.
- Never** use a lapping compound on a new valve, take a dummy valve to do this grinding operation.
- Please take notice; during every rebuild the valve seats must be machined, this to assure a 100 % valve to seat contact and making the seat free from the hardened shell. The width of the contact zone on a valve seat with the valve face should be at least 1mm. In general the angle is 45°, however consult the O.E.M. specification first.
- New valve seats should be soft, material as Nodular Iron, Bronze, or Beryllium-Copper, all heat treated to Rockwell, RC32 or less. Most of the original valve seats used in combination with titanium valves are made of such an alloy.
Attention: After every rebuild the seat is getting thinner which makes the heat transfer worse, increasing the natural hardening process. The back set position of the valve (Recess) after every time one machines the valve seat, worsening the engine's breathing. Besides of reducing the engine's efficiency this also effects the cooling down effect negatively.
- Use only original valve springs or ones with forces not exceeding the originals.



CLUTCH BASKETS & CLUTCH RUBBER SETS

(O.E.M. Replacemant Clutch Baskets)

ProX offers a complete line of clutch baskets kits for the Dirtbike and ATV segment. The **ProX** clutch baskets are manufactured from mainly forged 7075 alloy, like the material used in the aircraft and aerospace industry. The use of this material offers improved strength over the OEM die-cast alloy baskets. The **ProX** clutch baskets are machined to exact OEM specifications and tolerances for perfect fit. The complete surface of the baskets is hard anodised for higher mechanical properties and resistance for impact and fatigue. Most clutch baskets come complete with fasteners and damper rubbers for easy installation. The **ProX** baskets will work together with other **ProX** clutch components as well as OEM clutch components. A full line of **ProX** clutch baskets for Dirtbike and ATV models is available from stock.



Part No.	Notes	Rubbers	Qty.	Clutch Rubber Set	O.E.M. Reference
17.1186F	-	-	-	-	22100-GC4-600
17.1220F	Rubbers Included	17.9-1287	8x	17.CRS1287-8	22100-KZ4-A90 22100-KRN-670 22100-KSC-A10
17.1227F	-	-	-	-	22100-KSE-670
17.1287F	Rubbers Included	17.9-1287	8x	17.CRS1287-8	22100-KZ4-700
17.1340F	Rubbers Included	17.9-1287	8x	17.CRS1287-8	22100-KRN-A40
17.1386	Rubbers Included	17.9-1386	8x	17.CRS1386-8	22100-ML3-000
17.1387	Rubbers Included	17.9-1386	8x	17.CRS1386-8	22100-KZ3-000
17.1403F	Rubbers Included	17.9-1386	8x	17.CRS1386-8	22100-KZ3-860 22100-MEB-770 22100-MEY-670
17.1408F	Rubbers Included	17.9-1386	8x	17.CRS1386-8	22100-MEN-A10
17.1409F	Rubbers Included	17.9-1386	8x	17.CRS1386-8	22100-MEN-A30
17.1413F	Rubbers Included	17.9-1386	8x	17.CRS1386-8	22100-MEN-A70
17.1484	Rubbers Included	17.9-1386	8x	17.CRS1386-8	22100-KA5-700
17.1490	Rubbers Included	17.9-1386	8x	17.CRS1386-8	22100-ML3-910
17.1499F	-	-	-	-	22100-KCY-670
17.1505F	-	-	-	-	22100-HN1-A40
17.2020	-	-	-	-	31K-16150-01
17.2193F	-	-	-	-	4ES-16150-00
17.2196F	-	-	-	-	5PA-16150-10
17.2281F	-	-	-	-	3JM-16150-01
17.2293F	Rubbers Included	17.9-2288	6x	17.CRS2288-8	5NY-16150-00
17.2295	-	-	-	-	1C3-16150-00
17.2393	Rubbers Included	17.9-2288	8x	17.CRS2288-8	5DJ-16150-00
17.2401F	Rivets Included	-	-	-	5NL-16150-10
17.2404F	-	-	-	-	3AJ-16150-00 5BE-16150-00
17.2406	-	-	-	-	5JG-16150-00
17.2423	Rubbers Included	17.9-2424	8x	17.CRS2424-8	5TA-16150-10
17.2424F	Rubbers Included	17.9-2424	8x	17.CRS2424-8	5XD-16150-60 5XD-16150-10 B11-16150-00
17.2434F	-	-	-	-	5TG-16150-00
17.3187F	-	-	-	-	21200-02B41
17.3187F	-	-	-	-	21200-02B41
17.3292F	Rubbers Included	17.9-3292	8x	17.CRS3292-8	21200-36F00
17.3338F	Rubbers Included	17.9-3386	8x	17.CRS3386-8	21200-49H00
17.3393	Rubbers Included	17.9-3386	8x	17.CRS3386-8	21200-28C41
17.3396F	Rubbers Included	17.9-3386	8x	17.CRS3386-8	21200-37E00
17.3400F	-	-	-	-	21200-29F10 21200-07G10
17.3403	Rubbers Included	17.9-3386	8x	17.CRS3386-8	21200-37F10
17.3405F	Rubbers Included	17.9-3405	8x	17.CRS3405-8	21200-35G00
17.3408F	Rubbers Included	17.9-3405	8x	17.CRS3405-8	21200-28H00
17.4085F	-	-	-	-	13095-1042 K13095-1042
17.4188	Rubbers Included	17.9-4198	6x	17.CRS4198-6	13095-1165
17.4198F	Rubbers Included	17.9-4198	6x	17.CRS4198-6	13095-1154 13095-1406
17.4286F	Rubbers Included	17.9-4389	6x	17.CRS4389-6	13095-1287
17.4285	Rubbers Included	17.9-4389	6x	17.CRS4389-6	13095-1189



CLUTCH BASKETS & RUBBER SETS continued..

Part No.	Notes	Rubbers	Qty.	Clutch Rubber Set	O.E.M. Reference
17.4290	Rubbers Included	17.9-4389	7x	17.CRS4389-7	13095-1106
17.4293	Rubbers Included	17.9-4389	7x	17.CRS4389-7	13095-1258
17.4294F	Rubbers Included	17.9-2288	8x	17.CRS2288-8	13095-1136
17.4303F	Rubbers Included	17.9-2288	8x	17.CRS2288-8	13095-1412
17.4334F	Rubbers Included	17.9-2288	8x	17.CRS2288-8	13095-0018 K1309-50018
17.4336F	Rubbers Included	17.9-4336	8x	17.CRS4336-8	13095-0049 K1309-50049
17.4389	Rubbers Included	17.9-4389	8x	17.CRS4389-8	13095-1206 13095-1196
17.4392F	Rubbers Included	17.9-4389	8x	17.CRS4389-8	13095-1419
17.4396F	Rubbers Included	17.9-4389	8x	17.CRS4389-8	13095-0048
17.4406F	Rubbers Included	17.9-4389	8x	17.CRS4389-8	13095-0052
17.5305	-	-	-	-	546.32.001.272
17.6020F	-	-	-	-	460.32.000.144
17.6103F	-	-	-	-	470.32.001.100
17.6218F	Rubbers Included	17.9-1287	8x	17.CRS1287-8	503.32.001.044 503.32.000.073
17.6226F	Rubbers Included	17.9-1287	8x	17.CRS1287-8	503.32.000.073
17.6323F	-	-	-	17.CRS1287-8	548.32.001.000
17.6326F	Rubbers Included	17.9-1287	8x	17.CRS1287-8	770.32.001.100
17.6427F	Rubbers Included	17.9-1386	8x	17.CRS1386-8	780.32.001.144 780.32.001.000 773.32.001.244



CLUTCH PLATES

ProX clutch friction and steel plates are manufactured by the leading OEM factories, mainly in Japan. All friction plates are made to exact OEM specifications and offer maximum performance and durability. Steel plates offer longevity, durability and feel of the OEM. ProX clutch plates sets contain a complete pack of friction or steel plates for the application you need and are the easy and best replacement for your clutch. All plates can be used in combination with other ProX clutch components like the hard-anodised clutch baskets, Inner Hubs, Pressure plates and the heavy-duty clutch spring kits.



- ProX Clutch Plate Set features**
- Manufactured by the leading OEM factories.
 - Made to exact OEM specifications to offer maximum performance and durability.
 - Complete Friction or Steel plate sets per application for easy replacement.
 - Can be used in combination with all other ProX or OEM clutch components.
 - Full program for MX and ATV models available from ready stock.
 - The best replacement and the choice for every professional rider.

HONDA

Part No.	O.E.M. Reference	Remarks
16.1105	22201-GS2-000	Friction
16.1106	22201-GBF-B40	Friction
16.1154	22311-KN4-680	Steel
16.1201	22201-GF6-000	Friction
16.1202	22201-KAE-000	Friction
16.1205	22201-KS6-700	Friction
16.1252	22311-200-000	Steel
16.1253	22321-KA3-710	Alloy
16.1257	22321-KSE-670	Steel
16.1315	22201-KZ3-730	Friction
16.1331	22321-KF0-770	Steel
16.1335	22201-KRN-670	Friction
16.1336	22202-KSC-670	Friction
16.1338	22201-K95-A20	Friction
16.1339	22202-K95-A20	Friction
16.1340	22203-K95-A20	Friction
16.1351	22321-KZ3-690	Steel
16.1353	22321-KA4-741	Alloy
16.1417	22321-MKE-A00	Steel
16.1422	22201-MEB-670	Friction
16.1494	22201-HP1-670	Friction
16.1495	22201-MAL-600	Friction
16.1503	22201-ML4-610	Friction
16.1554	22202-ML4-611	Friction
16.1604	22201-MK2-000	Friction
16.1654	22321-KA4-710	Steel
16.1661	22201-MW3-960	Friction
16.1662	22201-MBN-670	Friction
16.1692	22201-MV4-000	Friction
16.1695	22202-MAE-000	Friction
16.1995	22201-MAE-000	Friction
16.1996	22201-MAS-000	Friction
16.1997	22202-MAT-000	Friction
16.1998	22201-MAT-000	Friction
16.1999	22201-MAT-E00	Friction

HUSQVARNA

Part No.	O.E.M. Reference	Remarks
16.6250	8000 88818	Steel

KTM

Part No.	O.E.M. Reference	Remarks
16.6020	460.32.011.000	Friction
16.6098	460.32.010.000	Steel
16.6103	470.32.011.000	Friction
16.6104	470.32.010.000	Steel
16.6313	548.32.011.000	Friction
16.6361	590.32.011.100	Friction
16.6394	548.32.012.100	Steel
16.6400	590.32.011.000	Friction
16.6408	773.32.011.000	Friction
16.6428	780.32.011.000	Friction
16.6429	780.32.111.100	Friction
16.6462	590.32.010.100	Steel
16.6463	590.32.010.200	Steel
16.6457	773.32.010.000	Steel
16.6459	780.32.010.100	Steel
16.6460	780.32.010.200	Steel
16.6608	583.32.011.300	Friction
16.6609	583.32.111.300	Friction
16.6460	780.32.010.200	Steel
16.6608	583.32.011.300	Friction
16.6609	583.32.111.300	Friction

KAWASAKI

Part No.	O.E.M. Reference	Remarks
16.4104	13088-1010	Friction
16.4106	13088-1070	Friction
16.4108	13088-1016	Friction
16.4151	13089-1009	Steel
16.4152	13089-1120	Steel
16.4204	13088-1058	Friction
16.4207	13088-1076	Friction
16.4214	13088-1102	Friction
16.4216	13088-1085	Friction
16.4219	13088-1057	Friction
16.4244	13089-1070	Steel
16.4245	13089-013	Steel
16.4246	13089-1089	Alloy
16.4304	13088-1009	Friction
16.4306	13088-1114	Friction
16.4312	13088-1105	Friction
16.4336	13088-0014	Friction
16.4337	13088-0015	Friction
16.4354	13089-1095	Steel
16.4419	13088-0600	Friction
16.4454	13089-1079	Alloy
16.4695	13088-1124	Friction
16.4791	13088-1087	Friction
16.4795	13088-040	Friction
16.4982	13088-1143	Friction
16.4983	13088-1140	Friction
16.4984	13088-1131	Friction
16.4991	13088-1139	Friction
16.4994	13088-0013	Friction
16.4995	13088-0003	Friction

SUZUKI

Part No.	O.E.M. Reference	Remarks
16.3189	21451-36200	Steel
16.3202	21441-13A01	Friction
16.3212	21441-43D00	Friction
16.3214	21441-36F00	Friction
16.3254	21451-43D00	Steel
16.3303	21441-37400	Friction
16.3304	21441-07A02	Friction
16.3316	21441-37E00	Friction
16.3324	21441-37F20	Friction
16.3325	21441-37F30	Friction
16.3326	21441-37F50	Friction
16.3341	21441-40F10	Friction
16.3351	21451-28C31	Steel
16.3354	21451-37F00	Steel
16.3355	21451-37E00	Alloy
16.3402	21441-29F00	Friction
16.3403	21442-29F00	Friction
16.3405	21441-35G00	Friction
16.3406	21441-45G00	Friction
16.3451	21451-44D00	Steel
16.3452	21451-35G00	Steel
16.3453	21452-35G00	Steel
16.3605	21441-29F20	Friction
16.3907	21441-31E00	Friction
16.3908	21442-31E00	Friction
16.3909	21441-31E70	Friction
16.3910	21442-31E21	Friction
16.3911	21441-31E60	Friction
16.3912	21441-24F30	Friction
16.3996	21441-24F00	Friction
16.3997	21441-24F10	Friction
16.3998	21441-24F20	Friction
16.3999	21442-24F00	Friction

YAMAHA

Part No.	O.E.M. Reference	Remarks
16.2019	5Y1-16331-01	Friction
16.2020	5Y1-16321-00	Friction
16.2021	1KT-16321-00	Friction
16.2102	131-16324-00	Steel
16.2103	21V-16321-00	Friction
16.2104	1HX-16331-00	Friction
16.2105	4ES-16321-00	Friction
16.2200	598-16321-01	Friction
16.2205	3JD-16321-00	Friction
16.2206	3XJ-16321-00	Friction
16.2208	5DH-16321-00	Friction
16.2251	3XJ-16324-00	Steel
16.2252	1V1-16324-00	Steel
16.2304	5X5-16321-00	Friction
16.2305	22U-16321-00	Friction
16.2306	3XK-16321-00	Friction
16.2307	5JG-16321-00	Friction
16.2308	5XC-16321-00	Friction
16.2319	7B-16321-00	Friction
16.2351	4X7-16325-00	Steel
16.2352	5NL-16325-00	Steel
16.2353	498-16325-00	Steel
16.2405	1TA-16325-00	Steel
16.2418	5BE-16321-00	Friction
16.2419	5BE-16331-00	Friction
16.2423	5TA-16321-00	Friction
16.2434	5TG-16321-00	Friction
16.2435	5TG-16331-00	Friction
16.2436	1TD-16331-00	Friction
16.2452	5JG-16325-00	Steel
16.2693	5SL-16321-00	Friction
16.2694	4H7-16321-02	Friction
16.2695	4JH-16321-00	Friction
16.2699	4FN-16321-00	Friction
16.2901	5LV-16321-00	Friction
16.2902	5LV-16321-10	Friction
16.2903	5LV-16321-20	Friction
16.2904	5VY-16321-00	Friction
16.2906	5VY-16331-00	Friction
16.2999	4XV-16331-00	Friction

BETA

Part No.	O.E.M. Reference	Remarks
16.2436	006031530 000	Friction

PISTON PARTS
 CRANKSHAFT PARTS
 VALVE TRAIN PARTS
 CLUTCH PARTS
 GASKETS
 DRIVE TRAIN PARTS
 BRAKE PARTS
 SUSPENSION PARTS
 WHEEL & STEERING PARTS
 FUEL & AIR PARTS
 DIMENSIONS

PISTON PARTS
 CRANKSHAFT PARTS
 VALVE TRAIN PARTS
 CLUTCH PARTS
 GASKETS
 DRIVE TRAIN PARTS
 BRAKE PARTS
 SUSPENSION PARTS
 WHEEL & STEERING PARTS
 FUEL & AIR PARTS
 DIMENSIONS

CLUTCH PLATE SET ASSEMBLIES



All ProX clutch plate assemblies are assembled in the exact same configuration as the OEM clutch plate sets. A list of each specific clutch plate assembly content can be found below.

Set Part No.	Remarks	Plate No. 1	Qty.	Plate No. 2	Qty.	Plate No. 3	Qty.	Plate No. 4	Qty.
16.S10029	Friction Set	16.1201	3	-	-	-	-	-	-
16.S11001	Friction Set	16.1105	5	-	-	-	-	-	-
16.S11002	Steel Set	16.1154	4	-	-	-	-	-	-
16.S11003	Friction Set	16.1106	5	-	-	-	-	-	-
16.S11030	Friction Set	16.1201	4	-	-	-	-	-	-
16.S11031	Friction Set	16.1105	4	-	-	-	-	-	-
16.S12004	Friction Set	16.1205	7	-	-	-	-	-	-
16.S12005	Steel Set	16.1252	6	-	-	-	-	-	-
16.S12006	Friction Set	16.1205	8	-	-	-	-	-	-
16.S12007	Steel Set	16.1252	7	-	-	-	-	-	-
16.S12023	Friction Set	16.1106	6	-	-	-	-	-	-
16.S12024	Steel Set	16.1257	5	-	-	-	-	-	-
16.S12032	Friction Set	16.1201	5	-	-	-	-	-	-
16.S13008	Friction Set	16.1315	7	-	-	-	-	-	-
16.S13009	Alloy Set	16.1353	6	-	-	-	-	-	-
16.S13010	Friction Set	16.1315	8	-	-	-	-	-	-
16.S13011	Alloy Set	16.1353	7	-	-	-	-	-	-
16.S13012	Alloy & Steel Set	16.1353	5	16.1351	2	-	-	-	-
16.S13013	Friction Set	16.1335	8	-	-	-	-	-	-
16.S13014	Steel Set	16.1331	7	-	-	-	-	-	-
16.S13033	Friction Set	16.1202	6	-	-	-	-	-	-
16.S13034	Friction Set	16.1495	6	-	-	-	-	-	-
16.S13035	Friction Set	16.1335	7	16.1336	1	-	-	-	-
16.S13036	Friction Set	16.1495	4	16.1995	2	-	-	-	-
16.S13037	Steel Set	16.1331	5	-	-	-	-	-	-
16.S13093	Friction Set	16.1338	6	16.1339	1	16.1340	1	-	-
16.S14015	Friction Set	16.1422	8	-	-	-	-	-	-
16.S14016	Steel Set	16.1351	7	-	-	-	-	-	-
16.S14017	Friction Set	16.1495	7	-	-	-	-	-	-
16.S14018	Steel Set	16.1331	6	-	-	-	-	-	-
16.S14022	Friction Set	16.1422	7	16.1494	1	-	-	-	-
16.S14039	Friction Set	16.1422	7	16.1662	1	-	-	-	-
16.S14091	Friction Set	16.1422	6	16.1662	1	-	-	-	-
16.S14092	Steel Set	16.1417	6	-	-	-	-	-	-
16.S15029	Friction Set	16.1503	6	16.1554	1	-	-	-	-
16.S15030	Friction Set	16.1503	7	-	-	-	-	-	-
16.S16019	Friction Set	16.1604	7	-	-	-	-	-	-
16.S16020	Steel Set	16.1654	6	-	-	-	-	-	-
16.S16021	Friction Set	16.1661	6	16.1662	1	-	-	-	-
16.S16023	Friction Set	16.1692	8	16.1554	1	-	-	-	-
16.S16024	Friction Set	16.1495	8	16.1695	1	-	-	-	-
16.S16038	Friction Set	16.3909	6	16.1695	1	16.1995	1	-	-
16.S19025	Friction Set	16.1995	8	16.1695	1	-	-	-	-
16.S19026	Friction Set	16.1996	9	16.1695	1	-	-	-	-
16.S19027	Friction Set	16.1998	8	16.1997	1	-	-	-	-
16.S19028	Friction Set	16.1999	5	16.1998	2	-	-	-	-
16.S20018	Friction Set	16.2105	4	16.2103	2	-	-	-	-
16.S20019	Steel Set	16.2102	5	-	-	-	-	-	-
16.S21001	Friction Set	16.2103	5	-	-	-	-	-	-
16.S21002	Friction Set	16.2105	6	-	-	-	-	-	-
16.S21003	Friction Set	16.2105	5	16.2103	2	-	-	-	-
16.S21004	Steel Set	16.2102	6	-	-	-	-	-	-
16.S22004	Friction Set	16.2206	7	-	-	-	-	-	-
16.S22005	Steel Set	16.2251	6	-	-	-	-	-	-
16.S22006	Friction Set	16.2206	8	-	-	-	-	-	-
16.S22007	Steel Set	16.2251	7	-	-	-	-	-	-
16.S22009	Friction Set	16.2208	8	-	-	-	-	-	-
16.S22010	Friction Set	16.2208	6	16.2206	2	-	-	-	-
16.S22024	Friction Set	16.2103	6	16.2104	1	-	-	-	-
16.S22025	Steel Set	16.2252	6	-	-	-	-	-	-
16.S22055	Friction Set	16.2200	5	-	-	-	-	-	-
16.S23011	Friction Set	16.2304	7	-	-	-	-	-	-
16.S23012	Friction Set	16.2305	7	-	-	-	-	-	-
16.S23013	Steel Set	16.2351	6	-	-	-	-	-	-
16.S23014	Friction Set	16.2306	7	-	-	-	-	-	-
16.S23015	Friction Set	16.2306	8	-	-	-	-	-	-
16.S23016	Steel Set	16.2351	7	-	-	-	-	-	-
16.S23017	Friction Set	16.2208	7	16.2206	2	-	-	-	-
16.S23018	Steel Set	16.2352	8	-	-	-	-	-	-
16.S23026	Friction Set	16.2019	7	-	-	-	-	-	-
16.S23027	Steel Set	16.2353	6	-	-	-	-	-	-
16.S23047	Friction Set	16.2021	6	-	-	-	-	-	-

Set Part No.	Remarks	Plate No. 1	Qty.	Plate No. 2	Qty.	Plate No. 3	Qty.	Plate No. 4	Qty.
16.S23048	Friction Set	16.2019	6	16.2694	1	-	-	-	-
16.S23049	Friction Set	16.2308	9	-	-	-	-	-	-
16.S23050	Friction Set	16.2208	4	16.2206	2	-	-	-	-
16.S23051	Steel Set	16.2251	5	-	-	-	-	-	-
16.S23060	Friction Set	16.2021	4	16.2208	2	-	-	-	-
16.S23065	Friction Set	16.2319	8	-	-	-	-	-	-
16.S24019	Friction Set	16.2418	7	16.2419	1	-	-	-	-
16.S24020	Friction Set	16.2306	9	-	-	-	-	-	-
16.S24021	Steel Set	16.2452	8	-	-	-	-	-	-
16.S24022	Friction Set	16.2306	8	16.2307	1	-	-	-	-
16.S24023	Friction Set	16.2423	9	-	-	-	-	-	-
16.S24025	Steel Set	16.2405	4	16.2351	3	-	-	-	-
16.S24028	Friction Set	16.2434	7	16.2435	1	-	-	-	-
16.S24031	Friction Set	16.2434	7	16.2307	1	-	-	-	-
16.S24041	Friction Set	16.2423	8	-	-	-	-	-	-
16.S24052	Friction Set	16.2423	7	16.2307	1	-	-	-	-
16.S24056	Friction Set	16.2904	6	16.2423	2	-	-	-	-
16.S24057	Friction Set	16.2423	8	16.2307	1	-	-	-	-
16.S24058	Friction Set	16.2423	5	16.2904	3	-	-	-	-
16.S24059	Friction Set	16.2904	5	16.2436	3	-	-	-	-
16.S24062	Friction Set	16.2308	7	16.2206	2	-	-	-	-
16.S24063	Friction Set	16.2904	5	16.2423	3	-	-	-	-
16.S25043	Friction Set	16.2020	8	-	-	-	-	-	-
16.S25046	Friction Set	16.2305	6	-	-	-	-	-	-
16.S26029	Friction Set	16.2020	6	16.2019	2	-	-	-	-
16.S26030	Friction Set	16.2423	7	16.2435	1	-	-	-	-
16.S26031	Friction Set	16.2103	9	-	-	-	-	-	-
16.S26032	Friction Set	16.2695	9	-	-	-	-	-	-
16.S26033	Friction Set	16.2695	7	16.2205	2	-	-	-	-
16.S26034	Friction Set	16.2699	6	16.2694	2	-	-	-	-
16.S26035	Friction Set	16.2699	8	-	-	-	-	-	-
16.S26036	Friction Set	16.2699	6	16.2693	2	-	-	-	-
16.S26053	Friction Set	16.2903	7	16.2693	1	16.2699	1	-	-
16.S26054	Friction Set	16.2305	4	16.2423	2	16.2435	1	-	-
16.S28044	Friction Set	16.2694	9	-	-	-	-	-	-
16.S28045	Friction Set	16.2694	8	-	-	-	-	-	-
16.S29040	Friction Set	16.2904	8	16.2906	1	-	-	-	-
16.S29042	Friction Set	16.2305	8	-	-	-	-	-	-
16.S31003	Friction Set	16.3202	5	-	-	-	-	-	-
16.S31089	Steel Set	16.3189	4	-	-	-	-	-	-
16.S32004	Friction Set	16.3212	8	-	-	-	-	-	-
16.S32005	Steel Set	16.3254	7	-	-	-	-	-	-
16.S32006	Friction Set	16.3214	8	-	-	-	-	-	-
16.S33007	Friction Set	16.3304	8	-	-	-	-	-	-
16.S33008	Steel Set	16.3351	7	-	-	-	-	-	-
16.S33009	Friction Set	16.3304	9	-	-	-	-	-	-
16.S33010	Steel Set	16.3351	8	-	-	-	-	-	-
16.S33011	Friction Set	16.3316	8	-	-	-	-	-	-
16.S33012	Steel Set	16.3354	7	-	-	-	-	-	-
16.S33013	Friction Set	16.3324	6	16.3325	2	-	-	-	-
16.S33014	Friction Set	16.3326	8	-	-	-	-	-	-
16.S33028	Friction Set	16.4337	8	-	-	-	-	-	-
16.S33029	Friction Set	16.3303	7	-	-	-	-	-	-
16.S33032	Friction Set	16.3341	8	-	-	-	-	-	-
16.S33033	Friction Set	16.3304	7	-	-	-	-	-	-
16.S33034	Friction Set	16.3911	6	16.3908	1	-	-	-	-
16.S34015	Friction Set	16.3402	7	16.3403	1	-	-	-	-
16.S34016	Steel Set	16.3451	7	-	-	-	-	-	-
16.S34017	Friction Set	16.3405	6	16.3325	2	-	-	-	-
16.S34018	Steel Set	16.3452	6	16.3453	1	-	-	-	-
16.S34019	Friction Set	16.3402	9	-	-	-	-	-	-
16.S34020	Steel Set	16.3451	8	-	-	-	-	-	-
16.S34021	Friction Set	16.3406	6	16.3325	2	-	-	-	-
16.S34030	Friction Set	16.3325	5	16.3405	3	-	-	-	-
16.S34031	Friction Set	16.3325	4	16.3406	4	-	-	-	-
16.S35021	Friction Set	16.3303	7	-	-	-	-	-	-
16.S36022	Friction Set	16.3605	6	16.3403	1	-	-	-	-
16.S39023	Friction Set	16.3912	8	16.3997	1	16.3999	1	-	-
16.S39024	Friction Set	16.3907	9	16.3908	1	-	-	-	-
16.S39025	Friction Set	16.3909	8	16.3910	1	16.3911	1	-	-
16.S39026	Friction Set	16.3996	8	16.3997	2	-	-	-	-
16.S39027	Friction Set	16.3998	8	16.3997	1	16.3999	1	-	-
16.S41001	Friction Set	16.4104	5	-	-	-	-	-	-
16.S41002	Steel Set	16.4151	4	-	-	-	-	-	-

CLUTCH PLATE SET ASSEMBLIES continued..

Set Part No.	Remarks	Plate No. 1	Qty.	Plate No. 2	Qty.	Plate No. 3	Qty.	Plate No. 4	Qty.
16.S41003	Friction Set	16.4104	4	-	-	-	-	-	-
16.S41004	Steel Set	16.4151	3	-	-	-	-	-	-
16.S41005	Friction Set	16.4104	6	-	-	-	-	-	-
16.S41006	Steel Set	16.4151	5	-	-	-	-	-	-
16.S41007	Friction Set	16.4106	7	-	-	-	-	-	-
16.S41008	Steel Set	16.4151	6	-	-	-	-	-	-
16.S41009	Friction Set	16.4108	6	-	-	-	-	-	-
16.S41010	Steel Set	16.4152	5	-	-	-	-	-	-
16.S42011	Friction Set	16.4204	7	-	-	-	-	-	-
16.S42012	Steel Set	16.4244	6	-	-	-	-	-	-
16.S42013	Friction Set	16.4214	7	-	-	-	-	-	-
16.S42014	Steel Set	16.4245	6	-	-	-	-	-	-
16.S42015	Friction Set	16.4214	5	16.4219	2	-	-	-	-
16.S42016	Friction Set	16.4216	8	-	-	-	-	-	-
16.S42017	Steel Set	16.1331	7	-	-	-	-	-	-
16.S42040	Friction Set	16.4207	7	16.4204	1	-	-	-	-
16.S43018	Friction Set	16.4304	7	-	-	-	-	-	-
16.S43019	Friction Set	16.4306	8	-	-	-	-	-	-
16.S43020	Steel Set	16.4354	7	-	-	-	-	-	-
16.S43021	Alloy Set	16.4454	7	-	-	-	-	-	-
16.S43022	Steel Set	16.3354	7	-	-	-	-	-	-
16.S43023	Friction Set	16.4312	8	-	-	-	-	-	-
16.S43024	Friction Set	16.4336	6	16.4337	2	-	-	-	-
16.S43025	Steel Set	16.4245	7	-	-	-	-	-	-
16.S43026	Friction Set	16.4336	6	16.4337	2	-	-	-	-
16.S43027	Friction Set	16.4337	8	-	-	-	-	-	-
16.S44028	Friction Set	16.3402	6	16.1422	2	-	-	-	-
16.S44029	Friction Set	16.1422	7	16.4419	1	-	-	-	-
16.S44039	Friction Set	16.1422	7	16.1662	1	-	-	-	-
16.S46029	Friction Set	16.4695	9	-	-	-	-	-	-
16.S46030	Friction Set	16.4695	8	-	-	-	-	-	-
16.S46037	Friction Set	16.4795	7	-	-	-	-	-	-
16.S46038	Friction Set	16.4312	7	-	-	-	-	-	-
16.S47031	Friction Set	16.4791	8	-	-	-	-	-	-
16.S47032	Friction Set	16.4795	8	-	-	-	-	-	-
16.S49031	Friction Set	16.4791	8	-	-	-	-	-	-
16.S49033	Friction Set	16.4695	10	-	-	-	-	-	-
16.S49034	Friction Set	16.4994	8	16.4995	2	-	-	-	-
16.S49035	Friction Set	16.4982	9	16.4983	2	16.4984	1	-	-
16.S49036	Friction Set	16.4991	7	16.4795	2	-	-	-	-
16.S50012	Friction Set	16.6020	6	-	-	-	-	-	-
16.S50013	Steel Set	16.6098	5	-	-	-	-	-	-
16.S51011	Friction Set	16.6103	7	-	-	-	-	-	-
16.S51012	Steel Set	16.6104	6	-	-	-	-	-	-
16.S52001	Friction Set	16.1205	7	-	-	-	-	-	-
16.S52002	Alloy & Steel Set	16.1253	4	16.1252	2	-	-	-	-
16.S52004	Alloy & Steel Set	16.1253	4	16.1252	3	-	-	-	-
16.S53011	Friction Set	16.6361	8	-	-	-	-	-	-
16.S53014	Friction Set	16.6313	9	-	-	-	-	-	-
16.S53015	Steel Set	16.6394	8	-	-	-	-	-	-
16.S53016	Friction Set	16.6361	7	-	-	-	-	-	-
16.S53027	Steel Set	16.6463	6	16.6462	2	-	-	-	-
16.S53029	Steel Set	16.6463	7	16.6462	2	-	-	-	-
16.S54006	Steel Set	16.6457	8	-	-	-	-	-	-
16.S54007	Friction Set	16.6404	7	-	-	-	-	-	-
16.S54008	Friction Set	16.6400	7	-	-	-	-	-	-
16.S54009	Steel Set	16.6462	8	-	-	-	-	-	-
16.S54010	Steel Set	16.6462	4	16.6463	4	-	-	-	-
16.S54015	Friction Set	16.6408	9	-	-	-	-	-	-
16.S54016	Friction Set	16.6428	9	-	-	-	-	-	-
16.S54017	Friction Set	16.6428	8	16.6429	1	-	-	-	-
16.S54020	Steel Set	16.6459	8	-	-	-	-	-	-
16.S54021	Steel Set	16.6459	7	16.6460	1	-	-	-	-
16.S56016	Friction Set	16.6608	7	16.6609	1	-	-	-	-
16.S62000	Steel Set	16.6250	6	-	-	-	-	-	-
16.S63001	Friction Set	16.1335	7	-	-	-	-	-	-
16.S63002	Steel Set	16.1331	6	-	-	-	-	-	-
16.S71018	Steel Set	16.7114	7	-	-	-	-	-	-
16.S72018	Alloy Set	16.1253	6	-	-	-	-	-	-
16.S73008	Friction Set	16.1335	9	-	-	-	-	-	-
16.S73011	Friction Set	16.1335	8	16.7124	1	-	-	-	-
16.S73013	Friction Set	16.2423	7	16.2436	1	-	-	-	-
16.S73018	Steel Set	16.7114	8	-	-	-	-	-	-
16.S73028	Friction Set	16.7318	6	16.7319	2	-	-	-	-

HEAD & BASE GASKET SETS

The ProX Head & Base gasket sets gaskets are made of all premium base materials. Each gasket is precision cut for optimal fit and perfect seal. The new ProX Head & Base gasket sets just contain 1 head gasket and 1 base gasket. This results in a more cost efficient kit when not all components are being replaced. A full range of Dirtbike Head & Base gasket is available.



ProX Head & Base Gasket Features :

- Manufactured of all premium base materials
- Precision cut for optimal fit and perfect seal
- Cost efficient assembly
- Full range of Dirtbike sets available

OEM Reference

PART #	BASE GASKET	HEAD GASKET #1	HEAD GASKET #2
36.1103	12191-GBF-B40	12251-GBF-B01	-
36.1200	12191-KZ4-L10	12251-KZ4-A91	-
36.1203	12191-KZ4-L30	12251-KZ4-A91	-
36.1204	12191-KSR-A00	12251-KSR-A01	-
36.1205	12191-KSR-731	12251-KSR-731	-
36.1207	12191-KSE-671	12251-KSE-671	-
36.1304	12191-KRN-731	12251-KRN-731	-
36.1305	12191-KSK-731	12254-KSK-731	-
36.1310	12191-KRN-A41	12251-KRN-A41	-
36.1392	12191-KZ3-880	12254-KZ3-860	-
36.1402	12191-MEB-671	12251-MEB-671	-
36.1405	12191-MEY-671	12251-MEY-671	-
36.1407	12191-MEB-671	12251-MEY-671	-
36.1409	12191-MEN-A31	12251-MEN-A31	-
36.1419	12191-MKE-A71	12251-MKE-A71	-
36.2018	BR8-11351-00	93210-50582	93210-76MF8
36.2102	4ES-11351-00-00	93210-56459-00	93210-84724-00
36.2119	B4B-11351-00-00	93210-56459-00	93210-84724-00
36.2205	1C3-11351-00-00	93210-63442-00	93210-90785-00
36.2299	5DH-11351-01-00	93210-63442-00	93210-90785-00
36.2301	5NL-11351-00-00	5NL-11181-00-00	-
36.2314	1SM-11351-00-00	1SM-11181-00-00	-
36.2319	B4B-11351-00-00	93210-56459-00	93210-84724-00
36.2397	4XL-11351-01-00	93210-77363-00	93211-11770-00
36.2399	5UP-11351-00-00	93210-74316-00	93211-02703-00
36.2403	5TA-11351-00-00	5TA-11181-00-00	-
36.2406	2S2-11351-00-00	2S2-11181-00-00	-
36.2410	33D-11351-00-00	33D-11181-00-00	-
36.2414	1SL-11351-00-00	33D-11181-00-00	-
36.2418	BR9-11351-00-00	BR9-11181-00-00	-
36.2706	1S3-11351-00-00	3B4-11181-00-00	-
36.3191	11241-03B01	11147-03B00	11148-03B00
36.3201	11241-36F00	11147-27C11	11148-27C11
36.3292	11241-27C10	11147-27C11	11148-27C11
36.3301	11241-37F01	11147-37F00	11148-37F00
36.3303	11241-37F20	11147-37F00	11148-37F00
36.3307	11241-10H00	11141-10H00	-
36.3310	11241-49H10	11141-49H00	-
36.3396	11241-37E00	11147-28C20	11148-28C20
36.3399	11241-37E31	11147-28C20	11148-28C20
36.3405	11241-35G01	11141-35G01	-
36.3407	11241-35G01	11141-35G10	-
36.3408	11241-28H10	11141-28H00	-
36.4100	11060-1921	11004-1346	-
36.4101	11060-1779	11004-1360	-
36.4114	11060-1779	11004-0737	-
36.4185	11060-1873	11004-1218	-
36.4198	11060-1779	11004-1214	-
36.4200	11060-1998	11004-1300	-
36.4203	11061-0039	92055-1678	92055-1679
36.4301	11060-1493	11004-0013	-
36.4304	11061-0025	11004-0089	-
36.4305	11061-0091	92055-0049	92055-0050
36.4309	11061-0357	11004-0738	-
36.4393	11060-1493	11004-0013	-
36.4406	11061-0160	11004-0088	-
36.4409	11061-0353	11004-0088	-
36.4410	11061-0768	11004-0088	-
36.4419	11061-1220	11004-0777	-
36.6306	770.30.035.200	770.30.036.000	-
36.6307	548.30.030.002	077.07.30.020	077.01.05.020
36.6311	772.30.035.000	772.30.036.000	-
36.6313	772.30.035.000	777.30.036.085	-
36.6314	772.30.035.000	778.30.036.085	-
36.6329	792.30.035.000	793.30.036.086	-
36.6407	077.01.08.018 (2x) + 773.30.035.000	773.30.036.000	-
36.6412	594.30.035.000	595.30.036.000	-
36.6414	780.30.035.000	789.30.036.010	-

DRIVE CHAINS

ProX has developed a premium line of Roller Chains to team up together with the ProX front and rear sprockets. The ProX Roller Chain is a top quality chain, exclusively manufactured for ProX by the reputable and leading OEM factory in Japan.

All ProX chains are made using highest grade Japanese steel. The MX chains are assembled out of various different component that all have their specific and crucial function to make the chain a high quality product. Pins do feature an exclusive pin treatment providing an extremely hard outside coating, leaving a softer inside to increase strength while reducing overall chain wear. The pins are heavy press fitted and do feature quad staked riveting for ultra strong connection. The solid bush inside the shot-peened, solid roller and plates are all heat treated to offer an incredible tensile strength in combination with low friction and high wear resistance. Inner plates are designed in a specific shape allowing less material to be used which in combination with the unique lightning holes results in a 3% overall lighter chain without compromising tensile strength. Specifically for the Offroad, Enduro, ATV and big 4-Stroke Motocross bikes ProX also offers a lightweight, narrow type X-Ring chain using a QX-type seal offering 40% less friction and at least 150% increased durability over a standard MX Chain.

All ProX chains are pre-stressed and pre-stretched to reduce initial chain stretch and immediate performance and come with a clip type chain link as standard.



ProX Rollerchain features

- Exclusively manufactured for ProX by the reputable and leading OEM factory in Japan.
- Pins features special treatment providing an extremely hard coating leaving softer inside to increase strength while reducing overall chain wear.
- Pins are heavy press-fitted and do have quad staked riveting for ultra strong connection.
- Solid type bush, roller and plates are all heat treated for incredible tensile strength in combination with low friction and high wear resistance.
- Inner plates are designed in specific shape and in combination with unique lightning hole resulting in 3% overall lighter chain.
- X-Ring type chain uses QX-type seal offering 40% less friction and at least 150% increased durability over standard MX chain.
- All chains are pre-stressed and pre-stretched to reduce initial chain stretch and immediate performance.
- Chains come with a clip type chain link as standard.
- Separate chain links available for each type of chain.

SPECIFICATIONS

Part No.	Chain		Roller		Pin		Plate Thickness		Weight Kg / 100 Links	Tensile Strength kN	Masterlink included	Remarks
	Type	Length	Width (mm.)	Diameter (mm.)	Diameter (mm.)	Length (mm.)	Inner (mm.)	Outer (mm.)				
07.RC420130C	420	130	6.35	7.75	3.95	17.30	2.00	2.00	1.01	23.1	Cliplink	MX Chain / Made in Japan
07.RC428130C	428	130	7.95	8.50	4.50	19.00	1.80	1.80	1.03	22.2	Cliplink	MX Chain / Made in Japan
07.RC520120C	520	120	6.35	10.15	5.25	17.50	2.00	2.00	1.52	39.7	Cliplink	MX Chain / Made in Japan
07.RC520120CG	520	120	6.35	10.15	5.25	17.50	2.00	2.00	1.52	39.7	Cliplink	MX Chain Gold / Made in Japan
07.RC520120XC	520	120	6.35	10.15	5.40	20.00	2.00	2.00	1.57	37.8	Cliplink	X-Ring Chain / Made in Japan
07.RC520120XCG	520	120	6.35	10.15	5.40	20.00	2.00	2.00	1.57	37.8	Cliplink	X-Ring Chain Gold / Made in Japan

SEPERATE MASTERLINKS

Part No.	Type		Remarks
	Rivetlink	Cliplink	
07.RC420CL	-	X	MX Chain
07.RC428CL	-	X	MX Chain
07.RC520CL	-	X	MX Chain
07.RC520CLG	-	X	MX Chain Gold
07.RC520XCL	-	X	X-Ring Chain
07.RC520XCLG	-	X	X-Ring Chain Gold
07.RC520XRL	X	-	X-Ring Chain
07.RC520XRL	X	-	X-Ring Chain

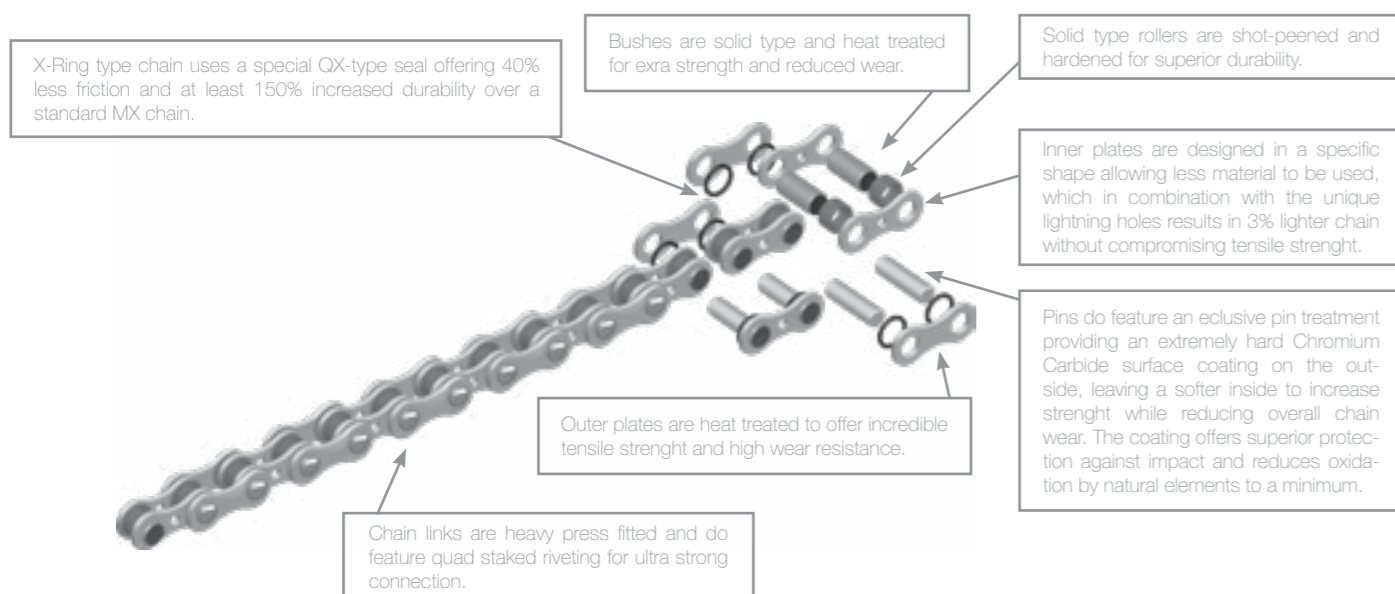

BRAKE PAD SCHEMATICS

The ProX brake pad schematics do show DIMENSIONS and shape of each indivial brake pad set.

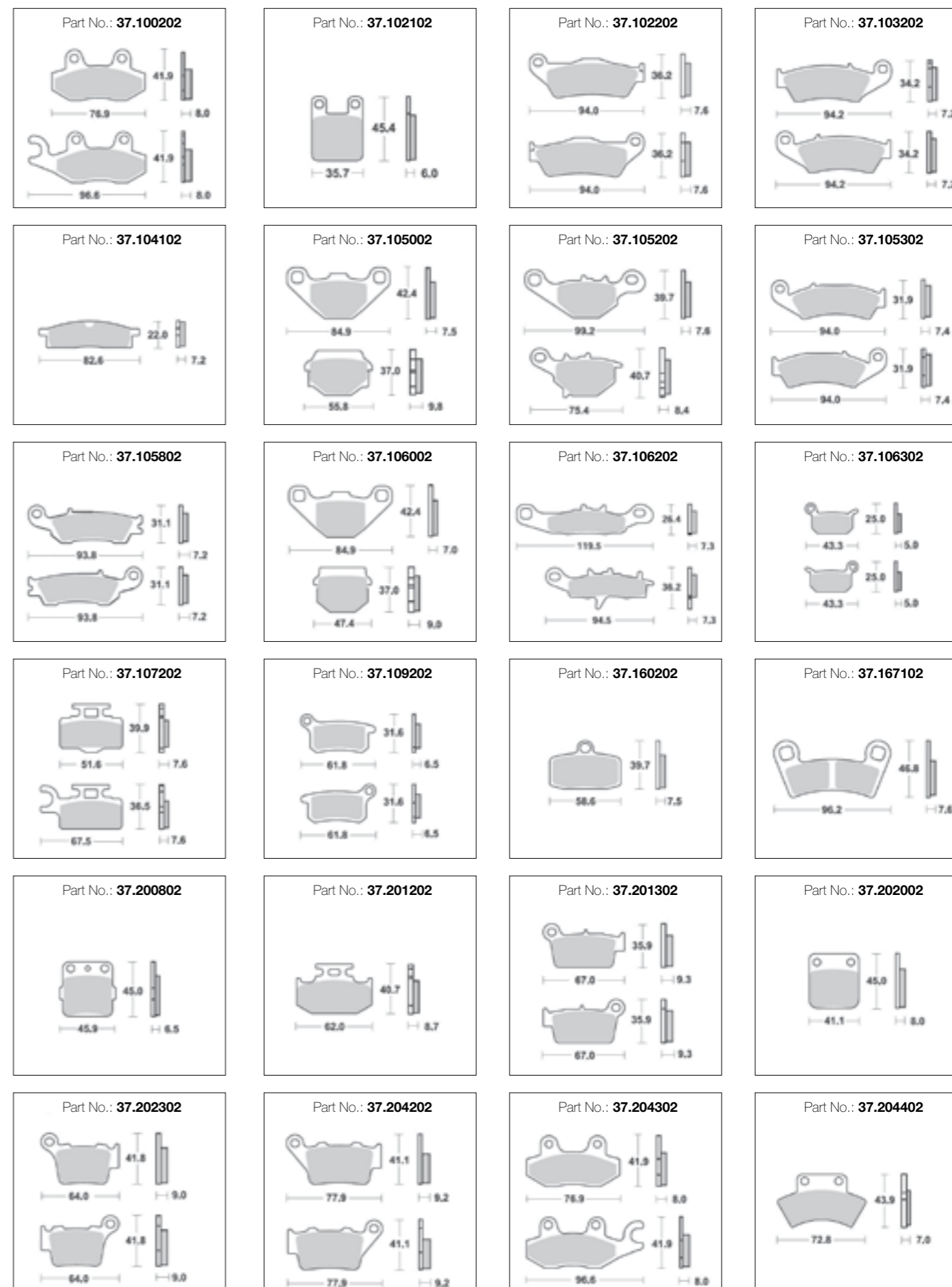

BRAKE PAD SCHEMATICS

The ProX brake pad schematics do show DIMENSIONS and shape of each individual brake pad set.

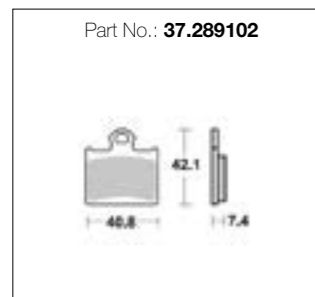
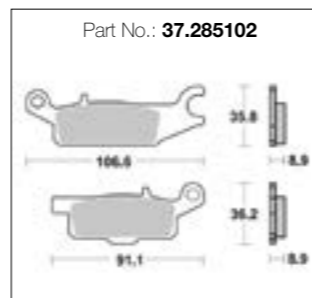
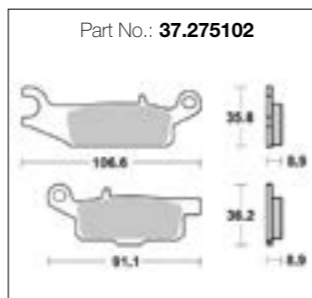
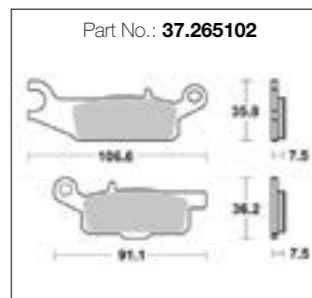
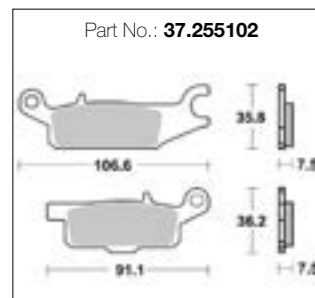
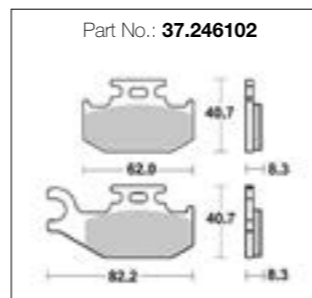
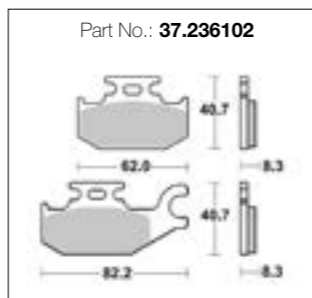
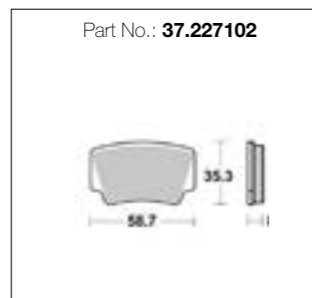
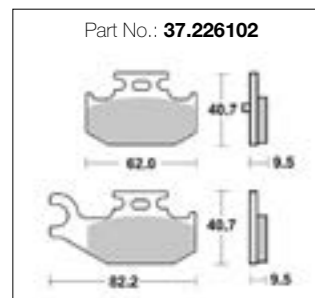
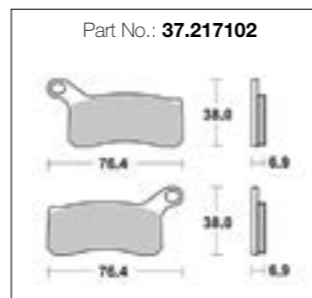
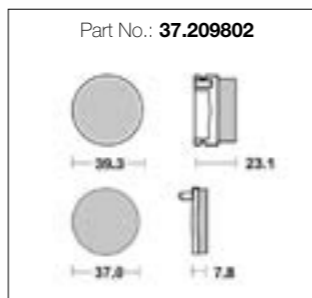
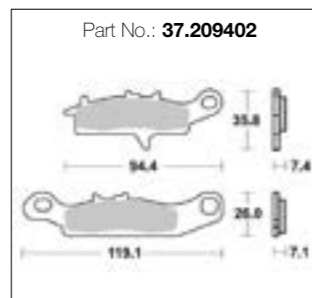
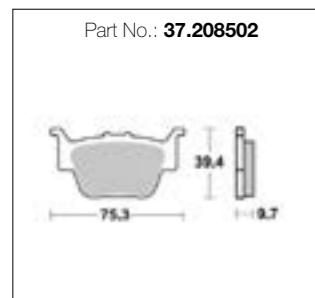
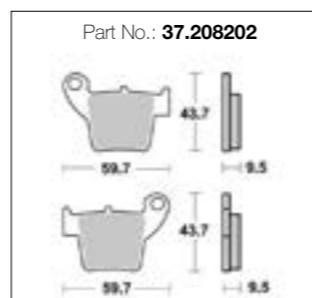
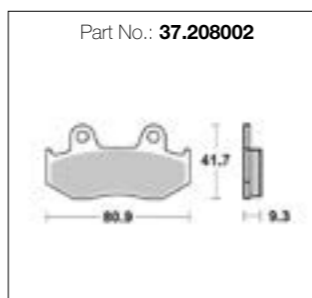
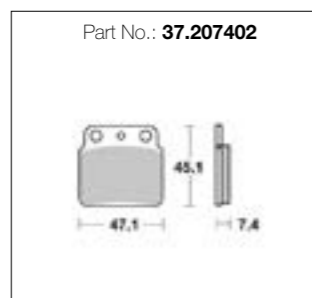
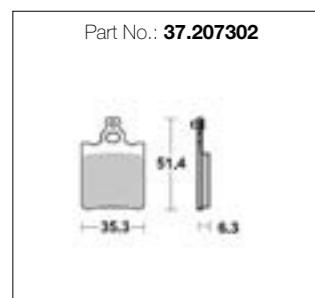
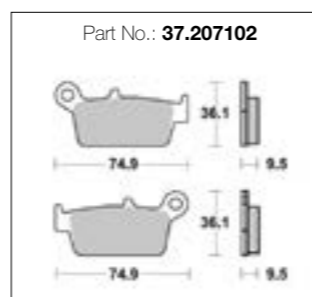
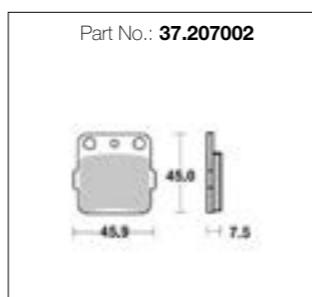
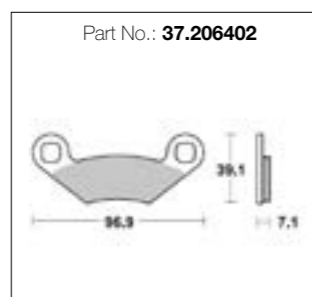
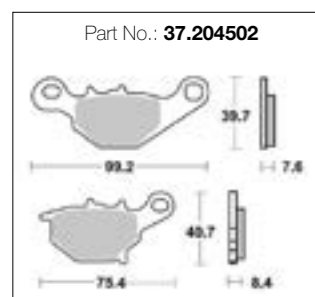

WHEEL BEARINGS

Maintain your wheel hubs with Genuine wheel bearings offered by ProX. The highest quality, Japanese OEM style bearings are double-side sealed to protect against dirt and water. The bearings are produced according strict OEM tolerance and will bring the very best performance and durability.

ALL

Part No.	Size (mm)	Remarks
23.6001-2RS	12 x 28 x 8	2 side sealed
23.6002-2RS	15 x 32 x 9	2 side sealed
23.6003-2RS	17 x 35 x 10	2 side sealed
23.6004-2RS	20 x 42 x 12	2 side sealed
23.6005-2RS	25 x 47 x 12	2 side sealed
23.6022-2RS	22 x 44 x 12	2 side sealed
23.6200-2RS	10 x 39 x 9	2 side sealed
23.6201-2RS	12 x 32 x 10	2 side sealed
23.6202-2RS	15 x 35 x 11	2 side sealed
23.6203-2RS	17 x 40 x 12	2 side sealed

Part No.	Size (mm)	Remarks
23.6204-2RS	20 x 47 x 14	2 side sealed
23.6205-2RS	25 x 52 x 15	2 side sealed
23.6222-2RS	22 x 50 x 14	2 side sealed
23.6300-2RS	10 x 35 x 11	2 side sealed
23.6301-2RS	12 x 37 x 11	2 side sealed
23.6302-2RS	15 x 42 x 13	2 side sealed
23.6303-2RS	17 x 47 x 14	2 side sealed
23.6304-2RS	20 x 52 x 15	2 side sealed
23.6305-2RS	25 x 62 x 17	2 side sealed
23.6904-2RS	20 x 37 x 9	2 side sealed
23.6905-2RS	25 x 42 x 9	2 side sealed
23.6906-2RS	30 x 47 x 9	2 side sealed
23.6922-2RS	22 x 39 x 9	2 side sealed

STEERING BEARINGS

(individual)



The ProX individual steering bearings are the highest quality, Japanese OEM style bearings. Manufactured in the leading Japanese OEM factories like NTN or KOYO, these tapered steering bearings are produced according strict OEM tolerance and will bring the very best performance and durability.

ALL

Size (mm)	Part No.
25 x 47 x 17	24.1044
25 x 47 x 18	24.1040
28 x 52 x 16	24.1030
30 x 51 x 15	24.1010
30 x 52 x 16	24.1032
30 x 55 x 17.5	24.1043
30 x 55 x 19	24.1041

SWINGARM BEARINGS

(O.E.M. Replacement Bearings)



Maintain your swingarm with Genuine swingarm bearings offered by ProX. The highest quality, Japanese OEM style bearings are produced according strict OEM tolerance and will bring the very best performance and durability.

ALL

Size (mm)	Part No.
17 x 24 x 14.85	25.1509
17 x 24 x 20	25.1504
20 x 26 x 20	25.1502
20 x 26 x 30	25.1503
20 x 27 x 30	25.1506
22 x 28 x 12	25.1508

FRONTFORK OIL SEALS & DUST SEALS

(O.E.M. Replacement oilseals & dustseals)

ProX offer a wide range of frontfork oilseals and dustseals for the MX and Dirtbike segment. Most of the seals are manufactured by the leading OEM factories in Japan such as NOK. The seals are all manufactured from high quality base materials and are made to OEM specs and tolerances to guarantee quality and superior durability. Forkseals and dustseals are available in sets of 2 oilseals or 2 dustseals, in bulk packaging of 10 oilseals or 10 dustseals and also in sets of 2 oilseals plus 2 dustseals for a complete frontfork rebuild.

ProX Fronfork Oilseals and Dustseals features

- Manufactured by the leading OEM factories in Japan such as NOK.
- High quality base materials made to OEM specifications and tolerances for guaranteed quality and superior durability.
- Available separately or in sets to be a simple and cost efficient OEM replacement.
- Full range of oilseals and dustseals for MX and Dirtbike available from ready stock.



ALL

Size (mm)	Suspension	Oilseal (Pack of 10 pcs.)	Dustseal (Pack of 10 pcs.)	Oilseal Set (Set of 2 pcs.)	Dustseal Set (Set of 2 pcs.)	Oilseal & Dustseal Set (Set of 2 pcs. each)
30 x 42 x 11	Kayaba	40.304211-10	-	-	-	-
33 x 46 x 11	Kayaba	40.334611P-10	40.3346DP-10	40.F334611P	40.F3346DP	40.S334611P
35 x 46 x 11	-	40.354611P-10	40.3546.8DP-10	40.F354611P	40.F3546.8DP	40.S354611P
35 x 47 x 10	Marzocchi	40.354710P-10	40.3547.4DP-10	40.F3654710P	40.F3547.4DP	40.S354710P
35 x 48 x 11	Showa	40.354811-10	40.3548D-10	40.F354811	40.F3548D	40.S354811
36 x 48 x 8	Kayaba	40.36488P-10	40.3648DP-10	40.F36488P	40.F3648DP	40.S36488P
37 x 50 x 11	Showa	40.375011-10	40.3750D-10	40.F375011	40.F3750D	40.S375011
38 x 50 x 8	-	40.38508-10	-	-	40.F38508	-
41 x 53 x 8.5	Showa	-	40.4153D-10	-	-	40.S41539
43 x 52.9 x 9	WP	40.4352.99P-10	40.4353.4DP-10	40.F4352.99P	40.F4353.4DP	40.S4352.99P
43 x 54 x 9.5	Showa	40.43549-10	40.4354DP-10	40.F43549	40.F4354DP	40.S43549
43 x 54 x 11	Showa	40.435411-10	40.4354DP-10	40.F435411	40.F4354DP	40.S435411
43 x 55 x 9.5	Kayaba	40.43559-10	40.4355DP-10	40.F43559	40.F4355DP	40.S43559
45 x 57 x 11	Showa	40.455711P-10	40.4557DP-10	40.F455711P	40.F4557DP	40.S455711
46 x 58 x 9.5	Showa	40.46589-10	40.4658D-10	40.F46589	40.F4658D	40.S46589
47 x 58 x 10	Showa	40.475810-10	40.4758D-10	40.F475810	40.F4758D	40.S475810
48 x 57.8 x 9.5	WP	40.4857.89-10	40.4857.8D-10	40.F4857.89	40.F4857.8D	40.S4857.89
48 x 58 x 9.4	Kayaba PSF	40.48589.4-10	40.4858D-10	40.F48589.4	40.F4858D	40.S48589.4
48 x 58 x 10	Kayaba	40.485810-10	40.4858D-10	40.F485810	40.F4858D	40.S485810
49 x 60 x 10.5	Showa	40.496011-10	40.4960D-10	40.F496011	40.F4960D	40.S496011

OUR METERS

WIRED HOUR METERS

ProX offer two different wired meters. The Hour Meter, which shows the hours the engine has ran and the Hour/Tach meter that displays the engine running hours and RPM as well when the engine is running. When the engine is off the meter shows total hours accumulated. Both meters' display can be read at all times, with engine off or on. There is no clicking like mechanical meters. Also the encapsulated epoxy case is water resistant and shock proof.

ProX Hour/Tach Meter Features :

- Works on all 2/4 stroke gasoline engines up to 2 cylinder including newer FI bikes.
- Easy installation, no wiring necessary just plug and play.
- Adjustable RPM input for dual or single spark ignition systems.
- Real time reading of tach upto 20.000 rpm.
- All flash alerts count down the last 10 hours left before service.
- All flash alerts are easily reset with a touch of a button.
- Meter also includes timer mode to record individual riding sessions.
- Total hours accumulated is not re-settable and cannot be erased.
- No power required, includes a 10 year battery sealed inside.
- 100% epoxy encapsulated casing is water resistant and shock-proof.

Partnumbers	Description
43.HM001	Prox Hour Meter
43.HM002	Prox Hour/Tach Meter
43.HM003	ProX Wireless Hour Meter

WIRELESS HOUR METER

ProX now has a state of art Wireless Hour Meter! Unique by eliminating wires the ProX Wireless Hour Meter is a surface mounted vibration activated hour meter, which provides what today's Powersports user needs and expect from hour meters.

Motorcycle engines have strict maintenance schedules that must be followed to honor the service life of components and secure reliability of the engine. Knowing what to service and when, is key to a successful preventative maintenance program for your motorcycle, ATV, PWC, boat or snowmobile.

Installation is easy without needing to install a wire. Solid state electronics, modern LCD, superb environmental durability and enhanced functionality offer the best of all possibilities without sacrifice to performance, operation or budget.

The wireless hour meter display can be read at all times, with engine off or on. The encapsulate epoxy case is water resistant and shock proof.

With the ProX Wireless Hour Meter you can measure your hours for hours!

ProX Wireless Hour Meter Features :

- Easy installation, no battery and wiring required.
- Sensitivity can be set to high or low.
- Partial hours can be reset to zero.
- Works on all 2/4 stroke gasoline engines.
- 100% epoxy encapsulated casing is water resistant and shock-proof.
- Automatic Roll over.
- Records and Displays to 99999 hours,
- Stand-by time up to over 45.000 hours.



FRONT FORK SEAL PROTECTORS

The ProX neoprene fork seal protector is a great and simple product to prevent blown fork seals from dirt getting stuck in the seal lips. Simply sliding down the neoprene sleeve to your fork leg, covering the seals and you're good to go. The sleeve will be kept in place with zip ties provided.

The stretchy and durable neoprene material protects the fork tube and fork seal from sand, rocks and other dirt while it does not deteriorate from fork oil.

ProX fork seal Protectors are sold in pairs and do fit various diameter of fork legs from 44 mm. up to 50 mm. Also each set is available in 2 lengths, a 360 mm length will cover the entire fork tube and a 130 mm length will cover the fork seal and short part of the fork tube. The full length 360 mm. can be used for bikes using open type fork leg guards and the shorter 130 mm. type can be used for most bikes using closed type fork leg guards.

ProX Racing Parts neoprene fork seal protector features :

- Ultimate protection against sand, rocks or dirt
- Available in different length for optimal fit
- Simple and easy fit
- Sold in pairs including zip ties

Partnumbers	Description
40.FSP1304450	ProX Neoprene Forkseal Protector 130 x 44-50 mm.
40.FSP3604450	ProX Neoprene Forkseal Protector 360 x 44-50 mm.



CARBURETTOR MAIN / PILOT JETS

CARBURETTOR MAIN JETS to replace Keihin 99101-357 SERIES*

Size	Part No.	Size	Part No.
100	45.100	160	45.160
102	45.102	162	45.162
105	45.105	165	45.165
108	45.108	168	45.168
110	45.110	170	45.170
112	45.112	172	45.172
115	45.115	175	45.175
117	45.117	178	45.178
120	45.120	180	45.180
125	45.125	182	45.182
128	45.128	185	45.185
130	45.130	188	45.188
132	45.132	190	45.190
135	45.135	192	45.192
138	45.138	195	45.195
140	45.140	198	45.198
142	45.142	200	45.200
145	45.145	205	45.205
148	45.148	210	45.210
150	45.150	215	45.215
152	45.152	220	45.220
155	45.155	225	45.225
158	45.158		

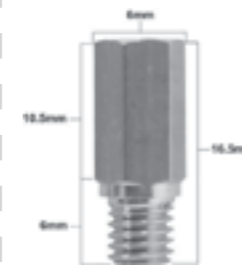

Main Jet to Replace Keihin 99101-357 Series

* To fit Keihin PWM Racing Carbs, CR Roundside Carbs, FCR MX Carbs, Flatside CR Carbs, PWK Carbs, PJ Carbs and PE Carbs.

CARBURETTOR PILOT JETS to replace Keihin N424-21 SERIES*

Size	Part No.
40	46.040
42	46.042
45	46.045
48	46.048
50	46.050
52	46.052
55	46.055
58	46.058
60	46.060
62	46.062
65	46.065
68	46.068
70	46.070
72	46.072
75	46.075
78	46.078
80	46.080
82	46.082
85	46.085



Pilot Jet to Replace Keihin N424-21 Series

* To fit Keihin FCR MX Carbs, PJ, PWK, PWM and some smoothbore Carbs.

CARBURETTOR MAIN JETS to replace Keihin 99101-116 SERIES*

Size	Part No.
70	45.116070
72	45.116072
75	45.116075
78	45.116078
80	45.116080
82	45.116082
85	45.116085
88	45.116088
90	45.116090
92	45.116092
95	45.116095
98	45.116098
100	45.116100
105	45.116105
110	45.116110
115	45.116115
120	45.116120

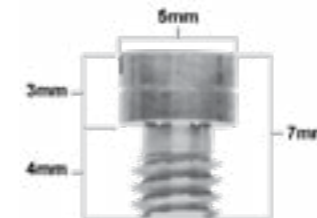

Main Jet to Replace Keihin 99101-116 Series

* To fit Keihin PB Carbs (Small ATV).

CARBURETTOR PILOT JETS to replace Keihin N424-26 SERIES*

Size	Part No.
25	46.F025
27.5	46.F027.5
30	46.F030
32.5	46.F032.5
35	46.F035
37.5	46.F037.5
40	46.F040
42	46.F042
45	46.F045
48	46.F048
50	46.F050
52	46.F052
55	46.F055
58	46.F058
60	46.F060



Pilot Jet to Replace Keihin N424-26 Series

* To fit Keihin for some Honda PE Carbs.

CARBURETTOR MAIN JETS to replace Keihin 99101-393 SERIES*

Size	Part No.	Size	Part No.
95	45.393095	180	45.393180
98	45.393098	185	45.393185
100	45.393100	190	45.393190
105	45.393105		
110	45.393110		
115	45.393115		
120	45.393120		
125	45.393125		
130	45.393130		
135	45.393135		
140	45.393140		
145	45.393145		
150	45.393150		
155	45.393155		
160	45.393160		
165	45.393165		
170	45.393170		
175	45.393175		

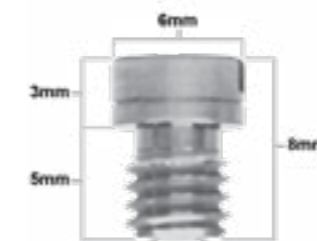

Main Jet to Replace Keihin 99101-393 Series

* To fit Keihin PB Carbs (Small ATV).

CARBURETTOR MAIN / PILOT JETS

CARBURETTOR MAIN JETS to replace Mikuni 4/042 SERIES*

Size	Part No.	Size	Part No.
90	47.090	435	47.435
100	47.100	440	47.440
110	47.110	445	47.445
120	47.120	450	47.450
130	47.130	455	47.455
140	47.140	460	47.460
150	47.150	465	47.465
160	47.160	470	47.470
170	47.170	480	47.480
180	47.180	485	47.485
190	47.190	490	47.490
200	47.200	495	47.495
210	47.210	500	47.500
220	47.220	510	47.510
230	47.230	520	47.520
240	47.240	530	47.530
250	47.250	540	47.540
260	47.260	550	47.550
270	47.270	560	47.560
280	47.280	570	47.570
290	47.290	580	47.580
300	47.300		
310	47.310		
320	47.320		
330	47.330		
340	47.340		
350	47.350		
360	47.360		
370	47.370		
380	47.380		
390	47.390		
400	47.400		
405	47.405		
410	47.410		
415	47.415		
420	47.420		
425	47.425		
430	47.430		

* To fit Mikuni VM Roundslide and TMX Carbs.



Main Jet to Replace Mikuni 4/042 Series

CARBURETTOR PILOT JETS to replace Mikuni VM11/22 SERIES*

Size	Part No.
65	47.VM11065
70	47.VM11070
75	47.VM11075
80	47.VM11080
85	47.VM11085
90	47.VM11090
95	47.VM11095
100	47.VM11100
105	47.VM11105
110	47.VM11110
115	47.VM11115
120	47.VM11120
125	47.VM11125
130	47.VM11130
135	47.VM11135
140	47.VM11140



Pilot Jet to Replace Mikuni VM11/22 Series

CARBURETTOR MAIN JETS to replace Mikuni N100/604 SERIES*

Size	Part No.
90	47.604090
92.5	47.604092.5
95	47.604095
97.5	47.604097.5
100	47.604100
102.5	47.604102.5
105	47.604105
107.5	47.604107.5
110	47.604110
112.5	47.604112.5
115	47.604115
117.5	47.604117.5
120	47.604120
125	47.604125
130	47.604130
135	47.604135
140	47.604140
145	47.604145
150	47.604150
155	47.604155
160	47.604160



Main Jet to Replace Mikuni N100/604 Series

* To fit Mikuni RS Carbs.

CARBURETTOR PILOT JETS to replace Mikuni N224 /103 SERIES

Size	Part No.
10	49.010
12.5	49.012.5
15	49.015
17.5	49.017.5
20	49.020
22.5	49.022.5
25	49.025
27.5	49.027.5
30	49.030
32.5	49.032.5
35	49.035
37.5	49.037.5
40	49.040
45	49.045



Pilot Jet to Replace Mikuni N224/103 Series

CARBURETTOR MAIN JETS to replace Mikuni N102/221 SERIES*

Size	Part No.
110	47.221110
112.5	47.221112.5
115	47.221115
117.5	47.221117.5
120	47.221120
122.5	47.221122.5
125	47.221125
127.5	47.221127.5
130	47.221130
132.5	47.221132.5
135	47.221135
137.5	47.221137.5
140	47.221140
142.5	47.221142.5
145	47.221145
147.5	47.221147.5
150	47.221150
152.5	47.221152.5
155	47.221155
157.5	47.221157.5
160	47.221160
162.5	47.221162.5
165	47.221165
167.5	47.221167.5
170	47.221170



Main Jet to Replace Mikuni N102/221 Series

CARBURETTOR PILOT JETS to replace Mikuni VM22/210 SERIES*

Size	Part No.
15	48.015
20	48.020
25	48.025
30	48.030
35	48.035
40	48.040
45	48.045
50	48.050
55	48.055
60	48.060
65	48.065
70	48.070
75	48.075
80	48.080



Pilot Jet to Replace Mikuni VM22/210 Series

MAIN JET ASSORTMENT BOX FOR KEIHIIN CARBURETTORS Partnumber = pack of 5 pieces !

Assortment Box Partnumber: 45.99

Size / Part No.	Size / Part No.	Size / Part No.
135 / 45.135	160 / 45.160	185 / 45.185
138 / 45.138	162 / 45.162	188 / 45.188
140 / 45.140	165 / 45.165	190 / 45.190
142 / 45.142	168 / 45.168	192 / 45.192
145 / 45.145	170 / 45.170	195 / 45.195
148 / 45.148	172 / 45.172	198 / 45.198
150 / 45.150	175 / 45.175	200 / 45.200
152 / 45.152	178 / 45.178	205 / 45.205
155 / 45.155	180 / 45.180	
158 / 45.158	182 / 45.182	

PILOT JET ASSORTMENT BOX FOR KEIHIIN CARBURETTORS Partnumber = pack of 5 pieces !

Size / Part No.	Size / Part No.	Size / Part No.
.040 / 46.040	.065 / 46.065	
.042 / 46.042	.068 / 46.068	
.045 / 46.045	.070 / 46.070	
.048 / 46.048	.072 / 46.072	
.050 / 46.050	.075 / 46.075	
.052 / 46.052	.078 / 46.078	
.055 / 46.055	.080 / 46.080	
.058 / 46.058	.082 / 46.082	
.060 / 46.060	.085 / 46.085	
.062 / 46.062		

MAIN JET ASSORTMENT BOX FOR MIKUNI CARBURETTORS Partnumber = pack of 5 pieces !

Assortment Box Partnumber: 47.99

Size / Part No.	Size / Part No.	Size / Part No.
.160 / 47.160	.260 / 47.260	.440 / 47.440
.170 / 47.170	.270 / 47.270	.450 / 47.450
.180 / 47.180	.360 / 47.360	.460 / 47.460
.190 / 47.190	.370 / 47.370	.470 / 47.470
.200 / 47.200	.380 / 47.380	.480 / 47.480
.210 / 47.210	.390 / 47.390	.490 / 47.490
.220 / 47.220	.400 / 47.400	.500 / 47.500
.230 / 47.230	.410 / 47.410	.510 / 47.510
.240 / 47.240	.420 / 47.420	
.250 / 47.250	.430 / 47.430	

PILOT JET ASSORTMENT BOX FOR MIKUNI CARBURETTORS Partnumber = pack of 5 pieces !

Size / Part No.	Size / Part No.	Size / Part No.
.015 / 48.015	.065 / 48.065	.025 / 49.025
.020 / 48.020	.070 / 48.070	.027.5 / 49.027.5
.025 / 48.025	.075 / 48.075	.030 / 49.030
.030 / 48.030	.080 / 48.080	.032.5 / 49.032.5
.035 / 48.035		.035 / 49.035
.040 / 48.040		.037.5 / 49.037.5
.045 / 48.045		.040 / 49.040
.050 / 48.050		.045 / 49.045
.055 / 48.055		
.060 / 48.060		

PISTON DIMENSIONS

2-Stroke

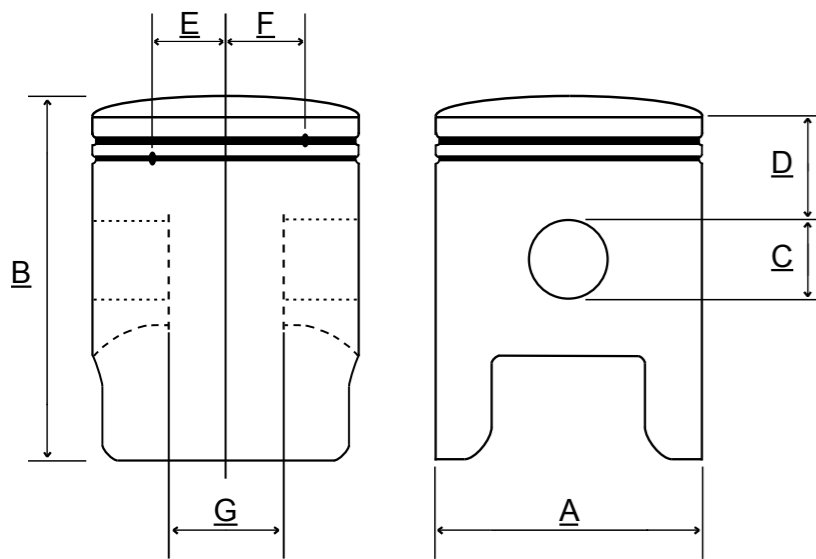

- A = Diameter *
- B = Total height
- C = Pinhole diameter
- D = Compression height
- E = Ring location pin position from center
- F = Ring location pin position from center
- G = Pin boss spacing

All dimensions in mm.
 * In case of cast iron cylinder, piston bore diameter is mentioned
 * In case of nicasil cylinder, actual piston diameter is mentioned

4-Stroke

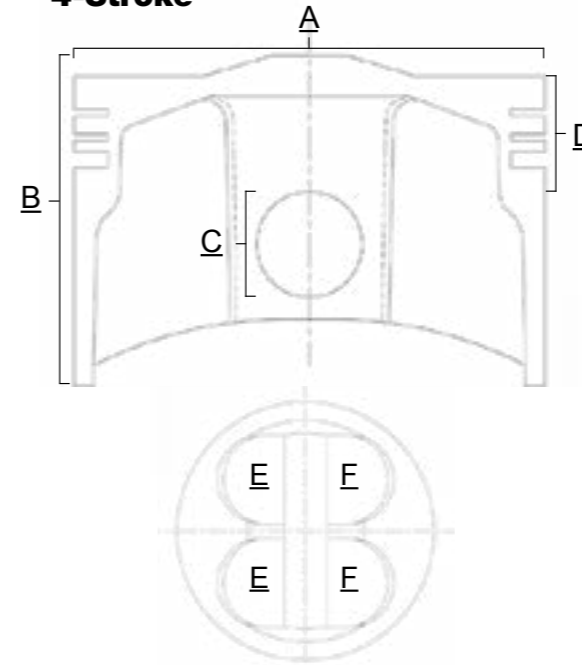

- A = Diameter *
- B = Total height
- C = Pinhole diameter
- D = Compression height
- E = Intake valve pocket diameter
- F = Exhaust valve pocket diameter

All dimensions in mm.
 * In case of cast iron cylinder, piston bore diameter is mentioned
 * In case of nicasil cylinder, actual piston diameter is mentioned

HONDA

Part No.	Engine	Std. Bore	A	B	C	D	E	F	G	Piston Head Shape	Remarks	Coating	Piston
01.1002.xxx	2-Stroke	40.00	-	51.00	10.00	20.50	10.75	10.75	13.50	Dome	-	-	Cast
01.1003.xxx	2-Stroke	39.00	-	50.50	12.00	17.50	12.00	12.00	15.00	Dome	-	-	Cast
01.1008.xxx	2-Stroke	41.00	-	48.00	10.00	15.00	12.00	12.00	13.00	Dome	-	-	Cast
01.1010.xxx	2-Stroke	39.00	-	53.50	12.00	21.70	8.75	8.75	15.00	Dome	-	-	Cast
01.1012.xxx	2-Stroke	40.00	-	51.00	12.00	19.25	11.00	11.00	15.00	Dome	-	-	Cast
01.1040.xxx	4-Stroke	39.00	-	36.30	13.00	10.50	-	-	15.40	Hollow	2 Valve Pockets	-	Cast
01.1050.xxx	4-Stroke	39.00	-	50.50	13.00	16.00	-	-	15.00	Dome	1 Valve Pocket	-	Cast
01.1052.xxx	4-Stroke	51.00	-	50.00	13.00	13.00	-	-	20.00	Dome	2 Valve Pockets	-	Cast
01.1070.xxx	4-Stroke	47.00	-	49.00	13.00	14.00	-	-	16.00	Dome	2 Valve Pockets	-	Cast
01.1075.xxx	4-Stroke	47.00	-	41.30	13.00	10.50	-	-	16.00	Dome	2 Valve Pockets	-	Cast
01.1090.xxx	4-Stroke	47.00	-	42.30	13.00	13.00	-	-	16.00	Hollow	2 Valve Pockets	-	Cast
01.1095.xxx	4-Stroke	50.00	-	44.20	13.00	12.75	-	-	16.00	Flat	-	-	Cast
01.1110.x	2-Stroke	46.00	45.95	53.00	14.00	17.00	-	11.50	16.50	Dome	Reed cut-out	-	Cast
01.1111.x	2-Stroke	47.00	46.95	53.00	14.00	17.00	-	12.00	16.00	Dome	Reed cut-out	-	Cast
01.1113.x	2-Stroke	47.50	47.45	53.00	14.00	17.00	-	12.00	16.00	Dome	Reed cut-out	Mos2 Skirt Coating	Cast
01.1160.xxx	2-Stroke	48.00	-	51.00	12.00	19.25	14.00	14.00	14.50	Dome	-	-	Cast
01.1163.xxx	2-Stroke	48.00	-	55.50	12.00	19.00	13.50	13.50	15.50	Dome	-	-	Cast
01.1175.xxx	4-Stroke	56.50	-	53.00	15.00	15.50	-	-	19.50	Flat	2 Valve Pockets	-	Cast
01.1176.xxx	4-Stroke	56.50	-	56.50	15.00	15.30	-	-	20.00	Dome	2 Valve Pockets	-	Cast
01.1200.x	2-Stroke	56.00	55.96	67.25	16.00	22.50	12.50	12.50	19.50	Dome	2 Intake Holes	-	Cast
01.1204.xxx	2-Stroke	54.00	-	60.50	14.00	21.00	12.50	-	19.50	Dome	Reed cut-out	-	Cast
01.1205.xxx	2-Stroke	54.00	-	60.50	14.00	21.00	13.00	-	19.00	Dome	-	-	Cast
01.1208.x	2-Stroke	54.00	53.93	60.50	15.00	20.50	11.50	-	17.50	Dome	-	-	Cast
01.1218.x	2-Stroke	54.00	53.94	58.00	15.00	20.50	11.50	-	17.50	Flat	Intake Hole	Mos2 Skirt Coating	Cast
01.1222.x	2-Stroke	54.00	53.94	60.50	15.00	20.50	11.00	-	18.00	Dome	Intake Hole	-	Forged
01.1225.x	2-Stroke	54.00	53.94	62.00	15.00	20.50	0.00	-	18.00	Dome	-	Mos2 Skirt Coating	Cast
01.1227.x	4-Stroke	66.00	65.97	32.40	14.00	13.50	-	-	15.50	Dome	4 Valve Pockets	-	Forged
01.1228.x	4-Stroke	66.00	65.97	33.20	14.00	13.50	-	-	15.50	Dome	4 Valve Pockets	-	Forged
01.1232.x	4-Stroke	66.00	65.97	27.60	14.00	13.50	-	-	15.50	Dome	4 Valve Pockets	-	Forged
01.1265.xxx	4-Stroke	63.00	-	50.75	15.00	17.20	-	-	22.50	Hollow	2 Valve Pockets	-	Cast
01.1272.xxx	4-Stroke	65.00	-	51.60	15.00	17.00	-	-	21.00	Flat	2 Valve Pockets	-	Cast
01.1280.xxx	4-Stroke	53.00	-	43.50	14.00	12.70	-	-	17.50	Flat	1 Valve Pocket	-	Cast
01.1281.xxx	4-Stroke	65.50	-	50.60	15.00	17.50	-	-	22.00	Flat with raised top	2 Valve Pockets	-	Forged
01.1300.xxx	2-Stroke	66.00	-	78.50	18.00	24.00	14.00	14.00	23.50	Dome	Intake Hole	-	Cast
01.1309.xxx	2-Stroke	66.00	-	78.50	18.00	29.00	13.75	13.75	24.00	Dome	Reed cut-out	-	Cast
01.1315.x	2-Stroke	66.40	66.34	79.00	18.00	29.00	14.00	14.00	23.50	Dome	Reed cut-out	Mos2 Skirt Coating	Cast
01.1320.x	2-Stroke	66.40	66.34	75.50	18.00	29.00	14.00	14.00	23.00	Flat	Reed cut-out	Mos2 Skirt Coating	Cast
01.1323.x	2-Stroke	66.40	66.34	75.00	18.00	29.00	13.00	13.00	23.50	Flat	-	Mos2 Skirt Coating	Cast
01.1325.x	2-Stroke	66.40	66.34	79.00	18.00	29.00	13.00	-	23.00	Dome	-	Mos2 Skirt Coating	Cast
01.1338.x	4-Stroke	78.00	77.97	30.00	16.00	11.00	-	-	16.80	Dome	4 Valve Pockets	Mos2 Skirt Coating	Forged
01.1339.x	4-Stroke	78.00	77.97	32.50	16.00	11.00	-	-	16.80	Dome	4 Valve Pockets	Mos2 Skirt Coating	Forged
01.1341.x	4-Stroke	76.80	76.77	33.20	16.00	11.00	-	-	20.00	Dome	4 Valve Pockets	-	Forged
01.1342.x	4-Stroke	76.80	76.77	33.40	16.00	11.00	-	-	16.80	Flat with raised top	4 Valve Pockets	-	Forged
01.1343.x	4-Stroke	76.80	76.77	34.60	16.00	11.00	-	-	16.80	Flat with raised top	4 Valve Pockets	-	Forged
01.1346.x	4-Stroke	76.80	76.77	34.50	16.00	11.00	-	-	16.80	Flat with raised top	4 Valve Pockets	-	Forged

PISTON DIMENSIONS

HONDA continued..

Part No.	Engine	Std. Bore	A	B	C	D	E	F	G	Piston Head Shape	Remarks	Coating	Piston
01.1348.x	4-Stroke	79.00	78.97								4 Valve Pockets	-	Forged
01.1358.xxx	4-Stroke	73.00	-	49.90	17.00	16.50	-	-	22.00	Flat	4 Valve Pockets	-	Cast
01.1363.xxx	4-Stroke	65.50	-	44.20	15.00	13.50	-	-	20.30	Flat	2 Valve Pockets	-	Cast
01.1403.x	4-Stroke	96.00	95.96	34.00	19.00	14.20	-	-	19.50	Hollow	4 Valve Pockets	-	Forged
01.1408.xxx	2-Stroke	89.00	-	87.00	20.00	30.00	19.00	19.00	30.00	Dome	Reed cut-out	Mos2 Skirt Coating	Cast
01.1410.x	4-Stroke	96.00	95.96	37.00	19.00	11.20	-	-	22.80	Flat	4 Valve Pockets	-	Forged
01.1411.x	4-Stroke	96.00	95.96	34.40	19.00	11.20	-	-	22.80	Flat	4 Valve Pockets	Mos2 Skirt Coating	Forged
01.1413.x	4-Stroke	96.00	95.96	35.80	19.00	11.30	-	-	19.70	Flat with raised top	4 Valve Pockets	-	Forged
01.1414.x	4-Stroke	96.00	95.96	34.00	19.00	14.20	-	-	19.30	Dome	4 Valve Pockets	-	Forged
01.1417.x	4-Stroke	96.00	95.96	39.30	19.00	10.70	-	-	19.70	Raised top, hollow area	4 Valve Pockets	-	Forged
01.1419.x	4-Stroke	96.00	95.96	34.00	19.00	13.80	-	-	19.80	Flat	4 Valve Pockets	-	Forged
01.1432.xxx	4-Stroke	74.00	-	54.40	17.00	15.00	-	-	23.00	Flat	4 Valve Pockets	-	Cast
01.1480.xxx	4-Stroke	78.50	-	57.30	17.00	15.70	-	-	20.50	Dome with hollow	-	-	Cast
01.1485.xxx	4-Stroke	86.00	-	55.75	19.00	15.00	-	-	22.00	Flat	-	-	Cast
01.1487.xxx	4-Stroke	86.50	-	55.10	19.00	14.60	-	-	23.00	Flat	2 Valve Pockets	-	Cast
01.1494.xxx	4-Stroke	94.00	-	54.35	21.00	15.50	-	-	20.00	Flat	4 Valve Pockets	-	Cast
01.1495.xxx	4-Stroke	85.00	-	53.00	20.00	16.00	-	-	20.00	Flat	4 Valve Pockets	-	Cast
01.1496.x	4-Stroke	96.00	95.96	38.50	19.00	14.30	-	-	19.50	Flat	4 Valve Pockets	-	Forged
01.1497.x	4-Stroke	96.00	95.96	41.40	19.00	14.30	-	-	19.50	Flat	4 Valve Pockets	-	Forged
01.1498.xxx	4-Stroke	90.00	-	55.60	19.00	15.00	-	-	21.00	Flat with hollow	-	-	Cast
01.1509.xxx	4-Stroke	89.00	-	58.50	21.00	18.50	-	-	27.30	Flat	-	-	Forged
01.1589.xxx	4-Stroke	92.00	-	57.20	24.00	20.90	-	-	25.60	Flat	-	-	Forged
01.1654.xxx	4-Stroke	97.00	-	63.00	24.00	17.70	-	-	28.60	Flat	4 Valve Pockets	-	Cast
01.1660.xxx	4-Stroke	100.00	-	56.00	24.00	17.10	-	-	32.90	Flat	-	-	Forged
01.1662.x	4-Stroke	100.00	99.94	59.00	23.00	17.50	-	-	19.20	Hollow	4 Valve Pockets	-	Forged
01.1708.xxx	4-Stroke	102.00	-	56.00	24.00	17.00	-	-	21.00	Flat with hollow	4 Valve Pockets	-	Forged

YAMAHA

Part No.	Engine	Std. Bore	A	B	C	D	E	F	G	Piston Head Shape	Remarks	Coating	Piston
01.2003.xxx	2-Stroke	40.00	-	50.50	12.00	17.00	14.00	14.00	17.00	Dome	2 Intake Holes	-	Cast
01.2004.xxx	2-Stroke	40.00	-	50.50	12.00	17.00	9.00	9.00	17.00	Dome	2 Intake Holes	-	Cast
01.2005.xxx	2-Stroke	40.00	-	50.00	10.00	20.00	13.00	13.00	13.50	Dome	-	-	Cast
01.2006.xxx	2-Stroke	40.00	-	50.50	10.00	20.50	11.50	11.50	13.00	Dome	2 Intake Holes	-	Cast
01.2008.xxx	2-Stroke	47.00	-	59.00	12.00	24.00	16.50	16.50	17.00	Dome	-	-	Cast
01.2018.x	2-Stroke	43.50	43.44	50.00	12.00	18.00	9.50	-	17.00	Dome	2 Lub. Holes Exh. Skirt	-	Cast
01.2020.xxx	2-Stroke	64.00	-	72.00	16.00	28.00	14.50	14.50	22.50	Dome	2 Intake Holes, 2 Reed cut-outs	Mos2 Skirt Coating	Cast
01.2021.xxx	2-Stroke	54.00	-	69.50	16.00	22.00	12.50	12.50	21.00	Dome	2 Intake Holes	-	Cast
01.2080.xxx	2-Stroke	49.00	-	59.00	12.00	23.50	17.00	17.00	17.00	Dome	-	-	Cast
01.2107.x	2-Stroke	46.00	45.94	54.25	14.00	19.00	11.00	-	17.00	Dome	2 Lub. Holes Exh. Skirt	-	Cast
01.2109.x	2-Stroke	47.00	46.94	54.50	14.00	19.00	11.00	-	17.25	Dome	2 Lub. Holes Exh. Skirt	-	Cast
01.2114.x	2-Stroke	47.50	47.44	54.50	14.00	19.00	11.00	-	17.00	Dome	2 Lub. Holes Exh. Skirt	Mos2 Skirt Coating	Cast
01.2202.xxx	2-Stroke	56.00	-	56.50	16.00	23.00	-	10.00	20.00	Dome	Reed cut-out	-	Cast
01.2203.xxx	2-Stroke	56.00	-	56.50	16.00	23.00	-	16.00	20.00	Dome	Reed cut-out	-	Cast
01.2205.xxx	2-Stroke	56.00	-	56.50	16.00	22.25	-	0.00	20.00	Dome	Reed cut-out	-	Cast
01.2207.x	2-Stroke	56.00	55.95	56.50	16.00	22.25	-	0.00	20.00	Dome	Reed cut-out	-	Cast
01.2211.x	2-Stroke	56.00	55.95	55.00	16.00	20.00	11.50	-	20.00	Flat	Reed cut-out, 2 Lub. Holes Exh. Skirt	-	Cast
01.2215.x	2-Stroke	54.00	53.94	60.50	16.00	20.00	13.00	-	20.00	Dome	2 Lub. Holes Exh. Skirt	-	Cast
01.2217.x	2-Stroke	54.00	53.95	60.30	15.00	20.50	13.00	-	18.20	Dome	Intake Hole, 2 Lub. Holes Exh. Skirt	Mos2 Skirt Coating	Cast
01.2224.x	2-Stroke	54.00	53.94	60.50	15.00	20.50	0.00	-	18.00	Dome	Intake Hole, 2 Lub. Holes Exh. Skirt	Mos2 Skirt Coating	Cast
01.2225.x	2-Stroke	54.00	53.95	58.50	15.00	20.50	0.00	-	17.70	Flatened Dome	2 Lub. Holes Exh. Skirt	Mos2 Skirt Coating	Cast
01.2245.xxx	2-Stroke	56.00	-	65.50	16.00	22.50	13.50	13.50	19.00	Dome	Reed cut-out, Intake Hole	-	Cast
01.2246.xxx	2-Stroke	56.00	-	65.50	16.00	22.00	14.25	14.25	19.00	Dome	Reed cut-out, Intake Hole	-	Cast
01.2247.xxx	2-Stroke	56.40	-	65.50	16.00	22.50	14.00	14.00	20.00	Dome	Reed cut-out, 4 Lub. Holes Exh. Skirt	-	Cast
01.2250.xxx	2-Stroke	56.00	-	66.00	16.00	22.00	15.00	15.00	20.25	Dome	2 Intake Holes	-	Cast
01.2252.xxx	2-Stroke	56.00	-	66.00	16.00	27.00	16.25	16.25	20.00	Dome	2 Intake Holes	-	Cast
01.2272.xxx	2-Stroke	66.00	-	69.50	16.00	27.00	18.50	18.50	23.75	Dome	2 Intake Holes	-	Cast
01.2275.xxx	2-Stroke	66.00	-	67.50	16.00	22.00	18.50	18.50	23.00	Dome	2 Intake Holes	-	Cast
01.2280.xxx	2-Stroke	66.00	-	69.00	16.00	22.00	15.00	15.00	23.00	Dome	2 Intake Holes	Mos2 Skirt Coating	Cast
01.2281.xxx	2-Stroke	66.00	-	69.00	16.00	22.00	15.00	15.00	23.00	Dome	2 Intake Holes	Mos2 Skirt Coating	Cast
01.2304.xxx	2-Stroke	68.00	-	76.00	18.00	27.00	12.75	12.75	23.50	Dome	Reed cut-out	-	Cast
01.2314.x	2-Stroke	68.00	67.95	75.00	18.00	27.00	14.50	14.50	23.00	Dome	Reed cut-out	Mos2 Skirt Coating	Cast
01.2321.x	2-Stroke	66.40	-	79.00	18.00	29.00	12.75	12.75	23.30	Dome	Reed cut-out, Intake Hole	Mos2 Skirt Coating	Cast
01.2406.x	4-Stroke	77.00	76.95	37.70	16.00	14.10	-	-	17.50	Hollow	5 Valve Pockets	-	Forged
01.2409.x	4-Stroke	77.00	76.95	40.10	16.00	14.30	-	-	17.30	Flat with Raised Top	5 Valve Pockets	-	Forged
01.2412.x	4-Stroke	77.00	76.95	40.40	16.00	14.30	-	-	17.00	Flat with Raised Top	5 Valve Pockets	-	Forged
01.2414.x	4-Stroke	77.00	76.95	38.70	16.00	12.30	-	-	17.40	Flat with Raised Top	4 Valve Pockets	-	Forged
01.2416.x	4-Stroke	77.00	76.95	33.30	16.00	12.00	-	-	17.00	Flat with Raised Top	4 Valve Pockets	-	Forged
01.2417.x	4-Stroke	77.00	76.95	33.30	16.00	12.00	-	-	17.00	Flat with Raised Top	4 Valve Pockets	-	Forged
01.2419.x	4-Stroke	92.00	91.95	42.00	18.00	15.00	-	-	20.70	Hollow	5 Valve Pockets	-	Forged
01.2426.x	4-Stroke	95.00	94.95	40.40	18.00	14.50	-	-	19.50	Hollow	5 Valve Pockets	-	Forged
01.2427.x	4-Stroke	95.00	94.95	41.60	19.00	14.50	-	-	20.70	Hollow	5 Valve Pockets	-	Forged
01.2428.x	4-Stroke	95.00	94.95	41.60	19.00	14.50	-	-	20.70	Hollow	5 Valve Pockets	-	Forged
01.2429.x	4-Stroke	95.00	94.95	40.40	18.00	14.50	-	-	19.50	Hollow	5 Valve Pockets	-	Forged

PISTON DIMENSIONS

YAMAHA continued..

Part No.	Engine	Std. Bore	A	B	C	D	E	F	G	Piston Head Shape	Remarks	Coating	Piston
01.2435.x	4-Stroke	95.00	94.95	42.10	20.00	15.00	-	-	21.50	Hollow	5 Valve Pockets	-	Forged
01.2436.x	4-Stroke	95.00	94.95	42.10	20.00	15.00	-	-	21.50	Hollow	5 Valve Pockets	-	Forged
01.2439.x	4-Stroke	77.00	76.95	33.40	16.00	12.00	-	-	16.80	Flat with Raised Top	4 Valve Pockets	-	Forged
01.2440.x	4-Stroke	97.00	96.95	40.30	18.00	15.20	-	-	22.50	Flat	4 Valve Pockets	-	Forged
01.2441.x	4-Stroke	97.00	96.95	42.10	18.00	15.20	-	-	22.50	Flat	4 Valve Pockets	-	Forged
01.2444.x	4-Stroke	97.00	96.95	40.40	18.00	15.20	-	-	21.50	Flat with Raised Top	4 Valve Pockets	-	Forged
01.2448.x	4-Stroke	97.00	96.95	40.90	18.00	15.50	-	-	19.80	Flat with Raised Top	4 Valve Pockets	-	Forged
01.2458.x	4-Stroke	77.00	76.95	42.00	17.00	14.30	-	-	19.90	Flat	4 Valve Pockets	-	Forged
01.2487.xxx	4-Stroke	83.00	-	51.30	19.00	18.80	-	-	30.00	Hollow	2 Valve Pockets	-	Cast
01.2510.xxx	2-Stroke	81.00	-	81.00	20.00	26.00	14.50	14.50	25.00	Dome	-	Mos2 Skirt Coating	Cast
01.2514.xxx	2-Stroke	84.00	-	81.00	20.00	26.00	15.00	15.00	25.00	Dome	Intake Hole	Mos2 Skirt Coating	Cast
01.2518.x	2-Stroke	80.00	79.90	85.50	22.00	25.00	15.00	15.00	26.30	Dome	Reed cut-out, Intake Hole	-	Cast
01.2520.x	2-Stroke	84.00	83.90	86.50	22.00	25.00	15.00	15.00	23.50	Dome	Intake Hole	-	Forged
01.2576.xxx	4-Stroke	87.00	-	68.70	20.00	19.00	-	-	27.60	Dome	2 Valve Pockets	-	Cast
01.2599.xxx	2-Stroke	72.00	71.94	76.40	18.00	27.00	17.50	17.50	23.30	Dome	Reed cut-out	Mos2 Skirt Coating, Anodised Dome	Cast
01.2601.xxx	4-Stroke	95.00	-	58.00	22.00	17.00	-	-	31.00	Flat with hollow	2 Valve Pockets	-	Forged
01.2660.xxx	4-Stroke	100.00	-	54.25	22.00	16.00	-	-	25.00	Flat	1 Valve Pocket	-	Cast
01.2664.x	4-Stroke	100.00	99.95	54.50	23.00	15.80	-	-	31.50	Flat	4 Valve Pockets	-	Forged
01.2697.xxx	2-Stroke	74.80	74.68	77.90	20.00	25.90	12.50	12.50	25.40	Dome	Reed cut-out, Intake Hole	Mos2 Skirt Coating, Anodised Dome	Cast
01.2706.x	4-Stroke	102.00	101.94	50.10	23.00	16.00	-	-	26.30	Flat with Raised Top	4 Valve Pockets	-	Forged
01.2707.x	4-Stroke	102.00	101.94	52.70	23.00	16.00	-	-	26.30	Flat with Raised Top	4 Valve Pockets	-	Forged
01.2714.x	4-Stroke	102.00	101.94	48.30	23.00	17.00	-	-	26.90	Flat with hollow	4 Valve Pockets	-	Forged
01.2798.xxx	4-Stroke	69.00	68.93	69.30	20.00	18.70	12.75	12.75	22.50	Dome	Intake Hole	Mos2 Skirt Coating, Anodised Dome	Cast
01.2901S.xxx	2-Stroke	90.00	-	75.00	23.00	28.30	30.00	29.00	24.00	Dome	Intake Hole	-	Cast
01.2901P.xxx	2-Stroke	90.00	-	75.00	23.00	28.30	29.00	30.00	24.00	Dome	Intake Hole	-	Cast
01.2905.x	4-Stroke	76.00	75.95	40.70	17.00	14.45	-	-	20.90	Flat with hollow	5 Valve Pockets	-	Forged
01.2909.x	4-Stroke	86.00	85.95	53.00	22.00	21.80	-	-	26.60	Flat with hollow	4 Valve Pockets	-	Forged

SUZUKI

Part No.	Engine	Std. Bore	A	B	C	D	E	F	G	Piston Head Shape	Remarks	Coating	Piston
01.3001.xxx	2-Stroke	41.00	-	51.50	12.00	20.50	9.25	9.25	17.00	Dome	-	-	Cast
01.3002.xxx	2-Stroke	41.00	-	46.00	10.00	14.50	11.50	11.50	14.00	Dome	-	-	Cast
01.3004.xxx	4-Stroke	39.00	-	35.80	12.00	11.00	-	-	16.50	Dome	2 Valve Pockets	-	Cast
01.3005.xxx	2-Stroke	56.00	-	66.00	14.00	21.50	12.00	12.00	20.80	Dome	-	-	Cast
01.3008.xxx	2-Stroke	56.00	-	60.50	14.00	20.00	21.00	21.00	21.00	Dome	Intake Hole	-	Cast
01.3018.xxx	2-Stroke	64.00	-	75.00	16.00	24.00	14.50	14.50	20.70	Dome	-	-	Cast
01.3111.xxx	2-Stroke	47.50	-	53.00	14.00	20.00	11.00	-	16.00	Dome	2 Lub. Holes Exh. Skirt	-	Cast
01.3122.x	2-Stroke	48.00	47.94	53.00	14.00	20.00	0.00	-	16.75	Dome	-	Mos2 Skirt Coating	Cast
01.3180.xxx	2-Stroke	50.00	-	61.50	12.00	21.30	12.75	12.75	16.70	Dome	-	-	Cast
01.3205.xxx	2-Stroke	54.00	-	57.00	14.00	22.50	12.00	-	20.50	Flat	Reed cut-out, 2 Lub. Holes Exh. Skirt	-	Cast
01.3206.xxx	2-Stroke	54.00	-	57.00	15.00	22.00	12.00	-	20.50	Flat	Reed cut-out, 2 Lub. Holes Exh. Skirt	-	Cast
01.3207.xxx	2-Stroke	54.00	-	59.00	15.00	22.00	-	11.50	22.00	Dome	2 Lub. Holes Exh. Skirt	-	Cast
01.3214.x	2-Stroke	54.00	53.94	59.50	15.00	22.00	10.00	-	20.00	Dome	2 Lub. Holes Exh. Skirt	Mos2 Skirt Coating	Cast
01.3220.x	2-Stroke	54.00	53.94	59.50	15.00	22.00	0.00	-	20.00	Dome	-	Mos2 Skirt Coating	Cast
01.3224.x	2-Stroke	54.00	53.95	58.00	15.00	22.00	0.00	-	20.00	Flat	-	Mos2 Skirt Coating	Cast
01.3303.xxx	2-Stroke	70.00	-	75.00	18.00	24.00	16.00	-	22.35	Dome	-	-	Cast
01.3304.xxx	2-Stroke	70.00	-	78.00	18.00	25.00	18.00	18.00	24.00	Dome	-	-	Cast
01.3310.x	2-Stroke	67.00	66.94	77.50	18.00	28.00	-	16.00	22.00	Dome	-	-	Cast
01.3311.x	2-Stroke	67.00	66.94	77.50	18.00	28.00	15.00	15.00	22.00	Dome	-	-	Cast
01.3319.x	2-Stroke	66.40	66.34	79.00	18.00	29.00	15.00	15.00	22.50	Dome	Reed cut-out, 2 Intake Holes	-	Cast
01.3320.x	2-Stroke	66.40	66.34	75.50	18.00	29.00	14.50	14.50	23.20	Flat	Reed cut-out, 2 Intake Holes	-	Cast
01.3338.x	4-Stroke	77.00	76.96	35.95	16.00	11.70	-	-	18.40	Dome	4 Valve Pockets	-	Forged
01.3341.x	4-Stroke	77.00	76.96	36.10	16.00	11.70	-	-	17.00	Flat with Raised Top	4 Valve Pockets	-	Forged
01.3359.x	2-Stroke	56.00	55.94	59.00	16.00	20.50	10.50	10.50	20.00	Flat	Reed cut-out, 2 Lub. Holes Exh. Skirt	-	Forged
01.3404.x	4-Stroke	90.00	89.96	48.20	20.00	15.40	-	-	24.40	Flat with Raised Top	4 Valve Pockets	-	Forged
01.3406.x	4-Stroke	95.50	95.47	42.50	19.00	15.00	-	-	22.50	Flat	4 Valve Pockets	-	Forged
01.3407.x	4-Stroke	95.50	95.46	45.20	19.00	15.00	-	-	22.50	Flat with Raised Top	4 Valve Pockets	-	Forged
01.3408.x	4-Stroke	96.00	95.96	41.00	19.00	13.60	-	-	19.60	Flat	4 Valve Pockets	-	Forged
01.3409.x	4-Stroke	96.00	95.96	42.80	19.00	13.60	-	-	19.60	Flat with Raised Top	4 Valve Pockets	-	Forged
01.3410.x	4-Stroke	95.50	95.47	40.00	19.00	12.70	-	-	22.60	Flat	4 Valve Pockets	-	Forged
01.3411.x	4-Stroke	95.50	95.47	42.00	19.00	12.90	-	-	22.60	Flat with Raised Top	4 Valve Pockets	-	Forged
01.3413.x	4-Stroke	96.00	95.96	39.70	19.00	13.30	-	-	22.00	Flat	4 Valve Pockets	-	Forged
01.3420.x	4-Stroke	90.00	89.96	47.50	20.00	15.30	-	-	23.50	Flat	4 Valve Pockets	-	Forged

KAWASAKI

Part No.	Engine	Std. Bore	A	B	C	D	E	F	G	Piston Head Shape	Remarks	Coating	Piston
01.4005.xxx	2-Stroke	56.00	-	67.00	14.00	27.00	17.00	17.00	20.00	Dome	-	-	Cast
01.4020.xxx	2-Stroke	55.00	-	67.00	15.00	25.40	13.50	13.50	19.40	Dome	-	-	Cast
01.4022.x	2-Stroke	44.50	44.45	50.50	12.00	17.50	10.50	10.50	16.00	Dome	2 Lub. Holes Exh. Skirt	Mos2 Skirt Coating	Cast
01.4100.x	2-Stroke	43.00	42.95	50.00	12.00	17.50	10.25	10.25	16.00	Dome	-	-	Cast
01.4103.x	2-Stroke	47.00	46.95	58.00	14.00	19.00	12.00	12.00	17.80	Dome	Reed cut-out	-	Cast
01.4108.x	2-Stroke	48.00	47.94	54.00	14.00	19.00	16.00	10.00	17.50	Dome	Reed cut-out, Intake Hole, 2 Lub. Holes Exh. Skirt	-	Cast
01.4118.x	2-Stroke	47.00	46.95	54.00	14.00	19.00	17.00	10.50	17.50	Dome	Reed cut-out, Intake Hole, 2 Lub. Holes Exh. Skirt	-	Cast

PISTON DIMENSIONS

KAWASAKI continued..

Part No.	Engine	Std. Bore	A	B	C	D	E	F	G	Piston Head Shape	Remarks	Coating	Piston
01.4121.x	2-Stroke	48.50	48.45	54.00	14.00	19.00	17.00	10.00	17.50	Dome	Reed cut-out, Intake Hole, 2 Lub. Holes Exh. Skirt	-	Cast
01.4124.x	2-Stroke	48.50	48.45	54.00	14.00	19.00	18.00	-	17.70	Dome	Reed cut-out, Intake Hole	-	Cast
01.4194.x	2-Stroke	52.50	52.45	53.50	14.00	19.00	8.00	19.00	17.70	Dome	2 Lub. Holes Exh. Skirt	-	Cast
01.4195.x	2-Stroke	52.50	52.45	53.50	14.00	19.00	19.50	-	17.70	Dome	2 Lub. Holes Exh. Skirt	-	Cast
01.4175.xxx	2-Stroke	62.50	-	68.75	16.00	23.50	24.75	24.75	22.50	Dome	2 Intake Holes	-	Cast
01.4210.x	2-Stroke	54.00	53.95	58.00	16.00	21.50	11.00	-	20.50	Flat	2 Lub. Holes Exh. Skirt	-	Cast
01.4213.x	2-Stroke	54.00	53.95	58.00	15.00	22.00	11.00	-	20.60	Flat	2 Lub. Holes Exh. Skirt	-	Forged
01.4214.x	2-Stroke	54.00	53.95	58.00	15.00	22.00	11.00	-	20.60	Flat	2 Lub. Holes Exh. Skirt	-	Cast
01.4216.x	2-Stroke	54.00	53.95	59.00	15.00	22.00	12.50	-	20.50	Dome	2 Lub. Holes Exh. Skirt	-	Forged
01.4218.x	2-Stroke	54.00	53.96	59.00	15.00	21.75	11.00	-	21.00	Dome	2 Lub. Holes Exh. Skirt	-	Cast
01.4221.x	2-Stroke	54.00	53.96	60.00	15.00	21.75	10.00	-	20.75	Dome	2 Lub. Holes Exh. Skirt	-	Cast
01.4223.x	2-Stroke	54.00	53.95	60.50	15.00	22.00	12.00	-	20.40	Dome	Intake Hole, 2 Lub. Holes Exh. Skirt	-	Cast
01.4251.x	2-Stroke	54.00	53.94	67.00	16.00	25.00	14.50	14.50	20.50	Dome	-	-	Forged
01.4285.x	2-Stroke	66.00	65.94	70.00	16.00	24.00	15.50	15.50	20.50	Dome	Reed cut-out, Intake Hole, 4 Lub. Holes Exh. Skirt	-	Cast
01.4286.x	2-Stroke	66.00	65.94	70.00	16.00	24.00	15.50	15.50	21.00	Dome	Reed cut-out, Intake Hole, 4 Lub. Holes Exh. Skirt	-	Forged
01.4306.x	2-Stroke	67.40	67.35	76.00	18.00	28.00	15.00	15.00	24.50	Dome	Reed cut-out, Intake Hole	-	Cast
01.4322.x	2-Stroke	66.40	66.35	79.50	18.00	28.00	14.25	14.25	25.00	Dome	Reed cut-out, Intake Hole	Mos2 Skirt Coating	Cast
01.4325.x	2-Stroke	66.40	66.35	77.50	18.00	28.00	13.75	13.75	24.75	Dome	Reed cut-out, Intake Hole	Mos2 Skirt Coating	Cast
01.4335.x	4-Stroke	77.00	76.96	35.10	16.00	11.50	-	-	17.25	Flat	4 Valve Pockets	-	Forged
01.4337.x	4-Stroke	77.00	76.96	36.00	16.00	11.50	-	-	17.25	Flat with Raised Top	4 Valve Pockets	-	Forged
01.4340.x	4-Stroke	77.00	76.96	32.20	16.00	12.00	-	-	18.70	Flat	4 Valve Pockets	-	Forged
01.4342.x	4-Stroke	77.00	76.96	32.00	16.00	10.90	-	-	17.50	Flat with Raised Top	4 Valve Pockets	-	Forged
01.4345.x	4-Stroke	77.00	76.96	32.30	16.00	11.90	-	-	17.60	Flat with Raised Top	4 Valve Pockets	-	Forged
01.4347.x	4-Stroke	77.00	76.96	33.50	16.00	11.80	-	-	16.90	Flat with Raised Top	4 Valve Pockets	-	Forged
01.4406.x	4-Stroke	96.00	95.97	42.40	19.00	14.00	-	-	20.00	Flat with Raised Top	4 Valve Pockets	-	Forged
01.4408.x	4-Stroke	86.00	85.94	87.00	19.00	28.00	20.00	20.00	26.50	Dome	Reed cut-out	-	Cast
01.4409.x	4-Stroke	96.00	95.97	43.20	19.00	14.00	-	-	22.60	Flat	4 Valve Pockets	-	Forged
01.4413.x	4-Stroke	96.00	95.97	39.00	19.00	14.00	-	-	19.50	Flat	4 Valve Pockets	-	Forged
01.4415.x	4-Stroke	96.00	95.97	40.00	19.00	14.50	-	-	21.20	Flat with Raised Top	4 Valve Pockets	-	Forged
01.4418.x	4-Stroke	96.00	95.95	40.70	21.00	16.00	-	-	22.00	Flat	4 Valve Pockets	-	Forged
01.4419.x	4-Stroke	96.00	95.95	43.10	21.00	16.00	-	-	22.00	Flat with Raised Top	4 Valve Pockets	-	Forged
01.4429.x	4-Stroke	96.00	95.97	36.10	19.00	14.30	-	-	19.50	Flat with Raised Top	4 Valve Pockets	-	Forged
01.4503.xxx	2-Stroke	68.00	-	70.00	16.00	23.00	0.00	-	23.00	Dome	-	-	Cast
01.4504.xxx	2-Stroke	75.00	-	68.75	16.00	23.00	25.00	25.00	23.50	Dome	-	-	Cast
01.4515.xxx	2-Stroke	80.00	-	79.50	22.00	21.00	19.50	19.50	26.00	Dome	-	-	Cast
01.4520.xxx	2-Stroke	73.00	-	85.00	20.00	23.70	15.00	15.00	26.50	Dome	-	-	Cast
01.4523.xxx	2-Stroke	82.00	-	79.00	22.00	21.00	19.75	19.75	25.50	Dome	-	-	Cast
01.4554.x	4-Stroke	83.00	82.95	48.20	21.00	14.50	-	-	23.70	Flat with hollow	4 Valve Pockets	-	Forged
01.4559.x	4-Stroke	83.00	82.95	53.80	21.00	20.70	-	-	24.00	Flat with hollow	4 Valve Pockets	-	Forged
01.4561.x	4-Stroke	83.00	82.95	47.00	21.00	17.50	-	-	28.00	Flat with hollow	-	-	Forged
01.4687.xxx	4-Stroke	100.00	-	67.10	24.00	18.50	-	-	32.90	Flat	4 Valve Pockets	-	Forged
01.4693.x	4-Stroke	100.00	99.94	60.50	24.00	17.75	-	-	28.00	Flat with hollow	4 Valve Pockets	-	Forged
01.4705.x	4-Stroke	85.00	84.96	53.00	20.00	16.00	-	-	20.00	Flat with hollow	4 Valve Pockets	Mos2 Skirt Coating, Anodised Dome	Cast

KTM

Part No.	Engine	Std. Bore	A	B	C	D	E	F	G	Piston Head Shape	Remarks	Coating	Piston
01.6012.x	2-Stroke	39.50	39.46	48.00	12.00	15.50	10.50	-	15.00	Dome	Reed cut-out, 2 Intake Holes	Mos2 Skirt Coating	Cast
01.6017.x	2-Stroke	43.50	43.46	48.00	12.00	15.75	-	0.00	17.00	Dome	Reed cut-out, 2 Intake Holes	-	Cast
01.6022.x	2-Stroke	45.00	44.96	48.00	12.00	15.75	-	0.00	17.50	Dome	Reed cut-out, 2 Intake Holes	Mos2 Skirt Coating	Cast
01.6029.x	2-Stroke	45.00	44.96	48.00	12.00	15.75	-	0.00	18.40	Dome	-	Mos2 Skirt Coating	Cast
01.6105.x	2-Stroke	47.00	46.95	53.50	14.00	17.00	-	0.00	17.40	Dome	-	Mos2 Skirt Coating	Cast
01.6219.x	2-Stroke	54.25	54.19	58.00	15.00	20.50	-	0.00	21.50	Flat	Reed cut-out	-	Forged
01.6220.x	2-Stroke	54.00	53.94	58.00	15.00	22.00	0.00	-	20.00	Flat	-	Mos2 Skirt Coating	Cast
01.6226.x	2-Stroke	54.00	53.94	58.00	15.00	22.00	1.25	1.25	21.20	Dome	-	Mos2 Skirt Coating	Cast
01.6228.x	2-Stroke	56.00	55.94	59.50	15.00	22.00	1.35	1.35	20.75	Flat	-	Mos2 Skirt Coating	Cast
01.6236.x	2-Stroke	58.00	57.94	58.00	15.00	22.00	1.50	1.50	20.75	Dome	-	-	Forged
01.6249.x	2-Stroke	64.00	63.94	66.00	16.00	20.00	1.75	1.75	21.00	Flat	Reed cut-out	Mos2 Skirt Coating	Cast
01.6301.x	4-Stroke	75.00	74.95	43.00	20.00	15.00	-	-	24.50	Flat with Raised Top	4 Valve Pockets	-	Forged
01.6310.x	2-Stroke	67.50	67.44	75.50	18.00	20.60	13.75	13.75	20.00	Dome	Reed cut-out	-	Cast
01.6317.x	2-Stroke	67.50	67.44	72.20	18.00	17.60	14.00	14.00	21.00	Dome	Reed cut-out	-	Forged
01.6319.x	2-Stroke	66.40	66.34	75.80	18.00	29.00	12.00	-	24.00	Flat	Reed cut-out	-	Forged
01.6320.x	2-Stroke	66.40	66.34	75.50	18.00	29.00	13.00	-	21.00	Flat	Reed cut-out	-	Cast
01.6322.x	2-Stroke	66.40	66.34	75.30	18.00	29.00	1.50	1.50	23.40	Flat	Reed cut-out	-	Forged
01.6323.x	2-Stroke	66.40	66.34	79.00	18.00	29.00	0.00	-	20.00	Dome	-	-	Cast
01.6324.x	2-Stroke	66.40	66.34	79.00	18.00	29.00	1.75	1.75	20.70	Dome	-	Mos2 Skirt Coating	Cast
01.6329.x	4-Stroke	76.00	75.96	35.00	16.00	11.60	-	-	20.00	Flat with Raised Top	4 Valve Pockets	-	Forged
01.6333.x	4-Stroke	78.00	77.96	28.10	16.00	11.50	-	-	17.70	Flat with Raised Top	4 Valve Pockets	-	Forged
01.6338.x	4-Stroke	76.00	75.96	34.50	16.00	11.60	-	-	20.20	Flat with Raised Top	4 Valve Pockets	-	Forged
01.6343.x	2-Stroke	66.40	66.34	79.00	18.00	29.00	1.75	1.75	20.70	Dome	-	Mos2 Skirt Coating	Cast
01.6346.x	4-Stroke	78.00	77.96	37.30	16.00	12.00	-	-	17.80	Flat with Raised Top	4 Valve Pockets	-	Forged
01.6351.x	4-Stroke	88.00	87.96	35.85	18.00	11.50	-	-	18.50	Flat with Raised Top	4 Valve Pockets	-	Forged
01.6352.x	4-Stroke	88.00	87.96	37.90	18.00	11.50	-	-	18.50	Flat with Raised Top	4 Valve Pockets	-	Forged
01.6362.x	4-Stroke	88.00	87.96	35.80	18.00	11.50	-	-	19.00	Flat with Raised Top	4 Valve Pockets	-	Forged
01.6367.x	4-Stroke	88.00	87.96	35.50	18.00	11.80	-	-	18.40	Flat with Raised Top	4 Valve Pockets	-	Forged

PISTON DIMENSIONS

KTM continued..

Part No.	Engine	Std. Bore	A	B	C	D	E	F	G	Piston Head Shape	Remarks	Coating	Piston
01.6387.x	2-Stroke	72.00	71.94	75.50	18.00	29.00	1.75	1.75	21.00	Flat	Reed cut-out	-	Forged
01.6388.x	2-Stroke	72.00	71.94	75.50	18.00	29.00	1.75	1.75	21.00	Flat	Reed cut-out	-	Forged
01.6394.x	2-Stroke	72.00	71.94	75.50	18.00	29.00	1.35	1.35	20.70	Flat	Reed cut-out	-	Cast
01.6396.x	2-Stroke	72.00	71.94	73.80	18.00	17.65	15.00	15.00	21.20	Flat	Reed cut-out	-	Forged
01.6397.x	2-Stroke	78.00	77.94	72.50	18.00	18.20	16.40	16.40	22.00	Flat	Reed cut-out	-	Forged
01.6398.x	2-Stroke	78.00	77.94	75.60	18.00	18.10	16.00	16.00	21.85	Flat	Reed cut-out	-	Forged
01.6413.x	4-Stroke	89.00	88.95	47.50	20.00	13.50	-	-	24.00	Flat with Raised Top	4 Valve Pockets	-	Forged
01.6414.x	4-Stroke	89.00	88.95	47.50	20.00	11.50	-	-	24.00	Flat with Raised Top	4 Valve Pockets	-	Forged
01.6424.x	4-Stroke	95.00	94.94	40.00	20.00	11.80	-	-	24.30	Flat with Raised Top	4 Valve Pockets	-	Forged
01.6425.x	4-Stroke	95.00	94.94	42.00	20.00	11.80	-	-	24.30	Flat with Raised Top	4 Valve Pockets	-	Forged
01.6427.x	4-Stroke	97.00	96.94	38.20	19.00	11.80	-	-	22.50	Flat with Raised Top	4 Valve Pockets	-	Forged
01.6428.x	4-Stroke	97.00	96.94	38.20	19.00	11.80	-	-	22.50	Flat with hollow	4 Valve Pockets	-	Forged
01.6429.x	4-Stroke	95.00	94.94	39.60	19.00	13.50	-	-	22.50	Flat with Raised Top	4 Valve Pockets	-	Forged
01.6432.x	4-Stroke	95.00	94.94	36.00	19.00	13.00	-	-	21.00 / 16.00	Flat with Raised Top	4 Valve Pockets	-	Forged
01.6433.x	4-Stroke	95.00	94.95	40.70	19.00	13.00	-	-	22.00 / 17.00	Flat with Raised Top	4 Valve Pockets	-	Forged
01.6439.x	4-Stroke	97.00	96.94	40.00	19.00	13.80	-	-	15.00 / 22.00	Flat with Raised Top	4 Valve Pockets	-	Forged
01.6508.x	4-Stroke	100.00	99.94	36.50	20.00	11.90	-	-	22.40	Flat	4 Valve Pockets	-	Forged
01.6509.x	4-Stroke	100.00	99.94	37.20	20.00	11.90	-	-	22.40	Flat with Raised Top	4 Valve Pockets	-	Forged
01.6512.x	4-Stroke	95.00	94.95	39.00	19.00	13.00	-	-	22.80 / 17.00	Hollow with dome	4 Valve Pockets	-	Forged
01.6521.x	4-Stroke	95.00	94.94	40.20	20.00	13.50	-	-	23.80	Flat	4 Valve Pockets	-	Forged
01.6522.x	4-Stroke	95.00	94.94	41.70	20.00	13.50	-	-	23.80	Flat with Raised Top	4 Valve Pockets	-	Forged
01.6528.x	4-Stroke	95.00	94.94	39.80	19.00	14.75	-	-	22.50	Flat with hollow	4 Valve Pockets	-	Forged
01.6604.x	4-Stroke	101.00	100.94	54.00	22.00	15.20	-	-	25.00	Dome	4 Valve Pockets	-	Forged
01.6608.x	4-Stroke	102.00	101.94	39.00	20.00	15.60	-	-	23.00	Flat	4 Valve Pockets	-	Forged
01.6905.x	4-Stroke	101.00	100.95	44.75	22.00	16.50	-	-	24.00	Flat	4 Valve Pockets	-	Forged
01.6909.x	4-Stroke	101.00	100.95	44.75	20.00	17.75	-	-	22.50	Flat	4 Valve Pockets	-	Forged

MISCELLANEOUS

Part No.	Engine	Std. Bore	A	B	C	D	E	F	G	Piston Head Shape	Remarks	Coating	Piston
01.5400.xxx	2-Stroke	69.50	69.40	71.00	18.00	21.20	15.00	-	23.60	Dome	-	Mos2 Skirt Coating, Anodised Dome	Cast
01.5503.xxx	2-Stroke	76.00	75.86	70.20	20.00	19.10	18.00	18.00	23.50	Dome	-	Mos2 Skirt Coating, Anodised Dome	Cast
01.5508.xxx	2-Stroke	82.00	-	79.75	20.00	23.00	17.50	17.50	24.50	Dome	-	-	Cast
01.5510.xxx	2-Stroke	82.00	-	83.75	20.00	25.00	17.00	17.00	24.00	Dome	Intake Hole	-	Cast
01.5513.xxx	4-Stroke	92.00	92.00	53.60	23.00	22.00	-	-	23.00	Flat with hollow	4 Valve Pockets	Mos2 Skirt Coating, Anodised Dome	Cast
01.5515.xxx	2-Stroke	88.00	-	85.00	21.00	27.00	22.50	22.50	25.00	Dome	-	-	Cast
01.5586.xxx	2-Stroke	72.00	71.94	71.90	18.00	29.00	14.00	0.00	22.80	Dome	-	Mos2 Skirt Coating, Anodised Dome	Cast
01.5591.xxx	2-Stroke	76.00	75.89	76.70	18.00	21.70	12.50	-	24.50	Dome	-	Mos2 Skirt Coating, Anodised Dome	Cast
01.5592.xxx	2-Stroke	73.40	73.30	79.50	20.00	22.10	21.00	21.00	26.10	Dome	-	Mos2 Skirt Coating, Anodised Dome	Cast
01.5593.xxx	2-Stroke	75.40	75.31	79.40	20.00	22.00	21.00	21.00	26.20	Dome	-	Mos2 Skirt Coating, Anodised Dome	Cast
01.5594.xxx	4-Stroke	100.00	-	50.00	23.00	18.00	-	-	27.00	Hollow	4 Valve Pockets	-	Forged
01.5595.xxx	2-Stroke	72.00	71.90	70.90	18.00	19.70	11.50	0.00	23.50	Dome	-	Mos2 Skirt Coating, Anodised Dome	Cast
01.5597.xxx	2-Stroke	71.00	70.91	69.10	20.00	20.20	14.75	14.75	26.20	Flat	2 Lub. Holes Exh. Skirt	Mos2 Skirt Coating, Anodised Dome	Cast
01.5598.xxx	2-Stroke	69.50	69.39	74.50	18.00	23.30	14.50	14.50	23.50	Dome	-	Mos2 Skirt Coating, Anodised Dome	Cast
01.5599.xxx	2-Stroke	73.00	72.90	77.50	18.00	27.00	17.50	0.00	22.70	Dome	-	Mos2 Skirt Coating, Anodised Dome	Cast
01.5600.xxx	2-Stroke	72.00	71.87	78.00	20.00	22.90	16.00	16.00	23.50	Dome	-	Mos2 Skirt Coating, Anodised Dome	Cast
01.5601.xxx	2-Stroke	78.00	77.90	69.10	22.00	19.10	16.00	16.00	26.20	Flat	-	Mos2 Skirt Coating, Anodised Dome	Cast
01.5603.xxx	2-Stroke	77.25	77.12	74.40	20.00	23.20	15.50	15.50	24.00	Dome	-	Mos2 Skirt Coating, Anodised Dome	Cast
01.5693.xxx	2-Stroke	78.00	77.90	79.70	20.00	22.90	15.50	15.50	23.50	Dome	-	Mos2 Skirt Coating, Anodised Dome	Cast
01.5695.xxx	2-Stroke	65.00	64.90	68.70	16.00	23.00	12.00	0.00	22.80	Dome	-	Mos2 Skirt Coating, Anodised Dome	Cast
01.5696.xxx	2-Stroke	66.50	66.41	65.50	18.00	19.60	14.25	14.25	24.10	Flat	-	Mos2 Skirt Coating, Anodised Dome	Cast
01.5698.xxx	2-Stroke	78.00	77.90	69.20	20.00	20.30	16.00	16.00	26.20	Flat	2 Lub. Holes Exh. Skirt	Mos2 Skirt Coating, Anodised Dome	Cast
01.5699.xxx	2-Stroke	76.00	75.87	71.70	20.00	20.20	18.00	-	23.50	Dome	-	Mos2 Skirt Coating, Anodised Dome	Cast
01.5700.xxx	2-Stroke	78.00	77.87	78.00	20.00	22.90	17.00	-	23.50	Dome	-	Mos2 Skirt Coating, Anodised Dome	Cast
01.5703.xxx	2-Stroke	79.70	79.58	82.50	22.00	26.90	16.50	16.50	26.20	Dome	-	Mos2 Skirt Coating, Anodised Dome	Cast
01.5799.xxx	2-Stroke	81.00	80.86	74.50	20.00	22.80	17.00	17.00	22.50	Dome	-	Mos2 Skirt Coating, Anodised Dome	Cast
01.5800.xxx	2-Stroke	82.00	81.84	79.70	20.00	24.90	16.25	16.25	23.40	Dome	-	Mos2 Skirt Coating, Anodised Dome	Cast
01.5801.xxx	2-Stroke	85.00	84.79	80.00	22.00	22.20	19.25	19.25	25.60	Dome	-	Mos2 Skirt Coating, Anodised Dome	Cast
01.5802.xxx	2-Stroke	81.00	80.91	83.50	24.00	20.80	16.50	16.50	26.20	Dome	-	Mos2 Skirt Coating, Anodised Dome	Cast
01.5805.x	4-Stroke	80.00	79.95	46.80	18.00	18.30	-	-	20.70	Hollow with dome	2 Valve Pockets	Mos2 Skirt Coating, Anodised Dome	Cast
01.5807.xxx	2-Stroke	85.00	84.87	82.50	22.00	27.00	17.50	17.50	26.20	Dome	-	Mos2 Skirt Coating, Anodised Dome	Cast
01.5808.xxx	2-Stroke	82.00	81.84	79.70	21.00	27.50	16.75	16.75	25.30	Dome	-	Mos2 Skirt Coating, Anodised Dome	Cast
01.5809.xxx	2-Stroke	85.00	84.87	75.50	22.00	20.30	17.25	17.25	25.60	Dome	-	Mos2 Skirt Coating, Anodised Dome	Cast
01.5810.xxx	2-Stroke	85.00	84.88	75.50	22.00	20.20	18.50	18.50	25.80	Dome	-	Mos2 Skirt Coating, Anodised Dome	Cast
01.5811.xxx	2-Stroke	85.00	84.88	82.50	22.00	26.90	18.00	18.00	26.00	Dome	4 Lub. Holes Exh. Skirt	Mos2 Skirt Coating, Anodised Dome	Cast
01.5903.xxx	2-Stroke	85.00	84.90	83.50	24.00	20.90	17.50	17.50	26.20	Dome	-	Mos2 Skirt Coating, Anodised Dome	Cast
01.5906.xxx	2-Stroke	83.00	82.85	90.70	22.00	24.00	16.75	16.75	25.50	Dome	Intake Hole	Mos2 Skirt Coating, Anodised Dome	Cast
01.6216.x	2-Stroke	54.00	53.94	58.00	15.00	20.50	-	0.00	18.00	Flat	-	Mos2 Skirt Coating	Cast
01.6307.x	4-Stroke	77.00	76.96	37.50	16.00	14.30	-	-	17.45	Flat	4 Valve Pockets	-	Forged
01.6311.x	4-Stroke	77.00	76.95	34.70	16.00	12.00	-	-	17.80	Flat with Raised Top	4 Valve Pockets	-	Forged
01.6336.x	4-Stroke	76.00	75.96	34.20	16.00	12.00	-	-	20.35	Dome	4 Valve Pockets	-	Forged
01.6339.x	4-Stroke	83.00	82.96	34.30	16.00	12.00	-	-	18.00	Flat with Raised Top	4 Valve Pockets	-	Forged
01.6340.x	4-Stroke	79.00	78.96	33.50	14.00	11.00	-	-	18.65	Flat with Raised Top	4 Valve Pockets	-	Forged
01.6341.x	4-Stroke	79.00	78.95	35.00	14.00	11.00	-	-	20.00	Dome with hollow	4 Valve Pockets	-	Forged

PISTON DIMENSIONS

MISCELLANEOUS continued

Part No.	Engine	Std. Bore	A	B	C	D	E	F	G	Piston Head Shape	Remarks	Coating	Piston
01.6342.x	4-Stroke	82.00	81.96	35.80	16.00	15.00	-	-	17.00	Flat with Raised Top	4 Valve Pockets	-	Forged
01.6403.x	4-Stroke	100.00	99.94	44.30	20.00	14.30	-	-	23.15	Flat with Raised Top	4 Valve Pockets	-	Forged
01.6409.x	4-Stroke	91.50	91.44	41.90	20.00	14.20	-	-	24.30	Flat	4 Valve Pockets	-	Forged
01.6411.x	4-Stroke	98.00	97.95	35.80	20.00	15.00	-	-	22.55	Flat	4 Valve Pockets	-	Forged
01.6415.x	4-Stroke	98.00	97.95	40.00	19.00	16.00	-	-	21.20	Flat with hollow	4 Valve Pockets	-	Forged
01.6419.x	4-Stroke	95.00	94.94	38.05	19.00	11.50	-	-	22.60	Flat	4 Valve Pockets	-	Forged
01.6436.x	4-Stroke	97.00	96.96	42.00	20.00	14.50	-	-	20.30	Flat with hollow	4 Valve Pockets	-	Forged
01.6438.x	4-Stroke	97.00	96.96	42.00	20.00	14.50	-	-	20.10	Flat with hollow	4 Valve Pockets	-	Forged
01.6503.x	4-Stroke	100.00	99.95	39.70	20.00	13.30	-	-	22.50	Flat	4 Valve Pockets	-	Forged
01.6511.x	4-Stroke	101.00	100.94	43.50	20.00	15.00	-	-	24.00	Hollow with dome	4 Valve Pockets	-	Forged
01.6516.x	4-Stroke	97.00	96.95	42.25	20.00	15.00	-	-	20.10	Flat with hollow	4 Valve Pockets	-	Forged
01.6518.x	4-Stroke	97.00	96.95	42.30	20.00	14.50	-	-	20.30	Flat with hollow	4 Valve Pockets	-	Forged
01.6519.x	4-Stroke	100.00	99.95	42.60	20.00	14.50	-	-	23.00	Hollow with dome	4 Valve Pockets	-	Forged
01.6601.x	4-Stroke	98.00	97.94	42.00	22.00	13.80	-	-	23.50	Flat with hollow	4 Valve Pockets	-	Forged
01.6602.x	4-Stroke	98.00	97.94	42.00	22.00	13.80	-	-	23.50	Flat	4 Valve Pockets	-	Forged
01.6606.x	4-Stroke	100.00	99.95	41.20	20.00	14.50	-	-	23.00	Hollow	4 Valve Pockets	-	Forged
01.7005.xxx	2-Stroke	40.00	-	54.00	12.00	19.75	11.75	11.75	14.90	Dome	-	-	Cast
01.7010.x	2-Stroke	39.90	39.85	49.00	12.00	18.00	9.00	9.00	16.00	Dome	-	-	Cast
01.7015.xxx	2-Stroke	47.00	-	50.00	12.00	18.50	11.00	11.00	15.90	Dome	Reed cut-out	-	Cast
01.7016.xxx	2-Stroke	47.00	-	50.00	10.00	19.50	14.00	14.00	14.80	Dome	2 Intake Holes	-	Cast
01.7203.x	2-Stroke	54.00	53.95	63.50	15.00	21.50	13.00	13.00	20.50	Dome	-	Mos2 Skirt Coating	Cast
01.7207.x	2-Stroke	56.00	55.94	62.40	15.00	21.50	0.00	-	17.70	Dome	-	-	Forged
01.7218.x	2-Stroke	56.00	55.96	61.20	16.00	17.00	14.50	14.50	23.50	Dome	Reed cut-out, Intake Hole	-	Forged
01.7219.x	2-Stroke	56.00	55.96	61.20	16.00	17.00	14.50	14.50	23.50	Dome	Reed cut-out, Intake Hole	-	Cast
01.7221.x	2-Stroke	56.00	55.95	57.00	16.00	17.00	0.00	-	24.00	Flat	Reed cut-out, Intake Hole	-	Forged
01.7222.x	2-Stroke	54.00	53.94	61.50	15.00	21.50	0.00	-	20.50	Dome	-	-	Cast
01.7223.x	2-Stroke	54.00	53.94	61.50	15.00	21.50	0.00	-	20.50	Dome	-	-	Forged
01.7250.x	4-Stroke	72.00	71.95	38.50	15.00	16.00	-	-	20.80	Flat with hollow	2 Valve Pockets	-	Cast
01.7300.x	2-Stroke	72.00	71.94	79.30	18.00	29.00	16.00	16.00	23.50	Dome	-	-	Forged
01.7301.xxx	4-Stroke	72.70	-	49.10	17.00	14.00	-	-	22.00	Dome	2 Valve Pockets	-	Cast
01.7302.x	2-Stroke	72.00	71.94	79.65	18.00	29.00	0.00	0.00	23.20	Dome	2 Lub. Holes Exh. Skirt	-	Forged
01.7307.x	2-Stroke	66.40	66.33	78.85	18.00	29.00	12.00	16.00	23.20	Dome	-	-	Forged
01.7309.x	2-Stroke	66.40	66.34	80.40	18.00	29.00	0.00	0.00	23.30	Dome	2 Lub. Holes Exh. Skirt	-	Forged
01.7314.x	4-Stroke	76.00	75.96	31.40	16.00	10.50	-	-	17.50	Flat	4 Valve Pockets	-	Forged
01.7324.x	4-Stroke	84.00	83.95	31.90	16.00	11.00	-	-	16.00	Flat with hollow	4 Valve Pockets	-	Forged
01.7337.x	2-Stroke	66.40	66.34	75.70	18.00	28.50	1.75	1.75	24.60	Flat with Raised Top	-	-	Forged
01.7334.x	2-Stroke	66.40	66.34	79.00	18.00	29.00	1.75	1.75	24.00	Dome	-	-	Forged
01.7346.x	2-Stroke	72.00	71.94	75.60	18.00	28.50	2.00	2.00	24.50	Flat with Raised Top	-	-	Forged
01.7351.x	4-Stroke	88.00	87.96	35.20	18.00	13.50	-	-	21.60	Flat with hollow	4 Valve Pockets	-	Forged
01.7393.x	2-Stroke	72.00	71.94	75.25	18.00	28.90	1.75	1.75	20.60	Flat	-	-	Forged
01.7398.x	2-Stroke	72.00	71.94	78.50	18.00	29.00	1.75	1.75	20.90	Dome	-	-	Forged
01.7411.x	4-Stroke	95.00	94.95	42.80	20.00	28.90	-	-	22.50	Flat with hollow	4 Valve Pockets	-	Forged
01.7412.x	4-Stroke	95.00	94.95	39.50	20.00	13.50	-	-	22.40	Flat with hollow	4 Valve Pockets	-	Forged
01.7512.x	4-Stroke	100.00	99.95	39.30	20.00	13.50	-	-	22.10	Flat with hollow	4 Valve Pockets	-	Forged
01.7705.x	4-Stroke	85.00	84.94	41.50	21.00	16.00	-	-	26.80	Flat with hollow	4 Valve Pockets	-	Forged
01.8010.xxx	2-Stroke	67.75	-	71.00	18.00	29.00	0.00	14.50	27.40	Dome	-	-	Cast

CONNECTING ROD DIMENSIONS SHOULD ONLY BE USED AS INDICATION

2-Stroke

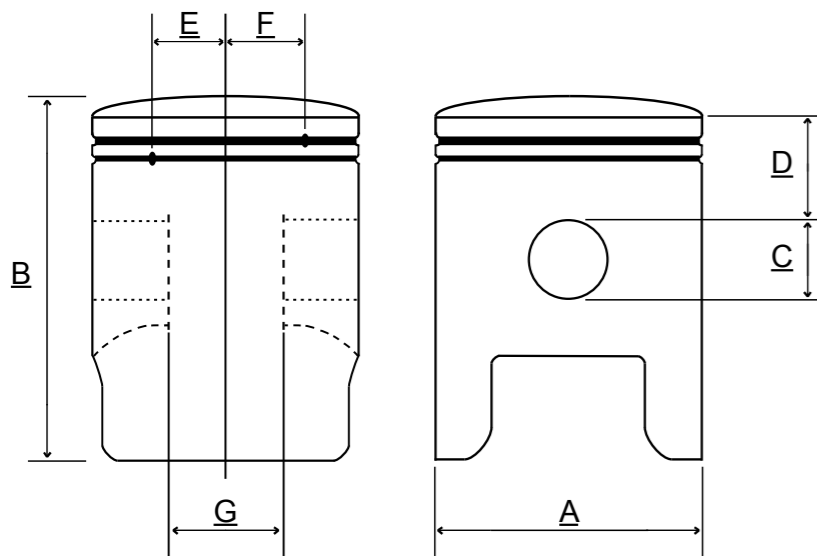

- A = Diameter *
- B = Total height
- C = Pinhole diameter
- D = Compression height
- E = Ring location pin position from center
- F = Ring location pin position from center
- G = Pin boss spacing

All dimensions in mm.
 * In case of cast iron cylinder, piston bore diameter is mentioned
 * In case of nicasil cylinder, actual piston diameter is mentioned

TECHNICAL

4-Stroke

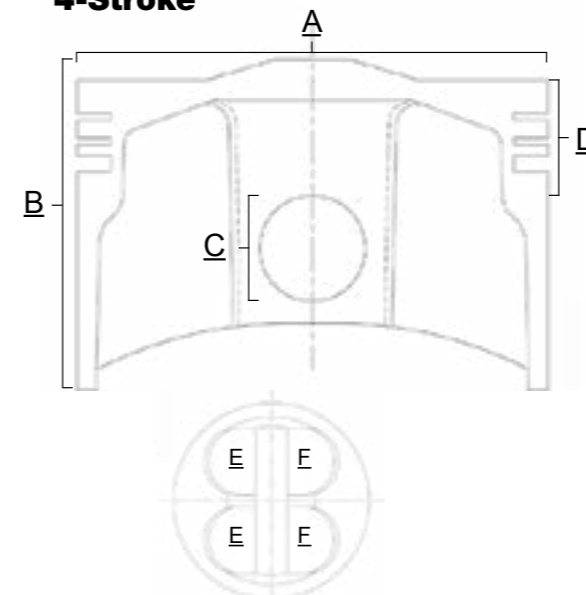

- A = Diameter *
- B = Total height
- C = Pinhole diameter
- D = Compression height
- E = Intake valve pocket diameter
- F = Exhaust valve pocket diameter

All dimensions in mm.
 * In case of cast iron cylinder, piston bore diameter is mentioned
 * In case of nicasil cylinder, actual piston diameter is mentioned

TECHNICAL

CONNECTING ROD DIMENSIONS

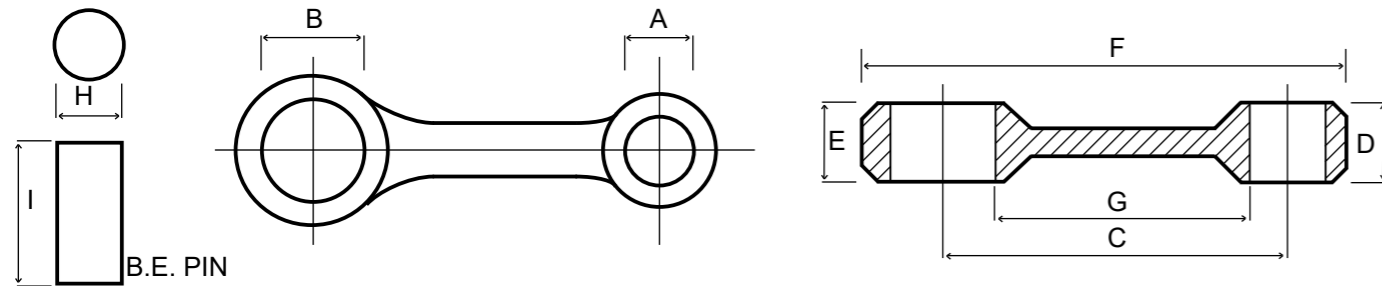

HONDA

Part No.	A	B	C	D	E	F	G	H	I	Washers	Remarks
03.1000	14.00	22.00	75.00	12.00	12.00	99.00	57.00	16.00	33.00	16 x 29 x 1.0	
03.1003	17.00	22.00	80.00	13.50	13.50	106.25	60.50	16.00	40.00	16 x 29 x 1.0	
03.1005	17.00	22.00	91.00	13.50	13.50	116.50	71.50	16.00	41.00	16 x 29 x 1.0	
03.1010	17.00	24.00	80.00	12.00	12.00	107.50	59.60	18.00	33.50	18 x 31 x 1.0	
03.1050	13.00	28.00	91.00	14.00	14.00	120.00	70.50	23.00	39.00	None	
03.1075	13.00	30.10	94.00	14.00	14.00	122.90	72.50	25.10	39.00	None	
03.1080	13.00	26.00	91.00	14.00	14.00	119.50	71.50	21.00	35.00	None	
03.1090	13.00	28.00	94.00	14.00	14.00	121.25	73.50	23.00	39.00	None	
03.1102	17.00	24.00	91.00	13.50	13.50	118.55	70.50	18.00	40.75	18 x 31 x 1.0	
03.1103	19.00	26.00	100.00	14.00	14.00	130.35	77.50	20.00	48.00	20 x 33 x 1.0	
03.1105	18.00	26.00	97.00	14.15	14.15	126.25	75.00	20.00	45.00	20 x 33 x 1.0	
03.1176	15.00	38.00	105.50	18.00	18.00	140.45	79.00	30.00	54.05	None	
03.1200	20.00	28.00	100.00	16.00	16.00	131.30	76.00	22.00	55.00	22 x 37 x 1.0	
03.1210	19.00	31.00	104.00	16.70	16.70	137.00	79.00	24.00	49.00	24 x 41 x 1.0	
03.1212	19.00	29.00	104.00	16.00	16.00	137.00	80.00	22.00	53.75	22 x 37 x 1.0	Barreled Rod
03.1227	14.00	32.00	75.50	14.00	15.80	105.40	52.50	25.00	50.00	25 x 39 x 1.0	Barreled Rod
03.1253	15.00	38.00	103.50	16.00	16.00	138.00	77.00	30.00	54.00	None	
03.1255	15.00	38.00	103.50	18.00	18.00	139.00	77.00	30.00	54.00	30 x 46 x 1.0	
03.1260	14.00	36.00	95.00	14.00	14.00	127.40	70.00	28.00	42.40	None	
03.1280	14.00	33.00	91.00	14.00	14.00	122.20	67.50	26.00	43.50	None	
03.1300	22.00	31.00	130.30	16.75	16.75	166.00	103.80	24.00	59.60	24 x 40 x 1.5	
03.1315	22.00	31.00	125.30	20.00	16.70	160.00	99.00	24.00	59.60	24 x 41 x 1.0	/ 24 x 40 x 1.5
03.1322	22.00	32.00	125.25	20.00	16.50	163.00	98.30	25.00	59.60	25 x 42 x 1.0	Barreled Rod
03.1334	16.00	38.00	90.00	15.00	17.80	126.10	63.00	30.00	53.00	30 x 50 x 1.0	Barreled Rod
03.1348	16.00	38.00	91.50	16.00	19.80	127.25	64.50	30.00	54.90	30 x 50 x 1.0	Barreled Rod
03.1353	19.00	41.00	113.00	20.00	20.00	153.00	83.00	33.00	61.00	None	
03.1355	17.00	41.00	106.50	18.00	18.00	144.00	77.50	32.00	56.00	32 x 50 x 1.0	
03.1357	17.00	41.00	105.00	18.00	18.00	143.00	76.00	32.00	58.00	32 x 50 x 1.0	
03.1358	17.00	41.00	102.50	17.80	17.80	-	73.50	32.00	58.00	32 x 50 x 1.0	
03.1363	15.00	38.00	110.00	18.00	18.00	145.20	83.50	30.00	54.00	None	Barreled Rod
03.1402	19.00	42.00	105.50	18.00	19.75	145.60	75.00	34.00	61.00	None	Barreled Rod
03.1405	19.00	42.00	105.50	18.00	19.75	145.60	75.00	34.00	64.90	34 x 53 x 2.0	Barreled Rod
03.1406	25.00	35.00	144.00	24.00	20.00	183.00	114.00	26.00	67.75	26 x 42 x 1.5	
03.1409	19.00	41.00	102.00	18.00	19.80	142.20	72.00	33.00	60.85	33 x 51 x 1.0	Barreled Rod
03.1417	19.00	43.00	102.00	18.00 / 15.70	19.80	142.20	71.00	35.00	67.00	35 x 53 x 1.0	Barreled Rod
03.1495	20.00	43.00	122.50	20.00	20.00	165.00	91.00	34.00	65.85	None	
03.1553	21.00	42.00	141.00	20.00	20.00	186.00	109.50	34.00	60.00	34 x 53 x 1.0	
03.1654	24.00	48.00	134.00	23.00	23.00	182.00	98.00	38.00	65.00	38 x 57 x 1.0	
03.1660	24.00	45.00	132.00	23.00	23.00	179.00	97.50	36.00	71.00	None	
03.1661	23.00	50.00	140.25	23.00	23.00	190.00	103.75	38.00	65.00	38 x 60 x 1.0	Barreled Rod

KAWASAKI

Part No.	A	B	C	D	E	F	G	H	I	Washers	Remarks
03.4005	18.00	27.00	96.00	18.00	15.00	127.00	73.50	20.00	49.90	20 x 33 x 1.0	
03.4022	16.00	27.00	85.00	14.00	14.00	114.00	63.50	20.00	46.00	20 x 33 x 1.0	
03.4108	18.00	29.00	92.00	16.00	14.00	126.50	68.50	22.00	46.00	22 x 37 x 1.0	
03.4118	18.00	29.00	92.00	16.00	16.00	124.30	68.50	22.00	46.00	22 x 37 x 1.0	
03.4214	19.00	29.00	106.00	17.00	17.00	140.00	82.00	22.00	51.00	22 x 37 x 1.0	
03.4218	19.00	29.00	104.00	17.00	17.00	137.00	80.00	22.00	51.20	22 x 37 x 1.0	Barreled Rod
03.4223	19.00	29.00	104.00	17.00	17.00	137.00	80.00	22.00	55.00	22 x 42 x 1.0	Barreled Rod
03.4250	21.00	29.00	106.00	17.00	17.00	142.00	81.00	22.00	54.00	22 x 37 x 1.0	
03.4285	21.00	29.00	109.00	17.00	17.00	142.85	84.00	22.00	51.00	22 x 37 x 1.0	
03.4309	22.00	32.00	125.00	22.00	20.00	162.50	98.00	24.00	58.50	24 x 40 x 1.5	Barreled Rod
03.4334	16.00	38.00	92.50	15.00	18.00	129.50	65.50	30.00	54.80	None	Barreled Rod
03.4340	16.00	38.00	92.50	15.00	18.00	128.90	65.50	30.00	55.85	30 x 48 x 0.5	Barreled Rod
03.4342	16.00	38.00	92.50	15.00	19.00	129.10	65.50	30.00	55.85	None	Barreled Rod
03.4347	16.00	30.00	92.50	15.00	19.00	126.80	69.50	30.00	55.85	None	Barreled Rod, Plain Bearing
03.4406	19.00	42.00	101.00	18.00	20.00	142.40	70.50	34.00	60.10	None	Barreled Rod
03.4409	19.00	42.00	101.00	18.00	22.00	142.30	70.50	34.00	62.00	None	Barreled Rod

KTM

Part No.	A	B	C	D	E	F	G	H	I	Washers	Remarks
03.6011	15.00	22.00	85.00	14.00		110.90	66.50	16.00	35.90	16 x 30 x	Barreled Rod
03.6017	15.00	24.00	88.00	12.90	14.90	116.70	68.50	18.00	56.00	18 x 33 x 1.0	
03.6023	15.00	24.00	88.00	12.90	14.90	116.70	68.50	18.00	42.00	18 x 33 x 1.0	
03.6029	15.00	24.00	88.00	12.90	14.90	116.70	68.50	18.00	54.30	18 x 33 x 1.0	Barreled Rod
03.6104	18.00	28.00	96.00	12.90	16.00	127.70	73.00	22.00	46.00	22 x 39 x 1.0	Barreled Rod
03.6113	18.00	26.00	96.00	14.00	14.95	126.10	74.00	20.00	45.90	20 x 33 x 1.0	Barreled Rod
03.6209	19.00	26.00	109.90	14.85	14.85	142.00	87.40	20.00	55.90	20 x 34 x 1.0	4x Washers Needed
03.6220	19.00	28.00	110.00	16.00	16.00	142.00	86.50	22.00	54.90	22 x 37 x 1.0	Barreled Rod
03.6226	19.00	28.00	110.00	16.00	16.00	142.00	86.50	22.00	55.90	22 x 37 x 1.0	Barreled Rod
03.6248	20.00	28.00	118.00	15.90	15.90	151.40	94.00	22.00	55.00	22 x 37 x 1.0	Barreled Rod
03.6310	22.00	30.00	132.00	17.00	17.00	167.75	106.00	24.00	59.60	24 x 40 x 1.0	
03.6311	22.00	30.00	132.00	17.00	17.00	167.75	106.00	24.00	59.60	24 x 40 x 1.0	Barreled Rod
03.6320	22.00	30.00	129.00	16.85	16.85	164.75	103.00	24.00	59.70	24 x 41 x 1.0	
03.6323	22.00	30.00	125.00	16.90	16.90	162.45	99.00	24.00	60.00	24 x 41 x 1.0	Barreled Rod
03.6326	16.00	38.00	98.00	17.90	17.90	135.90	71.00	30.00	53.60	None	Barreled Rod
03.6333	16.00	30.00	98.00	15.00 / 10.90	18.00	136.20	75.00	30.00	56.00	None	Snakehead Type S/e, Plain Bearing
03.6337	16.00	30.00	92.00	15.00 / 10.80	18.00	130.70	69.00	30.00	56.00	None	Snakehead Type S/e, Plain Bearing
03.6351	18.00	40.00	102.00	16.90	19.90	141.30	73.00	32.00	59.90	None	Barreled Rod
03.6363	18.00	32.00	102.00	17.00 / 13.50	20.00	138.25	77.00	32.00	59.90	None	Snakehead Type S/e, Plain Bearing
03.6366	18.00	32.00	96.00	17.00 / 13.40	20.00	132.00	71.00	32.00	59.90	None	Snakehead Type S/e, Plain Bearing
03.6423	20.00	40.00	119.00	19.90	19.90	162.40	89.00	32.00	64.60	None	Barreled Rod
03.6427	19.00	42.00	107.40	17.00	19.90	149.70	76.90	35.00	63.90	None	Barreled Rod
03.6428	19.00	42.00	114.00	19.80	19.90	156.10	83.50	35.00	62.70	None	Barreled Rod
03.6432	19.00	42.00	114.00	14.70	19.90	154.70	83.50	35.00	62.70	None	Barreled Rod
03.6433	19.00	35.00	114.00	20.00 / 15.00	20.00	153.45	87.00	35.00	62.70	None	Snakehead Type S/e, Plain Bearing
03.6436	19.00	35.00	107.60	20.00 / 15.00	20.00	147.00	80.60	35.00	62.00	None	Snakehead Type S/e, Plain Bearing
03.6508	20.00	42.00	106.70	17.90	19.90	148.65	75.70	35.00	63.90	None	Barreled Rod
03.6512	19.00	42.00	122.40	19.90	19.90	163.15	91.90	35.00	62.70	None	Barreled Rod
03.6519	22.00	50.00	141.50	22.90	22.90	190.90	105.50	40.00	65.00	40 x 60 x 1.0	Barreled Rod
03.6520	20.00	43.00	129.00	21.90	21.90	174.20	97.50	35.00	64.70	35 x 55 x 1.0	Barreled Rod
03.6528	19.00	42.00	120.80	19.90	19.90	162.40	90.30	35.00	62.70	None	Barreled Rod
03.6512	19.00	42.00	122.40	19.90	19.90	163.15	91.90	35.00	62.70	None	Barreled Rod
03.6519	22.00	50.00	141.50	22.90	22.90	190.90	105.50	40.00	65.00	40 x 60 x 1.0	Barreled Rod
03.6520	20.00	43.00	129.00	21.90	21.90						

CONNECTING ROD DIMENSIONS continued..

YAMAHA continued

Part No.	A	B	C	D	E	F	G	H	I	Washers	Remarks
03.2018	16.00	24.00	90.00	14.00	14.00	117.75	70.00	18.00	43.30	18 x 31 x 1.0	
03.2020	21.00	29.00	110.00	18.00	16.00	143.00	85.00	-	-	22 x 37 x 1.0	No Big End Pin
03.2021	21.00	29.00	110.00	18.00	17.00	142.50	85.00	-	-	22 x 37 x 1.0	No Big End Pin
03.2021F	21.00	29.00	110.00	18.00	17.00	142.50	85.00	-	-	22 x 37 x 1.0	Flat Big-End Cage
03.2025	20.00	28.00	110.00	16.00	16.00	141.50	86.00	22.00	50.75	22 x 37 x 1.0	
03.2070	20.00	28.00	115.00	16.00	16.00	147.00	91.00	22.00	51.00	22 x 37 x 1.0	
03.2104	17.00	24.00	90.00	14.00	14.00	117.70	69.50	18.00	41.30	18 x 31 x 1.0	
03.2105	18.00	26.00	96.00	14.00	14.00	126.40	74.00	20.00	43.25	20 x 33 x 1.0	
03.2119	18.00	26.00	92.00	14.00	14.00	121.60	70.00	20.00	43.25	20 x 33 x 1.0	Barreled Rod
03.2203	20.00	29.00	98.00	17.00	17.00	130.00	73.50	22.00	54.50	22 x 36 x 0.5	/ 22 x 37 x 1.0
03.2217	20.00	29.00	105.00	16.00	17.00	138.00	80.50	22.00	54.50	22 x 37 x 1.0	
03.2221	19.00	29.00	105.00	16.00	17.00	138.00	81.00	22.00	54.50	22 x 37 x 1.0	
03.2225	19.00	29.00	102.00	16.00	17.00	134.25	78.00	22.00	54.50	22 x 37 x 1.0	Barreled Rod
03.2250	20.00	28.00	105.00	18.00	16.00	136.00	81.00	22.00	54.50	22 x 37 x 1.0	
03.2251	20.00	28.00	110.00	16.00	16.00	142.00	86.00	22.00	54.50	22 x 37 x 1.0	
03.2255	21.00	29.00	110.00	18.00	16.00	143.00	85.00	22.00	54.50	22 x 37 x 1.0	
03.2265	15.00	37.00	105.00	20.00	20.00	142.10	79.00	30.00	55.10	None	
03.2301	20.00	28.00	105.00	16.00	16.00	136.50	81.00	22.00	54.50	22 x 37 x 1.0	
03.2303	20.00	28.00	100.00	16.00	16.00	130.70	76.00	22.00	54.00	22 x 37 x 1.0	
03.2304	23.00	31.00	130.00	20.00	20.00	157.00	103.00	25.00	60.00	25 x 40 x 1.0	
03.2306	23.00	31.00	125.00	20.00	20.00	161.80	98.00	25.00	59.90	25 x 40 x 1.0	
03.2308	17.00	40.00	100.50	20.00	20.00	139.75	72.00	32.00	67.75	None	
03.2309	22.00	31.00	125.00	20.00	17.00	161.30	98.50	24.00	59.00	24 x 41 x 1.0	
03.2310F	21.00	29.00	110.00	18.00	17.00	142.00	85.00	22.00	56.40	22 x 37 x 1.0	Flat Big-End Cage
03.2320	16.00	37.00	101.55	20.00	20.00	138.05	75.05	30.00	55.10	None	
03.2325	16.00	37.00	100.50	20.00	20.00	138.00	74.00	30.00	55.00	None	
03.2400	18.00	42.00	102.00	18.00	20.00	142.50	72.00	34.00	60.75	None	
03.2401	16.00	38.00	93.50	15.00	18.00	129.75	66.50	30.00	54.80	None	Barreled Rod
03.2403	16.00	40.00	93.50	15.00	18.00	131.00	65.50	32.00	54.80	None	Barreled Rod
03.2414	16.00	38.00	92.50	15.00	18.00	129.45	65.50	30.00	54.80	30 x 50 x 1.0	Barreled Rod
03.2420	19.00	42.00	102.00	18.00	20.00	142.50	71.50	34.00	60.75	None	
03.2423	18.00	42.00	103.50	18.00	20.00	143.50	73.50	34.00	60.75	None	
03.2426	18.00	42.00	103.50	18.00	20.00	143.50	73.50	34.00	60.75	None	
03.2432	18.00	42.00	103.50	18.00	21.00	143.50	73.50	34.00	60.75	34 x 54 x 0.5	
03.2434	20.00	42.00	102.50	18.00	20.00	143.50	71.50	34.00	60.80	None	
03.2436	20.00	42.00	101.50	18.00	21.00	142.70	70.50	34.00	60.75	34 x 54 x 0.5	Washer not for '06-07
03.2439	20.00	45.00	108.00	18.00	23.00	150.70	75.50	36.00	62.80	None	Barreled Rod
03.2440	18.00	42.00	103.00	18.00	21.00	144.15	73.00	34.00	60.80	-	Barreled Rod
03.2444	20.00	45.00	108.25	18.00	23.00	151.30	75.75	36.00	62.80	None	Barreled Rod
03.2487	19.00	41.00	112.50	20.30	20.00	151.80	82.50	33.00	57.75	33 x 50 x 1.0	Barreled Rod
03.2576	20.00	42.00	145.20	23.80	23.80	188.50	114.20	34.00	73.70	None	
03.2600	22.00	43.00	135.50	22.00	22.00	181.30	103.00	35.00	74.00	None	
03.2661	22.00	45.00	136.50	22.00	22.00	182.20	103.00	37.00	73.80	None	
03.2706	23.00	50.00	135.00	22.00	22.00	183.00	98.50	40.00	73.80	None	Barreled Rod

MISCELLANEOUS

Part No.	A	B	C	D	E	F	G	H	I	Washers	Remarks
03.5215	19.00	36.00	125.00	17.00	20.00	162.30	97.50	28.00	48.00	28 x 44 x 0.6	
03.5316	22.00	40.00	130.00	22.00	22.00	173.50	99.00	32.00	60.00	32 x 49.5 x 0.65	
03.5506	22.00	30.00	125.00	16.90	16.90	161.50	99.00	24.00	52.00	24 x 41 x 1.0	
03.5507	25.00	30.00	125.00	17.00	17.00	163.25	97.50	24.00	52.00	24 x 41 x 1.0	
03.5508	24.00	33.00	125.00	18.00	18.00	165.40	96.50	26.00	53.00	26 x 43 x 0.9	
03.5509	24.00	33.00	125.00	18.00	18.00	165.40	96.50	26.00	55.00	26 x 43 x 0.9	
03.5510	24.00	35.00	140.00	17.85	17.85	181.60	110.50	28.00	55.00	28 x 45 x 1.0	Barreled Rod
03.5515	25.00	36.00	140.00	20.00	20.00	183.00	109.50	28.00	57.00	28 x 45 x 1.0	Barreled Rod
03.6217	19.00	30.00	105.00	16.00	16.00	138.00	80.50	24.00	55.00	24 x 39 x 1.0	Barreled Rod
03.6319	22.00	30.00	125.00	17.00	17.00	160.00	99.00	24.00	58.10	24 x 41 x 1.0	Barreled Rod
03.6336	16.00	38.00	98.00	15.00	18.00	135.50	71.00	30.00	56.55	None	Barreled Rod
03.6340	14.00	40.00	92.00	17.00	18.00	129.30	65.00	32.00	56.00	None	Barreled Rod
03.6425	20.00	42.00	106.00	18.00	19.80	148.65	75.00	34.00	58.30	None	Barreled Rod
03.6505	20.00	38.00	110.00	18.00	18.00	149.70	81.00	30.00	56.50	None	Barreled Rod
03.6605	22.00	30.00	115.00	13.00	13.00	151.20	89.00	24.00	45.00	24 x 41 x 1.0	
03.6610	22.00	30.00	115.00	15.00	15.00	151.10	89.00	24.00	47.00	24 x 41 x 1.0	
03.6688	23.00	32.30	125.05	15.75	15.75	163.90	97.40	24.30	54.00	24.3 x 38 x 1.0	
03.7202	19.00	26.00	110.00	14.85	14.85	141.60	87.50	20.00	49.00	20 x 33 x 1.0	
03.7204	15.00	33.00	87.00	16.00	16.00	-	63.00	26.00	39.00	None	
03.7220	20.00	28.00	110.00	16.00	16.00	141.50	86.00	22.00	51.00	22 x 37 x 1.0	Flat Big-End Cage
03.7313	22.00	31.00	125.00	20.00	17.00	161.30	98.50	24.00	59.00	24 x 41 x 1.0	
03.7318	22.00	31.00	125.00	20.00	17.00	161.30	98.50	24.00	59.00	24 x 41 x 1.0	