



QUADBOSS

**QUADBOSS
2020**



**WE KEEP
YOUR RIDING!**





SEALS UP TO 1/2" PUNCTURE IN THE TREAD AND 1/4" PUNCTURE IN THE SIDEWALL



ENVIRONMENTALLY BENIGN AND WATER WASHABLE



WILL NOT RUST STEEL, CORRODE ALUMINUM WHEELS, OR CLOG VALVE CORE



STOPS BEAD LEAKS, VALVE STEM LEAKS AND PINHOLE LEAKS IN RIMS



WORKS FOR THE LIFE OF THE TIRE



MADE IN THE USA



WILL NOT SOLIDIFY OR FREEZE (ABOVE -33°F)

- 16 oz. 530848
- 32 oz. 530850
- 1G 530849
- 5G 530855
- 5G with Pump 530860
- 55G Drum 530856

**Not recommended for extreme high speed competition applications*

TIRE SEALANT

DEALER PROGRAM



WE GUARANTEE

THAT YOUR CUSTOMERS WILL NOT HAVE A FLAT ON THEIR ATV OR UTV FROM A PUNCTURE FOR THE LIFE OF THEIR TIRES OR WE'LL PAY TO FIX THEM!

FLAT-FREE GUARANTEE!

GAIN A COMPETITIVE EDGE OVER THE COMPETITION BY OFFERING YOUR CUSTOMERS A TIRE SEALANT THAT REALLY WORKS!

QUADBOSS TIRE SEALANT DEALER PROGRAM PACKAGE HIGHLIGHTS:

PACKAGING LEVELS	DISCOUNT*	INCLUDED WITH PACKAGE
PACKAGE #1	12%	DISPLAY STAND
PACKAGE #2	14%	DISPLAY STAND AND QUADBOSS TACKLE BOX
PACKAGE #3	15%	DISPLAY STAND, TACKLE BOX AND TIRE DEMO KIT
PACKAGE #4	1/3, 1/3, 1/3	DISPLAY STAND, TACKLE BOX, DEMO KIT AND INJECTION CART

No additional discounts apply

INTRODUCING THE QUADBOSS TIRE SEALANT DEALER PROGRAM

The program consists of 4 levels of buy-in and the Dealer is rewarded with larger discounts and additional marketing materials as the order grows in size.

The rewards are on product with discounts up to 15% off of current Dealer Best and the marketing materials include a free standing display rack, a tackle box which includes special orange valve caps to denote that a tire has been treated, fender stickers, additional valve cores, a valve core tool and tire gauge, plus an instructional DVD. Lastly is the all important sample tire filled with sealant and mounted on a display stand; hammer and spike are also included.

Injection cart is available at 1/3 of the dealer best cost when purchased with a 55 Gallon drum.



**//08 TIRE &
WHEEL**

**//50 REPLACEMENT
PARTS**

//64 RAMPS

//16 LIGHTS

//70 COVERS

//22 WINCHES

//72 DISPLAYS

//24 ACCESSORIES

//78 APPAREL





**NEW FOR
2020**

QBT454 UTILITY TIRES

QuadBoss® QBT454 Radial Utility Tires are designed to provide a smooth and consistent ride as well as optimal traction in a variety of terrain.

608475-608484



QBT445 UTILITY TIRES

Advanced tread that grabs and reduces skidding on wet surfaces. O.E.M replacement for Kawasaki Mule 2500 and up. Bias, 4-ply with 14mm tread depth. Front and rear application. Load capacity 1660 lbs.

23x11-10 608971



QBT447 UTILITY TIRES

Designed for optimal performance in intermediate-to-loose terrain, this tire's exclusive center tread pattern is guaranteed to keep you moving where others might bog down. Tough 6-ply bias construction with 3/4" tread depth. Wraparound lugs give extra sidewall protection and excellent bite for cornering. Available in popular 11", 12" and 14" diameter sizes.

608974-608979, 608988



QBT448 UTILITY TIRES

QBT448 Utility Tires feature large center knobs, reducing roll-resistance, while improving traction and tread life. Directional tread pattern excels in loose-to-intermediate terrain. Diverse shoulder knobs increase handling and cornering. Multi-purpose use. Bias, 6-ply rated. 3/4" tread depth. Available in popular 11", 12" and 14" diameter sizes.

609336-609343



QBT346 SAND TIRES

Specifically designed for high-powered UTVs to improve performance in the dunes. Custom spider web design stands out and looks great. 6-ply, lightweight radial carcass delivers a high level of flotation. Tri-ribbed design on front tires allow for optimal turning and traction. Rear tire design creates a quick hook-up and acceleration. 7/8" thread depth. Available in popular 14" diameter sizes.

609322-609325



QBT673 MUD TIRES

The most aggressive Mud Tire in the QuadBoss® line of tires. If muddin' is your game, then the QuadBoss QBT673 are the tires for you. Built-in rim guard to protect wheels from dents and dings. Directional tread for optimal traction. 2" thread depth. Available in popular 14" and 15" diameter sizes.

609318-609321, 609332



QBT671 MUD TIRES

Have the terrain begging for mercy when this 6-ply constructed rubber meets the mud. The unique scale design in the tread valley provides extra traction and unparalleled clean out. Slotted lugs add traction and provide weight savings for better steering control. Wraparound lugs give extra sidewall protection and excellent cornering bite. Sidewall features rim guard for wheel protection. Load rated for most ATVs and UTVs. Available in popular 12" diameter sizes.

608980-608987



QBT700 SPORT SERIES TIRES

When performance comes first, the lightweight 4-ply bias construction of the QuadBoss® QB700 series will make the most of your motor. This dynamic tread pattern brings acceleration and braking traction in soft to hard pack conditions. Available in popular 8", 9" and 10" diameter sizes.

608970, 908672-608973, 608994-608999



QBT672 RADIAL MUD TIRE

With a unique directional tread design and 8-ply, puncture-resistant construction, the QuadBoss® QBT672 Radial Mud Tires are up to the challenge of the most arduous terrain. 1-1/4" mud lugs for aggressive bite in muddy and soft conditions. Built-in rim guard protects wheels from trail damage. Available in popular 12" and 14" diameter sizes.

609311-609317



QBT846 RADIAL UTILITY TIRE

Aggressive sidewall tread to grab traction in ruts and sticky situations. Meets or exceeds D.O.T. specifications. Perfect for intermediate-to-hard terrain with built-in rim guard that protects wheel. 8-ply radial casing for a smooth, consistent ride. Long-lasting 3/4" tread depth that stands up to the abuse of today's modern ATVs and UTVs. Available in popular 12", 14" and 15" diameter sizes.

609326-609331



QBT446 RADIAL UTILITY TIRE

A non-directional tread design guarantees optimal traction on even the most difficult terrains. Ultra-durable, 8-ply radial carcass. Radial casing with over-center tread design for a super-smooth ride. Extremely puncture-resistant. Built-in rim guard protects wheels from trail damage. 3/4" tread depth. Available in popular 12", 14" and 15" diameter sizes.

609300-609310, 609333-609335



SLICER WHEELS

Gloss Black/Machined 608469-608474, 608520-608523

Radical designs with an impressive finish take the look of your ride to the next level. Precision-machined, high-quality aluminum offers superior performance. Comes with black center caps.



SLICER WHEELS

Machined/Matte Black 608524-608527



BLITZ WHEELS

Machined/Black 608460-608464

Precision-machined, high-quality aluminum offers superior performance in an ultra-strong, super-lightweight package. Radical designs with an impressive finish take the look of your ride to the next level. Wheels are rated from 700 to 1000 lbs. Includes black center caps.



STRYKER WHEELS

Gun Metal 608466-608468



**SHOCKER
WHEELS**

Machined/Matte Black 608516-608519



**GRINDER
WHEELS**

Matte Black/Machined 608500-608515



**BOSS LOCK
WHEELS**

Matte Black/Machined 608528-608531

STEELY WHEELS



**NEW FOR
2020**

QuadBoss® Steely Wheels feature a stylish rock-crawler design that's been powder-coated black for a durable, long-lasting finish. Available in 12" and 14".

Black 608485-608493



LIFT KITS

Size does, indeed, matter when it comes to tires and ground clearance, so make sure you have enough of one to satisfy the other with this quality lift kit.

WHEEL SPACERS

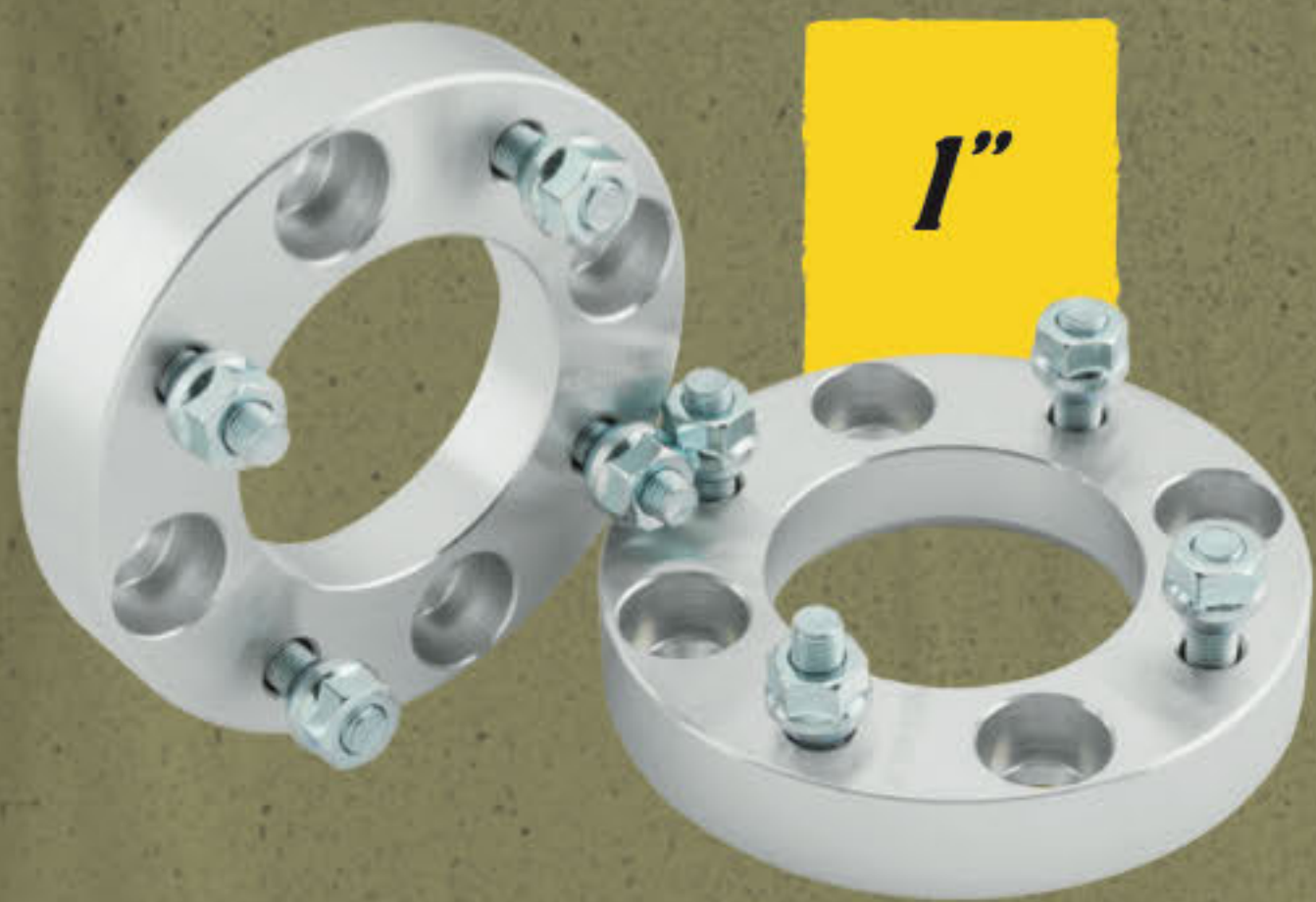

Your ride's stability is assured with these top-of-the-line wheel spacers. Precision-made from high-quality aluminum. Strong and durable, yet lightweight. Increases stability and provides extra clearance. Wheel studs and nuts included.

From 1" to 3" Wheel Spacers Available
563516-563619, 563531-563538, 563866-563893



**NEW FOR
2020**

DRL SINGLE ROW LIGHT BARS



41.5"



31.5"



21.5"



11.5"

The QuadBoss® DRL Single Row Light Bars feature zero glare half surface optics housed in a heavy-duty, extruded aluminum casing with abrasion and shatter-resistant lens. Combo flood and spot beams with white daytime running light that's available in 11.5", 21.5", 31.5" and 41.5" sizes. IP68 waterproof rating with a stainless steel military breather and 50,000+ hrs. life expectancy. Works with 9-32V DC applications. Includes DT harness and switch. One-year manufacturer's warranty.

- 11.5" 568920
- 21.5" 568921
- 31.5" 568922
- 41.5" 568923

**COMES WITH HARNESS
AND SWITCH**

HIGH-INTENSITY DRL PODS

The QuadBoss® High-Intensity DRL Pods feature four high-intensity 4-Watt LEDs, paired with a white daytime running light. Housed in a heavy-duty, cast aluminum housing with abrasion and shatter-resistant lens. 20-Watts @ 1,600 lumens. Works with 9-32V DC applications. 50,000+ hrs of life expectancy. Available in spot or flood beam models. Stainless steel military breather. IP67 waterproof rated. Includes DT harness and switch. Sold in pairs. One-year manufacturer's warranty.

Spot 568918

**COMES WITH HARNESS
AND SWITCH**



NEW FOR
2020

SINGLE ROW LIGHT BARS



40"



31.5"

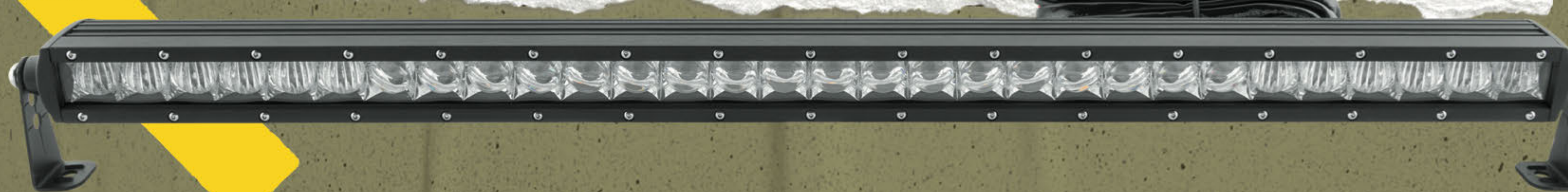

The QuadBoss® Single Row LED Light Bar features high-intensity, combo flood and spot beam LEDs housed in a heavy-duty, aluminum casing with an abrasion and shatter-resistant lens. Real 4D optics available in 6.5", 11.5", 21.5", 31.5" and 40" sizes. IP67 waterproof rating with stainless steel military breather and 50,000+hour life expectancy. Works with 10-30V DC applications. Includes DT harness and switch. One-year manufacturer's warranty.

**COMES WITH HARNESS
AND SWITCH**

- 6.5" 568908
- 11.5" 568909
- 21.5" 568910
- 31.5" 568911
- 40" 568912



LED POD LIGHTS

The QuadBoss® LED Pod Lights feature an abrasion and shatter-resistant lens that's housed in a heavy-duty cast aluminum housing for durability in extreme conditions. 20-Watts @ 1,712 lumens. 4x 5-Watt high-intensity LEDs, with a 50,000+ hour life expectancy that's available in spot or flood pattern options. IP67 waterproof rating. Works with 11-24V DC applications. Includes DT Harness and switch. Sold in pairs. One-year manufacturer's warranty.

**COMES WITH HARNESS
AND SWITCH**

Spot 568906
Flood 568907

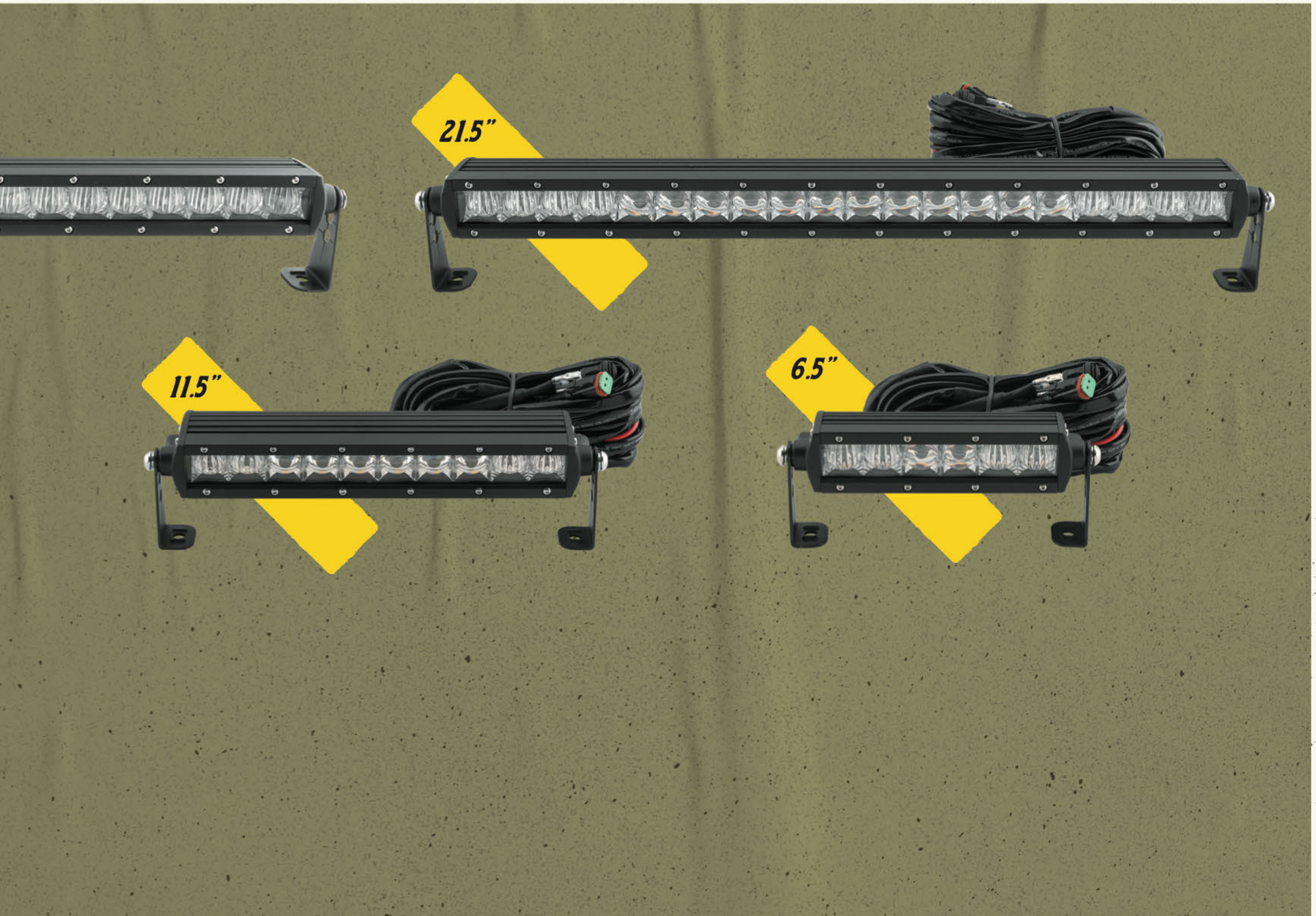

NEW FOR
2020

DOUBLE ROW LIGHT BARS

The QuadBoss® Double Row LED Light Bar features high-intensity, combo flood and spot beam LEDs housed in a heavy-duty, aluminum casing with an abrasion and shatter-resistant lens. Available in 13.5", 22", 32" and 42" sizes. IP68 waterproof rating with stainless steel military breather and 50,000+ hrs. life expectancy. Works with 9-32V DC applications. Includes DT harness and switch. One-year manufacturer's warranty

13.5" 568914
22" 568915
32" 568916
42" 568917

**COMES WITH HARNESS
AND SWITCH**

42"



32"



22"

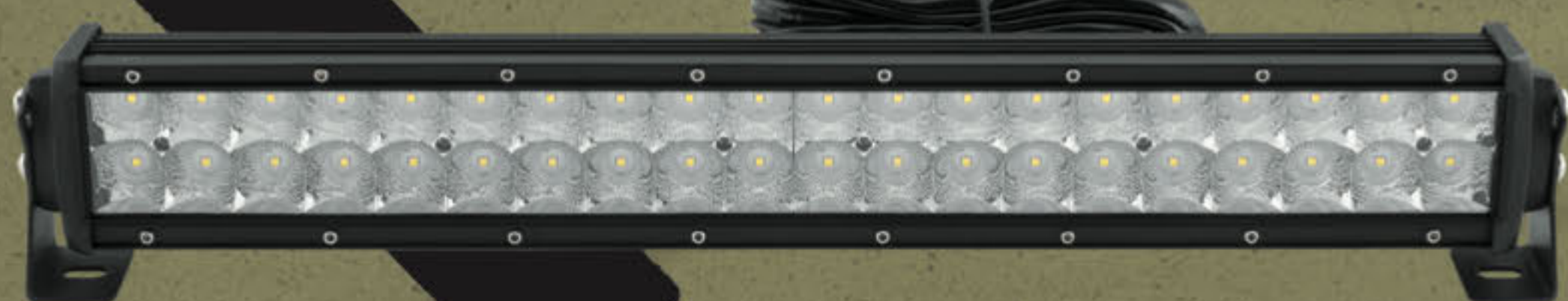

13.5"





ROCK LIGHT KIT

Mounts inside wheel wells or under the chassis to illuminate the wheels and tires. Compact fixtures with rubber mounting base provide a clean integrated mount. Each rock light has 13.5 ft. of wire to ensure proper mounting. Kit includes four lights and a harness that connects all four lights together; main harness needed and sold separately P/N 568139. Individual light includes three LEDs rated at 2-Watts each with 125-Lumen output and 120° flood beam pattern. Simple and quick installation. One-year manufacturer's warranty.

568565



SINGLE ROW HI-LUX LED BARS

Slim, single row LED bars with ultra-high efficient Hi-Lux OSRAM LEDs generate huge performance. Low-profile, sleek housing design provides multiple mounting bracket options. One-year manufacturer's warranty.

- 5" Spot Light 568570
- 5" Flood Light 568571
- 9" Spot Light 568572
- 9" Flood Light 568573
- 32" Combo Light 568575



LED MOUNTING CLAMPS

Mounting tab rotates 360° for versatile mounting position. Precision-milled CNC billet aluminum construction for extreme durability. Kit includes two mounting clamps with brackets and hardware. One-year manufacturer's warranty. Available in 1.5", 1.75" and 2" sizes.

568562-568564



5,000 LBS. WINCH

WITH DYNEEMA ROPE

3-stage, metal-planetary gear system for fast line speed and includes 50 ft. synthetic Dyneema® rope.

608851



3,500 LBS. WINCH

WITH DYNEEMA ROPE

Rated to pull 3,500 lbs. and comes equipped with Dyneema® rope, which is 15x stronger than steel. 2-stage, metal planetary gear system.

608703



2,500 LBS. WINCH

WITH DYNEEMA ROPE

Rated to pull 2,500 lbs. and comes equipped with Dyneema® rope, which is 15x stronger than steel. 2-stage, metal planetary gear system.

608701



5,000 LBS. WINCH

WITH WIRE CABLE

3-stage, metal-planetary gear system for fast line speed and includes 50 ft. wire cable.

608850



3,500 LBS. WINCH

WITH WIRE CABLE

Rated to pull 3,500 lbs. and equipped with a corded remote. 2-stage, metal planetary gear system.

608702



2,500 LBS. WINCH

WITH WIRE CABLE

Rated to pull 2,500 lbs. and equipped with a handlebar-mounted switch. 2-stage planetary gear system for fast line speed, 3hp motor with roller fairlead.

608700

UTV CABS



Featuring high-visibility, automotive-quality design, tough materials and fine craftsmanship, QuadBoss® Cabs are built for function and durability. Cabs do not need to be removed for trailering at highway speeds. All roofs are securely bolted to the chassis with the exception of the Polaris® XP 900, which easily installs with over-center, cam-lock quick-clamps. Most applications have gas-operated door struts as standard equipment, along with driver and passenger rearview mirrors.



UTV CAB HEATER

Easy to install, complete kit that taps into vehicle coolant system and has rear heater core.



ROOFS

Put a roof between you and the elements. Strong topside protection from sun, rain and dirt. Durable polyethylene with UV stabilizers. Molded-in drains allow water to run off. Molded-in cargo tray allows for extra storage on some models. Made in USA.



CARGO BED COVER

Durable polyethylene with UV stabilizers.

326779



UNIVERSAL ROOFS

Roofs with universal fit for all kinds of tough conditions.

WINDSHIELDS

Premium 0.177" thick, optically clear, polycarbonate material. Rubber-coated, stainless steel mount straps to attach to roll cage. Folding windshields are hinged for use in up or down position; toolless operation. Includes mounting hardware. Made in USA.

Folding Windshields
Half Windshields

WINDSHIELD REPLACEMENT HARDWARE

Hardware Mounting Kit

Replacement Strap



WIPER AND WASHER SET

Easy to install complete kit with the wiper and washer.

373966





UTILITY BOX

Lightweight and durable, the Utility Box is constructed of lightweight aluminum diamond plate that can take a beating and keep its contents protected. The aluminum one-piece tub and lid is designed to support heavy loads, absorb tool drops and prevent leakage. The patented, foam-filled lid creates a solid structure to prevent bending or warping and ensures easy opening and closing from either side.

157174

UTILITY BOX MOUNTS

Mounting hardware for Utility Box.

157179-157183



SIDE-MOUNTED UTILITY BOX

Easily reach your tools with the Side-Mounted Utility Box from QuadBoss®. Constructed from aluminum diamond plate, allowing it to take a beating and keep its contents protected. The aluminum one-piece tub and lid is designed to support heavy loads, absorb tool drops and prevent leakage. The patented foam-filled lid creates a solid structure to prevent bending or warping and ensures easy opening.

155311



RANGER BED BOX

Organize and secure equipment and supplies to maximize bed space. Quick-mount pegs allow for easy installation and removal to create multiple configurations, inside and outside the bed.

157304



RANGER CARGO BOX SET

Designed for maximum storage space with heavy-duty lid for extra durability. Sold in pairs. Made in USA.

157303

**NEW FOR
2020**



JOURNEY CARGO BOX

The QuadBoss® Journey Cargo Box is constructed from low density, polyethylene making it durable and lightweight. Lid and base are gasket sealed to protect stored items and dual black metal lockable latches. No tools or extra hardware needed.

270 liter dimensions: 35" L x 26" W x 19" H

275 liter dimensions: 42" L x 26" W x 16" H

270L 157285

275L 157286



EXPEDITION SERIES UTV CARGO BOX

Sized-right to provide convenient cargo storage in the bed of the UTV. The trunk lid opens 110° for easy access to gear. Secure extra items to the aluminum bar with bungee cords.

78L 157175

85L 157142

175L 157143



UTV UNIVERSAL FRONT RACK

Holds up to 80 lbs. of gear to increase carrying capacity. Wraparound front extensions keep cargo from sliding off. No drilling or modifications required. UTV specific mount sold separately. Made in USA.

568277

UTV FRONT RACK MOUNTS

UTV Front Rack sold separately. Model specific kits to install UTV Front Racks.



UTV LIGHT-DUTY CARGO NET

Ensure your cargo makes it safely to its destination with our UTV Light-Duty Cargo Net. 12 movable hooks for secure tie down. Light-duty, not recommended for securing heavy loads.

156628





NEW FOR
2020

REFLECTIVE SERIES REAR RACK BAGS

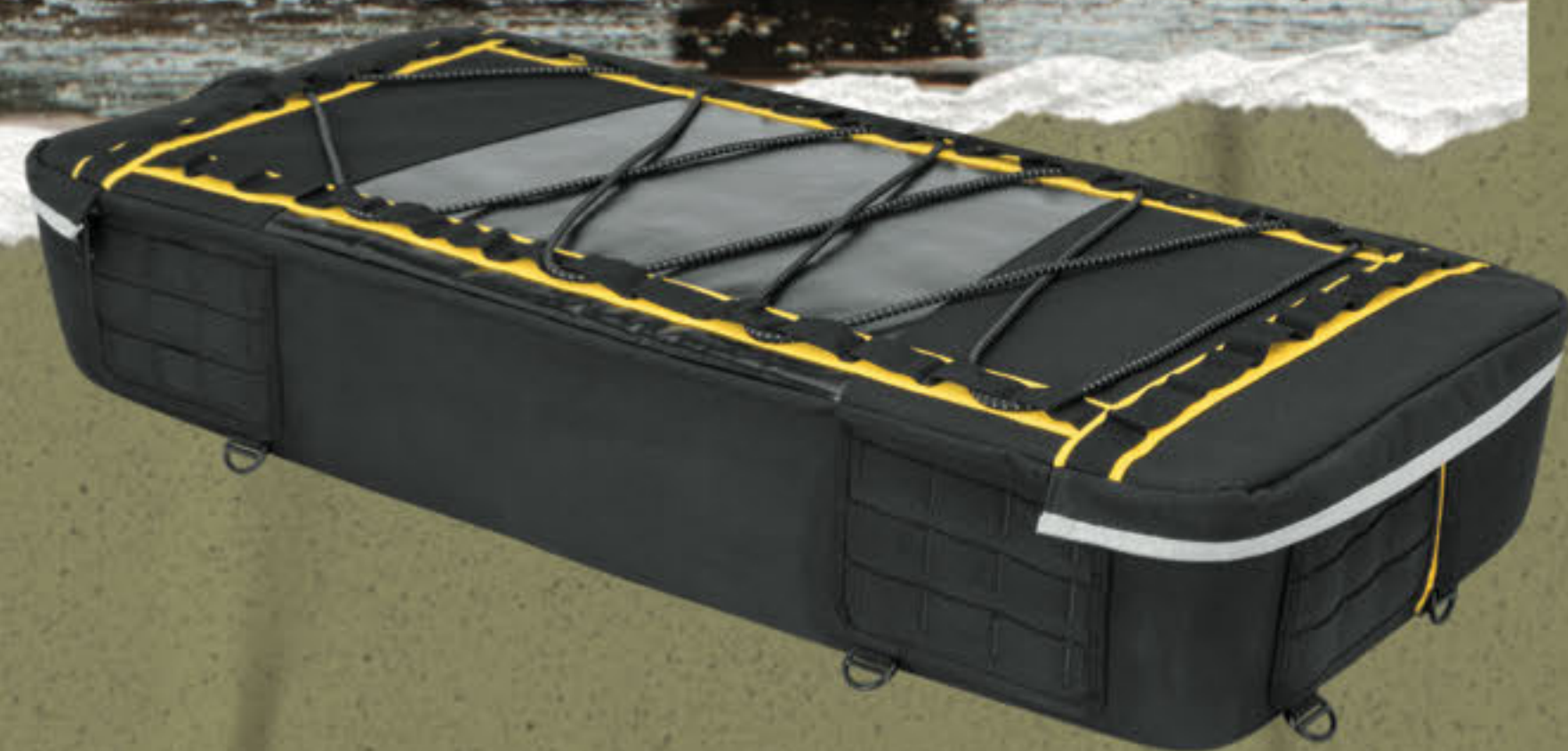

Built rugged and reinforced, the QuadBoss® Reflective Series Rear Rack Bag 2.0 is constructed with a 600-denier polyester body and weatherproof lids to protect against rain, dust, mud and snow. Features an EVA-molded foam bottom that can withstand the harshest conditions, abrasion-resistant protectors and a rigid design that holds its shape during packing or unpacking. D-ring tie-downs for easy installation, water-resistant and two stretch net pockets inside lid and zigzag bungee cord provides additional storage option on lid. MOLLE webbing attachment points to fit a variety of attachments.

156146

REFLECTIVE SERIES ATV MITTS

Rugged 600-denier polyester with reinforced corners. Deflects wind, rain, snow, brush and rocks. Hand warmer pocket to keep hands warm. One size fits most ATVs and sold in pairs.

156669



FRONT TRUNK

Lightweight and durable trunk with molded carrying handles; installs quickly with rubber cords. Tongue-and-groove lid system for secure closure and rotomolded for uniform thickness, strength and durability. Includes rubber cords.

156600



REAR LOUNGER

After a long ride, kick back in this lounger with a cushioned seat and padded arms and back.

157302



TRAVELER TRUNK

Take a break, lean back and relax for a while or grab the fishing rod and catch some dinner. Two lockable trunk compartments are large enough to pack an axe and store a small full-face helmet.

157050



REST-N-STORE REAR TRUNK

Lockable, dual compartments are large enough for full-face helmets.

156711



WEEKENDER TRUNK

Our biggest seat and storage system! Convenient compartments underneath each armrest and a middle compartment right-sized for a gas container.

157070



FRONT STORAGE BOX

Ample storage for a day's worth of supplies and equipment in one large trunk that easily mounts to ATV front rack. Double-wall lid provides extra rigidity. Weather-resistant, closed-cell foam gasket lid and constructed of durable, rotomolded linear low-density textured black polyethylene.

157300



REAR STORAGE BOX

Maximum storage space in a durable and rigid storage box. Lid features a weather-resistant, closed-cell foam gasket. Durable, rotomolded, linear low-density textured black polyethylene and easily mounts to ATV rack.

157301



UNIVERSAL MESH RACKS

QuadBoss® Universal Mesh Racks are constructed from heavy-duty, expanded steel mesh and reinforced with a 3/4", 16-gauge square steel frame that's ideal for transporting large, bulky items to meet your hard working needs. Powder-coated for a tough, durable finish with mounting hardware included.

Front 559448

Rear 559449



REAR RACKS FOR SPORT ATVS

Need some space for cargo? These racks will hold up to 50 lbs. of gear, and in most installs, do not require drilling or modifications. Choose your preferred rack size and appropriate mount kit with a black powder-coated finish.

Universal Rear Racks
Rear Rack Mount Kits



ADJUSTABLE FRONT AND REAR RACK EXTENSIONS

Two ways to adjust rack extensions; the unique, adjustable-width feature with spring-locking buttons to size for cargo load and the industry's first adjustable corner angle (up to 30°) to fit almost any ATV rack. Strong steel tubular construction with lasered-steel support plates.



CUSHIONED GUN AND BOW RACK

Nothing spoils a good hunt like a damaged gun or bow. Never let that be an issue with the Cushioned Gun and Bow Rack from QuadBoss®. Soft rubber teeth and "cushion" air pockets help provide superior shock absorption. Internal steel fork holds your heavier items. Easy-to-grip locking knobs allow for adjustment without tools. Master Blocks™ mounts attach to all ATV brands.

150727



FENDER PROTECTOR

Your first line of defense. Protect your favorite toy from scratches on the back fender. Installs only with luggage rack with several adjustments for easy installation. 1" tube for strength.

FENDER PROTECTOR REPLACEMENT FOOTPEG

563285



ATV LICENSE AND REGISTRATION KIT

Keep Rosco off your back. Convenient license and registration kit to ensure your ATV's paperwork is properly displayed.

211906-211907



ATV SAFETY EMBLEM

Break the rules, not the law. Keep your tail covered if you decide to go rogue. Mounts to rear cargo rack and chassis in seconds. Includes 14" impact-resistant reflective safety emblem and mounting hardware.

211908



2" ATV RECEIVER HITCH

Heavy-duty 1/4" steel, fixture welded for precise fit and a powder-coated for durability. Mounting hardware and instructions included.



ATV BACKREST

Heavy-duty, 2" thick cushion, covered with durable, wear-resistant polyester. Attaches quickly to your cargo rack with the included hardware and folds flat for safe trail riding. Sturdy, square tubular steel frame supports the soft, foam backrest. Fits metal or composite racks. One-year manufacturer's warranty.

565145

ATV SEAT COVERS

Preserve your asset with the QuadBoss® ATV seat cover. Keep your original seat clean and dry and protect it from dirt, sun and weather. UV-resistant fabric with PU backing for extra weather and abrasion protection. Elasticized hem and adjustable straps mean quick, easy and custom fit on most standard ATVs. Water-repellent for easy cleaning.

Black 156398





ATV SLIP-ON MUFFLER



Steel with a black finish, the QuadBoss® Slip-On Muffler can be directly installed on O.E.M. pipes with its special coupler; no gaskets needed. Equipped with a galvanized main tube and spark arrestor. All internal parts are fully welded. One-year manufacturer's warranty. Made in North America.

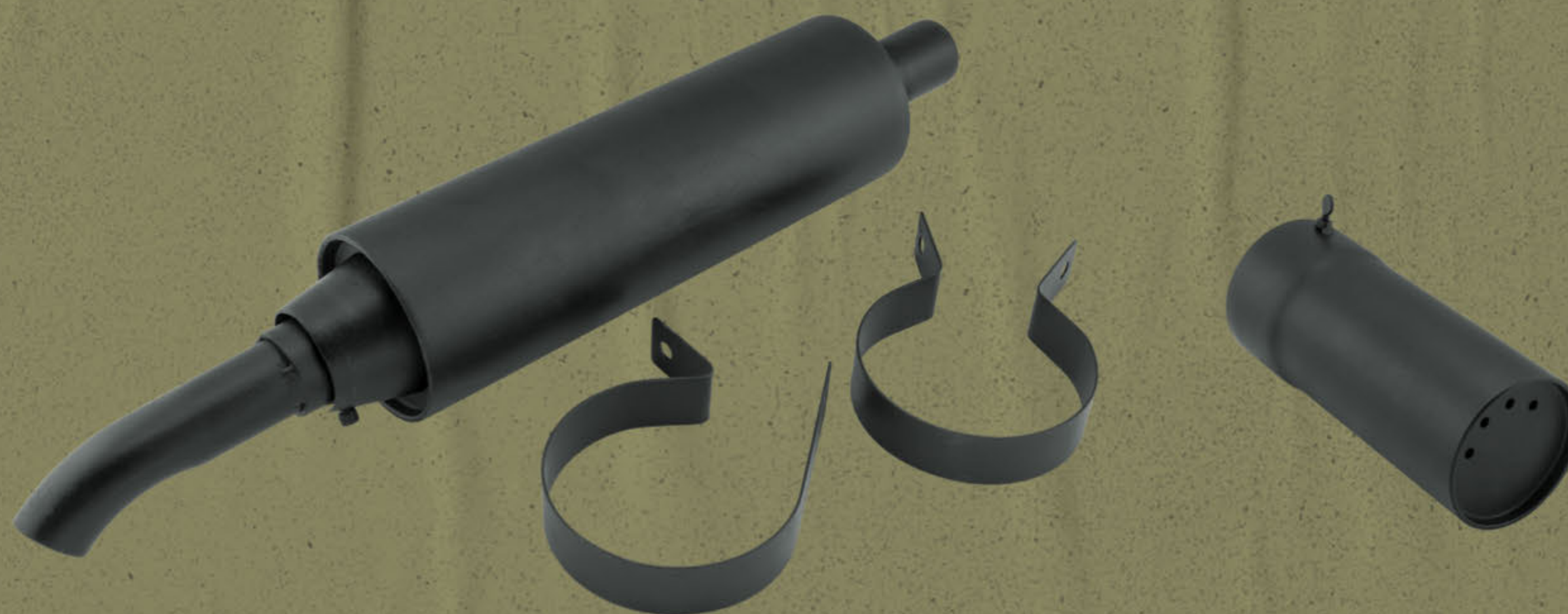

ATV UNIVERSAL SLIP-ON MUFFLER

This QuadBoss® Slip-On Muffler is steel and has a black finish. It can be directly installed on O.E.M. pipes with its special coupler; no gaskets needed. Equipped with a galvanized main tube and spark arrestor. All internal parts are fully welded. One-year manufacturer's warranty. Made in North America.

HUNTING MUFFLER END CAP

Easily installs on any QuadBoss® muffler, lowering the sound by 20 to 30 decibels quieter than stock.

157168

HEATED GRIPS WITH THUMB WARMER

Don't let cold weather force you inside. Five-level controller adjusts heat accurately to avoid uncomfortable temperatures. QuadBoss® heated grips with thumb warmer works on all thumb throttle models. Easy to install.

101920



HEATED GRIPS

The elegant, open-end grip design makes the QuadBoss® heated grip both stylish and functional. The highly efficient heating design delivers heat faster than traditional heated grips. Specially selected rubber materials resist the outdoor environment and provide a secure and comfortable grip. The five-level controller adjusts heat accurately to avoid uncomfortable temperatures. Even at high temperatures, the grip remains resistant to damage. Suitable for 12-Volt DC application only.

101921



QUICK-RELEASE WINDSHIELDS

On and off with ease. Protects you from the elements when you want it, removes in under 10 seconds with quick-release 1/4-turn fasteners when you don't.

QUICK-RELEASE WINDSHIELD REPLACEMENT HARDWARE

Easy push-and-turn function for speedy replacement. Includes four fasteners and four receptacles.

560186

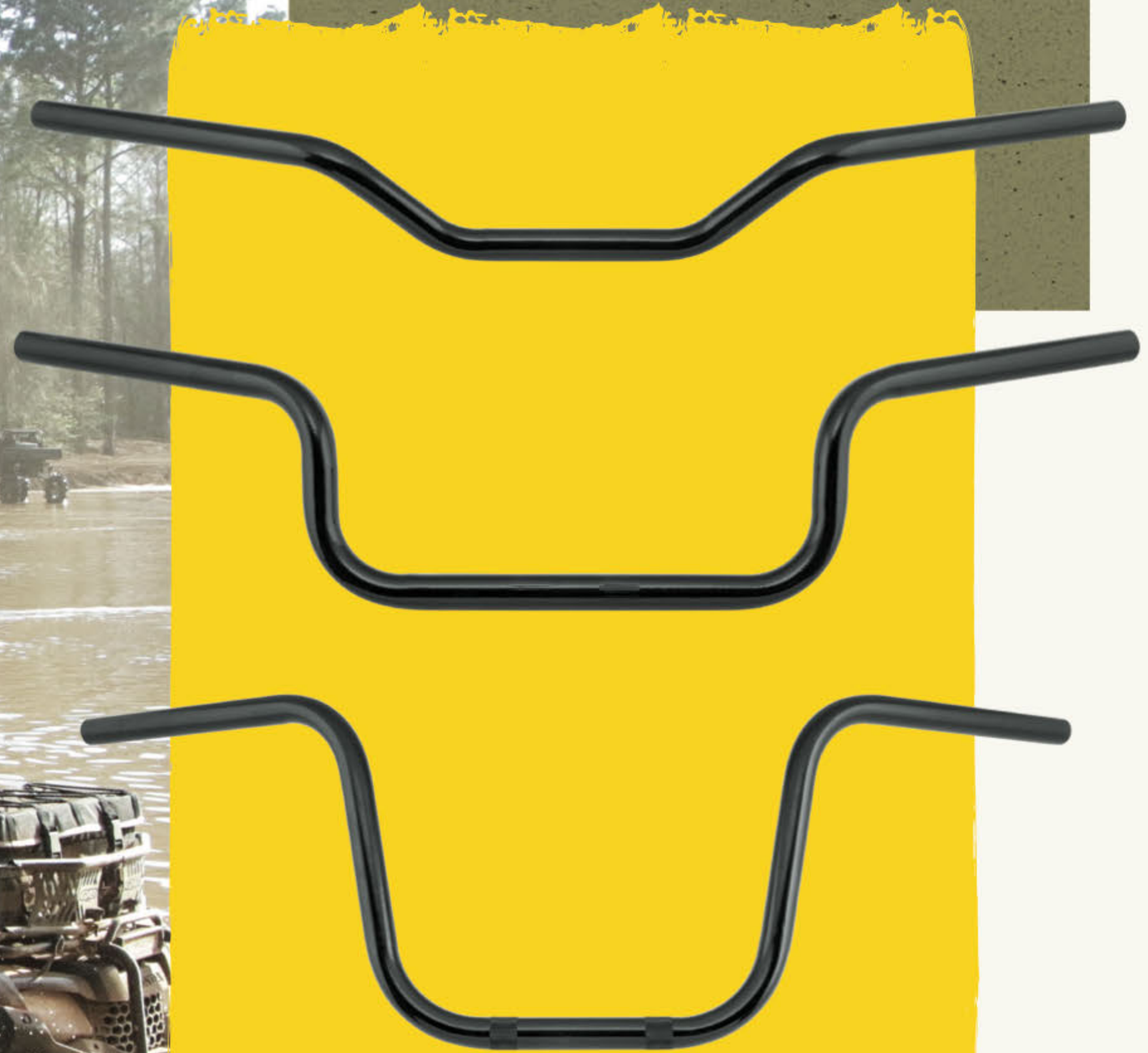

ATV O.E.M. REPLACEMENT HANDLEBARS

7/8" diameter with O.E.M. bends. Built from 14-gauge steel with a gloss black, powder-coated finish.

520055-520059



ECONOMY DUMP TRAILER

Durable 18-gauge bolt together cart body. Heavy-duty, 14-gauge steel undercarriage and drawbar.

566750



HEAVY-DUTY DUMP TRAILER

Durable 18-gauge welded cart body. Heavy-duty, 11-gauge steel undercarriage and drawbar.

566771



LARGE HEAVY-DUTY DUMP TRAILER

Durable 16-gauge welded cart body. Heavy-duty, 11-gauge steel undercarriage and drawbar.

566770



ULTIMATE POLY DUMP CART

Molded-in features include stake pockets, tie down bars, slots for load dividers, 2x4 cross member slots, ledge for adding shelf and holes on top for future attachments.

Poly Dump Cart 566772
Wood Side Panel Kit 566776



SWIVEL DUMP TRAILER

Structural foam cart body will not rust. Pass-through undercarriage provides a full 12" of ground clearance.

566775



ROUGH CUT MOWER

The ultimate time saver for mowing ditches, fence lines and fields. Designed to dramatically reduce mowing time and easily attaches to any ATV/UTV with a trailer hitch.



FINISH CUT MOWER

Triple blade for a manicured cut. Side discharge, true floating deck. Reduces scalping and also offsets to mow on either side. Guaranteed height select, which matches the exact cutting height of your rider.



25-GALLON BOOMLESS ATV SPRAYER

No need to lower any boom with this powerful sprayer. Corrosion-resistant polyethylene tank, 45 psi, 12-Volt with a 3.8 gallon per minute pump.

567177



15-GALLON SPOT SPRAYER

Get the work out of the way quickly, with this powerful and reliable sprayer.

567176





Heavy-duty all steel construction that's ideal for lifting offroad vehicles and farm equipment, up to 3,000 lbs. Can be utilized for winching, spreading and hoisting with an adjustable top clamp clevis.

581388



TOW STRAP

Breaking strength at 5,000 lbs. Steel shackle and mesh storage bag included. 12 ft. of 1" strap. Has closed loops at both ends.

156155



HEAVY-DUTY TOW STRAP

Whether work, play or rescue, this durable strap can pull you out of any situation. Tough polyester strap construction with a breaking strength of 10,000 lbs. 20 ft. of 2" strap with closed loop at both ends.

156156



WINCH ACCESSORY KIT

Get all of the winch accessories you need all in one package. Includes 8,000 lbs. snatch block, 1/2" D-shackle, 1" x 8' tree trunk protector and tool bag.

608894



WINCH BUMPER

Heavy-duty construction. Prevents the cable from breaking, by stopping the hook before it reaches the roller fairlead. Stops rattling noises by keeping the cable tight.

157158

HITCH ACCESSORIES

BALL MOUNT CONVERSION:

Converts ball mount to 2" square receiver
Rust-resistant, black powder-coated finish
Ground clearance not effected

EZ-HITCH ADAPTOR:

Converts 1-1/4" to popular 2" receiver opening
Rust-resistant, black powder-coated finish

EZ-HITCH BALL:

1-7/8" replacement ball for EZ-Hitch

Ball Replacement 411464

Hitch Adaptor 411465

Hitch Ball Mount 411466



TRAILER HITCH

Heavy-duty 1/4" steel. Fixture welded for precise fit. Powder-coated for durability.



THREE-WAY HITCH ADAPTOR

Allows both the use of a ball hitch and pin hitch and even tow straps. Install in the down position to lower your hitch height by 2" or reverse to raise your hitch height. Works with trailer balls that have 3/4" shank. Powder-coated steel.

566758



ATV/UTV HITCH

Designed for ATVs and UTVs to tow a variety of trailers without the need to change hitches. Fits most ATV/UTVs with factory receiver.

1-1/4" 411462

2" 411463

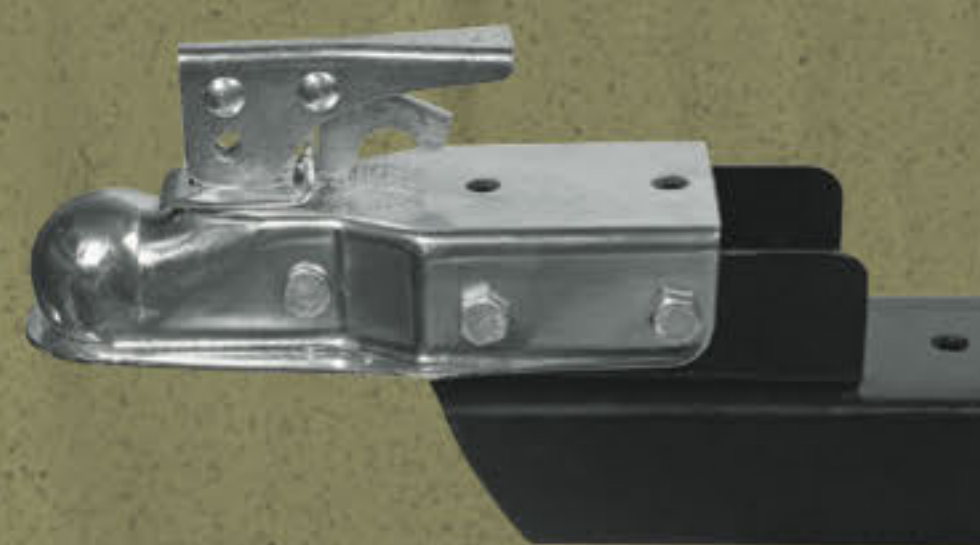

HITCH CONVERSION KIT

Since not all trailers are created equal, it's best to be prepared. Converts QuadBoss® ATV carts from pin hitch to a ball hitch. Comes complete with necessary hardware to bolt to cart drawbar. Comes with a one-year manufacturer's warranty.

Universal 566759



UTV WINCH MOUNTS

Mounts of heavy-gauge, laser-cut steel construction utilize multi-point frame mounting for superior strength. UTV mounts accept most winches up to 5,000 lbs. rating, including wide drum models. Durable black powder-coated finish.

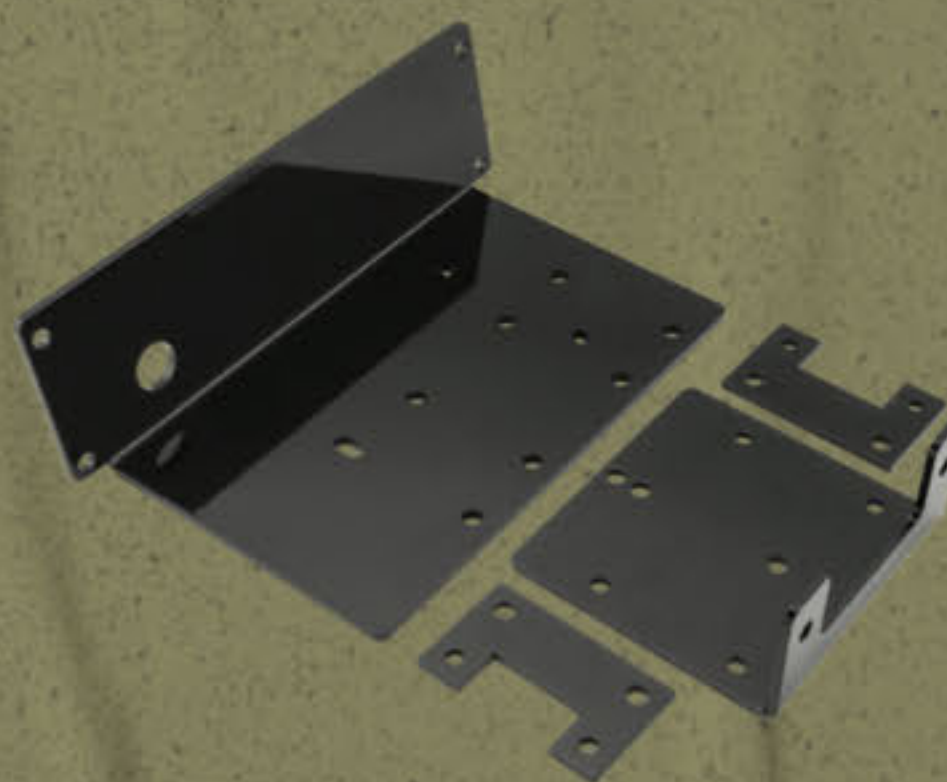

ATV WINCH MOUNTS

Make sure that winch doesn't leave you in the lurch with this durable and secure mount. Heavy-gauge, laser-cut steel construction and utilizes multipoint frame mounting for superior strength. ATV mounts accept most two- and four-bolt winches up to 3,500 lbs. rating.



REFLECTIVE SERIES DRINK TUBE

Secure storage for up to six drinks, even on rough trails. Convenient drink holder securely attaches to UTV roll cage and ATV racks with hook-and-loop straps. Holds six 12 oz. cans. Insulated with closed-cell foam and lined with nylon to keep drinks cold. Convenient handle and shoulder strap. Rugged 600-denier polyester body material. Colorfast, UV-resistant and water-repellent. Reflective trim.

156671



REFLECTIVE SERIES UTV DRINK HOLDER

Secure storage for drinks, even on rough trails. Convenient roll cage drink holder securely attaches to UTV roll cage with hook-and-loop straps. Holds a wide variety of drink bottles or cans. Insulated with closed-cell foam and lined with nylon to keep drinks cold or hot. Rugged 600-denier polyester body material. Colorfast, UV-resistant and water-repellent. Reflective trim.

156147



REFLECTIVE SERIES UTV GRAB HANDLE

Comfortable, molded ergonomic handle attaches to UTV roll cages with hook-and-loop straps. A great grip for lifting yourself into the UTV seat and hanging on during rough rides.

156148



REFLECTIVE SERIES DRINK HOLDER BACKPACK

Roll cage drink holder that folds out into a durable nylon backpack.

156674

FIRE EXTINGUISHER HOLDER

Adjustable hook-and-loop straps for a secure fit on multiple sizes of fire extinguishers. Secures to any size roll bar.

156149



UTV JUMP SEAT

Cushioned seat wrapped in 300-denier water-resistant nylon on a powder-coated steel frame with built-in safety belts. Easily installs on most UTVs using quick-detach brackets. Perfect for relaxing at the trail's end.

565146





SIDE VIEW MIRRORS

Highly adjustable, convex surface provides maximum wide-angle view and image stability. Flip-back, foldaway design prevents damage to mirror and housing. Low-profile mounting bracket minimizes interference with other attachments. High-impact housing resists damage. Sold in pairs.

1.75" Mount 570080
2" Mount 5570081
Polaris Pro Fit 570082

REAR VIEW MIRROR

Low-profile mounting bracket minimizes interference with other attachments. Includes shatter-resistant safety glass with convex surface for a wide-angle view and image stability. Adjustable mounting system provides maximum viewing range. Overall size: 10.2" x 3.9". Lifetime warranty.

1.75" Mount 570083
2" Mount 570084
Polaris Pro Fit 570085



UNIVERSAL REAR/ SIDE VIEW MIRROR

The most convenient way to add mirrors to your UTV. Simple clamp on system for easy installation. Shatterproof convex mirror is in a high-impact ABS housing for durability and safety. Now available for 1-3/4" or 2" roll cages.

570031-570032





V-BAR TIRE CHAIN

Sharp points on the V-bar results in superior traction!
Packaged in a plastic storage box. QuadBoss® recommends
using tire chain tensioners, P/N 563558 with this product.

8 V-Bars per row, Small 563554
9 V-Bars per row, Medium 563555
10 V-Bars per row, Large 563556
11 V-Bars per row, X-Large 563557

TIRE CHAIN TENSIONERS

Heavy-duty rubber with seven connection points, pulls
tire chains tight and even. Increases the life of tire chain.
QuadBoss® recommends using this product with V-Bar
Tire Chains to get the best performance and safety while
operating your ATV/UTV.

563558





RUGGED AXLES



Ride with confidence with QuadBoss Rugged Axles made from precision ground, high strength, Chromoly steel.



REPLACEMENT AXLES

High-strength, 40CR chromium bar that's precision-machined to match O.E.M. fitment specs. QuadBoss® Replacement Axles feature a laminate coating that resists rust and corrosion and neoprene boots to create a waterproof seal. Visit your dealer for fitment.



RAPID REPAIR CV BOOT

Expandable universal CV Boot that slides and expands over reusable cone tool for quick CV Boot replacement. Two clamping diameters ensure a good fit on most vehicles. Boot material stays flexible under extreme cold and hot temperatures. Save your expensive axles and carry a kit in your tool box as an inexpensive quick repair on the trail or in your garage.

CV Boot Kit 414177

CV Boot Kit XL 414244



CV BOOT KITS

Suitable for angles of today's ATVs and UTVs and easier to install than most O.E.M. boots. Kit includes one boot, two clamps and a 2 oz. package of grease. Lithium based Molybdenum grease insures lubrication for longer life.



CENTER CAPS

Enhance your wheels with these slick caps.

For Grinder, Blitz, Stryker, Slicer, Fury, Shocker and Boss Lock wheels 608532-608535



STANDARD LUG NUTS

You have beer nuts and peanuts, but none of those will ever be as important offroad as these durable lug nuts. Sold in pack of four.

608926-608933



SPLINE LUG NUTS

You have beer nuts and peanuts, but none of those will ever be as important offroad as these durable lug nuts. Sold in packs of 16.

608816-608819

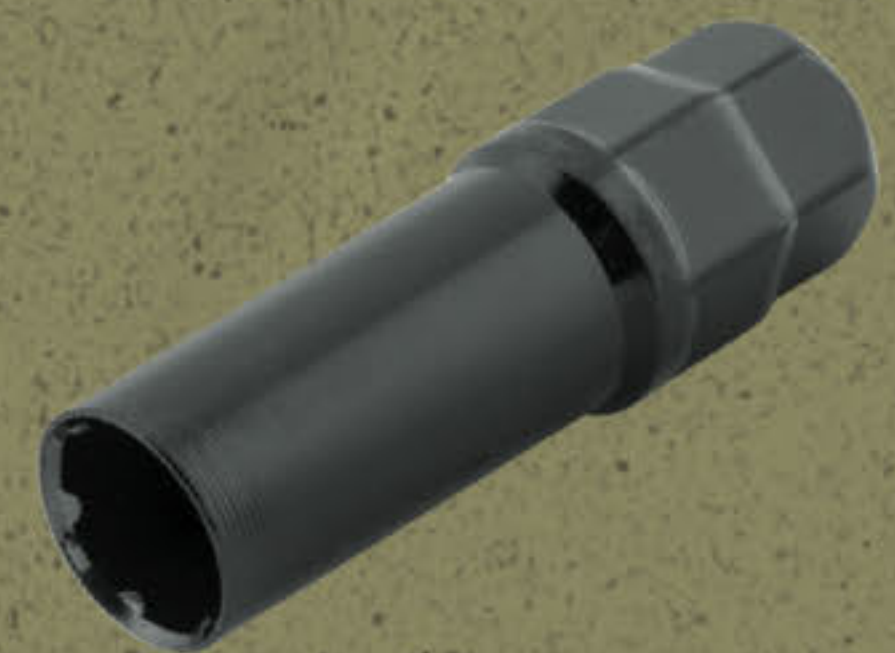

LUG NUT KEY

Key for QuadBoss® Lug Nuts.

608815



FRONT WHEEL STUD AND NUT KIT

Direct O.E.M. replacement with press-in wheel studs. Kit Includes studs and lug nuts.

608236-608286

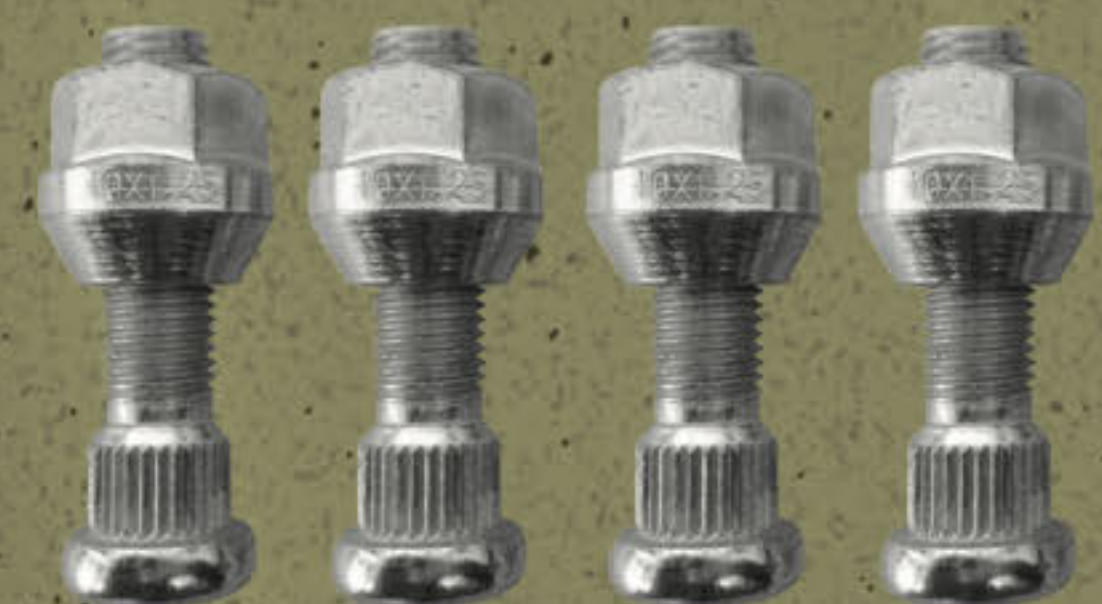

REPLACEMENT STUD KIT

For use with QuadBoss® Wheel Spacers.

563520-563523

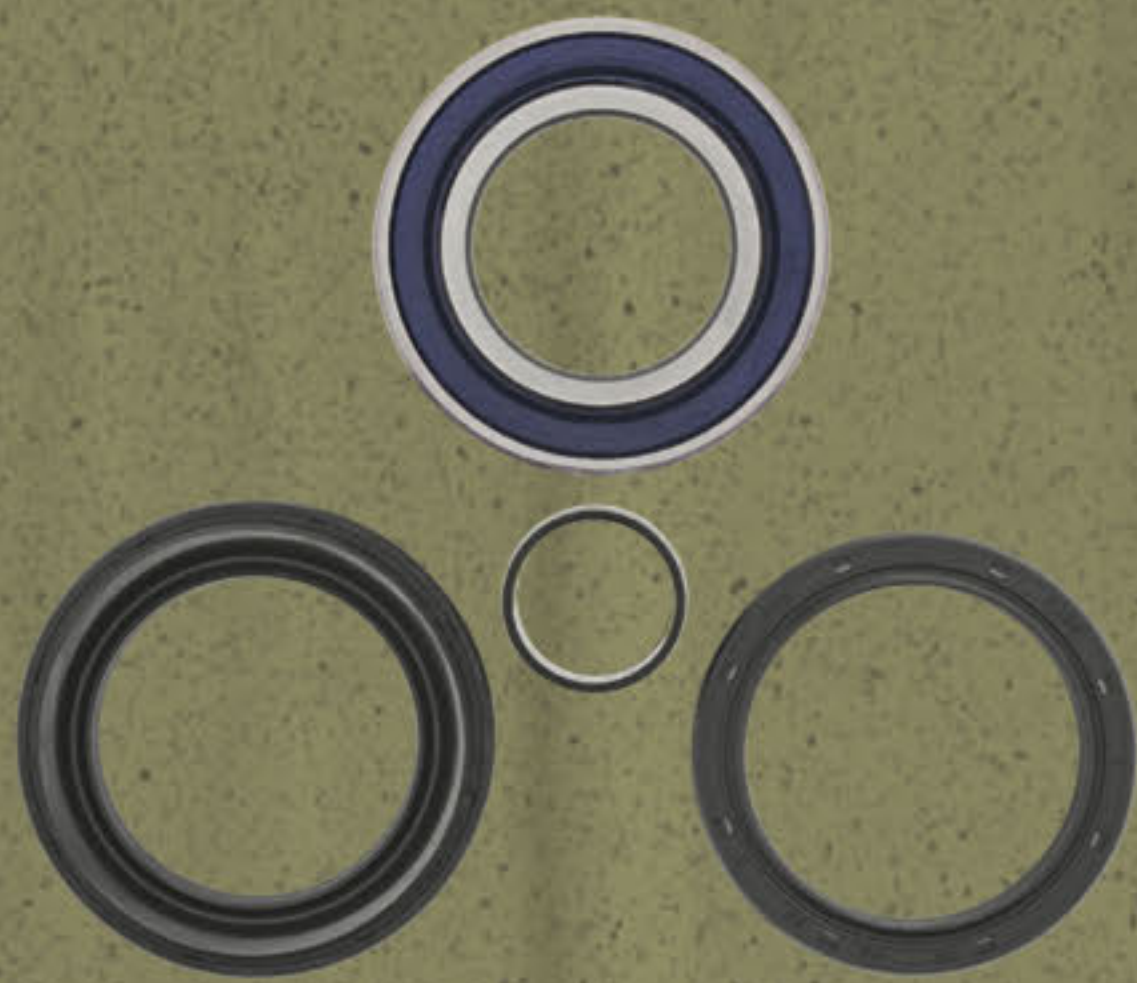

ATV WHEEL BEARING AND SEAL KITS

Contains all the bearings and seals required to refit a wheel. High-speed bearings are manufactured to ABEC 3 precision levels. Triple-lip rubber seals keep the grease in and the water and dirt out. Chevron SRI 2 grease contains rust and oxidation inhibitors (-29° C to 177° C). Double-lip® TC seals with stainless steel garter springs.

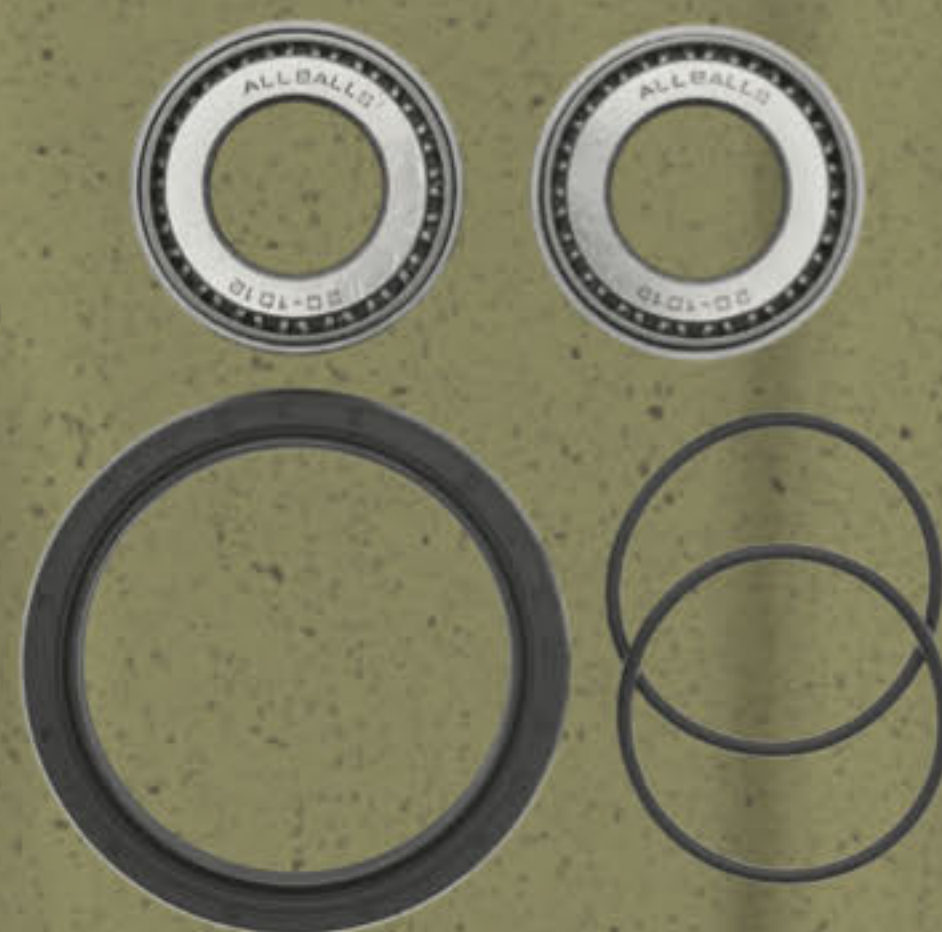

UTV WHEEL BEARING AND SEAL KITS

Contains all the bearings and seals required to re-fit a wheel. High-speed bearings are manufactured to ABEC 3 precision levels. Triple-lip rubber seals keep the grease in and the water and dirt out. For Polaris using a front strut, the wheel bearings, located in the wheel hub, rotate while in two-wheel drive mode. In four-wheel drive mode, a magnetic clutch is activated to engage the strut bearings, which are located in the strut tower. Chevron SRI 2 grease contains rust and oxidation inhibitors (-29° C to 177° C). Double-lip® TC seals with stainless steel garter springs.

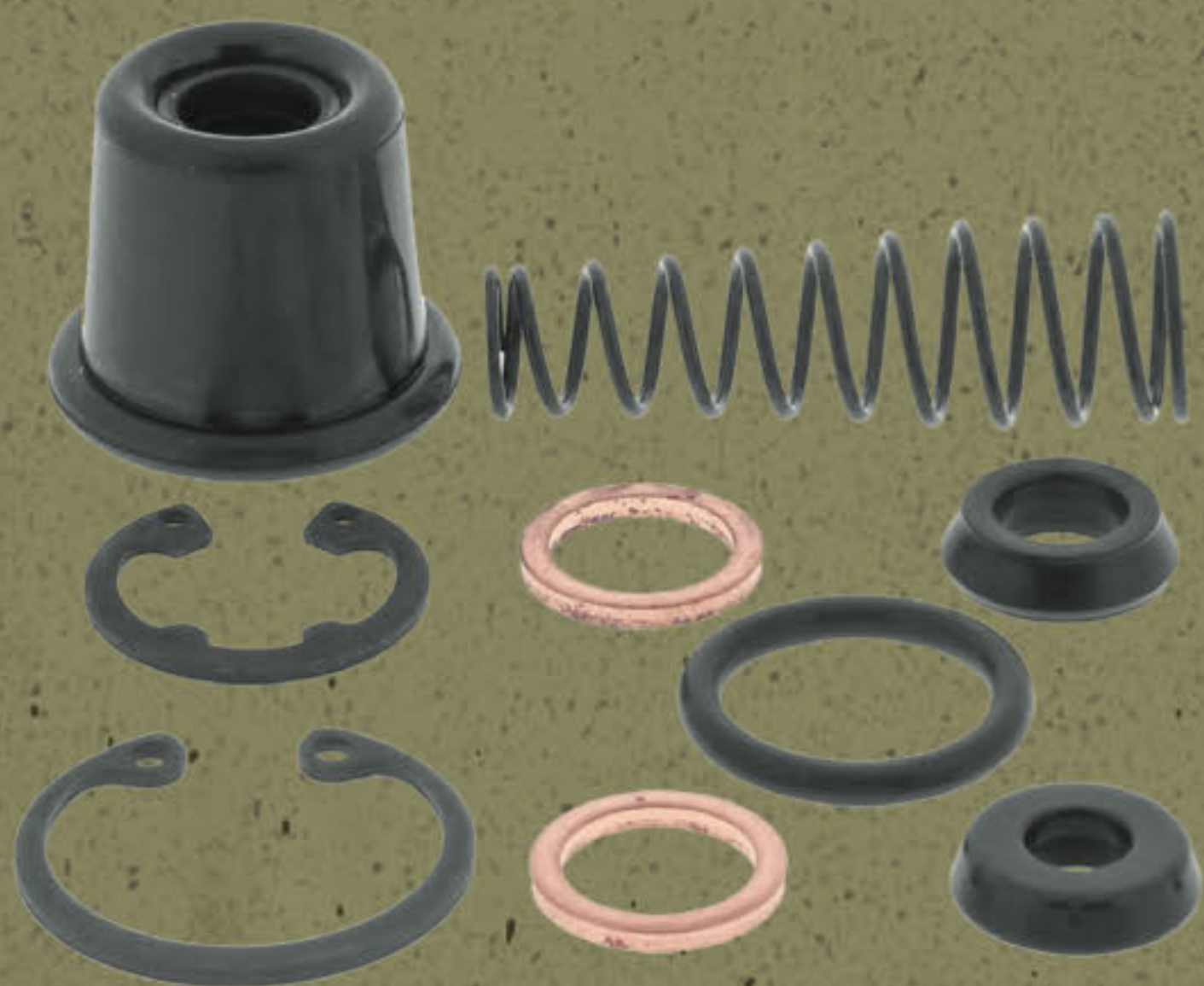

MASTER CYLINDER SEAL KITS

All the seals, O-rings and springs needed to reseal a master cylinder.



CALIPER REBUILD KIT

Each kit contains all rubber parts necessary to rebuild one caliper. Includes boots, seals, bleeder cap, brake pad retaining pins and copper washers.

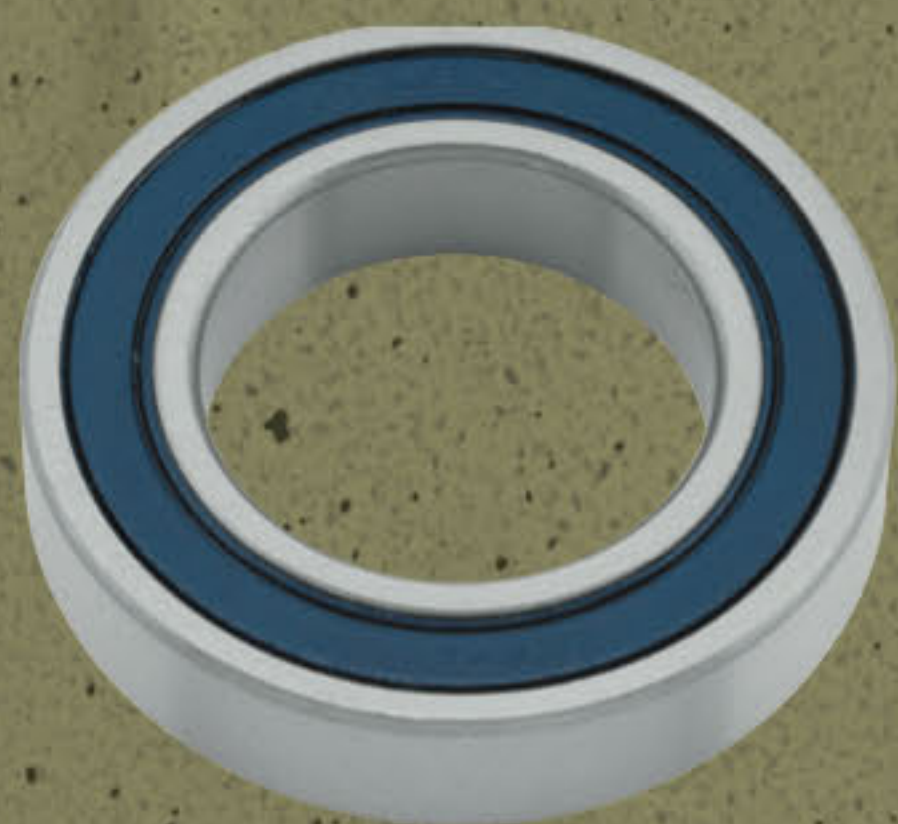

INDIVIDUAL WHEEL BEARINGS

High-speed bearings are manufactured to ABEC 3 precision levels. Triple-lip rubber seals keep the grease in and the water and dirt out. Chevron SRI 2 grease contains rust and oxidation inhibitors (-29° C to 177° C).



INDIVIDUAL WHEEL SEALS

Double-lip TC seals with stainless steel garter springs.



BRAKE DRUM SEAL KITS

Direct O.E.M. replacement seal. Protect expensive brake components and prolong shoe life by replacing seals.



DRIVE BELTS

QuadBoss® Drive Belts are a direct O.E.M. replacement that's engineered and designed for performance and reliability. Specially formulated rubber compounds and aramid cord provide strength and durability. One-year limited manufacturer's warranty. Made in USA.

CABLE ASSEMBLIES

Black PVC outer sheathing provides maximum flexibility and durability. Pre-stretched inner wire is flared out before the terminal end, and is cast for superior pull-out resistance. Molded-rubber components feature EPDM rubber for high UV-resistance and longer life. Rubber boots are designed with a tighter fit than O.E.M. for superior water and dirt resistance. Meets or exceeds O.E.M. standards.



CLUTCH CABLE



THROTTLE CABLE



REAR BRAKE CABLE

565200-565220



REAR HAND BRAKE CABLE



PARKING BRAKE CABLE

565255



FLAG AND FIBERGLASS ANTENNA

Ensure your crew will always know where to find you with this highly visible flag. High-visibility orange and includes mounting hardware.

156568, 156655, 156599



QUICK ATTACH FASTENER

The Quick Attach Fastener is designed to attach QuadBoss Front and Rear Trunks to the Polaris Lock & Ride® or Can-Am® LinQ ATV/UTV composite systems.

563466-563467



REPLACEMENT U-BOLT

563317

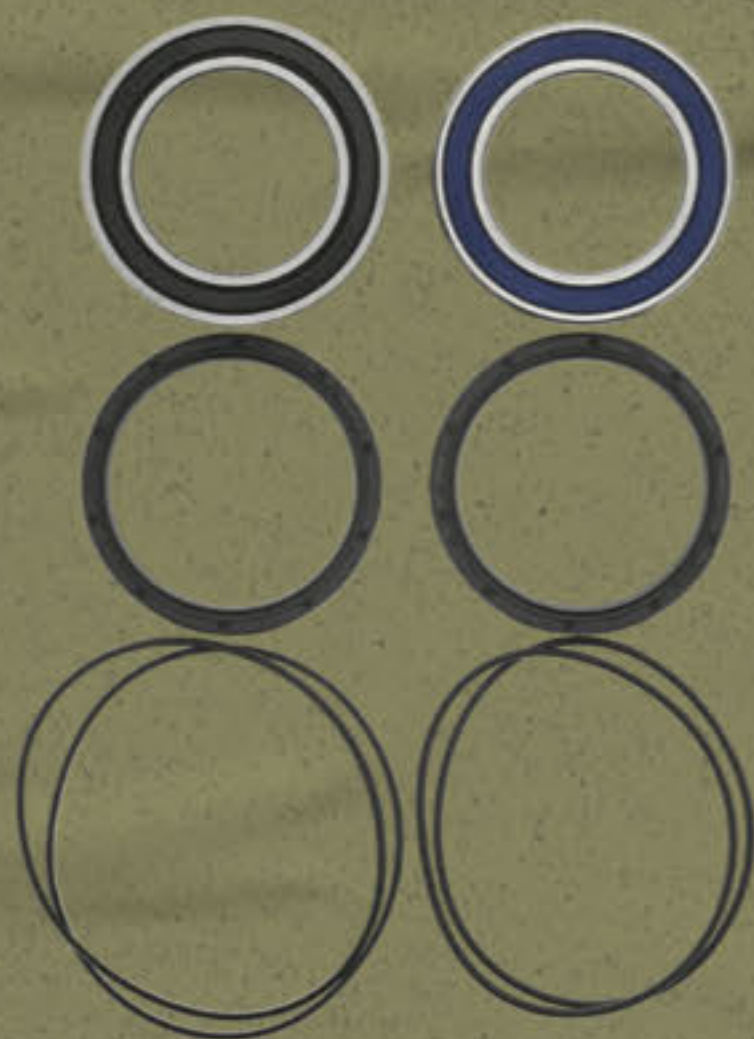

REAR CARRIER BEARING UPGRADE KIT FOR SPORT ATVS

Replace two side-by-side bearings with one double-wide angular contact bearing. Kits for all late 450cc sport ATVs. Increase bearing capacity and bearing life by 30%.

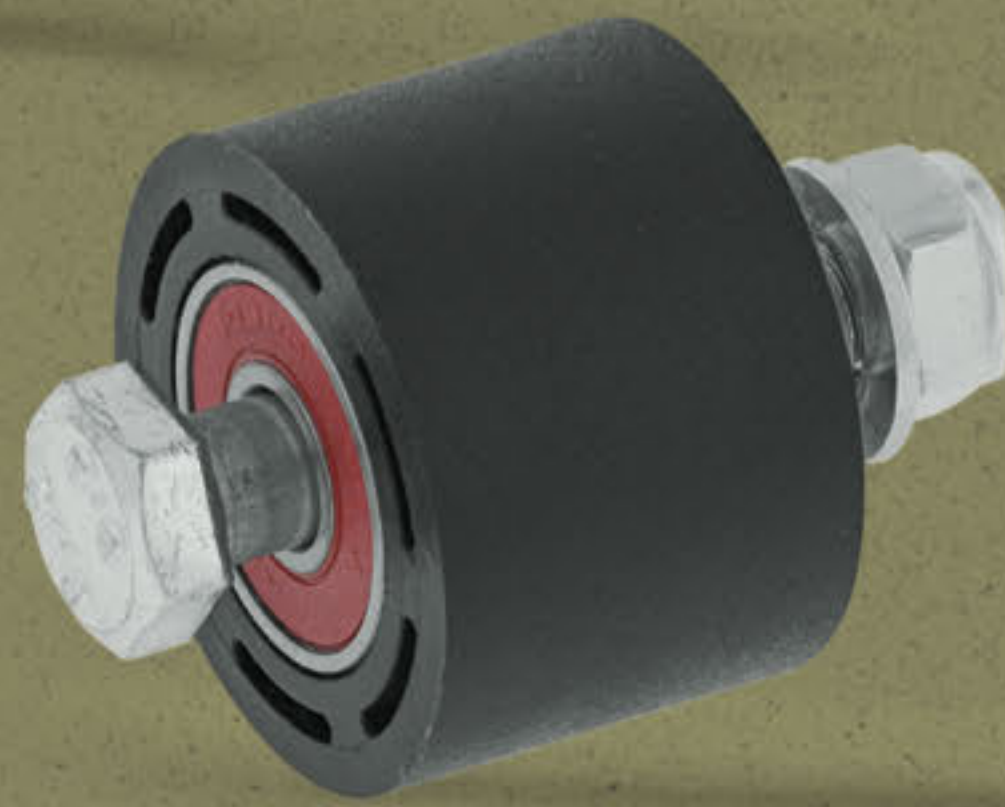

CHAIN ROLLERS

Direct O.E.M. replacement. Triple lip sealed ball bearings for superior dirt exclusion compared to O.E.M. bearings.

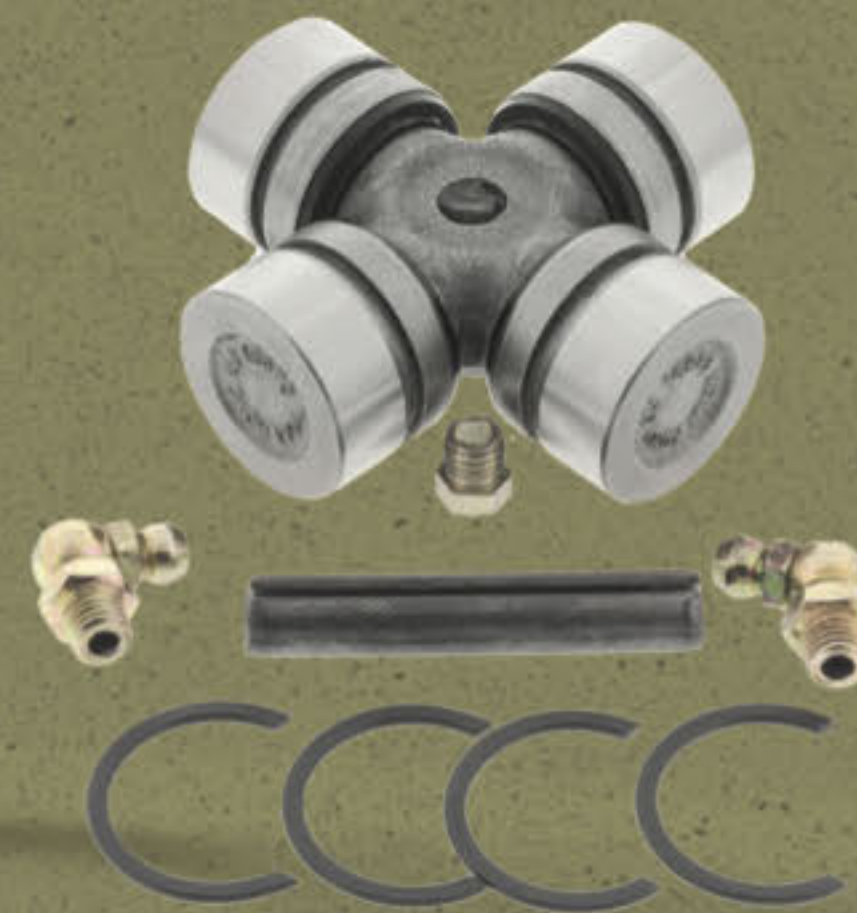

UNIVERSAL JOINTS

Heavy-duty construction for increased static strength and longer life. Precision-ground trunnion and bearing surfaces ensure trouble-free operation. Easy-to-lube during fitting and during the re-lube cycle.

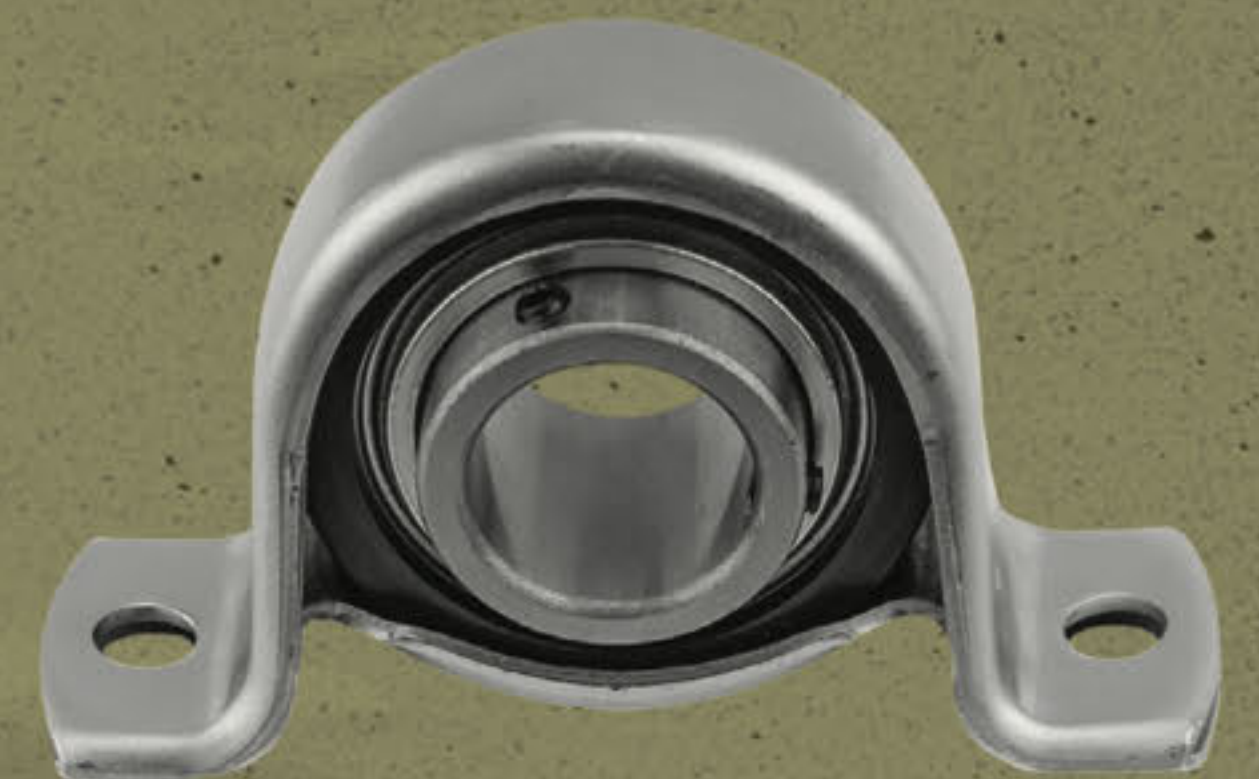

CENTER DRIVE SHAFT BEARINGS

More aggressive than the O.E.M. seals. Keeps dirt and water out of the bearing better than O.E.M. seals.



COUNTERSHAFT BUSHING AND SEAL KIT

Kit includes case-hardened bushing: stronger than O.E.M., replacement outer seal along with any O-rings, snap rings or lock washers required to complete the repair.



DIFFERENTIAL SEAL KITS

Kits contain the three outer case seals for repairing oil leaks.



DIFFERENTIAL BEARING AND SEAL KITS

Kit contains all of the bearings and seals required to service an ATV differential.

PERFORMANCE CLUTCH KITS

Designed to improve performance on or off the trails, without losing the reliability of your ATV. More efficient in transferring the power of your ATV down to the tires. Designed to improve low- and mid-range acceleration. Decreases belt slippage, which decreases clutch heat. Enhances back shifting and throttle response. Field-tested to assure your satisfaction. Designed for stock motor and stock exhaust.



SPORT UTILITY CLUTCH

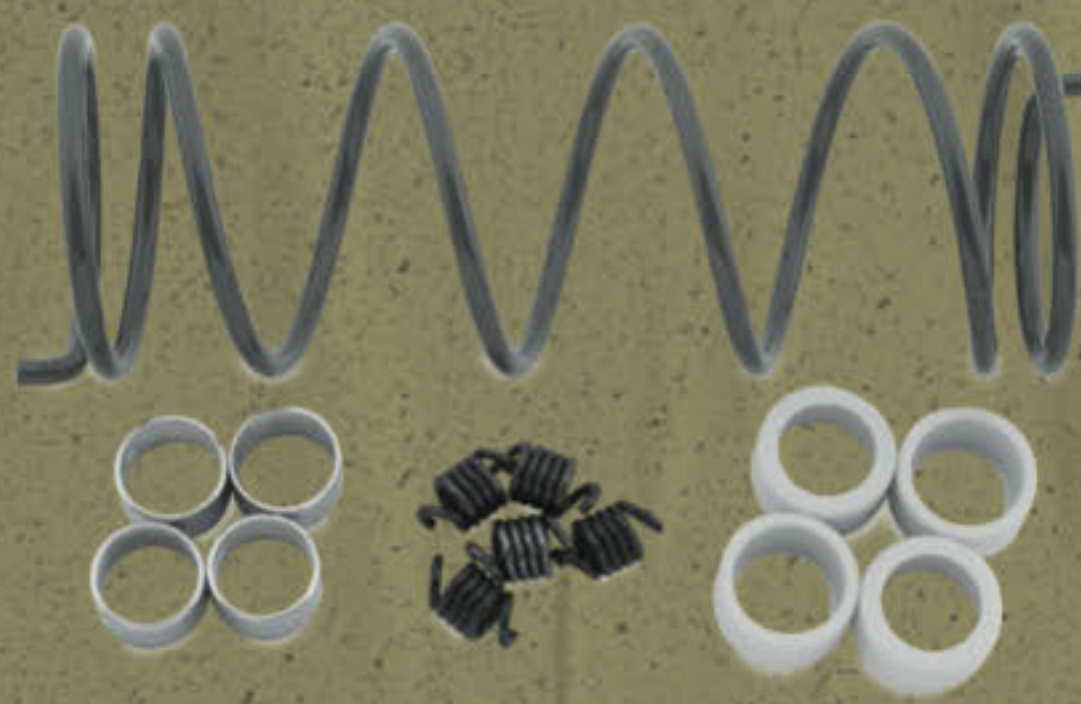

MUD CLUTCH

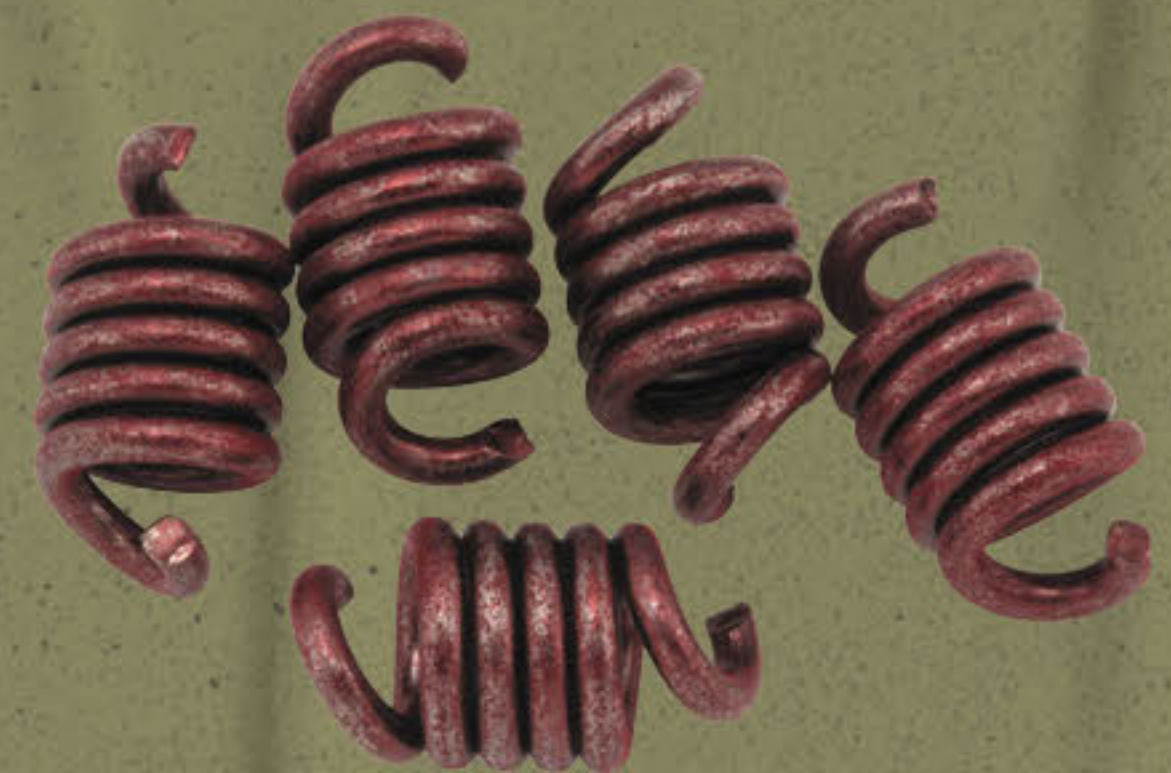

COMPETITION STALL



ECONOMY CLUTCH

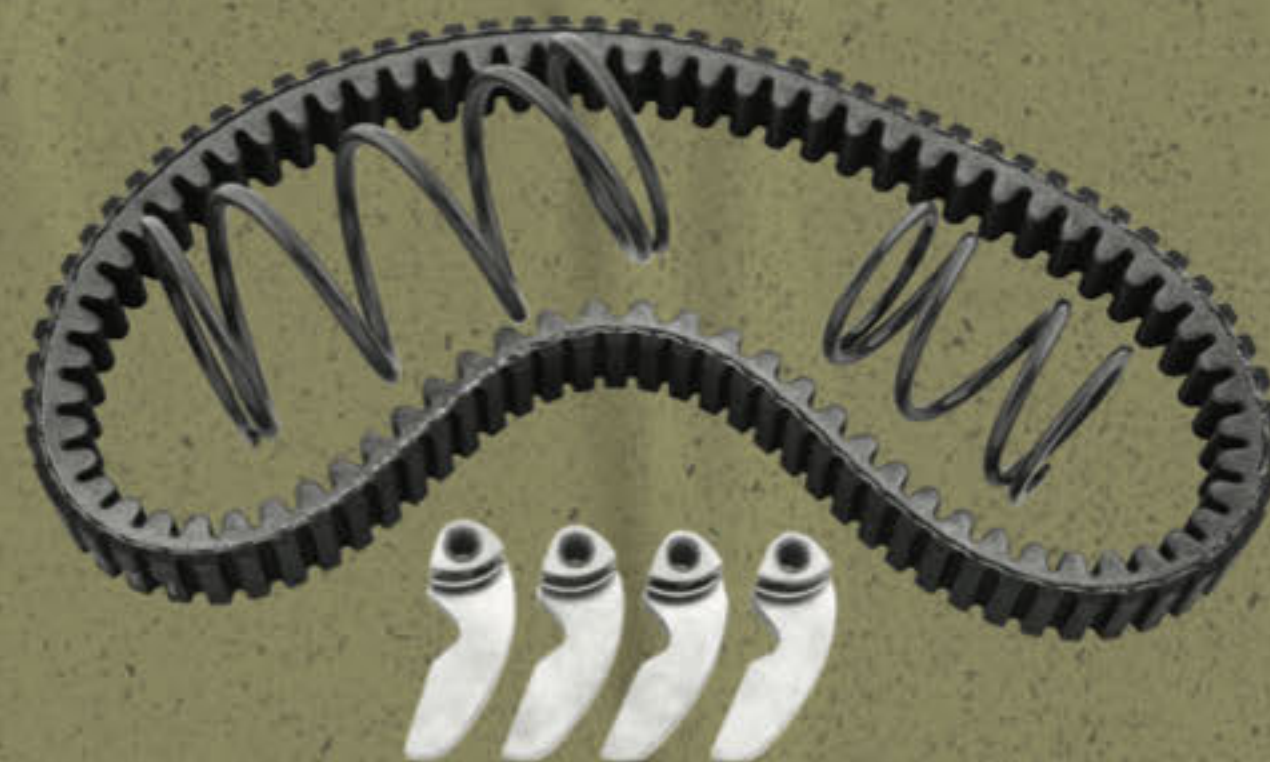

UTILITY CLUTCH



SAND DUNE CLUTCH

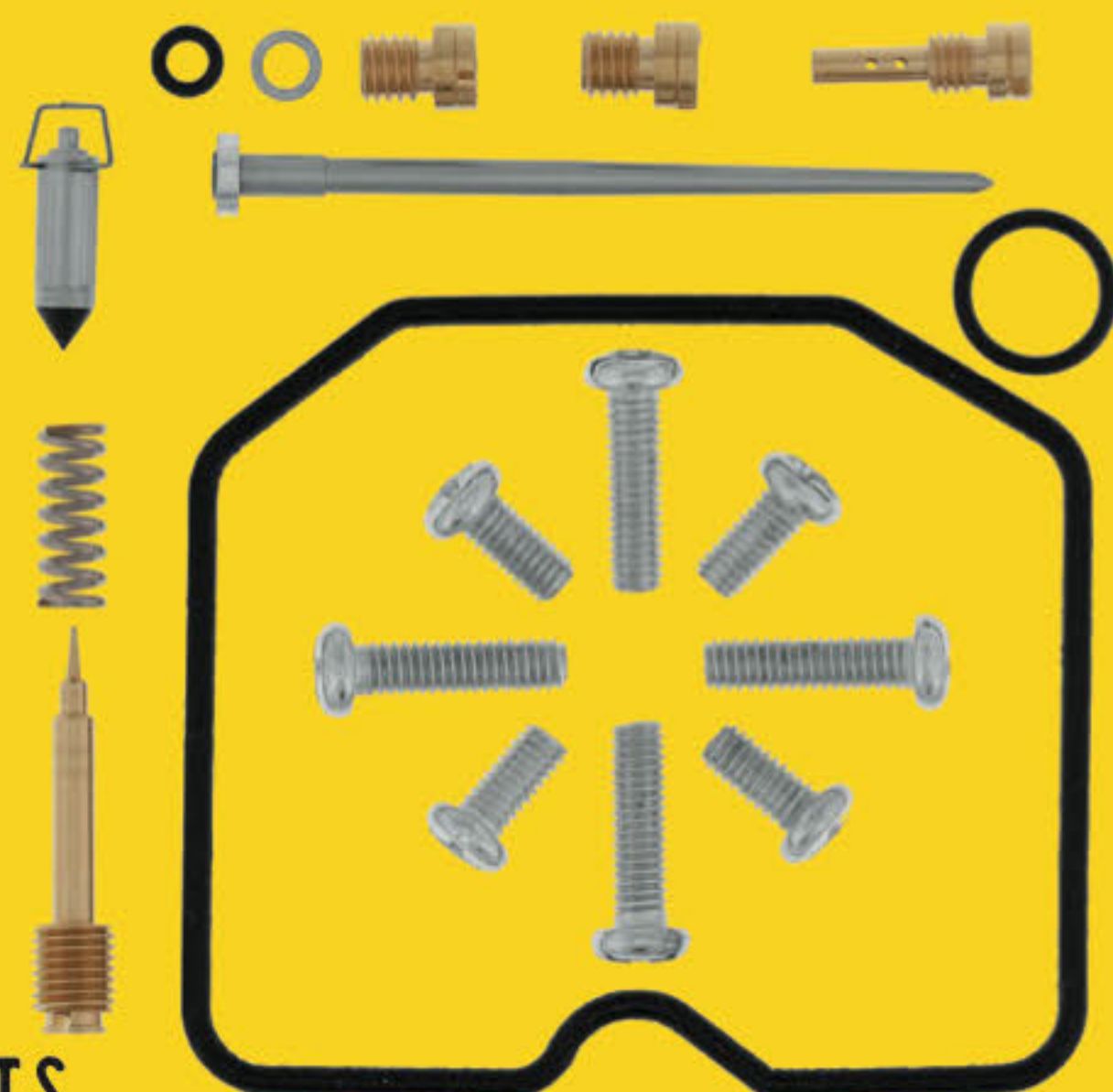

CARBURETOR KITS

Kits include all necessary components to repair carburetor; models with two carburetors include components to repair both carburetors. Components included in the kits are based off of US models and discretion must be used when attempting to install the kit on a non-US model.



ONE WAY CLUTCH BEARING KIT

Stock bearings are sealed on the outside only, providing minimum protection. Our Clutch Bearing Kit includes double-sided bearings and eliminates grinding during gear shifting from forward to reverse.

411171-411172

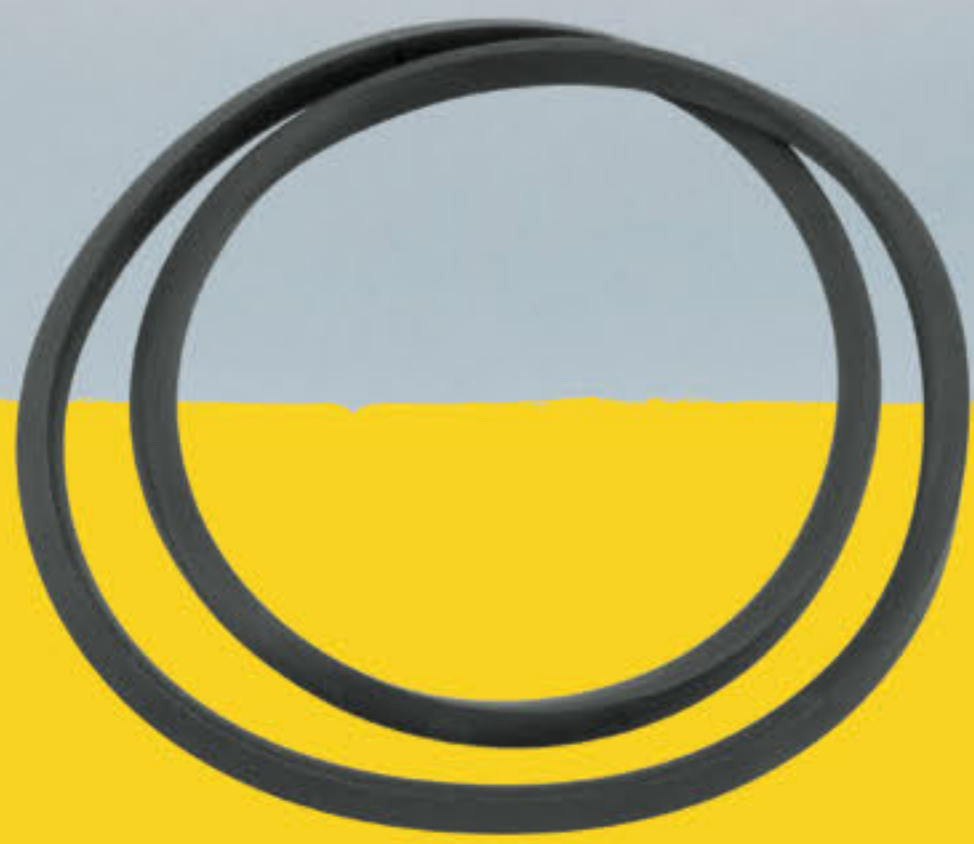

COMPLETE GASKET SET WITH OIL SEALS

Set includes all gaskets and oil seals necessary to rebuild the engine and transmission, including output shaft, water pump, clutch, shift and starter seals.

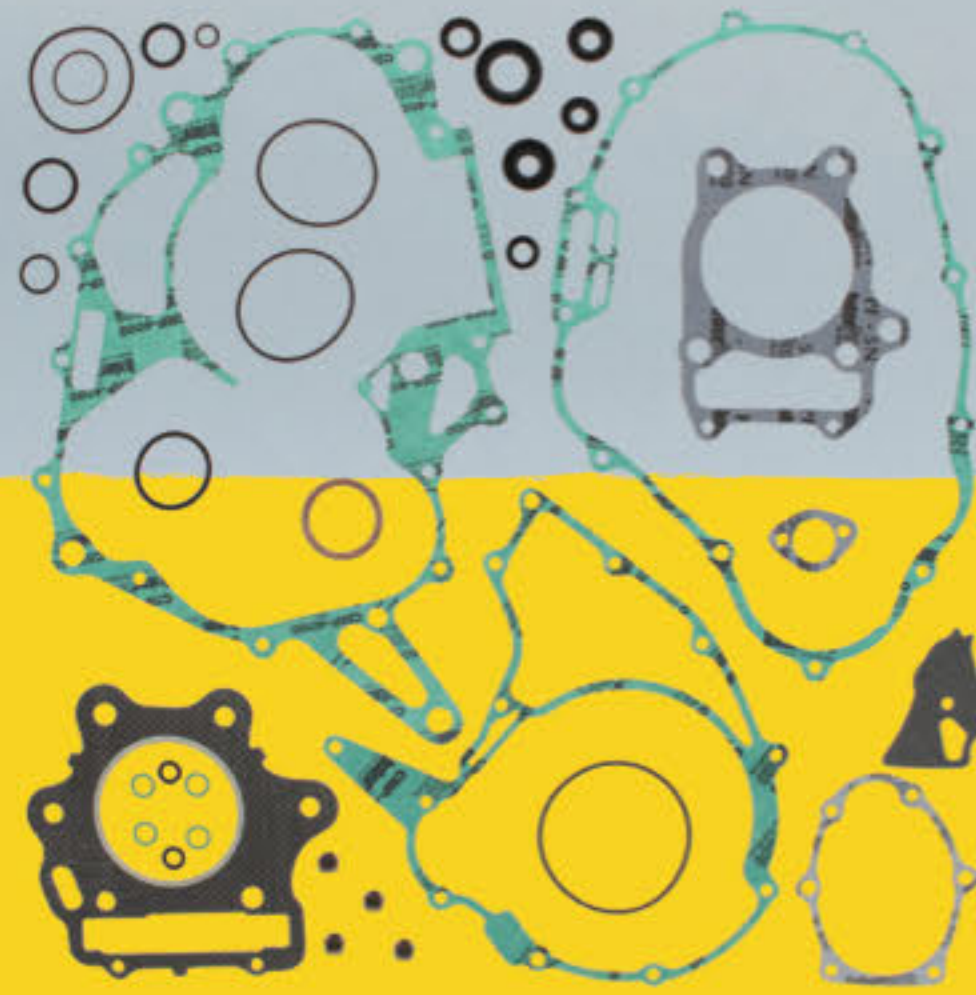

CLUTCH COVER GASKET

Replaces O.E.M. foam cover gasket. O.E.M.-quality replacement part.



OIL SEAL SET

Includes all oil seals necessary to rebuild the engine and transmission including crankshaft, output shaft, water pump, clutch, shift and starter seals.

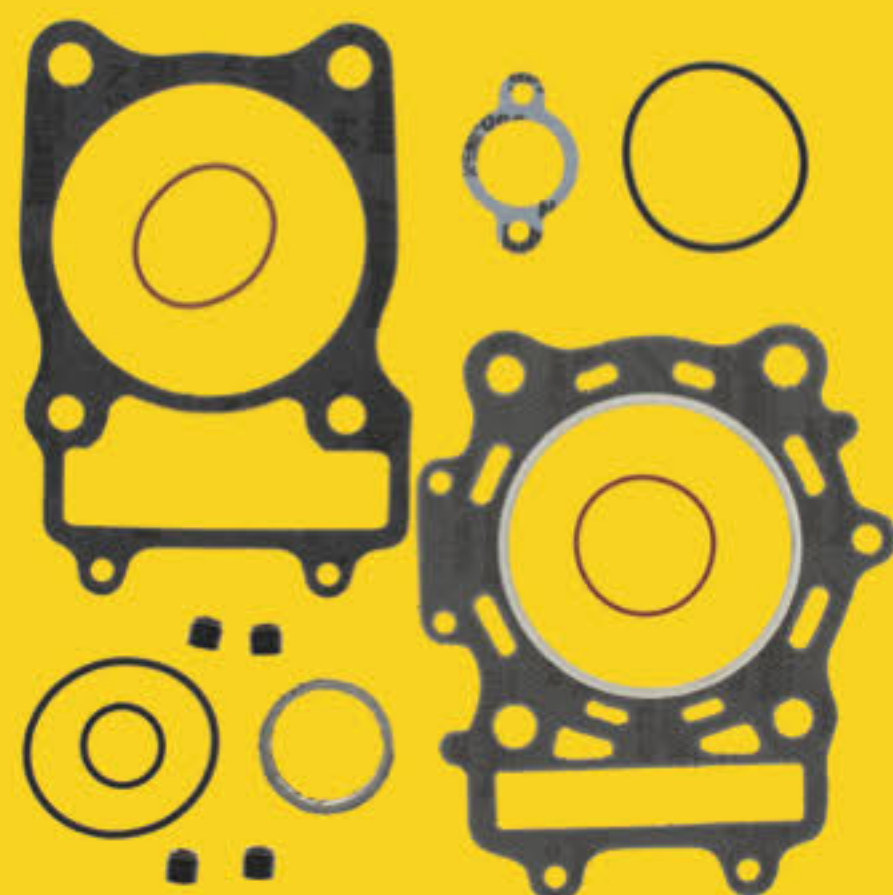

TOP END GASKET SET

Piston sets designed for piston replacement.

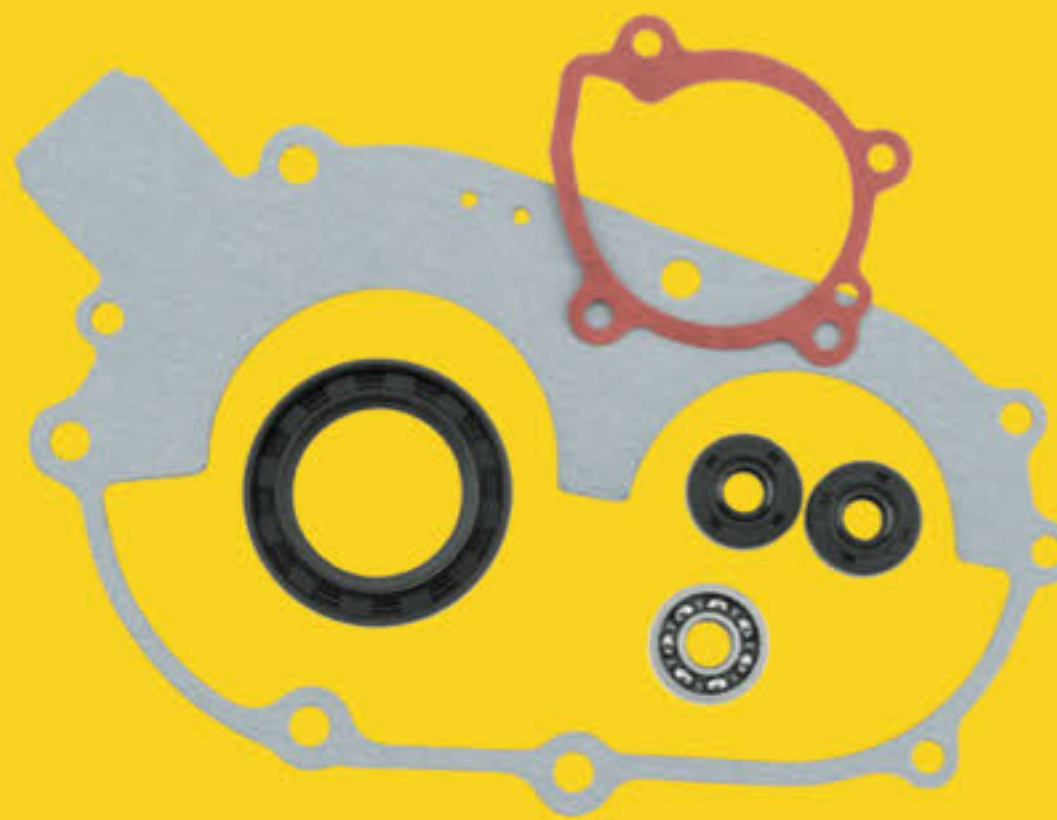

WATER PUMP REBUILD KIT

Includes all necessary hardware to rebuild one water pump.



CRANKSHAFT BEARING AND SEAL KITS

Koyo® precision crank bearings. Double-lip seals with PTFE contact area tolerates dry start conditions with less crankshaft pin wear.



EXHAUST GASKET KITS

Two stroke kits include all applicable O-rings, springs, washers and gaskets. Four stroke kits include the exhaust gasket. Multi-cylinder applications include enough items for the entire machine. Polaris® kits include gasket, both header donuts and springs.

568924-568968



WATER PUMP MECHANICAL SEALS

The QuadBoss® Water Pump Mechanical Seals are direct O.E.M. replacements at a fraction of the cost. Features high-quality seal face material that performs better, combined with corrosion and chemical-resistant materials that keep the engine cleaner, safer and cooler. Meets or exceeds O.E.M. specifications.

566601-566609

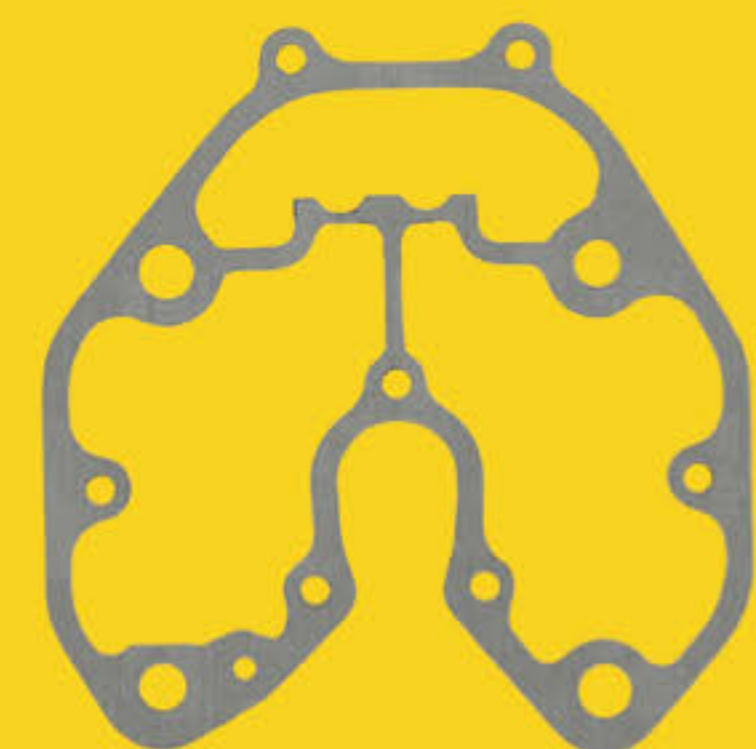

VALVE COVER GASKETS

QuadBoss® Valve Cover Gaskets are made from superior materials, designed to match O.E.M. valve cover specifications preventing leaks and lasting longer, when compared to stock covers. High compressibility allows for tight seal, even on worn and irregular surfaces.



BATTERY ISOLATOR KIT

Designed for dual battery systems. Connects between batteries only, no alternator or ignition connection needed. Protects electronics during start up and saves charge on your starting battery when using electrical accessories.

608822



BUS BAR

The QuadBoss® Bus Bar alleviates multiple connections to battery terminals by allowing you to connect various power accessories. Bus material is made of tin-plated solid copper for maximum conductivity and resistance to corrosion.

568102



CDI BOXES

Unleash the power. These CDI Boxes are designed to enhance overall 4-wheeler performance. Includes duplication circuits for maximum reliability, increased RPM redline and altered ignition advance curves. Comes with altered advance curves to increase performance throughout the RPM range.

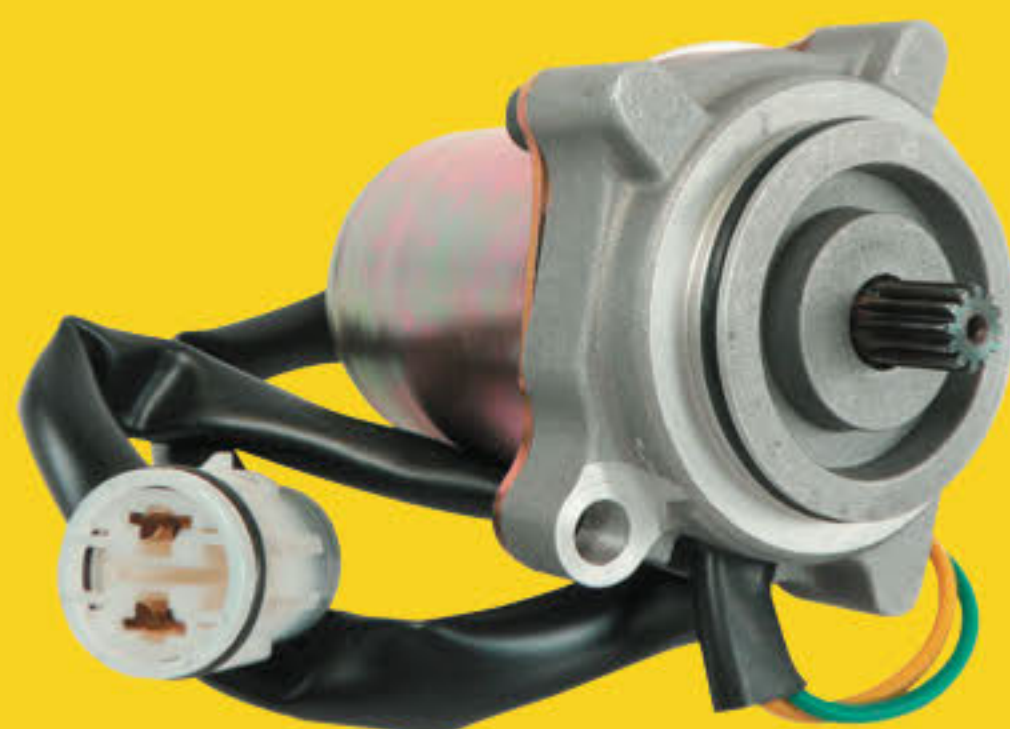

SHIFT CONTROL MOTORS

This direct O.E.M. replacement will get precise shifting action back to your machine at a fraction of the cost. Fully sealed construction for long life in harsh conditions. Plug-and-play connectors a direct fit to O.E.M. harness.



VOLTAGE REGULATORS

These voltage regulators are designed to handle increased power loads and keep your voltage strong and steady. Designed to meet or exceed original equipment. Includes O.E.M.-style connectors and stock mounting locations.



IGNITION COILS

Put the punch back in your spark. A new Ignition Coil can restore lost power or fix a weak or no spark issue.



ALTERNATORS

Get charged up. Keep your battery charged and ready to go with a steady supply of power from these Alternators. O.E.M.-style connectors with stock mounting locations. Designed to meet or exceed original equipment specifications.



UNIVERSAL SOLENOID SWITCHES

The easiest hook-up ever. These Universal Solenoid Switches come with multiple connections, which makes them easy-to-install.

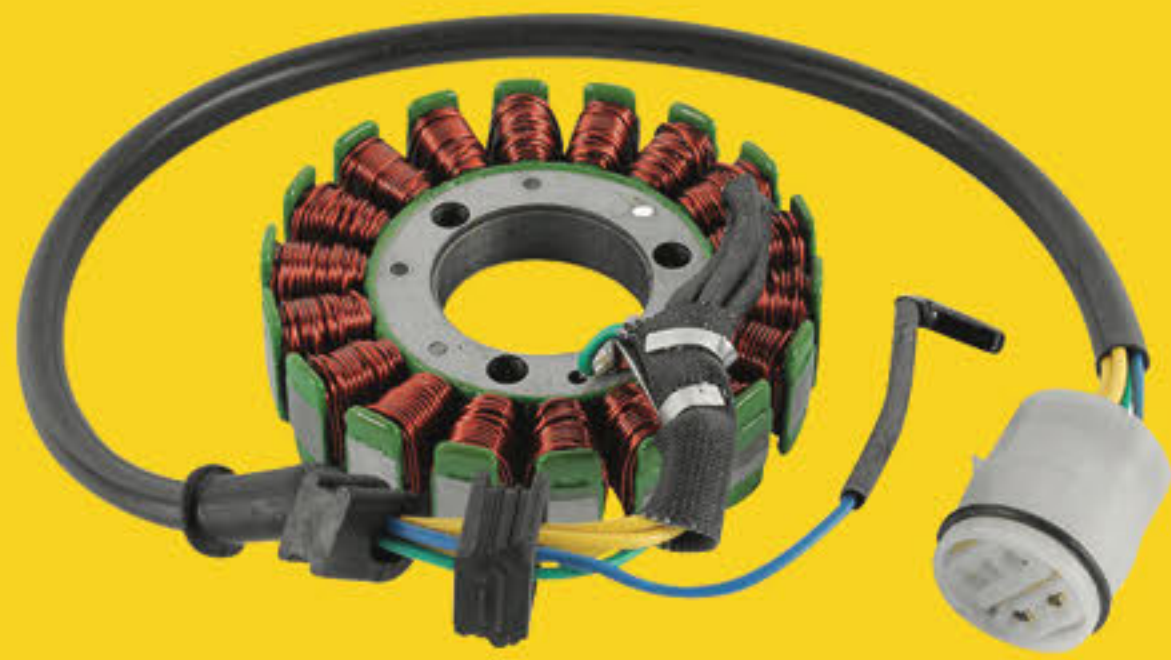

STATORS

A good stator will spark a strong start-up and keep your engine running smoothly. O.E.M.-style connectors with stock mounting locations. Designed to meet or exceed original equipment specification.



STARTERS

Keep your Quad humming and wheels turning with a powerful and reliable starter.



STARTER CLUTCHES

Don't be sidelined by a worn clutch. Restore full torque to the starter system for reliable starts every time. Meets or exceeds original manufacturer's specifications. 100% O.E.M. interchangeable; no modifications needed for installation.



STARTER SOLENOIDS AND RELAYS

It's time to get started. These solenoids and relays offer maximum magnetic pull strength for reliable starts, longer life and reduced voltage drop. Plated brackets and canisters to eliminate corrosion.



ATV AND UTV COOLING FAN ASSEMBLIES

No need to get overheated. Our cooling fan assemblies will keep your engine cool when the ride heats up.



FAN MOTOR ONLY

Nonstop cooling. A strong fan motor will help your engine stay cool. A direct O.E.M. replacement.



FAN BLADE ONLY

Don't lose your cool. If a rock or crash damages a fan blade, just swap it out and get back to riding. A direct O.E.M. replacement.



SHIFT ANGLE SENSOR

Direct O.E.M. replacement. Replaces the most common cause of shifting issues. Rubber o-ring included.

402294





LINKAGE REPAIR KITS

An offroad vehicle is only as good as its weakest link. Make sure that never becomes an issue with this kit. Kit contains all of the components required to properly rebuild the linkage bearing assembly. Needle bearing shafts are made with 52100 bearing steel that has been hardened and precision ground. All metal bushings are case-hardened and plated to prevent wear and corrosion.

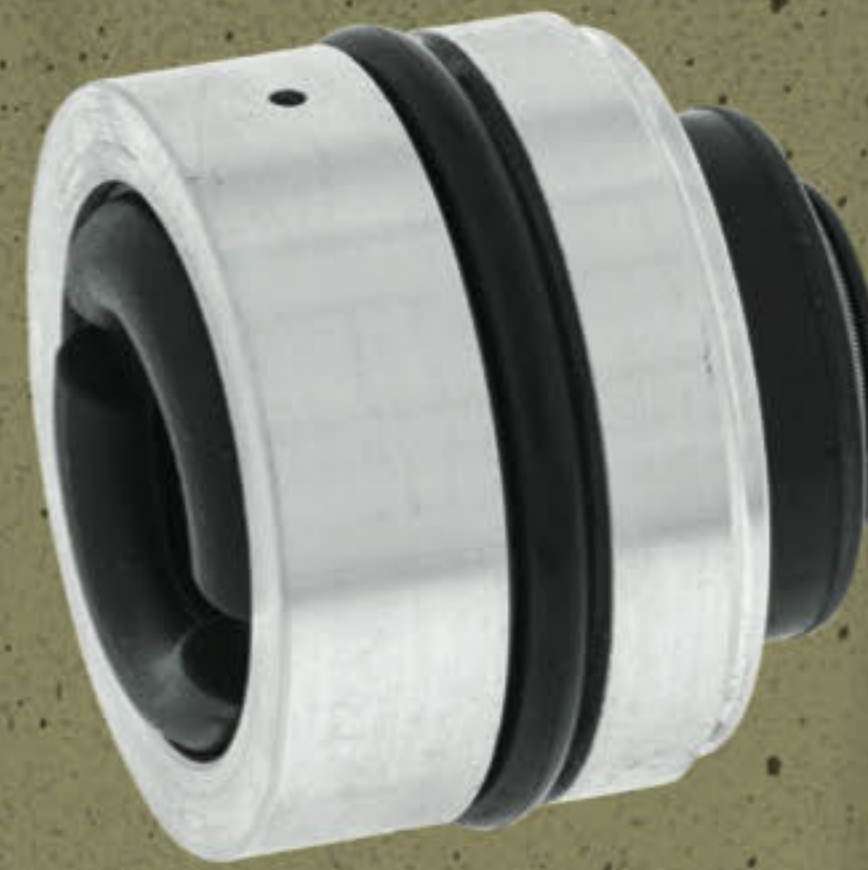

SHOCK SEAL HEAD KITS

Complete assembly and ready-to-install. Direct O.E.M. replacement featuring the latest O.E.M.-style seal with pre-scraper. All designs incorporate an air bleed hole for easy reassembly.



SUSPENSION SPRINGS

Bottoming out is not a pleasant sensation, and one that can be avoided with these durable suspension springs. Heavy-duty springs are approximately 25-30% heavier than stock and made of high-quality chrome silicone.



REAR SHOCK BEARING ASSEMBLIES

Take the friction out of your rear end with these rear shock bearing assemblies. Direct O.E.M. replacement bearing assembly containing all of the required components.



ELECTRIC POWER STEERING KITS

Stable-output torque provides smooth steering at all radiuses of the steering wheel, significantly reducing steering effort. Waterproof ECU, motor and connectors. Maximum assist power. Detailed instructions included for a trouble-free installation. One-year manufacturer's warranty.



REAR INDEPENDENT SUSPENSION REPAIR KITS

Keep your upper and lower A-arm and knuckle in fighting shape with this quality repair kit. Kit contains all of the components required to rebuild the upper and lower A-arm and knuckle. Needle bearing shafts are made with 52100 bearing steel that has been hardened and precision ground. Self-lubricating acetal nylon bushings for better wear and performance. All metal bushings are case hardened and plated to prevent wear and corrosion.



SWINGARM REPAIR KITS

Ensure your swingarm bearing assembly is properly rebuilt with this repair kit. Needle bearing shafts are made with 52100 bearing steel that has been hardened and precision ground. All metal bushings are case-hardened and plated to prevent wear and corrosion. POM composite washer bearings replace thrust needle washers for increased service life and superior resistance to water and dirt.



FRONT A-ARM REPAIR KITS

A direct O.E.M. replacement kit guaranteed to get your A-arm out of its sling and back into fighting shape in no time at all. Contains all of the bearings/bushings, bearing shafts, seals, shims and spacers required to rebuild one A-arm.



KAWASAKI BRUTE FORCE A-ARM UPGRADE KIT

The O.E.M. design uses two spherical bearings to carry the thrust load of the entire front end. Over time, bearings begin to wear and the external seals become ineffective due to excess play, which allows water and debris to enter the assembly.



LOWER SHOCK BUSHING KIT

No one likes a defective bushing, so ensure it stays in good shape with this kit. Kit contains direct O.E.M. replacement bearing assembly with all of the required components. Lower Shock Bushing Kits are sold individually for front and rear position.



TIE ROD END KITS

All the necessary elements to guarantee optimal tie rod end performance.

STEERING RACK ASSEMBLY

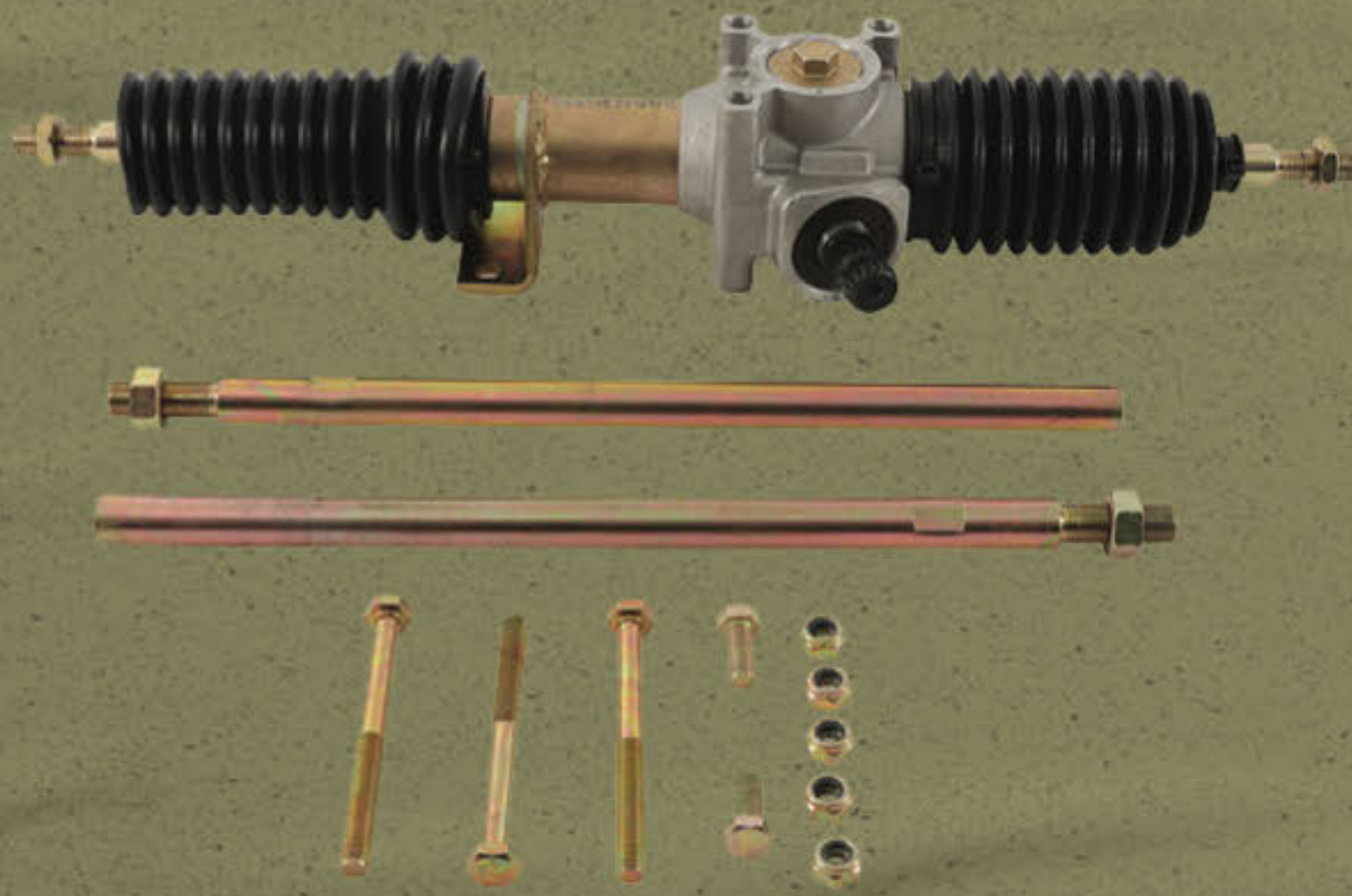

The QuadBoss® Steering Rack Assembly not only comes with the rack, but with tie-rods and inner tie-rod ends to replace the worn or broken O.E.M assembly, at a fraction of the price. Compatible with O.E.M., QuadBoss® and All Balls Racing Tie-Rods, Boots and Tie-Rod Ends. Outer ends not included, sold separately.

411973-411984

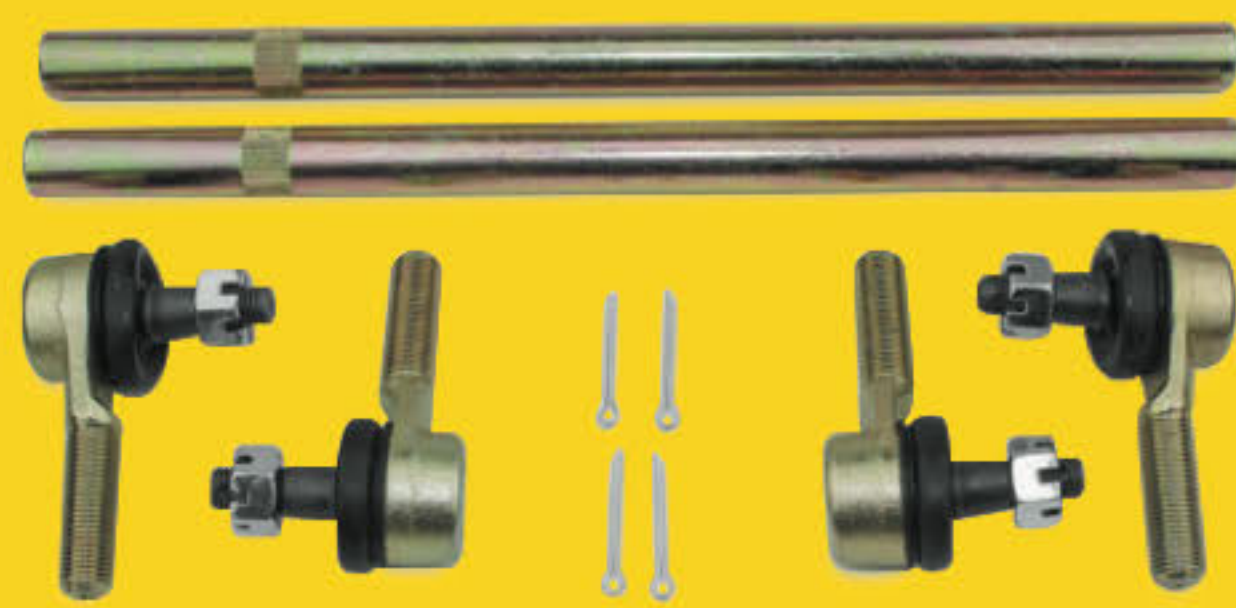

TIE ROD ASSEMBLY UPGRADE KITS

Failure is not an option when out on a ride, so ensure it remains an anomaly with this upgrade kit. Upgrade failure-prone 10mm tie rod ends to heavy-duty 12mm ends. Kits include four rod ends, two rods and all hardware for a full conversion.



STEERING RACK TIE ROD ASSEMBLY KITS

Repair instead of replacing the entire steering rack assembly. Tie Rod Kit, Outer Only: contains one tie rod, which attaches to the steering knuckle. Tie Rod End Kit, Inner and Outer: contains both tie rod end and shaft that connects to the steering rack as well as the outer tie rod end, boot and the required hardware for one side.



BALL JOINT KITS

Put an end to premature Honda® ball joint failure by upgrading from the O.E.M. aluminum joint to our heavy-duty steel joint. We also offer replacement ball joints for those Kawasaki and Suzuki applications that force you to buy an expensive A-arm or steering knuckle.



STEERING STEM BEARING AND SEAL KITS

Keep your lower steering bearing and seals in optimal condition with this kit. Includes lower steering stem bearing and seals.



KING PIN KITS

Save a ton of money over O.E.M. with this kit. Includes all bushings, pins and seals needed for repair.



SWAY BAR LINKAGE BUSHING KIT

Replacement bushing pins and washers for Can-Am sway bar linkages. Kit includes eight high-performance polyurethane bushings, four steel pins and eight washers.



QUADLITE BI-FOLD RAMP

Heavy-duty and durable bi-fold with fully welded construction. The Big Daddy ramp is lightweight with heavy-duty hinges and joints welded for extra strength. Rubber-coated tabs protect your tailgate from scratches. Two-year manufacturer's warranty.

Big Daddy Ramp 565099
Bi-Fold Ramp 565100



QUADLITE XTREME RAMP

12" x 89" arched aluminum ramps prevent clearance issues and sturdy fully-welded construction with extra support beams create a trusty path for your vehicle. Extruded rectangular side rails resist bending while a taller rectangular cross section supports more weight. Exclusive high-traction mesh surface brings more stability and loading grip. The rubber-coated tabs prevent tailgate scratches. Ready to support loads of 2500 lbs. between a pair of ramps. Two-year manufacturer's warranty.

Pair 565148

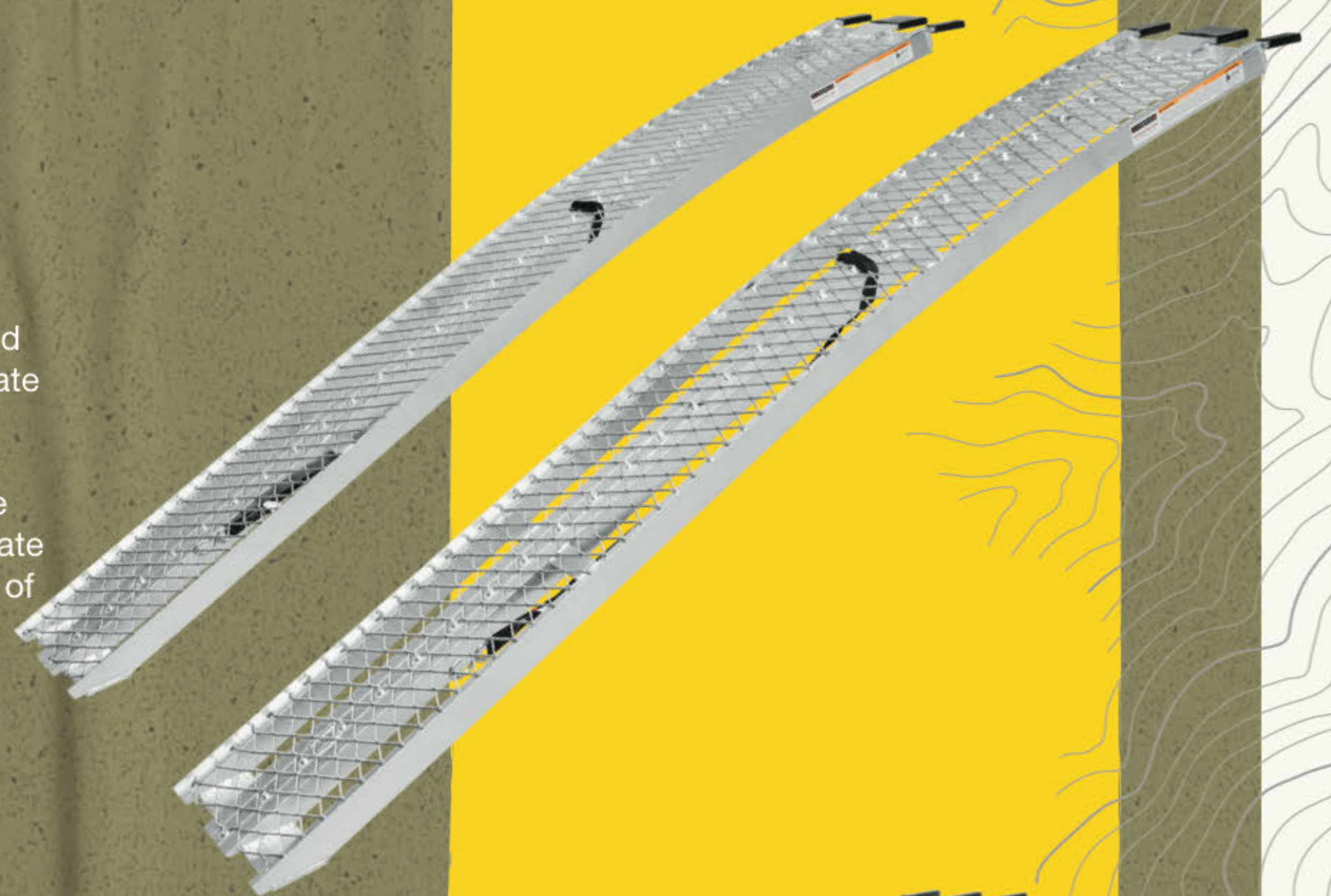

QUADLITE XL

Lightweight, fully welded aluminum construction. Rectangular formed side rails resist bending and cross sections support more weight. Tread-gripping mesh surface makes loading ATVs quick and easy. Heavy-duty hinges and joints are welded for extra strength. Rubber-coated tabs protect your tailgate from scratches.

Single 565101
Pair 565102

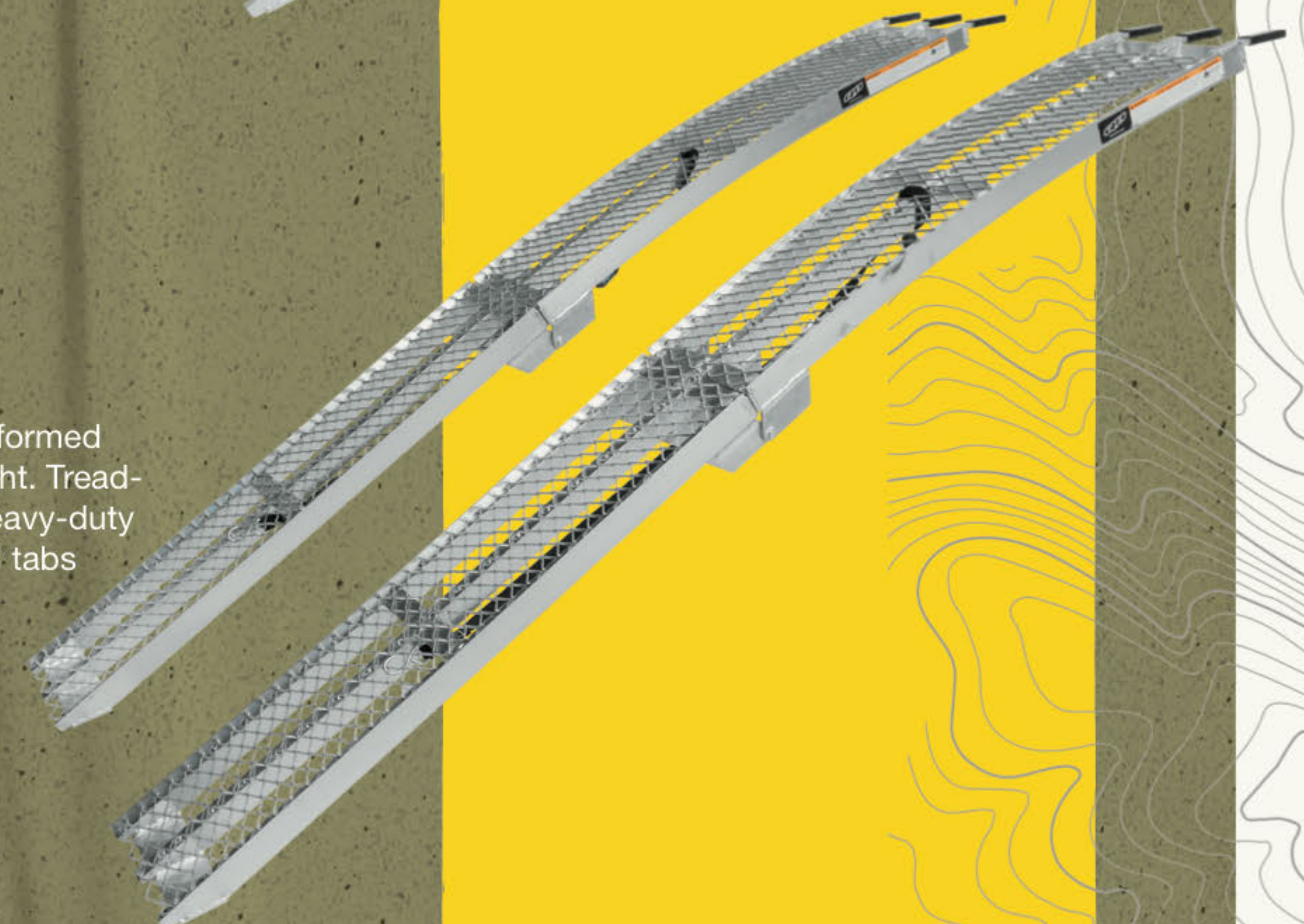



ATV ARCHED RAMPS

Arched ramps can provide additional, needed clearance to avoid bottoming out while loading. Robotically welded 6063-T5 aluminum billet. Lightweight with vinyl-coated tips.

Single 560054

Pair 560055

ATV BI-FOLD RAMPS

Made in USA with 6063T5 aluminum billet. Robotically welded, lightweight structure of 0.07" thick walls with vinyl-coated tips. Multiple widths are available; measure the width of your ATV at its widest point and pad that number slightly to determine the ramp width you need.

44" x 71" 560050

41" x 81" 560051

50" x 72" 560052

50" x 81" 560093





UTV FOLDING ARCHED RAMPS

Arched ramps can provide additional, needed clearance to avoid bottoming out while loading. Remember, weight capacity should well exceed total overall weight, including rider and all attached accessories! Dual runners have a combined weight capacity of 2,400 lbs. Single runner weight capacity is 1,200 lbs. Made in USA with 6063-T5 aluminum billet. Robotically welded. Lightweight with vinyl-coated tips.

Single 560328
Pair 570088

ATV TRI-FOLD RAMPS

Low-profile, when folded, fits between tires of most ATVs. Made in USA with 6063-T5 aluminum billet. Robotically welded, lightweight structure with vinyl-coated tips.

560053





BIG DADDY QUADLITE RAMP

Heavy-duty and durable bi-fold with fully welded construction. Lightweight and compact for easy storage. Heavy-duty hinges and joints are welded for extra strength. Rubber-coated tabs protect your tailgate from scratches. Two-year manufacturer's warranty.

565099



FOLDING WIDE-BOY CRUISER RAMP

Load and unload with confidence. The wide-width and rungs spaced 2-3/4" apart make this an easy walk. Arched top half of ramp helps prevent drag. Made in USA with robotically welded 6063-T5 aluminum billet. Lightweight with vinyl-coated tips.

563858



WHEEL CHOCK

Crafted of durable steel tubing and powder-coated for lasting resistance to rust and corrosion. Chocks are easily removed using quick-release fasteners. Fits tires up to 11-1/4" wide. One-year manufacturer's warranty.

565147



COVER FOR CREW UTV

Keep the elements from beating down your UTV during its downtime. Heavy-duty weather and storage protection for your Crew UTV. Reliable all-weather protection for your utility vehicle. Heavy-duty, coated polyester with maximum water repellency and UV resistance. Vents on both sides help prevent blowing off in high winds. An elastic cord sewn into the bottom hem ensures a snug fit.

156186



QUAD COVERS

Extra-large sizing to fit the largest quads, fits most lawn tractors, too. Heavy-duty, water-repellent nylon and the durable construction is UV-resistant.

Black, XL 156180
Woodlands Camo, XL 156181
Black, 2XL 156182
Woodlands Camo, 2XL 156183

COVER FOR UTV WITH ROLL CAGE

Protect your UTV during its downtime. Optimal storage and weather protection. Large enough to entirely cover a UTV with a roll cage and durable enough to ensure protection from the weather and unexpected storage damage. Reliable all-weather protection for your utility vehicle. Heavy-duty, coated polyester with maximum water repellency and UV resistance. Vents on both sides help prevent blowing off in high winds. An elastic cord sewn into the bottom hem ensures a snug fit.

156184



COVER FOR 4-SEATER UTV

Reliable all-weather protection for your 4-seater. High-quality cover provides heavy-duty protection regardless of weather conditions.

156185





QRE
QUADBOSS

MAKE IT YOURS

ATV & UTV

QRE
QUADBOSS
ATV & UTV PARTS & ACCESSORIES





FREE BRAND IN A BOX

WITH \$2,500 INITIAL ORDER OF QUADBOSS PRODUCTS

KIT INCLUDES:

- ONE 10' X 3' HEADER GRAPHIC
- ONE 36" X 18" LOGO SIGN
- ONE 2' X 8' POSTER
- FOUR 2' X 8' WALLPAPER STRIPS
- SET UP INSTRUCTIONS
- CUTTING KNIFE
- SMOOTHING TOOL

Dealers who have purchased \$5,000 or more in QuadBoss products with the current calendar year only need a \$500 qualifying order to receive a free display.

504693



TIRE & WHEEL DISPLAY

Allows you to display QuadBoss® wheels or mounted tire/wheel combos. FREE with \$2,500 qualifying order of QB Tires and Wheels.

505655



TIRE SEALANT DISPLAY

Program consists of a three-level buy-in and the dealer is rewarded with marketing materials and discounts to help grow business. Promo product is free with qualifying orders.

Stand 091086
Graphics 091084



WINCH DISPLAY

Allow your customers an up close view of four different QuadBoss® Winches at one time. They can easily compare the features and feel confident that they have all of the details before making their purchase. Free with qualifying purchase of four different QB winches.

608897



LED LIGHT DISPLAY

Slatwall and counter display to showcase QuadBoss® LED Lights. Multiple display configurations. On/Off "Try Me" buttons. Free with qualifying purchase.

505669

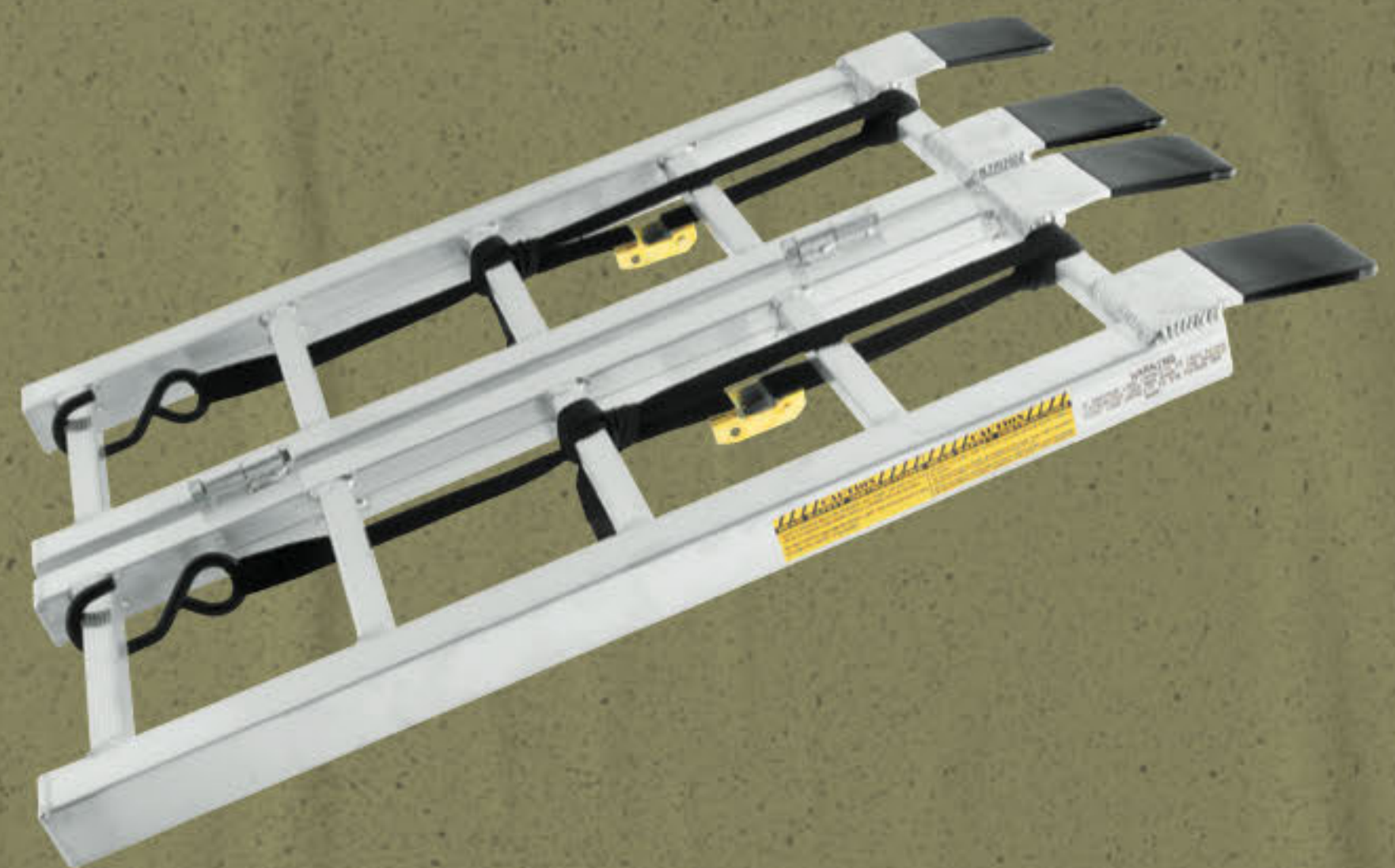

COUNTER DISPLAY/LOADING RAMP

Half scale, full-feature loading ramp display is great for demonstrating our exclusive QuadBoss® full-size loading ramps. Same extrusions, hinges, security cables and tips as the full-size ramps.

May be displayed on parts counter or by cash register. Free with the purchase of 40 QuadBoss ramps. General Display Claim Form required to receive free display. See your Sales Rep, or call Customer Service, to place an order.

560049



CANOPY TOP

Heavy-duty nylon material with taped seams and a coated underside make this canopy waterproof and fire resistant.

155630



SAIL FLAG

No one will doubt your allegiance with this eye-catching flag.

155631



BAR STOOL

360° swivel bar stool with chrome-plated frame. PVC-covered foam padded seat.

151704



SHOP FLOOR MAT

Rubber-backed, heavy-duty mat with anti-slip material and fade-resistant, fast-drying fibers. Brushes dirt and debris from shoes while absorbing moisture. Dimensions: 5' L x 3' W.

155270

LOGO BANNERS

48" x 48" 155621
72" x 29" 155622
88" x 34" 155623



ATV BANNERS

94" x 47" 155607



UTV BANNERS

94" x 47" 155609



TAPPING
THAT GAS

ARIS

TAPPIN GAS TEE



4.5 oz., 100% Ring-spun cotton

M-3XL 155322-155326

MUD KING TEE



4.5 oz., 100% Ring-spun cotton

M-3XL 155312-155316

LIKE A BOSS TEE



4.5 oz., 100% Ring-spun cotton

M-3XL 155317-155321

SNAP HAT



Medium crown, embroidered logo.
One-size fits most.

155305

BEANIE



Headgear for those who demand thermal
conservation and aerodynamics. One size
fits all.

800164



MERCHANDISE BAGS

Box of 500.

340612









QB
QUADBOSS

When it comes to quality powersports drivetrain and transmission parts, QuadBoss is the brand you can depend on.