

2007 & Up Jeep® Wrangler

# CATALOG **2015**

*Accessories, Performance & Replacement Parts*



**WE MAKE  
JEEPS ROCK!**



OMIX-ADA, Inc.







Established in 2005, Rugged Ridge® has become synonymous with quality Jeep parts and accessories. As a brand from Omix-ADA, an industry leader in Jeep® restoration and replacement parts, Rugged Ridge® has the pedigree and quickly became a household name among Jeep® and off road enthusiasts. With over 3,000 product developed and manufactured to date, Rugged Ridge® continues to add hundreds of new products each year to satisfy the Jeep® and off road enthusiast's desires to personalize their Jeep®. Over the past nine years, Rugged Ridge® has developed many unique and patented items, which sets us apart from other manufacturers in the market. Items like the Modular XHD bumpers, modular snorkel, X-Clamp, Hurricane fender flares are just some of these. Tested and proven by Rugged Ridge's engineering team and employees, you can trust that Rugged Ridge products are the perfect fit for your Jeep®.



## BUY WITH CONFIDENCE

We take pride in building quality products and back them up with a minimum 5 Year Limited Warranty so you can buy with confidence and have peace of mind.

## A FEW WORDS ABOUT PRODUCT SAFETY

The Omix-ADA®, Rugged Ridge®, Outland Automotive® and Alloy USA® brand products illustrated in this catalog are generally intended to increase the utility and enjoyment of your off-road capable Jeep® or street rod. We hope this catalog will help acquaint you with our featured products as well as the broader offerings in each of our product families. Before installation, please take a moment to review the safety information and installation instructions accompanying your product. Safety information for particular products is summarized in this catalog but is not intended as a substitute for your review and understanding of actual product instructions and warnings! Important safety information is generally preceded by one of three signal words indicating the relative risk of injury. The signal words mean:

### ⚠ WARNING

A hazardous situation which, if not avoided, could result in death or serious injury. **You can be killed or seriously hurt if you don't follow instructions.**

### ⚠ CAUTION

A hazardous situation which, if not avoided, could result in minor or moderate injury. **You can be moderately hurt and also may suffer property damage if you don't follow instructions.**

### ⚠ NOTICE

Careful attention is required to this instruction or operation but does not generally relate to personal injury. Damage to your product or other property may result if you don't follow instructions in their entirety.

We hope you enjoy your Omix®, Rugged Ridge®, Outland Automotive® and Alloy USA® purchases and are here to help if you still have questions after reviewing this safety information and instructions. See Customer Service contacts included with your Limited Warranty.

## PROP. 65 INFO FOR CALIFORNIA RESIDENTS:

### ⚠ WARNING

California Prop. 65  
Certain products in this catalog may contain chemicals known to the State of California to cause birth defects and other reproductive harm. For example PVC products may unavoidable be formulated with DEHP (a phthalate) known to the State of California to cause birth defects or other reproductive harm. To minimize risks of harm, follow all product instructions, do not store food directly on PVC covers or allow young children to chew or ingest PVC materials.

The Dana® Trademarks referred to herein are Trademarks of Dana Limited. The Dana® Trademarks are used for informational purposes only, and there is no connection between Omix-ADA, Rugged Ridge or Alloy USA and Dana®

Jeep® is a registered trademark of FCA US LLC, Omix-ADA® is not affiliated with FCA US LLC.





SATIN BLACK



GUNMETAL



BLACK W/  
MACHINED LIP



SILVER

## WE MAKE JEEPS ROCK!

Today, Rugged Ridge® serves as one of the most notable and leading Jeep accessory sources. As a division of Omix-ADA, the market-leader for replacement and restoration Jeep® parts, Rugged Ridge has an established pedigree in the enthusiast market.

With the emergence of the Jeep® Wrangler (JK) in 2007, the market has since then exploded with new consumers who are looking for turn-key Jeeps that are pre-loaded to fit their off-roading needs. Now merging form, function, and style into one, Rugged Ridge offers the convenience of 11 restyling packages, allowing you the choice from simple upgrades to building your dream "take me anywhere" Jeep®.

These Jeep® restyling packages offer the most up-to-date and innovative products on the market that'll gear your Jeep® with everything you need to take on the trails in no time at all. Conquering rocky or vicious terrain? No problem! Tromping through sand dunes in the Sahara? Don't sweat it! Rugged Ridge wants to give you the confidence to believe you can go anywhere and do anything. It's time to unleash your inner trailblazer! Where does yours take you?



**BUY WITH CONFIDENCE, MINIMUM 5  
YEAR WARRANTY ON ALL PRODUCTS**

[Running Boards & Step Bars](#)

# EXPLORATION PACKAGES

## 07-15 Jeep® Wrangler (JK)

### AVAILABLE FOR 2-DOOR & 4-DOOR MODELS

Close your eyes—now imagine trekking through the world’s roughest terrain. Envision spending your weekend navigating through sand dunes in the Sahara desert, climbing the rockiest of mountains or trudging through the deepest of water crossings to see what new journey waits on the other side before the sun sets across the horizon. All this and more is possible with the Exploration Package deal from Rugged Ridge. Designed to outfit your Wrangler with the most up-to-date and innovative products on the market including our new Drakon Wheel, Hurricane Flat Fender Flares, Sherpa Roof Rack, and XHD Modular Snorkel, now you’re prepared to have the most ultimate off-roading experience of your life. It’s time to inspire your imagination, unleash the adventure within, build your confidence in blazing new paths, and immerse yourself in new experiences. Possibilities are endless with this adventure-based package which has molded form, function, and style to offer you everything you could need for your next journey. Go beyond your imagination. Where does yours take you?

#### Part Descriptions

#### Part #

All Terrain Modular Front Bumper, 07-15 Wrangler	11542.02
All Terrain Stubby Bumper Ends, 07-15 Wrangler	11542.23
All Terrain Double X Striker, 07-15 Wrangler	11542.13
D-Shackle Set, 3/4-inch	11235.01
XHD Rear Bumper, Textured Black, 07-15 Wrangler	11546.20
XHD Swing & Lock Tire Carrier (GEN II), 07-15 Wrangler	11546.25
Billet Grille Insert, Black, 07-15 Wrangler	11306.30
Locking Gas Cap Door, Black, 07-15 Wrangler	11229.03
Hurricane Flat Fender Flare Kit, 07-15 Wrangler	11640.10
Performance Vented Hood, Primered, 07-15 Wrangler	17759.01
Aluminum Hood Catches, Black, 07-15 Wrangler	11210.11
Lift Kit w/ Shocks, 4-inches, 07-15 Wrangler	18415.60
Drop Pitman Arm, Power Steering, 07-15 Wrangler	18006.55
Steering Stabilizer, 07-15 Wrangler	18475.03
Wheel/Tire Pkg, 17" Drakon, Black Satin, 07-12	15391.45
Wheel/Tire Pkg, 17" Drakon, Black Satin, 13-15	15391.34
Heavy Duty Off Road Winch, 10,500 lb, Synthetic Rope	15100.11
Winch Plate, 07-15 Wrangler	11541.13
XHD Snorkel w/ Pre-Filter, 3.6L & 3.8L, 07-15 Wrangler	17756.22
Sherpa Roof Rack, 4-Door, 07-15 Wrangler / Sherpa Roof Rack, 2-Door, 07-15 Wrangler	11703.02/ 17703.01
Light Bar Lowering Kit, 07-15 Wrangler	11232.22
LED Driving Light, 16-Watt, 3-inch Square (4)	15209.03
Off Road Light Installation Harness, 2 Lights (2)	15210.62
Front Floor Liner, Black, 07-15 Wrangler	12920.03
Rear Floor Liner, 07-15 Wrangler (2-door or 4-door)	12950.02/ 12950.01
Cargo Liner, Black, 11-15 Wrangler	12975.03
Headlight Euro Guards, Black, 07-15 Wrangler	11230.03
Turn Signal Euro Guards, Black, 07-15 Wrangler	11231.11
Adjustable Track Bar 07-15 Wrangler (1)	18205.08
Frame Drop Bracket Front Control Arm 07-15 Wrangler (1)	18205.24



17759.01







**Package Descriptions**

Package Descriptions	Part#
Exploration Package, 07-12 2-Door Wrangler	12498.60
Exploration Package, 13-15 2-Door Wrangler	12498.90
Exploration Package, 07-12 4-Door Wrangler	12498.61
Exploration Package, 13-15 4-Door Wrangler	12498.91

*(Shown with alternate gunmetal Drakon Alloy Wheels)*

**Suggested Parts**

Suggested Parts	Part#
H/D Wrangler JK ball joint kit	11800
Inverted Drag link	18205.26





# PIONEER PACKAGE

## 07-15 Jeep® Wrangler (JK)

Whether you're an avid off-roading enthusiast, seasoned adventurer, or curious rookie to the trails, dressing up your Wrangler to prepare for your next trip is no easy task. Now available, The Pioneer Package from Rugged Ridge features a wide array of accessories for the 2007-2015 Wrangler and allows you to customize your Jeep with everything at an affordable price! From front bumpers and euro guards, to hood catches and floor liners, this package offers you the fittings necessary so you can go further and conquer more territory than ever before. How far will you go?



Part Descriptions	Part #
3-inch Bull Bar, Black Powdercoat, 10-15 Wrangler	11564.02
Mesh Grille Insert, Black, 07-15 Wrangler	11401.31
Euro Guard Light Kit, 10 pieces, Black, 07-15 Wrangler	12496.02
Aluminum Hood Catches, Black, 07-15 Wrangler	11210.11
LED Driving Light, 16 Watt, 3-inch Circle	15209.01
Off Road Light Installation Harness, 2 Lights	15210.62
Front Floor Liner, Black, 07-15 Wrangler	12920.03
Rear Floor Liner, 07-15 Wrangler (2-door or 4-door)	12950.02/ 12950.01



Package Descriptions	Part#
Pioneer Package, 07-09 Wrangler	12498.71
Pioneer Package, 10-15 Wrangler	12498.81



12496.02





# ASPEN PACKAGE

## 07-15 Jeep® Wrangler (JK)

Where does your sense of adventure lie? Whether you're rock-crawling, mud-plowing or whatever off-road adventure you find yourself in, you know the importance of having reliable tires and wheels while on the trails. The Aspen Package offers you everything you need to conquer those vicious and hilly terrains including larger 2.5" lift kits, 17" Drakon Wheels, and 35" Baja ATZ tires. Now, what's stopping you?



Package Descriptions	Part#
Aspen Package, 07-12 Wrangler	12498.73
Aspen Package, 13-15 Wrangler	12498.83

Part Descriptions	Part #
2.5-inch Lift Kit with Shocks, 07-15 Wrangler	18415.50
Steering Stabilizer, 07-15 Wrangler	18475.03
Wheel/Tire Pkg, 18" Drakon, Black Satin, 07-12	15391.43
Wheel/Tire Pkg, 18" Drakon, Black Satin, 13-15	15391.26
Front Floor Liner, Black, 07-15 Wrangler	12920.03
Rear Floor Liner, 07-15 Wrangler (2-door or 4-door)	12950.02/ 12950.01
Frame Drop Bracket Front Control Arm 07-15 Wrangler	18205.24
Drop Pitman Arm 07-15 Wrangler	18006.55
Adjustable Track Bar 07-15 Wrangler	18205.08

Suggested Parts	Part#
H/D Wrangler JK ball joint kit	11800
Inverted Drag link	18205.26



15302.01



18205.08



# LADY RUGGED RIDGE PACKAGE

## 07-15 Jeep® Wrangler (JK)

Girls just wanna have fun, right? Pretty meets wild in this exclusive Lady Rugged Ridge restyling package as we turn the average Wrangler into an elegant yet capable off-road machine. Offering all new black accessories that can be easily custom painted to create that one-of-a-kind look, your Jeep will look good and ride smooth. Whether you let your hair down and go off-roading or have your hair all done up for an evening on the town, Lady Rugged Ridge is your restyling package.

Part Description	Part #
A Pillar Light Mount, Semi-Gloss Black, 07-15 Wrangler	11232.30
3-Inch Cube LED Driving Light, 16 Watt	15209.03
Headlight Euro Guards, Black, 07-15 Jeep Wrangler	11230.03
Euro Guard, Turn Signal, Black, 07-15 Wrangler	11231.11
Euro Guards, Side Marker Light, Blk, 07-15 Wrangler	11231.12
Tail Light Euro Guards, Black, 07-15 Jeep Wrangler	11226.02
Door Handle Cover, 07-12 Jeep Wrangler	13311.10
Door Handle Cover, 13-15 Jeep Wrangler	
Door Handle Recess Guard Kit, 07-14 Wrangler	11651.25
Non-Locking Gas Cap Door, Black, 07-14 Wrangler	11229.02
Stainless Axle Back Exhaust System, 07-15 Wrangler	17606.75
XHD Winch Mount Front Bumper, 07-14 Jeep Wrangler	11540.10
XHD High Clearance Bumper Ends 07-14 Wrangler	11540.24
XHD Over Rider Hoop, 76-15 JK Wrangler	11540.14
3-Inch Cube LED Driving Light, 16 Watt	15209.03
LED Light Mount Brackets, Square, 07-14 Wrangler	11232.24
Performance 8,500 lbs Off Road Winch	15100.02
XHD Bumper Tow Point Cover, 07-15 Wrangler	11540.26
Grille Inserts, Black, 07-15 Jeep Wrangler	11306.30
Performance Vented Hood, 07-14 Jeep Wrangler	17759.01
Hood Catches, Black, 07-15 Jeep Wrangler	11210.11
Hood Light Bar, Black, 07-15 Wrangler	11232.03
20 Inch LED Light Bar, 60 Watt	15209.12
Front Floor Liners, Black, 14-15 Jeep Wrangler	12920.03
Floor Liners, Rear, Black, 07-15 Wrangler	12950.02
Cargo Liner, Black, 07-12 Wrangler 2 - door	12975.01
Cargo Liner, Black, 07-12 Wrangler 4 - door	12975.03
Dash Multi-Mount System, 07-10 Wrangler	13551.12
Dash Multi-Mount System, 13-15 Wrangler	13551.11
A Pillar Switch Pod, 07-10 Jeep Wrangler LHD	17235.56
A Pillar 4 Switch Pod Kit Blk LHD 11-15 Wrangler	17235.96
Neoprene Arm Rest Cover, Blk, 07-12 Wrangler	13107.01
Neoprene Arm Rest Cover, Blk, 13-15 Wrangler	13108.01
Rear Side Grab Handles Blk 07-15 Wrangler Unlimited	13305.14
Front Headrest Grab Handles, Black, 07-15 Wrangler	13305.10
Ultimate Grab Handles, Black, 07-14 Wrangler	13505.04
Coil Lift, 1.75 In, Shocks, 07-15 Wrangler	18360.22
XHD Rear Bumper, Textured Black, 07-14 Wrangler	11546.20
4 1/4-In Oval Side Steps, SS, 2-Door, 07-15	11593.07
4 1/4-In Oval Side Steps, SS, 4-Door, 07-15	11593.08
Rocker Guard, Body Armor, 2 Door, 07-14 Wrangler	11651.13
Rocker Guard, Body Armor, 4 Door, 07-14 Wrangler	11651.14
Rim Protector, 18 Inch, Black, 07-14 Wrangler	15250.03
Wheel/Tire Pkg, 18" XHD, Black Satin, 07-12	15391.46
Wheel/Tire Pkg, 18" XHD, Black Satin, 13-15	15391.36



\* Custom paint job is not included with package

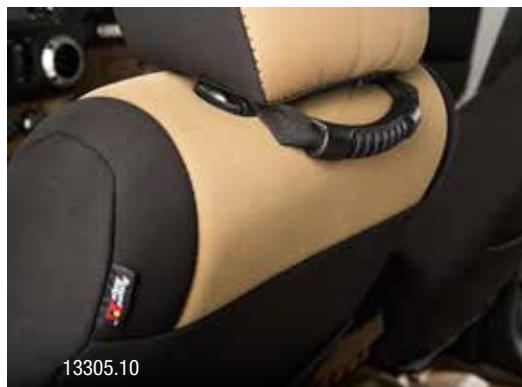

13305.10



11210.11



**Package Descriptions**

**Part#**

Lady Rugged Ridge Package, 07-10	2-Door Wrangler	12498.65
Lady Rugged Ridge Package, 11-12	2-Door Wrangler	12498.66
Lady Rugged Ridge Package, 13-15	2-Door Wrangler	12498.67
Lady Rugged Ridge Package, 07-10	4-Door Wrangler	12498.68
Lady Rugged Ridge Package, 11-12	4-Door Wrangler	12498.69
Lady Rugged Ridge Package, 13-15	4-Door Wrangler	12498.70



13551.11



11232.30



17759.01

Shown painted white



# TETON PACKAGE

## 07-15 Jeep® Wrangler (JK)

Ready to revamp your Wrangler for your next off-roading venture? Style and functionality have combined to bring you this rugged package that'll be sure to prepare your Wrangler for anything Mother Nature can throw at you! From our rear tire carrier which allows you to safely and securely mount larger wheels and tires on the trails to our reliable winch that you can rely on for recovering your Jeep from unforeseen circumstances you may encounter on the trails, Rugged Ridge has you covered!

Part Description	Part #
All Terrain Modular Front Bumper, 07-15 Wrangler	11542.02
All Terrain Stubby Bumper Ends, 07-15 Wrangler	11542.23
All Terrain Double X Striker, 07-15 Wrangler	11542.13
D-Shackle Set, 3/4-inch	11235.01
XHD Rear Bumper, Textured Black, 07-15 Wrangler	11546.20
XHD Swing & Lock Tire Carrier (GEN II), 07-15 Wrangler	11546.25
Billet Grille Insert, Black, 07-15 Wrangler	11401.30
Locking Gas Cap Door, Black, 07-15 Wrangler	11229.03
Hurricane Flat Fender Flare Kit, 07-15 Wrangler	11640.10
Performance Vented Hood, Primered, 07-15 Wrangler	17759.01
Aluminum Hood Catches, Black, 07-15 Wrangler	11210.11
Lift Kit w/ Shocks, 2.5-inches, 07-15 Wrangler	18415.50
Steering Stabilizer, 07-15 Wrangler	18475.03
Wheel/Tire Pkg, 17" Drakon, Black Satin, 07-12	15391.43
Wheel/Tire Pkg, 17" Drakon, Black Satin, 13-15	15391.26
Heavy Duty Off Road Winch, 8500 lb. Synthetic Rope	15100.02
Winch Plate, 07-15 Wrangler	11541.13
Front Floor Liner, Black, 07-15 Wrangler	12920.03
Rear Floor Liner, 07-15 Wrangler 2-door	12950.02/
Rear Floor Liner, 07-15 Wrangler 4-door	12950.01
Tail Light Euro Guards, Black, 07-15 Wrangler	11226.02
Headlight Euro Guards, Black, 07-15 Wrangler	11230.03
Turn Signal Euro Guards, Black, 07-15 Wrangler	11231.11
Adjustable Track Bar 07-15 Wrangler (1)	18205.08
Frame Drop Bracket Front Control Arm 07-15 Wrangler (1)	18205.24
Drop Pitman Arm 07-15 Wrangler	18006.55



15302.01



11546.25  
& 11546.20



17759.01



12920.03



**Package Descriptions**

	Part#
Teton Package, 07-12 Wrangler	12498.78
Teton Package, 13-15 Wrangler	12498.88

**Suggested Parts**

	Part#
H/D Wrangler JK ball joint kit	11800
Inverted Drag link	18205.26

*(Shown with alternate gunmetal Drakon Wheels)*



11230.03 &  
11210.11

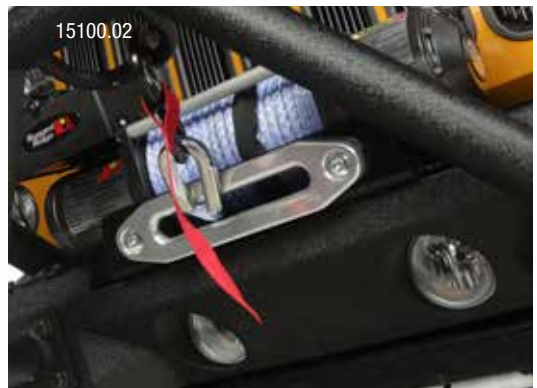

15100.02



# ROCKY PACKAGE

## 07-15 Jeep® Wrangler (JK)

What upgrade will make you most proud of your mighty Wrangler? Rugged Ridge believes that when it comes to trailblazing, you need something truly unique and impressive. The Rocky Package offers the perfect add-ons to show off your true adventurous nature on the trails. Featuring our Hurricane Flat Fender Flares, XHD Swing and Lock Tire Carrier, Heavy Duty Off-Road Winch, and heavy duty XHD Modular Bumper with the stubby ends add on and over-rider hoop, you won't be able to resist trying out your vehicle over rough terrain!

Part Descriptions	Part #
XHD Winch Mount Front Bumper, 07-15 Wrangler	11540.10
Stubby Bumper Ends, XHD Front Bumper, Textured Black	11540.23
XHD Over Rider Hoop, 07-15 Wrangler	11540.14
XHD Rear Bumper, Textured Black, 07-15 Wrangler	11546.20
XHD Swing & Lock Tire Carrier (GEN II), 07-15 Wrangler	11546.25
Grille Insert, Black, 07-15 Wrangler	11306.30
Locking Gas Cap Door, Black, 07-15 Wrangler	11229.03
Hurricane Flat Fender Flare Kit, 07-15 Wrangler	11640.10
Aluminum Hood Catches, Black, 07-15 Wrangler	11210.11
Budget Boost w/ Shocks	18360.22
Wheel/Tire Pkg, 17" XHD machined lip, 07-12	15391.40
Wheel/Tire Pkg, 17" XHD machined lip, 13-15	15391.10
Rim Protector, Satin Black, 07-15 Wrangler	15250.02
Heavy Duty Off Road Winch, 8500 lb, Synthetic Rope	15100.02
Front Floor Liner, Black, 07-15 Wrangler	12920.03
Tail Light Euro Guards, Black, 07-15 Wrangler	11226.02
Headlight Euro Guards, Black, 07-15 Wrangler	11230.03
Turn Signal Euro Guards, Black, 07-15 Wrangler	11231.11
Mickey Thompson Baja ATZ Tire, 33-inch	
Adjustable Track Bar 07-15 Wrangler	18205.08



11546.25 / 11546.20



12920.03



11210.11



Rugged Ridge

Jeep

*(Shown with alternate silver Rim Protectors)*

**Package Descriptions**

**Part#**

Rocky Package, 07-12 Wrangler  
 Rocky Package, 13-15 Wrangler

12498.77  
 12498.87

11640.10



15100.02





# SUMMIT PACKAGE

## 07-15 Jeep® Wrangler (JK)

What's your passion? If it's navigating through rocky back roads and tackling the rough terrain of the countryside, this is the package deal for you. Designed to withstand even the harshest landscape, the Summit Package features the most up-to-date and innovative products on the market including our XHD Modular Bumper, grille inserts, and XHD Swing and Lock Tire Carrier, giving your Jeep the upgraded look you like, while outfitting your Wrangler with the accessories you need to take on any off-road excursion. Now, let's get ready to rock!

### Part Descriptions

Part Descriptions	Part #
XHD Winch Mount Front Bumper, 07-15 Wrangler	11540.10
Stubby Bumper Ends, XHD Front Bumper, Textured Black	11540.23
Stinger, XHD Front Bumper, Textured Black	11540.13
D-Shackle Set, 3/4-inch	11235.01
XHD Rear Bumper, Textured Black, 07-15 Wrangler	11546.20
XHD Swing & Lock Tire Carrier (GEN II), 07-15 Wrangler	11546.25
Grille Insert, Black, 07-15 Wrangler	11306.30
Locking Gas Cap Door, Black, 07-15 Wrangler	11229.03
Hurricane Flat Fender Flare Kit, 07-15 Wrangler	11640.10
Performance Vented Hood, Primered, 07-15 Wrangler	17759.01
Aluminum Hood Catches, Black, 07-15 Wrangler	11210.11
Lift Kit w/ Shocks, 4-inches, 07-15 Wrangler	18415.60
Steering Stabilizer, 07-15 Wrangler	18475.03
Drop Pitman Arm, Power Steering, 07-15 Wrangler	18006.55
Wheel/Tire Pkg, 17" XHD black satin, 07-12	15391.44
Wheel/Tire Pkg, 17" XHD black satin, 13-15	15391.28
Heavy Duty Off Road Winch, 10,500 lb, Synthetic Rope	15100.11
XHD Snorkel w/ Pre-Filter, 3.6L & 3.8L, 07-15 Wrangler	17756.22
Front Floor Liner, Black, 07-15 Wrangler	12920.03
Rear Floor Liner, 07-15 Wrangler (2-door or 4-door)	12950.02/ 12950.01
Tail Light Euro Guards, Black, 07-15 Wrangler	11226.02
Headlight Euro Guards, Black, 07-15 Wrangler	11230.03
Turn Signal Euro Guards, Black, 07-15 Wrangler	11231.11
Adjustable Track Bar 07-15 Wrangler	18205.08
Frame Drop Bracket Front Control Arm 07-15 Wrangler	18205.24



17756.22



17759.01



11640.10



11226.02  
& 11229.03



**Package Descriptions**

Package Descriptions	Part#
Summit Package, 07-12 Wrangler	12498.79
Summit Package, 13-15 Wrangler	12498.89

**Suggested Parts**

Suggested Parts	Part#
H/D Wrangler JK ball joint kit	11800
Inverted Drag link	18205.26

*(Shown with alternate Black w/ Machined Lip XHD Aluminum Wheels)*



11546.20 & 11546.25



15100.11



# CANYON PACKAGE

## 07-15 Jeep® Wrangler (JK)

Get back to basics and nature with the Canyon Package from Rugged Ridge. Including an XHD All-Terrain Modular Front Bumper, mesh grille inserts, XHD Locking Gas Cap Door, XHD Aluminum Hood Catch, and the new Drakon wheel which offers the best fit and style possible, this package turns your Jeep into a no-nonsense vehicle that's at its best when the pavement ends. Equipping you to climb over rocks, cross streams and frolic in the sand dunes whenever you please, this package has it all!

Part Descriptions	Part #
All Terrain Modular Front Bumper, 07-15 Wrangler	11542.02
All Terrain Stubby Bumper Ends, 07-15 Wrangler	11542.23
D-Shackle Set, 3/4-inch	11235.01
Grille Inserts, Black, 07-15 Wrangler	11306.30
Locking Gas Cap Door, Black, 07-15 Wrangler	11229.03
Aluminum Hood Catches, Black, 07-15 Wrangler	11210.11
Budget Boost w/ Shocks	18360.22
Wheel/Tire Pkg, 17" Drakon, satin black, 07-12	15391.41
Wheel/Tire Pkg, 17" Drakon, satin black, 13-15	15391.14
Front Floor Liner, Black, 07-15 Wrangler	12920.03
Rear Floor Liner, 07-15 Wrangler (2-door or 4-door)	12950.02/ 12950.01
Adjustable Track Bar 07-15 Wrangler	18205.08

Package Descriptions	Part#
Canyon Package, 07-12 Wrangler	12498.74
Canyon Package, 13-15 Wrangler	12498.84





12920.03



11306.30



# GRANITE PACKAGE

## 07-15 Jeep® Wrangler (JK)

When the going gets tough on the trails, don't be caught off guard. Rugged Ridge has your back with our Granite Package. Featuring our XHD Modular Bumper that includes XHD High Clearance Ends and XHD Over Rider Hoop, durable and long lasting wheels and tires that provide extra clearance for rock climbing, and x-clamps with LED lights that were specially engineered to provide nighttime off-roaders with reliable illumination, you have everything you need! These accessories are custom designed for your Wrangler, as each component maximizes the oversized look on your Jeep. Ready to go Jeepin'?

Part Descriptions	Part #
XHD Modular Front Bumper, 07-15 Wrangler	11540.10
XHD Over Rider Hoop, 07-15 Wrangler	11540.14
XHD High Clearance Bumper Ends, 07-15 Wrangler	11540.24
Mesh Grille Insert, Black, 07-15 Wrangler	11401.31
Euro Guard Light Kit, 10 pieces, Black, 07-15 Wrangler	12496.02
Locking Gas Cap Door, Black, 07-15 Wrangler	11229.03
Aluminum Hood Catches, Black, 07-15 Wrangler	11210.11
Budget Boost w/ Shocks	18360.22
Wheel/Tire Pkg, 17" XHD, satin black, 07-12	15391.40
Wheel/Tire Pkg, 17" XHD, satin black, 13-15	15391.10
Heavy Duty Off Road Winch, 8500 lb, 5/16-inch Steel Cable	15100.01
3-inch Square LED Driving Light, 16 Watt	15209.03
Off Road Light Installation Harness, 2 Lights	15210.62
X-Clamps, 2.25-3-inch, Black, Pair	11030.02
Front Floor Liner, Black, 07-15 Wrangler	12920.03
Rear Floor Liner, 07-15 Wrangler (2-door or 4-door)	12950.02/ 12950.01
Adjustable Track Bar 07-15 Wrangler	18205.08

12496.02





**Package Descriptions**

**Part#**

Granite Package, 07-12 Wrangler  
 Granite Package, 13-15 Wrangler

12498.76  
 12498.86



11210.11



12920.03



11030.02 & 15209.03



# BOULDER PACKAGE

## 07-15 Jeep® Wrangler (JK)

Versatility has no limits—and on the trails, neither will you! Now offering you every component you need to equip your Jeep to be able to endure gnarly terrain in deserts, swamps, jungles, and anything you could imagine in an all in one inclusive functional, package deal! The Boulder Package includes everything you could need - from our recovery winch to get yourself out of sticky situations, to our Hurricane Flat Fender Flares for extra clearance and paint protection from flying rocks and debris. Now you never have to be uncertain of what lies ahead!

Part Descriptions	Part #
All Terrain Modular Front Bumper, 07-15 Wrangler	11542.02
All Terrain Stubby Bumper Ends, 07-15 Wrangler	11542.23
All Terrain Double X Striker, 07-15 Wrangler	11542.13
D-Shackle Set, 3/4-inch	11235.01
XHD Rear Bumper, Textured Black, 07-15 Wrangler	11546.20
XHD Swing & Lock Tire Carrier (GEN II), 07-15 Wrangler	11546.25
Billet Grille Insert, Black, 07-15 Wrangler	11401.30
Locking Gas Cap Door, Black, 07-15 Wrangler	11229.03
Hurricane Flat Fender Flare Kit, 07-15 Wrangler	11640.10
Aluminum Hood Catches, Black, 07-15 Wrangler	11210.11
Heavy Duty Off Road Winch, 8500 lb, 5/16-inch Steel Cable	15100.01
Winch Plate, 07-15 Wrangler	11541.13
Windshield Auxiliary Light Mounting Brackets, 07-15 Wrangler	11027.03
3-inch Square LED Driving Light, 16 Watt	15209.03
Off Road Light Installation Harness, 2 Lights (2)	15210.62
Front Floor Liner, Black, 07-15 Wrangler	12920.03
Rear Floor Liner, 07-15 Wrangler (2-door or 4-door)	12950.02/ 12950.01
Tail Light Euro Guards, Black, 07-15 Wrangler	11226.02
Headlight Euro Guards, Black, 07-15 Wrangler	11230.03
Turn Signal Euro Guards, Black, 07-15 Wrangler	11231.11

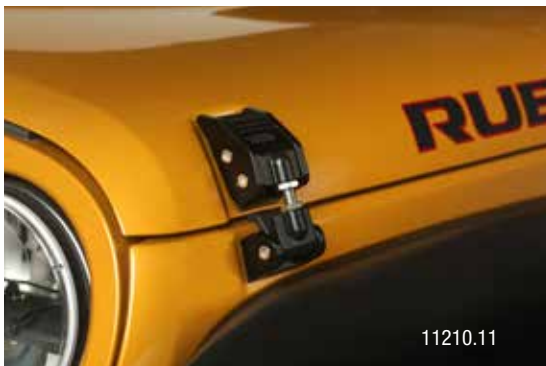



**Package Descriptions**

Part#

Boulder Package, 07-15 Wrangler

12498.85



15100.01



11027.03 & 15209.03



# APPALACHIAN PACKAGE

## 07-15 Jeep® Wrangler (JK)

Thinking about journeying for your next off-roading expedition? Regardless of whether you're heading to your favorite fishing spot that's off a beaten path, taking your family out for a day of hiking, or going sightseeing to a nearby waterfall - preparation is key. For serious off-road adventures, you'll need the Appalachian Package from Rugged Ridge to provide the accessories necessary to withstand the punishment of off-road obstacles including its budget lift kit, 17" XHD wheels, and 33" Baja ATZ tires. This package was designed to see you through any challenge!



*(Shown with alternate Silver XHD Aluminum Wheels)*

### Part Descriptions

Part Descriptions	Part
Budget Boost with Shocks, 07-15 Wrangler	18360.22
Front Floor Liner, Black, 07-15 Wrangler	12920.03
Rear Floor Liner, 07-15 Wrangler (2-door or 4-door)	12950.02/ 12950.01
Wheel/Tire Pkg, 17" XHD, satin black, 07-12	15391.40
Wheel/Tire Pkg, 17" XHD, satin black, 13-15	15391.10
Adjustable Track Bar 07-15 Wrangler (1)	18205.08

### Package Descriptions

Package Descriptions	Part#
Appalachian Package, 07-12 Wrangler	12498.72
Appalachian Package, 13-15 Wrangler	12498.82



15301.01



12920.03

**HOT  
& NEW**

# HOT & NEW PRODUCTS



## HOOD VENT INSERT

The new JK Hood Louvers from Rugged Ridge mount to the factory JK hood and are designed to provide more ventilation surface area to assist with reducing heat build-up in the engine compartment. Our hood louvers promote proper airflow through and out of the engine compartment, while adding style and design to your JK. Allows for full opening and closing of the console lid. No drilling required. Patent No. D585,674

Hood Vent Insert	Part #
Hood Vent Insert, Black, 07-15 Wrangler	17759.10
Hood Vent Insert, Primered, 07-15 Wrangler	17759.11

## XHD BUMPER TOW POINT COVERS *New!*

Are you looking for protection or Rugged Ridge D rings? This pair of European styled XHD bumper tow point covers feature a hard-wearing injection molded plastic design that matches the factory one for an overall integrated look. For use with 11540.10 and 11540.11 XHD bumpers only. Easily removable at the trail for better access to the D-ring.

XHD Bumper Tow Point Covers	Part #
07-15 Wrangler	11540.26



BUY WITH CONFIDENCE  
MINIMUM 5 YEAR WARRANTY

## PERFORATED GRILLE INSERT SCREENS *New!*

This grille insert from Rugged Ridge is available in a durable black powder-coat and stainless steel finish. Featuring a perforated metal design that will enhance the front of your Jeep adding great styling with a unique flair, this insert also comes with corrosion resistant hardware and a 5-year limited warranty.

Perforated Grille Insert Screens for 07-15 Wrangler	Part #
Perforated Grille Insert Screen, Satin Stainless	11401.22
Perforated Grille Insert Screen, Black	11401.32



## REAR CORNER BODY ARMOR KIT *New!*

Rugged Ridge® Rear Corner Body Armor is constructed from impact resistant polycarbonate and have a stylish matte black finish to give your Jeep® that tougher look. With an easy no drill installation, each body armor rear corner attaches to your Jeep® with automotive grade high-bond tape to ensure a secure fit.

Rear Corner Body Armor Kit	Part #
07-15 Wrangler Matte Black, Pair	11651.07



# EXO-TOP™



**New!**

## EXO-TOP™ POSITIONS

### 2-Door Top Positions:

1. Full Up (closed)
2. Full Down (rear tailgate)
3. Full Down (over soundbar)
4. Windows Out
5. Full Safari (summer top)
6. Sun Slider® Safari Top (summer top)
7. Full Up (Sun Slider® position)

### 4-Door Top Positions:

1. Full Up (closed)
2. Full Down (rear tailgate)
3. Full Down (over soundbar)
4. Windows Out
5. Full Safari (summer top)
6. Sun Slider® Safari Top (summer top)
7. Mid Retract Safari Top (Sun Slider® position)
8. Full Retract Safari Top (Sun Slider® position)
9. Full Up (mid retract Sun Slider® position)
10. Full Up (full retract Sun Slider® position)



**HOT  
& NEW**



## ***ROOF RACK AND SOFT TOP FOR THE PRICE OF JUST ONE!***

The Exo-Top™ is an innovative new design that for the first time ever combines the joy of top-down driving with the utility of a roof rack, taking convenience, function, and style to new levels by allowing Jeep owners the ability of conveniently lowering, raising or removing the Jeep's soft top with ease without having to unload gear from the roof-rack cargo. By combining the soft top and roof rack, the Exo-Top™ allows owners to experience a Jeep to its full potential for camping, off-roading, or any lifestyle hobby they may have. This new top also features an innovative Sun Slider® retractable function which allows the top to slide back with the release of just two latches, creating an open-top experience for owners without the hassle of getting out of the driver's seat. Integrated into the 300-lb. capacity roof rack is an advanced externally suspended soft-top design that fastens using a series of Velcro straps along the perimeter bars of the roof rack. The pulling force applied by the Velcro helps to tighten and shape the soft top. Offered for both the two- and four-door configurations, the Exo-Top™ features a patent-pending design that is a direct bolt-on application with no drilling required for installation.



### **Benefits:**

- Externally suspended replacement soft top integrated with a roof rack – so you get two products for the price of one.
- Innovative Sun Slider retractable roof easily operates from the convenience of the front seat.
- Soft top operation without unloading gear
- Multi-position top configuration not available in any other top system
- Frees up much needed storage space
- Offers patent pending design with industry leading five year warranty
- Unique aggressive styling

### **Exo-Top™**

Exo-Top™, 4-Door, 07-15 Wrangler  
Exo-Top™, 2-Door, 07-15 Wrangler

### **Omix#**

13516.02  
13516.01



## HD TIRE CARRIER KIT *New!*

Our HD Tire Carrier features an aggressive off road design, is constructed from heavy duty cast aluminum, and offers an easy to install, no drill solution that effectively reduces wear on your tailgate and tailgate hinges. By replacing the factory hinges with the tire carrier and upgraded spindles using the factory mounting points, the Jeep owner has now the ability to operate both the carrier and tailgate simultaneously without any hassle. This design also incorporates an adjustable wheel mount. The heavy duty tire carrier can be used with either stock or aftermarket rear bumpers. Patent Pending.



*ARRIVING  
SPRING 2015!*

Description	Omix#
HD Tire Carrier Kit, Black, 07-15 Jeep Wrangler	11546.50
HD Tire Carrier, Hinge Casting	11546.51
HD Tire Carrier, Wheel Mount	11546.52

## PERFORMANCE VENTED HOOD INSERT *New!*

These Rugged Ridge Performance Vented Hood Inserts are the perfect add on accessory, offering an aggressive style for your vented hood. Injection molded for a precision fit, these inserts promote proper air flow and mount to the Performance Vented Hood (17759.01) or JK factory hood.



*ARRIVING  
SPRING 2015!*

Description	Omix#
Performance Vented Hood Insert	17759.09

## DASH MULTI MOUNT

With this Dash Multi Mount Phone kit from Rugged Ridge, you can take your smartphone along for the ride! The custom fitted cradle holds your smartphone securely during trail rides. With your hands safely on the steering wheel, now you have an attachment point for convenient access to your phone, Go Pro, or POV Camera, so you won't miss a moment of trail action. This system mounts to the dash recess of the JK Wrangler with no drilling required. Will accept up to 3.6-inch wide phones. Parent Pending.



Dash Accessory Multi-Mount	Part #
11-15 Wrangler Dash Multi-Mount System	13551.11
07-10 Wrangler Dash Multi-Mount System	13551.12
11-15 Wrangler Dash Multi-Mount Phone Kit	13551.16
07-10 Wrangler Dash Multi-Mount Phone Kit	13551.17

## DANA 44 SUPER X-JOINT *New!*

Replace your stock 68017182AA U-joint with Alloy USA's new 11502 X-joint! A serviceable grease Zerk fitting at each cap allows you to flush grime and fill with grease to ensure that your Super X-joints will last! The dependable cold forged steel composition is made of chromium, molybdenum and nickel alloy. Features hardened case for excellent wear resistance and backed by a 5 year limited warranty.



Description	Omix#
Dana 44 Super X-Joint	11502

HOT  
& NEW

# SPARTAN GRILLE

12034.01 (shown painted)

Designed to appeal to avid Jeep® enthusiasts, our new Spartan Grille offers Jeep owners extreme versatility with interchangeable inserts that match their style for a customized off-road look. Each grille is easily paintable and is injection molded for a precise factory like fit. Steel mesh construction and a larger opening provides increased vented surface area, allowing for better air flow and cooling throughout the engine compartment. Patent Pending.

Spartan Grille & Inserts <i>New!</i>	Omix#
Spartan Grille, Black w/ black screen, 07-15 Wrangler	12034.01
Spartan Grille Insert, Star, 07-15 Wrangler	12034.21
Spartan Grille Insert, American Flag, 07-15 Wrangler	12034.22
Spartan Grille Insert, Teeth, 07-15 Wrangler	12034.24
Dual Circular 3.5" LED Grille Insert, 07-15 Wrangler	12034.13
20" Rectangular LED Grille Insert, 07-15 Wrangler	12034.11





## LED WINDSHIELD LIGHT BAR *New!*

Are you looking for an alternate location on your Jeep to install your LED Lights? Rugged Ridge's new LED Windshield Light Bar offers an affordable solution to mounting your LED lights above your windshield for optimal trail illumination during nighttime off-roading. This easy, no drill solution uses a clean welded design and mounts up to three 13.5 inch LED Light Bars (15209.11)



LED Windshield Light Bar for 07-15 Wrangler	Omix#
LED Windshield Light Bar	11232.25



## WINDSHIELD DUAL LIGHT BRACKET *New!*

Now offering additional mounting places for your LED lights while on the trails, this new Windshield Dual Light Bracket securely mounts two LED lights on each A-pillar of your JK using existing mounting bolt holes. No drilling or cutting required. Available in semi-gloss black and textured black, these mounts are constructed of heavy duty steel with a long lasting black powder-coated finish. Compatible with most 4 inch and under cubed and round LED lights. Also works with other accessories.

Windshield Dual Light Bracket for 07-15 Wrangler	Omix#
Windshield Dual Light Bracket, Textured Black, Pair	11232.31
Windshield Dual Light Bracket, Gloss Black, Pair	11232.30



## HURRICANE FLAT FENDER FLARES, SMOOTH FINISH *New!*

Jeep® enthusiasts can now get that aggressive off-road look and tire clearance with the complete newly designed Hurricane Flat Fender Flares by Rugged Ridge. A combination of popular fender flare styles, this design was inspired by earlier concepts and the 1941 Willys MA. The double bolt pockets provide a modern twist on the traditional flares and come with two sets of durable corrosion resistant fasteners (stainless steel and black) allowing the consumer to customize their own look. The Hurricane Flat Fender Flare is constructed of durable thermoplastic material, which creates a flexible yet very strong fender flare. Rugged Ridge uses the injection molding process for these fender flares, which produces a better fitting, more consistent flare. The Hurricane Flat Fender Flare will really set you apart from the crowd. Patent No. D712,324

Description	Omix#
Hurricane Flat Flare Kit, Smooth Black, 07-15 Jeep Wrangler (JK)	11640.25

*ARRIVING  
EARLY 2015!*

**HOT  
& NEW**

# X-CLAMPS & LED LIGHTING

*NOW AVAILABLE  
FOR 1.25-2 INCH  
BARS!*



11030.40

## FEATURING PIVOTAL FIT TECHNOLOGY™

The X-Clamp from Rugged Ridge® features an innovative and unique adjustment which allows mounting to tubes ranging from 1.25" to 3". Rotate the X-Clamp to fit your tube and pivot the mounting bracket to the desired position. Patent Pending.

- Extremely versatile mounting system allows accessories to be mounted anywhere you have tubing!
- Rugged die cast aluminum construction
- Mounts lights, antennas, cameras, etc. to tubes ranging from 1.25"-3" (available in two sizes, 1.25"-2" and 2.25"-3")
- Available in durable silver, black or textured black powder coated finish



11030.10



11031.01

### X-Clamps & LED Light Kits

	Black	Silver	Textured Black
X-Clamp, 2.25-3", Single	11030.01	11030.10	11030.40
X-Clamp, 2.25-3", Pair	11030.02	11030.11	11030.41
X-Clamp, 2.25-3", 3pc	11030.03	11030.12	11030.42
X-Clamp Kit, 2.25-3", Single with 1 Square LED Light	15210.01	15210.10	-
X-Clamp Kit, 2.25-3", Pair with 2 Square LED Lights	15210.02	15210.11	-
X-Clamp Kit, 2.25-3", 3pc with 3 Square LED Lights	15210.03	15210.12	-
X-Clamp Kit, 1.25-2", Single	11031.01	11031.10	11030.20
X-Clamp Kit, 1.25-2", Pair	11031.02	11031.11	-
X-Clamp Kit, 1.25-2", Single with 1 Square LED Light	15210.21	15210.31	-
X-Clamp Kit, 1.25-2", Pair with 2 Square LED Lights	15210.22	15210.32	-
X-Clamp Kit, 1.25-2", Single with 1 Round LED Light	15210.24	15210.34	-
X-Clamp Kit, 1.25-2", Pair with 2 Round LED Lights	15210.25	15210.35	-

### LED Lights

	Omix#
LED Light 16 Watt Square 3in	15209.03
LED Light 18 Watt Round 3.5in	15209.01
LED Light Bar 72 Watt 13.5in	15209.11
LED Light Bar, 60 Watt 20 Inch	15209.12





# ROCKER PANEL BODY ARMOR *New!*

Rugged Ridge's new Rocker Panel Body Armor offers the perfect solution in rugged off-road protection. These rocker panels are constructed of impact resistant polycarbonate. This easy no drill solution attaches to your vehicle with super strong automotive grade 3M acrylic adhesive and bolts. Available for both two and four door Wranglers.

Description	Omix#
Rocker Panel Armor, 07-15 Wrangler, 2-Door	11651.11
Rocker Panel Armor, 07-15 Wrangler, 4-Door	11651.12

*ARRIVING  
EARLY 2015!*



## FREEDOM PANEL STORAGE BAG

If it's nice outside and you're looking for an open air experience, but have nowhere to store your Freedom Panels when you remove them, Rugged Ridge® has you covered. This black vinyl storage bag offers a quick and affordable solution to protecting your hard top Freedom Panels, allowing you to enjoy the great outdoors.

Freedom Panel Storage Bag	Omix#
Freedom Panel Storage Bag, 07-15 Wrangler	12107.06

# WINCH PLATE *New!*

This black powder coated winch plate was custom designed for the Rubicon X bumper. Also works with the Rubicon 10th Anniversary Edition and Rubicon Hard Rock bumpers as well as with all popular aftermarket winches. Features two-piece design that pulls from the frame horn to the frame rails for added strength and long lasting use.

*ARRIVING  
SPRING 2015!*



Description	Omix#
Winch Plate for Rubicon X Bumper, Black, 07-15 Wrangler	11543.13

## ECLIPSE SUN SHADE - FULL SIZE

Craving that top down experience in your Jeep®, but still want protection from harsh sunlight? This full-length shade protects both front and rear passengers from the sun while offering a "top-down feeling". With mesh construction, this sun shade is held between the windshield and the rear crossbar eliminating the need for a header channel. The built-in elastic straps allows this design to retain access to the Jeep's top clamps, so you can keep the shade in place and still use the factory soft or hard top.

Description	Omix#
Eclipse Sun Shade, Full Cover, 07-15 Wrangler	13579.06
Eclipse Sun Shade, Full Cover, 07-15 Wrangler Unlimited	13579.05





**HOT & NEW**

# TEXTURED BLACK ACCESSORIES



Textured Black Hood Accessories	Omix#
Hood Catches, Textured Black, Pair, 07-15 Wrangler	11210.17
Hood Dress Up Kit, Black, 13-15 Jeep Wrangler	11201.03
Windshield Tie Down Kit, Black, 13-15 Jeep Wrangler	11201.06
Textured Black Quick Release Mirrors & Relocation Brackets	Omix#
Rectangular Quick Release Mirrors, 07-15 Wrangler	11025.14
Round Quick Release Mirrors, 07-15 Wrangler	11025.15
Mirror Filler Plates, 07-15 Jeep Wrangler	11025.06
Mirror Relocation Bracket, 07-15 Wrangler	11025.07
Textured Black X-Clamps	Omix#
X-Clamp, 2.25-3", Single	11030.40
X-Clamp, 2.25-3", Pair	11030.41
X-Clamp, 2.25-3", 3pc	11030.42
X-Clamp, 1.25-2", Single	11030.20
Textured Black Euro Guards	Omix#
Headlight Euro Guards, Textured Black, 07-15 Wrangler	11230.11
Tail Light Euro Guards, Textured Black, 07-15 Wrangler	11226.11
Turn Signal Euro Guards, Textured Black, 07-15 Wrangler	11231.21
Side Marker Euro Guards, Textured Black, 07-15 Wrangler	11231.22
Euro Guards, Fog Light, Textured Black, 07-15 Wrangler	11231.23
Euro Guard Kit, 10-Piece, Textured Black, 07-15 Wrangler	12496.31
Euro Guard Kit, 8-Piece, Textured Black, 07-15 Wrangler	12496.32
Textured Black Light Bars & Mounts	Omix#
Windshield Auxiliary Light Brackets, 07-15 Wrangler, Pair	11027.04
Windshield Dual Light Brackets, 07-15 Wrangler, Pair	11232.31
Hood Light Bar, 07-15 Wrangler	11232.10





# WHEEL & TIRE PACKAGES

Rugged Ridge offers the best option for wheel and tire packages! Designed for style and performance, these convenient packages provide wheels and tires that were manufactured using strict quality control standards with exact vehicle fitment, so your Jeep will perform at its best both on and off-road. Each package includes an XHD or Drakon wheel, each giving your Wrangler that bold yet sleek look you love, and a Mickey Thompson ATZ P3 tire that is pre-mounted and balanced with a TPMS sensor and ready to bolt right on, saving you time and money!

15391.16



15391.35



15391.25

Year Range	WHEEL	TIRE	Omix #
07-12 Wrangler	17 Inch XHD, Black Satin	33" Mickey Thompson All Terrain	15391.10
13-15 Wrangler	17 Inch XHD, Gun Metal	33" Mickey Thompson All Terrain	15391.12
13-15 Wrangler	17 Inch XHD, Silver	33" Mickey Thompson All Terrain	15391.13
13-15 Wrangler	17 Inch Drakon, Black Satin	33" Mickey Thompson All Terrain	15391.14
13-15 Wrangler	17 Inch Drakon, Gun Metal	33" Mickey Thompson All Terrain	15391.15
13-15 Wrangler	17 Inch XHD, Black Satin	34" Mickey Thompson All Terrain	15391.16
13-15 Wrangler	17 Inch XHD, Gun Metal	34" Mickey Thompson All Terrain	15391.18
13-15 Wrangler	17 Inch XHD, Silver	34" Mickey Thompson All Terrain	15391.19
13-15 Wrangler	17 Inch Drakon, Black Satin	34" Mickey Thompson All Terrain	15391.20
13-15 Wrangler	17 Inch Drakon, Gun Metal	34" Mickey Thompson All Terrain	15391.21
13-15 Wrangler	17 Inch XHD, Black Satin	35" Mickey Thompson All Terrain	15391.22
13-15 Wrangler	17 Inch XHD, Gun Metal	35" Mickey Thompson All Terrain	15391.24
13-15 Wrangler	17 Inch XHD, Silver	35" Mickey Thompson All Terrain	15391.25
13-15 Wrangler	17 Inch Drakon, Black Satin	35" Mickey Thompson All Terrain	15391.26
13-15 Wrangler	17 Inch Drakon, Gun Metal	35" Mickey Thompson All Terrain	15391.27
13-15 Wrangler	17 Inch XHD, Black Satin	37" Mickey Thompson All Terrain	15391.28
13-15 Wrangler	17 Inch XHD, Gun Metal	37" Mickey Thompson All Terrain	15391.30
13-15 Wrangler	17 Inch XHD, Silver	37" Mickey Thompson All Terrain	15391.31
13-15 Wrangler	17 Inch Drakon, Black Satin	37" Mickey Thompson All Terrain	15391.32
13-15 Wrangler	17 Inch Drakon, Gun Metal	37" Mickey Thompson All Terrain	15391.33
07-12 Wrangler	17 Inch XHD, Black Satin	33" Mickey Thompson All Terrain	15391.40
07-12 Wrangler	17 Inch Drakon, Black Satin	33" Mickey Thompson All Terrain	15391.41
07-12 Wrangler	17 Inch XHD, Black Satin	34" Mickey Thompson All Terrain	15391.42
07-12 Wrangler	17 Inch Drakon, Black Satin	34" Mickey Thompson All Terrain	15391.43
07-12 Wrangler	17 Inch XHD, Black Satin	37" Mickey Thompson All Terrain	15391.44
13-15 Wrangler	18 Inch XHD, Black Satin	33" Mickey Thompson All Terrain	15391.36
07-12 Wrangler	18 Inch XHD, Black Satin	33" Mickey Thompson All Terrain	15391.46
13-15 Wrangler	20 Inch Drakon, Black Satin	37" Mickey Thompson All Terrain	15391.34
13-15 Wrangler	20 Inch Drakon, Gun Metal	37" Mickey Thompson All Terrain	15391.35
07-12 Wrangler	20 Inch Drakon, Black Satin	37" Mickey Thompson All Terrain	15391.45



BUY WITH CONFIDENCE  
MINIMUM 5 YEAR WARRANTY



HOT  
& NEW



# VINYL DECALS

Set your Wrangler apart from the rest with Rugged Ridge's exclusive vinyl decals. Offering the perfect look for the hood and sides of your Jeep, these designs range from mild to wild and are an easy and inexpensive way to customize your ride. These graphics are made from the highest quality 3-mil vinyl featuring a smooth matte black surface to produce vivid graphics. Each decal was designed to ensure a perfect, long-lasting fit on your Wrangler every time so it'll stand out whether you're cruising the boulevard or riding the trails!

Vinyl Decals for 07-15 Wrangler <i>New!</i>	Omix#
Vinyl Hood Decal, Rugged Ridge	12300.11
Vinyl Hood Decal, Barbed Wire	12300.12
Vinyl Hood Decal, Skull	12300.13
Vinyl Hood Decal, Hibiscus	12300.14
Vinyl Hood Decal, Star	12300.15
Vinyl Side Decal, Rugged Ridge, Pair	12300.31
Vinyl Side Decal, Barbed Wire, Pair	12300.32



12300.14



12300.13

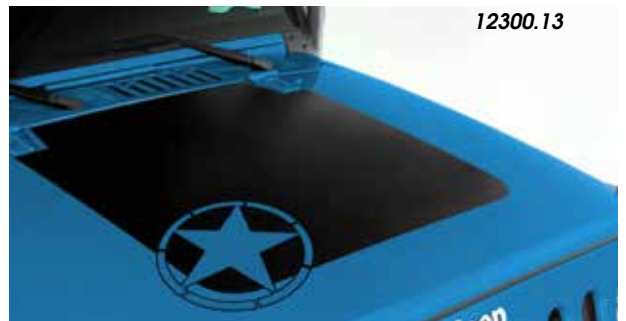

12300.13

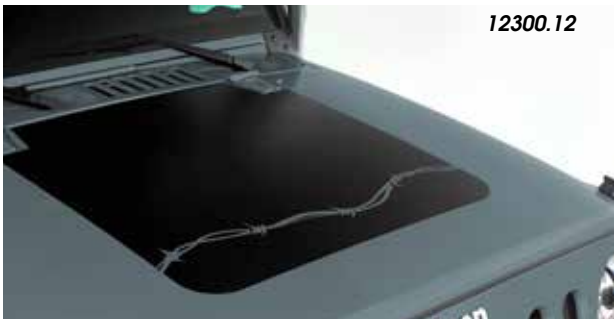

12300.12



12300.12



# CARGO NET SYSTEM



The Cargo Net System from Rugged Ridge® for the 07-15 Wrangler protects and contains your cargo to keep you on the go with ease and keep your gear in place. With easy installation, high quality nylon webbing, nickel hardware, and no hassle removal, you can ensure the security of your gear while off-roading. Our net system is reinforced around the edges for a stonger, durable, and a clean look.

Cargo Net System	Part #
07-15 Wrangler, 4-Door Full	13552.71
07-15 Wrangler, 2-Door Full	13552.70



*Go Wheeling  
In Style*

13552.71



# ECLIPSE SUN SHADE



Our Eclipse Sun Shade is a mesh shade that installs in between the front portion of a JK sport bar providing an open air experience while protecting passengers from the sun. Works with soft tops & hard tops while allowing access to the top clamps without uninstalling the shade. This sun shade does not require a separate header channel. Installs quickly and easily with a simple bungee system that is sewn into the sun shade. It comes with a small mesh carrying bag for storage when not in use.

Eclipse Sun Shade	Part #
07-15 Wrangler, 2 & 4-Door, Front Seats	13579.04
07-15 Wrangler, 4-Door Full	13579.05
07-15 Wrangler, 2-Door Full	13579.06





# MESH SUMMER BRIEFS/ISLAND TOPPERS™

Special UV treated mesh fabric blocks the heat while allowing the cool breeze to flow through. The special weave of the Rugged Ridge® mesh brief/Island Topper is designed for strength and durability while providing open air protection from the harsh sunlight. The Summer Brief that goes to the center hoop and the "Island Topper" that goes back to cover those rear seat passengers. Don't forget the Header/Windshield channel needed to install these tops!

Mesh Summer Briefs/Island Topper™	Part #
10-15 Wrangler 2 & 4-Door, Mesh Summer Brief, Each*	13579.12
10-15 Wrangler 2-Door, Mesh Summer Island Topper, Each*	13579.11
10-15 Wrangler 4-Door, Mesh Summer Island Topper, Each*	13579.13
07-09 Wrangler 2 & 4-Door, Mesh Summer Brief, Each*	13579.02
07-09 Wrangler 2-Door, Mesh Summer Island Topper, Each*	13579.01
07-09 Wrangler 4-Door, Mesh Summer Island Topper, Each*	13579.03

\* Requires a separate Windshield Header (#13308.05) for installation



**WARNING**

# POCKET BRIEFS/ISLAND TOPPERS

Tired of papers and other small items flying around the cab of your Jeep® when using your Summer Brief? Introducing the most innovative new addition to a Summer Brief in over 50 years. The Pocket Brief from Rugged Ridge®! features a revolutionary design incorporates two mesh zippered corner pockets directly over the driver and passenger, creating much needed storage space. Special two sided mesh and nylon "pocket" seals shut with a reinforced zipper, keeping small items secure even in the most severe conditions. Built directly into the Rugged Ridge® Summer Brief to ensure a clean, tight fit. Constructed of durable soft top fabric for long life. Available in matching soft top colors to give your Jeep® a finished integrated look.



Pocket Island Toppers	Diamond Black	Diamond Khaki
10-15 Wrangler, 2-Door *	13591.35	13591.36
10-15 Wrangler, 4-Door *	13592.35	13592.36
07-09 Wrangler, 2-Door *	13588.35	13588.36
07-09 Wrangler, 4-Door *	13589.35	13589.36

\* Requires a separate Windshield Header (#13308.05) for installation

Pocket Brief	Diamond Black	Diamond Khaki
Pocket Brief 10-15 Wrangler, 2-Door & 4-Door*	13590.35	13590.36
Pocket Brief 07-09 Wrangler, 2-Door & 4-Door*	13587.35	13587.36

\* Requires a separate Windshield Header (#13308.05) for installation



Pocket Island Toppers feature zippered pockets to securely stow away important items like cell phones, maps and sunglasses.

**WARNING**

# WINDSHIELD HEADERS

These upgraded preassembled Rugged Ridge Windshield Headers install quickly and easily! Just attach your Brief/Island Topper and place the header channel on the top of your windshield, slide the clamps onto the supplied knobs and clamp the channel in place. That's it! The channel is now securely held in place and ready for summer wheeling. No drilling or modifications required! Note: will work with Bestop and other after market summer tops. No drill Windshield Header required for installation of Pocket Briefs and Island Toppers on all 07-15 Wranglers.

Windshield Header	Part #
07-15 Wrangler, Extruded Aluminum, 2 & 4-Door, Deluxe	13308.05
07-15 Wrangler, Deluxe, 2 & 4-Door, Stamped Steel*	13308.06

\*For use with Summer Briefs, Island Toppers and all other brands of summer tops



**WARNING**

Loss of vehicle control involves risk of death or serious injury, particularly to parts of your body not restrained within vehicle. This product is intended for weather protection only and should not be relied upon to contain occupants in the event of an accident or to protect from either ground contact or falling objects. To reduce risk of accident injury:

- Always wear seat belts.
- Read and follow all instructions and warnings accompanying this product, in vehicle owners manual and Off Road Driving Supplement.

# XHD REPLACEMENT SOFT TOPS



Rugged Ridge® soft tops use only the finest vinyl & sailcloth fabrics. Each fabric color is specially formulated to match the original equipment colored top to make your Jeep® look like it came off the show room floor. These fabric only soft tops are designed to fit over your original factory hardware

Fabric Replacement Tops for JK	Diamond Black	Diamond Khaki
Without Door Skins, Jeep® Wrangler (JK) 07-09 2-Door	13736.35	13736.36
Without Door Skins, Jeep® Wrangler (JK) 07-09 4-Door	13741.35	13741.36

Sailcloth Fabric Replacement Tops for JK	Black Sailcloth
Sailcloth, With Tinted Windows, without Door Skins, Jeep® Wrangler (JK) 07-09 2-Door	13737.01
Sailcloth, With Tinted Windows, without Door Skins, Jeep® Wrangler (JK) 07-09 4-Door	13737.35

Black Diamond Sailcloth Soft Tops <i>New!</i>	Part #
Sailcloth Soft Top, Black Diamond, 10-15 Wrangler 2-Door	13737.01
Sailcloth Soft Top, Black Diamond, 10-15 Wrangler 4-Door	13742.01
Replacement Top, Black Diamond, 10-15 Wrangler 2-Door	13737.35
Replacement Top, Black Diamond, 10-15 Wrangler 4-Door	13742.35



BUY WITH CONFIDENCE  
MINIMUM 5 YEAR WARRANTY





# RUGGED RIDGE® SOFT TOP ACCESSORIES

## HARD TOP SOUND DEADENER/INSULATION

If you chose the hard top option for your 07-15 Wrangler then you need Rugged Ridge®'s Hard Top Sound Deadener. This insulation is custom fit for the factory multi-piece hard top and greatly reduces noise inside your vehicle. The special insulation material is surrounded by heavy duty pleated nylon providing added interior comfort by insulating the cab from heat and cold. Durable hook and loop fasteners allows for an easy no drill installation without removing your hard top.



Sound Deadener for 07-14 Wrangler Hard Top	Part #
11-15 Wrangler 2-Door, 3 pcs.	12109.03
11-15 Wrangler 4-Door, 4 pcs.	12109.04
07-10 Wrangler 2-Door, 3 pcs.	12109.01
07-10 Wrangler 4-Door, 4 pcs.	12109.02

## JK SOFT TOP STORAGE BOOT

Want to cruise around with the top off, but keep your top close in case of sudden showers or temperature drops? The Rugged Ridge® Soft Top Storage Boot is the solution to protect your soft top when it is folded down. Designed to be used with the windows zipped out.



JK Soft Top Storage Boot	Part #
07-15 Wrangler, 2-Door, Black Diamond, Each	12104.50
07-15 Wrangler, 4-Door, Black Diamond, Each	12104.51

## SOFT TOP DISCONNECTS

Upgrade your factory 2007-12 Wrangler soft top hardware with these Soft Top Disconnects. allows for easy, no tool disconnect of your soft top bows from your Jeep®. Installation is easy and quick, no drilling required.

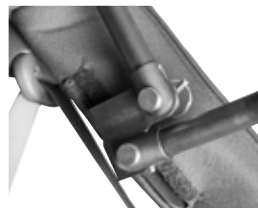

Soft Top Disconnect Kit	Part #
07-12 Wrangler 4-Door, 4 pack	11251.04

Will not work with 2013-15 OE spring assist tops.

## WINDOW STORAGE ROLL BAG

Protect your soft top windows from scratching and other damage with a window storage roll bag from Rugged Ridge®. This easy to use storage bag stores your rear windows using a soft internal material and a heavy duty exterior fabric for the ultimate in protection. The internal fabric is placed between the windows to prevent scratching and window on window contact. Simply place the windows in between the fabric and gently roll the windows into an easy to store "window roll". The rolled up bag can now be easily installed to the rear of your sport bar with attached nylon straps and buckles. This window storage bag solution is a must for those soft top owners who want to keep their windows out of harm's way and prolong the life of their soft top. Each storage bag is backed by an industry leading five year limited warranty.



Window Storage Sport Bar Bag	Part #
07-15 Wrangler, 2-Door or 4-Door, Black	12107.05

## ROLLBAR COVERS

Replace your worn and faded factory roll bar covers with these high quality replacements from Rugged Ridge®. Available in OE style polyester or premium vinyl, the padded Roll Bar Covers install easily using zippers and "hook & loop" attachments. Special cut-outs allow you to install the covers without removing the rear seat belts!

Roll Bar Covers	Part #
07-15 Wrangler, 2-Door, Roll Bar Cover, Black, Polyester	13613.02
07-15 Wrangler, 2-Door, Roll Bar Cover, Black, Vinyl	13613.06
07-15 Wrangler, 4-Door, Roll Bar Cover, Black, Polyester	13613.01
07-15 Wrangler, 4-Door, Roll Bar Cover, Black, Vinyl	13613.05



# WATER RESISTANT CAB/FULL COVERS

Custom fit Rugged Ridge® Cab Covers protect your vehicles interior from dust, dirt and light showers. Constructed of vinyl coated polyester fabric or a space age cover material (Weather Lite/Three Layer Covers), these easy to use covers install in minutes. Reinforced elastic side straps and under body hooks hold the cab cover in place. No drilling required. Complete vehicle covers also available in breathable Weather Lite fabric or durable three layer fabric. Weather Lite is perfect for inside storage while the Three Layer covers are designed for short term outdoor use.

Complete Cover kits with lock and storage bag available.

## 3 LAYER PROTECTION!

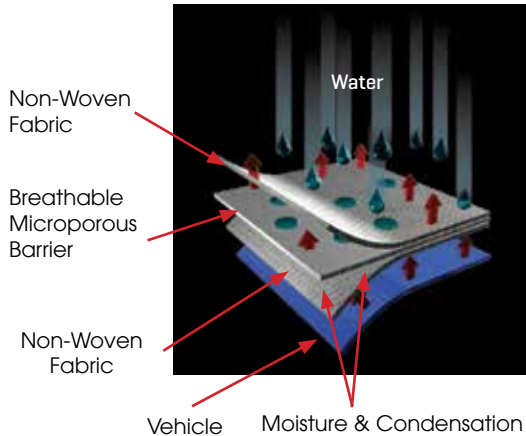

BUY WITH CONFIDENCE  
MINIMUM 5 YEAR WARRANTY

Full Covers	Part #
Three Layer Full Car Cover (w/Bag & Lock) 07-15 4-Door Wrangler	13321.73
Three Layer Full Car Cover (Cover only) 07-15 4-Door Wrangler	13321.71
Three Layer Full Car Cover (w/Bag & Lock), 07-15 2-Door Wrangler	13321.81
Three Layer Full Car Cover (Cover only), 07-15 2-Door Wrangler	13321.80
Car Cover Storage Bag	12105.01
Cab Cover, Weather Lite, 07-15 2-Door Wrangler	13317.10
Cab Cover, Weather Lite, 07-15 4-Door Wrangler	13318.10
Cab Cover, Vinyl, 07-15 2-Door Wrangler	13317.09
Cab Cover, Vinyl, 07-15 4-Door Wrangler	13318.09

# FREEDOM PANEL STORAGE BAG *New!*

If it's nice outside and you're looking for an open air experience, but have nowhere to store your Freedom Panels when you remove them, Rugged Ridge® has you covered. This black vinyl storage bag offers a quick and affordable solution to protecting your hard top Freedom Panels, allowing you to enjoy the great outdoors.



Freedom Panel Storage Bag	Part #
Freedom Panel Storage Bag, 07-15 Wrangler	12107.06

# RUGGED RIDGE® JK DOOR STORAGE BAGS

Prolong the life of your hard doors with this handy storage option from Rugged Ridge®. Each storage bag features special soft fabric sides that are padded to "cradle" your hard door. We use oversized zippers and durable nylon fabrics for long life and weather resistance. Special handle placement allows for easy carrying and storage, and each bag includes a strap that allows them to hang on the wall of your shop or garage.



JK Door Storage Bags	Part #
Door Storage Bags Front, Pair, 07-15 Wrangler	12108.10
Door Storage Bags Rear, Pair, 07-15 Wrangler	12108.20

# TIRE COVERS

Rugged Ridge® Tire Covers are custom designed to fit today's most popular sized tires. Constructed of durable vinyl coated polyester fabric. Colors match other Rugged Ridge® soft accessories. Please measure tire diameter.

Tire Diameter	Black	Gray	Denim Black	Diamond Black
27-29"	12801.01	12801.09	12801.15	12801.35
30-32"	12802.01	12802.09	12802.15	12802.35
33"	-	12803.09	12803.15	12803.35
35-36"	-	12804.09	12804.15	12804.35

Note: To ensure proper fit, measure the diameter of the tire you are covering and pick the appropriate tire cover size listed above.





# HALF DOORS

Looking for an economical way to replace your factory full steel doors with a set of half doors? Rugged Ridge® Half Doors help keep the elements out while maintaining that open air experience. The Half Doors are constructed from paintable, impact resistant, thermoplastic outer door skins mounted to rigid powder coated internal steel door frames. The Half Doors interchange easily with the factory steel doors and require no body modification for installation. They feature lockable door handles, an internal storage pouch, waterproof seals, OE style hinges, and mirror mounts. The Half Doors are also available with optional upper soft doors.

## Features and Benefits

- Impact resistant thermoplastic black ABS material with enhanced UV protection.
- Matte finish is easily paintable for custom match factory look.
- Specially reinforced internal steel frame provides strength and is powder coated to resist corrosion.
- The textured inner ABS panels provide a finished look and feature a grab handle and storage pocket.
- Each door has a weather tight seal to keep out moisture and reduce wind noise.
- OE Style Hinges provide a factory look and are designed to last.
- Durable and lockable paddle handle.
- Matching soft upper doors available for all season protection from the weather.
- Designed to work with your original mirror or Rugged Ridge® replacement mirrors.

Rugged Ridge® Half Doors	Part #
Half Door, Front, Jeep Wrangler (JK) 07-15 (Pair)	11509.01
Half Door, Rear, Jeep Wrangler (JK) 07-15 (Pair)	11509.02
Upper Soft Door, Front, Jeep Wrangler (JK) 07-15 (Pair)	13711.15
Upper Soft Door, Rear, Jeep Wrangler (JK) 07-15 (Pair)	13712.15



### WARNING

This product is intended to provide added off-road convenience and utility to your vehicle. This product is not intended to provide occupant containment or protection in the event of an accident or roll-over. Further, on road use may involve increased risk of serious injury in the event of side-impact accidents.

### TO REDUCE RISK FROM THESE TYPE OF INJURIES:

- Always wear seat belt and shoulder harness for all vehicle occupants.
- Keep arms and body inside vehicle.
- Drive safely, read and understand all manufacturers warnings and product instructions before installation.

# TUBE DOORS

Like the "doors off" feel but also want the added convenience and utility of having doors on the trail? Rugged Ridge® Tube Doors are constructed from durable 1.5 inch mandrel bent steel tube that is E-Coated primed and then textured powder coated for a long lasting finish. Tube doors help increase visibility when climbing obstacles and trail riding. The Tube Doors interchange easily with the factory steel doors and require no body modification for installation. They are light weight and small enough to be stored easily in back of the vehicle when not in use.



## Features and Benefits

- Thicker than most other tube doors with durable 1.5" diameter steel tubing construction, providing added strength and great looks.
- E-coat and textured powder coat for corrosion resistance.
- Designed to work with original mirror or for added convenience permanently install a pair of Rugged Ridge® replacement mirrors.
- Half doors are easy to install and remove and are small enough to be stored in the vehicle.
- Durable and lockable paddle handle.
- Full door frame and rattle free.

Rugged Ridge® Tube Doors	Part #
Tube Doors Front, Jeep Wrangler JK 07-15, pair	11509.10
Tube Doors Rear, Jeep Wrangler JK 4-Door 07-15, pair	11509.11

# TUBE DOOR CARGO COVERS

Add a fully adjustable Molle / Pals storage solution to your tube doors! The Rugged Ridge® Tube Door Cargo Covers are made from 600 denier polyester fabric with a durable vinyl backing. Our storage solution features an assortment of five different storage pouches with internal storage compartments. The great Molle / Pals mounting system allows you to arrange the pouches however you wish, or grab them and go!



CAUTION

Rugged Ridge® Tube Doors Cargo Covers	Part #
Tube Door Cargo Covers, JK 07-15	13247.01

# DOOR LATCH SET



Door latches are included with half doors and tube doors, but are available separately for custom applications.



Door Latches	Part #
Half & Tube Doors, 07-15 Wrangler, Pair	11812.80

# QUICK RELEASE MIRROR RELOCATION

The mirrors mount to a bolt on bracket and are secured with a locking knob that allows for easy installation and removal. The long adjustable arms give you great visibility with your doors off or on! Available in durable black powder coat or stainless steel finish.

07-15 Wrangler Relocation Mirrors	Part #
Round Quick Release Mirror Kit, Pair, Black, does both sides	11025.10
Round Mirror Kit, Round, Black, Includes mirror, LH or RH, does one side	11025.11
Round Quick Release Mirror Kit, Pair, Stainless Steel, does both sides	11026.10
Round Mirror Kit, Stainless Steel, LH or RH does one side	11026.11
Rectangular Quick Release Mirror Kit, Pair, Black, does both sides	11025.12
Rectangular Mirror Kit, Black, Includes Mirror, LH or RH does one side	11025.13
Rectangular Quick Release Mirror Kit, Pair, Stainless Steel, does both sides	11026.12
Rectangular Mirror Kit, Stainless Steel, LH or RH does one side	11026.13

07-15 Wrangler Textured Relocation Mirrors <i>New!</i>	Part #
Round Quick Release Mirror Pair, Textured Black	11025.16
Rectangular Quick Release Mirror Pair, Textured Black	11025.18



# FACTORY STYLE JK MIRRORS FOR WRANGLER

- Replicas of the factory original mirrors allowing you to maintain an OEM look.
- Easy no-drill installation, mounts into original mirror location.
- Durable UV protected black plastic
- Mirrors including LED turn indicators require some wiring.



Factory Style Replacement Mirrors for JK	Black	Black w/LED	Chrome	Chrome w/LED
07-15 Wrangler, Passenger Side	11002.12	11002.14	11010.12	11010.14
07-15 Wrangler, Driver Side	11002.13	11002.15	11010.13	11010.15
07-15 Wrangler, Kit, Pair	11002.21	11002.22	11010.11	11010.16

Fits 2011-2014 Wrangler models equipped with manual mirrors. Will not work with power mirrors.

# MIRROR RELOCATION BRACKETS & DOOR FILLER PLATES

Custom designed brackets bolt into existing holes on the windshield relocating your mirrors off the door. The perfect add-on accessory for those off-road adventures where you do not want your doors. Each bracket kit for the 2007-14 Wrangler comes with a special paintable filler plate to cover the hole created when you remove your mirrors. Sold in pairs.

Mirror Relocation Brackets	Black	Stainless
07-15 Wrangler w/Filler Plate, Pair	11025.04	11026.04
07-15 Wrangler, Pair	11025.10	11026.10
07-15 Wrangler, Each	11025.11	11026.11

Fits 2011-2015 Wrangler models equipped with manual mirrors. Will not work with power mirrors.

Mirror Relocation Filler Plates	Part #
07-15 Wrangler, Black, Pair	11025.05

Fits 2011-2014 Wrangler models equipped with manual mirrors. Will not work with power mirrors.

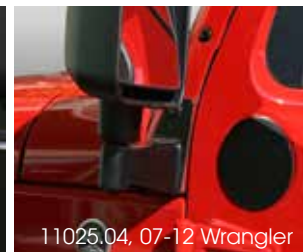

# CAST BLACK STEEL DOOR HINGES

Featuring heavy duty cast construction and a powder coated finish these Cast Black Steel Door Hinges from Rugged Ridge® are built to last. The hinges are offered in sets for both the doors and hood. Includes matching black allen head bolts to complete the installation. They are direct bolt on replacement hinges for an out of the box solution, but without all the fuss and mess of painting your factory hinges.

Door Hinges	Part #
Cast Steel Hinges, RH, Pair, JK 07-15	11202.22
Cast Steel Hinges, LH, Pair JK 07-15	11202.23





# ALL TERRAIN FLOOR LINERS

## The only floor liner with patented "Deep Tread" Technology!

These floor liners are a totally new concept that combines all the best features of a deep rib floor mat and the 'old style' liners. Precision engineering using state of the art technology ensures an exact fit to the shape and contour of your vehicle's floor. The deeply molded chevron-shape tread pattern channels dirt, mud and snow away from the driver to keep shoes and pant legs clean. It also contains the movement and sloshing around of any trapped water. The high perimeter wall offers a large footprint and maximum interior protection and containment. Unlike ordinary liners that utilize an inconsistent vacuum thermoform process and slippery lower grade plastic, these liners are high pressure injection molded from OE-quality thermoplastic that looks and feels like rubber and provides a nonslip surface. Raised ribs on the bottom provide maximum retention and keep the liner in place. The unique self-sealing floor hook attachment helps to prevent dirt and moisture from getting through. Easy to remove and clean. Simply hose them off and go! The mat actually reseals itself around the hook. Patents D627,285 & 8,163,369.



BUY WITH CONFIDENCE  
MINIMUM 5 YEAR WARRANTY

*New Colors!*



### Rugged Ridge® Floor Liners & Cargo Liners

	Black	Tan	Gray
Floor Liner, Front, 2 and 4-Door 07-15 Wrangler, Pair	12920.03	13920.03	14920.03
Floor Liner, Rear, 4-Door 07-15 Wrangler, One Piece Design	12950.01	13950.01	14950.01
Floor Liner, Rear, 2-Door 07-15 Wrangler, Pair	12950.02	13950.02	14950.02
Cargo Liner, 2 and 4-Door 07-10 Wrangler	12975.01	13975.01	14975.01
Cargo Liner, 2 and 4-Door 11-15 Wrangler	12975.03	13975.03	14975.03
Floor Liner Kit, Front and Rear, 07-15 Wrangler 4-Door	12987.01	13987.01	14987.01
Floor Liner Kit, Front and Rear, 07-15 Wrangler 2-Door	12987.02	13987.02	14987.02
Floor Liner, Front, 2 and 4-Door 07-15 Wrangler, Pair (RHD)	12920.02	13920.02	14920.02

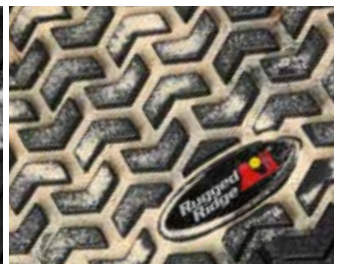

### All Season Protection!

#### ⚠ WARNING

Unsecured front liners may shift, restricting pedal movement which may lead to loss of control. TO AVOID SERIOUS INJURY: Replace vehicles floor anchor if damaged. Do not stack or use other liners or movable carpet under your Omix®(i) liner. Read and follow all instructions and other warnings included with this product and within your vehicle owner's manual.

#### ⚠ WARNING

California Prop. 65  
Certain products in this catalog may contain chemicals known to the State of California to cause birth defects and other reproductive harm. For example PVC products may unavoidable be formulated with DEHP (a phthalate) known to the State of California to cause birth defects or other reproductive harm. To minimize risks of harm, follow all product instructions, do not store food directly on PVC covers or allow young children to chew or ingest PVC materials.

## FIRE EXTINGUISHER HOLDERS

This specially designed fire extinguisher holder incorporates thick nylon web straps that secures your fire extinguisher to the roll bar. Straps are fully adjustable and secured with hook and loop fasteners. Holds one 3lb. fire extinguisher (not included).



Roll Bar Fire Extinguisher Holder	Black	Red
For all Jeep® 3" Roll Bars, Each	13305.21	13305.20

## ROLL BAR DRINK HOLDER

This roll bar drink holder quickly places a convenient drink holder anywhere along your Jeep's sport bars. Padded nylon drink holders attach with quick release "hook & loop" straps and hold a variety of cups and water bottle sizes. Foam insulation keeps your favorite beverage cool in the hot summer sun. Packed in pairs for both front and back seat use.



Roll Bar Drink Cup Holder	Part #
For all Jeep Roll Bars, Pair	12101.51

## ROLL BAR COAT HANGER KIT

This makes hanging your coat or laundry easy. Attaches to the roll bar with two nylon straps. Sold in pairs.



Roll Bar Coat Hanger	Part #
For all Jeeps w/Roll Bars	11250.03



## TAILGATE STOP

This billet aluminum door stop incorporates a sliding arm that locks into place, keeping your tailgate door open even on the most severe slopes. Load your Jeep® with ease! Some drilling required for installation.



Tailgate Stop	Part #
07-15 Wrangler, Each	11238.11

## LED COURTESY LIGHTS

The natural design of a Jeep® interior does not provide adequate interior lighting for map reading or looking for items inside your Wrangler. Now you have two outstanding options for interior lighting with the new Rugged Ridge® LED Courtesy Lights. Each lighting option features an extra bright, energy efficient LED light powered by 3 AAA batteries (not included) so there is no wiring required. The roll bar mount design attaches to any 2-3 inch roll bar using heavy duty straps and hook and loop fasteners. The NEW header mount courtesy light attaches with screws to the interior location of your choice.



LED Courtesy Lights	Part #
Interior Courtesy Light, LED, Front Header Screw mount, Wrangler (JK) 07-15	12430.01
Interior Courtesy Light, LED, Roll Bar Mounted, Universal (with 2-3 Inch Roll Bar)	11250.08

## BACK SEAT HEATER

This 300 watt, 12 volt heater will warm your vehicle quickly, keeping you and your passengers comfortable. Designed to fit on the rear wheel well of any Jeep®, this easy to use heater wires easily to your existing electrical system. Some drilling may be required for installation.



Back Seat Heater	Part #
All Jeeps & SUV's	13150.01

## ROLL BAR DOME LIGHT

This roll bar dome light features hard wired light illuminates the cab area of your Jeep. Attaches to the roll bar with easy to use straps. No drilling required.



Roll Bar Dome Light	Part #
For all Jeeps® Roll Bars	11250.01

## NEOPRENE GRAB HANDLE & DOOR HANDLE COVERS

Protect and upgrade the look of your Wrangler with these easy to install door and grab handle wraps. Each wrap is constructed of durable neoprene and covers each door handle as well as the passenger side grab handle.

Grab & Door Handle Kit	Black	Red
07-10 Wrangler 4-Door, 5 pc. Kit	13305.54	13305.55
07-10 Wrangler 2-Door, 3 pc. Kit	13305.56	13305.57







13305.02 Deluxe Grab Handle



13505.03 Ultimate Grab Handle



13305.01 Sport Grab Handle

## ULTIMATE/DELUXE/NEOPRENE AND SPORT GRAB HANDLES

Put easy to use Grab Handles wherever you need them. Constructed of tough nylon webbing with either a molded sure-grip handle (Ultimate), soft foam handle (Deluxe) or plain Nylon webbing (Sport). The Ultimate Grab Handles are available in two hot colors to accent the Jeeps interior-red & black. Deluxe and Sport models fit all Jeep® roll bars and 3 inch roll cages with padding. Ultimate Grab Handles will fit 2 or 3 inch padded or un-padded roll bars. All designs are packed in pairs.

Ultimate/Deluxe and Sport Handles, 07-15 Wrangler	Part #
Ultimate Grab Handles, Pair - Red	13505.03
Ultimate Grab Handles, Pair - Black	13505.04
Deluxe Grab Handles, Pair	13305.02
Sport Grab Handles, Pair	13305.01
Neoprene Wrapped Deluxe Grab Handles, Passenger/Driver Side Roll Bar, Pair - Black	13305.30
Neoprene Wrapped Deluxe Grab Handles, Passenger/Driver Side Roll Bar, Pair - Red	13305.31

## GRAB HANDLES FOR 07-15 JEEP WRANGLER

With three styles to choose from these Rear Side Grab Handles for easy entry and exit attach directly into factory mounting holes with your original hardware. They also double as Front Seat Grab Handles by easily attaching to the windshield pillar with supplied hardware. Rear Seat Grab Handles attach to the head rest of your JK front seats. Finally, we have developed a neoprene wrapped design for both driver and passenger that completes the entire JK package!

Grab Handles	Black	Red
07-15 Wrangler, Seat Mount Grab Handles, Pair	13305.10	13305.11
07-15 Wrangler Rear Side/Windshield Pillar Grab Handles, Pair	13305.14	13305.15
07-15 Wrangler, Black, 5 Piece Kit*	12496.14	-

\*Includes: 13305.04, 13305.14 & 13305.12



13305.10



13305.15

Dual Application



13305.14



13305.15



13305.13 Center Roll Bar Dual Grab Handle

## REAR DUAL GRAB STRAP FOR JEEP

This gives back seat passengers a place to hold on while on the trail. Constructed of durable nylon webbing with soft molded foam handles for ease of use and comfort. Easily attaches with hook and loop around the center roll bar or to factory mounts. No drilling required. Special side "pockets" create a handy spot for hanging clothes.

Rear Dual Grab Strap	Black	Red
07-15 Wrangler, Each	13305.12	13305.13

## FLASHLIGHT HOLDERS

Keep your flashlight in a secure and easily accessible place. Choose either the sport bar holder or the steel mounting brackets. Flashlight not included.

Flashlight Holders	Part #
Sport Bar Flashlight Holder, 07-15 Wrangler, Each	11205.20
Mounting Brackets for 1.5" Diameter Flashlights, Universal Application, drilling required, Pair.	11238.06



## CENTER CONSOLE ARMREST PAD FOR 11-15 WRANGLER

This easy to use arm rest pad/cover from Rugged Ridge® provides protection and comfort all in one! Constructed of heavy duty neoprene (wet suit material) with an added layer of padding for the arm rest, this slip on cover provides an extra soft place to put your arm while driving. Since it covers the entire top of the arm rest, this cover also provides added arm rest protection from pet claws, dirt and sticky fingers. Installation is easy with an elastic band; no drilling or tools required. Black Neoprene compliments your vehicle's interior and will match custom fit Neoprene seat covers. Limited 5 year warranty.



Center Console Armrest Pad 	Part #
11-15 Wrangler, Black, Neoprene	13108.01



## ARM REST PAD FOR 07-10 WRANGLER

Rugged Ridge®'s patented Arm Rest Pad bolts directly into existing JK mounting screws-no need to remove the OE lid. Steel brackets ensure durability. Uses either Neoprene or tough vinyl coated polyester fabric with a dense foam center for comfort, performance and a great look in the vehicle. Allows for full opening and closing of the console lid. No drilling required. Patent# D585,674

Arm Rest Pad For 07-10 Wrangler 	Part #
Black Diamond Vinyl, Each, 07-10	13107.35
Black/Gray Neoprene, Each, 07-10	13107.09
Black Neoprene, Each, 07-10	13107.01

## SUV/JEEP® STORAGE BAG

Custom designed to provide removable storage for Jeep® vehicles. Special size fits behind rear seat to organize and store your cargo. Constructed of durable vinyl with a zipper top and removable cargo dividers - easy to use shoulder strap included.



Off-Jeep®/SUV Storage Bag 	Part #
Universal all Jeep®	13551.01



## NEOPRENE SEAT PROTECTORS

Protect your seats from the elements, wet bathing suits and spills while providing a great look. Each set of seat protectors includes back pockets for rear storage as well as a removable cup holder. Cushioned center portion gives the Seat Protector a great look and provides you extra comfort on those long road trips. New solid color design further enhances the look of your Jeep®.

07-15 Wrangler Neoprene Seat Protector 	Black	Gray	Tan
With Factory Side Air bags, Pair	13235.30	13235.32	13235.21

## OFF-ROAD ORGANIZER

Custom design for use in Jeep® glove boxes. Special pockets allow you to effectively organize owners manuals, maps, tire gauges, vehicle registration and more. Constructed of durable nylon in a tri-fold configuration.

Off-Road Organizer 	Part #
Universal	13305.06





# CUSTOM FIT NEOPRENE SEAT COVERS

Protect your Jeep's® interior with these Custom Fit Neoprene Seat Covers from Rugged Ridge®. These covers are constructed of durable 100% neoprene with no filler fabrics creating the best fitting, longest lasting neoprene seat cover available. Neoprene (wetsuit material) is a great fabric to protect your seats from dirt, water and whatever mother nature can throw at you! Each cover is custom tailored for your Jeep's® original equipment seat style making your seats look like they have been recently reupholstered.

Installation is easy with special designed elastic cords, nylon straps and hooks that attach to your seat and to the seat cover mounting points. All seams have been double reinforced for strength and a special backing fabric is used on the seams for added protection against rips and tears. Available in black on black, grey on black, red on black and tan on black to complement virtually any Jeep® interior.



Custom Neoprene Seat Covers 	Black/Black	Black/Gray	Black/Red	Black/ Tan
Front, 07-10 Wrangler with or without Side Airbags, Pair	13214.01	13214.09	13214.53	-
Front, 11-15 Wrangler with or without Side Airbags, Pair	13215.01	13215.09	13215.53	13215.04
Rear, 07-15 Wrangler 4-Door, Pair	13264.01	13264.09	13264.53	13264.04
Rear, 07-15 Wrangler 2-Door, Pair	13265.01	13265.09	13265.53	13265.04



BUY WITH CONFIDENCE  
MINIMUM 5 YEAR WARRANTY

# RUGGED RIDGE® CARGO SEAT COVERS

Protect your seats and increase interior storage with our NEW Cargo Seat Covers! Constructed of heavy duty 600 denier polyester fabric with a special PVC liner on the seating area, these seat covers provide great protection from water, dirt and spills while giving your Jeep® a great look. Each cover has been specially designed with special elastic and Velcro straps to optimize the fit on your OE or aftermarket seat. The back of the cover incorporates five multi-use pouches, plus one sunglass pouch with elastic tool holding loops, and one knife / multi tool pouch that can also be used for iPod® and cell phone storage. Each of these seven pouches are easily removable and provide the needed storage every Jeep is lacking. Front Cargo Seat Covers are sold individually and are available in black and tan. Front Cargo Seat Covers are universal and fit most Jeep® applications from 1976-2015. They can be used with side air bags on 2007-2015 JK models.



Cargo Seat Covers 	Part #
Cargo Seat Cover, Front Bucket Seat, Black, Molle Pals System, Rugged Ridge, 07-15 Wrangler, Sold Each	13236.01
Cargo Seat Cover, Front Bucket Seat, Tan, Molle Pals System, Rugged Ridge, 07-15 Wrangler, Sold Each	13236.04

# SEAT BACK TRASH BIN

The new seat back removable trash bin from Rugged Ridge® makes it easier to "pack it in, pack it out". The easily accessible bin attaches to the headrest for convenience. Its 700 cubic inches of storage allows you to collect three gallons of debris, so you can keep the wilderness wild and the trails open.



Seat Back Trash Bins 	Part #
Seat Back Removable Trash Bin by Rugged Ridge, Black, Universal Application	13551.40

# SUNGLASS HOLDER/ROLL BAR STORAGE

Another perfect organization solution for your Jeep®! This sunglass holder allows you to stow your sunglasses, wallet, GPS, or other small accessories within arms reach. A perfect size zipper storage pouch allows for added storage right where you need it. Attaches easily to your sport bar using hook and loop fasteners. No drilling required.



Sunglass Holder	Part #
All Jeep® Wranglers	12101.52

# INTERIOR STORAGE



## DASH MULTI-MOUNT SYSTEM

With this Dash Multi Mount Phone kit from Rugged Ridge, you can take your smartphone along for the ride! The custom fitted cradle holds your smartphone securely during trail rides. With your hands safely on the steering wheel, now you have an attachment point for convenient access to your phone, Go Pro, or POV Camera, so you won't miss a moment of trail action. This system mounts to the dash recess of the JK Wrangler with no drilling required. Will accept up to 3.6-inch wide phones. Patent Pending.

Dash Accessory Multi-Mount	Part #
11-15 Wrangler Dash Multi-Mount System	13551.11
07-10 Wrangler Dash Multi-Mount System <b>NEW</b>	13551.12
11-15 Wrangler Dash Multi-Mount Phone Kit	13551.16
07-10 Wrangler Dash Multi-Mount Phone Kit <b>NEW</b>	13551.17



BUY WITH CONFIDENCE  
MINIMUM 5 YEAR WARRANTY

## DASH ORGANIZER

This innovative product incorporates existing mounting points to install a dual tray storage system right on your dash. Now you can easily store coins, pens, sunglasses, cell phones and other small items right in reach of both the passenger and driver. Installation is a snap; simply remove the original equipment screw covers on your dash, screw in the exclusive double headed mount and attach the Dash Organizer.



Rugged Ridge® Organizers	Part #
Dash Organizer, 07-10 Wrangler	13551.10

\*will not fit 11-14 models

## CB RADIO MOUNT

The Rugged Ridge CB Radio Mount offers you this easy to install solution. The CB Radio Mount conveniently mounts over the rearview mirror for an easy reach. Made from durable black powder coated steel, now your CB is attached high and within reach without having to take your eyes off the road or trail. Minor drilling required for 07-10 JK Wrangler, no drilling required for 11 and up JK Wrangler.



Rugged Ridge® CB Radio Mount	Part #
CB Radio Mount, 07-15 Wrangler	11503.95

## SUN VISOR COVERS

Each pair of visor covers quickly and easily attach to your factory sun visors without drilling or vehicle modification. Constructed of durable interior matching textured black vinyl, these covers will provide the storage and features you want while looking great.



Rugged Ridge® Sun Visor Covers 	Part #
07-09 Wrangler	13305.07
10-15 Wrangler	13305.08

## REAR VIEW MIRRORS

11020.02 Rear View Mirror, Black, 07-12 Jeep® Wrangler



Rear View	Part #
07-12 Wrangler, Each*	11020.02
Mounting Glue, Each	11021.01

\* Includes mounting glue.



## JK REAR SEAT ORGANIZERS

The perfect organization solution for your Jeep! The new Rugged Ridge® Back Seat Organizer features storage areas to organize wayward trash, toys, drinks, iPods and other clutter. Each organizer is designed to instantly fit into the rear cup holders of your 07-15 Jeep Wrangler and includes a removable double walled lid. The large storage area will hold up to three 12oz. soda cans or two 16.9oz. water bottles with ice. Easily removable to clean and empty, this truly is a must for your Jeep! Patent Pending.

JK Rear Seat Organizer	Part #
Rear Seat Organizer, Wrangler (JK) 07-10, Black	13551.15
Rear Seat Organizer, Wrangler (JK) 11-15, 2DR, Black	13551.50
Rear Seat Organizer, Wrangler (JK) 11-15, 4DR, Black	13551.51
Rear Seat Organizer, Wrangler (JK) 11-15, 2DR, Tan	13551.52
Rear Seat Organizer, Wrangler (JK) 11-15, 4DR, Tan	13551.53



11-15 Wrangler



07-10 Wrangler

## RUGGED RIDGE® OVERHEAD STORAGE CONSOLE

The Rugged Ridge® Overhead Storage Console instantly turns the area underneath your top into usable storage space without any interference or modification to your Wrangler. Works with soft tops, hardtops, the top up or down. The Overhead Storage Console is a fully enclosed storage compartment that installs easily without any tools or drilling. It is constructed from durable blow molded high-density polyethylene (HDPE), so it is safer and lighter than steel. A non-skid pad is adhered to the inside of the console to help keep your gear from sliding around, and a mesh storage net helps keep it safely stowed yet easily accessible. The console measures 41.5 x 2.5 x 6.5 inches and offers more than 450 cubic inches of storage.

Rugged Ridge® Overhead Storage Console	Part #
07-15 Wrangler	13551.14



## TRAIL BAGS

Rugged Ridge® has the answer for your onboard storage needs. These soft-side storage bags feature heavy canvas construction and oversized zippers. Great for carrying recovery gear, spare parts, camping gear, clothes, or any other necessity for a wheeling trip. Rugged nylon straps keep the bags in place during even the most insane wheeling. Make the most out of your roll cage with a full complement of Rugged Ridge® storage bags. These bags are easy to install and remove and work with both hard and soft tops.

Trail Bags	Part #
Seat Back Trail Bag, Detachable, 07-15 Wrangler, Each	13551.25
Seat Back Trail Bag, 07-15 Wrangler, Each	13551.26
Sport Bar Trail Bag, Canvas Storage Bag, 07-15 2-Door Wrangler, Each	11250.06
Sport Bar Trail Tube Bag, 07-15 Wrangler, Each	11250.05



11250.05 Sport Bar Trail Tube Bag

13550.06 Sport Bar Trail Bag

13551.25 Seat Back Trail Bag

## REAR STORAGE BIN

Protect your carpet from moisture, dirt, and grease with the exclusive Rugged Ridge® Storage Bin for 07-10 Wrangler. This custom fit storage bin fits perfectly in the rear cargo area storage compartment providing protection and an easy to use removable tote. Molded from rigid and durable ABS plastic for a perfect contoured fit and long life. The unique chevron pattern matches the look of the All Terrain Floor and Cargo Liners. Each bin features integrated handles making it easier to remove and clean.

Rugged Ridge® Storage Bin	Part #
Rugged Ridge® Storage Bin, 07-10 Wrangler	13122.01



# CHARCOAL/SILVER INTERIOR TRIM FOR 11-15 WRANGLER



Charcoal



11157.24



Charcoal

Dressing up your Wrangler has never been more fun! Now with Rugged Ridge's Interior Trim Kits, luxury and style are within arm's reach. These high profile finishes offer you the quality you want for the rugged look you love! Each piece has been custom designed for a flawless fit, giving your interior the showroom look. These injection molded plastic accents are molded directly from the factory interior pieces for an exact fit. Installation is a snap thanks to the pre-installed high-strength adhesive tape. Available for both 2-door and 4-door Wranglers, these interior add-ons are a must for any Jeep®. Available in brushed silver and charcoal.

**2-Door Kits include:** accents for Center Cup Console, Steering Wheel Trim, Front Door Net Trim, and Front Door Handle Trim

**4-Door Kits include:** all the accents in the 2-Door Kit plus Rear Door Handles & Net Trim



BUY WITH CONFIDENCE  
MINIMUM 5 YEAR WARRANTY

Kits	Silver	Charcoal
Interior Trim Accent Kit, 11-15 Wrangler 2-Door - Manual Transmission	11152.90	11157.90
Interior Trim Accent Kit, 11-15 Wrangler 2-Door - Automatic Transmission	11152.91	11157.91
Interior Trim Accent Kit, 11-15 Wrangler 4-Door - Manual Transmission	11152.95	11157.95
Interior Trim Accent Kit, 11-15 Wrangler 4-Door - Automatic Transmission	11152.96	11157.96



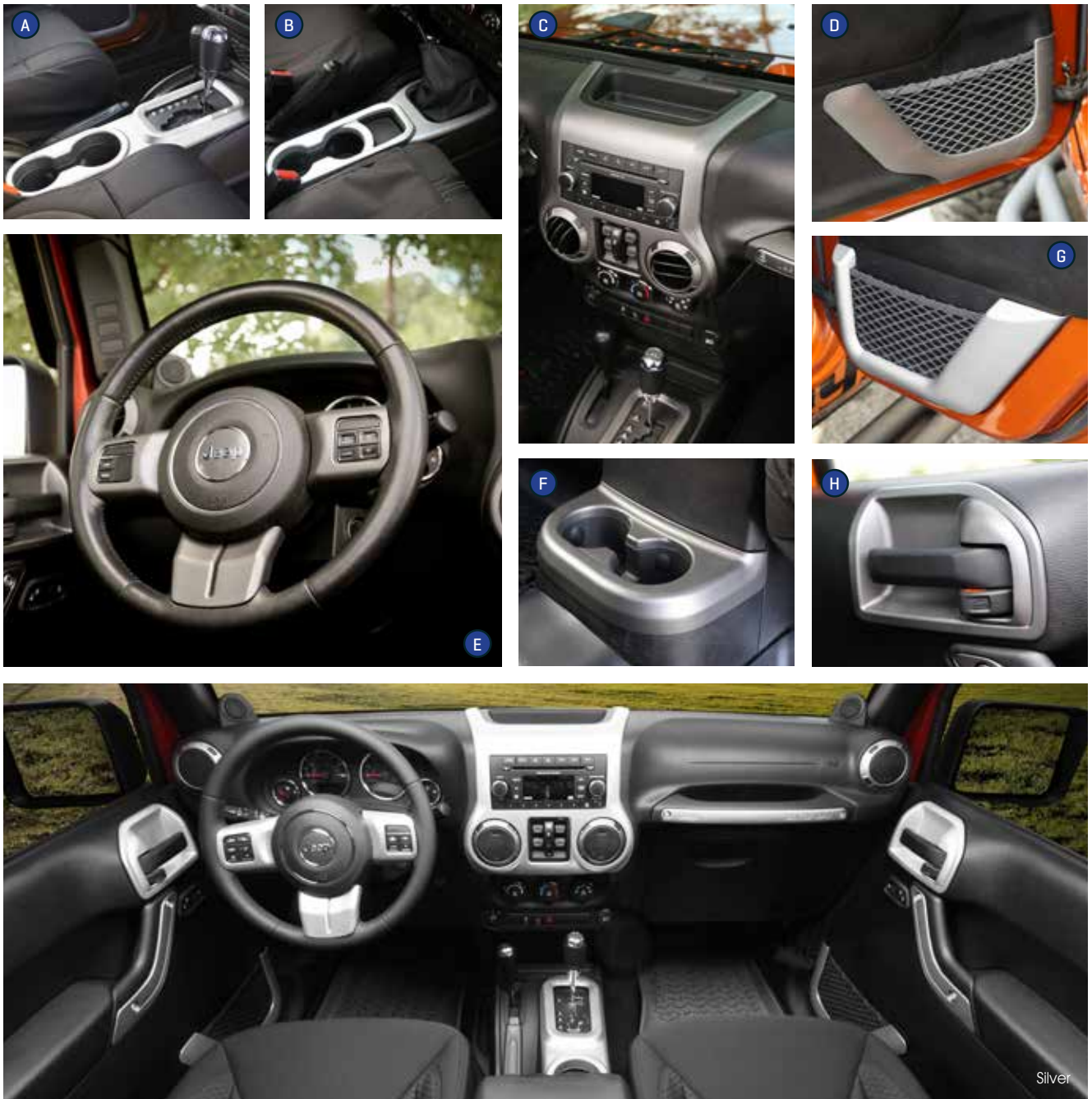

There's something about a stylish interior that gives your Jeep® that WOW factor. Now, Rugged Ridge has made it even easier to upgrade your style and personalize the inside of your ride with our customized interior components available in brushed silver or charcoal for 11-15 Wrangler.

Individual Components 11-15 Wrangler	Silver	Charcoal
A. Center Cup Console, Automatic	11152.13	11157.13
B. Center Cup Console, Manual	11152.23	11157.23
C. Center Radio Console	11152.24	11157.24
D. Door Net Trim, Front	11152.21	11157.21
E. Steering Wheel Trim	11152.12	11157.12
F. Center Cup Console, 2nd Row	11152.18	11157.18
G. Door Net Trim, 2nd Row	11152.22	11157.22
H. Interior Door (pair) *Need 2 pairs for 4-Door	11152.20	11157.20

# BRUSHED SILVER/CHROME INTERIOR TRIM FOR 07-10 WRANGLER



Dressing up your Wrangler has never been more fun! Now with Rugged Ridge's Interior Trim Kits, luxury and style are within arm's reach. These high profile finishes offer you the quality you want for the rugged look you love! Each piece has been custom designed for a flawless fit, giving your interior the showroom look. These injection molded plastic accents are molded directly from the factory interior pieces for an exact fit. Installation is a snap thanks to the pre-installed high-strength adhesive tape. Available for both 2-door and 4-door Wranglers, these interior add-ons are a must for any Jeep®. Available in brushed silver and chrome.



**2-Door Kits include:** accents for Shifter, AC Vent Covers, Tweeter Speakers, Steering Wheel, Front Clip Holder, Dash Panel, Grab Handle, Front Door Handles, and Front Door Pulls.

**4-Door Kits include:** all the accents in the 2-Door Kit plus Rear Door Handles & Rear Door Pulls.

\*Manual window kits do not include door pulls.



**BUY WITH CONFIDENCE**  
MINIMUM 5 YEAR WARRANTY

Kits	Brushed Silver	Chrome
Interior Trim Accent Kit, 07-10 Wrangler 2-Door - Manual Trans - Manual Windows	11151.92	11156.92
Interior Trim Accent Kit, 07-10 Wrangler 2-Door - Auto Trans - Manual Windows	11151.93	11156.93
Interior Trim Accent Kit, 07-10 Wrangler 4-Door - Manual Trans - Manual Windows	11151.97	11156.97
Interior Trim Accent Kit, 07-10 Wrangler 4-Door - Auto Trans - Manual Windows	11151.98	11156.98
Interior Trim Accent Kit, 07-10 Wrangler 2-Door - Manual Trans - Auto Windows	11151.90	11156.90
Interior Trim Accent Kit, 07-10 Wrangler 2-Door - Auto Trans - Auto Windows	11151.91	11156.91
Interior Trim Accent Kit, 07-10 Wrangler 4-Door - Manual Trans -Auto Windows	11151.95	11156.95
Interior Trim Accent Kit, 07-10 Wrangler 4-Door - Auto Trans - Auto Windows	11151.96	11156.96





There's something about a stylish interior that gives your Jeep® that WOW factor. Now, Rugged Ridge has made it even easier to upgrade your style and personalize the inside of your ride with our customized interior components available in brushed silver or chrome for 07-10 Wrangler.

Individual Components 07-10 Wrangler	Brushed Silver	Chrome
A. Tweeter Speaker Grille (pair)	11151.11	11156.11
B. Grab Bar Handle	11151.15	11156.15
C. Front Cup Holder Trim	11151.13	11156.13
D. Dash Panel Accent Trim (pair)	11151.14	11156.14
E. Rear Cup Holder Accent, 2Dr/4Dr,	11151.18	11156.18
F. Front Door Pull Handle (pair) *	11151.16	11156.16
G. Rear Door Pull Handle (pair). (For 4-Door Only) *	11151.17	11156.17
H. Interior Door Handle Covers (pair) *Need 2 pairs for 4-Door	11151.20	11156.20
I. Shifter Trim Automatic Transmission	11151.02	11156.02
J. Shifter Trim Manual Transmission	11151.01	11156.01
K. AC Vent Cover (pair) *Need 2 pairs	11151.10	11156.10

\* For models equipped with power windows only. Will not work with manual windows.

# BILLET INTERIOR TRIM & UNDER HOOD GARNISH

Enhance the appearance of your Jeep® with these premium CNC machined billet aluminum accessories from Rugged Ridge®. Available in a lightly brushed or black anodized finish. These high quality accessories replace your factory components with no drilling or modification. The easy installation allows you to upgrade your interior in minutes with simple hand tools!

Also available in black!



BUY WITH CONFIDENCE  
MINIMUM 5 YEAR WARRANTY

## Billet Aluminum Components

	Brushed Aluminum	Black
Wrangler 07-10, Automatic Transmission Shifter Knob, Billet Aluminum	11421.01	11422.01
Wrangler 07-10, Manual Transmission Shifter Knob, Billet Aluminum	11421.02	11422.02
Wrangler 07-10, Transfer Case Shifter Knob, Billet Aluminum	11421.03	11422.03
Wrangler 07-10, Emergency Brake Handle Cover, Billet Aluminum	11421.04	11422.04
Wrangler 07-10, Passenger Grab Bar Handle, Billet Aluminum	11421.10	11422.10
Wrangler 07-10, Automatic Transmission Shifter Bezel, Billet Aluminum	11421.11	11422.11
Wrangler 07-10, Manual Transmission Shifter Bezel, Billet Aluminum	11421.12	11422.12
Wrangler 07-10, Cup Holder Bezel, Front, Billet Aluminum	11421.14	11422.14
Wrangler 07-10, AC Vent Bezels, Set of Four, Billet Aluminum	11421.15	11422.15
Wrangler 07-11, Power Steering Cap, Billet Aluminum	11430.01	11431.01
Wrangler 07-15, Brake Master Cylinder, Billet Aluminum	11430.02	11431.02
Wrangler 07-11, Oil Cap, Billet Aluminum	11430.04	11431.04
Wrangler 07-15, Washer Fluid Cap, Billet Aluminum	11430.05	11431.05
Wrangler 07-11, Oil Dipstick Handle, Billet Aluminum	11430.07	11431.07
Wrangler 07-15, Auto Transmission Dipstick Handle, Billet Aluminum	11430.08	11431.08

# BILLET ALUMINUM CLIMATE CONTROL KNOBS

These stylish billet aluminum Wrangler Climate Control Knobs are easily installed by pulling off the factory knobs and pushing these back in their place. Choose red or blue colored inserts in the face of the knobs to illuminate at night and show their position.



Billet Aluminum Climate Control Knobs	Part #
07-10 Wrangler/Unlimited, Blue Indicator Lights, Set of 3	11420.05
07-10 Wrangler/Unlimited, Red Indicator Lights, Set of 3	11420.06

11420.06



## BLACK & STAINLESS ENTRY GUARDS

Protect your door threshold with these stylish entry guards. Available in three different finishes black, polished stainless and aluminum to enhance the look of your Jeep® while providing the ultimate in protection. 07-15 Wrangler entry guards available for two & four door models (2-door kits will fit front 4dDoor applications). 07-14 Wrangler models attach without screws using durable double sided automotive grade adhesive.

Entry Guards	Black	Stainless
07-15 Wrangler Front Door Openings Only (2 & 4-Door) Pair	11216.10	11119.04
07-15 Wrangler 4-Door Front & Rear, (4 pcs set)	11216.11	11119.05



11216.10

## SPLASH GUARDS

Looking for some protection for the bottom and lower side panels of your vehicle to prevent mud and water splatters? Rugged Ridge has you covered with our Splash Guards! Featuring high quality injection molded TPE material; these guards are paintable and offer styling accents to customize your vehicle's look.

Splash Guards for 07-14 Wrangler	Part #
Splash Guard Kit, Black, 4 pieces	11642.10
Splash Guards, Black, Front, Pair	11642.11
Splash Guards, Black, Rear, Pair	11642.12



11642.11



11642.12

## LED FOG LIGHT MOUNTS *New!*

Mount your Rugged Ridge cube or round LED lights with these Fog Light Mounts. The mounts work with OE, Rugged Ridge and other aftermarket bumpers. They are easily installed without any drilling required and are built to last with their durable textured powdercoating.

LED Fog Light Mount	Part #
LED Fog Light Mount, Cube	11232.23
LED Fog Light Mount, Round	11232.24
LED Bracket Kit, Cube, 07-15 Jeep Wrangler	11232.28
LED Bracket Kit, Round, 07-15 Jeep Wrangler	11232.27



11232.23



11232.24

## BUG DEFLECTOR SHIELD

Protect your windshield and hood from flying debris and bugs with this durable Bug Deflector Shield from Rugged Ridge®. Constructed of tough shatter resistant smoked acrylic, this bug shield is designed to last the test of time. Installation is easy using double sided automotive adhesive tape and under hood screw attachments (some drilling required).

Rugged Ridge® Bug Deflector Shield	Part #
07-15 Wrangler	11350.02

## WINDSHIELD HINGES/BRACKETS

Windshield Hinge Bracket	Part #
07-15 Wrangler, Windshield Hinge Brackets, Pair	11209.03

## PARKING LIGHT BEZELS

Parking Light Bezels	Part #
Black, 07-15 Wrangler, Pair	12419.26

## HEADLIGHT BEZELS

Complete the unique look of your grille with these easy to install head light and turn signal lamp bezels from Rugged Ridge®. Each UV treated bezel easily attaches to factory mounting points creating a clean look. Matched up with the Rugged Ridge® Grille Inserts, you now have that sleek off road look.

Headlight Bezels	Black
07-15 Wrangler, Pair	12419.25

## HOOD SCOOP

Increase the efficiency of your heater and air conditioner with these easy to install Rugged Ridge Hood Scoops. Available in UV treated chrome plastic, black UV treated plastic or durable smoked acrylic for long life and matching good looks. Ram Induction hood scoop is designed to provide maximum air flow to your passenger compartment. Installation is easy with double sided automotive grade tape. No drilling required. Mounts facing either direction.

Hood Scoops	Smoked	Black
07-15 Wrangler	11352.10	11352.12

## FRONT EURO-GUARDS

Protect your headlights from debris and get that off road look with a set of Rugged Ridge® Euro-Guards. Constructed of durable powder coated steel, these front Euro-Guards are designed to last. No drilling required for installation. Each kit comes with a pair of guards to cover both sides of the vehicle. The side marker light guards are a great complement to our front light Euro-Guards. The turn signal light guards are designed to match Rugged Ridge Headlight Euro-Guards and feature the same great style and construction.

Black Front Euro Light Guards	Part #
07-15 Wrangler, Head Light Guards, Pair*	11230.03
07-15 Wrangler, Parking Light Guards, Pair*	11231.11
07-15 Wrangler, Side Marker Light Guards, Pair*	11231.12
07-15 Wrangler, Parking Light & Side Marker Guards, 4 Pc Kit	11231.02

\* fits 2 and 4-Door Wrangler



The Complete Look for your JK:  
11230.03, 11231.11, 11231.12, 11231.13



## BILLET STYLE GAS COVERS

Create a custom look in just a few minutes. This special design fits directly over the existing gas cap opening. Available in locking and non-locking versions. They are specially treated to resist blemishes caused by gasoline or other hazardous chemicals.

Billet Style Gas Covers		Part #
07-15 Wrangler	Black Aluminum	11425.05
07-15 Wrangler	Black Aluminum, Locking	11425.06
07-15 Wrangler	Black Painted Stainless	11229.02
07-15 Wrangler	Black Painted Stainless, Locking	11229.03

## WINDOW RAIN DEFLECTORS

Rugged Ridge® Window Rain Deflector	Part #
Front, Smoked Acrylic, Wrangler 2-Door (JK) 07-15	11351.11
Front & Rear, Smoked Acrylic, Wrangler 4-Door (JK) 07-15	11351.12

## HINGE TREATMENTS

These cast steel design Rugged Ridge Hinge Treatments are guaranteed not to rust while providing a new rugged look. Door and Hood Hinge covers feature an easy-to-install design. Replacing your existing hinges can break & crack the surrounding paint, as the hinges were painted at the factory after installation.

Hinge Treatment, Black	Part #
07-15 Wrangler, Pair	11205.10*
07-15 Wrangler 2-Door, Set of 4	11202.04
07-15 Wrangler 4-Door, Set of 8	11202.05

## HOOD ACCESSORIES

Powder coated in a semi gloss finish to protect your investment against the elements. Every part or kit comes with complete hardware to ensure a trouble free installation.

Hood Set, Black	Part #
07-12 Wrangler, Set	11201.04
13-15 Wrangler, Set	11201.03

Hood Vent Cover	Part #
07-15 Wrangler, Each	11206.05

Windshield Tie Down Kits	Part #
07-12 Wrangler (1 footman loop, 2 hood bumper accents, & 1 washer nozzle cover), 4-Pc. Kit	11201.05



11201.04 Hood Set

## FOG LAMP EUROGUARDS

Protect those expensive fog lights from impact with the Rugged Ridge® Euro Light Guards. Each Euro Light Guard is easy to install with no adhesive or drilling required. They are available in a textured black powder coat finish for long life and to match the other Rugged Ridge® Euroguards.



BUY WITH CONFIDENCE  
MINIMUM 5 YEAR WARRANTY



Euro Guard Fog Light Covers	Part #
07-15 Wrangler	11231.13*

\* Except Sahara models

## REAR EURO-GUARDS

Protect and upgrade the look of your Jeep® with a set of Rugged Ridge® Euro Taillight Guards. Each Rear Euro Taillight Guard is easy to install with no drilling required. Rubber inserts around the mounting screws on 2007-15 models keep the metal Euro Guard off the taillight, preventing scratching and rattles.



Rear Euro Guards	Part #
07-15 Wrangler, Pair	11226.02

## QUICK RELEASE MIRROR RELOCATION

Love taking your doors off, but hate the hassle of swapping out your mirrors? Have mirror relocation brackets, but dislike the limited visibility they offer with doors on? The Rugged Ridge Quick Release Mirror Relocation Kit is the perfect solution for your Wrangler. The mirrors mount to a bolt-on bracket and are secured with a locking knob that allows for easy installation and removal. The long adjustable arms give you great visibility with your doors on or off.



Black Quick Release Mirrors	Part #
Round Quick Release Mirrors, 07-15 Wrangler, Pair	11025.10
Round Quick Release Mirrors, 07-15 Wrangler	11025.11
Rectangular Quick Release Mirrors, 07-15 Wrangler, Pair	11025.12
Rectangular Quick Release Mirrors, 07-15 Wrangler	11025.13



11210.11



11116.07



11210.17

## ALUMINUM HOOD CATCHES

The Rugged Ridge Aluminum Hood Catches were built as a strong direct replacement for the OE catches that degrade and fail after years of off-road abuse. Available in black powder coated and durable silver finishes, these hood catches incorporate an adjustable tension rod guaranteeing a precise fit. Installation is a breeze for any do-it-yourselfer with just basic hand tools. The catches were designed to be a bolt-on solution using the same mounting points as the factory hardware. Patent D692, 290

Aluminum Hood Catches, 07-15 Wrangler	Part #
Black, Pair	11210.11
Textured Black, Pair <b>NEW</b>	11210.18
Silver, Pair	11116.07

**Rugged Ridge**

BUY WITH CONFIDENCE  
MINIMUM 5 YEAR WARRANTY



## DOOR RECESS GUARDS

Give your Jeep® a great new custom look in just a few minutes! Made from ABS plastic, these exterior trim pieces are designed to save your paint from fingernail scratches. Easy installation! They install in seconds using pre-applied double-sided tape.

Door Recess Guard Kit	Part #
Door Handle Recess Guard Kit, Black, 07-15 Wrangler Unlimited, 5 pieces	11651.26
Door Handle Recess Guard Kit, Black, 07-15 Wrangler, 3 pieces	11651.25





# TEXTURED BLACK EXTERIOR ACCESSORIES

## TEXTURED BLACK EURO GUARDS

Protect your lights from debris and get that off road look with a set of Rugged Ridge® Euro-Guards. Constructed of durable powder coated steel, these front Euro-Guards are designed to last. No drilling required for installation. Each kit comes with a pair of guards to cover both sides of the vehicle.

*New!*

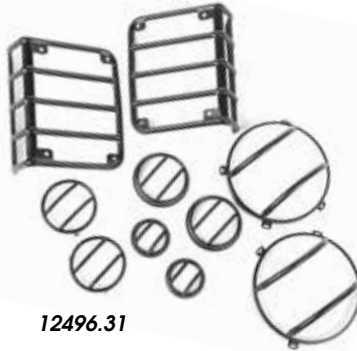

12496.31



Textured Black Euro Guards	Part #
Headlight Euro Guards, 07-15 Wrangler	11230.11
Tail Light Euro Guards, 07-15 Wrangler	11226.11
Turn Signal Euro Guards, 07-15 Wrangler	11231.21
Side Marker Euro Guards, 07-15 Wrangler	11231.22
Euro Guards, Fog Light, 07-15 Wrangler	11231.23
Euro Guard Kit, 10-Piece, 07-15 Wrangler	12496.31
Euro Guard Kit, 8-Piece, 07-15 Wrangler	12496.32



11201.03

## TEXTURED BLACK HOOD ACCESSORIES *New!*

Each Rugged Ridge hood accessory is powder coated to protect your investment against the elements. Every part or kit comes with complete hardware to ensure a trouble free installation.

Textured Black Hood Accessories	Part #
Hood Dress Up Kit, 8 pieces, 13-15 Wrangler	11201.03
Windshield Tie Down Kit, 5 pieces, 13-15 Wrangler	11201.06



11025.14

11025.15

## TEXTURED BLACK QUICK RELEASE MIRROR RELOCATION

Love taking your doors off, but hate the hassle of swapping out your mirrors? Have mirror relocation brackets, but dislike the limited visibility they offer with doors on? The Rugged Ridge Quick Release Mirror Relocation Kit is the perfect solution for your Wrangler. The mirrors mount to a bolt-on bracket and are secured with a locking knob that allows for easy installation and removal. The long adjustable arms give you great visibility with your doors on or off.

Textured Black Quick Release Mirrors for 07-15 Wrangler	Part #
Rectangular Quick Release Mirrors, 07-15 Wrangler	11025.14
Round Quick Release Mirrors, 07-15 Wrangler	11025.15
Rectangular Quick Release Mirrors, 07-15 Wrangler, Pair	11025.18
Round Quick Release Mirrors, 07-15 Wrangler, Pair	11025.16
Mirror Filler Plates, 07-15 Jeep Wrangler	11025.06



*New!*

## MIRROR RELOCATION BRACKET

Custom designed brackets bolt into existing holes on the windshield, relocating your mirrors off the door. The perfect add-on accessory for those off-road adventures where you do not want your doors. Each bracket kit for the 07-15 Wrangler comes with a special paintable filler plate to cover up the hole created when you remove your mirrors. Sold in pairs.

Textured Black Mirror Relocation Bracket	Part #
07-15 Wrangler, Pair	11025.07

# STAINLESS HINGE TREATMENTS

These cast stainless design hinge treatments are guaranteed not to rust while providing a new tough look. Door and Hood Hinge covers feature a easy-to-install design. Replacing your existing hinges can break & crack the surrounding paint, as the hinges were painted at the factory after installation. These covers retain the stock hinge but give it a new look without harming your expensive paint. A direct bolt on - no drilling required, fits either side.

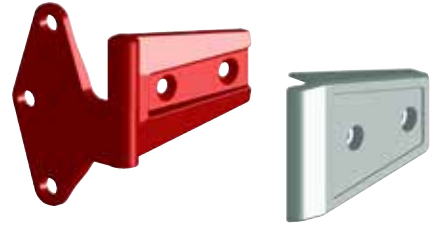

Hinge Treatment	Stainless
Hood Kit, 07-15 Wrangler, Pair	11111.10
Door Kit, 07-15 Wrangler 2-Door Kit, 4 Hinges	11113.05
Door Kit, 07-15 Wrangler 4-Door Kit, 8 Hinges	11113.06

## QUICK RELEASE MIRROR RELOCATION

Love taking your doors off, but hate the hassle of swapping out your mirrors? Have mirror relocation brackets, but dislike the limited visibility they offer with doors on? The Rugged Ridge Quick Release Mirror Relocation Kit is the perfect solution for your Wrangler. The mirrors mount to a bolt-on bracket and are secured with a locking knob that allows for easy installation and removal. The long adjustable arms give you great visibility with your doors on or off.



Stainless Steel Quick Release Mirrors	Part #
Round Quick Release Mirrors, 07-15 Wrangler, Pair	11026.10
Round Quick Release Mirrors, 07-15 Wrangler	11026.11
Rectangular Quick Release Mirrors, 07-15 Wrangler, Pair	11026.12
Rectangular Quick Release Mirrors, 07-15 Wrangler	11026.13

## STAINLESS WINDSHIELD BRACKETS

These hinges and brackets are one of those pieces that really shows off an attention to detail. They install quickly and easily and add a little bit of bling. Sold as a matching left/right hand pair. Includes all necessary hardware.



Stainless Windshield Hinges	Part #
07-15 Wrangler, Pair - Bracket	11112.03

## HOOD CATCHES

Get the ultimate WOW factor with Rugged Ridge polished stainless steel accessories. These beautiful bolt on accessories turn even the most worn Jeep into a hot street machine. Constructed of prime 304 stainless steel that has been polished to a mirror finish.



Hood Catch, Stainless	Part #
07-15 Wrangler, Pair (Cast Stainless)	11116.06

## STAINLESS & BILLET STYLE GAS HATCH COVERS

Create a custom look in just a few minutes. This special design fits directly over the existing gas cap opening. These tough gas covers are available in either stamped stainless steel, polished aluminum or chromed aluminum and are specially treated for resistance to gasoline and other chemicals. Available with or without locking mechanism. Please note that your factory gas cap is still required.

Stainless & Billet Style Gas Covers	Part #
07-15 Wrangler, Each	Stainless Steel 11134.02
07-15 Wrangler, Each	Stainless Steel, Locking 11134.03
07-15 Wrangler, Each	Chromed Aluminum 11425.03
07-15 Wrangler, Each	Chromed Aluminum, Locking 11425.04





# STAINLESS STEEL EXTERIOR ACCESSORIES

Get the ultimate WOW factor with Rugged Ridge® polished stainless steel accessories! These beautiful bolt on accessories turn even the most worn Jeep® into a hot street machine. Constructed of durable 304 stainless steel that has been polished to a mirror finish, these accessories are built to last. 304 stainless steel is virtually rust proof guaranteeing that these parts will stand the test of time. All hardware is also constructed of stainless steel so the polished look you are going for is complete. Rugged Ridge® offers the most complete line of stainless accessories so you can truly customize the look of your vehicle. When you want the best, look to Rugged Ridge® Stainless Accessories!

## EURO-GUARDS

Protect those expensive lights from impact with the Rugged Ridge® Euro Light Guards. Each euro light guard is easy to install with no drilling required. They are of polished stainless steel for a true attention to detail.

Front Euro-Guards	Part #
07-15 Wrangler, Headlight Guards, Pair	11142.04
07-15 Wrangler, Parking Light Guards, Pair	11142.11
07-15 Wrangler, Side Marker Light Guards, Pair	11142.12
07-15 Wrangler, Fog Light Guards, Pair	11142.13
07-15 Wrangler, Tail Light Guards, Pair	11103.03



## STAINLESS HINGES

Solid stainless steel can't be beat for longevity and that's why Rugged Ridge® now offers stainless steel hinges for the 07-15 Wrangler. These hinges are a direct bolt-on replacement for the stock units. Installation is easy with only simple hand tools. Both door and hood hinge sets are available for a complete vehicle makeover. Includes matching stainless steel hardware.

Stainless Steel Hinges for 07-14 Wrangler	Part #
Hood Hinge Kit, 07-15 Wrangler, Pair	11111.22
Door Hinge Kit, 07-15 Wrangler 2-Door, 4 Hinges	11111.20
Door Hinge Kit, 07-15 Wrangler 4-Door, 8 Hinges	11111.21

## ANTENNA BASE COVER

This chromed plastic antenna base cover is a quick and easy way to add a touch of flash to your 07-15 Wrangler. Simply unscrew your factory antenna and place the cover over the factory antenna base. Installation is easy thanks to the pre-attached durable double sided automotive grade tape.

Antenna Base Cover	Part #
07-15 Wrangler, Each	13311.26



## DOOR HANDLE COVERS/RECESS GUARDS

Give your Jeep® a great new custom chrome look in just a few minutes! Made from triple chrome plated ABS plastic, these exterior trim pieces are designed to resist flaking and oxidation. Easy no drill installation!

Door Handle Covers/ Recess Guards	Part #
Chrome Door Handle Covers, 2-Door, 07-15 Wrangler, 3 Pc. Kit	13311.11
Chrome Door Handle Covers, 4-Door, 07-15 Wrangler, 5 Pc. Kit	13311.12
Chroms Door Handle Cover Replacement Piece, 07-15 Wrangler	13311.10
Chrome Door Handle Reccess Guards, 2-Door, 07-15 Wrangler, 3 Pc. Kit	13311.15
Chrome Door Handle Reccess Guards, 4-Door, 07-15 Wrangler, 5 Pc. Kit	13311.16
Chrome Door Handle Covers & Reccess Guard Kit, 2-Door, 07-15 Wrangler, 6 Pc. Kit	13311.17
Chrome Door Handle Covers & Reccess Guard Kit, 4-Door, 07-15 Wrangler, 10 Pc. Kit	13311.18
Black Door Handle Reccess Guards, 2-Door, 07-15 Wrangler, 3 Pc. Kit	11651.25
Black Door Handle Reccess Guards, 4-Door, 07-15 Wrangler, 5 Pc. Kit	11651.26



## MIRROR & MIRROR ARM COVERS

Give your JK Wrangler a unique look with these mirror and arm covers. Available in pairs as mirror covers, just the arms or a kit for both. Made from chrome plated ABS plastic, these pieces are an easy install, using pre-applied double-sided tape.

Mirror & Mirror Arm Covers	Part #
Mirror Covers, Chrome, 07-15 Wrangler, Pair	13311.01
Mirror Arm Covers, Chrome, 07-15 Wrangler, Pair	13311.02
Mirror Cover Kit, Chrome, 07-15 Wrangler, 4 Piece Kit	13311.03



BUY WITH CONFIDENCE  
MINIMUM 5 YEAR WARRANTY

## HOOD ACCESSORIES

Each Rugged Ridge hood accessory is made of stainless steel to protect your investment against the elements. Every part or kit comes with complete hardware to ensure a trouble free installation.

Hood Kit, Stainless	Part #	Hood Vent, Stainless	Part #
07-12 Wrangler, 7 pc. Kit	11101.04	07-15 Wrangler	11117.05
13-15 Wrangler, 8 pc. Kit	11101.07		
Hood Scoop, Chrome	Part #		
07-15 Wrangler	11352.11		
Windshield Tie Down Kit	Part #		
07-12 Wrangler, Stainless Kit (Footman loop, windshield bumper covers, washer cover)	11101.05		



## WINDSHIELD LIGHT BRACKETS

These Rugged Ridge Windshield Light Brackets are easily and quickly mounts to your factory windshield hinge creating two great spots for off-road lighting. Foam backing protects your vehicle's finish. No drilling required for installation. Sold in pairs with all mounting hardware (light not included).

Stainless Windshield Light Brackets (Pair)	Part #
07-15 Wrangler	11028.03

## TAILGATE HINGE COVERS

These UV-treated chromed plastic Tailgate Hinge Covers attach to your vehicle with durable double sided tape.



Stainless Tailgate Hinge Covers	Part #
07-15 Wrangler	13311.24





# X-CLAMPS

## *FEATURING PIVOTAL FIT TECHNOLOGY™*

The X-Clamp from Rugged Ridge® features an innovative and unique adjustment which allows mounting to tubes ranging from 1.25 to 3 inches. Rotate the X-Clamp to fit your tube and pivot the mounting bracket to the desired position. Perfect for mounting off-road accessories including lights and cameras. Patent Pending.

- Extremely versatile mounting system allows accessories to be mounted anywhere you have tubing!
- Rugged die cast aluminum construction
- Mounts lights, antennas, cameras, etc. to tubes ranging from 1.25"-3" (available in two sizes, 1.25"-2" and 2.25"-3")
- Available in durable silver or black powder coated finish



***NOW AVAILABLE IN TEXTURED BLACK!***

<b>X-Clamps &amp; LED Light Kits</b>	Black	Silver	Textured Black
X-Clamp, 2.25-3", Single	11030.01	11030.10	11030.40
X-Clamp, 2.25-3", Pair	11030.02	11030.11	11030.41
X-Clamp, 2.25-3", 3pc	11030.03	11030.12	11030.42
X-Clamp Kit, 2.25-3", Single with 1 Square LED Light	15210.01	15210.10	-
X-Clamp Kit, 2.25-3", Pair with 2 Square LED Lights	15210.02	15210.11	-
X-Clamp Kit, 2.25-3", 3pc with 3 Square LED Lights	15210.03	15210.12	-
X-Clamp Kit, 1.25-2", Single	11031.01	11031.10	11030.20
X-Clamp Kit, 1.25-2", Pair	11031.02	11031.11	-
X-Clamp Kit, 1.25-2", Single with 1 Square LED Light	15210.21	15210.31	-
X-Clamp Kit, 1.25-2", Pair with 2 Square LED Lights	15210.22	15210.32	-
X-Clamp Kit, 1.25-2", Single with 1 Round LED Light	15210.24	15210.34	-
X-Clamp Kit, 1.25-2", Pair with 2 Round LED Lights	15210.25	15210.35	-



# XHD ALUMINUM BUMPER SYSTEM

The XHD Aluminum Bumper System was designed to be a whole new look while being extremely light weight allowing you to save on fuel and the need for front suspension spacers. The bumper is all aluminum but uses the current steel XHD D-rings. Each bumper comes with a built in top filler plate. Each new aluminum XHD has cutouts and mounting points for the factory fog lights and a great looking "Jeep® Style" front slat look that will make this bumper stand out. If you want to run a winch, simply remove the filler plate and attach the optional JK winch mounting plate (steel plate). The XHD Aluminum Bumper is approximately 80lbs+ lighter than the average steel off road bumper. Government studies show a fuel economy benefit of 2% for every 100lbs of weight savings. Patent NOs 7,703,834 & 8,393,656

## Available Components:

- Aluminum center section with steel D-rings
- Stubby Bumper Ends - aluminum
- JK winch plate - special design for this bumper
- Special aluminum over-rider with front slope



Note: Aluminum XHD & Steel XHD components are not interchangeable.



## Just How Light is the Aluminum XHD Bumper?

Front Bumper	Weight
Aluminum XHD - Standard Configuration*	26.9lbs
OE Bumper	35.7lbs
Brand X Off Road Bumper	110lbs & Up

\*Standard Configuration: Bumper Base, Filler Plate & D-Rings. The optional Hoop Over-rider, Stubby Ends & Winch Plate make the maximum overall weight of the bumper 62.6lbs.

JK Aluminum Front Bumper	Part #
07-15 Wrangler Non-Winch, Textured Blk,	11541.02
07-15 Wrangler With Winch, Textured Blk,	11541.01
07-15 Wrangler Winch Plate,	11541.13
07-15 Wrangler Front Bumper Ends, <sup>1</sup>	11541.10
07-15 Wrangler Over Rider, <sup>1</sup>	11541.14
07-15 Wrangler Double X-Striker	11542.13
D-Ring Pair, 3/4" (F)	11235.01

# XHD ALUMINUM REAR BUMPER PODS

Taking the lightweight theme further, we have developed steel inner framed Aluminum Rear Bumper Pods. These new lightweight pods still allow for over sized tires but take a huge chunk of weight out of the bumper. (The picture shows the rear pods installed with the enclosed steel D rings for the XHD Rear Tire Carrier). Each pod can be used with tire carrier part #11546.20 to hang those 35-inch+ tires shown in picture with the optional center step. The XHD Aluminum Bumper Pods are approximately 40lbs+ lighter than the average steel off road bumper. Government studies show a fuel economy benefit of 2% for every 100lbs of weight savings.



BUY WITH CONFIDENCE  
MINIMUM 5 YEAR WARRANTY

11547.01

11547.10



## Just How Light is the Aluminum XHD Rear Bumper?

Rear Bumper	Weight
Aluminum XHD - Standard Configuration*	43.45lbs
OE Plastic Bumper Cover	16.5lbs
Brand X Off Road Bumper	85lbs & Up

\*Standard Configuration: Pods, Brackets & D-Rings. The optional Step adds an additional 6lbs.

JK Aluminum Rear Bumper	Part #
07-15 Wrangler XHD Bumper Pods, Textured Blk,	11547.01
07-15 Wrangler XHD Bumper Pod Center Step, Textured Blk,	11547.10





# XHD MODULAR BUMPER SYSTEM

THE MOST ADVANCED, TOUGHEST, MOST FLEXIBLE BUMPER SYSTEM EVER CREATED! THE ONE & ONLY ORIGINAL.



No other bumper can give your Jeep® this many looks. The modular design provides dozens of different looks and styles, you can build the exact bumper of your choice! Custom designed for the 2007-2015 Jeep® Wranglers, each component maximizes the oversized look of the vehicle. All components are constructed of heavy-duty textured black powder coated steel with a tough E-Coat undercoating or polished, no rust, prime 304 stainless steel for the ultimate look! These tough finishes will provide years of heavy-duty use. Matching rear bumpers are available for a complete look. Patent NOs 7,703,834 & 8,393,656



### Application

Application	Part #
07-15 Wrangler, Short Base, Winch Mount, Textured Black D-Rings (A)	11540.10
07-15 Wrangler, Short Base, Non-Winch, Light Mount, Textured Black D-Rings	11540.11
07-15 Wrangler, RRC Mount, 2.5" Tube, Textured Black for XHD Bumper (B)	11540.18
07-15 Wrangler, Stinger, 2" Textured Black for XHD Bumper (C)	11540.13
07-15 Wrangler, Hoop Over-Rider, 60mm Textured Black for XHD Bumper (D)	11540.14
07-15 Wrangler, Standard Ends, Textured Black for XHD Bumper (E)	11540.12
07-15 Wrangler, Storage Ends, Textured Black for XHD Bumper*	11540.22
07-15 Wrangler, Tube Ends, Textured Black for XHD Bumper (F)	11540.21
07-15 Wrangler, Stubby Ends, Textured Black for XHD Bumper (G)	11540.23
07-15 Wrangler, D-Rings, Pair For Use With Stinger & RRC D-Ring Mounts (H)	11235.01
Mounting Plates For Warn Power Plant Winch (for use on 11540.10 only)	11540.15
07-15 Wrangler, D-Rings, Pair (Included w/ XHD Bumper base) (J)	11540.20
07-15 Wrangler, High Clearance Ends, for XHD Front Bumper <b>NEW</b> (K)	11540.24
07-15 Wrangler, Double X Striker, for XHD Front Bumper <b>NEW</b> (L)	11540.25
07-15 Wrangler, XHD Bumper Tow Hook Covers <b>NEW</b>	11540.26

\*Storage ends will not work with the (B) RRC front bumper mount\*





## HD TIRE CARRIER KIT *New!*

Our newest tire carrier features an aggressive off road design, is constructed from heavy duty cast aluminum, and offers an easy to install, no drill solution that effectively reduces wear on your tailgate and tailgate hinges. By replacing the factory hinges with the tire carrier and upgraded spindles using the factory mounting points, the Jeep owner now has the ability to operate both the carrier and tailgate simultaneously without any hassle. This design also incorporates an adjustable wheel mount. The Heavy Duty Tire Carrier can be used with either stock or aftermarket rear bumpers. Patent Pending.

Description	Part #
HD Tire Carrier Kit, Black, 07-15 Jeep Wrangler	11546.50
HD Tire Carrier, Hinge Casting	11546.51
HD Tire Carrier, Wheel Mount	11546.52



## XTREME HEAVY-DUTY (XHD) REAR BUMPER SYSTEM FOR 07-15 WRANGLER

Versatility has no limits with our XHD Rear Bumper System. Features easy installation, amazing looks and two reinforced heavy-duty D-Ring attachment points. A special "inner mounting plate" provides an extremely secure mounting point - strong enough for off-road use! The two-piece design allows use with and without tire carrier options. Heavy-duty powder coated steel design looks great but is extremely tough. Mount on the optional Heavy Duty Tire Carrier and you can hold up to a 35-inch tire.



### Xtreme Heavy-Duty Rear Bumper

	Part #
Rear XHD Bumper, Textured Black, 07-15 Wrangler	11546.20
Rear Receiver Hitch, 07-15 Wrangler	11580.10
Rear Receiver Hitch, 07-15 Wrangler, With Wiring Harness	11580.51



BUY WITH CONFIDENCE  
MINIMUM 5 YEAR WARRANTY

## XHD STORAGE ENDS

Looking for an easily accessible yet secure storage solution for your Wrangler? XHD Storage Ends from Rugged Ridge® turn your bumper into a stylish watertight storage vault. The XHD Storage ends are a great place to stow recovery gear and other valuables. Beefy steel construction, a watertight seal, and lockable lid helps keep mud and water out and your gear in.

### XHD Storage Ends

	Part #
07-15 Wrangler, Storage Ends, Textured Black	11540.22



BUY WITH CONFIDENCE  
MINIMUM 5 YEAR WARRANTY



## ALSO AVAILABLE IN STAINLESS FOR A WHOLE NEW LOOK!

### XHD Bumper System (Stainless Steel)

	Part #
07-15 Wrangler, Short Base, Light Mount, Stainless Steel, Stainless D-Rings*	11540.71
07-15 Wrangler, Hoop Over-Rider, 60mm Stainless for XHD Bumper**	11540.16
07-15 Wrangler, Standard Ends, Stainless for XHD Bumper, Pair	11540.19
07-15 Wrangler, Tube Ends, Stainless for XHD Bumper, Pair	11540.73
07-15 Wrangler, Polished Stainless D-Rings, Replaces Standard XHD D-Rings, Pair	11540.17

\* Includes Stainless D-Rings \*\* Will not work with Warn Power Plant Winch.







## XHD TIRE CARRIER MOUNT FOR 07-15 WRANGLER

Unlike previous designs, Rugged Ridge's GEN II Swing & Lock Tire Carrier maintains full mobility of the rear tailgate and eliminates the cumbersome two-stage opening process present in other designs. Using the factory latch mechanism and a reinforced spindle, Jeep owners have the ability to mount up to a 37-inch tire and operate both the carrier and tailgate simultaneously without any hassle.

XHD Tire Carrier Mount	Part #
GEN II Swing & Lock Tire Carrier 07-15 JK Wrangler	11546.25



## TIRE CARRIER LINKAGE

Has opening your rear tailgate become a burden since you added a swing out tire carrier? Has it become easier to crawl over the rear seat to grab your gear, than struggling with the tire carrier? The Rugged Ridge® Tire Carrier Linkage Kit eliminates this issue and makes accessing the cargo area quick and painless. Once installed, the linkage mates the tire carrier to the tailgate, so both open in a single fluid movement. The Tire Carrier Linkage is designed to work with Rugged Ridge® XHD, rear bumper and tire carriers, but will also work with most other aftermarket tire carriers. No drilling is required to mount the linkage to the tailgate, but some minor drilling is required to mount the linkage to the tire carrier. (Not needed with 11546.25)

Tire Carrier Linkage	Part #
Tire Carrier Linkage, 07-15 Wrangler (JK)	11503.91



**Rugged Ridge**

BUY WITH CONFIDENCE  
MINIMUM 5 YEAR WARRANTY

## TIRE CARRIER RECOVERY (TCR) BAG

The TCR bag has been designed to mount to Rugged Ridge® RRC, XHD & Classic rear tire carrier bumpers. This bag allows the storage of all your recovery gear between the A-frame uprights on your rear tire carrier. Constructed of weather resistant material & features a zipper flap to help protect your gear from the environment.



Tire Carrier Recovery Bag (Each) 	Part #
TCR Bag Fits XHD Rear Bumper with Classic Tire Carrier	12801.50

## THIRD BRAKE LIGHT EXTENSION

The third brake light extension kit from Rugged Ridge is the brake light solution JK owners have been waiting for. Our brake light extension kit is fully adjustable in 1" increments and works with the OE spare tire carrier and most aftermarket units as well. It is made from durable black powder coated steel. It moves the third brake light up above oversized spare tires from 33-inch to 42-inch. Off road antenna mount or send flag mount integrated into design.



Third Brake Light Extension	Part #
Third Brake Light Extension, 07-15 Wrangler	11546.23

## RRC SIDE ARMOR

Keep your rocker panels from being beaten to a pulp on the trail with Rugged Ridge® Side Armor. Built from heavy-duty 2 x 0.120-inch black textured powder coated steel tubing, these guards will take the beating that was meant for your sheet metal. JK models feature a simple bolt-on design that utilizes existing body mount locations for a secure, rattle free installation. The black texture finish resists scratches and gives a slip-resistant surface for door entry. Sold as a pair and includes all necessary installation hardware.

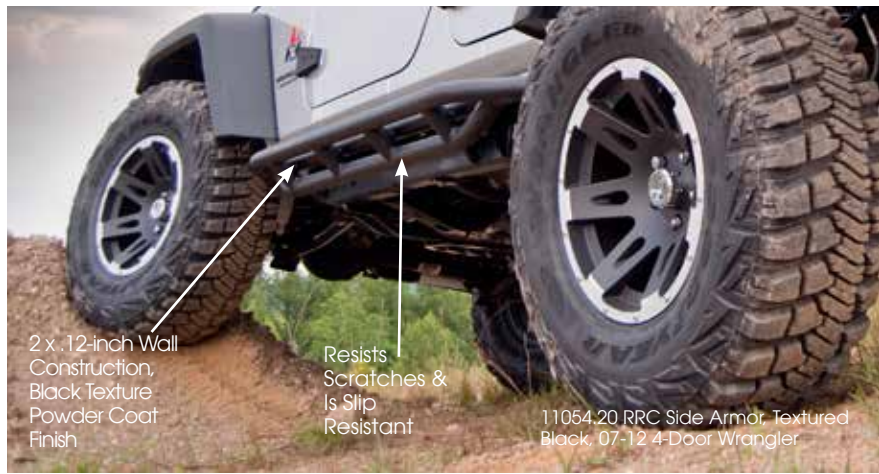

2 x .12-inch Wall Construction, Black Texture Powder Coat Finish

Resists Scratches & Is Slip Resistant

11054.20 RRC Side Armor, Textured Black, 07-12 4-Door Wrangler



07-15 Wrangler models have simple bolt on design. Utilizes existing body mount locations on frame.

RRC Side Armor	Textured Black
07-15 Wrangler, 4-Door Pair	11504.20
07-15 Wrangler, 2-Door Pair	11504.21

## RRC ROCK SLIDERS

This true Rock Crawling design puts protection tight up under the side of your Jeep® while adding a special side "hoop" to block those large outcroppings. A special no drill frame mounted design provides secure, bounce-free installation while keeping the mounting points above the bottom of the frame for greater ground clearance. Each RRC Rock slider mounts to your Wrangler using a simple bolt on frame mount design for ease of installation and extra durability.

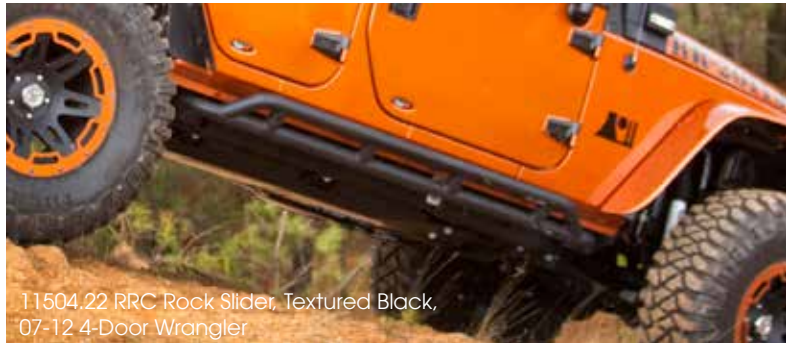

11504.22 RRC Rock Slider, Textured Black, 07-12 4-Door Wrangler



BUY WITH CONFIDENCE  
MINIMUM 5 YEAR WARRANTY

RRC Rocker Sliders	Textured Black
07-15 Wrangler 4-Door Pair	11504.22
07-15 Wrangler 2-Door Pair	11504.23

## SIDE TUBE STEPS

Complete the look with a set of Rugged Ridge® tubular tough duty side steps. Available in 3-inch round, 4-inch round, and 4.25-inch oval diameter sizes. The large 4.25-inch oval and 4-inch round tubes provide a much cleaner look and are not "dwarfed" by oversized tires and oversized body style features of the 07-15 Wrangler. Rugged Ridge® Stainless Tube Steps feature primed 304L, .05-inch wall stainless tubing polished to a mirror finish. Rugged Ridge® painted steel tube steps feature special E-coated, .07-inch wall steel that is "thick source" powder coated for a tough chip resistant finish. All Rugged Ridge® tube steps feature a truly custom fit with installation brackets constructed of durable 3/16-inch powder coated steel for long life and years of flex-free use. Each tube step features special UV treated no-slip step pads with 5 mounting pins. These step pads are preinstalled on top of the tube - no exposed metal to rust. All 07-15 Wrangler models are no drill designs.



11593.07

Side Tube Steps	Black	Textured Black	Stainless
07-15 Wrangler 3" Round, 2-Door Pair	11590.05	11591.05	11593.05
07-15 Wrangler 3" Round, 4-Door Pair	11590.06	11591.06	11593.06
07-15 Wrangler 4" Round, 2-Door Pair	-	-	11593.09
07-15 Wrangler 4" Round, 4-Door Pair	-	-	11593.10
07-15 Wrangler 4¼" Oval, 2-Door Pair	-	11591.07	11593.07
07-15 Wrangler 4¼" Oval, 4-Door Pair	-	11591.08	11593.08



# ALL TERRAIN MODULAR BUMPER



Modeled after our XHD Modular Bumper System, but with the more budget-oriented consumer in mind, Rugged Ridge® set out to create an affordable yet strong and functional bumper system. The All Terrain Modular Bumper System is built from black powder coated steel and has a renewed focus on style and functionality, allowing owners to design and build a bumper to fit their specific needs. The new Double X-Striker is an option currently exclusive to the All Terrain Modular Bumper System. A unique feature of this bumper is that it can be upgraded from a non-winch to a winch bumper. A removable steel plate covers the winch area until the consumer is ready to add a winch. All Terrain bumper options are not compatible with any of the XHD bumpers. Patent NOs 7,703,834 & 8,393,656

## GIVE YOUR WRANGLER RUGGED PROTECTION WITHOUT BREAKING THE BANK!

### JK All Terrain Front Bumper

	Part #
07-15 Wrangler, All Terrain Front Non-Winch Bumper* (A)	11542.02
07-15 Wrangler, Steel Double X-Striker (B)	11542.13
07-15 Wrangler, Steel Hoop Over Rider (C)	11542.14
07-15 Wrangler, Steel Bumper Ends for All Terrain Bumper (D)	11542.23
07-15 Wrangler, Steel Winch Plat (E)	11541.13
D-Ring Pair, 3/4-inch (F)	11235.01
D-Ring Pair, 3/4-inch, Black (F)	11235.04

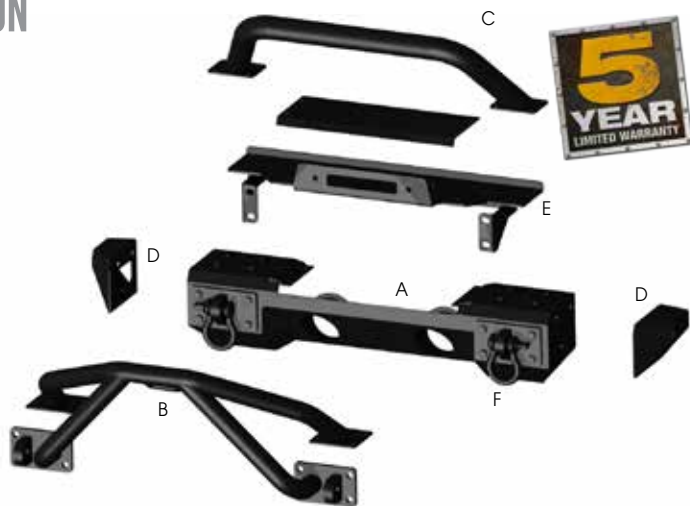

BUY WITH CONFIDENCE  
MINIMUM 5 YEAR WARRANTY



Double-X Striker



Hoop Over Rider



Front Non-Winch Bumper

## REAR TUBE BUMPER

Get the off-road look with a Rugged Ridge® Tube Bumper! Each bumper has smooth ground welds, welded end caps (not plastic end caps!) and the unique style only available from Rugged Ridge®. Center tire cut-out allows for larger tires while still keeping that off-road look, accommodates tire sizes up to 35-inch. Each rear tube bumper includes a special UV treated textured plastic filler plate to fill in the gap between the body and the bumper, a Rugged Ridge® exclusive.



Rear Tube Bumper	Textured Black	Stainless
Rear Tube Bumper, 07-15 Wrangler	11571.10	11573.10



BUY WITH CONFIDENCE  
MINIMUM 5 YEAR WARRANTY

## RRC REAR BUMPERS

The Rugged Ridge® RRC Rear Bumper provides the off road protection you are looking for! The frame mounted platform features a heavy-duty grid like system with raised sides for the ultimate protection and greatest ground clearance. Each RRC bumper is constructed of durable powder coat painted .120 wall welded end cap steel tubing for long life and extreme durability.



RRC Rear Bumpers	Textured Black
07-15 Wrangler, RRC Rear Bumper w/Hitch Each	11503.15

## OFF ROAD JACK MOUNT

JK Off-Road Jack Mount allows you to carry your off-Road jack on the outside of your vehicle saving precious cargo space. Fast and easy bolt on installation. Compatible with stock and most aftermarket rear bumpers (without tire carriers) as well as Rugged Ridge® XHD Rear Bumper with or without tire carrier. Bracket is sturdy and secures the jack in two locations to eliminate any vibration noise during vehicle operation. Durable textured finish looks great. Fits most off-road style jacks including Hi-Lift™.



Off Road Jack Mount	Part #
Off Road Jack Mounting Bracket, Hi-Lift Style, Jeep Wrangler 07-15	11586.01

## HOOD LOCK

Special design virtually disappears into the grille. Cam lock design keeps people out of the engine compartment of your Jeep®. These clever applications install in minutes. An upgraded internal lock cover keeps ice and debris from fouling the lock mechanism.



BUY WITH CONFIDENCE  
MINIMUM 5 YEAR WARRANTY

Hood Lock Kits	Part #
07-15 Wrangler, Each	11252.05

## OFF ROAD JACK ROLL BAR MOUNTING BRACKET

Get your Hi Lift style jack out of the elements with this roll bar mounting kit from Rugged Ridge®. Storing your jack outside leaves it vulnerable to water, debris, ice and theft. These great new brackets allow you to secure your jack to the sports bar without sacrificing cargo area storage, and increase the longevity and function of your jack! The simple no drill installation allows for easy removal and storage of the jack.



Off Road Jack Roll Bar Mounting Bracket	Part #
07-15 Wrangler	11586.02

## OFF ROAD JACK HANDLE STRAP

This handy Off Road Jack Handle Retainer Strap pulls taut to firmly secure the jack handle to the jack and eliminates obnoxious rattles. Fits most off road style farm jacks including Hi-Lift.



Off Road Jack Handle Retainer Strap	Part #
Universal Application, Black	13305.60

## CB ANTENNA MOUNT

This durable mounting bracket installs directly to factory tire carrier on your Jeep® Wranglers without drilling. Each powder coated textured black steel bracket is extremely durable and provides a hidden mounting point for your CB or off road antenna. Each antenna mount includes mounting hardware and bracket.



Spare Tire Carrier CB Antenna Mount	Part #
Spare Tire Carrier CB Antenna Mount, 07-15 Wrangler,	11503.89



# FRONT TUBE BUMPERS

Rugged Ridge® bumpers have been engineered to the industry's most exacting specifications. All powder coated bumpers are "E-coated" to ensure a no rust finish and can take small rock chips and still maintain their rust protection. All Rugged Ridge® front and rear bumpers feature smooth ground welds for an unbelievable look and further rust protection. This exclusive smooth grind process virtually eliminates small weld "pockets" that never seem to get full paint coverage and tend to rust over time. Need to mount a winch on your Jeep®? The winch mount version of the Rugged Ridge® Front Tube Bumper features a built-in winch mounting plate. Nothing extra to buy! Finally, all Rugged Ridge® Bumpers feature welded end caps rather than plastic end caps.

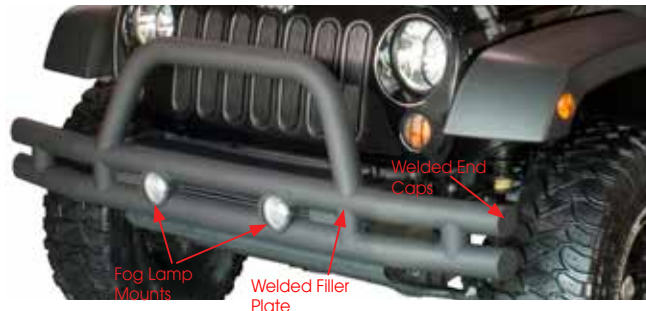

Front Bumpers	Front Bumper with Riser	Black	Textured Black	Stainless
07-15 Wrangler *	Front Tube Bumper w/Riser	-	11561.10	11563.10
07-15 Wrangler * (1)	Front Bumper w/ Built-in Winch Plate	-	11561.11	-
For All Tube Bumpers	License Plate Mounting Bracket	11503.80	-	-
For All Tube Bumpers	Light Mounting Bracket Each	11503.81	-	-
For All Tube Bumpers	CB Antenna Mounting Bracket Each	11503.88	-	-

\* Fits 2 & 4-Door. 07-15 Wrangler, has cut-outs for OE fog lamps. (1) Winch mount plate included.



# JK STUBBY TUBE BUMPER

Rugged Ridge® has taken their industry leading Front Tube Bumper and re-designed the ends to make the ultimate high clearance off-road winch bumper. This unique design has a built-in winch mount and special cut-outs for the JK Wrangler factory fog lamps. Like our regular tube bumper, we have cut into the front tubing allowing the bumper to "hug" the front end of the Jeep®. Each bumper includes durable welded end caps and polished smooth welds for the ultimate in durability. NEW: special inside pre-coat eliminates any chance of interior rusting. A Rugged Ridge® exclusive!



Stubby Tube Bumper	Part #
Stubby Tube Bumper, 07-15 Wrangler (JK) Each	11561.12

# BULL BARS FOR 07-15 WRANGLER

Get that heavy-duty look with a Bull Bar from Rugged Ridge®! Each design has been custom designed for your JK Wrangler utilizing tough 3/8-inch-1/4-inch thick heavy-duty mounting brackets. Each Bull Bar offers smooth ground welds and laser cut skid plates. The black model has a dual stage powder coat finish with a tough E-coat under coating. The polished stainless version has been polished to a mirror finish providing a beautiful look on your Jeep®.

Bull Bars	Part #
3-inch Black Powder Coated Each, 07-09 Wrangler	11564.01
3-inch Stainless Steel Each, 07-09 Wrangler	11565.01
3-inch Black Powder Coated Each, 10-15 Wrangler	11564.02
3-inch Stainless Steel Each, 10-15 Wrangler	11565.02



Pre-drilled light tabs for off-road light mounting.



# X-CLAMP MOUNTING SYSTEM FEATURING PIVOTAL FIT TECHNOLOGY™

The X-Clamp from Rugged Ridge® features an innovative and unique adjustment which allows mounting to tubes ranging from 1.25-inch to 2-inch or 2.25-inch to 3-inch. Rotate the X-Clamp to fit your tube, pivot the mounting bracket to the desired position, and then apply the logo to the front. Patent Pending.

Rugged Ridge X-Clamp Mounting System	Part #
X-Clamp, 2.25-3in, Black	11030.01
X-Clamp, 2.25-3in, Silver	11030.10
X-Clamp, 1.25-2in, Black	11031.01
X-Clamp, 1.25-2in, Silver	11031.10

# SHERPA JK ROOF RACK SYSTEM



The new Sherpa Roof Rack System by Rugged Ridge® is an easy bolt-on solution for two and four-door Wranglers that requires no modifications to the body of your Jeep®.

The unique tilt feature allows you to access your soft top with ease, and the hard top or freedom panels can be removed without removing the rack system. As an added bonus, the forward mounting bar acts as an integrated light bar. The Roof Rack System accepts the Rugged Ridge drop down light bracket (PN 11232.22) to mount up to four lights.



Remove your Freedom Panels without having to move the roof rack.



Designed to allow removal of hard top without moving the roof rack.



Unique roof rack tilt function allows you to easily put your soft top back.

## Sherpa Roof Rack System

	Part #
07-15 Wrangler, 2-Door, Sherpa Roof Rack System	11703.01
07-15 Wrangler, 4-Door, Sherpa Roof Rack System	11703.02
Sherpa Roof Rack Cross Bar Adapter	11703.10
Sherpa Roof Rack Cross Bar <b>NEW</b>	11703.11



BUY WITH CONFIDENCE  
MINIMUM 5 YEAR WARRANTY



11703.10

Use the optional Roof Rack Adapters to mount cross bars.





# EXO-TOP™

## *ROOF RACK AND SOFT TOP FOR THE PRICE OF JUST ONE!*

The Exo-Top™ is an innovative new design that for the first time ever combines the joy of top-down driving with the utility of a roof rack, taking convenience, function, and style to new levels by allowing Jeep owners the ability of conveniently lowering, raising or removing the Jeep's soft top with ease without having to unload gear from the roof-rack cargo. By combining the soft top and roof rack, the Exo-Top™ allows owners to experience a Jeep to its full potential for camping, off-roading, or any lifestyle hobby they may have. This new top also features an innovative Sun Slider® retractable function which allows the top to slide back with the release of just two latches, creating an open-top experience for owners without the hassle of getting out of the driver's seat. Integrated into the 300-lb. capacity roof rack is an advanced externally suspended soft-top design that fastens using a series of Velcro straps along the perimeter bars of the roof rack. The pulling force applied by the Velcro helps to tighten and shape the soft top. Offered for both the two- and four-door configurations, the Exo-Top™ features a patent-pending design that is a direct bolt-on application with no drilling required for installation.

### Description

### Part #

Exo-Top™, 4-Door, 07-15 Wrangler  
 Exo-Top™, 2-Door, 07-15 Wrangler

13516.02  
 13516.01

***New!***

***ARRIVING  
 SUMMER 2015!***



# RECEIVER HITCH

The custom design bolts directly to factory mounting points on the rear of the vehicle, very similar design to the OE receiver hitch. Durable powder coated design sheds water and provides a long lasting rust free finish. Includes cutout for factory wiring harness mounting. Engineered as a one-piece welded assembly for added strength, we built our hitch receiver to match the towing capacity of your Jeep®: 3,500-lb tow rating, 350-lb tongue weight rating with weight distributing equipment; otherwise 2000-lb tow rating, 200-lb tongue weight rating, 2-inch opening.



11580.54

Receiver Hitch	Part #	Tow Wiring Harness	Part #
07-15 Wrangler, Each	11580.10	07-15 Wrangler, Each	17275.01

Hitch Kit Rear	Part #
Hitch & Wiring, 07-15 JK	11580.51
Hitch & Wiring, 07-15 JK with Jeep® Plug	11580.52
Hitch & Wiring Kit with 1 7/8-inch Ball, 07-15 JK	11580.53
Hitch & Wiring Kit with 1 7/8-inch Ball, 07-15 JK	11580.54
Hitch & Wiring, 07-15 JK with Rugged Ridge® Plug	11580.60

**WARNING**



BUY WITH CONFIDENCE  
MINIMUM 5 YEAR WARRANTY

# 2" DRAWBAR AND HITCH PIN

Includes clip and pin. Ball not included. For Jeep® use only. 2000-lb tow rating, 200-lb tongue weight rating.



**WARNING**

Drawbar and Hitch Pin	Part #
2-inch Square, Each	11237.02

# RECEIVER HITCH EXTENDER

Constructed from solid steel the extender lengthens your 2-inch receiver up to 12 inches! (Hitch mount accessories only - not tow rated)



**WARNING**

Receiver Hitch Extender	Part #
12-inch Extender, Each	11580.50

# RECEIVER SHACKLE BRACKET

This heavy-duty steel design fits into any 2-inch receiver box. It is rated up to 9,500 lbs. pulling capacity on evenly distributed straight pulls. Note: never exceed your receiver capacity. Not designed for towing. Does not include hitch pin.



Receiver Shackle Bracket	Part #
All 2-inch Receivers, Each	11234.01

**WARNING**

# HITCH BALL

Hitch Ball includes a matching mounting nut and lock washer. Pick from two standard sizes.



Hitch Ball Kit	Part #
2-inch x 3/4-inch	11305.01
1-7/8-inch x 3/4-inch	11305.02

**WARNING**

# HOOD LIFT KITS

Eliminate the factory prop rod with a pair of gas charged hood lifts. This kit includes all the brackets and gas shocks needed to clean up the underhood appearance of your rig. Easy installation.



Hood Lift Kit	Part #
07-15 Wrangler, Kit	11252.51

Service Replacement Shock	Part #
07-15 Wrangler	11252.81

# RECEIVER TOW HOOK

Heavy-duty black powder coated tow hook inserts into any 2-inch style hitch (does not include hitch pin, not designed for towing).



Receiver Tow Hook	Part #
Fits All 2-inch Receivers, Each	11237.01

**WARNING**



# LOCKABLE SPARE TIRE MOUNT BIKE CARRIER

This easy-to-use bike rack mounts to any emergency tire mounting studs. The bike rack carries two bikes directly off the spare tire. It is constructed of 2-inch powder coated steel tubing for maximum rust protection and durability. The bike clamp features rubber pads to protect your bike's finish. The carrier comes with two keys for the locking mechanism. Fits wheel off sets from 2-5/8-inch to 6-inch. For all Jeep® outside spare tire applications.



Bike Carrier	Part #
Spare Tire Mount Bike Carrier, Each	11237.10

To avoid risk of serious injury or death:

- Review & follow all required towing options, weight limitations and recommendations in Towing section of your Jeep® Owners manual.
- Never exceed smallest GVWR of your trailer towing system (Jeep® vehicle, hitch, draw bar and ball). Receiver draw bar and ball included with this kit are Class 2 rated (trailer GVWR 2000 lb {less than symbol} 3500 lb). Vertical tongue weight {less than symbol} 200 lbs.



## FRONT SKID PLATE

Custom designed to protect the steering components on your Jeep® Wrangler, this overbuilt skid plate is a must for those off road adventures. Constructed of durable 1/4-inch powder coated steel with a rust resistant E-Coating, this skid plate is designed to take whatever the trail throws at you! Designed to fit with all Rugged Ridge® front bumpers (looks amazing with the XHD bumper system!) or all factory front bumpers. This skid plate provides protection for all front steering components including the very expensive electric sway bar disconnect system found on Rubicon models. The easy to install frame mount design incorporates special gussets and welded brackets to ensure long life and great off road performance.



### Front Skid Plate for 07-15 Wrangler

Part #

Front Skid Plate- All RR bumpers, all factory original bumpers

18003.30

## HEAVY-DUTY DIFFERENTIAL COVERS

Made from 3/8-inch cast steel, these heavy-duty covers are designed to protect your differential and all its working parts for as long as you own your vehicle.



16595.30

### Cast Differential Cover

Part #

Dana 30, Each	16595.30
Dana 35, Each	16595.35
Dana 44, Each	16595.44
Dana 60, Each	16595.60



BUY WITH CONFIDENCE  
MINIMUM 5 YEAR WARRANTY

## HEAVY-DUTY DIFFERENTIAL SKID PLATES

Protect your factory differential cover with these heavy-duty skid plates that are designed to fit the contours of your stock differential cover. Constructed of durable 3/16-inch black powder coated steel, these skid plates will help you slide over obstacles without getting hung up. Includes replacement mounting hardware and instructions. Now available with the Jeep® logo stamped into the face as an Authentic Jeep® Licensed product.



### Heavy-Duty Differential Skid Plates

Part #

Dana 30 Diff. Skid Plate	16597.30
Dana 30 Diff. Skid Plate with Jeep® Logo	DMC-16597.30
Dana 35 Diff. Skid Plate	16597.35
Dana 35 Diff. Skid Plate with Jeep® Logo	DMC-16597.35
Dana 44 Diff. Skid Plate	16597.44
Dana 44 Diff. Skid Plate with Jeep® Logo	DMC-16597.44

## MUFFLER SKID PLATE

The Muffler Skid Plate is constructed of durable 5mm thick black powder coated steel, and mounts to existing body holes using the factory hardware. It helps transfer the load of an impact away from the muffler and to the frame.



### Muffler Skid Plate

Part #

07-15 Wrangler New  
\* For OE exhaust only.

18003.31

## HEAVY DUTY SKID PLATES

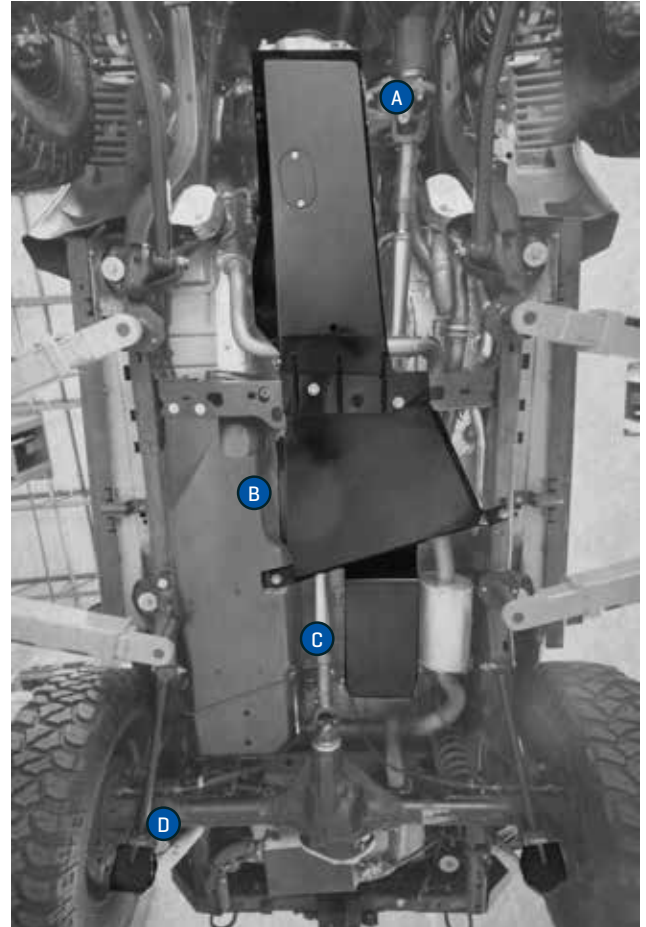

Our heavy duty skid plates are constructed of durable 3/16-inch thick black powder coated steel, and mount to existing body holes using the factory hardware. They are engineered to protect the most valuable areas of your Jeep's underside, and help protect you from whatever the trail throws at you!

### Heavy-Duty Skid Plates

Part #

Engine & Transmission Skid Plate, 07-11 Wrangler (A)	18003.50
Engine & Transmission Skid Plate, 12-15 Wrangler (A)	18003.51
Transfer Case Skid Plate, 07-15 Wrangler (B)	18003.32
Evaporator Skid Plate, 07-11 Wrangler (C)	18003.40
Evaporator Skid Plate, 12-15 Wrangler (C)	18003.42
Control Arm Skid Plates, Front Pair, 07-15 Wrangler	18003.35
Control Arm Skid Plates, Rear Pair, 07-15 Wrangler (D)	18003.36
Control Arm Skid Plates, Front & Rear Kit, 07-15 Wrangler	18003.37

# RUGGED RIDGE® SHOCKS

Rugged Ridge® uses only nitrogen charged gas shocks for all their kits, which provide a better ride both on and off road. By using a Rugged Ridge® lift kit and matching gas shocks, you optimize the suspension's capabilities giving you a better ride both on and off road.

## Shock features include:

- 150 PSI pressurized nitrogen gas
- Internal valving - the internal orifice will rotate when the piston moves more than 2 inches automatically adjusts to make the ride as smooth as possible
- Twin tube construction to lower heat build up and protect the shock from off road damage
- Bonded Iron 14mm piston with extra chroming - provides for a longer, rust free life
- Includes polyurethane bushings
- Limited lifetime warranty on the shocks

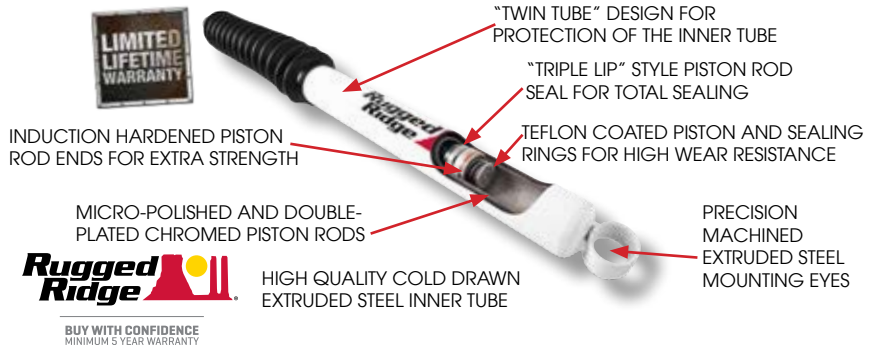

BUY WITH CONFIDENCE  
MINIMUM 5 YEAR WARRANTY

## Rugged Ridge® Shocks

	Front	Extended	Collapsed	Rear	Extended	Collapsed
Nitrogen Series Shock, 07-15 Jeep® Wrangler 2-Door, 3.5" Lift, 07-15 Wrangler 4-Door 2.5" Lift	18465.09	22.75"	13.54"	18465.10	25.35"	15.05"
Nitrogen Series Shock, 07-15 Jeep® Wrangler 2-Door, 5" Lift, 07-15 Wrangler 4-Door 4" Lift	18465.11	26.79"	15.56"	18465.12	28.38"	16.65"

# COLORED SHOCK BOOTS

These durable shock boots keep mud and debris from prematurely ruining your shocks while maintaining a stylish look. Works on ORV™ Nitrogen Shocks and most other brands as well! Sold each.

Shock Boots	Part#
Shock Boot, Black, Universal Application	18479.50
Shock Boot, Red, Universal Application	18479.51
Shock Boot, Blue, Universal Application	18479.52



# RUGGED RIDGE® STEERING STABILIZERS

Rugged Ridge® recommends upgrading your current steering stabilizer or adding a stabilizer on all lifted Jeep® vehicles. The Rugged Ridge® Steering Stabilizer dampens out the roughness of the highway and the vibration from running larger tires and wheels. Rugged Ridge® Hydraulic Stabilizers also make it easier to move those larger tires and wheels both on and off road. These noticeable handling improvements are well worth the small investment!



## ORV™ Steering Stabilizers

	Part#
ORV™ Hydraulic Series Steering Stabilizer, 07-15 Jeep® Wrangler 2 & 4-Door	18475.03

**WARNING**

# INVERTED DRAG LINK

The inverted drag link is designed to restore the steering geometry on lifted Wranglers. The re-designed drag link is inverted or flipped up over the knuckle to increase ground clearance and reduce bumpsteer. This part may reduce need for a drop pitman arm. NOTE: a 13/16 inch drill bit is required for installation.

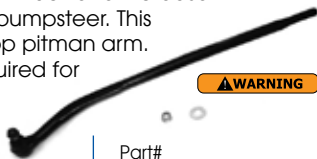

Inverted Drag Link	Part#
07-15 Wrangler, Inverted Drag Link	18205.26

# ADJUSTABLE TRACKBAR

This heavy duty adjustable track bar helps bring your axle back to being centered under your Jeep after being lifted.



**WARNING**

Adjustable Trackbar	Part #
Adjustable Trackbar, 07-15 Wrangler	18205.08

# FRAME BRACE KIT

The heavy duty frame brace and trackbar drop bracket kit from Rugged Ridge has been designed to reduce front end movement and shimming on lifted JK Wranglers. The frame brace includes a trackbar drop bracket to help maintain the proper steering geometry. The kit is recommended on any JK Wrangler with 3 inch or more of lift and an adjustable trackbar. Welding is required for installation.



Frame Brace Kit	Part#
07-15 Wrangler, Frame Brace Kit	18205.25



# LIFT KITS

## What to Buy:

When looking at which kit is best for your application you need to determine two important things: size of tire and use of vehicle. On the 2007-15 JK Wranglers, 2.5-3.5" coil kit is designed for up to a 34" x 12.5" x 16" tire and moderate off road use. The 4"-5" coil kit is designed for more severe off road use and up to a 35" x 12.5" x 16" tire.

### Rugged Ridge® 2.5"-3.5" Coil Spring Lift - With shocks part # 18415.50

- The most complete kit available on the market for JK.
- Includes four powder coated and E-coated 5160H hot rolled bar, and 5/8 inch coil springs that are set to factory rates, eliminating any possibility of future sag.
- Setting coil springs to factory rates gives you the best on road ride possible and the ability to use a larger tire.
- Each kit includes a rear track bar brace to strengthen the original track bar mount.
- Four Door JK's will get on average a 2.5 inch lift. Two door models will get up to a 3.5 inch lift.



BUY WITH CONFIDENCE  
MINIMUM 5 YEAR WARRANTY

**WARNING**



### Rugged Ridge® 4"-5" Coil Spring Lift - With shocks part # 18415.60

- Includes 4 powder coated, E-coated 5160H hot rolled bar 5/8" coil springs, set to factory rates for longer life and better ride!
- Each kit includes a rear track bar brace to strengthen the original track bar mount.
- Kit includes sway bar disconnects for more articulation off road.
- Uses tough, over built extended control arms for added strength and performance.
- In most cases control arms are longer than factory to adjust for caster.
- 4-Door JK's will get on average a 4 inch lift. Two door models will get up to a 5 inch lift.
- Due to the changed pinion angle, we highly recommend a new drive shaft be installed when using any 4 inch or greater lift kit on a four door Wrangler. A new drive shaft will be required on any 2007-15 2-Door Wrangler due to the shorter wheel base.
- All 4 inch Kits require a drop pitman arm. (Sold separately: Part# 18006.55)



07-15 Jeep® Wrangler JK/Rubicon, 4WD (2 & 4-Door models)	Kit w/o Shocks	Kit w/ Shocks	Max Tire Size HxWxD	Max Wheel Offset	Est. Install Time
2.5"-3.5" Lift, 07-15 Jeep® Wrangler, 2 & 4-Door	18360.21	18415.50	34"x12.5"x16"	4.5"	6 Hrs
4"-5" Lift, 07-15 Jeep® Wrangler, 2 & 4-Door*	18360.22	18415.60	35"x12.5"x16"	4.5"	8 Hrs

Note: due to vehicle weight, the 2-Door models may receive an additional 1" lift over 4-Door models

\* Will require a drop pitman arm 18006.55. Sold Separately

18401.50 Kit includes: (4) coil springs, rear track bar bracket, rear bump stop bracket, rear track bar brace, hardware kit

18401.60 Kit includes: (4) coil springs, (2) lower front links, (2) lower rear links, (2) rear bump stop brackets, (2) rear bump stop spacers, front track bar bracket, rear track bar bracket, (2) front double disconnect end links, (2) rear extended sway bar end links, rear track bar brace, hardware kit

## CV EQUIPPED DRIVE SHAFTS

Reduce or eliminate driveline vibration with a CV-equipped driveshaft. constant velocity (CV) joints use two U-joints (double cardan style) in the place of a single U-joint. This smooths out the driveline angle and reduces vibration due to extreme lifts or driveline changes. Works with stock to 6 inch lift.



CV Equipped Drive Shafts	Part #
07-15 Wrangler, Front 2/4-Door	16592.22
07-15 Wrangler, Rear 2-Door	16592.21
07-15 Wrangler, Rear 4-Door	16592.20

## DROP PITMAN ARM

This drop pitman arm helps reduce the angle of your drag link so it reduces the bumpsteer created when a 3.5-inch to 6-inch suspension lift is installed.



**WARNING**

Drop Pitman Arm	Part #
Drop Pitman Arm, Power Steering, 07-15 Wrangler	18006.55

# XHD ALUMINUM WHEELS



Gunmetal  
15301.30 - 17"  
15305.30 - 18"  
15306.02 - 20"



Satin Black with  
Machined Lip  
15301.10 - 17"



Silver  
15301.40 - 17"  
15305.40 - 18"  
15306.03 - 20"



Chrome  
15301.20 - 17"



Satin Black  
15301.01 - 17"  
15305.01 - 18"  
15306.01 - 20"

Rugged Ridge® is proud to introduce the toughest new design in custom wheels for 2007-15 Wranglers. This hub-centric design exactly centers the wheel over the hub providing proper balance, clearance for brake rotors, steering components and suspension. A better fit, with no wheel vibration! Stainless steel button-head socket cap screws around the perimeter of the outer wheel face give a great 3-piece look, and you accessorize with our optional trim ring. Available in five finishes: satin black powder coated, satin black powder coated with machined lip, silver powder coated, dual-stage polished chrome, and gunmetal. The durable powder coated finish gives an ultra-hard finish for long life and a great look. The chrome finish uses a dual-stage process to give a deep reflective mirror-like shine that commands attention. Rugged Ridge® wheels have been independently tested and certified to meet/exceed SAE J2530 standards for wheel strength and durability. Limited lifetime structural warranty and one year finish warranty (see warranty information for details and limitations). Backspacing is 4.53 inch with a -12mm offset. Patent pending.

## Rugged Ridge® Hub Centric XHD Aluminum Wheels

Part #

07-15 Wrangler, 17"x9" Wheel, Satin Black	15301.01
07-15 Wrangler, 17"x9" Wheel, Satin Black with Machined Lip	15301.10
07-15 Wrangler, 17"x9" Wheel, Silver	15301.40
07-15 Wrangler, 17"x9" Wheel, Chrome	15301.20
07-15 Wrangler, 17"x9" Wheel, Gunmetal	15301.30
07-15 Wrangler, 18"x9" Wheel, Satin Black	15305.01
07-15 Wrangler, 18"x9" Wheel, Silver	15305.40
07-15 Wrangler, 18"x9" Wheel, Gunmetal	15305.30
07-15 Wrangler, 20"x9" Wheel, Satin Black <b>NEW</b>	15306.01
07-15 Wrangler, 20"x9" Wheel, Silver <b>NEW</b>	15306.03
07-15 Wrangler, 20"x9" Wheel, Gunmetal <b>NEW</b>	15306.02
Center Cap, Replacement Part for 17" XHD Wheels	15201.50
Modular Center Cap, Replacement for 18" XHD Wheels	15305.51



New modular center cap design for the 18 inch & 20 inch XHD wheels allows for multiple looks - full center cap or low profile. Patent Pending.

### **⚠ WARNING**

Improper wheel/spacer installation and torquing may degrade handling and result in wheel separating from vehicle.

TO REDUCE RISK OF INJURY OR DAMAGE ALWAYS:

- Torque lugs using vehicle manufacturer's recommendations & sequence, assuring clean threads, wheel cold and compatibility of lugs nuts to wheel surface.
- Inspect & re-torque lugs after 50 miles (80 Km.) of installation or wheel service.

# RIM PROTECTORS FOR XHD WHEELS

Trim rings are available in either satin black powder coated or polished stainless steel. These trim rings are a great way to protect the wheel lip and tire bead, and allow you to change the look of your wheels with just a few bolts. For use with Rugged Ridge® aluminum wheels only.

## Rugged Ridge® Rim Protectors for Rugged Ridge® XHD Aluminum Wheels Only

Part #

07-15 Wrangler, Rugged Ridge® Rim Protector, 17", Polished Stainless Steel	15250.01
07-15 Wrangler, Rugged Ridge® Rim Protector, 17", Satin Black	15250.02
07-15 Wrangler, Rugged Ridge® Rim Protector, 18", Black Stainless Steel	15250.03
07-15 Wrangler, Rugged Ridge® Rim Protector, 20", Black Stainless Steel <b>NEW</b>	15250.04





# JESSE SPADE WHEELS



BUY WITH CONFIDENCE  
MINIMUM 5 YEAR WARRANTY



Satin Gunmetal  
15303.93



Satin Black  
15303.91

*New!*

Designed to appeal to even the most hardcore Jeep® enthusiasts, the new Jesse Spade Wheel from Rugged Ridge® is offered in two finishes of satin black and satin gun metal. Offering the best styling and fit possible this 17x9 inch wheel features a 5x5 inch bolt pattern, -12 mm offset, 4.53 inch backspacing, and 71.5 mm center bore. This wheel also features exclusive valve stem pockets which protect the valve stem from potential off-road damage. The Jesse Spade Wheel was built to deliver the handling that your rides performance requires while offering the best design and quality possible.



## Jesse Spade® 17x9 Wheels

	Part #
07-15 Wrangler, Jesse Spade® Wheel, 17x9 inch, Satin Black	15303.90
07-15 Wrangler, Jesse Spade® Wheel, 17x9 inch, Satin Gun Metal	15303.92

# DRAGON ALLOY WHEELS



Satin Black



Gunmetal

The Drakon Alloy Wheel by Rugged Ridge is a cast aluminum alloy available in two stunning finishes for a truly unique appearance. Purposed for the 07-15 Jeep Wrangler (JK), Drakon wheels are DOT approved, have a 4.53 inch backspacing, -12mm offset, a 2200 lb. load rating, 5 on 5 inch bolt pattern and include a center cap. The hub-centric design means this wheel will center perfect every time. Bring the look of any JK to a whole new level with the Drakon Wheel. Rugged Ridge wheels have been independently tested and certified to meet/exceed SAE J2530 standards for wheel strength and durability. Limited lifetime structural warranty and one year finish warranty. Patent No. D701, 156.

## Rugged Ridge® Drakon Alloy Wheels

	Part #
07-15 Wrangler, 17"x9" Drakon Alloy Wheel, Satin Black	15302.01
07-15 Wrangler, 17"x9" Drakon Alloy Wheel, Gunmetal	15302.30
07-15 Wrangler, 18"x9" Drakon Alloy Wheel, Satin Black	15302.02
07-15 Wrangler, 18"x9" Drakon Alloy Wheel, Gunmetal	15302.31
07-15 Wrangler, 20"x9" Drakon Alloy Wheel, Satin Black	15304.01
07-15 Wrangler, 20"x9" Drakon Alloy Wheel, Gunmetal	15304.30

Patent No. D701, 156

## STEEL D-WINDOW WHEELS

Legendary looks with brutally epic strength. Each Rugged Ridge® Steel D-Window wheel is stamped from heavy gauge steel and powder coated with a durable black finish. Our wheels have been engineered, tested and certified to meet and exceed the strenuous SAE J2530 standards for wheel strength and durability. Turning a million cycles at double their load capacity, these wheels are sure to withstand off-road abuse. A Jeep® isn't just a Jeep® until it's lifted and outfitted with oversized tires. All Rugged Ridge® Steel D Window wheels include a FREE polished center cap!



Shown Painted



**WARNING**

Steel D-Window Wheels	Part #
07-15 Wrangler, Black, 17X9, 5 on 5 Bolt pattern, 4.5 Backspacing	15500.70

## HEAVY DUTY TIRE SPACER

This Rugged Ridge® bolts to your existing factory spare tire mount and relocates the tire two inches up and out. Features 5x4.5 inch and 5x5.5 inch wheel bolt patterns and tough powder coated black textured finish. Caution: The tailgates on 07-15 Wrangler models are not designed to hold extra large tires. Therefore, do not use a tire larger than a 33x12.50 inch or equivalent tire with this spacer. If you want to carry a larger tire, we recommend using the XHD Rear Bumper with Tire Carrier.



HD Tire Carrier & Spacer	Part #
07-15 Wrangler, Textured Black, Each	11585.02

**CAUTION:** The tire carrier spacer is designed to fit tires 33" in diameter or less. Do not exceed these tire sizes.

## WHEEL SPACERS & ADAPTERS

These hub centric spacers / adapters move your wheels out to help fit wider tires and give your vehicle a wider track and improve stability. Constructed of double anodized black extra thick 6061T6 aluminum for long life and extra corrosion resistance. All hardware is grade-8 for extra strength. Each part number comes as a spacer pair. Included are ten pre-installed grade-8 wheel studs, ten lug nuts and a thread locker.

**CAUTION:** Rugged Ridge® recommends use of wheel spacers with all suspension lifts to reduce risk of roll over or other accident associated with handling the higher tire load capacities. See additional product safety information and WARNINGS at back of catalog.



Front or Rear

Wheel Spacer & Adapter Kits	Part #
07-15 Wrangler, Pair 1.5" Spacer	15201.05
07-15 Wrangler, Pair * 1.375" Adapter	15201.06
07-15 Wrangler, Pair ** 1.375" Adapter	15201.07
* converting 5 on 5" to 5 on 4.5" bolt pattern	
** converting 5 on 5" to 5 on 5.5" bolt pattern	

**WARNING**

## LUG NUTS & WHEEL LOCKS

An extra set of lug nuts are always handy to have for when you lose one by accident. Our locking sets secure your wheels to prevent others from taking your wheels off. All lug nuts, both locking and non-locking work with existing Rugged Ridge wheels.

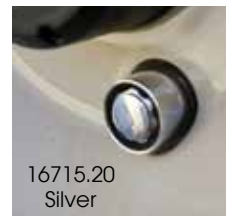

16715.20  
Silver

Lug Nuts & Wheel Locks	Part #
Wheel Lug Nut, 1/2in x 20, Black, Acorn Hex	16715.07
Wheel Lock Set, Chrome, 5 Piece, 1/2in x 20	16715.20
Wheel Lock Set, Black, 5 Piece, 1/2in x 20	16715.21
Wheel Lock Set, Chrome, 5 Piece, 12mm x 1.25	16715.22

## STAINLESS STEEL BRAIDED BRAKE HOSES

Rugged Ridge® Braided Stainless Steel Brakes Hoses feature a tough stainless steel braided outer cover with a flexible teflon inner core that withstand trail hazards better than OE rubber hoses. They provide up to 4 inches of additional length over stock hoses, a must for any lifted vehicle! These brake hoses also improve braking performance so you won't suffer from a soft brake pedal caused by OE rubber hose expansion. Meets or exceeds DOT FMVSS-106 regulations. Backed by the Rugged Ridge® industry leading Five Year Limited Lifetime Warranty.

Stainless Steel Braided Brake Hoses	Part #
07-15 Wrangler, Stainless Steel Braided Brake Hose Kit, Front and Rear Hoses	16734.10

**Rugged Ridge**  
BUY WITH CONFIDENCE  
MINIMUM 5 YEAR WARRANTY





Rugged Ridge offers the best option for wheel and tire packages! Designed to last, these convenient packages provide high quality wheels and tires that were manufactured using strict quality control standards with exact vehicle fitment, so your Jeep will perform at its best both on and off-road. Each package includes an XHD or Drakon wheel, each giving your Wrangler that bold yet sleek look you love, and a Mickey Thompson ATZ P3 tire that is pre-mounted and balanced with a TPMS sensor and ready to bolt right on, saving you time and money!

## 15391.16



## 15391.35



## 15391.25

Year Range	WHEEL	TIRE	Omix #
07-12 Wrangler	17 Inch XHD, Black Satin	33" Mickey Thompson All Terrain	15391.10
13-15 Wrangler	17 Inch XHD, Gun Metal	33" Mickey Thompson All Terrain	15391.12
13-15 Wrangler	17 Inch XHD, Silver	33" Mickey Thompson All Terrain	15391.13
13-15 Wrangler	17 Inch Drakon, Black Satin	33" Mickey Thompson All Terrain	15391.14
13-15 Wrangler	17 Inch Drakon, Gun Metal	33" Mickey Thompson All Terrain	15391.15
13-15 Wrangler	17 Inch XHD, Black Satin	34" Mickey Thompson All Terrain	15391.16
13-15 Wrangler	17 Inch XHD, Gun Metal	34" Mickey Thompson All Terrain	15391.18
13-15 Wrangler	17 Inch XHD, Silver	34" Mickey Thompson All Terrain	15391.19
13-15 Wrangler	17 Inch Drakon, Black Satin	34" Mickey Thompson All Terrain	15391.20
13-15 Wrangler	17 Inch Drakon, Gun Metal	34" Mickey Thompson All Terrain	15391.21
13-15 Wrangler	17 Inch XHD, Black Satin	35" Mickey Thompson All Terrain	15391.22
13-15 Wrangler	17 Inch XHD, Gun Metal	35" Mickey Thompson All Terrain	15391.24
13-15 Wrangler	17 Inch XHD, Silver	35" Mickey Thompson All Terrain	15391.25
13-15 Wrangler	17 Inch Drakon, Black Satin	35" Mickey Thompson All Terrain	15391.26
13-15 Wrangler	17 Inch Drakon, Gun Metal	35" Mickey Thompson All Terrain	15391.27
13-15 Wrangler	17 Inch XHD, Black Satin	37" Mickey Thompson All Terrain	15391.28
13-15 Wrangler	17 Inch XHD, Gun Metal	37" Mickey Thompson All Terrain	15391.30
13-15 Wrangler	17 Inch XHD, Silver	37" Mickey Thompson All Terrain	15391.31
13-15 Wrangler	17 Inch Drakon, Black Satin	37" Mickey Thompson All Terrain	15391.32
13-15 Wrangler	17 Inch Drakon, Gun Metal	37" Mickey Thompson All Terrain	15391.33
07-12 Wrangler	17 Inch XHD, Black Satin	33" Mickey Thompson All Terrain	15391.40
07-12 Wrangler	17 Inch Drakon, Black Satin	33" Mickey Thompson All Terrain	15391.41
07-12 Wrangler	17 Inch XHD, Black Satin	34" Mickey Thompson All Terrain	15391.42
07-12 Wrangler	17 Inch Drakon, Black Satin	34" Mickey Thompson All Terrain	15391.43
07-12 Wrangler	17 Inch XHD, Black Satin	37" Mickey Thompson All Terrain	15391.44
13-15 Wrangler	18 Inch XHD, Black Satin	33" Mickey Thompson All Terrain	15391.36
07-12 Wrangler	18 Inch XHD, Black Satin	33" Mickey Thompson All Terrain	15391.46
13-15 Wrangler	20 Inch Drakon, Black Satin	37" Mickey Thompson All Terrain	15391.34
13-15 Wrangler	20 Inch Drakon, Gun Metal	37" Mickey Thompson All Terrain	15391.35
07-12 Wrangler	20 Inch Drakon, Black Satin	37" Mickey Thompson All Terrain	15391.45

## TIRE INFLATOR/DEFLATOR

Allows for controlled and precise inflation or deflation with an easy to read gauge.

Tire Inflator/Deflator	Part #
Tire Inflator/Deflator, Universal	15104.55



BUY WITH CONFIDENCE  
MINIMUM 5 YEAR WARRANTY





## FRONT AXLE KITS COMPLETE INNERS/OUTERS WITH U-JOINTS & CLIPS

High tensile strength 4340 Chromoly is heat-treated, tempered and induction hardened to produce these heavy-duty axles that are up to 40 percent stronger than stock 1040 axles. Each axle shaft is backed by Alloy USA®'s exclusive ten-year warranty! We use the latest splining technology to produce splines that are stronger than traditional cut splines. The shafts are then precision CNC machined and magnaflux inspected for cracks before receiving a slick black anodized finish. Our front axle shaft kits include everything you need to complete the job: both passenger and drive side inner and outer axle shafts, seals, U-joints and clips.



Application	Part #	Inner	Outer	Ring
Jeep Wrangler (JK) 07-15, Dana 30™ 27-Spline Kit	12152	27	32	D30
Jeep Wrangler (JK) Rubicon 07-15, Dana 44™ 30-Spline Kit	12155	30	32	D44

## PERFORMANCE REAR AXLE SHAFTS & KITS

High tensile strength 4140 Chromoly is heat-treated, tempered and induction hardened to produce these heavy-duty axles that are up to 35 percent stronger than stock 1040 axles. Alloy USA® uses the latest cold rolled splining technology, to produce splines that are stronger than traditional cut splines. Our shafts are covered by an exclusive ten year warranty! Rear axle shaft kits include everything you need for your installation: both passenger and driver side shafts, seals, bearings and wheel studs.



Jeep 2 Axles - Bearings - Seals - Wheel Studs	Part #	Spline	Ring
Jeep Wrangler (JK) 07-15, Dana 44™ Grande 30-Spline Kit	12156	30	D44
Jeep Wrangler (JK) 07-15 Rubicon, Dana 44™ Grande 32-Spline Kit	12158	32	D44

Jeep Axle Shafts, Sold Individually. Wheel Bearings, Seals, & Wheels Studs Available Separately	Part #	Spline	Length	Side	Ring
Jeep Wrangler (JK) 07-15, Dana 44™, LH/RH, 30-Spline	21204C	30	31.49"	LH/RH	D44
Jeep Wrangler Rubicon (JK) 07-15, Dana 44™, LH	21205C	32	30.79"	LH	D44
Jeep Wrangler Rubicon (JK) 07-15, Dana 44™, RH	21206C	32	32.165"	RH	D44

## ALLOY USA® AXLE TUBE SEALS

Keep water, mud and debris from entering your front axle housing. These CNC machined aluminum housings feature two seals to provide double protection from the environment.



Axle Tube Seals	Part #
07-15 Wrangler w/ Grande Axles (JK) Dana 30 or 44™ front axle (2)	11105 (RED) 11106 (BLACK)
Replacement Rubber Inner Seal For 11105 and 11106	11109

## HEAVY DUTY BALL JOINT KITS

Big tires will accelerate wear on factory ball joints, which can lead to death wobble. Alloy USA® has the solution with these new Heavy Duty Ball Joint kits for the 07-15 JK Wrangler! Featuring a high strength steel construction for greater strength and hardness to minimize wear. Includes low-profile Zerk fittings for regular maintenance, a feature not available with the factory original style. Features an exclusive threaded preload system to ensure precise tolerance for prolonged ball joint life and precise steering.



Ball Joint Kit	Part #
Ball Joint Kit, Front, Heavy Duty, Includes 2 Upper and 2 Lower, 07-15 Wrangler	11800



# RING & PINIONS

Ring & Pinions	Ratio	Part #
<b>FRONT Dana 30™</b>		
Wrangler (JK) 07-15, Front Dana 30™, 3.73 Ratio*	3.73	D30373RJK
Wrangler (JK) 07-15, Front Dana 30™, 4.10, Ratio*	4.10	D30410RJK
Wrangler (JK) 07-15, Front Dana 30™, 4.56, Ratio*	4.56	D30456RJK
Wrangler (JK) 07-15 Front Dana 30™, 4.88 Ratio*	4.88	D30488RJK
Wrangler (JK) 07-15, Front Dana 30™, 5.13 Ratio*	5.13	D30513RJK
<b>FRONT Dana 44™</b>		
Wrangler (JK) 07-15 (w/ TruLok) 08-12 All, Front Dana 44™, 4.10 Ratio*	4.10	D44410RJK
Wrangler (JK) 07-15, Front Dana 44™, 4.56 Ratio*	4.56	D44456RJK
Wrangler (JK) 07-15, Front Dana 44™, 4.88 Ratio*	4.88	D44488RJK
Wrangler (JK) 07-15, Front Dana 44™, 5.13 Ratio*	5.13	D44513RJK
Wrangler (JK) 07-15, Front Dana 44™, 5.38 Ratio*	5.38	D44538RJK
<b>REAR Dana 44™</b>		
Wrangler (JK) 07-15, Rear 7/16 Bolts, Dana 44™, 4.10 Ratio*	4.10	D44410JK
Wrangler (JK) 07-15, Rear Dana 44™, 4.56 Ratio*	4.56	D44456JK
Wrangler (JK) 07-15, Rear Dana 44™, 4.88 Ratio*	4.88	D44488JK
Wrangler (JK) 07-15, Rear Dana 44™, 5.13 Ratio*	5.13	D44513JK
Wrangler (JK) 07-15, Rear Dana 44™, 5.38 Ratio*	5.38	D44538JK

These affordable high strength gear sets come in all the popular ratios to satisfy everyone's gearing needs. Oversized tires require higher ring & pinion ratios to restore performance. Made from high quality 8620 forgings and Gleason gear cutting technology, these gears are made to last. Complete installation kits are available separately to complete the job. Exclusive five year warranty. Available in 3.73, 4.10, 4.56, 4.88, 5.13 and 5.38 ratios.



\*2012 and up models may require an aftermarket programmer to sync the new gear ratio to the transmission controller

## RING & PINION MASTER & OVERHAUL KITS

Ring & Pinion Master Installation & Overhaul Kits	Part #
Wrangler (JK) 07-15, Dana 30™, Front	352050
Wrangler (JK) 07-15, Dana 44™, Front	352051
Wrangler Rubicon (JK) 07-15, Dana 44™, Rear	352052
Wrangler X, Sahara (JK) 07-15, Dana 44™, Rear	352053

These great kits offer all the components you will need to complete your differential rebuild or ring & pinion installation. Complete with bearings, pinion seals, pinion shims, crush sleeve, pinion nut, ring gear bolts and marking compound.



## HD DIFFERENTIAL COVERS

Indestructible! You won't break these covers, we guarantee it. Made from either 3/8 inch cast steel or 5/16 inch stamped steel, painted black inside and out, these heavy-duty covers are designed to protect your differential and all its working parts for as long as you own your vehicle. These indestructible covers have been ".44 caliber tested" - if they can take a bullet at point blank range (don't try this at home!), they can take all that the trail has to offer. Available for most popular Dana differential types and include extra reinforcement protection for the fill plug area. All mounting hardware and instructions are included for ease of installation.



Differential Cover	Cast 3/8" Steel	Stamped 5/16" Steel
HD Dana 30™	11206	11200
HD Dana 44™	11202	-
HD Dana 60™	11207	11203



## FRONT AXLE X-JOINT *New!*

A serviceable U-joint for Dana 44 applications is now available to you. Replace your 760X U-joint with Alloy USA's new X-joint!



Heavy Duty Front Axle X-Joint	Part #
Alloy X-joint, Complete U-joint With Bearings (760 Style) Replaces 5-297X/5-760X, 07-15 Wrangler Dana 30™	11500

## WHEEL SPACERS

1.50" Width  
5 on 5.0" Bolt Pattern

**WARNING**



Wheel Spacers	Part #
07-15 Jeep Wrangler, Front or Rear	11300

## SLOTTED BRAKE ROTORS

Alloy USA® slotted & drilled brake rotors improve braking performance right out of the box and maximize cooling! These rotors improve brake pad bite and reduce brake fade.



Slotted Brake Rotors	Part #
Slotted and Drilled Disc Brake Rotors (Front), 07-15 Wrangler, Pair	11353
Slotted and Drilled Disc Brake Rotors (Rear), 07-15 Wrangler, Pair	



# PERFORMANCE VENTED HOOD

(hood shown painted)

Inspired by Chrysler's aggressive SRT® designs, Rugged Ridge's Performance Vented Hood was engineered to provide 50 percent more ventilating surface area over similar designs, helping heat quickly escape from the engine compartment to maximize engine efficiency. Made from high quality stamped steel, the new Performance Vented Hood uses a factory inner core assuring it fits like the OE hood. In addition to fitting like a factory piece, Rugged Ridge ships each of the hoods standard with a rust preventative E-coat that's ready to be painted. Uses factory attachment points and most aftermarket accessories will simply bolt into place. Got heat? You need this hood! Patent Pending.

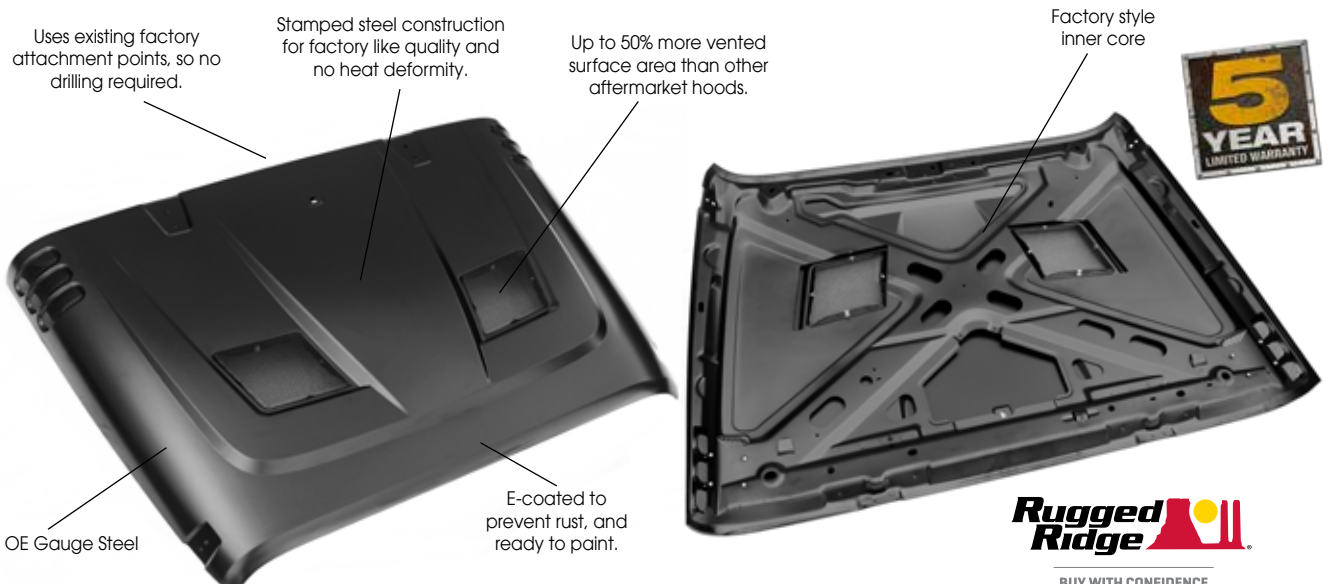

Uses existing factory attachment points, so no drilling required.

Stamped steel construction for factory like quality and no heat deformity.

Up to 50% more vented surface area than other aftermarket hoods.

Factory style inner core



OE Gauge Steel

E-coated to prevent rust, and ready to paint.



BUY WITH CONFIDENCE  
MINIMUM 5 YEAR WARRANTY

<b>Performance Vented Hood for 07-15 Wrangler</b>	Part #
Performance Vented Hood	17759.01

## PERFORMANCE VENTED HOOD INSERT *New!*

These Rugged Ridge Performance Vented Hood Inserts are the perfect add on accessory, offering an aggressive OE style for your vented hood. Injection molded for a precise fit, these inserts promote proper air flow into your engine compartment and mount to the Performance Vented Hood (17759.01) or JK OE hood.

<b>Performance Vented Hood Insert</b>	Omix#
Performance Vented Hood Insert, 07-15 Wrangler <b>NEW</b>	17759.09

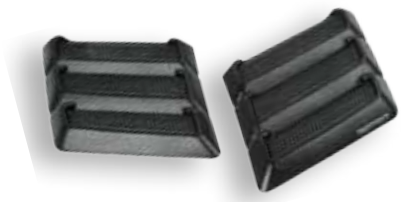





# GRILLES & INSERTS

## SPARTAN GRILLE & INSERTS *New!*

Designed to appeal to avid Jeep® enthusiasts, our new Spartan Grille offers Jeep owners extreme versatility with interchangeable inserts that match their style for a customized off-road look. Each grille is easily paintable and is injection molded for a precise factory like fit. Steel mesh construction and a larger opening provides increased vented surface area, allowing for better air flow and cooling throughout the engine compartment. Patent Pending.

Description	Omix#
Spartan Grille, Black w/ black screen, 07-15 Wrangler	12034.01
Spartan Grille Insert, Star, 07-15 Wrangler	12034.21
Spartan Grille Insert, American Flag, 07-15 Wrangler	12034.22
Spartan Grille Insert, Teeth, 07-15 Wrangler	12034.24
Dual Circular 3.5" LED Grille Insert, 07-15 Wrangler	12034.13
20" Rectangular LED Grille Insert, 07-15 Wrangler	12034.11



12034.22

## GRILLE INSERT SCREENS

Grille Insert Screens for 07-15 Wrangler	Part #
Perforated Grille Insert Screen, Satin Stainless <b>NEW</b>	11401.22
Perforated Grille Insert Screen, Black <b>NEW</b>	11401.32
Mesh Grille Insert Screen, Gloss Black	11401.31
Mesh Grille Insert Screen, Stainless Steel	11401.21



11401.22



11401.31

## GRILLE INSERTS

Durable UV treated inserts enhance the front of your Jeep®. Available in your choice of Black or Chrome with or without aluminum billet inserts, these inserts add great styling and a unique appearance. All Rugged Ridge® inserts easily install without drilling or tools. Just click them in and go! Add on the black or stainless Euro-Guards or black headlight bezels for the sharpest look on the market!

Grille Insert for 07-15 Wrangler	Part #
Black plastic, Set of 7	11306.30
Chrome plastic, Set of 7	11306.20
Black w/ Aluminum Billet, Set of 7	11401.30
Polished w/ Aluminum Billet, Set of 7	11401.20



11401.30

# ALL TERRAIN FLAT FENDER FLARES

Now, with the All-Terrain Flat Fender Flares from Rugged Ridge® you can add a bigger tire option for a true off road look. You can also use in combination with a suspension lift for maximum off road performance. These exciting new flares are out-of-the-box ready to turn your street Jeep® into an off road machine. By removing your original flares and replacing them with these high clearance designs, you can run larger tires without interference from the flare. The ability to run a larger tire with little or no suspension lift means a "lower center of gravity" making your JK more stable, with the necessary ground clearance necessary for off road. With 1.5 inches less coverage in the front and 1 inch less in the rear these flares are slightly narrower than factory flares, yet still maintain proper tire coverage and aggressive looks. Constructed of a flexible UV treated high impact thermoplastic, these flares are designed for the trail and create a whole new look for your JK. Easy to install, these flares replace your factory flares, attaching to the mounting points with no drilling. Simply remove your original flares and add on the All Terrain Flat Fender Flares. The kit also includes easy to install mounting brackets that allow you to relocate and use the existing factory side marker lights.



All Terrain Flat Fender Flare Kit	Part #
07-15 Wrangler, 2 and 4-Door, Flat Fender Flare Kit, 4 Pcs.	11620.10
07-15 Wrangler, Flat Fender Flare & Liner Kit, 8 Pcs.	11620.11

## FLARE WHEEL LINER KIT

Designed for use in combination with the Rugged Ridge® All Terrain Flat Flares for JK, PN: 11620.10, these wheel well liners help keep mud and debris out of the engine compartment and provide a clean finished look. Constructed from durable HDPE, the wheel liners replace the factory wheel well liners that must be removed when running aftermarket flares. Simple bolt in installation, no cutting or drilling required. Kit includes all four wheel well liners and mounting hardware.



Flare Wheel Liner Kit	Part #
07-15 Wrangler, 4 Pcs.	11620.50



## REPLACEMENT FENDER FLARE KITS

Rugged Ridge® provides the most comprehensive replacement Fender Flare program on the market today. We have you covered when it is time to replace or upgrade your factory fender flares. Each Flare is constructed of virtually indestructible, durable, UV treated thermoplastic to provide years of service. Each replacement flare is designed to fit into your factory mounting holes for ease of installation. Just need to replace one flare? No problem. Rugged Ridge® offers individual replacements to keep your investment to a minimum.



Fender Flare Kits	Complete 4-pc Kit	Front Passenger	Front Driver	Rear Passenger	Rear Driver	Hardware Kit
07-15 Wrangler*	11609.01	11609.10	11609.11	11609.12	11609.13	11609.25

\*Except Sahara





# HURRICANE FLAT FENDER FLARES

Jeep® enthusiasts can now get that aggressive off-road look with the newly designed Hurricane Flat Fender Flares by Rugged Ridge. This design was inspired by the 1941 Willys MA. The double bolt pockets provide a new modern twist to classic flares and come with two sets of durable corrosion resistant fasteners (stainless steel and black). Constructed of durable injection molded thermoplastic material, the flares rest high on the vehicle providing 2 inches more of extra clearance with an additional 1 inch of extra width for oversized wheels while on trails. Backed by an industry leading 5 year limited warranty, the Hurricane Flat Fender Flares will really set your JK apart from the crowd! Patent No. D712,324.



Smooth finish shown painted



BUY WITH CONFIDENCE  
MINIMUM 5 YEAR WARRANTY

Hurricane Fender Flares for 07-15 Wrangler	Part #
Hurricane Flat Fender Flare Kit, Textured Black	11640.10
Hurricane Flat Fender Flare Kit, Smooth Black <b>NEW</b>	11640.25

# BODY ARMOR

Get that offroad look with Rugged Ridge® Body Armor! Each Body Armor piece is constructed of black diamond plate UV treated thermoplastic for the coolest, toughest looking upgrade for your Jeep®. Each body armor attaches to your Jeep® with ultra strong 3M tape to ensure a secure fit. Have a scratch or dent on your paint? Cover it up with Body Armor! Simply fill in the scratched area with touch-up paint (to prevent rust) and install the Body Armor. You have now repaired and upgraded! Available in individual pieces or complete styling "kits", so you can customize the look of your Jeep® the way you want.

## COWL ARMOR

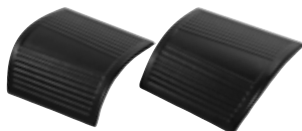

Whenever your door limiter straps are disconnected the door can over extend causing damage to your cowl area. These new cowl covers protect your cowl area while providing a great look. Constructed of durable UV thermoplastic, these covers easily attach using 3M® automotive grade acrylic adhesive tape. Packed in pairs.

Cowl Body Armor	Part #
07-15 Wrangler Matte Black, Pair	11651.18

11651.17 Hood Stone Guard



## REAR CORNER BODY ARMOR KIT



Rugged Ridge® Rear Corner Body Armor is constructed from impact resistant polycarbonate and have a stylish matte black finish to give your Jeep® that tougher look. With an easy no drill installation, each body armor rear corner attaches to your Jeep® with 3M® automotive grade acrylic adhesive tape to ensure a secure fit.

Rear Corner Body Armor Kit	Part #
07-15 Wrangler, 2-door, Matte Black, Pair <b>NEW</b>	11651.07
07-15 Wrangler, 4-door, Matte Black, Pair <b>NEW</b>	11651.09

Body Armor Components	07-15 Wrangler 2-Door	07-15 Wrangler 4-Door
Rear Tall Corner, Pair *	11651.02	11651.01
Rocker Side Panel, Kit *	11651.06	11651.05
Hood Stone Guard, Each	11651.17	11651.17

\* May require modification to fit with Bushwacker brand rear fender flares.

Body Armor Kits - Diamond Tread		Part #
07-15 Wrangler 2-Door, Kit <sup>1</sup>	Rear Tall Corners, Pair (11651.02) Rocker Side Panel, Pair (11651.06) Hood Stone Guard (11651.17)	11651.51
07-15 Wrangler 4-Door, Kit <sup>1</sup>	Rear Tall Corners, Pair (11651.01) Rocker Side Panel, Pair (11651.05) Hood Stone Guard (11651.17)	11651.50

## ROCKER PANEL BODY ARMOR *New!*

Rugged Ridge's new Rocker Panel Body Armor offers the perfect solution in rugged off-road protection. These rocker panels are constructed of impact resistant polycarbonate. This easy no drill solution attaches to your vehicle with super strong 3M® automotive grade acrylic adhesive tape and bolts. Available for both 2 and 4 door Wranglers.

Description	Omix#
Rocker Panel Armor, 07-15 Wrangler, 2-Door	11651.11
Rocker Panel Armor, 07-15 Wrangler, 4-Door	11651.12

**ARRIVING  
SPRING 2015!**





## MATTE BLACK VISORS & DEFLECTORS

New from Rugged Ridge, these Rugged Ridge window visors are aerodynamically designed to reduce wind noise while channeling airflow to keep your vehicles interior free of smoke, stale air and window fogging. The special design channels rain around your window while still allowing air to flow. Tired of bugs and road debris ruining the look of your hood and windshield? The Bug Deflector takes care of that and creates a great unique look, especially when combined with the Rugged Ridge window visors. Constructed of durable scratch resistant matte black finish acrylic, these wind and bug deflectors easily install with special automotive grade tape.

Matte Black Acrylic Accessories	Part#
07-15 Wrangler, Bug Deflector, Matte Black	11348.02
07-15 Wrangler 2-Door, Window Visors, Matte Black	11349.11
07-15 Wrangler 4-Door, Window Visors, Matte Black	11349.12



## SMOKED VISORS & DEFLECTORS

These smoked acrylic accessories offer the same features and benefits of our matte black visors & deflectors, but with a scratch resistant smoked OEM style finish. The special design channels rain around your window while still allowing air to flow through your windows. These no-drill deflectors allow you to drive with windows cracked open but not let rain in. These are packed in pairs on two door models or in sets of four on four door models.

Protect your windshield and hood from flying debris and bugs with this durable bug deflector from Rugged Ridge®. Installation is easy using double sided automotive adhesive tape and under hood screw attachments (some drilling required).

Smoked Acrylic Accessories	Part#
07-15 Wrangler, Bug Deflector, Smoked	11350.02
07-15 Wrangler 2-Door, Window Visors, Smoked	11351.11
07-15 Wrangler 4-Door, Window Visors, Smoked	11351.12

# RUGGED RIDGE GEN I WINCHES

## 8,500 LB WINCHES

- Durable 5.5 HP series wound motor for long life and extra pulling power.
- Hawse fairlead included
- Tough 3 stage planetary gear box with a 172.8:1 gear ratio delivering power and reliability
- Automatic load holding brake system (in the drum brake system)
- Exclusive light mount roller fairlead included- allows for easy no-drill mounting of up to two off road lights!
- Tough stainless hardware is used on the body of the winch to eliminate rust
- Each winch includes a durable 12 foot all weather cable remote solenoid box that can be mounted in multiple positions (over cable or over motor) and angles to accommodate most winch bumpers including the Rugged Ridge® XHD Bumper System!
- Limited five year warranty against manufacturing defects



ALL WEATHER 12' CABLE REMOTE INCLUDED FOR ALL WINCHES



ALL RUGGED RIDGE® SYNTHETIC WINCHES INCLUDE AN ALUMINUM HAWSE FAIRLEAD

8,500 LB. Heavy Duty Winch with Steel Cable	Part #
8,500 LB Heavy Duty Winch with Steel Cable	15100.01

- Includes 94' of 5/16 inch diameter wire rope and latched hook



8,500 LB Performance Winch with Synthetic Rope	Part #
8,500 LB Performance Winch with Synthetic Rope	15100.02

- Constructed with Dyneema SK-75 fiber from the Netherlands.
- Same high strength fabric used in ballistic body armor.
- Stronger than same diameter steel cable and up to 40 percent stronger than Kevlar
- 1/7 the weight of the same diameter wire rope.
- Will not splinter, kink or curl like wire rope & floats in water.
- Specially coated to be resistant to UV, abrasions, and chemical solvents.
- Heavy duty 11/32 inch 12-strand braid with a breaking force of 16,550lbs

## 10,500 LB WINCHES

- Durable 6.6 HP series wound motor for long life and extra pulling power
- Tough 3-stage planetary gear box with a 218:1 gear ratio delivering power and reliability
- Automatic load holding brake system (in the drum brake system)
- Exclusive light mount roller fairlead included- allows for easy no-drill mounting of up to two off road lights!
- Tough stainless hardware is used on the body of the winch to eliminate rust
- Each winch includes a durable 12 foot all weather cable remote solenoid box that can be mounted in multiple positions (over cable or over motor) and angles to accommodate most winch bumpers including the Rugged Ridge® XHD Bumper System!
- Limited five year warranty against manufacturing defects

10,500 LB. Heavy Duty Winch with Steel Cable	Part #
10,500 LB Heavy Duty Winch with Steel Cable	15100.10

- Includes 94 feet of 23/64 inch diameter wire rope and latched hook

10,500 LB Performance Winch with Synthetic Rope	Part #
10,500 LB Performance Winch with Synthetic Rope	15100.11

- Constructed with Dyneema SK-75 fiber from the Netherlands.
- Same high strength fabric used in ballistic body armor.
- Stronger than same diameter steel cable and up to 40 percent stronger than Kevlar
- 1/7 the weight of the same diameter wire rope.
- Will not splinter, kink or curl like wire rope & floats in water.
- Specially coated to be resistant to UV, abrasions, and chemical solvents.
- Heavy duty 3/8 inch 12-strand braid with a breaking force of 19,310lbs



ALL WEATHER 12' CABLE REMOTE INCLUDED FOR ALL WINCHES



ALL RUGGED RIDGE® SYNTHETIC WINCHES INCLUDE AN ALUMINUM HAWSE FAIRLEAD





# WINCH & RECOVERY

## RUGGED RIDGE GEN II WINCHES *New!*

### 8,500 LB WINCHES

- Durable 5.5 HP series wound motor for long life and extra pulling power
- Tough 3-stage planetary gear box with a 172.8:1 gear ratio delivering power and reliability
- Includes 94 feet of 21/64 inch steel cable / 100 feet of 23/64 inch synthetic rope and latched hook
- Automatic load holding brake system
- Tough stainless hardware is used on the body of the winch to eliminate rust
- Each winch includes a durable 12 feet all weather cable remote
- Remote solenoid box can be mounted in multiple positions
- Limited five year warranty against manufacturing defects

8,500 LB. GEN II Winch	Part #
8,500 LB Heavy Duty Winch with Steel Cable	15100.30
8,500 LB Performance Winch with Synthetic	15100.31



**WARNING**

ALL RUGGED RIDGE® SYNTHETIC WINCHES INCLUDE LIGHT MOUNT ROLLER FAIRLEAD

### 10,500 LB WINCHES

- Durable 6.6 HP series wound motor for long life and extra pulling power
- Tough 3-stage planetary gear box with a 218:1 gear ratio delivering power and reliability
- Includes 94 feet of 23/64 inch steel cable and latched hook / 94 feet of 25/64 inch synthetic rope and latched hook
- Automatic load holding brake system
- Tough stainless hardware is used on the body of the winch to eliminate rust
- Each winch includes a durable 12 feet all weather cable remote
- Remote solenoid box can be mounted in multiple positions
- Limited five year warranty against manufacturing defects

10,500 LB. GEN II Winch	Part #
10,500 LB Heavy Duty Winch with Steel Cable	15100.40
10,500 LB Performance Winch with Synthetic	15100.41

**WARNING**



BUY WITH CONFIDENCE  
MINIMUM 5 YEAR WARRANTY

### 12,500 LB WINCHES

- Durable 6.6 HP series wound motor for long life and extra pulling power
- Tough 3-stage planetary gear box with a 265:1 gear ratio delivering power and reliability
- Includes 94 feet of 23/64 inch steel cable / 100 feet of 23/64 inch synthetic rope and latched hook
- Automatic load holding brake system
- Tough stainless hardware is used on the body of the winch to eliminate rust
- Each winch includes a durable 12 feet all weather cable remote
- Remote solenoid box can be mounted in multiple positions
- Limited five year warranty against manufacturing defects

12,500 LB. GEN II Winch	Part #
12,500 LB Heavy Duty Winch with Steel Cable	15100.20
12,500 LB Performance Winch with Synthetic	15100.21

**WARNING**



# SYNTHETIC WINCH ROPE

Stronger and lighter, the two key elements of Synthetic Rope that make it the choice of competition off road vehicles everywhere. Rugged Ridge® high strength synthetic Winch Rope is constructed from genuine Dyneema SK-75 fiber imported from the Netherlands. This revolutionary fiber is the choice of off-road enthusiast worldwide. It is stronger and lighter than wire rope and never kinks or splinters! Our synthetic line is woven from twelve UV-treated strands, resulting in increased strength, and a power to weight ratio unmatched by wire rope. Each synthetic rope comes with a protective sleeve that prevents it from over heating on the winch drum, black powder coated latched hook, stainless steel thimble, and is pre-terminated for ease of installation. Synthetic rope does not store energy like steel cables, and in the event of a failure it is much less likely to result in severe injuries caused by the whiplash of broken wire rope.

Synthetic Winch Rope	Part #
Synthetic Winch Rope 11/32" x 100', Breaking Force of 16,550 lbs, Each	15102.10
Synthetic Winch Rope 3/8" x 94', Breaking Force of 19,310 lbs, Each	15102.11



**WARNING**

# DUAL BATTERY RELAY KIT

The Rugged Ridge® Dual Battery Relay Kit is the perfect companion to the Rugged Dual Battery Tray. This relay kit allows you to connect two batteries to your electrical system. The last thing you want when you're out on the trail or headed to the beach is a dead battery.

Rugged Ridge® Dual Battery Relay Kit	Part #
07-15 Jeep® Wrangler	17265.01

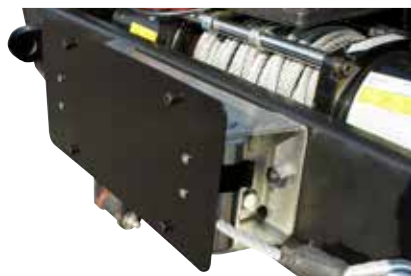

# WINCH FAIRLEAD LICENSE PLATE HOLDERS

**WARNING**

If your state requires a front license plate, we have a solution for you. Instead of drilling holes in your bumper or risking not running a front plate, this easy to install license plate holder attaches to your winch fairlead. Simply bolt your license plate to the bracket and snap the holder in place. Your license plate is now securely mounted yet easily removable for winching.

Winch Fairlead License Plate Holders	Part #
Roller Fairlead License Plate Holder, Each	11238.05
Hawse Fairlead License Plate Holder, Each	11238.07

# LIGHT MOUNT ROLLER FAIRLEAD

Turn your roller fairlead into an off road light mount! This revolutionary new design allows for two off road lights to be easily mounted while not interfering with the winch operation.

Light Mount Roller Fairlead	Part #
Light Mount Roller Fairlead, Each	11238.03



**WARNING**

# WINCH CABLE STOPPER

**WARNING**



Winch Cable Stopper	Part #
Red, Universal Application	15102.05
Black, Universal Application	15102.06

# WINCH COVER

Keep your winch looking as good as the day you bought it with the Rugged Ridge® Winch Cover. Constructed of durable vinyl with reinforced grommets. Custom fit for Rugged Ridge® Winches

Rugged Ridge® Winch Cover	Part #
Winch Cover, All Rugged Ridge® Winches <small>*Will not fit UTV winches</small>	15102.02

**WARNING**





# RECOVERY GEAR

Rugged Ridge® Recovery Gear	Part #
A Recovery Strap 3" x 30' 30,000 lbs, Each	15104.01
A Recovery Strap 2" x 30' 20,000 lbs, Each	15104.02
A Recovery Strap 4" x 30' 40,000 lbs, Each	15104.03
B Tree Trunk Protector, 3" x 6' 30,000 lbs, Each	15104.10
B Tree Trunk Protector, 2" x 6' 20,000 lbs, Each	15104.11
C Recovery Bag, Each	15104.40
D Recovery Gloves, Pair	15104.41
E Winch Line Dampener, Each	15104.43
F Heavy Duty 9,500 lb Zinc Coated D-Rings, Pair	11235.01
F Heavy Duty 13,500 lb Zinc Coated D-Rings, Pair	11235.03
G Heavy Duty 8" 20,000 lb Snatch Block Pulley, Each	11235.10
G Heavy Duty 9" 30,000 lb Snatch Block Pulley, Each	11235.11



## RECOVERY GEAR KITS

The Rugged Ridge® Recovery Gear Kit includes everything you need to help your buddy next time he gets stuck in the mud. The durable carrying case is filled with our most popular recovery products to make sure you can get out of those trouble spots quickly and safely.

### 20,000lb Kit

- Durable Recovery Gear Bag.
- Heavy Duty 8" 20,000lb Snatch Block Pulley.
- Premium 2" x 30' 20,000lb Recovery Strap.
- Premium 3" x 6' 30,000lb Tree Trunk Protector Strap.
- Heavy Duty 9,500lb zinc coated pair of D-Rings.
- Winch Line Dampener.
- Pair of leather Recovery Gloves.

### 30,000lb Kit

- Durable Recovery Gear Bag.
- Heavy Duty 9" 30,000lb Snatch Block Pulley.
- Premium 3" x 30' 30,000lb Recovery Strap.
- Premium 3" x 6' 30,000lb Tree Trunk Protector Strap.
- Heavy Duty 13,500lb zinc coated pair of D-Rings.
- Winch Line Dampener.
- Pair of Leather Recovery Gloves.

Rugged Ridge® Recovery Gear Kit	Part #
20,000 lb, Recovery Gear, Kit, Universal Application	15104.25
30,000 lb, XHD Recovery Gear Kit, Universal Application	15104.28



## ALUMINUM HAWSE FAIRLEAD

This hawse fairlead will help guide the synthetic winch rope to and from the spool. Required for synthetic rope. Not recommended for steel cable.



Aluminum Hawse Fairlead	Part #
Aluminum Hawse Fairlead, Each	11238.01



## WINCH CABLE HANDLE

The winch hook handle is the perfect solution for handling a winch cable. It is constructed of tough nylon webbing with a molded sure-grip handle. Perfect for getting a good solid grip of the winch hook when free spooling cable for a recovery and a safe way to respool your cable without endangering your fingers. Just slip your winch hook through the nylon webbing and you are ready to rock!



Winch Cable Handle	Part #
Winch Cable Handle, Each	15102.01



## DUAL BATTERY TRAY

Outfitting a trail rig can add greater strain to the electrical system. Adding on a winch, air compressor, fog lights, driving lights, a spot light, electric fuel pump, and a stereo amp can really tax the battery. The Rugged Ridge Dual Battery Tray is a great way to combat that strain to install dual batteries. This is especially true when using a winch, which can draw big amps for an extended period. These kits are designed to mount two batteries in place of the factory single battery location. The trays and brackets feature a black powder coated finish. These are mounting kits only and do not include any wiring. A suggested wiring diagram is included.

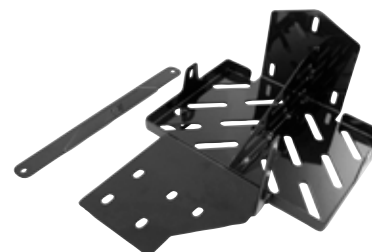

Rugged Ridge® Dual Battery Tray	Part #
07-11 Jeep® Wrangler	11214.53

# TIRE DEFLATOR KITS

Fully inflated tires are great for the road and gas mileage, but they deliver a washboard ride on the trail. Air down your tires for a softer ride and more tread grip. Rugged Ridge® offers two great tire deflator kits to fit your lifestyle and budget.

Rugged Ridge® Tire Deflator Kits	Part #
Adjustable Tire Deflator Kit, 4 Piece Kit	15104.53
Keychain Tire Deflator Kit, 4 Pieces	15104.50
Tire Deflator/Inflator with Gauge	15104.55



# TIRE REPAIR KIT

Be prepared for what ever the trail throws at you! The Rugged Ridge® Tire Repair Kit is essential recovery gear for any road or trailside tire repair. The kit includes: two sturdy aluminum handles, two reamers, two needles, two Allen head wrenches, and 25 self vulcanizing tire plugs all self contained in a heavy duty storage case.

Rugged Ridge® Tire Repair Kit	Part #
Tire Repair Kit, Each	15104.51

# OFF ROAD JACK HANDLE STRAP

The Rugged Ridge Off Road Jack Handle Retainer Strap pulls taut to secure the jack handle to the jack eliminating obnoxious rattle. Simply loop the strap around the jack handle and pull it tight and go! Fits most off road style farm jacks including Hi-Lift.

Off Road Jack Handle Retainer Strap	Part #
Universal Application, Black	13305.60



# XHD OVERRIDER LIGHT CLAMPS

Light mount brackets for use with XHD part numbers 11540.14, 11540.16 and any other 2-2.5 inch bumper overrider/tubes. Easy mount design makes these a must for mounting Rugged Ridge® Lights to your bumper. Also available for smaller 1.5-1.75 inch tube sizes. Sold as each.

Light Clamps	Part #
2"-2.5" Over Rider Mount Bracket	11503.82



# TRI FOLD RECOVERY SHOVEL

The Rugged Ridge® Tri Fold Recovery Shovel is a fully functional collapsible shovel that features two serrated edges for cutting or digging. The heavy duty black powder coated body is 23 inches when open and folds to a mere 9 inches. It can be stowed easily in any vehicle, but is still rugged enough for the toughest of jobs. Includes durable storage case.



Tri Fold Off Road Shovel	Part #
Tri Fold Off Road Shovel, Each	15104.42



## ROCKER PANEL SWITCHES

- Rocker Style Switch.
- Heavy duty marine grade surpasses OE specifications.
- Available in four great colors: Red, Blue, Green and Amber.
- Switch illuminated in the "ON" Position.
- 3 post terminal, 20-amp design works with most aftermarket accessories.

Rocker Panel Switches	Part #
Rocker Switch Amber	17235.01
Rocker Switch Red	17235.02
Rocker Switch Blue	17235.03
Rocker Switch Green	17235.04



## ROCKER SWITCH HOUSING KIT

This housing kit allows you to mount two, three or four switches to numerous dash locations by using a series of interlocking interchangeable pods.



BUY WITH CONFIDENCE  
MINIMUM 5 YEAR WARRANTY

Rocker Switch Housing Kit	Part #
Mounts 2,3 OR 4 Switches	17235.20
Rocker Switch Housing Kit, Universal Application. Includes Four Interlocking Switch Housings and Four Different Color Rocker Switches	17235.89



## A-PILLAR SWITCH PODS

Looking for a handy place to mount your accessory switches that doesn't require cutting or other modifications? The Rugged Ridge® A-Pillar Switch Pod has premolded cutouts to allow you to mount up to four aftermarket switches in easy reach on the driver's side A-pillar, and out of the way of the shifter handle. Our Pillar Pod has the textured molded finish just like the factory plastic pillar cover it replaces. It snaps into place just like the factory original panel!

A-Pillar Switch Pod	Part #
Wrangler 07-10 LH	17235.56
Wrangler 07-10 RH	17235.57
Wrangler 11-15 LH	17235.58
Wrangler 11-15 RH	17235.59

A-Pillar Switch Pod Kit *	Part #
Wrangler 07-10 LH	17235.86
Wrangler 07-10 RH	17235.87
Wrangler 11-15 LH	17235.96
Wrangler 11-15 RH	17235.97

\*Includes four rocker switches.



## LOWER CONSOLE SWITCH POD

The Rugged Ridge® Center Console Mount Switch Pod replaces your original equipment "filler plate" by simply popping the filler plate out and putting in the switch plate. Each plate will hold up to four switches and is custom built for all 2007-2010 Jeep® Wranglers with an automatic transmission. This exciting new mounting plate looks great and places auxiliary switches within reach. Purchase the switch pod and four multi color rocker switches all together and save (see kit part number below.) Limited five year Warranty.

Low Switch Panel	Part #
07-10 Wrangler w/ Automatic Transmission, Black, Mounts Four Switches	17235.55

Low Switch Panel Kit	Part #
07-10 Wrangler w/ Automatic Transmission. Includes Switch Pod and Four Rocker Switches	17235.85



## OE JK FOG LIGHT

Stock replacement lens and housing assembly. Fits either side.

OE Fog Light	Part #
Fog Light Assembly, Jeep Wrangler (JK) 07-09 LH/RH	12407.12
Fog Light Assembly, Jeep Wrangler (JK) 10-15 LH/RH	12407.16



BUY WITH CONFIDENCE  
MINIMUM 5 YEAR WARRANTY





# LED LIGHTING

Illuminate the area around you with new LED Lighting from Rugged Ridge®. Designed, engineered and tested to optimize your adventure during off-roading, these new lights will have you ready to rock in no time. The power and longevity of LED lights exceeds that of other lights on the market today allowing that extra time on the trails with our lights which provide a stable light output. Featuring black powder-coated aluminum housing for toughness and sustainability, LED Lights are vibration, corrosion, and submersion tested to provide prime performance throughout the night; so you will no longer need to watch the clock and can safely enjoy wheeling into the night.

LED Off Road Lights	Part #
3.5-inch Round LED Light	15209.01
3-inch LED Light Cube	15209.03
13.5-inch LED Lightbar	15209.11
20-inch LED Lightbar <b>NEW</b>	15209.12



15209.11



15209.01



15209.12



15209.03

## LED COVERS

These black plastic off road light covers from Rugged Ridge protect LED lights and meet state laws for covering off road lights.

Rugged Ridge® LED Covers	Part #
LED Light Cover, Square, 3-inch (Fits 15209.03)	15210.48
13.5-inch LED Light Bar Cover Kit	15210.47
LED Light Cover, Round, 3.5-inch (Fits 15209.01)	15210.64
20-inch LED Light Bar Cover Kit	15210.66



15210.48



15210.64



15210.47



15210.66



# X-CLAMP MOUNTING SYSTEM FEATURING PIVOTAL FIT TECHNOLOGY™

The X-Clamp from Rugged Ridge® features an innovative and unique adjustment which allows mounting to tubes ranging from 1.25-inch to 2-inch or 2.25-inch to 3-inch. Rotate the X-Clamp to fit your tube, pivot the mounting bracket to the desired position. Patent Pending.

Rugged Ridge X-Clamp Mounting System	Part #
X-Clamp, 2.25-3in, Black	11030.01
X-Clamp, 2.25-3in, Silver	11030.10
X-Clamp, 1.25-2in, Black	11031.01
X-Clamp, 1.25-2in, Silver	11031.10
X-Clamp, 2.25-3in, Textured Black	11031.40
X-Clamp, 1.25-2in, Textured Black	11031.20



11030.01 (two shown)



11030.10

## WINDSHIELD LED LIGHT BAR

This windshield LED light bar is constructed from sturdy two-inch welded steel tubing and is secured to the vehicle using specially engineered A-pillar brackets that replace the OE windshield brackets. The contour hugging light bar frames the windshield, accommodating three Rugged Ridge 13.5-inch LED Light Bar with low profile tabs engineered to minimize wind noise.

Rugged Ridge Windshield LED Light Bar	Part #
Windshield LED Light Bar, 07-15 JK	11232.25
Windshield LED Light Bar w/ Three 13.5-inch Lights, 07-15 JK	11232.26



11232.26

## LED LIGHT MOUNT KIT

These pairs of LED light mounting brackets have round or square openings that allow you to mount either the 3.5-inch round LED lights or the 3-inch Cube LED lights into the factory or Rugged Ridge® bumper systems (XHD and All-Terrain) for the ultimate in nighttime illumination on the trails.



11232.27

LED Light & Mount Kit, 07-15 Wrangler	Part #
LED Light & Mount Kit, Circle, Pair	11232.27
LED Light & Mount Kit, Square, Pair	11232.28

## WINDSHIELD BRACKETS LED KITS

This pair of black powder coated windshield auxiliary light mounting brackets bolt to the windshield hinges of your Wrangler. Each bracket allows for easy mounting of auxiliary lighting and is custom designed for an exact fit.



11027.16

Windshield Bracket LED Kits, 07-15 Wrangler	Part #
Windshield Bracket LED Kit, Textured Black, Square	15207.70
Windshield Bracket LED Kit, Textured Black, Round	15207.72
Windshield Bracket LED Kit, Black, Square	11027.10
Windshield Bracket LED Kit, Black, Round	11027.11

## HOOD LIGHT BAR

This hood mounted light bar comes in a gloss black powdercoat or textured black finish and fits 07-15 Wranglers.

Hood Light Bar, 07-15 Wrangler	Black	Text. Black
Hood Light Bar, 3 square LED	11232.04	11232.11
Hood Light Bar, 5 square LED	11232.05	11232.12
Hood Light Bar, 3 round LED	11232.06	11232.13
Hood Light Bar, 5 round LED	11232.07	11232.14



## LED TAIL LIGHT SET

This LED tail light set is D.O.T. compliant, and features a smoke tinted lens for a modern appearance. Direct OEM fit replacement tail lights feature simple plug and play installation. No drilling required.



LED Tail Light Set, Smoke	Part #
07-15 Wrangler, Pair	12403.88

## A-PILLAR DUAL LIGHT MOUNT KITS

This pair of A-Pillar Dual Light Mounts is constructed from heavy-duty steel and are available in long-lasting semi-gloss and textured black finishes. These brackets are easily mounted to the lower windshield mount using the JK's existing mounting bolt holes.



11232.32

A-Pillar Dual Light Mount Kits, 07-15 Wrangler	Part #
A-Pillar Dual Light Mount Kit, Black, 4 Round LED	11232.32
A-Pillar Dual Light Mount Kit, Black, 4 Square LED	11232.33
A-Pillar Dual Light Mount Kit, Text. Black, 4 Round LED	11232.34
A-Pillar Dual Light Mount Kit, Text. Black, 4 Square LED	11232.35

# HID LIGHTING

We mated the brilliance of high intensity discharge bulbs with the rugged construction of our traditional halogen off road lights. The result is a more efficient and powerful beam better capable of illuminating the night sky. Rugged Ridge® HID Lights are 2½ times more powerful than halogen lights and draw 60% less current than a standard 100W fog light. Our 6-inch and 5-inch HID Lights are constructed with heavy duty stamped steel housings, and are available in corrosion resistant black or stainless steel finish.



HID Off Road Lighting	Single Light	2 Light Kit w/ Wiring Harness	3 Light Kit w/ Wiring Harness
6" Round, Fog, Black	15205.01	15205.51	15205.61
5" Round, Fog, Black	15205.02	15205.52	15205.62
7" Round, Long Range, Black, Plastic	15205.03	15205.53	15205.63
5" Round, Long Range, Black, Composite	15205.04	15205.54	15205.64
6" Round, Long Range, Stainless	15206.01	15206.51	15206.61
5" Round, Long Range, Stainless	15206.02	15206.52	15206.62

HID Accessories/Replacement Parts	Part #
HID Lighting Covers, 7", Smoked	15210.51
HID Lighting Covers, 6", Black	15210.50
HID Lighting Covers, 5", Black	15210.52
HID Lighting Installation Harness for a pair of lights	15210.60
HID Lighting Installation Harness for three lights	15210.61
Replacement HID Bulb for 5" and 6" lights	15210.80
Replacement HID Bulb for 7" lights	15210.81



# HALOGEN LIGHTING

Designed, engineered, and tested to optimize your time on the trails, our lights are constructed with heavy-duty stamped steel housings, and crystal glass lenses set in shock absorbent weatherproof rubber gaskets. The brilliant 12V 100 watt halogen bulbs slice through fog, rain or snow to help illuminate the road even under the toughest conditions. Available in round, rectangular and slim housings in either a black or stainless steel finish to best suit your application.

Rugged Ridge® Off Road Lights, 100W	Single Light	2 Light Kit w/ Wiring Harness	3 Light Kit w/ Wiring Harness
6" Round, Long Range, Black	15207.01	15207.51	15207.61
5" x 7", Fog, Black	15207.05	15207.55	15207.65
6" Slim, Long Range, Black	15207.10	15207.58	15207.68
6" Round, Long Range, Stainless	15208.01	15208.51	15208.61
6" Slim, Long Range, Stainless	15208.10	15208.58	15208.68



Halogen Light Accessories	Part #
Off Road Light Cover, 6-inch Black	15210.53
Off Road Light Cover, 6-inch White	15210.54
Off Road Light Cover, 5x7-inch Black	15210.55
Off Road Light Cover, 5x7-inch White	15210.56
Off Road Light Cover, 6-inch Black Slim	15210.57
Off Road Light Cover, 6-inch White Slim	15210.58
Off Road Light Installation Harness, For Pair Of Lights	15210.62
Off Road Light Installation Harness, For Three Lights	15210.63
Halogen H3 Off Road Light Bulb, 100w Replacement	15210.82
Halogen H3 Off Road Light Bulb, 130w Replacement	15210.83



Rectangular lights give your vehicle a whole new look



## FRONT BUMPER LIGHT BARS

Rugged Ridge® has engineered a durable and easy to install light bar that allows you to add auxiliary lighting to your factory Wrangler bumper. The light bar bolts to existing mounting holes and installs easily without cutting, drilling, or removing the bumper. With a few simple hand tools you will be able to install your light bar and mount up to three lights on your Jeep while retaining your factory bumper. Lights not included.

Front Bumper Light Bars	Part #
07-15 Wrangler, Textured Black, Each	11232.20
07-15 Wrangler, Stainless Steel, Each	11138.20



11232.20, 07-14 Wrangler

## WINDSHIELD HINGE LIGHT BRACKETS

Special black powder coated or polished stainless brackets mount directly to the windshield hinge of your Wrangler. Allows for easy mounting of auxiliary lighting. Each bracket is custom designed for an exact mount and 07-15 models include a rubber gasket to protect the paint during installation/removal. Sold in pairs. Lights not included.



Windshield Hinge Light Brackets	Black	Stainless
07-15 Wrangler	11027.03	11028.03

## HOOD MOUNTED LIGHT KIT

This innovative product mounts a pair of 3-inch 55-watt halogen lights directly to your factory hood latches without drilling or modification. Kit includes textured black powder coated brackets, two 3-inch halogen lights, wiring harness, relay and switch for a complete light solution.



Hood Mounted Off Road Light Kit 07-15 Wrangler	Part #
Hood Mounted Lights, 3" Black, 2 Light Kit w/ Wiring Harness	15207.70
Spare Light for Hood Mounted Light Kit	15207.72

## JK WINDSHIELD LIGHT BAR

The Ultimate Light Bar for your Wrangler! This exciting new design has been created to give the durable look of a five tab light bar with features found nowhere else. Through extensive testing, this heavy duty light bar incorporates a special wind deflector below the light bar to dramatically reduce whistling and "buffeting" of your soft top. Oversized 2-inch textured black tubing attaches to your windshield mounts with no drilling. Each light bar has five light tabs for use with Rugged Ridge® lighting options (fits up to five 7-inch lights). Each light bar has been specially developed to work with Rugged Ridge® light mount brackets and/or Rugged Ridge® mirror relocation brackets. Special three piece design makes the packaging small for easy shipping. This is truly the most advanced light bar on the market!

Windshield Light Bar	Part #
Textured Black, Jeep Wrangler (JK) 07-15, Each	11232.21



## LIGHT BAR LOWERING KIT

The Rugged Ridge® Light Bar Lowering Kit, allows you to mount lights lower on your light bar. Not always do you need the lights all the way on the top due to clearance issues or you want to reduce the wind resistance. The lowering kit allows you to mount up to 7-inch lights.

Windshield Light Bar Lowering Kit	Part #
Textured Black, Jeep Wrangler (JK) 07-15, Each	11232.22



## SPARE TIRE LIGHT MOUNT

The new Spare Tire Light Mount from Rugged Ridge® offers a utility light mount that is easily removable for access to the spare tire, and also offers you a place to relocate the license plate from the vulnerable original location. Featuring a textured black steel construction with stainless steel hardware.

Shown with 100 watt halogen light - part # 15207.05 (Not Included)

Spare Tire Light Mount	Part #
Spare Tire Light Mount, Jeep Wrangler (JK) 07-15, Each	11217.02



# REPLACEMENT & REPAIR PARTS

Direct OE replacement Jeep® parts and accessories built to the original specifications by Omix-ADA®. Limited 5 year manufacturer's warranty.



16523.55



16507.43



16512.69

## Axle

	Part #
Differential Spider Gear Set, Rear, Dana 44™, 07-15 Wrangler <b>NEW</b>	16507.43
Differential Cross Shaft, Rear Dana 44™, 07-15 Wrangler <b>NEW</b>	16507.62
Differential Carrier, Rear Dana 44™, 07-15 Wrangler <b>NEW</b>	16508.22
Ring & Pinion Kit, Rear Dana 44™, 3.21 Ratio, 07-15 Wrangler <b>NEW</b>	16514.59
Front Axle Shaft Guide, Dana 44™, 07-15 Wrangler Rubicon <b>NEW</b>	16526.09
Axle Stub Shaft Locking Nut, Front, 07-15 Wrangler (Dana Super 30™ and Dana 44™)	16527.01
Axle Seal Retainer, Rear, 07-15 Wrangler (Dana 35™ Or Dana 44™)	16535.40
Axle Shaft Assembly, Front Right Inner and Outer, Dana 30™, 07-15 Wrangler	16523.54
Axle Shaft Assembly, Front Left Inner and Outer, Dana 30™, 07-15 Wrangler	16523.55
Axle Shaft Assembly, Front Right Inner and Outer, Dana 44™, 07-15 Wrangler	16523.56
Axle Shaft Assembly, Front Left Inner and Outer, Dana 44™, 07-15 Wrangler	16523.57
Ring Gear Bolt Sleeve by Alloy USA, 1/2" to 3/16", Universal Application	13380.18
Differential Bearing Kit, Front, Dana 44™, 07-15 Wrangler	16509.10
Differential Bearing Shim Kit, Front, Dana 44™, 07-15 Wrangler	16512.23
Differential Internal Parts Kit, Front (Dana Super 30™, 07-15 Wrangler	16512.69
Pinion Baffle, Front, 07-15 Wrangler (Dana Super 30™ and Dana 44™)	16512.22
Tube Seal and Guide, Front, Dana 44™, 07-15 Wrangler	16526.10
Differential Case Assembly, 3.73 to 4.88 Ratio (Dana Super 30™), Front, With Internal Parts, 07-15 Wrangler	16503.67
Ring and Pinion Kit, Front Dana 44™, 3.73 Ratio, 07-15 Wrangler	16514.58
U-Joint, Dana 44™ Front, 07-15 Wrangler, Rubicon	11502



## Brakes

	Part #
Parking Brake Cable, Rear, 07-15 2-Door Wrangler <b>NEW</b>	16730.54
Parking Brake Cable, Rear, 07-15 4-Door Wrangler <b>NEW</b>	16730.55
Rear Brake Hose, Right, 07-15 Wrangler <b>NEW</b>	16733.14
Rear Brake Hose, Left, 07-15 Wrangler <b>NEW</b>	16733.15
Front Brake Caliper, Right, 07-15 Wrangler <b>NEW</b>	16745.14
Front Brake Caliper, Left, 07-15 Wrangler <b>NEW</b>	16745.15
Rear Brake Caliper, Right, 07-15 Wrangler <b>NEW</b>	16757.07
Rear Brake Caliper, Left, 07-15 Wrangler <b>NEW</b>	16757.08
Disc Brake Master Cylinder, 07-14 Wrangler (Except BR6)	16719.25
Disc Brake Rotor, Front, 07-15 Wrangler	16702.12
Disc Brake Rotor, Rear, 07-15 Wrangler	16703.05
Disc Brake Pads, Front, 07-15 Wrangler	16728.15
Disc Brake Rotor, Rear, 07-15 Wrangler	16729.11
Brake Hose, Front Left, 07-15 Wrangler	16732.29
Brake Hose, Front Right, 07-15 Wrangler	16732.30
Emergency Brake Shoes, 07-15 Wrangler	16731.08
Wheel Hub Assembly, Front, 07-15 Wrangler	16705.14



16702.12



16745.14



16728.15



## Cooling

	Part #
Radiator, 1 Row, 07-11 Wrangler (3.8L)	17101.38
Fan Assembly, 07-11 Jeep Wrangler (3.8L)	17102.57
Coolant Overflow Bottle, 3.8L, 07-11 Wrangler <b>NEW</b>	17103.06
Water Pump, 07-11 Wrangler (3.8L)	17104.22
Thermostat 195°, 07-11 Wrangler (3.8L)	17106.06
Upper Radiator Hose, 07-11 Wrangler (3.8L)	17113.27
Lower Radiator Hose, 07-11 Wrangler (3.8L)	17114.25
Serpentine Belt, 07-11 Wrangler (3.8L with AC)	17111.38
Serpentine Belt, 07-11 Wrangler (3.8L without AC)	17111.39
Idle Pulley, 07-11 Wrangler (3.8L)	17112.07
Serpentine Belt, 12-15 Wrangler (3.6L)	17111.51
Water Pump Gasket, 07-11 Wrangler (3.8L)	17119.04
Fan Shroud, 07-11 Jeep Wrangler (3.8L)	17102.06



17111.39



17104.22



17101.38





12012.30



12040.08



12040.03

**Body**

	Part #
Hood, 07-15 Wrangler	12040.01
Hood Catch Bracket, 07-15 Jeep Wrangler	11210.12
Hood Catch, 07-15 Jeep Wrangler	11210.13
Hood Catch & Bracket, 07-15 Jeep Wrangler	11210.14
Hood Catch Kit, 07-15 Jeep Wrangler	11210.16
License Plate Bracket, 07-15 Wrangler <b>NEW</b>	11233.07
Window Regulator, Frt, Manual, RH, 07-15 Wrangler <b>NEW</b>	11821.26
Window Regulator, Frt, Manual, LH, 07-15 Wrangler <b>NEW</b>	11821.27
Window Regulator, Rear, Manual, RH, 07-15 Wrangler <b>NEW</b>	11821.28
Window Regulator, Rear, Manual, LH, 07-15 Wrangler <b>NEW</b>	11821.29
Fender, Left, 07-15 Wrangler	12040.03
Fender, Right, 07-15 Wrangler	12040.02
Front Bumper Cover, With Fog Light Cut Outs, 07-15 Wrangler	12040.05
Grille Overlay (Appliqué), Chrome, 07-15 Wrangler	12033.05
Bumper Appliqué, Front, Silver, Matches OE Sahara Model Cover But Fits All Models, 07-15 Wrangler	12040.08
Bumper Appliqué, Rear, Silver, Matches OE Sahara Model Cover But Fits All Models, 07-15 Wrangler	12040.09
Liftgate Support Strut (Shock), LH or RH, 07-15 Wrangler	12012.17
JK8 Independence Pickup Truck Conversion Kit by Mopar, 07-15 Wrangler Unlimited (4-Door)	77070049
Mirror, Right, Power Heated, Black, 11-15 Wrangler (Non-power option)	11002.24
Mirror, Left, Power Heated, Black, 11-15 Wrangler (Non-power option)	11002.25
Fender Flare Support Bracket, Right, 07-15 Wrangler	12029.36
Fender Flare Support Bracket, Left, 07-15 Wrangler	12029.37
Lock Nut, Hex, Mounting, Tail, Stop, Turn Signal, or Side Marker Lamp. M6x1.00, 07-15 Wrangler	12410.02
4-Piece Replacement Fender Flare Kit, 07-15 Jeep Wrangler (JK)	11609.01
Fender Flare, Left Front, 07-15 Jeep Wrangler	11609.11
Fender Flare, Right Front, 07-15 Jeep Wrangler	11609.10
Fender Flare, Left Rear, 07-15 Jeep Wrangler	11609.13
Fender Flare, Right Rear, 07-15 Jeep Wrangler	11609.12
Liftgate Ball Stud, Right Side, 07-15 Wrangler <b>NEW</b>	12012.30
Liftgate Ball Stud, Left Side, 07-15 Wrangler <b>NEW</b>	12012.31



11002.24

**Clutch**

	Part #
Clutch Bearing, 07-15 Wrangler with Manual Transmission	16906.06
Clutch Kit, 12-15 Jeep Wrangler, include clutch disc, pressure plate and throw-out bearing	16902.21

**Fuel**

	Part #
Non-Locking Gas Cap , 07-15 Jeep Wrangler	17726.15
Locking Gas Cap, 07-15 Jeep Wrangler	17726.16
Fuel Pump Module, 11-15 Jeep Wrangler	17709.39



17447.15



17465.95

**Engine**

	Part #
Cylinder Head Gasket, Left, 07-11 Wrangler (3.8L)	17466.13
Cylinder Head Gasket, Right, 07-11 Wrangler (3.8L)	17466.12
Valve Cover Gasket, Pair, 07-11 Wrangler (3.8L)	17447.15
Lower Engine Gasket Set, 07-11 Jeep Wrangler (3.8L)	17442.11
Upper Gasket Set, 07-11 Wrangler (3.8L)	17441.13
Main Bearing Set, Standard Size, 07-11 Wrangler (3.8L)	17465.95
Engine Mount, LH or RH, 2007-2011 Wrangler (3.8L)	17473.26
Valve Stem Seal (individual), Intake or Exhaust, 07-11 Wrangler (3.8L), 12 Required	17443.07
Oil Filler Cap, 11-15 Wrangler (3.6L)	17403.09



17473.26

# REPLACEMENT & REPAIR PARTS

Direct OE replacement Jeep® parts and accessories built to the original specifications by Omix-ADA®. Limited 5 year manufacturer's warranty.

17225.18



17227.19



17247.15



17245.18



## Electrical

	Part #
Alternator, 140 Amp, 07-11 Wrangler (3.8L)	17225.20
Ignition Spark Plug Wire Set, 07-11 Wrangler (3.8L)	17245.18
Ignition Switch, 07-15 Wrangler	17251.09
Crankshaft Position Sensor, 07-11 Wrangler (3.8L with Automatic Transmission)	17220.16
MAP Sensor, 07-11 Wrangler (3.8L)	17223.04
Coolant Temperature Sensor, 07-11 Wrangler (3.8L)	17218.09
Air Intake Temperature Sensor, 07-11 Wrangler (3.8L)	17221.04
Oil Pressure Sender, 07-11 Wrangler (3.8L)	17219.15
ABS Speed Sensor, Front, LH or RH, 07-10 Wrangler	17259.06
ABS Speed Sensor, Rear, LH or RH, 07-12 Wrangler	17259.07
Vehicle Speed Sensor, 07-11 Wrangler <b>NEW</b>	17259.08
Neutral Safety Switch, 07-11 Wrangler with Automatic Transmission	17261.01
Alternator, 160 Amp, 07-11 Wrangler (3.8L)	17225.18
Tire Pressure Monitoring Service Kit, 07-15 Wrangler	17237.11
Tire Pressure Monitor (TPMS) Sensor, 13-15 Wrangler, One Needed Per Tire <b>NEW</b>	17237.20
Tire Pressure Monitor (TPMS) Sensor, 07-12 Wrangler, One Needed Per Tire	17237.13
Wiper Blade Front (15"), 07-15 Wrangler	19712.08
Starter, 12V 10 Tooth, 07-08 Wrangler (3.8L with Automatic Transmission) , 07-11 Wrangler (3.8L with Manual Transmission)	17227.18
Starter, 12V 10 Tooth, 09-11 Wrangler (3.8L with Automatic Transmission)	17227.19
Oxygen Sensor, Front Before Catalytic Converter, LH, 07-11 Wrangler (3.8L)	17222.41
Oxygen Sensor, Front Before Catalytic Converter, RH, 07-11 Wrangler (3.8L)	17222.40
Oxygen Sensor, Rear After Catalytic Converter, 07-11 Wrangler (3.8L)	17222.28
Crankshaft Position Sensor, 09-11 Wrangler (3.8L with Manual Transmission)	17220.04
Backup Switch, NSG370, 07-11 Wrangler	17234.27
Ignition Coil, 07-11 Wrangler (3.8L)	17247.15
Ignition Coil, 11-14 Wrangler (3.6L)	17247.17

## Exhaust

	Part #
Exhaust Manifold Gasket, Pair, 07-11 Wrangler (3.8L)	17451.16
Muffler, 07-15 Wrangler (3.8L & 3.6L)	17609.30
Intermediate Pipe, 07-11 Wrangler 4-Door (3.8L)	17608.05



17451.16



17609.30

## Filters

	Part #
Oil Filter, 07-11 Wrangler (3.8L)	17436.09
Oil Filter, 12-13 Wrangler (3.6L)	17436.20
Oil Filter, 14-15 Wrangler (3.6L) <b>NEW</b>	17436.24
Fuel Filter, , 07-11 Wrangler (2.8L Diesel) <b>NEW</b>	17718.08
Air Filter, 11 Wrangler (3.8L), 12-15 Wrangler (3.6L)	17719.09
PCV Valve, 07-11 Wrangler (3.8L)	17404.13

17436.20



17719.09





Heat/AC	Part #
Blower Motor Resistor, 07-10 Jeep Wrangler (JK)	17909.04
A/C Condenser, 07-12 Jeep Wrangler (JK)	17950.12

Interior	Part #
Accelerator Pedal, 07-11 Wrangler	17733.04

Lighting	Part #
Headlight Assembly, Left, 07-15 Wrangler	12402.21
Headlight Assembly, Right, 07-15 Wrangler	12402.20
Fog Light Assembly, Left or Right, 07-09 Wrangler	12407.12
Fog Light Assembly, LH or RH, 10-15 Jeep Wrangler	12407.16
Park Lamp, Left, Amber, 07-15 Wrangler	12405.25
Park Lamp, Right, Amber, 07-15 Wrangler	12405.24
Park Lamp Assembly, Clear, Right, 07-15 Wrangler <b>NEW</b>	12405.32
Park Lamp Assembly, Clear, Left, 07-15 Wrangler <b>NEW</b>	12405.33
Side Marker Light, Amber, Left, 07-15 Wrangler	12401.25
Side Marker Light, Amber, Right, 07-15 Wrangler	12401.24
Tail Light, Left, 07-15 Wrangler	12403.37
Tail Light, Right, 07-15 Wrangler	12403.36
Parking Lamp Bulb, Clear, 07-15 Wrangler <b>NEW</b>	12408.10



Steering	Part #
Tie Rod End, LH, To Pitman Arm, 07-15 Wrangler	18044.01
Tie Rod End, RH, Knuckle to Adjuster, 07-15 Wrangler	18044.02
Tie Rod End, LH, Outer, To Knuckle, 11in Long, 07-15 Wrangler	18044.03
Tie Rod Tube Adjustment Sleeve, To LH Outer Tie Rod, 07-15 Wrangler	18044.04
Steering Link Adjuster, LHD, 07-15 Wrangler <b>NEW</b>	18044.06
Steering Stabilizer, 07-15 Wrangler	18040.05
Power Steering Pump, 12-15 Wrangler <b>NEW</b>	18008.22
Power Steering Pump Reservoir, 08-15 Wrangler <b>NEW</b>	18009.03
Power Steering Pump Pulley, 3.8L, 07-11 Wrangler <b>NEW</b>	18011.02
Power Steering Pressure Hose, 07-11 Wrangler	18012.22
Power Steering Supply Hose Clamp, 26mm, 3.8L, 07-11 Wrangler <b>NEW</b>	6502017
Pitman Arm, LHD, 07-15 Wrangler, Stock Replacement	18006.11
Drag Link, 07-15 Wrangler <b>NEW</b>	18050.10



Suspension	Part #
Ball Joint Kit, Front, Includes 1 Upper and 1 Lower (Does one side), Dana Super 30™ or Dana Super 44™, 07-15 Wrangler	18036.05
Ball Joint, Upper, Dana Super 30™ or Dana Super 44™, 07-15 Wrangler	18037.05
Control Arm Front Lower, LH or RH, 07-15 Wrangler	18285.11
Control Arm Front Upper, LH or RH, 07-15 Wrangler	18285.10
Control Arm Rear Lower, 07-15 Wrangler	18285.14
Control Arm Rear Upper, LH or RH, 07-15 Wrangler	18285.12
Front Swaybar Bushing, 07-15 Jeep Wrangler <b>NEW</b>	18283.14
Front Sway Bar End Link, 07-15 Wrangler <b>NEW</b>	18283.25
Upper Control Arm Bushing, Front, Axle End, 07-15 Wrangler <b>NEW</b>	18283.15
Shock Absorber, Front, 07-15 Wrangler	18203.24
Shock Absorber, Rear, 07-15 Wrangler	18203.25

# PERFORMANCE BY RUGGED RIDGE®

## STAINLESS STEEL CAT-BACK EXHAUST SYSTEM

Open up your Jeep®'s exhaust with this great looking & long lasting dual exhaust system. The 2 1/4-inch mandrel bent pipes give hot exhaust gases a smooth exit without the constrictions found in crush-bent pipes. This added flow decreases back pressure and will actually increase the horsepower of your 3.8L or 3.6L engine! This is a bolt-on system that installs after the catalytic converter to keep your emissions legal. The dual split exits feature slash cut and rounded oval tips. Each kit includes all necessary mounting hardware for an easy bolt on installation.

Stainless Steel Cat-Back Exhaust System	Part #
07-15 Wrangler 2-Door & 4-Door, Polished, Kit	17606.75
07-15 Wrangler 2-Door & 4-Door, Black, Kit <b>NEW</b>	17606.77



## JK HEAVY DUTY OFF-ROAD MUFFLER

Designed to deliver a more aggressive tone than the stock muffler, the off-road muffler produces a deep tone throughout the RPM range. It is designed to sit as high as possible for extreme off-road ground clearance. The exhaust tip is designed to be protected by the body frame to reduce trail damage. Stainless steel and aluminized steel construction with Black hi-temp coating insures extended durability.

Heavy Duty Off-Road Muffler	Part #
07-15 Wrangler 2-Door & 4-Door, Kit	17606.70



## EXHAUST SPACER KIT

Jeep® moved the exhaust forward on the 12-15 Wrangler. Unfortunately, on Jeeps® with 2.5-inch or more of lift that means their front driveshaft is liable to make contact with the exhaust Y-Pipe melting the CV boot and causing the driveshaft to fail prematurely. The Rugged Ridge® Exhaust Spacer Kit for 3.6L Wranglers helps move the Y-pipe further back and increases the amount of front suspension travel from 2.5 to over 5.5-inch, thus saving your driveshaft. The spacers install on the flanges between the front headers and Y-pipe. The great thing is the kit is easy to install and does not require permanent modification to the exhaust. Hardware included. Backed by Rugged Ridge's® exclusive three-year limited warranty.



Exhaust Spacer Kit	Part #
Exhaust Spacer Kit by Rugged Ridge, 12-15 JK Wrangler (w/ 2.5-Inch + Lift)	17606.76

## COLD AIR INTAKES

A Rugged Ridge® Cold Air Intake System can boost your performance, while helping you keep extra cash in your wallet. Our polished aluminum mandrel bent intake tube replaces the restrictive factory air box to help improve fuel economy. A black powder coated heat shield separates the filter from engine heat, dirt and debris, as cold air is drawn through a high-flow conical air filter. Our dry panel design never needs oiling, which keeps your mass airflow sensor from being damaged by excess oil! The simple bolt on installation gives you power you can feel, adding up to 10HP and 12ft lbs of torque.



Rugged Ridge® Cold Air Intake Systems	Part #
07-11 Wrangler 3.8L	17750.06
12-15 Wrangler 3.6L	17750.07



## STAINLESS HEADERS

Our custom Stainless Exhaust Headers are engineered to deliver improved performance. The 3.8L isn't a bad motor it just needs more air to "breathe" properly. Each complete kit includes manifolds, gaskets, hardware, clamps and easy to read instruction sheets.



Stainless Steel Headers	Part #
07-11 Wrangler w/3.8L Engine, Each	17650.53

## THROTTLE BODY SPACER

The Rugged Ridge® Throttle Body Spacer raises the throttle body 1/2-inch above the intake manifold. The lift helps optimize power and performance by drawing in colder denser air, producing more horsepower and torque. Solid aluminum construction.



Throttle Body Spacer	Part #
07-11 Wrangler 3.8L	17755.02
12-15 Wrangler 3.6L	17755.03





LOW MOUNT



PRE-FILTER

## XHD MODULAR SNORKEL

Dusty trail rides and deep water fordings. –Anyone who takes their rig off-road is likely to encounter these conditions. The new Modular XHD Snorkel System from Rugged Ridge® relocates the venerable stock air intake location to help reduce dust clogged filters and the risk of hydro-locking your engine. It is also the first snorkel designed with the modular functionality of a Pre-filter Low Mount and Ram High Mount air intake design. Unlike other snorkels, you don't have to give up flexibility for functionality. Not only did we engineer our snorkel to allow the windshield to fold and doors to be removed, we built it for use with our dual battery tray, windshield light bar and windshield light mounting tabs... Because what good is having a snorkel to cross the river, if you have to leave your lights and the dual battery (to power your winch) on the other side? Note: Windshield light mounting tabs only compatible with low mount.

The Modular XHD Snorkel System comes standard with the Pre-filter Low Mount. The Pre-filter Low Mount relocates the air intake to just below the windshield and draws cool air from outside the hot engine compartment. The optional Ram High Mount design allows the air intake to be extended up an additional 21" to the top of the windshield. The two air intake mounts are easily interchangeable to give you the modular functionality best suited to your needs. The system is manufactured from premium thermoformed plastic, mandrel bent aluminum and hi-temp silicone connection hoses. Built in manual drain valves channel away excess water to prevent it from entering the intake system. It installs with minor modification to the fender, but without the major cutting and surgery that other kits require. The new lower air cleaner box installs in place of the factory unit, so you don't have to "hack and tap". Just attached the factory upper air box, chose from the Pre-filter Low Mount or Ram High Mount design and go! Patent #'s D687,071 & D687,072.

Modular XHD Snorkel	Part #
Modular XHD Snorkel Low Mount, 07-11 Wrangler 3.8L	17756.06
Modular XHD Snorkel Low Mount, 12-14 Wrangler 3.6L	17756.08
Modular XHD Snorkel Kit*, 07-11 Wrangler 3.8L	17756.20
Modular XHD Snorkel Kit*, 12-14 Wrangler 3.6L	17756.21
Modular XHD Snorkel High Mount w/Ram Intake, 07-14 Wrangler	17756.07
Modular XHD Snorkel with Pre-filter, 07-14 Jeep Wrangler, 3.6L & 3.8L	17756.22
Modular XHD Snorkel Pre-filter, 07-14 Wrangler	17756.09

\*Includes Low Mount & Ram High Mount



HIGH MOUNT W/ RAM INTAKE



High Mount w/ Ram Intake 17756.07



BUY WITH CONFIDENCE  
MINIMUM 5 YEAR WARRANTY

Complete Snorkel Kit 17756.21

Low Mount 17756.06



# LIFESTYLE ITEMS BY RUGGED RIDGE®

## RUGGED RIDGE® BACKPACK

A great light weight backpack perfect for grabbing and going, this knapsack is a must have for any day hike, camping trip, or outdoor adventure. Featuring a large 10 x 11 inch front pocket with two interior compartments for added storage and organization, this new black backpack is made of a weather resistant nylon material and has the Rugged Ridge® logo embroidered across the front. You can use your marketing funds to give these to your special customers.



Backpack	Part #
Rugged Ridge® Backpack	12595.40

## RUGGED RIDGE® BEACH TOWEL

Ready to rock, just in a softer style? This exclusive Rugged Ridge beach towel is a must have for any Jeep® enthusiast. Featuring a beautiful beach scene, this towel gets you ready for your next pool or beach trip. Made from 100% cotton, this heavy (400 grams per square meter) beach towel measures a comfortable 29.5 x 59 inches. The printed velour pattern is extremely soft with a white terry cloth back. Durable crafted hems prevent unraveling. Machine wash. You can use your marketing funds to give these to your special customers.



Beach Towel	Part #
Beach Towel, Rugged Ridge®	14230.01



## STAINLESS STEEL TRAVEL MUG

Stay on the go in style and enjoy your favorite beverage with this high profile stainless steel travel mug from Omix-ADA and its family of brands. Perfect for the strap-it-to-your-pack and on the go commuter, this double wall vacuum-insulated mug is engineered to keep your hot drinks hot and cold drinks cold for your everyday errands!

Travel Mug	Part #
Travel Mug, Omix-ADA®	12595.09

## OMIX-ADA®/RUGGED RIDGE®/ALLOY USA® BASEBALL CAP

Featuring a pro-level design with contrast stitching, these stylish one-size-fits all baseball caps come embroidered with the Omix family of brands and offer excellent comfort for all your outdoor adventures. Going hiking? Great! Hitting the trails in your Jeep? Awesome! Available in three popular colors, the structured silhouette and adjustable style gives you a custom fit and an authentic "going jeepin" style to complete your off-roading look. Perfect for showing off your favorite brands and standing out on the trails.



14080.16

14080.27

Baseball Caps	Part #
Omix-ADA® Cap, Khaki	14080.16
Alloy USA® Cap, Black	14080.27
Alloy USA® Cap, Black, Fitted	14080.26
Rugged Ridge® Cap, Black and White	14080.24
Rugged Ridge® Cap, Black and White	14080.25
Rugged Ridge® Cap, Red and White	14080.22
Rugged Ridge® Cap, Red and White	14080.23
Rugged Ridge® Cap, Blue and White	14080.20
Rugged Ridge® Cap, Blue and White	14080.21



14080.23



14080.21



# STAMPED STEEL BUMPER

Rugged Ridge's new Stamped Front & Rear Bumpers features a tough powder coated texture with a sturdy 11 gauge stamped steel construction. The stamping process used allows for the most advanced styling on the market, creating a bumper lighter than most aftermarket steel bumpers and is designed to work with all popular winch models.

- Stamping process allows for most advanced styling in the market
- Stamping also allows for efficient use of materials resulting in a bumper lighter than most aftermarket steel bumpers
- Injection molded crush can covers add modern styling while keeping vehicle within factory spec (front bumper only)
- Stamped in knuckles strengthen vulnerable bottom edge while providing a rugged and tougher look
- Rear bumper accepts 7/8-inch D-Rings
- Front bumper uses the factory tow hooks



11544.09

Description	Part #
Stamped Front Bumper, Black, 07-15 Wrangler	11544.01
Stamped Front Bumper w/Override, Black, 07-15 Wrangler	11544.09
Stamped Bumper Winch Plate, Black, 07-15 Wrangler	11543.13
Stamped Rear Bumper JK, Black, 07-15 Wrangler	11544.51
Receiver Hitch, 2-inch, 07-15 Wrangler	11580.10
Hitch & Wiring, 07-15 Wrangler	11580.51
Receiver Hitch Kit, RR Logo, 07-15 Wrangler	11580.61



11543.13



11544.51

*ARRIVING  
SUMMER 2015!*



11544.51

