



sparco



**ORIGINAL
EQUIPMENT**

**INNOVATION
& DESIGN**



**Fiesta
Rally3**
M-SPORT

sparco

sparco®



**MORE THAN
300 TEAMS WORLDWIDE**



WE ARE MOTORSPORT



PARTNER OF OFFICIAL CHAMPIONSHIPS AND CIRCUITS



sparco[®]

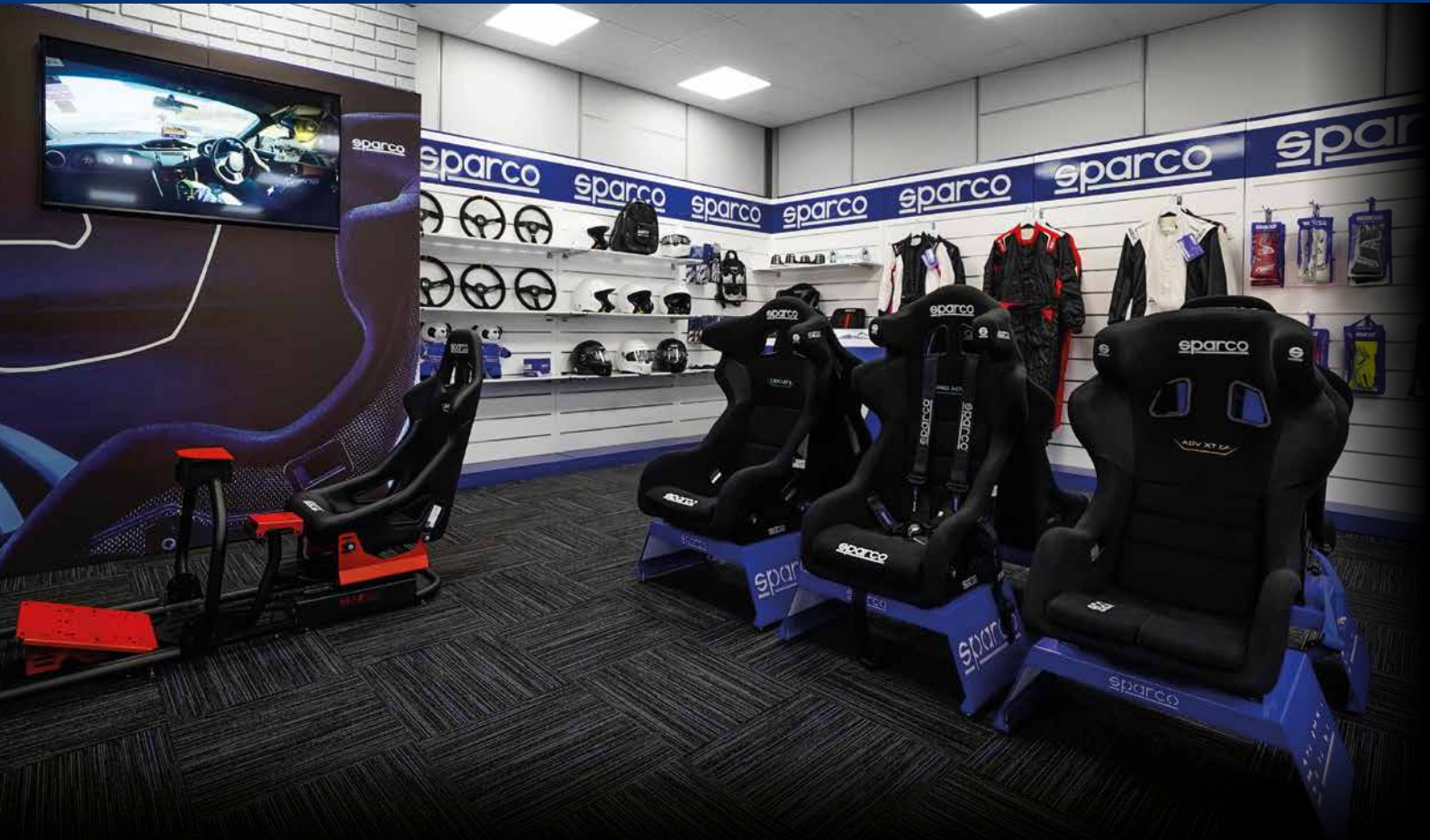

**1000 RETAILERS
IN OVER 100 COUNTRIES**



WE ARE MOTORSPORT



PRESTIGIOUS CO-BRANDING & LICENSES





sparco[®]

**FORMULA 1
TEAM MCLAREN**





POPPY BANK

POPPY

POPPY BANK

xfinity
SERIES
CHAMPION
Daniel Hemmings

x

xfinity

sparco[®]

**NASCAR XFINITY
TEAM TOYOTA**



INDEX

SPARCO

WORLD

INDEX

SPARCO

WORLD

INDEX

RACING

pg. 16	Suits
pg. 36	Underwear
pg. 48	Shoes
pg. 76	Gloves
pg. 88	Helmets
pg. 116	Seats
pg. 156	Harnesses
pg. 172	Steering Wheels
pg. 188	Mechanics / Technical

CHAIRS

pg. 332	Chairs
---------	--------

TEAMWEAR

pg. 342	Teamwear
pg. 354	Bags

KARTING

pg. 220	Suits
pg. 238	Underwear
pg. 240	Shoes
pg. 250	Gloves
pg. 260	Protection
pg. 268	Helmets

LIFESTYLE

pg. 364	Clothing
pg. 375	Accessories
pg. 378	Youth
pg. 379	Baby

PERFORMANCE

pg. 274	Seats / Harnesses
pg. 294	Steering Wheels

E-MOBILITY

pg. 382	E-mobility
---------	------------

SIM RACING

pg. 304	Sim Racing
---------	------------

STANDARD SIZE CHARTS

YOUTH BODY SIZE CHART

BABY	CHEST CIRCUMF.	WAIST CIRCUMF.	PELVIS CIRCUMF.	THIGH CIRCUMF.	SHOULDER WIDTH	SLEEVE LENGHT	FRONT CHEST LENGHT	EXTERNAL LEG LENGHT	INSEAM LEG LENGHT	BACK LENGHT	NECK CIRCUMF.	TOTAL CROTCH LENGHT	HEIGHT	WEIGHT
	CM	CM	CM	CM	CM	CM	CM	CM	CM	CM	CM	CM	CM	KG
AGE/SIZE	A	B	C	D	E	F	G	H	L	M	N	P		
6-7/120	60-63	55-60	69-71	37-39	28-30	44-47	41-44	67-71	52-54	29-31	32-34	104-106	116-125	20-23
8-9/130	64-67	61-63	72-75	40-42	31-33	48-51	45-48	75-79	57-60	32-34	34-36	107-110	126-135	24-28
10-11/140	68-71	64-67	76-79	43-44	34-36	52-55	49-52	83-87	63-66	35-37	37-39	111-113	136-145	29-36
12-13/150	72-75	68-71	80-83	45-47	37-39	56-59	53-56	91-95	69-72	38-41	40-42	114-117	146-155	37-44

MAN BODY SIZE CHART

MAN	CHEST CIRCUMF.	WAIST CIRCUMF.	PELVIS CIRCUMF.	THIGH CIRCUMF.	SHOULDER WIDTH	SLEEVE LENGHT	FRONT CHEST LENGHT	EXTERNAL LEG LENGHT	INSEAM LEG LENGHT	BACK LENGHT	NECK CIRCUMF.	HEIGHT	WEIGHT	
	CM	CM	CM	CM	CM	CM	CM	CM	CM	CM	CM	CM	KG	
SIZES	A	B	C	D	E	F	G	H	L	M	N			
XS	44	86-89	74-77	86-89	45-48	37-40	54-57	62-64	97-100	72-74	41-43	37-38	164-167	54
	46	90-93	78-81	90-93	47-50	39-42	56-59	64-66	98-101	73-75	42-43	38-39	167-170	60
S	48	94-97	82-85	94-97	49-52	41-44	58-61	66-68	99-102	74-76	42-44	39-40	170-173	66
	50	98-101	86-87	98-101	51-54	42-46	60-63	68-70	100-103	75-77	43-44	40-41	173-176	72
M	52	102-105	88-93	102-105	54-57	45-48	62-65	70-72	101-104	76-78	44-45	41-42	176-179	78
	54	106-109	94-97	106-109	56-59	47-50	64-67	72-74	102-105	77-79	45-46	42-43	179-182	84
L	56	110-113	98-101	110-113	58-62	49-52	66-69	74-76	103-106	78-80	46-48	43-44	182-185	90
	58	114-117	102-105	114-117	61-64	51-54	68-71	76-78	103-107	79-81	48-49	45-46	185-188	96
XL	60	118-121	106-109	118-121	64-67	53-56	70-73	78-80	105-108	80-82	49-51	46-47	188-191	102
	62	122-125	110-113	122-125	67-70	56-58	72-75	80-82	107-110	81-83	51-52	47-48	191-194	108
XXL	64	126-129	114-117	126-129	69-72	57-60	74-77	82-84	108-111	82-84	52-54	49-50	194-197	114
	66	130-133	118-121	130-133	72-75	59-62	76-79	84-86	109-112	83-85	53-55	51-52	197-200	120

NB: If Your measurements differ from standard size, please verify with a tailor measuring tape and complete the Driver's chart measurements; It's recommended also complete the optional measures. Please note that these physical measurements charts are indicative only for commercial purposes, then are only useful for Sparco products. Note only for the youths product sizes: Take into account any uses of chest protectors and its related footprint.

LADY BODY SIZE CHART (CM)

WOMAN				BREAST TAKEN ON THE MOST PROMINENT	WAIST CIRCUMF.	PELVIS CIRCUMF.	THIGH CIRCUMF.	ARM OUTSIDE	INSIDE LEG LENGHT	WEIGHT	HEIGHT
INTERN. SIZES	UK	US	TG	A	B	C	D	F	L	KG	CM
XXS	6	2	38	78-81	60-63	84-87	51-52	55-58	71-73	45-49	160-162
		40	82-85	64-67	88-91	52-53	56-59	72-74	50-54	162-164	
XS	8	4	42	86-89	68-71	92-95	53-54	57-60	73-75	55-59	164-166
		44	90-93	72-75	96-99	55-56	58-61	74-76	60-64	166-168	
M	10	6	46	94-97	76-79	100-103	57-58	59-62	75-77	65-69	168-170
		48	98-101	80-83	104-107	59-60	60-63	76-78	70-74	170-172	
L	12	8	50	102-105	84-87	108-111	61-62	61-64	77-79	75-79	172-174



Please note that this table is only intended as a guide and can differ from manufacturers measurements.

WIDTH CM	17	18,3	19,7	21	22,3	23	23,7	24,3	25	25,7	26,3	27	27,7	28,3	29	29,6	30,3	31	31,6
EUROPE	26	28	30	32	34	35	36	37	38	39	40	41	42	43	44	45	46	47	48
UK	11	12	13	1	2	2,5	3,5	4	5	5,5	6,5	7	8	9	9,5	10,5	11	12	13
USA	9,5	11	12,5	1	3	3,5	4,5	5	6	6,5	7,5	8	9	10	10,5	11,5	12	13	14

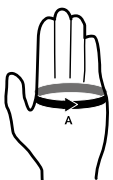

A											
SIZES	4	5	6	7	8	9	10	11	12	13	
INCH.	5½-6	6-6½	6½-7	7-7½	7½-8	8-8½	8-8½	8½-9	9-9½	9½-10	
CM	14-15	15-16,5	16,5-18	18-18,5	18,5-19	19-19,5	19-19,5	19,5-20	20-21,5	21,5-22,5	
USA	YXS	XXXXXS	XXXS	XXS	XS	S	M	L	XL	XXL	

MADE TO MEASURE CHART

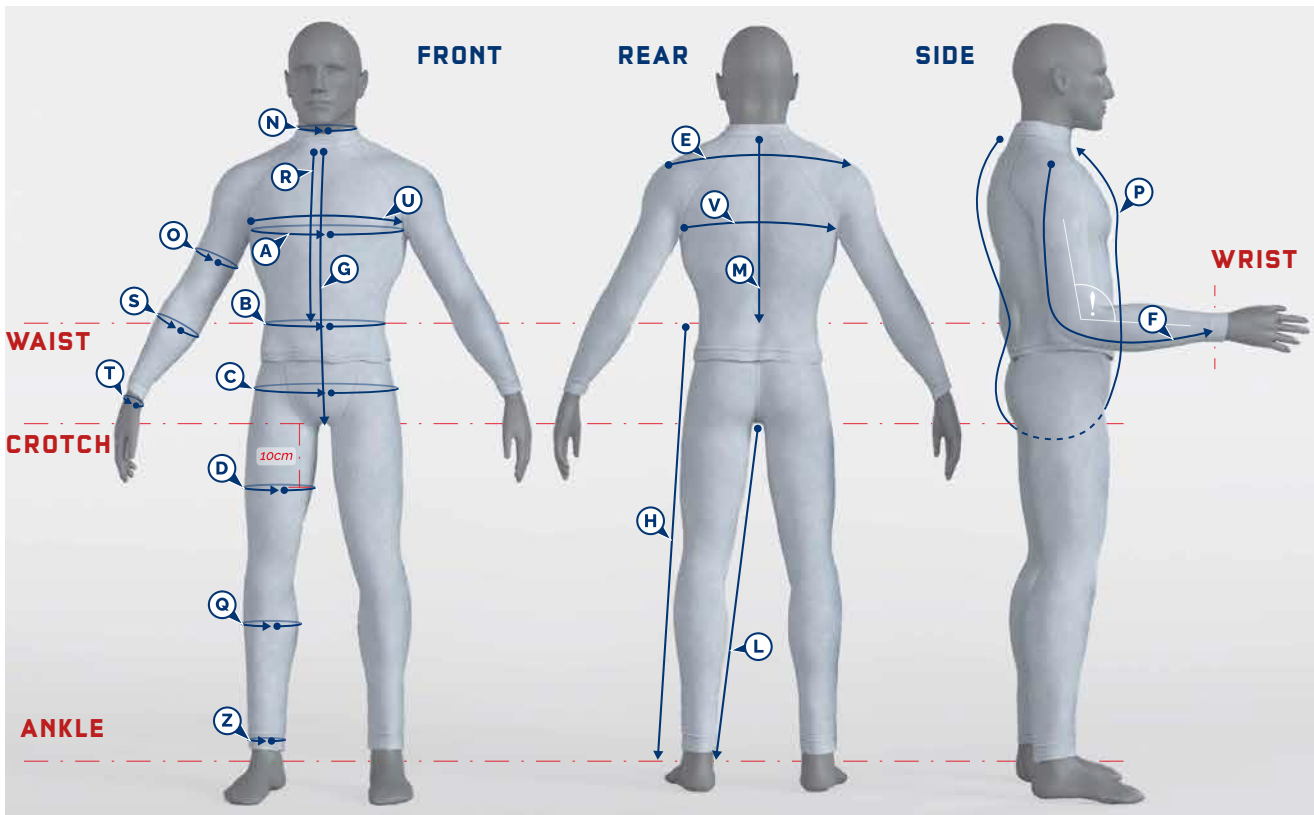

A CHEST CIRCUMFERENCES

cm:

Run tape measure under armpit, put in the largest part of the chest in horizontal position, arms relaxed at your sides.

B WAIST CIRCUMFERENCE

cm:

Run tape measure around waist horizontally, arms at your sides.

C HIPS CIRCUMFERENCE

cm:

Run tape measure around hips at the widest point, arms at your sides. (10-20 cm under waist point)

D THIGH CIRCUMFERENCE

cm:

Measure the largest part of the thigh. Tape should be around 10 cm from below the crotch.

E SHOULDER WIDTH

cm:

Arms at your sides, run tape measure from bone to bone.

F SLEEVE LENGTH

cm:

Start the measurement from shoulder bone, running around elbow (arm flexed) ending at wrist.

G FRONTAL CHEST LENGTH

cm:

Take the measure starting from the notch of the neck down to below the crotch.

H EXTERNAL LEG

cm:

Run tape from waist to ankle bone.

L INTERNAL LEG

cm:

Run tape from crotch to internal ankle bone.

M BASE OF NECK TO WAIST

cm:

Run the tape measure from lower vertebra of the neck to the waist.

N NECK CIRCUMFERENCE

cm:

Run your tape measure around the neck at the thickest point.

O BICEP CIRCUMFERENCE

cm:

Run the tape measure around the widest point of the biceps.

P TORSO LENGTH

cm:

Starting from the notch of the neck in front, run tape through crotch to base of neck in back.

P TORSO LENGTH

cm:

Run tape measure around the widest point of the calf.

R NECK TO WAIST (FRONT)

cm:

Run tape measure from notch of the neck in front to waist strap.

S FOREARM CIRCUMFERENCE

cm:

Run tape measure around waist horizontally, arms at your sides.

T WRIST CIRCUMFERENCE

cm:

Run the tape measure around the wrist bone.

U CHEST WIDTH

cm:

Arms at your sides, run tape measure from armpit to armpit.

V BACK WIDTH

cm:

Arms at your sides, run tape measure from armpit to armpit.

Z ANKLE CIRCUMFERENCE

cm:

Run the tape measure around the ankle bone.

We recommend sending photos of your full figure in the positions shown above to better understand the distribution of your measurements.

STANDARD COLOUR CHARTS





PRIME

						
MT0100008B0	MT0100008NR	MT0100008AR149	MT0100008AZ	MT0100008BM	MT0100008RS	MT0100008RS201C
						
MT0100008AMR	MT0100008GR423C	MT0100008285C	MT01000087545C	MT0100008AR166C	MT0100008AR804C	MT0100008CE
						
MT0100008GF	MT0100008GL	MT0100008GR152	MT0100008GR431C	MT0100008GRL	MT0100008GRS	MT0100008MG

SUPERLEGERA

						
MT0100008B0	MT0100008NR	MT0100008AR149	MT0100008AZ	MT0100008BM	MT0100008RS	MT0100008RS201C
						
MT0100008AMR	MT0100008GR423C	MT0100008285C	MT01000087545C	MT0100008AR166C	MT0100008AR804C	MT0100008CE
						
MT0100008GF	MT0100008GL	MT0100008GR152	MT0100008GR431C	MT0100008GRL	MT0100008GRS	MT0100008MG

VICTORY

			
MT0100042B0	MT0100042GR431C	MT0100042NR	MT0100042BRFXC

COMPETITION · LADY · VINTAGE

						
MT0100011AL1	MT0100011AR804C	MT0100011BL1	MT0100011BML1	MT0100011BRFXC1	MT0100011CE	MT0100011CG11C
						
MT0100011FG121	MT0100011GL1	MT0100011GJ	MT0100011GL	MT0100011GOLD1	MT0100011GRL	MT0100011GRS1
						
MT0100011NL1	MT0100011PP	MT0100011RFE1	MT0100011RFL1	MT0100011VD1	MT0100011VML	MT0100011VULTIM

SPRINT

						
MT010047LBO	MT010047LGR423C	MT010047LNR	MT010047LRC1	MT010047LPINK	MT010047LGF	MT010047LVF
						
MT010047BM16B	MT010047LBEL	MT010047LBM	MT010047LAZ			



RACING SUITS RACING SUITS RACING SUITS RACING SUITS RACING SUITS RACING SUITS

RACING SUITS RACING SUITS RACING SUITS RACING SUITS RACING SUITS RACING SUITS

RACING SUITS RACING SUITS RACING SUITS RACING SUITS RACING SUITS RACING SUITS

RACING SUITS RACING SUITS RACING SUITS RACING SUITS RACING SUITS RACING SUITS

RACING SUITS RACING SUITS RACING SUITS RACING SUITS RACING SUITS RACING SUITS

RACING SUITS RACING SUITS RACING SUITS RACING SUITS RACING SUITS RACING SUITS

RACING SUITS RACING SUITS RACING SUITS RACING SUITS RACING SUITS RACING SUITS



L. Norris - F1 Driver

PRIME **NEW**

HOMOLOGATION:
FIA 8856-2018
SFI 3.2A/5
SIZES: 48-60
CUSTOMIZATION:
ON DEMAND



001146..BI



001146..NR



001146..NRGF

SUPERLEGGERA **NEW**

HOMOLOGATION:
FIA 8856-2018
SFI 3.2A/5
SIZES: 48-66
CUSTOMIZATION:
▪ CUSTOM EASY
▪ ON DEMAND



001142..BBAR



001142..BNRR



001142..GSGF



001142..NBAZ



001142..NRGR

INFINITY

HOMOLOGATION:
FIA 8856-2018
SIZES: ON DEMAND
CUSTOMIZATION:
ON DEMAND



0011028SP

VICTORY

HOMOLOGATION:
FIA 8856-2018
SFI 3.2A/5
SIZES: 48-66
CUSTOMIZATION:
ON DEMAND



001138H..BNRS



001138H..BGBL



001138H..GNAR



001138H..NGBO

COMPETITION **NEW**

HOMOLOGATION:
FIA 8856-2018
SFI 3.2A/5
SIZES: 48-66
CUSTOMIZATION:
ON DEMAND



001144..BMBB



001144..BNRR



001144..NBGR



001144..NRRB



001144..NRGF

COMPETITION LADY **NEW****HOMOLOGATION:**

FIA 8856-2018
SFI 3.2A/5

SIZES: 38-50

CUSTOMIZATION:

ON DEMAND



001144L..BRNR



001144L..NRRB

VINTAGE CLASSIC **NEW****HOMOLOGATION:**

FIA 8856-2018
SFI 3.2A/5

SIZES: 48-66

CUSTOMIZATION:

ON DEMAND



001144V..

SPRINT **NEW****HOMOLOGATION:**

FIA 8856-2018 - SFI 3.2A/5

SIZES: 48-66

CUSTOMIZATION:

- CUSTOM EASY
- 3D CONFIGURATOR
- ON DEMAND



001093..NRGF



001093..RSNR



001093..BELN



001093..BMBI



001093..NRRS



001093..NR

ONE**HOMOLOGATION:**

SFI 3.2A/1

SIZES: S-XXL

CUSTOMIZATION:

NOT CUSTOMIZABLE



001059..NRRS



001059..NRAZ



001059..NRBI



HIGHLIGHTS



Full floating 360°
Arm Gussets.



Large rear stretch panel.



Breathable inner thigh
stretch insert.

MAXIMUM LEVEL OF PERFORMANCE



001146..BI



001146..NR

001146..NRGF



SUPERLEGGERA

NEW

HOMOLOGATION: FIA 8856-2018 - SFI 3.2A/5

SIZES: 48-66

CUSTOMIZATION: CUSTOM EASY / ON DEMAND



APPROVED

MANUFACTURER: SPARCO
MODEL: R564
HOM. NO: DC.142.21-O
FIA STANDARD: 8856-2018

HIGHLIGHTS



Special 4 Way stretch panels on full sides and elbows.



Large rear stretch panel.



Breathable inner thigh stretch insert.

LIGHTNESS UNMATCHED



001142..BBAR



001142..BNRR



001142..GSGF



001142..NBAZ



001142..NRGR



A. Fourmaux - Rally driver

HOMOLOGATION: FIA 8856-2018
SIZES: ON DEMAND
CUSTOMIZATION: ON DEMAND

HIGHLIGHTS



Extraction handle.



Elasticated side inserts.



Sublimation printing graphics.

NO LIMITS TO YOUR CREATIVITY



Unlimited creativity thanks to the latest technology in sublimation printing.



0011028SP



HOMOLOGATION: FIA 8856-2018 - SFI 3.2A/5 (ON DEMAND)

SIZES: 48-66

CUSTOMIZATION: ON DEMAND

HIGHLIGHTS



Underarm breathable stretch panels.



Large rear stretch panel.



Hidden pockets.

PATENTED SPARCO TECHNOLOGY

HOCOTEX^{14LX}

- 2X MORE BREATHABLE
- 30% MORE FIRE RESISTANT
- 30% THINNER



001138H..BNRS



001138H..BGBL



001138H..GNAR



001138H..NGBO



COMPETITION



APPROVED

NEW

MANUFACTURER: SPARCO
MODEL: R567
HOM. NO: DC.163.21-O
FIA STANDARD: 8856-2018

HOMOLOGATION: FIA 8856-2018 - SFI 3.2A/5

SIZES: 48-66 / COMPETITION LADY 38-50

CUSTOMIZATION: ON DEMAND / COMPETITION LADY ON DEMAND

HIGHLIGHTS



PAG. 84

Unique elastic cuff system designed for Lap gloves.



Large rear stretch panel.



Breathable inner thigh stretch insert.

COMPETITION READY



001144..BMBB



001144..BRNR



001144..NBGR



001144..NRRB



001144..NRGF

COMPETITION LADY



001144L..BRNR



001144L..NRRB



VINTAGE

NEW

HOMOLOGATION: FIA 8856-2018 - SFI 3.2A/5
SIZES: 48-66
CUSTOMIZATION: ON DEMAND



APPROVED

MANUFACTURER: SPARCO
MODEL: R567
HOM. NO: DC.163.21-O
FIA STANDARD: 8856-2018

HIGHLIGHTS



Original Sparco epaulets.



Form fitting rear elastic.



Period correct front belt.

RETRO STYLE WITH MODERN TECHNOLOGY



001144V..



SPRINT

NEW



APPROVED

MANUFACTURER: SPARCO
MODEL: R566
HOM. NO: DC.159.21-O
FIA STANDARD: 8856-2018

HOMOLOGATION: FIA 8856-2018 - SFI 3.2A/5

SIZES: 48-66 (44-66 NR VERSION ONLY)

CUSTOMIZATION: CUSTOM EASY / 3D CONFIGURATOR / ON DEMAND

HIGHLIGHTS



Modern Sparco epaulets.



Large rear stretch panel.



Hidden front pockets.

VALUE & PERFORMANCE



001093..RSNR



001093..BELN



001093..BMBI



001093..NRRS



001093..NR



001093..NRGF

sparc



ONE

HOMOLOGATION: SFI 3.2A/1

SIZES: S-XXL

CUSTOMIZATION: NOT CUSTOMIZABLE

HIGHLIGHTS



Modern Sparco epaulets.



Form fitting rear elastic.



Adjustable ankle closure.

SINGLE LAYER PROTECTION



001059..NRRS



001059..NRAZ

001059..NRBI

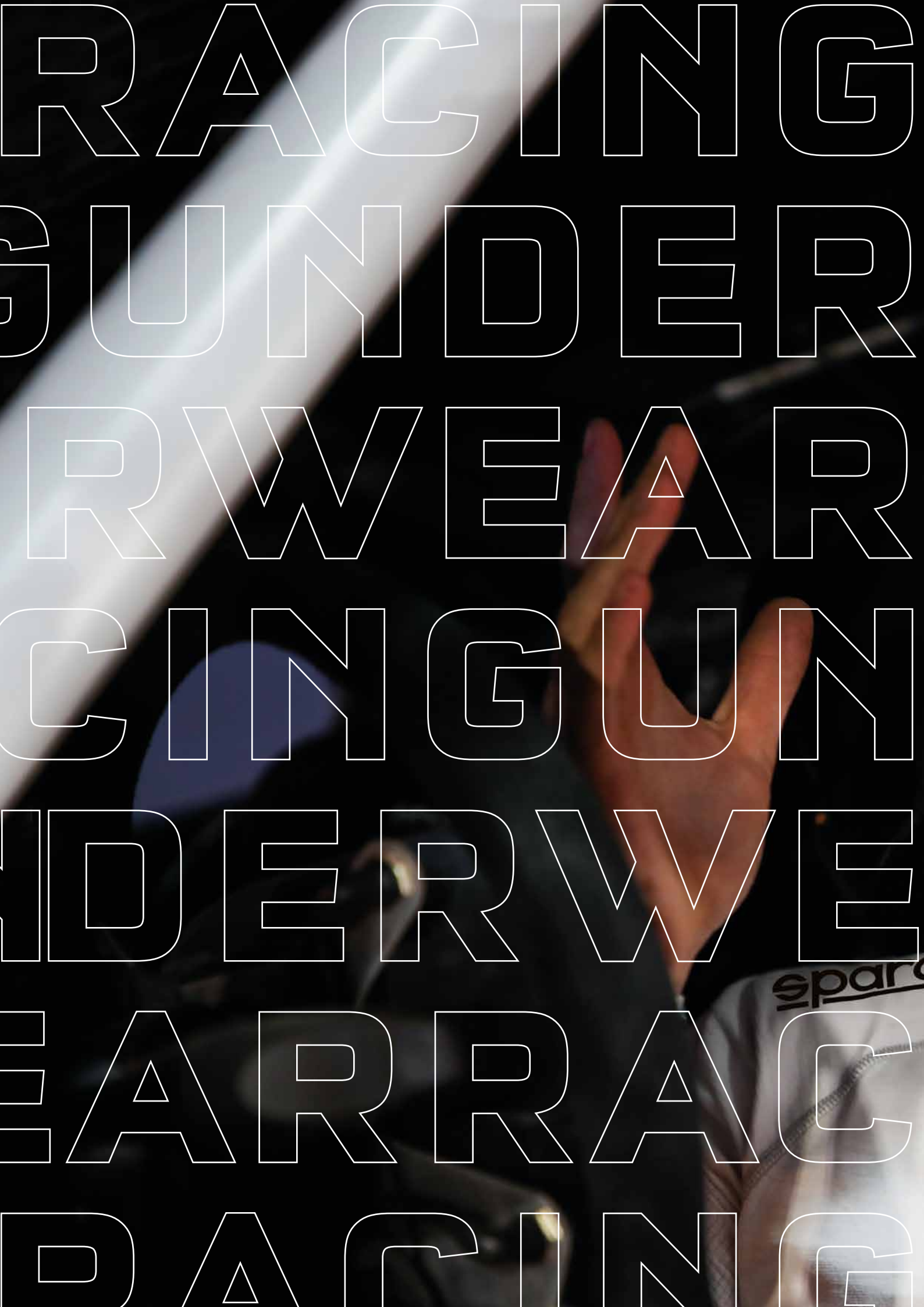

RACING

GUNDER

RWWEAR

CINGUN

DERWE

EARRAC

PACING



S. Loeb - Rally Driver

RACING UNDERWEAR

IQ®



MANUFACTURER: SPARCO
MODEL: R570
HOM. NO: DC.XXX.XX-B
FIA STANDARD: 8856-2018

WEIGHT: 190 G/M²
ONE SIZE



□ 001406B0 ● 001406NR

- Fully seamless structure.
- Ultra-light construction.
- Anti-abrasion silicone printed logos.
- Material: 96% Meta-Aramid, 4% Elastane.

- Fully seamless structure.
- Ultra-light construction.
- X-COOL treatment, reactive cooling and anti-bacterial.
- Anti-abrasion silicone printed logos.
- Material: 96% Meta-Aramid, 4% Elastane.
- Customization: custom easy.



□ 001784MBO.. ● 001784MNR..



MANUFACTURER: SPARCO
MODEL: R570
HOM. NO: DC.XXX.XX-T
FIA STANDARD: 8856-2018

WEIGHT: 190 G/M²
SIZES:
XS - S/M - L/XL - XXL



MANUFACTURER: SPARCO
MODEL: R570
HOM. NO: DC.XXX.XX-L
FIA STANDARD: 8856-2018

WEIGHT: 190 G/M²
SIZES:
XS - S/M - L/XL - XXL



□ 001784PBO.. ● 001784PNR..

- Fully seamless structure.
- Ultra-light construction.
- X-COOL treatment, reactive cooling and anti-bacterial.
- Anti-abrasion silicone printed logos.
- Material: 96% Meta-Aramid, 4% Elastane.

- Unique helical structure provides gradual compression.
- Added compression for arch support.
- Reinforced, durable foot bed.
- Darned heel and toe.
- Material: 67% viscose, 27% Meta-Aramid, 5% Elastane, 1% antistatic fibre.



□ 001523BI.. ● 001523NR..



MANUFACTURER: SPARCO
MODEL: R572
HOM. NO: DC.XXX.XX-S
FIA STANDARD: 8856-2018

SIZES: 38-39 / 40-41
42-43 / 44-45 / 46



SHIELD PRO

JACQUARD

HOMOLOGATION: FIA 8856-2018

FIA APPROVED
 MANUFACTURER: SPARCO
 MODEL: R563
 HOM. NO: DC.124.21-B
 FIA STANDARD: 8856-2018

ONE SIZE



001403NR

- Opening for drink system.
- Seamless front chin.
- Extra-flat offset crown seams.
- Double Layer on front.
- Material: 69% Modal Viscose, 28% Meta-Aramid, 1% Antistatic fiber, 2% Elastane.
- Customization: transfer.

- Seamless construction. Raglan sleeves.
- X-COOL treatment, reactive cooling and anti-bacterial.
- Material: 69% Modal Viscose, 28% Meta-Aramid, 1% Antistatic fiber, 2% Elastane.
- Customization: transfer.



001778MNR..

FIA APPROVED
 MANUFACTURER: SPARCO
 MODEL: R563
 HOM. NO: DC.125.21-T
 FIA STANDARD: 8856-2018

SIZES:
 XS-S / M-L / XL-XXL

FIA APPROVED
 MANUFACTURER: SPARCO
 MODEL: R563
 HOM. NO: DC.126.21-L
 FIA STANDARD: 8856-2018

SIZES:
 XS-S / M-L / XL-XXL



001778PNR..

- Seamless construction.
- X-COOL treatment, reactive cooling and anti-bacterial.
- Material: 69% Modal Viscose, 28% Meta-Aramid, 1% Antistatic fiber, 2% Elastane.
- Customization: transfer.



FIA APPROVED
 MANUFACTURER: SPARCO
 MODEL: R558
 HOM. NO: DC.055.19-B
 FIA STANDARD: 8856-2018

ONE SIZE



□ 001402BI ● 001402NR

- Composition: jersey, 69% Modal Viscose, 28% Meta-Aramid, 1% Antistatic Fiber, 2% Elastane.
- Anti-abrasion silicone printed logos.
- Seamless front seam.

NEW

- Composition: jersey, 69% Modal Viscose, 28% Meta-Aramid, 1% Antistatic Fiber, 2% Elastane.
- Raglan sleeve.
- X-COOL treatment, reactive cooling and anti-bacterial.
- Anti-abrasion silicone printed logos.
- Seamless construction.



□ 001783MBO.. ● 001783MNR..

FIA APPROVED
 MANUFACTURER: SPARCO
 MODEL: R558
 HOM. NO: DC.056.19-T
 FIA STANDARD: 8856-2018

SIZES:
 XS - S/M - L/XL - XXL

FIA APPROVED
 MANUFACTURER: SPARCO
 MODEL: R558
 HOM. NO: DC.057.19-L
 FIA STANDARD: 8856-2018

SIZES:
 XS - S/M - L/XL - XXL



□ 001777PBO.. ● 001777PNR..

- Composition: jersey, 69% Modal Viscose, 28% Meta-Aramid, 1% Antistatic Fiber, 2% Elastane.
- X-COOL treatment, reactive cooling and anti-bacterial.
- Anti-abrasion silicone printed logos.
- Seamless construction.

X-COOL RECHARGE

The X-Cool Recharge kit extends the X-Cool Effect on Sparco factory treated suits and underwear.



001157RECHARGE



FIA APPROVED
 MANUFACTURER: SPARCO
 MODEL: R571
 HOM. NO: DC.185.21-B
 FIA STANDARD: 8856-2018

ONE SIZE



001405BO

001405NR

- "Body-size" fibre knit structure.
- Differentiated front and back amour.
- Composition: 57% viscose, 38% Meta-Aramid, 3% Polyamide, 2% Elastane.

FIA APPROVED
 MANUFACTURER: SPARCO
 MODEL: R571
 HOM. NO: DC.186.21-T
 FIA STANDARD: 8856-2018

SIZES: XS-S / M-L / XL-XXL



001780MBO..

001780MNR..

- "Body-size" fibre knit structure.
- No side seams for maximum comfort.
- Stretch rib collar.
- X-COOL treatment, reactive cooling and anti-bacterial.
- Composition: 57% viscose, 38% Meta-Aramid, 3% Polyamide, 2% Elastane.

RW-7 SOCKS

FIA APPROVED
 MANUFACTURER: SPARCO
 MODEL: R560
 HOM. NO: DC.039.19-S
 FIA STANDARD: 8856-2018

**SIZES: 38-39 / 40-41
 42-43 / 44-45 / 46**

- Supportive ribbed calve construction.
- Jersey foot bed and arch support.
- Darned heel and toe.
- Composition: 67% Meta-Aramid, 27% viscose, 6% Elastane.



001522BI..

001522NR..

FIA APPROVED
 MANUFACTURER: SPARCO
 MODEL: R571
 HOM. NO: DC.187.21-L
 FIA STANDARD: 8856-2018

SIZES: XS-S / M-L / XL-XXL



001781PBO..

001781PNR..

- "Body-size" fibre knit structure.
- Ribbed stretch band.
- X-COOL treatment, reactive cooling and anti-bacterial.
- Composition: 57% viscose, 38% Meta-Aramid, 3% Polyamide, 2% Elastane.



MANUFACTURER: SPARCO
MODEL: R574
HOM. NO: DC.205.21-B
FIA STANDARD: 8856-2018

ONE SIZE



001487BI

- Soft-touch interlock construction.
- Simplified and optimised structure.
- Composition: 60% modacrylic, 40% cellulose.



MANUFACTURER: SPARCO
MODEL: R574
HOM. NO: DC.203.21-T
FIA STANDARD: 8856-2018

SIZES: S-M-L-XL-XXL



001782MBI..

- Soft-touch interlock construction.
- Simplified and optimised structure.
- Regular fit.
- Composition: 60% modacrylic, 40% cellulose.

RW-4 SOCKS



MANUFACTURER: SPARCO
MODEL: R573
HOM. NO: DC.XXX.XX-S
FIA STANDARD: 8856-2018

SIZES: 38-39 / 40-41
42-43 / 44-45 / 46

- Supportive ribbed calve construction.
- Jersey foot bed and arch support.
- Darned heel and toe.
- Composition: 100% Meta-Aramid



001516BI..



MANUFACTURER: SPARCO
MODEL: R574
HOM. NO: DC.204.21-L
FIA STANDARD: 8856-2018

SIZES: S-M-L-XL-XXL



001782PBI..

- Soft-touch interlock construction.
- Simplified and optimised structure.
- Regular fit.
- Composition: 60% modacrylic, 40% cellulose.

RW-4 NEW

NOT FIA APPROVED

- Soft-touch interlock construction.
- Simplified and optimised structure.
- Single-layer balaclava.
- Not FIA approved.
- Composition: 60% modacrylic, 40% cellulose.

ONE SIZE



001488BI

KNEE PADS



00156N

- Low neck T-shirt.
- Half sleeves.
- Soft-touch interlock construction.
- Not FIA approved.

SIZES: S-M-L-XL-XXL



001797BI..

ELBOW PADS



00157N

- Bermuda.
- Soft-touch interlock construction.
- Not fia approved.

SIZES: S-M-L-XL-XXL



001711BBI..

ARM RESTRAINTS



- **00158SETRS**
- **00158SETAZ**
- **00158SETNR**

Arm restraints system recommended for open vehicles such as Dragsters, Midgets and Off-road Vehicles. SFI 3.3 homologated.





R. SHWARTZMAN



FERRARI
DRIVER ACADEMY

SMP RACING

eparco

eparco

SMP RACING

SMP RACING

R. Swartzman - F2 Driver

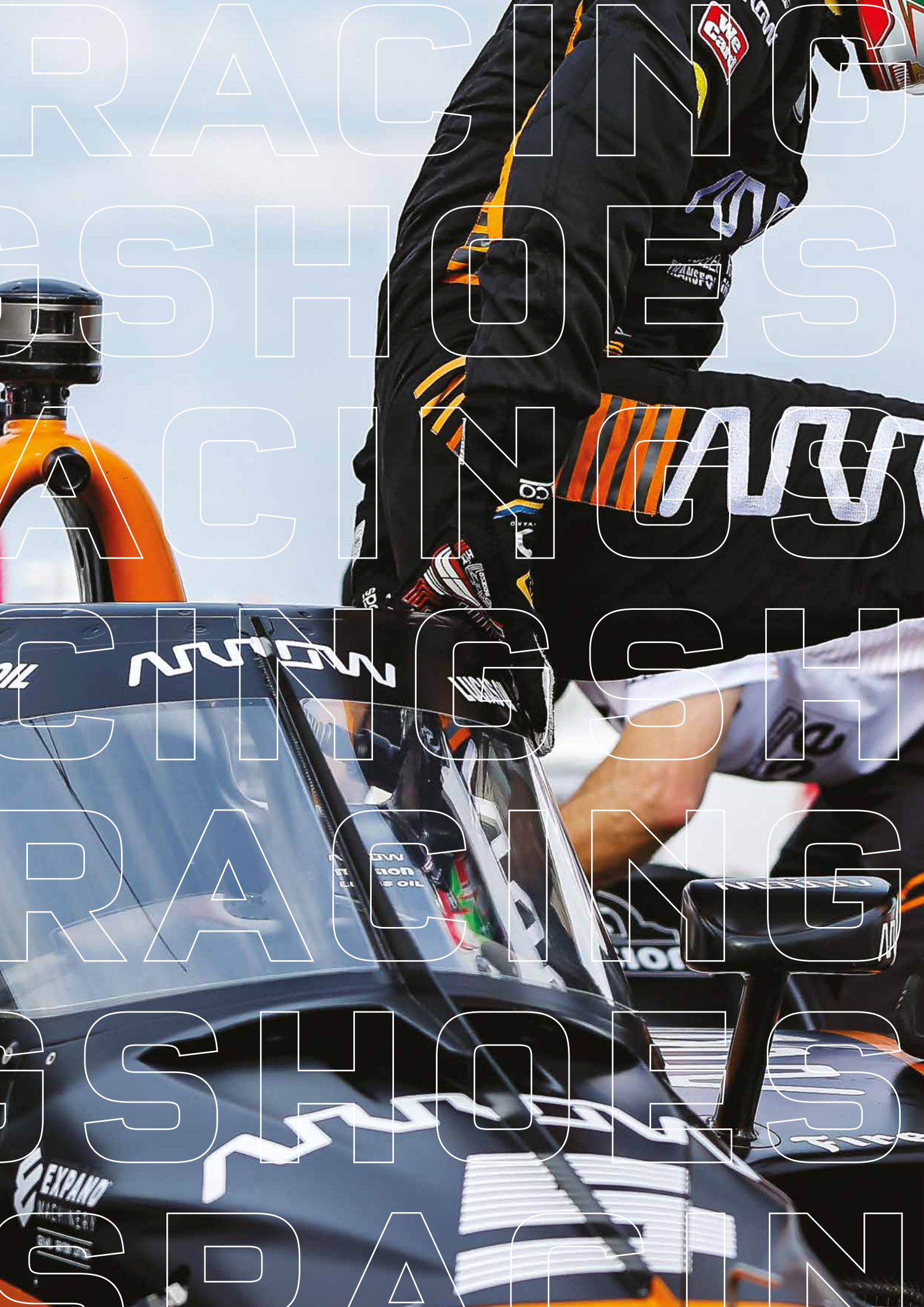



Arrow McLaren - IndyCar Series

RACING SHOES

10[®]

PRIME EVO NEW

HOMOLOGATION: FIA 8856-2018

MATERIAL: KANGAROO LEATHER WITH INKJET PRINT

SOLE: OIL AND HYDROCARBON RESISTANT RUBBER PLATE SOLE

SIZES: 37-48 **CUSTOMIZATION:** ON DEMAND



001297..BI



001297..NR

PRIME T NEW

HOMOLOGATION: FIA 8856-2018

MATERIAL: KANGAROO LEATHER **SOLE:** NATURAL RUBBER + EVA

SIZES: 37-48 **CUSTOMIZATION:** ON DEMAND / INFINITY



001281..BINR



001281..NRBI



001281..BMAR

PRIME R NEW

HOMOLOGATION: FIA 8856-2018

MATERIAL: KANGAROO LEATHER AND PU LEATHER **SOLE:** NATURAL RUBBER + EVA

SIZES: 37-48 **CUSTOMIZATION:** ON DEMAND / INFINITY



001282..BINR



001282..NRBI



001282..NRRS

X-LIGHT+ NEW

HOMOLOGATION: FIA 8856-2018 - SFI 3.3/5 ON DEMAND

MATERIAL: KANGAROO LEATHER AND FABRIC **SOLE:** NATURAL RUBBER + CARBON

SIZES: 39-46 **CUSTOMIZATION:** ON DEMAND / INFINITY



001278..NRGF



001278..NRRS



001278..NR



001278..NRAF



001278..BINR

X-LIGHT 

HOMOLOGATION: FIA 8856-2018 - SFI 3.3/5 (ON DEMAND)
MATERIAL: TUMBLED LEATHER AND PU LEATHER **SOLE:** TPU FR + EVA
SIZES: 37-48 **CUSTOMIZATION:** 3D CONFIGURATOR / ON DEMAND



001283..BIRS



001283..GRAF



001283..BMBI



001283..NRGR

FORMULA NEW

HOMOLOGATION: FIA 8856-2018 - SFI 3.3/5 (ON DEMAND)
MATERIAL: TUMBLED LEATHER **SOLE:** NATURAL RUBBER
SIZES: 37-48 (32-36 ON DEMAND) **CUSTOMIZATION:** ON DEMAND



001296..BINR



001296..RSBI



001296..NRBI



001296..NRRS



001296..BXBI

SKID+

HOMOLOGATION: FIA 8856-2018
MATERIAL: TUMBLED LEATHER AND PU LEATHER **SOLE:** TPU FR + EVA
SIZES: 38-48 **CUSTOMIZATION:** ON DEMAND



001279..NRRS



001279..NRGR

SKID

HOMOLOGATION: FIA 8856-2018 - SFI 3.3/5
MATERIAL: TUMBLED LEATHER AND PU LEATHER **SOLE:** TPU FR + EVA
SIZES: 37-48 **CUSTOMIZATION:** 3D CONFIGURATOR / ON DEMAND



001275..BIBI



001275..RSNR



001275..NRNR



001275..BNBI



001275..NRGR

TOP

HOMOLOGATION: FIA 8856-2018

MATERIAL: CALF LEATHER **SOLE:** NATURAL RUBBER

SIZES: 37-48 **CUSTOMIZATION:** ON DEMAND



001287..RS



001287..BRFX



001287..NR

SLALOM+ FABRIC AND SUEDE

HOMOLOGATION: FIA 8856-2018 - SFI 3.3/5

MATERIAL: FABRIC AND SUEDE **SOLE:** NATURAL RUBBER

SIZES: 35-48



001274F..RSNR



001274F..BXNR



001274F..NRNR

SLALOM+

HOMOLOGATION: FIA 8856-2018 - SFI 3.3/5

MATERIAL: FULL SUEDE **SOLE:** NATURAL RUBBER

SIZES: 35-48 **CUSTOMIZATION:** ON DEMAND



001274..RS



001274..BRFX



001274..NR

SLALOM NEW

HOMOLOGATION: FIA 8856-2018 - SFI 3.3/5

MATERIAL: FULL SUEDE **SOLE:** NATURAL RUBBER

SIZES: 36-48



001295..NRRS



001295..NR



001295..BRFX



001295..NRGF



NEW

MANUFACTURER: SPARCO
 MODEL: PRIME EVO
 HOM. NO: DC.XXX.XX-Z
 FIA STANDARD: 8856-2018

HOMOLOGATION: FIA 8856-2018
WEIGHT: 210 GR. TG.42 **SIZES:** 37-48
CUSTOMIZATION: ON DEMAND / INFINITY

HIGHLIGHTS

- Quick strap closure with ultra-flat perforated tape.
- Kangaroo leather upper with inkjet print.
- Antiperspirant and breathable lining.
- Ergonomic footbed.
- Oil and hydrocarbon resistant rubber plate sole.



Single-layer stretch jacquard tongue.



Single-layer stretch jacquard.



Real flexible carbon sole with differentiated areas.



001297..BI



001297..NR



NEW

HOMOLOGATION: FIA 8856-2018
WEIGHT: 220GR. TG.42 **SIZES:** 37-48
CUSTOMIZATION: ON DEMAND / INFINITY

HIGHLIGHTS

- Padded tongue in ultra-breathable fabric.
- Comfortable insole.
- Overlap strap with perforated ultragrip.
- Anti-perspiration and breathable lining.
- Fully printed kangaroo leather uppers.
- Thin rubber sole with differentiated grip zones.



Perforations for maximum breathability.



Shock absorber and anti vibration eva heel.



001281..BMAR



001281..NRBI



001281..BINR

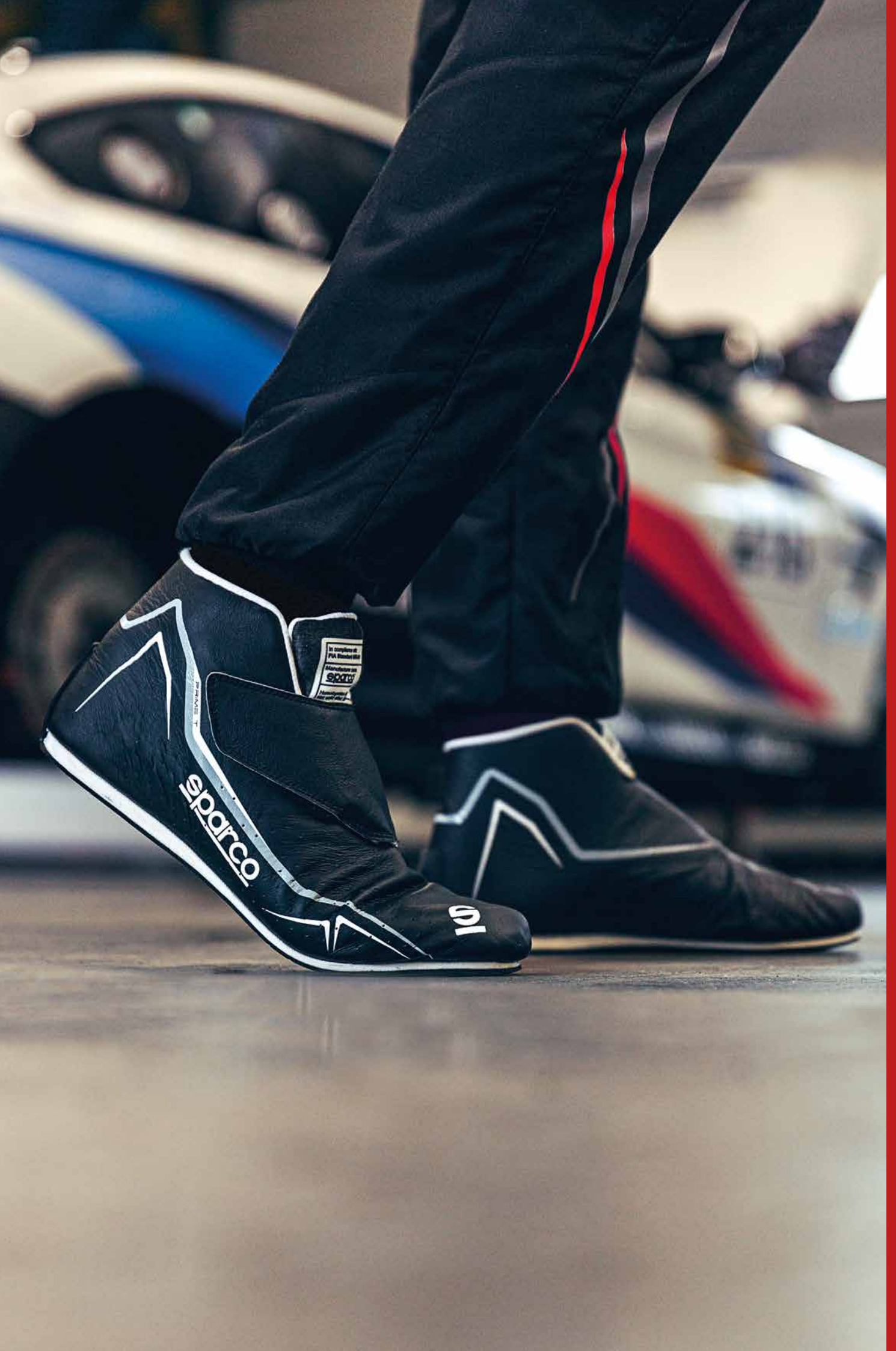

NEW

HOMOLOGATION: FIA 8856-2018
WEIGHT: 240GR. TG.42 **SIZES:** 37-48
CUSTOMIZATION: ON DEMAND / INFINITY

HIGHLIGHTS

- Ultralight flat laces.
- Anti-perspiration and breathable lining.
- Padded tongue in ultra-breathable fabric.
- Perforations for maximum breathability.
- Fully printed kangaroo leather uppers.
- Comfortable insole.
- Thin rubber sole with differentiated grip texture.



Strap for blocking laces and ankle.



High abrasion-resistant leather inserts.



001282..BINR



001282..NRBI



001282..NRRS



NEW

HOMOLOGATION: FIA 8856-2018 - SFI 3.3/5 (ON DEMAND)
WEIGHT: 220GR. TG.42 **SIZES:** 39-46
CUSTOMIZATION: ON DEMAND / INFINITY

HIGHLIGHTS

- Rollable ankle fabric with lace flap.
- Ultra-light external closure. Supplied with double laces.
- Jaquard uppers.
- Printed kangaroo leather.
- Thin rubber sole with differentiated grip zones.



Protective 3D texture.



High abrasion-resistant leather heel.



Real flexible carbon sole with differentiated areas.



001278..NRGF



001278..NRRS



001278..NR



001278..NRAF



001278..BINR



HOMOLOGATION: FIA 8856-2018 - SFI 3.3/5
WEIGHT: 260GR. TG.42 **SIZES:** 37-48
CUSTOMIZATION: 3D CONFIGURATOR / ON DEMAND

HIGHLIGHTS

- Flat, light glossy laces.
- Elasticated jaquard rear insert.
- Strong and ultra-light Kevlar loops.
- Silkscreen printed tumbled calfskin uppers.
- Perforations for maximum breathability.
- Comfortable insole.
- TPU FR sole with differentiated grip texture.



Rollable jaquard tongue with lace flap.



High abrasion-resistant leather inserts.



001283..BIRS



001283..GRAF



001283..BMBI



001283..NRGR



NEW

MANUFACTURER: SPARCO
 MODEL: FORMULA
 HOM. NO: DC.179.21-Z
 FIA STANDARD: 8856-2018

HOMOLOGATION: FIA 8856-2018 - SFI 3.3/5
WEIGHT: 300GR. TG.42 **SIZES:** 37-48 (32-36 ON DEMAND)
CUSTOMIZATION: ON DEMAND

HIGHLIGHTS

- Anti-perspiration and breathable lining.
- Adjustable strap with ultra-flat tape.
- Tumbled calfskin uppers silkscreen printed.
- Single-layer stretch jacquard back insert.
- Foam footbed.
- Rubber sole.



Quick lacing system.



Perforations for maximum breathability.



001296..NRBI



001296..BINR



001296..RSBI



001296..BXBI



001296..NRRS



HOMOLOGATION: FIA 8856-2018
WEIGHT: 420GR. TG.42 **SIZES:** 38-48
CUSTOMIZATION: ON DEMAND

HIGHLIGHTS

- Anti-perspiration and breathable lining.
- Ultra resistant Kevlar Loops.
- Overlap tongue integrated with side.
- Ergonomic and shock-absorber insole.
- EVA and TPU sole specifically designed to improve mechanics and co-driver movements.



High abrasion-resistant PU lateral insert and perforated leather.



Elasticated rear insert.



001279..NRRS



001279..NRGR



HOMOLOGATION: FIA 8856-2018 - SFI 3.3/5

WEIGHT: 310GR. TG.42 **SIZES:** 37-48

CUSTOMIZATION: 3D CONFIGURATOR / ON DEMAND

HIGHLIGHTS

- Anti-perspiration and breathable lining.
- Elasticated rear insert.
- Comfortable insole.
- TPU FR sole with differentiated grip texture.



Overlap tongue integrated with side.



Ultra resistant Kevlar Loops.



001275..RSNR



001275..BIBI



001275..BNBI



001275..NRGR



001275..NRNR



HOMOLOGATION: FIA 8856-2018
WEIGHT: 385 GR. TG.42 **SIZES:** 37-48
CUSTOMIZATION: ON DEMAND

HIGHLIGHTS

- Anti-perspiration and breathable lining.
- Embroidered logos.
- Natural leather insole.
- Natural rubber sole.



Adjustable ultra-flat strap.



Suede with smooth leather inserts.



001287..RS



001287..BRFX



001287..NR



SLALOM+

FABRIC AND SUEDE



APPROVED

MANUFACTURER: SPARCO
 MODEL: SLALOM +
 HOM. NO: DC.037.19-Z
 FIA STANDARD: 8856-2018

HOMOLOGATION: FIA 8856-2018 - SFI 3.3/5
WEIGHT: 330 GR. TG.42
SIZES: 35-48

HIGHLIGHTS

- Anti-perspiration and breathable lining.
- Perforated tongue.
- High abrasion-resistant reinforced leather heel.
- Silkscreen printed perforated suede leather uppers.
- Comfortable insole.
- Natural rubber sole with differentiated grip zones.



Reinforced toe.



Fabric insert.



001274F..RSNR



001274F..BXNR



001274F..NRNR

SLALOM+



APPROVED

MANUFACTURER: SPARCO
MODEL: SLALOM +
HOM. NO: DC.037.19-Z
FIA STANDARD: 8856-2018

HOMOLOGATION: FIA 8856-2018 - SFI 3.3/5

WEIGHT: 330 GR. TG.42

SIZES: 35-48 **YOUTH SIZES:** 28-30-32-34 (ON DEMAND)

HIGHLIGHTS

- Anti-perspiration and breathable lining.
- Perforated tongue.
- Silkscreen printed perforated suede leather uppers.
- Comfortable insole.
- Natural rubber sole with differentiated grip zones.



Reinforced toe.



High abrasion-resistant reinforced leather heel.



001274..RS



001274..BRFX



001274..NR

NEW

HOMOLOGATION: FIA 8856-2018 - SFI 3.3/5
WEIGHT: 350 GR. TG.42
SIZES: 36-48



MANUFACTURER: SPARCO
 MODEL: SLALOM
 HOM. NO: DC.164.21-Z
 FIA STANDARD: 8856-2018

HIGHLIGHTS

- Embroidered logos.
- Side leather insert with printed logo.
- High resistance glossy round laces.
- Leather insole.
- Natural rubber sole.



Embroidered suede
 Leather uppers.



Fabric back insert.



001295..NR



001295..BRFX



001295..NRGF



001295..NRRS



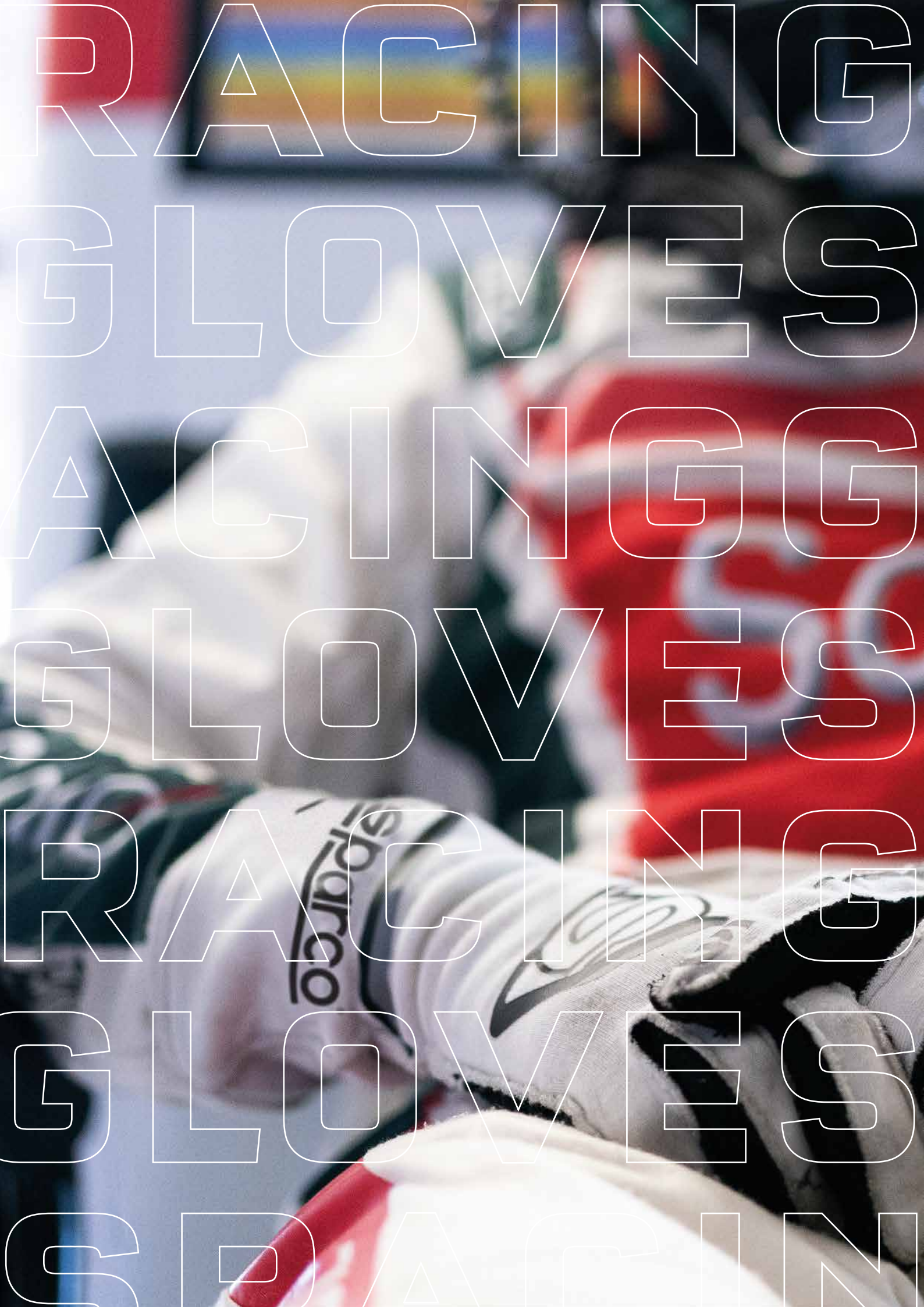

RACING

GLOVES

RACING

GLOVES

RACING

GLOVES

SPEED



Team Jota - WEC

RACING GLOVES

10[®]

TIDE

HOMOLOGATION: FIA 8856-2018 - SFI 3.3/5
PALM COMPOSITION: HTX - VULCANO
PRECURVED: YES
SEAMS: EXTERNAL
SIZES: 8-13
CUSTOMIZATION: 3D CONFIGURATOR / ON DEMAND



001356..BINR



001356..RSNR



001356..AZBI



001356..NRAF



001356..NRRS

ARROW

HOMOLOGATION: FIA 8856-2018 - SFI 3.3/5
PALM COMPOSITION: HTX - FLAT
PRECURVED: YES
SEAMS: EXTERNAL
SIZES: 7-13
CUSTOMIZATION: INFINITY PROJECT / 3D CONFIGURATOR / ON DEMAND



001314..BINR



001314..BIGR



001314..RSNR



001314..NRBI



001314..BMBI



001314..NRRS

LAP **NEW**

HOMOLOGATION: FIA 8856-2018 - SFI 3.3/5
PALM COMPOSITION: SILICONE
PRECURVED: YES
SEAMS: DIFFERENTIATED
SIZES: 7-13
CUSTOMIZATION: ON DEMAND



001316..BINR



001316..RSNR



001316..BXBI



001316..NRBI

LAND+ **HOMOLOGATION:** FIA 8856-2018 - SFI 3.3/5**PALM COMPOSITION:** SILICONE**PRECURVED:** NOT**SEAMS:** INTERNAL**SIZES:** 8-13**CUSTOMIZATION:** ON DEMAND

001362..GF



001362..RS



001362..EB



001362..NR

LAND NEW**HOMOLOGATION:** FIA 8856-2018 - SFI 3.3/5**PALM COMPOSITION:** SUEDE**PRECURVED:** NOT**SEAMS:** INTERNAL**SIZES:** 8-13 / 4 AND 6 ON DEMAND**CUSTOMIZATION:** ON DEMAND

001363..GF



001363..RS



001363..EB



001363..NR

LAND CLASSIC NEW**HOMOLOGATION:** FIA 8856-2018 - SFI 3.3/5**PALM COMPOSITION:** SUEDE**PRECURVED:** NOT**SEAMS:** INTERNAL**SIZES:** 8-13**CUSTOMIZATION:** FROM STOCK

001364..EC



001364..BM

HOMOLOGATION: FIA 8856-2018 - SFI 3.3/5
SIZES: 8-13
CUSTOMIZATION: 3D CONFIGURATOR / ON DEMAND

HIGHLIGHTS

- Precurved glove.
- Aramid jersey fabric.
- Thumb joined to back.
- External seams.
- Touch-S on index finger and thumb.
- Internal wrist stitching.

HTX

TECHNOLOGY
 PATENTED
ALL RIGHTS RESERVED

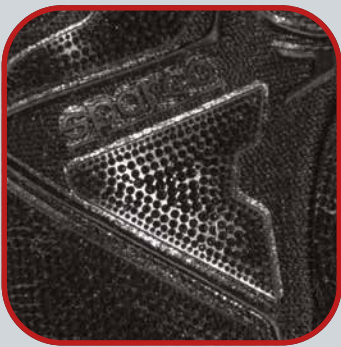

HTX 3D Volcano palm with differentiated zones.



Ergonomic seam on thumb.



001356..RSNR



001356..BINR



001356..AZBI



001356..NRAF



001356..NRRS



HOMOLOGATION: FIA 8856-2018 - SFI 3.3/5

SIZES: 7-13

CUSTOMIZATION: INFINITY PROJECT / 3D CONFIGURATOR / ON DEMAND

HIGHLIGHTS

- Precurved glove.
- Ergonomic seam on thumb.
- Aramid jersey fabric.
- External seams.

HTX

TECHNOLOGY
 PATENTED
ALL RIGHTS RESERVED



HTX flat palm.



Touch-S on index finger and thumb.



In compliance with:
 FIA Standard 8856-2018
 Manufacturer name:
 sparco
 Homologation N°: DC.000.XX-X
 Not valid after: 20XX



001314..BINR



001314..BIGR



001314..RSNR



001314..NRBI



001314..BMBI



001314..NRRS

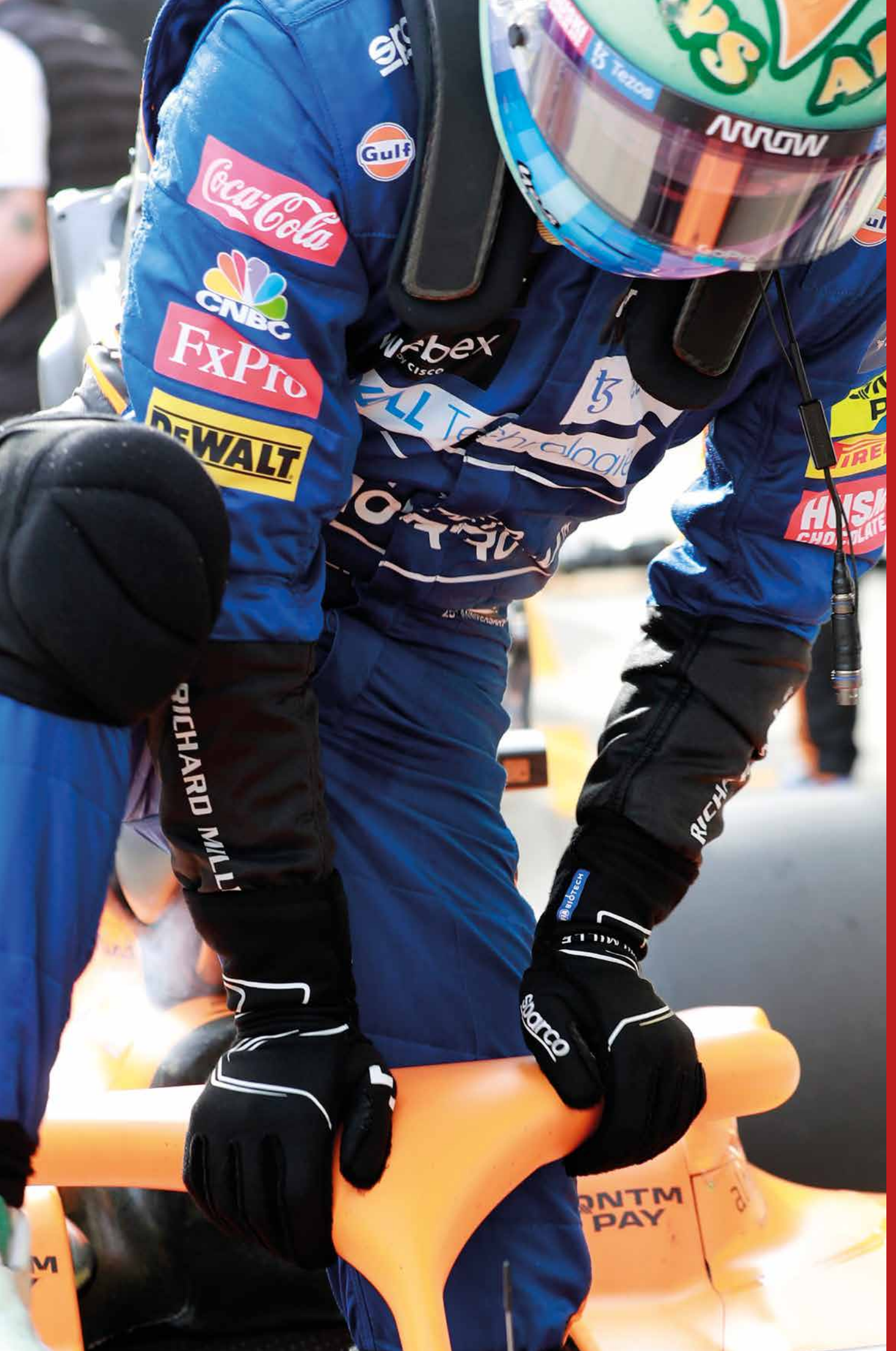

HIGHLIGHTS

- Differentiated external and internal stitching on fingers.
- External stitching on thumb.
- Back joined with the thumb.



New silicone palm for maximum grip on the wheel.



Single-layer stretch wrist insert



PG. 29

Best matching with the new Competition seamless elastic sleeves.



001316..RSNR



001316..NRBI



001316..BXBI



001316..BINR

HOMOLOGATION: FIA 8856-2018 - SFI 3.3/5

SIZES: 8-13

CUSTOMIZATION: ON DEMAND

HIGHLIGHTS

- Internal seams.
- Palm joined with thumb.

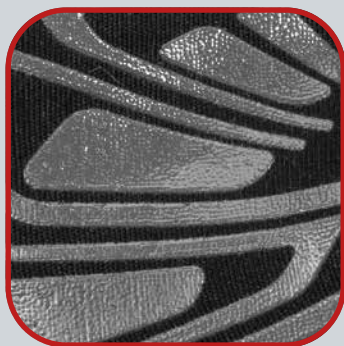

Palm with silicone inserts.



Printed graphics.



Straight cut cuff.



In compliance with:
 FIA Standard 8856-2018
 Manufacturer name:
sparco
 Homologation N°: DC.XXXX.XX-X
 Not valid after: 200X



001362..GF



001362..RS



001362..EB



001362..NR

HOMOLOGATION: FIA 8856-2018 - SFI 3.3/5
SIZES: 8-13 / 4 AND 6 ON DEMAND
CUSTOMIZATION: ON DEMAND

MANUFACTURER: SPARCO
 MODEL: LAND
 HOM. NO: DC.170.21-G
 FIA STANDARD: 8856-2018

HIGHLIGHTS

- Straight cut cuff.
- Internal seams.



Printed graphics.



Palm with suede inserts.



Elastic on wrist.



In compliance with:
 FIA Standard 8856-2018
 Manufacturer name:
sparco
 Homologation N°: DC.XXX.XX-X
 Not valid after: 20XX



001363..GF



001363..EB



001363..RS



001363..NR

NEW

HOMOLOGATION: FIA 8856-2018 - SFI 3.3/5

SIZES: 8-13

CUSTOMIZATION: FROM STOCK

HIGHLIGHTS

- Internal seams.
- New back with Sparco patch.



Patch with embroidered Sparco logo.



Palm with suede inserts.



Straight cut cuff.



001364..EC



001364..BM

RACING

HELMET

HELMETS

INGHEL

RACING

HELMET

TSPADI

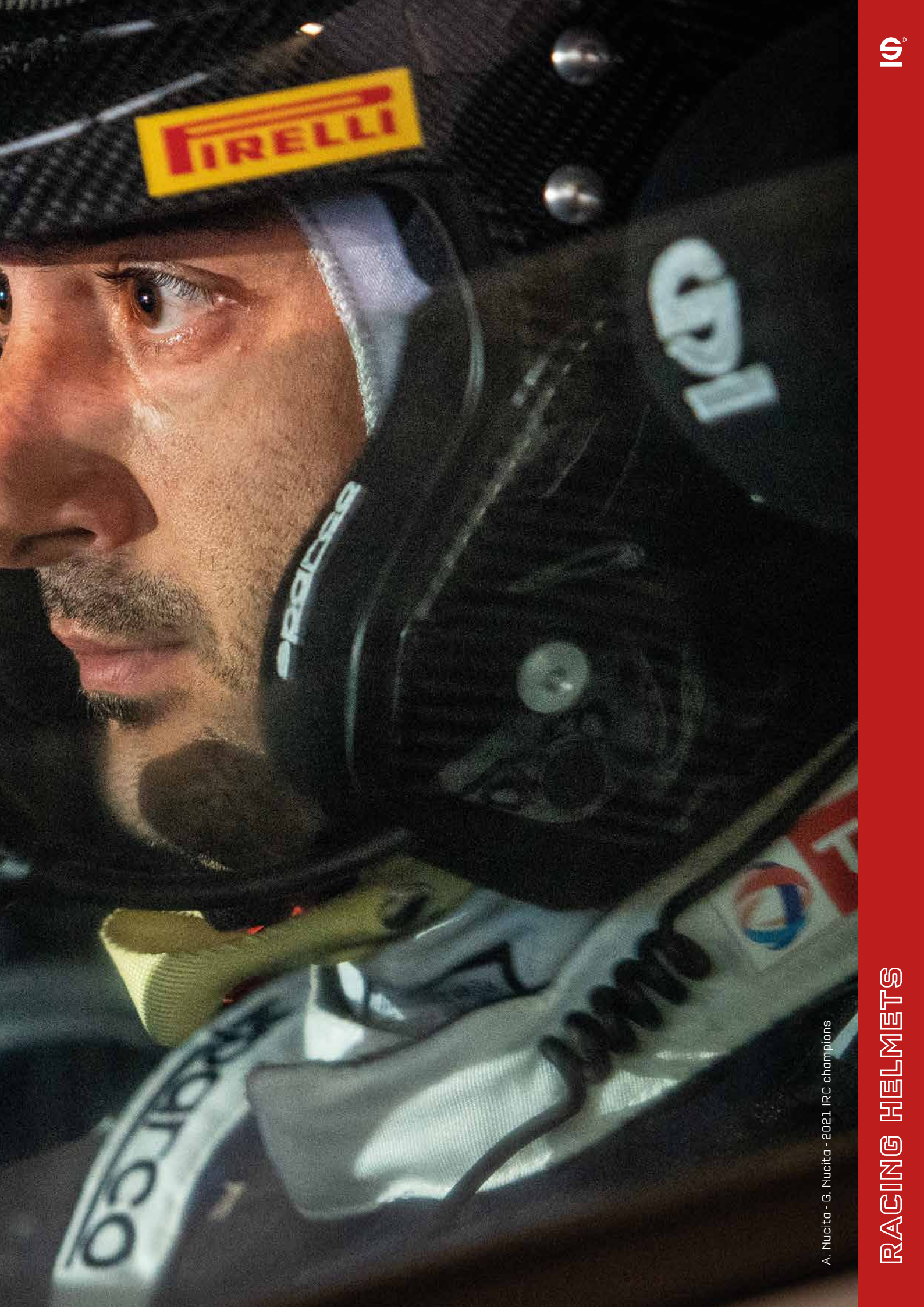

A. Nucita - G. Nucita - 2021 IRC champions

RACING HELMETS

IG

FULL FACE HELMETS

PRIME RF-10W SUPERCARBON 8860-2018  **HOMOLOGATION:** FIA 8860-2018 ABP - FIA 8860-2018 / SNELL SA 2020**MATERIAL:** HIGH TENSILE CARBON FIBER - **HANS® CLIPS****SIZES:** XS-XL

003376ZSP

003373ZNR

003373ZRS

SKY RF-7W CARBON  **HOMOLOGATION:** FIA 8859-2015 SNELL SA 2020**MATERIAL:** CARBON - **HANS® CLIPS****SIZES:** XS-XL

003374ZNR

003374ZRS

AIR PRO RF-5W  **HOMOLOGATION:** FIA 8859-2015 SNELL SA 2020**MATERIAL:** FIBERGLASS / CARBON-KEVLAR - **HANS® CLIPS****SIZES:** XS-XXL

003375NR

003375NRRS

003375BI

003375BIRS

RJ-i SUPERCARBON 8860-2018  **HOMOLOGATION:** FIA 8860-2018 SNELL SA 2020**MATERIAL:** HIGH TENSILE CARBON FIBER - **HANS® CLIPS****SIZES:** XS-XL

003372ZNR

003372ZRS

RJ-i CARBON  **HOMOLOGATION:** FIA 8859-2015 SNELL SA 2020**MATERIAL:** CARBON - **HANS® CLIPS****SIZES:** XS-XL

003371ZNR

003371ZRS

RJ-i  **HOMOLOGATION:** FIA 8859-2015 SNELL SA 2020**MATERIAL:** FIBERGLASS / CARBON-KEVLAR - **HANS® CLIPS****SIZES:** XS-XXL

003369NR

003369NRRS

003369BI

003369BIRS

RJ  **HOMOLOGATION:** FIA 8859-2015 SNELL SA 2020**MATERIAL:** FIBERGLASS / CARBON-KEVLAR - **HANS® CLIPS****SIZES:** XS-XXL

003370BI

AIR PRO 1977  **HOMOLOGATION:** FIA 8859-2015 SNELL SA 2020**MATERIAL:** FIBERGLASS / CARBON-KEVLAR - **HANS® CLIPS****SIZES:** XS-XXL

003375AZ

003375RS

RJ-i 1977  **HOMOLOGATION:** FIA 8859-2015 SNELL SA 2020**MATERIAL:** FIBERGLASS / CARBON-KEVLAR - **HANS® CLIPS****SIZES:** XS-XXL

003369AZ

003369RS

OPEN FACE HELMETS
WITH INTERCOMOPEN FACE HELMET
WITHOUT INTERCOM

1977 HELMETS

ECE 22-05 HELMETS

CLUB X-1

HOMOLOGATION: ECE 22-05
MATERIAL: ATM (ADVANCED THERMO MATERIAL)
SIZES: XS-XXL

CLUB J-1

HOMOLOGATION: ECE 22-05
MATERIAL: ATM (ADVANCED THERMO MATERIAL)
SIZES: XS-XL



003319N



003319



003317N



003317



F. Sceriffo - Drifter

PRIME RF-10W 8860-2018

SUPERCARBON **NEW**

HOMOLOGATION: FIA 8860-2018 ABP - FIA 8860-2018 / SNELL SA 2020
SIZES: XS-XL

92

HIGHLIGHTS

- ABP (Advanced Ballistic Protection), the Ultimate Safety Standard.
- Double-sized shell and polystyrene with vents.
- Stronger protection into the upper part of the helmet shell.
- Customizable, removable and washable interior.
- Ergonomic variable padding density.
- Ready for drink system.
- FIA homologated visor with continuous adjustment.
- Hans® clip.



High tensile carbon fiber shell.



ABP (Advanced Ballistic Protection).



PG. 107

* HELMET SHOWN WITH OPTIONAL DARK VISOR.

AVAILABLE LINING COLOURS



BLACK
IN STOCK

RED
IN STOCK



BLUE
ON DEMAND

GREEN
ON DEMAND

YELLOW
ON DEMAND



APPROVED

MANUFACTURER: SPARCO
MODEL: XXXXXX
HOM. NO: AH.XXX.XX-X
FIA STANDARD: 8860-2018

Available from May 2022

FIA 8860-2018



003373ZNR

003373ZRS

SUPERCARBON		
XS	53-54	003373Z..0XS
S	55-56	003373Z..1S
M	57-58	003373Z..2M
M+	59	003373Z..3ML
L	60	003373Z..4L
XL	61	003373Z..5XL

FIA 8860-2018 ABP (ADVANCED BALLISTIC PROTECTION)



003376ZSP

SUPERCARBON - ABP		
XS	53-54	003376ZSP0XS
S	55-56	003376ZSP1S
M	57-58	003376ZSP2M
M+	59	003376ZSP3ML
L	60	003376ZSP4L
XL	61	003376ZSP5XL

SKY RF-7W

CARBON NEW



MANUFACTURER: VM SAFETY
 MODEL: SPARCO SKY RF-7W
 HOM. NO: PH.036.16-C
 FIA STANDARD: 8859-2015

HOMOLOGATION: FIA 8859-2015 / SNELL SA 2020
SIZES: XS-XL

HIGHLIGHTS

- Shell and polystyrene adjustable by 2 sizes with air ducts.
- Carbon fiber shell reinforced with carbon-kevlar.
- Adjustable and washable interiors.
- Predisposed for drink system.
- FIA homologated visor with continuous adjustment.
- Hans® clips.



AVAILABLE LINING COLOURS



BLACK
IN STOCK



RED
IN STOCK



BLUE
ON DEMAND



GREEN
ON DEMAND



YELLOW
ON DEMAND

CARBON		
XS	53-54	003374Z..0XS
S	55-56	003374Z..1S
M	57-58	003374Z..2M
M+	59	003374Z..3ML
L	60	003374Z..4L
XL	61	003374Z..5XL



003374ZNR



003374ZRS



AIR PRO

RF-5W **NEW**



APPROVED

MANUFACTURER: VM SAFETY
MODEL: SPARCO AIR RF-5W
HOM. NO: PH.037.16-C
FIA STANDARD: 8859-2015

HOMOLOGATION: FIA 8859-2015 / SNELL SA 2020

SIZES: XS-XXL

HIGHLIGHTS

- Double-sized shell and polystyrene with vents.
- Fiberglass shell reinforced with carbon-kevlar.
- New breathable fireproof jersey available in different colour options.
- Adjustable and washable interior.
- Ready for drink system.
- FIA approved visor.
- Hans® clip.



AVAILABLE LINING COLOURS



BLACK
IN STOCK



RED
IN STOCK



BLUE
ON DEMAND



GREEN
ON DEMAND



YELLOW
ON DEMAND

WHITE		
XS	53-54	003375BI0XS
S	55-56	003375BI1S
M	57-58	003375BI2M
M+	59	003375BI3ML
L	60	003375BI4L
XL	61	003375BI5XL
XXL	62	003375BI6XXL

MATT BLACK		
XS	53-54	003375NR0XS
S	55-56	003375NR1S
M	57-58	003375NR2M
M+	59	003375NR3ML
L	60	003375NR4L
XL	61	003375NR5XL
XXL	62	003375NR6XXL



003375BI



003375BIRS



003375NR



003375NRRS

PRIME RJ-i 8860-2018

SUPERCARBON **NEW**

HOMOLOGATION: FIA 8860-2018 / SNELL SA 2020
SIZES: XS-XL

HIGHLIGHTS

- High tensile carbon fiber shell.
- Double-sized shell and polystyrene with vents.
- New breathable fire retardant jersey available in different colour options.
- Ergonomic variable padding density.
- Military type connection through female Nexus integrated in the shell.
- New electronics with the adoption of earphones.
- Hans® clip.



Peak with removable insert for the installing of the adjustable sun visor (available as accessories).



Integrated microphone cover and semi-rigid arm with reduced bulk for easy adjustment and maximum visibility.



PG. 107

- Customizable, removable and washable interior.
- Fully adjustable sun visor available.

AVAILABLE LINING COLOURS



BLACK
IN STOCK

RED
IN STOCK



BLUE
ON DEMAND

GREEN
ON DEMAND

YELLOW
ON DEMAND



APPROVED

MANUFACTURER: SPARCO
MODEL: XXXXXX
HOM. NO: XX.XXX.XX-X
FIA STANDARD: 8860-2018

Available from May 2022



003372ZNR



003372ZRS



RJ-i SUPERCARBON		
XS	53-54	003372Z.0XS
S	55-56	003372Z.1S
M	57-58	003372Z.2M
M+	59	003372Z.3ML
L	60	003372Z.4L
XL	61	003372Z.5XL

HOMOLOGATION: FIA 8859-2015 / SNELL SA 2020
SIZES: XS-XL

HIGHLIGHTS

- Double-sized shell and polystyrene with vents.
- Pre-preg carbon fibre shell reinforced with carbon-kevlar layers.
- New breathable fireproof jersey available in different colour options.
- Military type connection through male Nexus (die-cast Nexus connector).
- Clip Hans[®].



New peak design optimized for sun protection.



New intercom system with ear cups and noise canceling microphone.



AVAILABLE LINING COLOURS



BLACK
IN STOCK

RED
IN STOCK



BLUE
ON DEMAND

GREEN
ON DEMAND

YELLOW
ON DEMAND



APPROVED

MANUFACTURER: VM SAFETY
MODEL: SPARCO SKY RJ-7
HOM. NO: PH.041.16-O
FIA STANDARD: 8859-2015



003371ZRS



003371ZNR

CARBON		
XS	53-54	003371Z.0XS
S	55-56	003371Z.1S
M	57-58	003371Z.2M
M+	59	003371Z.3ML
L	60	003371Z.4L
XL	61	003371Z.5XL

HOMOLOGATION: FIA 8859-2015 / SNELL SA 2020
SIZES: XS-XXL

HIGHLIGHTS

- Double-sized shell and polystyrene with vents.
- Fiberglass shell reinforced with carbon-kevlar.
- New breathable fireproof jersey available in different colour options.
- Adjustable and washable interior.
- New peak design optimised for sun protection.
- New intercom system with ear cups and noise canceling microphone.
- Military type connection through male Nexus (die-cast Nexus connector).
- Hans® clip.



AVAILABLE LINING COLOURS



BLACK
IN STOCK



RED
IN STOCK



BLUE
ON DEMAND



GREEN
ON DEMAND



YELLOW
ON DEMAND

WHITE		
XS	53-54	003369BI0XS
S	55-56	003369BI1S
M	57-58	003369BI2M
M+	59	003369BI3ML
L	60	003369BI4L
XL	61	003369BI5XL
XXL	62	003369BI6XXL

MATT BLACK		
XS	53-54	003369NR0XS
S	55-56	003369NR1S
M	57-58	003369NR2M
M+	59	003369NR3ML
L	60	003369NR4L
XL	61	003369NR5XL
XXL	62	003369NR6XXL



003369BIRS



003369BI



003369NR



003369NRRS

HOMOLOGATION: FIA 8859-2015 / SNELL SA 2020
SIZES: XS-XXL

HIGHLIGHTS

- Double-sized shell and polystyrene with vents.
- Fibreglass shell reinforced with carbon-kevlar.
- New breathable fireproof jersey.
- Adjustable and washable interior
- New electronics with adoption of earphones.
- New peak design optimised for sun protection.
- Hans[®] clip.



003370BI

WHITE		
XS	53-54	003370BI0XS
S	55-56	003370BI1S
M	57-58	003370BI2M
M+	59	003370BI3ML
L	60	003370BI4L
XL	61	003370BI5XL
XXL	62	003370BI6XXL

APPROVED
NEW

 MANUFACTURER: VM SAFETY
 MODEL: SPARCO AIR RF-5W
 HOM. NO: PH.037.16-C
 FIA STANDARD: 8859-2015

HOMOLOGATION: FIA 8859-2015 / SNELL SA 2020

SIZES: XS-XXL

102

HIGHLIGHTS

- Double-sized shell and polystyrene with vents.
- Fibreglass shell reinforced with carbon-kevlar layers.
- New breathable fireproof jersey.
- Adjustable and washable interiors.
- Ready for drink system.
- FIA approved visor.
- Hans® clips.



THESE RETRO HELMET GRAPHICS WERE FIRST USED BY SPARCO PROFESSIONAL DRIVERS IN THE LATE 70'S INTO THE 80'S.

WHITE - BLUE		
XS	53-54	003375AZ0XS
S	55-56	003375AZ1S
M	57-58	003375AZ2M
M+	59	003375AZ3ML
L	60	003375AZ4L
XL	61	003375AZ5XL
XXL	62	003375AZ6XXL

WHITE - RED		
XS	53-54	003375RS0XS
S	55-56	003375RS1S
M	57-58	003375RS2M
M+	59	003375RS3ML
L	60	003375RS4L
XL	61	003375RS5XL
XXL	62	003375RS6XXL

003375AZ

003375RS

RJ-i 1977

NEW



APPROVED

MANUFACTURER: VM SAFETY
 MODEL: SPARCO AIR RF-5W
 HOM. NO: PH.037.16-C
 FIA STANDARD: 8859-2015

HOMOLOGATION: FIA 8859-2015 / SNELL SA 2020
SIZES: XS-XXL

HIGHLIGHTS

- Double-sized shell and polystyrene with vents.
- Fibreglass shell reinforced with carbon-kevlar.
- New breathable fireproof jersey.
- Adjustable and washable interior.
- New electronics with adoption of earphones.
- Military type connection (die-cast Nexus connector).
- Hans® clip.



THESE RETRO HELMET GRAPHICS WERE FIRST USED BY SPARCO PROFESSIONAL DRIVERS IN THE LATE 70'S INTO THE 80'S.

WHITE - RED		
XS	53-54	03369RS0XS
S	55-56	03369RS1S
M	57-58	03369RS2M
M+	59	03369RS3ML
L	60	03369RS4L
XL	61	03369RS5XL
XXL	62	03369RS6XXL

WHITE - BLUE		
XS	53-54	03369AZ0XS
S	55-56	03369AZ1S
M	57-58	03369AZ2M
M+	59	03369AZ3ML
L	60	03369AZ4L
XL	61	03369AZ5XL
XXL	62	03369AZ6XXL



003369RS



003369AZ

HOMOLOGATION: ECE 22-05
SIZES: XS-XXL

HIGHLIGHTS

- ATM (Advanced Thermo Material) shell.
- Not homologated for FIA competitions.
- Inner lining in hypoallergenic material.
- Helmet suitable for kart rental.



WHITE		
XS	53-54	0033190XS
S	55-56	0033191S
M	57-58	0033192M
M+	59	0033193ML
L	60	0033194L
XL	61	0033195XL
XXL	62	0033196XXL

MATT BLACK		
XS	53-54	003319N0XS
S	55-56	003319N1S
M	57-58	003319N2M
M+	59	003319N3ML
L	60	003319N4L
XL	61	003319N5XL
XXL	62	003319N6XXL



003319



003319N

CLUB J-1

HOMOLOGATION: ECE 22-05
SIZES: XS-XL

HIGHLIGHTS

- ATM (Advanced Thermo Material) shell.
- Not homologated for FIA competitions.
- Inner lining in hypoallergenic material.
- Supplied with anti-sun peak.



WHITE		
XS	53-54	0033170XS
S	55-56	0033171S
M	57-58	0033172M
L	60	0033174L
XL	61	0033175XL

MATT BLACK		
XS	53-54	003317N0XS
S	55-56	003317N1S
M	57-58	003317N2M
L	60	003317N3L
XL	61	003317N4XL



003317



003317N

ACCESSORIES - OPEN FACE HELMETS

■ = STANDARD/REPLACEMENT □ = OPTIONAL

	INTERCOM SYSTEM	MATT BLACK ABS PEAK	WHITE ABS PEAK	CARBON PEAK	SET OF SMALL MATT BLACK AIR INTAKE	SET OF SMALL WHITE AIR INTAKE	NEW MIC. 00537037	CARBON PEAK 8860	LONG VISOR	SHORT VISOR
OPEN FACE 8860 CARBON	FACTORY FITTED	NOT FITTABLE	NOT FITTABLE	NOT FITTABLE	NOT FITTABLE	NOT FITTABLE	NOT FITTABLE	FACTORY FITTED	00314V11	00314V10
RJ-i CARBON	FACTORY FITTED	00316F06	00316F07	00316F08	00315K04	0032WTXK06	FACTORY FITTED	NOT FITTABLE	NOT FITTABLE	NOT FITTABLE
RJ-i WHITE	FACTORY FITTED	00316F06	00316F07	00316F08	00315K04	0032WTXK06	FACTORY FITTED	NOT FITTABLE	NOT FITTABLE	NOT FITTABLE
RJ-i BLACK	FACTORY FITTED	00316F06	00316F07	00316F08	00315K04	0032WTXK06	FACTORY FITTED	NOT FITTABLE	NOT FITTABLE	NOT FITTABLE
RJ WHITE	NOT FITTABLE	00316F06	00316F07	00316F08	00315K04	0032WTXK06	NOT FITTABLE	NOT FITTABLE	NOT FITTABLE	NOT FITTABLE

ACCESSORIES - FULL FACE HELMETS

■ = STANDARD/REPLACEMENT □ = OPTIONAL

	CLEAR VISOR	DARK VISOR	BLUE IRIIDIUM VISOR	SILVER IRIIDIUM VISOR	RED IRIIDIUM VISOR	LIGHT YELLOW VISOR	SET OF 5 TEAR OFFS	VISOR FASTENER KIT	CENTRAL MATT BLACK AIR INTAKE	SET OF SMALL MATT BLACK AIR INTAKES	CENTRAL WHITE AIR INTAKE	SET OF SMALL WHITE AIR INTAKES	CLEAR VISOR 8860	DARK VISOR 8860
FULL FACE 8860	NOT FITTABLE	NOT FITTABLE	NOT FITTABLE	NOT FITTABLE	NOT FITTABLE	NOT FITTABLE	NOT FITTABLE	NOT FITTABLE	NOT FITTABLE	NOT FITTABLE	NOT FITTABLE	NOT FITTABLE	00314V08	00314V09
SKY RF-7W	00314V01	00314V02	00314V03	00314V04	00314V06	00314V07	00315K01	00315K02	00315K03	00315K04	0032WTXK04	0032WTXK06	NOT FITTABLE	NOT FITTABLE
AIR PRO RF-5W WHITE	00314V01	00314V02	00314V03	00314V04	00314V06	00314V07	00315K01	00315K02	00315K03	00315K04	0032WTXK04	0032WTXK06	NOT FITTABLE	NOT FITTABLE
AIR PRO RF-5W BLACK	00314V01	00314V02	00314V03	00314V04	00314V06	00314V07	00315K01	00315K02	00315K03	00315K04	0032WTXK04	0032WTXK06	NOT FITTABLE	NOT FITTABLE

ACCESSORIES

VISORS

8860-2018 FULL FACE VISORS

CLEAR VISOR NEW
INTEGRALE FIA 8860-2018

DARK VISOR NEW
INTEGRALE FIA 8860-2018



00314V08



00314V09

8860-2018 OPEN FACE VISORS

SHORT DARK VISOR NEW
JET FIA 8860-2018

LONG DARK VISOR NEW
JET FIA 8860-2018



00314V10



00314V11

8859-2015 FULL FACE VISORS FIA APPROVED

CLEAR VISOR

DARK VISOR

BLUE IRIDIUM VISOR

SILVER IRIDIUM VISOR



00314V01



00314V02



00314V03



00314V04

NOT FIA APPROVED

BLUE IRIDIUM VISOR NEW

YELLOW IRIDIUM VISOR NEW



00314V06



00314V07

FULL FACE SPARE PARTS

SET OF 5 TEAR-OFFS

VISOR FASTENER KIT



00315K01



00315K02

ACCESSORIES

PEAKS AND SPOILERS

PEAK RJ NEW

Carbon

00316F08

Black ABS

00316F06

White ABS

00316F07

ABS PEAK

Black

00316F01

Matt black



00316F02

White

00316F03

FRONT SPOILER

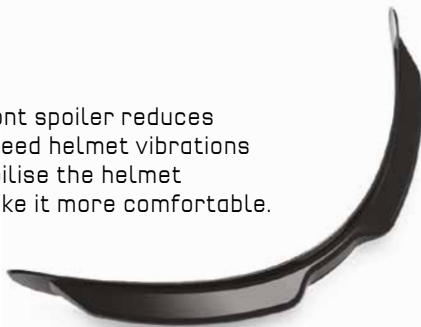
The front spoiler reduces high-speed helmet vibrations to stabilise the helmet and make it more comfortable.

 □ **00315K07** ■ **00315K08**

PUMPER



■ XS-M/L	00317P02
■ L-XXL	00317P04
□ XS-M/L	00317P01
□ L-XXL	00317P03

REAR SPOILER

VAT not included

The rear spoiler stabilises the helmet at high speeds and at the same time facilitates hot air extraction from the helmet.

 □ **00315K09** ■ **00315K10**

AIR INTAKES

Central

00315K03 **0032WTXK04**

Lateral

00315K04 **0032WTXK06**

ACCESSORIES

INTERCOM KIT

FULL FACE HELMET INTERCOM KIT

OPEN FACE HELMET INTERCOM KIT

Nexus Connection.
Noise cancelling microphone.
High-quality speakers.

Nexus Connection.
Noise cancelling microphone installed
on flexible arm.



00537025



00537026



00537013



00537011



00537015



00537019

ACCESSORIES

PADDINGS

FULL FACE CHEEK PADDING NEW



ON DEMAND



ON DEMAND



ON DEMAND



THICKNESS	BLACK	RED
25 mm	0032RF02NR25	0032RF02RS25
30 mm	0032RF02NR30	0032RF02RS30
35 mm	0032RF02NR35	0032RF02RS35
40 mm	0032RF02NR40	0032RF02RS40

OPEN FACE CHEEK PADDING NEW



ON DEMAND



ON DEMAND



ON DEMAND



THICKNESS	BLACK	RED
25 mm	0032RJ02NR25	0032RJ02RS25
30 mm	0032RJ02NR30	0032RJ02RS30
35 mm	0032RJ02NR35	0032RJ02RS35

TOP PADDING

These kits allow for the best possible helmet fitting, with the right choice of thickness for the user's needs. **Installation is simple and rapid, thanks to the strap fastenings.**



THICKNESS	BLACK
10 mm	0032R01XXL
15 mm	0032R01MMLXL
15+5 mm	0032R01XXS

HELMET BAG

DIMENSION: h 28 x l 42 x p 24 cm - 28 LT.



003111NR

HELMETS NET



00313

TWO HELMET CASE



■ 01662A



■ 01662N

HELMET HOOK



01666

THANKS TO THE NEW TRADE AGREEMENT, SPARCO IS ABLE TO PROVIDE THE BEST RANGE OF HEAD RESTRAINT FOR SIZES, STRUCTURE, WEIGHT AND PRICE.

FEATHERLITE

Material: 100% high strength Carbon.
 Weight: about 310g.
 Sliding Tethers.
 New curvature beam.

DEGREE	SIZES
30	M
20	M
20	L

00396F..



ULTIMATE

Material: 100% Carbon.
 Weight: about 490.
 Improved fitting.
 Sliding Tethers.

DEGREE	SIZES
30	L
20	M - L

00393U..



MOREOVER, THANKS TO THE USUAL CARE FOR ITS PRODUCTS, SPARCO IS THE ONLY FACTORY ABLE TO PROVIDE TO CUSTOMERS A FULLY COMPATIBLE PACKAGE INCLUDING THE ENTIRE SET (HELMET, HARNESS AND SEAT).

CLUB 3

Material: Thermoplastic.
 Weight: about 640g.
 2 sizes available.
 Sliding Tethers.

DEGREE	SIZES
20	M - L

00394C..



CLUB

Material: high resistance PVC.
 Weight: around 950g.
 Ergonomic design shape.
 Sliding Tethers.

DEGREE	SIZES
20	M/L - L/XL

00391C..



GSM

- GSM control unit for clear and stable driver-pits communication.
- Magnetic GSM antenna.
- Antenna fixing bracket for plastic surfaces.
- Nexus male connector.
- Integrated SIM slot.
- On/Off potentiometer with volume control.
- 12V power cable.
- Rollcage or dashboard installation.



00537033

Notes: disable the PIN function on the SIM card, the performance of the system depends on the availability of the GSM signal.

IS-BT 150

- Professional Digital DSP intercom control unit kit with preset noise filters.
- Double potentiometer with independent Driver and Co-Driver volume.
- Bluetooth telephone module.
- Nexus Female - Female connectors with 2m cables.
- RCA connector for in-car camera.
- AUX connector for telephone and radio.
- Power cable for connection to the 12V car battery.
- Rollcage or dashboard attachment with anti-vibration pad.



00537030

IS 140

- Professional intercom control unit kit.
- Double potentiometer with independent Driver and Co-Driver volume.
- Nexus Female - Female connectors with 2m cables.
- RCA connector for in-car camera.
- Power cable for connection to the 12V car battery. 9V power supply with battery compartment.
- Automatic exclusion of the 9V battery in the presence of a 12V power supply.
- Rollcage or dashboard attachment with anti-vibration pad.



00537029

IS 110

- Entry level intercom control unit kit with single volume potentiometer.
- 12V car battery connection cable.
- 9V battery compartment.
- 2m driver/navigator cable with 6.3mm female output jack.
- Bottom suitable for rollcage or dashboard attachment.



00537028

NX-1 HEADSET

Asymmetrical design for better microphone fit with ambient noise ablation and Nexus connectors.



00537023



A. Fourmaux - Rally Driver

SUPERCARBON TECHNOLOGY

ADV PRIME NEW**SHELL:** CARBON FIBER**SIZE:** L**HRS:** YES**WEIGHT (GR):** SHELL: 8300 / SEAT: 10500

008033ZNR

ADV XT**SHELL:** CARBON FIBER**SIZE:** L**HRS:** YES**WEIGHT (GR):** SHELL: 7500 / SEAT: 10750

008002ZNR

ADV ELITE**SHELL:** CARBON FIBER**SIZE:** L**HRS:** YES**WEIGHT (GR):** SHELL: 7810 / SEAT: 10300

00849ZNR

ADV SCX**SHELL:** CARBON FIBER**SIZE:** M/L**HRS:** YES**WEIGHT (GR):** SHELL: 8575 / SEAT: 10750

00804ZNR

ADV SC**SHELL:** CARBON FIBER**SIZE:** M**HRS:** YES**WEIGHT (GR):** SHELL: 10485 / SEAT: 12900

008020ZNR

FIBERGLASS TECHNOLOGY

ADV XT GF**SHELL:** FIBERGLASS**SIZE:** L**HRS:** YES**WEIGHT (GR):** SHELL: 18100 / SEAT: 20000

008002FNR

HOMOLOGATION 8855-2021

NEW 8855-2021 STANDARD

ADV XT NEW

SHELL: FIBERGLASS
SIZE: L
HRS: YES
WEIGHT (GR): SHELL: 9700 / SEAT: 12000



008032FNR

MASTER NEW

SHELL: FIBERGLASS
SIZE: L
HRS: YES
WEIGHT (GR): SHELL: 11250 / SEAT: 14000



008030FNR

HOMOLOGATION 8855-1999

CARBON / CARBON-KEVLAR TECHNOLOGY

QRT-C

SHELL: CARBON FIBER
SIZE: M
HRS: NO
WEIGHT (GR): SHELL: 4300 / SEAT: 5500



008025ZNR

LEGEND

SHELL: CARBON-KEVLAR
SIZE: S
HRS: NO
WEIGHT (GR): SHELL: 5300 / SEAT: 6000



008021ZRS



008021ZNR

QRT TECHNOLOGY

QRT-R / QRT-R SKY

SHELL: QRT SIZE: M **HRS:** NO

WEIGHT (GR): SHELL: **QRT-R:** 5900 / SEAT **QRT-R:** 7600

SHELL **QRT-R SKY:** 5900 / SEAT **QRT-R SKY:** 8300



008012RNR



008012RNRSKY

PILOT QRT

SHELL: QRT

SIZE: L/XL

HRS: YES

WEIGHT (GR): SHELL: 9300 / SEAT: 11100



008018RNR

PRO ADV QRT

SHELL: QRT

SIZE: M/L

HRS: YES

WEIGHT (GR): SHELL: 7800 / SEAT: 9300



008017RNR

CIRCUIT QRT / CIRCUIT II QRT

SHELL: QRT

SIZE: L

HRS: YES

WEIGHT (GR): SHELL **CIRCUIT:** 7100 / SEAT **CIRCUIT:** 8600

SHELL **CIRCUIT II:** 7200 / SEAT **CIRCUIT II:** 9600



008019RNR



008011RNR

EVO QRT RANGE

SHELL: QRT

TAGLIA: M/L/XL

HRS: NO

WEIGHT (GR): SHELL **EVO L QRT:** 6500 / SEAT **EVO L QRT:** 7700

SHELL **EVO XL QRT:** 6700 / SEAT **EVO XL QRT:** 7900

SHELL **EVO QRT:** 5000 / SEAT **EVO QRT:** 7300

SHELL **EVO SKY QRT:** 5000 / SEAT **EVO SKY QRT:** 7300



008013RNR



008015RNR



008007RNR



008007RNRSKY

HOMOLOGATION 8855-1999

HOMOLOGATION 8855-1999

QRT TECHNOLOGY

EVO QRT X RANGE NEW

SHELL: QRT
SIZE: M/L/XL
HRS: NO
WEIGHT (GR): SHELL **EVO L QRT X:** 6500
 SEAT **EVO L QRT X:** 7700
 SHELL **EVO XL QRT X:** 6700
 SEAT **EVO XL QRT X:** 7900
 SHELL **EVO QRT X:** 5000
 SEAT **EVO QRT X:** 7300



008007XNR



008015XNR



008013XNR



008016RNR



008009RNR



008009RNR SKY



008014RNR

PRO 2000 QRT

SHELL: QRT
SIZE: L
HRS: NO
WEIGHT (GR): SHELL: 6800 / SEAT: 8000

GRID-Q / GRID-Q SKY

SHELL: QRT
SIZE: M
HRS: NO
WEIGHT (GR): SHELL **GRID-Q:** 6500 / SEAT **GRID-Q:** 7300
 SHELL **GRID-Q SKY:** 6500 / SEAT **GRID-Q SKY:** 7700

REV QRT

SHELL: QRT
SIZE: M
HRS: NO
WEIGHT (GR): SHELL: 6000 / SEAT: 7100

TUBULAR FRAME TECHNOLOGY

SPRINT RANGE

SHELL: TUBULAR
SIZE: M/L
HRS: NO
WEIGHT (GR): SHELL **SPRINT L:** 10400
 SHELL **SPRINT/SPRINT SKY:** 7940
 SEAT **SPRINT L:** 11000
 SEAT **SPRINT/SPRINT SKY:** 9700



008235..



008234L..



008235NR SKY

* THE INDICATED WEIGHT IS CALCULATED ON THE AVERAGE VALUE OF THE ANALYZED SAMPLES, THEREFORE IT IS POSSIBLE THAT IT WILL UNDERGO VARIATIONS.

HOMOLOGATION 8855-1999



NEW

HOMOLOGATION: FIA 8862-2009
MATERIAL: CARBON FIBER
WEIGHT (GR): SHELL: 8300 / SEAT: 10500

HIGHLIGHTS



New use of k-point fabric.



Full-length cushion with separate leg rest.



004990ADV

The seat is approved in conjunction with the side mounting frames 004990ADV.



● **008033ZNR**

- Developed in collaboration with M-sport.
- FIA approved energy absorbing padding.
- New lining design.
- M12 lateral fastening with 290 mm spacing.
- Self-extinguishing fabric lining.

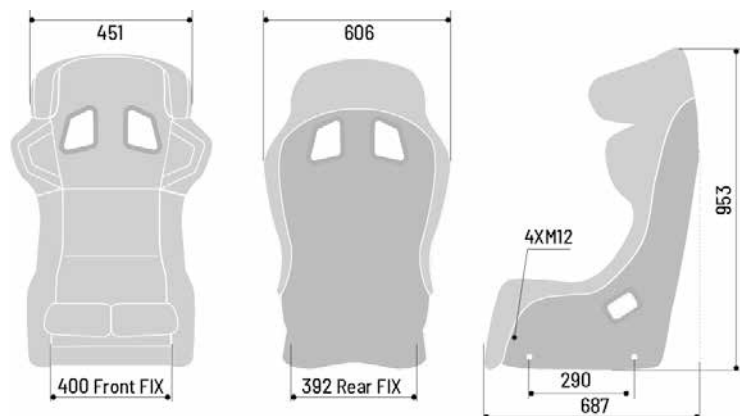



ADV XT



APPROVED

MANUFACTURER: SPARCO
MODEL: ADV XT
HOM. NO: AS.064.17
FIA STANDARD: 8862-2009

HOMOLOGATION: FIA 8862-2009
MATERIAL: CARBON FIBER
WEIGHT (GR): SHELL: 7500 / SEAT: 10750

HIGHLIGHTS



Self-extinguishing fabric lining.



Split leg rest cushion.



0049605

The seat is approved in conjunction with the side mounting frames 0049605.



008002ZNR

- FIA-approved energy absorbing padding.
- Attached using M12 lateral fastenings with 290 mm spacing.
- Non-slip fabric for shoulders and seat.

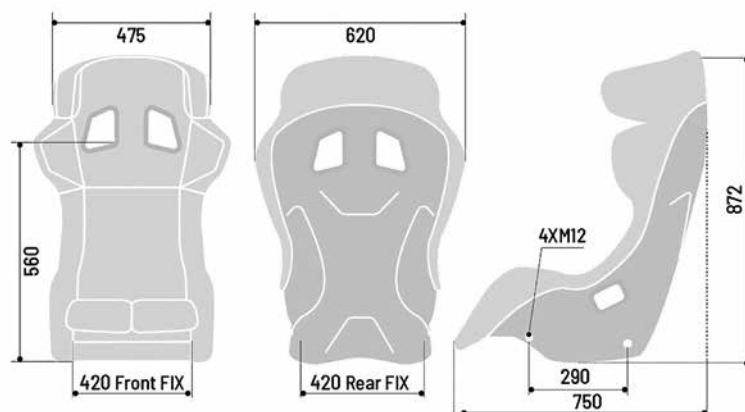



ADV ELITE



APPROVED

MANUFACTURER: SPARCO
MODEL: ADV ELITE
HOM. NO: AS.037.14
FIA STANDARD: 8862-2009

HOMOLOGATION: FIA 8862-2009

MATERIAL: CARBON FIBER

WEIGHT (GR): SHELL: 7810 / SEAT: 10300

HIGHLIGHTS



FIA-approved energy absorbing padding.



Non-slip fabric for shoulders and seat.



004988ADV

The seat is approved in conjunction with the side mounting frames 004988ADV.



● **00849ZNR**

- Self-extinguishing fabric lining.
- Improved habitability and comfort.
- Attached using M12 lateral fastenings with 290 mm spacing.

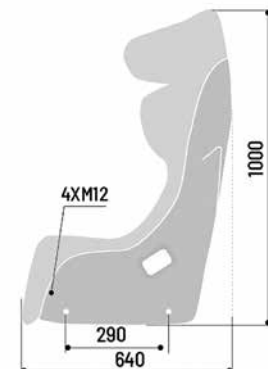



ADV SCX



APPROVED

MANUFACTURER: SPARCO
MODEL: ADV-SCX
HOM. NO: AS.022.12
FIA STANDARD: 8862-2009

HOMOLOGATION: FIA 8862-2009

MATERIAL: CARBON FIBER

WEIGHT (GR): SHELL: 8575 / SEAT: 10750

HIGHLIGHTS



Non-slip fabric for shoulders and seat.



Split legrest cushion.



004985ADV

The seat is approved in conjunction with the side mounting frames ADV SCX 004985ADV.



■ 00804ZNR

- Self-extinguishing fabric lining.
- Attached using M12 lateral fastenings with 290 mm spacing.
- FIA-approved energy absorbing padding.

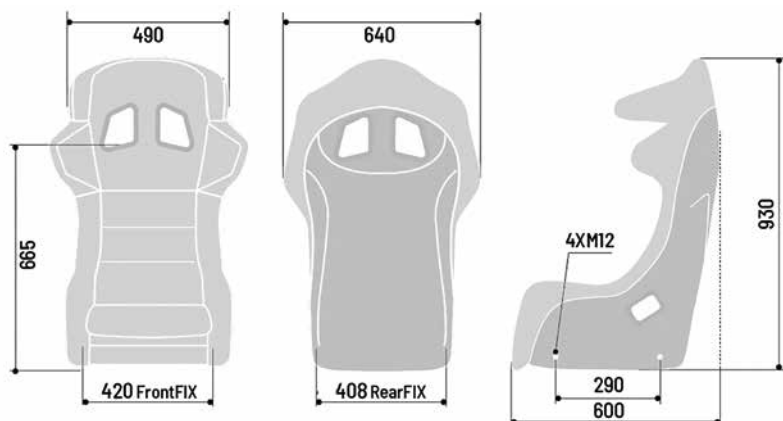

HOMOLOGATION: FIA 8862-2009
MATERIAL: CARBON FIBER
WEIGHT (GR): SHELL: 10485 / SEAT: 12900

HIGHLIGHTS



Self-extinguishing fabric lining.

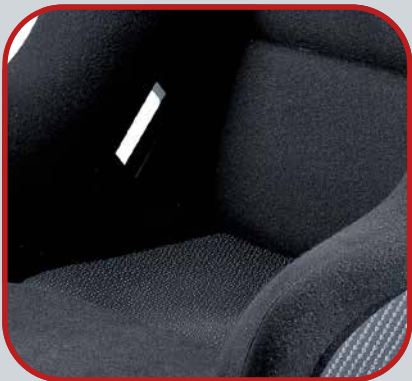

Non-slip fabric for shoulders and seat.



004982ADV

The seat is approved in conjunction with the side mounting frames 004982ADV.



■ **008020ZNR**

- FIA-approved energy absorbing padding.
- Attached using M12 lateral fastenings with 290 mm spacing.

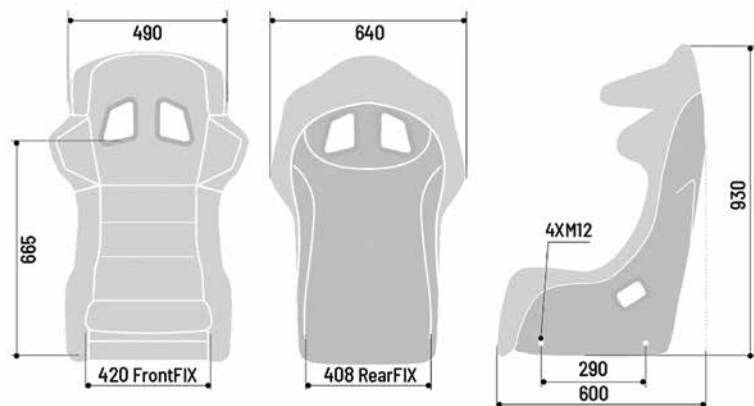

ADV XT GF



APPROVED

MANUFACTURER: SPARCO
MODEL: ADV-SC 19
HOM. NO.: AS.080.19
FIA STANDARD: 8862-2009

HOMOLOGATION: FIA 8862-2009

MATERIAL: FIBERGLASS

WEIGHT (GR): SHELL: 18100 / SEAT: 20000

HIGHLIGHTS



Self-extinguishing fabric lining.



Splitted leg rest and seat cushions.



0049605

The seat is approved in conjunction with the side mounting frames 0049605.



008002FNR

- FIA-approved energy absorbing padding.
- Attached using M12 lateral fastenings with 290 mm spacing.

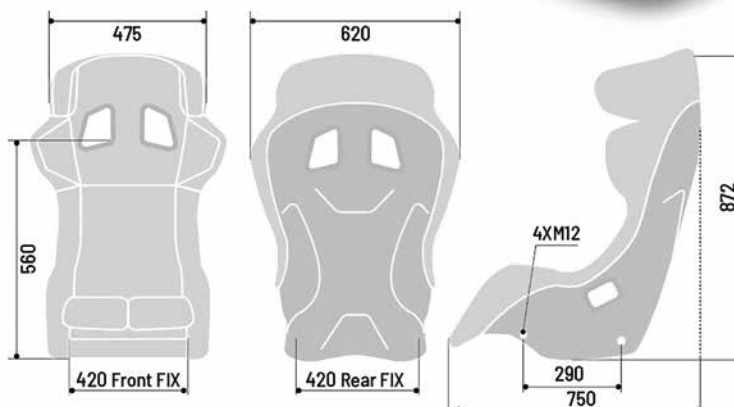

HOMOLOGATION: FIA 8855-1999
MATERIAL: CARBON FIBER
WEIGHT (GR): SHELL: 4300 / SEAT: 5500

HIGHLIGHTS



Non-slip fabric for shoulders and seat.



High structural strength.



Attached using M8 lateral fastenings with 290 mm spacing.



008025ZNR

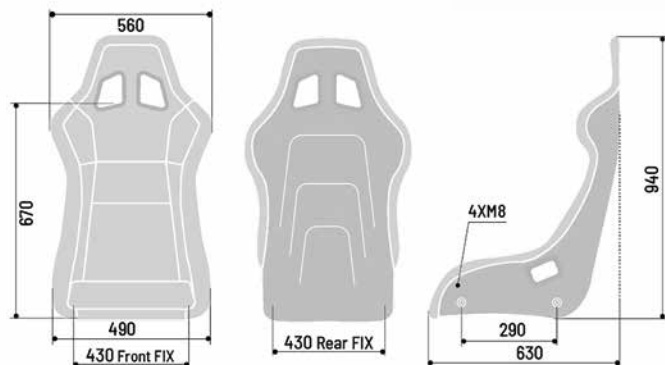

LEGEND



APPROVED

MANUFACTURER: SPARCO
MODEL: LEGEND
HOM. NO: CS.459.20
FIA STANDARD: 8855-1999

HOMOLOGATION: FIA 8855-1999

MATERIAL: CARBON-KEVLAR PRE-PREG

WEIGHT (GR): SHELL: 5300 / SEAT: 6000

HIGHLIGHTS



VEP fabric with original checkered lining.



Pre-preg carbon-kevlar frame.



Lower fasteners 317x345 (M8) (does not mount on guide 00943..).



008021ZRS



008021ZNR

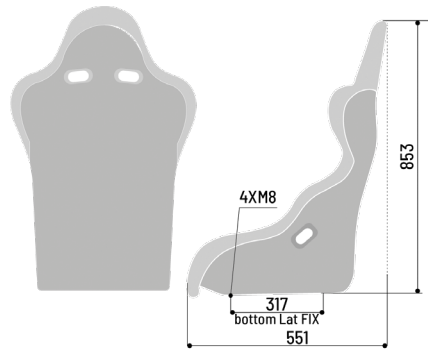
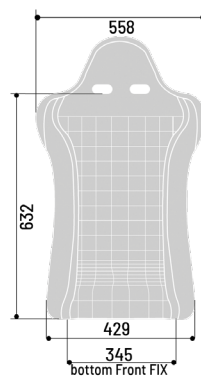



sparco

101

101 sparco

8855-2021
MASTER

NEW 8855-2021 FIA STANDARD

1ST MANUFACTURER TO RUN FIA 8855-2021 TESTS



8855-2021 ROAD MAP

CATEGORIES	2022	2023	2024	NOTE
GT3		Mandatory on all cars homologated before 01.01.2016		
RALLY CROSS			Mandatory on all RX categories (except RX1 and RX1E)	
RALLY / WRC	Rally 3, Rally 4, Rally 5, RGT: <ul style="list-style-type: none"> vehicles homologated from 01.01.2022 vehicles homologated before 01.01.2022 can install seats homologated according to the standard 8855-1999 with a validity date until 2026 			Mandatory 8855-2021 for all rally categories from 01.01.2027
CROSS COUNTRY		T1	T2, T3, T4 (TBC)	
HILL CLIMB	TBD			

HOMOLOGATION: FIA 8855-2021

MATERIAL: FIBERGLASS

WEIGHT (GR): SHELL: 11250 / SEAT: 14000

HIGHLIGHTS



Insertion of internal memory foam pads.



Integrated racing net guides.



004919

The seat is approved in conjunction with mounting frames **004919**.



● **008030FNR**

- New seat compliant with the more stringent 8855-2021 approval.
- Shock absorbing foam on the head.
- Suitable for drivers between 1.75 - 1.95 m in height.
- Non-slip fabric for shoulders and seat.

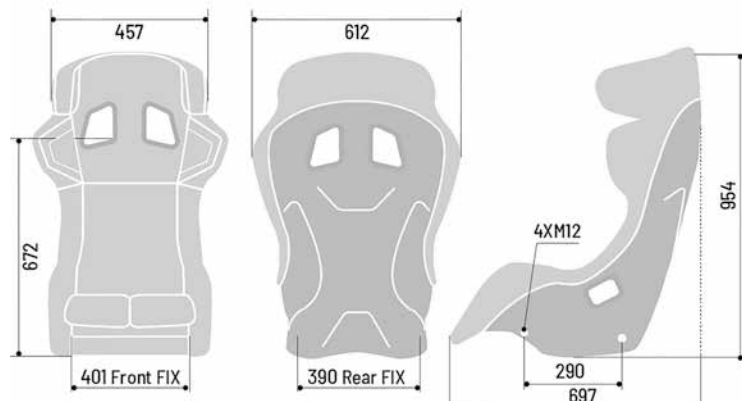

ADV XT

NEW

HOMOLOGATION: FIA 8855-2021
MATERIAL: FIBERGLASS
WEIGHT (GR): SHELL: 9700 / SEAT: 12000



APPROVED

MANUFACTURER: SPARCO
MODEL: ADV XT 8855-2021
HOM. NO: CS.008.21
FIA STANDARD: 8855-2021

IG®

137

HIGHLIGHTS



FIA-approved energy absorbing padding.



Integrated racing net guides.



004932H

004932L

The seat is approved with two different side mounting frames height (in conjunction with mounting frames **004932H** e **004932L**).



● 008032FNR

- Self-extinguishing fabric lining.
- Suitable for drivers between 1.65 - 1.80 m in height.
- Split leg rest cushion.
- Attached using M12 lateral fastenings with 290 mm spacing.

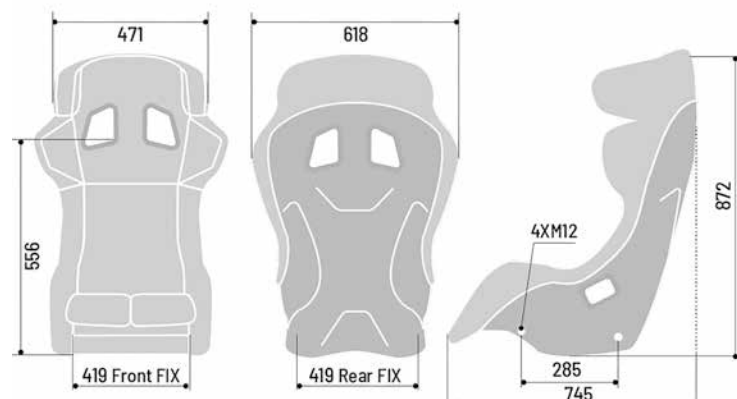

sparco

sparco®

CIRCUIT

sparco®



**ADVANCED
VACUUM TECH**

ULTRALIGHT-WEIGHT

**PROVIDE
THE BEST FITTING**

HOMOLOGATION: FIA 8855-1999
MATERIAL: QRT
WEIGHT (GR): SHELL: 5900 / SEAT: 7600

HIGHLIGHTS



Non-slip fabric for shoulders and seat.

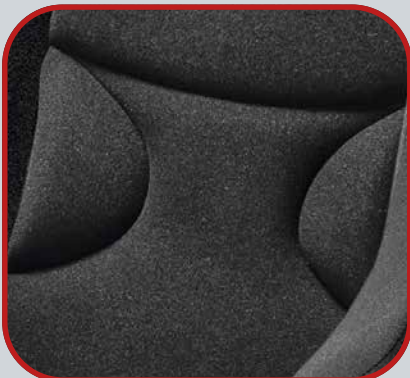

Integrated lumbar support.



Attached using M8 lateral fastenings with 290 mm spacing.



● 008012RNR

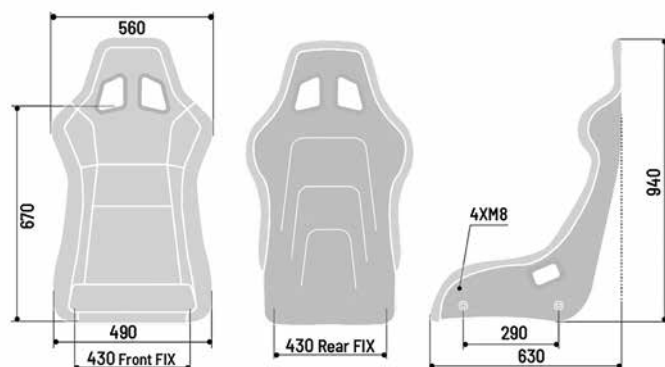

QRT-R SKY



APPROVED

MANUFACTURER: SPARCO
MODEL: QRT-C 20
HOM. NO: CS.397.18
FIA STANDARD: 8855-1999

HOMOLOGATION: FIA 8855-1999

MATERIAL: QRT

WEIGHT (GR): SHELL: 5900 / SEAT: 8300

HIGHLIGHTS



Non-slip fabric for shoulders and seat.



Integrated lumbar support.



Sky upholstery.



■ 008012RNR5KY

- Attached using M8 lateral fastenings with 290 mm spacing.

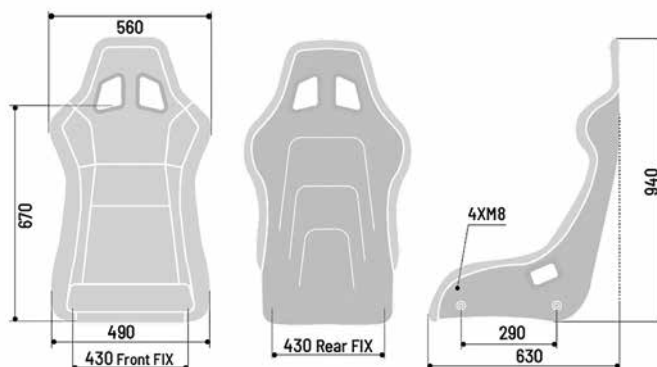

HOMOLOGATION: FIA 8855-1999

MATERIAL: QRT

WEIGHT (GR): SHELL: 9300 / SEAT: 11100

HIGHLIGHTS



Integrated, narrow head restraint for small car interiors.



Non-slip fabric for shoulder and seat restraint.



Divisible leg rest and seat cushion.



■ 008018RNR

- Attached using M8 lateral fastenings with 290 mm spacing.

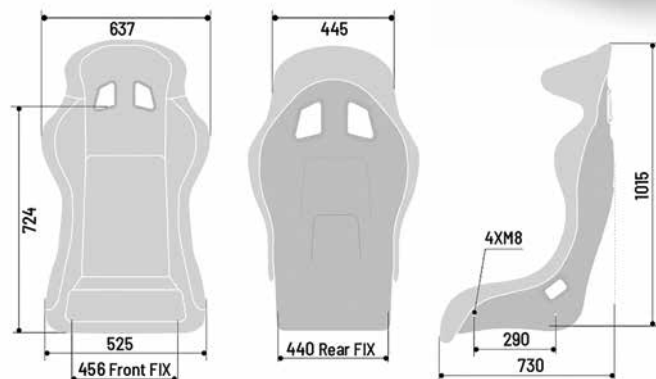

PRO ADV QRT



APPROVED

MANUFACTURER: SPARCO
MODEL: PRO ADV QRT
HOM. NO: CS.434.19
FIA STANDARD: 8855-1999

HOMOLOGATION: FIA 8855-1999

MATERIAL: QRT

WEIGHT (GR): SHELL: 7800 / SEAT: 9300

HIGHLIGHTS



Non-slip fabric for shoulder and seat restraint.



Divisible leg rest and seat cushion.



Attached using M8 lateral fastenings.



● 008017RNR

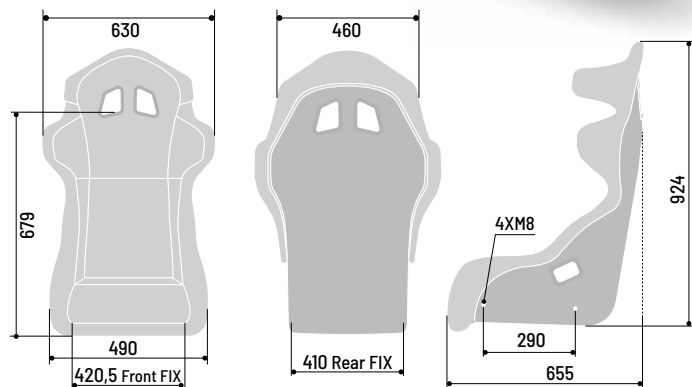

HOMOLOGATION: FIA 8855-1999

MATERIAL: QRT

WEIGHT (GR): SHELL **CIRCUIT QRT:** 7100 / SEAT **CIRCUIT QRT:** 8600
 SHELL **CIRCUIT II QRT:** 8600 / SEAT **CIRCUIT II QRT:** 9600

HIGHLIGHTS



Head Restraint System integrated.



Non-slip fabric for shoulder and seat restraint.



Divisible leg rest and seat cushion.

CIRCUIT QRT



■ 008019RNR

- Attached using M8 lateral fastenings with 290 mm spacing.

CIRCUIT II QRT



APPROVED

MANUFACTURER: SPARCO
 MODEL: CIRCUIT II QRT 20
 HOM. NO: CS.431.19
 FIA STANDARD: 8855-1999



■ 008011RNR

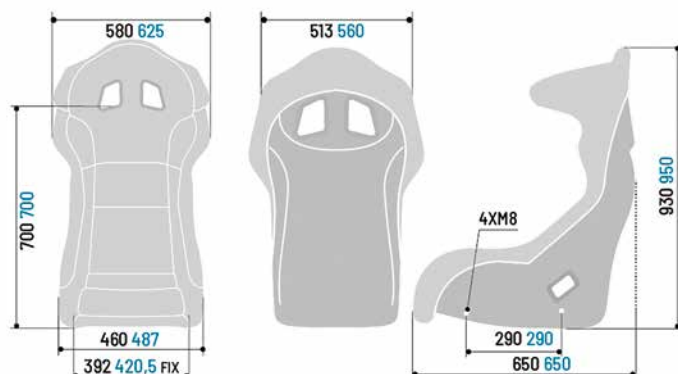

PRO 2000 QRT



APPROVED

MANUFACTURER: SPARCO
MODEL: PRO 2000 QRT
HOM. NO: CS.424.19
FIA STANDARD: 8855-1999

HOMOLOGATION: FIA 8855-1999

MATERIAL: QRT

WEIGHT (GR): SHELL 6800 / SEAT 8000

HIGHLIGHTS



Non-slip fabric for shoulder and seat restraint.



Lateral kidney supports.



Divisible leg rest and seat cushion.



● 008016RNR

- Lower attached directly on M8 271x345 base.
- Attached using M8 lateral fastenings with 290 mm spacing.

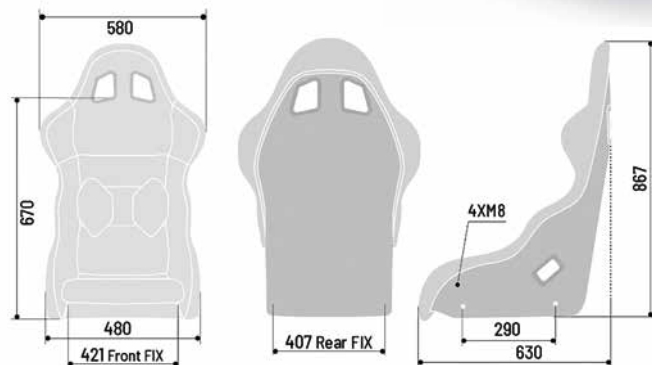

HOMOLOGATION: FIA 8855-1999

MATERIAL: QRT

WEIGHT (GR): SHELL: 5000 / SEAT: 7300

HIGHLIGHTS



New backrest with integrated lumbar cushions.



Divisible leg rest and seat cushion.



Attached using M8 lateral fastenings with 290 mm spacing.

EVO QRT



■ 008007RNR

EVO SKY QRT

■ Sky upholstery.



■ 008007RNRSKY

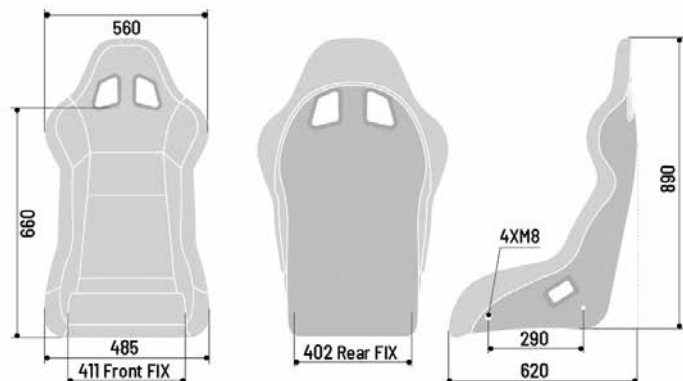

EVO QRT L/XL



MANUFACTURER: SPARCO
 MODEL: EVO L QRT
 HOM. NO: CS.432.19
 FIA STANDARD: 8855-1999

HOMOLOGATION: FIA 8855-1999

MATERIAL: QRT

WEIGHT (GR): SHELL **EVO L QRT:** 6500 / SEAT **EVO L QRT:** 7700
 SHELL **EVO XL QRT:** 6700 / SEAT **EVO XL QRT:** 7900

HIGHLIGHTS



New backrest with integrated lumbar cushions.



Divisible leg rest and seat cushion.



Attached using M8 lateral fastenings with 290 mm spacing.

EVO L QRT



● 008013RNR

EVO XL QRT



MANUFACTURER: SPARCO
 MODEL: EVO XL QRT
 HOM. NO: CS.433.19
 FIA STANDARD: 8855-1999



● 008015RNR

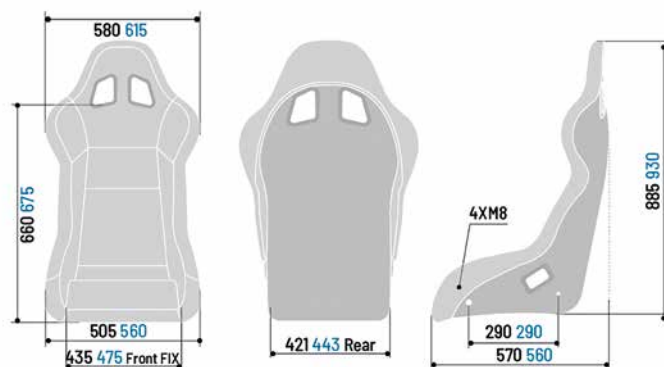

EVO QRT X

WATER-REPELLENT **NEW**



MANUFACTURER: SPARCO
 MODEL: EVO QRT
 HOM. NO: CS.373.17
 FIA STANDARD: 8855-1999

HOMOLOGATION: FIA 8855-1999

MATERIAL: QRT

WEIGHT (GR): SHELL EVO QRT X: 5000 / SEAT EVO QRT X: 7300

HIGHLIGHTS



Waterproof fabric specific for off-road use.



Divisible leg rest and seat cushion.



Attached using M8 lateral fastenings with 290 mm spacing.



■ 008007XNR

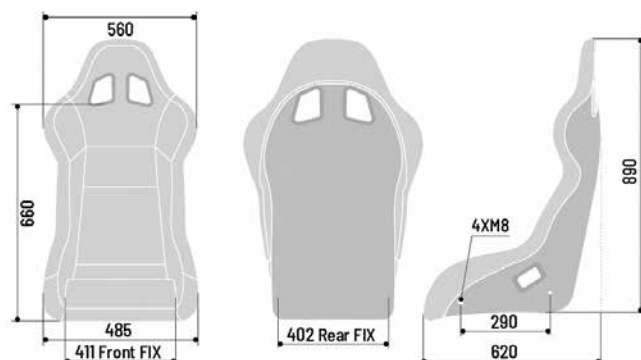

EVO QRT X L/XL

WATER-REPELLENT **NEW**



APPROVED

MANUFACTURER: SPARCO
MODEL: EVO L QRT
HOM. NO: CS.432.19
FIA STANDARD: 8855-1999

HOMOLOGATION: FIA 8855-1999 MATERIAL: QRT

WEIGHT (GR): SHELL EVO L QRT X: 6500 / SEAT EVO XL QRT X: 7700

SHELL EVO XL QRT X: 6700 / SEAT EVO XL QRT X: 7900

HIGHLIGHTS



Waterproof fabric specific for off-road use.



Divisible leg rest and seat cushion.



Attached using M8 lateral fastenings with 290 mm spacing.

EVO L QRT X



● 008013XNR

EVO XL QRT X



APPROVED

MANUFACTURER: SPARCO
MODEL: EVO XL QRT
HOM. NO: CS.433.19
FIA STANDARD: 8855-1999



● 008015XNR

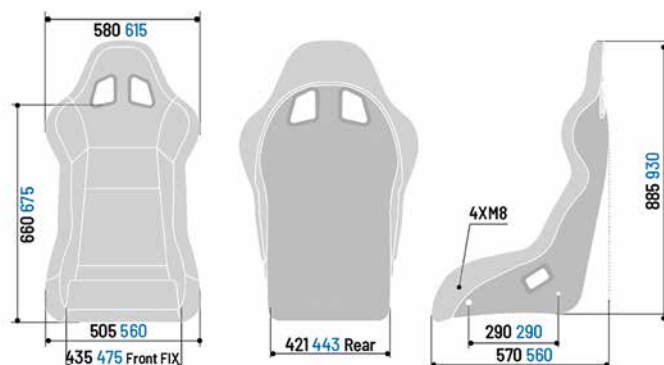

HOMOLOGATION: FIA 8855-1999

MATERIAL: QRT

WEIGHT (GR): SHELL 6500 / SEAT 7300

HIGHLIGHTS



Non-slip fabric for shoulder and seat restraint.



Customizable padded pads.



Divisible leg rest and seat cushion.

GRID-Q QRT



● 008009RNR

GRID-Q SKY QRT

- Attached using M8 lateral fastenings with 290 mm spacing.



● 008009RNRSKY

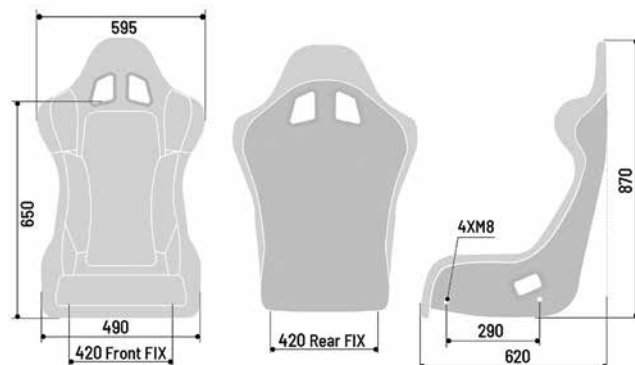

REV QRT



APPROVED

MANUFACTURER: SPARCO
MODEL: REV QRT
HOM. NO: CS.423.19
FIA STANDARD: 8855-1999

HOMOLOGATION: FIA 8855-1999

MATERIAL: QRT

WEIGHT (GR): SHELL 6000 / SEAT 7100

HIGHLIGHTS



Non-slip fabric for shoulder and seat restraint.



New backrest with integrated lumbar cushions.



Attached using M8 lateral fastenings with 290 mm spacing.



008014RNR

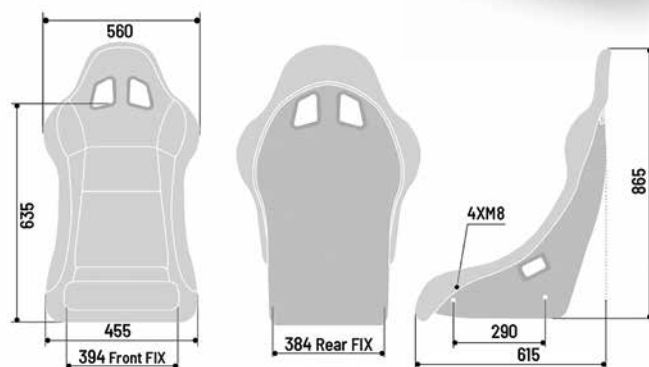

SPRINT/SPRINT L



APPROVED

MANUFACTURER: SPARCO
 MODEL: SPRINT
 HOM. NO: CS.332.15
 FIA STANDARD: 8855-1999

HOMOLOGATION: FIA 8855-1999

MATERIAL: TUBULAR FRAME

WEIGHT (GR): SHELL **SPRINT:** 7940 / SEAT **SPRINT:** 9700

SHELL **SPRINT L:** 10400 / SEAT **SPRINT L:** 11000

HIGHLIGHTS



Non-slip fabric for shoulder and seat restraint.



Tubular frame with elastic backrest and seat structure.



Lower attached directly on M8 271x345 base. Attached using M8 lateral fastenings with 290 mm spacing.

SPRINT



- 008235RS
- 008235AZ
- 008235NR

SPRINT L



APPROVED

MANUFACTURER: SPARCO
 MODEL: SPRINT L
 HOM. NO: CS.314.14
 FIA STANDARD: 8855-1999

- 008234LRS
- 008234LAZ
- 008234LNR

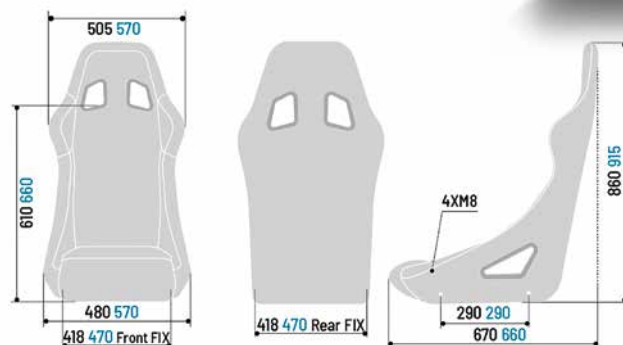

SPRINT SKY



APPROVED

MANUFACTURER: SPARCO
MODEL: SPRINT
HOM. NO: CS.332.15
FIA STANDARD: 8855-1999

HOMOLOGATION: FIA 8855-1999

MATERIAL: TUBULAR FRAME

WEIGHT (GR): SHELL **SPRINT SKY:** 7940 / SEAT **SPRINT SKY:** 9700

HIGHLIGHTS



Non-slip fabric for shoulder and seat restraint.



Sky upholstery.



Attached using M8 lateral fastenings with 290 mm spacing.



■ 008235NRSKY

- Elastic backrest and seat structure.
- Lower attached directly on M8 271x345 base.

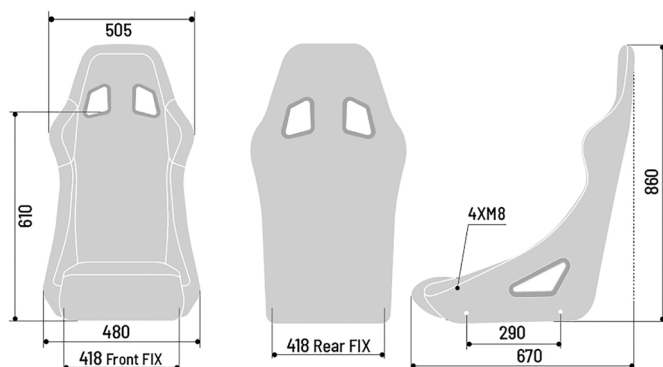

FIA-APPROVED MOUNTING FRAMES FOR SEATS WITH SIDE MOUNTING



004903

Longitudinal distance between holes 290 mm. Max length 415 mm. Simple mounting in the car with more than 25 positions. 6 mm anodized aluminium. **FIA compliant.**



00492LAT

Dismountable mounting frame made of Steel. Maximum height and length adjustability (22 eyelets on the base element). New L shape of the lateral element to allow a double lockage with the base element.

MOUNTING FRAMES - 500 MM



004915

290 mm spacing. High resistance steel, 3 mm thick. 500 mm length.



004902

Longitudinal distance between holes 290 mm. Max length 400 mm. Simple mounting in the car with more than 25 positions. 3 mm black powder coated. **FIA compliant.**



004901NR

(L max 360 mm)
Longitudinal wheelbase 290 mm.
3 mm thick steel.

SUBFRAMES FOR BOTTOM MOUNTING

FOR THE COMPLETE APPLICATION LIST SEE THE PRICE LIST.



DRIVER DRINK



01045NR

Drink bag. Insulates from outside heat and keeps drinks at a constant temperature. Holds 1.5 litres, inner bottle and spout also available as spare parts. Four braces for attachment to the seat.

OFF ROAD CUSHION LOW NEW



01033NR

Memory foam cushion for off-road use - **FIA compliant.**

OFF ROAD CUSHION HIGH NEW



01034XNR

Memory foam cushion for off-road use.

OPTIONAL PADDING



04108009PAD

Pair of side cushions suitable for FIA 8855-1999 seats.



01011

Leg support cushion.



- **01022NR**
- **01022AZ**
- **01022RS**

Pair of lumbar side backrests.



01023

Universal lumbar backrest.

CUSHION FULL KIT (BACK + BOTTOM)

NEW



CODE	SEAT
01048KIT8007NR	EVO QRT
01048KIT8007SKY	EVO QRT SKY
01048KIT8013NR	EVO L QRT
01048KIT8015NR	EVO XL QRT
01048KIT8014NR	REV QRT
01048KIT8012NR	QRT R
01048KIT8012SKY	QRT-R SKY
01048KIT8025NR	QRT-C



CODE	SEAT
01048KIT8019NR	CIRCUIT
01048KIT8011NR	CIRCUIT II
01048KIT8017NR	PRO ADV QRT
01048KIT8016NR	PRO 2000 QRT
01048KIT8018NR	PILOT QRT
01048KIT8009NR	GRID Q
01048KIT8009SKY	GRID Q SKY

RACING

HARNE

YESSES

ARNES

RACING

HARNES

ESSES



McLaren F1 Car

RACING HARNESSSES

10[®]

FORMULA
PRIME H-10 EVO  **NEW**
TYPE: FORMULA

FIXING: DOGBONE (OR BOLT ON ON DEMAND)

ANCHORAGE POINT: 6 POINTS (8 POINTS ON DEMAND)

04842HNR

PRIME H-10 
TYPE: FORMULA

FIXING: DOGBONE (OR BOLT ON ON DEMAND)

ANCHORAGE POINT: 6 POINTS (8 POINTS ON DEMAND)

04822H

04823H 
TYPE: FORMULA

FIXING: DOGBONE ON SHOULDER / BOLT ON

ANCHORAGE POINT: 6 POINTS

04823HNR

04819H2
TYPE: FORMULA

FIXING: ROLLCAGE / BOLT ON

ANCHORAGE POINT: 6 POINTS

04819H2RS



04819H2AZ



04819H2NR

HOMOLOGATION 8853-2016

RALLY / GT / SALOON
PRIME H-9 EVO 
TYPE: RALLY / GT / SALOON

FIXING: ROLLCAGE / CARABINER

ANCHORAGE POINT: 6 POINTS

04825HRS



04825HNR

PRIME H-8 ENDURANCE  **NEW**
TYPE: RALLY / GT / SALOON

FIXING: BOLT ON / ROLLCAGE / DOGBONE (ON DEMAND)

ANCHORAGE POINT: 6 POINTS

04835HNR

PRIME H-7
TYPE: RALLY / GT / SALOON

FIXING: ROLLCAGE / SNAP ON / CARABINER

ANCHORAGE POINT: 6 POINTS

04821HMRS



04821HMAZ



04821HMNR

HOMOLOGATION 8853-2016

HOMOLOGATION 8853-2016

RALLY / GT / SALOON

04818RHALPD1

TYPE: RALLY / GT / SALOON
 FIXING: ROLLCAGE / SNAP ON
 ANCHORAGE POINT: 6 POINTS



04818RHALPD1RS

04818RHALPD1AZ

04818RHALPD1NR

04818RAL

TYPE: RALLY / GT / SALOON
 FIXING: ROLLCAGE / SNAP ON
 ANCHORAGE POINT: 6 POINTS



04818RALRS

04818RALAZ

04818RALNR

04818RH1

TYPE: RALLY / GT / SALOON
 FIXING: ROLLCAGE / SNAP ON
 ANCHORAGE POINT: 6 POINTS



04818RH1RS

04818RH1AZ

04818RH1NR

04818RAC

TYPE: RALLY / GT / SALOON
 FIXING: ROLLCAGE / SNAP ON
 ANCHORAGE POINT: 6 POINTS



04818RACRS

04818RACAZ

04818RACNR

04834HPD

TYPE: RALLY / GT / SALOON
 FIXING: ROLLCAGE / SNAP ON
 ANCHORAGE POINT: 6 POINTS



04834HPDRS

04834HPDAZ

04834HPDNR

RALLY / SALOON / HISTORICAL

04716M1

TYPE: RALLY / SALOON
 FIXING: SNAP ON
 ANCHORAGE POINT: 4 POINTS



04716M1RS

04716M1AZ

04716M1NR

OFFROAD / OFFSHORE

04806SFI / 04806SFIVDM

TYPE: OFFROAD / OFFSHORE
 FIXING: SNAP ON
 ANCHORAGE POINT: 5 POINTS



04806SFIVD

04806SFIVDM

04806SFINR

SFI

HIGHLIGHTS

- 6-Point or 8-Point (on demand) belt.
- 2" FHR specific shoulder straps.
- Aluminium adjusters i284.
- Dogbone fasteners (or screw on request).



Strap 40% lighter than the prime H-10 belt.



Full release titanium buckle.



04842HNR

**THE LIGHTEST
 IN THE WORLD
 CHOSEN BY
 F1 TEAMS**

PRIME H-10



APPROVED

MANUFACTURER: SPARCO
MODEL: 04822H
HOM. NO: SH.060.19-T-6
FIA STANDARD: 8853-2016

10[®]

HOMOLOGATION: FIA 8853-2016

161

HIGHLIGHTS

- 6-Point or 8-Point (on demand) belt.
- 2" specific FHR shoulder straps.
- Full release titanium buckle.
- Aluminium adjusters.
- Dogbone fixing (screw fixing on request).
- McLaren F1 Racing and Alfa Romeo racing official equipment.



04822HNR



McLaren F1 Car

RACING HARNESSSES

HIGHLIGHTS

- 6 point seat belt for single-seater.
- 2" specific FHR straps.
- Aluminium buckle.
- Aluminium adjusters only on shoulder straps.
- Adjustable abdominal and thigh straps.
- Fixings: Loop with tribar on each branch for dog bone fixing.



04823HNR

04819H2

HIGHLIGHTS

- 6 point seat belt for single-seater.
- 2" specific FHR straps.
- Aluminium buckle.
- Steel adjusters on shoulder and abdominal straps.
- Triangle screw fixings, 13 mm diameter hole, roll-cage or dog bone mounting possible by eliminating triangles.



- **04819H2NR**
- **04819H2RS**
- **04819H2AZ**



Prema F2 Car

PRIME H-9 EVO



APPROVED

MANUFACTURER: SPARCO
 MODEL: 04825H
 HOM. NO: SH.071.19-T-6
 FIA STANDARD: 8853-2016

HOMOLOGATION: FIA 8853-2016

HIGHLIGHTS

- 6 point harness.
- 2" FHR specific straps.
- Compact T-bar.
- Aluminium buckle.
- Aluminium adjusters.
- Rollcage fasteners (shoulders and thigh) and ultra-light carabiner (abdominal).
- M-Sport racing team Official WRC Championship harness equipment.



● 04825HNR
 ● 04825HRS

04818RHALPD1



APPROVED

MANUFACTURER: SPARCO
 MODEL: 04818RH
 HOM. NO: SH.005.16-T-6
 FIA STANDARD: 8853-2016

HOMOLOGATION: FIA 8853-2016

HIGHLIGHTS

- 6 point seat belt.
- 3" specific FHR shoulder straps with reduction to 2".
- Aluminium buckle.
- Aluminium shoulder and abdominal strap adjusters.
- Pull down adjustment on abdominal straps.
- Snap-hook fasteners on all straps.
- Possibility of roll-cage fixing on shoulder and thigh straps.



● 04818RHALPD1NR
 ● 04818RHALPD1RS
 ● 04818RHALPD1AZ



M-Sport WRC Car

PRIME H-8

ENDURANCE **NEW**

FIA APPROVED

MANUFACTURER: SPARCO
 MODEL: 04835HNR
 HOM. NO: SH.085.21-T-6
 FIA STANDARD: 8853-2016

166

HOMOLOGATION: FIA 8853-2016

HIGHLIGHTS

- 6-point endurance belt
- 2" Specific FHR shoulder straps.
- Aluminium buckle.
- Aluminium adjuster on shoulder straps.
- Steel adjuster on thigh and abdomen.
- Screw fasteners on all branches.
- Roll fixing bars for shoulder straps and leg harnesses.
- Official Dallara Stradale harness equipment.



04835HNR

PRIME H-7

FIA APPROVED

MANUFACTURER: SPARCO
 MODEL: 04821HM
 HOM. NO: SH.019.17-T-6
 FIA STANDARD: 8853-2016

HOMOLOGATION: FIA 8853-2016

HIGHLIGHTS

- 6 point seat belt.
- 2" specific FHR shoulder straps.
- Aluminium buckle.
- High resistance steel adjusters.
- Roll-cage fastening for shoulder and thigh straps, abdominals with carabiner for 7/16 eyebolt.



● **04821HMNR**
 ● **04821HMRS**
 ● **04821HMAZ**

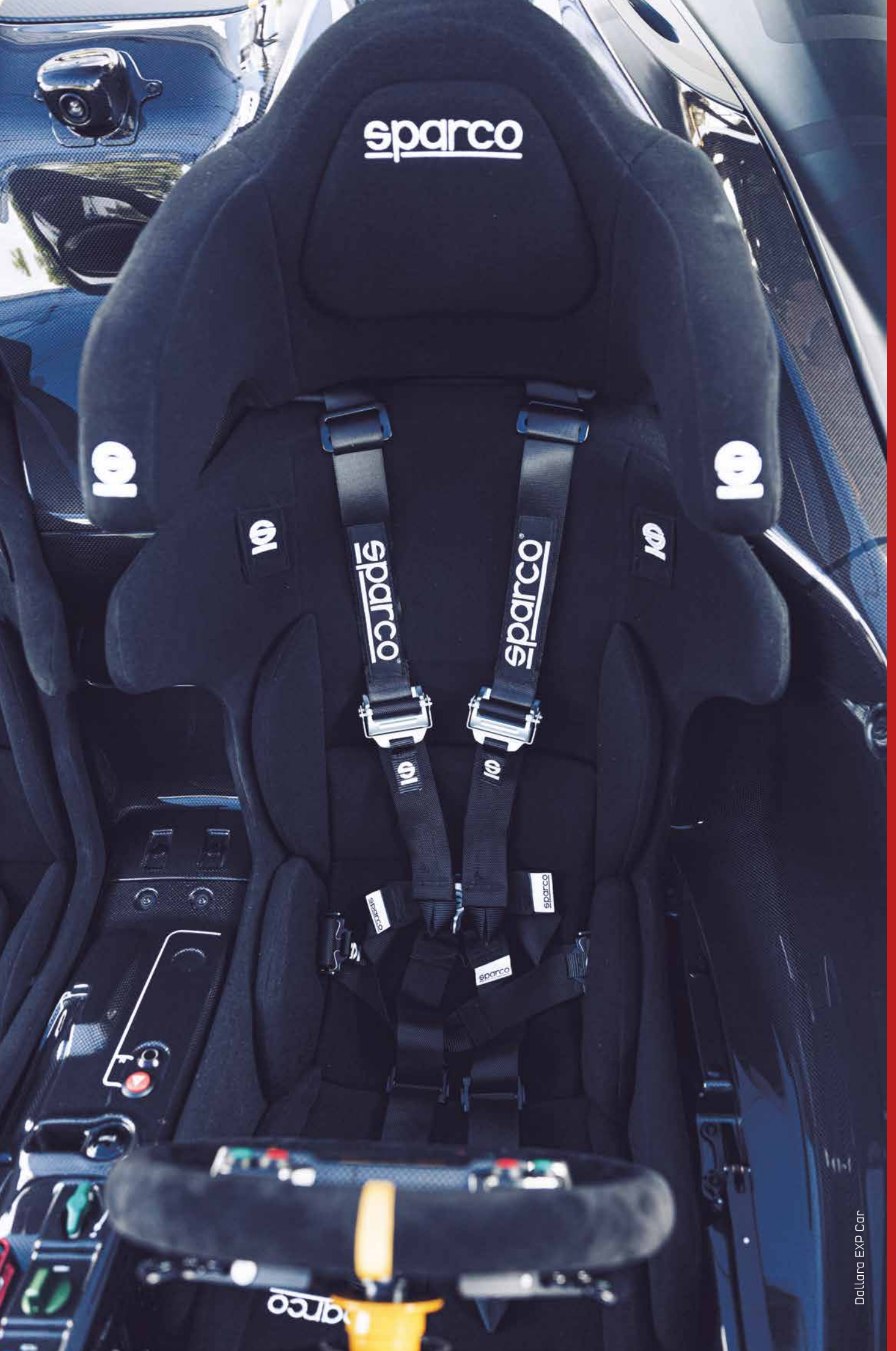

Dallara EXP Car

HIGHLIGHTS

- 6 point seat belt.
- 3" shoulder straps.
- Aluminium buckle.
- Aluminium adjusters.
- Snap-hook fasteners on all straps.
- Rollbar fixing by removing the snap-hook.



- 04818RALNR
- 04818RALRS
- 04818RALAZ

04818RH1

HIGHLIGHTS

- 6 point seat belt.
- 3" specific FHR shoulder straps with reduction to 2".
- Aluminium buckle.
- Steel shoulder and abdominal strap adjusters.
- Snap-hook fasteners on all straps.
- Possibility of roll-cage fixing on shoulder and thigh straps.



- 04818RH1NR
- 04818RH1RS
- 04818RH1AZ

04818RAC



APPROVED

MANUFACTURER: SPARCO
MODEL: 04818RH
HOM. NO: SH.005.16-T-6
FIA STANDARD: 8853-2016

HOMOLOGATION: FIA 8853-2016

HIGHLIGHTS

- 6 point seat belt.
- 3" shoulder straps.
- Aluminium buckle.
- Steel adjusters.
- Snap-hook fasteners on all straps.
- Rollbar fixing by removing the snap-hook.



- 04818RACNR
- 04818RACRS
- 04818RACAZ

04834HPD



APPROVED

MANUFACTURER: SPARCO
MODEL: 04834HPD
HOM. NO: SH.076.20-T-6
FIA STANDARD: 8853-2016

HOMOLOGATION: FIA 8853-2016

HIGHLIGHTS

- 6 point harness.
- 2" FHR specific straps.
- Aluminium buckle.
- High resistance steel adjusters.
- Pull down adjustment on abdominals.
- Snap hooks.
- Compact T-bar.



- 04834HPDNR
- 04834HPDRS
- 04834HPDAZ

HIGHLIGHTS

- 4 point seat belt.
- Aluminium buckle.
- High resistance steel adjusters.
- Snap-hook fasteners on all straps.



- 04716M1NR
- 04716M1RS
- 04716M1AZ

04806SFI

HOMOLOGATION: SFI 16.1

HIGHLIGHTS

- 5 point seat belt.
- Latch-n-link buckle.
- Ideal for off-road vehicles and/or boats.



- 04806SFNR
- 04806SFVD

04806SFIVDM

HOMOLOGATION: SFI 16.1

HIGHLIGHTS

- 5 point seat belt.
- Latch-n-link buckle.
- Ideal for off-road vehicles and/or boats.



04806SFIVDM

ACCESSORIES

PAIRS OF SHOULDER PADS

- Pair of pads for 3" harnesses. Made of padded velour. NOT FIREPROOF.



01098S3R



01098S3A



01098S3N

Thread 7/16



04501

Thread 7/16



04502



RACING

STEERING

ENGINE

STEERING

RACING

STEERING

ENGINE



M-Sport JWRC Car

RACING STEERING WHEELS

IQ

STEERING WHEELS INDEX

F-10C

TYPE: FORMULA
DIAMETER (MM): 270



015PC270SSN

F-10A

TYPE: FORMULA
DIAMETER (MM): 270



015P270SSN

P310/P310 OPEN

TYPE: FORMULA / SALOON
DIAMETER (MM): 310



015P310F2SN



NEW

015P310OPN

P300

TYPE: FORMULA / SALOON
DIAMETER (MM): 300



015P300SN

R323

TYPE: RALLY / SALOON
DIAMETER (MM): 270



015R323PSNR

R330 / R330B

TYPE: FORMULA / SALOON
DIAMETER (MM): 330



015R330CSO



015R330CLO



015R330PSO

R350 / R350B

TYPE: FORMULA / SALOON
DIAMETER (MM): 350



015R350CSO



015R350CLO



015R350PSO

R215 / R215 FLAT 

TYPE: RALLY
DIAMETER (MM): 350



015R215CSN



015R215FL

NEW



015R215FS

NEW

R325 

TYPE: RALLY
DIAMETER (MM): 350



015R325CSN

R345 

TYPE: RALLY
DIAMETER (MM): 350



015R345MLN

R353 

TYPE: RALLY / SALOON
DIAMETER (MM): 330



015R353PSN

R368 

TYPE: RALLY
DIAMETER (MM): 380



015R368MSN

R375 

TYPE: RALLY / SALOON
DIAMETER (MM): 350



015R375PSN

R383 

TYPE: RALLY / SALOON
DIAMETER (MM): 330



015R383PSN

F-10C

176

MATERIAL: SUEDE

HIGHLIGHTS

- Carbon steering wheel for prototype single-seater and sports vehicle.
- Ergonomic grip, designed based on experience gained with the racing teams of the most prestigious motor manufacturers.
- Hole interaxis 3x50.8 mm.

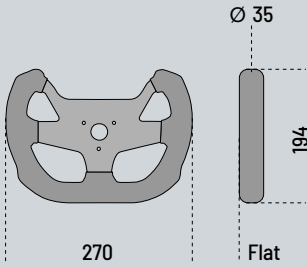

015PC270SSN



F-10A

MATERIAL: SUEDE

HIGHLIGHTS

- Aluminium steering wheel for prototype single-seater and sports vehicle.
- Ergonomic grip, designed based on experience gained with the racing teams of the most prestigious motor manufacturers.
- Hole interaxis 3x50.8 mm.

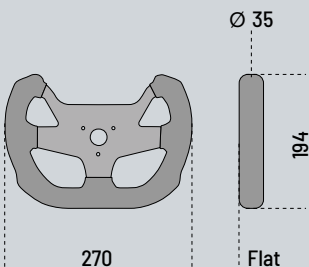

015P270SSN



P310

MATERIAL: SUEDE

HIGHLIGHTS

- Flat steering wheel ideal for GT car.
- Hole interaxis: 6x70 mm.

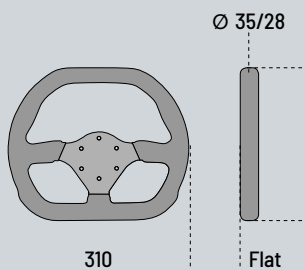

015P310F2SN



P310 OPEN

NEW

MATERIAL: SUEDE

HIGHLIGHTS

- Open top, ideal for GT cars.
- Hole interaxis: 6x70 mm.

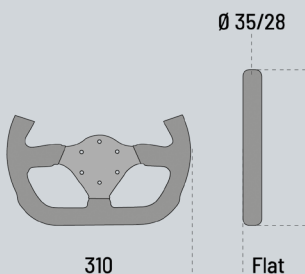

015P3100PN



HIGHLIGHTS

- Flat steering wheel with small grip.
- Hole interaxis: 6x70 mm.

New horn button colour kit included.

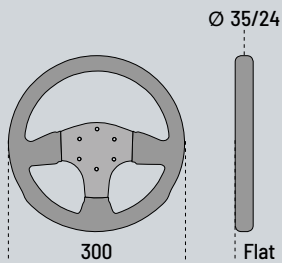

015P300SN

R323 

HIGHLIGHTS

- Flat steering wheel with small grip.
- Hole interaxis: 6x70 mm.

New horn button colour kit included.

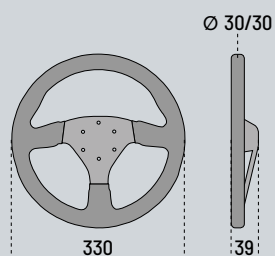

015R323PSNR



R330 / R330 B



MATERIAL: SUEDE

HIGHLIGHTS

- Hole interaxis: 6x70 mm.

WITHOUT BUTTONS Ø 33/25

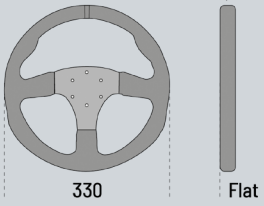

WITH BUTTONS Ø 33/25

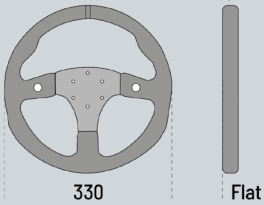

015R330CLO
LEATHER WITHOUT BUTTONS

- IP68 buttons for water and dust protection.

015R330CSO
SUEDE WITHOUT BUTTONS

015R330PSO
SUEDE + BUTTONS



R350 / R350 B



MATERIAL: SUEDE / LEATHER

HIGHLIGHTS

- Hole interaxis: 6x70 mm.

WITHOUT BUTTONS Ø 33/25

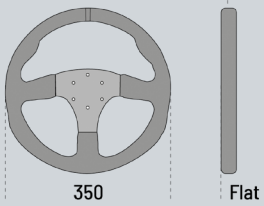

WITH BUTTONS Ø 33/25

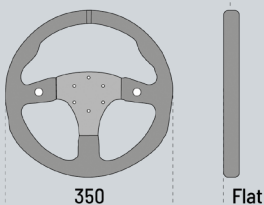

015R350CLO
LEATHER WITHOUT BUTTONS

- IP68 buttons for water and dust protection.

015R350CSO
SUEDE WITHOUT BUTTONS

015R350PSO
SUEDE + BUTTONS



R353

MATERIAL: SUEDE

HIGHLIGHTS

- Dished steering wheel with large grip.
- Hole interaxis: 6x70 mm.

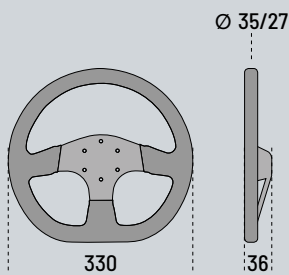

015R353PSN

R375

MATERIAL: SUEDE

HIGHLIGHTS

- Special 36 mm dished.
- Hole interaxis: 6x70 mm.

New horn button colour kit included.

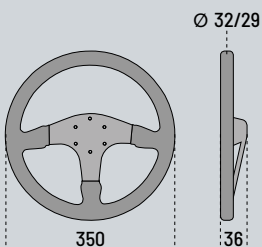

015R375PSN

R215

MATERIAL: SUEDE

HIGHLIGHTS

- Dished steering wheel with lighter spokes.
- Hole interaxis: 6x70 mm.

New horn button colour kit included.

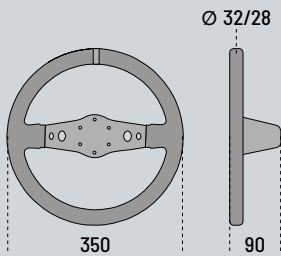

015R215CSN

R215 FLAT

NEW

MATERIAL: SUEDE / LEATHER

HIGHLIGHTS

- Suede flat steering wheel for rally use.
- Hole interaxis: 6x70 mm.

New horn button colour kit included.

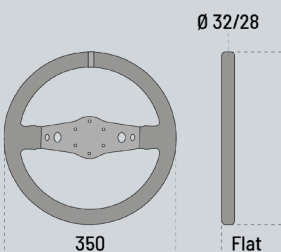

015R215FL
LEATHER

015R215FS
SUEDE

R368

MATERIAL: SUEDE

HIGHLIGHTS

- Dished steering wheel optimal for off-road use.
- Hole interaxis: 6x70 mm.

New horn button colour kit included.

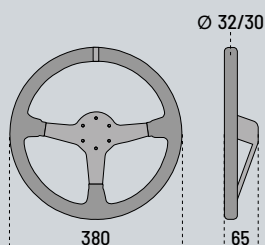

015R368MSN

R383

MATERIAL: SUEDE

HIGHLIGHTS

- Steering wheel with special comfortable grip shape.
- Hole interaxis: 6x70 mm.

New horn button colour kit included.

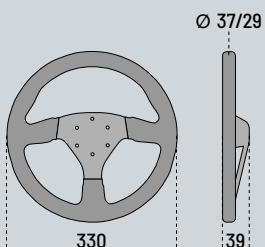

015R383PSN

R325

MATERIAL: SUEDE

HIGHLIGHTS

- Dished steering wheel with three spokes and small grip.
- Hole interaxis: 6x70 mm.

New horn button colour kit included.

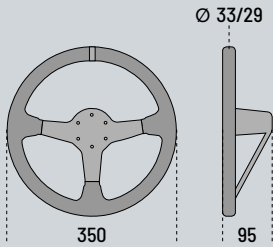

015R325CSN

R345

MATERIAL: SUEDE / LEATHER

HIGHLIGHTS

- Dished steering wheel with small grip.
- Hole interaxis: 6x70 mm.

New horn button colour kit included.

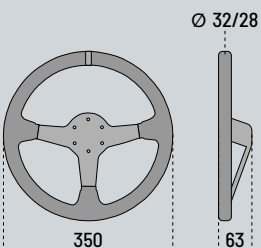

015R345MLN
LEATHER

015R345MSN
SUEDE

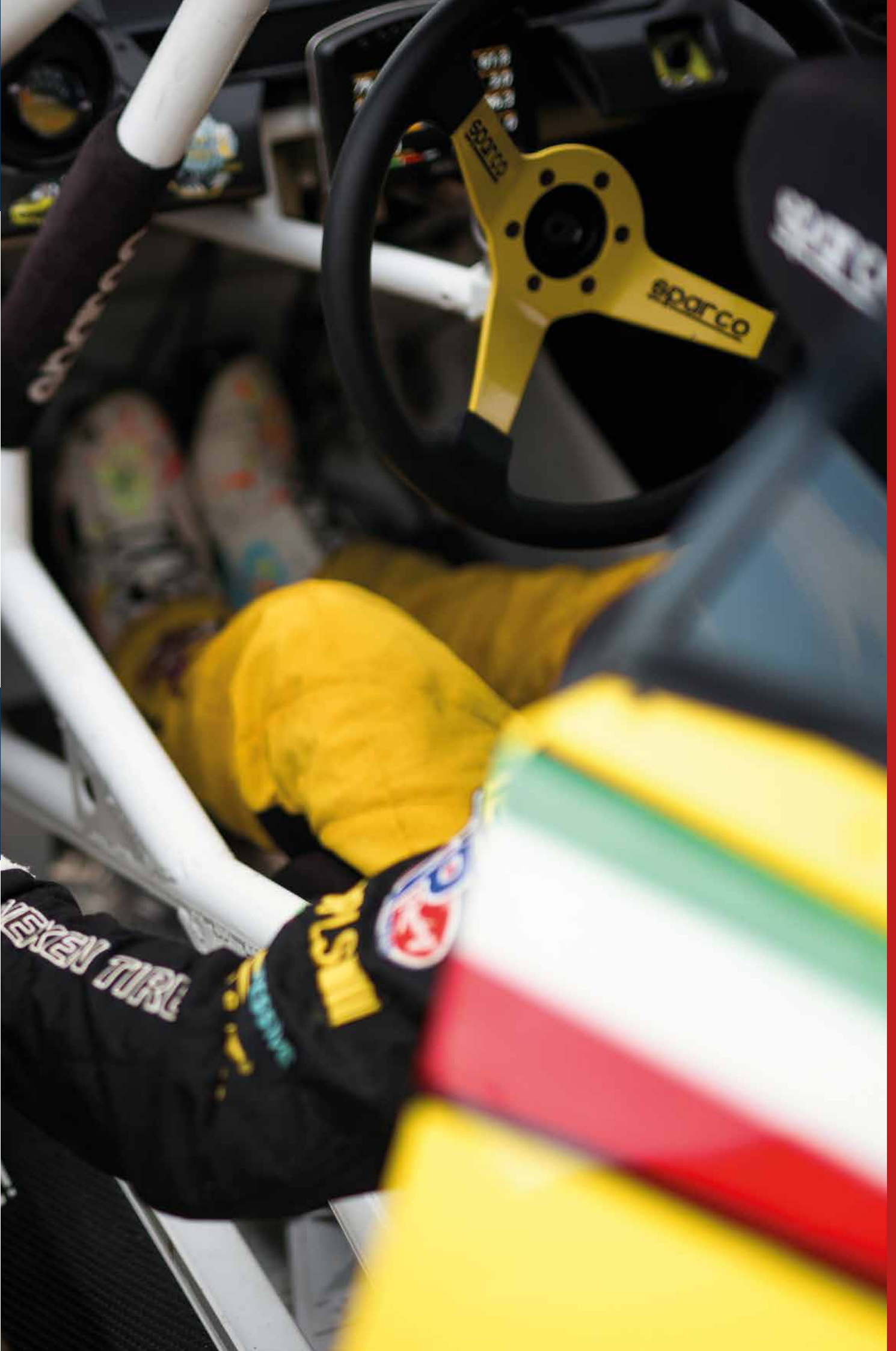

PRE-WIRED QUICK RELEASE **NEW**

- 6+6 Hole detachable steering wheel hub with electrical connection, pre-wired with 8 central pins.



015R98EL

QUICK RELEASE

- CNC processed aeronautical aluminium.
- Hard anodised for resistance and reliability.
- Slots for 6x70 mm mount.
- FIA compliant (annex J).



015R98R

SW PAD **NEW**

Steering wheel protection pad.



015002NR



015NE981



015NE982



HORN DELETE KIT

HORN DELETE KIT MATT



0159ZMNR



HORN DELETE KIT GLOSSY



0159ZNR

RING



01599NR

ANODIZED STEERING WHEEL SPACERS

ANODIZED ALUMINIUM



01595ANR



01595A

STEEL WHEEL HUB

**FOR THE APPLICATION LIST
PLEASE CHECK PRICE LIST.**

Sparco collapsible hubs are made from cast iron with a steel frame that collapse during impacts. This item absorbs kinetics energy avoiding transfer to the driver.

The Sparco steering wheels are TÜV approved only if coupled with the Sparco hubs.





RACING
MECHANICS/
TECHNICAL
RACING
FILTERS



sparco

24h
LE MANS

A



MS-5

HOMOLOGATION: NOT HOMOLOGATED
SIZES: S-XXL

HIGHLIGHTS



Reinforced elbow material.



Elasticated back panel.



Removable kneepads.



002019NR..



002019GR..



MS-4

HOMOLOGATION: NOT HOMOLOGATED
SIZES: S-XXL

HIGHLIGHTS



Front pocket.



Elasticated band.



Side pockets.



002020AZ..



002020GR..



002020RS..



002020NR..

HOMOLOGATION: FIA 8856-2018
SIZES: 38-48

HIGHLIGHTS

- Soft transfer printed leather uppers.
- Rubberized leather reinforced insert.
- EVA and TPU sole specifically designed to improve mechanics and co-driver movements.
- Ergonomic and shock-absorber insole.



Perforated areas for maximum breathability.



Soft back insert.



001265..NR

TORQUE

01 CERTIFICATION (EN ISO 20347:2012)

SIZES: 37-47

METAL FREE

HIGHLIGHTS

- Breathable mesh lining.
- Easy lacing.
- Phylon sole and oil and hydrocarbon resistant rubber bottom.
- SRA Level slip resistance.



Tip with ultra-resistant coated reinforcement.



Energy absorption heel.

Ultra-lightweight and breathable OCCUPATIONAL footwear.



001289..BMAF



001289..NRAZ



001289..NRNR



001289..NRGF



001289..NRRS

HOMOLOGATION: FIA 8856-2018
SIZES: 9-13

HIGHLIGHTS

- Aramide knit knuckle and finger reinforcement with silicone coating.
- Thumb reinforcement for maximum cut and abrasion protection.
- Internal seams.



Silicone palm with ultragrip texture..



Fully ribbed cuff for maximum fit.



In compliance with:
 FIA Standard 8856-2018
 Manufacturer name:
sparco
 Homologation N°: DC.XXX.XX-G
 Not valid after: 20XX



001317..NR



001317..GF

NEW

HOMOLOGATION: NOT HOMOLOGATED
SIZES: 8-12

HIGHLIGHTS

- FIA 8856-2018 Standard compliant materials.
- Aramide knit knuckle and finger Reinforcements with silicone coating.
- Ergonomic pre-curved construction.
- Internal seams.



Palm with HTX 3D print vulcano with differentiated zones for maximum grip to absorb vibrations.



Thumb reinforcement for maximum cut and abrasion protection.



001318..NR



001318..GF

SIZES: S-XL

COMPOSITION: 47% POLYESTER 35% SUEDE 18% ELASTANE

HIGHLIGHTS

- The backs of Meca-3 gloves are made from elasticised, printed, scuff resistant fabric.
- The palms are in synthetic, scuff resistant hide and there are reinforcements positioned between thumb and index finger.
- Pads between the fingers provide better breathing.
- Strap for tighter fitting.



NEW



002093NRGF

NEW



002093BMAF



002093AZ



002093NR



002093RS



SPORTAC

PROTECTIVE GLOVES

NEW

SIZES: 8-11

CERTIFICATION: PPE CAT.2 / EN 388:2016 / EN ISO 21420

HIGHLIGHTS

- Adamant® diamond structure for a maximum level of cutting resistance.
- Exceptional comfort and dexterity.
- Palm resistant to grease and wet grime.
- Impact resistant on the back.
- Shock absorbing structure on the palm of the hand.



002097.GI

PPE CATEGORY II:

Synthetic glove protecting against mechanical risks.

ABRASION RESISTANCE:

4 (performance levels).

RESISTANCE TO BLADE CUTTING:

Coupe test: X (not done).

TEAR RESISTANCE:

4 (performance levels).

PUNCTURE RESISTANCE:

3 (performance levels).

RESISTANCE TO CUTTING BY BLADE EN ISO 13997:

D (performance levels).

EN PROTECTION AGAINST IMPACTS:

P (performance level).

MECA OVERGLOVES

SIZES: S-L

COMPOSITION:

51% cotton
47% aramide
2% others



00259NR..

SEATTLE SOFT SHELL

SIZES: S-XXL**COMPOSITION:** 100% polyester

02404BM..

02404NR..

PHOENIX - FULL ZIP SWEATSHIRT

SIZES: S-XXL**COMPOSITION:** Outside 100% polyester - inside 100% cotton

02406BM..

02406NR..

HOUSTON - CARGO-TECH

SIZES: S-XXL**COMPOSITION:**
98% canvas cotton - 2% elastane

02401GSRS..

BOSTON - CARGO MULTISEASON

SIZES: S-XXL**COMPOSITION:** 98% drill cotton - 2% elastane

02400GS..

02400NR..

PORTLAND POLO

SIZES: S-XXXL
COMPOSITION: 100% cotton



02407AZ..

02407BM..

02407BM..

TRENTON T-SHIRT

SIZES: S-XXXL
COMPOSITION: 95% cotton - 5% elastane



02408AZ..

02408BM..

02408NR..

BERMUDA **NEW**

SIZES: S-XXL
COMPOSITION:
 97% cotton - 3% elastane



02410GS..



02410NR..

DUNGAREES

SIZES: S-XXL



0020011NR..



0020011AZ..

TOOLS BELT

SIZES: M-XL

Radio belts,
adjustable with snap buckle.



M-L
min 90 - max 120 cm **016451ML**

L-XL
min 120 - max 150 cm **016451LXL**

FIA 8865

014777EXP ■ ■ NEW

ACTIVATION: ELECTRIC
 TYPE: RALLY/CIRCUIT
 CAPACITY (LT.): 3,9
 WEIGHT (KG.): 5,9



014777EXP

014779EXP ■ ■ NEW

ACTIVATION: ELECTRIC
 TYPE: RALLY/CIRCUIT
 CAPACITY (LT.): 2,5
 WEIGHT (KG.): 5,9



014779EXP

014778EXL2 SP205 ■ ■ NEW

ACTIVATION: ELECTRIC
 TYPE: RALLY/CIRCUIT
 CAPACITY (LT.): 2,5
 WEIGHT (KG.): 3,9



014778EXL2

014778EXL3 SP305 ■ ■ NEW

ACTIVATION: ELECTRIC
 TYPE: RALLY/CIRCUIT
 CAPACITY (LT.): 3,9
 WEIGHT (KG.): 5,1



014778EXL3

FIA 2000

014772FEAL ■ ■

ACTIVATION: ELECTRIC
 TYPE: FORMULA
 CAPACITY (LT.): 0,9
 WEIGHT (KG.): 1,8



014772FEAL

014772EXL ■ ■

ACTIVATION: ELECTRIC
 TYPE: RALLY/CIRCUIT
 CAPACITY (LT.): 4,25
 WEIGHT (KG.): 6,7



014772EXL

014772MSL ■ ■

ACTIVATION: MECHANIC
 TYPE: RALLY/CIRCUIT
 CAPACITY (LT.): 4,25
 WEIGHT (KG.): 8,1



014772MSL

ART. 253/J

014773BXLN2 

ACTIVATION: HAND HELD
TYPE: RALLY
CAPACITY (LT.): 2
WEIGHT (KG.): 3,4



014773BXLN2

014773BXL24 

ACTIVATION: HAND HELD
TYPE: RALLY
CAPACITY (LT.): 2,4
WEIGHT (KG.): 4,5



014773BXL24

EN3

014773BSS2 

ACTIVATION: HAND HELD
TYPE: RALLY
CAPACITY (LT.): 2
WEIGHT (KG.): 2,8



014773BSS2

PERFORMANCE

PG. 288

014775BXL2 

ACTIVATION: HAND HELD
TYPE: RALLY
CAPACITY (LT.): 2
WEIGHT (KG.): 2,8



014775BXL2



NEW

MANUFACTURER: SPARCO
 MODEL: 014777EXP
 HOM. NO: EX.027.21
 FIA STANDARD: 8865-2015

HIGHLIGHTS

- FIA (8865-2015) approved pressurised extinguishing system.
- 4.3 Kg of FK-5-1-12 extinguishing agent.
- Electric ignition.
- 3.9 L stainless steel tank diameter 130mm length 346 mm.
- 1 Cockpit nozzle + 1 engine nozzle.
- For 2.3m³ - 4.1m³ cockpits.



014777EXP

ACCESSORIES

MA0142131
+ MA0142098

MA0142107



MA0142108



MA0142109



MA0142117



MA0142122



MA0142127



MA0142128 - MA0142129



MA0142133



MA0142134



MA0142135



MA0142023



MA0140024



NEW

MANUFACTURER: SPARCO
MODEL: 014779EXP
HOM. NO: EX.028.21
FIA STANDARD: 8865-2015

HOMOLOGATION: FIA 8865

HIGHLIGHTS

- FIA (8865-2015) approved pressurised extinguishing system.
- 3.3 Kg of FK-5-1-12 extinguishing agent.
- Electric activation.
- 2.5l stainless steel tank diameter 114mm.
- Length 302 mm.
- 1 Cockpit nozzle + 1 engine nozzle.
- For 1.2m³ - 2.3m³ volume cockpits.



014779EXP

ACCESSORIES



MA0142131
+ **MA0142098**



MA0142107



MA0142109



MA0142117



MA0142122



MA0142127



MA0142128 - MA0142129



MA0142133



MA0142134



MA0142135



MA0142023



MA0140024

HIGHLIGHTS

- Electrically operated ultra-light extinguishing system.
- 2.5L stainless steel tank diameter 110mm.
- Length 302 mm.
- AFFF extinguishing agent (2 litres).
- Bullet nozzles.
- Full metal fittings.



014778EXL2

ACCESSORIES

MA0142103
+ MA0142082

MA0142040



MA0142041



MA0142042



MA0142043



MA0142029



MA0140024



MA0142030



MA0142023

HOMOLOGATION: FIA 2000

HIGHLIGHTS

- Electrically operated ultra-light extinguishing system.
- 3.9L stainless steel tank. diameter 130mm length 346 mm.
- AFFF extinguishing agent (3 litres).
- Bullet nozzles.
- Full metal fittings.



014778EXL3

ACCESSORIES



**MA0142131
+ MA0142098**



MA0142040



MA0142041



MA0142042



MA0142043



MA0142029



MA0140024



MA0142030



MA0142023

HIGHLIGHTS

- 1.3 litre aluminium single-seater extinguishing system.
- Dimension: diameter 106mm
length 190mm.
- AFFF extinguishing agent (0.9 litres).
- Pressurised to 16 Bar.
- Solid block-machined nozzles,
all-metal connectors.



014772FEAL

ACCESSORIES



MA0142042



MA0142040



MA0142043



MA0142041



**MA0142083
MA0142082**



MA0142029



MA0140024



MA0142023



MA0142030

HOMOLOGATION: FIA 2000

209

HIGHLIGHTS

- Ultra-light, electrically activated extinguisher system.
- Dimension: diameter 160mm length 330mm.
- CE certified bottle in stainless steel (tested at over 40 Bar).
- AFFF foam extinguisher (4.25 litres).
- Solid block-machined nozzles, all-metal connectors.



014772EXL

ACCESSORIES



MA0142042



MA0142040



MA0142043



MA0142041



MA0142013
MA0142049
MA01480



MA0142029



MA0140024



MA0142023



MA0142030

HIGHLIGHTS

- Mechanically activated extinguisher system.
- Dimension: diameter 160mm
length 330mm.
- CE certified bottle in steel
(tested at over 40 Bar).
AFFF foam extinguisher
(4.25 litres).
- Solid block-machined nozzles,
all-metal connectors.



014772MSL

ACCESSORIES



MA0142042



MA0142040



MA0142043



MA0142041



MA0142013
 MA0142049
 MA01480



MA0142029



MA014RL24CL



MA0142023

HAND HELD EXTINGUISHERS

014773BXLN2 ■ ■

- Ultra-light FIA approved extinguisher.
- 2 litre Novec extinguishing agent.

014773BXLN2



014773BXL24 ■ ■

- Ultra-light FIA approved extinguisher.
- 2.4 litre AFFF extinguishing agent.
- 3.9 litre stainless steel cylinder (h 345 mm diameter 130).

014773BXL24



014773BSS2 ■ ■

- Hand-held extinguisher 2.0 kg EN3 compliant powder.
- Complete with 2 brackets.
- Ultra-light FIA approved extinguisher.

014773BSS2



FEATURES: Passage adhering to the body shell wherever possible. Accurate manufacturing. Specific boxed reinforcements. Made with certified material. Front suspension fixing points on some models.

- **1A** Multipoint welded-in, 25CrMo4 with front suspension fixing points.
- **1B** Multipoint welded-in, Fe45 with front suspension fixing points.
- **2A** Multipoint built-in, 25CrMo4 with front suspension fixing points.
- **2B** Multipoint built-in, Fe45 with front suspension fixing points.
- **3A** 25CrMo4 roll cage without front suspension fixing points.
- **3B** Fe45 roll cage without front suspension fixing points.
- **3C** Weld-in roll cage without front suspension point..
- **4** Roll cages with door bars Fe 45.

FOR THE COMPLETE APPLICATION LIST PLEASE CHECK PRICE LIST.

● **1A - 1B**

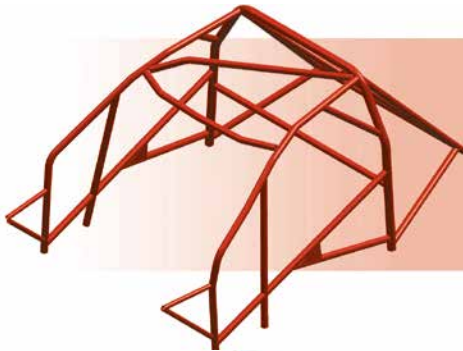

● **2A - 2B**

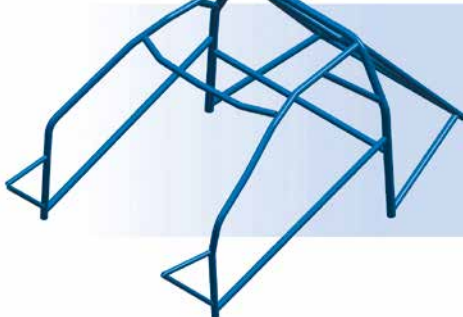

● **3A - 3B - 3C**

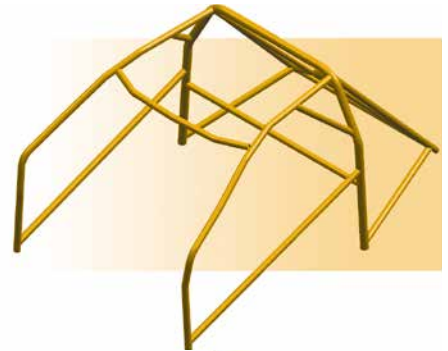

● **4**

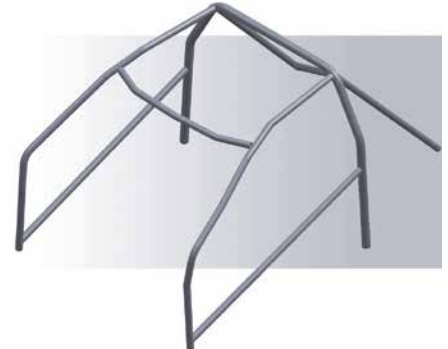

RACING START ADAPTATION KIT

00780KS

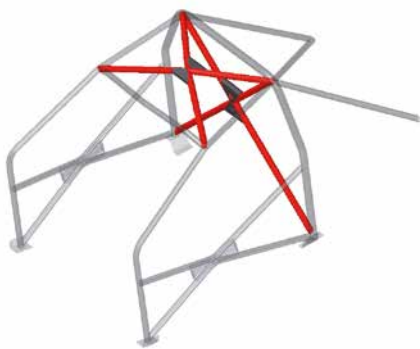

Racing start kit is proposed to upgrade the existing Appendix J roll cages. This kit is composed of 6 tubes to build up the cross reinforcement for the roof and the main roll bar, complete with reinforcement gussets.

DOOR BARS KIT

00797

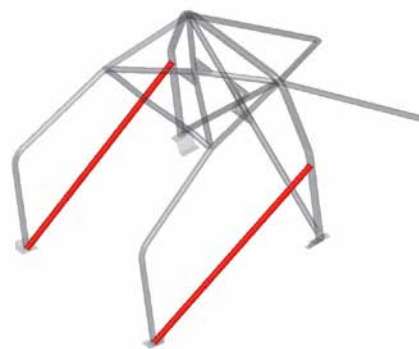

Universal kit composed of 2x door bars (diam. 40x2 mm) with 2x welded plugs on one side, 4x M 10 screws, 4x M10 self-locking bolts, 4x forks, 2x plugs.



ROLL BAR PADDINGS



As from 01.01.2003 FIA-approved padding has become compulsory in all types of races and cars, Sparco supplies a material certified in accordance with FIA regulation 8857-2001, in different choices of length and diameter. The paddings are fitted to the roll cages in all possible points of contact with driver with harnesses fastened.



MANUFACTURER: SPARCO
MODEL: FIA PADDING
HOM. NO: CP.0003-03-A
FIA STANDARD: 8857-2001

0076050

Ø 50 mm - 500 mm - 122 g - Set 2 pcs



MANUFACTURER: SPARCO
MODEL: FIA PADDING
HOM. NO: CP.0003-03-A
FIA STANDARD: 8857-2001

0076045

Ø 45 mm - 500 mm - 131 g - Set 2 pcs



MANUFACTURER: SPARCO
MODEL: FIA PADDING
HOM. NO: CP.0003-03-A
FIA STANDARD: 8857-2001

0076040

Ø 40 mm - 500 mm - 129 g - Set 2 pcs



MANUFACTURER: SPARCO
MODEL: FIA PADDING
HOM. NO: CP.0003-03-A
FIA STANDARD: 8857-2001

0076035

Ø 35 mm - 500 mm - 135 g - Set 2 pcs

ROLL CAGE FORK



0078130S

Ø 40 mm **0078140S**
Ø 50 mm **0078150S**

Fork for tubes' assembly, using plug + fork system (tube diameter 40 mm) (tube diameter 50 mm).

ROLL CAGE PLUGS



00780M

Pair of perforated sleeves (diameter 45 mm) for tubes' assembly.

REINFORCEMENT PLATES + COUNTERPLATES FIA 2010 UPDATING KIT



00780P

Kit composed of 4x perforated plates + 4x flat counterplates (3 mm thick). These plates must be adapted in accordance to the different configurations of roll cages or body shells and allow to update the roll cage fixing in accordance with 2010 FIA regulation.

UNIVERSAL GUSSET KIT FOR ROOF



00798SP1

Kit composed of 2x universal reinforcement gussets to be mounted on the tubes' cross joint (dimensions 190x85 mm). This is a universal kit so it's could be necessary for the user to adapt it to his own roll cage.

UNIVERSAL GUSSET KIT FOR DOORBAR CROSS



00798SP2

Kit composed of 4x universal reinforcement gussets to be mounted on the tubes' cross joint (dimensions 100x170 mm). This is a universal kit so it's could be necessary for the user to adapt it to his own roll cage.

ROLL CAGE PLUG



00782NTS

Forged plug for tubes' assembly, using plug + fork system.

PEDAL SETS

03779AN



3 piece set in embossed anodised aluminium, complete with brackets, bolts and screws.

DRIVER FOOTRESTS

03780AN



Embossed anodised aluminium, with brackets, bolts and screws.

PEDAL SETS

03783L



3-piece set in pre-bent and shaped mixed carbon. Brake and clutch with non-slip inserts.

DRIVER FOOTRESTS

03788BRI
(until stock last)



Footrest collapsible in the event of a crash. Embossed anodised aluminium.

KIT OF 8 STICKERS



ASPA002

BONNET PINS

Pair of stainless steel bonnet pins with captive slide pin.



01606S

01606AA

01606AR

01608

FUEL CAPS

270040A



With key.

270050A



Without key.

HAMMERS

01615



01613



Hammer with seatbelt cutter built-in.

AERO FUEL CAP

27009G



BATTERY MASTER SWITCH

01337



Battery master switch with rotating lever. Instant disconnection of all electric circuits. Provision for remote control. Complies with FIA spec. Suitable for 6, 12 and 24V systems, rated at 100A continuous.

01336



Bipolar master battery cutout switch with rotating lever. Instant disconnection of master electric circuit. Provision for remote control. Suitable for 6, 12 and 24V systems, rated at 100A continuous.

TYRE WARMERS

For the application list please check price list.



- 2980SPNR
- 2980SPRS
- 2980SPAZ

PIT SIGNAL BOARD

Pit signal kit.
00594

Cover.
00594C

Number sets.
00592/1

Pit board.
00594T



4row reflection-proof black aluminium frame.

RACING NETS

FIA 8863-2013 APPROVED WINDOW NET SPECIFICALLY FOR TRACK USE

Seat side fixing with 1" belts and 2 bar adjusters for fixing to rollbar.

Dashboard side fixing with optional double use:

- Quick release fixing with 1" strap.
- Quick release fixing 2" strap and spring-operated adjuster for better net tension.

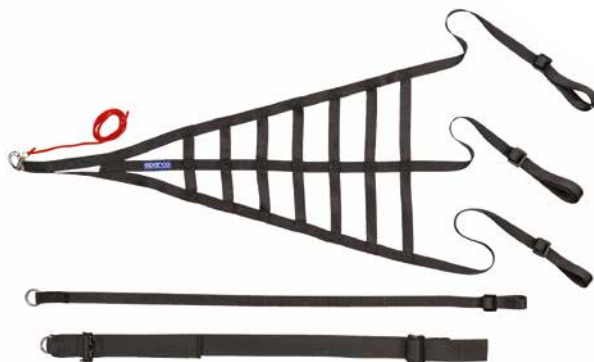

002193NR



Seat side fixing with 1" belts and 2 bar adjusters for fixing to rollbar.

Dashboard side fixing with optional double use:

- Quick release fixing with 1" strap.
- Quick release fixing 2" strap and spring-operated adjuster for better net tension.
- Pelican hook system that allows the pre-tensioning of the net as prescribed by the FIA standard.

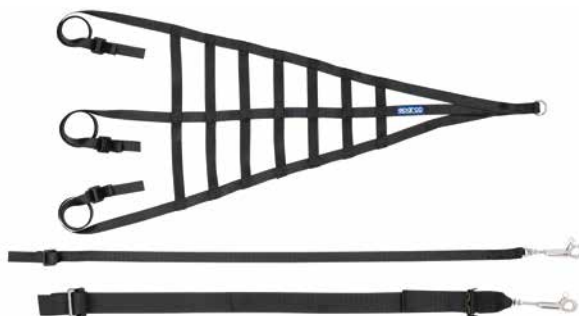

002194NR



WINDOW NETS

In compliance with FIA annex J 253.

Dimensions: L. 50 cm, H. 52 cm.

Tape for quick fastening to roll bar.

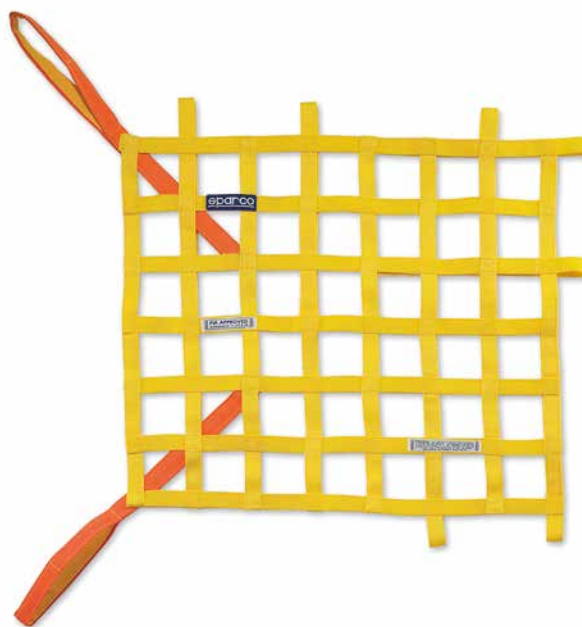

- 002192FA-R
- 002192FA-G
- 002192FA-BM

ANALOG PRESSURE GAUGE

∅ 63 mm

Scale 0-4 bar, aluminium handle, rubber cap, high-precision recording.



2941063A

∅ 100 mm



29410100A

DIGITAL PRESSURE GAUGE

∅ 63 mm

Scale 0-4 bar, aluminium handle, rubber cap, high-precision recording.

VAT not included



2941063D

CIRCUIT/RALLY STOP-WATCH



29424103

MAPLIGHTS

Led Reading lamp, length 49 cm, flexible tube, 12V.



01628

ROAD BOOK



03725

RACERS TAPE



0169550

Transparent, scratchproof adhesive tape. Roll 50 mm wide x50 m.

01691

All-purpose heavy duty racer tape. Roll 50 mm wide x50 metres. 7 different colours.

01692

Aluminised tape. Roll 50 mm wide x50 m.

Universal spare wheel fastening with high-strength tape, complete with locking ratchet, 3 eyebolts and 3 fixing plates.

Cross spannerfastening with retainer springs and anti-vibration rubber.

03773



03776



STEEL TOWBARS FIA

50 mm

FIA annex J 253 compliant.



01627RS50

80 mm

FIA annex J 253 compliant.



01627RS80

TOW STRAP FIA

FIA annex J 253 compliant.



01637RS

TOW STRAP (NOT FIA APPROVED)

Hole diameter: 15 mm.



● **01638NR**



● **01638AZ**



● **01638ARF**



● **01638AGF**



babyRace

babyRace

504

sparco

babyRace
DRIVER ACADEMY

sparco®

**WSK
TEAM BABY RACE**





KARTING

GSUITS

KARTING

SUITSK

GSUITS

KARTING

GSUITS



P. Ippolito - CRG Team Karting Driver

KARTING SUITS

PRIME-K NEW

HOMOLOGATION:

CIK-FIA 2013-1

SIZES: 44-62

CUSTOMIZATION:

ON DEMAND



002308NBGF..

002308NBRS..

002308EBNR..

002308NARS..

PRIME-K YOUTH NEW

HOMOLOGATION:

CIK-FIA 2013-1

SIZES: 120-150

CUSTOMIZATION:

ON DEMAND



002308NBGF..

002308NBRS..

002308EBNR..

002308NARS..

X-LIGHT NEW

HOMOLOGATION:

CIK-FIA 2013-1

SIZES: 44-62

CUSTOMIZATION:

CUSTOM EASY

ON DEMAND



002309BGFN..

002309NRBI..

002309NGGF..

002309NBRN..

X-LIGHT YOUTH NEW

HOMOLOGATION:

CIK-FIA 2013-1

SIZES: 120-150

CUSTOMIZATION:

ON DEMAND



002309BGFN..

002309NRBI..

002309NGGF..

002309NBRN..

KERB

HOMOLOGATION:

CIK-FIA 2013-1

SIZES: XS-XXL

CUSTOMIZATION:

BY STOCK



002341RNBO..

002341BNGB..

002341BNBV..

002341GNBG..

002341NBAF..

002341NBRN..

KERB YOUTH

HOMOLOGATION:

CIK-FIA 2013-1

SIZES: 120-150

CUSTOMIZATION:

BY STOCK



002341RNBO..

002341BNGB..

002341BNBV..

002341GNBG..

002341NBAF..

002341NBRN..

KERB LADY

HOMOLOGATION:
CIK-FIA 2013-1
SIZES: XS-XXL
CUSTOMIZATION:
BY STOCK



002341LNRBF..

002341LNRGF..

KERB GIRL

HOMOLOGATION:
CIK-FIA 2013-1
SIZES: 120-150
CUSTOMIZATION:
BY STOCK



002341LNRBF..

002341LNRGF..

THUNDER

HOMOLOGATION:
CIK-FIA 2013-1
SIZES: XS-XXL
CUSTOMIZATION:
BY STOCK



002342RSNR..

002342BSRS..

002342GSGF..

002342NRAF..

002342NRRS..

002342NRAZ..

THUNDER YOUTH

HOMOLOGATION:
CIK-FIA 2013-1
SIZES: 120-150
CUSTOMIZATION:
BY STOCK



002342RSNR..

002342BSRS..

002342GSGF..

002342NRAF..

002342NRRS..

002342NRAZ..

ROOKIE

HOMOLOGATION:
NOT HOMOLOGATED
SIZES: XS-XXL
CUSTOMIZATION:
NOT CUSTOMIZABLE



002343NRGF..

002343NREB..

002343NRRS..

ROOKIE YOUTH

HOMOLOGATION:
NOT HOMOLOGATED
SIZES: 120-150
CUSTOMIZATION:
NOT CUSTOMIZABLE



002343NRRS..



PRIME K

NEW

HOMOLOGATION: CIK-FIA N2013.1 CE
SIZES: 44-62 **YOUTH SIZES:** 120-150
CUSTOMIZATION: FULLY PRINTABLE



APPROVED

MANUFACTURER: SPARCO
MODEL: K45
HOM. NO: CIK-FIA 2013/055
FIA STANDARD: N 2013-1

IG[®]

227

HIGHLIGHTS



Anti-abrasion Cordura®
back protection.



Elasticated perforated
back panel.



Fully printed, light and
resistant fabric.



002308NBGF..



002308NBR..



002308EBNR..



002308NARS..



X-LIGHT K

NEW

HOMOLOGATION: CIK-FIA N2013.1 CE
SIZES: 44-62 **YOUTH SIZES:** 120-150
CUSTOMIZATION: CUSTOM EASY - ON DEMAND



APPROVED

MANUFACTURER: SPARCO
MODEL: K45
HOM. NO: CIK-FIA 2013/055
FIA STANDARD: N 2013-1

IG[®]

229

HIGHLIGHTS



Hybrid construction with fully printed inserts.



Elasticated anti abrasion back panel.



Ergonomic impact-absorbing padding (on the outside elbow and inside knee).



002309BGFN..



002309NRBI..



002309NGGF..



002309NBRS..



HOMOLOGATION: CIK-FIA N2013.1 CE

MAN SIZES: XS-XXL **WOMAN SIZES:** XXS-L **YOUTH SIZES:** 120-150

CUSTOMIZATION: BY STOCK

HIGHLIGHTS



Breathable inserts on inside leg and underarm.



Elasticated back panel.



New waist adjustment using straps.



002341RNBO..



002341BNGB..



002341BNBV..



002341GNBG..



002341NBAF..



002341NBRS..

KERB LADY



002341LNRBF..

002341LNRGF..



THUNDER



APPROVED

MANUFACTURER: SPARCO
MODEL: K43 THUNDER
HOM. NO: CIK-FIA 2013/046
FIA STANDARD: N 2013-1

HOMOLOGATION: CIK-FIA N2013.1 CE
SIZES: XS-XXL **YOUTH SIZES:** 120-150
CUSTOMIZATION: BY STOCK

HIGHLIGHTS



Low collar.



Elasticated back panel.



Breathable inserts
on inside leg
and underarm.



002342RSNR..



002342GSGF..



002342NRAF..



002342NRRS..



002342NRAZ..



002342BSRS..



ROOKIE

HOMOLOGATION: NOT HOMOLOGATED

SIZES: XS-XXL

YOUTH SIZES: 120-150 (NRRS ONLY)

HIGHLIGHTS



Under arm elastic insert.



Rear elastic band.



Hidden hip pockets.



002343NRGF..



002343NRRS..

002343NREB..

T-1 EVO

WATERPROOF SUIT

236

SIZES: XS-XXL YOUTH SIZES: 120-150

HIGHLIGHTS

- 100% thermoplastic polyurethane (TPU).
- Double slider zip.
- Elastic waistband.



Elastic cuff bands.



Light cover flap with velcro.



00239T1E..

RAIN CLOAK

WATERPROOF

SIZES: S-M / L-XL YOUTH SIZES: 130

HIGHLIGHTS

- 100% thermoplastic polyurethane (TPU).
- Hood with visor with cord and cord stopper.
- Water resistant.



Front button closure.



Pockets with flap.



002393..

K-CARBON

UNDERWEAR

SIZES: XXS - XS/S - M/L - XL

MATERIAL: 80% POLYPROPYLENE - 12% POLYAMIDE - 4% ELASTANE - 4% CARBON

HIGHLIGHTS



Flat seams thanks to the use of the extra thin thread.



X-COOL treatment.



* Ergonomics fibres.



002202NREB...



002202BI...

NEW

**THE ENDLESS CARBON FABRIC THREAD
CREATES AN ANTI-STATIC EFFECT.**



002203NREB...



002203BI...

NEW

* The combination of these fibres promotes ergonomics, softness and comfort, hygroscopicity, breathability, body heat regulation, heat insulation, waterproofing, anti-static and bacteriostatic properties.

B-ROOKIE

UNDERWEAR **NEW**

SIZES: S-XXL

MATERIAL: 100% COTTON

- 160 Gsm.
- Low neck.



002204NR



002204AZ



002204RS



002204GF



002204BI

B-ROOKIE BALACLAVA

COMPOSITION: 100% cotton

- Extra flat seams.



002201NR



002201AZ



002201RS



002201GF



002201BI

BASIC BALACLAVA

- Extra flat seams.
- Single eye opening.

■ 002231N

□ 002231B



X-COOL RECHARGE

The X-COOL refill extends the refreshing treatment on suit and underwear. The application can be done by machine wash.



001157RECHARGE

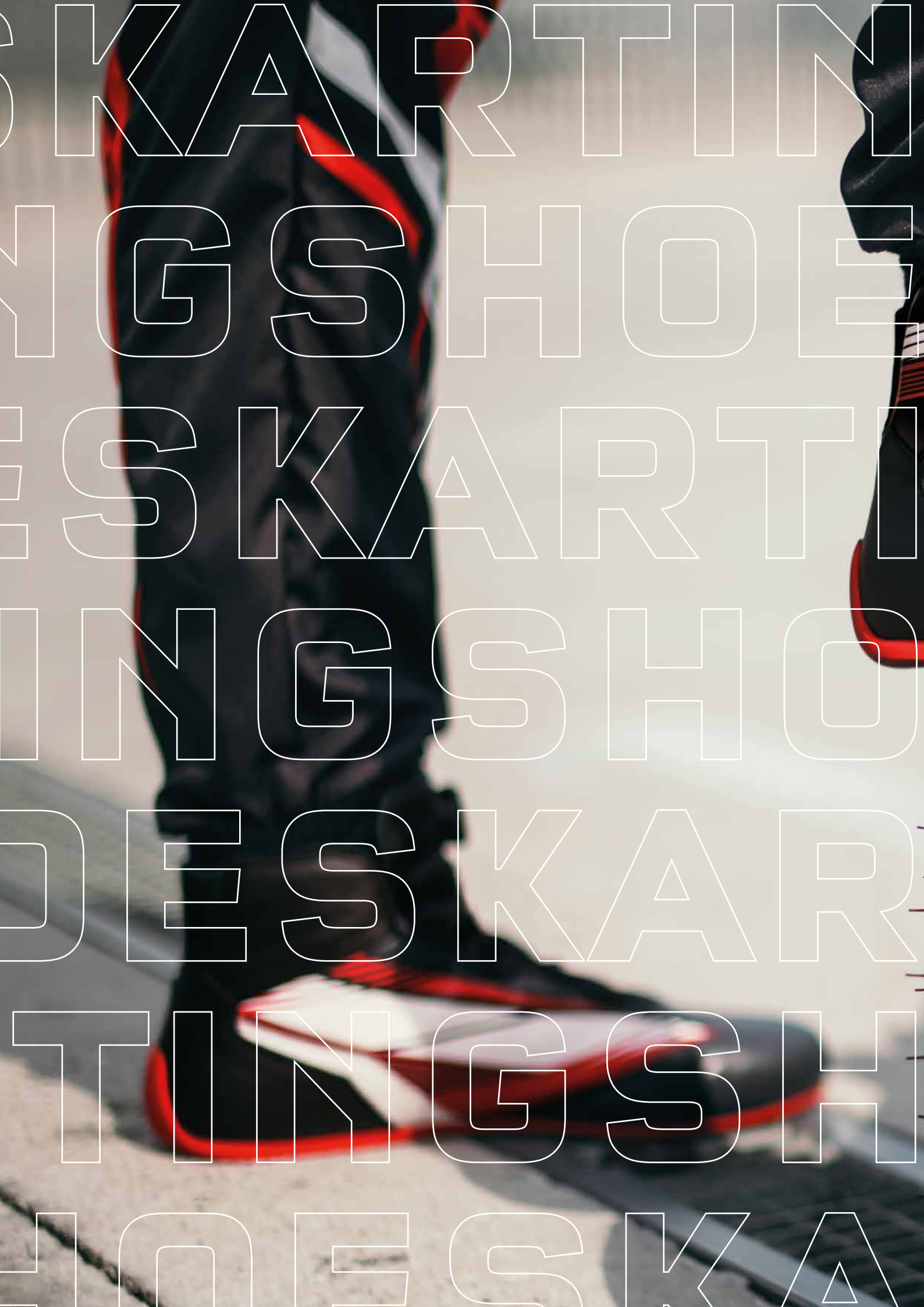

SKARTTIN

NGSHOE

ESKARTTI

INGSHO

DESKAR

TINGSH

DESKA



K-FORMULA INFINITY NEW

MATERIAL: TUMBLED LEATHER + MICROFIBER **SOLE:** THIN RACING RUBBER
SIZES: 32-34-36 ON DEMAND / 37-48 ON STOCK **CUSTOMIZATION:** ON DEMAND / INFINITY



001299..NRRS

K-FORMULA NEW

MATERIAL: TUMBLED LEATHER + MICROFIBER **SOLE:** THIN RACING RUBBER
SIZES: 32-34-36 ON DEMAND / 37-48 ON STOCK **CUSTOMIZATION:** ON DEMAND



001298..AZGF



001298..NRBI



001298..NRGF

K-SKID

MATERIAL: TUMBLED LEATHER + PU LEATHER **SOLE:** NATURAL RUBBER
SIZES: 35-48 **CUSTOMIZATION:** ON DEMAND



001277..NRAF



001277..BMBI



001277..RSNR



001277..NRNR

K-RUN

MATERIAL: MESH 3D + MICROFIBER **SOLE:** NATURAL RUBBER
SIZES: 35-48 **CUSTOMIZATION:** BY STOCK



001271..AZRS



001271..NRAF



001271..AZVF



001271..NRGF



001271..RSBI



001271..NRBI

K-RUN YOUTH

MATERIAL: MESH 3D + MICROFIBER **SOLE:** NATURAL RUBBER
SIZES: 26-28-30-32-34 **CUSTOMIZATION:** BY STOCK



001271..AZRS



001271..NRAF



001271..AZVF



001271..NRGF



001271..RSBI



001271..NRBI

K-POLE

MATERIAL: MICROFIBER

SOLE: NATURAL RUBBER **SIZES:** 35-48



001269..NRGF



001269..RSBI



001269..NRAF



001269..NRAZ



001269..BMBI



001269..NRNR

K-POLE YOUTH

MATERIAL: MICROFIBER

SOLE: NATURAL RUBBER **SIZES:** 26-28-30-32-34



001269..NRGF



001269..RSBI



001269..NRAF



001269..NRAZ



001269..BMBI



001269..NRNR

K-POLE WP

MATERIAL: MICROFIBER

SOLE: NATURAL RUBBER **SIZES:** 35-48



001269WP..NRNR

K-POLE WP YOUTH

MATERIAL: MICROFIBER

SOLE: NATURAL RUBBER **SIZES:** 26-28-30-32-34



001269WP..NRNR

K-FORMULA INFINITY

NEW

SIZES: 32-34-36 ON DEMAND / 37-48 ON STOCK
CUSTOMIZATION: ON DEMAND / INFINITY

HIGHLIGHTS

- Lightweight breathable lining.
- Direct print on microfiber.
- Comfort insole.
- Thin rubber racing sole.
- Customizable on demand.



Closing system with cables and rotor to speed up shoes opening and closing.



Elastic back insert.



001299..NRRS

K-FORMULA

NEW

SIZES: 32-34-36 ON DEMAND / 37-48 ON STOCK
CUSTOMIZATION: ON DEMAND

HIGHLIGHTS

- Lightweight breathable lining.
- Silkscreen prints.
- Comfort insole.
- Thin rubber racing sole.
- Customizable on demand.



Closing system with cables and rotor to speed up shoes opening and closing.



Elastic back insert.



001298..AZGF



001298..NRBI



001298..NRGF

SIZES: 35-48

CUSTOMIZATION: ON DEMAND

HIGHLIGHTS

- Light and breathable lining.
- Overlap tongue integrated with side.
- Silkscreen printed tumbled calfskin uppers.
- Perforations for maximum breathability.
- Ultra resistant Kevlar loops.
- Comfortable insole.
- Natural rubber sole with differentiated grip texture.



Elasticated rear insert.



High abrasion-resistant leather inserts.



001277..BMBI



001277..NRAF



001277..RSNR



001277..NRNR

K-RUN

SIZES: 35-48 **YOUTH SIZES:** 26-28-30-32-34
CUSTOMIZATION: BY STOCK

HIGHLIGHTS

- External lacing with strap.
- Ultra-breathable 3D mesh uppers.
- Thin round laces.
- Internal lateral reinforcement insert.
- Anatomical insole.
- Natural rubber sole with differentiated grip texture.



Silkscreen printed microfiber uppers with matt finish.



Printed anti-abrasion insert on heel.



001271..AZRS



001271..NRAF



001271..AZVF



001271..NRGF



001271..RSBI



001271..NRGR

HIGHLIGHTS

- External lacing with adjustment.
- Thin flat laces.
- Anatomical insole.
- Internal lateral reinforcement insert.
- Natural rubber sole with differentiated grip texture.



Silkscreen printed microfiber uppers with matt finish.



Reinforced heel insert.



001269..NRGF



001269..RSBI



001269..NRAF



001269..NRAZ



001269..BMBI



001269..NRNR

K-POLE

WATERPROOF

SIZES: 35-48 YOUTH SIZES: 26-28-30-32-34

HIGHLIGHTS

- Evolution of the k-pole shoe in wp version.
- External lacing with adjustment.
- Microfibre uppers with matt finish.
- Closure system with cables and rotor.
- Internal lateral reinforcement insert.
- Anatomical insole.
- Natural rubber sole with differentiated grip texture.



001269WP..NRNR

WATER PROOF

RAIN BOOTS

SIZES: 35-48 YOUTH SIZES: 24-26-28-30-32



002445..NRNR

- Natural rubber sole.
- Neoprene 100% with external coating 80% Nylon + 20% Spandex.

RALLY OVERSHOES

SIZES: S(38,5-40) - M(40-41,5)
L(41,5-43) - XL(43,5-45)



002431..

- Overshoes made of natural rubber, ideal to protect sole on wet or abrasive surfaces.



KARTIN
GLOVES
KARTING
GLOVES
ESKART
GLOVES
ESKART



TIDE-K

PRECURVED: YES **SEAMS:** EXTERNAL **SIZES:** 8-13 **CUSTOMIZATION:** ON DEMAND - BY STOCK



00286..NRAF



00286..NRVF



00286..RSNR



00286..NRNR

ARROW-K

PRECURVED: YES **SEAMS:** EXTERNAL **SIZES:** 7-12 **CUSTOMIZATION:** BY STOCK



002557..NRBI



002557..NRGF



002557..BINR



002557..RSBI



002557..BMBI

ARROW-K INFINITY

CUSTOMIZATION: ON DEMAND



002558..NRRS

RECORD

PRECURVED: YES **SEAMS:** EXTERNAL **SIZES:** 7-13 **CUSTOMIZATION:** BY STOCK



002555..AZRS



002555..NRBI



002555..NRGF



002555..NRRS

RECORD WP

PRECURVED: YES **SEAMS:** EXTERNAL **SIZES:** 4-13 **CUSTOMIZATION:** BY STOCK



002555WP..NR

RUSH

PRECURVED: NOT **SEAMS:** INTERNAL **SIZES:** 4-13 **CUSTOMIZATION:** BY STOCK



002556..BXVF



002556..GRGF



002556..VFNR



002556..RSNR



002556..AZNR



002556..BXNR



002556..GRNR



002556..GRAF

CRW

PRECURVED: NOT **SEAMS:** HEAT-SEALED **SIZES:** XXS-XL



00260NR..

SIZES: 8-13 CUSTOMIZATION: ON DEMAND - BY STOCK

HIGHLIGHTS

- Thumb joined to back.
- Internal wrist stitching.
- Precurved glove.
- Touch-S on index finger and thumb.
- Polyethylene and cotton jersey fabric.

HTX

TECHNOLOGY
PATENTED
ALL RIGHTS RESERVED



HTX 3D Volcano palm with differentiated zones.



Ergonomic seam on thumb.



00286..NRAF



00286..NRVF



00286..RSNR



00286..NRNR

HIGHLIGHTS

- External seams.
- Thumb finger with outer stitching.
- Polyethylene and cotton jersey fabric.
- Precurved glove.



Ultra grip silicone palm.



Touch-S on index finger and thumb.



002557..BINR



002557..RSBI



002557..BMBI



002557..NRGF



002557..NRBI NEW

ARROW-K INFINITY

NEW

SIZES: 7-12 CUSTOMIZATION: FULLY PRINTABLE ON DEMAND

HIGHLIGHTS

- External seams.
- Thumb finger with outer stitching.
- Polyethylene and cotton jersey fabric.
- Precurved glove.



Ultra grip silicone palm.



Touch-S on index finger and thumb.



002558..NRRS

HIGHLIGHTS

- External seams.
- Polyethylene and polyamide jersey fabric.
- Sublimation printed back.
- Reinforced in the carpal area.
- Precurved glove.



PaLm with differentiated silicone printed grip.



Adjustment strap.



002555..AZRS



002555..NRGF



002555..NRRS



002555..NRBI

RECORD WP



002555WP..NR

RUSH

SIZES: 4-13 CUSTOMIZATION: BY STOCK

HIGHLIGHTS

- Sublimation printed back.
- Polyethylene and polyamide jersey fabric.
- Wrist with grip print.
- Ultra breathable fabric in the forks.



Synthetic suede leather palm and silicone print.



Internal seams.



002556..VFNR



002556..BXVF



002556..GRGF



002556..RSNR



002556..AZNR



002556..BXNR



002556..GRNR



002556..GRAF

WP ACCESSORIES

RECORD WATER PROOF GLOVE

258

SIZES: 4-13 CUSTOMIZATION: BY STOCK

HIGHLIGHTS

- External seams.
- Antifreeze fleece lining with rainproof membrane. Pre-curved glove.
- Adjustment strap.
- Wrist with grip print.
- Palm with differentiated silicone printed grip.
- Reinforced in the carpal area.



002555WPNR..

CRW

SIZES: XXS-XL

HIGHLIGHTS

- Neoprene with 80% Nylon, 20% Spandex outer coating. Heat-sealed seams.
- Ergonomic preformed palm with silicone print.



00260NR..



Energy Corse Racing Karts

KARTING ACCESSORIES



WARTING

NG PROT

ECTION

WARTING

NG PROT

ECTION

ADTING



J. Iglesiás. - Karting Driver

KARTING PROTECTION

IQ[®]

K-TRACK PROTECTOR **NEW**



MANUFACTURER: SPARCO
MODEL: K-TRACK
HOM. NO: KBP.006.21-A
FIA STANDARD: 8870-2018

HOMOLOGATION: FIA 8870-2018
SIZES: XXS-L **YOUTH SIZES:** 120-150
SHELL MATERIAL: MULTILAYERED STRUCTURE

HIGHLIGHTS



Customizable with direct printing.



Light and easily adjustable.



Stretch kart fabric lining.



FLEXIBLE AND ERGONOMIC ADAPTS TO THE SHAPE OF THE BODY IN THE DRIVER'S SEAT.



002406K..NRRS



002406K..NRBI



J. Iglésias. - Karting Driver

KARTING PROTECTION

SIZES: XS-XXL

SHELL MATERIAL: CARBON FIBER

264

HIGHLIGHTS



F1-derived ultralight tape.



Adjustable width.



Ultra-strong strap.



002404K..

S.I.TECH

SPARCO IMPACT TECHNOLOGY

Sparco Impact Technology: the new technology made in SPARCO® developed by combining a 4 mm EPDM material with a 6 mm PU foam that provides an incredible performance in terms of anti-vibration and shock absorber. All the energy absorption performances have been verified with an impact attenuation test foreseen by the EN 1621-2 standard with a mass of 2500 g (10 Joule) and a fall height of 50 cm.

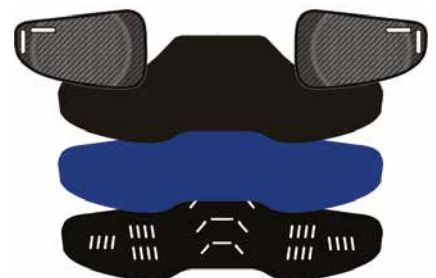

RIB PRO K-7

SIZES: XS-XXL

SHELL MATERIAL: HAND LAMINATED FIBERGLASS

HIGHLIGHTS



F1-derived ultralight tape.



Adjustable width.



Ultra-strong strap.



002403K..
(UNTIL STOCK LAST)

S.I. TECH

SPARCO IMPACT TECHNOLOGY

Sparco Impact Technology: the new technology made in SPARCO® developed by combining a 4 mm EPDM material with a 6 mm PU foam that provides an incredible performance in terms of anti-vibration and shock absorber. All the energy absorption performances have been verified with an impact attenuation test foreseen by the EN 1621-2 standard with a mass of 2500 g (10 Joule) and a fall height of 50 cm.

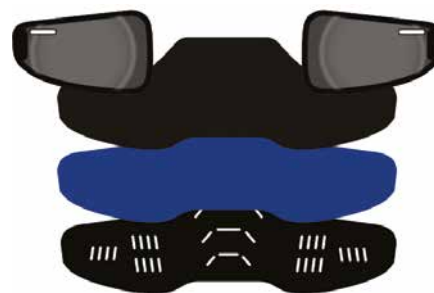

RIB PRO K-4

SIZES: XS-XXL

SHELL MATERIAL: THERMOPLASTIC

HIGHLIGHTS



High-strength tape.



Adjustable width.



Ultra-strong strap.



002405K..

S.I.TECH

SPARCO IMPACT TECHNOLOGY

Sparco Impact Technology: the new technology made in SPARCO® developed by combining a 4 mm EPDM material with a 6 mm PU foam that provides an incredible performance in terms of anti-vibration and shock absorber.

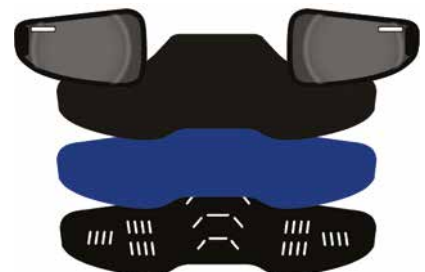

SJ PRO K-3

SIZES: XS-XXL **YOUTH SIZES:** 120-140
EXTERNAL MATERIAL: STRETCH POLYESTER

HIGHLIGHTS



Preformed and ergonomic back padding.



Elastic band.



Front zip closure.



002402K..

This protective jacket has been designed for both outdoor and indoor use, for the non-professional pilot who wants to ensure high shock absorption and anti-vibration performance without sacrificing comfort and lightness. The outer fabric is characterized by a great breathability combined with excellent resistance to abrasion and tearing. It is also breathable and antibacterial to ensure maximum comfort even during the most intense driving sessions. The padding on the back is preformed and the grooves have been specially developed to facilitate the pilot while driving.

The frontal zip closure allows the pilot to wear the jacket quickly.

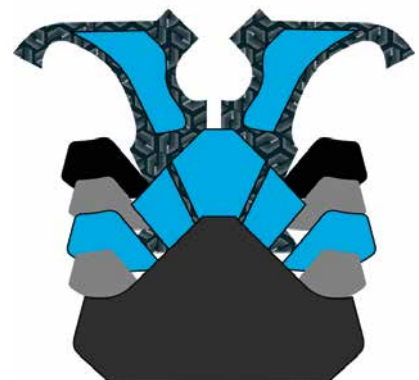



AIR KF-7W

CARBON

HOMOLOGATION: SNELL K 2015

SIZES: SMALL SHELL FROM XS TO M+ - LARGE SHELL FROM L TO XL

HIGHLIGHTS

- Carbon fiber shell reinforced with carbon-kevlar.
- Double size shell and polystyrene with ventilation ducts.
- Removable, adjustable and washable interiors.
- Predisposed for drink system.
- FIA homologated visor with continuous adjustment.



003354..

CARBON		
XS	53-54	0033540XS
S	55-56	0033541S
M	57-58	0033542M
M+	59	0033543ML
L	60	0033544L
XL	61	0033545XL

HOMOLOGATION: SNELL K 2015

SIZES: SMALL SHELL FROM XS TO M+ - LARGE SHELL FROM L TO XXL

HIGHLIGHTS

- Fiberglass shell reinforced with carbon-kevlar layers.
- Double size shell and polystyrene with ventilation ducts.
- Removable, adjustable and washable interiors.
- Predisposed for drink system.
- FIA homologated visor with continuous adjustment.



WHITE		
XS	53-54	0033550XS
S	55-56	0033551S
M	57-58	0033552M
M+	59	0033553ML
L	60	0033554L
XL	61	0033555XL
XXL	62	0033556XXL

MATT BLACK		
XS	53-54	0033550XSNR
S	55-56	0033551SNR
M	57-58	0033552MNR
M+	59	0033553MLNR
L	60	0033554LNR
XL	61	0033555XLNR
XXL	62	0033556XXLNR



003355..



003355..NR



GP KF-4W CMR

HOMOLOGATION: SNELL CMR 2016
SIZES: XS-S-M-L

HIGHLIGHTS

- Fiberglass shell reinforced with carbon-kevlar layers.
- Continuously adjustable visor.
- Shell with ventilation ducts.



WHITE		
XS	53-54	0033580XS
S	55-56	0033581S
M	57-58	0033582M
L	59	0033583L

003358..

K-RING COLLARS **NEW**

- High density foam collar.
- Sternum support.
- Back support for load distribution on the shoulder blades.
- Fast and safe closing with internal magnet and external strap.
- Removable and washable.



001604NRRS
YOUTH
001604NRRS-B

001604NRBI
YOUTH
001604NRBI-B

NECK SUPPORT COLLARS

Until stock last.

Characterized by a special rear anatomic shape and variable density padding (more consistent in the helmet support area and softer under the chin and in the spoiler) in order to reduce the weight of the helmet on the back.



001602AZNR
YOUTH
001602AZNR-B



001602RSNR
YOUTH
001602RSNR-B



001602GRNR
YOUTH
001602GRNR-B



ELBOW PADS



00155EN

KNEE PADS



00154KN

KART COVER

- Outline for the steering wheel, case included.
- Professional, wide to suit any type of kart.



02712R



02712

ADHESIVE PROTECTION FOR SEATS

- Adaptable to any type of seat.
- New density, softer.
- Colour: black.



02798

TIRE BAG

COMPOSITION: 100% polyester

- Light.
- Very resistant.



02702NR



PERFORMANCE

PERFORMANCE

PERFORMANCE

PERFORMANCE

PERFORMANCE

PERFORMANCE

PERFORMANCE



The image shows a close-up of a black Sparco racing seat. The seat is made of a smooth, dark material, likely leather or a high-quality synthetic material, with visible stitching along the edges. The Sparco logo is embossed in the center of the seat's backrest. The logo consists of the word "sparco" in a bold, lowercase, sans-serif font, with a horizontal line underneath the letters. Below the seat, a teal-colored interior insert is visible, which appears to be a gel or foam cushion designed for comfort and support during racing. The background is a plain, light-colored surface.

sparco

PERFORMANCE SEATS/HARNESSES

10[®]

SPX

SHELL MATERIAL: CARBON
LINING: LEATHER / ALCANTARA®



00974ZN

SPR

SHELL MATERIAL: FIBERGLASS
LINING: SKY / MICROFIBER



00906NRNR

QRT PERFORMANCE

SHELL MATERIAL: QRT
LINING: LEATHER / ALCANTARA®



008006RNR

STRADALE

SHELL MATERIAL: QRT
LINING: SKY



009101RNR

STRADALE PERFORMANCE

SHELL MATERIAL: QRT
LINING: LEATHER / ALCANTARA®



009102RNR

GT

SHELL MATERIAL: TUBULAR FRAME
LINING: SKY / MICROFIBER



009012NR

R333

SHELL MATERIAL: TUBULAR FRAME
LINING: FABRIC



009011NRRS



009011NRGR



009011NR

R100+ NEW

SHELL MATERIAL: TUBULAR FRAME
LINING: FABRIC



009016ANR



009016NRNR



009016NRRS

R100 MY 2022 NEW**SHELL MATERIAL:** TUBULAR FRAME**LINING:** FABRIC

009014NRRS



009014NRGR



009014NRAZ



009014NRNR

R100 SKY MY 2022 NEW**SHELL MATERIAL:** TUBULAR FRAME**LINING:** SKY

009014NR5KY

HARNESSES INDEX

04604BM1 ■ ■**ANCHORAGE POINT:** 4 POINTS**TYPE:** CLUBMAN / STRADALE**FIXING:** SNAP ON

04604BM1RS



04604BM1AZ



04604BM1NR

04608DF1 ■ ■**ANCHORAGE POINT:** 3 POINTS**TYPE:** CLUBMAN**FIXING:** SNAP ON

04608DF1RS



04608DF1AZ



04608DF1NR

04604BV1 ■ ■**ANCHORAGE POINT:** 4 POINTS**TYPE:** CLUBMAN / STRADALE**FIXING:** BOLT ON

04604BV1RS



04604BV1AZ



04604BV1NR

04608BV1 ■ ■**ANCHORAGE POINT:** 3 POINTS**TYPE:** CLUBMAN**FIXING:** BOLT ON

04608BV1RS



04608BV1AZ



04608BV1NR

**SEAT HANDCRAFTED IN ITALY
AVAILABLE IN 2 VERSIONS, DRIVER AND PASSENGER**

HIGHLIGHTS

- Hand sewn.
- Backrest with knob for millimetric adjustment.



Reclining carbon fiber seat that meets the same specifications as those imposed on OEMs.



Leather and Alcantara® upholstery.



00974ZNR5X



00974ZNRDX

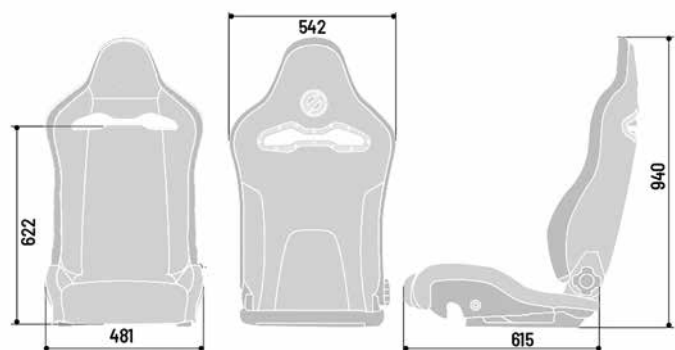

HIGHLIGHTS

- 271x345 mm lower fastening.
- Base set for belt branch mount (7/16" thread).



OEM derived recliner.



Fibreglass frames.



00906NRNR

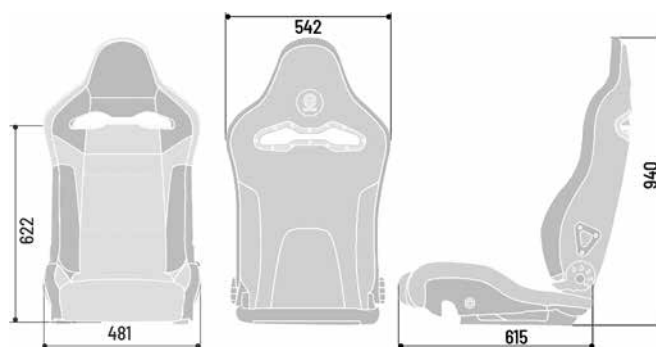

HIGHLIGHTS



Made with QRT technology.



Leather and Alcantara® upholstery.



0049616QRT



008006RNR

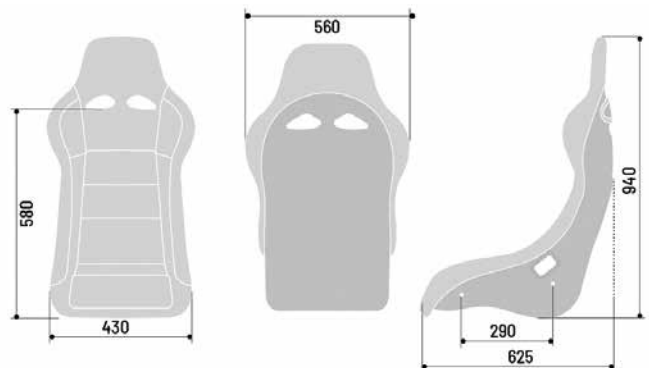

STRADALE

STREET USE QRT SEAT

HIGHLIGHTS



Seat without headrest for old school applications.



SKY upholstery.
Leather and Alcantara® upholstery Performance version.



Lateral fixings 290 mm apart.



009101RNR

STRADALE PERFORMANCE



009102RNR

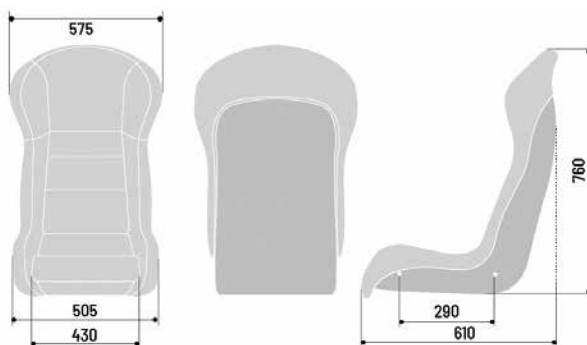

HIGHLIGHTS

- 271x345 mm lower fastening.
- Steel tubular frame.



Adjustable headrest.



Tilt lever and back adjustment on both sides.



009012NR

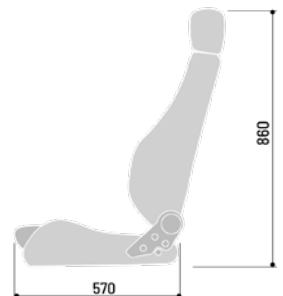

R333

COMPATIBLE WITH 3 AND 4 POINT SPORTS SEAT BELTS

HIGHLIGHTS

- 271x345 mm lower fastening.
- Tubular frame.



Modern design and ergonomic sitting.



Double adjustment lever and rapid tilting.



● 009011NRRS

● 009011NRGR

● 009011NR

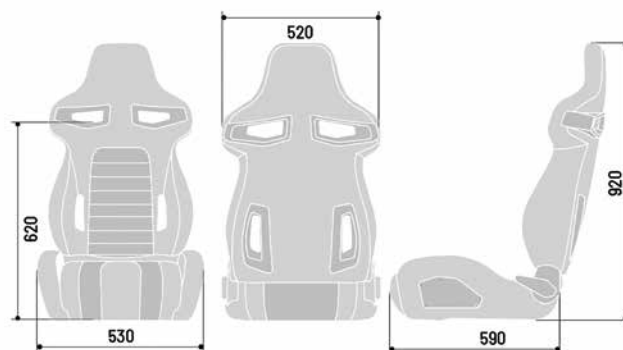

R100+

SKY AND MICROFIBER **NEW**

284 NEW PERFORMANCE SEAT WITH TUBULAR FRAME

HIGHLIGHTS

- Compatible with belts to 4 points.
- Double adjustment lever and rapid tilting.
- Reclining.



High ergonomics.



Sky and microfiber upholstery.



009016ANR

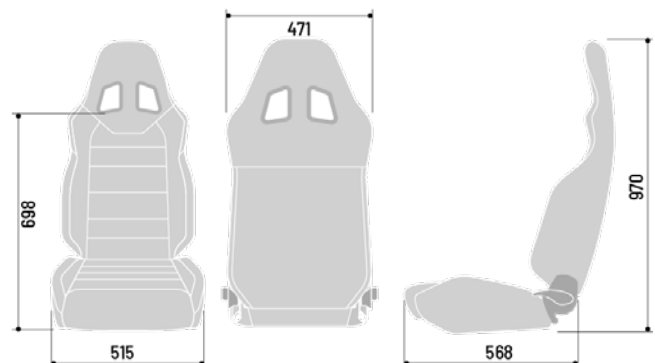

R100+

SKY **NEW**

NEW PERFORMANCE SEAT WITH TUBULAR FRAME

HIGHLIGHTS

- Compatible with belts to 4 points.
- Double adjustment lever and rapid tilting.
- Reclining.



High ergonomics.



Sky upholstery with red contrast or tone on tone black stitchings.



● 009016NRRS ● 009016NRNR

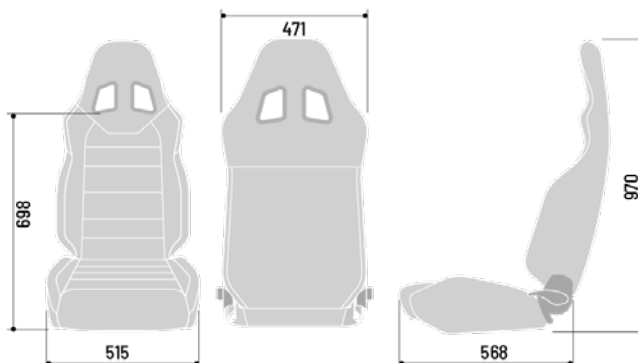

HIGHLIGHTS

- Tubular frame.
- 3D fabric upholstery.
- Double adjustment lever and rapid tilting.
- 271x345 mm lower fastening.



Improved ergonomic:
greater lumbar comfort
and lowered sitting.



● 009014NRAZ ● 009014NRGR ● 009014NRNR ● 009014NRRS

R100 (UNTIL STOCK LAST)

● 00961NRAZ ● 00961NRGR ● 00961NRNR ● 00961NRRS

R100 SKY

MY 2022 **NEW**

COMPATIBLE WITH 3 AND 4 POINT SPORTS SEAT BELTS

HIGHLIGHTS

- Tubular frame.
- SKY upholstery.
- Double adjustment lever and rapid tilting.
- 271x345 mm lower fastening.



Improved ergonomic:
greater lumbar comfort
and lowered sitting.

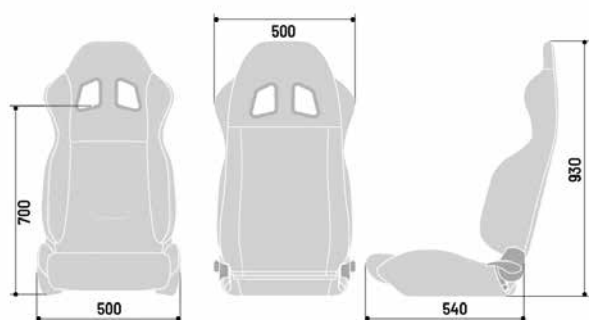

● 009014NRSKY

R100 (UNTIL STOCK LAST)

● 00961NRSKY

SLIDE RUNNERS KR NEW



0049306

Longitudinal distance 271 mm.

UNIVERSAL FITTING KIT

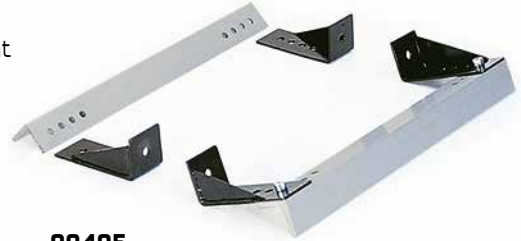

00495

With 4 brackets with height adjustment, 2 reinforced aluminium corner pieces and the necessary screws and nuts.

SET OF SLIDE RUNNERS

0049302



00493

Longitudinal distance 271 mm.

TILT FORWARD BRACKET



00494

To be fitted between slides and subframes to allow easy access to the rear seats also on cars with front seats with fixed backrest.

ADAPTOR



00497RACE

For racing seats on seat rails.

*For the complete application List see the price list.

UNIVERSAL SUBFRAME



00491

With mechanism to adjust the height of the seat, for cars with removable slides from the original seat with distance between slides up to 430 mm.

MUD FLAPS



- **03791RS**
- **03791BI**
- **03791AZ**
- **03791NR**

Curved polyethylene mud guards kit thickness 1,5 mm.
Not FIA compliant.

EXTINGUISHER

HAND HELD

Ultra-light extinguisher.
2.0 litre AFFF extinguishing agent.
Stainless steel cylinder complete with frame and clamp.



014775BXL2

GT

Thin microfiber pads.



01090R3RS



01090R3AZ



01090R3NR

MINI

Pair of pads in Microfiber with high grip neoprene inner layer.

- Useful to improve comfort of driving when fitted on steering wheels or handbrake handle.



01099RS



01099AZ



01099NR

TOW STRAPS 

High resistance steel hook.

- Hole diameter: 15 mm.
- Fixed tape.



01638NR



01638AZ



01638ARF



01638AGF

04604BM1

HOMOLOGATION: ECE

HIGHLIGHTS

- 4 fixing points, snap on.
- Lap reinforcement.



● 04604BM1RS



● 04604BM1NR



● 04604BM1AZ

04608DF1

HOMOLOGATION: ECE

HIGHLIGHTS

- 3 fixing points.
- Double buckle snap on.
- Lap reinforcement.



● 04608DF1RS



● 04608DF1AZ



● 04608DF1NR

04604BV1

HOMOLOGATION: ECE

HIGHLIGHTS

- 4 fixing point by bolt.
- Lap reinforcement.



● 04604BV1RS



● 04604BV1AZ



● 04604BV1NR

04608BV1

HOMOLOGATION: ECE

HIGHLIGHTS

- 3 fixing points.
- Bolted fixing.



● 04608BV1NR



● 04608BV1AZ



● 04608BV1RS



Kimera Automobili - EV037

PERFORMANCE STEERING WHEELS

10[®]

STEERING WHEELS INDEX

F-10C  **NEW**

DIAMETER (MM): 270



015P271SSN

F-10A  **NEW**

DIAMETER (MM): 270



015PC271SSN

R383 CHAMPION 

DIAMETER (MM): 330



015R83PLUNRS



015R83PLUNNR

CHAMPION 

DIAMETER (MM): 330



015R330CHAMPION

TARGA 350 

DIAMETER (MM): 350



015TARGA350PLNR

L777 

DIAMETER (MM): 350



015L800PL



015L800SC

L550 

DIAMETER (MM): 350



015TTMZS1

L575 

DIAMETER (MM): 350



015L750PL



015L750SC

L505 

DIAMETER (MM): 350



015TL522TUV

L360 

DIAMETER (MM): 330



015TRGL1TUV



015TRGS1TUV

L999 

DIAMETER (MM): 330



015TMG22TUV

P222 

DIAMETER (MM): 345



015THPUGR345



015THPUNR345



F-10C

NEW

296

MATERIAL: SUEDE

HIGHLIGHTS

- Carbon steering wheel for prototype single-seater and sports vehicle.
- Ergonomic grip, designed based on experience gained with the racing teams of the most prestigious motor manufacturers.
- Hole interaxis 3x50.8 mm.

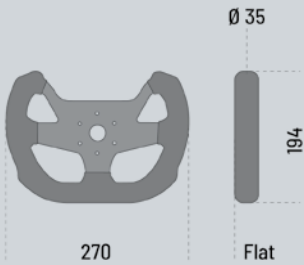

015PC271SSN

F-10A

NEW

MATERIAL: SUEDE

HIGHLIGHTS

- Aluminium steering wheel for prototype single-seater and sports vehicle.
- Ergonomic grip, designed based on experience gained with the racing teams of the most prestigious motor manufacturers.
- Hole interaxis 3x50.8 mm.

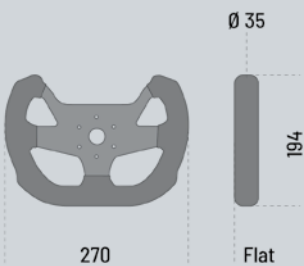

015P271SSN

R383 CHAMPION

MATERIAL: LEATHER

HIGHLIGHTS

- Leather.

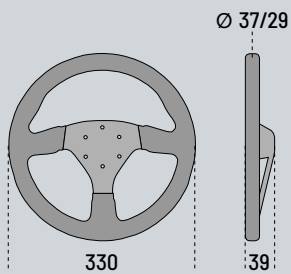

015R383PLUNNR



015R383PLUNRS

CHAMPION

MATERIAL: LEATHER

HIGHLIGHTS

- Leather.

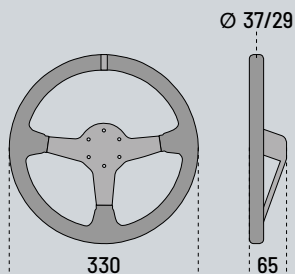

015R330CHAMPION

TARGA 350

298

MATERIAL: LEATHER

HIGHLIGHTS

- Leather.

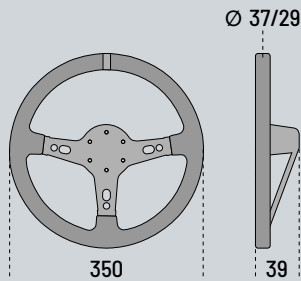

New horn button
colour kit included.

015TARGA350PLNR

L777

MATERIAL: LEATHER / SUEDE

HIGHLIGHTS

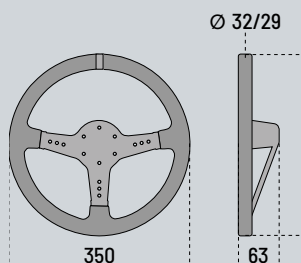

New horn button
colour kit included.

LEATHER

015R345MLN
SUEDE

015R345MSN

L550

MATERIAL: SUEDE

HIGHLIGHTS

- Suede.



New horn button colour kit included.

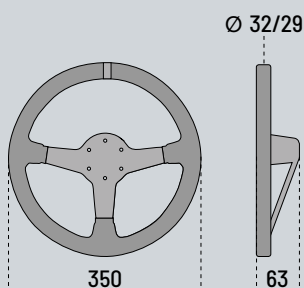

015TMZS1

L575

MATERIAL: LEATHER / SUEDE

HIGHLIGHTS



New horn button colour kit included.

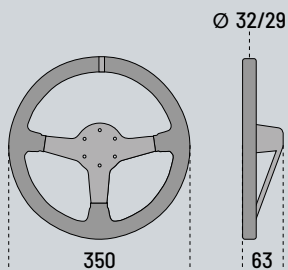

LEATHER



015L750PL

SUEDE



015L750SC

L505

300

MATERIAL: LEATHER

HIGHLIGHTS

- Leather.



New horn button colour kit included.

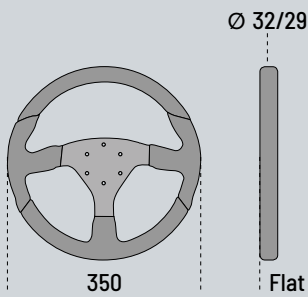

015TL522TUV

L360

MATERIAL: LEATHER / SUEDE

HIGHLIGHTS



New horn button colour kit included.

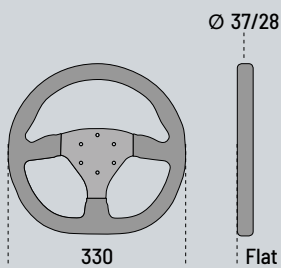

LEATHER

SUEDE



015TRGL1TUV



015TRGS1TUV

L999

MATERIAL: LEATHER / SUEDE

HIGHLIGHTS

- Leather / suede



New horn button colour kit included.

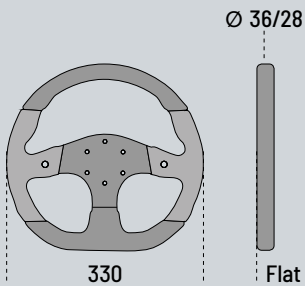

015TMG22TUV

P222

MATERIAL: POLYURETHANE

HIGHLIGHTS

- Polyurethane.



New horn button colour kit included.

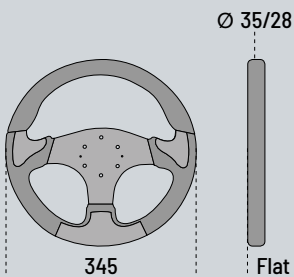

015THPUGR345



015THPUNR345

HUB

FOR THE APPLICATION LIST PLEASE CHECK PRICE LIST.

Sparco collapsible hubs are cast iron made with a steel frame that collapse during impacts. This item absorbs kinetics energy avoiding transfer to the driver. The Sparco steering wheels are TÜV approved only if coupled with the Sparco hubs.



HORN DELETE KIT

0159ZMNR
MATT CARBON

0159ZNR
POLISHED CARBON



QUICK RELEASE

RACING PUSH BUTTONS KIT



015R98TU

015NE981

015NE982



CNC machined with steel spline. Universal fixing system for 3 or 6 fixing point, steering hub, steering column.

Black anodized supports with push buttons.

ANODIZED STEERING WHEEL SPACERS

RING



01595ANR
01595A



01599NR

Anodized aluminium.

PEDAL SETS GEAR KNOBS

PIUMA



03741BN01



03741BT01

SETTANTA



03736AT



03736A0

Lightened grey/black gear knob.

Titan/black two colour gear knob.

CARBON



03783L (NO ECE)

3-piece set in mixed carbon.
Pre-bent and shaped.
Brake and clutch with non-slip inserts.

SETTANTA - OMOLOGAZIONE: ECE

037879IT01



0378790P04



0378790P01



Lightened universal black or silver pedal.

Set of pedals, long accelerator pedal.

sparco®

sparco
www.sparco.com



enèx enèx enèx enèx enèx enèx





sparco
Gaming

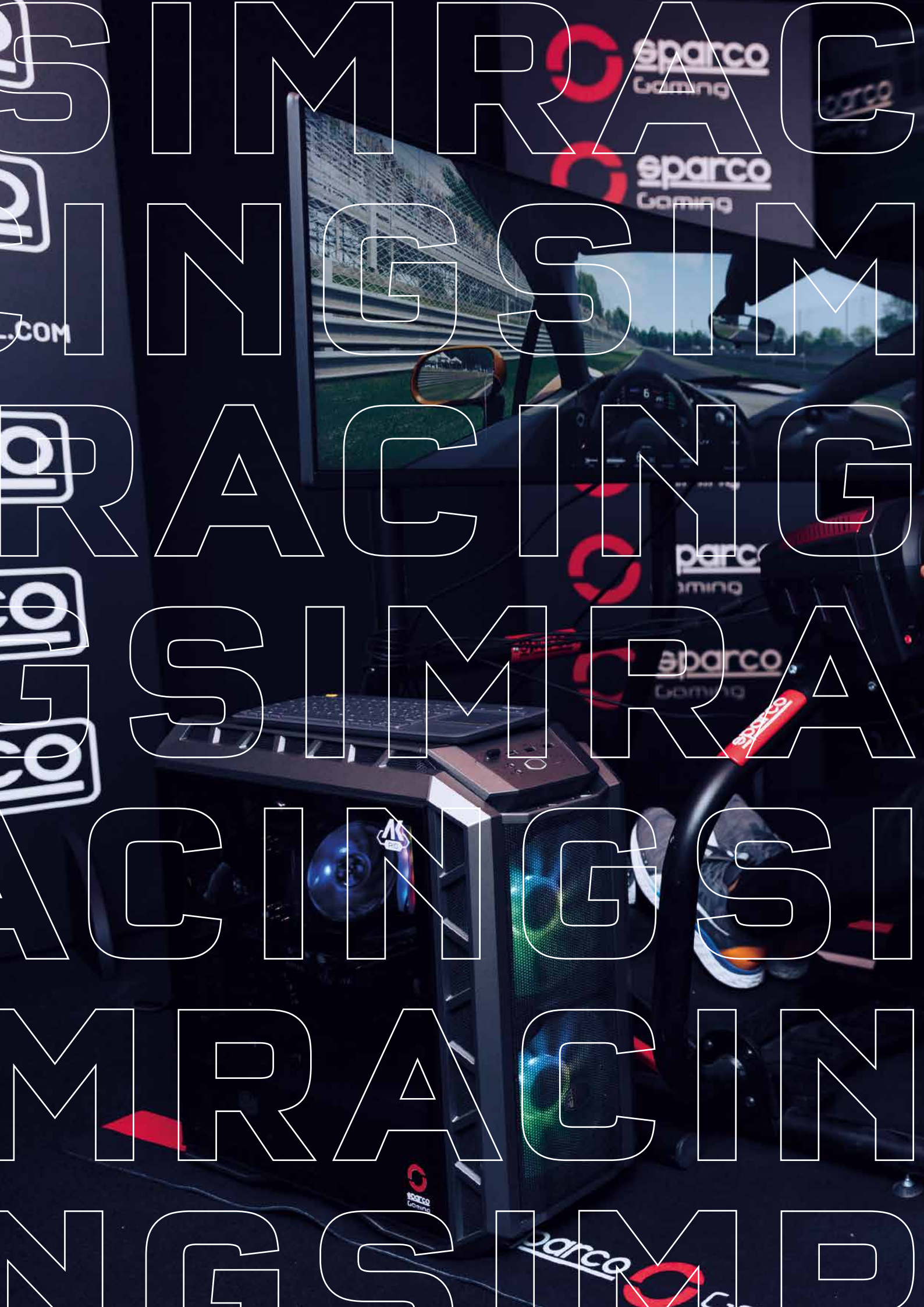

SIMRACING SIMRACING SIMRACING SIMRACING SIMRACING



L. Norris - F1 Driver

SIM RACING

IO®

- Integrated monitor support (from 24" to 49").
- Adjustable steering wheel and pedal support.
- Seat with fibreglass frame and customisable padding.



EVOLVE GP



FORMULA COCKPIT
DRIVING POSITION DERIVED FROM F1

CREATE YOUR OWN
SIM RACING COCKPIT
SPARCO SIM RACING CONFIGURATOR

EVOLVE GP

G03800NR



G03800RS



G03800NRSKY



GAMING
CURVED MONITOR 49"
SAMSUNG



- G03801NR
- G03801RS
- G03801NRSKY

GAMING PC AK RIG
SPARCO RACING
+
WIRELESS KEYBOARD
K400 PLUS
LOGITECH



- G03802NR
- G03802RS
- G03802NRSKY

GAMING
CURVED MONITOR 49"
SAMSUNG
+
GAMING PC AK RIG
SPARCO RACING
+
WIRELESS KEYBOARD
K400 PLUS
LOGITECH



- G03803NR
- G03803RS
- G03803NRSKY

- Ts-xw racer competition mod P310 steering wheel and pedal set.
- Curved gaming monitor 49" Samsung.
- Tm-stand1 monitor/tv stand (from 24" to 49").
- Gaming pc Ak rig - Sparco racing.
- Evolve 3.0 frame.
- PRO brackets kit.
- Logitech wireless K400 plus keyboard.



SIM RIG II



CONFIGURE YOUR RIG, CHOOSE YOUR SEAT

CREATE YOUR OWN
SIM RACING COCKPIT
SPARCO SIM RACING CONFIGURATOR

SIM RIG II KIT
G03400

CHOOSE YOUR QRT GAMING SEAT

-  **QRT-R**
008012GNR
-  **PILOT QRT**
008018GNR
-  **CIRCUIT I QRT**
008010GNR
-  **CIRCUIT II QRT**
008011GNR
-  **PRO2000 QRT**
008016GNR
-  **PRO2000 QRT
MARTINI RACING**
008016GMRBM 008016GMRGR
-  **EVO QRT**
008007GNR
-  **EVO L QRT**
008013GNR
-  **EVO XL QRT**
008015GNR
-  **GRID-Q QRT**
008009GNR
-  **REV QRT**
008014GNR

- Ts-xw racer competition mod P310 steering wheel and pedal set.
- Evolve 3.0 frame.
- PRO brackets kit.



SIM RIG I



CONFIGURE YOUR RIG, CHOOSE YOUR SEAT

CREATE YOUR OWN
SIM RACING COCKPIT
SPARCO SIM RACING CONFIGURATOR

SIM RIG I KIT

G03500

CHOOSE YOUR QRT GAMING SEAT

-  **QRT-R**
008012GNR
-  **PILOT QRT**
008018GNR
-  **CIRCUIT I QRT**
008010GNR
-  **CIRCUIT II QRT**
008011GNR
-  **PRO2000 QRT**
008016GNR
-  **PRO2000 QRT MARTINI RACING**
008016GMRBM
-  **PRO2000 QRT**
008016GMRGR
-  **EVO QRT**
008007GNR
-  **EVO L QRT**
008013GNR
-  **EVO XL QRT**
008015GNR
-  **GRID-Q QRT**
008009GNR
-  **REV QRT**
008014GNR

- Evolve 3.0 frame.
- PRO brackets kit.



EVOLVE PRO



CONFIGURE YOUR EVOLVE, CHOOSE YOUR SEAT

CREATE YOUR OWN
SIM RACING COCKPIT
SPARCO SIM RACING CONFIGURATOR

EVOLVE PRO

G03200





▪ Evolve 3.0 frame.



EVOLVE START



CONFIGURE YOUR EVOLVE, CHOOSE YOUR SEAT

CREATE YOUR OWN
SIM RACING COCKPIT
SPARCO SIM RACING CONFIGURATOR

EVOLVE START KIT

G03100

CHOOSE YOUR SEAT

+



009011NR



009011NRRS



009011NRGR

R333

+



009016ANR



009016NRRR



009016NRRS

R100+

+



009014NR5KY

R100SKY

+



009014NRRR



009014NRRS



009014NRAZ



009014NRGR

R100

F1 STYLE DRIVING POSITION

GP NEW



008026GNRSKY



008026GRS

GP NEW



008026GNR

RALLY / GT DRIVING POSITION (WITH HEAD RESTRAINT)

PILOT QRT



008018GNR

PRO ADV QRT



008017GNR

CIRCUIT II



008011GNR

CIRCUIT I



008010GNR

RALLY / GT DRIVING POSITION



QRT-R

008012GNR



PRO 2000 QRT

008016GNR



**PRO 2000 QRT
MARTINI
RACING**

008016GMRBM



**PRO 2000 QRT
MARTINI
RACING**

008016GMRGR



EVO QRT

008007GNR



EVO L QRT

008013GNR



EVO XL QRT

008015GNR



REV QRT

008014GNR



GRID-Q QRT

008009GNR

GAMING SEATS

WRAPPING CUSTOMIZATION **NEW**

POSSIBILITY TO PERSONALISE THE QRT SEATS WITH STANDARD CUSTOMIZATION (MARTINI RACING / GAMING 77) OR ON DEMAND WITH ALMOST INFINITE SOLUTIONS.

CIRCUIT II QRT WRAP



008011WG-PE

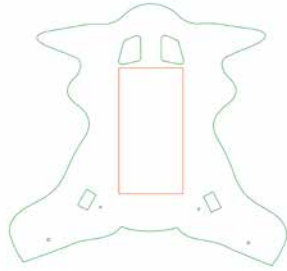

EVO QRT WRAP



008007WG-PE

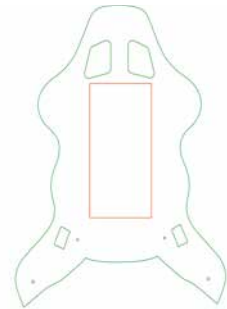

008011WG77NR

CIRCUIT II QRT GAMING 77 WRAP



008007WG77NR

EVO QRT GAMING 77 WRAP



**PRO 2000 QRT
MARTINI
RACING WRAP**

008016WGMRGR



**PRO 2000 QRT
MARTINI
RACING WRAP**

008016WGMRBM



**CIRCUIT II QRT
MARTINI
RACING WRAP**



008011WGMRNR



**EVO QRT
MARTINI
RACING WRAP**



008007WGMRNR

EVOLVE 3.0 FRAME

081988NRRS

PRO BRACKETS KIT

 EVOLVE 3.0
brackets Kit.
(NO EVOLVE GP)

G02400NRRS

TM-STAND1

24" to 49" monitor/TV support.
DIMENSIONS: L/D/H 570 mm
x700 mm x (1135-1275 mm).

 Up to 5 height and inclination
adjustments.

VESA 75x75 and 100x100 fixing.

G02385NRRS

GP BRACKETS KIT **NEW**

 Aftermarket
brackets Kit for
GP cockpit seat.
(NO EVOLVE GP)

G02500NRRS

OPTIONAL CUSHIONS

 Pair of lumbar side
backrests.

● **01022RS** ● **01022AZ** ● **01022NR**

 Universal
lumbar backrest.

01023

SET PEDALS T-LCM **NEW**

 "Load cell" magnetic pedal with force sensor
for PC, PS4 and XBOX ONE.

Only in combination with EVOLVE cockpit.

MG0230008

COCKPIT FLOOR MAT NEW

Sparco gaming cockpit floor mat.

DIMENSION: 180 x 120 cm

Graphic printed on resistant TNT (non-woven fabric). Washable.

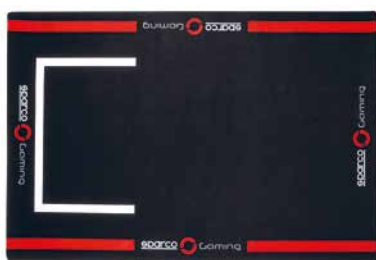

099101NRRS



EVOLVE-RHS / LHS

Gear shift and handbrake support.

Allows all handbrakes and sequential gear shifts on market.

Right.



G02085NRRS

Left.



G02285NRRS

KIT TSS HANDBRAKE + EVOLVE-RHS / LHS NEW

LHS gear shift and handbrake support for Evolve + gear shift/handbrake TSS by Thrustmaster.

Compatible with PC, XBOX ONE, PS4.

Right.



G02303DX

Left.



G02303SX

HYPER-T

T-SHIRT **NEW**

SIZES: S-XXL

COMPOSITION: 80% POLYPROPYLENE, 17% POLYAMIDE, 3% ELASTANE

324

HIGHLIGHTS

- Seamless jaquard t-shirt.
- The combination of these fibres promotes ergonomics, softness, hygroscopicity, breathability, body heat regulation and heat insulation.
- Customizable with transfer printing.



Breathable side inserts.



Breathable back insert.



01371NRRS..

GAMING ROOKIE

T-SHIRT **NEW**

SIZES: XS-XXL

COMPOSITION: 100% COTTON

HIGHLIGHTS

- Soft cotton 160 GSM.
- Regular fitting.
- Silk-screen printing logos and graphics.



01360NRRS

B-ROOKIE

T-SHIRT **NEW**

SIZES: S-XXL

COMPOSITION: 100% COTTON

HIGHLIGHTS

- Soft cotton 160 GSM.
- Low neck.



002204RS



002204NR



002204AZ



002204BI



002204GF

HYPER-P

GAMING TROUSERS **NEW**

SIZES: S-XXL

COMPOSITION: 100% POLYESTER

HIGHLIGHTS

- Comfortable and light even after many hours of use.
- Perforated and breathable inserts above the thighs.
- Elastic glove ring.
- Graphics and customisations through sublimation printing.



Breathable inner thigh insert.



Mobile phone pocket.



01370NRRS..

HYPER SPEED

DRIVING SOCKS

SIZES: 38/39 - 40/41 - 42/43 - 44/45 - 46/47

COMPOSITION: 100% NYLON MICROFIBER SOCK WITH SILVER IONS, HYPOALLERGENIC.

HIGHLIGHTS

- Maximum comfort and breathability.
- Structure with silicone yarn to maximise the grip between foot and sock, or insole and sock.
- Heel tab at back for easy pull-on.



Asymmetrical Plastisol coating for achieving maximum performance.



Heel reinforced with Cordura®.



01290NR..



Comfort configuration
(with removable insole)



Feeling configuration
(No insole)



HYPERDRIVE

GAMING SHOES

HIGHLIGHTS

- Shaped ankle to facilitate movement.
- Reflective tape on back.
- Microfibre reinforcements on toe and heel.
- Ergonomic fussbett.
- Racing-inspired sole.



Knitted sock upper, with differentiated structures.



Fluorescent Logo and Skid.



001293..NRRS



001293..NRAZ



001293..NRGF



001293..NRVF



HYPERGRIP+

GAMING GLOVES

HIGHLIGHTS

- Updated version of the iconic gaming glove.
- Improved fit.
- Improved pad ergonomics.
- Close fit.
- Elastic cuffs.



Added grip zones for better performance.



Touch-sensitive thumb and index finger.



002095..NRRS



002095..NRAZ



002095..NRVF



002095..NRGF

HYPERGRIP

GAMING GLOVES

SIZES: 8-12

HIGHLIGHTS

- Perforations in the part of the palm that separates the fingers.
- Micro-perforated microfibre on the palm guarantees maximum ventilation without compromising grip.
- Protective foam pads on the palm reduce the stress exerted on the hand.
- Touch-sensitive thumb and index finger.



002094..NRRS

MECA III

GLOVES

SIZES: S-XL

COMPOSITION: 47% POLYESTER 35% SUEDE 18% ELASTANE

HIGHLIGHTS

- The backs of Meca-3 gloves are made from elasticised, printed, scuff resistant fabric.
- The palms are in synthetic, scuff resistant hide and there are reinforcements positioned between thumb and index finger.
- Pads between the fingers provide better breathing.
- Strap for tighter fitting.



002093NRGF



002093BMAF

002093AZ



002093NR



002093RS



CHAIRS
CHAIRS
CHAIRS
CHAIRS
CHAIRS
CHAIRS
CHAIRS
CHAIRS
CHAIRS



sparco

spardo

spardo

sparco

CHAIRS

10^e

HIGHLIGHTS

- Special vep and sky multi-material zone upholstery.
- Cushions and accessories easily installed with strap on vep.
- Reclining backrest.
- Anti-tip device with backrest lock at 150°.
- Base with SGS/BIFMAX5.1/EN1335 certified piston.
- High resistance polymer spoke with 5 solid wheels.



Seat adjustable in height and inclination.



3D armrests with multidirectional movement.



00999NRGF 00999NRAF 00999NRAZ 00999NRVF 00999NRNR

Warning: this seat must not be used in a car, it is not a car seat.

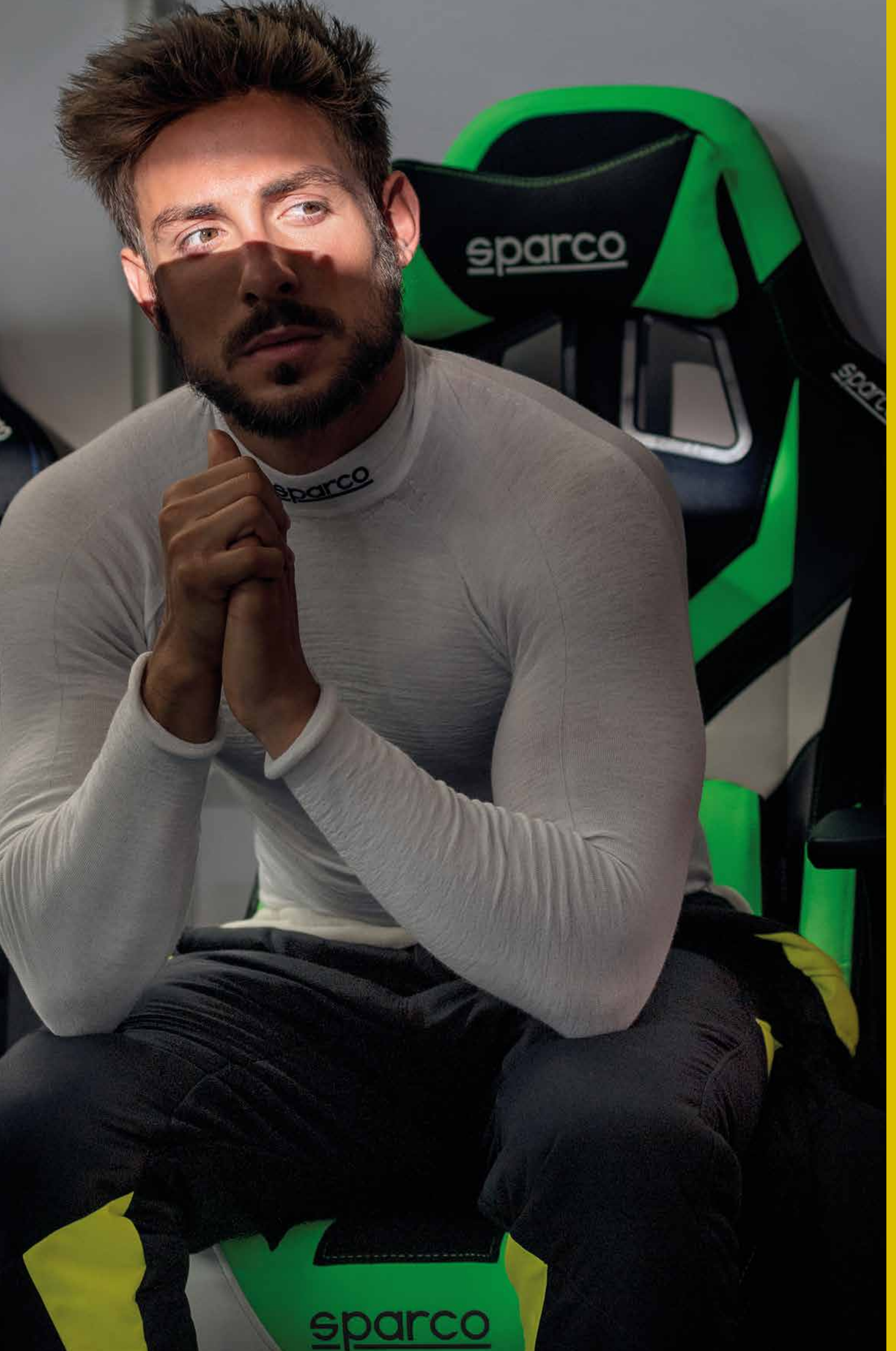

COMFORT SIZED CHAIR

CUSTOMIZATION: EASY CUSHION APPLICATION ON VEP AREA

HIGHLIGHTS

- Anti-tip device with backrest lock at 150°.
- Base with SGS/BIFMAX5.1/EN1335 certified piston.
- Colour-coded base with kickplate.
- Equipped with Pro Caster Lockable wheels.



Seat adjustable in height and inclination.



2D armrests with multidirectional movement.



009013NRRS 009013NRVF 009013NRAZ 009013NRNR

Warning: this seat must not be used in a car, it is not a car seat.

DESIGN INSPIRED BY THE SPARCO R333 SEAT

337

HIGHLIGHTS

- Reclining backrest with adjustment lumbar micrometric.
- Sparco AIRFLOW system for maximum breathability.
- Anti-tip device with backrest lock at 150°.
- Base with SGS/BIFMAX5.1/EN1335 certified piston.
- Colour-coded base with kickplate.
- Fitted with lockable Pro Caster wheels.



Seat adjustable in height and inclination.



4D armrests with multidirectional movement.



00988NRRS 00988NRAZ 00988NRNR

Warning: this seat must not be used in a car, it is not a car seat.

HIGHLIGHTS

- Special vep and sky multi-material zone upholstery.
- Reclinable backrest with micrometric lumbar adjustment.
- Cushions and accessories easily installed with strap on VEP.
- Anti-tip device with 150° backrest lock.
- Base with SGS/BIFMAX5.1/EN1335 certified piston.
- High resistance polymer spoke with 5 solid wheels.



Seat adjustable in height and inclination.



2D armrests with multidirectional movement.



00989NRGI 00989NRVF 00989NRAZ

Warning: this seat must not be used in a car, it is not a car seat.

SPARCO R100S REPLICA SPORTS CAR SEAT

HIGHLIGHTS

- Reclinable backrest with micrometric lumbar adjustment.
- Anti-tip device with 150° backrest lock.
- Base with SGS/BIFMAX5.1/EN1335 certified piston.
- High resistance polymer spoke with 5 solid wheels.



Seat adjustable in height and inclination.



2D armrests with multidirectional movement.



00998NRRS 00998NRAZ 00998NRNR

Warning: this seat must not be used in a car, it is not a car seat.

HIGHLIGHTS

- Ergonomic chair with F1 style position.
- Fiberglass monocoque seat with VEP or sky upholstery and removable cushions.
- Lined removable leg rest cushion.



Design tubular frame.



Integrated footrest.



G03700RS



G03700NR



G03700NRSKY

Warning: this seat must not be used in a car, it is not a car seat.

CHAIR FLOOR MAT **NEW**

DIMENSION: 97,5 x 110 cm.

Hexagonal shape.

Graphic printed on TNT.

Light and resistant.

Washable.



099102NRRS



CUSHIONS (STINT AND ICON EXCLUDED)

Ergonomic head cushion.



01024NR

Universal lumbar backrest.



01023NR

Lumbar side backrest kit.



■ 01022RS ■ 01022AZ ■ 01022NR

ARMRESTS COVER

Compatible with all chairs (Stint excluded).



010810

PRO CASTER WHEELS

Compatible with all chairs.



010811

TEAMMWE

VEARTE

EAMWE

EARTEA

MWEAR

TEAMMWE

EADTEA



C. Sainz Sr. - Rally Driver

3IN1 JACKET

NEW

SIZES: XS-XXL

COMPOSITION: JACKET: 100% POLYESTER - VEST: 100% POLYESTER

CUSTOMIZATION: FULLY CUSTOMIZABLE ON DEMAND

344

HIGHLIGHTS

- Outer jacket with 3-layer fabric, waterproof, with heat-taped seams.
- Coated zips with customized slider.
- Adjustable drawstring on the hood and on the bottom.
- Internal side pocket.
- Internal side stretch inserts.

3 In 1 jacket with hood.



01364GRNR



01364NRAZ



01364BMNR



01364NR

WINTER JACKET

NEW

SIZES: XS-XXL

COMPOSITION: 100% POLYESTER

CUSTOMIZATION: FULLY CUSTOMIZABLE ON DEMAND

HIGHLIGHTS

- 2-Layer fabric, waterproof, windproof.
- Double density padding stratification, optimised for extreme climate conditions.
- #9 high strength chain central zip.
- Neck cuff with magnetic closure.
- Elastic cuff inserted in the sleeve bottom.

Hooded winter jacket.



01361GRNR



01361NRAZ



01361BMNR



01361NR

NEW

SIZES: XS-XXL

COMPOSITION: 100% POLYESTER

CUSTOMIZATION: FULLY CUSTOMIZABLE ON DEMAND

346

HIGHLIGHTS

- 3-Layer fabric, waterproof, windproof, with coupled internal fleece.
- Stretch side inserts for comfort and superior fitting.
- Neck cuff with magnetic closure.
- Coated zips.
- Elastic cuff inserted in the sleeve bottom.

Softshell with comfort interior.



01363GRNR



01363NRAZ



01363BMNR



01363NR

WINDBREAKER

NEW

SIZES: XS-XXL

COMPOSITION: 100% POLYESTER

CUSTOMIZATION: FULLY CUSTOMIZABLE ON DEMAND

HIGHLIGHTS

- 2-Layer fabric, waterproof, windproof.
- Internal edged seams.
- Hood finished with Sparco customisations.
- Coated zips.
- Drawstring bottom adjustment.

Light hooded windbreaker.



01365GRNR



01365NRAZ



01365BMNR



01365NR

NEW

SIZES: XS-XXL

COMPOSITION: 100% POLYESTER

CUSTOMIZATION: FULLY CUSTOMIZABLE ON DEMAND

348

HIGHLIGHTS

- Custom coated central zip.
- Reversible, divisible zips.
- Side stretch inserts.
- Internal side pocket.
- Preformed comfort collar.

Windproof, padded, light
and lined fabric vest.



01362GRNR



01362NRAZ



01362BMNR



01362NR

FULL ZIP SWEATSHIRT

NEW

SIZES: XS-XXL

COMPOSITION: 53% COTTON, 41% POLYESTER, 6% ELASTANE

CUSTOMIZATION: FULLY CUSTOMIZABLE ON DEMAND

HIGHLIGHTS

- Trimmed double faced main fabric.
- Stretch side inserts.
- Stretch inserts on the wrists.

Full zip sweatshirt
with coated zips.



01366GRNR



01366NRAZ



01366BMNR



01366NR

NEW

SIZES: XS-XXL

COMPOSITION: 55% COTTON, 39% POLYESTER, 6% ELASTANE

CUSTOMIZATION: FULLY CUSTOMIZABLE ON DEMAND

350

HIGHLIGHTS

- Main fabric pique.
- Side inserts.
- Ultra-light coated zip.
- Chest pocket with invisible zip.

Stretch polyester and cotton fabric with cotton-touch feeling and piquet effect.



01367BI



01367NRAZ



01367BMNR



01367NR

SHIRT

LONG SLEEVES **NEW**

MAN SIZES: XS-XXL LADY SIZES: XXS-L

COMPOSITION: 97% COTTON, 3% ELASTANE

CUSTOMIZATION: FULLY CUSTOMIZABLE ON DEMAND

HIGHLIGHTS

- Chest pocket with invisible zip.
- Sparco logo printed on chest.
- French-style collar.
- Buttons with thread in contrast.

Stretch poplin
fabric shirt.

Man



01368BI

Lady



01369BI

WILSON WINDSTOPPER

352

SIZES: S-XXXL

COMPOSITION: 100% POLYESTER

HIGHLIGHTS

- Soft and lightweight water-repellent Polyester fabric.
- Coated zips with rubber pullers.
- Elasticated cuffs and hem.

Wind-proof jacket with lightweight water-repellent hood.



02405BM..



02405RS..



02405AZ..



02405NR..

FRAME VEST

SIZES: S-XXL

COMPOSITION: 100% POLYESTER

HIGHLIGHTS

- Water-repellent soft and light Polyester fabric.
- Coated zips with rubber pullers.
- Inner pocket.

Wilson windstopper in water-repellent fabric with internal pocket.



01259BM..



01259NR..

DENVER JEANS

SIZES: S-XXXL **WEIGHT:** 350 GR/M2

COMPOSITION: 98% COTONE / 2% ELASTANE



02409DE..

DAKAR

LARGE DUFFLE BAG **NEW**

DIMENSIONS: H70 X L40 X P40 CM **CAPACITY:** 110 L
MATERIAL: WATERPROOF TPU / POLYESTER

354

HIGHLIGHTS

- Can be used as a backpack or duffel bag.
- Detachable and adjustable shoulder strap.
- Hidden rain-proof zip.
- Transparent address holder.
- Washable interior.
- Printed logo and also applied on the sides of the product with a rubber label.

LARGE.



016442NRAZ



016442NRNR



016442NRRS

DAKAR

SMALL DUFFLE BAG **NEW**

DIMENSIONS: H53 X L32.5 X P32.5 CM **CAPACITY:** 60 L
MATERIAL: WATERPROOF TPU / POLYESTER

HIGHLIGHTS

- Can be used as a backpack or duffel bag.
- Detachable and adjustable shoulder strap.
- Hidden rain-proof zip.
- Transparent address holder.
- Washable interior.
- Printed logo and also applied on the sides of the product with a rubber label.

SMALL.



016443NRAZ



016443NRNR



016443NRRS

TOUR TROLLEY BAG

DIMENSIONS: H40 X L84 X P38 CM **WEIGHT:** 4,7 KG
CAPACITY: 127 LT **MATERIAL:** COATED POLYESTER

356

HIGHLIGHTS

- Double adjustable closure with seat belt style straps.
- Protective padding with racing suit style quilting.
- Lower compartment (2/3). Reinforced on the underside.
- Trolley with reinforced wheels.
- Upper compartment (1/3) with zip opening. Repositionable internal partition. Multi-pocket compartment with net.
- Repositionable internal partitions. Customised Sparco inner lining.



016437NRRS



016437NRSI

TRAVEL

SOFT CABIN SIZE TROLLEY

DIMENSIONS: H25 X L55 X P35 CM **WEIGHT:** 3 KG
CAPACITY: 48 LT **MATERIAL:** COATED POLYESTER

HIGHLIGHTS

- Telescopic handle.
- Double adjustable closure with seat belt style straps.
- Protective padding with racing suit style quilting.
- Trolley with reinforced wheels.
- Front document pockets. Customised Sparco inner lining.
- Reinforced on the underside.



016438NRRS



016438NRSI



TRIP

BAG WITH SHOULDER STRAP

DIMENSIONS: H35 X L66 X P38 CM **WEIGHT:** 2,1 KG
CAPACITY: 87 LT **MATERIAL:** POLYESTER

358

HIGHLIGHTS

- Double handle with seat belt style straps.
- Customised Sparco inner lining.
- Internal pocket with zip closure.
- Protective feet for the underside.



016439NRSI

STAGE RUCKSACK

DIMENSIONS: H40 X L30 X P14 CM **WEIGHT:** 0,76 KG
CAPACITY: 16 LT **MATERIAL:** POLYESTER

HIGHLIGHTS

- 2 hidden front pockets with graphics that echo the Sparco seat belt slider.
- Ergonomic padded and back lined with breathable mesh, horizontal band for inserting telescopic trolley bag handle.
- Padded seat belt style shoulder straps.
- Inner pocket for inserting PC up to 15". Customised Sparco inner lining.



016440NRRS



016440NRAZ



016440NRNR

DRY-TECH

HELMET HAND F.H.R. COLLAR BAG

DIMENSIONS: H35 X L35 X P40 CM **WEIGHT:** 1,3 KG
CAPACITY: 49 LT **MATERIAL:** POLYESTER

360

HIGHLIGHTS

- Helmet drying system with USB 12V power cable.
- Fan cover.
- Protective padding with racing suit style quilting. Customised Sparco inner lining.
- Seat belt style shoulder strap.



016441NRSI

CO-DRIVER

BAG

DIMENSIONS: H35 X L30 X P10 CM
CAPACITY: 10,5 LT **MATERIAL:** POLYESTER

HIGHLIGHTS

- Supplied with shoulder strap.
- Interior divided into 2 compartments with contrasting lining. Several pockets and external pocket in transparent PVC.
- Interior divided into 2 compartments with contrasting lining. Several pockets and external pocket in transparent PVC.



0164281NR

Bag developed with the co-drivers Ingrassia and Andreussi. Double closure.





LIFESTYLE

LIFE

LIFESTYLE

LIFE

LIFESTYLE

LIFE

LIFESTYLE



sparco

sparco

10

P. O'Ward - Indycar Driver

LIFESTYLE

10^a

NEW

FRAME  NEW

SIZES: S-XXL
COMPOSITION:
 65% cotton
 35% polyester



01315NR



01315BM



01315RS

FRAME LADY  NEW

SIZES: S-L
COMPOSITION:
 65% cotton
 35% polyester



01316NR



01316RS

ORIGINAL  NEW

SIZES: S-XXL
COMPOSITION:
 65% cotton
 35% polyester



01318BI

ORIGINAL LADY  NEW

SIZES: S-L
COMPOSITION:
 65% cotton
 35% polyester



01319BI

1977  NEW

SIZES: S-XXL
COMPOSITION:
 65% cotton
 35% polyester



01320NR



01320BM

VINTAGE  NEW

SIZES: S-XXL
COMPOSITION:
 65% cotton
 35% polyester



01317BM



01317BI

CREW NECK & POLO

NEW

CREW NECK SWEETSHIRT NEW

SIZES: S-XXL
COMPOSITION:
65% cotton
35% polyester



01321GR

WOOL CREWNECK NEW

SIZES: S-XXL
COMPOSITION:
50% merino wool
50% acrylic



01338BM

POLO CORPORATE NEW

SIZES: S-XXL
COMPOSITION:
100% cotton



01322BI



01322BM



01322NR

POLO CORPORATE LADY NEW

SIZES: S-L
COMPOSITION:
100% cotton



01323BI



T-SHIRTS

NEW

MAN SIZES: S-XXL WOMAN SIZES: S-L
COMPOSITION: 95% COTTON/5% ELASTANE

FRAME **NEW**



01324NR



01324BM



01324BI



01324RS

FRAME LADY **NEW**



01325NR



01325RS

ORIGINAL **NEW**



01327BI

ORIGINAL LADY **NEW**



01328BI

1977 **NEW**



01329NR



01329BM



01329GR

PILOTA



01291BM



01291BI

T-SHIRTS

NEW

MAN SIZES: S-XXL

COMPOSITION: 95% COTTON/5% ELASTANE

VINTAGE  NEW



01326BM



01326BI



01326GR



Low cut microfibre shoe racing inspired.



HIGHLIGHTS

- Detail of the Loop inspired by the curves of the R100s seat belt holes.
- Detail on the heel inspired by the curves of the SPX seat belt holes.
- P6 rubber outsole racing inspired.



001263..RSNR



001263..MBNR



001263..NRRS



001263..NRBI

SIZES: 36-46

369

Leather and breathable fabric sneakers.



HIGHLIGHTS

- Upper in suede leather with inserts in action leather and mesh for maximum breathability.
- High-visibility printing.
- Lining made of 50% coffee ground fibre (anti-odour and anti-bacterial). Ergonomic, cushioned fustbett, double lace (flat on the shoe and second, round, two-colour lace in the box). Ultra-flat asymmetrical tongue for maximum comfort.
- Suola in phylon con inserti in gomma.



001292..AZBI



001292..BMGI



001292..NRRS



001292..NRGR

PUMA SPEEDCAT

370

SIZES: 36-46

Iconic shoe inspired by the world of motorsports.



HIGHLIGHTS

- Lacing.
- Racing style rounded heel.
- Suede upper.
- Rubber sole.



001286..RSBI



001286..NRBI

TORQUE

01 CERTIFICATION (EN ISO 20347:2012)
SIZES: 37-47 METAL FREE

**Ultra-lightweight and breathable
OCCUPATIONAL footwear.**



HIGHLIGHTS

- Tip with ultra-resistant coated reinforcement.
- Breathable mesh lining.
- Energy absorption heel.
- Easy lacing.
- Phylon sole and oil and hydrocarbon resistant rubber bottom.
- SRA level slip resistance.



001289..BMAF



001289..NRAZ



001289..NRNR



001289..NRGF



001289..NRRS

Karting shoes inspired sneakers.



HIGHLIGHTS

- Ergonomic insole.
- Breathable fabric and microfibre upper.
- Karting sole.

PG. 378

Youth version



001288..BMAZ



001288..RBAZ



001288..NRRS



001288..BMBI



001288..NGBI



001288..NGRG



FLEXFIT - ORIGINAL CAP NEW

63% Polyester, 34% cotton, 3% pu baseball cap with elastic band spandex.



01357AZ



01357NR



01357BI



01357BM

SUEDE NEW

100% Suede cotton six-panel cap with 3d embroidered logo.



01353BM



01353GR



01353NR



01351BM



01351NR

STRETCH NEW

100% Polyester technical fabric five-panel cap with raised tpu rubber logo.

TRUCKER NEW

Trucker cap with visor and 100% cotton suede front panel and 100% pvc rear mesh for ventilation. Embroidered patch on the front.



01352BM

BEANIE REFLEX NEW

COMPOSITION:
50% Wool
50% Acrylic fabric.



01354AZBM

BEANIE WINDY

COMPOSITION:
100% Acrylic fabric.



01232BMAZ

ACCESSORIES

GYM TOWEL

DIMENSIONS: 100x50 cm
COMPOSITION: 90% Polyester
10% Nylon



099073

BEACH TOWEL

DIMENSIONS: 80x155 cm
COMPOSITION: 100% Cotton
(450 gr/sqm)



099078AZ

SPORT BACKPACK

DIMENSIONS:
35x48 cm

Side
pockets



0160037GR

SPORTSACK

DIMENSIONS:
33x51 cm



■ 0160013NR ■ 0160013AZ

SUIT BAG

DIMENSIONS:
44x35 cm



016BLU07

SUNGLASSES



099059

LOGO BELT

DIMENSIONS:
120 cm H 4cm



01356NR



01356AZ

CLOTHES HANGER



099091AZ

GOLF UMBRELLA

Automatic polyester umbrella.
Ø 130 cm



099068

LED UMBRELLA NEW

Foldable automatic polyester umbrella with light. Ø 96 cm



099105

WATER BOTTLE NEW

Steel 0,5L



099106AZ

MUG NEW

Stainless steel
0,3 L



099112AZ

LEATHER KEY HOLDER



099070..

NR AZ ARF GF RS

KEY HOLDER NEW



099092TEAMWORK

099092GAMING

099092SHOE

099092SPARCO

099092SUIT

099071GLOVE

099071SEAT

PVC KEY HOLDER

BRACELETS NEW



099093NR



099093GI



099093BX



099093RS



099093BI

PADDOCK

The comfortable Sparco paddock Chair has an aluminium frame and is finished in coloured Oxford 600D fabric. The soft arms are padded for maximum comfort at all times. Easy to transport thanks to its folding mechanism.



0990058

POUF

Soft pouf diameter 40 cm, height 40 cm, with printed S logo in the upper surface.



0750006B

WELCOME MAT

DIMENSIONS:
120x80 cm



099058

DOORMAT NEW

DIMENSIONS:
80x40 cm



099090

WINDSHIELD BANNER - FRONT NEW

137x17 cm.



099097AZ

WINDSHIELD BANNER - REAR NEW

120x10 cm.



099098AZ

NOTEBOOK NEW

Sizes A5



099109AZ

SPIRAL NOTEBOOK NEW

Sizes A5



099110AZ

LANYARD NEW

Official



099114AZ

Gaming



099103NRRS

METAL PIN NEW



099089

MAGNET NEW



099111AZ

KIT OF 10 STICKERS

2 PCS 18 cm
4 PCS 12 cm
4 PCS 8 cm.



09003

NEXT GENERATION NEW

T-SHIRT

Sizes: 3-11 years
100% organic cotton
with silk screen printing.



017026BI..

017026NR..

FUTURE DRIVER

T-SHIRT

Sizes: 3-11 years
100% cotton with
digital printing.



017013BI..

017013NR..

STRIPES DESIGN

T-SHIRT

Sizes: 3-11 years
100% cotton with
digital printing.



017020..

NEXT GENERATION NEW

SWEATSHIRT

Sizes: 3-11 years
100% organic cotton
with silk screen
printing.



017025NR..

NEXT GENERATION

SWEATSHIRT

Sizes: 3-11 years
80% cotton
20% polyester
with digital
printing.



017017NR..

STRIPES DESIGN

SWEATSHIRT

Sizes: 3-11
years
80% cotton
20% polyester
with digital
printing.



017021..

NEXT GENERATION NEW

HOODIE

Sizes: 3-11 years
100%
organic cotton
with silk screen
printing.



017024BM..

SH-17

Sizes: 26-34



001262..SIAZ

S-POLE YOUTH

Sizes: 26-34



001288B..BMAZ

CAP NEXT GENERATION NEW

100% polyester
3D embroidered
Logo.



017028NR

CAP CORPORATE NEW

100% cotton
3D Patch.



017027AZ

CAP REBEL

100% acrylic
adjustable
closure.



017015

BEANIE REFLEX NEW

50% wool
50% acrylic.

L:18xH19



017029AZBM

BEANIE WINDY

100% acrylic.

L:18xH19



017019BMAZ

BEANIE STRIPES DESIGN

50% wool
50% acrylic.

L:18xH19



017022BM

BABY EAGLE SUIT

Sizes:
3-6, 6-9
9-12, 12-18
18-24 (months)

100% organic cotton with digital printing.



017012AZ..

BABY SLEEPSUIT

Sizes:
3-6, 6-9
9-12, 12-18
18-24 (months)

100% organic cotton with digital printing.



017018AZ..

BABY STRIPE DESIGN

Sizes:
3-6, 6-9
9-12, 12-18
18-24 (months)

100% organic cotton with digital printing.



017023BM..

BABY RACER

SWEATSHIRT

Sizes: 3-6,
12-18
18-24 (months)

80% cotton
20% polyester
with digital
printing.



017016NR..

T-SHIRT

Sizes: 6-12,
12-18
18-24 (months)

80% cotton
20% polyester
with digital
printing.



017010NR..

BABY RACER

BODY

Sizes: 3-6, 6-9
9-12, 12-18
18-24 (months)

100% organic cotton with digital printing.



017011BI..

CAP REBEL

Sizes: 0-3, 3-6,
6-12 12-24
(months)

100% organic cotton with digital printing.



017014..

SPARKY PELUCHE

41 cm

Polyester.
+ 3 years.



099051



F1000KI

CHILD SEAT GROUP 1+2+3 (9-36KG) ISOFIX

380

HOMOLOGATION: ECE R44/04

MATERIAL: POLYESTER + PU + SUEDE + HDPE (HIGH DENSITY POLYETHYLENE) + PUR SPONGE

AGE: 9 m -12 years (approx).

ANCHORAGE SYSTEM: Universal, ISOFIX + TOP TETHER.



019221GR



019221RS



019221AZ

SK900I

BOOSTER SEAT ISOFIX (22-36 KG)

HOMOLOGATION: ECE R44/04

AGE: 6 - 12 years (approx).

ANCHORAGE SYSTEM: Universal, ISOFIX.



019211RS



019211AZ



019211GR

SK700

CHILD SEAT GROUP 1+2+3 (9-36KG) ISOFIX

HOMOLOGATION: ECE R44/04

MATERIAL: COVER 82% POLYESTER + 18% PU / FILLING 100% POLYESTER
WADDING 100% POLYPROPYLENE

AGE: 9 months - 12 years (approx).

ANCHORAGE SYSTEM: Universal.
ISOFIX + TOP TETHER.



01920AZ



01920RS



01920GR

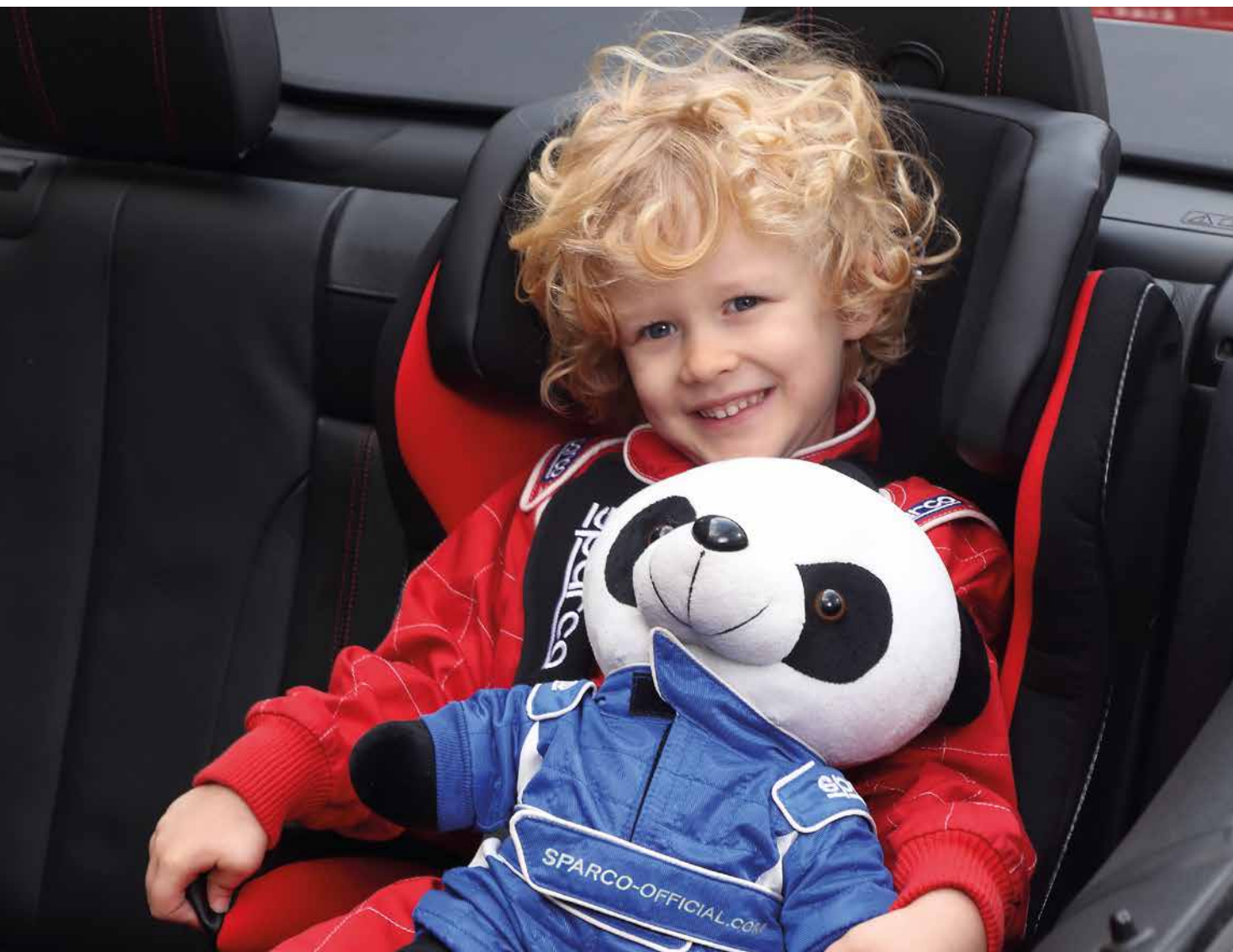



E-MOBILITY

ILITY E-MO

MOBILITY

PROOF
FACTS

E-MOBILITY

ILITY E-MO

MOBILITY



sparco

sparco

10

E-MOBILITY

10^e



MAX S2

NEW

MATERIAL: ALUMINIUM ALLOY **RANGE:** MAX 30KM **WEIGHT:** 20KG
MAXIMUM SPEED: 25KM/H **MAX LOAD:** 120KG **BATTERY:** 36V 7.8AH (SMART BMS)
CHARGING TIME: 4 HOURS **MOTOR POWER:** 350 W **WHEELS:** 10"

HIGHLIGHTS



Aluminium alloy.



10 Inch honeycomb tubeless tyres.



Front light + rear light + brake light.



099107NR

- Led display.
- Turn signal.
- Double suspension front
- 30km maximum distance
- 25km/h maximum speed.



099107AZ

SEM 1

MATERIAL: ALUMINIUM ALLOY **RANGE:** UP TO 25KM **WEIGHT:** 14,3KG
MAXIMUM SPEED: 25KM/H **MAX LOAD:** 120KG **BATTERY:** 36V/7.5 AH
CHARGING TIME: 4-6 HOURS **MOTOR POWER:** 350 W **WHEELS:** 8,5"

HIGHLIGHTS



Adjustable Height.



Electric and drum rear brake.



High-Luminous Front + Rear Light.



099075AZ

- Body size: 1150x480x1135 mm.
Folding size: 1030x220x405 mm.
Ground distance: 100 mm.
- High performance and long-lasting cells. Choose between 7.5Ah. Up to 35km on one single charge. Rapid charging system.
- Connects via Bluetooth to your phone. Shows Speed, total length, actual length, etc. Scooter Lock function for safety & security. Regulate 3 riding modes (Eco, Normal, Sport).



099075RS



099075GR



099075BI



099075NR



099075PINK

E-SCOOTER HELMET NEW

Tg: S-L



099116AZ



099116GF



099116NR

- Bike / electric scooter helmet with a dynamic and sporty design.
- High safety, good ventilation and comfortable fit.
- Material: PC and EPS (polystyrene foam)
- Safety standard: CE / EN1078 (EU), CPSC (USA).

- Sizes:
 - S (53-55 cm), 250g
 - M (55-58 cm), 260g
 - L (58-61 cm), 270g

PADLOCK NEW



099117AZ



099117GF



099117NR

- High strength cable lock for use on electric bikes/scooters.
- Material: zinc, brass, abs, pvc, steel.
- Dimensions: 12 x 1200 mm.

SPARCO GENERAL SALES TERMS AND CONDITIONS

DEFINITIONS

Purchaser: means any party (natural or legal person) that purchases one or more Products, accepting the General Conditions. **General Conditions:** means these general conditions of sale and any future new versions that may be published on the website by SPARCO. **Order Confirmation:** means the e-mail message in which SPARCO notifies the Purchaser about acceptance of the order. **Contracts of Sale:** means the contracts for the sale of Products completed between SPARCO and the Purchaser. **Orders:** means the orders for the purchase of Products submitted by the Purchaser in accordance with the General Conditions. **Parties:** means SPARCO and the Purchaser. **Price:** means the selling price of the Products, as indicated in the On-Line Shop next to each Product. **Products:** means the products presented for sale in the On-Line Shop. **SPARCO:** means Sparco S.p.A. with registered offices at Via Leini 524, Volpiano (Turin), CAP 10088, Italy.

RECITALS

The following "General Conditions of Sale" govern all sale contracts relating to SPARCO Products, where SPARCO is the seller of the Products. All amendments, clarifications and exceptions to the following general conditions of sale that are agreed and accepted in writing by SPARCO and the Purchaser shall be valid and prevail in the event of conflict. The Purchaser accepts these general conditions, including those regarding use of the trademark, and therefore agrees to comply with all their provisions.

SUBMISSION OF ORDERS

Orders must be submitted in writing to SPARCO Customer Service by e-mail, or via the SPARCO system designed for the specific purpose of selling the Products. Orders shall be deemed accepted by SPARCO, in the absence of communications to the contrary from SPARCO. Orders for special items are only accepted if accompanied by complete production details.

RESPONSIBILITIES OF THE PARTIES

The Purchaser is responsible for any erroneous production and/or non-conformities attributable to the supply of incorrect production information when ordering from SPARCO and, consequently, the Purchaser shall still be required to pay the agreed Price. In the case of special and/or customised Orders, SPARCO shall not be responsible for any use of logos, or for any infringement of logos and/or the rules that expressly govern their use and/or any rights claimed by the owner of the logos and/or by any third parties. The Purchaser requesting special production and/or the application of logos to SPARCO Products expressly confirms:

- i. his knowledge of the current regulations governing the use of logos and the civil and/or criminal consequences of any infringements of those regulations;
- ii. his relief of SPARCO from any and all liabilities deriving from and/or connected with the use of logos on SPARCO Products.

USE OF THE SPARCO TRADEMARK

SPARCO is the owner of the SPARCO trademark (word and figurative mark) and all use of that trademark must be authorised in writing by SPARCO. Use of the SPARCO trademark represents confirmation of the commercial origin of the product SPARCO and its authenticity. Use of the SPARCO trademark and its inclusion in advertising, websites, promotional articles, exhibition stands, window displays, signs, catalogues etc. must always be approved in advance by SPARCO Brand Management and must always comply with the guidelines approved by SPARCO. SPARCO is the only owner of all Internet domain names containing the word "Sparco" and use of the word must be governed by a specific licensing agreement. Use of the SPARCO trademark on third-party products (under licence) is subject to the supervision of SPARCO Brand Management and must be governed by specific contracts signed between SPARCO and the third party concerned. Images of drivers and/or teams that wear/use SPARCO products cannot be used unless specifically authorised by the driver and/or team concerned. Upon request and by the deadline indicated, the Purchaser has a duty to provide SPARCO with evidence of the use of its name in the Territory, including its use for advertising, selling and/or distribution purposes.

USE OF THIRD-PARTY LOGOS FOR CUSTOMISATION PURPOSES

In order to use third-party logos on a customised SPARCO Products (company emblems, sponsor logos, photographs etc.) it is necessary to hold rights over them and, therefore, in order to apply a third-party logo, SPARCO requires the Purchaser to confirm in writing that it is:

- i. authorised to use the logo for commercial purposes;
- ii. aware that SPARCO is not responsible for any unlawful use of third-party logos that infringes the rights claimed by their owners and/or by any third parties;
- iii. aware that the unlawful use of protected logos by third parties is punishable by law with application of the envisaged monetary penalties.

DELIVERY TERMS

The Products are delivered “ex works SPARCO”, unless any exceptions are agreed in writing. On shipment, all risks associated with the Products acquired are transferred to the Purchaser.

PRODUCT RANGE, PRICES AND PAYMENT

The Products illustrated in the SPARCO catalogues and/or price lists are merely indicative, as SPARCO reserves the right to modify the range, the specifications and the prices of Products at any time. If changes are made following the Order Confirmation, SPARCO will inform the Purchaser on a timely basis. The ownership of SPARCO Products is only transferred to the Purchaser on completion of the payment. Failure to pay an invoice will result in an immediate freeze on shipments and the acceptance of new Orders.

WARRANTY AND RETURN PROCEDURES

SPARCO Products are warranted against manufacturing defects for a period of 2 (two) years from the date of purchase. This warranty is void if Products are altered and/or used and/or maintained improperly, as determined with reference to the User and Maintenance Manual (when supplied). The SPARCO warranty excludes all labour and transport costs. The Purchaser accepts the SPARCO warranty conditions regarding the use and maintenance of the Products. Complaints about damaged shipments and/or theft must be notified to the courier before acceptance of the Products by the Purchaser. Requests for credit for damage and/or theft will be ignored unless specific reservations are written on the delivery documents presented by the courier. Manufacturing defects must be notified to SPARCO within 30 (thirty) days from the date of delivery. With regard to material or manufacturing defects, howsoever arising and with whatsoever consequences, SPARCO shall only be required to replace, repair or credit the price for the defective product, at its sole discretion. All complaints and returns under warranty must be authorised in writing by SPARCO before the Products are returned. Such authorisation will be given or refused on the basis of the description of the defect/complaint and the evidence provided by the Purchaser. Authorisation of the return shall not be deemed acceptance of the complaint or a reason for replacement. Products no longer in production or whose type approval has expired cannot be returned, except in the case of recognised manufacturing defects. All Products returns must be received “carriage paid” by SPARCO and must be accompanied by delivery documents that are complete and accurate in all respects (quantity/item code/description).

COMPLIANCE WITH THE CODE OF ETHICS

Pursuant to the provisions of Decree 231 dated 8 June 2001 and subsequent amendments and additions (the “Decree”), as well as to the principles, regulations and standards envisaged in the organisation, management and control model adopted by SPARCO pursuant to the Decree (the “Model”) and the code of ethics containing the corporate ethical standards adopted by SPARCO (the “Code of Ethics”), SPARCO has published the Model and the Code of Ethics on the SPARCO website, www.sparco-official.it. SPARCO invites the Purchaser to read the Model and Code of Ethics, to comply with the principles and values expressed in the Code of Ethics, to behave in a manner consistent with the Model and, in all cases, to behave in a way that does not expose SPARCO to the risk of incurring the penalties envisaged in the above Decree.

JURISDICTION

All disputes relating to these General Conditions of Sale and to the sales governed by them shall be referred to the sole jurisdiction of the Milan Court.

PRIVACY

All information processed by SPARCO that is identifiable as “personal data” will be processed in full compliance with current regulations, with particular reference to Regulation (EU) 2016/679 (“GDPR”), Decree 196/2003 and all other applicable regulations.





sparco[®]

WRC
TEAM M-SPORT



Discover other automotive seats on our website.