

CATALOG

FORN

SPEED

Performance



ECTRE®

PERFORMANCE

DREAM. BUILD. DRIVE.™



- *ENGINE ACCESSORIES*
- *AIR FILTERS*
- *INTAKE SYSTEMS*

CONTENTS

ENGINE COMPONENT COVERS 2

- GM Engine Component Covers 2
- Dodge/Chrysler Engine Component Covers . 6
- Ford Engine Component Covers 8

PERFORMANCE AIR FILTERS 12

- OE Replacement Performance Air Filters . . 12
- Air Filter Oil and Cleaner 13
- Universal Performance Air Filters 13
- Diesel Air Filters 18

INTAKE SYSTEMS 20

- Throttle Body Spacers 20
- Performance Air Intake Systems 22
- Diesel Air Intake Systems 23
- Muscle Car Intake Systems 24
- Build Your Own Intake System 30
 - Air Intake Plenums 31
 - Air Intake Heat Shields 34
 - Air Intake Tubes 36
- Modular Air Intake Systems (M.A.I.S.) . . . 42
- Air Intake Couplers and Ducting 46
- Air Intake Accessories 50
- Mass Air Flow Sensor Components 52
- Performance Airboxes 54

AIR CLEANERS 56

- Cowl Style Air Cleaners 56
- EXTRAFLOW® Air Cleaners 57
- Custom HPR™ Air Cleaners 58
- Chrome Air Cleaners 62
- Air Cleaner Accessories 66

ENGINE DETAILING 68

- Amc/Jeep 70
- Buick 70
- Cadillac 70
- Chevrolet 71
- Chrysler 91
- Ford 93
- Oldsmobile 99
- Pontiac 100
- Alternator Parts 101
- Valve Cover Hold Downs 102

- Spreader Bars 103
- Oil Filler Caps 103
- Breathers 105
- Power Steering Accessories 109

PLUMBING 110

- Vacuum Lines 110
- Fuel Lines 111
- Heater Hoses 112
- Radiator Hoses and Fittings 114
- Hose Sleeving and Fittings 118
- Radiator Caps and Accessories 120
- Water Neck 123

FUEL AND IGNITION 124

- Ignition Wire Accessories 125
- Distributor Accessories 127
- Wire Harness Accessories 128
- Fuel Pump Plates 129
- Fuel Lines 130
- Fuel Filters 132
- Pressure Gauges and Regulators 133
- Brackets, Cable and Springs 134
- Carburetor Mounting 136

HARDWARE 138

- Fasteners 138

DRIVETRAIN ACCESSORIES 142

- Transmission Accessories 142
- Differential Covers 151

GENERAL ACCESSORIES 158

- Interior/exterior Accessories 158
- Master Cylinder Covers 160
- Exhaust Tips and Components 160
- Oil Filter Covers 161

APPLICATION LISTINGS 162

- OE Replacement Performance Air Filters . . 162
- Performance Intake Systems 326

The following are trademarks and/or registered trademarks of Spectre Performance. Spectre, Spectre Logo, HPR Horsepower Rated Logo, Accucharge Precision Oiling System Logo, Extraflow, Magna Kool and Magnabraid. Spectre Performance protects its marks and other legal rights against infringers.

DREAM.**BUILD.****DRIVE.**

For over 30 years Spectre Performance has been obsessed with cars, racing and speed. Since 1983 Spectre has designed and offered unique and innovative parts and components to fuel your car or truck obsession. Our products are designed and tested to perform and last. Whether your fixation happens to be a street rod, classic muscle car or modern car or pickup truck, Spectre® will help fuel your passion for performance.

SPECTRE®

Performance



2010 - 15 V6/V8
CAMARO



2009 - 16 V6/V8
**CHALLENGER/CHRYSLER 300
CHARGER**



2011 - 16 V6/V8
MUSTANG



*May fit other vehicles. Please go to our Website for a complete application listing. **Not all covers will fit all applications.

DREAM. BUILD. DRIVE.™

ENGINE COMPONENT COVERS

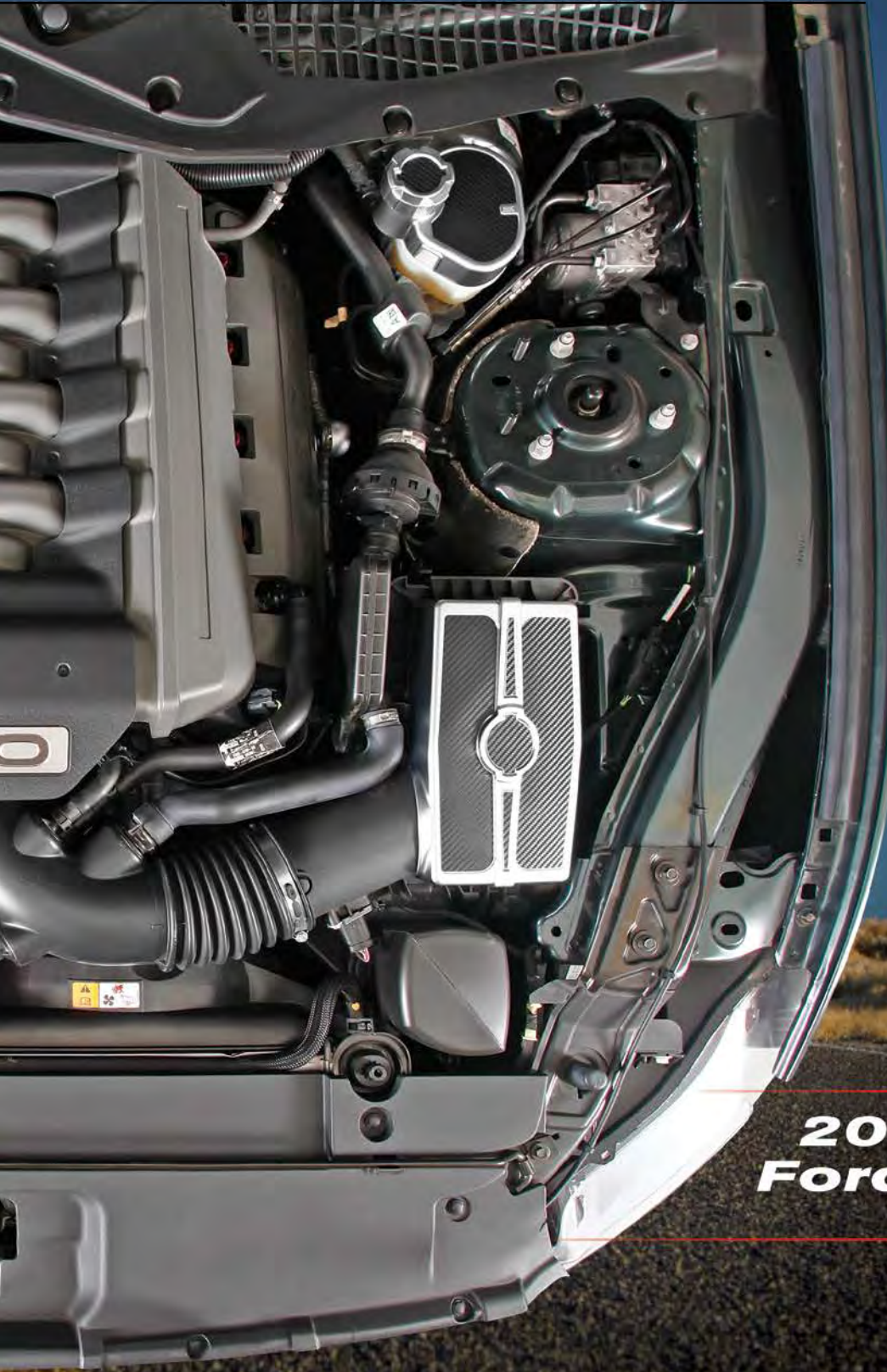

**EASILY ATTACHES TO YOUR
VEHICLE'S STOCK COMPONENTS**

- BRAKE FLUID RESERVOIR COVER*
- FUSE BOX COVER
- WASHER FLUID CAP COVER
- COOLANT RESERVOIR CAP COVER
- RADIATOR CAP COVER*
- BRAKE FLUID CAP COVER*
- OIL CAP COVER
- DIPSTICK HANDLE COVER
- BRAKE FITTING COVERS*
- AIR BOX COVER

* Not available for all applications

**2015-16 V6 / V8
Ford Mustang**

GM ENGINE COMPONENT COVERS



**2010 - 15 V6/V8
CAMARO**

- Personalize Your Engine Bay
- Fits 2010 - 2015 V-6 & V-8 Camaro*
- Covers Fit Over Existing Caps/Lids
- Durable ABS construction
- Variety of finishes each with a carbon fiber design accent
- Easy and secure installation
- Two styles available

BEFORE



AFTER

*May fit other vehicles. Please go to our Website for a complete application listing. **Not all covers will fit all applications.

GM ENGINE COMPONENT COVERS

MODERN DESIGN

These Spectre engine component covers are designed to match the modern muscle car engine bay. They fit securely over 10 different caps and components under the hood of 2010 - 2015 Chevrolet Camaro V-6 and V-8 models.*



2010 - 2015 Chevrolet Camaro V-6 and V-8*

Style Name - Modern	SPE Part # CHROME	SPE Part # BLACK	SPE Part # BRONZE	SPE Part # SILVER
BRAKE FLUID CAP COVER	42732	42732K	42732G	42732S
OVERFLOW CAP COVER	42733	42733K	42733G	42733S
RADIATOR CAP COVER	42734	42734K	42734G	42734S
OIL CAP COVER	42735	42735K	42735G	42735S
WINDSHIELD WASHER CAP COVER	42736	42736K	42736G	42736S
CAP KIT- (5 Caps total)	42739	42739K	42739G	42739S

*May fit other vehicles. Please go to our Website for a complete application listing. **Not all covers will fit all applications.

- ENGINE BAY COVERS
- PERFORMANCE AIR FILTERS
- INTAKE SYSTEMS
- AIR CLEANERS
- ENGINE DETAILING
- PLUMBING
- FUEL AND IGNITION
- HARDWARE
- DRIVETRAIN ACCESSORIES
- GENERAL ACCESSORIES











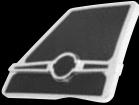

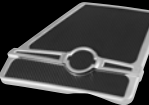
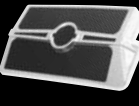





GM ENGINE COMPONENT COVERS

MODERN DESIGN

These Spectre® engine component covers are designed to match the modern muscle car engine bay. They fit securely over ten different caps and components under the hood of 2010 - 2015 Chevrolet Camaro V-6 and V-8 models.*

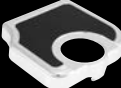
2010 - 2015 Chevrolet Camaro V-6 and V-8*

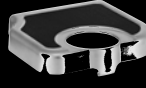
Style Name - Modern	SPE Part # CHROME	SPE Part # BLACK	SPE Part # BRONZE	SPE Part # SILVER
AIR INTAKE BOX COVER	42731	42731K	42731G	42731S
				
FUSE BOX COVER	42737	42737K	42737G	42737S
				
BRAKE FITTING COVERS (4)	42751	42751K	42751G	42751 S
				
OVERFLOW CAP COVER	42752	42752K	42752G	42752S
				
BRAKE FLUID RESERVOIR COVER	42753	42753K	42753G	42753S
				

MODERN DESIGN GENERAL APPLICATIONS**

These Spectre® chrome engine component covers may fit other GM/Chevy vehicles including those listed below. Please go to our website for a complete year and application listing.

2010 - 2015 CHEVROLET CAMARO SS 6.2L V8 F/I - AII & 3.6L V6 F/I - AII

2011 - 2013 CHEVROLET CAPRICE 6.0L V8 F/I - AII & 3.6L V6 F/I - AII

2012 - 2015 CHEVROLET CAPTIVA SPORT 3.0L V6 F/I - AII and 2.4L L4 F/I - AII

2008 - 2016 CHEVROLET EQUINOX 3.6L V6 F/I - AII & 2.4L L4 F/I - AII

2010 - 2012 CHEVROLET EQUINOX 3.0L V6 F/I - AII & 2.4L L4 F/I - AII

2007 - 2009 CHEVROLET EQUINOX 3.4L V6 F/I - AII

2015 - 2016 CHEVROLET IMPALA LIMITED POLICE 3.6L V6 F/I - AII

2013 - 2016 CHEVROLET IMPALA LIMITED 3.6L V6 F/I - AII

2012 - 2016 CHEVROLET IMPALA 3.6L V6 F/I - AII

2009 - 2011 CHEVROLET IMPALA 3.9L V6 F/I - AII & 3.5L V6 F/I - AII

2009 CHEVROLET IMPALA 5.3L V8 F/I - AII

2014 - 2015 GMC TERRAIN 3.6L V6 F/I - AII & 2.4L L4 F/I - AII

2010 - 2016 GMC TERRAIN 3.6L V6 F/I - AII — 3.0L V6 F/I - AII — 2.4L L4 F/I - AII

2014 CADILLAC CTS V-SPORT 3.6L V6 F/I - AII

2014 CADILLAC CTS 2.0L L4 F/I - AII

2011 - 2014 CADILLAC CTS 6.2L V8 F/I - AII

2009 - 2014 CADILLAC CTS 3.6L V6 F/I - AII

2010 - 2014 CADILLAC CTS 3.0L V6 F/I - AII

2009 - 2010 CADILLAC STS 4.6L V8 F/I - AII

2009 - 2010 CADILLAC STS 3.6L V6 F/I - AII

2009 CADILLAC STS-V 4.4L V8 F/I - AII

2009 - 2015 CADILLAC CTS-V 6.2L V8 F/I - AII









*May fit other vehicles. Please go to our Website for a complete application listing. **Not all covers will fit all applications.

GM ENGINE COMPONENT COVERS

CIRCULAR DESIGN

These Spectre® engine component covers are reminiscent of the classic punched or dimpled sheet metal look. They fit securely over the seven different caps and components under the hood of 2010 - 2015 Chevrolet Camaro V-6 and V-8 models.*

2010 - 2015 Chevrolet Camaro V-6 and V-8*

Style Name - Circular	SPE Part # CHROME	SPE Part # BLACK	SPE Part # BRONZE	SPE Part # SILVER
AIR INTAKE BOX COVER	42721	42721K	42721G	42721S
				
BRAKE FLUID CAP COVER	42722	42722K	42722G	42722S
				
OVERFLOW CAP COVER	42723	42723K	42723G	42723S
				
RADIATOR CAP COVER	42724	42724K	42724G	42724S
				
OIL CAP COVER	42725	42725K	42725G	42725S
				
WINDSHIELD WASHER CAP COVER	42726	42726K	42726G	42726S
				
FUSE BOX LID COVER	42727	42727K	42727G	42727S
				
CAP KIT- (5 Caps total)	42729	42729K	42729G	42729S
				

*May fit other vehicles. Please go to our Website for a complete application listing. **Not all covers will fit all applications.

ENGINE
BAY COVERSPERFORMANCE
AIR FILTERSINTAKE
SYSTEMS

AIR CLEANERS

ENGINE
DETAILING

PLUMBING

FUEL AND
IGNITION

HARDWARE

DRIVER/PA
ACCESSORIESGENERAL
ACCESSORIES

DODGE/CHRYSLER ENGINE COMPONENT COVERS



**2009 - 16 V6/V8
CHALLENGER / CHARGER
CHRYSLER 300**

- Personalize Your Engine Bay
- Fits 2009 - 2016 V-6 & V-8 Challenger/Charger/Chrysler 300*
- Covers Fit Over Existing Caps/Lids
- Durable ABS construction
- Variety of finishes each with a carbon fiber design accent
- Easy and secure installation



BEFORE



AFTER

*May fit other vehicles. Please go to our Website for a complete application listing. **Not all covers will fit all applications.

DODGE/CHRYSLER ENGINE COMPONENT COVERS

MODERN DESIGN

These Spectre® engine component covers are designed to match the modern muscle car engine bay look. They fit securely over the six different caps and components under the hood of 2009 - 2016 Dodge / Chrysler V-6 and V-8 models.*

2009 - 2016 Charger / Challenger / Chrysler 300 V-6 and V-8*

Style Name - Modern	SPE Part # CHROME	SPE Part # BLACK	SPE Part # BRONZE	SPE Part # SILVER
AIR INTAKE BOX COVER	42821	42821K	42821G	42821S
OVERFLOW CAP COVER	42823	42823K	42823G	42823S
OIL CAP COVER	42825	42825K	42825G	42825S
WINDSHIELD WASHER CAP COVER	42826	42826K	42826G	42826S
FUSE BOX LID COVER 2015 - 2016 MODELS	42827	42827K	42827G	42827S
FUSE BOX LID COVER 2009 - 2014 MODELS	42837	42837K	42837G	42837S
CAP KIT- (3 Caps total)	42829	42829K	42829G	42829S
OIL DIPSTICK COVER	42831	42831K	42831G	42831S

MODERN DESIGN GENERAL APPLICATIONS**

- 2013-2016 DODGE CHARGER 6.4L V8 F/I - All
- 2013-2016 DODGE CHARGER 6.2L V8 F/I - All
- 2011-2016 DODGE CHARGER 5.7L V8 F/I - All
- 2011-2016 DODGE CHARGER 3.6L V6 F/I - All
- 2011-2016 DODGE CHALLENGER 6.4L V8 F/I - All
- 2011-2016 DODGE CHALLENGER 6.2L V8 F/I - All
- 2011-2016 DODGE CHALLENGER 5.7L V8 F/I - All
- 2011-2016 DODGE CHALLENGER 3.6L V6 F/I - All
- 2011-2016 CHRYSLER 300, 300C 3.6L V6 F/I - All
- 2011-2016 CHRYSLER 300C, 300S 5.7L V8 F/I - All
- 2012-2015 CHRYSLER 300 6.4L V8 F/I - All

- ENGINE BAY COVERS
- PERFORMANCE AIR FILTERS
- INTAKE SYSTEMS
- AIR CLEANERS
- ENGINE DEFILING
- PLUMBING
- FUEL AND IGNITION
- HARDWARE
- DRIVER/PAINT ACCESSORIES
- GENERAL ACCESSORIES

*May fit other vehicles. Please go to our Website for a complete application listing. **Not all covers will fit all applications.

FORD ENGINE COMPONENT COVERS



- Personalize Your Engine Bay
- Fits 2016 – 2015 V-6 & V-8 Mustang*
- Covers Fit Over Existing Caps/Lids
- Durable ABS construction
- Variety of finishes each with a carbon fiber design accent
- Easy and secure installation

**2011 - 16 V6/V8
MUSTANG**

BEFORE



AFTER

*May fit other vehicles. Please go to our Website for a complete application listing. **Not all covers will fit all applications.

FORD ENGINE COMPONENT COVERS

MODERN DESIGN

These Spectre® engine component covers are designed to match the modern muscle car engine bay look. They fit securely over eight different caps and components under the hood of 2011 - 2016 Ford Mustang V-6 and V-8 models*:



2011 - 2016 FORD MUSTANG V-6 and V-8*

Style Name - Modern	SPE Part # CHROME	SPE Part # BLACK	SPE Part # BRONZE	SPE Part # SILVER
AIR BOX LID ACCENT 2015 - 2016 MODELS	42921	42921K	42921G	42921S
AIR BOX LID ACCENT 2011 - 2014 MODELS	42931	42931K	42931G	42931S
BRAKE RES. COVER	42922	42922K	42922G	42922S
OVERFLOW CAP COVER 2015 - 2016 MODELS	42923	42923K	42923G	42923S
OVERFLOW CAP COVER 2011 - 2014 MODELS	42933	42933K	42933G	42933S
OIL CAP	42925	42925K	42925G	42925S
WASHER FLUID CAP	42926	42926K	42926G	42926S

*May fit other vehicles. Please go to our Website for a complete application listing. **Not all covers will fit all applications.

- ENGINE
BAY COVERS
- PERFORMANCE
AIR FILTERS
- INTAKE
SYSTEMS
- AIR CLEANERS
- ENGINE
DEFILING
- PLUMBING
- FUEL AND
IGNITION
- HARDWARE
- DRIVETRAIN
ACCESSORIES
- GENERAL
ACCESSORIES

FORD ENGINE COMPONENT COVERS

MODERN DESIGN CHROME

These Spectre® engine component covers are designed to match the modern muscle car engine bay look. They fit securely over eight different caps and components under the hood of 2011 - 2016 Ford Mustang V-6 and V-8 models*.

2011 - 2016 Ford Mustang V-6 and V-8*

Style Name - Modern	SPE Part # CHROME	SPE Part # BLACK	SPE Part # BRONZE	SPE Part # SILVER
FUSE BOX LID ACCENT	42927	42927K	42927G	42927S

2015 - 2016 MODELS

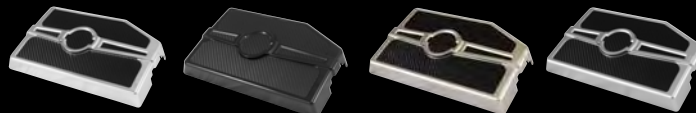

FUSE BOX LID ACCENT	42937	42937K	42937G	42937S
---------------------	-------	--------	--------	--------

2011 - 2014 MODELS

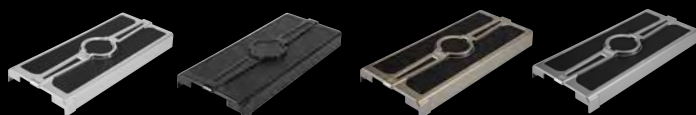

CAP KIT - (4 Caps total)	42929	42929K	42929G	42929S
--------------------------	-------	--------	--------	--------

2015 - 2016 MODELS



DIP STICK COVER	42951	42951K	42951G	42951S
-----------------	-------	--------	--------	--------



BRAKE FLUID RESERVOIR COVER	42954	42954K	42954G	42954S
-----------------------------	-------	--------	--------	--------

2011 - 2014 MODELS

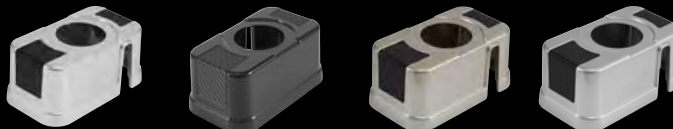

BRAKE FLUID RESERVOIR COVER	42953	42953K	42953G	42953S
-----------------------------	-------	--------	--------	--------

2015 - 2016 MODELS

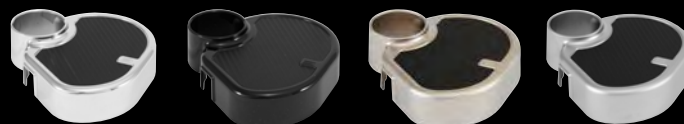

*May fit other vehicles. Please go to our Website for a complete application listing. **Not all covers will fit all applications.

FORD ENGINE COMPONENT COVERS

MODERN DESIGN GENERAL FORD APPLICATIONS**

These Spectre® chrome engine component covers may fit other vehicles, please go to our website for a complete application listing.

2007 - 2011 FORD CROWN VICTORIA
POLICE INTERCEPTOR 4.6L V8 F/I - All
2007 - 2011 FORD CROWN VICTORIA 4.6L V8 F/I - All

2011 - 2014 FORD EDGE 3.7L V6 F/I - All
2007 - 2016 FORD EDGE 3.5L V6 F/I - All
2015 FORD EDGE 2.7L V6 F/I - All

2003 - 2014 FORD EXPEDITION 5.4L V8 F/I - All
2003 - 2004 FORD EXPEDITION 4.6L V8 F/I - All

2011 - 2016 FORD EXPLORER 3.5L V6 F/I - All
2013 FORD EXPLORER SPORT 3.5L V6 F/I - All
2008 - 2010 FORD EXPLORER SPORT TRAC 4.6L V8 F/I - All
2003 FORD EXPLORER 4.6L V8 F/I - All

2001 - 2012 FORD ESCAPE 3.0L V6 F/I - All

2005 - 2007 FORD FIVE HUNDRED 3.0L V6 F/I - All

2009 - 2016 FORD FLEX 3.5L V6 F/I - All

2005 - 2007 FORD FREESTYLE 3.0L V6 F/I - All

2010 - 2012 FORD FUSION 3.5L V6 F/I - All
2006 - 2010 FORD FUSION 3.0L V6 F/I - All

2011 - 2017 FORD MUSTANG GT 5.0L V8 F/I - All
2011 - 2016 FORD MUSTANG 3.7L V6 F/I - All
2008 - 2009 FORD MUSTANG BULLITT 4.6L V8 F/I - All

2007 - 2010 FORD MUSTANG 4.6L V8 F/I - All
2005 - 2010 FORD MUSTANG GT 4.6L V8 F/I - All
2013 FORD MUSTANG BOSS 302 5.0L V8 F/I - All

2001 - 2008 FORD RANGER 3.0L V6 F/I - All

2014 FORD TAURUS SHO 3.5L V6 F/I - All
2008 - 2016 FORD TAURUS 3.5L V6 F/I - All
2008 - 2009 FORD TAURUS X 3.5L V6 F/I - All
2001 - 2007 FORD TAURUS 3.0L V6 F/I - All

2016 FORD F450 6.8L V10 F/I - All
2005 - 2016 FORD F450 SUPER DUTY 6.8L V10 F/I - All
2008 - 2009 FORD F450 6.8L V10 F/I - All
2007 FORD F450 CUTAWAY 6.8L V10 F/I - All
2011 - 2016 FORD F350 SUPER DUTY 6.2L V8 F/I - All
2005 - 2010 FORD F350 SUPER DUTY 6.8L V10 F/I - All
2011 - 2016 FORD F250 SUPER DUTY 6.2L V8 F/I - All
2005 - 2010 FORD F250 SUPER DUTY 6.8L V10 F/I - All

2011 - 2014 FORD F150 6.2L V8 F/I - All
2011 - 2016 FORD F150 5.0L V8 F/I - All
2015 - 2016 FORD F150 3.5L V6 F/I - All
2015 FORD F150 3.5L V6 F/I - All
2011 FORD F150 SVT RAPTOR 6.2L V8 F/I - All
2011 FORD F150 PLATINUM 6.2L V8 F/I - All
2011 - 2014 FORD F150 3.7L V6 F/I - All
2010 - 2014 FORD F150 SVT RAPTOR 6.2L V8 F/I - All
2010 FORD F150 SVT RAPTOR 5.4L V8 F/I - All
2005 - 2010 FORD F150 5.4L V8 F/I - All
2005 - 2010 FORD F150 4.6L V8 F/I - All

2005 - 2008 FORD F150 4.2L V6 F/I - All
2004 FORD F150 LIGHTNING 5.4L V8 F/I - All
2004 FORD F150 HERITAGE 5.4L V8 F/I - All
2004 FORD F150 HERITAGE 4.6L V8 F/I - All
2004 FORD F150 HERITAGE 4.2L V6 F/I - All
2004 FORD F150 5.4L V8 F/I - All
2004 FORD F150 4.6L V8 F/I - All
2004 FORD F150 4.2L V6 F/I - All

2010 - 2011 LINCOLN MKS 3.7L V6 F/I - All
2010 - 2014 LINCOLN MKS 3.5L V6 F/I - All
2012 - 2014 LINCOLN MKT 3.7L V6 F/I - All
2009 - 2014 LINCOLN NAVIGATOR 5.4L V8 F/I - All
2002 - 2010 LINCOLN TOWN CAR 4.6L V8 F/I - All
2007 - 2009 LINCOLN MKX 3.5L V6 F/I - All
2006 - 2008 LINCOLN MARK LT 5.4L V8 F/I - All
2000 - 2005 LINCOLN LS 3.0L V6 F/I - All
2006 LINCOLN ZEPHYR 3.0L V6 F/I - All

2007 - 2009 MERCURY GRAND MARQUIS 4.6L V8 F/I - All
2005 - 2009 MERCURY MARINER 3.0L V6 F/I - All
2006 - 2009 MERCURY MILAN 3.0L V6 F/I - All
2006 - 2007 MERCURY MONTEGO 3.0L V6 F/I - All
2009 MERCURY MOUNTAINEER 4.6L V8 F/I - All
2008 - 2009 MERCURY SABLE 3.5L V6 F/I - All
2000 - 2005 MERCURY SABLE 3.0L V6 F/I - All

ENGINE
BAY COVERSPERFORMANCE
AIR FILTERSINTAKE
SYSTEMS

AIR CLEANERS

ENGINE
DEFILLING

PLUMBING

FUEL AND
IGNITION

HARDWARE

DRIVE TRAIN
ACCESSORIESGENERAL
ACCESSORIES

*May fit other vehicles. Please go to our Website for a complete application listing. **Not all covers will fit all applications.

SPEED

Performance



SPECTRE®

PERFORMANCE

DREAM. BUILD. DRIVE.™



PERFORMANCE AIR FILTERS

OE REPLACEMENT PERFORMANCE AIR FILTERS

- High-flow replacement filter engineered for outstanding airflow and performance
- Easy to install with no special tools or skills required
- Quality materials used throughout, including high-quality synthetic media, urethane and steel mesh

**ENGINEERED TO
ADD PERFORMANCE**

**WASHABLE AND
REUSABLE**

**PRE-OILED AND
READY TO USE**

**WILL NOT VOID
NEW CAR WARRANTY**

***SEE PAGE 166 FOR COMPLETE
APPLICATION LISTINGS***

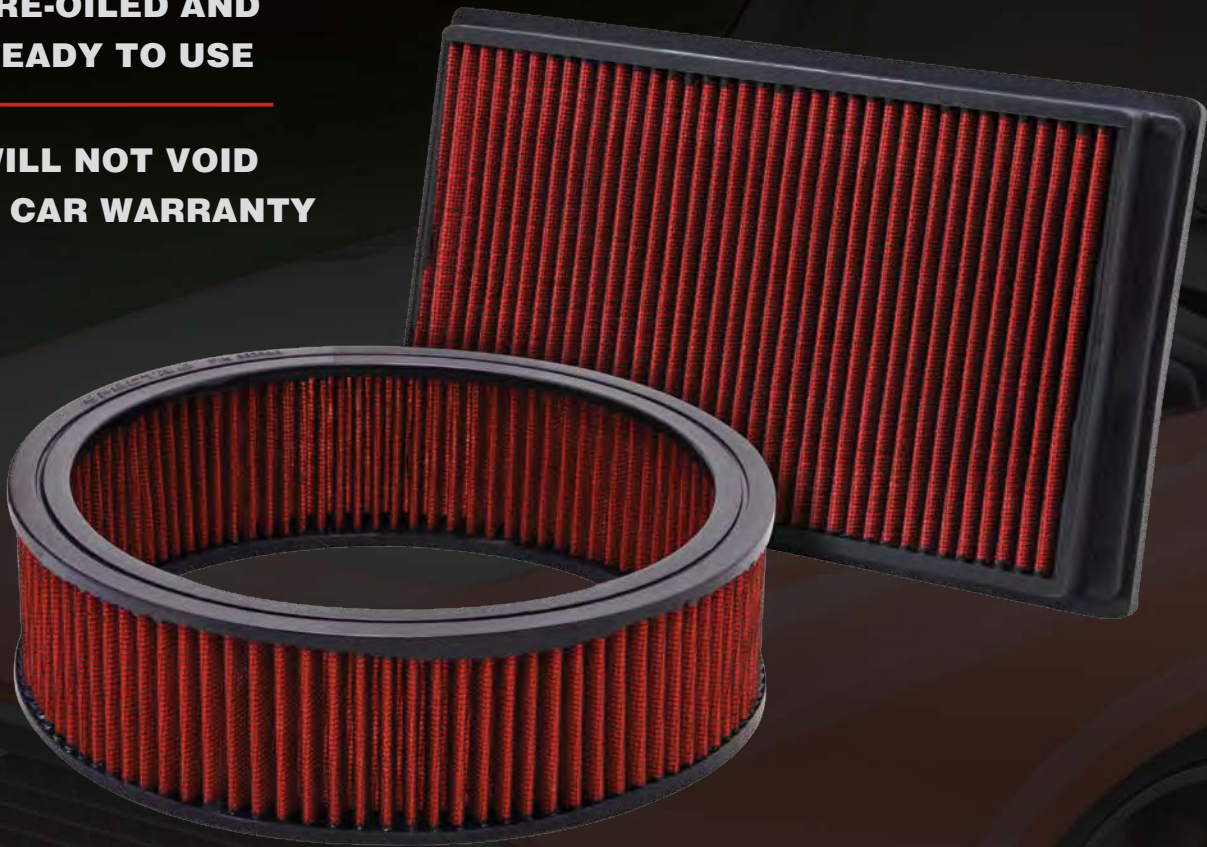

OUR PROMISE TO YOU

These filters are designed and engineered to produce more power and provide your vehicle with quicker acceleration. They are manufactured to exacting standards in order to outperform traditional air filters.

UNIVERSAL PERFORMANCE AIR FILTERS

- High-flow racing filter engineered for outstanding airflow and performance
- Quality materials used throughout, including high-quality synthetic media, urethane and steel mesh
- Many cone filters available with openings that range 2 1/2" to 6" in red, blue, black and white



ENGINE
BRAV COVERS

PERFORMANCE
AIR FILTERS

INTAKE
SYSTEMS

AIR CLEANERS

ENGINE
DEFILING

PLUMBING

FUEL AND
IGNITION

HARDWARE

DRIVETRAIN
ACCESSORIES

GENERAL
ACCESSORIES

AIR FILTER OIL AND CLEANER

- Designed specifically for the cleaning and care of all Spectre® air filters
- Comes complete with 12 fl. oz. cleaner and 8 fl. oz. oil bottles



#HPR4820



#884820

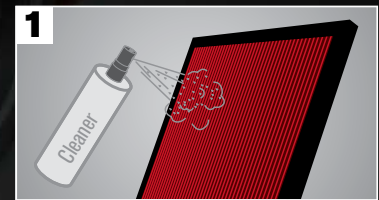

Apply Cleaner and wait 10 min.

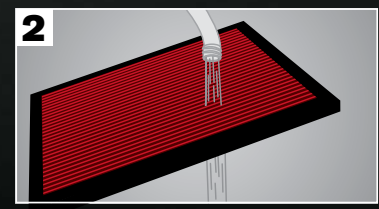

Rinse with low pressure water and allow filter to dry completely



Oil filter.

ACCUCHARGE
PRECISION OILING SYSTEM®

UNIVERSAL PERFORMANCE AIR FILTERS

CONE AIR FILTERS WITH MULTI-FIT BASE

- Multi fit base allows for use on 3", 3-1/2" and 4" applications

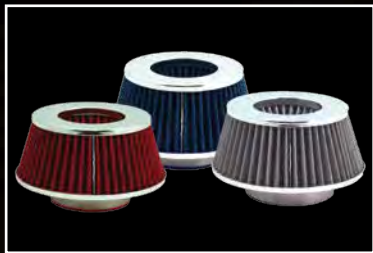
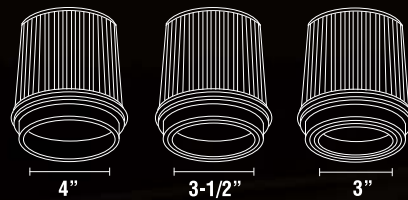

CONE FILTER - MULTI-FIT BASE

Color	Part Number
Red	8162
Blue	8166
White	8168
Black	8161

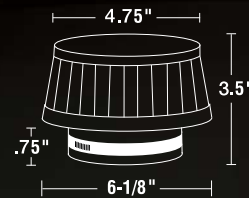

CONE FILTER - MULTI-FIT BASE

Color	Part Number
Red	8132
Blue	8136
White	8138
Black	8131



CONE FILTER - MULTI-FIT BASE

Color	Part Number
Red	9732
Blue	9736
White	9738
Black	9731

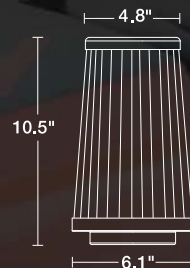

CONE AIR FILTERS



CONE FILTER - 3" INLET

Color	Part Number
Red	9132
Blue	9136
White	9138
Black	9131



2.5" HPR™ FILTER - 2.5" INLET

Color	Part Number
Red	HPR9609
Blue	HPR9609B
Black	HPR9609K
White	HPR9609W

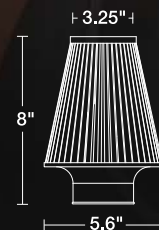

May not be legal for use on pollution-controlled vehicles. Check local laws.

UNIVERSAL PERFORMANCE AIR FILTERS

CONE AIR FILTERS



2.75" HPR™ FILTER - 2.75" INLET

Color	Part Number
Red	HPR9888
Blue	HPR9888B
Black	HPR9888K
White	HPR9888W

Replacement for #10268
Cold Air Intake Kit

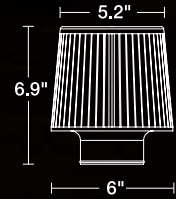

3" HPR™ FILTER - 3" INLET

Color	Part Number
Red	HPR9610
Blue	HPR9610B
Black	HPR9610K
White	HPR9610W

Replacement for #9944/9962
Cold Air Intake Kits

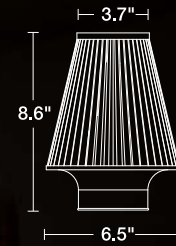

3" HPR™ FILTER - 3" INLET

Color	Part Number
Red	HPR9884
Blue	HPR9884B
Black	HPR9884K
White	HPR9884W

Replacement for #9902/9940/9961
Cold Air Intake Kits

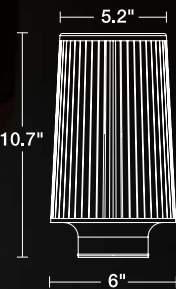

3.5" HPR™ FILTER - 3.5" INLET

Color	Part Number
Red	HPR9935
Blue	HPR9935B
Black	HPR9935K
White	HPR9935W

Replacement for #9022/9935
Cold Air Intake Kits

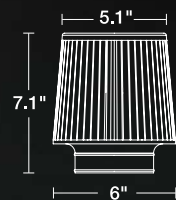

3.5" HPR™ FILTER - 3.5" INLET

Color	Part Number
Red	HPR9611
Blue	HPR9611B
Black	HPR9611K
White	HPR9611W

Replacement for #9022/9935
Cold Air Intake Kits

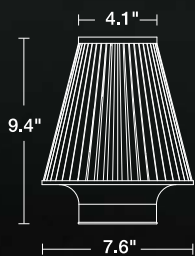

3.5" HPR™ FILTER - 3.5" INLET

Color	Part Number
Red	HPR9883
Blue	HPR9883B
Black	HPR9883K
White	HPR9883W

Replacement for #9901/
9903/9904/9932
Cold Air Intake Kits

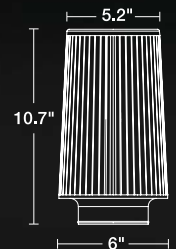

ENGINE
BAY COVERS

PERFORMANCE
AIR FILTERS

INTAKE
SYSTEMS

AIR CLEANERS

ENGINE
DEFILLING

PLUMBING

FUEL AND
IGNITION

HARDWARE

DRIVE TRAIN
ACCESSORIES

GENERAL
ACCESSORIES

May not be legal for use on pollution-controlled vehicles. Check local laws.

UNIVERSAL PERFORMANCE AIR FILTERS

CONE AIR FILTERS

4" HPR™ FILTER - 4" INLET



Color	Part Number
Red	HPR9616
Blue	HPR9616B
Black	HPR9616K
White	HPR9616W

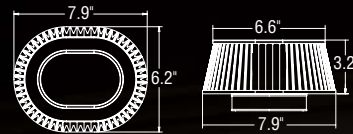

4" HPR™ FILTER - 4" INLET



Color	Part Number
Red	HPR9615
Blue	HPR9615B
Black	HPR9615K
White	HPR9615W

Replacement for #9906 Cold Air Intake Kit

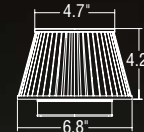

4" HPR™ FILTER - 4" INLET



Color	Part Number
Red	HPR9617
Blue	HPR9617B
Black	HPR9617K
White	HPR9617W

Replacement for #9901/9903/9904/9932 Cold Air Intake Kits

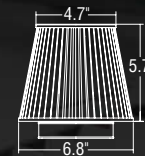

3.5" HPR™ FILTER - 3.5" INLET



Color	Part Number
Red	HPR9618
Blue	HPR9618B
Black	HPR9618K
White	HPR9618W

Replacement for #9912 Cold Air Intake Kit

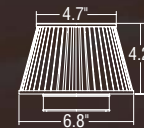

4" HPR™ FILTER - 4" INLET



Color	Part Number
Red	HPR9612
Blue	HPR9612B
Black	HPR9612K
White	HPR9612W

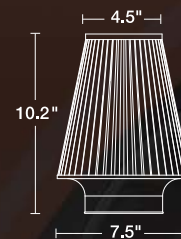

4" HPR™ FILTER - 4" INLET



Color	Part Number
Red	HPR9882
Blue	HPR9882B
Black	HPR9882K
White	HPR9882W

Replacement for #9920/9921/9922/9924/9925/9931 Cold Air Intake Kits



May not be legal for use on pollution-controlled vehicles. Check local laws.

UNIVERSAL PERFORMANCE AIR FILTERS

CONE AIR FILTERS

FILTERS FOR VELOCITY STACK ADAPTERS (SEE PAGE 9)



6" HPR™ FILTER - 6" INLET

Color	Part Number
Red	HPR9606
Blue	HPR9606B
Black	HPR9606K
White	HPR9606W

Replacement for #9003/
9014/9017/9051/9907/
9908/9909/9911/9974
Cold Air Intake Kit

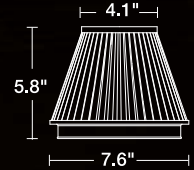

6" HPR™ FILTER - 6" INLET

Color	Part Number
Red	HPR9886
Blue	HPR9886B
Black	HPR9886K
White	HPR9886W

Replacement for #9017/
9024/9910/9913/9917/
9918/9923/9926/9929
Cold Air Intake Kits

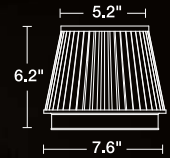

4" HPR™ FILTER - 4" INLET

Color	Part Number
Red	HPR9889
Blue	HPR9889B
Black	HPR9889K
White	HPR9889W

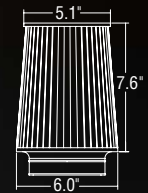

6" HPR™ FILTER - 6" INLET

Color	Part Number
Red	HPR9891
Blue	HPR9891B
Black	HPR9891K
White	HPR9891W

Replacement for #9004

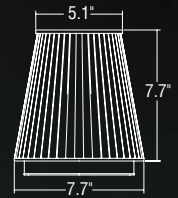

6" HPR™ FILTER - 6" INLET

Color	Part Number
Red	HPR9881
Blue	HPR9881B
Black	HPR9881K
White	HPR9881W

Replacement for #9900/
905034/905042/9963
Cold Air Intake Kits

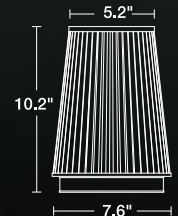

6" HPR™ FILTER - 6" INLET

Color	Part Number
Red	HPR9605
Blue	HPR9605B
Black	HPR9605K
White	HPR9605W

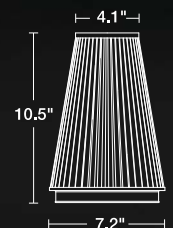

May not be legal for use on pollution-controlled vehicles. Check local laws.

ENGINE
BAY COVERS

PERFORMANCE
AIR FILTERS

INTAKE
SYSTEMS

AIR CLEANERS

ENGINE
DEFILING

PLUMBING

FUEL AND
IGNITION

HARDWARE

DRIVE TRAIN
ACCESSORIES

GENERAL
ACCESSORIES

UNIVERSAL PERFORMANCE AIR FILTERS

FILTERS FOR VELOCITY STACK ADAPTERS (SEE PAGE 9)



6" HPR™ FILTER - 6" INLET

Color	Part Number
Red	HPR9892
Blue	HPR9892B
Black	HPR9892K
White	HPR9892W

Replacement for
#9914/9932/9934/9970/
9033/9050/9016/9002
Cold Air Intake Kit

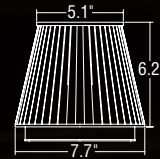

DIESEL AIR FILTERS

Specially Designed for diesel applications with double the filter media for even better filtration efficiency



6" HPR™ DIESEL FILTER - 6" INLET

Color	Part Number
Red	HPR0892
Blue	HPR0892B
Black	HPR0892K

Replacement for #9980
Cold Air Intake Kit

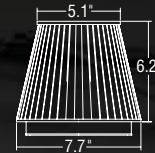

6" HPR™ DIESEL FILTER - 6" INLET

Color	Part Number
Red	HPR0891
Blue	HPR0891B
Black	HPR0891K

Replacement for #9005/
9938/9972/9973
Cold Air Intake Kit

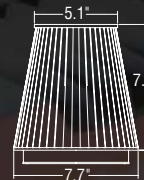

6" HPR™ DIESEL FILTER - 6" INLET

Color	Part Number
Red	HPR0881
Blue	HPR0881B
Black	HPR0881K

Replacement for #9939
Cold Air Intake Kit

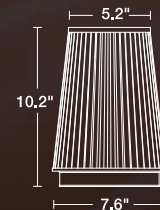

3.5" HPR™ DIESEL FILTER - 3.5" INLET

Color	Part Number
Red	HPR0883
Blue	HPR0883B
Black	HPR0883K

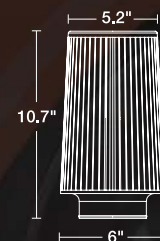

4" HPR™ DIESEL FILTER - 4" INLET

Color	Part Number
Red	HPR0882
Blue	HPR0882B
Black	HPR0882K

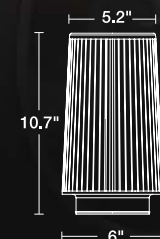

May not be legal for use on pollution-controlled vehicles. Check local laws.

UNIVERSAL PERFORMANCE AIR FILTERS

VELOCITY STACK ADAPTERS



Inlet	Height (x)	Part #
2.5" inlet centered	2.4"	9601
3" center	2.375"	9602
3.5" center	2.375"	9603
4" center	2.0"	9604
4" center	1.9"	9605
4" offset	1.9"	9606
4" angled center	3.625"	9609
4.5" center	1.9"	9610

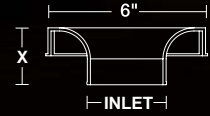

INLINE HPR™ FILTERS



#HPR0100 4" INLINE HPR™ FILTER

- Fits inside 4" O.D. tubing for a stealth look



#HPR9831 6" HPR™ FILTER

- Replacement filter for Spectre® Inline Air Box #9831



#HPR9832 5" INLINE HPR™ FILTER

- Replacement filter for Spectre® Inline Air Box #9832



#HPR9833 4" INLINE HPR™ FILTER

- Replacement filter for Spectre® Inline Air Box #9833 or Spectre® Cold Air Intake Kits #9943/9945/9948

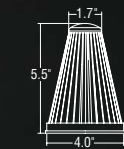
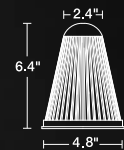
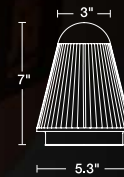
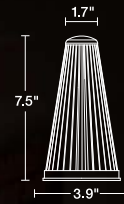

AIR FILTER HEAT SHIELDS



- Universal shield for use with HPR™ filters with 4" base or 3", 3.5" and 4" multi-fit bases
- Polished aluminum

Short	6.6"	#8130
Tall	10"	#9730

AIR FILTER WRAP

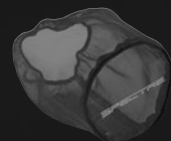

#8131DK

Fits Spectre® #813x series as well as most 6" long filters with a 6" base



#9731DK

Fits Spectre® #973x series as well as most 10" to 10 1/2 long filters with a 6" base

- This product wraps your air filter with an additional pre-filter
- Extends service interval of your filter
- Durable silicone treated polyester material with stitched elastic openings
- Water repellent treatment typically lasts 1 to 2 years

May not be legal for use on pollution-controlled vehicles. Check local laws.

ENGINE
BAY COVERS

PERFORMANCE
AIR FILTERS

INTAKE
SYSTEMS

AIR CLEANERS

ENGINE
DEFILING

PLUMBING

FUEL AND
IGNITION

HARDWARE

DRIVE TRAIN
ACCESSORIES

GENERAL
ACCESSORIES

SPEED

Perfor

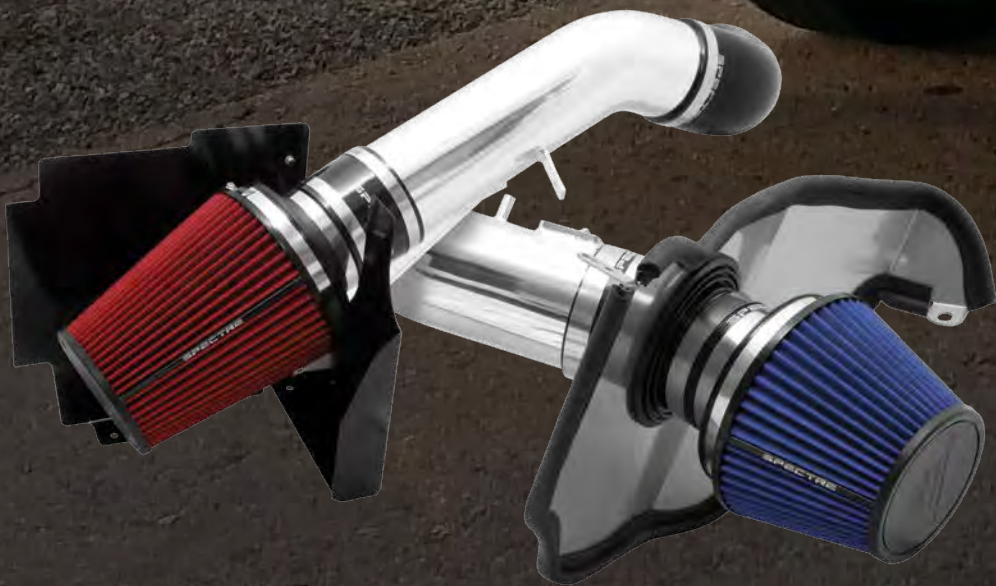

ETRE®

PERFORMANCE

DREAM. BUILD. DRIVE.™



INTAKES SYSTEMS

THROTTLE BODY SPACERS

- Designed to increase mid-range torque with the added benefits of faster acceleration and quicker throttle response
- Engineered with a slight peak on the leading edge of the entry point into the intake manifold, increasing the speed of the air entering the intake manifold which increases the internal pressure, creating additional torque and horsepower at lower RPM
- Also acts as a throttle body spacer which increases the volume of air inside the manifold adding even more power
- Includes all necessary gaskets and hardware to bolt directly to the factory components
- Can usually be installed in less than an hour using common hand tools with no drilling or cutting required
- Manufactured from quality machine finished aluminum
- Application specific - bolts directly to factory components
- 50 state legal - CARB exempt E.O. # D-629-5



CADILLAC

YEAR(S)	MODEL	PART #
1999-00	Escalade 5.7L Vortec	11257
2002-06	Escalade 5.3L, 6.0L	11251
2007-11	Escalade 6.0L, 6.2L	11256

CHEVROLET

YEAR(S)	MODEL	PART #
1999-06	Avalanche 4.8L, 5.3L, 6.0L, 8.1L	11251
2007-11	Avalanche 5.3L, 6.0L	11256
1986-95	C/K 1500 / 2500 / 3500 4.3L, 5.0L, 5.7L	11252
1987-90	C/K 1500 / 2500 / 3500 7.4L	11253
1996-00	C/K 1500 / 2500 / 3500 5.0L, 5.7L Vortec	11257
1988-95	S-10 4.3L	11252
1999-06	Silverado 1500 / 2500 / 3500 4.8L, 5.3L, 6.0L, 8.1L	11251
2007-11	Silverado 1500 4.8L, 5.3L, 6.0L, 6.2L	11256
2007	Silverado Classic 4.8L, 5.3L, 6.0L	11251
1999-06	Suburban 4.8L, 5.3L, 6.0L, 8.1L	11251
2007-11	Suburban 5.3L, 6.0L	11256
2007-11	Tahoe 4.8L, 5.3L, 6.0L, 6.2L	11256

DODGE/RAM

YEAR(S)	MODEL	PART #
2007-08	Aspen 5.7L Hemi	11258
2003-08	Durango 5.7L Hemi	11258
1994-02	Ram 1500 / 2500 / 3500 3.9L, 5.2L, 5.9L V8	11255
2003-08	Ram 1500 / 2500 / 3500 5.7L Hemi	11258

FORD

YEAR(S)	MODEL	PART #
2000-05	Excursion 6.8L	11254
1997-04	Expedition 4.6L, 5.4L	11261
2004-09	Expedition 5.4L SOHC	11259
1997-10	F-150 4.6L, 2-Valve	11261
1997-03	F-150 5.4L	11261
2004-09	F-150 5.4L SOHC	11259
1999-03	F-150 Lightning 5.4L DOHC	11254
1999-05	F-250 / F-350 Super Duty 6.8L	11254

GMC

YEAR(S)	MODEL	PART #
1986-95	C/K 1500 / 2500 / 3500 4.3L, 5.0L, 5.7L	11252
1987-90	C/K 1500 / 2500 / 3500 7.4L	11253
1996-00	C/K 1500 / 2500 / 3500 5.0L, 5.7L Vortec	11257
1988-95	S-15 4.3L	11252
1999-06	Sierra 1500 / 2500 / 3500 4.8L, 5.3L, 6.0L, 8.1L	11251
2007-11	Sierra 1500 4.8L, 5.3L, 6.0L, 6.2L	11256
2007	Sierra Classic 4.8L, 5.3L, 6.0L	11251
1999-06	Yukon 4.8L, 5.3L, 6.0L, 8.1L	11251
2007-11	Suburban 5.3L, 6.0L	11256
2007-11	Yukon / Yukon XL 4.8L, 5.3L, 6.0L, 6.2L	11256

THROTTLE BODY SPACERS



11254
• 1999-05 Ford Trucks - 5.4L V8, 6.8L V10



11251
• 1999-07 GM Trucks



11255
• 1994-02 Dodge - 3.9L V6, 5.2L, 5.9L V8



11252
• 1986-95 GM - 4.3L, 5.0L, 5.7L

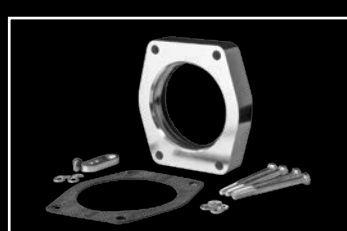

11256
• 1907-11 GM - 4.8L, 5.3L, 6.2L



11253
• 1987-90 GM - 7.4L



11257
• 1996-00 GM Trucks - 5.7L

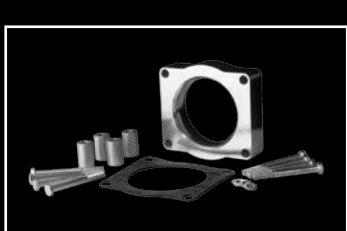

11259
• 2004-09 Ford Trucks - 5.4L

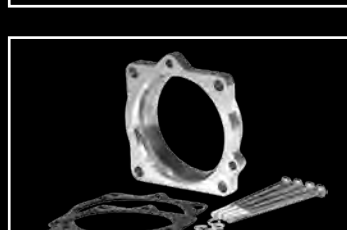

11258
• 2003-08 Dodge - 5.7L

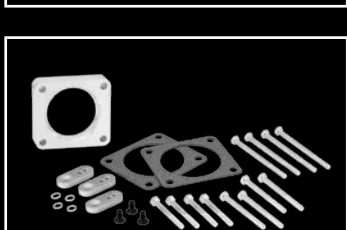

11261
• 1997-10 Ford Trucks - 4.6L, 5.4L

JEEP RENIX THROTTLE BODY ADAPTER - #99456



Spectre® 1987 - 1990 Jeep throttle body adapters are designed to fit Jeeps that had the 3-bolt Renix throttle body. This adapter provides a round neck flange on the throttle body so that you can attach a custom air intake tube on your classic Jeep.

- Bright anodized aluminum finish
- Includes gasket

May not be legal for use on pollution-controlled vehicles. Check local laws.

- ENGINE BRAKING COVERS
- PERFORMANCE AIR FILTERS
- INTAKE SYSTEMS**
- AIR CLEANERS
- ENGINE OILING
- PLUMBING
- FUEL AND IGNITION
- HARDWARE
- DRIVE TRAIN ACCESSORIES
- GENERAL ACCESSORIES

PERFORMANCE AIR INTAKE SYSTEMS

- Designed to increase horsepower and torque
- Manufactured from high quality polished aluminum or powder coated cast aluminum tubing
- Powder coated heat shield helps prevent hot air from entering the intake inlet
- Comes complete with an HPR™ air filter engineered for increased airflow and performance
- Most available with red, blue or black performance filter

SEE PAGE 326 FOR COMPLETE APPLICATION LISTINGS



**ENGINEERED TO ADD
HORSEPOWER
AND TORQUE**

**HIGH PERFORMANCE
AIR FILTER**

**HIGH QUALITY
ALUMINUM TUBING**

**MANY AVAILABLE
WITH MULTIPLE
AIR FILTER COLORS**



Some intake systems are not legal for sale or use on any pollution controlled motor vehicle in California or states adopting CA emission procedures.

DIESEL AIR INTAKE SYSTEMS

- Designed to increase horsepower and torque
- Manufactured from high quality polished aluminum or powder coated cast aluminum tubing
- Powder coated heat shield helps reduce hot air from entering the intake inlet
- Comes complete with a dual-layer HPR™ air filter engineered for increased airflow and performance
- Most intakes available with red, blue or black performance filter



Some intake systems are not legal for sale or use on any pollution controlled motor vehicle in California or states adopting CA emission procedures.

ENGINE
BAY
COVERSPERFORMANCE
AIR
FILTERSINTAKE
SYSTEMSAIR
CLEANERSENGINE
DEFILLING

PLUMBING

FUEL AND
IGNITION

HARDWARE

DRIVETRAIN
ACCESSORIESGENERAL
ACCESSORIES

MUSCLE CAR INTAKE SYSTEMS

- Designed to fit your classic muscle car
- Helps increase horsepower and torque by routing the intake inlet away from heat sources like the radiator or headers
- Manufactured from high quality polished aluminum tubing
- Powder coated heat shield helps reduce hot air from entering the intake inlet
- Comes complete with red HPR™ air filters engineered for increased airflow and performance
- Includes performance filter and all necessary boots, clamps, and hardware

DUAL SIDED FOR CARBURETED ENGINES

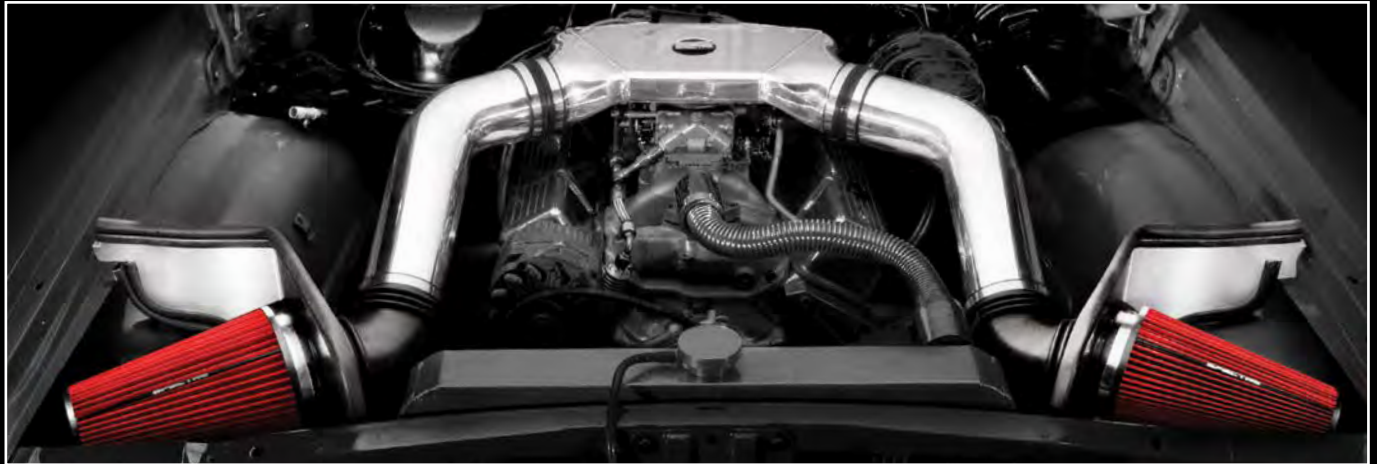

Battery must be relocated for dual intake installation

SINGLE INTAKE FOR CARBURETED ENGINES



Street legal in most states, but may not be used in California or states with similar emissions control laws except on pre 1976 vehicles.

Description	Filter Color	Part Number
1967-69 CAMARO		
Dual Intake Kit	Red	#900272
Single Intake Kit	Red	#900242
1970-81 CAMARO		
Dual Intake Kit	Red	#900172
Single Intake Kit	Red	#900142
1964-65 CHEVELLE		
Dual Intake Kit	Red	#901072
Single Intake Kit	Red	#901042
1966-67 CHEVELLE		
Dual Intake Kit	Red	#901172
Single Intake Kit Plenum	Red	#901142
1968-72 CHEVELLE		
Dual Intake Kit	Red	#901272
Single Intake Kit Plenum	Red	#901242
C-10 TRUCKS - 1967-72 CHEVROLET TRUCKS		
Driver Side Intake Kit	Red	#905042

Fits carburetors and throttle bodies with a 5 1/8" inlet. Always check for proper hood clearance before closing the hood.

MUSCLE CAR INTAKE SYSTEMS

DUAL SIDED FOR LS CONVERSIONS



Battery must be relocated for dual intake installation

SINGLE INTAKE FOR LS CONVERSIONS

Comes with a single one-piece tube and includes extra couplers for a boot-in MAF setup and weld-on MAF pad for a slot style MAF sensor



WITH BOOT-IN MAF



Designed for applications where LS engines have been installed using a boot-in MAFS system

WITH MAF PAD

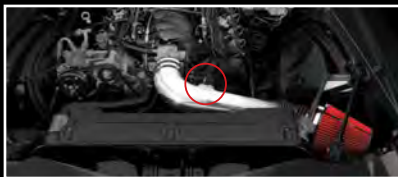

Designed for applications where LS engines have been installed using a slot style MAF sensor

Street legal in most states, but may not be used in California or states with similar emissions control laws except on pre 1976 vehicles.

Description	Filter Color	Part Number
1967-69 CAMARO WITH LS SWAP		
Dual Intake Kit	Red	#900202
Driver Side Intake Kit	Red	#900234
Passenger Side Intake Kit	Red	#900235
1970-81 CAMARO WITH LS SWAP		
Dual Intake Kit	Red	#900102
Driver Side Intake Kit	Red	#900134
Passenger Side Intake Kit	Red	#900135
1964-65 CHEVELLE WITH LS SWAP		
Dual Intake Kit	Red	#901002
Driver Side Intake Kit	Red	#901034
Passenger Side Intake Kit	Red	#901035
1966-67 CHEVELLE WITH LS SWAP		
Dual Intake Kit	Red	#901102
Driver Side Intake Kit	Red	#901134
Passenger Side Intake Kit	Red	#901135
1968-72 CHEVELLE WITH LS SWAP		
Dual Intake Kit	Red	#901202
Driver Side Intake Kit	Red	#901234
Passenger Side Intake Kit	Red	#901235
C-10 TRUCKS - 1967-72 CHEVROLET TRUCKS WITH LS SWAP		
Driver Side Intake Kit	Red	#905034

ENGINE
BAY
COVERSPERFORMANCE
AIR
FILTERSINTAKE
SYSTEMSAIR
CLEANERSENGINE
DEFILING

PLUMBING

FUEL
AND
IGNITION

HARDWARE

DRIVETRAIN
ACCESSORIESGENERAL
ACCESSORIES

MUSCLE CAR COLD AIR INTAKE SYSTEMS

Spectre® has engineered these universal air box systems for classic V6/V8 muscle cars/pickups that use a throttle body injection assembly or carburetor with a 5-1/8 inch neck. These air intake systems use enclosed filter assemblies with flexible air intake ducts, to help reduce hot under hood air. The tubes can be routed to a location that will provide cooler outside air.

16" AIR BOX KITS



CHROME AIR BOX KIT WITH BLACK DUCT

Kit includes:

- (2) Duct mounts
- (4) Duct cuffs
- (1) 16" chrome airbox
- (2) 4" black ducts
- (4) 4" hose clamps

120° Air Box #7118

180° Air Box #7168

(air cleaner nut not included)

Includes Air Filter #HPR0138

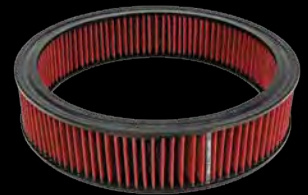

14" LOW PROFILE AIR BOX KITS



CHROME AIR BOX KIT WITH BLACK DUCT

Kit includes:

- (2) Duct mounts
- (4) Duct cuffs
- (1) 14" low profile chrome air box
- (2) 4" black ducts
- (4) 4" hose clamps

120° Air Box #733

135° Air Box #732

150° Air Box #731

180° Air Box #728

(air cleaner nut not included)

Includes Air Filter #HPR8699



SINGLE PLENUM/INLINE AIR BOX KITS



POLISHED ALUMINUM PLENUM/AIR BOX WITH BLACK DUCT

Kit includes:

- Single Plenum
- (4) Duct cuffs
- (2) Hose clamps
- (1) Duct mounting plate
- (1) 4" Black duct
- (1) Inline Air Box with filter
- (2) T-Bolt clamps
- (1) T-Bolt clamp bracket

Air Box Kit #743

(air cleaner nut not included)

Includes Air Filter #HPR9831



Street legal in most states, but may not be used in California or states with similar emissions control laws except on pre 1976 vehicles.

MUSCLE CAR COLD AIR INTAKE SYSTEMS

Spectre® muscle car air intake systems are designed to increase performance by routing the intake inlet away from heat sources like the radiator and headers. Manufactured from high quality polished 4" diameter aluminum tubing, these air intake systems are just the solution you are looking for.

SINGLE PLENUM WITH WELDED 45° X 90° TUBE

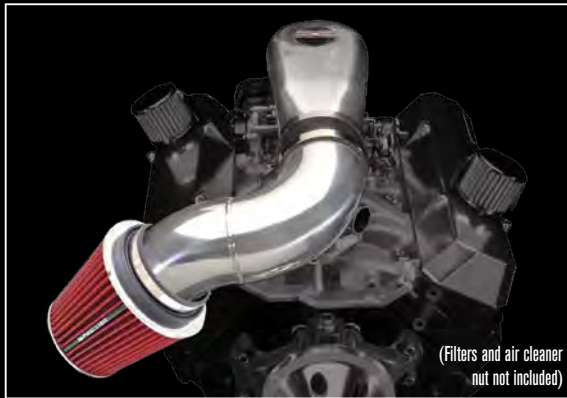

#741 PASSENGER SIDE

Kit includes:

- Single Plenum • (1) Coupler with 2-clamps
- 45° x 90° welded passenger side tube

#742 DRIVER SIDE

Kit includes:

- Single Plenum • (1) Coupler with 2-clamps
- 45° x 90° welded driver side tube

SINGLE PLENUM KIT WITH 90° TUBE



#747

Kit includes:

- Single Plenum
- 90° aluminum tube
- (1) Coupler with 2-clamps
- Can be used on driver side or passenger side

(Filters and air cleaner not included)

DUAL PLENUM KIT WITH 45° TUBES



#761

Kit includes:

- Dual Plenum
- (2) 45° Aluminum tubes
- (2) Couplers with 4 clamps

(Filters and air cleaner not included)



(shown here with tubes facing forward)

(Filters and air cleaner not included)

Street legal in most states, but may not be used in California or states with similar emissions control laws except on pre 1976 vehicles.

ENGINE
BAY COVERS

PERFORMANCE
AIR FILTERS

INTAKE
SYSTEMS

AIR CLEANERS

ENGINE
DETUNING

PLUMBING

FUEL AND
IGNITION

HARDWARE

DRIVE TRAIN
ACCESSORIES

GENERAL
ACCESSORIES

MUSCLE CAR COLD AIR INTAKE SYSTEMS

LOW PROFILE SINGLE PLENUM WITH 45° X 90° WELDED TUBES



#751 PASSENGER SIDE

Kit includes:

- Low profile single plenum
- (1) Coupler with 2-clamps
- 45° x 90° welded passenger side tube

#752 DRIVER SIDE

Kit includes:

- Low Profile Single Plenum
- (1) Coupler with 2-clamps
- 45° x 90° welded driver side tube

LOW PROFILE SINGLE PLENUM WITH 90° TUBE

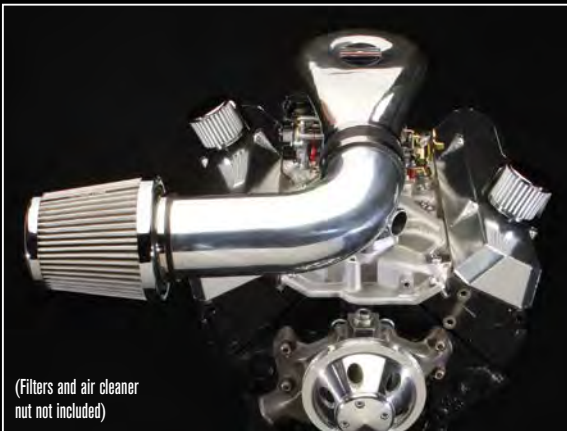

#757

Kit includes:

- Low profile dual plenum
- (1) 90° tube
- (1) Coupler with 2-clamps

LOW PROFILE DUAL PLENUM WITH 45° X 90° WELDED TUBES



#771

Kit includes:

- Low profile dual plenum
- 45° x 90° welded driver side tube
- 45° x 90° welded passenger side tube
- (2) Couplers with 2-clamps

Street legal in most states, but may not be used in California or states with similar emissions control laws except on pre 1976 vehicles.

MUSCLE CAR COLD AIR INTAKE SYSTEMS

LOW PROFILE DUAL PLENUM WITH Y-TUBE



#758

Kit includes:

- Low profile single plenum
- (1) Coupler with 2-clamps
- (1) 4" Y-tube with 150° angle and 90° legs

(Filters and air cleaner nut not included)

ULTRA LOW PROFILE DUAL PLENUM WITH WELDED 45° X 90° TUBES



#764

Kit includes:

- Low profile dual plenum
- (2) Couplers with 4 clamps
- 45° x 90° welded passenger side tube
- 45° x 90° welded driver side tube

(Filters and air cleaner nut not included)

ULTRA LOW PROFILE DUAL PLENUM WITH 90° TUBES

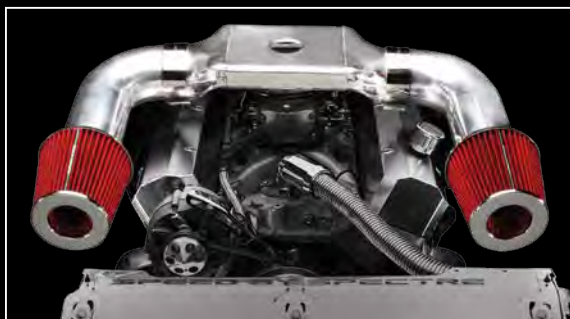

#765

Kit includes:

- Low Profile Dual Plenum
- (2) Couplers with 4 clamps
- (2) 90° aluminum tubes

(Filters and air cleaner nut not included)

Street legal in most states, but may not be used in California or states with similar emissions control laws except on pre 1976 vehicles.

ENGINE
BAY
COVERS

PERFORMANCE
AIR
FILTERS

INTAKE
SYSTEMS

AIR
CLEANERS

ENGINE
DEFILLING

PLUMBING

FUEL
AND
IGNITION

HARDWARE

DRIVE
TRAIN
ACCESSORIES

GENERAL
ACCESSORIES

BUILD YOUR OWN INTAKE SYSTEM

1. Start with a plenum or air box
2. Connect with tubes or duct using couplers or reducers
3. Finish with your choice of air filter!

AIR FILTERS

See page 12



COUPLERS

See page 46



PLENUMS

See page 31



TUBES

See page 36



BRACKETS/ADAPTERS

See page 50



HEAT SHIELDS

See page 34

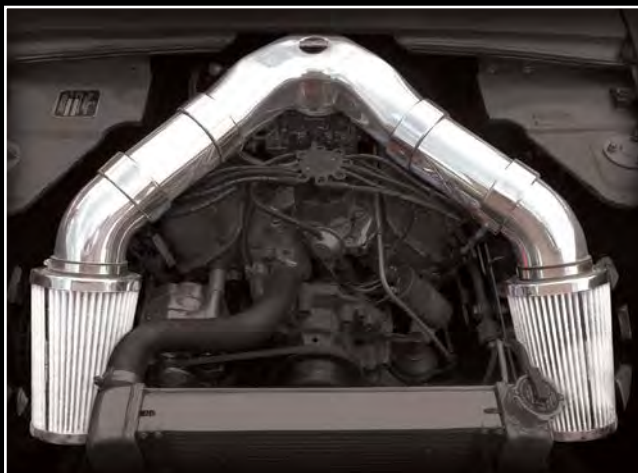
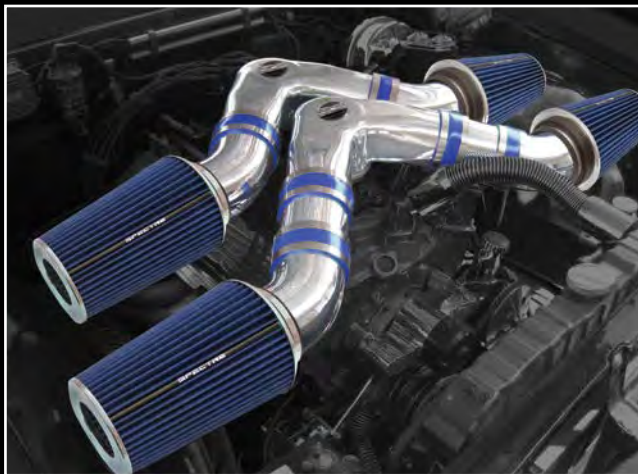

Street legal in most states, but may not be used in California or states with similar emissions control laws except on pre 1976 vehicles.

AIR INTAKE PLENUMS

- Polished cast and fabricated aluminum, offered in single or dual inlet and standard or low profile
- Applications to fit all carburetor and 4BBL throttle body injection systems with 5-1/8" inlet



#9849

4" SINGLE INLET

- 3.5" tall
- Cast aluminum construction
- Can be rotated to point in any direction
- Designed for maximum flow
- Polished aluminum finish

Air cleaner nut not included - see page 67

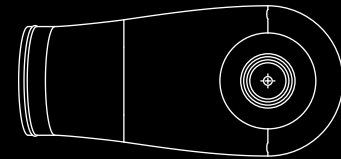
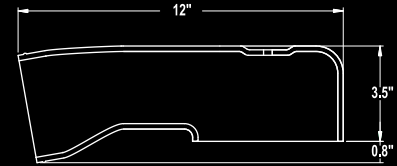

#98499

4" LOW PROFILE SINGLE INLET

- 2.4" tall
- Cast aluminum construction
- Can be rotated to point in any direction
- Designed for maximum hood clearance
- Use with #4208 or 4206 low profile nut for maximum clearance (not included)
- Polished aluminum finish

Air cleaner nut not included - see page 67

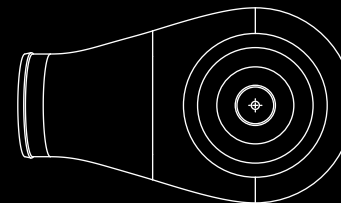
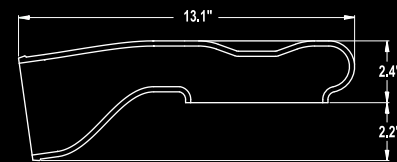

#98999

4" DUAL PLENUM FOR DOMINATOR® CARBURETORS

- Fits carburetors with 7 1/4" neck
- 3" tall
- Cast aluminum construction
- Inlets are 110° apart
- Designed for maximum flow and hood clearance
- Polished aluminum finish

Air cleaner nut not included - see page 67

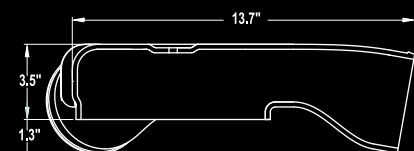
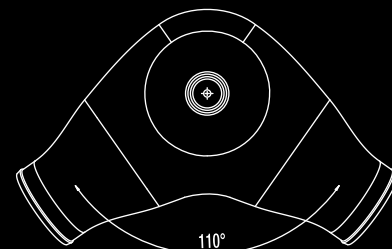

Street legal in most states, but may not be used in California or states with similar emissions control laws except on pre 1976 vehicles.

ENGINE
BRA
COVERSPERFORMANCE
AIR
FILTERSINTAKE
SYSTEMSAIR
CLEANERSENGINE
DETUNING

PLUMBING

FUEL AND
IGNITION

HARDWARE

DRIVE TRAIN
ACCESSORIESGENERAL
ACCESSORIES

AIR INTAKE PLENUMS



#9859

4" DUAL INLET

- 3.5" tall
- Cast aluminum construction
- Inlets are 90° apart
- Designed for maximum flow
- Polished aluminum finish

Air cleaner nut not included - see page 67

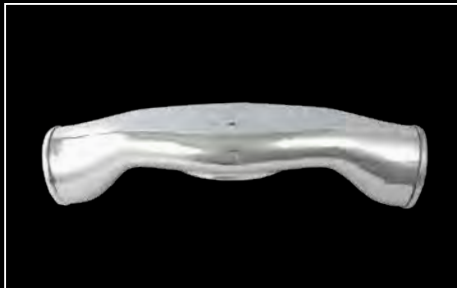
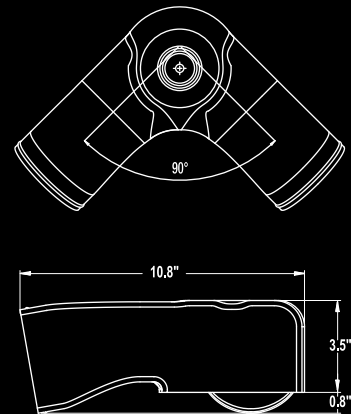

#98599

4" LOW PROFILE DUAL INLET

- 2.4" tall
- Cast aluminum construction
- Inlets are 180° apart
- Designed for maximum hood clearance
- Use with #4208 or #4206 low profile nut for maximum clearance (not included)
- Polished aluminum finish

Air cleaner nut not included - see page 67

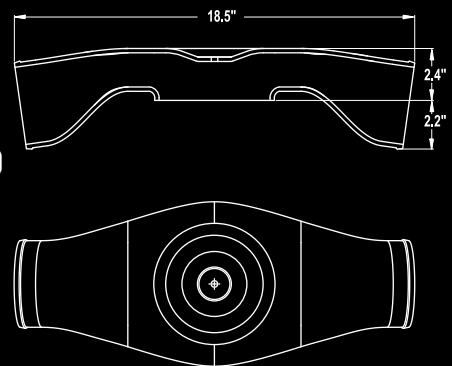

#9879

LT1 INLET PLENUM

- Cast aluminum construction
- Replaces stock LT1 air inlet elbow
- Includes adapters for sensors and vacuum hose
- Includes boots and clamps
- Polished aluminum finish

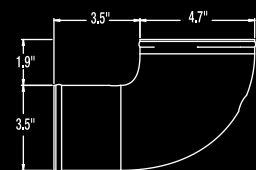

#98261

LSX PLENUM

- Sheet metal aluminum construction
- Designed for Chevrolet LS engine swaps
- Requires 4.25" minimum clearance between the throttle body and the fan or radiator
- Requires 7.25" inch minimum clearance from centerline of the throttle body to the underside of the hood
- Polished aluminum finish

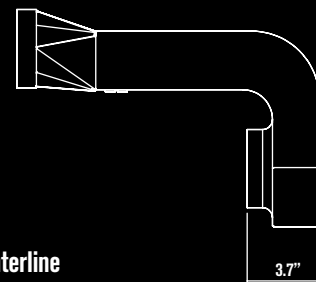

Street legal in most states, but may not be used in California or states with similar emissions control laws except on pre 1976 vehicles.

AIR INTAKE PLENUMS

- Sheet metal aluminum construction
- Polished aluminum finish
- 4" dual plenum
- Super low profile design will fit under most flat hoods
- Use with #4208 or #4206 low profile nut for maximum clearance (not included)



#9824
**4" ULTRA LOW
 120° ANGLE**

Air cleaner nut not included - see page 67

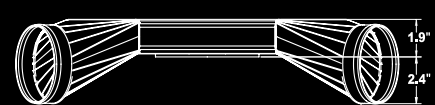
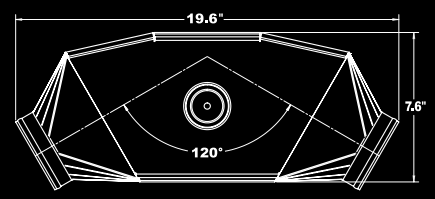

#9834
**4" ULTRA LOW
 135° ANGLE**

Air cleaner nut not included - see page 67

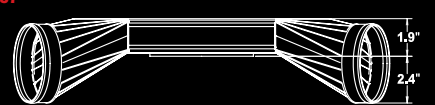
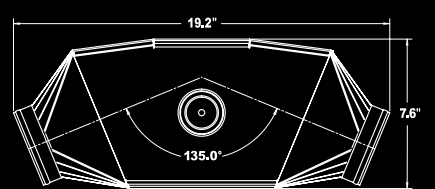

#9854
**4" ULTRA LOW
 150° ANGLE**

Air cleaner nut not included - see page 67

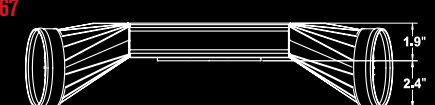
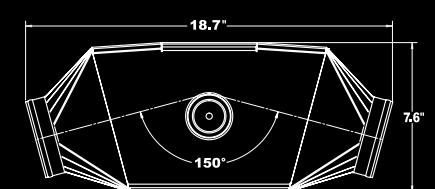

#9804
**4" ULTRA LOW
 180° ANGLE**

Air cleaner nut not included - see page 67

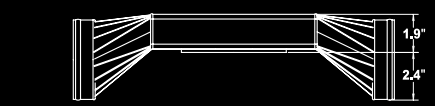
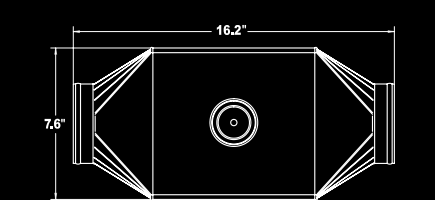

Street legal in most states, but may not be used in California or states with similar emissions control laws except on pre 1976 vehicles.

ENGINE BRAV COVERS

PERFORMANCE AIR FILTERS

INTAKE SYSTEMS

AIR CLEANERS

ENGINE DEFILLING

PLUMBING

FUEL AND IGNITION

HARDWARE

DRIVETRAIN ACCESSORIES

GENERAL ACCESSORIES

AIR INTAKE HEAT SHIELDS

- Available separately for many popular muscle car applications
- Manufactured from high quality aluminum with a powder coated silver finish
- Comes complete with all bulb seals and hardware needed for installation



1973 - 81 CHEVROLET PICKUP

Driver Side	#4371
Passenger Side	#4383



1967 - 72 CHEVROLET PICKUP

Driver Side	#4372
Passenger Side	#4384

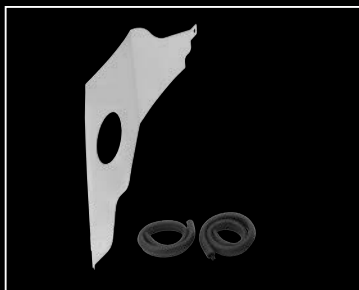
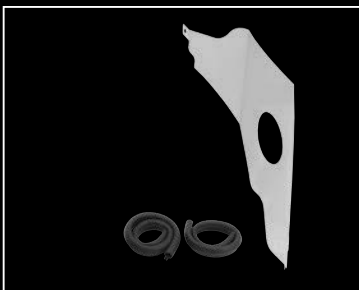

1968 - 72 CHEVROLET CHEVELLE

Driver Side	#4373
Passenger Side	#4385



1966 - 67 CHEVROLET CHEVELLE

Driver Side	#4374
Passenger Side	#4386

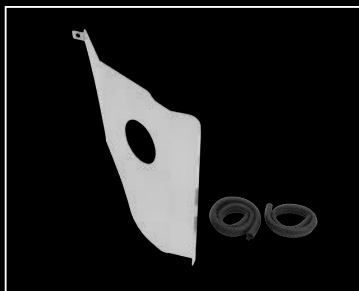
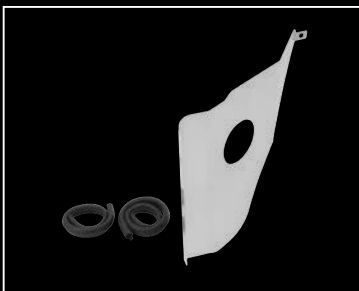

1964 - 65 CHEVROLET CHEVELLE

Driver Side	#4375
Passenger Side	#4387

AIR INTAKE HEAT SHIELDS

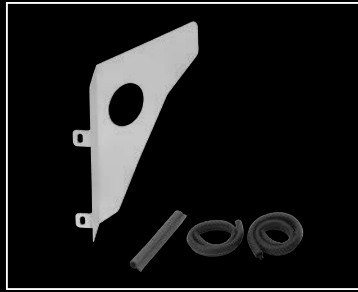
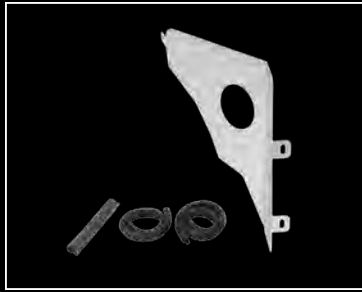

1968 - 74 CHEVROLET NOVA

Driver Side	#4376
Passenger Side	#4390

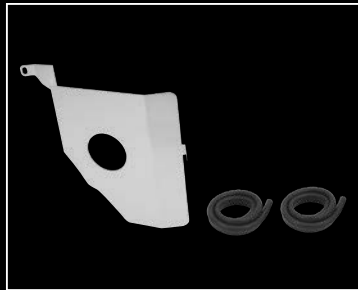
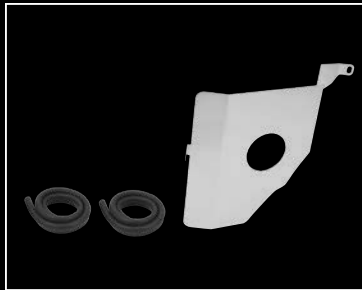

1967 - 69 CHEVROLET CAMARO

Driver Side	#4377
Passenger Side	#4391

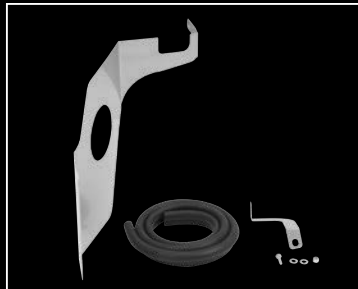
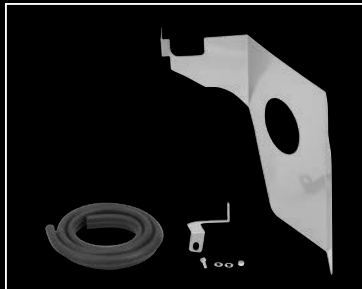

1970 - 81 CHEVROLET CAMARO

Driver Side	#4380
Passenger Side	#4392

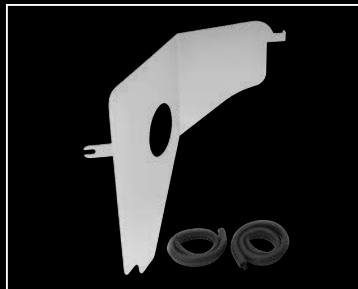
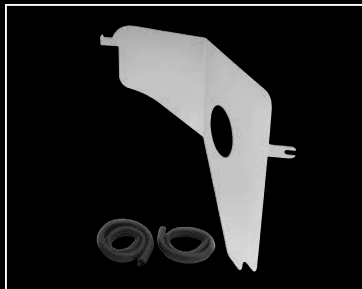

1965 - 66 CHEVROLET IMPALA

Driver Side	#4381
Passenger Side	#4393



1963 - 64 CHEVROLET IMPALA

Driver Side	#4382
Passenger Side	#4394

ENGINE
BAY COVERS

PERFORMANCE
AIR FILTERS

**INTAKE
SYSTEMS**

AIR CLEANERS

ENGINE
OILING

PLUMBING

FUEL AND
IGNITION

HARDWARE

DRIVE TRAIN
ACCESSORIES

GENERAL
ACCESSORIES

AIR INTAKE TUBES

- High quality polished aluminum tubing in 2-1/2" to 4" diameters and angles from 22° to 120°
- Tubes, Y-bends, brackets and hardware available to fabricate an intake for virtually any project



1" LONG STRAIGHT TUBE

3" diameter	#9421
4" diameter	#9721



2" LONG STRAIGHT TUBE

3" diameter	#9422
4" diameter	#9722



4" LONG STRAIGHT TUBE

2.5" diameter	#9209
3" diameter	#9409
3.5" diameter	#9509
4" diameter	#9709



6" LONG STRAIGHT TUBE

2.5" diameter	#9219
3" diameter	#9419
3.5" diameter	#9519
4" diameter	#9719



12" LONG STRAIGHT TUBE

4" diameter	#9723
-------------	-------



18" LONG STRAIGHT TUBE WITH MAF PAD

4" diameter	#9718
-------------	-------

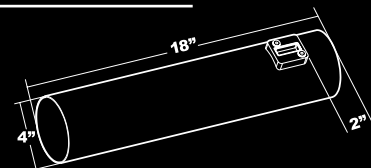

Street legal in most states, but may not be used in California or states with similar emissions control laws except on pre 1976 vehicles.

AIR INTAKE TUBES



24" LONG STRAIGHT TUBE

2.5" diameter	#9224
3" diameter	#9424
3.5" diameter	#9524
4" diameter	#9724



MAF ADAPTERS

3" diameter	#9405
4" diameter	#9705

9405 contains 5 adapters and three sleeves
9705 contains 1 adapter and 2 sleeves



22° MANDREL BENT TUBE

Diameter	Long Leg	Short Leg	Overall Height	Part #
2.5"	1"	1"	4.5"	#9229
3"	1"	1"	6"	#9429
3.5"	1"	1"	5.5"	#9529
4"	1"	1"	6.75"	#9729
4"	7"	1"	11.25"	#97290
4"	16"	4"	21.08"	#97291

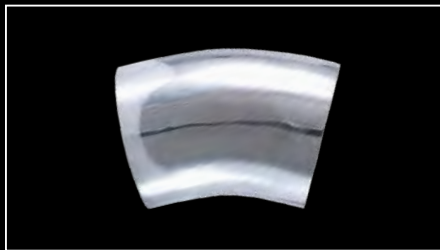

30° MANDREL BENT TUBE

Diameter	Long Leg	Short Leg	Overall Height	Part #
3"	1"	1"	5.08"	#9437
3.5"	1"	1"	5.05"	#9537
4"	1"	1"	5.92"	#9737
4"	7"	1"	11.10"	#97370
4"	16"	4"	21.91"	#97371

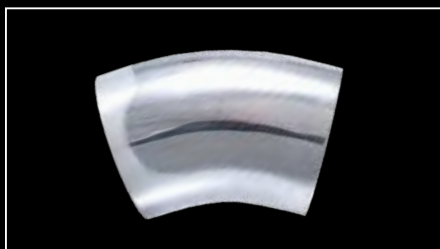

35° MANDREL BENT TUBE

Diameter	Long Leg	Short Leg	Overall Height	Part #
3"	1"	1"	5.26"	#9439
3.5"	1"	1"	5.5"	#9539
4"	1"	1"	6.13"	#9739
4"	7"	1"	11.04"	#97390
4"	16"	4"	21.42"	#97391

Street legal in most states, but may not be used in California or states with similar emissions control laws except on pre 1976 vehicles.

ENGINE
BAY
COVERS

PERFORMANCE
AIR
FILTERS

INTAKE
SYSTEMS

AIR
CLEANERS

ENGINE
DEFILLING

PLUMBING

FUEL
AND
IGNITION

HARDWARE

DRIVE
TRAIN
ACCESSORIES

GENERAL
ACCESSORIES

AIR INTAKE TUBES

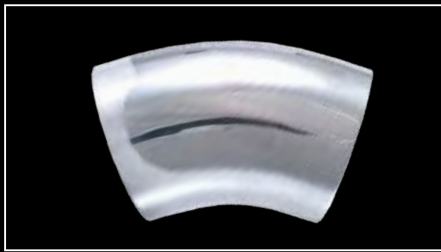

40° MANDREL BENT TUBE

Diameter	Long Leg	Short Leg	Overall Height	Part #
3"	1"	1"	5"	#9440
3.5"	1"	1"	5.78"	#9540
4"	1"	4"	5.27"	#9740
4"	7"	1"	10.86"	#97400
4"	16"	1"	20.76"	#97401

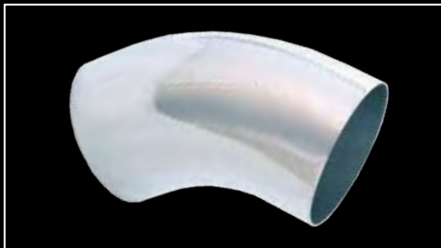

45° MANDREL BENT TUBE

Diameter	Long Leg	Short Leg	Overall Height	Part #
2.5"	1"	1"	4.5"	#9249
3"	1"	1"	6"	#9449
3.5"	1"	1"	6.13"	#9549
4"	1"	1"	6.4"	#9749
4"	7"	1"	10.72"	#97490
4"	16"	4"	20.10"	#97499

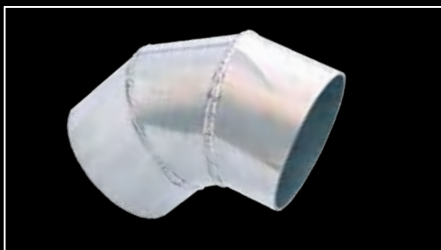

60° TWO WELD BENT TUBE

Diameter	Long Leg	Short Leg	Overall Height	Part #
2.5"	1"	1"	4.10"	#9268
3"	1"	1"	4.53"	#9468
3.5"	1"	1"	5"	#9568
4"	1"	1.25"	6"	#9768
4"	7.25"	1.25"	9"	#97680

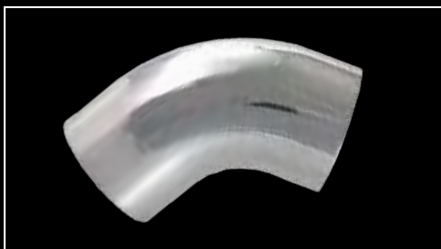

60° MANDREL BENT TUBE

Diameter	Long Leg	Short Leg	Overall Height	Part #
2.5"	1"	1"	4.75"	#9269
3"	1"	1"	5.40"	#9469
3.5"	1"	1"	6"	#9569
4"	1"	1"	6.70"	#9769
4"	7"	1"	10.35"	#97690
4"	16"	4"	17.20"	#97691

Street legal in most states, but may not be used in California or states with similar emissions control laws except on pre 1976 vehicles.

AIR INTAKE TUBES

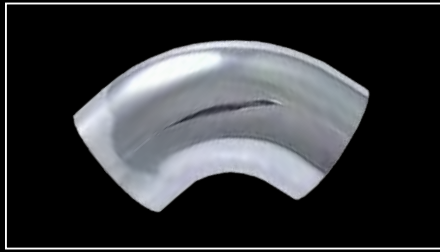

75° MANDREL BENT TUBE

Diameter	Long Leg	Short Leg	Overall Height	Part #
2.5"	1"	1"	4.88"	#9280
3"	1"	1"	5.6"	#9480
3.5"	1"	1"	6.33"	#9580
4"	1"	1"	7.05"	#9780
4"	7"	1"	8.60"	#97800
4"	16"	4"	13.94"	#97801

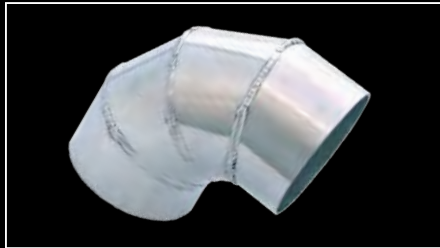

90° THREE WELD TUBE

Diameter	Long Leg	Short Leg	Overall Height	Part #
2.5"	1"	1"	4.18"	#9298
3"	1"	1"	4.7"	#9498
3.5"	1"	1"	4.96"	#9598
4"	1"	1"	5.6"	#9798
4"	7"	1"	11.68"	#97980

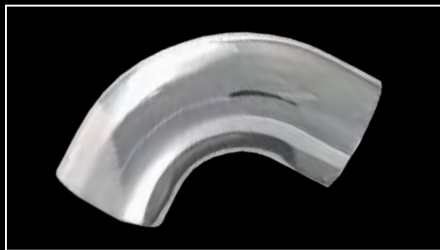

90° MANDREL BENT TUBE

Diameter	Long Leg	Short Leg	Overall Height	Part #
2.5"	1"	1"	4.75"	#9299
3"	1"	1"	5.50"	#9499
3"	6"	1"	10.50"	#94990
3.5"	1"	1"	6.25"	#9599
3.5"	7"	1"	12.25"	#95990
4"	1"	1"	7.0"	#9799
4"	6"	1"	12.0"	#97990
4"	16"	4"	22.0"	#97991



100° MANDREL BENT TUBE

Diameter	Long Leg	Short Leg	Overall Height	Part #
3"	6"	1"	11.19"	#94961
3.5"	7"	1"	13.06"	#95961
4"	6"	2"	12.95"	#97961
4"	16"	3"	22.80"	#97964

Street legal in most states, but may not be used in California or states with similar emissions control laws except on pre 1976 vehicles.

ENGINE
BAY
COVERSPERFORMANCE
AIR
FILTERSINTAKE
SYSTEMSAIR
CLEANERSENGINE
DEFILLING

PLUMBING

FUEL
AND
IGNITION

HARDWARE

DRIVETRAIN
ACCESSORIESGENERAL
ACCESSORIES

AIR INTAKE TUBES



110° MANDREL BENT TUBE

Diameter	Long Leg	Short Leg	Overall Height	Part #
3"	6"	1"	11.68"	#94962
3.5"	6"	1"	12.68"	#95962
4"	6"	2"	13.69"	#97962
4"	16"	3"	23.09"	#97965



120° MANDREL BENT TUBE

Diameter	Long Leg	Short Leg	Overall Height	Part #
3"	6"	1"	11.95"	#94963
3.5"	7"	1"	13.94"	#95963
4"	6"	2"	14.20"	#97963
4"	16"	3"	22.86"	#97966

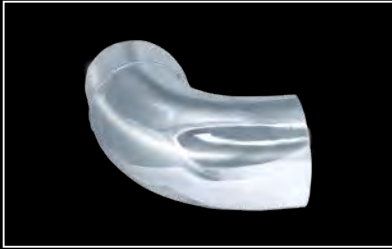

45°/90° BEND - 4" DIAMETER TUBE

Side	Overall Length	Part #
Driver	11.3"	#97495
Passenger	11.3"	#97496



22°/90° BEND - 4" DIAMETER TUBE

Side	Overall Length	Part #
Driver	11.7"	#97497
Passenger	11.7"	#97498



Y-TUBE

Tubes Y-off at 135° angles

Diameter	Leg Length	Overall Height	Part #
3"	1"	5.75"	#9479
4"	1"	6.1"	#9778



U-BEND TUBES

Tubes Y-off at 135° angles

Diameter	Long Leg	Short Leg	Overall Height	Part #
2.5"	10"		7.5"	#9290
3"	10"		9"	#9490
3.5"	10"		10.5"	#9590
4"	10"		12"	#9790

Street legal in most states, but may not be used in California or states with similar emissions control laws except on pre 1976 vehicles.

AIR INTAKE TUBES

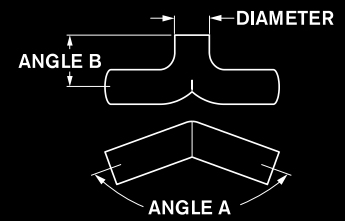

Y-BEND TUBES

Angle A	Angle B	Leg Length	Part #
120°	90°	6"	#97994
130°	90°	6"	#97995
140°	90°	6"	#97996
150°	90°	6"	#97997
180°	90°	6"	#97998
120°	100°	6"	#97974
130°	100°	6"	#97975
140°	100°	6"	#97976
150°	100°	6"	#97977
180°	100°	6"	#97978
120°	110°	6"	#97984
130°	110°	6"	#97985
140°	110°	6"	#97986
150°	110°	6"	#97987
180°	110°	6"	#97988
120°	90°	16"	#97952
130°	90°	16"	#97953
140°	90°	16"	#97954

Angle A	Angle B	Leg Length	Part #
150°	90°	16"	#97955
160°	90°	16"	#97956
170°	90°	16"	#97957
180°	90°	16"	#97958
120°	100°	16"	#97942
130°	100°	16"	#97943
140°	100°	16"	#97944
150°	100°	16"	#97945
160°	100°	16"	#97946
170°	100°	16"	#97947
180°	100°	16"	#97948
120°	110°	16"	#97932
130°	110°	16"	#97933
140°	110°	16"	#97934
150°	110°	16"	#97935
160°	110°	16"	#97936
170°	110°	16"	#97937
180°	110°	16"	#97938

UNIVERSAL AIR INTAKE SYSTEM - #8219



- 3" diameter air intake system
- Universal air intake system that fits many applications
- Includes:
 - 3" intake tube
 - Integrated air sensor inlets
 - Adapters and support brackets
- Spectre® air filter sold separately

Street legal in most states, but may not be used in California or states with similar emissions control laws except on pre 1976 vehicles.

ENGINE
BRA
COVERSPERFORMANCE
AIR
FILTERSINTAKE
SYSTEMSAIR
CLEANERSENGINE
DEFILING

PLUMBING

FUEL
AND
IGNITION

HARDWARE

DRIVE
TRAIN
ACCESSORIESGENERAL
ACCESSORIES

MODULAR AIR INTAKE SYSTEMS (M.A.I.S.)

- The Modular Air Intake System (MAIS) is an innovative clamp together system that allows you to add a cold air or short ram air intake system to practically any car
- Since the system is modular, the tubes can be combined in nearly infinite combinations and arrangements to bring cold air to hundreds of vehicles that would otherwise require a custom system
- To capitalize on the benefits of a cold air intake, we use a base material of an engineering grade co-polymer ABS with the low heat absorption characteristics and triple chrome plate the surface to help deflect heat
- The finished chrome surface also allows for easy cleaning for a great looking appearance

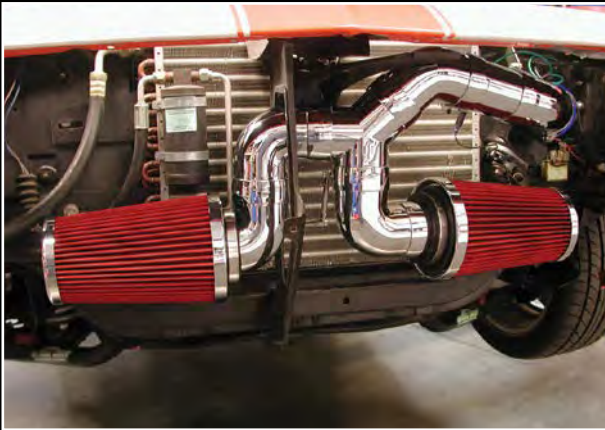

**HIGH PERFORMANCE
NOT HIGH COST**

EASY TO INSTALL

POLYMER RESIN COMPONENTS

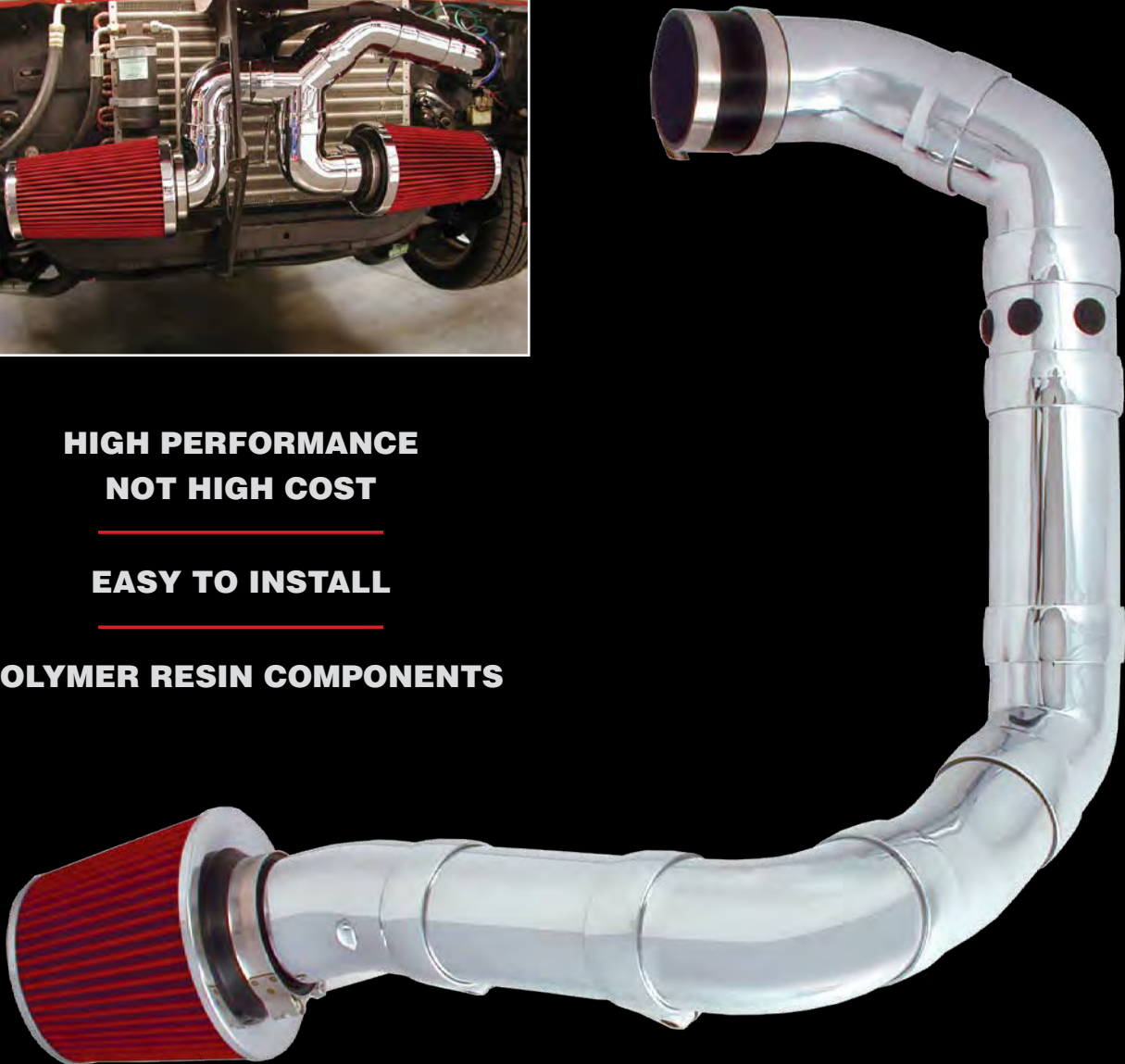

Street legal in most states, but may not be used in California or states with similar emissions control laws except on pre 1976 vehicles.

MODULAR AIR INTAKE SYSTEMS (M.A.I.S.)

M.A.I.S. STARTER KIT - #8208



- 3" diameter air intake system
- Kit includes:
 - (2) 4" long straight tubes with connector collars
 - (1) 45° elbow
 - (1) intake tube coupler/reducer
 - (2) gear drive clamps
 - (3) 3" O-rings
 - (1) vacuum sensor tube with connector collar
 - (2) universal mounting brackets
 - (1) each vacuum hose and tube adapters (5mm, 10mm and 13mm)
- Starter kit for many applications. Add additional M.A.I.S. parts for a more elaborate intake system or use as a starting point for your specific application.
- Increase horsepower! For every 10° decrease in intake air temperature, you get a 1.5% to 2% gain in power.



M.A.I.S. COMPONENTS

VELOCITY FUNNEL - #8788

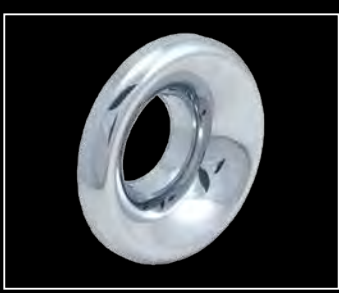

- Increases air flow up to 10%
- Combine with Spectre® Memory Flex Air Ducting to route cool air to intake system
- Triple Chrome-Plated



6.5" O.D. Diameter

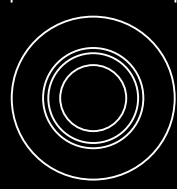

2.4" Tall
3" O.D. Diameter

Street legal in most states, but may not be used in California or states with similar emissions control laws except on pre 1976 vehicles.

- ENGINE BAY COVERS
- PERFORMANCE AIR FILTERS
- INTAKE SYSTEMS**
- AIR CLEANERS
- ENGINE DEFILING
- PLUMBING
- FUEL AND IGNITION
- HARDWARE
- DRIVE TRAIN ACCESSORIES
- GENERAL ACCESSORIES

M.A.I.S. COMPONENTS



#8708

4" STRAIGHT TUBE

- 3" diameter chrome tube
- Includes 1 collar clamp

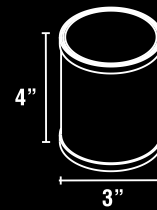

#8718

6" STRAIGHT TUBE

- 3" diameter chrome tube
- Includes 1 collar clamp

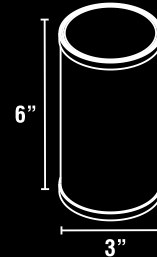

#8728

22° ELBOW

- 3" diameter chrome tube
- Includes 1 collar clamp

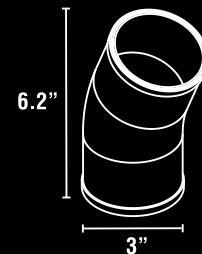

#8738

45° ELBOW

- 3" diameter chrome tube
- Includes 1 collar clamp

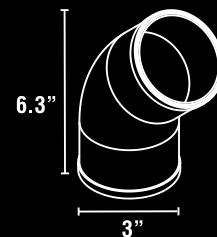

#8668

60° ELBOW

- 3" diameter chrome tube
- Includes 1 collar clamp

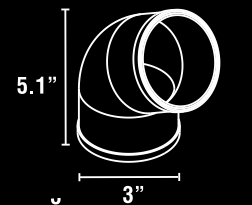

#8698

90° ELBOW

- 3" diameter chrome tube
- Includes 1 collar clamp

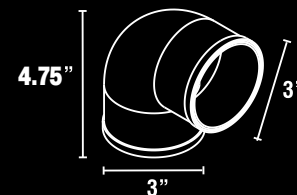

Street legal in most states, but may not be used in California or states with similar emissions control laws except on pre 1976 vehicles.

M.A.I.S. COMPONENTS

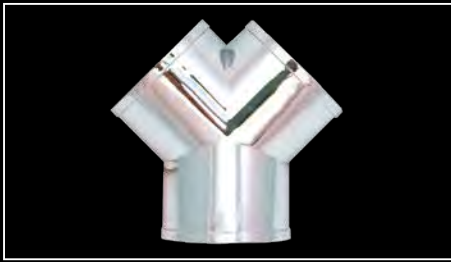

#8778
"Y" TUBE
• 3" diameter chrome tube

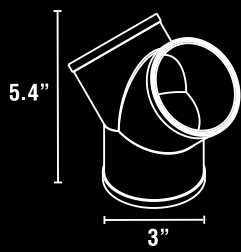

#8808
1-1/2" EXTENSION
• 3" diameter chrome tube

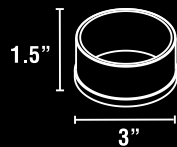

#8706
TUBE COLLAR
• 3" diameter chrome collar for M.A.I.S. tubes



#8705
AIR SENSOR MOUNT KIT
• 3" diameter chrome tube
• Includes collar clamp
• Includes 3 adapter plates that allow use of your stock sensor
Fits: 1998 and newer Toyota
2002 and newer Mazda
2002 and newer Subaru
2000 and newer Ford
2000 and newer Lexus



#8707
VACUUM/SENSOR TUBE
• 4" diameter, 2-7/8" length
• Kit includes:
3 grommets with plugs, tube and collar, 3 vacuum tube adapters (5mm, 10mm, 13mm)
• Use #8711 for other uses

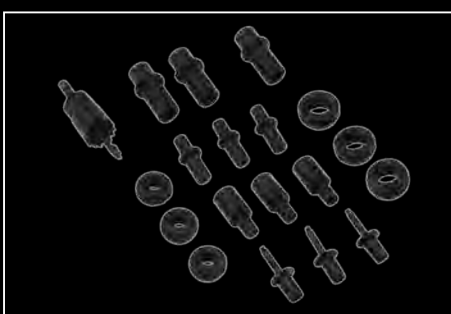
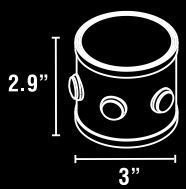

#8711
VACUUM/SENSOR ADAPTER KIT
• Attach vacuum lines and push-in sensors virtually anywhere on the intake tube
• Kit includes:
• (1 ea.) 5/8" and 7/8" hole saws
• (3) 10mm fittings, (3) 5mm fittings, (1) 13mm fitting, (2) 16mm fittings, (1) 19mm fitting, (3) 5/8" o.d. x 9mm i.d. grommets, (2) 7/8" o.d. x 15.5mm i.d. grommets

Street legal in most states, but may not be used in California or states with similar emissions control laws except on pre 1976 vehicles.

- ENGINE BRAE COVERS
- PERFORMANCE AIR FILTERS
- INTAKE SYSTEMS**
- AIR CLEANERS
- ENGINE DEFILTING
- PLUMBING
- FUEL AND IGNITION
- HARDWARE
- DRIVE TRAIN ACCESSORIES
- GENERAL ACCESSORIES

SILICONE AIR INTAKE COUPLERS

- High quality reinforced silicone for boost pipes and high heat applications
- Clamps sold separately



Color	Size	Part Number
Black	2.5"	#5-250
Black	3"	#5-300
Black	3.5"	#5-350
Black	4"	#5-400

PVC AIR INTAKE COUPLERS

- Spectre® couplers and reducers make building your own custom air intake a breeze
- A wide variety of shapes and sizes are available
- Not for turbo-charged or supercharged engines



PVC COUPLERS WITH ADAPTER

Color	Size	Part Number
Black	3" to 3" / 2.5"	#8771
Red	3" to 3" / 2.5"	#8772
Blue	3" to 3" / 2.5"	#8776



PVC COUPLERS

Color	Size	Part Number
Black	3.5"	#9571
Black	4"	#9771
Red	4"	#9772
Blue	4"	#9776

*Includes reducer sleeve for use with 3 7/8" GM MAF sensors



PVC REDUCER COUPLERS

Color	Size	Part Number
Black	3" to 2.5"	#8751
Red	3" to 2.5"	#8752
Blue	3" to 2.5"	#8756
Black	3.5" to 3"	#9541
Black	3.5" to 3.25"	#9551
Black	4" to 3"	#9761
Red	4" to 3"	#9762
Blue	4" to 3"	#9766
Black	4" to 3.5"	#9741
Red	4" to 3.5"	#9742
Blue	4" to 3.5"	#9746

Street legal in most states, but may not be used in California or states with similar emissions control laws except on pre 1976 vehicles.

PVC AIR INTAKE COUPLERS



90° ELBOW COUPLERS

Color	Description	Size	Part Number
Black	90° coupler with adapter	3" to 3" / 2.5"	#8791
Black	90° elbow coupler	4"	#9781

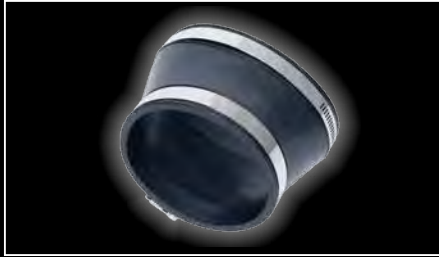

FORD 4.6L OVAL BOOT

Black	Oval to 4" round with clamps	#9791
Black	Oval to 4" round without clamps	#97911

AIR INTAKE COUPLERS

- Spectre® couplers and reducers possess outstanding heat, ozone and weather resistance properties
- A wide variety of shapes and sizes are available
- Not for turbo-charged or supercharged engines



COUPLERS WITH CLAMPS

Color	Size	Part Number
Black	3"	#87721
Red	3"	#87722
Blue	3"	#87726



COUPLERS WITHOUT CLAMPS

Color	Diameter	Length	Part Number
Black	3.5"	2"	#95711
Black	3.5"	3"	#95611
Black	4"	2"	#97711
Black	4"	3"	#97713

Street legal in most states, but may not be used in California or states with similar emissions control laws except on pre 1976 vehicles.

ENGINE
BAY
COVERS

PERFORMANCE
AIR
FILTERS

INTAKE
SYSTEMS

AIR
CLEANERS

ENGINE
OILING

PLUMBING

FUEL
AND
IGNITION

HARDWARE

DRIVE
TRAIN
ACCESSORIES

GENERAL
ACCESSORIES

AIR INTAKE COUPLERS



REDUCER COUPLERS WITH CLAMPS

Color	Size	Part Number
Black	3" to 2.5"	#87521
Red	3" to 2.5"	#87522
Blue	3" to 2.5"	#87526



Clamps sold separately

REDUCER COUPLERS WITHOUT CLAMPS

Color	Size	Part Number
Black	3" to 2.75"	#87831
Black	3.5" to 3"	#95411
Black	3.5" to 3.25"	#95511
Black	4" to 3"	#97611
Black	4" to 3.5"	#97411



Clamps sold separately

ANGLED ELBOW COUPLERS

Color	Angle	Size	Part Number
Black	90°	3"	#87911
Black	22°	4"	#97701
Black	30°	4"	#97771
Black	45°	4"	#97821
Black	90°	4"	#97811



FLEX COUPLERS WITH CLAMPS

Color	Size	Part Number
Black	3"	#9475
Black	3.5"	#9575
Black	4"	#9775



Clamps sold separately

ANGLED FLEX COUPLERS

Color	Angle	Size	Part Number
Black	22°	4"	#9770
Black	30°	4"	#9777
Black	45°	4"	#9782
Black	60°	4"	#9783
Black	75°	4"	#9784
Black	90°	3"	#9485
Black	90°	3.5"	#9585
Black	90°	4"	#9785
Black	110°	4"	#97941

Street legal in most states, but may not be used in California or states with similar emissions control laws except on pre 1976 vehicles.

DUCTING / DUCT BOOTS

Spectre® 3" and 4" Air Ducting features "Memory Flex", allowing it to conform to and retain countless positions. It can be used in conjunction with Spectre® Air Intake Tubes or directly with Plenums, Air Boxes or Air Filters.



AIR DUCT HOSE

- Includes two duct boots that "thread" onto the duct

Color	3"	4"
Chrome	#8748	#9758
Blue	#8746	-
Red	#8742	-
Black	#8741	#9751



Memory Flex Air Ducting will actually thread together to form longer sections as required.

AIR DUCT BOOTS

- Includes one boot per package

Color	3"	4"
Blue	#87416	#97516
Red	#87412	#97512
Black	#87411	#97511



Installed with "T" Bolt Clamp #8703



Installed with Drive Clamp #8704

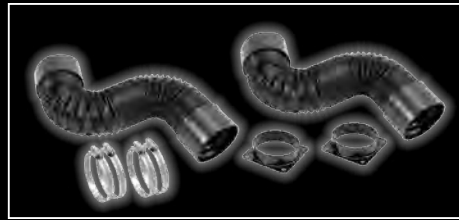

4" AIR DUCT HOSE KITS

- These kits include two - 4" flexible ducting tubes, two - 4" ABS duct mounting plates and four - 4" worm hose clamps

Color	Part Number
Black	#97519
Chrome	#97589

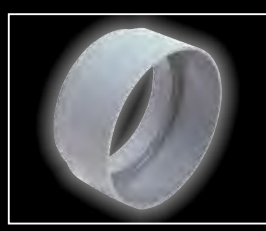

AIR DUCT HOSE FILTER ADAPTER

- Allows the attachment of 3" duct or intake components to the front of Spectre® multi-base cone filters

3-inch	#8147
--------	-------

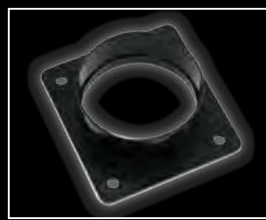

INTAKE DUCT MOUNTING PLATE

- Mount virtually anywhere to bring cool air into the intake
- Universal design made from ABS plastic

3-inch	#8148
4-inch	#9148

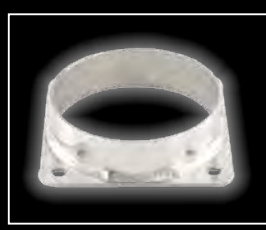

ALUMINUM INTAKE DUCT MOUNTING PLATE

- Mount virtually anywhere to bring cool air into the intake

4-inch	#91489
--------	--------



Street legal in most states, but may not be used in California or states with similar emissions control laws except on pre 1976 vehicles.

- ENGINE BAY COVERS
- PERFORMANCE AIR FILTERS
- INTAKE SYSTEMS**
- AIR CLEANERS
- ENGINE DETAILING
- PLUMBING
- FUEL AND IGNITION
- HARDWARE
- DRIVE TRAIN ACCESSORIES
- GENERAL ACCESSORIES

AIR INTAKE ACCESSORIES

Spectre® air intake clamps and brackets are designed to work with our air intake systems. They are made from high-quality materials and offer adjustability and flexibility for multiple intake configurations.



COLLAR CLAMPS (INCLUDES SEALING BOOT)

- Polished stainless steel
- T-bolt style clamp
- Covers boot completely

3" diameter	#9406
4" diameter	#9706
4" diameter - low profile	#9707



T BOLT CLAMP (EACH)

2.5" diameter	#9203
3" diameter	#8703
3.5" diameter	#9503
4" diameter	#9703



WORM GEAR CLAMP (PAIR)

2.5" diameter	#9204
3" diameter	#8704
3.5" diameter	#9504
3.5" diameter - wide	#95041
4" diameter	#9704
4" diameter - wide	#97041



ALUMINUM BRACKETS

- Mount filter or tubes directly to bracket and connect with flex duct or aluminum modular system
- Polished aluminum
- Sturdy construction designed for infinite adjustability

3"	#9402
4"	#9702



#9710

T-BOLT CLAMP BRACKET

- Use with T-bolt clamps to install and support intake components or filters
- Polished aluminum
- Sturdy construction designed for amazing adjustability

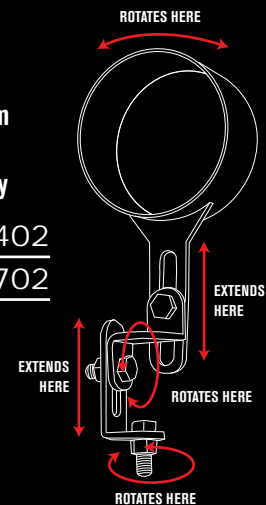

Street legal in most states, but may not be used in California or states with similar emissions control laws except on pre 1976 vehicles.

AIR INTAKE ACCESSORIES

VELOCITY STACK ADAPTERS



Inlet	Height (x)	Part #
2.5" inlet centered	2.4"	9601
3" center	2.375"	9602
3.5" center	2.375"	9603
4" center	2.0"	9604
4" center	1.9"	9605
4" offset	1.9"	9606
4" angled center	3.625"	9609
4.5" center	1.9"	9610

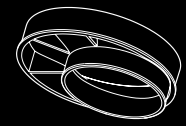
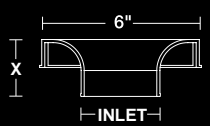

FOAM FABRICATION CONNECTOR

Spectre® foam inserts are used as a temporary “coupler” to attached air intake tubing when mocking up a custom air intake build. This insert fits inside and connects two ends of intake tubing to simplify the creation of your custom intake system.

3" diameter	#9420
4" diameter	#9720



#9789 HEADLIGHT AIR FUNNEL - ROUND

A very cool option for getting cold air to your intake system is replacing the two hi-beam bulbs found in many muscle car applications.



- Replaces 5-3/4" round headlight
- For 4" air intake system
- Constructed of 6061-T6 aircraft aluminum
- Allows you to ram cold air from the front of the car or truck directly into your intake
- Includes adapter to allow direct installation with factory headlight bezel
- Sold individually



#9787 HEADLIGHT AIR FUNNEL - RECTANGULAR

- For cars and trucks with four rectangular headlights
- 6.5 inches wide x 4 inches tall with a 4 inch outside diameter outlet
- Requires modification to the existing headlight bucket
- Universal application
- Sold individually

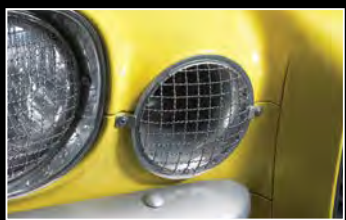
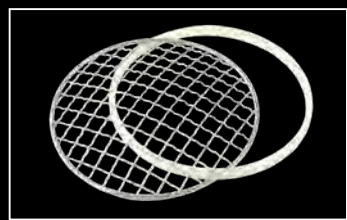

#97891 HEADLIGHT AIR FUNNEL SCREEN

- Protects the intake system from large debris
- Triple chrome-plated

Street legal in most states, but may not be used in California or states with similar emissions control laws except on pre 1976 vehicles.

- ENGINE BAY COVERS
- PERFORMANCE AIR FILTERS
- INTAKE SYSTEMS**
- AIR CLEANERS
- ENGINE DEFILLING
- PLUMBING
- FUEL AND IGNITION
- HARDWARE
- DRIVER/RAIN ACCESSORIES
- GENERAL ACCESSORIES

AIR INTAKE ACCESSORIES



#8701

UNIVERSAL INTAKE BRACKET

- Universal design
- Elbow bends and rotates for infinite angle options
- Attach to car with any existing engine bolts
- Studs and tubes adjust to any length you need
- Use with either T-Bolt Clamp #8703 or Collar Clamp #8706

MASS AIR FLOW SENSOR COMPONENTS

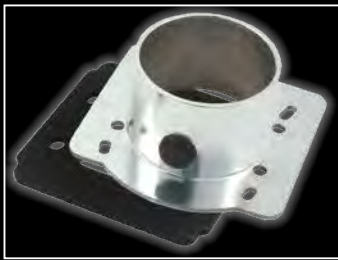

#81413

MASS AIR FLOW SENSOR ADAPTER

- 3" diameter
- Adapter allows use of Spectre® 3" diameter module air intake components and filter
- May require drilling and additional holes
- Fits select BMW, Lexus, Mazda, Nissan, and Toyota applications

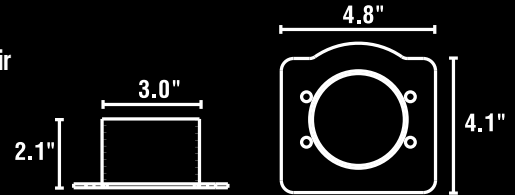

#81403

MASS AIR FLOW SENSOR ADAPTER

- Allows Spectre® cone style filters to be mounted directly to Dodge and Mitsubishi Air Flow Sensors
- 3/4" Thickness Adapter Plate for new Mitsubishi 2.2L
- Fits select Chrysler, Dodge, and Mitsubishi applications

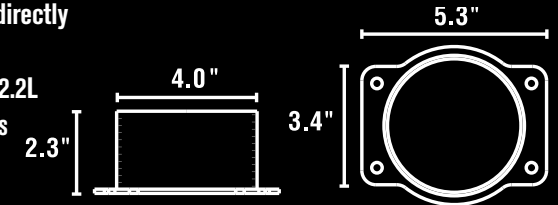

MASS AIR FLOW SENSOR ADAPTER

- Bolt on MAF adapters for Ford vehicles. To determine which adapter will work, measure the distance between the bolt holes and match to the drawings below.
- Adapts Mass Air Flow Sensors to accept 4" Intake System
- Polished aluminum
- Includes bolts

SMALL #8145

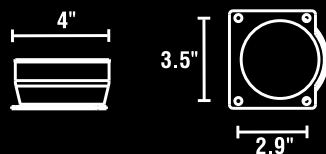

LARGE #8146

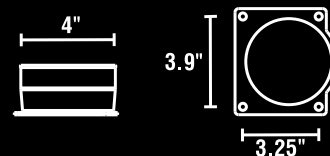

Street legal in most states, but may not be used in California or states with similar emissions control laws except on pre 1976 vehicles.

MASS AIR FLOW SENSOR COMPONENTS



MASS AIRFLOW CONVERSION KIT

Allows you to convert a boot-in GM sensor to a drop-in blade-style GM mass air flow sensor. A conversion harness, weld-on aluminum mass air flow pad, and screws are included to ensure easy installation. This kit requires computer reprogramming to correctly calibrate the mass air flow sensor.

3-wire	#7153
5-wire	#7155



WELD-ON MAF MOUNTING PADS

Slot style	#9924011
Late model GM 1 1/4" round with pin for LSA and LS9 Applications	#9918-03
M4 Stainless Cap Screw - 0.07 x 8mm	#07733

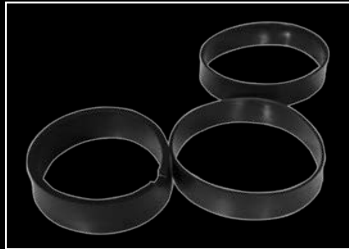

MAF SENSOR REDUCER SLEEVE

Spectre® intake couplers and sleeves for GM mass air flow sensors are designed to adapt most boot-in style GM mass air flow sensors to a 4 inch intake system. This kit includes a 3-5/8 inch to 4 inch sleeve as well as two 3-7/8 inch to 4 inch sleeves.

Reducer sleeve kit	#9774
Single 3-5/8 inch to 4 inch sleeve	#990003



VACUUM HOSE/MAF SENSOR ADAPTER KITS

Includes grommets and fittings to connect vacuum hoses or push-in style sensors into intake tubes.

Small fitting and grommet kit (5, 8 and 10mm)	#9712
Medium fitting and grommet kit (12, 14 and 17mm)	#9713
Large fitting and grommet kit (19 and 25mm)	#9714

Also available:

Grommet - 3/8" ID, 7/8" OD, 1/16" gap	#08283
90° barbed fitting - 3/8"	#08121

ENGINE
BAY COVERSPERFORMANCE
AIR FILTERSINTAKE
SYSTEMS

AIR CLEANERS

ENGINE
DEFILLING

PLUMBING

FUEL AND
IGNITION

HARDWARE

DRIVE TRAIN
ACCESSORIESGENERAL
ACCESSORIES

PERFORMANCE AIRBOXES

Spectre® polished aluminum inline airboxes come with a Spectre® performance air filter and a polished aluminum housing. They allow you to create a custom air intake that feeds the engine cool outside air for more power.



#9833
4" INLINE AIR BOX

- Use with 3" systems
- Includes an HPR™ high-flow filter
- Polished aluminum finish

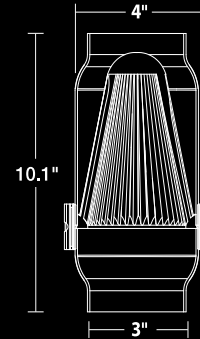

#9832
5" INLINE AIR BOX

- Use with 4" systems
- Includes an HPR™ high-flow filter
- Polished aluminum finish

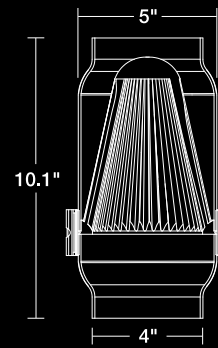

#9831
6" INLINE AIR BOX

- Use with 4" systems
- Includes an HPR™ high-flow filter
- Polished aluminum finish

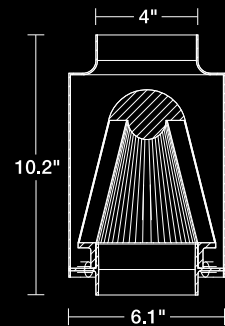

INLINE HPR™ AIR FILTERS

- Fits inside intake tubes for a stealth look

4" inline air filter	#HPR0100
Replacement for 4" inline airbox #9833	#HPR9833
Replacement for 5" inline airbox #9832	#HPR9832
Replacement for 6" conical inline airbox #9831	#HPR9831

Street legal in most states, but may not be used in California or states with similar emissions control laws except on pre 1976 vehicles.

LOW PROFILE ROUND AIR BOXES

Spectre® low profile air boxes come with a chrome plated exterior finish, Spectre® HPR™ air filter, and drop base for extra hood clearance. The air box is an enclosed housing around the air filter that is designed to help block engine heat from getting to the air filter. They can be run as is or by attaching air intake tubing or ducting to 4" round inlet tubes, you can make your own custom air intake.



14" DIAMETER CHROME AIRBOXES WITH OVAL INLET(S)

Single inlet	#98801
Dual inlet - 90°	#98891
Dual inlet - 180°	#98881
Replacement air filter for 14" airboxes	#HPR8699



14" DIAMETER CHROME AIRBOXES WITH ROUND INLET(S)

Single inlet	#98618
Dual inlet - 180°	#98628
Dual inlet - 150°	#98658
Dual inlet - 135°	#98648
Dual inlet - 120°	#98638
Replacement air filter for 14" airboxes	#HPR8699



16" DIAMETER CHROME AIRBOXES WITH ROUND INLET(S)

Single inlet	#98678
Dual inlet - 180°	#98688
Dual inlet - 150°	#98708
Dual inlet - 135°	#98668
Dual inlet - 120°	#98698
Replacement air filter for 16" airboxes	#HPR0138



Street legal in most states, but may not be used in California or states with similar emissions control laws except on pre 1976 vehicles.

- ENGINE BAY COVERS
- PERFORMANCE AIR FILTERS
- INTAKE SYSTEMS**
- AIR CLEANERS
- ENGINE DETAILING
- PLUMBING
- FUEL AND IGNITION
- HARDWARE
- DRIVETRAIN ACCESSORIES
- GENERAL ACCESSORIES

SPEED

Perfor

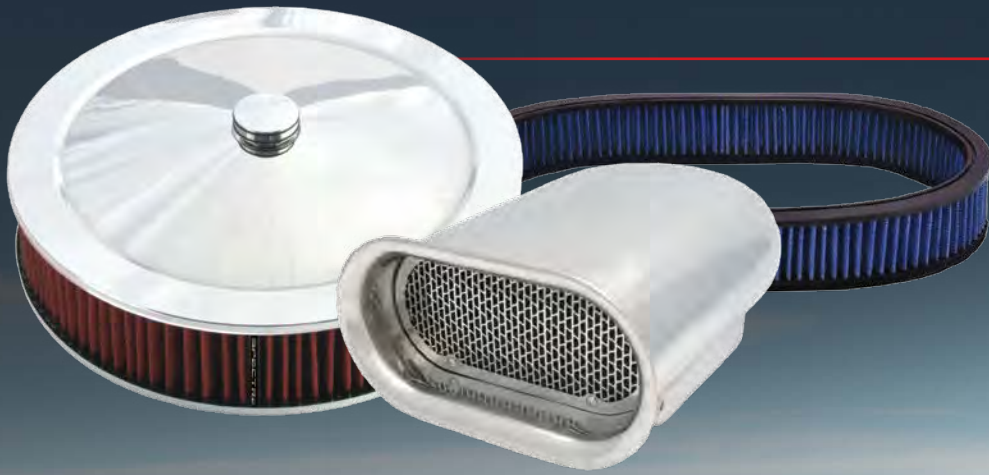

ETRE®

AMMO

DREAM. BUILD. DRIVE.™

AIR CLEANERS



COWL STYLE AIR CLEANERS

Spectre® open top cowl style air cleaners are designed to fit select 1955-1995 V6 and V8 vehicles. They feature an open top air box design that seals to the underside of the hood to help isolate the filter from engine heat and include a powder coated drop base for increased hood clearance.



WITH POWDER COATED LID

Color	3" Height	4" Height	5" Height
Red	#98302	#98421	#98521
Blue	#98361	#98461	#98561
White	#98391	#98491	#98591
Black	#98311	#98411	#98511



WITH TRAY AND POWDER COATED LID

Color	3" Height	4" Height	5" Height
Red	#98303	#98424	#98524
Blue	#98364	#98464	#98564
White	#98394	#98494	#98594
Black	#98314	#98414	#98514



WITH EXTRAFLOW® LID

Color	3" Height	4" Height	5" Height
Red	#98322	#98422	#98522
Blue	#98362	#98462	#98562
White	#98392	#98492	#98592
Black	#98312	#98412	#98512



WITH TRAY AND EXTRAFLOW® LID

Color	3" Height	4" Height	5" Height
Red	#98323	#98423	#98523
Blue	#98363	#98463	#98563
White	#98393	#98493	#98593
Black	#98313	#98413	#98513

May not be legal for use on pollution-controlled vehicles. Check local laws.

EXTRAFLOW® AIR CLEANERS

Spectre® EXTRAFLOW® air cleaners are designed to fit most 1955-1995 V6 and V8 vehicles. They feature EXTRAFLOW® air filter lids, which increases filter area and allows for even greater air flow.

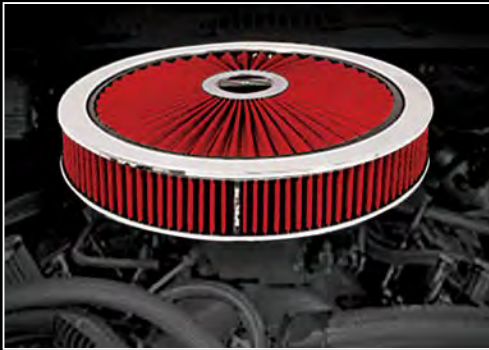

14" AIR FILTER ASSEMBLIES

- Includes 14" round air filter, EXTRAFLOW® air filter lid, and a zinc plated 1-1/4 inch drop base for increased hood clearance
- Fits all carburetors and TB style throttle bodies with 5 1/8" necks

Color	3" Height	4" Height	5" Height
Red	#47622	#47632	#47642
Blue	#47626	#47636	#47646
White	#47628	#47638	#47648
Black	#47621	#47631	#47641



14" AIR FILTER ASSEMBLY AND FILTER BREATHER KIT

- Includes 14" round air filter, EXTRAFLOW® air filter lid, zinc plated 1-1/4 inch drop base for increased hood clearance, vent filter breather, and mounting hardware
- Fits all carburetors and TB style throttle bodies with 5 1/8" necks

Color	3" Height	4" Height	5" Height
Red	#847622	#847632	#847642
Blue	#847626	#847636	#847646
White	#847628	#847638	#847648
Black	#847621	#847631	#847641



14" EXTRAFLOW® LIDS

- Fits 14" round air filters

Color	Part Number
Red	#47612
Blue	#47616
White	#47618
Black	#47611

May not be legal for use on pollution-controlled vehicles. Check local laws.

ENGINE
BAY COVERSPERFORMANCE
AIR FILTERSINTAKE
SYSTEMSAIR
CLEANERSENGINE
DETAILING

PLUMBING

FUEL AND
IGNITION

HARDWARE

DRIVETRAIN
ACCESSORIESGENERAL
ACCESSORIES

CUSTOM HPR™ AIR CLEANERS

With its performance synthetic air filter media, these air filters have been designed to add horsepower by allowing more air flow into your engine than ordinary paper filters. Available in a variety of shapes and sizes to fit a variety of applications.

14" X 3" HPR™ FILTER ELEMENT



Red	#48022
Blue	#48026
White	#48029
Black	#48021

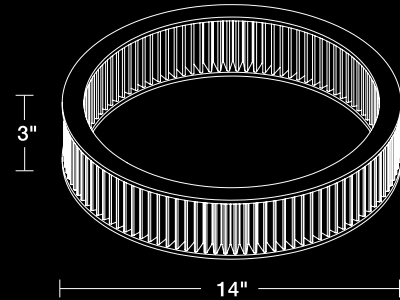

14" X 3" AIR CLEANERS

- Fits all carburetors and TBI style throttle bodies with 5-1/8" necks
- Drop base lowers air cleaner 1-1/4" for additional hood clearance

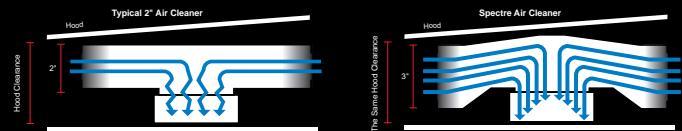

Drop base air cleaner assembly means increased filter area for increased airflow with the same low hood clearance.

#47602

MUSCLE CAR



- Triple chrome-plated steel top

Also available with:

- Blue Filter #47606
- White Filter #47609
- Black Filter #47601

#49132

SMOOTH



- Polished aluminum
- Includes mounting bolt

#49142

ALUMINUM FLAMED



- Polished aluminum
- Includes mounting bolt

#49152

BALL MILLED



- Polished aluminum
- Includes mounting bolt

May not be legal for use on pollution-controlled vehicles. Check local laws.

CUSTOM HPR™ AIR CLEANERS

14" X 4" HPR™ FILTER ELEMENT



- Red #HPR0138
- Blue #HPR0138B
- White #HPR0138W
- Black #HPR0138K

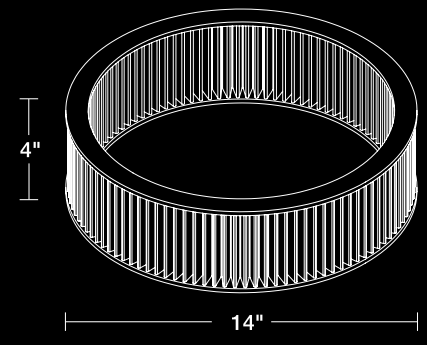

14" X 4" AIR CLEANERS

- Fits all carburetors and TBI style throttle bodies with 5-1/8" necks
- Drop base lowers air cleaner 1-1/4" for additional hood clearance

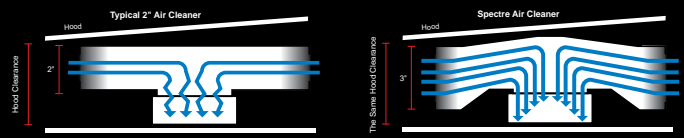

Drop base air cleaner assembly means increased filter area for increased airflow with the same low hood clearance.

#49134 SMOOTH



- Polished aluminum
- Includes mounting bolt

#49144 ALUMINUM FLAMED



- Polished aluminum
- Includes mounting bolt

#49154 BALL MILLED



- Polished aluminum
- Includes mounting bolt

9" X 2" HPR™ FILTER ELEMENT



- Red #HPR2606
- Blue #48056
- White #48059

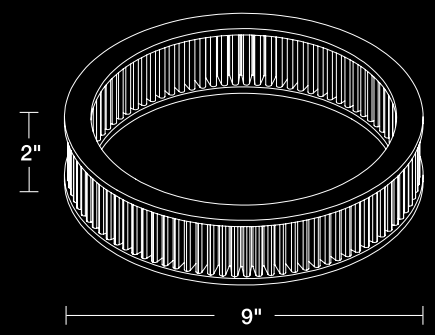

- Fits all carburetors and TBI style throttle bodies with 5-1/8" necks



#47708 9" X 2" MUSCLE CAR AIR CLEANER

- Triple chrome-plated steel

SEE PAGE 66 FOR AIR CLEANER NUTS

May not be legal for use on pollution-controlled vehicles. Check local laws.

- ENGINE BAY COVERS
- PERFORMANCE AIR FILTERS
- INTAKE SYSTEMS
- AIR CLEANERS
- ENGINE DETAILING
- PLUMBING
- FUEL AND IGNITION
- HARDWARE
- DRIVETRAIN ACCESSORIES
- GENERAL ACCESSORIES

CUSTOM HPR™ AIR CLEANERS

14" X 5" HPR™ FILTER ELEMENT



Red	#HPR0139
Blue	#HPR0139B
White	#HPR0139W
Black	#HPR0139K

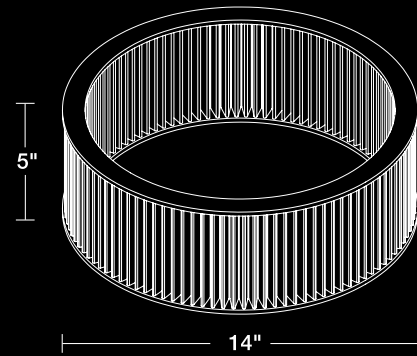

14" X 5" AIR CLEANERS

- Fits all carburetors and TBI style throttle bodies with 5-1/8" necks
- Drop base lowers air cleaner 1-1/4" for additional hood clearance

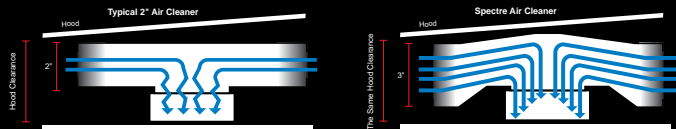

Drop base air cleaner assembly means increased filter area for increased airflow with the same low hood clearance.

#49135 SMOOTH



- Polished aluminum
- Includes mounting bolt

#49145 ALUMINUM FLAMED



- Polished aluminum
- Includes mounting bolt

#49155 BALL MILLED



- Polished aluminum
- Includes mounting bolt

14" X 3" TRIANGLE HPR™ FILTER ELEMENT



Red	#HPR4813
Blue	#HPR4813B
White	#HPR4813W
Black	#HPR4813K

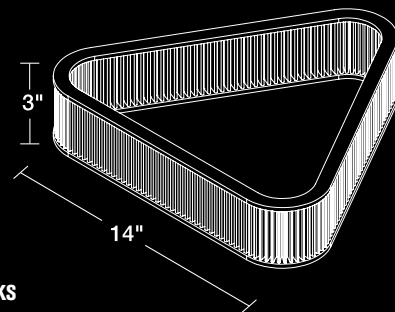

- Fits all carburetors and TBI style throttle bodies with 5-1/8" necks
- Drop base lowers air cleaner 1-1/4" for more hood clearance



#47502 14" X 3" TRIANGLE AIR CLEANER

- Custom triangle design
- Triple chrome-plated steel

SEE PAGE 66 FOR AIR CLEANER NUTS

May not be legal for use on pollution-controlled vehicles. Check local laws.

CUSTOM HPR™ AIR CLEANERS

12" OVAL HPR™ FILTER ELEMENT



Red	#HPR4808
Blue	#HPR4808B
White	#HPR4808W
Black	#HPR4808K

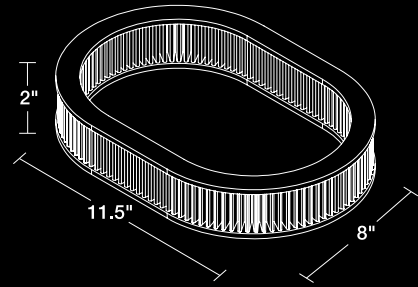

#49162

12" X 2" SMOOTH



- Polished aluminum
- Includes mounting bolt

15" OVAL HPR™ FILTER ELEMENT



Red	#HPR4810
Blue	#HPR4810B
White	#HPR4810W
Black	#HPR4810K

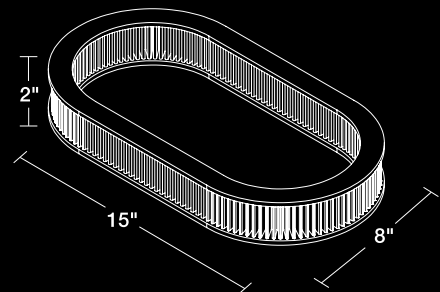

SEE PAGE 66 FOR AIR CLEANER NUTS

May not be legal for use on pollution-controlled vehicles. Check local laws.

ENGINE
BAY
COVERS

PERFORMANCE
AIR
FILTERS

INTAKE
SYSTEMS

AIR
CLEANERS

ENGINE
DETAILING

PLUMBING

FUEL AND
IGNITION

HARDWARE

DRIVE/TRAIN
ACCESSORIES

GENERAL
ACCESSORIES

CHROME AIR CLEANERS

Spectre® chrome air cleaners are designed with a flame resistant paper media and are available in a variety of shapes and sizes to fit a variety of applications.

PAPER AIR CLEANERS



- Fits all carburetors bodies with 5-1/8" necks
- Drop base lowers air cleaner 1-1/4" for additional hood clearance
- Spectre® Riser Kit #4954 makes it easy to raise the air cleaner to clear linkage or choke mechanism



#4760 14" X 3" ROUND CHROME AIR CLEANER

- Triple chrome-plated steel top
- Flame retardant filter element
- See Pg. 66 for air cleaner nuts



#4758 14" X 3" ROUND CHROME AIR CLEANER WITH EMBOSSED FLAMES

- Embossed flame design
- Triple chrome-plated steel top
- Flame retardant filter element
- Replacement element available #4802
- Air cleaner nut not included



#4770 9" X 2" ROUND CHROME AIR CLEANER

- Triple chrome-plated steel top
- Flame retardant filter element
- Flat base
- See Pg. 66 for air cleaner nuts

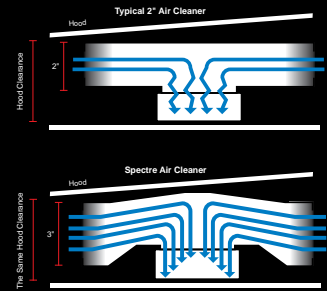

Drop base air cleaner assembly means increased filter area for increased airflow with the same low hood clearance.

AIR CLEANER BASES

- 14" diameter, 5-1/8" (Offset) and 7-1/4" (Dominator) opening
- Raises assembly 1-1/4" higher than our drop base cleaners



OFFSET- #4768



DOMINATOR- #4767



FLAT BASE - #4765

May not be legal for use on pollution-controlled vehicles. Check local laws.

CHROME AIR CLEANERS



#4780

6-3/8" X 2-1/2" ROUND CHROME AIR CLEANER

- Fits all carburetors with 5-1/8" neck
- Triple chrome-plated steel top
- Flame retardant filter element
- See Pg. 66 for air cleaner nuts



#4790

4" X 2" ROUND CHROME AIR CLEANER

- Fits all carburetors with 2-5/8" or 2-5/16" diameter neck
- Triple chrome-plated steel top
- Flame retardant filter element
- Zinc plated steel base
- See Pg. 66 for air cleaner nuts

ROUND PAPER AIR FILTER ELEMENTS

- Accommodates Spectre® and most other air cleaner assemblies
- Flame retardant filter media



14" x 3" - #4802



9" x 2" - #4805



15" x 2" - #4810



6-3/4" x 2-1/2" - #4806



4" x 2" - #4809



12" x 2" - #4808



**13.25" x 2.875" tall
Triangle - #4806**

May not be legal for use on pollution-controlled vehicles. Check local laws.

ENGINE
BAY COVERS

PERFORMANCE
AIR FILTERS

INTAKE
SYSTEMS

AIR
CLEANERS

ENGINE
DETAILING

PLUMBING

FUEL AND
IGNITION

HARDWARE

DRIVE/TRAIN
ACCESSORIES

GENERAL
ACCESSORIES

CHROME AIR CLEANERS

3" OVAL AIR CLEANER ASSEMBLIES

- Fit all carburetors with a 5-1/8" neck
- Polished billet style aluminum top
- Spectre® adapter (#4954) allows use on other carburetor neck sizes
- Flame retardant air filter
- Mounting bolt included

#4916

12" X 8 1/4" SMOOTH



#4910

12" X 8 1/4" BALL MILLED



#4925

15" X 8 1/4" SMOOTH



#4911

15" X 8 1/4" BALL MILLED



3" ROUND AIR CLEANER ASSEMBLIES

- Fit all carburetors with a 5-1/8" neck
- Polished billet style aluminum top
- Spectre® adapter (#4950) allows use on other carburetor neck sizes
- Flame retardant air filter
- Mounting bolt included

#4913

12" X 8 1/4" SMOOTH



#4914

12" X 8 1/4" BALL MILLED



#4915

12" X 8 1/4" FLAMED



May not be legal for use on pollution-controlled vehicles. Check local laws.

CHROME AIR CLEANERS



#4928 CHROME OEM AIR CLEANER LID

- 15-1/2", fits Camaro, Corvette '88-'92, Chevrolet/GMC SB V8 pickups
- Heavy-gauge chrome-plated steel
- OEM replacement
- Bonded rubber ring



#4938 CHROME OEM AIR CLEANER LID

- 15-1/2", fits '93 and later Chevrolet/ GMC SB V8 pickups with dual studs
- Heavy-gauge chrome-plated steel
- OEM replacement
- Bonded rubber ring



#4750 14" X 3" TRIANGLE AIR CLEANER

- Custom triangle design
- Triple chrome-plated steel
- Flame retardant filter



#4912 CHROME VELOCITY STACK

- Fits carburetors with a 5-1/8" neck
- Re-usable foam filter
- Easy to install



#4800 SUPERFLOW AIR CLEANER

- Fits carburetors with a 5-1/8" neck
- Re-usable foam filter

ENGINE
BAY
COVERSPERFORMANCE
AIR
FILTERSINTAKE
SYSTEMSAIR
CLEANERSENGINE
DETAILING

PLUMBING

FUEL
AND
IGNITION

HARDWARE

DRIVE/TRAIN
ACCESSORIESGENERAL
ACCESSORIES

AIR CLEANER ACCESSORIES



#4960 BREATHER TUBE FITTINGS

- Use with most 14" and 9" air cleaners
- Allows hook up between breather and air cleaner
- Fits 5/8" and 3/4" hoses
- Durable ABS resin
- Hardware included

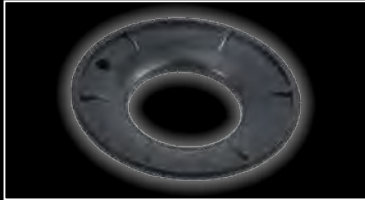

#4952 AIR CLEANER ADAPTER

- Fits two barrel carburetors with 2-5/8" neck flanges
- Permits use of air cleaners, plenums, and air boxes with 5-1/8" neck
- Adapter includes breather hose nipple integral to the main body



#4953 AIR CLEANER ADAPTER

- Fits two barrel carburetors with 3-1/16" neck flanges
- Permits use of air cleaners, plenums, and air boxes with 5-1/8" neck
- Adapter includes breather hose nipple integral to the main body

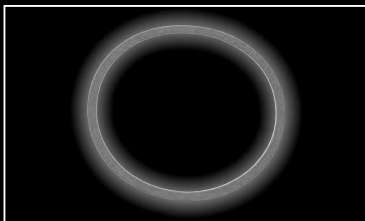
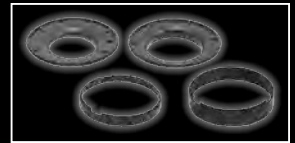

#4204 AIR CLEANER GASKET

- Fits all carburetors with 5-1/8" neck flanges
- Permits use of air cleaners, plenums, and air boxes with 5-1/8" neck
- Helps seal air cleaner or plenum at the carburetor neck

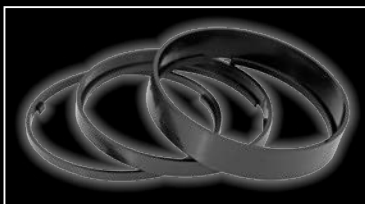

#4954 AIR CLEANER RISER KIT

- Includes 1/4", 1/2" and 1" risers that can be combined to add 1/4", 1/2", 3/4", 1", 1-1/4", 1-1/2" or 1-3/4" of height to your air cleaner

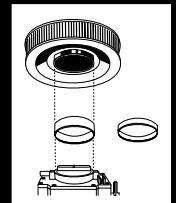

#5358 AIR CLEANER NUT T-BAR STYLE

- Triple chrome-plated
- 1/4" - 20 threads

LOW PROFILE AIR CLEANER NUT

- Ultra low profile
- Designed for use with low-profile air boxes and plenums

CHROME - #4208



LOGO - #4206



May not be legal for use on pollution-controlled vehicles. Check local laws.

AIR CLEANER ACCESSORIES

DELUXE AIR CLEANER NUTS

- Triple chrome-plated with 1/4" - 20 threads

KNURLED



SMALL
#1758



LARGE
#1768

BILLET O-RING



SMALL
#17585



LARGE
#17685

WINGED



SMALL
#4210



LARGE
#4209

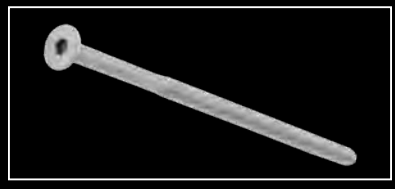

#4212
AIR CLEANER BOLT

- 5" air cleaner with tapered head for oval and round aluminum air cleaners
- Allen head socket
- Chrome-plated



#42133
AIR CLEANER STUD KIT

- Includes wing-nut
- Versatile- adjusts from 2-3/4" - 9"
- Includes 1/4"- 20 x 4" stud

#4205
STUD ADAPTER



- Converts any Spectre® stud from 1/4" - 20 to 5/16" - 18 thread



#4213
AIR CLEANER STUD

- Includes 1/4" - 20 x 5" stud
- Includes wing-nut



#4215
TBI AIR CLEANER STUD

- Includes 1/4" -20 x 5" stud
- Includes wing-nut
- Allows for use of 5-1/8" base air cleaners on General Motors single & dual stud throttle bodies



#4218
DODGE THROTTLE BODY AIR CLEANER STUD

- Allows for use of 5-1/8" air cleaners, plenums, and air boxes on Dodge down-draft style throttle bodies.
- 1/4"-20 threads.

May not be legal for use on pollution-controlled vehicles. Check local laws.

- ENGINE BAY COVERS
- PERFORMANCE AIR FILTERS
- INTAKE SYSTEMS
- AIR CLEANERS**
- ENGINE DETAILING
- PLUMBING
- FUEL AND IGNITION
- HARDWARE
- DRIVETRAIN ACCESSORIES
- GENERAL ACCESSORIES

SPEED

Performance



STRE[®]

ANNOUNCE

DREAM. BUILD. DRIVE.™



ENGINE DETAILING

ENGINE DETAILING AND ACCESSORIES

Spectre® engine accessories are manufactured using high quality materials and are designed to perform as good as they look. A wide variety of detailing components are available for many popular classic cars and custom applications.



CUSTOMIZED PERFORMANCE



ENGINE DETAILING AND ACCESSORIES

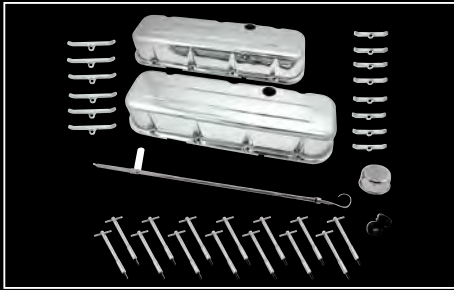

CHROME ENGINE KITS

Chrome always adds that great look under the hood. Spectre® offers kits that include chrome valve covers, valve cover hold downs, breathers, timing chain covers, dipsticks and in some kits chrome air cleaners or lids. Applications available for classic big block and small block Chevy, Chrysler, Ford and Oldsmobile engines.



VALVE COVERS

Spectre® valve covers are offered in various sizes, heights, and finishes depending on your engine. Engineered for optimum fit and function, Spectre® valve covers are available in triple chrome plated steel, polished aluminum, and even gold iridite finishes, ideal for any custom build.



OIL PANS

Spectre® offers multiple size and finish options for your replacement engine oil pans. We offer chrome plated steel, polished aluminum and raw finishes. These oil pans are designed to bolt directly onto your engine with ease. Deep sump pans are available with optional extended oil pan pick-up.



PULLEYS

Spectre® offers many styles of triple plated chrome or aluminum alternator, water pump, power steering and crank pulleys for various Ford, Chevy small block and big block engine applications.

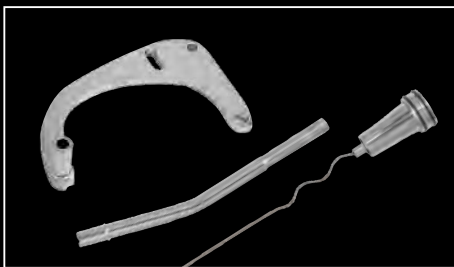

OTHER ACCESSORIES

Spectre's vast list of engine accessories include multiple brackets and latches, universal cap kits, master cylinder covers and power steering dipsticks for popular GM, Ford and Chrysler applications, engine oil and transmission pans and dipsticks, timing chain covers and many different interior and exterior accessories are also available. Engineered for optimum fit and function, Spectre® accessories are the perfect complementing detail piece on your custom build.

ENGINE
BAY
COVERSPERFORMANCE
AIR
FILTERSINTAKE
SYSTEMSAIR
CLEANERSENGINE
DETAILING

PLUMBING

FUEL AND
IGNITION

HARDWARE

DRIVETRAIN
ACCESSORIESGENERAL
ACCESSORIES

AMC/JEEP '64-'80 199-232-258 STRAIGHT SIX

OEM STYLE CHROME VALVE COVERS



#5245

- Will not fit vehicles with OEM plastic covers
- Triple Chrome-Plated steel
- Stock height
- Baffled
- Sold Individually
- Additional Parts
 - Hold Downs pg. 102
 - Breathers pg. 105
 - Spreader Bars pg. 103

AMC/JEEP '64-'80 304-360-390-401

OEM STYLE CHROME VALVE COVERS



#5275

- Triple chrome-plated steel
- Sold in pairs
- Additional Parts
 - Hold Downs pg. 102
 - Spreader Bars pg. 103
 - Breathers pg. 105

BUICK '68-'81 350

OEM STYLE CHROME VALVE COVERS



#5276

- Triple chrome-plated steel
- Sold in pairs
- Additional Parts
 - Hold Downs pg. 102
 - Spreader Bars pg. 103
 - Breathers pg. 105

CADILLAC

OEM STYLE CHROME VALVE COVERS



#5281

- Fits '68 - '76 Cadillac 472 - 500; '77-'79 425; and '80-'84 368
- Triple Chrome-Plated steel
- Stock height
- Sold in pairs
- Additional Parts
 - Hold Downs pg. 102
 - Breathers pg. 105
 - Spreader Bars pg. 103

1997-04 CHEVROLET LS

HEADER GASKETS

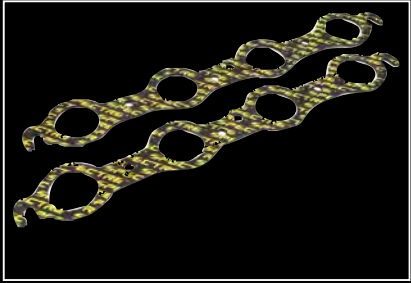

- #523 1/16" thick
- #423 1/8" thick
- Designed for '97-'04 Chevrolet LS1 and LS6 engines with 1.75" round ports
- Made from compressed ceramic fiber that out-performs typical non-asbestos gaskets
- 2 Gaskets per package
- Conforms to warped manifolds and header flanges
- Helps stop header leaks

WATER NECK LS



#4939
360° Swivel Design



#4932
Straight Design

- Fits 97" and later LSx engines
- Polished aluminum finish
- Uses OEM style Thermostat / O-rings
- Includes stainless steel bolts
- Ideal for use in LS engine conversions

VALVE COVER CHEVY LS1

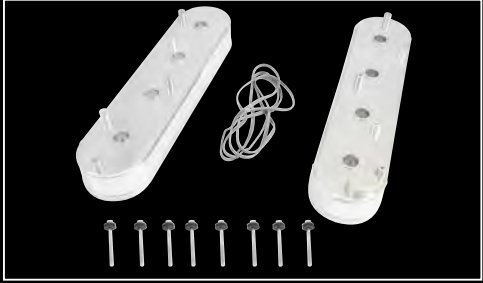

- #5224
- Polished aluminum finish
 - Mounting tabs for coils
 - Fabricated aluminum construction
 - Bolts and seals included

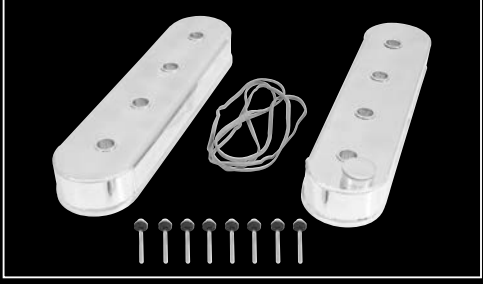

- #5225
- Polished aluminum finish
 - Without coil mounts
 - Fabricated aluminum construction
 - Bolts and seals included

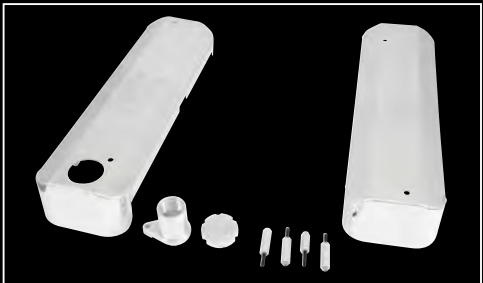

- #5226
- Coil covers
 - Polished aluminum finish
 - Fabricated aluminum construction
 - Attaches to stock valves covers
 - Bolts and hardware included

- ENGINE BAY COVERS
- PERFORMANCE AIR FILTERS
- INTAKE SYSTEMS
- AIR CLEANERS
- ENGINE DETAILING**
- PLUMBING
- FUEL AND IGNITION
- HARDWARE
- DRIVE TRAIN ACCESSORIES
- GENERAL ACCESSORIES

1958-86 CHEVROLET SMALL BLOCK 283-400

DELUXE CHROME ENGINE KITS



#5403 - FITS 1965-79

- Long lasting triple chrome plated
- Kit includes:
 - 1 pair stock height baffled valve covers
 - 8 spreader bars
 - 8 Y-wing hold downs
 - 1 breather
 - 1 dipstick and tube
 - 2 grommets
 - Timing cover kit
 - Adjustable timing tab with pointer
- For valve cover gasket (#585) see pg. 74



#5404 - FITS 1965-79

- Long lasting triple chrome plated
- Kit includes:
 - 1 pair tall profile baffled valve covers
 - 8 spreader bars
 - 8 T-bar hold downs
 - 1 breather
 - 1 dipstick and tube
 - 2 grommets
 - Timing cover kit
 - Adjustable timing tab with pointer
- For valve cover gasket (#585) see pg. 74

CHROME ENGINE KITS



#54083

- Long lasting triple chrome plated
- Kit includes:
 - 1 pair stock height baffled valve covers
 - 8 T-bar hold downs
 - 1 breather
 - 1 push-in PCV breather
 - 1 PCV braided stainless steel hose with two fittings
 - 1 twist-in oil filler cap
 - 2 grommets
- For valve cover gasket (#585) see pg. 74

Internal Baffle



#5402 - FITS 1965-79

- Long lasting triple chrome plated
- Kit includes:
 - 1 pair tall profile baffled valve covers
 - 8 spreader bars
 - 8 T-bar hold downs
 - 1 breather
 - 1 dipstick and tube
 - 2 grommets
- For valve cover gasket (#585) see pg. 74

1958-86 CHEVROLET SMALL BLOCK 283-400

OEM STYLE CHROME VALVE COVERS



- #5258
- OEM three-hole design
 - Accommodates factory filler cap, breather and PCV
 - Triple chrome-plated steel
 - Sold in pairs
 - Stock height
 - Baffled
 - Additional parts
 - Hold Downs pg. 102
 - Spreader Bars pg. 103
 - Breathers pg. 105
 - Gasket (#585) pg. 74

CHROMED STEEL VALVE COVERS



Stock Height
#5220



Stock Height - Flame
#5218



Tall Profile
#5210

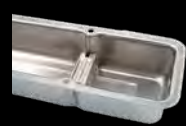

- Baffled
- Triple chrome-plated steel
- Sold in pairs
- Additional Parts
 - Hold Downs pg. 92
 - Spreader Bars pg. 93
 - Breathers pg. 95
 - Gasket (#585) pg. 74

POLISHED ALUMINUM VALVE COVERS



Stock Height
Smooth Polished
#4996



Stock Height
Ball-Milled
#4997



- Heavy die-cast polished aluminum
- Baffles included
- Sold in pairs
- Additional Parts
 - Hold downs pg. 92
 - Breathers pg. 95
 - Gasket (#585) pg. 74

- ENGINE BAY COVERS
- PERFORMANCE AIR FILTERS
- INTAKE SYSTEMS
- AIR CLEANERS
- ENGINE DETAILING**
- PLUMBING
- FUEL AND IGNITION
- HARDWARE
- DRIVE TRAIN ACCESSORIES
- GENERAL ACCESSORIES

1958-86 CHEVROLET SMALL BLOCK 283-400

CHROMED STEEL VALVE COVERS



Tall Profile
Smooth Polished
#4999



Tall Profile
Ball-Milled
#5000



- Heavy die-cast polished aluminum
- Baffles included
- Sold in pairs

- Additional Parts
 - Hold downs pg. 102
 - Breathers pg. 105

CIRCLE TRACK VALVE COVERS



Unplated Finish
#4991

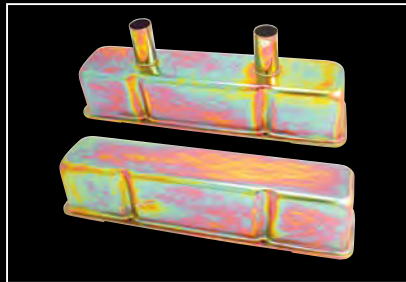

Gold Iridite Finish
#4992

- Design prevents breather oil splash common in circle track racing
- Unplated or gold iridite finish
- Steel construction
- Tall profile provides clearance for custom rocker assemblies
- Sold in pairs
- Breathers pg.105

SPREADER BAR SET AND VALVE COVER GASKET SET



Valve Cover Spreader
Bar Kits #5321

- Features a triple chrome-plated finish
- Constructed from heavy gauge steel
- Engineered to improve valve cover sealing



Valve Cover Gasket
#585

- OEM replacement
- Extra thick rubber with steel reinforced core
- Provides a superior seal

1958-86 CHEVROLET SMALL BLOCK 283-400

OEM STYLE OIL PANS

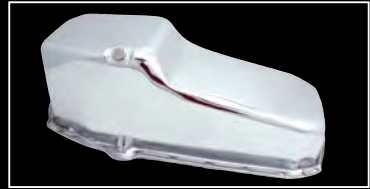

Chrome-Plated Steel
#5480



Unplated Steel
#5494

- Fits '55 - '79 small block Chevrolet 283 - 400 with driver's side dipstick (except '62-'67 Chevy II)
- Stock 4 quart capacity



Chrome-Plated Steel
#5481



Unplated Steel
#5501

- Fits '80 - '85 small block Chevrolet 305 - 350 with passenger side dipstick
- Stock 4 quart capacity

EXTRA CAPACITY OIL PANS

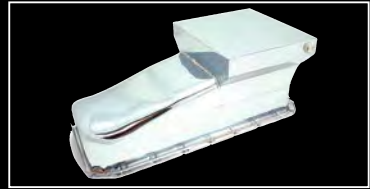

#5483



Extended Pickup #5484

- Fits '55 - '79 small block Chevrolet 283 - 400 with driver's side dipstick (except '62 - '67 Chevy II)
- Triple chrome-plated steel
- 7 quart capacity
- Requires extended pickup #5484

OIL PAN FINNED ALUMINUM STYLE

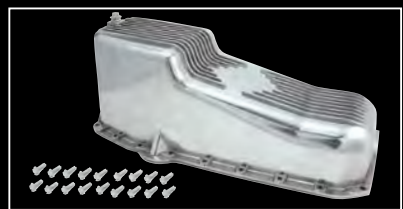

#4987

- Fits '55 - '79 small block Chevrolet 283 - 400 with driver's side dipstick (except '62 - '67 Chevy II and Corvette with stock exhaust)
- Heavy die-cast polished finned aluminum
- Stock 4 quart capacity
- Includes all necessary fasteners



#4988

- Fits '80 - '85 small block Chevrolet 305-350 with passenger side dipstick
- Heavy die-cast polished finned aluminum
- Stock 4 quart capacity
- Includes all necessary fasteners



#5478

- Magnetic drain plug
- Fits any oil pan with 1/2 in. - 20 threads
- Holds harmful metallic particles

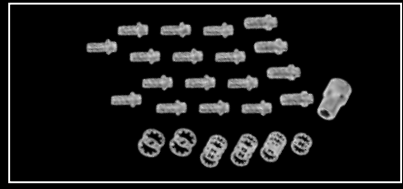

#4691

- Oil pan timing cover bolt kit
- Fits 265-400 small block Chevrolet engines
- 12-point socket included for easy installation

- ENGINE BAY COVERS
- PERFORMANCE AIR FILTERS
- INTAKE SYSTEMS
- AIR CLEANERS
- ENGINE DETAILING**
- PLUMBING
- FUEL AND IGNITION
- HARDWARE
- DRIVE TRAIN ACCESSORIES
- GENERAL ACCESSORIES

1958-86 CHEVROLET SMALL BLOCK 283-400

ENGINE OIL DIPSTICKS



#4255

- Fits '65 - '79
- Triple chrome-plated steel
- Tube made to OEM specifications

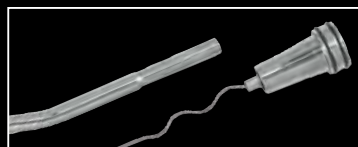

#42555

- Fits '65 - '79
- Triple chrome-plated steel
- Tube made to OEM specifications
- Billet handle



#5730

- Fits '65 - '79
- Billet aluminum handle steel dipstick
- Short custom application

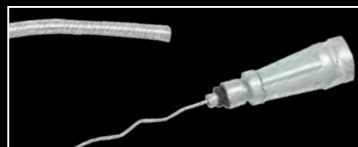

#5749

- Fits '80 - '82 305 - 350
- Triple chrome-plated steel
- Billet handle



#5726

- Fits '80 - '85 Camaro and Firebird V8
- Triple chrome-plated steel
- Tube made to OEM specifications

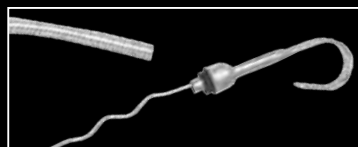

#5728

- Fits '80 - '82 305 - 350
- Triple chrome-plated steel

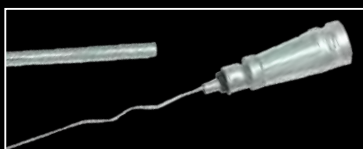

#5746

- Fits '80 - '85 Camaro and Firebird V8
- Triple chrome-plated steel
- Tube made to OEM specifications
- Billet handle



#42551

- Fits '55 - '79 small block Chevrolet
- Flexible tube with billet aluminum handle
- Tube made to OEM specifications
- Slim design allows mounting inside headers

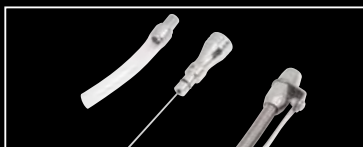

#57281

- Fits '80 - '85 small block Chevrolet
- Flexible tube with billet aluminum handle
- Tube made to OEM specifications
- Slim design allows mounting inside headers

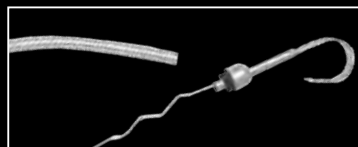

#57283

- Fits '80 - '96 small block Chevrolet
- Triple chrome-plated steel
- Tube made to OEM specifications

1958-86 CHEVROLET SMALL BLOCK 283-400

CHROME TIMING CHAIN COVER



#42353

- Triple chrome-plated steel
- Use with Spectre® timing tab #4237
- Kit includes:
 - Premium timing cover gasket
 - 10 Triple chrome-plated 12-point timing cover bolts and washers
 - Water pump gaskets
 - Pre-installed oil seal
 - 12-point bolts and thin wall socket allow for easy installation

ALUMINUM TIMING CHAIN COVER



#4935

- Polished aluminum
- Use with Spectre® timing tab #4237 or 4936
- Kit includes:
 - Water pump gaskets
 - Oil seal
 - 10 timing cover bolts

CHROME TIMING TAB



#4237

- Narrow body width is ideal because it does not conceal the timing marks on the harmonic balancer
- Use with 6", 7" or 8" balancers
- Triple chrome-plated steel
- Adjustable pointer
- Window in pointer for maximum clarity

ALUMINUM TIMING TAB



#4936

- Use with 6" or 7" balancers
- Polished aluminum
- Adjustable pointer
- Includes all necessary allen head bolts

DISTRIBUTOR HOLD DOWN



#5760

- Heavy gauge steel
- Triple chrome plated finish
- Fits Chevrolet V8 engines
- Installation hardware included
- OEM replacement

FUEL BLOCK OFF PLATES



#4946

- Fuel pump block off plate
- For electric fuel pumps
- Ball milled design - machined aluminum



#42493

- Fuel pump mounting plate
- Includes chrome bolts and gasket
- Triple chrome-plated steel



#42463

- Fuel pump block off plate
- Includes chrome bolts and gasket
- Triple chrome-plated steel

ENGINE
BAY
COVERSPERFORMANCE
AIR
FILTERSINTAKE
SYSTEMSAIR
CLEANERSENGINE
DETAILING

PLUMBING

FUEL
AND
IGNITION

HARDWARE

DRIVE
TRAIN
ACCESSORIESGENERAL
ACCESSORIES

1958-86 CHEVROLET SMALL BLOCK 283-400

WATER PUMP PULLEYS - SHORT WATER PUMP



Chrome-Plated Steel
7" Diameter
#4368



Machined Aluminum
6-5/8" Diameter
#4369

- Fits '55 - '68 with short water pump
- Single belt groove

Short Pump



Chrome-Plated Steel
6-1/4" Diameter
#4378



Machined Aluminum
6-5/8" Diameter
#4379

- Fits '55 - '68 with short water pump
- Double belt groove

CRANKSHAFT PULLEYS - SHORT WATER PUMP



Chrome-Plated Steel
6-3/4" Diameter
#4388



Machined Aluminum
6-5/8" Diameter
#4389

- Fits '55 - '68 with short water pump
- Single belt groove



Chrome-Plated Steel
7-3/8" Diameter
#4398



Machined Aluminum
6-5/8" Diameter
#4399

- Fits '55 - '68 with short water pump
- Double belt groove



Machined Aluminum
6-1/2" Diameter
#4401

- Fits '55 - '68 with short water pump
- Triple belt groove

CRANKSHAFT PULLEYS - SHORT WATER PUMP



#4478

- Fits '55 - '68 small block and '65 - '68 big block Chevrolet with short water pump
- Single belt groove
- Add on pulley for #4388 or #4398 (small block) or #4468 (big block) for air conditioning
- Triple chrome-plated steel
- 6-3/4" diameter

1958-86 CHEVROLET SMALL BLOCK 283-400

WATER PUMP PULLEYS - LONG WATER PUMP



Chrome-Plated Steel
6-1/8" Diameter
#4408



Machined Aluminum
6-9/16" Diameter
#4409

- Fits '69 - '85 with long water pump
- Single belt groove

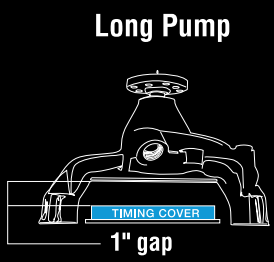

Chrome-Plated Steel
6-3/8" Diameter
#4418



Machined Aluminum
6-5/8" Diameter
#4419

- Fits '69 - '85 long water pump
- Double belt groove

CRANKSHAFT PULLEYS - LONG WATER PUMP



Chrome-Plated Steel
7" Diameter
#4428



Chrome-Plated Steel
6-1/2" Diameter
#4429

- Fits '69 - '85 with long water pump
- Single belt groove



Chrome-Plated Steel
7" Diameter
#4438



Machined Aluminum
6-5/8" Diameter
#4439

- Fits '69 - '85 with long water pump
- Double belt groove



Chrome-Plated Steel
7-3/4" Diameter
#4448



Machined Aluminum
6-5/8" Diameter
#4449

- Fits '69 - '85 with long water pump
- Triple belt groove

- ENGINE BAY COVERS
- PERFORMANCE AIR FILTERS
- INTAKE SYSTEMS
- AIR CLEANERS
- ENGINE DETAILING**
- PLUMBING
- FUEL AND IGNITION
- HARDWARE
- DRIVE TRAIN ACCESSORIES
- GENERAL ACCESSORIES

1958-86 CHEVROLET SMALL BLOCK 283-400

GM POWER STEERING PUMP PULLEYS



Chrome
#4487



Machined Aluminum
#4490

- Fits early GM through '84 with Keyway style pump
- Double belt groove
- 5-13/16" diameter
- Fits 5/8" shaft
- Won't fit Corvette



#4489

- Fits early GM through '84 with Keyway style pump
- Single belt groove
- Machined aluminum
- 5-3/4" diameter
- Bolt-on
- Won't fit Corvette



Chrome
#44851

- Fits early GM through '84 with Keyway style pump
- Single belt groove
- Triple chrome plated steel
- 5-13/16" diameter

FAN PULLEY NOSE



#4469

- Fits '55 - '68 with short water pump
- Machined aluminum
- Includes bolts and Allen wrench
- 1-3/4" bolt circle



#4479

- Fits '69 - '85 with long water pump
- Machined aluminum
- Includes bolts and Allen wrench
- 2-1/8" bolt circle

CHEVROLET WATER PUMP SHIM KIT

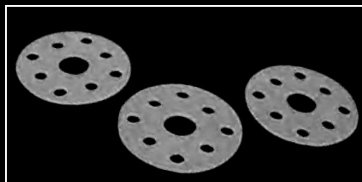

#4480

- Fits all Chevrolet water pumps
- Shims water pump pulley out 1/16", 1/8" or 3/16" for proper alignment with crank shaft pulley
- 3 shims per kit
- Water pump pulley bolts available - #4692 (sold separately)

CRANKSHAFT AND WATER PUMP PULLEY BOLT KIT



#4693

- Use with Chevrolet crankshaft pulleys
- Kit includes three grade 5 hex head bolts
- Bolts measure 3/18 inch - 24 by 1 inch
- Features a zinc-plated finish
- Made from high quality steel



#4692

- Use with aluminum water pump pulleys
- Kit includes four tapered Allen grade 8 bolts
- Bolts measure 5/16 inch - 24 by 3/4 inch
- Corrosion resistant black oxide plated finish
- Made from high quality steel
- Features countersunk socket heads

1958-86 CHEVROLET SMALL BLOCK 283-400

ALTERNATOR BRACKETS

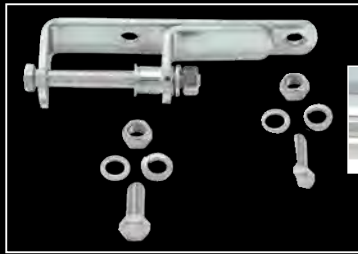

Precision bushing
ensures an accurate fit



#42273

- Fits '68 and earlier with short water pump and headers
- OEM style
- Fits left or right side
- Triple chrome-plated steel
- Includes all necessary chrome bolts
- Use with #42283



#42283

- Fits '68 and earlier with short water pump and headers
- Triple chrome-plated steel
- For use with headers
- Fits driver's side
- Includes all necessary chrome bolts
- Use with #42273

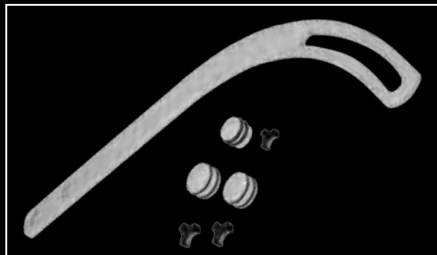

#42263

- Universal design
- Adjustable
- Triple chrome-plated steel
- Kit includes:
 - Billet Bolt Caps (3)
 - Retainers (3)
 - Bracket



#4716

- Fits '69-'86 with long water pump
- Triple chrome-plated
- OEM style
- Mounts on passenger side



#4717

- Fits '55-'68 with short water pump
- Triple chrome-plated
- Mounts on driver's side
- Lowers position of alternator

ENGINE
BAY
COVERSPERFORMANCE
AIR
FILTERSINTAKE
SYSTEMSAIR
CLEANERSENGINE
DETAILING

PLUMBING

FUEL
AND
IGNITION

HARDWARE

DRIVE
TRAIN
ACCESSORIESGENERAL
ACCESSORIES

1958-86 CHEVROLET SMALL BLOCK 283-400

CUSTOM UPPER ALTERNATOR BRACKET



#4715

- Fits '69 - '75 with long water pump
- Triple chrome-plated
- Allen bolt included
- Mounts on driver's side



#4714

- Fits '65 - '68 with short water pump
- Triple chrome-plated
- Allen bolt included
- Mounts on driver's side



#4713

- Fits '76 - '86 with long water pump
- Allen bolt included
- Triple chrome-plated
- Mounts on passenger side



#4710

- Fits '65 - '68 with short water pump
- OEM style
- Triple chrome-plated
- Mounts on driver's side

ALTERNATOR BRACKET SET



#47293

- Fits '69 - '86 with long water pump
- Triple chrome-plated steel
- Includes all necessary chrome bolts & hardware as shown

1988-95 CHEVY/GMC SMALL BLOCK 305-350 CENTER BOLT

CHROME ENGINE KITS



#5432 - FITS 1987-00

- Air cleaner with HPR™ filter
- Chrome valve covers and hold downs
- Oil cap, breather and PCV breather
- T-bar air cleaner nut and offset stud



#5430 - FITS 1987-00

- Air cleaner with HPR™ filter
- Chrome valve covers and hold downs
- Oil cap, breather and PCV breather
- T-bar air cleaner nut and offset stud



#5400 - FITS 1988-92

- Long lasting triple chrome plated
- Kit includes:
 - 1 pair stock height valve covers
 - 8 chrome valve cover bolts
 - 1 single-hole air cleaner top
 - 1 power steering cap cover
 - 1 oil filler plug

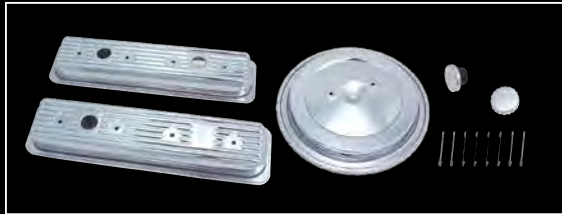

#5401 - FITS 1993-95

- Long lasting triple chrome plated
- Kit includes:
 - 1 pair stock height valve covers
 - 8 chrome valve cover bolts
 - 1 dual-hole air cleaner top
 - 1 power steering cap cover
 - 1 oil filler plug



#5428 - FITS 1988-95

- Long lasting triple chrome plated
- Kit includes:
 - 1 pair stock height valve covers
 - 1 PCV breather
 - 1 oil filler cap
 - 8 chrome valve cover hold downs
 - 1 offset air cleaner stud & wing nut which allows for use of 5-1/8" neck air cleaners on single and dual stud TBI's
 - 2 grommets

POLISHED ALUMINUM STOCK HEIGHT VALVE COVERS



Smooth Polished
#4994



Ball-Milled
#4995

- Heavy die-cast polished aluminum
- Baffles included
- Includes mounting bolts
- Sold in pairs
- Additional parts
 - Breathers pg. 105

May not be legal for use on pollution-controlled vehicles. Check local laws.

ENGINE
BRA
COVERS

PERFORMANCE
AIR FILTERS

INTAKE
SYSTEMS

AIR
CLEANERS

ENGINE
DETAILING

PLUMBING

FUEL AND
IGNITION

HARDWARE

DRIVE TRAIN
ACCESSORIES

GENERAL
ACCESSORIES

1988-95 CHEVY/GMC SMALL BLOCK 305-350 CENTER BOLT

CHROMED STEEL VALVE COVERS



#5260

- OEM three-hole design accommodates factory filler plug and breathers
- Baffled
- Triple chrome-plated steel
- Sold in pairs
- Additional parts
 - Hold downs see below
 - Breathers pg. 105

POLISHED ALUMINUM TALL PROFILE VALVE COVERS



Smooth Polished
#5017



Ball-Milled
#5016

- Heavy die-cast polished aluminum
- Baffles included
- Includes mounting bolts
- Sold in pairs
- Additional parts
 - Breathers pg. 105



#5288

- Valve cover hold downs bolts
- T-bar design

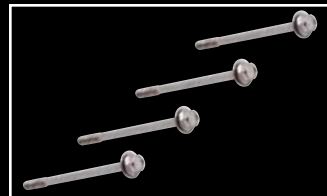

#5280

- Valve cover bolts
- Hex head design

FINNED DIAMOND ALUMINUM OIL PAN

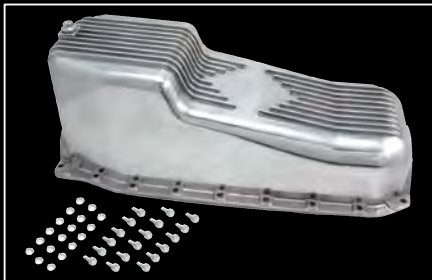

#4989

- Fits '86 and later small block Chevrolet 305 - 350 with passenger side dipstick
- Heavy die-cast polished finned aluminum
- Stock 4 quart capacity
- Includes all necessary fasteners

OEM STYLE OIL PANS



Chrome-Plated Steel
#5482



Unplated Steel
#5503

- Fits '86 and later small block Chevrolet 305 - 350
- For vehicles with one-piece rear main seal
- Stock 4 quart capacity

1965 AND LATER CHEVROLET BIG BLOCK 396-454

CHROME ENGINE KITS



#5405

- Long lasting triple chrome-plated
- Kit includes:
 - 1 pair stock height baffled valve covers
 - 14 spreader bars
 - 14 Y-wing hold downs
 - 1 breather
 - 1 dipstick and tube
 - 2 grommets
 - Will not fit Corvette with power brakes
- Gasket (#586) pg. 86



#5406

- Long lasting triple chrome-plated
- Kit includes:
 - 1 pair tall profile baffled valve covers
 - 14 spreader bars
 - 14 T-bar hold downs
 - 1 breather
 - 1 dipstick and tube
 - 2 grommets
 - Will not fit Corvette with power brakes
- Gasket (#586) pg. 86

CHROME OEM STYLE VALVE COVERS



#5261

Fits '65-'72 big block Chevrolet 396-454 without power brakes. Not for Corvettes.



#5262

Fits '65-'72 big block Chevrolet 396-454 with power brakes including Corvettes.

- Triple chrome-plated steel
- Stock height
- Baffled
- Sold in pairs
- Additional parts
 - Hold downs pg. 102
 - Spreader bars pg. 103
 - Breathers pg. 105
 - Gasket (#586) pg. 86

CHROMED STEEL VALVE COVERS



Stock Height
#5240



Tall Profile
#5230

- Triple chrome-plated steel
- Baffled
- Sold in pairs
- Additional parts
 - Hold downs pg. 102
 - Spreader bars pg. 103
 - Breathers pg. 105
 - Gasket (#586) pg. 86

- ENGINE BAY COVERS
- PERFORMANCE AIR FILTERS
- INTAKE SYSTEMS
- AIR CLEANERS
- ENGINE DETAILING**
- PLUMBING
- FUEL AND IGNITION
- HARDWARE
- DRIVE TRAIN ACCESSORIES
- GENERAL ACCESSORIES

1965 AND LATER CHEVROLET BIG BLOCK 396-454

POLISHED ALUMINUM VALVE COVERS - STOCK HEIGHT



Smooth Polished
#5022



Ball-Milled
#5021

- Heavy die-cast polished aluminum
- Bolts included
- Sold in pairs
- Baffles included

POLISHED ALUMINUM VALVE COVERS - TALL PROFILE



Smooth Polished
#5011



Ball-Milled
#5012

- Heavy die-cast polished aluminum
- Sold in pairs
- Includes mounting bolts
- Baffles included

VALVE COVER ACCESSORIES

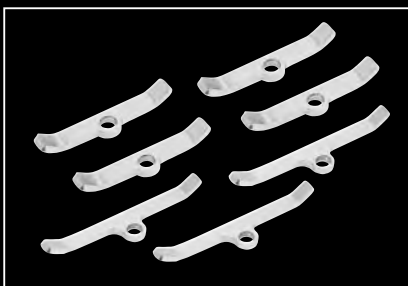

Spreader Bar Kits
#5322

- Triple chrome-plated finish
- Heavy gauge steel
- Engineered to improve valve cover seal

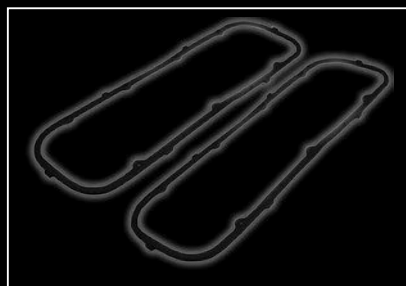

Valve Cover Gasket
#586

- Extra thick rubber
- Steel core reinforced
- Superior sealing
- Stops leaks

1965 AND LATER CHEVROLET BIG BLOCK 396-454

OEM STYLE OIL PANS



Chrome-Plated Steel
#5485



Unplated Steel
#5505

- Fits all big block Chevrolet 396 - 454 except '62 - '67 Chevy II, Chevelle and El Camino
- Stock 4 quart capacity

EXTRA CAPACITY OIL PANS



#5486



Extended Pickup
#5487

- Fits all big block Chevrolet 396 - 454 except '62 - '67 Chevy II, Chevelle and El Camino
- Triple chrome-plated steel
- 6 quart capacity
- Requires extended pickup #5487



#5478

- Magnetic oil drain plug
- Powerful magnet

ENGINE OIL DIPSTICKS



#5720

- Triple chrome-plated steel
- Tube base made to OEM specifications



#57201

- Flexible tube with billet handle
- Slim design for easy mounting

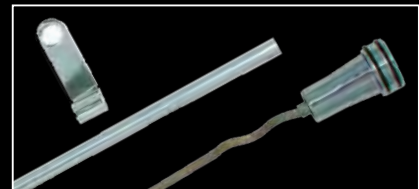

#57205

- Chrome-plated Billet handle with o-rings
- Tube base made to OEM specifications
- Easy to install
- Fully adjustable bracket

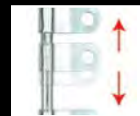

Stick markings match OEM for true accuracy. Gold Iridite-plated finish on dipstick shows oil better, won't flake off like chrome. 5720 and 57205 only.

TIMING CHAIN COVERS - COVER ONLY



#4233

- Fits '65-'90 big block Chevrolet 396-454
- Triple chrome-plated steel
- Use with Spectre® timing tab #4241
- Hardware not included

ENGINE
BAY
COVERS

PERFORMANCE
AIR
FILTERS

INTAKE
SYSTEMS

AIR
CLEANERS

ENGINE
DETAILING

PLUMBING

FUEL
AND
IGNITION

HARDWARE

DRIVE
TRAIN
ACCESSORIES

GENERAL
ACCESSORIES

1965 AND LATER CHEVROLET BIG BLOCK 396-454

ADJUSTABLE TIMING TAB



#4241

- Fits big block Chevrolet 396-454 with 8" balancers
- Triple chrome-plated steel
- Adjustable pointer

DISTRIBUTOR HOLD DOWN



#5760

- Heavy gauge steel
- Triple chrome-plated finish
- Fits Chevrolet V8 engines
- Installation hardware included

FUEL PUMP BLOCK OFF PLATE



#42473

- Fits big block Chevrolet and
- Triple chrome plated steel plate
- Bolts, washers and gasket included
- Covers the fuel pump opening

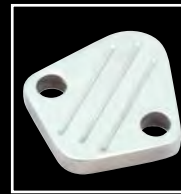

#4947

- Fuel pump block off plate
- Necessary when switching to electric fuel pump
- Ball milled finish

CHROME WATER PUMP PULLEY - LONG WATER PUMP



#4498

- Fits '69 and later big block Chevrolet with long water pump
- Double belt groove
- Triple chrome-plated steel
- 6 - 1/4" diameter



#4499

- Fits '69 and later big block Chevrolet with long water pump
- Double belt groove
- Machined aluminum
- 6 - 1/4" diameter

CRANKSHAFT PULLEY - LONG WATER PUMP



#4508

- Fits '69 and later big block Chevrolet
- Triple belt groove
- Triple chrome-plated steel
- 6 - 3/4" inner groove, 7 - 7/8" outer groove

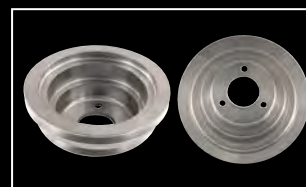

#4509

- Fits '69 and later big block Chevrolet with long water pump
- Double belt groove
- Machined aluminum
- 7 - 7/8" diameter

1965 AND LATER CHEVROLET BIG BLOCK 396-454

WATER PUMP PULLEYS - SHORT WATER PUMP



#4456

- Fits '65 - '68 big block Chevrolet with short water pump
- Single belt groove
- Machined aluminum
- 6-1/2" diameter



Chrome-Plated Steel
6-1/2" Diameter
#4458



Machined Aluminum
6-3/8" Diameter
#4459

- Fits '65 - '68 big block Chevrolet with short water pump
- Double belt groove

CRANKSHAFT - SHORT WATER PUMP



#4457

- Fits '65 - '68 big block Chevrolet
- Single belt groove
- Machined aluminum
- 6 - 1/2" diameter



Chrome-Plated Steel
7-3/4" Diameter
#4468



Machined Aluminum
6-1/2" Diameter
#4460

- Fits '65 - '68 big block Chevrolet with short water pump
- Double belt groove
- For air conditioning use with #4478

POWER STEERING PULLEYS



Chrome
#4487



Machined Aluminum
#4490

- Fits early GM through '84 with Keyway style pump
- Double belt groove
- 5 - 13/16" diameter
- Bolt-on
- Won't fit Corvette



Machined Aluminum
#4489

- Fits early GM through '84 with Keyway style pump
- Single belt groove
- Machined aluminum
- 5 - 3/4" diameter
- Bolt-on
- Won't fit Corvette

ENGINE
BAY
COVERS

PERFORMANCE
AIR
FILTERS

INTAKE
SYSTEMS

AIR
CLEANERS

ENGINE
DETAILING

PLUMBING

FUEL
AND
IGNITION

HARDWARE

DRIVE
TRAIN
ACCESSORIES

GENERAL
ACCESSORIES

1965 AND LATER CHEVROLET BIG BLOCK 396-454

ENGINE PULLEY SET



#4473

- Fits 1994-1996 GM 454 Throttle Body Injection engines
- Includes 5-7/8 inch crank pulley, 3 inch diameter alternator pulley
- Made from high quality polished aluminum
- Precision engineered for optimum fit and function

ENGINE PULLEY - SHIMS

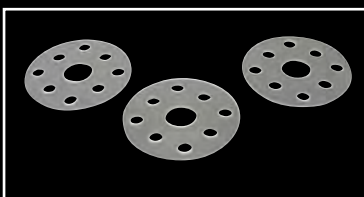

#4480

- Shims should be placed between the water pump flange and pulley
- Designed to space the pulley outwards for proper belt alignment
- Aluminum construction
- Kit includes three 1/16 inch shims
- Easy to install with no special tools required

CRANKSHAFT AND WATER PUMP PULLEY BOLT KIT



#4693

- For use with Chevrolet crankshaft pulleys
- Kit includes three grade 5 hex head bolts
- Bolts measure 3/18 inch -24 by 1 inch
- Features a zinc-plated finish
- Made from high quality steel

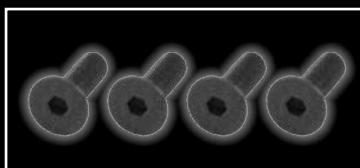

#4692

- For use with aluminum water pump pulleys
- Kit includes four tapered Allen grade 8 bolts
- Bolts measure 5/16 inch -24 by 3/4 inch
- Corrosion resistant black oxide plated finish
- Made from high quality steel
- Features countersunk socket heads

UPPER ALTERNATOR BRACKET



#4719

- Fits '69 and later with long water pump
- Triple chrome-plated
- Mounts on passenger side



#4720

- Fits '65 - '68 with short water pump
- Mounts on driver's side
- Triple chrome-plated

LOWER ALTERNATOR BRACKET



#4721

- Fits '69 and later with long water pump
- Mounts on passenger side
- Triple chrome-plated

CHEVROLET 6 CYLINDER

CHROME VALVE COVERS



#5232

- '50-'62 Chevy 235 Straight 6 cylinder engines
- Triple chrome-plated steel construction
- Stock height
- Features OEM style sealing edge

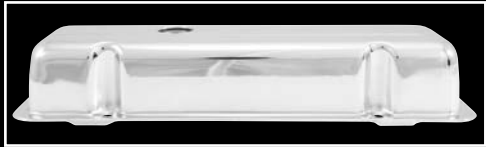

#5231

- '80 - '89 229 V6
- Triple chrome-plated steel construction
- Stock height
- Sold in pairs
- Features OEM style sealing edge



#5267

- '66 - '79 Chevy Straight 6 cylinder 194-230-250-292 engines
- Baffled for breather system compatibility
- Triple chrome-plated steel construction Stock height
- Features OEM style sealing edge

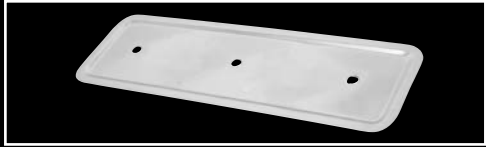

#5235

- Sidecover for 66 - 79 Chevy straight 6 194-230-250 engines
- 2 Required



#5268

- '80 - '89 Chevy/GMC 2.8L V6 engines
- Triple chrome-plated steel construction
- Stock height
- Sold in pairs
- Features OEM style sealing edge

CHRYSLER

CHROME VALVE COVERS



#5277

- '58-79 Chrysler Big Block 361-383 -400-413-426-440 engines
- Triple chrome-plated steel construction
- Sold in pairs



#5274

- '65-91 Chrysler 273-318-340 -360 engines
- Triple chrome-plated steel construction
- Sold in pairs



#5244

- 60-80 Chrysler Slant 6 170 cid - 60-71 198 cid - 62-80 225 cid
- Triple chrome-plated steel construction

- ENGINE BRN COVERS
- PERFORMANCE AIR FILTERS
- INTAKE SYSTEMS
- AIR CLEANERS
- ENGINE DETAILING**
- PLUMBING
- FUEL AND IGNITION
- HARDWARE
- DRIVE TRAIN ACCESSORIES
- GENERAL ACCESSORIES

CHRYSLER

CHROME ENGINE KITS



#5409

- Fits '58 - '79 Chrysler big block
- Comes complete with valve cover bolts, dip stick and breather
- Triple plated steel



#5407

- Fits '69 - '91 Chrysler 273-318-340-360 engines
- Comes complete with valve cover bolts, dip stick and breather
- Triple plated steel

CHROME OIL PAN



#5495

- '71 - '80 Dodge truck 360
- Stock capacity
- Rear sump pan for trucks
- Triple chrome-plated steel



#5493

- Small block Chrysler 273-340 engine blocks
- Stock 4 quart capacity
- Triple chrome-plated steel



#5479

- 71-80 Dodge truck Chrysler, Plymouth 383-440
- Stock capacity
- Triple chrome-plated steel



#5478

- Magnetic oil drain plug
- Powerful magnet
- Any oil pan with 1/2 in. -20 threads
- Holds harmful metallic particles

OIL DIPSTICK

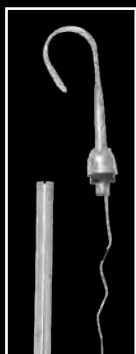

#5721

- Fits small block Chrysler 318-340-360

#5722

- Fits big block Chrysler 383-440-360
- Triple chrome-plated steel
- Markings match OEM
- Made to OEM specs
- Gold iridite-plated finish

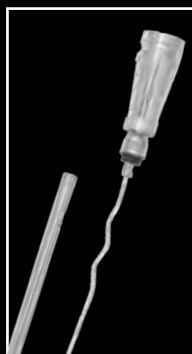

#5744

- Fits small block Chrysler 318-340-360

#5745

- Fits big block Chrysler 383-440-360
- Triple chrome-plated steel
- Markings match OEM
- Made to OEM specs
- Gold iridite-plated finish



#57321

- Fit Chrysler 5.7L / 6.1L
- Flexible tube with billet handle
- Slim design for easy mounting

CHRYSLER

ALTERNATOR BRACKET KIT

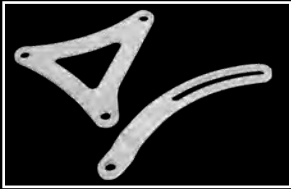

- Two piece set
 - Triple chrome-plated steel
- #4705
Big Block Chrysler
361-440



#4704
Small Block Chrysler
318-340

TIMING CHAIN COVER



- #4234
- Fits big block Chrysler 383-440
 - Triple chrome steel construction
 - OEM replacement
 - Requires timing tab (#4243)



- #4243
- Fits big block Chrysler engine
 - Triple chrome steel construction

FORD SMALL BLOCK 260-351W AND 5.0

CHROME STEEL ENGINE KIT / VALVE COVERS



- #54383
- Chrome valve covers
 - Chrome valve cover bolts
 - Dresses up the engine
 - Triple plated chrome



- Triple chrome-plated steel
- Sold in pairs
- Additional parts
 - Hold downs pg. 102
 - Spreader bars pg. 103
 - Breathers pg. 105
 - Gasket (#587)



#5265
'86-'95 Ford 5.0L

#5250 '62 and Later Small Block 260-351W

POLISHED ALUMINUM VALVE COVERS - TALL PROFILE



Smooth Polished
#5018



Ball-Milled
#5019



- Heavy die-cast polished aluminum
- Tall profile provides clearance for custom rocker assemblies
- Baffles included
- Sold in pairs

- Additional parts
 - Hold downs pg. 105
 - Breathers pg. 114
 - Gasket (#587)



#5323

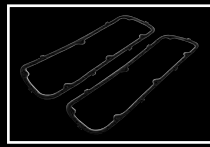

#587

- ENGINE BRG COVERS
- PERFORMANCE AIR FILTERS
- INTAKE SYSTEMS
- AIR CLEANERS
- ENGINE DETAILING
- PLUMBING
- FUEL AND IGNITION
- HARDWARE
- DRIVETRAIN ACCESSORIES
- GENERAL ACCESSORIES

FORD SMALL BLOCK 260-351W AND 5.0

OEM STYLE OIL PANS



Chrome-Plated Steel
#5489



Unplated Steel
#5507

- Fits small block Ford 221-302 with front sump (except Boss 302)
- Fits cars and 2WD trucks (will not fit 4WD or van)
- Stock capacity



'83-'93 Mustang 5.0L
#5488

- Dual sump
- Stock capacity
- Triple chrome-plated steel



Small Block Ford 351W
#5500



62-80 221-302W
with front sump #5486

- Heavy die-cast aluminum
- Polished finned finish
- Stock capacity

ENGINE OIL DIPSTICKS



#5723

- Fits small block Ford 260-302, 351W
- Triple chrome-plated steel
- Tube base made to OEM specifications

Stick markings match OEM for true accuracy. Gold Iridite-plated finish on dipstick shows oil better, won't flake off like chrome. 5723 and 57235 only.

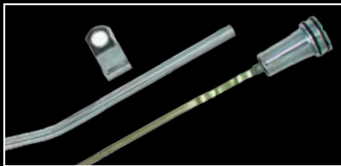

#57235

- Triple chrome-plated Billet handle with O-rings
- Tube base made to OEM specifications. Easy to install
- Fully adjustable bracket

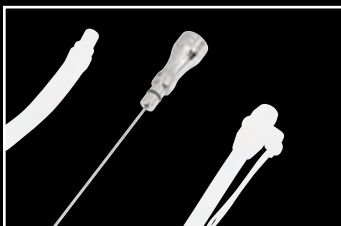

#57231

- Fits small block Ford 260 - 302, 351W
- Flexible tube with billet handle
- Slim design for easy mounting

WATER PUMP PULLEYS



#4491

- Fits '65 - '66 Ford 289
- Single belt groove
- Triple chrome-plated steel
- 6 - 1/8" diameter



#4494

- Fits '65 - '66 Ford 289
- Double belt groove
- Triple chrome-plated steel
- 5 - 7/8" diameter

FORD SMALL BLOCK 260-351W AND 4.0-5.0

CRANKSHAFT PULLEYS



#4492

- Fits '65 - '66 Ford 289
- Single belt groove
- Triple chrome-plated steel
- 6 - 5/16" diameter



#4493

- Fits '64 - '67 Ford 289
- Double belt groove
- Triple chrome-plated steel
- 6 - 5/8" diameter



#4495

- Fits '64 - '67 Ford 289
- Triple belt groove
- Triple Chrome-Plated steel
- 6 - 3/4" diameter

ENGINE PULLEY SETS



#4501

- Fits '94 - '95 Mustang 5.0L
- Includes crankshaft water pump, and alternator pulleys



#4503

- Fits '96 - '98 Mustang 4.6
- Includes crankshaft water pump, and alternator pulleys



#4504

- Fits '99 - '00 Mustang 4.6L
- Includes crankshaft water pump, and alternator pulleys



#4505

- Fits '96 - '98 Mustang 4.6
- Includes crankshaft water pump, and alternator pulleys

ALTERNATOR BRACKET SET



#4723

- Fits '65 - '73 Ford 289 - 302
- Triple chrome-plated steel
- Two piece set

DISTRIBUTOR HOLD DOWNS



#5761

- Manufactured from heavy gauge steel
- Features a triple chrome-plated finish
- Designed to fit Ford V8 engines

WATER NECK



#4232

- Fits 1962 - 1996 Ford 221, 289, 302 and 351W engines
- Includes bolts and sealing O-ring
- Has 1/2 inch by-pass hose fitting
- Triple chrome-plated
- Designed for OEM fit

ENGINE
BAY
COVERSPERFORMANCE
AIR FILTERSINTAKE
SYSTEMSAIR
CLEANERSENGINE
DETAILING

PLUMBING

FUEL AND
IGNITION

HARDWARE

DRIVE TRAIN
ACCESSORIESGENERAL
ACCESSORIES

FORD 351C, 351M AND BOSS 302

CHROME ENGINE KIT



Internal Baffle



#5439

- Long lasting triple chrome-plated
- Kit includes:
 - 1 pair stock height baffled valve covers
 - 16 valve cover tabs
 - 16 Y-wing hold downs
 - 1 breather
 - 1 dipstick and tube
 - 2 grommets

CHROME OEM STYLE VALVE COVERS



Internal Baffle



#5263

- Triple chrome-plated steel
- Baffled
- Sold in pairs
- Additional parts
 - Hold downs pg. 102
 - Spreader bars pg. 103
 - Breathers pg. 105

OEM STYLE OIL PAN



#5490

- Fits Ford 351 Cleveland, 351M and 400 with front sump
- Fits cars and 2WD trucks (will not fit 4WD or vans)
- Triple chrome-plated steel
- Stock capacity

ENGINE OIL DIPSTICK

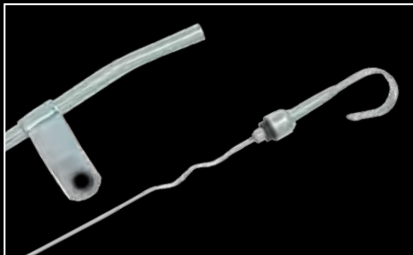

#5725

- Fits Ford 351 Cleveland and Boss 302
- Triple chrome-plated steel
- Tube base made to OEM specifications, to fit easily and correctly
- Stick markings match OEM for true accuracy

WATER NECK



#4735

- Fits Ford 351 Cleveland
- Chrome-plated
- Includes sealing O-ring and bolts

FORD BIG BLOCK 429-460

CHROME ENGINE KIT



Internal Baffle

#5441

- Long lasting triple chrome plated
- Kit includes:
 - 1 pair stock height baffled valve covers
 - 14 valve cover tabs
 - 14 Y-wing hold downs
 - 1 breather
 - 2 grommets

CHROME OEM STYLE VALVE COVERS



Internal Baffle

#5264

- Fits Ford big block 429-460
- Triple chrome-plated steel
- Baffled
- Sold in pairs
- Additional parts
 - Hold downs pg. 102
 - Spreader bars pg. 103
 - Breathers pg. 105

OEM STYLE OIL PAN



#5492

- Fits big block Ford 429-460 with front sump
- Fits cars and 2WD trucks (will not fit 4WD or vans)
- Triple chrome-plated steel
- Stock capacity



#4734

- Fits Ford 429 - 460 engines

FORD "FE" 332, 352, 360, 390, 406, 410, 427 AND 428

CHROME ENGINE KIT



Internal Baffle

#5442

- Long lasting triple chrome-plated
- Kit includes:
 - 1 pair stock height baffled valve covers
 - 10 valve cover tabs
 - 10 Y-wing hold downs
 - 1 breather
 - 2 grommets

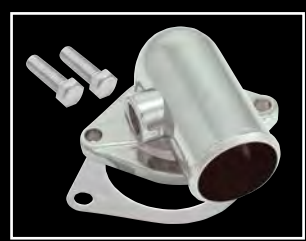

#4736

- Fits Ford 390, 427, 428 engines
- Fits 2" diameter thermostats
- Includes bolts and gaskets

- ENGINE BAY COVERS
- PERFORMANCE AIR FILTERS
- INTAKE SYSTEMS
- AIR CLEANERS
- ENGINE DETAILING
- PLUMBING
- FUEL AND IGNITION
- HARDWARE
- DRIVE TRAIN ACCESSORIES
- GENERAL ACCESSORIES

FORD "FE" 332, 352, 360, 390, 406, 410, 427 AND 428

CHROME OEM STYLE VALVE COVERS



Internal Baffle



#5270

- Triple chrome-plated steel
- Baffled
- Sold in pairs
- Additional parts
 - Hold downs pg. 102
 - Spreader bars pg. 103
 - Breathers pg. 105

OEM STYLE OIL PAN

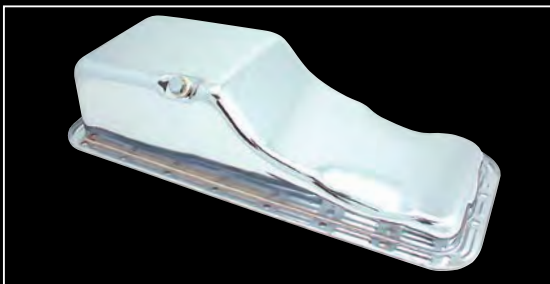

#5491

- Fits Ford "FE" 352, 360, 390, 406, 427, and 428 with front sump (except 428 CJ)
- Fits cars and 2WD trucks (will not fit 4WD)
- Triple chrome-plated steel
- Stock capacity



#5241

- Designed for Ford 292-312 V block engines
- Sold in pairs
- Triple chrome-plated steel construction
- Stock height
- Features OEM style sealing edge

FORD STRAIGHT SIX

CHROME OEM STYLE VALVE COVERS

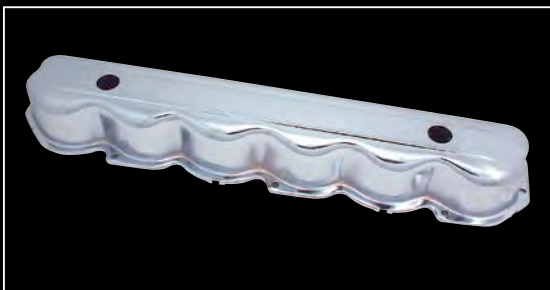

Internal Baffle



#5242

- Fits '65 - '87 Ford 240-300 straight six
- Triple chrome-plated steel
- Sold individually
- Additional parts
 - Breathers pg. 105

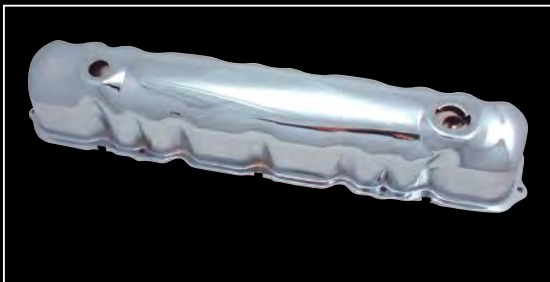

#5266

- Fits Ford '60-'80 144-170-200-250 Straight Six
- Triple chrome-plated steel
- Baffled
- Additional parts
 - Breathers pg. 105

OLDSMOBILE V8 330, 350, 400, 425 AND 455

CHROME ENGINE KIT



Internal Baffle

#5410

- Long lasting triple chrome-plated
- Kit includes:
 - 1 pair stock height baffled valve covers
 - 20 valve cover tabs
 - 20 Y-wing hold downs
 - 1 breather
 - 1 dipstick and tube
 - 2 grommets

OEM STYLE VALVE COVERS



#5278

- Triple chrome-plated steel
- Baffled
- Sold in pairs
- Additional parts
 - Breathers pg. 105

OEM STYLE OIL PAN



#5496

- Fits 350-455 Oldsmobile V8
- Triple chrome-plated steel
- Stock capacity

ENGINE OIL DIPSTICKS

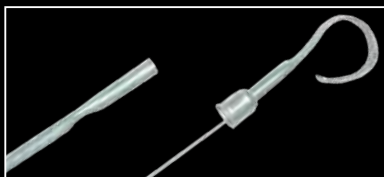

#5727

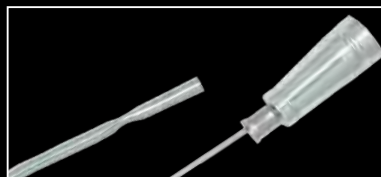

#5747

- Fits Oldsmobile 350-455
- Triple chrome-plated steel
- Tube base made to OEM specifications

WATER NECK



#4733

- Fits Oldsmobile 330, 350, 425 and 455 engines
- Chrome-plated
- Bolts and gasket included
- Designed for OEM fit

ENGINE
BAY COVERSPERFORMANCE
AIR FILTERSINTAKE
SYSTEMSAIR
CLEANERSENGINE
DETAILING

PLUMBING

FUEL AND
IGNITION

HARDWARE

DRIVE TRAIN
ACCESSORIESGENERAL
ACCESSORIES

PONTIAC V8 301, 326, 350, 389, 400, 421, 455

CHROME ENGINE KIT

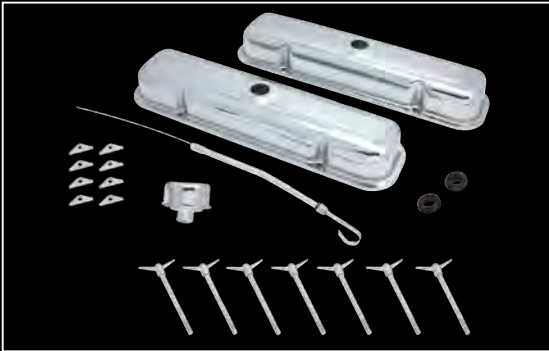

#5412

- Long lasting triple chrome plated
- Kit includes:
 - 1 pair stock height valve covers
 - 8 valve cover tabs
 - 8 Y-wing hold downs
 - 1 breather
 - 1 dipstick and tube
 - 2 grommets

CHROME OEM STYLE VALVE COVERS



Stock Height
#5273



Tall Profile
#5272

- Triple chrome-plated steel
- Stock height
- Sold in pairs
- Additional parts
 - Breathers pg. 105

OEM STYLE OIL PAN



#5497

- Triple chrome-plated steel
- Stock capacity

ENGINE OIL DIPSTICKS



#5729

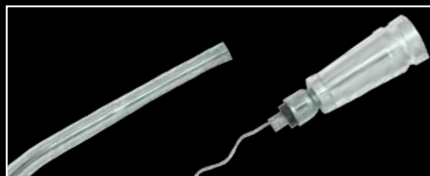

#5748

- Fits '55 - '79 Pontiac V8 except 389
- Triple chrome-plated steel
- Tube base made to OEM specifications, to fit easily and correctly

WATER NECK



#4737

- Fits '64 - '79 Pontiac V8 engines
- Includes sealing o-ring and bolts
- Chrome-plated

ALTERNATOR PARTS

ALTERNATOR PULLEY

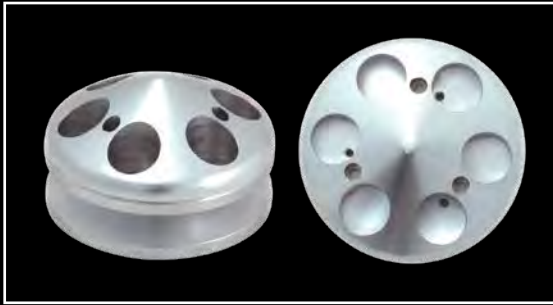

#4528

- Fits most General Motors and Ford
- Single belt groove
- Machined aluminum
- Allen screws included

ALTERNATOR PULLEY AND FAN



#44813

- Fits most General Motors and Ford
- Single belt groove
- Triple chrome-plated steel
- Nose cone included

ALUMINUM ALTERNATOR FAN



#4484

- Fits most General Motors and Ford
- Machined aluminum

ENGINE
BAY COVERSPERFORMANCE
AIR FILTERSINTAKE
SYSTEMSAIR
CLEANERSENGINE
DETAILING

PLUMBING

FUEL AND
IGNITION

HARDWARE

DRIVE TRAIN
ACCESSORIESGENERAL
ACCESSORIES

VALVE COVER HOLD DOWNS

Y-WING VALVE COVER HOLD DOWNS

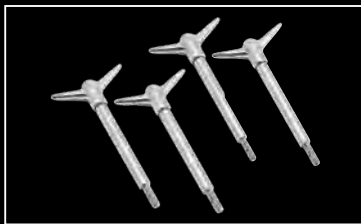

#5320

- For quicker removal and installation of valve covers
- 3-1/2" tall
- 4 pieces per package
- Most V8 engines with 1/4"-20 threads
- Triple chrome-plated steel



#5325

- Pontiac V8 & Ford "FE" 352-428 with 5/16"-18 threads
- 4 pieces per package
- Triple chrome-plated steel

T-BAR VALVE COVER HOLD DOWNS



#5298

- For quicker removal and installation of valve covers
- 1/4"-20 x 1" studs
- 4 pieces per package
- Triple chrome-plated steel
- 3 7/8" long

BILLET VALVE COVER HOLD DOWNS



#52985

- Simple to install
- 4" tall
- 1/4"-20 x 1" studs
- 4 pieces per package
- Triple chrome-plated billet steel

VALVE COVER BOLTS - CENTER BOLT STYLE



#5288

- Fits '87 and later Chevrolet V8 and 4.3 liter V6
- Triple chrome-plated steel
- 4 pieces per package

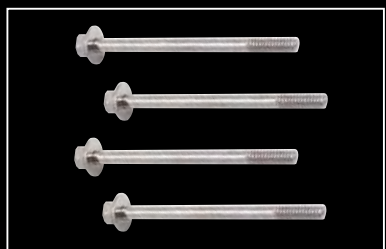

#5280

- Fits '87 and later Chevrolet V8 and 4.3 liter V6
- Triple chrome-plated steel
- 4 pieces per package

SPREADER BARS

SMALL BLOCK CHEVROLET SPREADER BARS

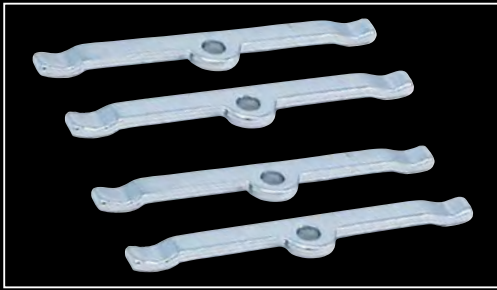

#5321

- Fits Chevrolet (265-400) engines
- Distributes clamping pressure to create better valve cover-to-cylinder head seal
- Triple chrome-plated heavy gauge steel
- Four pieces per package

BIG BLOCK CHEVROLET SPREADER BARS



#5322

- Fits Chevrolet (396-454) engines
- Distributes clamping pressure to create better valve cover-to-cylinder head seal
- Triple chrome-plated heavy gauge steel
- Seven pieces per package

SMALL BLOCK FORD SPREADER BARS



#5323

- Fits Ford (260-351W) engines
- Distributes clamping pressure to create better valve cover-to-cylinder head seal
- Triple chrome-plated heavy gauge steel
- Six pieces per package

VALVE COVER TABS

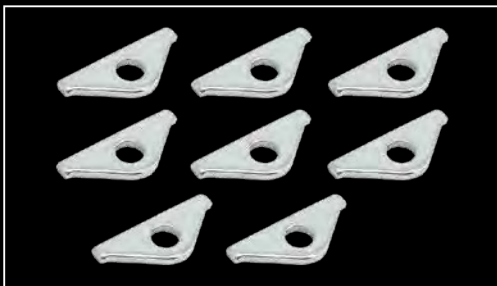

#5324

- Universal applications
- Distributes clamping pressure to create better valve cover-to-cylinder head seal
- Triple chrome-plated heavy gauge steel
- Eight pieces per package

ENGINE
BAY
COVERS

PERFORMANCE
AIR
FILTERS

INTAKE
SYSTEMS

AIR
CLEANERS

ENGINE
DETAILING

PLUMBING

FUEL
AND
IGNITION

HARDWARE

DRIVETRAIN
ACCESSORIES

GENERAL
ACCESSORIES

OIL FILLER CAPS

SCREW-IN OIL FILLER CAP CHROME



#4320

- Fits '87-'94 General Motors™ cars and trucks
- Triple chrome-plated ABS

TWIST-IN OIL FILLER CAP



Chrome
#4310



Billet O-Ring
#43105

- Triple chrome-plated steel
- For valve covers and oil filler extensions with twist-lock type holes

PUSH-IN OIL PLUG



Chrome
#1738



Billet O-Ring
#17385

- Triple chrome-plated steel
- For valve covers with 1-1/4" holes

PUSH-IN OIL FILLER CAP ALUMINUM



#4909

- Polished aluminum
- 1" diameter neck
- Use grommet #5339 or a 1" inside diameter grommet

BREATHERS

CLAMP-ON STYLE MINI BREATHER



#3991 Black #3992 Red #3996 Blue #3998 White

- 2" diameter base
- 1 3/4" tall element
- Triple chrome-plated steel
- Mini-cone style
- High-Flow synthetic fiber filter element
- Fits 8mm-10mm hose barbs (.31"-.39")
- Four colors available



- #3995
- Triple chrome-plated steel
 - Mini-cone style
 - High performance stainless steel mesh
 - Fits 8mm-10mm hose barbs (.31"-.39")

PUSH-IN STYLE BREATHERS



#42851 Black #42852 Red #42856 Blue #42859 White

- 3" diameter high-flow synthetic fiber filter element
- 2 3/8" tall element
- Triple chrome-plated steel top & base
- 1.25" outside diameter neck
- Four colors available
- Includes grommets



- #42869
- High-flow synthetic fiber filter element
 - High performance open filter
 - Triple chrome-plated steel shield & base
 - 1" outside diameter neck
 - Includes grommets



#42872 Red #42876 Blue #42879 White #42871 Black

- 3" diameter high-Flow synthetic filter element
- 2" tall overall height
- Triple chrome-plated steel top & base
- 1-1/4" push-in type valve cover breather
- Four colors available
- Use with #5339 grommet



- #4282
- For use on circle track valve covers
 - Triple chrome-plated steel top
 - High-flow filter element
 - 1.5" inside diameter base

Street legal in most states, but may not be used in California or states with similar emissions control laws except on pre 1976 vehicles.

ENGINE
BRAV COVERS

PERFORMANCE
AIR FILTERS

INTAKE
SYSTEMS

AIR
CLEANERS

ENGINE
DETAILING

PLUMBING

FUEL AND
IGNITION

HARDWARE

DRIVE TRAIN
ACCESSORIES

GENERAL
ACCESSORIES

BREATHERS

PUSH-IN STYLE BREATHERS WITH TUBE



#4279

- Triple chrome-plated steel
- Internal baffle prevents oil splash
- 1" outside diameter neck
- 5/8" tube for PCV hose
- Use grommet kit #5339 or a 1" inside diameter grommet



#4291

- Mopar OEM-style replacement
- 1" outside diameter neck
- Triple chrome-plated steel
- 5/8" tube for PCV hose
- Use grommet kit #5339 or a 1" inside diameter grommet

PUSH-IN STYLE BREATHERS



#4300

- Triple chrome-plated steel
- Internal baffle prevents oil splash
- 3/4" outside diameter neck
- Use grommet kit #5339 or a 3/4" inside diameter grommet



#4277

- Triple chrome-plated steel
- Internal baffle prevents oil splash
- 1" outside diameter neck
- Use grommet kit #5339 or a 1" inside diameter grommet



#42775

- Two-piece design allows foam center to be washed and reused
- Chrome-plated O-ring style billet
- Fits most valve covers with 1-1/4" filler holes
- Use grommet kit #5339



#4919

- Polished aluminum
- 1" outside diameter neck
- Use grommet kit #5339 or a 1" inside diameter grommet



#4920

- Polished Billet aluminum
- Ball milled
- 1" outside diameter neck
- Use grommet kit #5339 or a 1" inside diameter grommet

Street legal in most states, but may not be used in California or states with similar emissions control laws except on pre 1976 vehicles.

BREATHERS

PUSH-ON STYLE BREATHERS



#4280

- Triple chrome-plated steel
- For oil filler tubes or valve cover with tube extensions
- Can be used in conjunction with Spectre® oil filler tube #4270

TWIST-ON STYLE BREATHERS

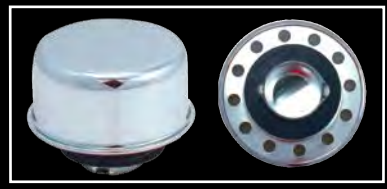

#4273

- Triple chrome-plated steel
- For valve covers and oil filler extensions with twist-type holes

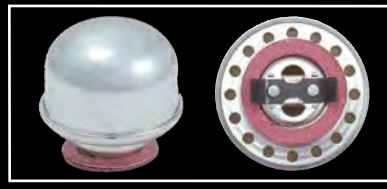

#4281

- Triple chrome-plated steel
- For valve covers and oil filler extensions with twist-type holes

PUSH-IN STYLE PCV BREATHERS WITH TUBE

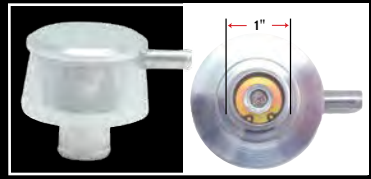

#4921

- Polished Billet aluminum
- 1" outside diameter neck
- Replaceable PCV valve
- 3/8" tube for PCV hose
- Use grommet kit #5339 or a 1" inside diameter grommet



#4922

- Polished and Billet aluminum
- Ball milled
- 1" outside diameter neck
- Replaceable PCV valve
- Use grommet kit #5339 or a 1" inside diameter grommet

- ENGINE BAY COVERS
- PERFORMANCE AIR FILTERS
- INTAKE SYSTEMS
- AIR CLEANERS
- ENGINE DETAILING**
- PLUMBING
- FUEL AND IGNITION
- HARDWARE
- DRIVE TRAIN ACCESSORIES
- GENERAL ACCESSORIES

Street legal in most states, but may not be used in California or states with similar emissions control laws except on pre 1976 vehicles.

BREATHERS

PUSH-IN STYLE PCV BREATHERS WITH TUBE



#42845

- Billet chrome steel
- O-ring design
- Replaceable PCV valve
- 3/8" tube for PCV hose
- Use grommet kit #5339 or a 3/4" inside diameter grommet



#4284

- Triple chrome-plated steel
- Replaceable PCV valve
- 3/8" tube for PCV hose
- Use grommet #5339 or a 3/4" inside diameter grommet



#4298

- Fits Spectre® #4284 and 42845 PCV valve breathers
- Use grommet #5339 or a 3/4" inside diameter grommet



#4924

- Polished aluminum
- 3/4" outside diameter neck
- 3/8" tube for PCV hose
- Use grommet kit #5339 or a 3/4" inside diameter grommet

OIL FILTER TUBE

OIL FILTER TUBE



#4270

- Fits Chevrolet V8 engines with front oil fill hole in intake manifold
- OEM style
- Use in conjunction with Spectre® push-on oil breather cap #4280
- Triple chrome-plated steel

VALVE COVER GROMMETS

REGULAR & BAFFLED



#5339

- OEM replacement grommets
- Designed for valve covers with 1 1/4" filler-breather holes
- Includes one 3/4" I.D. grommet and one 1" I.D. grommet per package



#5333

- OEM replacement grommets
- Designed for valve covers with 1 1/4" filler-breather holes
- Includes one 3/4" I.D. grommet and one 1" I.D. grommet per package
- Baffled to help eliminate breather oil splash

Street legal in most states, but may not be used in California or states with similar emissions control laws except on pre 1976 vehicles.

POWER STEERING ACCESSORIES

POWER STEERING DIPSTICK



#17985

- Fits most General Motors and many Ford and Chrysler vehicles with Saginaw style pump
- Triple chrome-plated
- Billet cap with O-rings



#1798

- Fits General Motors Saginaw power steering pumps and fits many Mopar and Ford Saginaw style pumps
- Triple chrome-plated

POWER STEERING DIP STICK CAP



#4289

- Saginaw style
- Snaps over stock General Motors Saginaw and many Ford and Chrysler power steering dip stick
- Chrome-plated ABS

POWER STEERING PULLEY KITS



#4121

- GM pump with key-way style pulley
- Polished billet power steering pump cover

POWER STEERING PULLEY



Chrome
#4487



Machined Aluminum
#4490

- Fits early GM through '84 with Keyway style pump
- Double belt groove
- 5-13/16" diameter
- Won't fit Corvette



Machined Aluminum
#4489

- Fits early GM through '84 with Keyway style pump
- Single belt groove
- Machined aluminum
- 5-3/4" diameter
- Won't fit Corvette

Street legal in most states, but may not be used in California or states with similar emissions control laws except on pre 1976 vehicles.

ENGINE
BAY
COVERSPERFORMANCE
AIR
FILTERSINTAKE
SYSTEMSAIR
CLEANERSENGINE
DETAILING

PLUMBING

FUEL
AND
IGNITION

HARDWARE

DRIVE
TRAIN
ACCESSORIESGENERAL
ACCESSORIES

SPEED

Perfor



SPECTRE®

ANNOUNCE

DREAM. BUILD. DRIVE.™



PLUMBING ACCESSORIES

VACUUM LINES

STEELFLEX™ STAINLESS STEEL VACUUM LINE



- STEELFLEX™ Vacuum Line is “304” grade stainless steel braid on high-quality nitrile rubber hose
- Exceeds all OEM requirements
- Ideal for all vacuum lines and wind shield washer hose
- Use with MAGNACLAMP™ fittings
- Easily cuts with scissors

5/32" Inside Diameter		7/32" Inside Diameter	
Part Number	Length	Part Number	Length
#19103	3 ft.	#19203	3 ft.
#19106	6 ft.	#19206	6 ft.
#19110	10 ft.	#19210	10 ft.
#19125	25 ft.	#19225	25 ft.

STEELFLEX™ STAINLESS STEEL VACUUM LINE KITS



- Kit includes 3 feet of STEELFLEX™ vacuum line with (2) MAGNACLAMPS™

5/32" Inside Diameter		7/32" Inside Diameter	
Part Number	Clamp Color	Part Number	Clamp Color
#19190	Red/Blue	#19290	Red/Blue
#19198	Chrome	#19298	Chrome

MAGNACLAMP™ VACUUM LINE FITTINGS

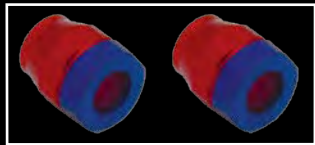

Red/Blue

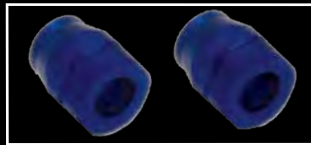

Blue



Red



Chrome

- Machined aluminum
- Available for 5/32" and 7/32" I.D. hoses

5/32" Inside Diameter			7/32" Inside Diameter		
Part Number	Color	Qty	Part Number	Color	Qty
#1160	Red/Blue	2	#1260	Red/Blue	2
#1161	Red/Blue	10	#1261	Red/Blue	10
#1162	Red	2	#1262	Red	2
#1166	Blue	2	#1266	Blue	2
#1168	Chrome	2	#1268	Chrome	2

MAGNA KOOL® STAINLESS STEEL VACUUM LINE

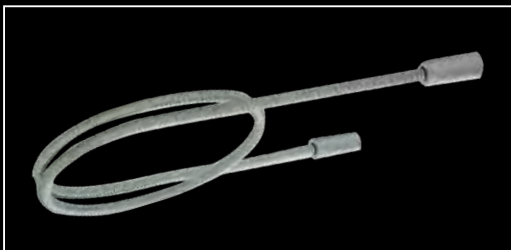

#7849

- Chromed stainless steel hose with chrome plated covers
- Can be trimmed to length with a fine tooth hacksaw
- Flexible to allow for tight bends
- Fits 5/32" vacuum line applications
- Kit includes:
 - 1 ea. 36" stainless steel hose
 - 2 ea. chrome-plated end covers
 - 2 ea. rubber sleeves

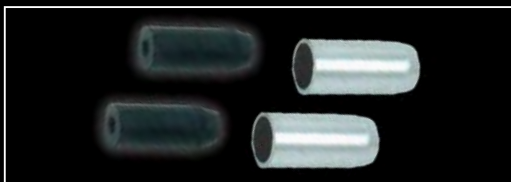

#7878

- Replacement end covers for MAGNA KOOL® vacuum Line
- Kit includes:
 - 2 each chrome plated end covers
 - 2 each rubber sleeves

FUEL LINES

STEELFLEX™ STAINLESS STEEL FUEL LINE



- STEELFLEX™ fuel line is “304” grade stainless steel braid on high quality nitrile rubber hose with an inner ply of braided cord and jacketed with Hypalon for extra durability
- Exceeds all OEM requirements
- Not for use with oil or fuel injection
- Easily cuts with fine-tooth hacksaw
- Use with MAGNA CLAMP™ fittings

1/4" Inside Diameter		5/16" Inside Diameter		3/8" Inside Diameter	
Part Number	Length	Part Number	Length	Part Number	Length
#29104	4 ft.	#29304	4 ft.	#29404	4 ft.
#29106	6 ft.	#29306	6 ft.	#29406	6 ft.
#29110	10 ft.	#29310	10 ft.	#29410	10 ft.
#29125	25 ft.	#29325	25 ft.	#29425	25 ft.

STEELFLEX™ STAINLESS STEEL FUEL LINE KIT



- Kit includes 3 feet of STEELFLEX™ fuel line with (2) MAGNA CLAMPS™

5/16" Inside Diameter		3/8" Inside Diameter	
Part Number	Clamp Color	Part Number	Clamp Color
#29390	Red/Blue	#29490	Red/Blue
#29398	Chrome	#29498	Chrome

MAGNA CLAMP™ FUEL FITTINGS

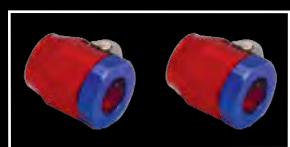

Red/Blue



Red/Blue

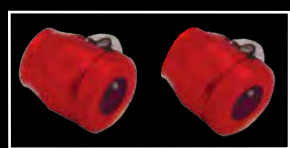

Red



Chrome

- Machined aluminum
- Stainless steel gear drive clamp makes installation a snap
- Available for 1/4", 5/16" and 3/8" I.D. hoses

1/4 and 5/16" Inside Dia. (#6 AN) 39/64" (.6101") Max Hose O.D. Including braid			3/8" Inside Dia. (#8 AN) 23/32" (.725") Max Hose O.D. Including braid		
Part Number	Color	Qty	Part Number	Color	Qty
#2160	Red/Blue	2	#2260	Red/Blue	2
#2161	Red/Blue	10	#2261	Red/Blue	10
#2162	Red	2	#2262	Red	2
#2166	Blue	2	#2266	Blue	2
#2168	Chrome	2	#2268	Chrome	2

MAGNA KOOL® FUEL LINE END COVERS



#7888

- Replacement end covers for MAGNA KOOL® Fuel Line
- Kit includes:
 - 2 each chrome plated end covers
 - 2 each rubber sleeves
 - 4 each hose clamps

ENGINTE BRN COVERS
 PERFORMANCE AIR FILTERS
 INTAKE SYSTEMS
 AIR CLEANERS
 ENGINTE DETAILING
PLUMBING
 FUEL AND IGNITION
 HARDWARE
 DRIVETRAIN ACCESSORIES
 GENERAL ACCESSORIES

FUEL LINES

MAGNA KOOL® STAINLESS STEEL FUEL LINE



#7839

- Chromed stainless steel hose with chrome-plated covers
- Can be trimmed to length with a fine tooth hacksaw
- Flexible to allow for tight bends
- Fits 3/8" fuel line hose applications

• Kit includes:

- 1 ea. 36" stainless steel hose
- 2 ea. 3/8" rubber sleeves
- 2 ea. Chrome-plated end covers
- 4 ea. hose clamps

STEELEX™ STAINLESS STEEL OIL LINE/HEATER HOSE



- STEELFLEX™ oil line is "304" grade stainless steel braid on special hose
- Exceeds all OEM requirements
- Suitable for oil cooler lines, and smaller heater hose applications
- Easily cuts with fine tooth hacksaw
- Use with MAGNACLAMP™ fittings

1/2" Inside Diameter

Part Number	Length
#39504	4 ft.
#39506	6 ft.
#39510	10 ft.
#39525	25 ft.

HEATER HOSES

MAGNA KOOL® STAINLESS STEEL HEATER HOSE KIT



- Can be trimmed to length with a fine-toothed hacksaw
- Flexible to allow for tight bends
- Fits both 5/8" and 3/4" heater hose applications

• Kit includes:

- 2 ea. 44" hoses
- 8 ea. hose clamps
- 4 ea. 3/4" rubber sleeves
- 4 ea. end covers
- 4 ea. 5/8" reducers

Part Number	Description
#7800	Chrome stainless steel hose with polished aluminum covers
#7809	Chrome stainless steel hose with chrome-plated covers

MAGNA KOOL® END COVERS



- Replacement end covers for MAGNA KOOL® heater hose
- Two per package

Part Number	Description
#7828	Chrome
#7829	Polished Aluminum

MAGNA KOOL® END SLEEVES



#7811

- Replacement rubber sleeve and adapter for MAGNA KOOL® heater hoses

• Kit includes:

- 1 ea. 3/4" rubber sleeve
- 1 ea. 5/8" reducer
- 2 ea. stainless steel hose clamps

HEATER HOSES

STEELFLEX™ STAINLESS STEEL HEATER HOSE



- STEELFLEX™ Heater Hose is “304” grade stainless steel braid on high quality EPDM rubber hose
- Exceeds all OEM requirements
- Resists temperatures in excess of 250°F
- Easily cuts with hacksaw
- Use with MAGNACLAMP™ fittings
- NOT for use with oil or fuel

5/8" Inside Diameter		3/4" Inside Diameter	
Part Number	Length	Part Number	Length
#39604	4 ft.	#39704	4 ft.
#39606	6 ft.	#39706	6 ft.
#39610	10 ft.	#39710	10 ft.
#39625	25 ft.	#39725	25 ft.

STEELFLEX™ STAINLESS STEEL HEATER HOSE KIT



Red/Blue



Chrome

- Kits include 4 feet of STEELFLEX™ heater hose with two (2) MAGNACLAMPS™
- STEELFLEX™ heater hose is “304” grade stainless steel braid on high-quality EPDM rubber hose
- Exceeds all OEM requirements
- Resists temperatures in excess of 250°F
- Easily cuts with hacksaw
- NOT for use with oil

5/8" Inside Diameter		3/4" Inside Diameter	
Part Number	Clamp Color	Part Number	Clamp Color
#39690	Red/Blue	#39790	Red/Blue
#39698	Chrome	#39798	Chrome

MAGNACLAMP™ HEATER HOSE, BYPASS AND OIL FITTING



Red/Blue



Red



Blue



Chrome

- Machined aluminum
- Sizes for 1/2", 5/8", 3/4", 7/8" and 1" I.D. hoses
- Two-piece design
- Stainless steel gear drive clamp makes installation a snap

1/2" Inside Dia. (#10 AN) 37/32" (.841") Max Hose O.D. Including braid			5/8" Inside Dia. (#12 AN) 1" Max Hose O.D. Including braid			3/4" Inside Dia. (#14 AN) 1-3/32" (1.1") Max Hose O.D. Including braid		
Part Number	Color	Qty	Part Number	Color	Qty	Part Number	Color	Qty
#3160	Red/Blue	1	#3260	Red/Blue	1	#3360	Red/Blue	1
#3161	Red/Blue	10	#3261	Red/Blue	10	#3361	Red/Blue	10
#3162	Red	1	#3262	Red	1	#3362	Red	1
#3166	Blue	1	#3266	Blue	1	#3366	Blue	1
#3168	Chrome	1	#3268	Chrome	1	#3368	Chrome	1

7/8" Inside Dia. (#18 AN) 1-25/64" (1.4") Max Hose O.D. Including braid			1" Inside Dia. (#18 AN) 1-1/2" (1.5") Max Hose O.D. Including braid		
Part Number	Color	Qty	Part Number	Color	Qty
#3460	Red/Blue	1	#3560	Red/Blue	1
#3462	Red	1	#3562	Red	1
#3466	Blue	1	#3566	Blue	1
#3468	Chrome	1	#3568	Chrome	1

ENGINE BAY COVERS
 PERFORMANCE AIR FILTERS
 INTAKE SYSTEMS
 AIR CLEANERS
 ENGINE DETAILING
PLUMBING
 FUEL AND IGNITION
 HARDWARE
 DRIVETRAIN ACCESSORIES
 GENERAL ACCESSORIES

HOSE KITS

STEEFLEX™ STAINLESS STEEL FLEXIBLE HOSE KITS



Length of radiator hose

Size	Red/Blue	Chrome
16" - 19"	#7710	#7718
19" - 22"	#7760	#7768
22" - 25"	#7720	#7728

- STEEFLEX™ engine hose kits are made from “304” grade stainless steel braid bonded to high-quality hose
- Includes anodized or chrome plated aluminum MAGNACLAMP™ hose end fittings
- MAGNACLAMPS™ feature a stainless steel gear drive clamp that makes installation a snap
- Kit includes:
 - Two (2) 4-foot sections of heater hose (3/4" and 5/8" I.D. hose) and four (4) fittings
 - One (1) 4-foot section of fuel line (3/8" I.D. hose) and two (2) fittings
 - One (1) 2-foot section of vacuum line (5/32" I.D. hose) and two (2) fittings
 - One (1) upper radiator hose (1-1/2" I.D. hose) and two (2) fittings

RADIATOR HOSES

STEEFLEX™ STAINLESS STEEL FLEXIBLE RADIATOR HOSES



- Reinforced flexible radiator hose with stainless steel braid
- Resists temperatures in excess of 250° F
- Use with the appropriate sized MAGNACLAMP™ fittings

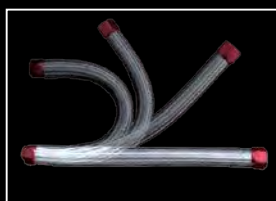

FLEXIBLE BRAIDED HOSE

Radiator hose without MAGNACLAMPS™

Part Number	Size Inside Dia.	Length
#5511	1-1/4"	11"
#5517	1-1/4"	17"
#5520	1-1/4"	20"
#5523	1-1/4"	23"
#5813	1-1/2"	13"
#5815	1-1/2"	15"
#5816	1-1/2"	16"
#5819	1-1/2"	19"

Radiator hose without MAGNACLAMPS™

Part Number	Size Inside Dia.	Length
#5822	1-1/2"	22"
#5825	1-1/2"	25"
#5530	1-1/2"	30"
#5920	1-1/2" - 1-3/4"	20"
#5922	1-1/2" - 1-3/4"	22"
#6813	1-3/4"	13"
#6816	1-3/4"	16"
#6818	1-3/4"	18"

RADIATOR HOSES

STEELFLEX™ STAINLESS STEEL FLEXIBLE HOSE



- STEELFLEX™ “304” Flexible Radiator Hose is stainless steel braid over rubber hose
- Resists temperatures in excess of 250°F
- Kits include 1 STEELFLEX™ flexible radiator hose with two (2) MAGNACLAMPS™

Radiator Hose with MAGNACLAMPS™

Red/Blue	Chrome	Size Inside Dia.	Length
#58191	#58198	1-1/2"	19"
#58221	#58228	1-1/2"	22"
#68181	#68188	1-3/4"	18"

To determine correct replacement hose size, remove existing hose and measure each end for inside diameter. Next lay the hose as flat as possible and measure length. Hoses can be cut up to 1-1/2" on each end for exact sizing. If the old hose is not available, measure the outside diameter of your radiator, thermostat and water pump outlets. Then, using some old heater hose or similar material, mock-up the hose shape using smooth curves as needed. Allow hose to overlap outlets by 1-1/2" to 2" on each end and trim. With the mock-up flat, measure the overall length. Order the closest size hose from one of the charts on this page.

RADIATOR HOSE FITTINGS

MAGNACLAMP™ RADIATOR HOSE FITTINGS



- Machined aluminum
- Sizes available for 1-1/16", 1-1/8", 1-1/4", 1-1/2", 1-3/4" I.D. hoses
- Two-piece design
- Stainless steel gear drive clamp makes installation a snap

1-1/16" Inside Dia. Hose (#20 AN)
1-19/32" (1.6") Max Hose O.D.
Including braid

Part Number	Color	Qty
#3860	Red/Blue	1
#3862	Red	1
#3866	Blue	1
#3868	Chrome	1

1-1/8" Inside Dia. Hose (#24 AN)
1-45/64" (1.7") Max Hose O.D.
Including braid

Part Number	Color	Qty
#3960	Red/Blue	1
#3962	Red	1
#3966	Blue	1
#3968	Chrome	1

1-1/4" Inside Dia. Hose (#20 AN)
1-3/4" (1.74") Max Hose O.D.
Including braid

Part Number	Color	Qty
#4160	Red/Blue	1
#4161	Red/Blue	4
#4162	Red	1
#4166	Blue	1
#4168	Chrome	1

1-1/2" Inside Dia. Hose (#28 AN)
2" Max Hose O.D.
Including braid

Part Number	Color	Qty
#5160	Red/Blue	1
#5161	Red/Blue	4
#5162	Red	1
#5166	Blue	1
#5168	Chrome	1

1-3/4" Inside Dia. Hose (#32 AN)
2-1/4" (2.5") Max Hose O.D.
Including braid

Part Number	Color	Qty
#6160	Red/Blue	1
#6161	Red/Blue	4
#6162	Red	1
#6166	Blue	1
#6168	Chrome	1

ENGINE
BRAV COVERS
PERFORMANCE
AIR FILTERS
INTAKE
SYSTEMS
AIR
CLEANERS
ENGINE
DEFILLING
PLUMBING
FUEL AND
IGNITION
HARDWARE
DRIVE TRAIN
ACCESSORIES
GENERAL
ACCESSORIES

RADIATOR HOSES

MAGNA KOOL® STAINLESS STEEL RADIATOR HOSES



- Fits all 1-1/4", 1-1/2", & 1-3/4" I.D.
- Chrome-plated or polished aluminum hose end covers
- Can be trimmed to length with a fine-toothed hacksaw
- Kit includes:
 - 1 - Chromed stainless steel hose
 - 2 - End covers
 - 2 - 1-3/4" I.D. rubber sleeves
 - 2 - Inserts reduce dia. to 1-1/4" I.D.
 - 2 - Inserts reduce dia. to 1-1/2" I.D.
 - 4 - Hose clamps

Part Number	Description
#7700	12" Hose kit with polished aluminum end covers
#7771	12" Hose kit without end covers
#7779	12" Hose kit with chrome end covers
#7759	20" Hose kit with chrome end covers
#7780	24" Hose kit with polished aluminum end covers
#7781	24" Hose kit without end covers
#7789	24" Hose kit with chrome end covers

Part Number	Description
#7769	30" Hose kit with chrome end covers
#7790	36" Hose kit with polished aluminum end covers
#7791	36" Hose kit without end covers
#7799	36" Hose kit with chrome end covers
#7740	48" Hose kit with polished aluminum end covers
#7741	48" Hose kit without end covers

MAGNA KOOL® RADIATOR HOSE END KIT



#7838

- MAGNA KOOL® replacement hose end cover kit
- Kit includes:
 - 1 - chrome hose end cover
 - 1 - 1-3/4" rubber hose end
 - 1 - 1-1/2" and 1-1/4" adapter insert
 - 2 - hose clamps

RADIATOR HOSE FITTINGS

MAGNA KOOL® END COVER 90°



#7898

- Replacement end covers for MAGNA KOOL® radiator hoses
- Use when a tight 90° bend is necessary
- Triple chrome-plated ABS

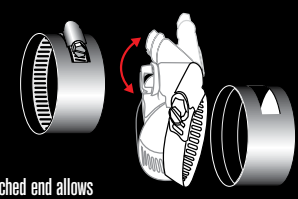

Detached end allows clamp to be inserted both ways

MAGNA KOOL® RADIATOR HOSE END COVER



- Replacement end covers for MAGNA KOOL® radiator hoses
- One piece per package

Part Number	Description
#7818	Chrome ABS
#7819	Polished aluminum
#7820	Chromed aluminum

MAGNA KOOL® RADIATOR HOSE END KIT



#7838

- MAGNA KOOL® replacement hose end cover kit
- Kit includes:
 - 1 - chrome hose end cover
 - 1 - 1-3/4" rubber hose end
 - 1 - 1-1/2" and 1-1/4" adapter insert
 - 2 - hose clamps

MAGNA KOOL® RADIATOR HOSE ADAPTER



- MAGNA KOOL® replacement hose end

- Kit includes:
 - 1 - 1-3/4" end
 - 1 - 1-1/4" adapter insert
 - 1 - 1-1/2" adapter insert
 - 2 - hose clamps

Part Number	Description
#7810	Complete kit
#7812	1-3/4" end & 1-1/2" adapter insert
#7813	1-1/4" adapter insert

MAGNA KOOL® 2" RADIATOR HOSE ADAPTER



#7814

- 2" adapter for MAGNA KOOL® radiator hoses
- Includes:
 - 2" radiator hose end
 - 2 hose clamps

ENGINE
BAY COVERS

PERFORMANCE
AIR FILTERS

INTAKE
SYSTEMS

AIR
CLEANERS

ENGINE
DETILING

PLUMBING

FUEL AND
IGNITION

HARDWARE

DRIVE TRAIN
ACCESSORIES

GENERAL
ACCESSORIES

HOSE SLEEVING

MAGNABRAID® STAINLESS STEEL AND MAGNACLAMP™ COMBO-PAK ENGINE SLEEVING KIT



- Kit combines MAGNABRAID® Stainless Steel hose sleeving with MAGNACLAMP™ fittings
- Fittings available in three anodized aluminum colors and chrome plated aluminum
- Sleeving slides over your existing hose
- Utilizes genuine T-304 grade stainless steel, will not change colors or corrode

Part Number	Clamp Color
#7490	Red/Blue
#7492	Red
#7496	Blue
#7498	Chrome

• Kit includes:

- 3-foot section of vacuum line sleeving and two (2) vacuum line fittings for 5/32" or 7/32" vacuum hoses
- 4-foot section of fuel line sleeving and two (2) fuel line clamps for 1/4", 5/16" or 3/8" fuel hoses
- 4-1/2 foot section of radiator hose sleeving and two (2) radiator hose clamps for 1-1/4" or 1-1/2" radiator hoses
- 12-foot section of heater hose sleeving and two (2) heater hose clamps for 5/8" and two (2) clamps for 3/4"

MAGNABRAID® HOSE SLEEVING

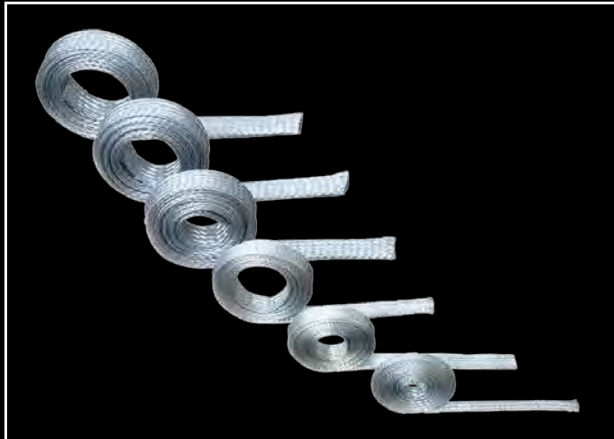

- MAGNABRAID® "304" grade stainless steel sleeving
- Expands over existing hose
- Available in 6' lengths to fit vacuum, fuel, heater and radiator hoses

Part Number	Application	Braid Inside Dia. Range
#1008B	Vacuum Hoses	1/4" - 3/8"
#2008B	Fuel Hoses	1/2" - 3/4"
#3008B	Heater Hoses	3/4" - 1-1/4"
#4008B	1-1/4" Inside Dai. Hoses	1-1/4" - 1-3/4"
#5008B	1-1/2" Inside Dai. Hoses	1-1/2" - 2"
#6008B	1-3/4" Inside Dai. Hoses	2" - 2-1/2"

IMPORTANT

Hose sleeving is sold in lengths measured while the sleeving is completely contracted. The hose sleeving becomes shorter as it expands. For example: 6' of braid will cover approximately 4' of hose.

FITTINGS

90° ELBOW CHROME HOSE FITTING



#5946

- 3/8" NPT to 3/8" barb
- Suitable for fuel and vacuum line applications

STRAIGHT CHROME HOSE FITTING



#5945

- 3/8" NPT to 3/8" barb
- Suitable for fuel and vacuum line applications

SHORT HEATER HOSE FITTING



#5953

- Threads into intake manifold
- Triple chrome-plated
- 1/2" NPT to 5/8" barb
- 1-3/4" long

LONG HEATER HOSE FITTING



#5954

- Threads into water pump
- Triple chrome-plated
- 1/2" NPT to 3/4" barb
- 2-7/8" long

PIPE PLUGS

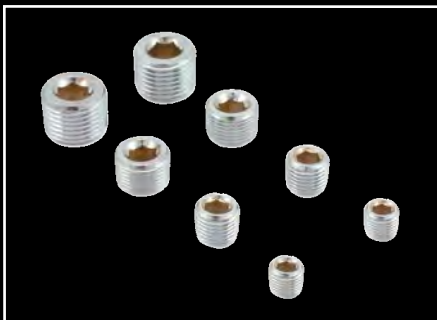

- Triple Chrome-Plated

ENGINE
BAY
COVERS

PERFORMANCE
AIR
FILTERS

INTAKE
SYSTEMS

AIR
CLEANERS

ENGINE
DETILING

PLUMBING

FUEL
AND
IGNITION

HARDWARE

DRIVE
TRAIN
ACCESSORIES

GENERAL
ACCESSORIES

RADIATOR CAPS

RADIATOR CAP

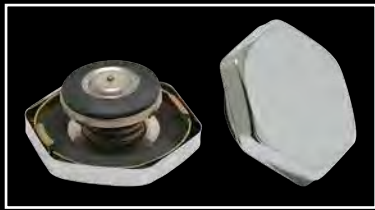

#4338



#43385

- Fits AM General, Buick, Cadillac, Chevrolet, Chrysler, Dodge, Ford, GMC, Isuzu, Jeep, Lincoln, Mercury, Merkur, Oldsmobile, Plymouth & Pontiac
- Triple chrome-plated
- 14-18 pound system

OVERFLOW TANKS

STAINLESS STEEL RADIATOR OVERFLOW TANKS



Part Number	Description
#4179	2" Dia. X 13" Long
#4180	2" Dia. X 15" Long
#4189	2" Dia. X 17" Long
#4192	3" Dia. X 10" Long

- Available in 3" or 2" diameter and various lengths
- Polished stainless steel
- Mounting brackets and bolts included

RADIATOR ACCESSORIES

RADIATOR FAN SHROUD



#4348

- Triple chrome-plated steel
- Hardware included
- 20 inch diameter
- 3" wide x 20" diameter



#4358

- Triple chrome-plated steel
- Hardware included
- 5-1/2" wide x 20" diameter

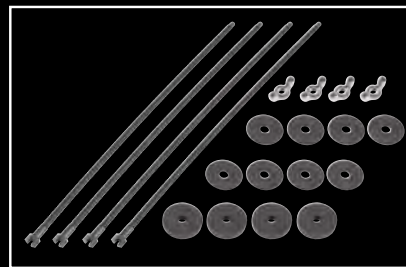

#4349

- Replacement hardware for kit #4348 and #4358 radiator shrouds

RADIATOR SUPPORT BARS

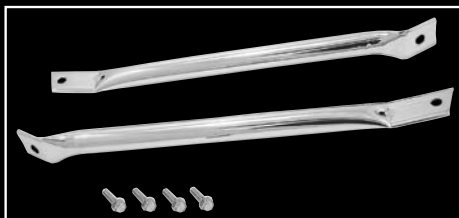

#4707

67' - 69 Camaros/Firebirds

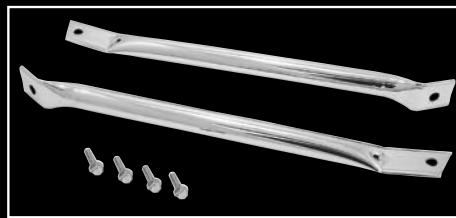

#4706

70' - 81 Camaros

- Manufactured from high quality steel
- Designed for 1976 - 1981 Chevrolet Camaros
- Triple chrome-plated finish
- Fasteners included
- Designed to ensure easy installation
- OEM replacement

RADIATOR SUPPORT PANELS

RADIATOR SUPPORT PANEL



#4363

- Fits '70 - '81 Camaro with heavy-duty radiator
- Measures 28-11/16" x 5-1/2" with 3 bolt holes
- Triple chrome-plated
- Bolts included



#4362

- Fits '70 - '81 Camaro with standard radiator
- Measures 23-7/8" x 5-1/4" with 3 bolt holes
- Triple chrome-plated
- Bolts included



#4365

- Fits '68 - '73 Chevelle with heavy-duty radiator
- Measures 31-1/8" x 5-3/4" with 4 bolt holes
- Triple chrome-plated
- Bolts included



#4364

- Fits '68 - '73 Chevelle and '68 - '79 Nova with standard radiator
- Measures 24" x 5-1/4" with 3 bolt holes
- Triple chrome-plated
- Bolts included



#4366

- Fits '73-'80 Chevrolet/GMC trucks with automatic transmission
- Measures 29-7/8" x 6-3/8" with 4 bolt holes
- Triple chrome-plated
- Bolts included

ENGINE
BAY
COVERSPERFORMANCE
AIR
FILTERSINTAKE
SYSTEMSAIR
CLEANERSENGINE
DETAILING

PLUMBING

FUEL AND
IGNITION

HARDWARE

DRIVE TRAIN
ACCESSORIESGENERAL
ACCESSORIES

WATER NECK

CHEVROLET V8



#42303

- 55' - 65' Chevy 265-454 V8 and 56' - 63' Chevy Corvette engines
- Triple chrome-plated
- Bolts and o-ring included



#42313

- 66' - 95' Chevy V8 engines
- Triple chrome-plated
- Bolts and o-ring included



#4727

- Fits Chevy V8 engines
- Vertical neck for custom systems
- Triple chrome-plated
- Bolts and o-ring included



#4730

- 55' - 65' Chevy 265-454 V8 and 56' - 63' Chevy Corvette engines
- Triple chrome-plated
- Bolts and o-ring included



#4930

- 55' - 65' Chevy V8 small block
- 360° swivel neck has a 45° angle
- Polished aluminum finish
- Bolts and o-ring included



#4931

- 55' - 65' Chevy V8
- Straight design
- Polished aluminum finish
- Bolts and o-ring included

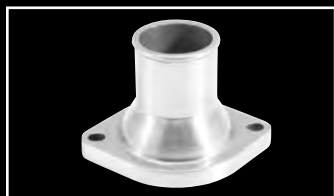

#4932

- Fits 97" and later LSx engines
- Polished aluminum finish
- Includes stainless steel bolts
- Uses OEM thermostat / o-rings



#4933

- 55' - 65' Chevy V8
- 90° neck with a 360° swivel design
- 2-7/8 inch height
- Polished aluminum finish
- Bolts and o-ring included



#4939

- Fits 97" and later LSx engines
- Polished aluminum finish
- Uses OEM thermostat / o-rings
- Includes stainless steel bolts
- 360° swivel design

CHRYSLER V8



#4739

- 64' and later Chrysler V8
- Triple chrome-plated
- Bolts and gasket included

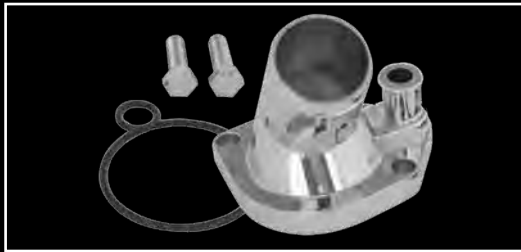
WATER NECK**FORD V8**

#4232

- 65' - 75 Ford 221, 289, 302 and 351W
- 1/2" by-pass hose fitting
- Bolts and o-ring included
- Triple chrome-plated



#4735

- 70' - 74' 351 Cleveland
- Vertical neck
- Bolts and o-ring included
- Triple chrome-plated



#4734

- 68' - 78' Ford 429 - 460 engines
- 3/8" NPT threaded hole
- Bolts and o-ring included
- Triple chrome-plated



#4736

- 62' - 76 Ford 390, 427 and 428 engines
- 1/2" NPT threaded hole for vacuum switch
- Bolts and gasket included
- Triple chrome-plated
- Fits 2" diameter thermostats

OLDSMOBILE V8

#4733

- 64' - 90' 330, 350, 425 and 455 engines
- Bolts and gasket included
- Triple chrome-plate

PONTIAC V8

#4737

- 64' - 79' Pontiac V8 engines
- Bolts and o-ring included
- Triple chrome-plated

ENGINE
BAY
COVERSPERFORMANCE
AIR
FILTERSINTAKE
SYSTEMSAIR
CLEANERSENGINE
DETAILING

PLUMBING

FUEL AND
IGNITION

HARDWARE

DRIVE TRAIN
ACCESSORIESGENERAL
ACCESSORIES

SPEED

Perfor



STREET®

PERFORMANCE

DREAM. BUILD. DRIVE.™



FUEL AND IGNITION

IGNITION WIRE ACCESSORIES

BILLET-STYLE WIRE DIVIDERS

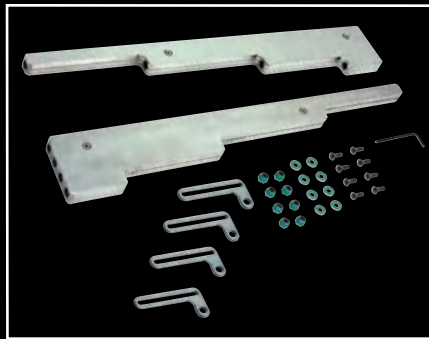

Smooth Polished
#4901



Ball-milled Design
#4902

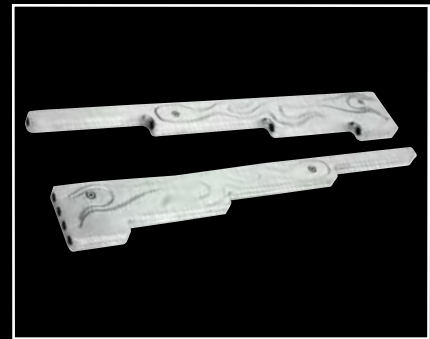

Flame Design
#4903

- Adjustable brackets fit any V8 except center bolt valve covers
- Polished aluminum
- Accommodates 7mm, 8mm and 9mm wires

SLIDER STYLE WIRE DIVIDERS

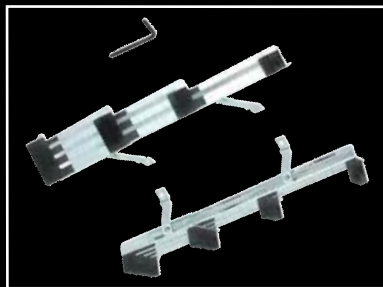

#18483

- Adjustable mounting tabs fit any V8 including centerbolt styles
- Adjusts to any size from 11-15 inches
- Triple chrome-plated steel
- Accommodates wire sizes 7mm, 8mm or 8.8mm
- Dielectric blocks prevent cross firing
- Blocks feature recessed Allen head bolts
- Kit includes:
 - Two adjustable-length dividers
 - 8 wire blocks
 - Center bolt adapter brackets
 - All necessary hardware
 - Allen wrench

Fits on Pre-'87
Valve Covers

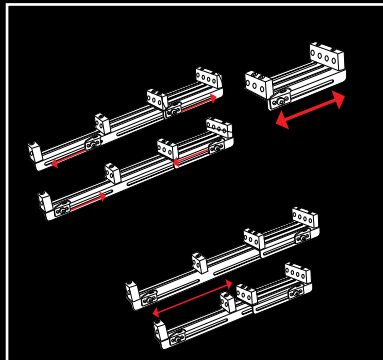

Fits '87 and later
Center bolt Valve Covers



Adjusts to any size from 11-15 inches



WIRE SEPARATORS ECONOMY

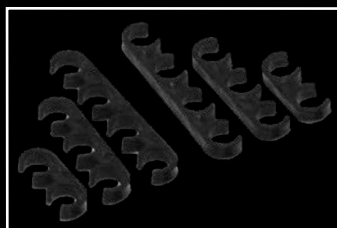

#4239

- 7 mm
- Kit includes:
 - 2-two-wire separators
 - 2-three-wire separators
 - 2-four-wire separators



#4238

- 8 mm
- Kit includes:
 - 2-two-wire separators
 - 2-three-wire separators
 - 2-four-wire separators

IGNITION WIRE ACCESSORIES

TWO-WIRE LOOMS



Standard Height
#45483



Tall Profile
#45583

- Universal fit
- Two triple chrome-plated steel looms
- Accommodates wire sizes from 7-8mm
- Package includes two chrome looms and rubber insulators in red, yellow, blue and black

FOUR-WIRE LOOMS

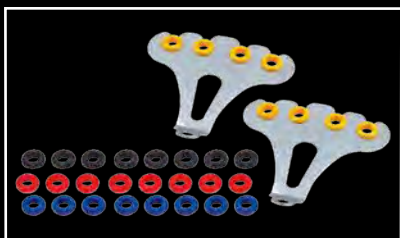

Standard Height
#45383

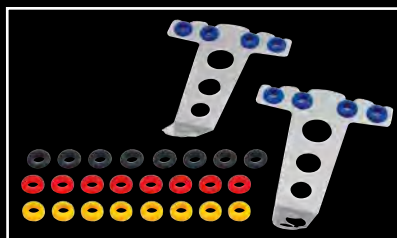

Tall Profile
#45683

- Universal fit
- Two triple chrome-plated steel looms
- Accommodates wire sizes from 7-8mm
- Package includes two chrome looms and rubber insulators in red, yellow, blue and black

WIRE SEPARATORS-PROFESSIONAL

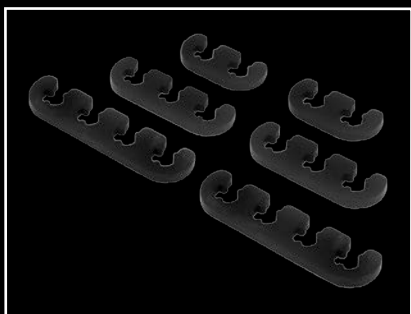

#4601
Black

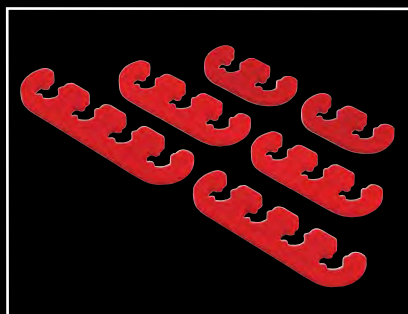

#4602
Red

- Heavy duty durable heat-resistant resin
- Accommodates 8 or 8.8 mm wires
- Universal design
- Available in blue, black, red and chrome

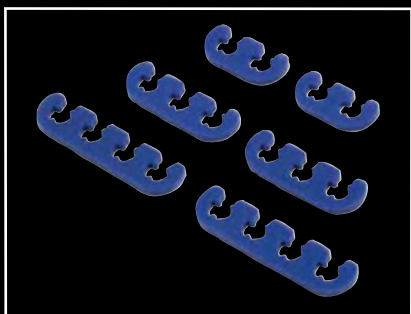

#4606
Blue

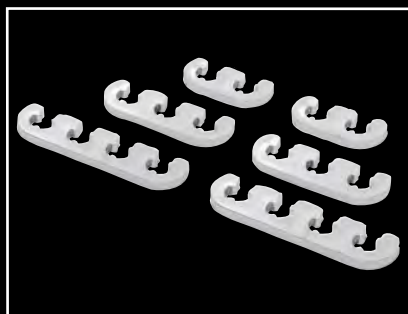

#4608
Chrome

ENGINE
BAY
COVERSPERFORMANCE
AIR
FILTERSINTAKE
SYSTEMSAIR
CLEANERSENGINE
DETILING

PLUMBING

FUEL AND
IGNITION

HARDWARE

DRIVE TRAIN
ACCESSORIESGENERAL
ACCESSORIES

IGNITION WIRE ACCESSORIES

WIRE SEPARATORS-PROFESSIONAL

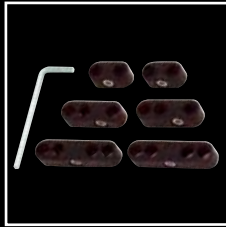

#4631
Black

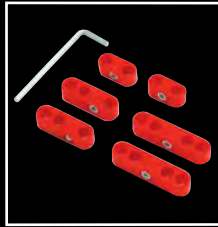

#4632
Red

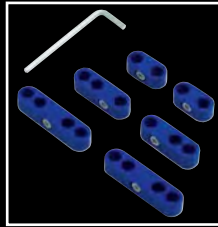

#4636
Blue

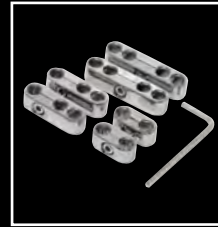

#4245
Chrome

- Heavy duty durable heat-resistant resin
- Accommodates 8mm or 8.8mm wire
- Kit includes:
 - 2 two-wire separators
 - 2 three-wire separators
 - 2 four-wire separators
 - Allen wrench
- Available in 4 colors

IGNITION WIRE MARKERS



#4244

- Eliminate incorrect spark plug wire placement
- Available for 7mm and 8mm wire
- Includes installation tool for ease of use



INSTALLATION TOOL

DISTRIBUTOR ACCESSORIES

DISTRIBUTOR HOLD DOWN



#5760

- Fits Chevrolet V8
- Heavy-duty
- Competition style
- Triple chrome-plated steel
- All necessary hardware included

DISTRIBUTOR HOLD DOWN-FORD V8



#5761

- Fits Ford V8
- Triple chrome-plated steel
- Bolt included

DISTRIBUTOR ACCESSORIES

VACUUM ADVANCE COVER



#1698

- Triple chrome-plated
- Fits on all standard round or hex vacuum advance diaphragm housings
- Double sided tape for easy installation

VACUUM ADVANCE CURVE KIT

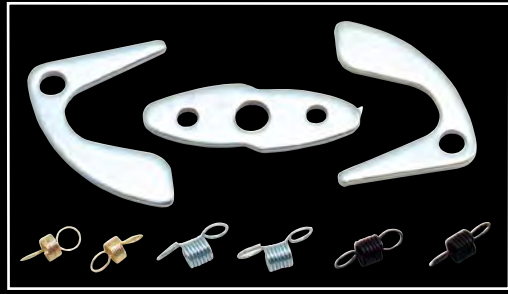

#5754

- For General Motors vehicles with HEI distributors
- Three spring rates included
- Simple instructions

HEI COVER



#5752

- For General Motors vehicles with HEI distributors
- Triple chrome-plated

UNIVERSAL MOUNT COIL BRACKET



#45183

- Works with horizontal or vertical mounted coils
- Triple chrome-plated steel

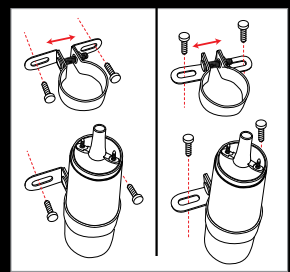

COMPLETELY UNIVERSAL

VACUUM CAPS

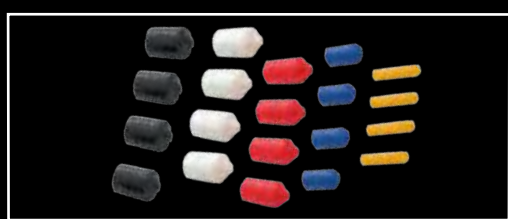

#4254

- Includes four each of the following five sizes: 1/8", 3/16", 1/4", 5/16", and 3/8"

- ENGINE BAY COVERS
- PERFORMANCE AIR FILTERS
- INTAKE SYSTEMS
- AIR CLEANERS
- ENGINE DETAILING
- PLUMBING
- FUEL AND IGNITION
- HARDWARE
- DRIVE TRAIN ACCESSORIES
- GENERAL ACCESSORIES

WIRE HARNESS ACCESSORIES

CONVOLUTED TUBING

- Covers and protects wires, small hoses, and small metal lines
- Organizes and dresses up engine compartment
- Pre-slit for easy installation
- Available in 4 colors

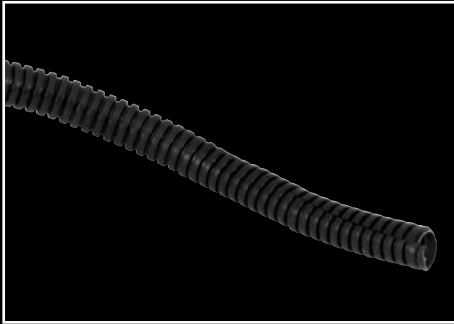

Black Convoluted Tubing

Inside Diameter	Length	Part Number
1/4"	10'	#29511
3/8"	8'	#29681
1/2"	6'	#29761
3/4"	4'	#29841
1"	4'	#29931
1-1/4"	4'	#29941

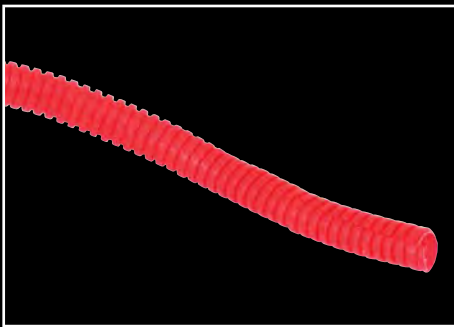

Red Convoluted Tubing

Inside Diameter	Length	Part Number
1/4"	10'	#29512
3/8"	8'	#29682
1/2"	6'	#29762
3/4"	4'	#29842
1"	4'	#29932
1-1/4"	4'	#29942

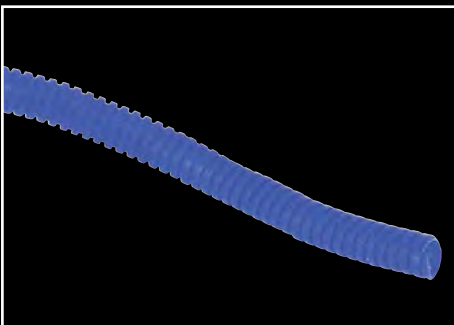

Blue Convoluted Tubing

Inside Diameter	Length	Part Number
1/4"	10'	#29516
3/8"	8'	#29686
1/2"	6'	#29766
3/4"	4'	#29846
1"	4'	#29936
1-1/4"	4'	#29946

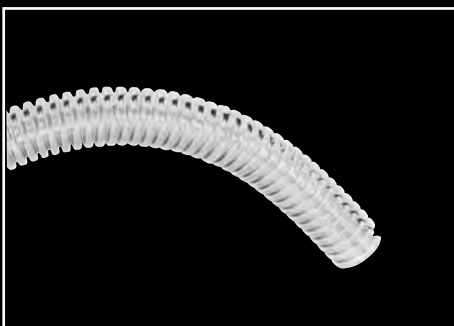

Chrome Convoluted Tubing

Inside Diameter	Length	Part Number
1/4"	10'	#29518
3/8"	8'	#29688
1/2"	6'	#29768
3/4"	4'	#29848
1"	4'	#29938
1-1/4"	4'	#29948

FUEL PUMP PLATES

FUEL PUMP BLOCK OFF PLATE

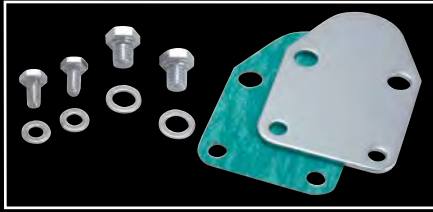

#42463

- Fits small block Chevrolet 265-400
- Triple chrome-plated steel
- Gasket & chrome-plated bolts included
- Necessary when switching to electric fuel pump



#4946

- Fits small block Chevrolet 265-400
- Ball milled Billet aluminum
- Necessary when switching to electric fuel pump



#42473

- Fits big block Chevrolet 396-454 and most V6's and V8's with 1-3/4" between bolt centers
- Triple chrome-plated steel
- Gasket & chrome-plated bolts included
- Necessary when switching to electric fuel pump



#4947

- Fits big block Chevrolet 396-454 and most V6's and V8's with 1-3/4" between bolt centers
- Ball milled Billet aluminum
- Necessary when switching to electric fuel pump

FUEL PUMP MOUNTING PLATE



#42493

- Fits small block Chevrolet 265-400
- Triple chrome-plated steel
- Gasket & chrome-plated bolts included
- For use with mechanical fuel pump

ENGINE
BAY
COVERS

PERFORMANCE
AIR
FILTERS

INTAKE
SYSTEMS

AIR
CLEANERS

ENGINE
DETAILING

PLUMBING

FUEL AND
IGNITION

HARDWARE

DRIVE TRAIN
ACCESSORIES

GENERAL
ACCESSORIES

FUEL LINES

DUAL FEED FUEL LINES FOR HOLLEY CARB

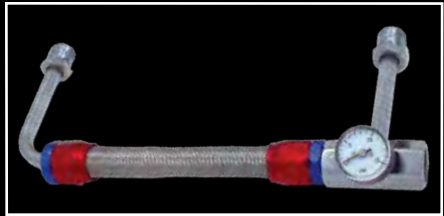

- Fits all Holley 4150 series Carburetors
- Machine-flared ends
- STEELFLEX™ 304 grade stainless steel
- #29603 red / blue hose fittings
- #29683 chrome fittings
- 0-15 psi gauge included
- Note: 3/8" NPT fuel fitting sold separately



- #2955
- Dual feed fuel line kit
 - Includes in-line fuel filter and gauge
 - Triple chrome plated hose fittings
 - Includes hoses and red / blue hose fittings

DUAL FEED FUEL LINES FOR HOLLEY CARB

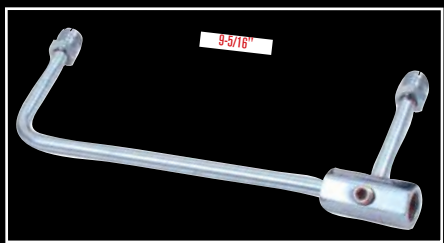

- #5951
- Fits Holley 3310 and 80508 with 8-21/32" centers
 - Machine-flared ends
 - 1/8" tap for fuel gauge
 - Note: 3/8" NPT fuel fitting sold separately

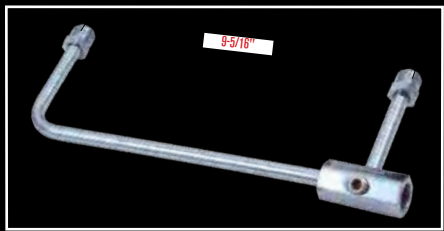

- #5952
- Fits Holley 4150 with 9-5/16" centers
 - Machine-flared ends
 - 1/8" tap for fuel gauge
 - Note: 3/8" NPT fuel fitting sold separately

SINGLE FEED FUEL LINE KITS



#2985



#2990

- #2985
- Fits Edelbrock/Carter carburetors
- #2990
- Fits Holley single feed carburetors
 - Includes fuel pressure gauge with fitting
 - Includes pro-plumbing in-line fuel filter
 - Triple chrome plated hose fitting
 - Includes hoses and clamps
 - Engineered for optimum fit and function

FUEL LINES

SINGLE FEED FUEL LINE

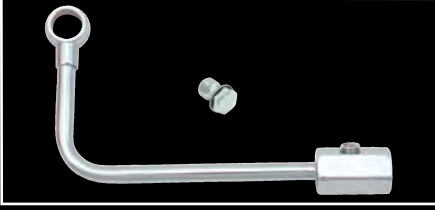

#29883

- Fits Edelbrock/Carter Carburetors
- Includes: 5/8"-20 banjo bolt
- 1/8" tap for fuel gauge
- Triple Chrome-Plated

SINGLE FEED FUEL LINE FOR 4160 SINGLE INLET HOLLEY



#2998

- Fits single feed Holley®
- Allows use of drop base filter assemblies
- For 3/8" diameter fuel line
- Includes: 9/16"-24 banjo bolt
- Triple chrome-plated



HOSE FITTINGS

CHROME HOSE FITTING



#5946

- 3/8" NPT to 3/8" barb
- Suitable for fuel and vacuum line applications
- 90° Elbow



#5945

- 3/8" NPT to 3/8" barb
- Suitable for fuel and vacuum line applications

FUEL FILTERS

UNIVERSAL CLEAR VIEW FUEL FILTER



#2369

- Clear glass body and white mesh filter allow for easy dirt visibility
- Includes fittings for 1/4", 5/16" and 3/8" fuel line applications
- Replaceable element #2358
- NOT for use on fuel injected engines

- ENGINE BAY COVERS
- PERFORMANCE AIR FILTERS
- INTAKE SYSTEMS
- AIR CLEANERS
- ENGINE DETAILING
- PLUMBING
- FUEL AND IGNITION
- HARDWARE
- DRIVE TRAIN ACCESSORIES
- GENERAL ACCESSORIES

FUEL FILTERS

PRO-PLUMBING FUEL FILTERS



Red/Blue
#2220



Red
#2222



Blue
#2226



Chrome
#2228

- Clear glass body and white mesh filter allow for easy dirt visibility
- Two MAGNACLAMP™ integral hose end fittings for 3/8" fuel line
- Replaceable element #2358
- NOT for fuel injected engines

UNIVERSAL FUEL FILTERS



#2379

- Chrome body
- For 3/8" fuel line
- NOT for fuel injected engines
- Replaceable element #2358

REPLACEMENT ELEMENTS FOR CLEAR VIEW FUEL FILTERS



#2358

- Three elements and six o-rings per package
- For pro-plumbing and universal clear view filters (#2220, 2222, 2226, 2228, 2369, 2379)

CANISTER FUEL FILTER



#5965

- Triple chrome-plated steel housing
- Fits 3/8" and 5/16" fuel line
- NOT for fuel injected engines

PRESSURE GAUGES

LIQUID FILLED FUEL PRESSURE GAUGE



#2515

- 0-15 psi
- 1-1/2" diameter face
- Liquid-filled
- Adapts to any fitting or dual feed line with 1/8" NPT threads

FUEL PRESSURE GAUGE



#59013

- 0-15 psi
- 1" diameter face
- Adapts to any fittings or dual feed line with 1/8" NPT threads

REGULATOR

FUEL PRESSURE REGULATOR



#2518
1psi - 4psi



#2519
5psi - 9psi

- Bright plated finish
- 3/8 In. barb fittings and mounting hardware included
- Made from high quality material
- Use with #2515 or 59013 fuel pressure gauge

ENGINE
BAY
COVERSPERFORMANCE
AIR
FILTERSINTAKE
SYSTEMSAIR
CLEANERSENGINE
DETILING

PLUMBING

FUEL AND
IGNITION

HARDWARE

DRIVE TRAIN
ACCESSORIESGENERAL
ACCESSORIES

BRACKETS/CABLE/SPRINGS

BRAIDED THROTTLE CABLE/BRACKET KIT

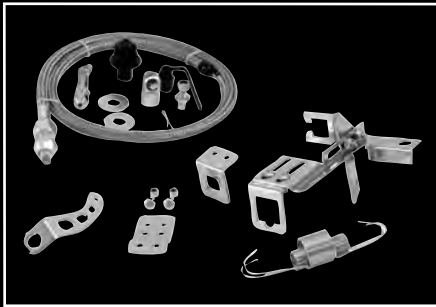

#2435

- Designed to help make changing carburetors quick and easy
- Includes adjustable throttle bracket
- 3 foot long throttle cable with braided stainless steel cable housing
- Includes hardware and return springs

THROTTLE CABLE BRACKET WITH AT KICKDOWN



#24283

- Improved allen head set screw eliminates bracket movement
- Ensures correct throttle cable operation
- Manual or automatic transmission
- Fully adjustable
- Throttle return spring mounting hole
- Fits most 2 bbl or 4 bbl carburetors
- Use with #2429 for 700R4 transmissions with kickdown

THROTTLE CABLE BRACKET ADAPTER

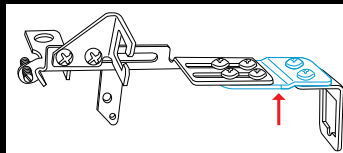

#2429

- For 700R4 with AT kickdown
- Use with #24283

THROTTLE RETURN SPRING & BRACKET

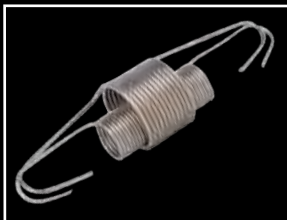

#4700

- Universal design
- Dual spring safety
- Triple chrome-plated springs



#4708

- Triple chrome-plated steel
- Universal

CABLE LINKAGE PLATE

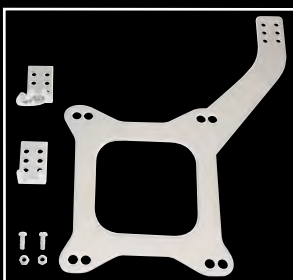

#2426

- Carb linkage plate for Holley/AFB
- Mounts between carburetor and intake manifold
- Includes bracket for GM style throttle cables
- Chrome-plated steel

BRACKETS/CABLES/SPRINGS**STAINLESS STEEL BRAIDED THROTTLE CABLE**

#2431

- 24" universal application
- Fully adjustable
- Fits stock and aftermarket gas pedals
- For use with bracket #24283

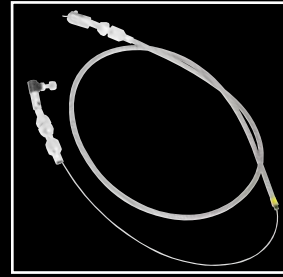

#2433

- 36" universal application
- Fully adjustable
- Fits stock and aftermarket gas pedals
- For use with bracket OE or aftermarket bracket

CHROME STEEL CHOKE CABLE

#2450

- 6 ft. universal application
- Fully adjustable

KICKDOWN CABLE

#2438

- Fits small block Chevrolet with TH350 transmission
- Braided stainless steel housing
- Fully adjustable
- For use with most throttle cable brackets
- Easily adjustable length

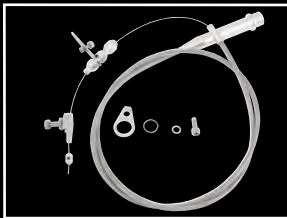

#2442

- 700R4 kickdown cable
- Fits Chevrolet with 700R4 transmission
- Braided stainless steel housing
- Fully adjustable
- For use with most throttle cable brackets
- Easily adjustable length



#2427

- Transmission kickdown cable bracket
- Universal fit design for use with cable #2442, 2443 and 2444
- Fully adjustable

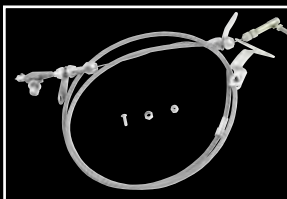

#2443

- Fits Chrysler 727 transmission
- Braided stainless steel housing
- For use with #2427 cable brackets

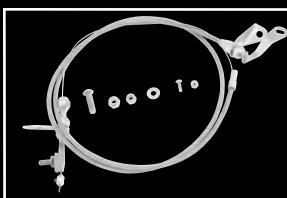

#2444

- Fits Ford C6 transmission
- Braided stainless steel housing
- For use with #2427 cable brackets

ENGINE
BAY
COVERSPERFORMANCE
AIR
FILTERSINTAKE
SYSTEMSAIR
CLEANERSENGINE
DETUNING

PLUMBING

FUEL AND
IGNITION

HARDWARE

DRIVE TRAIN
ACCESSORIESGENERAL
ACCESSORIES

CARBURETOR MOUNTING

CARB STUD KITS



1-1/2" Long
#42513



2" Long
#42523



2-1/2" Long
#42533

- Black oxide finish
- Hex head for ease of installation
- Bullet nose makes installing nuts easier
- Four extra thick gold irradiate nuts
- Four gold irradiate washers

DUAL PURPOSE CARBURETOR ADAPTER



#5765

- Heat insulating phenolic center
- Precision die-cast aluminum outer plate
- Adapts Holley or AFB 4bbl carburetor to Quadrajets manifold
- Gaskets and hardware included
- Universal open or 4-hole applications

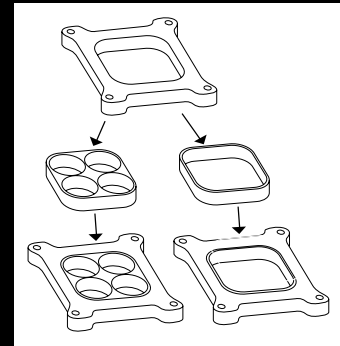

CARBURETOR ADAPTER



#5772

- Adapts 4bbl carburetor to 4-bolt 2bbl manifold or adapts 4-bolt 2bbl carburetor to 4bbl manifold
- Gaskets and hardware included
- Precision die-cast aluminum

CARBURETOR BASE GASKETS

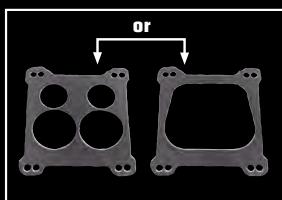

#466

- Spread bore four-barrel carburetors
- Accommodates both open and ported manifolds
- Pre-perforated for open port applications
- Engineered to withstand heat and pressure
- Can be used with Quadrajets or open port applications

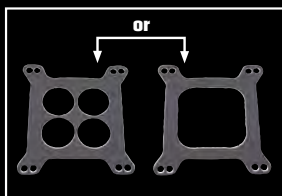

#469

- Spread bore four-barrel carburetors
- Designed for standard four-barrel carburetors
- Pre-perforated for open port applications
- Engineered to withstand heat and pressure
- Premium quality cellulose/nitrile composition

CARBURETOR MOUNTING

DUAL PURPOSE CARBURETOR SPACER



#5764

- Heat insulating phenolic center
- Precision die-cast aluminum outer plate
- Gaskets and hardware included
- Universal open 4-hole spacer for Holley or AFB carburetors
- Increases power by raising air/fuel velocity

Two Gaskets, ported or open applications
Center section perforated for easy removal.

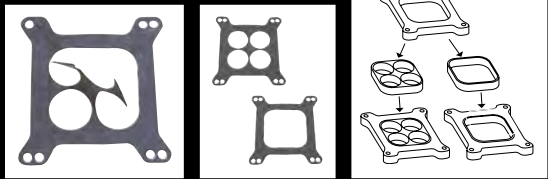

1" CARBURETOR SPACERS

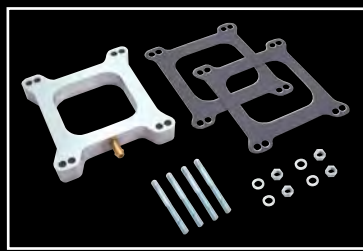

#5776

- 1" open spacer for Holley or AFB carburetors
- Increases power by raising air/fuel velocity
- Gaskets and hardware included
- Precision die-cast aluminum

2" CARBURETOR SPACERS

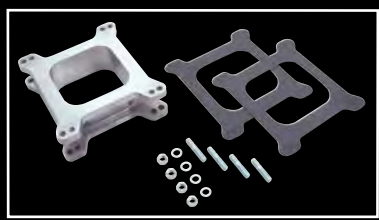

#5779

- 2" open spacer for Holley or AFB carburetor
- Gaskets and hardware included
- Precision die-cast aluminum

PHENOLIC CARBURETOR SPACERS



4-Hole Spacer
#5768

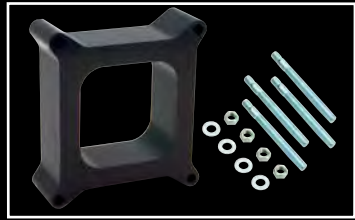

Open Spacer
#5769

- Heat insulating
- 2" for Holley or AFB carburetors
- Improves high RPM power
- Gaskets and hardware included

CARBURETOR LIFT PLATE

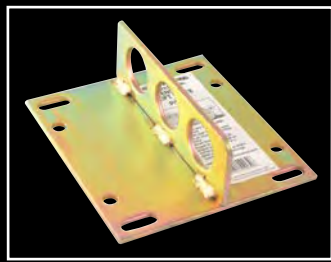

#903

- Bolts to 2 BBI or 4 BBI manifold
- Seals intake for safe storage
- Mounts to intake manifold
- Gold irradiate plated for corrosion resistance

- ENGINE BBI COVERS
- PERFORMANCE AIR FILTERS
- INTAKE SYSTEMS
- AIR CLEANERS
- ENGINE DETAILING
- PLUMBING
- FUEL AND IGNITION
- HARDWARE
- DRIVE TRAIN ACCESSORIES
- GENERAL ACCESSORIES

SPEED

Perfor

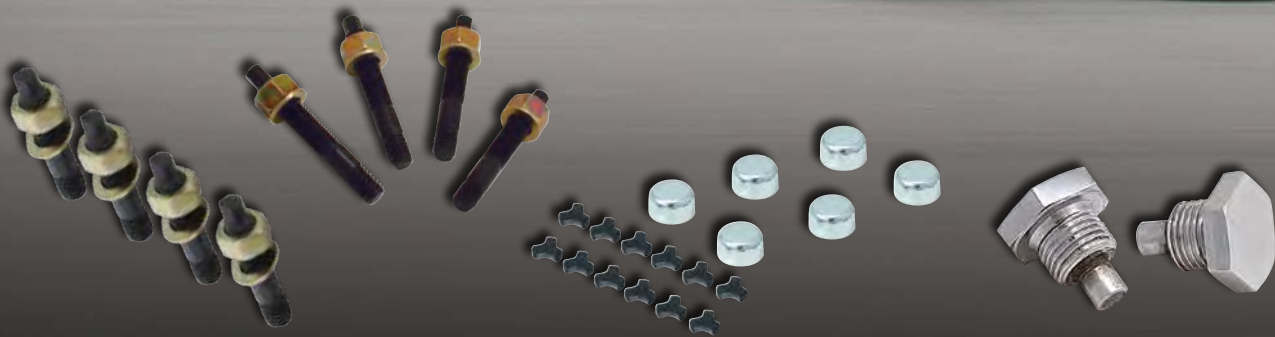

SPECTRE®

ULTIMATE

DREAM. BUILD. DRIVE.™



HARDWARE

FASTENERS

LOCKWIRE HEADER BOLTS

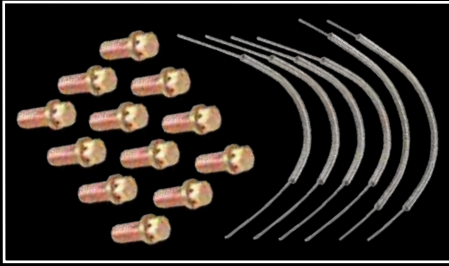

#4668

- 3/8" -16 x 7/8"
- Will not loosen!
- Fits all applications with 3/8" - 16 threads
- 12 bolts and 6 lock wires per package

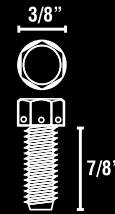

HEADER BOLTS SETS WITH TOOL



SPECIAL WRENCH INCLUDED



#46723

- 3/8" -16 x 7/8"
- Hex head
- Gold iridite
- 12 bolts per package
- Comes with special wrench

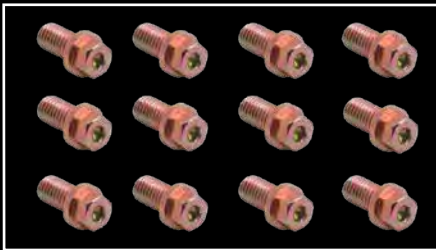

SPECIAL WRENCH INCLUDED



#46703

- 3/8" -16 x 3/4"
- Hex head
- Gold iridite
- 12 bolts per package
- Comes with special wrench

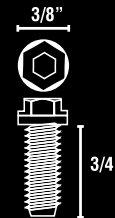

UNIVERSAL COLLECTOR BOLTS

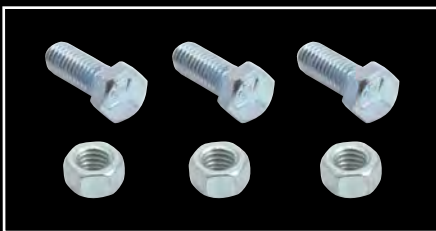

#4675

- 3/8" -16 x 1"
- Grade 5
- Zinc plated bolts and locknuts
- 3 bolts and locknuts per package

INTAKE BOLT SETS



#46533

- Fits small block Chevrolet 265-400 V8 and 90° V6 Chevrolet and Chrysler 273-440
- 3/8" -16 x 1"
- Allen head
- Zinc plated grade 5 bolts and washers
- Included ball head Allen socket allows bolt to be tightened at an angle



FASTENERS

INTAKE BOLT SETS

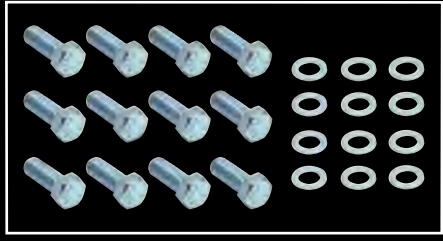

#4652

- Fits small block Chevrolet 265-400 V8 and 90° V6 Chevrolet and Chrysler 273-440
- 3/8"-16 x 1"
- Hex head
- Zinc plated grade 5 bolts and washers
- 12 bolts and washers per package

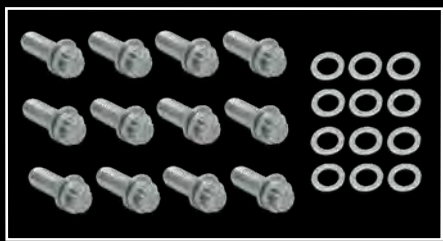
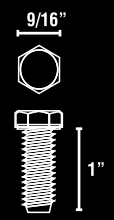

#46523

- Fits small block Chevrolet 265-400 V8 and 90° V6 Chevrolet and Chrysler 273-440
- 3/8"-16 x 1"
- 12 point head
- Zinc plated grade 5 bolts and washers
- 12-Point head allows for easier installation
- Compact design of the 12 point wrench lets you tighten in hard-to-reach areas

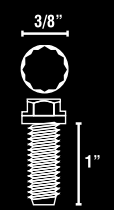

SPECIAL WRENCH INCLUDED

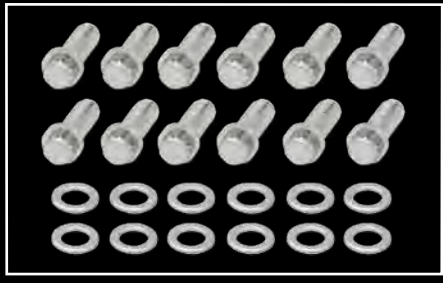

#46528

- Fits small block Chevrolet 265-400 V8 and 90° V6 Chevrolet and Chrysler 273-440
- 3/8"-16 x 1"
- 12 point head
- Chrome
- 12-Point head allows for easier installation
- Compact design of the 12 point wrench lets you tighten in hard-to-reach areas



SPECIAL WRENCH INCLUDED



BOLT CAPS KITS



- Bolt caps will not loosen, vibrate or fall-off!
- Patented (Pat. # 4,890,967) design
- Triple chrome-plated
- Easy to Install

Part No.	Fits:	Includes:
1428	7/16" & 10mm bolt heads	6 caps & 12 retainers
1408	1/2", 12mm & 13mm bolt heads	6 caps & 12 retainers
1418	9/16" & 14mm bolt heads	6 caps & 12 retainers

BILLET BOLT CAP KITS



- Bolt caps will not loosen, vibrate or fall-off!
- Patented (Pat. # 4,890,967) design
- Triple chrome-plated
- Easy to Install

Part No.	Fits:	Includes:
14285	7/16" & 10mm bolt heads	6 caps & 12 retainers
14185	9/16" & 14mm bolt heads	6 caps & 12 retainers
14085	1/2", 12mm & 13mm bolt heads	6 caps & 12 retainers

- ENGINE BAY COVERS
- PERFORMANCE AIR FILTERS
- INTAKE SYSTEMS
- AIR CLEANERS
- ENGINE DETAILING
- PLUMBING
- FUEL AND IGNITION
- HARDWARE**
- DRIVER/RAIN ACCESSORIES
- GENERAL ACCESSORIES

FASTENERS

CHEVROLET WATER PUMP PULLEY BOLTS

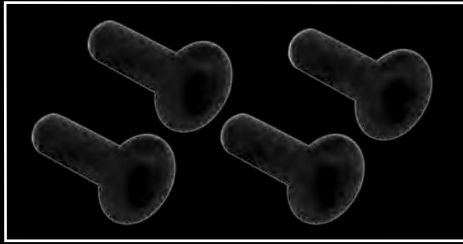

#4692

- Fits Chevrolet with aluminum pulley
- 5/16" -24 x 1"
- Countersunk socket heads
- Grade 8
- 4 bolts per package

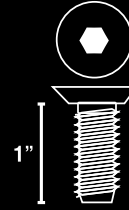

CRANK PULLEY BOLTS



#4693

- Fits Chevrolet
- 3/8" -24 x 1"
- Grade 5
- 3 bolts and washers per package



HARMONIC BALANCER BOLT KIT

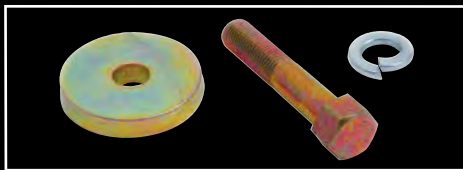

#4699

- Fits small block Chevrolet 265-400
- Grade 8

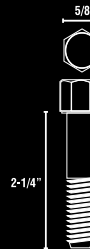

FLYWHEEL BOLTS

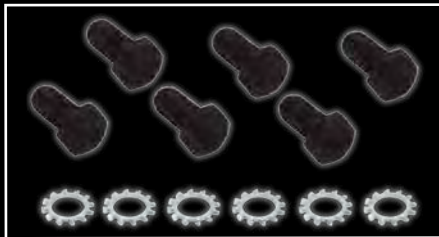

#4698

- Fits Chevrolet and Ford with standard transmission
- 7/16" -20 x 1"
- Grade 8
- 6 bolts and star washers per package

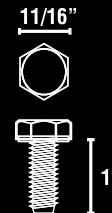

TORQUE CONVERTER BOLTS



#4697

- Fits General Motors TH350, powerglide and most TH400
- 3/8" -24 x 5/8"
- Grade 8
- 3 bolts and locknuts per package



FLEX PLATE BOLTS

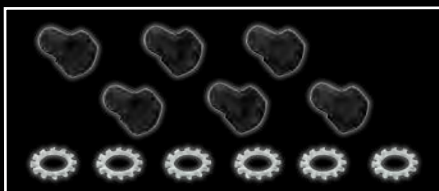

#4696

- Fits General Motors applications with automatic transmission
- 7/16" - 20 x 11/16"
- Grade 8
- 6 bolts and star washers per package

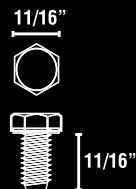

FASTENERS

REAR DIFFERENTIAL COVER BOLTS

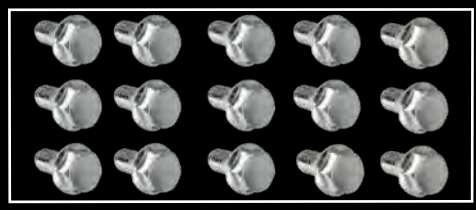

#4688

- Fits 10, 12 & 14 bolt covers with 5/16" -18 threads
- 5/16" -18 x 3/4"
- 14 spinloc bolts per package
- Triple chrome-plated steel



AUTOMATIC TRANSMISSION DRAIN PLUG KIT

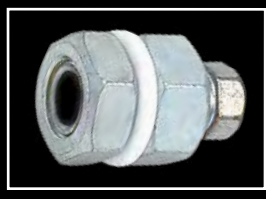

#5449

- Installs in stock transmission pan
- Allows for draining of transmission fluid without removing pan
- Easy to install

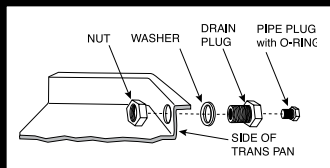

MAGNETIC OIL DRAIN PLUG BOLT



#5478

- Suitable for any oil pan with 1/2 In. -20 threads
- Holds harmful metallic particles

OIL PAN/TIMING CHAIN COVER KIT

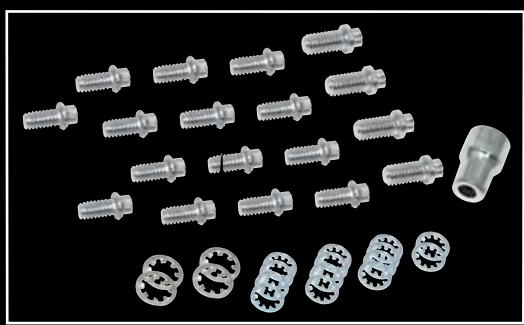

#4691

- Fits '58-'86 Chevrolet small block
- Complete kit oil pan or timing cover
- Triple chrome-plated
- Kit includes:
 - (14) 1/4" 20 x 1/2"
 - (4) 5/16" 18 x 3/4"
 - (14) 1/4" washers
 - (4) 5/16" washers
 - (1) 12 point socket

CARBURETOR STUD KITS



- Black oxide finish
- Hex head for ease of installation
- Bullet nose makes installing nuts easier
- 4 Extra thick gold iridite nuts
- 4 Gold iridite washers

1-1/2" Long
#42513



2" Long
#42523



2-1/2" Long
#42533

ENGINE
BAY COVERS

PERFORMANCE
AIR FILTERS

INTAKE
SYSTEMS

AIR
CLEANERS

ENGINE
DEFILLING

PLUMBING

FUEL AND
IGNITION

HARDWARE

DRIVERTRAIN
ACCESSORIES

GENERAL
ACCESSORIES

SPEED

Perfor



STRE[®]

AMMO

DREAM. BUILD. DRIVE.™



DRIVETRAIN

TRANSMISSION ACCESSORIES TORQUEFLITE 727

OEM STYLE TRANSMISSION PAN



#5457

- Manufactured from triple chrome-plated steel
- Designed for Chrysler 727 torqueflite transmissions
- Stock capacity
- Easy to install with no special tools or skills required
- Features fins for added cooling
- Includes drain plug

EXTRA CAPACITY TRANSMISSION PAN



#5465

- Manufactured from triple chrome-plated steel
- Designed for Chrysler 727 torqueflite transmissions
- 2 quarts of additional capacity
- Easy to install with no special tools or skills required
- Features fins for added cooling
- Includes drain plug

BRAIDED KICKDOWN CABLE

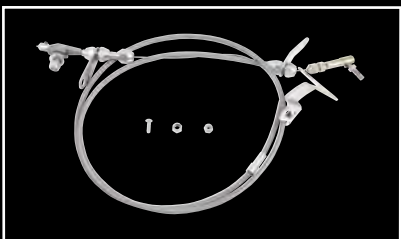

#2443

- Fits torqueflite 727 transmissions
- Braided stainless steel housing
- Fully adjustable

GM TRANSMISSION ACCESSORIES TURBO 350

EXTRA CAPACITY TRANSMISSION PAN



#5458

- Triple chrome-plated steel
- 2 quart additional capacity provides superior cooling
- Finned to provide added cooling
- Includes drain plug

ALUMINUM TRANSMISSION PAN



#5460

- Heavy die-cast polished aluminum
- Stock capacity
- Finned to provide added cooling
- Includes bolts, gaskets and drain plug

FLYWHEEL COVERS

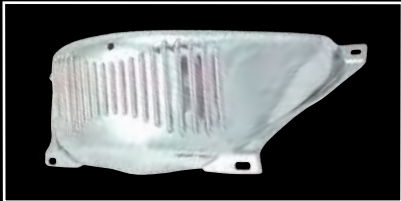

#5462

- Fits General Motors TH350 with 3-7/8" starter slot
- Polished finned aluminum
- Easy to install



#4360

- Fits General Motors TH350 and TH400 - 2-7/8" starter slot
- Triple chrome-plated steel
- Easy to install

OEM STYLE TRANSMISSION PAN



#5450

- Triple chrome-plated steel
- Stock capacity
- Finned to provide added cooling
- Includes drain plug

ENGINE
BAY
COVERSPERFORMANCE
AIR
FILTERSINTAKE
SYSTEMSAIR
CLEANERSENGINE
DETILING

PLUMBING

FUEL AND
IGNITION

HARDWARE

DRIVETRAIN
ACCESSORIESGENERAL
ACCESSORIES

GM TRANSMISSION ACCESSORIES TURBO 350

KICKDOWN CABLE



#2438

- Fits small block Chevrolet with TH350 transmission
- Braided stainless steel housing
- Fully adjustable
- For use with most throttle cable brackets
- Easily adjustable length
- For A/T Transmission

TRANSMISSION DIPSTICK

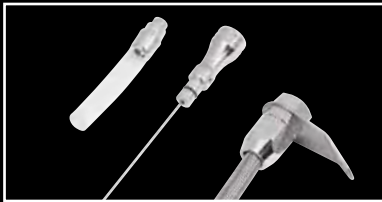

#54711

- Fits General Motors, TH350
- Flexible tube with Billet handle
- Bell housing mount
- Includes funnel adapter to assist in filling



Fully adjustable bracket

#5470

- Fits Chevrolet, TH350
- 34" length
- Triple chrome-plated steel
- Stick markings match OEM for true accuracy
- Fully adjustable bracket

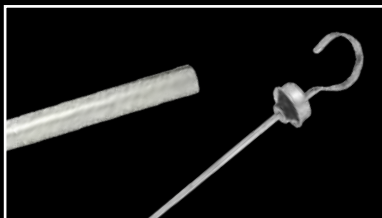

#54723

- Fits Cadillac, Chevrolet, Oldsmobile, Pontiac, GMC and Buick TH350 and TH400
- 27" length
- Tube made to OEM specifications, fits like it should
- Stick markings match OEM for true accuracy
- Fully adjustable bracket



If your transmission pan looks like #5450, you have a turbo 350

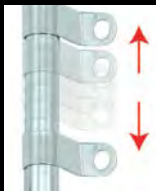

Fully adjustable bracket

#54725

- Fits Cadillac, Chevrolet, Oldsmobile, Pontiac, GMC, General Motors TH350 and TH400
- Triple chrome-plated Billet handle
- 27" length
- Fully adjustable bracket
- Gold Iridite-plated finish on dip stick shows oil better, won't flake off like chrome

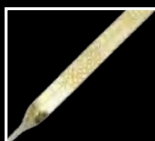

GM TRANSMISSION ACCESSORIES TURBO 400

OEM STYLE TRANSMISSION PAN



#5451

- Triple chrome-plated steel
- Stock capacity
- Finned to provide added cooling
- Includes drain plug

EXTRA CAPACITY TRANSMISSION PAN



#5459

- Triple chrome-plated steel
- Finned to provide added cooling
- 1.5 quart additional capacity provides superior cooling
- Includes drain plug

ALUMINUM TRANSMISSION PAN



#5461

- Heavy die-cast polished aluminum
- Stock capacity
- Finned to provide added cooling
- Includes bolts and gasket and drain plug

CHROMED STEEL FLYWHEEL COVER



#4360

- Fits General Motors TH350 and TH400 - 2-7/8" starter slot
- Triple chrome-plated steel
- Easy to install

ENGINE
BAY COVERS

PERFORMANCE
AIR FILTERS

INTAKE
SYSTEMS

AIR
CLEANERS

ENGINE
DETILING

PLUMBING

FUEL AND
IGNITION

HARDWARE

DRIVETRAIN
ACCESSORIES

GENERAL
ACCESSORIES

GM TRANSMISSION ACCESSORIES TURBO 400

TRANSMISSION DIPSTICKS

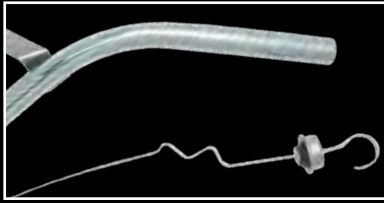

#5471

- 24" length
- Triple chrome-plated steel
- Tube made to OEM specifications, fits like it should
- Stick markings match OEM for true accuracy

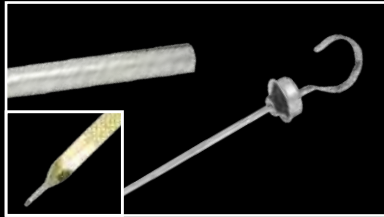

#54723

- Fits Cadillac, Chevrolet, Oldsmobile, Pontiac, GMC, and Buick TH350 and TH400
- 27" length
- Tube made to OEM specifications, fits like it should
- Stick markings match OEM for true accuracy
- Fully adjustable bracket

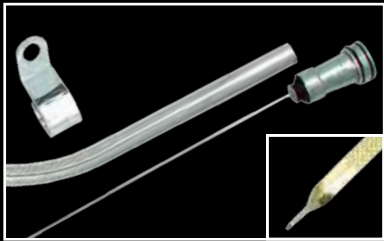

#54725

- Fits Cadillac, Chevrolet, Oldsmobile, Pontiac, GMC, General Motors TH350 and TH400
- 27" length
- Gold Iridite-plated finish on dip stick shows oil better, won't flake off like chrome
- Triple chrome-plated Billet handle
- Fully adjustable bracket

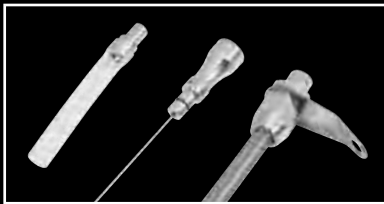

#54721

- Fits General Motors TH400
- Flexible tube with Billet handle
- Bell housing mount
- Includes funnel adapter to assist in filling

GENERAL MOTORS LS 97-UP

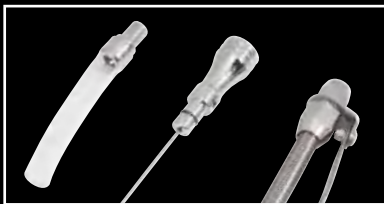

#57311

- Fits General Motors LS applications
- Flexible tube with Billet handle
- Bell housing mount
- Includes funnel adapter to assist in filling

GM TRANSMISSION ACCESSORIES POWERGLIDE

TRANSMISSION DIPSTICK

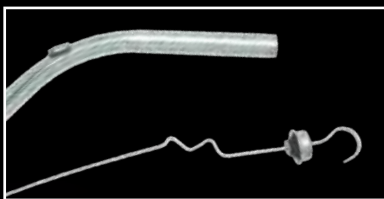

#5473

- 24" length
- Triple chrome-plated steel
- Tube base made to OEM specifications, fits like it should
- Stick markings match OEM for true accuracy

GM TRANSMISSION ACCESSORIES POWERGLIDE

OEM STYLE TRANSMISSION PAN

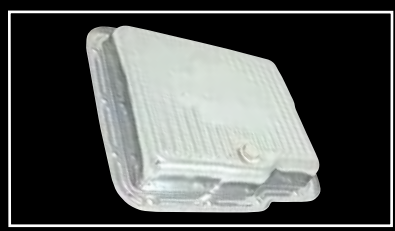

#5452

- Fits General Motors powerglide
- Triple chrome-plated steel
- Stock capacity
- Finned to provide added cooling
- Includes drain plug

FLYWHEEL COVER

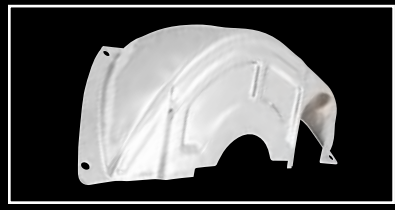

#4361

- Fits General Motors powerglide
- Triple chrome-plated steel

GM TRANSMISSION ACCESSORIES 700R4

TRANSMISSION OIL PAN



#5454

- Triple chrome-plated steel
- OEM replacement
- Stock capacity
- Includes drain plug



#5453

- Triple chrome-plated steel
- Extra deep for added capacity
- Finned to provide added cooling
- Includes drain plug

DRIVETRAIN ACCESSORIES



#4359

- Flywheel dust shield fits General Motors 700R4
- Triple chrome-plated steel

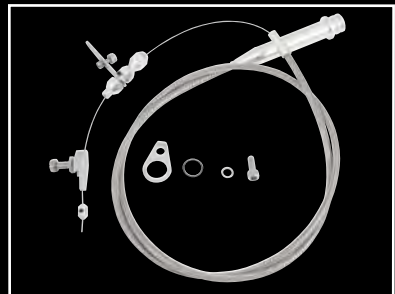

#2442

- 700R4 kickdown cable
- Braided stainless steel housing
- Fully adjustable
- For use with most throttle cable brackets

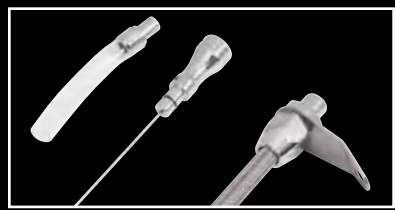

#54741

- Braided transmission dipstick fits GM 700R4
- Flexible tube
- Bell housing mount
- Includes funnel adapter to assist in filling

ENGINE BAY COVERS
PERFORMANCE AIR FILTERS
INTAKE SYSTEMS
AIR CLEANERS
ENGINE DEFILLING
PLUMBING
FUEL AND IGNITION
HARDWARE
DRIVETRAIN ACCESSORIES
GENERAL ACCESSORIES

TRANSMISSION ACCESSORIES FORD C4**TRANSMISSION OIL PAN**

#5455

- Triple chrome-plated steel
- Stock capacity
- Finned to provide added cooling
- Includes drain plug



#5463

- Triple chrome-plated steel
- Extra deep for added capacity
- Finned to provide added cooling
- Includes drain plug

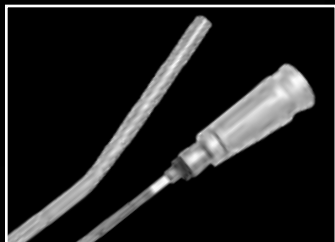
TRANSMISSION DIPSTICK

#5475

- Fits Ford C4 made to OEM specifications
- Triple chrome-plated steel



#54751

- Fits Ford C4
- Flexible tube with Billet handle
- Firewall mount
- Includes funnel adapter to assist in filling

TRANSMISSION ACCESSORIES FORD C6**TRANSMISSION OIL PAN**

#5456

- Triple chrome-plated steel
- Stock capacity
- Finned to provide added cooling
- Includes drain plug



#5464

- Triple chrome-plated steel
- Extra deep for added capacity
- Finned to provide added cooling
- Includes drain plug

TRANSMISSION ACCESSORIES FORD C6

TRANSMISSION KICKDOWN CABLE/DIPSTICKS

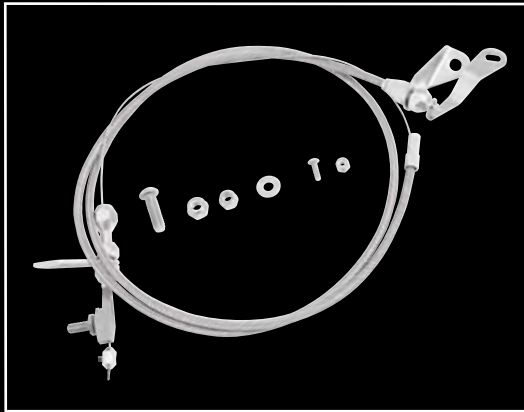

#2444

- Fits Ford C6 transmissions
- Braided stainless steel housing
- Fully adjustable
- For use with most throttle cable brackets

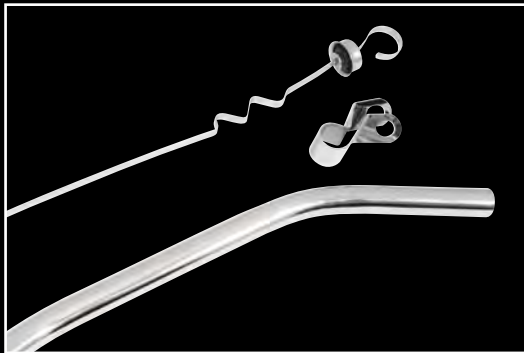

#5476

- Fits C6
- Triple chrome-plated steel tube
- Stock capacity
- Made to OEM specifications



#54761

- Fits C6
- Flexible tube with Billet handle
- Firewall mount
- Includes funnel adapter to assist in filling

TRANSMISSION ACCESSORIES FORD AOD

TRANSMISSION OIL PAN



#5469

- Triple chrome-plated steel
- Stock capacity
- Includes drain plug

ENGINE
BAY COVERS

PERFORMANCE
AIR FILTERS

INTAKE
SYSTEMS

AIR
CLEANERS

ENGINE
DETUNING

PLUMBING

FUEL AND
IGNITION

HARDWARE

DRIVETRAIN
ACCESSORIES

GENERAL
ACCESSORIES

UNIVERSAL TRANSMISSION ACCESSORIES

TRANSMISSION COOLERS



#5466

- 12"
- Finned polished aluminum
- Single pass design

#5467

- 15"
- Finned polished aluminum
- Single pass design

#5468

- 18"
- Finned polished aluminum
- Single pass design

AUTOMATIC TRANSMISSION DRAIN PLUG KIT



#5449

- Installs in stock transmission pan
- Allows for draining of transmission fluid without removing pan
- Easy to install

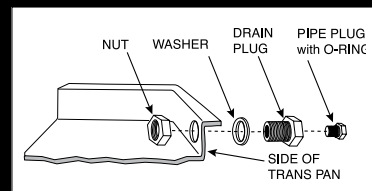

STARTER HEAT SHIELD



#4370

- Fits all Chevrolet V8 and V6 with block-mounted starters
- Protects starter from exhaust heat
- Recommended for vehicles with headers

DRIVESHAFT SAFETY LOOP

DRIVESHAFT SAFETY LOOP



#6079

- Universal driveshaft safety loop
- Simple bolt-on installation
- Heavy gauge steel
- Includes all necessary fasteners

DIFFERENTIAL COVERS

10 BOLT CHRYSLER



#6093

- Fits '61-'89 Chrysler cars with 8-1/4" ring gear
- Triple chrome-plated steel
- Includes triple chrome-plated bolts

DANA 30



#6081

- Triple chrome-plated steel
- Includes differential gasket
- Includes triple chrome-plated bolts



#60819

- Polished finned aluminum
- Includes differential gasket
- Includes gold-iridite Allen head bolts

DANA 35



#6090

- Fits '86-'90 Jeep XJ rear
- '86-'90 Jeep YJ Wrangler rear
- Triple chrome-plated steel
- Includes differential gasket
- Includes triple chrome-plated bolts

ENGINE
BAY
COVERS

PERFORMANCE
AIR
FILTERS

INTAKE
SYSTEMS

AIR
CLEANERS

ENGINE
DEFILLING

PLUMBING

FUEL AND
IGNITION

HARDWARE

DRIVETRAIN
ACCESSORIES

GENERAL
ACCESSORIES

DIFFERENTIAL COVERS

DANA 44



#6075

- Triple chrome-plated steel
- Includes differential gasket
- Includes triple chrome-plated bolts
- Fits '67-'80 Chevrolet / GM 1/2 & 3/4 ton 4 WD front
- '88-'03 Chevrolet / GMC 3/4 & 1 ton 2/4 WD rear
- '72-'03 Dodge Ram Pickup, 4 WD front
- '66-'79 F100/F150 / F250 / F350 Ford Bronco 4 WD front
- '41-'80 J Series Pickup / CJ's rear
- '74-'86 J Series Pickup / Cherokee / Wagoneer front
- '67-'80 Scout rear
- '75-'80 Scout front

#60759

- Polished finned aluminum
- Includes differential gasket
- Includes gold-iridite allen head bolts

DANA 60



#6082

- Triple chrome-plated steel
- Includes differential gasket
- Includes triple chrome-plated bolts
- Fits '72-'03 Dodge Ram Pickup rear
- '72-'99 Dodge Ram Pickup front
- '66-'85 F100 / F150 / F250 / F350 Ford Bronco 2/4 WD rear
- Ford F250 / F350 4 WD front
- Ford Excursion 4 WD front

#60829

- Polished finned aluminum
- Includes differential gasket
- Includes gold-iridite Allen head bolts

DANA 80

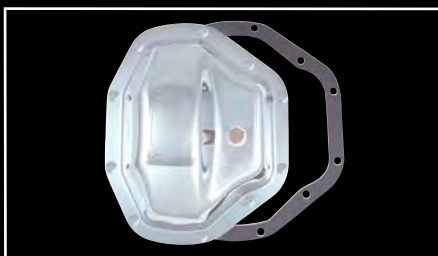

#6091

- Triple chrome-plated steel
- Includes differential gasket
- Includes triple chrome-plated bolts
- Fits '95-up Chevrolet / GMC 3500 with 13" ring gear rear
- '95-up Dodge Ram 3500 Pickup rear
- '95-up Ford F350 / F450 / F550 2/4 WD rear

#60919

- Polished finned aluminum
- Includes differential gasket
- Includes gold-iridite allen head bolts

DIFFERENTIAL COVERS

DODGE TRUCK

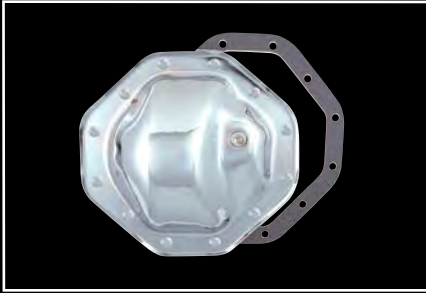

#6089

- Fits '74-'93 Ram 1/2 & 3/4 ton Pickup rear with 9.25" ring gear
- '94-'02 Dakota / Durango V8 2/4 WD rear with 9.25" ring gear
- '74-'02 Ram Van rear with 9.25" ring gear
- '90-'99 Ram 1500 2/4 WD rear
- '92-'99 Cherokee / Grand Cherokee Wrangler 4.0L rear with 9.25" ring gear
- Includes gold-iridite Allen head bolts
- Triple chrome-plated steel
- Includes differential gasket
- Includes triple chrome-plated bolts

FORD 7.5"



#6073

- Fits the following Ford vehicles with 7.5" ring gear:
 - '79-'03 Mustang / Capri V8
 - '84-'98 Aerostar
 - '82-'92 Bronco II rear
 - '82-'03 Ranger
- '94-'03 Mazda 2300 / 3000 rear
- Triple chrome-plated steel
- Includes differential gasket
- Includes triple chrome-plated bolts

FORD 8.8" 10 BOLT



#6083

- Fits the following Ford vehicles with 8.8" ring gear:
 - '86-'03 Mustang / Capri V8 (except '99-'03 Cobra)
 - '83-'03 F150 / Bronco 2/4 WD rear
 - '91-'03 Explorer / Mountaineer 2/4 WD
 - '83-'98 E150 / E250 Van
- '94-'03 Mazda 4000 rear
- Triple chrome-plated steel
- Includes differential gasket
- Includes triple chrome-plated bolts

ENGINE
BAY
COVERSPERFORMANCE
AIR
FILTERSINTAKE
SYSTEMSAIR
CLEANERSENGINE
DETILING

PLUMBING

FUEL
AND
IGNITION

HARDWARE

DRIVETRAIN
ACCESSORIESGENERAL
ACCESSORIES

DIFFERENTIAL COVERS

FORD 9-3/4"

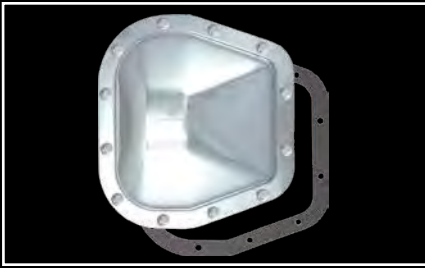

#6092

- Fits F150 2/4 WD rear 9-3/4" ring gear
- F250 2/4 WD rear 9-3/4" ring gear
- Triple chrome-plated steel
- Includes differential gasket
- Includes triple chrome-plated bolts

FORD 12 BOLT



#6084

- Triple chrome-plated steel
- Includes differential gasket
- Includes triple chrome-plated bolts
- Fits '86-'03 Ford Excursion / Expedition 2/4 WD with heavy duty Sterling axle
- '86-'03 Ford F150 / F250 / F350 2/4 WD with heavy duty Sterling axle
- '86-'03 Ford E250 / E350 Van with heavy duty Sterling axle



#60849

- Polished finned aluminum
- Includes differential gasket
- Includes gold-iridite allen head bolts

GENERAL MOTORS 10 BOLT



#6077

- Triple chrome-plated steel
- Includes differential gasket
- Includes triple chrome-plated bolts
- Fits '78-'88 Chevy / GMC 1/2 & 3/4 Ton 4 WD front
- '77-'91 Chevy / GMC Pickup / Suburban 1/2 & 3/4 Ton 4 WD front
- '77-'91 Suburban 4 WD front



#60779

- Polished finned aluminum
- Includes differential gasket
- Includes gold-iridite allen head bolts

DIFFERENTIAL COVERS

GENERAL MOTORS 10 BOLT



#6087

- Triple chrome-plated steel
- Includes differential gasket
- Includes triple chrome-plated bolts

- Fits '64-'72 Chevrolet / GMC Intermediates
- '73-'77 Camaro (with 8.5" ring gear)
- '82-'92 Camaro Z28 / IROC / Firebird T/A
- '84-'87 Grand National / Monte Carlo SS with 8.5" ring gear
- '93-'02 Camaro / Firebird V8 (will not fit heavy duty)
- '88-'02 Chevrolet / GMC Pickup / Blazer / Jimmy Suburban 1/2 ton 2/4 WD rear
- '99 Sierra / Silverado 1500 1/2 ton 2/4 WD with 8.5" ring gear
- '88-'99 Suburban 1500 1/2 ton 2/4 WD rear with 8.5" ring gear
- '94-'96 Impala SS
- '94-'99 Tahoe 2/4 WD rear with 8.5" ring gear

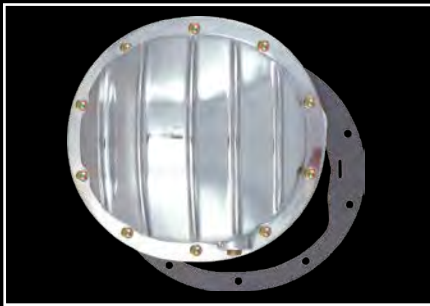

#60879

- Polished finned aluminum
- Includes differential gasket
- Includes gold-iridite allen head bolts



#60703

- Fits '64-'72 Chevrolet / GM Intermediates & Chevelle
- '83-'87 Chevrolet / GMC 1/2 ton 2/4 WD rear
- '67-'72 Camaro
- Triple chrome-plated steel
- Includes differential gasket
- Includes triple chrome-plated bolts



#6072

- Fits '64-'72 GM Intermediates
- '73-'77 Camaro (will not fit 8.5" ring gear)
- Triple chrome-plated steel
- Includes differential gasket
- Includes triple chrome-plated bolts



#6074

- Fits '78-up Chevrolet / GM Intermediates
- '82-up Camaro / Firebird with 8.5" and 8.6" ring gear
- '93-'02 Camaro / Firebird V6
- '82-'03 S10 / S15 / Envoy
- '85-'98 Astro / Safari Van rear
- '98-'03 Isuzu rear
- Triple chrome-plated steel
- Includes differential gasket
- Includes triple chrome-plated bolts

ENGINE
BAY
COVERSPERFORMANCE
AIR
FILTERSINTAKE
SYSTEMSAIR
CLEANERSENGINE
DETILING

PLUMBING

FUEL
AND
IGNITION

HARDWARE

DRIVETRAIN
ACCESSORIESGENERAL
ACCESSORIES

DIFFERENTIAL COVERS

GENERAL MOTORS 12 BOLT



#6076

- Triple chrome-plated steel
- Includes differential gasket
- Includes triple chrome-plated steel bolts

- Fits '62-'82 Chevrolet / GMC Pickup / Blazer Jimmy 1/2 - 3/4 ton 2/4 WD rear

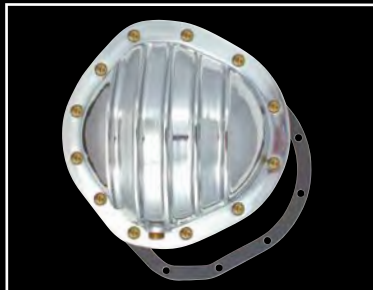

#60769

- Polished finned aluminum
- Includes differential gasket
- Includes gold-iridite Allen head bolts



#6071

- Triple chrome-plated steel
- Includes differential gasket
- Includes triple chrome-plated bolts

- Fits '64-'72 Chevrolet / General Motors intermediates
- '67-'72 Camaro
- '64-'72 Chevelle / El Camino
- '65-'67 Nova



#60713

- Polished finned aluminum
- Includes triple chrome-plated bolts

DIFFERENTIAL COVER BOLTS

DIFFERENTIAL COVERS BOLTS



#4688

- Fits General Motors 10 bolt, 12 bolt and 14 bolt steel covers 5/16" -18 x 3/4"
- 14 Spinloc bolts per package
- Triple chrome-plated steel

DIFFERENTIAL COVERS

GENERAL MOTORS 14 BOLT

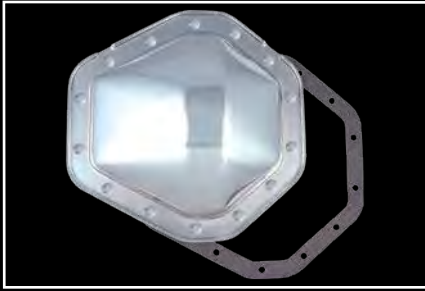

#6086

- Triple chrome-plated steel
- Includes differential gasket
- Includes triple chrome-plated bolts

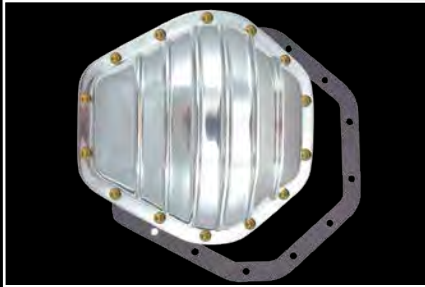

#60869

- Polished finned aluminum
- Includes differential gasket
- Includes gold-iridite Allen head bolts



#6080

- '81-up Chevrolet / GMC rear with 9.5" ring gear
- '73-'95 Chevrolet / GMC 3/4 & 1 ton 2/4 WD rear with 9.5" ring gear
- Triple chrome-plated steel
- Includes differential gasket
- Includes triple chrome-plated bolts

JEEP



#6085

- Triple chrome-plated steel
- Includes differential gasket
- Includes triple chrome-plated bolts



#60859

- Polished finned aluminum
- Includes differential gasket
- Includes gold-iridite Allen head bolts

ENGINE
BAY COVERS

PERFORMANCE
AIR FILTERS

INTAKE
SYSTEMS

AIR
CLEANERS

ENGINE
OILING

PLUMBING

FUEL AND
IGNITION

HARDWARE

DRIVETRAIN
ACCESSORIES

GENERAL
ACCESSORIES

SPEED

Perfor



STRE[®]

ULTIMATE

DREAM. BUILD. DRIVE.™



GENERAL ACCESSORIES

INTERIOR/EXTERIOR ACCESSORIES

SHIFT LEVER

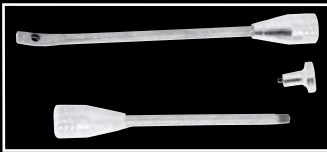

#4981

- 69'-76' GM vehicles with an A/T transmission
- Billet aluminum construction

• Kit includes:

- Automatic transmission shift lever
- Tilt lever
- Headlight knob

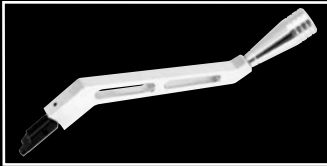

#4982

- Automatic transmission shift lever
- Billet aluminum construction
- Original equipment replacement
- Double slot styling
- Easy to install with no special tools

T-HANDLE SHIFT KNOB



#6280

- Competition style
- Universal fit, comes with hardware to fit:
1/2"-20, 7/16"-20 3/8"-16, 3/8"-24, 5/16"-18, 12mm-1.50
10mm-1.50, 8mm-1.25, 7mm-1.00 diameter shifters
- Polished aluminum

SHIFT BOOT

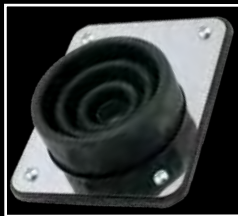

#6285

• 3" W x 4" L

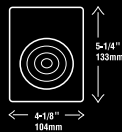

- Universal application
- Stainless steel plate
- Includes mounting screws

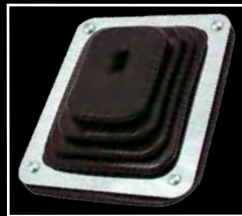

#6283

• 4" W x 5" L

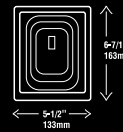

- Universal application
- Stainless steel plate
- Includes mounting screws

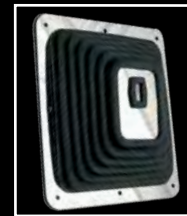

#6284

• 6-3/4" W x 7-3/4" L

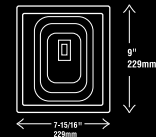

- Universal application
- Stainless steel plate
- Includes mounting screws

GAS PEDAL

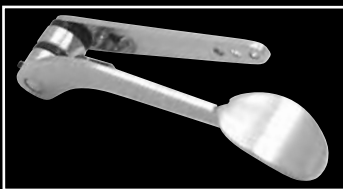

#6288

- Made from lightweight aluminum
- Triple chrome-plated
- Universal design fits a wide range of vehicles
- Easy to install

CHROME CAMARO HOOD LATCH KIT



#4709

- Fits '67-'81 Camaro
- Triple chrome-plated steel

INTERIOR/EXTERIOR ACCESSORIES

HOOD PIN KIT/HAIR PIN



#42563

- Triple chrome-plated steel
- Kit includes:
 - 2 posts
 - 2 hair pin clips
 - 4 lock nuts
 - 2 scuff plates
 - 8 screws
- Easy to follow instructions included
- Drilling required

HOOD PIN KIT/TORSION PIN



#4257

- Triple chrome-plated steel
- Kit includes:
 - 2 posts
 - 2 torsion clips
 - 2 scuff plates
 - 4 screws
- Easy to follow instructions included
- Drilling required

HOOD PIN LANYARDS

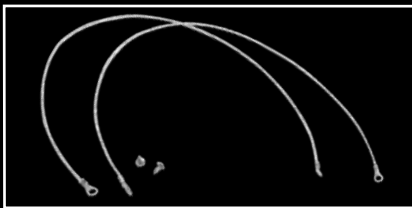

#4264

- 25" long
- Plastic-coated steel cable to reduce scratching of painted surfaces
- Two per package
- Use with Hair pin kit #42563 or with torsion pin kit #4257

HOOD LOCK KIT



#42613

- Triple chrome-plated mounting plates and locks
- Two keys included
- Easy-to-read instructions
- Must be used in conjunction with the factory latch
- Not to be used to hold down hood, use as locking device only
- Drilling required



Swivels to accommodate hood angle

HOOD PIN REPLACEMENT CLIPS



#4262

- Hair pin clip
- Triple chrome-plated steel
- Two per package



#4263

- Torsion clip
- Triple chrome-plated steel
- Two per package

ENGINE
BAY
COVERS

PERFORMANCE
AIR
FILTERS

INTAKE
SYSTEMS

AIR
CLEANERS

ENGINE
DETILING

PLUMBING

FUEL AND
IGNITION

HARDWARE

DRIVER/RAIN
ACCESSORIES

GENERAL
ACCESSORIES

MASTER CYLINDER COVERS

MASTER CYLINDER COVERS



#4222

- Fits General Motors
- 3" x 5-5/8"
- Triple chrome-plated steel
- Gasket not included



#4223

- Fits General Motors
- 3" x 5-3/4"
- Triple chrome-plated steel
- Gasket not included
- Will NOT fit Corvette



#4224

- Fits '73 - '83 Ford
- 2-3/4" x 5-3/4"
- Triple chrome-plated steel
- Gasket not included

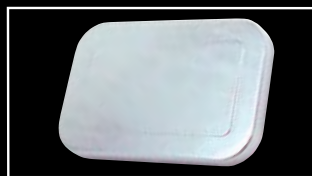

#4219

- Fits late model General Motors
- 4-1/2" x 6-7/8"
- Attaches to OEM cover
- Chrome-plated ABS plastic
- Will NOT fit Corvette



#4221

- Fits General Motors
- 2-3/8" x 5"
- Triple chrome-plated steel
- Gasket not included



#4220

- Fits '88-up Chevrolet - GMC pickups
- 3-1/2" x 6"
- Attaches to OEM cover
- Chrome-plated ABS plastic



#4225

- Fits '71-'79 Chrysler
- 3-1/4" x 6"
- Triple chrome-plated steel
- Gasket not included

EXHAUST TIPS AND COMPONENTS

UNIVERSAL EXHAUST TIPS



#22354

- Slant cut style for an aggressive look
- Polished stainless steel with resonator
- Includes installation hardware



#22421

- Slant cut style for an aggressive look
- Polished stainless steel with resonator
- Includes installation hardware



#22360

- Slant cut style end for aggressive look
- Black textured powder coated stainless steel with resonator
- Includes installation hardware



#22362

- Features a flat pencil-style end
- Black textured powder coated stainless steel with resonator
- Includes installation hardware



#22361

- Slant cut style for an aggressive look
- Black textured powder coated stainless steel with resonator
- Includes installation hardware

EXHAUST TIPS AND COMPONENTS

UNIVERSAL EXHAUST TIPS



- #25105
- Large oval opening for sporty look
 - Polished stainless steel with resonator
 - Includes installation hardware



- #25556
- Features a flat pencil-style end
 - Polished stainless steel finish
 - Includes installation hardware

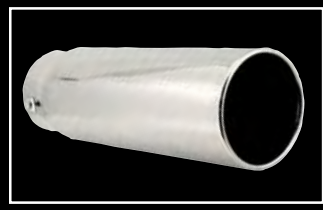

- #22431
- Features a flat pencil-style end
 - Polished stainless steel finish
 - Includes installation hardware

Exhaust Tube Dia.	Outside Dia.	Part Number
1-3/4" - 2-3/4"	3-1/2"	#22354
2-3/4" - 3-3/4"	4-1/2"	#22421
2-3/4" - 3-3/4"	4-1/2"	#22431
2-1/4" - 3-1/4"	4-1/2"	#25105
2" - 3"	4"	#25556
1-3/4" - 2-3/4"	3-1/2"	#22360

EXHAUST TIPS AND COMPONENTS

HEADER REDUCERS



- Nickel plated steel
- 1/8 inch thick compressed ceramic fiber
- Gaskets / hardware included
- #4641
- Two 3 in. to 2-1/2 inch reducers
- #4642
- Two 2-1/2 in. to 2-1/4 inch reducers

Street legal in most states, but may not be used in California or states with similar emissions control laws except on pre 1976 vehicles.

COLLECTOR GASKETS



- Made from compressed ceramic fiber
- Outperforms typical non-asbestos gaskets
- Will not deteriorate from excessive heat or pressure
- Conform to warped header flanges and manifolds
- Two gaskets per package

Inside Diameter	Thickness	Part Number
2-1/2"	1/8"	#430
3"	1/8"	#431
3-1/2"	1/8"	#432

Inside Diameter	Thickness	Part Number
2-1/2"	1/6"	#560
3"	1/6"	#561
3-1/2"	1/6"	#562

OIL FILTER COVERS

OIL FILTER COVER



#5989

- 4-9/32" high x 3-11/16" diameter
- Triple chrome-plated steel
- Easily attaches to your oil filter with set screw



#5991

- 5-3/16" high x 3-11/16" diameter
- Triple chrome-plated steel
- Easily attaches to your oil filter with set screw

ENGINE
BAY COVERS

PERFORMANCE
AIR FILTERS

INTAKE
SYSTEMS

AIR
CLEANERS

ENGINE
DEFILLING

PLUMBING

FUEL AND
IGNITION

HARDWARE

DRIVER/RAIN
ACCESSORIES

GENERAL
ACCESSORIES

Vehicle	Engine Type	Air Filter
2008 ACURA		
TSX	2.4L L4 F/I	HPR9564
2007 ACURA		
RSX	2.0L L4 F/I	HPR9493
TSX	2.4L L4 F/I	HPR9564
2006 ACURA		
CSX	2.0L L4 F/I	HPR9493
MDX	3.5L V6 F/I	HPR9361
RSX	2.0L L4 F/I	HPR9493
RSX Type-S	2.0L L4 F/I	HPR9493
TSX	2.4L L4 F/I	HPR9564
2005 ACURA		
EL	1.7L L4 F/I	HPR8911
MDX	3.5L V6 F/I	HPR9361
RSX	2.0L L4 F/I	HPR9493
RSX Type-S	2.0L L4 F/I	HPR9493
TSX	2.4L L4 F/I	HPR9564
2004 ACURA		
EL	1.7L L4 F/I	HPR8911
MDX	3.5L V6 F/I	HPR9361
RSX	2.0L L4 F/I	HPR9493
RSX Type-S	2.0L L4 F/I	HPR9493
TSX	2.4L L4 F/I	HPR9564
2003 ACURA		
CL	3.2L V6 F/I	HPR8475
EL	1.7L L4 F/I	HPR8911
MDX	3.5L V6 F/I	HPR9361
RSX	2.0L L4 F/I	HPR9493
RSX Type-S	2.0L L4 F/I	HPR9493
TL	3.2L V6 F/I	HPR8475
2002 ACURA		
CL	3.2L V6 F/I	HPR8475
EL	1.7L L4 F/I	HPR8911
MDX	3.5L V6 F/I	HPR9361
RSX	2.0L L4 F/I	HPR9493
RSX Type-S	2.0L L4 F/I	HPR9493
TL	3.2L V6 F/I	HPR8475
2001 ACURA		
CL	3.2L V6 F/I	HPR8475
EL	1.7L L4 F/I	HPR8911
MDX	3.5L V6 F/I	HPR9361
TL	3.2L V6 F/I	HPR8475
2000 ACURA		
TL	3.2L V6 F/I	HPR8475
1999 ACURA		
CL	2.3L L4 F/I	HPR7420
SLX	3.5L V6 F/I	HPR7417
TL	3.2L V6 F/I	HPR8475
1998 ACURA		
CL	2.3L L4 F/I	HPR7420
SLX	3.5L V6 F/I	HPR7417
1997 ACURA		
CL	2.2L L4 F/I	HPR7420
SLX	3.2L V6 F/I	HPR7417
1996 ACURA		
SLX	3.2L V6 F/I	HPR7417
2007 AUDI		
TT	1.8L L4 F/I	HPR8602

Vehicle	Engine Type	Air Filter
2006 AUDI		
TT	1.8L L4 F/I	HPR8602
TT Quattro	1.8L L4 F/I	HPR8602
TT Quattro	3.2L V6 F/I	HPR8602
TT Quattro	3.2L V6 F/I - Non-US, BHE Eng.	HPR8602
2005 AUDI		
A6	2.0L L4 F/I - 130BHP	HPR8080
Allroad Quattro	2.5L V6 DSL	HPR8080
Allroad Quattro	2.7L V6 F/I	HPR8080
Allroad Quattro	4.2L V8 F/I	HPR8080
TT	1.8L L4 F/I	HPR8602
TT Quattro	1.8L L4 F/I	HPR8602
TT Quattro	3.2L V6 F/I	HPR8602
TT Quattro	3.2L V6 F/I - Non-US	HPR8602
2004 AUDI		
A4 Quattro	3.0L V6 F/I	HPR8080
A6	1.8L L4 F/I	HPR8080
A6	1.9L L4 DSL	HPR8080
A6	2.0L L4 F/I	HPR8080
A6	2.4L V6 F/I	HPR8080
A6	2.5L V6 DSL	HPR8080
A6	2.7L V6 F/I	HPR8080
A6	2.8L V6 F/I	HPR8080
A6	3.0L V6 F/I - US	HPR8080
A6 Quattro	2.7L V6 F/I	HPR8080
A6 Quattro	3.0L V6 F/I	HPR8080
A6 Quattro	4.2L V8 F/I - Non-US	HPR8080
A6 Quattro	4.2L V8 F/I - US	HPR8080
A8 Quattro	4.2L V8 F/I	HPR8080
Allroad Quattro	2.5L V6 DSL	HPR8080
Allroad Quattro	2.7L V6 F/I	HPR8080
Allroad Quattro	4.2L V8 F/I	HPR8080
S6	4.2L V8 F/I	HPR8080
TT	1.8L L4 F/I	HPR8602
TT Quattro	1.8L L4 F/I	HPR8602
TT Quattro	3.2L V6 F/I	HPR8602
2003 AUDI		
A3	1.6L L4 F/I - to 5/03	HPR8602
A3	1.8L L4 F/I	HPR8602
A3	1.9L L4 DSL - to 4/03	HPR8602
A4	2.7L V6 F/I	HPR8080
A6	1.8L L4 F/I	HPR8080
A6	1.9L L4 DSL	HPR8080
A6	2.0L L4 F/I	HPR8080
A6	2.4L V6 F/I	HPR8080
A6	2.5L V6 DSL	HPR8080
A6	2.7L V6 F/I	HPR8080
A6	2.8L V6 F/I	HPR8080
A6	3.0L V6 F/I	HPR8080
A6 Quattro	2.7L V6 F/I	HPR8080
A6 Quattro	3.0L V6 F/I	HPR8080
A6 Quattro	4.2L V8 F/I - Non-US	HPR8080
A6 Quattro	4.2L V8 F/I - US	HPR8080
A8 Quattro	4.2L V8 F/I	HPR8080
Allroad Quattro	2.5L V6 DSL	HPR8080
Allroad Quattro	2.7L V6 F/I	HPR8080
Allroad Quattro	4.2L V8 F/I	HPR8080
RS4	2.7L V6 F/I	HPR8080
S3	1.8L L4 F/I	HPR8602
S6	4.2L V8 F/I	HPR8080
TT	1.8L L4 F/I	HPR8602
TT Quattro	1.8L L4 F/I	HPR8602
TT Quattro	3.2L V6 F/I	HPR8602

*Indicates 2 filters required ♦ Intake system available - see page 326 + throttle body spacer available - see page 20

HPR™ REPLACEMENT AIR FILTERS

AUDI

Vehicle	Engine Type	Air Filter	Vehicle	Engine Type	Air Filter
2002 AUDI			2000 AUDI		
A3	1.6L L4 F/I	HPR8602	A4	2.4L V6 F/I	HPR8080
A3	1.8L L4 F/I	HPR8602	A4	2.5L V6 DSL - 150BHP	HPR8080
A3	1.9L L4 DSL	HPR8602	A4	2.6L V6 F/I	HPR8080
A4	2.7L V6 F/I	HPR8080	A4	2.7L V6 F/I	HPR8080
A6	1.8L L4 F/I	HPR8080	A4	2.8L V6 F/I	HPR8080
A6	1.9L L4 DSL	HPR8080	A4 Quattro	1.8L L4 F/I	HPR8080
A6	2.0L L4 F/I	HPR8080	A4 Quattro	2.8L V6 F/I	HPR8080
A6	2.4L V6 F/I	HPR8080	A6	1.8L L4 F/I	HPR8080
A6	2.5L V6 DSL	HPR8080	A6	1.9L L4 DSL	HPR8080
A6	2.7L V6 F/I	HPR8080	A6	2.0L L4 F/I	HPR8080
A6	2.8L V6 F/I	HPR8080	A6	2.4L V6 F/I	HPR8080
A6	3.0L V6 F/I	HPR8080	A6	2.5L V6 DSL	HPR8080
A6 Quattro	2.7L V6 F/I	HPR8080	A6	2.7L V6 F/I	HPR8080
A6 Quattro	3.0L V6 F/I	HPR8080	A6	2.8L V6 F/I	HPR8080
A6 Quattro	4.2L V8 F/I - Non-US	HPR8080	A6 Quattro	2.7L V6 F/I	HPR8080
A6 Quattro	4.2L V8 F/I - US	HPR8080	A6 Quattro	2.8L V6 F/I	HPR8080
A8 Quattro	4.2L V8 F/I	HPR8080	A6 Quattro	4.2L V8 F/I	HPR8080
Allroad Quattro	2.5L V6 DSL	HPR8080	Allroad Quattro	2.5L V6 DSL	HPR8080
Allroad Quattro	2.7L V6 F/I	HPR8080	Allroad Quattro	2.7L V6 F/I	HPR8080
Allroad Quattro	4.2L V8 F/I	HPR8080	RS4	2.7L V6 F/I	HPR8080
RS4	2.7L V6 F/I	HPR8080	S3	1.8L L4 F/I	HPR8602
S3	1.8L L4 F/I	HPR8602	S4	2.7L V6 F/I	HPR8080
S4	2.7L V6 F/I	HPR8080	TT	1.8L L4 F/I	HPR8602
S6	4.2L V8 F/I	HPR8080	TT Quattro	1.8L L4 F/I	HPR8602
TT	1.8L L4 F/I	HPR8602	1999 AUDI		
TT Quattro	1.8L L4 F/I	HPR8602	A3	1.6L L4 F/I	HPR8602
2001 AUDI			A3	1.8L L4 F/I	HPR8602
A3	1.6L L4 F/I	HPR8602	A3	1.9L L4 DSL	HPR8602
A3	1.8L L4 F/I	HPR8602	A4	1.6L L4 F/I	HPR8080
A3	1.9L L4 DSL	HPR8602	A4	1.8L L4 F/I	HPR8080
A4	1.8L L4 F/I	HPR8080	A4	1.9L L4 DSL	HPR8080
A4	2.4L V6 F/I	HPR8080	A4	2.4L V6 F/I	HPR8080
A4	2.5L V6 DSL - 150BHP	HPR8080	A4	2.5L V6 DSL	HPR8080
A4	2.6L V6 F/I	HPR8080	A4	2.6L V6 F/I	HPR8080
A4	2.7L V6 F/I	HPR8080	A4	2.7L V6 F/I	HPR8080
A4	2.8L V6 F/I	HPR8080	A4	2.8L V6 F/I	HPR8080
A4 Quattro	1.8L L4 F/I	HPR8080	A4 Quattro	1.8L L4 F/I	HPR8080
A4 Quattro	2.8L V6 F/I	HPR8080	A4 Quattro	2.8L V6 F/I	HPR8080
A6	1.8L L4 F/I	HPR8080	A6	1.8L L4 F/I	HPR8080
A6	1.9L L4 DSL	HPR8080	A6	1.9L L4 DSL	HPR8080
A6	2.0L L4 F/I	HPR8080	A6	2.0L L4 F/I	HPR8080
A6	2.4L V6 F/I	HPR8080	A6	2.4L V6 F/I	HPR8080
A6	2.5L V6 DSL	HPR8080	A6	2.5L V6 DSL	HPR8080
A6	2.7L V6 F/I	HPR8080	A6	2.7L V6 F/I	HPR8080
A6	2.8L V6 F/I	HPR8080	A6	2.8L V6 F/I	HPR8080
A6 Quattro	2.7L V6 F/I	HPR8080	A6 Quattro	2.8L V6 F/I	HPR8080
A6 Quattro	2.8L V6 F/I	HPR8080	S3	1.8L L4 F/I	HPR8602
A6 Quattro	3.0L V6 F/I	HPR8080	S4	2.7L V6 F/I	HPR8080
A6 Quattro	4.2L V8 F/I	HPR8080	TT	1.8L L4 F/I	HPR8602
Allroad Quattro	2.5L V6 DSL	HPR8080	1998 AUDI		
Allroad Quattro	2.7L V6 F/I	HPR8080	A3	1.6L L4 F/I	HPR8602
RS4	2.7L V6 F/I	HPR8080	A3	1.8L L4 F/I	HPR8602
S3	1.8L L4 F/I	HPR8602	A3	1.9L L4 DSL	HPR8602
S4	2.7L V6 F/I	HPR8080	A4	1.6L L4 F/I	HPR8080
TT	1.8L L4 F/I	HPR8602	A4	1.8L L4 F/I	HPR8080
TT Quattro	1.8L L4 F/I	HPR8602	A4	1.9L L4 DSL	HPR8080
2000 AUDI			A4	2.4L V6 F/I	HPR8080
A3	1.6L L4 F/I	HPR8602	A4	2.5L V6 DSL	HPR8080
A3	1.8L L4 F/I	HPR8602	A4	2.6L V6 F/I	HPR8080
A3	1.9L L4 DSL	HPR8602	A4	2.7L V6 F/I	HPR8080
A4	1.6L L4 F/I	HPR8080	A4	2.8L V6 F/I	HPR8080
A4	1.8L L4 F/I	HPR8080	A4 Quattro	1.8L L4 F/I	HPR8080
A4	1.9L L4 DSL	HPR8080	A4 Quattro	2.8L V6 F/I	HPR8080

*Indicates 2 filters required ♦ Intake system available - see page 326 + throttle body spacer available - see page 20

Vehicle	Engine Type	Air Filter	Vehicle	Engine Type	Air Filter
1998 AUDI			1983 AUDI		
A6	1.8L L4 F/I	HPR8080	80	1.6L L4 F/I - 110BHP	HPR3660
A6	1.9L L4 DSL	HPR8080	4000	1.7L L4 F/I	HPR3660
A6	2.0L L4 F/I	HPR8080	1982 AUDI		
A6	2.4L V6 F/I	HPR8080	80	1.6L L4 F/I - 110BHP	HPR3660
A6	2.5L V6 DSL	HPR8080	80	1.8L L4 F/I	HPR3660
A6	2.7L V6 F/I	HPR8080	4000	1.7L L4 F/I	HPR3660
A6	2.8L V6 F/I - AHA Eng.	HPR8080	1981 AUDI		
A6 Quattro	2.8L V6 F/I	HPR8080	80	1.6L L4 F/I - 110BHP	HPR3660
A6 Quattro	2.8L V6 F/I - Sedan	HPR8080	80	1.8L L4 F/I	HPR3660
S4	2.7L V6 F/I	HPR8080	4000	1.7L L4 F/I	HPR3660
TT	1.8L L4 F/I	HPR8602	4000	2.2L L5 F/I	HPR3660
1997 AUDI			1980 AUDI		
A3	1.6L L4 F/I	HPR8602	80	1.6L L4 F/I - 110BHP	HPR3660
A3	1.8L L4 F/I	HPR8602	80	1.8L L4 F/I	HPR3660
A3	1.9L L4 DSL	HPR8602	4000	1.6L L4 F/I	HPR3660
A4	1.6L L4 F/I	HPR8080	4000	2.2L L5 F/I	HPR3660
A4	1.8L L4 F/I	HPR8080	1979 AUDI		
A4	1.9L L4 DSL	HPR8080	80	1.6L L4 F/I - 110BHP	HPR3660
A4	2.4L V6 F/I	HPR8080	80	1.8L L4 F/I	HPR3660
A4	2.6L V6 F/I	HPR8080	Fox	1.6L L4 F/I	HPR3660
A4	2.8L V6 F/I	HPR8080	1978 AUDI		
A4 Quattro	1.8L L4 F/I	HPR8080	80	1.6L L4 F/I - 110BHP	HPR3660
A4 Quattro	2.8L V6 F/I	HPR8080	80	1.8L L4 F/I	HPR3660
A6	1.8L L4 F/I - from 5/97	HPR8080	Fox	1.6L L4 F/I	HPR3660
A6	1.9L L4 DSL - from 3/97	HPR8080	1977 AUDI		
A6	2.0L L4 F/I	HPR8080	80	1.6L L4 F/I - 110BHP	HPR3660
A6	2.4L V6 F/I	HPR8080	Fox	1.6L L4 F/I	HPR3660
A6	2.5L V6 DSL - from 7/97	HPR8080	1976 AUDI		
A6	2.7L V6 F/I	HPR8080	80	1.6L L4 F/I - 110BHP	HPR3660
A6 Quattro	2.8L V6 F/I	HPR8080	Fox	1.6L L4 F/I	HPR3660
S4	2.7L V6 F/I	HPR8080	1975 AUDI		
1996 AUDI			1974 AUDI		
A3	1.6L L4 F/I	HPR8602	Fox	90 L4 CARB	HPR3660
A3	1.8L L4 F/I	HPR8602	1973 AUDI		
A3	1.9L L4 DSL	HPR8602	Fox	1.5L L4 F/I	HPR3660
A4	1.6L L4 F/I	HPR8080	Fox	90 L4 CARB	HPR3660
A4	1.8L L4 F/I	HPR8080	2014 BMW		
A4	1.9L L4 DSL	HPR8080	128i	3.0L L6 F/I	HPR10464
A4	2.6L V6 F/I	HPR8080	2013 BMW		
A4	2.8L V6 F/I	HPR8080	128i	3.0L L6 F/I	HPR10464
A4 Quattro	2.8L V6 F/I	HPR8080	328i	3.0L L6 F/I	HPR10464
A6 Quattro	2.8L V6 F/I	HPR8080	328i xDrive	3.0L L6 F/I	HPR10464
1995 AUDI			2012 BMW		
A4	1.6L L4 F/I	HPR8080	128i	3.0L L6 F/I	HPR10464
A4	1.8L L4 F/I	HPR8080	325i	3.0L L6 F/I - E90/91/92/93	HPR10464
A4	1.9L L4 DSL	HPR8080	328i	3.0L L6 F/I	HPR10464
A4	2.6L V6 F/I	HPR8080	328i xDrive	3.0L L6 F/I	HPR10464
A4	2.8L V6 F/I	HPR8080	330i	3.0L L6 F/I - E90/91/92/93	HPR10464
1994 AUDI			2011 BMW		
A4	1.8L L4 F/I	HPR8080	128i	3.0L L6 F/I	HPR10464
A4	1.9L L4 DSL	HPR8080	130i	3.0L L6 F/I	HPR10464
A4	2.6L V6 F/I	HPR8080	325i	3.0L L6 F/I	HPR10464
A4	2.8L V6 F/I	HPR8080	328i	3.0L L6 F/I	HPR10464
1986 AUDI			328i xDrive	3.0L L6 F/I	HPR10464
80	1.6L L4 F/I - 110BHP	HPR3660	330i	3.0L L6 F/I	HPR10464
1985 AUDI			630i	3.0L L6 F/I	HPR10022
80	1.6L L4 F/I - 110BHP	HPR3660	2011 BMW		
1984 AUDI			128i	3.0L L6 F/I	HPR10464
80	1.6L L4 F/I - 110BHP	HPR3660	130i	3.0L L6 F/I	HPR10464
4000	1.8L L4 F/I	HPR3660	325i	3.0L L6 F/I	HPR10464

*Indicates 2 filters required ♦ Intake system available - see page 326 + throttle body spacer available - see page 20

HPR™ REPLACEMENT AIR FILTERS

BMW

Vehicle	Engine Type	Air Filter	Vehicle	Engine Type	Air Filter
2010 BMW			2006 BMW		
128i	3.0L L6 F/I	HPR10464	530xi	3.0L L6 F/I	HPR10022
130i	3.0L L6 F/I - w/Panel Filter	HPR10464	630i	3.0L L6 F/I	HPR10022
325i	3.0L L6 F/I - w/Panel Filter	HPR10464	X3	2.5L L6 F/I - Non-US, to 8/06	HPR5350
328i	3.0L L6 F/I	HPR10464	X5	4.4L V8 F/I	HPR8080
328i xDrive	3.0L L6 F/I	HPR10464	X5	4.8L V8 F/I	HPR8080
330i	3.0L L6 F/I - w/Panel Filter	HPR10464	Z4	2.2L L6 F/I	HPR5350
523i	2.5L L6 F/I - E60, E61	HPR10022	Z4	2.5L L6 F/I - US	HPR5350
525i	3.0L L6 F/I	HPR10022	Z4	3.2L L6 F/I - Non-US	HPR10022
528i	3.0L L6 F/I - Non-US, E60, E61	HPR10022	2005 BMW		
528i	3.0L L6 F/I - US	HPR10022	520i	2.2L L6 F/I	HPR10022
528i xDrive	3.0L L6 F/I - Non-US, E60, E61	HPR10022	523i	2.5L L6 F/I	HPR10022
528i xDrive	3.0L L6 F/I - US	HPR10022	525i	2.5L L6 F/I	HPR10022
530i	3.0L L6 F/I	HPR10022	525xi	3.0L L6 F/I	HPR10022
630i	3.0L L6 F/I	HPR10022	530i	3.0L L6 F/I	HPR10022
2009 BMW			530xi	3.0L L6 F/I	HPR10022
128i	3.0L L6 F/I	HPR10464	545i	4.4L V8 F/I	HPR8080
328i	3.0L L6 F/I	HPR10464	630i	3.0L L6 F/I	HPR10022
328i xDrive	3.0L L6 F/I	HPR10464	X3	2.5L L6 F/I - Non-US	HPR5350
328xi	3.0L L6 F/I	HPR10464	X5	4.4L V8 F/I	HPR8080
523i	2.5L L6 F/I	HPR10022	X5	4.8L V8 F/I	HPR8080
525i	3.0L L6 F/I	HPR10022	Z4	2.2L L6 F/I	HPR5350
528i	3.0L L6 F/I	HPR10022	Z4	2.5L L6 F/I	HPR5350
528i xDrive	3.0L L6 F/I	HPR10022	Z4	3.0L L6 F/I	HPR5350
528xi	3.0L L6 F/I	HPR10022	2004 BMW		
530i	3.0L L6 F/I	HPR10022	320i	2.2L L6 F/I	HPR5350
630i	3.0L L6 F/I	HPR10022	520i	2.0L L6 F/I	HPR5350
Z4	3.2L L6 F/I	HPR10022	520i	2.2L L6 F/I - E39	HPR5350
2008 BMW			520i	2.2L L6 F/I - E60, E61	HPR10022
128i	3.0L L6 F/I	HPR10464	525i	2.5L L6 F/I - E39	HPR5350
328i	3.0L L6 F/I	HPR10464	525i	2.5L L6 F/I - E60, E61	HPR10022
328xi	3.0L L6 F/I	HPR10464	525i	2.5L L6 F/I - US	HPR10022
523i	2.5L L6 F/I	HPR10022	530i	3.0L L6 F/I - E39	HPR5350
525i	2.5L L6 F/I	HPR10022	530i	3.0L L6 F/I - E60, E61	HPR10022
525i	3.0L L6 F/I	HPR10022	530i	3.0L L6 F/I - US	HPR10022
525xi	3.0L L6 F/I	HPR10022	545i	4.4L V8 F/I	HPR8080
528i	3.0L L6 F/I	HPR10022	630i	3.0L L6 F/I	HPR10022
528xi	3.0L L6 F/I	HPR10022	M3	3.2L L6 F/I	HPR5350
530i	3.0L L6 F/I	HPR10022	X3	2.5L L6 F/I - Non-US	HPR5350
530xi	3.0L L6 F/I	HPR10022	X5	4.4L V8 F/I	HPR8080
630i	3.0L L6 F/I	HPR10022	X5	4.8L V8 F/I	HPR8080
Z4	3.2L L6 F/I	HPR10022	Z4	2.2L L6 F/I	HPR5350
2007 BMW			Z4	2.5L L6 F/I	HPR5350
328i	3.0L L6 F/I	HPR10464	Z4	3.0L L6 F/I	HPR5350
328xi	3.0L L6 F/I	HPR10464	2003 BMW		
523i	2.5L L6 F/I	HPR10022	320i	2.2L L6 F/I	HPR5350
525i	2.5L L6 F/I	HPR10022	520i	2.0L L6 F/I - E39	HPR5350
525i	3.0L L6 F/I	HPR10022	520i	2.0L L6 F/I - E60, E61	HPR10022
525xi	3.0L L6 F/I	HPR10022	520i	2.2L L6 F/I - E39	HPR5350
530i	3.0L L6 F/I	HPR10022	520i	2.2L L6 F/I - E60, E61	HPR10022
530xi	3.0L L6 F/I	HPR10022	525i	2.5L L6 F/I - E39	HPR5350
630i	3.0L L6 F/I	HPR10022	525i	2.5L L6 F/I - E60, E61	HPR10022
Z4	3.2L L6 F/I	HPR10022	525i	2.5L L6 F/I - US	HPR5350
2006 BMW			530i	3.0L L6 F/I - E39	HPR5350
325i	3.0L L6 F/I - US	HPR10464	530i	3.0L L6 F/I - E60	HPR10022
325Xi	3.0L L6 F/I	HPR10464	530i	3.0L L6 F/I - US	HPR5350
330i	3.0L L6 F/I - US	HPR10464	540i	4.4L V8 F/I	HPR8080
330Xi	3.0L L6 F/I - US	HPR10464	M3	3.2L L6 F/I	HPR5350
523i	2.5L L6 F/I	HPR10022	X5	4.4L V8 F/I	HPR8080
525i	2.5L L6 F/I	HPR10022	X5	4.6L V8 F/I	HPR8080
525i	3.0L L6 F/I	HPR10022	Z3	2.0L L6 F/I	HPR5350
525xi	3.0L L6 F/I	HPR10022	Z3	2.2L L6 F/I	HPR5350
530i	3.0L L6 F/I	HPR10022	Z3	3.0L L6 F/I	HPR5350
			Z3	3.2L L6 F/I	HPR5350

*Indicates 2 filters required ♦ Intake system available - see page 326 + throttle body spacer available - see page 20

Vehicle	Engine Type	Air Filter	Vehicle	Engine Type	Air Filter
2003 BMW			1999 BMW		
Z4	2.2L L6 F/I	HPR5350	323iS	2.5L L6 F/I	HPR5350
Z4	2.5L L6 F/I	HPR5350	323Ti	2.5L L6 F/I	HPR5350
Z4	3.0L L6 F/I	HPR5350	325i	2.5L L6 F/I	HPR5350
Z8	4.8L V8 F/I	HPR8080	328i	2.8L L6 F/I - Non-US, E36	HPR5350
2002 BMW			328i	2.8L L6 F/I - US	HPR5350
320i	2.2L L6 F/I	HPR5350	328ic	2.8L L6 F/I - US, E36	HPR5350
520i	2.0L L6 F/I	HPR5350	328iS	2.8L L6 F/I - US	HPR5350
520i	2.2L L6 F/I	HPR5350	520i	2.0L L6 F/I	HPR5350
525i	2.5L L6 F/I	HPR5350	523i	2.5L L6 F/I	HPR5350
530i	3.0L L6 F/I	HPR5350	528i	2.8L L6 F/I	HPR5350
540i	4.4L V8 F/I	HPR8080	540i	4.4L V8 F/I	HPR8080
M3	3.2L L6 F/I	HPR5350	728i	2.8L L6 F/I	HPR5350
X5	4.4L V8 F/I	HPR8080	728iL	2.8L L6 F/I	HPR5350
X5	4.6L V8 F/I	HPR8080	740i	4.4L V8 F/I	HPR8080
Z3	2.0L L6 F/I	HPR5350	740iL	4.4L V8 F/I	HPR8080
Z3	2.2L L6 F/I	HPR5350	M Coupe	3.2L L6 F/I	HPR5350
Z3	2.5L L6 F/I	HPR5350	M3	3.0L L6 F/I	HPR5350
Z3	3.0L L6 F/I	HPR5350	M3	3.2L L6 F/I	HPR5350
Z3	3.2L L6 F/I	HPR5350	Z3	2.0L L6 F/I	HPR5350
2001 BMW			Z3	2.5L L6 F/I	HPR5350
320i	2.2L L6 F/I	HPR5350	Z3	2.8L L6 F/I	HPR5350
520i	2.0L L6 F/I	HPR5350	Z3	3.2L L6 F/I	HPR5350
520i	2.2L L6 F/I	HPR5350	1998 BMW		
525i	2.5L L6 F/I	HPR5350	320i	2.0L L6 F/I - E36	HPR5350
530i	3.0L L6 F/I	HPR5350	323Ci	2.5L L6 F/I	HPR5350
540i	4.4L V8 F/I	HPR8080	323i	2.5L L6 F/I - E36	HPR5350
728i	2.8L L6 F/I	HPR5350	323i	2.5L L6 F/I - US	HPR5350
728iL	2.8L L6 F/I	HPR5350	323iS	2.5L L6 F/I	HPR5350
740i	4.4L V8 F/I	HPR8080	323Ti	2.5L L6 F/I	HPR5350
740iL	4.4L V8 F/I	HPR8080	325i	2.5L L6 F/I	HPR5350
M3	3.2L L6 F/I	HPR5350	328Ci	2.8L L6 F/I	HPR5350
X5	4.4L V8 F/I	HPR8080	328i	2.8L L6 F/I - Non-US, E36	HPR5350
Z3	2.0L L6 F/I	HPR5350	328i	2.8L L6 F/I - US	HPR5350
Z3	2.2L L6 F/I	HPR5350	328ic	2.8L L6 F/I - US	HPR5350
Z3	2.5L L6 F/I	HPR5350	328iS	2.8L L6 F/I	HPR5350
Z3	3.0L L6 F/I	HPR5350	520i	2.0L L6 F/I	HPR5350
Z3	3.2L L6 F/I	HPR5350	523i	2.5L L6 F/I	HPR5350
2000 BMW			528i	2.8L L6 F/I	HPR5350
323Ti	2.5L L6 F/I	HPR5350	540i	4.4L V8 F/I	HPR8080
520i	2.0L L6 F/I	HPR5350	728i	2.8L L6 F/I	HPR5350
520i	2.2L L6 F/I	HPR5350	728iL	2.8L L6 F/I	HPR5350
523i	2.5L L6 F/I	HPR5350	740i	4.4L V8 F/I	HPR8080
525i	2.5L L6 F/I	HPR5350	740iL	4.4L V8 F/I	HPR8080
528i	2.8L L6 F/I	HPR5350	M Coupe	3.2L L6 F/I	HPR5350
530i	3.0L L6 F/I	HPR5350	M3	3.0L L6 F/I	HPR5350
540i	4.4L V8 F/I	HPR8080	M3	3.2L L6 F/I	HPR5350
728i	2.8L L6 F/I	HPR5350	Z3	2.8L L6 F/I	HPR5350
728iL	2.8L L6 F/I	HPR5350	Z3	3.2L L6 F/I	HPR5350
740i	4.4L V8 F/I	HPR8080	1997 BMW		
740iL	4.4L V8 F/I	HPR8080	320i	2.0L L6 F/I	HPR5350
M3	3.0L L6 F/I	HPR5350	323i	2.5L L6 F/I	HPR5350
X5	4.4L V8 F/I	HPR8080	323iS	2.5L L6 F/I	HPR5350
Z3	2.0L L6 F/I	HPR5350	323Ti	2.5L L6 F/I	HPR5350
Z3	2.2L L6 F/I	HPR5350	325i	2.5L L6 F/I	HPR5350
Z3	2.5L L6 F/I	HPR5350	328Ci	2.8L L6 F/I	HPR5350
Z3	2.8L L6 F/I	HPR5350	328i	2.8L L6 F/I	HPR5350
Z3	3.0L L6 F/I	HPR5350	328iS	2.8L L6 F/I	HPR5350
Z3	3.2L L6 F/I	HPR5350	520i	2.0L L6 F/I	HPR5350
1999 BMW			523i	2.5L L6 F/I	HPR5350
320i	2.0L L6 F/I - E36	HPR5350	528i	2.8L L6 F/I	HPR5350
323Ci	2.5L L6 F/I	HPR5350	540i	4.4L V8 F/I	HPR8080
323i	2.5L L6 F/I - E36	HPR5350	728i	2.8L L6 F/I	HPR5350
			728iL	2.8L L6 F/I	HPR5350

*Indicates 2 filters required ♦ Intake system available - see page 326 + throttle body spacer available - see page 20

HPR™ REPLACEMENT AIR FILTERS

BMW

Vehicle	Engine Type	Air Filter
1997 BMW		
740i	4.4L V8 F/I	HPR8080
740iL	4.4L V8 F/I	HPR8080
840Ci	4.4L V8 F/I	HPR8080
M3	3.0L L6 F/I	HPR5350
M3	3.2L L6 F/I	HPR5350
Z3	2.8L L6 F/I	HPR5350
Z3	3.2L L6 F/I	HPR5350

Vehicle	Engine Type	Air Filter
1996 BMW		
320i	2.0L L6 F/I	HPR5350
323i	2.5L L6 F/I	HPR5350
325i	2.5L L6 F/I	HPR5350
328i	2.8L L6 F/I	HPR5350
328iS	2.8L L6 F/I	HPR5350
520i	2.0L L6 F/I - E39	HPR5350
523i	2.5L L6 F/I	HPR5350
528i	2.8L L6 F/I	HPR5350
728i	2.8L L6 F/I	HPR5350
728iL	2.8L L6 F/I	HPR5350
740iL	4.4L V8 F/I	HPR8080
840Ci	4.4L V8 F/I	HPR8080
M3	3.0L L6 F/I	HPR5350
M3	3.2L L6 F/I	HPR5350

Vehicle	Engine Type	Air Filter
1995 BMW		
320i	2.0L L6 F/I	HPR5350
323i	2.5L L6 F/I	HPR5350
325Ci	2.5L L6 F/I	HPR5350
325i	2.5L L6 F/I	HPR5350
325iS	2.5L L6 F/I	HPR5350
328i	2.8L L6 F/I	HPR5350
523i	2.5L L6 F/I	HPR5350
528i	2.8L L6 F/I	HPR5350
530i	3.0L V8 F/I	HPR8080
540i	4.0L V8 F/I	HPR8080
728i	2.8L L6 F/I	HPR5350
740i	4.0L V8 F/I	HPR8080
740iL	4.0L V8 F/I	HPR8080
840Ci	4.0L V8 F/I	HPR8080
M3	3.0L L6 F/I	HPR5350
M3	3.2L L6 F/I	HPR5350

Vehicle	Engine Type	Air Filter
1994 BMW		
320i	2.0L L6 F/I	HPR5350
325Ci	2.5L L6 F/I	HPR5350
325i	2.5L L6 F/I	HPR5350
325iS	2.5L L6 F/I	HPR5350
540i	4.0L V8 F/I	HPR8080
728i	2.8L L6 F/I	HPR5350
740i	4.0L V8 F/I	HPR8080
740iL	4.0L V8 F/I	HPR8080
840Ci	4.0L V8 F/I	HPR8080
M3	3.0L L6 F/I	HPR5350

Vehicle	Engine Type	Air Filter
1993 BMW		
320i	2.0L L6 F/I - E36	HPR5350
320i	2.0L L6 F/I - US	HPR5350
325Ci	2.5L L6 F/I - 24v	HPR5350
325i	2.5L L6 F/I - Non-US, E36	HPR5350
325i	2.5L L6 F/I - US	HPR5350
325iS	2.5L L6 F/I	HPR5350
740i	4.0L V8 F/I	HPR8080
740iL	4.0L V8 F/I	HPR8080
M3	3.0L L6 F/I	HPR5350

Vehicle	Engine Type	Air Filter
1992 BMW		
320i	2.0L L6 F/I	HPR5350

Vehicle	Engine Type	Air Filter
1992 BMW		
320i	2.0L L6 F/I - E36	HPR5350
325i	2.5L L6 F/I	HPR5350
325i	2.5L L6 F/I - E36	HPR5350
325iS	2.5L L6 F/I	HPR5350
M3	3.0L L6 F/I	HPR5350

Vehicle	Engine Type	Air Filter
1991 BMW		
320i	2.0L L6 F/I - E36	HPR5350
325i	2.5L L6 F/I - E36	HPR5350

Vehicle	Engine Type	Air Filter
1990 BMW		
320i	2.0L L6 F/I - E36	HPR5350

Vehicle	Engine Type	Air Filter
1976 BMW		
2002	121 L4 CARB	HPR3300

Vehicle	Engine Type	Air Filter
1975 BMW		
2002	121 L4 CARB	HPR3300
2002	2.0L L4 CARB	HPR3300

Vehicle	Engine Type	Air Filter
2012 BUICK		
Lucerne	3.9L V6 F/I	HPR9492
Lucerne	4.6L V8 F/I	HPR9492

Vehicle	Engine Type	Air Filter
2011 BUICK		
Lucerne	3.9L V6 F/I	HPR9492
Lucerne	4.6L V8 F/I	HPR9492

Vehicle	Engine Type	Air Filter
2010 BUICK		
Lucerne	3.9L V6 F/I	HPR9492
Lucerne	4.6L V8 F/I	HPR9492

Vehicle	Engine Type	Air Filter
2009 BUICK		
Allure	5.3L V8 F/I	HPR10014
LaCrosse	5.3L V8 F/I	HPR10014
Lucerne	3.9L V6 F/I	HPR9492
Lucerne	4.6L V8 F/I	HPR9492

Vehicle	Engine Type	Air Filter
2008 BUICK		
Allure	5.3L V8 F/I	HPR10014
LaCrosse	5.3L V8 F/I	HPR10014
Lucerne	3.8L V6 F/I	HPR9492
Lucerne	4.6L V8 F/I	HPR9492
Rainier	5.3L V8 F/I	HPR9345

Vehicle	Engine Type	Air Filter
2007 BUICK		
Lucerne	3.8L V6 F/I	HPR9492
Lucerne	4.6L V8 F/I	HPR9492
Rainier	4.2L L6 F/I	HPR9345
Rainier	5.3L V8 F/I	HPR9345
Rendezvous	3.5L V6 F/I	HPR7597
Terraza	3.9L V6 F/I	HPR7597

Vehicle	Engine Type	Air Filter
2006 BUICK		
Lucerne	3.8L V6 F/I	HPR9492
Lucerne	4.6L V8 F/I	HPR9492
Rainier	4.2L L6 F/I	HPR9345
Rainier	5.3L V8 F/I	HPR9345
Rendezvous	3.5L V6 F/I	HPR7597
Rendezvous	3.6L V6 F/I	HPR7597
Terraza	3.5L V6 F/I	HPR7597
Terraza	3.9L V6 F/I	HPR7597

Vehicle	Engine Type	Air Filter
2005 BUICK		
Century	3.1L V6 F/I	HPR6479
LeSabre	3.8L V6 F/I	HPR6479
Park Avenue	3.8L V6 F/I	HPR6479
Rainier	4.2L L6 F/I	HPR9345
Rainier	5.3L V8 F/I	HPR9345
Rendezvous	3.4L V6 F/I	HPR7597

*Indicates 2 filters required ♦ Intake system available - see page 326 + throttle body spacer available - see page 20

BUICK

HPR™ REPLACEMENT AIR FILTERS

Vehicle	Engine Type	Air Filter	Vehicle	Engine Type	Air Filter
2005 BUICK			1996 BUICK		
Rendezvous	3.6L V6 F/I	HPR7597	Park Avenue	3.8L V6 F/I	HPR6479
Terraza	3.5L V6 F/I	HPR7597	Regal	3.1L V6 F/I	HPR7597
2004 BUICK			Regal	3.8L V6 F/I	HPR7597
Century	3.1L V6 F/I	HPR6479	Riviera	3.8L V6 F/I	HPR6479
LeSabre	3.8L V6 F/I	HPR6479	Roadmaster	5.7L V8 F/I	HPR6479
Park Avenue	3.8L V6 F/I	HPR6479	Skylark	2.4L L4 F/I	HPR7598
Rainier	4.2L L6 F/I	HPR9345	Skylark	3.1L V6 F/I	HPR7598
Rainier	5.3L V8 F/I	HPR9345	1995 BUICK		
Regal	3.8L V6 F/I	HPR6479	Century	3.1L V6 F/I	HPR3902
Rendezvous	3.4L V6 F/I	HPR7597	LeSabre	3.8L V6 F/I	HPR6479
Rendezvous	3.6L V6 F/I	HPR7597	Park Avenue	3.8L V6 F/I	HPR6479
2003 BUICK			Regal	3.1L V6 F/I	HPR7597
Century	3.1L V6 F/I	HPR6479	Regal	3.8L V6 F/I	HPR7597
LeSabre	3.8L V6 F/I	HPR6479	Riviera	3.8L V6 F/I	HPR6479
Park Avenue	3.8L V6 F/I	HPR6479	Roadmaster	5.7L V8 F/I	HPR6479
Regal	3.8L V6 F/I	HPR6479	Skylark	2.3L L4 F/I	HPR7598
Rendezvous	3.4L V6 F/I	HPR7597	Skylark	3.1L V6 F/I	HPR7598
2002 BUICK			1994 BUICK		
Century	3.1L V6 F/I	HPR6479	Century	3.1L V6 F/I	HPR3902
LeSabre	3.8L V6 F/I	HPR6479	LeSabre	3.8L V6 F/I	HPR6479
Park Avenue	3.8L V6 F/I	HPR6479	Park Avenue	3.8L V6 F/I	HPR6479
Regal	3.8L V6 F/I	HPR6479	Regal	3.1L V6 F/I	HPR7597
Rendezvous	3.4L V6 F/I	HPR7597	Regal	3.8L V6 F/I	HPR7597
2001 BUICK			Roadmaster	5.7L V8 F/I	HPR6479
Century	3.1L V6 F/I	HPR6479	Skylark	2.3L L4 F/I	HPR7598
GL8	3.0L V6 F/I - China	HPR7597	Skylark	3.1L V6 F/I	HPR7598
LeSabre	3.8L V6 F/I	HPR6479	1993 BUICK		
Park Avenue	3.8L V6 F/I	HPR6479	Century	3.3L V6 F/I	HPR3916
Regal	3.8L V6 F/I	HPR6479	LeSabre	3.8L V6 F/I	HPR6479
2000 BUICK			Park Avenue	3.8L V6 F/I	HPR6479
Century	3.1L V6 F/I	HPR6479	Regal	3.1L V6 F/I	HPR6626
LeSabre	3.8L V6 F/I	HPR6479	Regal	3.8L V6 F/I	HPR3902
Park Avenue	3.8L V6 F/I	HPR6479	Riviera	3.8L V6 F/I	HPR3916
Regal	3.0L V6 F/I	HPR6479	Roadmaster	5.7L V8 F/I	HPR7017
Regal	3.8L V6 F/I	HPR6479	Skylark	2.3L L4 F/I	HPR3916
1999 BUICK			Skylark	3.3L V6 F/I	HPR3916
Century	3.1L V6 F/I	HPR6479	1992 BUICK		
LeSabre	3.8L V6 F/I	HPR6479	Century	2.5L L4 F/I	HPR3647
Park Avenue	3.8L V6 F/I	HPR6479	Century	3.3L V6 F/I	HPR3916
Regal	3.8L V6 F/I	HPR6479	LeSabre	3.8L V6 F/I	HPR6479
Riviera	3.8L V6 F/I	HPR6479	Park Avenue	3.8L V6 F/I	HPR6479
1998 BUICK			Regal	3.1L V6 F/I	HPR6626
Century	3.1L V6 F/I	HPR7597	Regal	3.8L V6 F/I	HPR3902
LeSabre	3.8L V6 F/I	HPR6479	Riviera	3.8L V6 F/I	HPR3916
Park Avenue	3.8L V6 F/I	HPR6479	Roadmaster	5.7L V8 F/I	HPR7017
Regal	3.8L V6 F/I	HPR7597	Skylark	2.3L L4 F/I	HPR3916
Riviera	3.8L V6 F/I	HPR6479	Skylark	3.3L V6 F/I	HPR3916
Skylark	2.4L L4 F/I	HPR7598	1991 BUICK		
Skylark	3.1L V6 F/I	HPR7598	Century	2.5L L4 F/I	HPR3647
1997 BUICK			Century	3.3L V6 F/I	HPR3916
Century	3.1L V6 F/I	HPR7597	LeSabre	3.8L V6 F/I	HPR3916
LeSabre	3.8L V6 F/I	HPR6479	Park Avenue	3.8L V6 F/I	HPR6479
Park Avenue	3.8L V6 F/I	HPR6479	Reatta	3.8L V6 F/I	HPR3916
Regal	3.8L V6 F/I	HPR7597	Regal	3.1L V6 F/I	HPR6626
Riviera	3.8L V6 F/I	HPR6479	Regal	3.8L V6 F/I	HPR3902
Skylark	2.4L L4 F/I	HPR7598	Riviera	3.8L V6 F/I	HPR3916
Skylark	3.1L V6 F/I	HPR7598	Roadmaster	5.0L V8 F/I	HPR7017
1996 BUICK			Skylark	2.3L L4 F/I	HPR3916
Century	3.1L V6 F/I	HPR3902	Skylark	2.5L L4 F/I	HPR3647
LeSabre	3.8L V6 F/I	HPR6479	Skylark	3.3L V6 F/I	HPR3916

*Indicates 2 filters required ♦ Intake system available - see page 326 + throttle body spacer available - see page 20

HPR™ REPLACEMENT AIR FILTERS

BUICK

Vehicle	Engine Type	Air Filter	Vehicle	Engine Type	Air Filter
1990 BUICK			1985 BUICK		
Century	2.5L L4 F/I	HPR3647	Century	2.5L L4 F/I	HPR3647
Century	3.3L V6 F/I	HPR3916	Century	3.0L V6 CARB	HPR0192
Electra	3.8L V6 F/I	HPR3916	Electra	5.0L V8 CARB	HPR0326
LeSabre	3.8L V6 F/I	HPR3916	LeSabre	3.8L V6 CARB	HPR0192
LeSabre	5.0L V8 CARB	HPR0326	LeSabre	5.0L V8 CARB	HPR0326
Reatta	3.8L V6 F/I	HPR3916	Regal	3.8L V6 CARB	HPR0192
Regal	3.1L V6 F/I	HPR6626	Regal	5.0L V8 CARB	HPR0326
Regal	3.8L V6 F/I	HPR3902	Riviera	5.0L V8 CARB	HPR0192
Riviera	3.8L V6 F/I	HPR3916		5.7L V8 DSL	48026
Skylark	2.3L L4 F/I	HPR3916			880136
Skylark	2.5L L4 F/I	HPR3647			HPR0136
Skylark	3.3L V6 F/I	HPR3916	Skyhawk	1.8L L4 F/I	HPR3647
1989 BUICK			Skyhawk	2.0L L4 F/I	HPR3647
Century	2.5L L4 F/I	HPR3647	Skylark	2.5L L4 F/I	HPR3647
Century	3.3L V6 F/I	HPR3916	Somerset Regal	2.5L L4 F/I	HPR3647
Electra	3.8L V6 F/I	HPR3916	1984 BUICK		
Estate Wagon	5.0L V8 CARB	HPR0326	Century	2.5L L4 F/I	HPR3647
LeSabre	3.8L V6 F/I	HPR3916	Century	3.0L V6 CARB	HPR0192
LeSabre	5.0L V8 CARB	HPR0326	Electra	4.1L V6 CARB	HPR0192
Reatta	3.8L V6 F/I	HPR3916	Electra	5.0L V8 CARB	HPR0326
Regal	2.8L V6 F/I	HPR6626	LeSabre	3.8L V6 CARB	HPR0192
Regal	3.1L V6 F/I	HPR6626	LeSabre	4.1L V6 CARB	HPR0192
Riviera	3.8L V6 F/I	HPR3916	LeSabre	5.0L V8 CARB	HPR0326
Skylark	2.5L L4 F/I	HPR3647	Regal	3.8L V6 CARB	HPR0192
Skylark	3.3L V6 F/I	HPR3916	Regal	4.1L V6 CARB	HPR0192
1988 BUICK			Regal	5.0L V8 CARB	HPR0326
Century	2.5L L4 F/I	HPR3647	Riviera	4.1L V6 CARB	HPR0192
Electra	3.8L V6 F/I	HPR3916	Riviera	5.0L V8 CARB	HPR0192
Estate Wagon	5.0L V8 CARB	HPR0326		5.7L V8 DSL	48026
LeSabre	3.8L V6 F/I	HPR3916			880136
LeSabre	5.0L V8 CARB	HPR0326			HPR0136
Reatta	3.8L V6 F/I	HPR3916	Skyhawk	1.8L L4 F/I	HPR3647
Riviera	3.8L V6 F/I	HPR3916	Skyhawk	2.0L L4 F/I	HPR3647
Skyhawk	2.0L L4 F/I	HPR3647	Skylark	2.5L L4 F/I	HPR3647
Skylark	2.5L L4 F/I	HPR3647	1983 BUICK		
1987 BUICK			Century	2.5L L4 F/I	HPR3647
Century	2.5L L4 F/I	HPR3647	Century	3.0L V6 CARB	HPR0192
Electra	3.8L V6 F/I	HPR3916	Electra	4.1L V6 CARB	HPR0192
Electra	5.0L V8 CARB	HPR0326	Electra	5.0L V8 CARB	HPR0326
Estate Wagon	5.0L V8 CARB	HPR0326	Estate Wagon	5.0L V8 CARB	HPR0326
LeSabre	3.8L V6 F/I	HPR3916	LeSabre	3.8L V6 CARB	HPR0192
LeSabre	5.0L V8 F/I	HPR0326	LeSabre	4.1L V6 CARB	HPR0192
Regal	3.8L V6 CARB	HPR0192	LeSabre	5.0L V8 CARB	HPR0326
Regal	5.0L V8 CARB	HPR0326	Regal	3.8L V6 2 BBL.	HPR0192
Riviera	3.8L V6 F/I	HPR3916	Regal	4.1L V6 CARB	HPR0192
Skyhawk	2.0L L4 F/I	HPR3647	Regal	5.0L V8 CARB	HPR0326
Skylark	2.5L L4 F/I	HPR3647	Riviera	4.1L V6 CARB	HPR0192
Somerset	2.5L L4 F/I	HPR3647	Riviera	5.0L V8 CARB	HPR0192
1986 BUICK				5.7L V8 DSL	48026
Century	2.5L L4 F/I	HPR3647			880136
Electra	3.8L V6 F/I	HPR3916			HPR0136
Electra	5.0L V8 CARB	HPR0326	Skyhawk	1.8L L4 F/I	HPR3647
LeSabre	3.0L V6 F/I	HPR3916	Skyhawk	2.0L L4 F/I	HPR3647
LeSabre	3.8L V6 F/I	HPR3916	Skylark	2.5L L4 F/I	HPR3647
LeSabre	5.0L V8 CARB	HPR0326	1982 BUICK		
Regal	3.8L V6 CARB	HPR0192	Century	2.5L L4 CARB	HPR3647
Regal	5.0L V8 CARB	HPR0326	Century	2.5L L4 F/I	HPR3647
Riviera	3.8L V6 F/I	HPR3916	Century	3.0L V6 CARB	HPR0192
Skyhawk	1.8L L4 F/I	HPR3647	Electra	4.1L V6 CARB	HPR0192
Skyhawk	2.0L L4 F/I	HPR3647	Electra	5.0L V8 CARB	HPR0326
Skylark	2.5L L4 F/I	HPR3647	Estate Wagon	5.0L V8 CARB	HPR0326
Somerset	2.5L L4 F/I	HPR3647	LeSabre	3.8L V6 CARB	HPR0192
			LeSabre	4.1L V6 CARB	HPR0192

*Indicates 2 filters required ♦ Intake system available - see page 326 + throttle body spacer available - see page 20

BUICK

HPR™ REPLACEMENT AIR FILTERS

Vehicle	Engine Type	Air Filter	Vehicle	Engine Type	Air Filter
1982 BUICK			1979 BUICK		
LeSabre	4.4L V8 CARB	HPR3588	Electra	403 V8 CARB	880136
LeSabre	5.0L V8 CARB	HPR0326			HPR0136
Regal	3.8L V6 2 BBL.	HPR0192	Estate Wagon	350 V8 CARB - VIN R	48026
Regal	4.1L V6 CARB	HPR0192			880136
Regal	4.4L V8 CARB	HPR3588			HPR0136
Regal	5.0L V8 CARB	HPR0326	Estate Wagon	350 V8 CARB - VIN X	HPR0326
Riviera	4.1L V6 CARB	HPR0192		403 V8 CARB	48026
Riviera	5.0L V8 CARB	HPR0192			880136
	5.7L V8 DSL	48026			HPR0136
		880136	LeSabre	231 V6 2 BBL.	HPR0192
		HPR0136	LeSabre	301 V8 CARB	HPR0192
Skyhawk	1.8L L4 CARB	HPR3647		350 V8 CARB - VIN R	48026
Skyhawk	1.8L L4 F/I	HPR3647			880136
Skylark	2.5L L4 F/I	HPR3647			HPR0136
1981 BUICK			LeSabre	350 V8 CARB - VIN X	HPR0326
Century	3.8L V6 CARB	HPR0192	Regal	196 V6 CARB	HPR0192
Century	4.4L V8 CARB	HPR3588	Regal	231 V6 CARB - VIN 2	HPR0192
Century	5.0L V8 CARB	HPR0326	Regal	231 V6 CARB - VIN A	HPR0192
Electra	4.1L V6 CARB	HPR0192	Regal	305 V8 CARB	HPR0326
Electra	5.0L V8 CARB	HPR0326	Riviera	350 V8 CARB	48026
Electra	5.7L V8 CARB	HPR0326			880136
Estate Wagon	5.0L V8 CARB	HPR0326			HPR0136
LeSabre	3.8L V6 CARB	HPR0192	Skyhawk	231 V6 CARB	HPR0192
LeSabre	4.1L V6 CARB	HPR0192	Skylark	231 V6 CARB	HPR0192
LeSabre	5.0L V8 CARB	HPR0326	Skylark	305 V8 CARB	HPR0192
Regal	3.8L V6 2 BBL.	HPR0192	Skylark	350 V8 CARB	HPR0326
Regal	4.4L V8 CARB	HPR3588	1978 BUICK		
Riviera	4.1L V6 CARB	HPR0192	Century	196 V6 CARB	HPR0192
Riviera	5.0L V8 CARB	HPR0192	Century	231 V6 CARB	HPR0192
	5.7L V8 DSL	48026	Century	305 V8 2 BBL.	HPR0192
		880136	Century	305 V8 4 BBL.	HPR0326
		HPR0136	Century	350 V8 CARB	HPR0326
1980 BUICK			Electra	350 V8 CARB - VIN R	48026
Century	231 V6 2 BBL.	HPR0192			880136
Century	301 V8 CARB	HPR0192			HPR0136
Century	305 V8 CARB	HPR0326	Electra	350 V8 CARB - VIN X	HPR0326
Electra	252 V6 CARB	HPR0192		403 V8 CARB	48026
Electra	350 V8 CARB - VIN R	HPR0326			880136
Electra	350 V8 CARB - VIN X	HPR0326			HPR0136
Estate Wagon	350 V8 CARB	HPR0326	Estate Wagon	350 V8 CARB - VIN R	48026
LeSabre	231 V6 2 BBL.	HPR0192			880136
LeSabre	252 V6 CARB	HPR0192			HPR0136
LeSabre	301 V8 CARB	HPR0192	Estate Wagon	350 V8 CARB - VIN X	HPR0326
LeSabre	350 V8 CARB - VIN R	HPR0326		403 V8 CARB	48026
LeSabre	350 V8 CARB - VIN X	HPR0326			880136
Regal	231 V6 2 BBL.	HPR0192			HPR0136
Regal	301 V8 CARB	HPR0192	LeSabre	231 V6 2 BBL.	HPR0192
Regal	305 V8 CARB	HPR0326	LeSabre	301 V8 CARB	HPR0192
Riviera	350 V8 CARB	HPR0192	LeSabre	305 V8 CARB	HPR0326
	350 V8 DSL	48026		350 V8 CARB - VIN R	48026
		HPR0136			880136
Skyhawk	231 V6 CARB	HPR0192	LeSabre	350 V8 CARB - VIN X	HPR0326
1979 BUICK				403 V8 CARB	48026
Century	196 V6 CARB	HPR0192			880136
Century	231 V6 2 BBL.	HPR0192			HPR0136
Century	301 V8 2 BBL.	HPR0192	Regal	231 V6 CARB - Exc. Turbo	HPR0192
Century	305 V8 CARB	HPR0326	Regal	305 V8 CARB	HPR0326
Century	350 V8 CARB	HPR0326	Riviera	350 V8 CARB - VIN R	48026
Electra	350 V8 CARB - VIN R	48026			880136
		880136			HPR0136
		HPR0136	Riviera	350 V8 CARB - VIN X	HPR0326
Electra	350 V8 CARB - VIN X	HPR0326		403 V8 CARB	48026
	403 V8 CARB	48026			880136

*Indicates 2 filters required ♦ Intake system available - see page 326 + throttle body spacer available - see page 20

HPR™ REPLACEMENT AIR FILTERS

BUICK

Vehicle	Engine Type	Air Filter	Vehicle	Engine Type	Air Filter
1978 BUICK			1976 BUICK		
Riviera	403 V8 CARB	HPR0136	Estate Wagon	455 V8 CARB	HPR0136
Skyhawk	231 V6 CARB - VIN 2	HPR0192	LeSabre	350 V8 CARB	HPR0192
Skylark	231 V6 CARB	HPR0192		455 V8 CARB	48026
Skylark	350 V8 CARB	HPR0326			HPR0136
1977 BUICK			Riviera	455 V8 CARB	48026
Century	231 V6 CARB	HPR0192			HPR0136
Century	305 V8 CARB	HPR0326	Skylark	260 V8 CARB	HPR0326
Century	350 V8 CARB - w/Chevrolet Eng.	HPR0192	Skylark	350 V8 CARB	HPR0192
	350 V8 CARB - w/Oldsmobile Eng.	48026	1975 BUICK		
		880136	Apollo	260 V8 CARB	HPR0326
		HPR0136	Apollo	350 V8 CARB	HPR0192
	403 V8 CARB	48026	Century	350 V8 CARB	HPR0192
		880136	Electra	455 V8 CARB	48026
		HPR0136			HPR0136
Electra	350 V8 CARB - VIN H	HPR0192	Estate Wagon	455 V8 CARB	48026
Electra	350 V8 CARB - VIN J	HPR0326			HPR0136
	350 V8 CARB - VIN R	48026	LeSabre	350 V8 CARB	HPR0192
		880136		400 V8 CARB	48026
		HPR0136			880136
	403 V8 CARB	48026		455 V8 CARB	HPR0136
		880136			48026
		HPR0136			880136
Estate Wagon	350 V8 CARB	48026	Regal	350 V8 CARB	HPR0192
		HPR0136	Riviera	455 V8 CARB	48026
	403 V8 CARB	48026			HPR0136
		HPR0136	Skylark	260 V8 CARB	HPR0326
LeSabre	231 V6 CARB	HPR0192	Skylark	350 V8 CARB	HPR0192
LeSabre	301 V8 CARB	HPR0192	1974 BUICK		
LeSabre	350 V8 CARB - VIN H	HPR0192	Apollo	350 V8 CARB - Exc. GS Series	HPR0192
LeSabre	350 V8 CARB - VIN J	HPR0192		350 V8 CARB - GS Series	48026
	350 V8 CARB - VIN R	48026			880136
		880136			HPR0136
		HPR0136	Century	350 V8 CARB - Exc. GS Series	HPR0192
	403 V8 CARB	48026		350 V8 CARB - GS Series	48026
		880136			880136
		HPR0136			HPR0136
Regal	231 V6 CARB	HPR0192	Century	455 V8 CARB - Exc. GS Series	HPR0192
Regal	305 V8 CARB	HPR0326		455 V8 CARB - GS Series	48026
Regal	350 V8 CARB - VIN H	HPR0192			880136
Regal	350 V8 CARB - VIN J	HPR0192			HPR0136
Regal	350 V8 CARB - VIN L	HPR0326	Electra	455 V8 CARB	48026
	350 V8 CARB - VIN R	48026			880136
		880136			HPR0136
		HPR0136	Estate Wagon	350 V8 CARB	48026
Riviera	350 V8 CARB - VIN J	HPR0326			880136
	350 V8 CARB - VIN R	48026		455 V8 CARB	HPR0136
		880136			48026
		HPR0136			880136
	403 V8 CARB	48026			HPR0136
		880136	LeSabre	350 V8 CARB	HPR0192
		HPR0136		455 V8 CARB	48026
Skylark	231 V6 CARB	HPR0192			880136
Skylark	301 V8 CARB	HPR0192			HPR0136
Skylark	305 V8 CARB	HPR0192			HPR0192
Skylark	350 V8 CARB - VIN L	HPR0326	Regal	350 V8 CARB - Exc. GS Series	HPR0192
	350 V8 CARB - VIN R	48026		350 V8 CARB - GS Series	48026
		880136			HPR0136
		HPR0136	Regal	455 V8 CARB - Exc. GS Series	HPR0192
1976 BUICK				455 V8 CARB - GS Series	48026
Century	350 V8 CARB	HPR0192			HPR0136
Electra	455 V8 CARB	48026	Riviera	455 V8 CARB	48026
		HPR0136			880136
Estate Wagon	455 V8 CARB	48026			HPR0136

*Indicates 2 filters required ♦ Intake system available - see page 326 + throttle body spacer available - see page 20

BUICK

HPR™ REPLACEMENT AIR FILTERS

Vehicle	Engine Type	Air Filter	Vehicle	Engine Type	Air Filter
1973 BUICK			1972 BUICK		
Apollo	350 V8 CARB	HPR0192	Skylark	455 V8 CARB	48026
Centurion	350 V8 CARB	HPR0192			880136
	455 V8 CARB	48026			HPR0136
		880136	Sportwagon	350 V8 CARB - Exc. GS Series	HPR0192
		HPR0136	350 V8 CARB - GS Series	48026	
Century	350 V8 CARB - Exc. GS Series	HPR0192			HPR0136
	350 V8 CARB - GS Series	48026	Centurion	455 V8 CARB	48026
		HPR0136			880136
Century	455 V8 CARB - Exc. GS Series	HPR0192			HPR0136
	455 V8 CARB - GS Series	48026	Electra	455 V8 CARB	48026
		880136			880136
		HPR0136			HPR0136
Electra	455 V8 CARB	48026	Estate Wagon	455 V8 CARB	48026
		880136			880136
		HPR0136			HPR0136
Estate Wagon	350 V8 CARB - Exc. GS Series	HPR0192	GS	350 V8 CARB	HPR0192
	350 V8 CARB - GS Series	48026	GS 455	455 V8 CARB	48026
		HPR0136			HPR0136
	455 V8 CARB	48026	LeSabre	350 V8 CARB	HPR0192
		880136		455 V8 CARB	48026
		HPR0136			880136
LeSabre	350 V8 CARB - Exc. GS Series	HPR0192			HPR0136
	350 V8 CARB - GS Series	48026	Riviera	455 V8 CARB	48026
		HPR0136			880136
	455 V8 CARB	48026			HPR0136
		880136	Skylark	350 V8 CARB	HPR0192
		HPR0136		455 V8 CARB	48026
Regal	350 V8 CARB - Exc. GS Series	HPR0192			880136
	350 V8 CARB - GS Series	48026			HPR0136
		HPR0136	Skylark Custom	350 V8 CARB	HPR0192
Regal	455 V8 CARB - Exc. GS Series	HPR0192	Sportwagon	350 V8 CARB - Exc. GS Series	HPR0192
	455 V8 CARB - GS Series	48026		350 V8 CARB - GS Series	48026
		HPR0136			880136
		48026			HPR0136
		880136	Electra	455 V8 CARB	48026
		HPR0136			HPR0136
Riviera	455 V8 CARB	48026	Estate Wagon	350 V8 CARB	HPR0192
		880136		455 V8 CARB	48026
		HPR0136			880136
					HPR0136
1972 BUICK			GS	350 V8 CARB	48026
Centurion	350 V8 CARB	HPR0192			HPR0136
	455 V8 CARB	48026	GS 455	455 V8 CARB	48026
		880136			HPR0136
		HPR0136	LeSabre	350 V8 CARB	HPR0192
Electra	455 V8 CARB	48026		455 V8 CARB	48026
		880136			880136
		HPR0136			HPR0136
Estate Wagon	350 V8 CARB - Exc. GS Series	HPR0192	Riviera	455 V8 CARB	48026
	350 V8 CARB - GS Series	48026			HPR0136
		HPR0136			HPR0136
	455 V8 CARB	48026	Skylark	350 V8 CARB - Exc. GS Series	HPR0192
		880136		350 V8 CARB - GS Series	48026
		HPR0136			880136
GS	350 V8 CARB	HPR0192			HPR0136
GS 455	455 V8 CARB	48026			HPR0136
		880136			HPR0136
		HPR0136			HPR0136
LeSabre	350 V8 CARB - Exc. GS Series	HPR0192		455 V8 CARB	48026
	350 V8 CARB - GS Series	48026			880136
		HPR0136			HPR0136
	455 V8 CARB	48026	Sportwagon	350 V8 CARB - Exc. GS Series	HPR0192
		880136		350 V8 CARB - GS Series	48026
		HPR0136			HPR0136
		48026			HPR0136
		880136			HPR0136
		HPR0136			HPR0136
Riviera	455 V8 CARB	48026		455 V8 CARB	48026
		880136			HPR0136
		HPR0136	Wildcat	455 V8 CARB	48026
		48026			
		880136			
		HPR0136			
Skylark	350 V8 CARB	HPR0192			

*Indicates 2 filters required ♦ Intake system available - see page 326 + throttle body spacer available - see page 20

HPR™ REPLACEMENT AIR FILTERS

BUICK

Vehicle	Engine Type	Air Filter
1970 BUICK		
Wildcat	455 V8 CARB	HPR0136
1969 BUICK		
Electra	430 V8 CARB	HPR0192
GS 350	350 V8 2 BBL.	HPR0192
	350 V8 4 BBL.	48026
		HPR0136
GS 400	400 V8 CARB	HPR0192
LeSabre	350 V8 CARB	HPR0192
Riviera	430 V8 CARB	HPR0192
Skylark	350 V8 CARB	HPR0192
Special	350 V8 CARB	HPR0192
Sportwagon	350 V8 CARB	HPR0192
Wildcat	430 V8 CARB	HPR0192
Electra	430 V8 CARB	48026
		HPR0136
GS 350	350 V8 4 BBL.	48026
		HPR0136
GS 400	400 V8 CARB	48026
		HPR0136
LeSabre	350 V8 2 BBL.	48026
	350 V8 4 BBL.	880136
		48026
		880136
		HPR0136
	350 V8 CARB - 4 BBL	48026
		880136
		HPR0136
	430 V8 CARB	48026
		HPR0136
Riviera	430 V8 CARB	48026
		HPR0136
Skylark	350 V8 2 BBL.	48026
		880136
	350 V8 4 BBL.	48026
		880136
		HPR0136
	350 V8 CARB - 4 BBL	48026
		880136
		HPR0136
	400 V8 CARB	48026
		880136
		HPR0136
Special	350 V8 2 BBL.	48026
		880136
	350 V8 4 BBL.	48026
		880136
		HPR0136
Sportwagon	400 V8 CARB	48026
		HPR0136
Wildcat	430 V8 CARB	48026
		HPR0136

2016 CADILLAC		
Escalade	6.2L V8 F/I	HPR8755
Escalade ESV	6.2L V8 F/I	HPR8755

2015 CADILLAC		
Escalade	6.2L V8 F/I	HPR8755 ♦
Escalade ESV	6.2L V8 F/I	HPR8755 ♦

2014 CADILLAC		
Escalade	6.2L V8 F/I	HPR8755 ♦
Escalade ESV	6.2L V8 F/I	HPR8755 ♦

Vehicle	Engine Type	Air Filter
2013 CADILLAC		
Escalade	6.0L V8 F/I	HPR8755 +
Escalade	6.2L V8 F/I	HPR8755 ♦♦
Escalade ESV	6.2L V8 F/I	HPR8755 ♦♦
Escalade EXT	6.2L V8 F/I	HPR8755 ♦♦

2012 CADILLAC		
Escalade	6.0L V8 F/I	HPR8755 +
Escalade	6.2L V8 F/I	HPR8755 ♦♦
Escalade ESV	6.2L V8 F/I	HPR8755 ♦♦
Escalade EXT	6.2L V8 F/I	HPR8755 ♦♦

2011 CADILLAC		
DTS	4.6L V8 F/I	HPR9492
Escalade	6.0L V8 F/I	HPR8755 +
Escalade	6.2L V8 F/I	HPR8755 ♦♦
Escalade ESV	6.2L V8 F/I	HPR8755 ♦♦
Escalade EXT	6.2L V8 F/I	HPR8755 ♦♦

2010 CADILLAC		
DTS	4.6L V8 F/I	HPR9492
Escalade	6.0L V8 F/I	HPR8755 +
Escalade	6.2L V8 F/I	HPR8755 ♦♦
Escalade ESV	6.2L V8 F/I	HPR8755 ♦♦
Escalade EXT	6.2L V8 F/I	HPR8755 ♦♦

2009 CADILLAC		
DTS	4.6L V8 F/I	HPR9492
Escalade	6.0L V8 F/I	HPR8755 +
Escalade	6.2L V8 F/I	HPR8755 ♦♦
Escalade ESV	6.2L V8 F/I	HPR8755 ♦♦
Escalade EXT	6.2L V8 F/I	HPR8755 ♦♦

2008 CADILLAC		
DTS	4.6L V8 F/I	HPR9492
Escalade	6.2L V8 F/I	HPR8755 ♦♦
Escalade ESV	6.2L V8 F/I	HPR8755 ♦♦
Escalade EXT	6.2L V8 F/I	HPR8755 ♦♦

2007 CADILLAC		
DTS	4.6L V8 F/I	HPR9492
Escalade	6.2L V8 F/I	HPR8755 ♦♦
Escalade ESV	6.2L V8 F/I	HPR8755 ♦♦
Escalade EXT	6.2L V8 F/I	HPR8755 ♦♦

2006 CADILLAC		
DTS	4.6L V8 F/I	HPR9492
Escalade	6.0L V8 F/I	HPR8755 ♦♦
Escalade ESV	6.0L V8 F/I	HPR8755 ♦♦
Escalade EXT	6.0L V8 F/I	HPR8755 ♦♦

2005 CADILLAC		
DeVille	4.6L V8 F/I	HPR7597
Escalade	5.3L V8 F/I	HPR8755 ♦♦
Escalade	6.0L V8 F/I	HPR8755 ♦♦
Escalade ESV	6.0L V8 F/I	HPR8755 ♦♦
Escalade EXT	6.0L V8 F/I	HPR8755 ♦♦

2004 CADILLAC		
DeVille	4.6L V8 F/I	HPR7597
Escalade	5.3L V8 F/I	HPR8755 ♦♦
Escalade	6.0L V8 F/I	HPR8755 ♦♦
Escalade ESV	6.0L V8 F/I	HPR8755 ♦♦
Escalade EXT	6.0L V8 F/I	HPR8755 ♦♦
Seville	4.6L V8 F/I	HPR7597
XLR	4.6L V8 F/I	HPR7597

2003 CADILLAC		
DeVille	4.6L V8 F/I	HPR7597
Escalade	5.3L V8 F/I	HPR8755 ♦♦

*Indicates 2 filters required ♦ Intake system available - see page 326 + throttle body spacer available - see page 20

CADILLAC

HPR™ REPLACEMENT AIR FILTERS

Vehicle	Engine Type	Air Filter	Vehicle	Engine Type	Air Filter
2003 CADILLAC			1992 CADILLAC		
Escalade	6.0L V8 F/I	HPR8755 ♦+	Allante	4.5L V8 F/I	HPR6626
Escalade ESV	6.0L V8 F/I	HPR8755 ♦+	Brougham	5.0L V8 F/I	HPR0326
Escalade EXT	6.0L V8 F/I	HPR8755 ♦+	Brougham	5.7L V8 F/I	HPR0326
Seville	4.6L V8 F/I	HPR7597	Commercial Chassis	5.7L V8 F/I	HPR0326
2002 CADILLAC			DeVille	4.9L V8 F/I	HPR6479
DeVille	4.6L V8 F/I	HPR7597	Eldorado	4.9L V8 F/I	HPR6479
Eldorado	4.6L V8 F/I	HPR6479	Fleetwood	4.9L V8 F/I	HPR6479
Escalade	5.3L V8 F/I	HPR8755 ♦+	Seville	4.9L V8 F/I	HPR6479
Escalade	6.0L V8 F/I	HPR8755 ♦+	1991 CADILLAC		
Seville	4.6L V8 F/I	HPR7597	Allante	4.5L V8 F/I	HPR6626
2001 CADILLAC			Brougham	5.0L V8 F/I	HPR0326
DeVille	4.6L V8 F/I	HPR7597	Brougham	5.7L V8 F/I	HPR0326
Eldorado	4.6L V8 F/I	HPR6479	Commercial Chassis	4.9L V8 F/I	HPR6479
Seville	4.6L V8 F/I	HPR7597	DeVille	4.9L V8 F/I	HPR6479
2000 CADILLAC			Eldorado	4.9L V8 F/I	HPR6479
DeVille	4.6L V8 F/I	HPR7597	Fleetwood	4.9L V8 F/I	HPR6479
Eldorado	4.6L V8 F/I	HPR6479	Seville	4.9L V8 F/I	HPR6479
Escalade	5.7L V8 F/I	HPR8038 +	1990 CADILLAC		
Seville	4.6L V8 F/I	HPR7597	Allante	4.5L V8 F/I	HPR6626
1999 CADILLAC			Brougham	5.0L V8 CARB	HPR0326
DeVille	4.6L V8 F/I	HPR6479	Brougham	5.7L V8 F/I	HPR0326
Eldorado	4.6L V8 F/I	HPR6479	Commercial Chassis	4.5L V8 F/I	HPR6479
Escalade	5.7L V8 F/I	HPR8038 +	DeVille	4.5L V8 F/I	HPR6479
Seville	4.6L V8 F/I	HPR7597	Eldorado	4.5L V8 F/I	HPR6479
1998 CADILLAC			Fleetwood	4.5L V8 F/I	HPR6479
DeVille	4.6L V8 F/I	HPR6479	Seville	4.5L V8 F/I	HPR6479
Eldorado	4.6L V8 F/I	HPR6479	1989 CADILLAC		
Seville	4.6L V8 F/I	HPR7597	Allante	4.5L V8 F/I	HPR6626
1997 CADILLAC			Brougham	5.0L V8 CARB	HPR0326
DeVille	4.6L V8 F/I	HPR6479	Commercial Chassis	4.5L V8 F/I	HPR6479
Eldorado	4.6L V8 F/I	HPR6479	DeVille	4.5L V8 F/I	HPR6479
Seville	4.6L V8 F/I	HPR6479	Eldorado	4.5L V8 F/I	HPR6479
1996 CADILLAC			Fleetwood	4.5L V8 F/I	HPR6479
DeVille	4.6L V8 F/I	HPR6479	Seville	4.5L V8 F/I	HPR6479
Eldorado	4.6L V8 F/I	HPR6479	1988 CADILLAC		
Fleetwood	5.7L V8 F/I	HPR6479	Brougham	5.0L V8 CARB	HPR0326
Seville	4.6L V8 F/I	HPR6479	Commercial Chassis	4.5L V8 F/I	HPR6479
1995 CADILLAC			DeVille	4.5L V8 F/I	HPR6479
DeVille	4.6L V8 F/I	HPR6479	Eldorado	4.5L V8 F/I	HPR6479
DeVille	4.9L V8 F/I	HPR6479	Fleetwood	4.5L V8 F/I	HPR6479
Eldorado	4.6L V8 F/I	HPR6479	Seville	4.5L V8 F/I	HPR6479
Fleetwood	5.7L V8 F/I	HPR6479	1987 CADILLAC		
Seville	4.6L V8 F/I	HPR6479	Brougham	5.0L V8 CARB	HPR0326
1994 CADILLAC			Commercial Chassis	4.1L V8 F/I	HPR3588
DeVille	4.6L V8 F/I	HPR6479	DeVille	4.1L V8 F/I	HPR3588
DeVille	4.9L V8 F/I	HPR6479	Fleetwood	4.1L V8 F/I	HPR3588
Eldorado	4.6L V8 F/I	HPR6479	1986 CADILLAC		
Fleetwood	5.7L V8 F/I	HPR6479	Cimarron	2.0L L4 F/I	HPR3647
Seville	4.6L V8 F/I	HPR6479	Commercial Chassis	4.1L V8 F/I	HPR3588
1993 CADILLAC			DeVille	4.1L V8 F/I	HPR3588
Allante	4.6L V8 F/I	HPR6479	Fleetwood	4.1L V8 F/I	HPR3588
Commercial Chassis	5.7L V8 F/I	HPR0326	Fleetwood	5.0L V8 CARB	HPR0326
DeVille	4.9L V8 F/I	HPR6479	1985 CADILLAC		
Eldorado	4.6L V8 F/I	HPR6479	Cimarron	2.0L L4 F/I	HPR3647
Eldorado	4.9L V8 F/I	HPR6479	Commercial Chassis	4.1L V8 F/I	HPR3588
Fleetwood	5.7L V8 F/I	HPR0326	DeVille	4.1L V8 F/I	HPR3588
Seville	4.6L V8 F/I	HPR6479	Eldorado	4.1L V8 F/I	HPR0192
Seville	4.9L V8 F/I	HPR6479		5.7L V8 DSL	48026
					880136
					HPR0136
			Fleetwood	4.1L V8 F/I - FWD	HPR3588

*Indicates 2 filters required ♦ Intake system available - see page 326 + throttle body spacer available - see page 20

HPR™ REPLACEMENT AIR FILTERS

CADILLAC

Vehicle	Engine Type	Air Filter	Vehicle	Engine Type	Air Filter
1985 CADILLAC			1981 CADILLAC		
Fleetwood	4.1L V8 F/I - RWD	HPR0192	Seville	5.7L V8 DSL	HPR0136
Seville	4.1L V8 F/I	HPR0192	Seville	6.0L V8 F/I	HPR0192
	5.7L V8 DSL	48026	1980 CADILLAC		
		880136	DeVille	252 V6 CARB	HPR0192
		HPR0136	DeVille	368 V8 CARB	HPR0326
1984 CADILLAC			Eldorado	350 V8 DSL	48026
Cimarron	2.0L L4 F/I	HPR3647			880136
DeVille	4.1L V8 F/I	HPR0192			HPR0136
Eldorado	4.1L V8 F/I	HPR0192	Eldorado	350 V8 F/I	HPR0192
	5.7L V8 DSL	48026	Eldorado	368 V8 F/I	HPR0192
		880136	Fleetwood	252 V6 CARB	HPR0192
		HPR0136	Fleetwood	368 V8 CARB	HPR0326
Fleetwood	4.1L V8 F/I	HPR0192	Seville	350 V8 DSL	48026
Fleetwood	6.0L V8 F/I	HPR0326			880136
Seville	4.1L V8 F/I	HPR0192			HPR0136
	5.7L V8 DSL	48026	Seville	350 V8 F/I	HPR0192
		880136	Seville	368 V8 F/I	HPR0192
		HPR0136	Eldorado	350 V8 DSL	48026
1983 CADILLAC					HPR0136
Cimarron	2.0L L4 F/I	HPR3647		5.7L V8 F/I	48026
Commercial Chassis	368 V8 CARB	HPR0326			HPR0136
DeVille	4.1L V8 F/I	HPR0192	Seville	5.7L V8 F/I	48026
Eldorado	4.1L V8 F/I	HPR0192			880136
	5.7L V8 DSL	48026			HPR0136
		880136			48026
		HPR0136			880136
Fleetwood	4.1L V8 F/I	HPR0192			HPR0136
Seville	4.1L V8 F/I	HPR0192			48026
	5.7L V8 DSL	48026			HPR0136
		880136			48026
		HPR0136			HPR0136
1982 CADILLAC			2017 CHEVROLET		
DeVille	4.1L V6 CARB	HPR0192	Silverado 1500	4.3L V6 F/I	HPR8755
DeVille	4.1L V8 F/I	HPR0192	Silverado 1500	5.3L V8 F/I	HPR8755
Eldorado	4.1L V6 CARB	HPR0192	Silverado 1500	6.2L V8 F/I	HPR8755
Eldorado	4.1L V8 TBI	HPR0192	2016 CHEVROLET		
	5.7L V8 DSL	48026	Silverado 1500	4.3L V6 F/I	HPR8755
		880136	Silverado 1500	5.3L V8 F/I	HPR8755
		HPR0136	Silverado 1500	6.2L V8 F/I	HPR8755
Fleetwood	4.1L V6 CARB	HPR0192	Silverado 2500 HD	6.0L V8 F/I	HPR8755 ♦
Fleetwood	4.1L V8 F/I	HPR0192	Silverado 3500 HD	6.0L V8 F/I	HPR8755 ♦
Fleetwood	6.0L V8 CARB	HPR0192	Suburban	5.3L V8 F/I	HPR8755
Fleetwood	6.0L V8 F/I	HPR0192	Tahoe	5.3L V8 F/I	HPR8755
Seville	4.1L V6 CARB	HPR0192	2015 CHEVROLET		
Seville	4.1L V8 F/I	HPR0192	Camaro	3.6L V6 F/I	HPR10690 ♦
	5.7L V8 DSL	48026	Camaro SS	6.2L V8 F/I	HPR10690 ♦
		880136	Camaro ZL1	6.2L V8 F/I	HPR10690
		HPR0136	Silverado 1500	4.3L V6 F/I	HPR8755
1981 CADILLAC			Silverado 1500	5.3L V8 F/I	HPR8755 ♦
Commercial Chassis	6.0L V8 CARB	HPR0326	Silverado 1500	6.2L V8 F/I	HPR8755 ♦
DeVille	4.1L V6 CARB	HPR0192	Silverado 2500 HD	6.0L V8 F/I	HPR8755 ♦
DeVille	6.0L V8 F/I	HPR0192	Silverado 3500 HD	6.0L V8 F/I	HPR8755 ♦
Eldorado	4.1L V6 CARB	HPR0192	Suburban	5.3L V8 F/I	HPR8755 ♦
	5.7L V8 DSL	48026	Tahoe	5.3L V8 F/I	HPR8755 ♦
		880136	2014 CHEVROLET		
		HPR0136	Camaro	3.6L V6 F/I	HPR10690 ♦
Eldorado	6.0L V8 F/I	HPR0192	Camaro SS	6.2L V8 F/I	HPR10690 ♦
Fleetwood	4.1L V6 CARB	HPR0192	Camaro ZL1	6.2L V8 F/I	HPR10690
Fleetwood	6.0L V8 F/I	HPR0192	Silverado 1500	4.3L V6 F/I	HPR8755 ♦
Seville	4.1L V6 CARB	HPR0192	Silverado 1500	5.3L V8 F/I	HPR8755 ♦
	5.7L V8 DSL	48026	Silverado 1500	6.2L V8 F/I	HPR8755 ♦
		880136			

*Indicates 2 filters required ♦ Intake system available - see page 326 + throttle body spacer available - see page 20

CHEVROLET HPR™ REPLACEMENT AIR FILTERS

Vehicle	Engine Type	Air Filter	Vehicle	Engine Type	Air Filter
2014 CHEVROLET			2010 CHEVROLET		
Silverado 2500 HD	6.0L V8 F/I	HPR8755 ♦	Cobalt	2.0L L4 F/I	HPR9969
Silverado 3500 HD	6.0L V8 F/I	HPR8755 ♦	Cobalt	2.2L L4 F/I	HPR9969
Suburban 1500	5.3L V8 F/I	HPR8755 ♦	Impala	3.5L V6 F/I	HPR10014
Tahoe	5.3L V8 F/I	HPR8755 ♦	Impala	3.9L V6 F/I	HPR10014
Tahoe Hybrid	6.0L V8 F/I	HPR8755	Malibu	2.4L L4 F/I	HPR9492
2013 CHEVROLET			Malibu	3.5L V6 F/I	HPR10014
Avalanche	5.3L V8 F/I	HPR8755 ♦	Malibu	3.6L V6 F/I	HPR9492
Camaro	3.6L V6 F/I	HPR10690 ♦	Silverado 1500	4.3L V6 F/I	HPR8755
Camaro SS	6.2L V8 F/I	HPR10690 ♦	Silverado 1500	4.8L V8 F/I	HPR8755 ♦+
Camaro ZL1	6.2L V8 F/I	HPR10690	Silverado 1500	5.3L V8 F/I	HPR8755 ♦+
Silverado 1500	4.3L V6 F/I	HPR8755	Silverado 1500	6.2L V8 F/I	HPR8755 ♦+
Silverado 1500	4.8L V8 F/I	HPR8755 ♦+	Silverado 1500 Hybrid	6.0L V8 F/I	HPR8755 +
Silverado 1500	5.3L V8 F/I	HPR8755 ♦+	Silverado 2500 HD	6.0L V8 F/I	HPR8755 +
Silverado 1500	6.2L V8 F/I	HPR8755 ♦+	Silverado 3500 HD	6.0L V8 F/I	HPR8755 +
Silverado 1500 Hybrid	6.0L V8 F/I	HPR8755 +	Suburban 1500	5.3L V8 F/I	HPR8755 ♦+
Silverado 2500 HD	6.0L V8 F/I	HPR8755 ♦	Suburban 2500	6.0L V8 F/I	HPR8755 ♦+
Silverado 3500 HD	6.0L V8 F/I	HPR8755 ♦+	Tahoe	5.3L V8 F/I	HPR8755 ♦+
Suburban 1500	5.3L V8 F/I	HPR8755 ♦+	Tahoe Hybrid	6.0L V8 F/I	HPR8755 +
Suburban 2500	6.0L V8 F/I	HPR8755 +	2009 CHEVROLET		
Tahoe	5.3L V8 F/I	HPR8755 ♦+	Avalanche	5.3L V8 F/I	HPR8755 ♦+
Tahoe Hybrid	6.0L V8 F/I	HPR8755 +	Avalanche	6.0L V8 F/I	HPR8755 ♦+
2012 CHEVROLET			Cobalt	2.0L L4 F/I	HPR9969
Avalanche	5.3L V8 F/I	HPR8755 ♦+	Cobalt	2.2L L4 F/I	HPR9969
Camaro	3.6L V6 F/I	HPR10690 ♦	Equinox	3.4L V6 F/I	HPR9492
Camaro SS	6.2L V8 F/I	HPR10690 ♦	Equinox	3.6L V6 F/I	HPR9492
Camaro ZL1	6.2L V8 F/I	HPR10690	Impala	3.5L V6 F/I	HPR10014
Malibu	2.4L L4 F/I	HPR9492	Impala	3.9L V6 F/I	HPR10014
Malibu	3.6L V6 F/I	HPR9492	Impala	5.3L V8 F/I	HPR10014
Silverado 1500	4.3L V6 F/I	HPR8755	Malibu	2.4L L4 F/I	HPR9492
Silverado 1500	4.8L V8 F/I	HPR8755 ♦+	Malibu	3.5L V6 F/I	HPR9492
Silverado 1500	5.3L V8 F/I	HPR8755 ♦+	Malibu	3.6L V6 F/I	HPR9492
Silverado 1500	6.2L V8 F/I	HPR8755 ♦+	Silverado 1500	4.3L V6 F/I	HPR8755
Silverado 1500 Hybrid	6.0L V8 F/I	HPR8755 +	Silverado 1500	4.8L V8 F/I	HPR8755 ♦+
Silverado 2500 HD	6.0L V8 F/I	HPR8755 ♦+	Silverado 1500	5.3L V8 F/I	HPR8755 ♦+
Silverado 3500 HD	6.0L V8 F/I	HPR8755 ♦+	Silverado 1500	6.0L V8 F/I	HPR8755 ♦+
Suburban 1500	5.3L V8 F/I	HPR8755 ♦+	Silverado 1500	6.2L V8 F/I	HPR8755 ♦+
Suburban 2500	6.0L V8 F/I	HPR8755 ♦+	Silverado 1500 Hybrid	6.0L V8 F/I	HPR8755
Tahoe	5.3L V8 F/I	HPR8755 ♦+	Silverado 2500 HD	6.0L V8 F/I	HPR8755 +
Tahoe Hybrid	6.0L V8 F/I	HPR8755 +	Silverado 3500 HD	6.0L V8 F/I	HPR8755 +
2011 CHEVROLET			Suburban 1500	5.3L V8 F/I	HPR8755 ♦+
Avalanche	5.3L V8 F/I	HPR8755 ♦+	Suburban 1500	6.0L V8 F/I	HPR8755 ♦+
Camaro	3.6L V6 F/I	HPR10690 ♦	Suburban 2500	6.0L V8 F/I	HPR8755 +
Camaro SS	6.2L V8 F/I	HPR10690 ♦	Tahoe	4.8L V8 F/I	HPR8755 ♦+
Impala	3.5L V6 F/I	HPR10014	Tahoe	5.3L V8 F/I	HPR8755 ♦+
Impala	3.9L V6 F/I	HPR10014	Tahoe	6.2L V8 F/I	HPR8755 ♦+
Malibu	2.4L L4 F/I	HPR9492	Tahoe Hybrid	6.0L V8 F/I	HPR8755 +
Malibu	3.6L V6 F/I	HPR9492	TrailBlazer	4.2L L6 F/I	HPR9345
Silverado 1500	4.3L V6 F/I	HPR8755	TrailBlazer	5.3L V8 F/I	HPR9345
Silverado 1500	4.8L V8 F/I	HPR8755 ♦+	TrailBlazer	6.0L V8 F/I	HPR9345
Silverado 1500	5.3L V8 F/I	HPR8755 ♦+	Uplander	3.9L V6 F/I	HPR7597
Silverado 1500	6.2L V8 F/I	HPR8755 ♦+	2008 CHEVROLET		
Silverado 1500 Hybrid	6.0L V8 F/I	HPR8755 +	Avalanche	5.3L V8 F/I	HPR8755 ♦+
Silverado 2500 HD	6.0L V8 F/I	HPR8755 ♦+	Avalanche	6.0L V8 F/I	HPR8755 ♦+
Silverado 3500 HD	6.0L V8 F/I	HPR8755 ♦+	Cobalt	2.0L L4 F/I	HPR9969
Suburban 1500	5.3L V8 F/I	HPR8755 ♦+	Cobalt	2.2L L4 F/I	HPR9969
Suburban 2500	6.0L V8 F/I	HPR8755 ♦+	Cobalt	2.4L L4 F/I	HPR9969
Tahoe	5.3L V8 F/I	HPR8755 ♦+	Equinox	3.4L V6 F/I	HPR9492
Tahoe Hybrid	6.0L V8 F/I	HPR8755 +	Equinox	3.6L V6 F/I	HPR9492
2010 CHEVROLET			Impala	3.5L V6 F/I	HPR10014
Avalanche	5.3L V8 F/I	HPR8755 ♦+	Impala	3.9L V6 F/I	HPR10014
Camaro	3.6L V6 F/I	HPR10690 ♦	Impala	5.3L V8 F/I	HPR10014
Camaro SS	6.2L V8 F/I	HPR10690 ♦	Malibu	2.2L L4 F/I	HPR7597
*Indicates 2 filters required ♦ Intake system available - see page 326 + throttle body spacer available - see page 20					

HPR™ REPLACEMENT AIR FILTERS CHEVROLET

Vehicle	Engine Type	Air Filter	Vehicle	Engine Type	Air Filter
2008 CHEVROLET			2007 CHEVROLET		
Malibu	3.6L V6 F/I	HPR9492	TrailBlazer	4.2L L6 F/I	HPR9345
Silverado 1500	4.3L V6 F/I	HPR8755	TrailBlazer	5.3L V8 F/I	HPR9345
Silverado 1500	4.8L V8 F/I	HPR8755 ♦+	TrailBlazer	6.0L V8 F/I	HPR9345 ♦
Silverado 1500	5.3L V8 F/I	HPR8755 ♦+	Uplander	3.9L V6 F/I	HPR7597
Silverado 1500	6.0L V8 F/I	HPR8755 ♦+	2006 CHEVROLET		
Silverado 2500 HD	6.0L V8 F/I	HPR8755 +	Avalanche 1500	5.3L V8 F/I	HPR8755 ♦+
Silverado 3500 HD	6.0L V8 F/I	HPR8755 +	Avalanche 2500	8.1L V8 F/I	HPR8755 +
Suburban 1500	5.3L V8 F/I	HPR8755 ♦+	Blazer	4.3L V6 F/I	HPR7421
Suburban 1500	6.0L V8 F/I	HPR8755 ♦+	Camaro	3.8L V6 F/I	HPR3914
Suburban 2500	6.0L V8 F/I	HPR8755 +	Camaro	5.7L V8 F/I	HPR3914
Tahoe	4.8L V8 F/I	HPR8755 ♦+	Cobalt	2.2L L4 F/I	HPR9969
Tahoe	5.3L V8 F/I	HPR8755 ♦+	Cobalt	2.4L L4 F/I	HPR9969
Tahoe Hybrid	6.0L V8 F/I	HPR8755 ♦+	Colorado	2.8L L4 F/I	HPR9778
TrailBlazer	4.2L L6 F/I	HPR9345	Colorado	3.5L L5 F/I	HPR9778
TrailBlazer	5.3L V8 F/I	HPR9345	Equinox	3.4L V6 F/I	HPR9492
TrailBlazer	6.0L V8 F/I	HPR9345	Impala	3.5L V6 F/I	HPR10014
Uplander	3.9L V6 F/I	HPR7597	Impala	3.9L V6 F/I	HPR10014
2007 CHEVROLET			Impala	5.3L V8 F/I	HPR10014
Avalanche	5.3L V8 F/I	HPR8755 ♦+	Malibu	2.2L L4 F/I	HPR7597
Avalanche	6.0L V8 F/I	HPR8755 ♦+	Malibu	3.5L V6 F/I	HPR7597
Blazer	4.3L V6 F/I	HPR7421	Monte Carlo	3.5L V6 F/I	HPR10014
Camaro	3.8L V6 F/I	HPR3914	Monte Carlo	3.9L V6 F/I	HPR10014
Camaro	5.7L V8 F/I	HPR3914	Monte Carlo	5.3L V8 F/I	HPR10014
Cobalt	2.2L L4 F/I	HPR9969	Silverado 1500	4.3L V6 F/I	HPR8755
Cobalt	2.4L L4 F/I	HPR9969	Silverado 1500	4.8L V8 F/I	HPR8755 ♦+
Colorado	2.9L L4 F/I	HPR9778	Silverado 1500	5.3L V8 F/I	HPR8755 ♦+
Colorado	3.7L L5 F/I	HPR9778	Silverado 1500	6.0L V8 F/I	HPR8755 ♦+
Equinox	3.4L V6 F/I	HPR9492	Silverado 1500 HD	6.0L V8 F/I	HPR8755 ♦+
Impala	3.5L V6 F/I	HPR10014	Silverado 2500 HD	6.0L V8 F/I	HPR8755 ♦+
Impala	3.9L V6 F/I	HPR10014	Silverado 2500 HD	8.1L V8 F/I	HPR8755
Impala	5.3L V8 F/I	HPR10014	Silverado 3500	6.0L V8 F/I	HPR8755 ♦+
Malibu	2.2L L4 F/I	HPR7597	Silverado 3500	8.1L V8 F/I	HPR8755 +
Monte Carlo	3.5L V6 F/I	HPR10014	Silverado SS	6.0L V8 F/I	HPR8755 ♦
Monte Carlo	5.3L V8 F/I	HPR10014	SSR	6.0L V8 F/I	HPR3914
Silverado 1500	4.3L V6 F/I	HPR8755	Suburban 1500	5.3L V8 F/I	HPR8755 ♦+
Silverado 1500	4.8L V8 F/I	HPR8755 ♦+	Suburban 1500	6.0L V8 F/I	HPR8755 ♦+
Silverado 1500	5.3L V8 F/I	HPR8755 ♦+	Suburban 2500	6.0L V8 F/I	HPR8755 ♦+
Silverado 1500	6.0L V8 F/I	HPR8755 ♦+	Suburban 2500	8.1L V8 F/I	HPR8755 +
Silverado 1500	4.3L V6 F/I	HPR8755	Tahoe	4.8L V8 F/I	HPR8755 ♦+
Classic			Tahoe	5.3L V8 F/I	HPR8755 ♦+
Silverado 1500	4.8L V8 F/I	HPR8755 ♦+	TrailBlazer	4.2L L6 F/I	HPR9345
Classic			TrailBlazer	5.3L V8 F/I	HPR9345
Silverado 1500	5.3L V8 F/I	HPR8755 ♦+	TrailBlazer	6.0L V8 F/I	HPR9345 ♦
Classic			Uplander	3.5L V6 F/I	HPR7597
Silverado 1500	6.0L V8 F/I	HPR8755 ♦+	Uplander	3.9L V6 F/I	HPR7597
Classic			2005 CHEVROLET		
Silverado 1500 HD	6.0L V8 F/I	HPR8755 ♦+	Astro	4.3L V6 F/I	HPR7421
Classic			Avalanche 1500	5.3L V8 F/I	HPR8755 ♦+
Silverado 2500 HD	6.0L V8 F/I	HPR8755 +	Avalanche 2500	8.1L V8 F/I	HPR8755 +
Silverado 2500 HD	6.0L V8 F/I	HPR8755 ♦+	Blazer	4.3L V6 F/I	HPR7421
Classic			Camaro	3.8L V6 F/I	HPR3914
Silverado 2500 HD	8.1L V8 F/I	HPR8755	Camaro	5.7L V8 F/I	HPR3914
Classic			Cavalier	2.2L L4 F/I	HPR3916
Silverado 3500	6.0L V8 F/I	HPR8755 ♦+	Classic	2.2L L4 F/I	HPR8221
Classic			Cobalt	2.2L L4 F/I	HPR9969
Silverado 3500	8.1L V8 F/I	HPR8755	Cobalt	2.4L L4 F/I	HPR9969
Classic			Colorado	2.8L L4 F/I	HPR9778
Silverado 3500 HD	6.0L V8 F/I	HPR8755 +	Colorado	3.5L L5 F/I	HPR9778
Silverado SS	6.0L V8 F/I	HPR8755 ♦+	Equinox	3.4L V6 F/I	HPR9492
Silverado SS Classic	6.0L V8 F/I	HPR8755 ♦+	Impala	3.4L V6 F/I	HPR6479
Suburban 1500	5.3L V8 F/I	HPR8755 ♦+	Impala	3.8L V6 F/I	HPR6479
Suburban 1500	6.0L V8 F/I	HPR8755 ♦+	Malibu	2.2L L4 F/I	HPR7597
Suburban 2500	6.0L V8 F/I	HPR8755 +	Malibu	3.5L V6 F/I	HPR7597
Tahoe	4.8L V8 F/I	HPR8755 ♦+			
Tahoe	5.3L V8 F/I	HPR8755 ♦+			

*Indicates 2 filters required ♦ Intake system available - see page 326 + throttle body spacer available - see page 20

CHEVROLET HPR™ REPLACEMENT AIR FILTERS

Vehicle	Engine Type	Air Filter	Vehicle	Engine Type	Air Filter
2005 CHEVROLET			2004 CHEVROLET		
Monte Carlo	3.4L V6 F/I	HPR6479	Venture	3.4L V6 F/I	HPR7597
Monte Carlo	3.8L V6 F/I	HPR6479	2003 CHEVROLET		
Silverado 1500	4.3L V6 F/I	HPR8755	Astro	4.3L V6 F/I	HPR7421
Silverado 1500	4.8L V8 F/I	HPR8755 ♦+	Avalanche 1500	5.3L V8 F/I	HPR8755 ♦+
Silverado 1500	5.3L V8 F/I	HPR8755 ♦+	Avalanche 2500	8.1L V8 F/I	HPR8755 +
Silverado 1500 HD	6.0L V8 F/I	HPR8755 ♦+	Blazer	4.3L V6 F/I	HPR7421 ♦
Silverado 2500 HD	6.0L V8 F/I	HPR8755 ♦+	Camaro	3.8L V6 F/I	HPR3914
Silverado 2500 HD	6.6L V8 DSL - w/Panel Filter	HPR8755	Camaro	5.7L V8 F/I	HPR3914
Silverado 2500 HD	8.1L V8 F/I	HPR8755	Cavalier	2.2L L4 F/I	HPR3916
Silverado 3500	6.0L V8 F/I	HPR8755 ♦+	Corvette	5.7L V8 F/I	HPR3914
Silverado 3500	6.6L V8 DSL - w/Panel Filter	HPR8755	Corvette Z06	5.7L V8 F/I	HPR3914
Silverado 3500	8.1L V8 F/I	HPR8755 +	Impala	3.4L V6 F/I	HPR6479
Silverado SS	6.0L V8 F/I	HPR8755 ♦	Impala	3.8L V6 F/I	HPR6479
SSR	6.0L V8 F/I	HPR3914	Malibu	3.1L V6 F/I	HPR8221
Suburban 1500	5.3L V8 F/I	HPR8755 ♦+	Monte Carlo	3.4L V6 F/I	HPR6479
Suburban 2500	6.0L V8 F/I	HPR8755 ♦+	Monte Carlo	3.8L V6 F/I	HPR6479
Suburban 2500	8.1L V8 F/I	HPR8755 +	S10 Pickup	2.2L L4 F/I	HPR7421 ♦
Tahoe	4.8L V8 F/I	HPR8755 ♦+	S10 Pickup	4.3L V6 F/I	HPR7421 ♦
Tahoe	5.3L V8 F/I	HPR8755 ♦+	Silverado 1500	4.3L V6 F/I	HPR8755
TrailBlazer	4.2L L6 F/I	HPR9345	Silverado 1500	4.8L V8 F/I	HPR8755 ♦+
TrailBlazer	5.3L V8 F/I	HPR9345	Silverado 1500	5.3L V8 F/I	HPR8755 ♦+
Uplander	3.5L V6 F/I	HPR7597	Silverado 1500 HD	6.0L V8 F/I	HPR8755 ♦+
Venture	3.4L V6 F/I	HPR7597	Silverado 2500	6.0L V8 F/I	HPR8755 ♦+
2004 CHEVROLET			Silverado 2500 HD	6.0L V8 F/I	HPR8755 ♦+
Astro	4.3L V6 F/I	HPR7421	Silverado 2500 HD	6.6L V8 DSL	HPR8755 ♦
Avalanche 1500	5.3L V8 F/I	HPR8755 ♦+	Silverado 2500 HD	8.1L V8 F/I	HPR8755
Avalanche 2500	8.1L V8 F/I	HPR8755 +	Silverado 3500	6.0L V8 F/I	HPR8755 ♦+
Blazer	4.3L V6 F/I	HPR7421 ♦	Silverado 3500	6.6L V8 DSL	HPR8755 ♦
Camaro	3.8L V6 F/I	HPR3914	Silverado 3500	8.1L V8 F/I	HPR8755 +
Camaro	5.7L V8 F/I	HPR3914	Silverado SS	6.0L V8 F/I	HPR8755 ♦
Cavalier	2.2L L4 F/I	HPR3916	SSR	5.3L V8 F/I	HPR3914
Classic	2.2L L4 F/I	HPR8221	Suburban 1500	5.3L V8 F/I	HPR8755 ♦+
Colorado	2.8L L4 F/I	HPR9778	Suburban 2500	6.0L V8 F/I	HPR8755 ♦+
Colorado	3.5L L5 F/I	HPR9778	Suburban 2500	8.1L V8 F/I	HPR8755 +
Corvette	5.7L V8 F/I	HPR3914	Tahoe	4.8L V8 F/I	HPR8755 ♦+
Corvette Z06	5.7L V8 F/I	HPR3914	Tahoe	5.3L V8 F/I	HPR8755 ♦+
Impala	3.4L V6 F/I	HPR6479	Tracker	2.0L L4 F/I	HPR8069
Impala	3.8L V6 F/I	HPR6479	Tracker	2.5L V6 F/I	HPR8069
Malibu	2.2L L4 F/I	HPR7597	TrailBlazer	4.2L L6 F/I	HPR9345
Malibu	3.5L V6 F/I	HPR7597	TrailBlazer	5.3L V8 F/I	HPR9345
Monte Carlo	3.4L V6 F/I	HPR6479	Venture	3.4L V6 F/I	HPR7597
Monte Carlo	3.8L V6 F/I	HPR6479	2002 CHEVROLET		
S10 Pickup	4.3L V6 F/I	HPR7421 ♦	Astro	4.3L V6 F/I	HPR7421
Silverado 1500	4.3L V6 F/I	HPR8755	Avalanche 1500	5.3L V8 F/I	HPR8755 ♦+
Silverado 1500	4.8L V8 F/I	HPR8755 ♦+	Avalanche 2500	8.1L V8 F/I	HPR8755 +
Silverado 1500	5.3L V8 F/I	HPR8755 ♦+	Blazer	4.3L V6 F/I	HPR7421 ♦
Silverado 2500	6.0L V8 F/I	HPR8755 ♦+	C3500	6.5L V8 DSL	HPR8038
Silverado 2500 HD	6.0L V8 F/I	HPR8755 ♦+	C3500	8.1L V8 F/I	HPR8755
Silverado 2500 HD	6.6L V8 DSL	HPR8755 ♦	C3500HD	8.1L V8 F/I	HPR8755
Silverado 2500 HD	8.1L V8 F/I	HPR8755	Camaro	3.8L V6 F/I	HPR3914
Silverado 3500	6.0L V8 F/I	HPR8755 ♦+	Camaro	5.7L V8 F/I	HPR3914
Silverado 3500	6.6L V8 DSL	HPR8755 ♦	Cavalier	2.2L L4 F/I	HPR3916
Silverado 3500	8.1L V8 F/I	HPR8755 +	Cavalier	2.4L L4 F/I	HPR3916
Silverado SS	6.0L V8 F/I	HPR8755 ♦	Corvette	5.7L V8 F/I	HPR3914
SSR	5.3L V8 F/I	HPR3914	Corvette Z06	5.7L V8 F/I	HPR3914
Suburban 1500	5.3L V8 F/I	HPR8755 ♦+	Express 2500	6.5L V8 DSL	HPR3914
Suburban 2500	6.0L V8 F/I	HPR8755 ♦+	Express 3500	6.5L V8 DSL	HPR3914
Suburban 2500	8.1L V8 F/I	HPR8755 +	Impala	3.4L V6 F/I	HPR6479
Tahoe	4.8L V8 F/I	HPR8755 ♦+	Impala	3.8L V6 F/I	HPR6479
Tahoe	5.3L V8 F/I	HPR8755 ♦+	Malibu	3.1L V6 F/I	HPR8221
Tracker	2.5L V6 F/I	HPR8069	Monte Carlo	3.4L V6 F/I	HPR6479
TrailBlazer	4.2L L6 F/I	HPR9345	Monte Carlo	3.8L V6 F/I	HPR6479
TrailBlazer	5.3L V8 F/I	HPR9345	Prizm	1.8L L4 F/I	HPR5466

*Indicates 2 filters required ♦ Intake system available - see page 326 + throttle body spacer available – see page 20

HPR™ REPLACEMENT AIR FILTERS CHEVROLET

Vehicle	Engine Type	Air Filter
2002 CHEVROLET		
S10 Pickup	2.2L L4 F/I	HPR7421 ♦
S10 Pickup	4.3L V6 F/I	HPR7421 ♦
Silverado 1500	4.3L V6 F/I	HPR8755
Silverado 1500	4.8L V8 F/I	HPR8755 ♦+
Silverado 1500	5.3L V8 F/I	HPR8755 ♦+
Silverado 1500 HD	6.0L V8 F/I	HPR8755 ♦+
Silverado 2500	5.3L V8 F/I	HPR8755 ♦+
Silverado 2500	6.0L V8 F/I	HPR8755 ♦+
Silverado 2500 HD	6.0L V8 F/I	HPR8755 ♦+
Silverado 2500 HD	6.6L V8 DSL	HPR8755 ♦
Silverado 2500 HD	8.1L V8 F/I	HPR8755
Silverado 3500	5.3L V8 F/I	HPR8755 ♦+
Silverado 3500	6.0L V8 F/I	HPR8755 ♦+
Silverado 3500	6.6L V8 DSL	HPR8755 ♦
Silverado 3500	8.1L V8 F/I	HPR8755 +
Suburban 1500	5.3L V8 F/I	HPR8755 ♦+
Suburban 2500	6.0L V8 F/I	HPR8755 ♦+
Suburban 2500	8.1L V8 F/I	HPR8755 +
Tahoe	4.8L V8 F/I	HPR8755 ♦+
Tahoe	5.3L V8 F/I	HPR8755 ♦+
Tracker	2.0L L4 F/I	HPR8069
Tracker	2.5L V6 F/I	HPR8069
TrailBlazer	4.2L L6 F/I	HPR9345
Venture	3.4L V6 F/I	HPR7597

Vehicle	Engine Type	Air Filter
2001 CHEVROLET		
Astro	4.3L V6 F/I	HPR7421
Avalanche 2500	8.1L V8 F/I	HPR8755
Blazer	4.3L V6 F/I	HPR7421 ♦
C3500	8.1L V8 F/I	HPR8755
C3500HD	6.5L V8 DSL	HPR8038
C3500HD	8.1L V8 F/I	HPR8755
Camaro	3.8L V6 F/I	HPR3914
Camaro	5.7L V8 F/I	HPR3914
Cavalier	2.2L L4 F/I	HPR3916
Cavalier	2.4L L4 F/I	HPR3916
Corvette	5.7L V8 F/I	HPR3914
Corvette Z06	5.7L V8 F/I	HPR3914
Express 2500	6.5L V8 DSL	HPR3914
Express 3500	6.5L V8 DSL	HPR3914
Impala	3.4L V6 F/I	HPR6479
Impala	3.8L V6 F/I	HPR6479
Lumina	3.1L V6 F/I	HPR7597
Malibu	3.1L V6 F/I	HPR8221
Monte Carlo	3.4L V6 F/I	HPR6479
Monte Carlo	3.8L V6 F/I	HPR6479
Prizm	1.8L L4 F/I	HPR5466
S10 Pickup	2.2L L4 F/I	HPR7421 ♦
S10 Pickup	4.3L V6 F/I	HPR7421 ♦
Silverado 1500	4.3L V6 F/I	HPR8755
Silverado 1500	4.8L V8 F/I	HPR8755 ♦+
Silverado 1500	5.3L V8 F/I	HPR8755 ♦+
Silverado 1500	5.3L V8 F/I	HPR8755 ♦+
Silverado 1500 HD	6.0L V8 F/I	HPR8755 ♦+
Silverado 2500	6.0L V8 F/I	HPR8755 ♦+
Silverado 2500 HD	6.0L V8 F/I	HPR8755 ♦+
Silverado 2500 HD	6.0L V8 F/I	HPR8755 ♦+
Silverado 2500 HD	6.6L V8 DSL	HPR8755 ♦
Silverado 2500 HD	8.1L V8 F/I	HPR8755
Silverado 3500	6.0L V8 F/I	HPR8755 ♦+
Silverado 3500	6.6L V8 DSL	HPR8755 ♦
Silverado 3500	8.1L V8 F/I	HPR8755 +
Suburban 1500	5.3L V8 F/I	HPR8755 ♦+
Suburban 2500	6.0L V8 F/I	HPR8755 ♦+
Suburban 2500	8.1L V8 F/I	HPR8755 +
Tahoe	4.8L V8 F/I	HPR8755 ♦+
Tahoe	5.3L V8 F/I	HPR8755 ♦+

Vehicle	Engine Type	Air Filter
2001 CHEVROLET		
Tracker	1.6L L4 F/I	HPR8069
Tracker	2.0L L4 F/I	HPR8069
Tracker	2.5L V6 F/I	HPR8069
Venture	3.4L V6 F/I	HPR7597

Vehicle	Engine Type	Air Filter
2000 CHEVROLET		
Astro	4.3L V6 F/I	HPR7421
Avalanche 2500	8.1L V8 F/I	HPR8755
Blazer	4.3L V6 F/I	HPR7421 ♦
C35	5.7L V8 F/I	HPR8038
C2500	5.7L V8 F/I	HPR8038 ♦+
C2500	6.5L V8 DSL	HPR8038
C2500	7.4L V8 F/I	HPR8038
C3500	5.7L V8 F/I	HPR8038 ♦+
C3500	6.5L V8 DSL	HPR8038
C3500	7.4L V8 F/I	HPR8038
C3500HD	6.5L V8 DSL	HPR8038
C3500HD	7.4L V8 F/I	HPR8038
Camaro	3.8L V6 F/I	HPR3914
Camaro	5.7L V8 F/I	HPR3914
Cavalier	2.2L L4 F/I	HPR3916
Cavalier	2.4L L4 F/I	HPR3916
Corvette	5.7L V8 F/I	HPR3914
Express 1500	4.3L V6 F/I	HPR3914
Express 1500	5.0L V8 F/I	HPR3914
Express 1500	5.7L V8 F/I	HPR3914
Express 2500	4.3L V6 F/I	HPR3914
Express 2500	5.0L V8 F/I	HPR3914
Express 2500	5.7L V8 F/I	HPR3914
Express 2500	6.5L V8 DSL	HPR3914
Express 3500	5.7L V8 F/I	HPR3914
Express 3500	6.5L V8 DSL	HPR3914
Express 3500	7.4L V8 F/I	HPR3914
Impala	3.4L V6 F/I	HPR6479
Impala	3.8L V6 F/I	HPR6479
K2500	5.7L V8 F/I	HPR8038 ♦+
K2500	6.5L V8 DSL	HPR8038
K2500	7.4L V8 F/I	HPR8038
K3500	5.7L V8 F/I	HPR8038 ♦+
K3500	6.5L V8 DSL	HPR8038
K3500	7.4L V8 F/I	HPR8038
Lumina	3.1L V6 F/I	HPR7597
Malibu	3.1L V6 F/I	HPR8221
Monte Carlo	3.4L V6 F/I	HPR6479
Monte Carlo	3.8L V6 F/I	HPR6479
Prizm	1.8L L4 F/I	HPR5466
S10 Pickup	2.2L L4 F/I	HPR7421 ♦
S10 Pickup	4.3L V6 F/I	HPR7421 ♦
Silverado 1500	4.3L V6 F/I	HPR8755
Silverado 1500	4.8L V8 F/I	HPR8755 ♦+
Silverado 1500	5.3L V8 F/I	HPR8755 ♦+
Silverado 2500	5.3L V8 F/I	HPR8755 ♦+
Silverado 2500	6.0L V8 F/I	HPR8755 ♦+
Suburban 1500	5.3L V8 F/I	HPR8755 ♦+
Suburban 2500	5.3L V8 F/I	HPR8755
Suburban 2500	6.0L V8 F/I	HPR8755 ♦+
Tahoe	4.8L V8 F/I	HPR8755 ♦+
Tahoe	5.3L V8 F/I	HPR8755 ♦+
Tahoe	5.7L V8 F/I	HPR8038 ♦+
Tracker	1.6L L4 F/I	HPR8069
Tracker	2.0L L4 F/I	HPR8069
Venture	3.4L V6 F/I	HPR7597

Vehicle	Engine Type	Air Filter
1999 CHEVROLET		
Astro	4.3L V6 F/I	HPR7421

*Indicates 2 filters required ♦ Intake system available - see page 326 + throttle body spacer available - see page 20

CHEVROLET HPR™ REPLACEMENT AIR FILTERS

Vehicle	Engine Type	Air Filter	Vehicle	Engine Type	Air Filter
1999 CHEVROLET			1999 CHEVROLET		
Blazer	4.3L V6 F/I	HPR7421 ♦	Tahoe	5.7L V8 F/I	HPR8038 ♦+
C35	5.7L V8 F/I	HPR8038	Tahoe	6.5L V8 DSL	HPR8038
C1500	5.0L V8 F/I	HPR8038 ♦+	Tracker	1.6L L4 F/I	HPR8069
C1500	5.7L V8 F/I	HPR8038 ♦+	Tracker	2.0L L4 F/I	HPR8069
C1500 Suburban	5.7L V8 F/I	HPR8038 ♦+	Venture	3.4L V6 F/I	HPR7597
C1500 Suburban	6.5L V8 DSL	HPR8038	1998 CHEVROLET		
C2500	5.0L V8 F/I	HPR8038	Astro	4.3L V6 F/I	HPR7421
C2500	5.7L V8 F/I	HPR8038 ♦+	Blazer	4.3L V6 F/I	HPR7421 ♦
C2500	6.5L V8 DSL	HPR8038	C35	5.7L V8 F/I	HPR8038
C2500	7.4L V8 F/I	HPR8038	C1500	4.3L V6 F/I	HPR8038
C2500 Suburban	5.7L V8 F/I	HPR8038 ♦+	C1500	5.0L V8 F/I	HPR8038 ♦+
C2500 Suburban	6.5L V8 DSL	HPR8038	C1500	5.7L V8 F/I	HPR8038 ♦+
C2500 Suburban	7.4L V8 F/I	HPR8038	C1500	6.5L V8 DSL	HPR8038
C3500	5.7L V8 F/I	HPR8038 ♦+	C1500 Suburban	5.7L V8 F/I	HPR8038 ♦+
C3500	6.5L V8 DSL	HPR8038	C1500 Suburban	6.5L V8 DSL	HPR8038
C3500	7.4L V8 F/I	HPR8038	C2500	5.0L V8 F/I	HPR8038 ♦+
C3500HD	6.5L V8 DSL	HPR8038	C2500	5.7L V8 F/I	HPR8038 ♦+
C3500HD	7.4L V8 F/I	HPR8038	C2500	6.5L V8 DSL	HPR8038
Camaro	3.8L V6 F/I	HPR3914	C2500	7.4L V8 F/I	HPR8038
Camaro	5.7L V8 F/I	HPR3914	C2500 Suburban	5.7L V8 F/I	HPR8038 ♦+
Cavalier	2.2L L4 F/I	HPR3916	C2500 Suburban	6.5L V8 DSL	HPR8038
Cavalier	2.4L L4 F/I	HPR3916	C2500 Suburban	7.4L V8 F/I	HPR8038
Corvette	5.7L V8 F/I	HPR3914	C3500	5.7L V8 F/I	HPR8038 ♦+
Express 1500	4.3L V6 F/I	HPR3914	C3500	6.5L V8 DSL	HPR8038
Express 1500	5.0L V8 F/I	HPR3914	C3500	7.4L V8 F/I	HPR8038
Express 1500	5.7L V8 F/I	HPR3914	C3500HD	6.5L V8 DSL	HPR8038
Express 2500	4.3L V6 F/I	HPR3914	C3500HD	7.4L V8 F/I	HPR8038
Express 2500	5.0L V8 F/I	HPR3914	Camaro	3.8L V6 F/I	HPR3914
Express 2500	5.7L V8 F/I	HPR3914	Camaro	5.7L V8 F/I	HPR3914
Express 2500	6.5L V8 DSL	HPR3914	Cavalier	2.2L L4 F/I	HPR3916
Express 3500	5.7L V8 F/I	HPR3914	Cavalier	2.4L L4 F/I	HPR3916
Express 3500	6.5L V8 DSL	HPR3914	Corvette	5.7L V8 F/I	HPR3914
Express 3500	7.4L V8 F/I	HPR3914	Express 1500	4.3L V6 F/I	HPR3914
K1500	5.0L V8 F/I	HPR8038 ♦+	Express 1500	5.0L V8 F/I	HPR3914
K1500	5.7L V8 F/I	HPR8038 ♦+	Express 1500	5.7L V8 F/I	HPR3914
K1500 Suburban	5.7L V8 F/I	HPR8038 ♦+	Express 2500	4.3L V6 F/I	HPR3914
K1500 Suburban	6.5L V8 DSL	HPR8038	Express 2500	5.0L V8 F/I	HPR3914
K2500	5.0L V8 F/I	HPR8038	Express 2500	5.7L V8 F/I	HPR3914
K2500	5.7L V8 F/I	HPR8038 ♦+	Express 2500	6.5L V8 DSL	HPR3914
K2500	6.5L V8 DSL	HPR8038	Express 3500	5.7L V8 F/I	HPR3914
K2500	7.4L V8 F/I	HPR8038	Express 3500	6.5L V8 DSL	HPR3914
K2500 Suburban	5.7L V8 F/I	HPR8038 ♦+	Express 3500	7.4L V8 F/I	HPR3914
K2500 Suburban	6.5L V8 DSL	HPR8038	K1500	4.3L V6 F/I	HPR8038
K2500 Suburban	7.4L V8 F/I	HPR8038	K1500	5.0L V8 F/I	HPR8038 ♦+
K3500	5.7L V8 F/I	HPR8038 ♦+	K1500	5.7L V8 F/I	HPR8038 ♦+
K3500	6.5L V8 DSL	HPR8038	K1500	6.5L V8 DSL	HPR8038
K3500	7.4L V8 F/I	HPR8038	K1500 Suburban	5.7L V8 F/I	HPR8038 ♦+
Lumina	3.1L V6 F/I	HPR7597	K1500 Suburban	6.5L V8 DSL	HPR8038
Lumina	3.8L V6 F/I	HPR7597	K2500	5.0L V8 F/I	HPR8038 ♦+
Malibu	2.4L L4 F/I	HPR8221	K2500	5.7L V8 F/I	HPR8038 ♦+
Malibu	3.1L V6 F/I	HPR8221	K2500	6.5L V8 DSL	HPR8038
Monte Carlo	3.1L V6 F/I	HPR7597	K2500	7.4L V8 F/I	HPR8038
Monte Carlo	3.8L V6 F/I	HPR7597	K2500 Suburban	5.7L V8 F/I	HPR8038 ♦+
P30	4.3L V6 F/I	HPR3914	K2500 Suburban	6.5L V8 DSL	HPR8038
P30	5.7L V8 F/I	HPR3914	K2500 Suburban	7.4L V8 F/I	HPR8038
P30	7.4L V8 F/I	HPR3914	K3500	5.7L V8 F/I	HPR8038 ♦+
Prizm	1.8L L4 F/I	HPR5466	K3500	6.5L V8 DSL	HPR8038
S10 Pickup	2.2L L4 F/I	HPR7421 ♦	K3500	7.4L V8 F/I	HPR8038
S10 Pickup	4.3L V6 F/I	HPR7421 ♦	Lumina	3.1L V6 F/I	HPR7597
Silverado 1500	4.3L V6 F/I	HPR8755	Lumina	3.8L V6 F/I	HPR7597
Silverado 1500	4.8L V8 F/I	HPR8755 ♦+	Malibu	2.4L L4 F/I	HPR8221
Silverado 1500	5.3L V8 F/I	HPR8755 ♦+	Malibu	3.1L V6 F/I	HPR8221
Silverado 2500	5.3L V8 F/I	HPR8755 ♦+	Monte Carlo	3.1L V6 F/I	HPR7597
Silverado 2500	6.0L V8 F/I	HPR8755 ♦+	Monte Carlo	3.8L V6 F/I	HPR7597

*Indicates 2 filters required ♦ Intake system available - see page 326 + throttle body spacer available - see page 20

HPR™ REPLACEMENT AIR FILTERS CHEVROLET

Vehicle	Engine Type	Air Filter	Vehicle	Engine Type	Air Filter
1998 CHEVROLET			1997 CHEVROLET		
P30	4.3L V6 F/I	HPR3914	Malibu	3.1L V6 F/I	HPR8221
P30	5.7L V8 F/I	HPR3914	Monte Carlo	3.1L V6 F/I	HPR7597
P30	7.4L V8 F/I	HPR3914	Monte Carlo	3.4L V6 F/I	HPR7597
Prizm	1.8L L4 F/I	HPR5466	P30	4.3L V6 F/I	HPR0192
S10 Pickup	2.2L L4 F/I	HPR7421 ♦	P30	5.7L V8 F/I	HPR0326
S10 Pickup	4.3L V6 F/I	HPR7421 ♦	P30	7.4L V8 F/I	HPR0326
Tahoe	5.7L V8 F/I	HPR8038 ♦+	S10 Pickup	2.2L L4 F/I	HPR7421
Tahoe	6.5L V8 DSL	HPR8038	S10 Pickup	4.3L V6 F/I	HPR7421 ♦
Venture	3.4L V6 F/I	HPR7597	Tahoe	5.7L V8 F/I	HPR8038 ♦+
1997 CHEVROLET			1996 CHEVROLET		
Astro	4.3L V6 F/I	HPR7421	Astro	4.3L V6 F/I	HPR7421
Blazer	4.3L V6 F/I	HPR7421 ♦	Beretta	2.2L L4 F/I	HPR7598
C35	5.7L V8 F/I	HPR8038	Beretta	3.1L V6 F/I	HPR7598
C1500	4.3L V6 F/I	HPR8038	Blazer	4.3L V6 F/I	HPR7421 ♦
C1500	5.0L V8 F/I	HPR8038 ♦+	C35	5.7L V8 F/I	HPR8038
C1500	5.7L V8 F/I	HPR8038 ♦+	C1500	4.3L V6 F/I	HPR8038
C1500	6.5L V8 DSL	HPR8038	C1500	5.0L V8 F/I	HPR8038 ♦+
C1500 Suburban	5.7L V8 F/I	HPR8038 ♦+	C1500	5.7L V8 F/I	HPR8038 ♦+
C1500 Suburban	6.5L V8 DSL	HPR8038	C1500 Suburban	5.7L V8 F/I	HPR8038 ♦+
C2500	5.0L V8 F/I	HPR8038 ♦+	C2500	5.0L V8 F/I	HPR8038 ♦+
C2500	5.7L V8 F/I	HPR8038 ♦+	C2500	5.7L V8 F/I	HPR8038 ♦+
C2500	6.5L V8 DSL	HPR8038	C2500	7.4L V8 F/I	HPR8038 ♦+
C2500	7.4L V8 F/I	HPR8038	C2500 Suburban	5.7L V8 F/I	HPR8038 ♦+
C2500 Suburban	5.7L V8 F/I	HPR8038 ♦+	C2500 Suburban	7.4L V8 F/I	HPR8038
C2500 Suburban	6.5L V8 DSL	HPR8038	C3500	5.7L V8 F/I	HPR8038 ♦+
C2500 Suburban	7.4L V8 F/I	HPR8038	C3500	6.5L V8 DSL	HPR8038
C3500	5.7L V8 F/I	HPR8038 ♦+	C3500	7.4L V8 F/I	HPR8038
C3500	6.5L V8 DSL	HPR8038	C3500HD	6.5L V8 DSL	HPR8038
C3500	7.4L V8 F/I	HPR8038	C3500HD	7.4L V8 F/I	HPR8038
C3500HD	6.5L V8 DSL	HPR8038	Camaro	3.8L V6 F/I	HPR7421
C3500HD	7.4L V8 F/I	HPR8038	Camaro	5.7L V8 F/I - w/o Ram Air	HPR7421
Camaro	3.8L V6 F/I	HPR7421	Camaro	5.7L V8 F/I - w/Ram Air	HPR3901
Camaro	5.7L V8 F/I - w/o Ram Air	HPR7421	Cavalier	2.2L L4 F/I	HPR3916
Camaro	5.7L V8 F/I - w/Ram Air	HPR3901	Cavalier	2.4L L4 F/I	HPR3916
Cavalier	2.2L L4 F/I	HPR3916	Corvette	5.7L V8 F/I	HPR3914
Cavalier	2.4L L4 F/I	HPR3916	Express 1500	4.3L V6 F/I	HPR3914
Corvette	5.7L V8 F/I	HPR3914	Express 1500	5.7L V8 F/I	HPR3914
Express 1500	4.3L V6 F/I	HPR3914	Express 2500	4.3L V6 F/I	HPR3914
Express 1500	5.7L V8 F/I	HPR3914	Express 2500	5.0L V8 F/I	HPR3914
Express 2500	4.3L V6 F/I	HPR3914	Express 2500	5.7L V8 F/I	HPR0192
Express 2500	5.0L V8 F/I	HPR3914	Express 2500	5.7L V8 F/I	HPR3914
Express 2500	5.7L V8 F/I	HPR3914	Express 3500	5.7L V8 F/I	HPR3914
Express 2500	6.5L V8 DSL	HPR3914	Express 3500	7.4L V8 MFI	HPR3914
Express 3500	5.7L V8 F/I	HPR3914	Express 3500	7.4L V8 TBI	HPR0326
Express 3500	6.5L V8 DSL	HPR3914	Express 3500	7.4L V8 TBI	HPR3914
Express 3500	7.4L V8 F/I	HPR3914	G30	4.3L V6 F/I	HPR0192
K1500	4.3L V6 F/I	HPR8038	G30	5.7L V8 F/I	HPR0192
K1500	5.0L V8 F/I	HPR8038 ♦+	G30	6.5L V8 DSL	HPR3914
K1500	5.7L V8 F/I	HPR8038 ♦+	G30	7.4L V8 F/I	HPR0326
K1500	6.5L V8 DSL	HPR8038	G30	7.4L V8 F/I	HPR0326
K1500 Suburban	5.7L V8 F/I	HPR8038 ♦+	Impala SS	5.7L V8 F/I	HPR6479 ♦
K1500 Suburban	6.5L V8 DSL	HPR8038	K1500	4.3L V6 F/I	HPR8038
K2500	5.7L V8 F/I	HPR8038 ♦+	K1500	5.0L V8 F/I	HPR8038 ♦+
K2500	6.5L V8 DSL	HPR8038	K1500	5.7L V8 F/I	HPR8038 ♦+
K2500	7.4L V8 F/I	HPR8038	K1500	6.5L V8 DSL	HPR8038
K2500 Suburban	5.7L V8 F/I	HPR8038 ♦+	K1500 Suburban	5.7L V8 F/I	HPR8038 ♦+
K2500 Suburban	6.5L V8 DSL	HPR8038	K2500	5.7L V8 F/I	HPR8038 ♦+
K2500 Suburban	7.4L V8 F/I	HPR8038	K2500	6.5L V8 DSL	HPR8038
K2500 Suburban	7.4L V8 F/I	HPR8038	K2500	7.4L V8 F/I	HPR8038
K3500	5.7L V8 F/I	HPR8038 ♦+	K2500 Suburban	5.7L V8 F/I	HPR8038 ♦+
K3500	6.5L V8 DSL	HPR8038	K2500 Suburban	7.4L V8 F/I	HPR8038
K3500	7.4L V8 F/I	HPR8038	K3500	5.7L V8 F/I	HPR8038 ♦+
Lumina	3.1L V6 F/I	HPR7597			
Lumina	3.4L V6 F/I	HPR7597			
Malibu	2.4L L4 F/I	HPR8221			

*Indicates 2 filters required ♦ Intake system available - see page 326 + throttle body spacer available - see page 20

CHEVROLET HPR™ REPLACEMENT AIR FILTERS

Vehicle	Engine Type	Air Filter	Vehicle	Engine Type	Air Filter
1996 CHEVROLET			1995 CHEVROLET		
K3500	6.5L V8 DSL	HPR8038	K2500	7.4L V8 F/I	HPR0326
K3500	7.4L V8 F/I	HPR8038	K2500 Suburban	5.7L V8 F/I	HPR0326 +
Lumina	3.1L V6 F/I	HPR7597	K2500 Suburban	7.4L V8 F/I	HPR0326
Lumina	3.4L V6 F/I	HPR7597	K3500	5.7L V8 F/I	HPR0326 +
Lumina APV	3.4L V6 F/I	HPR3916	K3500	6.5L V8 DSL	HPR8038
Monte Carlo	3.1L V6 F/I	HPR7597	K3500	7.4L V8 F/I	HPR0326
Monte Carlo	3.4L V6 F/I	HPR7597	LLV	2.2L L4 F/I	HPR3902
P30	4.3L V6 F/I	HPR0192	Lumina	3.1L V6 F/I	HPR7597
P30	5.7L V8 F/I	HPR0326	Lumina	3.4L V6 F/I	HPR7597
P30	7.4L V8 F/I	HPR0326	Lumina APV	3.1L V6 F/I	HPR3588
S10 Pickup	2.2L L4 F/I	HPR7421	Lumina APV	3.8L V6 F/I	HPR3916
S10 Pickup	4.3L V6 F/I	HPR7421 ♦	Monte Carlo	3.1L V6 F/I	HPR7597
Tahoe	5.7L V8 F/I	HPR8038 ♦+	Monte Carlo	3.4L V6 F/I	HPR7597
1995 CHEVROLET			Motorhome	4.3L V6 F/I - Class C	HPR0192
Astro	4.3L V6 F/I	HPR7421	Motorhome	5.0L V8 F/I - Class C	HPR0192
Beretta	2.2L L4 F/I	HPR7598	Motorhome	5.7L V8 F/I - VIN K, Class C, Exc. Off-Road	HPR0192
Beretta	3.1L V6 F/I	HPR7598	Motorhome	5.7L V8 F/I - VIN K, Class C, P Series	HPR0326
Blazer	4.3L V6 F/I	HPR7421 +	Motorhome	7.4L V8 F/I - Class C, w/3-7/16 inch Tall Filter	HPR0326
C35	5.7L V8 F/I	HPR0326	P30	4.3L V6 F/I	HPR0192
C1500	4.3L V6 F/I	HPR0192 +	P30	5.7L V8 F/I	HPR0326
C1500	5.0L V8 F/I	HPR0326 +	P30	7.4L V8 F/I	HPR0326
C1500	5.7L V8 F/I	HPR0326 +	S10 Pickup	2.2L L4 F/I	HPR7421
C1500 Suburban	5.7L V8 F/I	HPR0326 +	S10 Pickup	4.3L V6 CPI	HPR7421 +
C2500	4.3L V6 F/I	HPR0192 +	S10 Pickup	4.3L V6 TBI	HPR3588 +
C2500	5.0L V8 F/I	HPR0326 +	Tahoe	5.7L V8 F/I	HPR0326 +
C2500	5.7L V8 F/I	HPR0326 +	1994 CHEVROLET		
C2500	7.4L V8 F/I	HPR0326	Astro	4.3L V6 CPI	HPR7421
C2500 Suburban	5.7L V8 F/I	HPR0326 +	Astro	4.3L V6 TBI	HPR3588
C2500 Suburban	7.4L V8 F/I	HPR0326	Beretta	2.2L L4 F/I	HPR7598
C3500	5.7L V8 F/I	HPR0326 +	Beretta	2.3L L4 F/I	HPR7598
C3500	6.5L V8 DSL	HPR8038	Beretta	3.1L V6 F/I	HPR7598
C3500	7.4L V8 F/I	HPR0326	Blazer	5.7L V8 F/I	HPR0326 +
C3500HD	5.7L V8 F/I	HPR0326	C1500	4.3L V6 F/I	HPR0192 +
C3500HD	6.5L V8 DSL	HPR8038	C1500	5.0L V8 F/I	HPR0326 +
C3500HD	7.4L V8 F/I	HPR0326	C1500	5.7L V8 F/I	HPR0326 +
Camaro	3.4L V6 F/I	HPR7421	C1500 Suburban	5.7L V8 F/I	HPR0326 +
Camaro	3.8L V6 F/I	HPR7421	C2500	4.3L V6 F/I	HPR0192 +
Camaro	5.7L V8 F/I	HPR7421	C2500	5.0L V8 F/I	HPR0326 +
Caprice	4.3L V8 F/I	HPR6479	C2500	5.7L V8 F/I	HPR0326 +
Caprice	5.7L V8 F/I	HPR6479	C2500	7.4L V8 F/I	HPR0326
Cavalier	2.2L L4 F/I	HPR3916	C2500 Suburban	5.7L V8 F/I	HPR0326 +
Cavalier	2.3L L4 F/I	HPR3916	C2500 Suburban	7.4L V8 F/I	HPR0326
Corsica	2.2L L4 F/I	HPR7598	C3500	5.7L V8 F/I	HPR0326 +
Corsica	3.1L V6 F/I	HPR7598	C3500	6.5L V8 DSL	HPR8038
G10	4.3L V6 F/I	HPR0192	C3500	7.4L V8 F/I	HPR0326
G10	5.0L V8 F/I	HPR0192	C3500HD	5.7L V8 F/I	HPR0326
G20	4.3L V6 F/I	HPR0192	C3500HD	6.5L V8 DSL	HPR8038
G20	5.0L V8 F/I	HPR0192	C3500HD	7.4L V8 F/I	HPR0326
G20	5.7L V8 F/I	HPR0192	Camaro	3.4L V6 F/I	HPR7421
G20	6.5L V8 DSL	HPR3914	Camaro	5.7L V8 F/I	HPR7421
G30	4.3L V6 F/I	HPR0192	Caprice	4.3L V8 F/I	HPR6479
G30	5.7L V8 F/I	HPR0192	Caprice	5.7L V8 F/I	HPR6479
G30	6.5L V8 DSL	HPR3914	Cavalier	2.2L L4 F/I	HPR3916
G30	7.4L V8 F/I	HPR0326	Cavalier	3.1L V6 F/I	HPR3902
Impala SS	5.7L V8 F/I	HPR6479 ♦	Cavalier Z24	3.1L V6 F/I	HPR3902
K1500	4.3L V6 F/I	HPR0192 +	Corsica	2.2L L4 F/I	HPR7598
K1500	5.0L V8 F/I	HPR0326 +	Corsica	3.1L V6 F/I	HPR7598
K1500	5.7L V8 F/I	HPR0326 +	G10	4.3L V6 F/I	HPR0192
K1500	6.5L V8 DSL	HPR8038	G10	5.0L V8 F/I	HPR0192
K1500 Suburban	5.7L V8 F/I	HPR0326 +	G20	4.3L V6 F/I	HPR0192
K2500	4.3L V6 F/I	HPR0192 +	G20	5.0L V8 F/I	HPR0192
K2500	5.0L V8 F/I	HPR0326 +	G20	5.7L V8 F/I	HPR0192
K2500	5.7L V8 F/I	HPR0326 +			
K2500	6.5L V8 DSL	HPR8038			

*Indicates 2 filters required ♦ Intake system available - see page 326 + throttle body spacer available - see page 20

HPR™ REPLACEMENT AIR FILTERS CHEVROLET

Vehicle	Engine Type	Air Filter	Vehicle	Engine Type	Air Filter
1994 CHEVROLET			1993 CHEVROLET		
G20	6.5L V8 DSL	HPR3914	Camaro	3.4L V6 F/I	HPR7421
G30	4.3L V6 F/I	HPR0192	Camaro	5.7L V8 F/I	HPR7421
G30	5.7L V8 F/I	HPR0192	Caprice	4.3L V6 F/I	HPR7017
G30	6.5L V8 DSL	HPR3914	Caprice	5.0L V8 F/I	HPR7017
G30	7.4L V8 F/I	HPR0326	Caprice	5.7L V8 F/I	HPR7017
Impala SS	5.7L V8 F/I	HPR6479 ♦	Cavalier	2.2L L4 F/I	HPR3916
K1500	4.3L V6 F/I	HPR0192 +	Cavalier	3.1L V6 F/I	HPR3902
K1500	5.0L V8 F/I	HPR0326 +	Cavalier Z24	3.1L V6 F/I	HPR3902
K1500	5.7L V8 F/I	HPR0326 +	Corsica	2.2L L4 F/I	HPR3916
K1500	6.5L V8 DSL	HPR8038	G10	4.3L V6 F/I	HPR0192
K1500 Suburban	5.7L V8 F/I	HPR0326 +	G10	5.0L V8 F/I	HPR0192
K2500	4.3L V6 F/I	HPR0192 +	G10	5.7L V8 F/I	HPR0192
K2500	5.0L V8 F/I	HPR0326 +	G20	4.3L V6 F/I	HPR0192
K2500	5.7L V8 F/I	HPR0326 +	G20	5.0L V8 F/I	HPR0192
K2500	6.5L V8 DSL	HPR8038	G20	5.7L V8 F/I	HPR0192
K2500	7.4L V8 F/I	HPR0326	G30	4.3L V6 F/I	HPR0192
K2500 Suburban	5.7L V8 F/I	HPR0326 +	G30	5.7L V8 F/I	HPR0192
K2500 Suburban	7.4L V8 F/I	HPR0326	G30	7.4L V8 F/I	HPR0326
K3500	5.7L V8 F/I	HPR0326 +	K1500	4.3L V6 F/I	HPR0192 +
K3500	6.5L V8 DSL	HPR8038	K1500	5.0L V8 F/I	HPR0326 +
K3500	7.4L V8 F/I	HPR0326	K1500	5.7L V8 F/I	HPR0326 +
LLV	2.2L L4 F/I	HPR3902	K1500 Suburban	5.7L V8 F/I	HPR0326 +
Lumina	3.1L V6 F/I	HPR7597	K2500	4.3L V6 F/I	HPR0192 +
Lumina	3.4L V6 F/I	HPR7597	K2500	5.0L V8 F/I	HPR0326 +
Lumina APV	3.1L V6 F/I	HPR3588	K2500	5.7L V8 F/I	HPR0326 +
Lumina APV	3.8L V6 F/I	HPR3916	K2500	6.5L V8 DSL	HPR8038
Motorhome	4.3L V6 F/I - Class C	HPR0192	K2500	7.4L V8 F/I	HPR0326
Motorhome	5.0L V8 F/I - Class C	HPR0192	K2500 Suburban	5.7L V8 F/I	HPR0326 +
Motorhome	5.7L V8 F/I - VIN K, Class C, Exc. Off-Road	HPR0192	K2500 Suburban	7.4L V8 F/I	HPR0326
Motorhome	5.7L V8 F/I - VIN K, Class C, P Series	HPR0326	K3500	5.7L V8 F/I	HPR0326 +
Motorhome	7.4L V8 F/I - Class C, w/3-7/16 inch Tall Filter	HPR0326	K3500	6.5L V8 DSL	HPR8038
P30	4.3L V6 F/I	HPR0192	K3500	7.4L V8 F/I	HPR0326
P30	5.7L V8 F/I	HPR0326	Lumina	3.1L V6 F/I	HPR6626
P30	7.4L V8 F/I	HPR0326	Lumina	3.4L V6 F/I	HPR6626
S10 Blazer	4.3L V6 CPI	HPR7421 +	Lumina APV	3.1L V6 F/I	HPR3588
S10 Blazer	4.3L V6 TBI	HPR3588 +	Lumina APV	3.8L V6 F/I	HPR3916
S10 Pickup	2.2L L4 F/I	HPR7421	Motorhome	4.3L V6 F/I - Class C	HPR0192
S10 Pickup	4.3L V6 CPI	HPR7421 +	Motorhome	5.0L V8 F/I - Class C	HPR0192
S10 Pickup	4.3L V6 TBI	HPR3588 +	Motorhome	5.7L V8 F/I - VIN K, Class C, Exc. Off-Road	HPR0192
			Motorhome	5.7L V8 F/I - VIN K, Class C, P Series	HPR0326
			Motorhome	7.4L V8 F/I - Class A & C, w/3-7/16 inch Tall Filter	HPR0326
1993 CHEVROLET			P30	4.3L V6 F/I	HPR0192
Astro	4.3L V6 CPI	HPR7421	P30	5.7L V8 F/I	HPR0326
Astro	4.3L V6 TBI	HPR3588	P30	7.4L V8 F/I	HPR0326
Beretta	2.2L L4 F/I	HPR3916	S10 Blazer	4.3L V6 CPI	HPR7421 +
Beretta	2.3L L4 F/I	HPR3916	S10 Blazer	4.3L V6 TBI	HPR3588 +
Blazer	5.7L V8 F/I	HPR0326 +	S10 Pickup	2.5L L4 F/I	HPR3647
C1500	4.3L V6 F/I	HPR0192 +	S10 Pickup	2.8L V6 F/I	HPR3588
C1500	5.0L V8 F/I	HPR0326 +	S10 Pickup	4.3L V6 CPI	HPR7421 +
C1500	5.7L V8 F/I	HPR0326 +	S10 Pickup	4.3L V6 TBI	HPR3588 +
C1500	7.4L V8 F/I	HPR0326			
C1500 Suburban	5.7L V8 F/I	HPR0326 +	1992 CHEVROLET		
C2500	4.3L V6 F/I	HPR0192 +	Astro	4.3L V6 CPI	HPR7421
C2500	5.0L V8 F/I	HPR0326 +	Astro	4.3L V6 TBI	HPR3588
C2500	5.7L V8 F/I	HPR0326 +	Beretta	2.2L L4 F/I	HPR3916
C2500	7.4L V8 F/I	HPR0326	Beretta	2.3L L4 F/I	HPR3916
C2500 Suburban	5.7L V8 F/I	HPR0326 +	Blazer	5.7L V8 F/I	HPR0326 +
C2500 Suburban	7.4L V8 F/I	HPR0326	C1500	4.3L V6 F/I	HPR0192 +
C3500	5.7L V8 F/I	HPR0326 +	C1500	5.0L V8 F/I	HPR0326 +
C3500	6.5L V8 DSL	HPR8038	C1500	5.7L V8 F/I	HPR0326 +
C3500	7.4L V8 F/I	HPR0326	C1500	7.4L V8 F/I	HPR0326
C3500HD	5.7L V8 F/I	HPR0326	C1500 Suburban	5.7L V8 F/I	HPR0326 +
C3500HD	6.5L V8 DSL	HPR8038	C2500	4.3L V6 F/I	HPR0192 +
C3500HD	7.4L V8 F/I	HPR0326			

*Indicates 2 filters required ♦ Intake system available - see page 326 + throttle body spacer available - see page 20

CHEVROLET HPR™ REPLACEMENT AIR FILTERS

Vehicle	Engine Type	Air Filter	Vehicle	Engine Type	Air Filter
1992 CHEVROLET			1991 CHEVROLET		
C2500	5.0L V8 F/I	HPR0326 +	Beretta	2.2L L4 F/I	HPR3647
C2500	5.7L V8 F/I	HPR0326 +	Beretta	2.3L L4 F/I	HPR3916
C2500	7.4L V8 F/I	HPR0326	Blazer	5.7L V8 F/I	HPR0326 +
C2500 Suburban	5.7L V8 F/I	HPR0326 +	C1500	4.3L V6 F/I	HPR0192 +
C2500 Suburban	7.4L V8 F/I	HPR0326	C1500	5.0L V8 F/I	HPR0326 +
C3500	5.7L V8 F/I	HPR0326 +	C1500	5.7L V8 F/I	HPR0326 +
C3500	6.5L V8 DSL	HPR8038	C1500	7.4L V8 F/I - w/3-7/16 inch Tall Filter	HPR0326
C3500	7.4L V8 F/I	HPR0326	C2500	4.3L V6 F/I	HPR0192 +
C3500HD	5.7L V8 F/I	HPR0326	C2500	5.0L V8 F/I	HPR0326 +
C3500HD	6.5L V8 DSL	HPR8038	C2500	5.7L V8 F/I	HPR0326 +
C3500HD	7.4L V8 F/I	HPR0326	C2500	7.4L V8 F/I - w/3-7/16 inch Tall Filter	HPR0326
Camaro	3.1L V6 F/I	HPR3902	C3500	5.7L V8 F/I	HPR0326 +
Camaro	5.0L V8 TBI	HPR0192	C3500	7.4L V8 F/I - w/3-7/16 inch Tall Filter	HPR0326
Caprice	4.3L V6 F/I	HPR7017	C3500HD	5.7L V8 F/I	HPR0326
Caprice	5.0L V8 F/I	HPR7017	C3500HD	7.4L V8 F/I - w/3-7/16 inch Tall Filter	HPR0326
Caprice	5.7L V8 F/I	HPR7017	Camaro	3.1L V6 F/I	HPR3902
Cavalier	2.2L L4 F/I	HPR3916	Camaro	5.0L V8 TBI	HPR0192
Cavalier	3.1L V6 F/I	HPR3902	Caprice	5.0L V8 F/I	HPR7017
Cavalier Z24	3.1L V6 F/I	HPR3902	Caprice	5.7L V8 F/I	HPR7017
Corsica	2.2L L4 F/I	HPR3916	Cavalier	2.2L L4 F/I	HPR3647
G10	4.3L V6 F/I	HPR0192	Cavalier	3.1L V6 F/I	HPR3902
G10	5.0L V8 F/I	HPR0192	Cavalier Z24	3.1L V6 F/I	HPR3902
G10	5.7L V8 F/I	HPR0192	Corsica	2.2L L4 F/I	HPR3647
G20	4.3L V6 F/I	HPR0192	G10	4.3L V6 F/I	HPR0192
G20	5.0L V8 F/I	HPR0192	G10	5.0L V8 F/I	HPR0192
G20	5.7L V8 F/I	HPR0192	G10	5.7L V8 F/I	HPR0192
G30	4.3L V6 F/I	HPR0192	G20	4.3L V6 F/I	HPR0192
G30	5.7L V8 F/I	HPR0192	G20	5.0L V8 F/I	HPR0192
G30	7.4L V8 F/I	HPR0326	G20	5.7L V8 F/I	HPR0192
K1500	4.3L V6 F/I	HPR0192 +	G30	4.3L V6 F/I	HPR0192
K1500	5.0L V8 F/I	HPR0326 +	G30	5.7L V8 F/I	HPR0192
K1500	5.7L V8 F/I	HPR0326 +	G30	7.4L V8 F/I - w/3-7/16 inch Tall Filter	HPR0326
K1500 Suburban	5.7L V8 F/I	HPR0326 +	K1500	4.3L V6 F/I	HPR0192 +
K2500	4.3L V6 F/I	HPR0192 +	K1500	5.0L V8 F/I	HPR0326 +
K2500	5.0L V8 F/I	HPR0326 +	K1500	5.7L V8 F/I	HPR0326 +
K2500	5.7L V8 F/I	HPR0326 +	K2500	4.3L V6 F/I	HPR0192 +
K2500	6.5L V8 DSL	HPR8038	K2500	5.0L V8 F/I	HPR0326 +
K2500	7.4L V8 F/I	HPR0326	K2500	5.7L V8 F/I	HPR0326 +
K2500 Suburban	5.7L V8 F/I	HPR0326 +	K2500	7.4L V8 F/I - w/3-7/16 inch Tall Filter	HPR0326
K2500 Suburban	7.4L V8 F/I	HPR0326	K3500	5.7L V8 F/I	HPR0326 +
K3500	5.7L V8 F/I	HPR0326 +	LLV	2.5L L4 F/I	HPR3647
K3500	6.5L V8 DSL	HPR8038	Lumina	3.1L V6 F/I	HPR6626
K3500	7.4L V8 F/I	HPR0326	Lumina	3.4L V6 F/I	HPR6626
Lumina	3.1L V6 F/I	HPR6626	Lumina APV	3.1L V6 F/I	HPR3588
Lumina	3.4L V6 F/I	HPR6626	Motorhome	4.3L V6 F/I - Class C	HPR0192
Lumina APV	3.1L V6 F/I	HPR3588	Motorhome	5.0L V8 F/I - Class C	HPR0192
Lumina APV	3.8L V6 F/I	HPR3916	Motorhome	5.7L V8 F/I - Class C	HPR0192
Motorhome	4.3L V6 F/I - Class C	HPR0192	Motorhome	7.4L V8 F/I - Class A & C, w/3-7/16 inch Tall Filter	HPR0326
Motorhome	5.0L V8 F/I - Class C	HPR0192	P30	4.3L V6 F/I	HPR0192
Motorhome	5.7L V8 F/I - VIN K, Class C, Exc. Off-Road	HPR0192	P30	5.7L V8 F/I	HPR0326
Motorhome	5.7L V8 F/I - VIN K, Class C, P Series	HPR0326	P30	7.4L V8 F/I - w/3-7/16 inch Tall Filter	HPR0326
Motorhome	7.4L V8 F/I - Class A & C, w/3-7/16 inch Tall Filter	HPR0326	R1500 Suburban	5.7L V8 F/I	HPR0326 +
P30	4.3L V6 F/I	HPR0192	R2500 Suburban	5.7L V8 F/I	HPR0326 +
P30	5.7L V8 F/I	HPR0326	R2500 Suburban	7.4L V8 F/I - w/3-7/16 inch Tall Filter	HPR0326
P30	7.4L V8 F/I	HPR0326	R3500	5.7L V8 F/I	HPR0326 +
S10 Blazer	4.3L V6 CPI	HPR7421 +	R3500	7.4L V8 F/I - w/3-7/16 inch Tall Filter	HPR0326
S10 Pickup	2.5L L4 F/I	HPR3647	S10 Blazer	4.3L V6 F/I	HPR3588 +
S10 Pickup	2.8L V6 F/I	HPR3588	S10 Pickup	2.5L L4 F/I	HPR3647
S10 Pickup	4.3L V6 CPI	HPR7421	S10 Pickup	2.8L V6 F/I	HPR3588
S10 Pickup	4.3L V6 TBI	HPR3588 +	S10 Pickup	4.3L V6 F/I	HPR3588 +
1991 CHEVROLET			V1500 Suburban	5.7L V8 F/I	HPR0326 +
Astro	4.3L V6 F/I	HPR3588	V2500 Suburban	5.7L V8 F/I	HPR0326 +

*Indicates 2 filters required ♦ Intake system available - see page 326 + throttle body spacer available - see page 20

HPR™ REPLACEMENT AIR FILTERS CHEVROLET

Vehicle	Engine Type	Air Filter
1991 CHEVROLET		
V3500	5.7L V8 F/I	HPR0326 +
V3500	7.4L V8 F/I - w/3-7/16 inch Tall Filter	HPR0326
1990 CHEVROLET		
Astro	2.5L L4 F/I	HPR3647
Astro	4.3L V6 F/I	HPR3588
Beretta	2.2L L4 F/I	HPR3647
Beretta	2.3L L4 F/I	HPR3916
Blazer	5.7L V8 F/I	HPR0326 +
C1500	4.3L V6 F/I	HPR0192 +
C1500	5.0L V8 F/I	HPR0326 +
C1500	5.7L V8 F/I	HPR0326 +
C1500	7.4L V8 F/I - w/3-7/16 inch Tall Filter	HPR0326 +
C2500	4.3L V6 F/I	HPR0192 +
C2500	5.0L V8 F/I	HPR0326 +
C2500	5.7L V8 F/I	HPR0326 +
C3500	5.7L V8 F/I	HPR0326 +
C3500	7.4L V8 F/I - w/3-7/16 inch Tall Filter	HPR0326 +
Camaro	3.1L V6 F/I	HPR3902
Camaro	5.0L V8 TBI	HPR0192
Caprice	4.3L V6 F/I	HPR0192
Caprice	5.0L V8 CARB	HPR0326
Caprice	5.0L V8 F/I	HPR0326
Caprice	5.7L V8 F/I	HPR0326
Cavalier	2.2L L4 F/I	HPR3647
Cavalier	3.1L V6 F/I	HPR3902
Cavalier Z24	3.1L V6 F/I	HPR3902
Celebrity	2.5L L4 F/I	HPR3647
Corsica	2.2L L4 F/I	HPR3647
G10	4.3L V6 F/I	HPR0192
G10	5.0L V8 F/I	HPR0192
G10	5.7L V8 F/I	HPR0192
G20	4.3L V6 F/I	HPR0192
G20	5.0L V8 F/I	HPR0192
G20	5.7L V8 F/I	HPR0192
G30	4.3L V6 F/I	HPR0192
G30	5.7L V8 F/I	HPR0192
G30	7.4L V8 F/I	HPR0326
K1500	4.3L V6 F/I	HPR0192 +
K1500	5.0L V8 F/I	HPR0326 +
K1500	5.7L V8 F/I	HPR0326 +
K2500	4.3L V6 F/I	HPR0192 +
K2500	5.0L V8 F/I	HPR0326 +
K2500	5.7L V8 F/I	HPR0326 +
K3500	5.7L V8 F/I	HPR0326 +
K3500	7.4L V8 F/I - w/3-7/16 inch Tall Filter	HPR0326 +
LLV	2.5L L4 F/I	HPR3647
Lumina	3.1L V6 F/I	HPR6626
Lumina APV	3.1L V6 F/I	HPR3588
Motorhome	4.3L V6 F/I - Class C	HPR0192
Motorhome	5.0L V8 F/I - Class C	HPR0192
Motorhome	5.7L V8 F/I - Class A & C	HPR0192
Motorhome	7.4L V8 F/I - Class A & C, w/3-7/16 inch Tall Filter	HPR0326
P30	4.3L V6 F/I	HPR0192
P30	5.7L V8 F/I	HPR0326
P30	7.4L V8 F/I	HPR0326
R1500 Suburban	5.7L V8 F/I	HPR0326 +
R2500 Suburban	5.7L V8 F/I	HPR0326 +
R2500 Suburban	7.4L V8 F/I - w/3-7/16 inch Tall Filter	HPR0326 +
R3500	5.7L V8 F/I	HPR0326 +
R3500	7.4L V8 F/I - w/3-7/16 inch Tall Filter	HPR0326 +
S10 Blazer	2.8L V6 F/I	HPR3588
S10 Blazer	4.3L V6 F/I	HPR3588 +
S10 Pickup	2.5L L4 F/I	HPR3647

Vehicle	Engine Type	Air Filter
1990 CHEVROLET		
S10 Pickup	2.8L V6 F/I	HPR3588
S10 Pickup	4.3L V6 F/I	HPR3588 +
V1500 Suburban	5.7L V8 F/I	HPR0326 +
V2500 Suburban	5.7L V8 F/I	HPR0326 +
V2500 Suburban	7.4L V8 F/I - w/3-7/16 inch Tall Filter	HPR0326 +
V3500	5.7L V8 F/I	HPR0326 +
V3500	7.4L V8 F/I - w/3-7/16 inch Tall Filter	HPR0326 +
1989 CHEVROLET		
Astro	2.5L L4 F/I	HPR3647
Astro	4.3L V6 F/I	HPR3588
Blazer	5.7L V8 F/I	HPR0326 +
C1500	4.3L V6 F/I	HPR0192 +
C1500	5.0L V8 F/I	HPR0326 +
C1500	5.7L V8 F/I	HPR0326 +
C2500	4.3L V6 F/I	HPR0192 +
C2500	5.0L V8 F/I	HPR0326 +
C2500	5.7L V8 F/I	HPR0326 +
C3500	5.7L V8 F/I	HPR0326 +
C3500	7.4L V8 F/I - w/3-7/16 inch Tall Filter	HPR0326 +
Camaro	5.0L V8 TBI	HPR0192
Caprice	4.3L V6 F/I	HPR0192
Caprice	5.0L V8 CARB	HPR0326
Caprice	5.0L V8 F/I	HPR0326
Caprice	5.7L V8 F/I	HPR0326
Cavalier	2.8L V6 F/I	HPR3902
Cavalier Z24	2.8L V6 F/I	HPR3902
Celebrity	2.5L L4 F/I	HPR3647
Corvette	5.7L V8 F/I	HPR3914
G10	4.3L V6 F/I	HPR0192
G10	5.0L V8 F/I	HPR0192
G10	5.7L V8 F/I	HPR0192
G20	4.3L V6 F/I	HPR0192
G20	5.0L V8 F/I	HPR0192
G20	5.7L V8 F/I	HPR0192
G30	4.3L V6 F/I	HPR0192
G30	5.7L V8 F/I	HPR0192
G30	7.4L V8 F/I	HPR0326
K1500	4.3L V6 F/I	HPR0192 +
K1500	5.0L V8 F/I	HPR0326 +
K1500	5.7L V8 F/I	HPR0326 +
K2500	4.3L V6 F/I	HPR0192 +
K2500	5.0L V8 F/I	HPR0326 +
K2500	5.7L V8 F/I	HPR0326 +
K3500	5.7L V8 F/I	HPR0326 +
K3500	7.4L V8 F/I - w/3-7/16 inch Tall Filter	HPR0326 +
LLV	2.5L L4 F/I	HPR3647
Motorhome	4.3L V6 F/I - Class C	HPR0192
Motorhome	5.0L V8 F/I - Class C	HPR0192
Motorhome	5.7L V8 F/I - Class A & C	HPR0192
Motorhome	7.4L V8 F/I - Class A & C, w/3-7/16 inch Tall Filter	HPR0326
P20	5.7L V8 F/I	HPR0326
P30	5.7L V8 F/I	HPR0326
P30	7.4L V8 CARB	HPR0326
R1500 Suburban	5.7L V8 F/I	HPR0326 +
R2500	5.7L V8 F/I	HPR0326 +
R2500	7.4L V8 F/I - w/3-7/16 inch Tall Filter	HPR0326 +
R2500 Suburban	5.7L V8 F/I	HPR0326 +
R2500 Suburban	7.4L V8 F/I - w/3-7/16 inch Tall Filter	HPR0326 +
R3500	5.7L V8 F/I	HPR0326 +
R3500	7.4L V8 CARB - w/3-7/16 inch Tall Filter	HPR0326 +
R3500	7.4L V8 F/I - w/3-7/16 inch Tall Filter	HPR0326 +
S10 Blazer	2.5L L4 F/I	HPR3647

*Indicates 2 filters required ♦ Intake system available - see page 326 + throttle body spacer available - see page 20

CHEVROLET HPR™ REPLACEMENT AIR FILTERS

Vehicle	Engine Type	Air Filter	Vehicle	Engine Type	Air Filter
1989 CHEVROLET			1988 CHEVROLET		
S10 Blazer	2.8L V6 F/I	HPR3588	R20	7.4L V8 F/I - w/3-7/16 inch Tall Filter	HPR0326 +
S10 Blazer	4.3L V6 F/I	HPR3588 +	R20 Suburban	5.7L V8 F/I	HPR0326 +
S10 Pickup	2.5L L4 F/I	HPR3647	R20 Suburban	7.4L V8 F/I - w/3-7/16 inch Tall Filter	HPR0326 +
S10 Pickup	2.8L V6 F/I	HPR3588	R30	5.7L V8 F/I	HPR0326 +
S10 Pickup	4.3L V6 F/I	HPR3588 +	R30	7.4L V8 CARB - w/3-7/16 inch Tall Filter	HPR0326 +
V1500 Suburban	5.7L V8 F/I	HPR0326 +	R30	7.4L V8 F/I - w/3-7/16 inch Tall Filter	HPR0326 +
V2500 Suburban	5.7L V8 F/I	HPR0326 +	S10 Blazer	2.5L L4 F/I	HPR3647
V3500	5.7L V8 F/I	HPR0326 +	S10 Blazer	2.8L V6 F/I	HPR3588
V3500	7.4L V8 CARB - w/3-7/16 inch Tall Filter	HPR0326 +	S10 Blazer	4.3L V6 F/I	HPR3588 +
V3500	7.4L V8 F/I - w/3-7/16 inch Tall Filter	HPR0326 +	S10 Pickup	2.5L L4 F/I	HPR3647
1988 CHEVROLET			S10 Pickup	2.8L V6 F/I	HPR3588
Astro	2.5L L4 F/I	HPR3647	S10 Pickup	4.3L V6 F/I	HPR3588 +
Astro	4.3L V6 F/I	HPR3588	V10 Suburban	5.7L V8 F/I	HPR0326 +
Blazer	5.7L V8 F/I	HPR0326 +	V20 Suburban	5.7L V8 F/I	HPR0326 +
C1500	4.3L V6 F/I	HPR0192 +	V20 Suburban	7.4L V8 F/I - w/3-7/16 inch Tall Filter	HPR0326 +
C1500	5.0L V8 F/I	HPR0326 +	V30	5.7L V8 F/I	HPR0326 +
C1500	5.7L V8 F/I	HPR0326 +	V30	7.4L V8 F/I - w/3-7/16 inch Tall Filter	HPR0326 +
C2500	4.3L V6 F/I	HPR0192 +	1987 CHEVROLET		
C2500	5.0L V8 F/I	HPR0326 +	Astro	2.5L L4 F/I	HPR3647
C2500	5.7L V8 F/I	HPR0326 +	Astro	4.3L V6 F/I	HPR3588
C3500	5.7L V8 F/I	HPR0326 +	Blazer	5.0L V8 F/I	HPR0326 +
C3500	7.4L V8 F/I - w/3-7/16 inch Tall Filter	HPR0326 +	Blazer	5.7L V8 F/I	HPR0326 +
Camaro	5.0L V8 TBI	HPR0192	Camaro	5.0L V8 CARB	HPR0192
Caprice	4.3L V6 F/I	HPR0192	Caprice	4.3L V6 F/I	HPR0192
Caprice	5.0L V8 CARB	HPR0326	Caprice	5.0L V8 CARB	HPR0326
Caprice	5.7L V8 CARB	HPR0326	Caprice	5.7L V8 CARB	HPR0326
Cavalier	2.8L V6 F/I	HPR3902	Cavalier	2.8L V6 F/I	HPR3902
Cavalier Z24	2.8L V6 F/I	HPR3902	Cavalier Z24	2.8L V6 F/I	HPR3902
Celebrity	2.5L L4 F/I	HPR3647	Celebrity	2.5L L4 F/I	HPR3647
Corvette	5.7L V8 F/I	HPR3914	Corvette	5.7L V8 F/I	HPR3914
G10	4.3L V6 F/I	HPR0192	El Camino	4.3L V6 F/I	HPR0192
G10	5.0L V8 F/I	HPR0192	El Camino	5.0L V8 CARB	HPR0326
G10	5.7L V8 F/I	HPR0192	G10	4.3L V6 F/I	HPR0192
G20	4.3L V6 F/I	HPR0192	G10	5.0L V8 F/I	HPR0192
G20	5.0L V8 F/I	HPR0326	G10	5.7L V8 F/I	HPR0192
G20	5.7L V8 F/I	HPR0192	G20	4.3L V6 F/I	HPR0192
G30	4.3L V6 F/I	HPR0192	G20	5.0L V8 F/I	HPR0192
G30	5.7L V8 CARB	HPR0326	G20	5.7L V8 F/I	HPR0192
G30	5.7L V8 F/I	HPR0192	G30	4.3L V6 F/I	HPR0192
G30	7.4L V8 F/I	HPR0326	G30	5.7L V8 CARB	HPR0192
K1500	4.3L V6 F/I	HPR0192 +	LLV	2.5L L4 F/I	HPR3647
K1500	5.0L V8 F/I	HPR0326 +	Monte Carlo	4.3L V6 F/I	HPR0192
K1500	5.7L V8 F/I	HPR0326 +	Monte Carlo	5.0L V8 CARB	HPR0326
K2500	4.3L V6 F/I	HPR0192 +	Motorhome	4.3L V6 F/I - Class C	HPR0192
K2500	5.0L V8 F/I	HPR0326 +	Motorhome	5.0L V8 F/I - Class C	HPR0192
K2500	5.7L V8 F/I	HPR0326 +	Motorhome	5.7L V8 F/I - Class A & C	HPR0192
K3500	5.7L V8 F/I	HPR0326 +	Motorhome	7.4L V8 F/I - Class A & C, w/3-7/16 inch Tall Filter	HPR0326
K3500	7.4L V8 F/I - w/3-7/16 inch Tall Filter	HPR0326 +	P20	5.7L V8 CARB	HPR0326
LLV	2.5L L4 F/I	HPR3647	P20	5.7L V8 F/I	HPR0326
Monte Carlo	4.3L V6 F/I	HPR0192	P30	5.7L V8 CARB	HPR0326
Monte Carlo	5.0L V8 CARB	HPR0326	P30	5.7L V8 F/I	HPR0326
Motorhome	4.3L V6 F/I - Class C	HPR0192	P30	7.4L V8 CARB	HPR0326
Motorhome	5.0L V8 F/I - Class C	HPR0192	R10 Suburban	5.0L V8 F/I	HPR0326 +
Motorhome	5.7L V8 F/I - Class A & C	HPR0192	R10 Suburban	5.7L V8 F/I	HPR0326 +
Motorhome	7.4L V8 F/I - Class A & C, w/3-7/16 inch Tall Filter	HPR0326	R10 Truck	4.3L V6 F/I	HPR0192 +
P20	5.7L V8 F/I	HPR0326	R10 Truck	5.0L V8 F/I	HPR0326 +
P30	5.7L V8 CARB	HPR0326	R10 Truck	5.7L V8 F/I	HPR0326 +
P30	7.4L V8 CARB	HPR0326	R20	4.3L V6 F/I	HPR0192 +
R10 Suburban	5.7L V8 F/I	HPR0326 +	R20	5.0L V8 F/I	HPR0326 +
R20	4.3L V6 F/I	HPR0192 +	R20	5.7L V8 F/I	HPR0326 +
R20	5.0L V8 F/I	HPR0326 +	R20	7.4L V8 F/I - w/3-7/16 inch Tall Filter	HPR0326 +
R20	5.7L V8 F/I	HPR0326 +	R20 Suburban	5.7L V8 F/I	HPR0326 +

*Indicates 2 filters required ♦ Intake system available - see page 326 + throttle body spacer available - see page 20

HPR™ REPLACEMENT AIR FILTERS CHEVROLET

Vehicle	Engine Type	Air Filter	Vehicle	Engine Type	Air Filter
1987 CHEVROLET			1986 CHEVROLET		
R20 Suburban	7.4L V8 F/I - w/3-7/16 inch Tall Filter	HPR0326 +	K10 Suburban	5.7L V8 CARB	HPR0326 +
R30	5.7L V8 F/I	HPR0326 +	K20	5.7L V8 CARB	HPR0326 +
R30	7.4L V8 CARB - w/3-7/16 inch Tall Filter	HPR0326 +	K20 Suburban	5.0L V8 CARB	HPR0326 +
R30	7.4L V8 F/I - w/3-7/16 inch Tall Filter	HPR0326 +	K20 Suburban	5.7L V8 CARB	HPR0326 +
S10 Blazer	2.5L L4 F/I	HPR3647	K30	5.7L V8 CARB	HPR0326 +
S10 Blazer	2.8L V6 F/I	HPR3588	K30	7.4L V8 CARB	HPR0326
S10 Pickup	2.5L L4 F/I	HPR3647	Monte Carlo	4.3L V6 F/I	HPR0192
S10 Pickup	2.8L V6 F/I	HPR3588	Monte Carlo	5.0L V8 CARB	HPR0326
V10	4.3L V6 F/I	HPR0192 +	Motorhome	4.3L V6 4 BBL. - Class C	HPR0192
V10	5.0L V8 F/I	HPR0326 +	Motorhome	5.0L V8 4 BBL. - Class C	HPR0192
V10	5.7L V8 F/I	HPR0326 +	Motorhome	5.7L V8 4 BBL. - Class A & C	HPR0192
V10 Suburban	5.7L V8 F/I	HPR0326 +	Motorhome	7.4L V8 4 BBL. - Class A & C, w/3-7/16 inch Tall Filter	HPR0326
V20	5.7L V8 F/I	HPR0326 +	P20	5.7L V8 CARB	HPR0326
V20 Suburban	5.7L V8 F/I	HPR0326 +	P30	5.7L V8 CARB	HPR0326
V20 Suburban	7.4L V8 F/I - w/3-7/16 inch Tall Filter	HPR0326 +	P30	7.4L V8 CARB	HPR0326
V30	5.7L V8 CARB	HPR0326 +	S10 Blazer	2.5L L4 F/I	HPR3647
V30	5.7L V8 F/I	HPR0326 +	S10 Blazer	2.8L V6 F/I	HPR3588
V30	7.4L V8 F/I - w/3-7/16 inch Tall Filter	HPR0326 +	S10 Pickup	2.5L L4 F/I	HPR3647
			S10 Pickup	2.8L V6 F/I	HPR3588
1986 CHEVROLET			1985 CHEVROLET		
Astro	2.5L L4 F/I	HPR3647	Astro	2.5L L4 F/I	HPR3647
Astro	4.3L V6 F/I	HPR3588	Astro	4.3L V6 CARB	HPR3588
C10	4.3L V6 CARB	HPR0192 +	C10	4.3L V6 CARB	HPR0326
C10	4.3L V6 CARB - w/3-1/2 inch Tall Filter	HPR0326 +	C10	5.0L V8 CARB	HPR0326
C10	5.0L V8 CARB	HPR0326 +	C10	5.7L V8 CARB - w/3-7/16 inch Tall Filter	HPR0326
C10	5.7L V8 CARB	HPR0326 +	C10 Suburban	5.0L V8 CARB	HPR0326
C10 Suburban	5.0L V8 CARB	HPR0326 +	C10 Suburban	5.7L V8 CARB	HPR0326
C10 Suburban	5.7L V8 CARB	HPR0326 +	C20	4.3L V6 CARB	HPR0326
C20	4.3L V6 CARB	HPR0326 +	C20	5.0L V8 CARB	HPR0326
C20	5.0L V8 CARB	HPR0326 +	C20	5.7L V8 CARB - w/3-7/16 inch Tall Filter	HPR0326
C20	5.7L V8 CARB	HPR0326 +	C20	7.4L V8 CARB - w/3-7/16 inch Tall Filter	HPR0326
C20	7.4L V8 CARB	HPR0326	C20 Suburban	5.0L V8 CARB	HPR0326
C20 Suburban	5.0L V8 CARB	HPR0326 +	C20 Suburban	5.7L V8 CARB	HPR0326
C20 Suburban	5.7L V8 CARB	HPR0326 +	C20 Suburban	7.4L V8 CARB - w/3-7/16 inch Tall Filter	HPR0326
C20 Suburban	7.4L V8 CARB - w/3-7/16 inch Tall Filter	HPR0326	C30 Truck	5.7L V8 CARB - w/3-7/16 inch Tall Filter	HPR0326
C30 Truck	5.0L V8 CARB	HPR0326 +	C30 Truck	7.4L V8 CARB - w/3-7/16 inch Tall Filter	HPR0326
C30 Truck	5.7L V8 CARB	HPR0326 +	C30 Truck	5.7L V8 CARB - w/3-7/16 inch Tall Filter	HPR0326
C30 Truck	7.4L V8 CARB	HPR0326	C35	5.7L V8 CARB - w/3-7/16 inch Tall Filter	HPR0326
C35	5.7L V8 CARB	HPR0326 +	Camaro	2.5L L4 F/I	HPR3647
Camaro	2.5L L4 F/I	HPR3647	Camaro	5.0L V8 CARB	HPR0192
Camaro	5.0L V8 CARB	HPR0192	Caprice	4.3L V6 F/I	HPR0192
Caprice	4.3L V6 F/I	HPR0192	Caprice	5.0L V8 CARB	HPR0326
Caprice	5.0L V8 CARB	HPR0326	Caprice	5.7L V8 CARB	HPR0326
Caprice	5.7L V8 CARB	HPR0326	Cavalier	2.0L L4 F/I	HPR3647
Cavalier	2.0L L4 F/I	HPR3647	Celebrity	2.5L L4 F/I	HPR3647
Celebrity	2.5L L4 F/I	HPR3647	Corvette	5.7L V8 F/I	HPR3914
Corvette	5.7L V8 F/I	HPR3914	El Camino	4.3L V6 F/I	HPR0192
El Camino	4.3L V6 F/I	HPR0192	El Camino	5.0L V8 CARB	HPR0326
El Camino	5.0L V8 CARB	HPR0326	G10	4.3L V6 CARB	HPR0192
G10	4.3L V6 CARB	HPR0192	G10	5.0L V8 CARB	HPR0192
G10	5.0L V8 CARB	HPR0192	G10	5.7L V8 CARB	HPR0192
G10	5.7L V8 CARB	HPR0192	G20 Van	4.3L V6 CARB	HPR0192
G20 Van	4.3L V6 CARB	HPR0192	G20 Van	5.0L V8 CARB	HPR0192
G20 Van	5.0L V8 CARB	HPR0192	G20 Van	5.7L V8 CARB	HPR0192
G20 Van	5.7L V8 CARB	HPR0192	G30	4.3L V6 CARB	HPR0192
G30	4.3L V6 CARB	HPR0192	G30	5.0L V8 CARB	HPR0192
G30	5.7L V8 CARB	HPR0192	G30	5.7L V8 CARB	HPR0192
K5 Blazer	5.0L V8 CARB	HPR0326 +	G20 Van	4.3L V6 CARB	HPR0192
K5 Blazer	5.7L V8 CARB	HPR0326 +	G20 Van	5.0L V8 CARB	HPR0192
K10	4.3L V6 CARB	HPR0326 +	G20 Van	5.7L V8 CARB	HPR0192
K10	5.0L V8 CARB	HPR0326 +	G30	4.3L V6 CARB	HPR0192
K10	5.7L V8 CARB	HPR0326 +	G30	5.0L V8 CARB	HPR0192
K10	5.7L V8 CARB	HPR0326 +	G30	5.7L V8 CARB	HPR0192
K10 Suburban	5.0L V8 CARB	HPR0326 +	Impala	4.3L V6 F/I	HPR0192

*Indicates 2 filters required ♦ Intake system available - see page 326 + throttle body spacer available - see page 20

CHEVROLET HPR™ REPLACEMENT AIR FILTERS

Vehicle	Engine Type	Air Filter	Vehicle	Engine Type	Air Filter
1985 CHEVROLET			1984 CHEVROLET		
Impala	5.0L V8 CARB	HPR0326	El Camino	3.8L V6 CARB - VIN 9	HPR3588
Impala	5.7L V8 CARB	HPR0326	El Camino	3.8L V6 CARB - VIN A	HPR0192
Impala	5.7L V8 DSL	HPR0326	El Camino	5.0L V8 CARB	HPR0326
K5 Blazer	5.0L V8 CARB	HPR0326	G10	5.0L V8 CARB	HPR0192
K5 Blazer	5.7L V8 CARB	HPR0326	G10	5.7L V8 CARB	HPR0192
K10	4.3L V6 CARB	HPR0326	G20 Van	5.0L V8 CARB	HPR0192
K10	5.0L V8 CARB	HPR0326	G20 Van	5.7L V8 CARB	HPR0192
K10	5.7L V8 CARB - w/3-7/16 inch Tall Filter	HPR0326	G30	5.0L V8 CARB	HPR0192
K10 Suburban	5.0L V8 CARB	HPR0326	G30	5.7L V8 CARB	HPR0192
K10 Suburban	5.7L V8 CARB	HPR0326	Impala	3.8L V6 CARB - VIN 9	HPR3588
K20	4.3L V6 CARB	HPR0326	Impala	3.8L V6 CARB - VIN A	HPR0192
K20	5.0L V8 CARB	HPR0326	Impala	5.0L V8 CARB	HPR0326
K20	5.7L V8 CARB - w/3-7/16 inch Tall Filter	HPR0326	Impala	5.7L V8 CARB	HPR0326
K20 Suburban	5.0L V8 CARB	HPR0326	Impala	5.7L V8 DSL	HPR0326
K20 Suburban	5.7L V8 CARB	HPR0326	K5 Blazer	5.0L V8 CARB	HPR0326
K20 Suburban	7.4L V8 CARB - w/3-7/16 inch Tall Filter	HPR0326	K5 Blazer	5.7L V8 CARB	HPR0326
K30	5.7L V8 CARB - w/3-7/16 inch Tall Filter	HPR0326	K10	5.0L V8 CARB	HPR0326
K30	7.4L V8 CARB - w/3-7/16 inch Tall Filter	HPR0326	K10	5.7L V8 CARB - w/3-7/16 inch Tall Filter	HPR0326
Monte Carlo	4.3L V6 F/I	HPR0192	K10 Suburban	5.0L V8 CARB	HPR0326
Monte Carlo	5.0L V8 CARB	HPR0326	K10 Suburban	5.7L V8 CARB	HPR0326
Motorhome	4.3L V6 4 BBL. - Class C	HPR0192	K20	5.0L V8 CARB	HPR0326
Motorhome	5.0L V8 4 BBL. - Class C	HPR0192	K20	5.7L V8 CARB - w/3-7/16 inch Tall Filter	HPR0326
Motorhome	5.7L V8 4 BBL. - Class A & C	HPR0192	K20 Suburban	5.7L V8 CARB	HPR0326
Motorhome	7.4L V8 4 BBL. - Class A & C, w/3-7/16 inch Tall Filter	HPR0326	K30	5.7L V8 CARB - w/3-7/16 inch Tall Filter	HPR0326
P20	5.7L V8 CARB	HPR0326	K30	7.4L V8 CARB - w/3-7/16 inch Tall Filter	HPR0326
P30	5.7L V8 CARB	HPR0326	Monte Carlo	3.8L V6 CARB - VIN 9	HPR3588
P30	7.4L V8 CARB	HPR0326	Monte Carlo	3.8L V6 CARB - VIN A	HPR0192
S10 Blazer	2.5L L4 F/I	HPR3647	Monte Carlo	5.0L V8 CARB	HPR0326
S10 Pickup	1.9L L4 CARB	HPR0352	Motorhome	5.0L V8 4 BBL. - Class C	HPR0192
S10 Pickup	2.2L L4 DSL	HPR0352	Motorhome	5.7L V8 4 BBL. - Class A & C	HPR0192
S10 Pickup	2.5L L4 F/I	HPR3647	Motorhome	7.4L V8 4 BBL. - Class A & C, w/3-7/16 inch Tall Filter	HPR0326
1984 CHEVROLET			P20	5.7L V8 CARB	HPR0192
C10	5.0L V8 CARB	HPR0326	P30	5.7L V8 CARB	HPR0192
C10	5.7L V8 CARB - w/3-7/16 inch Tall Filter	HPR0326	P30	7.4L V8 CARB	HPR0326
C10 Suburban	5.0L V8 CARB	HPR0326	S10 Blazer	1.9L L4 CARB	HPR0352
C10 Suburban	5.7L V8 CARB	HPR0326	S10 Blazer	2.2L L4 DSL	HPR0352
C15	5.7L V8 CARB - w/3-7/16 inch Tall Filter	HPR0326	S10 Blazer	2.5L L4 F/I	HPR3647
C20	5.0L V8 CARB	HPR0326	S10 Pickup	1.9L L4 CARB	HPR0352
C20	5.7L V8 CARB - w/3-7/16 inch Tall Filter	HPR0326	S10 Pickup	2.2L L4 DSL	HPR0352
C20	7.4L V8 CARB - w/3-7/16 inch Tall Filter	HPR0326	1983 CHEVROLET		
C20 Suburban	5.0L V8 CARB	HPR0326	C10	5.0L V8 CARB	HPR0326
C20 Suburban	5.7L V8 CARB	HPR0326	C10	5.7L V8 CARB - w/3-7/16 inch Tall Filter	HPR0326
C20 Suburban	7.4L V8 CARB - w/3-7/16 inch Tall Filter	HPR0326	C10 Suburban	5.0L V8 CARB	HPR0326
C30 Truck	5.7L V8 CARB - w/3-7/16 inch Tall Filter	HPR0326	C10 Suburban	5.7L V8 CARB	HPR0326
C30 Truck	7.4L V8 CARB - w/3-7/16 inch Tall Filter	HPR0326	C20	5.0L V8 CARB	HPR0326
C35	5.7L V8 CARB - w/3-7/16 inch Tall Filter	HPR0326	C20	5.7L V8 CARB - w/3-7/16 inch Tall Filter	HPR0326
Camaro	2.5L L4 F/I	HPR3647	C20	7.4L V8 CARB - w/3-7/16 inch Tall Filter	HPR0326
Camaro	5.0L V8 CARB	HPR0192	C20 Suburban	5.0L V8 CARB	HPR0326
Caprice	3.8L V6 CARB - VIN 9	HPR3588	C20 Suburban	5.7L V8 CARB	HPR0326
Caprice	3.8L V6 CARB - VIN A	HPR0192	C20 Suburban	7.4L V8 CARB - w/3-7/16 inch Tall Filter	HPR0326
Caprice	5.0L V8 CARB	HPR0326	C30 Truck	5.7L V8 CARB - w/3-7/16 inch Tall Filter	HPR0326
Cavalier	2.0L L4 CARB	HPR3647	C30 Truck	7.4L V8 CARB - w/3-7/16 inch Tall Filter	HPR0326
Cavalier	2.0L L4 F/I	HPR3647	C35	5.7L V8 CARB - w/3-7/16 inch Tall Filter	HPR0326
Celebrity	2.5L L4 F/I	HPR3647	Camaro	2.5L L4 F/I	HPR3647
Citation II	2.5L L4 F/I	HPR3647	Camaro	5.0L V8 CARB	HPR0192
			Caprice	3.8L V6 CARB - VIN 9	HPR3588

*Indicates 2 filters required ♦ Intake system available - see page 326 + throttle body spacer available - see page 20

HPR™ REPLACEMENT AIR FILTERS CHEVROLET

Vehicle	Engine Type	Air Filter	Vehicle	Engine Type	Air Filter
1983 CHEVROLET			1982 CHEVROLET		
Caprice	3.8L V6 CARB - VIN A	HPR0192	C30 Truck	5.7L V8 CARB	HPR0326
Caprice	5.0L V8 CARB	HPR0326	C30 Truck	7.4L V8 CARB	HPR0326
Cavalier	2.0L L4 CARB	HPR3647	Camaro	2.5L L4 F/I	HPR3647
Cavalier	2.0L L4 F/I	HPR3647	Camaro	5.0L V8 CARB	HPR0192
Celebrity	2.5L L4 CARB	HPR3647	Caprice	3.8L V6 CARB - VIN A	HPR0192
Celebrity	2.5L L4 F/I	HPR3647	Caprice	3.8L V6 CARB - VIN K	HPR3588
Citation	2.5L L4 CARB	HPR3647	Caprice	4.4L V8 CARB	HPR3588
Citation	2.5L L4 F/I	HPR3647	Caprice	5.0L V8 CARB	HPR0326
El Camino	3.8L V6 CARB - VIN 9	HPR3588	Celebrity	2.5L L4 CARB	HPR3647
El Camino	3.8L V6 CARB - VIN A	HPR0192	Celebrity	2.5L L4 F/I	HPR3647
El Camino	5.0L V8 CARB	HPR0326	Citation	2.5L L4 CARB	HPR3647
G10	5.0L V8 CARB	HPR0192	Citation	2.5L L4 F/I	HPR3647
G10	5.7L V8 CARB	HPR0192	El Camino	3.8L V6 CARB - VIN A	HPR0192
G20 Van	5.0L V8 CARB	HPR0192	El Camino	3.8L V6 CARB - VIN K	HPR3588
G20 Van	5.7L V8 CARB	HPR0192	El Camino	4.4L V8 CARB	HPR3588
G30	5.0L V8 CARB	HPR0192	El Camino	5.0L V8 CARB	HPR0326
G30	5.7L V8 CARB	HPR0192	G10	5.0L V8 CARB	HPR0192
Impala	3.8L V6 CARB - VIN 9	HPR3588	G10	5.7L V8 CARB	HPR0192
Impala	3.8L V6 CARB - VIN A	HPR0192	G20 Van	5.0L V8 CARB	HPR0192
Impala	5.0L V8 CARB	HPR0326	G20 Van	5.7L V8 CARB	HPR0326
Impala	5.7L V8 CARB	HPR0326	G30	5.0L V8 CARB	HPR0192
Impala	5.7L V8 DSL	HPR0326	G30	5.7L V8 CARB	HPR0326
K5 Blazer	5.0L V8 CARB	HPR0326	Impala	3.8L V6 CARB - VIN A	HPR0192
K5 Blazer	5.7L V8 CARB - w/3-7/16 inch Tall Filter	HPR0326	Impala	3.8L V6 CARB - VIN K	HPR3588
K10	5.0L V8 CARB	HPR0326	Impala	4.4L V8 CARB	HPR3588
K10	5.7L V8 CARB - w/3-7/16 inch Tall Filter	HPR0326	Impala	5.0L V8 CARB	HPR0326
K10 Suburban	5.0L V8 CARB	HPR0326	Impala	5.7L V8 CARB	HPR0326
K10 Suburban	5.7L V8 CARB	HPR0326	Impala	5.7L V8 DSL	HPR0326
K20	5.0L V8 CARB	HPR0326	K5 Blazer	5.0L V8 CARB	HPR0326
K20	5.7L V8 CARB - w/3-7/16 inch Tall Filter	HPR0326	K5 Blazer	5.7L V8 CARB	HPR0326
K20 Suburban	5.7L V8 CARB	HPR0326	K10	5.0L V8 CARB	HPR0192
K30	5.7L V8 CARB - w/3-7/16 inch Tall Filter	HPR0326	K10	5.7L V8 CARB	HPR0326
K30	7.4L V8 CARB - w/3-7/16 inch Tall Filter	HPR0326	K10 Suburban	5.0L V8 CARB	HPR0326
Malibu	3.8L V6 CARB - VIN 9	HPR3588	K10 Suburban	5.7L V8 CARB	HPR0326
Malibu	3.8L V6 CARB - VIN A	HPR0192	K20	5.0L V8 CARB	HPR0192
Malibu	5.0L V8 CARB	HPR0326	K20	5.7L V8 CARB	HPR0326
Monte Carlo	3.8L V6 CARB - VIN 9	HPR3588	K20 Suburban	5.7L V8 CARB	HPR0326
Monte Carlo	3.8L V6 CARB - VIN A	HPR0192	K30	5.7L V8 CARB	HPR0326
Monte Carlo	5.0L V8 CARB	HPR0326	K30	7.4L V8 CARB	HPR0326
Motorhome	5.0L V8 4 BBL. - Class C	HPR0192	Luv	1.8L L4 CARB	HPR0352
Motorhome	5.7L V8 4 BBL. - Class A & C	HPR0192	Luv	2.2L L4 DSL	HPR0352
Motorhome	7.4L V8 4 BBL. - Class A & C, w/3-7/16 inch Tall Filter	HPR0326	Malibu	3.8L V6 CARB - VIN A	HPR0192
P20	5.7L V8 CARB	HPR0192	Malibu	3.8L V6 CARB - VIN K	HPR3588
P30	5.7L V8 CARB	HPR0192	Malibu	4.4L V8 CARB	HPR3588
P30	7.4L V8 CARB	HPR0326	Malibu	5.0L V8 CARB	HPR0326
S10 Blazer	1.9L L4 CARB	HPR0352	Monte Carlo	3.8L V6 CARB - VIN A	HPR0192
S10 Pickup	1.9L L4 CARB	HPR0352	Monte Carlo	3.8L V6 CARB - VIN K	HPR3588
S10 Pickup	2.2L L4 DSL	HPR0352	Monte Carlo	4.4L V8 CARB	HPR3588
1982 CHEVROLET			Monte Carlo	5.0L V8 CARB	HPR0326
C10	5.0L V8 CARB	HPR0192	Motorhome	5.0L V8 4 BBL. - Class C	HPR0192
C10	5.7L V8 CARB	HPR0326	Motorhome	5.7L V8 4 BBL. - Class A & C	HPR0192
C10 Suburban	5.0L V8 CARB	HPR0326	Motorhome	7.4L V8 4 BBL. - Class A & C, w/3-7/16 inch Tall Filter	HPR0326
C10 Suburban	5.7L V8 CARB	HPR0326	Motorhome	5.7L V8 CARB	HPR0326
C20	5.0L V8 CARB	HPR0192	P20	5.7L V8 CARB	HPR0326
C20	5.7L V8 CARB	HPR0326	P30	5.7L V8 CARB	HPR0326
C20	7.4L V8 CARB	HPR0326	P30	7.4L V8 CARB	HPR0326
C20 Suburban	5.0L V8 CARB	HPR0326	S10 Blazer	2.0L L4 CARB	HPR0352
C20 Suburban	5.7L V8 CARB	HPR0326	S10 Pickup	1.9L L4 CARB	HPR0352
C20 Suburban	7.4L V8 CARB - w/3-7/16 inch Tall Filter	HPR0326	1981 CHEVROLET		
1982 CHEVROLET			Bel Air	4.4L V8 CARB	HPR3588
C10	5.0L V8 CARB	HPR0192	Bel Air	5.0L V8 CARB	HPR0326
C10	5.7L V8 CARB	HPR0326	C10	5.0L V8 2 BBL.	HPR0192 ♦
C10 Suburban	5.0L V8 CARB	HPR0326	C10	5.0L V8 4 BBL.	HPR0326 ♦
C10 Suburban	5.7L V8 CARB	HPR0326	C10	5.7L V8 CARB	HPR0326 ♦
C20	5.0L V8 CARB	HPR0192			
C20	5.7L V8 CARB	HPR0326			
C20	7.4L V8 CARB	HPR0326			
C20 Suburban	5.0L V8 CARB	HPR0326			
C20 Suburban	5.7L V8 CARB	HPR0326			
C20 Suburban	7.4L V8 CARB - w/3-7/16 inch Tall Filter	HPR0326			

*Indicates 2 filters required ♦ Intake system available - see page 326 + throttle body spacer available - see page 20

CHEVROLET HPR™ REPLACEMENT AIR FILTERS

Vehicle	Engine Type	Air Filter	Vehicle	Engine Type	Air Filter
1981 CHEVROLET			1981 CHEVROLET		
C10 Suburban	5.0L V8 2 BBL.	HPR0192	Monte Carlo	5.7L V8 CARB	HPR0326
C10 Suburban	5.0L V8 4 BBL.	HPR0326 ♦	Motorhome	5.0L V8 4 BBL. - Class C	HPR0192
C10 Suburban	5.7L V8 CARB	HPR0326 ♦	Motorhome	5.7L V8 4 BBL. - Class A & C	HPR0192
C20	5.0L V8 CARB	HPR0326 ♦	Motorhome	7.4L V8 4 BBL. - Class A & C, w/3-7/16 inch Tall Filter	HPR0326
C20	5.7L V8 CARB	HPR0326 ♦	P20	5.7L V8 CARB	HPR0326
C20	7.4L V8 CARB	HPR0326 ♦	P30	5.7L V8 CARB	HPR0326
C20 Suburban	5.0L V8 CARB	HPR0326 ♦	P30	7.4L V8 CARB	HPR0326
C20 Suburban	5.7L V8 CARB	HPR0326 ♦	1980 CHEVROLET		
C20 Suburban	7.4L V8 CARB - w/3-7/16 inch Tall Filter	HPR0326 ♦	C10	305 V8 CARB	HPR0192 ♦
C30 Truck	5.7L V8 CARB	HPR0326 ♦	C10	350 V8 2 BBL.	HPR0192 ♦
C30 Truck	7.4L V8 CARB	HPR0326 ♦	C10	350 V8 4 BBL. - w/3-7/16 inch Tall Filter	HPR0326 ♦
Camaro	3.8L V6 CARB - VIN A	HPR0192	C10	400 V8 CARB - w/3-7/16 inch Tall Filter	HPR0326 ♦
Camaro	3.8L V6 CARB - VIN K	HPR3588	C10	454 V8 CARB - w/3-7/16 inch Tall Filter	HPR0326 ♦
Camaro	4.4L V8 CARB	HPR3588	C10 Suburban	305 V8 CARB	HPR0192 ♦
Camaro	5.0L V8 CARB	HPR0326 ♦	C10 Suburban	350 V8 CARB - w/3-7/16 inch Tall Filter	HPR0326 ♦
Camaro	5.7L V8 CARB	HPR0326 ♦	C10 Suburban	454 V8 CARB - w/3-7/16 inch Tall Filter	HPR0326 ♦
Caprice	3.8L V6 CARB - VIN A	HPR0192	C20	305 V8 CARB	HPR0192 ♦
Caprice	3.8L V6 CARB - VIN K	HPR3588	C20	350 V8 2 BBL.	HPR0192 ♦
Caprice	4.4L V8 CARB	HPR3588	C20	350 V8 4 BBL. - w/3-7/16 inch Tall Filter	HPR0326 ♦
Caprice	5.0L V8 CARB	HPR0326	C20	400 V8 CARB - w/3-7/16 inch Tall Filter	HPR0326 ♦
Caprice	5.7L V8 CARB	HPR0326	C20	454 V8 CARB - w/3-7/16 inch Tall Filter	HPR0326 ♦
Corvette	5.7L V8 CARB	HPR0326	C20 Suburban	305 V8 CARB	HPR0192 ♦
El Camino	3.8L V6 CARB - VIN A	HPR0192	C20 Suburban	350 V8 CARB - w/3-7/16 inch Tall Filter	HPR0326 ♦
El Camino	3.8L V6 CARB - VIN K	HPR3588	C20 Suburban	400 V8 CARB - w/3-7/16 inch Tall Filter	HPR0326 ♦
El Camino	4.4L V8 CARB	HPR3588 ♦	C20 Suburban	454 V8 CARB - w/3-7/16 inch Tall Filter	HPR0326 ♦
El Camino	5.0L V8 CARB	HPR0326 ♦	C30 Truck	350 V8 CARB - w/3-7/16 inch Tall Filter	HPR0326 ♦
G10	5.0L V8 2 BBL.	HPR0192	C30 Truck	454 V8 CARB - w/3-7/16 inch Tall Filter	HPR0326 ♦
G10	5.0L V8 4 BBL.	HPR0326	Camaro	231 V6 CARB	HPR0192
G10	5.7L V8 CARB	HPR0192	Camaro	305 V8 CARB	HPR0326 ♦
G20 Van	5.0L V8 2 BBL.	HPR0192	Camaro	350 V8 CARB	HPR0326 ♦
G20 Van	5.0L V8 4 BBL.	HPR0326	Caprice	229 V6 CARB	HPR0192
G20 Van	5.7L V8 CARB	HPR0326	Caprice	231 V6 CARB	HPR0192
G30	5.7L V8 CARB	HPR0326	Caprice	267 V8 CARB	HPR0192
Impala	3.8L V6 CARB - VIN A	HPR0192	Caprice	305 V8 CARB	HPR0326
Impala	3.8L V6 CARB - VIN K	HPR3588	Caprice	350 V8 CARB	HPR0326
Impala	4.4L V8 CARB	HPR3588	Caprice	350 V8 DSL	HPR0326
Impala	5.0L V8 CARB	HPR0326	Corvette	305 V8 CARB	HPR0326
Impala	5.7L V8 CARB	HPR0326	Corvette	350 V8 CARB	HPR0326
Impala	5.7L V8 DSL	HPR0326	El Camino	229 V6 CARB	HPR3588
K5 Blazer	5.0L V8 2 BBL.	HPR0192 ♦	El Camino	231 V6 CARB	HPR0192
K5 Blazer	5.0L V8 4 BBL.	HPR0326 ♦	El Camino	267 V8 CARB	HPR0192
K5 Blazer	5.7L V8 CARB	HPR0326 ♦	El Camino	305 V8 CARB	HPR0326
K10	5.0L V8 CARB	HPR0326 ♦	G10	305 V8 CARB	HPR0192
K10	5.7L V8 CARB	HPR0326 ♦	G10	350 V8 CARB	HPR0192
K10 Suburban	5.0L V8 2 BBL.	HPR0192	G20 Van	305 V8 CARB	HPR0192
K10 Suburban	5.0L V8 4 BBL.	HPR0326 ♦	G20 Van	350 V8 CARB	HPR0192
K10 Suburban	5.7L V8 CARB	HPR0326 ♦	G20 Van	400 V8 CARB	HPR0192
K20	5.0L V8 CARB	HPR0326 ♦	G30	350 V8 CARB	HPR0192
K20	5.7L V8 CARB	HPR0326 ♦	G30	400 V8 CARB	HPR0192
K20 Suburban	5.7L V8 CARB	HPR0326 ♦	Impala	229 V6 CARB	HPR0192
K30	5.7L V8 CARB	HPR0326 ♦	Impala	231 V6 CARB	HPR0192
K30	7.4L V8 CARB	HPR0326 ♦	Impala	267 V8 CARB	HPR0192
Luv	1.8L L4 CARB	HPR0352	Impala	305 V8 CARB	HPR0326
Luv	2.2L L4 DSL	HPR0352	Impala	350 V8 CARB	HPR0326
Malibu	3.8L V6 CARB - VIN A	HPR0192	Impala	350 V8 DSL	HPR0326
Malibu	3.8L V6 CARB - VIN K	HPR3588			
Malibu	4.4L V8 CARB	HPR3588			
Malibu	5.0L V8 CARB	HPR0326			
Malibu	5.7L V8 CARB	HPR0326			
Monte Carlo	3.8L V6 CARB - VIN A	HPR0192			
Monte Carlo	3.8L V6 CARB - VIN K	HPR3588			
Monte Carlo	4.4L V8 CARB	HPR3588			
Monte Carlo	5.0L V8 CARB	HPR0326			

*Indicates 2 filters required ♦ Intake system available - see page 326 + throttle body spacer available - see page 20

HPR™ REPLACEMENT AIR FILTERS CHEVROLET

Vehicle	Engine Type	Air Filter	Vehicle	Engine Type	Air Filter
1980 CHEVROLET			1979 CHEVROLET		
K5 Blazer	305 V8 CARB	HPR0192 ♦	C30 Truck	454 V8 CARB	HPR0326 ♦
K5 Blazer	350 V8 CARB - w/3-7/16 inch Tall Filter	HPR0326 ♦	Caparo	350 V8 CARB	HPR0326 ♦
K10	350 V8 CARB - w/3-7/16 inch Tall Filter	HPR0326 ♦	Caprice	305 V8 CARB	HPR0326
K10	400 V8 CARB - w/3-7/16 inch Tall Filter	HPR0326 ♦	Caprice	350 V8 CARB	HPR0326
K10	454 V8 CARB - w/3-7/16 inch Tall Filter	HPR0326 ♦	Corvette	350 V8 CARB	HPR0326
K10 Suburban	305 V8 CARB	HPR0192 ♦	El Camino	200 V6 CARB	HPR0192
K10 Suburban	350 V8 CARB - w/3-7/16 inch Tall Filter	HPR0326 ♦	El Camino	231 V6 CARB	HPR0192
K20	305 V8 CARB	HPR0192 ♦	El Camino	267 V8 CARB	HPR0192
K20	350 V8 CARB - w/3-7/16 inch Tall Filter	HPR0326 ♦	El Camino	305 V8 CARB	HPR0326
K20	400 V8 CARB - w/3-7/16 inch Tall Filter	HPR0326 ♦	El Camino	350 V8 CARB	HPR0326
K20	454 V8 CARB - w/3-7/16 inch Tall Filter	HPR0326 ♦	G10	305 V8 CARB	HPR0192
K20 Suburban	350 V8 2 BBL.	HPR0192 ♦	G10	350 V8 CARB	HPR0192
K20 Suburban	350 V8 4 BBL. - w/3-7/16 inch Tall Filter	HPR0326 ♦	G20	400 V8 CARB	HPR0192
K20 Suburban	400 V8 CARB - w/3-7/16 inch Tall Filter	HPR0326 ♦	G20 Van	305 V8 CARB	HPR0192
K30	350 V8 CARB - w/3-7/16 inch Tall Filter	HPR0326 ♦	G20 Van	350 V8 CARB	HPR0192
K30	400 V8 CARB - w/3-7/16 inch Tall Filter	HPR0326 ♦	G30	305 V8 CARB	HPR0192
K30	454 V8 CARB - w/3-7/16 inch Tall Filter	HPR0326 ♦	G30	350 V8 CARB	HPR0192
Luv	111 L4 CARB	HPR0352	G30	400 V8 CARB	HPR0192
Malibu	229 V6 CARB	HPR0192	Impala	305 V8 CARB	HPR0192
Malibu	231 V6 CARB	HPR0192	Impala	350 V8 CARB	HPR0326
Malibu	267 V8 CARB	HPR0192	K5 Blazer	305 V8 CARB	HPR0192 ♦
Malibu	305 V8 CARB	HPR0326	K5 Blazer	350 V8 CARB	HPR0326 ♦
Malibu	350 V8 CARB	HPR0326	K5 Blazer	400 V8 CARB	HPR0326 ♦
Monte Carlo	229 V6 CARB	HPR0192	K10	305 V8 CARB	HPR0192 ♦
Monte Carlo	231 V6 2 BBL.	HPR0192	K10	350 V8 CARB	HPR0326 ♦
Monte Carlo	267 V8 CARB	HPR0192	K10	400 V8 CARB	HPR0326 ♦
Monte Carlo	305 V8 CARB	HPR0326	K10	454 V8 CARB	HPR0326 ♦
Monza	231 V6 CARB	HPR0192	K10 Suburban	305 V8 CARB	HPR0192 ♦
Motorhome	305 V8 4 BBL. - Class C	HPR0192	K10 Suburban	350 V8 CARB	HPR0326 ♦
Motorhome	350 V8 4 BBL. - Class A & C	HPR0192	K10 Suburban	400 V8 CARB	HPR0326 ♦
Motorhome	400 V8 4 BBL. - Class C	HPR0192	K20	350 V8 CARB	HPR0326 ♦
Motorhome	454 V8 4 BBL. - Class A & C, w/3-7/16 inch Tall Filter	HPR0326	K20	400 V8 CARB	HPR0326 ♦
P20	350 V8 CARB	HPR0192	K20	454 V8 CARB	HPR0326 ♦
P30	350 V8 CARB	HPR0192	K20 Suburban	350 V8 CARB	HPR0326 ♦
P30	454 V8 CARB - w/3-7/16 inch Tall Filter	HPR0326	K20 Suburban	400 V8 CARB	HPR0326 ♦
1979 CHEVROLET			K30	350 V8 CARB	HPR0326 ♦
C10	305 V8 CARB	HPR0192 ♦	K30	400 V8 CARB	HPR0326 ♦
C10	350 V8 CARB	HPR0192 ♦	Luv	111 L4 CARB	HPR0352
C10	400 V8 CARB	HPR0326 ♦	Malibu	200 V6 CARB	HPR0192
C10	454 V8 CARB	HPR0326 ♦	Malibu	231 V6 CARB	HPR0192
C10 Suburban	305 V8 CARB	HPR0192 ♦	Malibu	267 V8 CARB	HPR0192
C10 Suburban	350 V8 CARB	HPR0192 ♦	Malibu	305 V8 CARB	HPR0326
C10 Suburban	454 V8 CARB	HPR0326 ♦	Malibu	350 V8 CARB	HPR0326
C20	305 V8 CARB	HPR0192 ♦	Monte Carlo	200 V6 CARB	HPR0192
C20	350 V8 CARB	HPR0192 ♦	Monte Carlo	231 V6 CARB	HPR0192
C20	400 V8 CARB	HPR0326 ♦	Monte Carlo	267 V8 CARB	HPR0192
C20	454 V8 CARB	HPR0326 ♦	Monte Carlo	305 V8 CARB	HPR0326
C20 Suburban	305 V8 CARB	HPR0192 ♦	Monza	196 V6 CARB	HPR0192
C20 Suburban	350 V8 CARB	HPR0192 ♦	Monza	231 V6 CARB	HPR0192
C20 Suburban	400 V8 CARB	HPR0326 ♦	Motorhome	305 V8 4 BBL. - Class C	HPR0192
C20 Suburban	454 V8 CARB	HPR0326 ♦	Motorhome	350 V8 4 BBL. - Class C	HPR0192
C30 Truck	305 V8 CARB	HPR0192 ♦	Motorhome	400 V8 4 BBL. - Class C	HPR0192
C30 Truck	350 V8 CARB	HPR0192 ♦	Motorhome	454 V8 4 BBL. - Class A & C, w/3-7/16 inch Tall Filter	HPR0326
C30 Truck	400 V8 CARB	HPR0326 ♦	Nova	305 V8 CARB	HPR0192
1978 CHEVROLET			Nova	350 V8 CARB	HPR0326
C10	305 V8 CARB	HPR0192 ♦	P10	305 V8 CARB	HPR0192
C10	350 V8 CARB	HPR0192 ♦	P20	350 V8 CARB	HPR0192

*Indicates 2 filters required ♦ Intake system available - see page 326 + throttle body spacer available - see page 20

CHEVROLET HPR™ REPLACEMENT AIR FILTERS

Vehicle	Engine Type	Air Filter	Vehicle	Engine Type	Air Filter
1978 CHEVROLET			1978 CHEVROLET		
C10	400 V8 CARB	HPR0326 ♦	Motorhome	454 V8 4 BBL. - Class A & C, w/3-7/16 inch Tall Filter	HPR0326
C10	454 V8 CARB	HPR0326 ♦	Nova	305 V8 CARB	HPR0192
C10 Suburban	305 V8 CARB	HPR0192 ♦	Nova	350 V8 CARB	HPR0326
C10 Suburban	350 V8 CARB	HPR0326 ♦	P10	350 V8 CARB	HPR0192
C10 Suburban	454 V8 CARB	HPR0326 ♦	P20	350 V8 CARB	HPR0192
C20	305 V8 CARB	HPR0192 ♦	P20	454 V8 CARB	HPR0326
C20	350 V8 CARB	HPR0192 ♦	P30	350 V8 CARB	HPR0192
C20	400 V8 CARB	HPR0326 ♦	P30	454 V8 CARB	HPR0326
C20	454 V8 CARB	HPR0326 ♦	1977 CHEVROLET		
C20 Suburban	305 V8 CARB	HPR0192 ♦	C10	305 V8 CARB	HPR0192 ♦
C20 Suburban	350 V8 CARB	HPR0192 ♦	C10	350 V8 CARB	HPR0326 ♦
C20 Suburban	400 V8 CARB	HPR0326 ♦	C10	400 V8 CARB	HPR0326 ♦
C20 Suburban	454 V8 CARB	HPR0326 ♦	C10	454 V8 CARB	HPR0326 ♦
C30 Truck	305 V8 CARB	HPR0192 ♦	C10 Suburban	305 V8 CARB	HPR0192 ♦
C30 Truck	350 V8 CARB	HPR0326 ♦	C10 Suburban	350 V8 CARB	HPR0326 ♦
C30 Truck	400 V8 CARB	HPR0326 ♦	C10 Suburban	454 V8 CARB	HPR0326 ♦
C30 Truck	454 V8 CARB	HPR0326 ♦	C20	305 V8 CARB	HPR0192 ♦
Camaro	305 V8 CARB	HPR0192 ♦	C20	350 V8 CARB	HPR0326 ♦
Camaro	350 V8 CARB	HPR0326 ♦	C20	400 V8 CARB	HPR0326 ♦
Caprice	305 V8 CARB	HPR0326	C20	454 V8 CARB	HPR0326 ♦
Caprice	350 V8 CARB	HPR0326	C20 Suburban	305 V8 CARB	HPR0192 ♦
Corvette	350 V8 CARB	HPR0326	C20 Suburban	350 V8 CARB	HPR0326 ♦
El Camino	200 V6 CARB	HPR0192	C20 Suburban	400 V8 CARB	HPR0326 ♦
El Camino	231 V6 CARB	HPR0192	C20 Suburban	454 V8 CARB	HPR0326 ♦
El Camino	305 V8 CARB	HPR0192	C30 Truck	350 V8 CARB	HPR0326 ♦
El Camino	350 V8 CARB	HPR0326	C30 Truck	400 V8 CARB	HPR0326 ♦
G10	305 V8 CARB	HPR0192	C30 Truck	454 V8 CARB	HPR0326 ♦
G10	350 V8 CARB	HPR0192	Camaro	305 V8 CARB	HPR0192 ♦
G20	305 V8 CARB	HPR0192	Camaro	350 V8 CARB	HPR0326 ♦
G20	400 V8 CARB	HPR0192	Caprice	305 V8 CARB	HPR0326
G20 Van	350 V8 CARB	HPR0192	Caprice	350 V8 CARB	HPR0326
G30	305 V8 CARB	HPR0192	Corvette	350 V8 CARB	HPR0326
G30	350 V8 CARB	HPR0192	El Camino	305 V8 CARB	HPR0326
G30	400 V8 CARB	HPR0192	El Camino	350 V8 CARB	HPR0326
Impala	305 V8 CARB	HPR0326	G10	305 V8 CARB	HPR0192
Impala	350 V8 CARB	HPR0326	G10	350 V8 CARB	HPR0192
K5 Blazer	305 V8 CARB	HPR0192 ♦	G20	305 V8 CARB	HPR0192
K5 Blazer	350 V8 CARB	HPR0326 ♦	G20	350 V8 CARB	HPR0192
K5 Blazer	400 V8 CARB	HPR0326 ♦	G20	400 V8 CARB	HPR0192
K5 Blazer	454 V8 CARB	HPR0326 ♦	G30	350 V8 CARB	HPR0192
K10	350 V8 CARB	HPR0326 ♦	G30	400 V8 CARB	HPR0192
K10	400 V8 CARB	HPR0326 ♦	Impala	305 V8 CARB	HPR0326
K10	454 V8 CARB	HPR0326 ♦	Impala	350 V8 CARB	HPR0326
K10 Suburban	350 V8 CARB	HPR0326 ♦	K5 Blazer	305 V8 CARB	HPR0192 ♦
K10 Suburban	400 V8 CARB	HPR0326 ♦	K5 Blazer	350 V8 CARB	HPR0326 ♦
K20	350 V8 CARB	HPR0326 ♦	K5 Blazer	400 V8 CARB	HPR0326 ♦
K20	400 V8 CARB	HPR0326 ♦	K5 Blazer	454 V8 CARB	HPR0326 ♦
K20	454 V8 CARB	HPR0326 ♦	K10	305 V8 CARB	HPR0192 ♦
K20 Suburban	350 V8 CARB	HPR0326 ♦	K10	350 V8 CARB	HPR0326 ♦
K20 Suburban	400 V8 CARB	HPR0326 ♦	K10	400 V8 CARB	HPR0326 ♦
K30	350 V8 CARB	HPR0326 ♦	K10	454 V8 CARB	HPR0326 ♦
K30	400 V8 CARB	HPR0326 ♦	K10 Suburban	305 V8 CARB	HPR0192 ♦
Luv	111 L4 CARB	HPR0352	K10 Suburban	350 V8 CARB	HPR0326 ♦
Malibu	200 V6 CARB	HPR0192	K10 Suburban	400 V8 CARB	HPR0326 ♦
Malibu	231 V6 CARB	HPR0192	K20	305 V8 CARB	HPR0192 ♦
Malibu	305 V8 CARB	HPR0192	K20	350 V8 CARB	HPR0326 ♦
Malibu	350 V8 CARB	HPR0326	K20	400 V8 CARB	HPR0326 ♦
Monte Carlo	200 V6 CARB	HPR0192	K20	454 V8 CARB	HPR0326 ♦
Monte Carlo	231 V6 CARB	HPR0192	K20 Suburban	305 V8 CARB	HPR0192 ♦
Monte Carlo	305 V8 CARB	HPR0192	K20 Suburban	350 V8 CARB	HPR0326 ♦
Monza	305 V8 CARB	HPR0192	K20 Suburban	400 V8 CARB	HPR0326 ♦
Motorhome	305 V8 4 BBL. - Class C	HPR0192	K30	350 V8 CARB	HPR0326 ♦
Motorhome	350 V8 4 BBL. - Class A & C	HPR0192	K30	400 V8 CARB	HPR0326 ♦
Motorhome	400 V8 4 BBL. - Class C	HPR0192			

*Indicates 2 filters required ♦ Intake system available - see page 326 + throttle body spacer available - see page 20

HPR™ REPLACEMENT AIR FILTERS CHEVROLET

Vehicle	Engine Type	Air Filter	Vehicle	Engine Type	Air Filter
1977 CHEVROLET			1976 CHEVROLET		
K30	454 V8 CARB	HPR0326 ♦	K10 Suburban	305 V8 CARB	HPR0192 ♦
Luv	111 L4 CARB	HPR0352	K10 Suburban	350 V8 CARB	HPR0326 ♦
Malibu	305 V8 CARB	HPR0326	K10 Suburban	400 V8 CARB	HPR0326 ♦
Malibu	350 V8 CARB	HPR0326	K20	350 V8 CARB	HPR0326 ♦
Monte Carlo	305 V8 CARB	HPR0326	K20	400 V8 CARB	HPR0326 ♦
Monte Carlo	350 V8 CARB	HPR0326	K20	454 V8 CARB	HPR0326 ♦
Monza	305 V8 CARB	HPR0192	K20 Suburban	350 V8 CARB	HPR0326 ♦
Motorhome	305 V8 4 BBL. - Class C	HPR0192	K20 Suburban	400 V8 CARB	HPR0326 ♦
Motorhome	350 V8 4 BBL. - Class A & C	HPR0192	Laguna	350 V8 CARB	HPR0326
Motorhome	400 V8 4 BBL. - Class C	HPR0192	Laguna	400 V8 CARB	HPR0326
Motorhome	454 V8 4 BBL. - Class A & C, w/3-7/16 inch Tall Filter	HPR0326	Luv	111 L4 CARB	HPR0352
Nova	305 V8 CARB	HPR0192	Malibu	350 V8 CARB	HPR0326
Nova	350 V8 CARB	HPR0326	Malibu	400 V8 CARB	HPR0326
P10	350 V8 CARB	HPR0192	Monte Carlo	305 V8 CARB	HPR0326
P10	400 V8 CARB	HPR0192	Monte Carlo	350 V8 CARB	HPR0326
P20	350 V8 CARB	HPR0192	Monte Carlo	400 V8 CARB	HPR0326
P20	454 V8 CARB	HPR0326	Monza	262 V8 CARB	HPR0192
P30	350 V8 CARB	HPR0192	Monza	305 V8 CARB	HPR0192
P30	454 V8 CARB	HPR0326	Motorhome	305 V8 4 BBL. - Class C	HPR0192
1976 CHEVROLET			Motorhome	350 V8 4 BBL. - Class A & C	HPR0192
C10	305 V8 CARB	HPR0192 ♦	Motorhome	400 V8 4 BBL. - Class C	HPR0192
C10	350 V8 CARB	HPR0326 ♦	Motorhome	454 V8 4 BBL. - Class A & C, w/3-7/16 inch Tall Filter	HPR0326
C10	400 V8 CARB	HPR0326 ♦	Nova	305 V8 CARB	HPR0192
C10	454 V8 CARB	HPR0326 ♦	Nova	350 V8 CARB	HPR0326
C10 Suburban	305 V8 CARB	HPR0192 ♦	P20	350 V8 CARB	HPR0192
C10 Suburban	350 V8 CARB	HPR0326 ♦	P20	454 V8 CARB	HPR0326
C10 Suburban	454 V8 CARB	HPR0326 ♦	P30	250 L6 CARB	HPR0192
C20	350 V8 CARB	HPR0326 ♦	P30	350 V8 CARB	HPR0192
C20	400 V8 CARB	HPR0326 ♦	P30	400 V8 CARB	HPR0192
C20	454 V8 CARB	HPR0326 ♦	P30	454 V8 CARB	HPR0326
C20 Suburban	305 V8 CARB	HPR0192 ♦	1975 CHEVROLET		
C20 Suburban	350 V8 CARB	HPR0326 ♦	Bel Air	350 V8 2 BBL.	HPR0326
C20 Suburban	400 V8 CARB	HPR0326 ♦	Bel Air	350 V8 4 BBL.	HPR0326
C20 Suburban	454 V8 CARB	HPR0326 ♦	Bel Air	400 V8 CARB	HPR0326
C30 Truck	350 V8 CARB	HPR0326 ♦	Bel Air	454 V8 CARB	HPR0326
C30 Truck	400 V8 CARB	HPR0326 ♦	C10	350 V8 2 BBL.	HPR0192 ♦
C30 Truck	454 V8 CARB	HPR0326 ♦	C10	350 V8 4 BBL.	HPR0326 ♦
Camaro	305 V8 CARB	HPR0192 ♦	C10	454 V8 CARB	HPR0326 ♦
Camaro	350 V8 CARB	HPR0326 ♦	C10 Suburban	350 V8 2 BBL.	HPR0192 ♦
Caprice	350 V8 CARB	HPR0326	C10 Suburban	350 V8 4 BBL.	HPR0326 ♦
Caprice	400 V8 CARB	HPR0326	C10 Suburban	454 V8 CARB	HPR0326 ♦
Caprice	454 V8 CARB	HPR0326	C20	350 V8 2 BBL.	HPR0192 ♦
Corvette	350 V8 CARB	HPR0326	C20	350 V8 4 BBL.	HPR0326 ♦
El Camino	305 V8 CARB	HPR0326	C20	454 V8 CARB	HPR0326 ♦
El Camino	350 V8 CARB	HPR0326	C20 Suburban	350 V8 2 BBL.	HPR0192 ♦
El Camino	400 V8 CARB	HPR0326	C20 Suburban	350 V8 4 BBL.	HPR0326 ♦
G10	350 V8 CARB	HPR0192	C20 Suburban	454 V8 CARB	HPR0326 ♦
G10	400 V8 CARB	HPR0192	C30 Truck	350 V8 2 BBL.	HPR0192 ♦
G20	350 V8 CARB	HPR0192	C30 Truck	350 V8 4 BBL.	HPR0326 ♦
G20	400 V8 CARB	HPR0192	C30 Truck	454 V8 CARB	HPR0326 ♦
G20	454 V8 CARB	HPR0326	Camaro	350 V8 2 BBL.	HPR0192 ♦
G30	350 V8 CARB	HPR0192	Camaro	350 V8 4 BBL.	HPR0326 ♦
G30	400 V8 CARB	HPR0192	Caprice	350 V8 2 BBL.	HPR0326
G30	454 V8 CARB	HPR0326	Caprice	350 V8 4 BBL.	HPR0326
Impala	350 V8 CARB	HPR0326	Caprice	400 V8 CARB	HPR0326
Impala	400 V8 CARB	HPR0326	Caprice	454 V8 CARB	HPR0326
Impala	454 V8 CARB	HPR0326	Corvette	350 V8 CARB	HPR0326
K5 Blazer	350 V8 CARB	HPR0326 ♦	El Camino	350 V8 2 BBL.	HPR0326
K5 Blazer	400 V8 CARB	HPR0326 ♦	El Camino	350 V8 4 BBL.	HPR0326
K5 Blazer	454 V8 CARB	HPR0326 ♦	El Camino	400 V8 CARB	HPR0326
K10	350 V8 CARB	HPR0326 ♦	El Camino	454 V8 CARB	HPR0326
K10	400 V8 CARB	HPR0326 ♦	G10	350 V8 2 BBL.	HPR0192
K10	454 V8 CARB	HPR0326 ♦	G10	350 V8 4 BBL.	HPR0192

*Indicates 2 filters required ♦ Intake system available - see page 326 + throttle body spacer available - see page 20

CHEVROLET HPR™ REPLACEMENT AIR FILTERS

Vehicle	Engine Type	Air Filter	Vehicle	Engine Type	Air Filter
1975 CHEVROLET			1974 CHEVROLET		
G20	350 V8 2 BBL.	HPR0192	C10 Pickup	350 V8 2 BBL.	HPR0192 ♦
G20	350 V8 4 BBL.	HPR0192			HPR0326 ♦
G20	400 V8 CARB	HPR0192	C10 Pickup	350 V8 4 BBL.	HPR0326 ♦
G30	350 V8 2 BBL.	HPR0192	C10 Pickup	454 V8 CARB	HPR0326 ♦
G30	350 V8 4 BBL.	HPR0192	C10 Suburban	350 V8 2 BBL.	HPR0326 ♦
G30	400 V8 CARB	HPR0192	C10 Suburban	350 V8 4 BBL.	HPR0326 ♦
G30	454 V8 CARB - w/3-7/16 inch Tall Filter	HPR0326	C10 Suburban	454 V8 CARB	HPR0326 ♦
Impala	350 V8 2 BBL.	HPR0326	C20 Pickup	350 V8 2 BBL.	HPR0326 ♦
Impala	350 V8 4 BBL.	HPR0326	C20 Pickup	350 V8 4 BBL.	HPR0326 ♦
Impala	400 V8 CARB	HPR0326	C20 Pickup	454 V8 CARB	HPR0326 ♦
Impala	454 V8 CARB	HPR0326	C20 Suburban	350 V8 2 BBL.	HPR0326 ♦
K5 Blazer	350 V8 2 BBL.	HPR0192 ♦	C20 Suburban	350 V8 4 BBL.	HPR0326 ♦
K5 Blazer	350 V8 4 BBL.	HPR0326 ♦	C20 Suburban	454 V8 CARB	HPR0326 ♦
K5 Blazer	400 V8 CARB	HPR0326 ♦	C30 Pickup	350 V8 2 BBL.	HPR0326 ♦
K10	350 V8 2 BBL.	HPR0326 ♦	C30 Pickup	350 V8 4 BBL.	HPR0326 ♦
K10	350 V8 4 BBL.	HPR0326 ♦	C30 Pickup	454 V8 CARB	HPR0326 ♦
K10	400 V8 CARB	HPR0326 ♦	Camaro	350 V8 CARB	HPR0192 ♦
K10 Suburban	350 V8 2 BBL.	HPR0326 ♦	Camaro Z28	350 V8 CARB	48026 ♦
K10 Suburban	350 V8 4 BBL.	HPR0326 ♦			HPR0136 ♦
K10 Suburban	400 V8 CARB	HPR0326 ♦	Caprice	350 V8 CARB	HPR0326
K20	350 V8 2 BBL.	HPR0192 ♦	Caprice	400 V8 CARB	HPR0326
K20	350 V8 4 BBL.	HPR0326 ♦	Caprice	454 V8 CARB	HPR0326
K20	400 V8 CARB	HPR0326 ♦	Corvette	350 V8 CARB	HPR0326
K20 Suburban	350 V8 2 BBL.	HPR0192 ♦	Corvette	454 V8 CARB	HPR0326
K20 Suburban	350 V8 4 BBL.	HPR0326 ♦	El Camino	350 V8 CARB	HPR0326
K20 Suburban	400 V8 CARB	HPR0326 ♦	El Camino	400 V8 CARB	HPR0326
Laguna	350 V8 2 BBL.	HPR0326	El Camino	454 V8 CARB	HPR0326
Laguna	350 V8 4 BBL.	HPR0326	G10 Van	350 V8 CARB	HPR0326
Laguna	400 V8 CARB	HPR0326	G10 Van	454 V8 CARB	HPR0326
Laguna	454 V8 CARB	HPR0326	G20 Van	350 V8 CARB	HPR0192
Luv	111 L4 CARB	HPR0352	G20 Van	454 V8 CARB	HPR0326
Malibu	350 V8 2 BBL.	HPR0326	G30 Van	350 V8 CARB	HPR0326
Malibu	350 V8 4 BBL.	HPR0326	G30 Van	454 V8 CARB	HPR0326
Malibu	400 V8 CARB	HPR0326	Heavy Duty Truck	250 L6 2 BBL. - 40, 50, 60 w/HD Filter	HPR0192
Malibu	454 V8 CARB	HPR0326	Impala	350 V8 CARB	HPR0326
Monte Carlo	350 V8 2 BBL.	HPR0326	Impala	400 V8 CARB	HPR0326
Monte Carlo	350 V8 4 BBL.	HPR0326	Impala	454 V8 CARB	HPR0326
Monte Carlo	400 V8 CARB	HPR0326	K10 Pickup	350 V8 2 BBL.	HPR0326 ♦
Monte Carlo	454 V8 CARB	HPR0326	K10 Pickup	350 V8 4 BBL.	HPR0326 ♦
Monza	262 V8 CARB	HPR0192	K10 Pickup	454 V8 CARB - w/3-7/16 inch Tall Filter	HPR0326 ♦
Monza	350 V8 CARB	HPR0326			
Motorhome	350 V8 2 BBL. - Class C	HPR0192	K10 Suburban	350 V8 2 BBL.	HPR0326 ♦
Motorhome	350 V8 4 BBL. - Class C	HPR0192	K10 Suburban	350 V8 4 BBL.	HPR0326 ♦
Motorhome	400 V8 CARB - Class C	HPR0192	K10 Suburban	454 V8 CARB	HPR0326 ♦
Motorhome	454 V8 4 BBL. - Class A & C, w/3-7/16 inch Tall Filter	HPR0326	K20 Pickup	350 V8 2 BBL.	HPR0326 ♦
Nova	262 V8 CARB	HPR0192	K20 Pickup	350 V8 4 BBL.	HPR0326 ♦
Nova	350 V8 2 BBL.	HPR0192	K20 Pickup	454 V8 CARB - w/3-7/16 inch Tall Filter	HPR0326 ♦
Nova	350 V8 4 BBL.	HPR0326			
P10	350 V8 CARB	HPR0192	K20 Suburban	350 V8 2 BBL.	HPR0192 ♦
P20	350 V8 CARB	HPR0192	K20 Suburban	350 V8 4 BBL.	HPR0326 ♦
P30	350 V8 2 BBL.	HPR0192	K20 Suburban	454 V8 CARB	HPR0326 ♦
P30	350 V8 4 BBL.	HPR0192	K30 Pickup	350 V8 2 BBL.	HPR0326 ♦
P30	454 V8 CARB - w/3-7/16 inch Tall Filter	HPR0326	K30 Pickup	350 V8 4 BBL.	HPR0326 ♦
			K30 Pickup	454 V8 CARB - w/3-7/16 inch Tall Filter	HPR0326 ♦
			Laguna	350 V8 CARB	HPR0326
			Laguna	400 V8 CARB	HPR0326
			Laguna	454 V8 CARB	HPR0326
			Luv Pickup	111 L4 CARB	HPR0352
			Malibu	350 V8 CARB	HPR0326
			Malibu	400 V8 CARB	HPR0326
			Malibu	454 V8 CARB	HPR0326
			Monte Carlo	350 V8 CARB	HPR0326
			Monte Carlo	400 V8 CARB	HPR0326
			Monte Carlo	454 V8 CARB	HPR0326

*Indicates 2 filters required ♦ Intake system available - see page 326 + throttle body spacer available - see page 20

HPR™ REPLACEMENT AIR FILTERS CHEVROLET

Vehicle	Engine Type	Air Filter	Vehicle	Engine Type	Air Filter
1974 CHEVROLET			1973 CHEVROLET		
Motorhome	350 V8 4 BBL. - Class C	HPR0192	G30 Van	350 V8 CARB - w/Std. Filter	HPR0192
Motorhome	400 V8 4 BBL. - Class C	HPR0326	G30 Van	454 V8 CARB	HPR0326
Motorhome	454 V8 4 BBL. - Class A & C, w/3-7/16 inch Tall Filter	HPR0326	Heavy Duty Truck	250 L6 2 BBL. - 40, 50, 60 w/HD Filter	HPR0192
Nova	350 V8 CARB	HPR0192	Impala	350 V8 CARB	HPR0326
P20 Van	350 V8 CARB	HPR0326	Impala	400 V8 CARB	HPR0326
P30 Van	350 V8 CARB	HPR0326	Impala	454 V8 CARB	HPR0326
P30 Van	454 V8 CARB	HPR0326	K10 Pickup	292 L6 CARB	HPR0192
1973 CHEVROLET			K10 Pickup	307 V8 CARB	HPR0192 ♦
Australian Assembled Models	327 V8 CARB	HPR0326	K10 Pickup	350 V8 CARB	HPR0326 ♦
Bel Air	350 V8 CARB	HPR0326	K10 Pickup	454 V8 CARB	HPR0326 ♦
Bel Air	400 V8 CARB	HPR0326	K10 Suburban	307 V8 CARB	HPR0192 ♦
Bel Air	454 V8 CARB	HPR0326	K10 Suburban	350 V8 CARB	HPR0192 ♦
Blazer	292 L6 CARB - w/3-1/2 inch Tall Filter	HPR0192	K10 Suburban	454 V8 CARB	HPR0326 ♦
Blazer	307 V8 CARB	HPR0192 ♦	K20 Pickup	292 L6 CARB	HPR0192
Blazer	350 V8 CARB	HPR0192 ♦	K20 Pickup	307 V8 CARB	HPR0192 ♦
Blazer	454 V8 CARB - w/3-1/2 inch Tall Filter	HPR0326 ♦	K20 Pickup	350 V8 CARB	HPR0326 ♦
C10 Pickup	292 L6 CARB	HPR0192	K20 Pickup	454 V8 CARB	HPR0326 ♦
C10 Pickup	307 V8 CARB	HPR0192 ♦	K20 Suburban	292 L6 CARB	HPR0192
C10 Pickup	350 V8 CARB	HPR0326 ♦	K20 Suburban	307 V8 CARB	HPR0192 ♦
C10 Pickup	454 V8 CARB	HPR0326 ♦	K20 Suburban	350 V8 CARB	HPR0326 ♦
C10 Suburban	292 L6 CARB	HPR0192	K20 Suburban	454 V8 CARB	HPR0326 ♦
C10 Suburban	307 V8 CARB	HPR0192 ♦	K30 Pickup	292 L6 CARB	HPR0192
C10 Suburban	350 V8 CARB	HPR0326 ♦	K30 Pickup	307 V8 CARB	HPR0192 ♦
C10 Suburban	454 V8 CARB	HPR0326 ♦	K30 Pickup	350 V8 CARB	HPR0326 ♦
C20 Pickup	292 L6 CARB	HPR0192	K30 Pickup	454 V8 CARB	HPR0326 ♦
C20 Pickup	307 V8 CARB	HPR0192 ♦	Laguna	350 V8 CARB	HPR0326
C20 Pickup	350 V8 CARB	HPR0326 ♦	Laguna	454 V8 CARB	HPR0326
C20 Pickup	454 V8 CARB	HPR0326 ♦	Luv Pickup	111 L4 CARB	HPR0352
C20 Suburban	292 L6 CARB	HPR0192	Malibu	307 V8 CARB	HPR0326
C20 Suburban	307 V8 CARB	HPR0192 ♦	Malibu	350 V8 CARB	HPR0326
C20 Suburban	350 V8 CARB	HPR0326 ♦	Malibu	454 V8 CARB	HPR0326
C20 Suburban	454 V8 CARB	HPR0326 ♦	Monte Carlo	350 V8 CARB	HPR0326
C30 Pickup	292 L6 CARB	HPR0192	Monte Carlo	400 V8 CARB	HPR0326
C30 Pickup	307 V8 CARB	HPR0192 ♦	Monte Carlo	454 V8 CARB	HPR0326
C30 Pickup	350 V8 CARB	HPR0326 ♦	Motorhome	307 V8 4 BBL. - Class C	HPR0192
C30 Pickup	454 V8 CARB	HPR0326 ♦	Motorhome	350 V8 4 BBL. - Class C, w/12 in OD Filter	HPR0326
Camaro	350 V8 CARB - Exc. Z28	HPR0192 ♦	Motorhome	350 V8 4 BBL. - Class C, w/Std. Filter	HPR0192
	350 V8 CARB - Z28	48026 ♦	Motorhome	400 V8 4 BBL. - Class C	HPR0326
		HPR0136 ♦	Motorhome	454 V8 4 BBL. - Class A & C, w/3-7/16 inch Tall Filter	HPR0326
Caprice	350 V8 CARB	HPR0326	Nova	350 V8 CARB	HPR0192
Caprice	400 V8 CARB	HPR0326	P10 Van	350 V8 CARB - w/12 in OD Filter	HPR0326
Caprice	454 V8 CARB	HPR0326	P10 Van	350 V8 CARB - w/Std. Filter	HPR0192
Chevella	307 V8 CARB	HPR0326	P10 Van	454 V8 CARB	HPR0326
Chevella	350 V8 CARB	HPR0326	P20 Van	292 L6 CARB	HPR0192
Chevella	454 V8 CARB	HPR0326	P20 Van	350 V8 CARB - w/12 in OD Filter	HPR0326
Corvette	350 V8 CARB - Exc. Hi Perf.	HPR0192	P20 Van	350 V8 CARB - w/Std. Filter	HPR0192
	350 V8 CARB - Hi Perf.	48026	P20 Van	454 V8 CARB	HPR0326
		880136	P30 Van	292 L6 CARB	HPR0192
		HPR0136	P30 Van	350 V8 CARB - w/12 in OD Filter	HPR0326
Corvette	454 V8 CARB	HPR0192	P30 Van	350 V8 CARB - w/Std. Filter	HPR0192
El Camino	307 V8 CARB	HPR0326	P30 Van	454 V8 CARB	HPR0326
El Camino	350 V8 CARB	HPR0326	1972 CHEVROLET		
El Camino	454 V8 CARB	HPR0326	Australian Assembled Models	327 V8 CARB	HPR0326
G10 Van	307 V8 CARB	HPR0192	Bel Air	350 V8 CARB	HPR0326
G10 Van	350 V8 CARB - w/12 in OD Filter	HPR0326	Bel Air	400 V8 CARB	HPR0326
G10 Van	350 V8 CARB - w/Std. Filter	HPR0192	Bel Air	402 V8 CARB	HPR0326
G10 Van	454 V8 CARB	HPR0326	Bel Air	454 V8 CARB	HPR0326
G20 Van	350 V8 CARB - w/12 in OD Filter	HPR0326	Biscayne	350 V8 CARB	HPR0326
G20 Van	350 V8 CARB - w/Std. Filter	HPR0192	Biscayne	400 V8 CARB	HPR0326
G20 Van	454 V8 CARB	HPR0326	Biscayne	402 V8 CARB	HPR0326
G30 Van	350 V8 CARB - w/12 in OD Filter	HPR0326			

*Indicates 2 filters required ♦ Intake system available - see page 326 + throttle body spacer available - see page 20

CHEVROLET HPR™ REPLACEMENT AIR FILTERS

Vehicle	Engine Type	Air Filter	Vehicle	Engine Type	Air Filter
1972 CHEVROLET			1972 CHEVROLET		
Biscayne	454 V8 CARB	HPR0326	G30 Van	350 V8 CARB - w/12 in OD Filter	HPR0326
Blazer	292 L6 CARB	HPR0192	G30 Van	350 V8 CARB - w/Std. Filter	HPR0192
Blazer	307 V8 CARB	HPR0192 ♦	Heavy Duty Truck	250 L6 2 BBL. - 40, 50, 60 w/HD Filter	HPR0192
Blazer	350 V8 CARB	HPR0326 ♦	Impala	350 V8 CARB	HPR0326
Brookwood	350 V8 CARB	HPR0326	Impala	400 V8 CARB	HPR0326
Brookwood	400 V8 CARB	HPR0326	Impala	402 V8 CARB	HPR0326
Brookwood	402 V8 CARB	HPR0326	Impala	454 V8 CARB	HPR0326
C10 Pickup	292 L6 CARB	HPR0192	K10 Pickup	292 L6 CARB	HPR0192 ♦
C10 Pickup	307 V8 CARB	HPR0192 ♦	K10 Pickup	307 V8 CARB	HPR0192 ♦
C10 Pickup	350 V8 2 BBL.	HPR0192 ♦	K10 Pickup	350 V8 CARB	HPR0326 ♦
C10 Pickup	350 V8 2 BBL. - VIN H	HPR0192 ♦	K10 Pickup	402 V8 CARB	HPR0192 ♦
C10 Pickup	350 V8 4 BBL.	HPR0326 ♦	K10 Pickup	402 V8 CARB	HPR0192 ♦
C10 Pickup	402 V8 CARB	HPR0192 ♦	K10 Suburban	307 V8 CARB	HPR0192 ♦
C10 Suburban	292 L6 CARB	HPR0192	K10 Suburban	350 V8 CARB	HPR0192 ♦
C10 Suburban	307 V8 CARB	HPR0192 ♦	K10 Suburban	402 V8 CARB	HPR0192 ♦
C10 Suburban	350 V8 CARB	HPR0192 ♦	K20 Pickup	292 L6 CARB	HPR0192 ♦
C10 Suburban	402 V8 CARB	HPR0192 ♦	K20 Pickup	307 V8 CARB	HPR0192 ♦
C20 Pickup	292 L6 CARB	HPR0192 ♦	K20 Pickup	350 V8 CARB	HPR0326 ♦
C20 Pickup	307 V8 CARB	HPR0192 ♦	K20 Pickup	402 V8 CARB	HPR0192 ♦
C20 Pickup	350 V8 CARB	HPR0326 ♦	K20 Suburban	292 L6 CARB	HPR0192 ♦
C20 Pickup	402 V8 CARB	HPR0192 ♦	K20 Suburban	307 V8 CARB	HPR0192 ♦
C20 Suburban	292 L6 CARB	HPR0192 ♦	K20 Suburban	350 V8 CARB	HPR0192 ♦
C20 Suburban	307 V8 CARB	HPR0192 ♦	K20 Suburban	402 V8 CARB	HPR0192 ♦
C20 Suburban	350 V8 CARB	HPR0192 ♦	K30 Pickup	292 L6 CARB	HPR0192 ♦
C20 Suburban	402 V8 CARB	HPR0192 ♦	K30 Pickup	307 V8 CARB	HPR0192 ♦
C30 Pickup	292 L6 CARB	HPR0192 ♦	K30 Pickup	350 V8 CARB	HPR0192 ♦
C30 Pickup	307 V8 CARB	HPR0192 ♦	K30 Pickup	402 V8 CARB	HPR0192 ♦
C30 Pickup	350 V8 CARB	HPR0326 ♦	Kingswood	350 V8 CARB	HPR0326
C30 Pickup	402 V8 CARB	HPR0192 ♦	Kingswood	400 V8 CARB	HPR0326
Camaro	350 V8 CARB	HPR0192 ♦	Kingswood	402 V8 CARB	HPR0326
Camaro	402 V8 CARB	HPR0192 ♦	Kingswood	454 V8 CARB	HPR0326
Camaro Z28	350 V8 CARB	48026 ♦	Luv Pickup	111 L4 CARB	HPR0352
		HPR0136 ♦	Monte Carlo	350 V8 CARB	HPR0326
Caprice	350 V8 CARB	HPR0326	Monte Carlo	400 V8 CARB	HPR0326
Caprice	400 V8 CARB	HPR0326	Monte Carlo	402 V8 CARB	HPR0326
Caprice	402 V8 CARB	HPR0326		454 V8 CARB - w/hood scoop	48026
Caprice	454 V8 CARB	HPR0326			HPR0136
Chevelle	307 V8 CARB	HPR0326 ♦	Monte Carlo	454 V8 CARB - w/o hood scoop	HPR0326
Chevelle	350 V8 CARB	HPR0326 ♦	Motorhome	307 V8 4 BBL. - Class C	HPR0192
Chevelle	400 V8 CARB - w/ A/C	HPR0192 ♦	Motorhome	350 V8 4 BBL. - Class C, w/12 in OD Filter	HPR0326
Chevelle	400 V8 CARB - w/o A/C	HPR0326 ♦	Motorhome	350 V8 4 BBL. - Class C, w/Std. Filter	HPR0192
Chevelle	402 V8 CARB - w/ A/C	HPR0192 ♦	Motorhome	400 V8 4 BBL. - Class C	HPR0326
Chevelle	402 V8 CARB - w/o A/C	HPR0326 ♦	Motorhome	402 V8 4 BBL. - Class A	HPR0192
	454 V8 CARB - w/hood scoop	48026 ♦	Motorhome	454 V8 4 BBL. - Class A & C, w/3-7/16 inch Tall Filter	HPR0326
		880136 ♦			
		HPR0136 ♦	Nova	307 V8 CARB	HPR0192 ♦
Chevelle	454 V8 CARB - w/o hood scoop	HPR0192 ♦	Nova	350 V8 CARB	HPR0192 ♦
Corvette	350 V8 CARB - w/ Rochester Carb.	HPR0192	P20 Van	292 L6 CARB	HPR0192
	350 V8 CARB - w/Holley Carb.	48026	P20 Van	350 V8 CARB - w/12 in OD Filter	HPR0326
		880136	P20 Van	350 V8 CARB - w/Std. Filter	HPR0192
		HPR0136	P30 Van	292 L6 CARB	HPR0192
Corvette	454 V8 CARB	HPR0192	P30 Van	350 V8 CARB - w/12 in OD Filter	HPR0326
El Camino	307 V8 CARB	HPR0326 ♦	P30 Van	350 V8 CARB - w/Std. Filter	HPR0192
El Camino	350 V8 CARB	HPR0326 ♦	P30 Van	402 V8 CARB	HPR0326
El Camino	400 V8 CARB	HPR0192 ♦	Townsmen	350 V8 CARB	HPR0326
El Camino	402 V8 CARB	HPR0326 ♦	Townsmen	400 V8 CARB	HPR0326
El Camino	454 V8 CARB	HPR0192 ♦	Townsmen	402 V8 CARB	HPR0326
G10 Van	307 V8 CARB	HPR0192	Townsmen	454 V8 CARB	HPR0326
G10 Van	350 V8 CARB - w/12 in OD Filter	HPR0326			
G10 Van	350 V8 CARB - w/Std. Filter	HPR0192	1971 CHEVROLET		
G20 Van	292 L6 CARB	HPR0192	Australian Assembled Models	327 V8 CARB	HPR0326
G20 Van	350 V8 CARB - w/12 in OD Filter	HPR0326	Bel Air	350 V8 CARB	HPR0326
G20 Van	350 V8 CARB - w/Std. Filter	HPR0192	Bel Air	400 V8 CARB	HPR0326
G30 Van	292 L6 CARB	HPR0192			

*Indicates 2 filters required ♦ Intake system available - see page 326 + throttle body spacer available - see page 20

HPR™ REPLACEMENT AIR FILTERS CHEVROLET

Vehicle	Engine Type	Air Filter	Vehicle	Engine Type	Air Filter
1971 CHEVROLET			1971 CHEVROLET		
Bel Air	402 V8 CARB	HPR0326	G10 Van	350 V8 CARB	HPR0192
Bel Air	454 V8 CARB	HPR0326	G20 Van	292 L6 CARB	HPR0192
Biscayne	350 V8 CARB	HPR0326	G20 Van	350 V8 CARB	HPR0192
Biscayne	400 V8 CARB	HPR0326	G30 Van	292 L6 CARB	HPR0192
Biscayne	402 V8 CARB	HPR0326	G30 Van	350 V8 CARB	HPR0192
Biscayne	454 V8 CARB	HPR0326	Heavy Duty Truck	250 L6 2 BBL. - 40, 50, 60 w/HD Filter	HPR0192
Blazer	292 L6 CARB	HPR0192	Impala	350 V8 CARB	HPR0326
Blazer	307 V8 CARB	HPR0192 ♦	Impala	400 V8 CARB	HPR0326
Blazer	350 V8 CARB	HPR0326 ♦	Impala	402 V8 CARB	HPR0326
Brookwood	350 V8 CARB	HPR0326	Impala	454 V8 CARB	HPR0326
C10 Pickup	292 L6 CARB	HPR0192 ♦	K10 Pickup	292 L6 CARB	HPR0192 ♦
C10 Pickup	307 V8 CARB	HPR0192 ♦	K10 Pickup	307 V8 CARB	HPR0192 ♦
C10 Pickup	350 V8 CARB	HPR0192 ♦	K10 Pickup	350 V8 CARB	HPR0192 ♦
C10 Pickup	402 V8 CARB	HPR0192 ♦	K10 Pickup	402 V8 CARB	HPR0192 ♦
C10 Suburban	292 L6 CARB	HPR0192 ♦	K10 Suburban	307 V8 CARB	HPR0192 ♦
C10 Suburban	307 V8 CARB	HPR0192 ♦	K10 Suburban	350 V8 CARB	HPR0192 ♦
C10 Suburban	350 V8 CARB	HPR0192 ♦	K10 Suburban	402 V8 CARB	HPR0192 ♦
C10 Suburban	402 V8 CARB	HPR0192 ♦	K20 Pickup	292 L6 CARB	HPR0192 ♦
C20 Pickup	292 L6 CARB	HPR0192 ♦	K20 Pickup	307 V8 CARB	HPR0192 ♦
C20 Pickup	307 V8 CARB	HPR0192 ♦	K20 Pickup	350 V8 CARB	HPR0192 ♦
C20 Pickup	350 V8 CARB	HPR0192 ♦	K20 Pickup	402 V8 CARB	HPR0192 ♦
C20 Pickup	402 V8 CARB	HPR0192 ♦	K20 Suburban	292 L6 CARB	HPR0192 ♦
C20 Suburban	292 L6 CARB	HPR0192 ♦	K20 Suburban	307 V8 CARB	HPR0192 ♦
C20 Suburban	307 V8 CARB	HPR0192 ♦	K20 Suburban	350 V8 CARB	HPR0192 ♦
C20 Suburban	350 V8 CARB	HPR0192 ♦	K20 Suburban	402 V8 CARB	HPR0192 ♦
C20 Suburban	402 V8 CARB	HPR0192 ♦	K30 Pickup	292 L6 CARB	HPR0192 ♦
C30 Pickup	292 L6 CARB	HPR0192 ♦	K30 Pickup	307 V8 CARB	HPR0192 ♦
C30 Pickup	307 V8 CARB	HPR0326 ♦	K30 Pickup	350 V8 CARB	HPR0192 ♦
C30 Pickup	350 V8 CARB	HPR0192 ♦	K30 Pickup	402 V8 CARB	HPR0192 ♦
C30 Pickup	402 V8 CARB	HPR0192 ♦	Kingswood	350 V8 CARB	HPR0326
Camaro	350 V8 CARB - Exc. Z28	HPR0192 ♦	Kingswood	400 V8 CARB	HPR0326
	350 V8 CARB - Z28	48026 ♦	Kingswood	402 V8 CARB	HPR0326
		880136 ♦	Monte Carlo	350 V8 CARB	HPR0326
		HPR0136 ♦	Monte Carlo	400 V8 CARB	HPR0326
Camaro	402 V8 CARB	HPR0192 ♦	Monte Carlo	402 V8 CARB	HPR0326
Caprice	350 V8 CARB	HPR0326	Monte Carlo	454 V8 CARB	HPR0326
Caprice	400 V8 CARB	HPR0326	Motorhome	307 V8 4 BBL. - Class C	HPR0192
Caprice	402 V8 CARB	HPR0326	Motorhome	350 V8 4 BBL. - Class C	HPR0192
Caprice	454 V8 CARB	HPR0326	Motorhome	400 V8 4 BBL. - Class C	HPR0326
Chevelle	307 V8 CARB	HPR0326 ♦	Motorhome	402 V8 4 BBL. - Class A	HPR0192
Chevelle	350 V8 CARB	HPR0326 ♦	Nova	350 V8 CARB	HPR0192 ♦
Chevelle	400 V8 CARB	HPR0326 ♦	P20 Van	292 L6 CARB	HPR0192
Chevelle	402 V8 CARB	HPR0326 ♦	P20 Van	350 V8 CARB	HPR0192
	454 V8 CARB	48026 ♦	P20 Van	454 V8 CARB	HPR0192
		880136 ♦	P30 Van	292 L6 CARB	HPR0192
		HPR0136 ♦	P30 Van	350 V8 CARB	HPR0192
Chevelle SS	454 V8 CARB	48026 ♦	P30 Van	454 V8 CARB	HPR0192
		880136 ♦	Townsmen	350 V8 CARB	HPR0326
Chevelle SS	454 V8 CARB - w/o A/C	HPR0192 ♦	Townsmen	400 V8 CARB	HPR0326
Corvette	350 V8 CARB - w/ Rochester Carb.	HPR0192	Townsmen	402 V8 CARB	HPR0326
	350 V8 CARB - w/Holley Carb.	48026			
		HPR0136	1970 CHEVROLET		
Corvette	454 V8 CARB - w/ Rochester Carb.	HPR0192	Australian Assembled Models	327 V8 CARB	HPR0326
	454 V8 CARB - w/Holley Carb.	48026	Bel Air	250 L6 CARB - w/3-1/2 inch Tall Filter	HPR0192
		HPR0136	Bel Air	350 V8 CARB	HPR0326
El Camino	307 V8 CARB - Exc. 300 models	HPR0326 ♦	Bel Air	400 V8 CARB	HPR0326
El Camino	350 V8 CARB	HPR0326 ♦	Bel Air	402 V8 CARB	HPR0326
El Camino	400 V8 CARB	HPR0326 ♦	Bel Air	454 V8 CARB	HPR0326
El Camino	402 V8 CARB	HPR0326 ♦	Biscayne	250 L6 CARB - w/3-1/2 inch Tall Filter	HPR0192
El Camino	454 V8 CARB - Exc. Hi Perf.	HPR0192 ♦	Biscayne	350 V8 CARB	HPR0326
El Camino	454 V8 CARB - Hi Perf.	48026 ♦	Biscayne	400 V8 CARB	HPR0326
		880136 ♦	Biscayne	402 V8 CARB	HPR0326
		HPR0136 ♦			
G10 Van	307 V8 CARB	HPR0192			

*Indicates 2 filters required ♦ Intake system available - see page 326 + throttle body spacer available - see page 20

CHEVROLET HPR™ REPLACEMENT AIR FILTERS

Vehicle	Engine Type	Air Filter	Vehicle	Engine Type	Air Filter
1970 CHEVROLET			1970 CHEVROLET		
Biscayne	454 V8 CARB	HPR0326	G10 Van	307 V8 CARB	HPR0192
Blazer	292 L6 CARB	HPR0192 ♦	G10 Van	350 V8 CARB	HPR0192
Blazer	307 V8 CARB	HPR0192 ♦	G20 Van	307 V8 CARB	HPR0192
Blazer	350 V8 CARB	HPR0192 ♦	G20 Van	350 V8 CARB	HPR0192
Brookwood	350 V8 CARB	HPR0326	G30 Van	350 V8 CARB	HPR0192
Brookwood	400 V8 CARB	HPR0326	Heavy Duty Truck	250 L6 2 BBL. - 40, 50, 60 w/HD Filter	HPR0192
Brookwood	402 V8 CARB	HPR0326	Heavy Duty Truck	350 V8 2 BBL. - 40, 50, Partial	HPR0192
C10 Pickup	292 L6 CARB	HPR0192 ♦	Impala	250 L6 CARB - w/3-1/2 inch Tall Filter	HPR0192
C10 Pickup	307 V8 CARB	HPR0192 ♦	Impala	307 V8 CARB	HPR0326
C10 Pickup	350 V8 CARB	HPR0192 ♦	Impala	350 V8 CARB	HPR0326
C10 Pickup	402 V8 CARB	HPR0192 ♦	Impala	400 V8 CARB	HPR0326
C10 Suburban	292 L6 CARB	HPR0192 ♦	Impala	402 V8 CARB	HPR0326
C10 Suburban	307 V8 CARB	HPR0192 ♦	Impala	454 V8 CARB	HPR0326
C10 Suburban	350 V8 CARB	HPR0192 ♦	K10 Pickup	292 L6 CARB	HPR0192 ♦
C10 Suburban	402 V8 CARB	HPR0192 ♦	K10 Pickup	307 V8 CARB	HPR0192 ♦
C20 Pickup	292 L6 CARB	HPR0192 ♦	K10 Pickup	350 V8 CARB	HPR0192 ♦
C20 Pickup	307 V8 CARB	HPR0192 ♦	K10 Pickup	402 V8 CARB	HPR0192 ♦
C20 Pickup	350 V8 CARB	HPR0192 ♦	K10 Suburban	292 L6 CARB	HPR0192 ♦
C20 Pickup	402 V8 CARB	HPR0192 ♦	K10 Suburban	307 V8 CARB	HPR0192 ♦
C20 Suburban	292 L6 CARB	HPR0192 ♦	K10 Suburban	350 V8 CARB	HPR0192 ♦
C20 Suburban	307 V8 CARB	HPR0192 ♦	K10 Suburban	402 V8 CARB	HPR0192 ♦
C20 Suburban	350 V8 CARB	HPR0192 ♦	K20 Pickup	292 L6 CARB	HPR0192 ♦
C20 Suburban	402 V8 CARB	HPR0192 ♦	K20 Pickup	307 V8 CARB	HPR0192 ♦
C30 Pickup	292 L6 CARB	HPR0192 ♦	K20 Pickup	350 V8 CARB	HPR0192 ♦
C30 Pickup	307 V8 CARB	HPR0192 ♦	K20 Pickup	402 V8 CARB	HPR0192 ♦
C30 Pickup	350 V8 CARB	HPR0192 ♦	K20 Suburban	292 L6 CARB	HPR0192 ♦
C30 Pickup	402 V8 CARB	HPR0192 ♦	K20 Suburban	307 V8 CARB	HPR0192 ♦
Camaro	350 V8 CARB	HPR0192 ♦	K20 Suburban	350 V8 CARB	HPR0192 ♦
	396 V8 CARB	48026 ♦	K20 Suburban	402 V8 CARB	HPR0192 ♦
		880136 ♦	K30 Pickup	292 L6 CARB	HPR0192 ♦
		HPR0136 ♦	K30 Pickup	307 V8 CARB	HPR0192 ♦
	402 V8 CARB	48026 ♦	K30 Pickup	350 V8 CARB	HPR0192 ♦
		HPR0136 ♦	K30 Pickup	402 V8 CARB	HPR0192 ♦
Caprice	350 V8 CARB	HPR0326	Kingswood	350 V8 CARB	HPR0326
Caprice	400 V8 CARB	HPR0326	Kingswood	400 V8 CARB	HPR0326
Caprice	402 V8 CARB	HPR0326	Kingswood	402 V8 CARB	HPR0326
Caprice	454 V8 CARB	HPR0326	Kingswood	454 V8 CARB	HPR0326
Chevelle	307 V8 CARB	HPR0326 ♦	Monte Carlo	350 V8 CARB	HPR0326
Chevelle	350 V8 CARB	HPR0326 ♦	Monte Carlo	400 V8 CARB	HPR0326
	396 V8 CARB	48026 ♦	Monte Carlo	402 V8 CARB	48026
		880136 ♦			HPR0326
		HPR0136 ♦			HPR0326
	400 V8 CARB	48026 ♦	Monte Carlo	454 V8 CARB	HPR0326
		HPR0136 ♦	Motorhome	307 V8 4 BBL. - Class C	HPR0192
		HPR0326 ♦	Motorhome	350 V8 4 BBL. - Class C	HPR0192
	402 V8 CARB	48026 ♦	Nova	350 V8 CARB	HPR0192 ♦
		880136 ♦		396 V8 CARB	48026 ♦
		HPR0136 ♦			880136 ♦
	454 V8 CARB	48026 ♦			HPR0136 ♦
		880136 ♦			48026 ♦
		HPR0136 ♦		402 V8 CARB	880136 ♦
Corvette	350 V8 CARB - w/High Output	48026			HPR0136 ♦
		HPR0136	P20 Van	292 L6 CARB	HPR0192
Corvette	350 V8 CARB - w/o High Output	HPR0192	P20 Van	350 V8 CARB	HPR0192
	454 V8 CARB	48026		454 V8 CARB	48026
		HPR0136			HPR0136
El Camino	307 V8 CARB - Exc. 300 models	HPR0326 ♦	P30 Van	292 L6 CARB	HPR0192
El Camino	350 V8 CARB	HPR0326 ♦	P30 Van	350 V8 CARB	HPR0192
El Camino	396 V8 CARB	HPR0192 ♦		454 V8 CARB	48026
El Camino	400 V8 CARB	HPR0326 ♦	Townsmen	350 V8 CARB	HPR0136
El Camino	402 V8 CARB	HPR0326 ♦	Townsmen	400 V8 CARB	HPR0326
	454 V8 CARB	48026 ♦	Townsmen	402 V8 CARB	HPR0326
		880136 ♦	Townsmen	454 V8 CARB	HPR0326
		HPR0136 ♦			

*Indicates 2 filters required ♦ Intake system available - see page 326 + throttle body spacer available - see page 20

HPR™ REPLACEMENT AIR FILTERS CHEVROLET

Vehicle	Engine Type	Air Filter	Vehicle	Engine Type	Air Filter
1969 CHEVROLET			1969 CHEVROLET		
Australian Assembled Models	327 V8 CARB	HPR0326	Camaro	396 V8 CARB	HPR0136 ♦
Bel Air	250 L6 CARB - Heavy Duty Filter	HPR0192		427 V8 CARB	48026 ♦
Bel Air	327 V8 CARB	HPR0326	Caprice	250 L6 CARB - w/3-1/2 inch Tall Filter	HPR0136 ♦
Bel Air	350 V8 CARB	HPR0326	Caprice	327 V8 CARB	HPR0192
Bel Air	396 V8 CARB	HPR0326	Caprice	350 V8 CARB	HPR0326
	427 V8 CARB	48026	Caprice	396 V8 CARB	HPR0326
		880136	Caprice	427 V8 CARB - Exc. Hi Perf.	HPR0192
		HPR0136	Caprice	427 V8 CARB - Hi Perf.	48026
Biscayne	250 L6 CARB - Heavy Duty Filter	HPR0192			880136
Biscayne	327 V8 CARB	HPR0326			HPR0136
Biscayne	350 V8 CARB	HPR0326	Chevelle	307 V8 CARB	HPR0326 ♦
Biscayne	396 V8 CARB	HPR0326	Chevelle	350 V8 CARB	HPR0326 ♦
	427 V8 CARB	48026	Chevelle	396 V8 CARB	HPR0192 ♦
		880136	Chevelle Malibu	307 V8 CARB	HPR0326 ♦
		HPR0136	Corvair	164 H6 CARB	HPR0192
Blazer	307 V8 CARB	HPR0192 ♦	Corvette	350 V8 CARB	48026
Blazer	350 V8 CARB	HPR0192 ♦			HPR0136
Brookwood	250 L6 CARB - w/3-1/2 inch Tall Filter	HPR0192		427 V8 4 BBL.	48026
Brookwood	350 V8 CARB	HPR0326			HPR0136
C10 Pickup	230 L6 CARB	HPR0192	El Camino	307 V8 CARB	HPR0326 ♦
C10 Pickup	292 L6 CARB	HPR0192 ♦	El Camino	327 V8 CARB	HPR0326 ♦
C10 Pickup	307 V8 CARB	HPR0192 ♦	El Camino	350 V8 CARB	HPR0326 ♦
C10 Pickup	350 V8 CARB	HPR0192 ♦	El Camino	396 V8 CARB	HPR0192 ♦
C10 Pickup	396 V8 CARB - Exc. Hi Perf.	HPR0192 ♦	G10 Van	230 L6 CARB	HPR0192
C10 Pickup	396 V8 CARB - Hi Perf.	48026 ♦	G10 Van	307 V8 CARB	HPR0192
		880136 ♦	G20 Van	307 V8 CARB	HPR0192
		HPR0136 ♦	Heavy Duty Truck	230 L6 2 BBL. - 40-80	HPR0192
C10 Suburban	292 L6 CARB	HPR0192 ♦	Heavy Duty Truck	250 L6 2 BBL. - 40, 50, 60 w/HD Filter	HPR0192
C10 Suburban	307 V8 CARB	HPR0192 ♦	Impala	250 L6 CARB - Heavy Duty Filter	HPR0192
C10 Suburban	350 V8 CARB	HPR0192 ♦	Impala	307 V8 CARB	HPR0326
C10 Suburban	396 V8 CARB - Exc. Hi Perf.	HPR0192 ♦	Impala	327 V8 CARB	HPR0326
	396 V8 CARB - Hi Perf.	48026 ♦	Impala	350 V8 CARB	HPR0326
		880136 ♦	Impala	396 V8 CARB	HPR0326
		HPR0136 ♦		427 V8 CARB	48026
C20 Pickup	292 L6 CARB	HPR0192 ♦			880136
C20 Pickup	307 V8 CARB	HPR0192 ♦			HPR0136
C20 Pickup	350 V8 CARB	HPR0192 ♦	K10 Pickup	292 L6 CARB	HPR0192 ♦
C20 Pickup	396 V8 CARB - Exc. Hi Perf.	HPR0192 ♦	K10 Pickup	307 V8 CARB	HPR0192 ♦
	396 V8 CARB - Hi Perf.	48026 ♦	K10 Pickup	350 V8 CARB	HPR0192 ♦
		880136 ♦	K10 Pickup	396 V8 CARB - Exc. Hi Perf.	HPR0192 ♦
		HPR0136 ♦	K10 Pickup	396 V8 CARB - Hi Perf.	48026 ♦
C20 Suburban	292 L6 CARB	HPR0192 ♦			880136 ♦
C20 Suburban	307 V8 CARB	HPR0192 ♦	K10 Suburban	292 L6 CARB	HPR0192 ♦
C20 Suburban	350 V8 CARB	HPR0192 ♦	K10 Suburban	307 V8 CARB	HPR0192 ♦
C20 Suburban	396 V8 CARB - Exc. Hi Perf.	HPR0192 ♦	K10 Suburban	350 V8 CARB	HPR0192 ♦
	396 V8 CARB - Hi Perf.	48026 ♦	K10 Suburban	396 V8 CARB - Exc. Hi Perf.	HPR0192 ♦
		880136 ♦		396 V8 CARB - Hi Perf.	48026 ♦
		HPR0136 ♦			880136 ♦
C30 Pickup	292 L6 CARB	HPR0192 ♦	K20 Pickup	292 L6 CARB	HPR0192 ♦
C30 Pickup	307 V8 CARB	HPR0192 ♦	K20 Pickup	307 V8 CARB	HPR0192 ♦
C30 Pickup	350 V8 CARB	HPR0192 ♦	K20 Pickup	350 V8 CARB	HPR0192 ♦
C30 Pickup	396 V8 CARB - Exc. Hi Perf.	HPR0192 ♦	K20 Pickup	396 V8 CARB - Exc. Hi Perf.	HPR0192 ♦
	396 V8 CARB - Hi Perf.	48026 ♦		396 V8 CARB - Hi Perf.	48026 ♦
		880136 ♦			880136 ♦
		HPR0136 ♦			HPR0136 ♦
Camaro	302 V8 CARB	48026 ♦	K20 Suburban	292 L6 CARB	HPR0192 ♦
		880136 ♦	K20 Suburban	307 V8 CARB	HPR0192 ♦
		HPR0136 ♦	K20 Suburban	350 V8 CARB	HPR0192 ♦
Camaro	327 V8 CARB	HPR0326 ♦	K20 Suburban	396 V8 CARB - Exc. Hi Perf.	HPR0192 ♦
Camaro	350 V8 2 BBL.	HPR0192 ♦		396 V8 CARB - Hi Perf.	48026 ♦
Camaro	350 V8 4 BBL.	HPR0326 ♦			880136 ♦
	396 V8 CARB	48026 ♦			HPR0136 ♦
		880136 ♦			HPR0192 ♦

*Indicates 2 filters required ♦ Intake system available - see page 326 + throttle body spacer available - see page 20

CHEVROLET HPR™ REPLACEMENT AIR FILTERS

Vehicle	Engine Type	Air Filter	Vehicle	Engine Type	Air Filter
1969 CHEVROLET			1968 CHEVROLET		
K20 Suburban	396 V8 CARB - Hi Perf.	HPR0136 ♦	C20 Suburban	396 V8 CARB - Hi Perf.	880136 ♦
K30 Pickup	292 L6 CARB	HPR0192 ♦			HPR0136 ♦
K30 Pickup	307 V8 CARB	HPR0192 ♦	C30 Pickup	292 L6 CARB	HPR0192 ♦
K30 Pickup	350 V8 CARB	HPR0192 ♦	C30 Pickup	307 V8 CARB	HPR0192 ♦
K30 Pickup	396 V8 CARB - Exc. Hi Perf.	HPR0192 ♦	C30 Pickup	327 V8 CARB	HPR0192 ♦
	396 V8 CARB - Hi Perf.	48026 ♦	C30 Pickup	396 V8 CARB - Exc. Hi Perf.	HPR0192 ♦
		880136 ♦		396 V8 CARB - Hi Perf.	48026 ♦
		HPR0136 ♦			880136 ♦
Kingswood	350 V8 CARB	HPR0326			HPR0136 ♦
Motorhome	350 V8 4 BBL. - Class C	HPR0192	Camaro	302 V8 CARB	48026 ♦
Nova	350 V8 CARB - Exc. Hi Perf.	HPR0326 ♦			880136 ♦
	350 V8 CARB - Hi Perf.	48026 ♦			HPR0136 ♦
		HPR0136 ♦		307 V8 CARB	48026 ♦
Nova	396 V8 CARB - Exc. Hi Perf.	HPR0192 ♦			880136 ♦
	396 V8 CARB - Hi Perf.	48026 ♦			HPR0136 ♦
		880136 ♦	Camaro	327 V8 2 BBL.	HPR0326 ♦
		HPR0136 ♦	Camaro	327 V8 4 BBL. - Exc. Hi Perf.	HPR0326 ♦
P10 Van	230 L6 CARB	HPR0192		327 V8 4 BBL. - Hi Perf.	48026 ♦
P10 Van	250 L6 CARB	HPR0192			HPR0136 ♦
P20 Van	292 L6 CARB	HPR0192	Camaro	350 V8 CARB	HPR0326 ♦
P20 Van	307 V8 CARB	HPR0192		396 V8 CARB	48026 ♦
P30 Van	292 L6 CARB	HPR0192			880136 ♦
P30 Van	307 V8 CARB	HPR0192			HPR0136 ♦
Townsmen	350 V8 CARB	HPR0326	Caprice	250 L6 CARB - Heavy Duty Filter	HPR0192
1968 CHEVROLET			Caprice	307 V8 CARB	HPR0326
Australian Assembled Models	327 V8 CARB	HPR0326	Caprice	327 V8 CARB	HPR0326
Bel Air	250 L6 CARB - Heavy Duty Filter	HPR0192	Caprice	427 V8 CARB - Exc. Hi Perf.	HPR0192
Bel Air	307 V8 CARB	HPR0326		427 V8 CARB - Hi Perf.	48026
Bel Air	327 V8 CARB	HPR0326			880136
	427 V8 CARB	48026			HPR0136
		880136	Chevelle	327 V8 CARB - Exc. Hi Perf.	HPR0326 ♦
		HPR0136		327 V8 CARB - Hi Perf.	48026 ♦
Biscayne	250 L6 CARB - Heavy Duty Filter	HPR0192			HPR0136 ♦
Biscayne	327 V8 CARB	HPR0326	Chevelle	396 V8 CARB - Exc. Hi Perf.	HPR0192 ♦
	427 V8 CARB	48026		396 V8 CARB - Hi Perf.	48026 ♦
		880136			880136 ♦
		HPR0136	Chevelle Malibu	307 V8 CARB	HPR0326 ♦
C10 Pickup	292 L6 CARB	HPR0192 ♦	Chevy II	327 V8 CARB - Exc. Hi Perf.	HPR0326
C10 Pickup	307 V8 CARB	HPR0192 ♦		327 V8 CARB - Hi Perf.	48026
C10 Pickup	327 V8 CARB	HPR0192 ♦			HPR0136
C10 Pickup	396 V8 CARB - Exc. Hi Perf.	HPR0192 ♦	Chevy II	350 V8 CARB - Exc. Hi Perf.	HPR0326
	396 V8 CARB - Hi Perf.	48026 ♦		350 V8 CARB - Hi Perf.	48026
		880136 ♦			HPR0136
		HPR0136 ♦	Chevy II	396 V8 CARB - Exc. Hi Perf.	HPR0192
C10 Suburban	292 L6 CARB	HPR0192 ♦		396 V8 CARB - Hi Perf.	48026
C10 Suburban	307 V8 CARB	HPR0192 ♦			HPR0136
C10 Suburban	327 V8 CARB	HPR0192 ♦	Corvaire	164 H6 CARB	HPR0192
C10 Suburban	396 V8 CARB - Exc. Hi Perf.	HPR0192 ♦	Corvette	327 V8 CARB	48026
	396 V8 CARB - Hi Perf.	48026 ♦			HPR0136
		880136 ♦			48026
		HPR0136 ♦			HPR0136
C20 Pickup	292 L6 CARB	HPR0192 ♦	El Camino	230 L6 CARB - w/3-1/2 inch Tall Filter	HPR0192
C20 Pickup	307 V8 CARB	HPR0192 ♦			
C20 Pickup	327 V8 CARB	HPR0192 ♦	El Camino	250 L6 CARB - w/3-1/2 inch Tall Filter	HPR0192
C20 Pickup	396 V8 CARB - Exc. Hi Perf.	HPR0192 ♦	El Camino	307 V8 CARB	HPR0192 ♦
	396 V8 CARB - Hi Perf.	48026 ♦	El Camino	327 V8 CARB	HPR0326 ♦
		880136 ♦	El Camino	396 V8 CARB	HPR0192 ♦
		HPR0136 ♦	G10 Van	230 L6 CARB	HPR0192
C20 Suburban	292 L6 CARB	HPR0192 ♦	G10 Van	250 L6 CARB - Heavy Duty Filter	HPR0192
C20 Suburban	307 V8 CARB	HPR0192 ♦	G10 Van	307 V8 CARB	HPR0192
C20 Suburban	327 V8 CARB	HPR0192 ♦	G20 Van	307 V8 CARB	HPR0192
C20 Suburban	396 V8 CARB - Exc. Hi Perf.	HPR0192 ♦	Heavy Duty Truck	230 L6 2 BBL. - 40-80	HPR0192
	396 V8 CARB - Hi Perf.	48026 ♦			

*Indicates 2 filters required ♦ Intake system available - see page 326 + throttle body spacer available - see page 20

HPR™ REPLACEMENT AIR FILTERS CHEVROLET

Vehicle	Engine Type	Air Filter	Vehicle	Engine Type	Air Filter
1968 CHEVROLET			1967 CHEVROLET		
Heavy Duty Truck	250 L6 2 BBL. - 40, 50, 60 w/HD Filter	HPR0192	C10 Pickup	250 L6 CARB - Heavy Duty Filter	HPR0192
Impala	250 L6 CARB - w/3-1/2 inch Tall Filter	HPR0192	C10 Pickup	283 V8 CARB	HPR0192 ♦
Impala	307 V8 CARB	HPR0326	C10 Pickup	292 L6 CARB	HPR0192 ♦
Impala	327 V8 CARB	HPR0326	C10 Suburban	283 V8 CARB	HPR0192 ♦
	427 V8 CARB	48026	C10 Suburban	292 L6 CARB	HPR0192 ♦
		880136	C10 Suburban	327 V8 CARB	HPR0192 ♦
		HPR0136	C20 Pickup	250 L6 CARB - Heavy Duty Filter	HPR0192
K10 Pickup	292 L6 CARB	HPR0192 ♦	C20 Pickup	283 V8 CARB	HPR0192 ♦
K10 Pickup	307 V8 CARB	HPR0192 ♦	C20 Pickup	292 L6 CARB	HPR0192 ♦
K10 Pickup	327 V8 CARB	HPR0192 ♦	C20 Suburban	283 V8 CARB	HPR0192 ♦
K10 Pickup	396 V8 CARB - Exc. Hi Perf.	HPR0192 ♦	C20 Suburban	292 L6 CARB	HPR0192 ♦
	396 V8 CARB - Hi Perf.	48026 ♦	C20 Suburban	327 V8 CARB	HPR0192 ♦
		880136 ♦	C30 Pickup	250 L6 CARB - Heavy Duty Filter	HPR0192
		HPR0136 ♦	C30 Pickup	283 V8 CARB	HPR0192 ♦
K10 Suburban	307 V8 CARB	HPR0192 ♦	C30 Pickup	292 L6 CARB	HPR0192 ♦
K10 Suburban	327 V8 CARB	HPR0192 ♦	Camaro	302 V8 CARB	48026 ♦
K10 Suburban	396 V8 CARB - Exc. Hi Perf.	HPR0192 ♦			880136 ♦
	396 V8 CARB - Hi Perf.	48026 ♦	Camaro	327 V8 2 BBL.	48026 ♦
		880136 ♦		327 V8 4 BBL.	880136 ♦
		HPR0136 ♦			48026 ♦
K20 Pickup	292 L6 CARB	HPR0192 ♦			880136 ♦
K20 Pickup	307 V8 CARB	HPR0192 ♦			HPR0136 ♦
K20 Pickup	327 V8 CARB	HPR0192 ♦		350 V8 CARB	48026 ♦
K20 Pickup	396 V8 CARB - Exc. Hi Perf.	HPR0192 ♦			880136 ♦
	396 V8 CARB - Hi Perf.	48026 ♦		396 V8 CARB	HPR0136 ♦
		880136 ♦			48026 ♦
		HPR0136 ♦			880136 ♦
K20 Suburban	292 L6 CARB	HPR0192 ♦			HPR0136 ♦
K20 Suburban	307 V8 CARB	HPR0192 ♦	Caprice	250 L6 CARB - Heavy Duty Filter	HPR0192
K20 Suburban	327 V8 CARB	HPR0192 ♦		327 V8 CARB	48026
K20 Suburban	396 V8 CARB	HPR0192			880136
K30 Pickup	292 L6 CARB	HPR0192 ♦			HPR0136
K30 Pickup	307 V8 CARB	HPR0192 ♦		396 V8 CARB	48026
K30 Pickup	327 V8 CARB	HPR0192 ♦			880136
K30 Pickup	396 V8 CARB - Exc. Hi Perf.	HPR0192 ♦			HPR0136
	396 V8 CARB - Hi Perf.	48026 ♦		427 V8 CARB	48026
		880136 ♦			880136
		HPR0136 ♦			HPR0136
P10 Van	230 L6 CARB	HPR0192	Chevelle	327 V8 CARB	48026 ♦
P10 Van	250 L6 CARB	HPR0192			880136 ♦
P20 Van	292 L6 CARB	HPR0192			HPR0136 ♦
P20 Van	307 V8 CARB	HPR0192		396 V8 CARB	48026 ♦
P30 Van	292 L6 CARB	HPR0192			880136 ♦
P30 Van	307 V8 CARB	HPR0192			HPR0136 ♦
Bel Air	327 V8 CARB	48026	Corvaire	164 H6 CARB	HPR0192
		880136		327 V8 CARB	48026
		HPR0136			HPR0136
	396 V8 CARB	48026		427 V8 4 BBL.	48026
		880136			HPR0136
		HPR0136	El Camino	250 L6 CARB - w/3-1/2 inch Tall Filter	HPR0192
	427 V8 CARB	48026		396 V8 CARB	48026 ♦
		880136			HPR0136 ♦
		HPR0136	G10 Van	250 L6 CARB - Heavy Duty Filter	HPR0192
Biscayne	250 L6 CARB - Heavy Duty Filter	HPR0192	G20 Van	250 L6 CARB - Heavy Duty Filter	HPR0192
	327 V8 CARB	48026	Heavy Duty Truck	250 L6 2 BBL. - 40, 50, 60 w/HD Filter	HPR0192
		880136	Impala	327 V8 CARB	48026
		HPR0136			880136
	396 V8 CARB	48026			HPR0136
		880136		396 V8 CARB	48026
		HPR0136			880136
	427 V8 CARB	48026			HPR0136
		880136		427 V8 CARB	48026
		HPR0136			

*Indicates 2 filters required ♦ Intake system available - see page 326 + throttle body spacer available - see page 20

CHEVROLET HPR™ REPLACEMENT AIR FILTERS

Vehicle	Engine Type	Air Filter	Vehicle	Engine Type	Air Filter
1967 CHEVROLET			1966 CHEVROLET		
Impala	427 V8 CARB	880136	Chevy II	327 V8 CARB	HPR0136
		HPR0136	Corvair	164 H6 CARB - Exc. Turbo	HPR0192
K10 Pickup	283 V8 CARB	HPR0192 ♦	Corvette	327 V8 CARB	48026
K10 Pickup	292 L6 CARB	HPR0192 ♦			HPR0136
K10 Suburban	283 V8 CARB	HPR0192 ♦		427 V8 CARB	48026
K10 Suburban	292 L6 CARB	HPR0192 ♦			HPR0136
K10 Suburban	327 V8 CARB	HPR0192 ♦	El Camino	327 V8 CARB	48026 ♦
K20 Panel	250 L6 CARB - Heavy Duty Filter	HPR0192			HPR0136 ♦
K20 Panel	283 V8 CARB	HPR0192 ♦		396 V8 CARB	48026 ♦
K20 Pickup	283 V8 CARB	HPR0192 ♦			HPR0136 ♦
K20 Pickup	292 L6 CARB	HPR0192 ♦	Impala	327 V8 CARB	48026
K20 Suburban	283 V8 CARB	HPR0192 ♦			880136
K20 Suburban	292 L6 CARB	HPR0192 ♦			HPR0136
K20 Suburban	327 V8 CARB	HPR0192 ♦		396 V8 CARB	48026
Malibu	327 V8 CARB	48026			880136
		880136			HPR0136
		HPR0136		427 V8 CARB	48026
	396 V8 CARB	48026			880136
		880136			HPR0136
		HPR0136	K10 Pickup	230 L6 CARB - Heavy Duty Filter	HPR0192
P10 Series	292 L6 CARB	HPR0192	K20 Pickup	292 L6 CARB	HPR0192
P20 Series	292 L6 CARB	HPR0192	Malibu	327 V8 CARB	48026
P30 Series	292 L6 CARB	HPR0192			880136
Bel Air	327 V8 CARB	48026			HPR0136
		880136			48026
		HPR0136		396 V8 CARB	880136
	396 V8 CARB	48026			HPR0136
		880136	P10 Series	250 L6 CARB - Heavy Duty Filter	HPR0192
		HPR0136	P20 Series	250 L6 CARB - Heavy Duty Filter	HPR0192
	427 V8 CARB	48026	P20 Series	292 L6 CARB	HPR0192
		880136	P30 Series	292 L6 CARB	HPR0192
		HPR0136	Suburban	292 L6 CARB	HPR0192
Biscayne	327 V8 CARB	48026	Bel Air	327 V8 CARB	48026
		880136			HPR0136
		HPR0136		396 V8 CARB	48026
	396 V8 CARB	48026			880136
		880136			HPR0136
		HPR0136	Biscayne	327 V8 CARB	48026
	427 V8 CARB	48026			HPR0136
		880136			48026
		HPR0136		396 V8 CARB	880136
C10 Pickup	230 L6 CARB - Heavy Duty Filter	HPR0192			HPR0136
C10 Pickup	250 L6 CARB - Heavy Duty Filter	HPR0192	C10 Panel	230 L6 CARB - Heavy Duty Filter	HPR0192
C10 Pickup	292 L6 CARB	HPR0192	C10 Pickup	230 L6 CARB - Heavy Duty Filter	HPR0192
C20 Pickup	292 L6 CARB	HPR0192	C10 Pickup	292 L6 CARB	HPR0192
C20 Pickup	366 V8 CARB	HPR0326	C20 Pickup	230 L6 CARB - Heavy Duty Filter	HPR0192
C30 Pickup	292 L6 CARB	HPR0192	C20 Pickup	292 L6 CARB	HPR0192
C30 Pickup	366 V8 CARB	HPR0326	C30 Panel	230 L6 CARB - Heavy Duty Filter	HPR0192
Caprice	327 V8 CARB	48026	C30 Pickup	230 L6 CARB - Heavy Duty Filter	HPR0192
		880136	C30 Pickup	292 L6 CARB	HPR0192
		HPR0136	Chevelle	396 V8 CARB	48026 ♦
	396 V8 CARB	48026			880136 ♦
		880136			HPR0136 ♦
		HPR0136	Corvair	164 H6 CARB - w/o A/C	HPR0192
	427 V8 CARB	48026	Corvette	396 V8 CARB	48026
		880136			880136
		HPR0136			HPR0136
Chevelle	327 V8 CARB	48026 ♦	Impala	327 V8 CARB	48026
		880136 ♦			HPR0136
		HPR0136 ♦		396 V8 CARB	48026
	396 V8 CARB	48026 ♦			880136
		880136 ♦			HPR0136
		HPR0136 ♦	K10 Pickup	230 L6 CARB - Heavy Duty Filter	HPR0192
Chevy II	327 V8 CARB	48026	K10 Pickup	292 L6 CARB	HPR0192

*Indicates 2 filters required ♦ Intake system available - see page 326 + throttle body spacer available - see page 20

HPR™ REPLACEMENT AIR FILTERS CHEVROLET

Vehicle	Engine Type	Air Filter
1965 CHEVROLET		
K20 Pickup	230 L6 CARB - Heavy Duty Filter	HPR0192
K20 Pickup	292 L6 CARB	HPR0192
1964 CHEVROLET		
C10 Panel	230 L6 CARB - Heavy Duty Filter	HPR0192
C10 Pickup	230 L6 CARB - Heavy Duty Filter	HPR0192
C20 Pickup	230 L6 CARB - Heavy Duty Filter	HPR0192
C30 Panel	230 L6 CARB - Heavy Duty Filter	HPR0192
C30 Pickup	230 L6 CARB - Heavy Duty Filter	HPR0192
K10 Pickup	230 L6 CARB - Heavy Duty Filter	HPR0192
K20 Pickup	230 L6 CARB - Heavy Duty Filter	HPR0192
1963 CHEVROLET		
C10 Panel	230 L6 CARB - Heavy Duty Filter	HPR0192
C10 Pickup	230 L6 CARB - Heavy Duty Filter	HPR0192
C20 Pickup	230 L6 CARB - Heavy Duty Filter	HPR0192
C30 Panel	230 L6 CARB - Heavy Duty Filter	HPR0192
C30 Pickup	230 L6 CARB - Heavy Duty Filter	HPR0192
K10 Pickup	230 L6 CARB - Heavy Duty Filter	HPR0192
K20 Pickup	230 L6 CARB - Heavy Duty Filter	HPR0192
2017 CHRYSLER		
300	3.6L V6 F/I	HPR11257
300	5.7L V8 F/I	HPR11257
2016 CHRYSLER		
300	3.6L V6 F/I	HPR11257 ♦
300	6.4L V8 F/I	HPR11257
300C	5.7L V8 F/I	HPR11257
300S	5.7L V8 F/I	HPR11257
2015 CHRYSLER		
300	3.6L V6 F/I	HPR11257 ♦
300	6.4L V8 F/I	HPR11257 ♦
300C	3.6L V6 F/I	HPR11257 ♦
300C	5.7L V8 F/I	HPR11257 ♦
300S	5.7L V8 F/I	HPR11257 ♦
2014 CHRYSLER		
200	2.4L L4 F/I	HPR9054
300	3.6L V6 F/I	HPR11257 ♦
300	6.4L V8 F/I	HPR11257 ♦
300C	3.6L V6 F/I	HPR11257 ♦
300C	5.7L V8 F/I	HPR11257 ♦
300S	5.7L V8 F/I	HPR11257 ♦
2013 CHRYSLER		
200	2.4L L4 F/I	HPR9054
300	3.6L V6 F/I	HPR11257 ♦
300	6.4L V8 F/I	HPR11257 ♦
300C	5.7L V8 F/I	HPR11257 ♦
300S	5.7L V8 F/I	HPR11257 ♦
2012 CHRYSLER		
200	2.4L L4 F/I	HPR9054
300	3.6L V6 F/I	HPR11257 ♦
300	6.4L V8 F/I	HPR11257 ♦
300C	5.7L V8 F/I	HPR11257 ♦
300S	5.7L V8 F/I	HPR11257 ♦
2011 CHRYSLER		
200	2.4L L4 F/I	HPR9054
300	3.6L V6 F/I	HPR11257 ♦
300C	5.7L V8 F/I	HPR11257 ♦
Voyager IV	2.8L V6 DSL	HPR9054
Voyager IV	3.8L V6 F/I	HPR9054
2010 CHRYSLER		
300	2.7L V6 F/I	HPR9838

Vehicle	Engine Type	Air Filter
2010 CHRYSLER		
300	3.5L V6 F/I	HPR9838
300C	3.0L V6 DSL	HPR9997
300C	5.7L V8 F/I	HPR9838 ♦
300C	6.1L V8 F/I	HPR9838 ♦
Sebring	2.0L L4 DSL	HPR9054
Sebring	2.0L L4 F/I	HPR9054
Sebring	2.4L L4 F/I	HPR9054
Sebring	2.7L V6 F/I	HPR9054
Sebring	3.5L V6 F/I	HPR9054
Town & Country	3.3L V6 F/I	HPR9054
Town & Country	3.8L V6 F/I	HPR9054
Town & Country	4.0L V6 F/I	HPR9054
Voyager IV	2.8L V6 DSL	HPR9054
Voyager IV	3.8L V6 F/I	HPR9054
2009 CHRYSLER		
300	2.7L V6 F/I	HPR9838
300	3.5L V6 F/I	HPR9838
300C	3.0L V6 DSL	HPR9997
300C	5.7L V8 F/I	HPR9838 ♦
300C	6.1L V8 F/I	HPR9838 ♦
Aspen	4.7L V8 F/I	HPR9762
Aspen	5.7L V8 F/I	HPR9762
Sebring	2.0L L4 DSL	HPR9054
Sebring	2.0L L4 F/I	HPR9054
Sebring	2.4L L4 F/I	HPR9054
Sebring	2.7L V6 F/I	HPR9054
Sebring	3.5L V6 F/I	HPR9054
Town & Country Van	3.3L V6 F/I	HPR9054
Town & Country Van	3.8L V6 F/I	HPR9054
Town & Country Van	4.0L V6 F/I	HPR9054
Voyager IV	2.8L V6 DSL	HPR9054
Voyager IV	3.8L V6 F/I	HPR9054
2008 CHRYSLER		
300	2.7L V6 F/I	HPR9838
300	3.5L V6 F/I	HPR9838
300C	2.7L V6 F/I	HPR9838
300C	3.0L V6 DSL	HPR9997
300C	3.5L V6 F/I	HPR9838
300C	5.7L V8 F/I	HPR9838 ♦
300C	6.1L V8 F/I	HPR9838 ♦
Aspen	4.7L V8 F/I	HPR9762
Aspen	5.7L V8 F/I	HPR9762 +
Sebring	2.0L L4 DSL	HPR9054
Sebring	2.0L L4 F/I	HPR9054
Sebring	2.4L L4 F/I	HPR9054
Sebring	2.7L V6 F/I	HPR9054
Sebring	3.5L V6 F/I	HPR9054
Town & Country Van	3.3L V6 F/I	HPR9054
Town & Country Van	3.8L V6 F/I	HPR9054
Town & Country Van	4.0L V6 F/I	HPR9054
Voyager III	2.4L L4 F/I	HPR9054
Voyager III	2.5L L4 DSL	HPR9054
Voyager III	2.8L L4 DSL	HPR9054
Voyager III	3.3L V6 F/I	HPR9054
Voyager III	3.8L V6 F/I	HPR9054
Voyager IV	2.8L V6 DSL	HPR9054
Voyager IV	3.8L V6 F/I	HPR9054
2007 CHRYSLER		
300	2.7L V6 F/I	HPR9838
300	3.5L V6 F/I	HPR9838
300C	2.7L V6 F/I	HPR9838
300C	3.0L V6 DSL	HPR9997
300C	3.5L V6 F/I	HPR9838

*Indicates 2 filters required ♦ Intake system available - see page 326 + throttle body spacer available - see page 20

CHRYSLER HPR™ REPLACEMENT AIR FILTERS

Vehicle	Engine Type	Air Filter	Vehicle	Engine Type	Air Filter
2007 CHRYSLER			2004 CHRYSLER		
300C	5.7L V8 F/I	HPR9838 ♦	Intrepid	2.7L V6 F/I	HPR8606
300C	6.1L V8 F/I	HPR9838 ♦	Intrepid	3.5L V6 F/I	HPR8606
Aspen	4.7L V8 F/I	HPR9762	Neon II	2.0L L4 F/I	HPR8805
Aspen	5.7L V8 F/I	HPR9762 +	PT Cruiser	1.6L L4 F/I	HPR8747
Sebring	2.0L L4 DSL	HPR9054	PT Cruiser	2.0L L4 F/I	HPR8747
Sebring	2.0L L4 F/I	HPR9054	PT Cruiser	2.4L L4 F/I	HPR8747
Sebring	2.4L L4 F/I	HPR9054	Sebring	2.4L L4 F/I	HPR9053
Sebring	2.7L V6 F/I	HPR9054	Sebring	2.7L V6 F/I	HPR9053
Sebring	3.5L V6 F/I	HPR9054	Sebring	3.0L V6 F/I	HPR7344
Town & Country Van	3.3L V6 F/I	HPR9054	Stratus	2.4L L4 F/I - Coupe	HPR7344
Town & Country Van	3.8L V6 F/I	HPR9054	Stratus	2.4L L4 F/I - Sedan	HPR9053
Voyager III	2.4L L4 F/I	HPR9054	Town & Country Van	3.3L V6 F/I	HPR9054
Voyager III	2.5L L4 DSL	HPR9054	Town & Country Van	3.8L V6 F/I	HPR9054
Voyager III	2.8L L4 DSL	HPR9054	Voyager III	2.4L L4 F/I	HPR9054
Voyager III	3.3L V6 F/I	HPR9054	Voyager III	2.5L L4 DSL	HPR9054
Voyager III	3.8L V6 F/I	HPR9054	Voyager III	2.8L L4 DSL	HPR9054
			Voyager III	3.3L V6 F/I	HPR9054
			Voyager III	3.8L V6 F/I	HPR9054
2006 CHRYSLER			2003 CHRYSLER		
300	2.7L V6 F/I	HPR9838	300M	2.7L V6 F/I	HPR8606
300	3.5L V6 F/I	HPR9838	300M	3.5L V6 F/I	HPR8606
300C	3.0L V6 DSL	HPR9997	Concorde	2.7L V6 F/I	HPR8606
300C	3.5L V6 F/I	HPR9838	Concorde	3.5L V6 F/I	HPR8606
300C	5.7L V8 F/I	HPR9838 ♦	Intrepid	2.7L V6 F/I	HPR8606
300C	6.1L V8 F/I	HPR9838 ♦	Intrepid	3.5L V6 F/I	HPR8606
Sebring	2.4L L4 F/I	HPR9053	Neon II	2.0L L4 F/I	HPR8805
Sebring	2.7L V6 F/I	HPR9053	PT Cruiser	1.6L L4 F/I	HPR8747
Town & Country Van	3.3L V6 F/I	HPR9054	PT Cruiser	2.0L L4 F/I	HPR8747
Town & Country Van	3.8L V6 F/I	HPR9054	PT Cruiser	2.4L L4 F/I	HPR8747
Voyager III	2.4L L4 F/I	HPR9054	Sebring	2.4L L4 F/I	HPR7344
Voyager III	2.5L L4 DSL	HPR9054	Sebring	2.4L L4 F/I - Non-US	HPR9053
Voyager III	2.8L L4 DSL	HPR9054	Sebring	2.7L V6 F/I	HPR9053
Voyager III	3.3L V6 F/I	HPR9054	Sebring	3.0L V6 F/I	HPR7344
Voyager III	3.8L V6 F/I	HPR9054	Stratus	2.4L L4 F/I - Coupe	HPR7344
			Stratus	2.4L L4 F/I - Sedan	HPR9053
2005 CHRYSLER			Town & Country Van	3.3L V6 F/I	HPR9054
300	2.7L V6 F/I	HPR9838	Town & Country Van	3.8L V6 F/I	HPR9054
300	3.5L V6 F/I	HPR9838	Voyager III	2.4L L4 F/I	HPR9054
300C	3.0L V6 DSL	HPR9997	Voyager III	2.5L L4 DSL	HPR9054
300C	3.5L V6 F/I	HPR9838	Voyager III	3.3L V6 F/I	HPR9054
300C	5.7L V8 F/I	HPR9838 ♦	Voyager III	3.8L V6 F/I	HPR9054
300C	6.1L V8 F/I	HPR9838 ♦	Voyager Van	2.4L L4 F/I	HPR9054
Neon II	2.0L L4 F/I	HPR8805	Voyager Van	3.3L V6 F/I	HPR9054
PT Cruiser	1.6L L4 F/I	HPR8747	2002 CHRYSLER		
PT Cruiser	2.0L L4 F/I	HPR8747	300M	2.7L V6 F/I	HPR8606
PT Cruiser	2.4L L4 F/I	HPR8747	300M	3.5L V6 F/I	HPR8606
Sebring	2.4L L4 F/I - DOHC	HPR9053	Concorde	2.7L V6 F/I	HPR8606
Sebring	2.4L L4 F/I - Non-US	HPR9053	Concorde	3.5L V6 F/I	HPR8606
Sebring	2.4L L4 F/I - SOHC	HPR7344	Intrepid	2.7L V6 F/I	HPR8606
Sebring	2.7L V6 F/I	HPR9053	Intrepid	3.5L V6 F/I	HPR8606
Sebring	3.0L V6 F/I	HPR7344	Neon	2.0L L4 F/I	HPR8805
Town & Country Van	3.3L V6 F/I	HPR9054	Neon II	2.0L L4 F/I	HPR8805
Town & Country Van	3.8L V6 F/I	HPR9054	Prowler	3.5L V6 F/I	HPR3660
Voyager III	2.4L L4 F/I	HPR9054	PT Cruiser	2.0L L4 F/I	HPR8747
Voyager III	2.5L L4 DSL	HPR9054	PT Cruiser	2.4L L4 F/I	HPR8747
Voyager III	2.8L L4 DSL	HPR9054	Sebring	2.4L L4 F/I - DOHC	HPR9053
Voyager III	3.3L V6 F/I	HPR9054	Sebring	2.4L L4 F/I - Non-US	HPR9053
Voyager III	3.8L V6 F/I	HPR9054	Sebring	2.4L L4 F/I - SOHC	HPR7344
			Sebring	2.7L V6 F/I	HPR9053
2004 CHRYSLER			Sebring	3.0L V6 F/I	HPR7344
300C	2.7L V6 F/I	HPR9838	Stratus	2.4L L4 F/I - Coupe	HPR7344
300C	3.5L V6 F/I	HPR9838	Stratus	2.4L L4 F/I - Sedan	HPR9053
300C	5.7L V8 F/I	HPR9838	Town & Country Van	3.3L V6 F/I	HPR9054
300M	2.7L V6 F/I	HPR8606			
300M	3.5L V6 F/I	HPR8606			
Concorde	2.7L V6 F/I	HPR8606			
Concorde	3.5L V6 F/I	HPR8606			

*Indicates 2 filters required ♦ Intake system available - see page 326 + throttle body spacer available - see page 20

HPR™ REPLACEMENT AIR FILTERS CHRYSLER

Vehicle	Engine Type	Air Filter	Vehicle	Engine Type	Air Filter
2002 CHRYSLER			2000 CHRYSLER		
Town & Country Van	3.8L V6 F/I	HPR9054	Stratus	2.4L L4 F/I	HPR7432
Voyager III	2.4L L4 F/I	HPR9054	Stratus	2.5L V6 F/I	HPR7432
Voyager III	2.5L L4 DSL	HPR9054	Town & Country Van	3.3L V6 F/I	HPR3660
Voyager III	3.3L V6 F/I	HPR9054	Town & Country Van	3.8L V6 F/I	HPR3660
Voyager III	3.8L V6 F/I	HPR9054	Voyager II	2.0L L4 F/I	HPR3660
Voyager Van	2.4L L4 F/I	HPR9054	Voyager II	2.4L L4 F/I	HPR3660
Voyager Van	3.3L V6 F/I	HPR9054	Voyager II	2.5L L4 DSL	HPR3660
2001 CHRYSLER			1999 CHRYSLER		
300M	2.7L V6 F/I	HPR8606	300M	2.7L V6 F/I	HPR8606
300M	3.5L V6 F/I	HPR8606	300M	3.5L V6 F/I	HPR8606
Concorde	2.7L V6 F/I	HPR8606	Cirrus	2.5L V6 F/I	HPR7432
Concorde	3.2L V6 F/I	HPR8606	Concorde	2.7L V6 F/I	HPR8606
Intrepid	2.7L V6 F/I	HPR8606	Concorde	3.2L V6 F/I	HPR8606
Intrepid	3.2L V6 F/I	HPR8606	Intrepid	2.7L V6 F/I	HPR8606
Intrepid	3.5L V6 F/I	HPR8606	Intrepid	3.2L V6 F/I	HPR8606
LHS	3.5L V6 F/I	HPR8606	LHS	3.5L V6 F/I	HPR8606
Neon	2.0L L4 F/I	HPR8805	Neon	1.8L L4 F/I	HPR3660
Neon II	2.0L L4 F/I	HPR8805	Neon	2.0L L4 F/I	HPR3660
PT Cruiser	2.0L L4 F/I	HPR8747	Neon II	2.0L L4 F/I	HPR8805
PT Cruiser	2.4L L4 F/I	HPR8747	Sebring	2.0L L4 F/I	HPR7344
Sebring	2.4L L4 F/I - DOHC	HPR9053	Sebring	2.5L V6 F/I - VIN H	HPR7432
Sebring	2.4L L4 F/I - Non-US	HPR9053	Sebring	2.5L V6 F/I - VIN N	HPR7344
Sebring	2.4L L4 F/I - SOHC	HPR7344	Stratus	2.0L L4 F/I	HPR7432
Sebring	2.7L V6 F/I	HPR9053	Stratus	2.4L L4 F/I	HPR7432
Sebring	3.0L V6 F/I	HPR7344	Stratus	2.5L V6 F/I	HPR7432
Stratus	2.4L L4 F/I - Coupe	HPR7344	Town & Country Van	3.3L V6 F/I	HPR3660
Stratus	2.4L L4 F/I - Sedan	HPR9053	Town & Country Van	3.8L V6 F/I	HPR3660
Stratus	2.5L V6 F/I	HPR7432	Voyager	3.3L V6 F/I	HPR3660
Town & Country Van	3.3L V6 F/I	HPR9054	Voyager II	2.0L L4 F/I	HPR3660
Town & Country Van	3.8L V6 F/I	HPR9054	Voyager II	2.4L L4 F/I	HPR3660
Voyager II	2.0L L4 F/I	HPR3660	Voyager II	2.5L L4 DSL	HPR3660
Voyager II	2.4L L4 F/I	HPR3660	Voyager II	3.0L V6 F/I	HPR3660
Voyager II	2.5L L4 DSL	HPR3660	Voyager II	3.3L V6 F/I	HPR3660
Voyager II	3.0L V6 F/I	HPR3660	Voyager II	3.8L V6 F/I	HPR3660
Voyager II	3.8L V6 F/I	HPR3660	1998 CHRYSLER		
Voyager III	2.4L L4 F/I	HPR9054	300M	2.7L V6 F/I	HPR8606
Voyager III	2.5L L4 DSL	HPR9054	300M	3.5L V6 F/I	HPR8606
Voyager III	3.3L V6 F/I	HPR9054	Cirrus	2.5L V6 F/I	HPR7432
Voyager III	3.8L V6 F/I	HPR9054	Cirrus	2.7L V6 F/I	HPR8606
Voyager Van	2.4L L4 F/I	HPR9054	Concorde	3.2L V6 F/I	HPR8606
Voyager Van	3.3L V6 F/I	HPR9054	Intrepid	2.7L V6 F/I	HPR8606
2000 CHRYSLER			Intrepid	3.2L V6 F/I	HPR8606
300M	2.7L V6 F/I	HPR8606	Neon	1.8L L4 F/I	HPR3660
300M	3.5L V6 F/I	HPR8606	Neon	2.0L L4 F/I	HPR3660
Cirrus	2.0L L4 F/I	HPR7432	Sebring	2.0L L4 F/I	HPR7344
Cirrus	2.4L L4 F/I	HPR7432	Sebring	2.4L L4 F/I	HPR7432
Cirrus	2.5L V6 F/I	HPR7432	Sebring	2.5L V6 F/I - VIN H	HPR7432
Concorde	2.7L V6 F/I	HPR8606	Sebring	2.5L V6 F/I - VIN N	HPR7344
Concorde	3.2L V6 F/I	HPR8606	Stratus	2.0L L4 F/I	HPR7432
Grand Voyager	3.0L V6 F/I	HPR3660	Stratus	2.4L L4 F/I	HPR7432
Grand Voyager	3.3L V6 F/I	HPR3660	Stratus	2.5L V6 F/I	HPR7432
Intrepid	2.7L V6 F/I	HPR8606	Town & Country Van	3.3L V6 F/I	HPR3660
Intrepid	3.2L V6 F/I	HPR8606	Town & Country Van	3.8L V6 F/I	HPR3660
Intrepid	3.5L V6 F/I	HPR8606	1998 CHRYSLER		
LHS	3.5L V6 F/I	HPR8606	300M	2.7L V6 F/I	HPR8606
Neon	2.0L L4 F/I	HPR8805	300M	3.5L V6 F/I	HPR8606
Neon II	2.0L L4 F/I	HPR8805	Cirrus	2.5L V6 F/I	HPR7432
PT Cruiser	2.0L L4 F/I	HPR8747	Cirrus	2.7L V6 F/I	HPR8606
PT Cruiser	2.4L L4 F/I	HPR8747	Concorde	3.2L V6 F/I	HPR8606
Sebring	2.5L V6 F/I - VIN H	HPR7432	Intrepid	2.7L V6 F/I	HPR8606
Sebring	2.5L V6 F/I - VIN N	HPR7344	Intrepid	3.2L V6 F/I	HPR8606
Stratus	2.0L L4 F/I	HPR7432	Neon	1.8L L4 F/I	HPR3660
Stratus	2.4L L4 F/I	HPR7432	Neon	2.0L L4 F/I	HPR3660
Stratus	2.5L V6 F/I	HPR7432	Sebring	2.0L L4 F/I	HPR7344
Town & Country Van	3.3L V6 F/I	HPR3660	Sebring	2.4L L4 F/I	HPR7432
Town & Country Van	3.8L V6 F/I	HPR3660	Sebring	2.5L V6 F/I - VIN H	HPR7432
			Sebring	2.5L V6 F/I - VIN N	HPR7344
			Stratus	2.0L L4 F/I	HPR7432
			Stratus	2.4L L4 F/I	HPR7432
			Stratus	2.5L V6 F/I	HPR7432
			Town & Country Van	3.3L V6 F/I	HPR3660
			Town & Country Van	3.8L V6 F/I	HPR3660

*Indicates 2 filters required ♦ Intake system available - see page 326 + throttle body spacer available - see page 20

CHRYSLER HPR™ REPLACEMENT AIR FILTERS

Vehicle	Engine Type	Air Filter	Vehicle	Engine Type	Air Filter
1998 CHRYSLER			1995 CHRYSLER		
Voyager	3.3L V6 F/I	HPR3660	Voyager II	2.4L L4 F/I	HPR3660
Voyager II	2.0L L4 F/I	HPR3660	Voyager II	2.5L L4 DSL	HPR3660
Voyager II	2.4L L4 F/I	HPR3660	Voyager II	3.0L V6 F/I	HPR3660
Voyager II	2.5L L4 DSL	HPR3660	Voyager II	3.3L V6 F/I	HPR3660
Voyager II	3.0L V6 F/I	HPR3660	Voyager II	3.8L V6 F/I	HPR3660
Voyager II	3.3L V6 F/I	HPR3660	1994 CHRYSLER		
Voyager II	3.8L V6 F/I	HPR3660	LeBaron	3.0L V6 F/I	HPR3660
1997 CHRYSLER			Neon	2.0L L4 F/I	HPR3660
Cirrus	2.4L L4 F/I	HPR7432	Town & Country Van	3.8L V6 F/I	HPR3559
Cirrus	2.5L V6 F/I	HPR7432	Voyager I	2.5L L4 F/I	HPR3559
Neon	1.8L L4 F/I	HPR3660	Voyager I	3.0L V6 F/I	HPR3660
Neon	2.0L L4 F/I	HPR3660	Voyager I	3.3L V6 F/I	HPR3559
Sebring	2.0L L4 F/I	HPR7344	1993 CHRYSLER		
Sebring	2.4L L4 F/I	HPR7432	Daytona	2.2L L4 F/I	HPR3660
Sebring	2.5L V6 F/I - VIN H	HPR7432	Daytona	3.0L V6 F/I	HPR3660
Sebring	2.5L V6 F/I - VIN N	HPR7344	Dynasty	3.3L V6 F/I	HPR3559
Stratus	2.0L L4 F/I	HPR7432	Imperial	3.8L V6 F/I	HPR3559
Stratus	2.4L L4 F/I	HPR7432	LeBaron	2.5L L4 F/I	HPR3660
Stratus	2.5L V6 F/I	HPR7432	LeBaron	3.0L V6 F/I	HPR3660
Town & Country Van	3.3L V6 F/I	HPR3660	New Yorker	3.3L V6 F/I	HPR3559
Town & Country Van	3.8L V6 F/I	HPR3660	New Yorker	3.8L V6 F/I	HPR3559
Voyager	3.3L V6 F/I	HPR3660	Town & Country Van	3.3L V6 F/I	HPR3559
Voyager II	2.0L L4 F/I	HPR3660	Voyager I	2.5L L4 F/I	HPR3559
Voyager II	2.4L L4 F/I	HPR3660	Voyager I	3.0L V6 F/I	HPR3660
Voyager II	2.5L L4 DSL	HPR3660	Voyager I	3.3L V6 F/I	HPR3559
Voyager II	3.0L V6 F/I	HPR3660	1992 CHRYSLER		
Voyager II	3.3L V6 F/I	HPR3660	Daytona	2.2L L4 F/I	HPR3660
Voyager II	3.8L V6 F/I	HPR3660	Daytona	3.0L V6 F/I	HPR3660
1996 CHRYSLER			Dynasty	3.3L V6 F/I	HPR3559
Cirrus	2.4L L4 F/I	HPR7432	Imperial	3.8L V6 F/I	HPR3559
Cirrus	2.5L V6 F/I	HPR7432	LeBaron	3.0L V6 F/I	HPR3660
Neon	2.0L L4 F/I	HPR3660	New Yorker	3.3L V6 F/I	HPR3559
Sebring	2.0L L4 F/I	HPR7344	Town & Country Van	3.3L V6 F/I	HPR3559
Sebring	2.4L L4 F/I	HPR7432	Voyager I	2.5L L4 F/I	HPR3559
Sebring	2.5L V6 F/I - VIN H	HPR7432	Voyager I	3.0L V6 F/I	HPR3660
Sebring	2.5L V6 F/I - VIN N	HPR7344	Voyager I	3.3L V6 F/I	HPR3559
Stratus	2.0L L4 F/I	HPR7432	1991 CHRYSLER		
Stratus	2.4L L4 F/I	HPR7432	Daytona	3.0L V6 F/I	HPR3660
Stratus	2.5L V6 F/I	HPR7432	Dynasty	3.3L V6 F/I	HPR3559
Town & Country Van	3.3L V6 F/I	HPR3660	Imperial	3.3L V6 F/I	HPR3559
Town & Country Van	3.8L V6 F/I	HPR3660	Imperial	3.8L V6 F/I	HPR3559
Voyager	3.3L V6 F/I	HPR3660	LeBaron	3.0L V6 F/I	HPR3660
Voyager II	2.0L L4 F/I	HPR3660	New Yorker	3.3L V6 F/I	HPR3660
Voyager II	2.4L L4 F/I	HPR3660	New Yorker	3.8L V6 F/I	HPR3559
Voyager II	2.5L L4 DSL	HPR3660	TC Maserati	3.0L V6 F/I	HPR3660
Voyager II	3.0L V6 F/I	HPR3660	Town & Country Van	3.3L V6 F/I	HPR3559
Voyager II	3.3L V6 F/I	HPR3660	Voyager I	2.5L L4 F/I	HPR3559
Voyager II	3.8L V6 F/I	HPR3660	Voyager I	3.0L V6 F/I	HPR3660
1995 CHRYSLER			Voyager I	3.3L V6 F/I	HPR3559
Cirrus	2.4L L4 F/I	HPR7432	1990 CHRYSLER		
Cirrus	2.5L V6 F/I	HPR7432	Daytona	3.0L V6 F/I	HPR3660
LeBaron	3.0L V6 F/I	HPR3660	Dynasty	3.0L V6 F/I	HPR3660
Neon	2.0L L4 F/I	HPR3660	Dynasty	3.3L V6 F/I	HPR3559
Sebring	2.0L L4 F/I	HPR7344	Imperial	3.3L V6 F/I	HPR3660
Sebring	2.5L V6 F/I	HPR7344	LeBaron	3.0L V6 F/I	HPR3660
Stratus	2.0L L4 F/I	HPR7432	New Yorker	3.3L V6 F/I	HPR3660
Stratus	2.5L V6 F/I	HPR7432	TC Maserati	2.2L L4 F/I	HPR3559
Town & Country Van	3.8L V6 F/I	HPR3559	TC Maserati	3.0L V6 F/I	HPR3660
Voyager	3.3L V6 F/I	HPR3559	Town & Country Van	3.3L V6 F/I	HPR3660
Voyager I	2.5L L4 F/I	HPR3559	Voyager I	2.5L L4 F/I	HPR3559
Voyager I	3.0L V6 F/I	HPR3660	Voyager I	3.0L V6 F/I	HPR3660
Voyager I	3.3L V6 F/I	HPR3559			
Voyager II	2.0L L4 F/I	HPR3660			

*Indicates 2 filters required ♦ Intake system available - see page 326 + throttle body spacer available - see page 20

HPR™ REPLACEMENT AIR FILTERS CHRYSLER

Vehicle	Engine Type	Air Filter	Vehicle	Engine Type	Air Filter
1990 CHRYSLER			1984 CHRYSLER		
Voyager I	3.3L V6 F/I	HPR3559	Laser	2.2L L4 F/I - Exc. Turbo	HPR3660
1989 CHRYSLER			Laser	2.2L L4 F/I - Turbo	HPR3559
Daytona	2.2L L4 F/I	HPR3559	LeBaron	2.2L L4 CARB	HPR3559
Daytona	2.5L L4 F/I	HPR3559	LeBaron	2.2L L4 F/I - Exc. Turbo	HPR3660
Dynasty	3.0L V6 F/I	HPR3660	LeBaron	2.2L L4 F/I - Turbo	HPR3559
LeBaron	2.2L L4 F/I - Exc. Turbo	HPR3660	New Yorker	2.2L L4 F/I - Exc. Turbo	HPR3660
LeBaron	2.2L L4 F/I - Turbo	HPR3559	New Yorker	2.2L L4 F/I - Turbo	HPR3559
LeBaron	2.5L L4 F/I - Exc. Turbo	HPR3660	Town & Country	2.2L L4 CARB	HPR3559
LeBaron	2.5L L4 F/I - Turbo	HPR3559	Voyager I	2.5L L4 F/I	HPR3559
New Yorker	3.0L V6 F/I	HPR3660	Voyager I	3.0L V6 F/I	HPR3660
TC Maserati	2.2L L4 F/I	HPR3559	1983 CHRYSLER		
Voyager I	2.5L L4 F/I	HPR3559	Cordoba	3.7L L6 CARB	HPR0160
Voyager I	3.0L V6 F/I	HPR3660	Cordoba	5.2L V8 CARB	HPR0160
1988 CHRYSLER			E-Class	2.2L L4 CARB	HPR3559
Daytona	2.2L L4 F/I	HPR3559	Fifth Avenue	3.7L L6 1 BBL.	HPR0160
Dynasty	3.0L V6 F/I	HPR3660	Fifth Avenue	3.7L L6 CARB	HPR0160
Fifth Avenue	5.2L V8 CARB	HPR0160	Fifth Avenue	5.2L V8 CARB	HPR0160
LeBaron	2.2L L4 F/I - Exc. Turbo	HPR3660	Imperial	5.2L V8 CARB	HPR0160
LeBaron	2.2L L4 F/I - Turbo	HPR3559	LeBaron	2.2L L4 CARB	HPR3559
New Yorker	2.2L L4 F/I	HPR3559	New Yorker	2.2L L4 CARB	HPR3559
New Yorker	3.0L V6 F/I	HPR3660	Town & Country	2.2L L4 CARB	HPR3559
Town & Country	2.2L L4 F/I	HPR3559	1982 CHRYSLER		
Voyager I	2.5L L4 F/I	HPR3559	Cordoba	3.7L L6 CARB	HPR0160
Voyager I	3.0L V6 F/I	HPR3660	Cordoba	5.2L V8 2 BBL.	HPR0160
1987 CHRYSLER			LeBaron	2.2L L4 CARB	HPR3559
Daytona	2.2L L4 F/I	HPR3559	New Yorker	3.7L L6 CARB	HPR0160
Daytona	2.5L L4 F/I	HPR3559	New Yorker	5.2L V8 2 BBL.	HPR0160
Fifth Avenue	5.2L V8 CARB	HPR0160	Town & Country	2.2L L4 CARB	HPR3559
LeBaron	2.2L L4 F/I - Exc. Turbo	HPR3660	1981 CHRYSLER		
LeBaron	2.2L L4 F/I - Turbo	HPR3559	Cordoba	3.7L L6 CARB	HPR0160
New Yorker	2.2L L4 F/I	HPR3559	Cordoba	5.2L V8 2 BBL.	HPR0160
Town & Country	2.2L L4 F/I	HPR3559	LeBaron	3.7L L6 CARB	HPR0160
Voyager I	2.5L L4 F/I	HPR3559	LeBaron	5.2L V8 2 BBL.	HPR0160
Voyager I	3.0L V6 F/I	HPR3660	New Yorker	5.2L V8 2 BBL.	HPR0160
1986 CHRYSLER			Newport	3.7L L6 CARB	HPR0160
Daytona	2.2L L4 F/I	HPR3559	Newport	5.2L V8 2 BBL.	HPR0160
Fifth Avenue	5.2L V8 CARB	HPR0160	1980 CHRYSLER		
Laser	2.2L L4 F/I - Exc. Turbo	HPR3660	Cordoba	225 L6 1 BBL. - w/10 in OD Filter	HPR0160
Laser	2.2L L4 F/I - Turbo	HPR3559	Cordoba	225 L6 2 BBL. - w/10 in OD Filter	HPR0160
LeBaron	2.2L L4 F/I - Exc. Turbo	HPR3660	Cordoba	318 V8 2 BBL.	HPR0160
LeBaron	2.2L L4 F/I - Turbo	HPR3559	LeBaron	225 L6 1 BBL. - w/10 in OD Filter	HPR0160
New Yorker	2.2L L4 F/I	HPR3559	LeBaron	225 L6 2 BBL. - w/10 in OD Filter	HPR0160
Town & Country	2.2L L4 F/I	HPR3559	LeBaron	318 V8 2 BBL.	HPR0160
Voyager I	2.5L L4 F/I	HPR3559	New Yorker	318 V8 2 BBL.	HPR0160
Voyager I	3.0L V6 F/I	HPR3660	New Yorker	360 V8 CARB	HPR0160
1985 CHRYSLER			Newport	225 L6 CARB - w/10 in OD Filter	HPR0160
Daytona	2.2L L4 F/I	HPR3559	Newport	318 V8 2 BBL.	HPR0160
Fifth Avenue	5.2L V8 CARB	HPR0160	Newport	360 V8 CARB	HPR0160
Laser	2.2L L4 F/I - Exc. Turbo	HPR3660	Town & Country	225 L6 CARB	HPR0160
Laser	2.2L L4 F/I - Turbo	HPR3559	1979 CHRYSLER		
LeBaron	2.2L L4 F/I - Exc. Turbo	HPR3660	Cordoba	318 V8 2 BBL.	HPR0160
LeBaron	2.2L L4 F/I - Turbo	HPR3559	LeBaron	225 L6 1 BBL. - w/10 in OD Filter	HPR0160
New Yorker	2.2L L4 F/I	HPR3559	LeBaron	225 L6 2 BBL. - w/10 in OD Filter	HPR0160
Town & Country	2.2L L4 F/I	HPR3559	LeBaron	318 V8 2 BBL.	HPR0160
Voyager I	2.5L L4 F/I	HPR3559	New Yorker	318 V8 CARB	HPR0160
Voyager I	3.0L V6 F/I	HPR3660	Newport	225 L6 CARB	HPR0160
1984 CHRYSLER			Newport	318 V8 2 BBL.	HPR0160
Daytona	2.2L L4 F/I	HPR3559	Town & Country	225 L6 CARB - w/10 in OD Filter	HPR0160
E-Class	2.2L L4 F/I - Exc. Turbo	HPR3660	1978 CHRYSLER		
E-Class	2.2L L4 F/I - Turbo	HPR3559	Cordoba	318 V8 2 BBL.	HPR0160
Fifth Avenue	5.2L V8 CARB	HPR0160	LeBaron	225 L6 2 BBL.	HPR0160

*Indicates 2 filters required ♦ Intake system available - see page 326 + throttle body spacer available - see page 20

CHRYSLER HPR™ REPLACEMENT AIR FILTERS

Vehicle	Engine Type	Air Filter	Vehicle	Engine Type	Air Filter
1978 CHRYSLER			2015 DODGE		
LeBaron	318 V8 2 BBL.	HPR0160	2500	6.4L V8 F/I	HPR9401
Town & Country	225 L6 2 BBL.	HPR0160	3500	5.7L V8 F/I	HPR9401
Town & Country	318 V8 CARB	HPR0160	3500	6.4L V8 F/I	HPR9401
1977 CHRYSLER			4500	6.4L V8 F/I	HPR9401
Cordoba	318 V8 CARB	HPR0160	5500	6.4L V8 F/I	HPR9401
LeBaron	318 V8 CARB	HPR0160	Challenger	3.6L V6 F/I	HPR11257 ♦
1976 CHRYSLER			Challenger	5.7L V8 F/I	HPR11257 ♦
Cordoba	318 V8 CARB	HPR0160	Challenger	6.2L V8 F/I	HPR11257
1975 CHRYSLER			Challenger	6.4L V8 F/I	HPR11257 ♦
Cordoba	318 V8 CARB	HPR0160	Charger	3.6L V6 F/I	HPR11257 ♦
1974 CHRYSLER			Charger	5.7L V8 F/I	HPR11257 ♦
Newport	265 L6 CARB	HPR0160	Charger	6.2L V8 F/I	HPR11257
Town & Country	265 L6 CARB	HPR0160	Charger	6.4L V8 F/I	HPR11257 ♦
1973 CHRYSLER			Durango	3.6L V6 F/I	HPR10755
Newport	265 L6 CARB	HPR0160	Durango	5.7L V8 F/I	HPR10755
Town & Country	265 L6 CARB	HPR0160	2014 DODGE		
1972 CHRYSLER			4500	6.4L V8 F/I	HPR9401
Newport	265 L6 CARB	HPR0160	5500	6.4L V8 F/I	HPR9401
2017 DODGE			Avenger	2.4L L4 F/I	HPR9054
1500	3.0L V6 DSL	HPR9401	Challenger	3.6L V6 F/I	HPR11257 ♦
1500	3.6L V6 F/I	HPR9401	Challenger	5.7L V8 F/I	HPR11257 ♦
1500	5.7L V8 F/I	HPR9401	Challenger	6.4L V8 F/I	HPR11257 ♦
2500	5.7L V8 F/I	HPR9401	Charger	3.6L V6 F/I	HPR11257 ♦
2500	6.4L V8 F/I	HPR9401	Charger	5.7L V8 F/I	HPR11257 ♦
3500	5.7L V8 F/I	HPR9401	Charger	6.4L V8 F/I	HPR11257 ♦
3500	6.4L V8 F/I	HPR9401	Durango	3.6L V6 F/I	HPR10755 ♦
Challenger	3.6L V6 F/I	HPR11257	Durango	5.7L V8 F/I	HPR10755 ♦
Challenger	5.7L V8 F/I	HPR11257	Ram 1500	5.7L V8 F/I	HPR9401 ♦
Challenger	6.2L V8 F/I	HPR11257	Ram 1500 Pickup	3.0L V6 DSL	HPR9401 ♦
Challenger	6.4L V8 F/I	HPR11257	Ram 1500 Pickup	3.6L V6 F/I	HPR9401 ♦
Charger	3.6L V6 F/I	HPR11257	Ram 2500	5.7L V8 F/I	HPR9401 ♦
Charger	5.7L V8 F/I	HPR11257	Ram 2500 Pickup	6.4L V8 F/I	HPR9401
Charger	6.4L V8 F/I	HPR11257	Ram 3500	5.7L V8 F/I	HPR9401
Durango	3.6L V6 F/I	HPR10755	Ram 3500 Pickup	6.4L V8 F/I	HPR9401
Durango	5.7L V8 F/I	HPR10755	2013 DODGE		
2016 DODGE			Avenger	2.4L L4 F/I	HPR9054
1500	3.0L V6 DSL	HPR9401 ♦	Challenger	3.6L V6 F/I	HPR11257 ♦
1500	3.6L V6 F/I	HPR9401	Challenger	5.7L V8 F/I	HPR11257 ♦
1500	5.7L V8 F/I	HPR9401	Challenger	6.4L V8 F/I	HPR11257 ♦
2500	5.7L V8 F/I	HPR9401	Charger	3.6L V6 F/I	HPR11257 ♦
2500	6.4L V8 F/I	HPR9401	Charger	5.7L V8 F/I	HPR11257 ♦
3500	5.7L V8 F/I	HPR9401	Charger	6.4L V8 F/I	HPR11257 ♦
3500	6.4L V8 F/I	HPR9401	Durango	3.6L V6 F/I	HPR10755 ♦
4500	6.4L V8 F/I	HPR9401	Durango	5.7L V8 F/I	HPR10755 ♦
5500	6.4L V8 F/I	HPR9401	Ram 1500	5.7L V8 F/I	HPR9401 ♦
Challenger	3.6L V6 F/I	HPR11257 ♦	Ram 1500 Pickup	3.6L V6 F/I	HPR9401 ♦
Challenger	5.7L V8 F/I	HPR11257	Ram 1500 Pickup	4.7L V8 F/I	HPR9401
Challenger	6.2L V8 F/I	HPR11257	Ram 2500	5.7L V8 F/I	HPR9401 ♦
Challenger	6.4L V8 F/I	HPR11257	Ram 3500	5.7L V8 F/I	HPR9401
Charger	3.6L V6 F/I	HPR11257 ♦	2012 DODGE		
Charger	5.7L V8 F/I	HPR11257	Avenger	2.4L L4 F/I	HPR9054
Charger	6.2L V8 F/I	HPR11257	Challenger	3.6L V6 F/I	HPR11257 ♦
Charger	6.4L V8 F/I	HPR11257	Challenger	5.7L V8 F/I	HPR11257 ♦
Durango	3.6L V6 F/I	HPR10755	Challenger	6.4L V8 F/I	HPR11257 ♦
Durango	5.7L V8 F/I	HPR10755	Charger	3.6L V6 F/I	HPR11257 ♦
2015 DODGE			Charger	5.7L V8 F/I	HPR11257 ♦
1500	3.0L V6 DSL	HPR9401 ♦	Charger	6.4L V8 F/I	HPR11257 ♦
1500	3.6L V6 F/I	HPR9401	Durango	3.6L V6 F/I	HPR10755 ♦
1500	5.7L V8 F/I	HPR9401 ♦	Durango	5.7L V8 F/I	HPR10755 ♦
2500	5.7L V8 F/I	HPR9401 ♦	Ram 1500	5.7L V8 F/I	HPR9401 ♦
			Ram 1500 Pickup	3.7L V6 F/I	HPR9401
			Ram 1500 Pickup	4.7L V8 F/I	HPR9401
			Ram 2500 Pickup	5.7L V8 F/I	HPR9401

*Indicates 2 filters required ♦ Intake system available - see page 326 + throttle body spacer available - see page 20

HPR™ REPLACEMENT AIR FILTERS

DODGE

Vehicle	Engine Type	Air Filter
2012 DODGE		
Ram 2500 Pickup	6.7L L6 DSL	HPR10261 ♦
Ram 3500 Pickup	5.7L V8 F/I	HPR9401
Ram 3500 Pickup	6.7L L6 DSL	HPR10261 ♦
Ram 4500	6.7L L6 DSL	HPR10261
Ram 5500	6.7L L6 DSL	HPR10261

2011 DODGE		
Avenger	2.4L L4 F/I	HPR9054
Challenger	3.6L V6 F/I	HPR11257 ♦
Challenger	5.7L V8 F/I	HPR11257 ♦
Challenger	6.4L V8 F/I	HPR11257 ♦
Charger	3.6L V6 F/I	HPR11257 ♦
Charger	5.7L V8 F/I	HPR11257 ♦
Dakota	3.7L V6 F/I	HPR3901
Dakota	4.7L V8 F/I	HPR3901
Durango	3.6L V6 F/I	HPR10755 ♦
Durango	5.7L V8 F/I	HPR10755 ♦
Ram 1500	5.7L V8 F/I	HPR9401 ♦
Ram 1500 Pickup	3.7L V6 F/I	HPR9401
Ram 1500 Pickup	4.7L V8 F/I	HPR9401
Ram 2500 Pickup	5.7L V8 F/I	HPR9401 ♦
Ram 2500 Pickup	6.7L L6 DSL	HPR10261 ♦
Ram 3500 Pickup	5.7L V8 F/I	HPR9401 ♦
Ram 3500 Pickup	6.7L L6 DSL	HPR10261 ♦
Ram 4500	6.7L L6 DSL	HPR10261
Ram 5500	6.7L L6 DSL	HPR10261

2010 DODGE		
Avenger	2.0L L4 DSL	HPR9054
Avenger	2.4L L4 F/I	HPR9054
Avenger	2.7L V6 F/I	HPR9054
Avenger	3.5L V6 F/I	HPR9054
Challenger	3.5L V6 F/I	HPR9838
Challenger	5.7L V8 F/I	HPR9838 ♦
Challenger	6.1L V8 F/I	HPR9838 ♦
Charger	2.7L V6 F/I	HPR9838
Charger	3.5L V6 F/I	HPR9838
Charger	5.7L V8 F/I	HPR9838 ♦
Charger	6.1L V8 F/I	HPR9838 ♦
Dakota	3.7L V6 F/I	HPR3901
Dakota	4.7L V8 F/I	HPR3901
Grand Caravan	3.3L V6 F/I	HPR9054
Grand Caravan	3.8L V6 F/I	HPR9054
Grand Caravan	4.0L V6 F/I	HPR9054
Ram 1500 Pickup	3.7L V6 F/I	HPR9401
Ram 1500 Pickup	4.7L V8 F/I	HPR9401
Ram 1500 Pickup	5.7L V8 F/I	HPR9401 ♦
Ram 2500 Pickup	5.7L V8 F/I	HPR9401 ♦
Ram 2500 Pickup	6.7L L6 DSL	HPR10261 ♦
Ram 3500 Pickup	6.7L L6 DSL	HPR10261 ♦
Ram 4500	6.7L L6 DSL	HPR10261
Ram 5500	6.7L L6 DSL	HPR10261

2009 DODGE		
Avenger	2.0L L4 DSL	HPR9054
Avenger	2.4L L4 F/I	HPR9054
Avenger	2.7L V6 F/I	HPR9054
Avenger	3.5L V6 F/I	HPR9054
Challenger	3.5L V6 F/I	HPR9838
Challenger	5.7L V8 F/I	HPR9838 ♦
Challenger	6.1L V8 F/I	HPR9838 ♦
Charger	2.7L V6 F/I	HPR9838
Charger	3.5L V6 F/I	HPR9838
Charger	5.7L V8 F/I	HPR9838 ♦
Charger	6.1L V8 F/I	HPR9838 ♦
Dakota	3.7L V6 F/I	HPR3901

Vehicle	Engine Type	Air Filter
2009 DODGE		
Dakota	4.7L V8 F/I	HPR3901
Durango	3.7L V6 F/I	HPR9762
Durango	4.7L V8 F/I	HPR9762
Durango	5.7L V8 F/I	HPR9762
Grand Caravan	3.3L V6 F/I	HPR9054
Grand Caravan	3.8L V6 F/I	HPR9054
Grand Caravan	4.0L V6 F/I	HPR9054
Ram 1500 Pickup	3.7L V6 F/I	HPR9401
Ram 1500 Pickup	4.7L V8 F/I	HPR9401
Ram 1500 Pickup	5.7L V8 F/I	HPR9401 ♦
Ram 2500 Pickup	5.7L V8 F/I	HPR9401 ♦
Ram 3500 Pickup	5.7L V8 F/I	HPR9401 ♦

2008 DODGE		
Avenger	2.0L L4 DSL	HPR9054
Avenger	2.4L L4 F/I	HPR9054
Avenger	2.7L V6 F/I	HPR9054
Avenger	3.5L V6 F/I	HPR9054
Caravan	3.3L V6 F/I	HPR9054
Challenger	6.1L V8 F/I	HPR9838 ♦
Charger	2.7L V6 F/I	HPR9838
Charger	3.5L V6 F/I	HPR9838
Charger	5.7L V8 F/I	HPR9838 ♦
Charger	6.1L V8 F/I	HPR9838 ♦
Dakota	3.7L V6 F/I	HPR3901
Dakota	4.7L V8 F/I	HPR3901
Durango	3.7L V6 F/I	HPR9762
Durango	4.7L V8 F/I	HPR9762
Durango	5.7L V8 F/I	HPR9762 +
Grand Caravan	3.3L V6 F/I	HPR9054
Grand Caravan	3.8L V6 F/I	HPR9054
Grand Caravan	4.0L V6 F/I	HPR9054
Magnum	2.7L V6 F/I	HPR9838
Magnum	3.5L V6 F/I	HPR9838
Magnum	5.7L V8 F/I	HPR9838 ♦
Magnum	6.1L V8 F/I	HPR9838 ♦
Ram 1500 Pickup	3.7L V6 F/I	HPR9401
Ram 1500 Pickup	4.7L V8 F/I	HPR9401 ♦
Ram 1500 Pickup	5.7L V8 F/I	HPR9401 ♦+
Ram 2500 Pickup	5.7L V8 F/I	HPR9401 ♦+
Ram 3500 Pickup	5.7L V8 F/I	HPR9401 +

2007 DODGE		
Avenger	2.0L L4 DSL	HPR9054
Caravan	2.4L L4 F/I	HPR9054
Caravan	3.3L V6 F/I	HPR9054
Charger	2.7L V6 F/I	HPR9838
Charger	3.5L V6 F/I	HPR9838
Charger	5.7L V8 F/I	HPR9838 ♦
Charger	6.1L V8 F/I	HPR9838 ♦
Dakota	3.7L V6 F/I	HPR3901
Dakota	4.7L V8 F/I	HPR3901
Durango	3.7L V6 F/I	HPR9762
Durango	4.7L V8 F/I	HPR9762
Durango	5.7L V8 F/I	HPR9762 +
Grand Caravan	3.3L V6 F/I	HPR9054
Grand Caravan	3.8L V6 F/I	HPR9054
Magnum	2.7L V6 F/I	HPR9838
Magnum	3.5L V6 F/I	HPR9838
Magnum	5.7L V8 F/I	HPR9838 ♦
Magnum	6.1L V8 F/I	HPR9838 ♦
Ram 1500 Pickup	3.7L V6 F/I	HPR9401
Ram 1500 Pickup	4.7L V8 F/I	HPR9401 ♦
Ram 1500 Pickup	5.7L V8 F/I	HPR9401 ♦+
Ram 2500 Pickup	5.7L V8 F/I	HPR9401 ♦+

*Indicates 2 filters required ♦ Intake system available - see page 326 + throttle body spacer available - see page 20

DODGE

HPR™ REPLACEMENT AIR FILTERS

Vehicle	Engine Type	Air Filter	Vehicle	Engine Type	Air Filter
2007 DODGE			2004 DODGE		
Ram 3500 Pickup	5.7L V8 F/I	HPR9401 +	Intrepid SXT	3.5L V6 F/I	HPR8606
2006 DODGE			Neon	2.0L L4 F/I	HPR8805
Caravan	2.4L L4 F/I	HPR9054	Neon SRT-4	2.4L L4 F/I	HPR8805
Caravan	3.3L V6 F/I	HPR9054	Ram 1500 Pickup	3.7L V6 F/I	HPR9401
Charger	2.7L V6 F/I	HPR9838	Ram 1500 Pickup	4.7L V8 F/I	HPR9401 ♦
Charger	3.5L V6 F/I	HPR9838	Ram 1500 Pickup	5.7L V8 F/I	HPR9401 ♦+
Charger	5.7L V8 F/I	HPR9838 ♦	Ram 2500 Pickup	5.7L V8 F/I	HPR9401 ♦+
Charger	6.1L V8 F/I	HPR9838 ♦	Ram 3500 Pickup	5.7L V8 F/I	HPR9401 +
Dakota	3.7L V6 F/I	HPR3901	Stratus	2.4L L4 F/I - Coupe	HPR7344
Dakota	4.7L V8 F/I	HPR3901	Stratus	2.4L L4 F/I - Sedan	HPR9053
Durango	3.7L V6 F/I	HPR9762	Stratus	2.7L V6 F/I	HPR9053
Durango	4.7L V8 F/I	HPR9762	Stratus	3.0L V6 F/I	HPR7344
Durango	5.7L V8 F/I	HPR9762 +	SX 2.0	2.0L L4 F/I	HPR8805
Grand Caravan	3.3L V6 F/I	HPR9054	2003 DODGE		
Grand Caravan	3.8L V6 F/I	HPR9054	Caravan	2.4L L4 F/I	HPR9054
Magnum	2.7L V6 F/I	HPR9838	Caravan	3.3L V6 F/I	HPR9054
Magnum	3.5L V6 F/I	HPR9838	Dakota	3.9L V6 F/I	HPR3901
Magnum	5.7L V8 F/I	HPR9838 ♦	Dakota	4.7L V8 F/I	HPR3901
Magnum	6.1L V8 F/I	HPR9838 ♦	Dakota	5.9L V8 F/I	HPR3901
Ram 1500 Pickup	3.7L V6 F/I	HPR9401	Durango	4.7L V8 F/I	HPR3901
Ram 1500 Pickup	4.7L V8 F/I	HPR9401 ♦	Durango	5.9L V8 F/I	HPR3901
Ram 1500 Pickup	5.7L V8 F/I	HPR9401 ♦+	Grand Caravan	3.3L V6 F/I	HPR9054
Ram 2500 Pickup	5.7L V8 F/I	HPR9401 ♦+	Grand Caravan	3.8L V6 F/I	HPR9054
Ram 3500 Pickup	5.7L V8 F/I	HPR9401 +	Intrepid	2.7L V6 F/I	HPR8606
Stratus	2.4L L4 F/I	HPR9053	Intrepid	3.5L V6 F/I	HPR8606
Stratus	2.7L V6 F/I	HPR9053	Neon	2.0L L4 F/I	HPR8805
2005 DODGE			Neon R/T	2.0L L4 F/I	HPR8805
Caravan	2.4L L4 F/I	HPR9054	Neon SRT-4	2.4L L4 F/I	HPR8805
Caravan	3.3L V6 F/I	HPR9054	Ram 1500 Pickup	3.7L V6 F/I	HPR9401
Dakota	3.7L V6 F/I	HPR3901	Ram 1500 Pickup	4.7L V8 F/I	HPR9401 ♦
Dakota	4.7L V8 F/I	HPR3901	Ram 1500 Pickup	5.7L V8 F/I	HPR9401 ♦+
Durango	3.7L V6 F/I	HPR9762	Ram 1500 Pickup	5.9L V8 F/I	HPR9401
Durango	4.7L V8 F/I	HPR9762	Ram 1500 Van	3.9L V6 F/I	HPR0160
Durango	5.7L V8 F/I	HPR9762 +	Ram 1500 Van	5.2L V8 F/I	HPR0160
Grand Caravan	3.3L V6 F/I	HPR9054	Ram 1500 Van	5.9L V8 F/I	HPR0160
Grand Caravan	3.8L V6 F/I	HPR9054	Ram 2500 Pickup	5.7L V8 F/I	HPR9401 ♦+
Magnum	2.7L V6 F/I	HPR9838	Ram 2500 Pickup	8.0L V10 F/I	HPR9401
Magnum	3.5L V6 F/I	HPR9838	Ram 2500 Van	5.2L V8 F/I	HPR0160
Magnum	5.7L V8 F/I	HPR9838 ♦	Ram 2500 Van	5.9L V8 F/I	HPR0160
Neon	2.0L L4 F/I	HPR8805	Ram 3500 Pickup	5.7L V8 F/I	HPR9401 +
Neon SRT-4	2.4L L4 F/I	HPR8805	Ram 3500 Pickup	8.0L V10 F/I	HPR9401
Ram 1500 Pickup	3.7L V6 F/I	HPR9401	Ram 3500 Van	5.2L V8 F/I	HPR0160
Ram 1500 Pickup	4.7L V8 F/I	HPR9401 ♦	Ram 3500 Van	5.9L V8 F/I	HPR0160
Ram 1500 Pickup	5.7L V8 F/I	HPR9401 ♦+	Stratus	2.4L L4 F/I - Coupe	HPR7344
Ram 2500 Pickup	5.7L V8 F/I	HPR9401 ♦+	Stratus	2.4L L4 F/I - Sedan	HPR9053
Ram 3500 Pickup	5.7L V8 F/I	HPR9401 +	Stratus	2.7L V6 F/I	HPR9053
Stratus	2.4L L4 F/I - Coupe	HPR7344	Stratus	3.0L V6 F/I	HPR7344
Stratus	2.4L L4 F/I - Sedan	HPR9053	2002 DODGE		
Stratus	2.7L V6 F/I	HPR9053	Caravan	2.4L L4 F/I	HPR9054
Stratus	3.0L V6 F/I	HPR7344	Caravan	3.3L V6 F/I	HPR9054
SX 2.0	2.0L L4 F/I	HPR8805	Dakota	2.5L L4 F/I	HPR3901
2004 DODGE			Dakota	3.9L V6 F/I	HPR3901
Caravan	2.4L L4 F/I	HPR9054	Dakota	4.7L V8 F/I	HPR3901
Caravan	3.3L V6 F/I	HPR9054	Dakota	5.9L V8 F/I	HPR3901
Dakota	3.7L V6 F/I	HPR3901	Durango	4.7L V8 F/I	HPR3901
Dakota	4.7L V8 F/I	HPR3901	Durango	5.9L V8 F/I	HPR3901
Durango	3.7L V6 F/I	HPR9762	Grand Caravan	3.3L V6 F/I	HPR9054
Durango	4.7L V8 F/I	HPR9762	Grand Caravan	3.8L V6 F/I	HPR9054
Durango	5.7L V8 F/I	HPR9762 +	Intrepid	2.7L V6 F/I	HPR8606
Grand Caravan	3.3L V6 F/I	HPR9054	Intrepid	3.5L V6 F/I	HPR8606
Grand Caravan	3.8L V6 F/I	HPR9054	Neon	2.0L L4 F/I	HPR8805
Intrepid	2.7L V6 F/I	HPR8606	Neon ACR	2.0L L4 F/I	HPR8805
Intrepid	3.5L V6 F/I	HPR8606	Neon R/T	2.0L L4 F/I	HPR8805

*Indicates 2 filters required ♦ Intake system available - see page 326 + throttle body spacer available - see page 20

HPR™ REPLACEMENT AIR FILTERS

DODGE

Vehicle	Engine Type	Air Filter	Vehicle	Engine Type	Air Filter
2002 DODGE			2000 DODGE		
Ram 1500 Pickup	3.7L V6 F/I	HPR9401	Durango	4.7L V8 F/I	HPR3901
Ram 1500 Pickup	4.7L V8 F/I	HPR9401 ♦	Durango	5.2L V8 F/I	HPR3901
Ram 1500 Pickup	5.9L V8 F/I	HPR9401 +	Durango	5.9L V8 F/I	HPR3901
Ram 1500 Van	3.9L V6 F/I	HPR0160	Grand Caravan	3.0L V6 F/I	HPR3660
Ram 1500 Van	5.2L V8 F/I	HPR0160	Grand Caravan	3.3L V6 F/I	HPR3660
Ram 1500 Van	5.9L V8 F/I	HPR0160	Grand Caravan	3.8L V6 F/I	HPR3660
Ram 2500 Pickup	5.9L L6 DSL	HPR7640 ♦	Intrepid	2.7L V6 F/I	HPR8606
Ram 2500 Pickup	5.9L V8 F/I	HPR3901 +	Intrepid	3.2L V6 F/I	HPR8606
Ram 2500 Van	5.2L V8 F/I	HPR0160	Intrepid	3.5L V6 F/I	HPR8606
Ram 2500 Van	5.9L V8 F/I	HPR0160	Neon	2.0L L4 F/I	HPR8805
Ram 3500 Pickup	5.9L L6 DSL	HPR7640 ♦	Ram 1500 Pickup	3.9L V6 F/I	HPR3901 +
Ram 3500 Pickup	5.9L V8 F/I	HPR3901 +	Ram 1500 Pickup	5.2L V8 F/I	HPR3901 ♦+
Ram 3500 Van	5.2L V8 F/I	HPR0160	Ram 1500 Pickup	5.9L V8 F/I	HPR3901 ♦+
Ram 3500 Van	5.9L V8 F/I	HPR0160	Ram 1500 Van	3.9L V6 F/I	HPR0160
Stratus	2.4L L4 F/I - Coupe	HPR7344	Ram 1500 Van	5.2L V8 F/I	HPR0160
Stratus	2.4L L4 F/I - Sedan	HPR9053	Ram 1500 Van	5.9L V8 F/I	HPR0160
Stratus	2.7L V6 F/I	HPR9053	Ram 2500 Pickup	5.9L L6 DSL	HPR7640 ♦
Stratus	3.0L V6 F/I	HPR7344	Ram 2500 Pickup	5.9L V8 F/I	HPR3901 ♦+
2001 DODGE			Ram 2500 Van	5.2L V8 F/I	HPR0160
Caravan	2.4L L4 F/I	HPR9054	Ram 2500 Van	5.9L V8 F/I	HPR0160
Caravan	3.3L V6 F/I	HPR9054	Ram 3500 Pickup	5.9L L6 DSL	HPR7640 ♦
Dakota	2.5L L4 F/I	HPR3901	Ram 3500 Pickup	5.9L V8 F/I	HPR3901 +
Dakota	3.9L V6 F/I	HPR3901	Ram 3500 Van	5.2L V8 F/I	HPR0160
Dakota	4.7L V8 F/I	HPR3901	Ram 3500 Van	5.9L V8 F/I	HPR0160
Dakota	5.9L V8 F/I	HPR3901	Stratus	2.0L L4 F/I	HPR7432
Durango	4.7L V8 F/I	HPR3901	Stratus	2.4L L4 F/I	HPR7432
Durango	5.9L V8 F/I	HPR3901	Stratus	2.5L V6 F/I	HPR7432
Grand Caravan	3.3L V6 F/I	HPR9054	1999 DODGE		
Grand Caravan	3.8L V6 F/I	HPR9054	Avenger	2.0L L4 F/I	HPR7344
Intrepid	2.7L V6 F/I	HPR8606	Avenger	2.5L V6 F/I	HPR7344
Intrepid	3.2L V6 F/I	HPR8606	Caravan	2.4L L4 F/I	HPR3660
Intrepid	3.5L V6 F/I	HPR8606	Caravan	3.0L V6 F/I	HPR3660
Neon	2.0L L4 F/I	HPR8805	Caravan	3.3L V6 F/I	HPR3660
Neon ACR	2.0L L4 F/I	HPR8805	Caravan	3.8L V6 F/I	HPR3660
Neon R/T	2.0L L4 F/I	HPR8805	Dakota	2.5L L4 F/I	HPR3901
Ram 1500 Pickup	3.9L V6 F/I	HPR3901 +	Dakota	3.9L V6 F/I	HPR3901
Ram 1500 Pickup	5.2L V8 F/I	HPR3901 ♦+	Dakota	5.2L V8 F/I	HPR3901
Ram 1500 Pickup	5.9L V8 F/I	HPR3901 ♦+	Dakota	5.9L V8 F/I	HPR3901
Ram 1500 Van	3.9L V6 F/I	HPR0160	Durango	3.9L V6 F/I	HPR3901
Ram 1500 Van	5.2L V8 F/I	HPR0160	Durango	5.2L V8 F/I	HPR3901
Ram 1500 Van	5.9L V8 F/I	HPR0160	Durango	5.9L V8 F/I	HPR3901
Ram 2500 Pickup	5.9L L6 DSL	HPR7640 ♦	Grand Caravan	3.0L V6 F/I	HPR3660
Ram 2500 Pickup	5.9L V8 F/I	HPR3901 ♦+	Grand Caravan	3.3L V6 F/I	HPR3660
Ram 2500 Van	3.9L V6 F/I	HPR0160	Grand Caravan	3.8L V6 F/I	HPR3660
Ram 2500 Van	5.2L V8 F/I	HPR0160	Intrepid	2.7L V6 F/I	HPR8606
Ram 2500 Van	5.9L V8 F/I	HPR0160	Intrepid	3.2L V6 F/I	HPR8606
Ram 3500 Pickup	5.9L L6 DSL	HPR7640 ♦	Neon	2.0L L4 F/I	HPR3660
Ram 3500 Pickup	5.9L V8 F/I	HPR3901 +	Ram 1500 Pickup	3.9L V6 F/I	HPR3901 +
Ram 3500 Van	5.2L V8 F/I	HPR0160	Ram 1500 Pickup	5.2L V8 F/I	HPR3901 ♦+
Ram 3500 Van	5.9L V8 F/I	HPR0160	Ram 1500 Pickup	5.9L V8 F/I	HPR3901 ♦+
Stratus	2.4L L4 F/I - Coupe	HPR7344	Ram 1500 Van	3.9L V6 F/I	HPR0160
Stratus	2.4L L4 F/I - Sedan	HPR9053	Ram 1500 Van	5.2L V8 F/I	HPR0160
Stratus	2.7L V6 F/I	HPR9053	Ram 1500 Van	5.9L V8 F/I	HPR0160
Stratus	3.0L V6 F/I	HPR7344	Ram 2500 Pickup	5.9L L6 DSL	HPR7640 ♦
2000 DODGE			Ram 2500 Pickup	5.9L V8 F/I	HPR3901 ♦+
Avenger	2.5L V6 F/I	HPR7344	Ram 2500 Van	5.2L V8 F/I	HPR0160
Caravan	2.4L L4 F/I	HPR3660	Ram 2500 Van	5.9L V8 F/I	HPR0160
Caravan	3.0L V6 F/I	HPR3660	Ram 3500 Pickup	5.9L L6 DSL	HPR7640 ♦
Caravan	3.3L V6 F/I	HPR3660	Ram 3500 Pickup	5.9L V8 F/I	HPR3901 +
Dakota	2.5L L4 F/I	HPR3901	Ram 3500 Van	5.2L V8 F/I	HPR0160
Dakota	3.9L V6 F/I	HPR3901	Ram 3500 Van	5.9L V8 F/I	HPR0160
Dakota	4.7L V8 F/I	HPR3901	Stratus	2.0L L4 F/I	HPR7432
Dakota	5.9L V8 F/I	HPR3901	Stratus	2.4L L4 F/I	HPR7432

*Indicates 2 filters required ♦ Intake system available - see page 326 + throttle body spacer available - see page 20

DODGE

HPR™ REPLACEMENT AIR FILTERS

Vehicle	Engine Type	Air Filter	Vehicle	Engine Type	Air Filter
1999 DODGE			1997 DODGE		
Stratus	2.5L V6 F/I	HPR7432	Ram 1500 Pickup	5.2L V8 F/I	HPR3901 ♦+
1998 DODGE			Ram 1500 Pickup	5.9L V8 F/I	HPR3901 ♦+
Avenger	2.0L L4 F/I	HPR7344	Ram 2500 Pickup	5.9L L6 DSL	HPR7640 ♦
Avenger	2.5L V6 F/I	HPR7344	Ram 2500 Pickup	5.9L V8 F/I	HPR3901 ♦+
B1500 Van	3.9L V6 F/I	HPR0160	Ram 3500 Pickup	5.9L L6 DSL	HPR7640 ♦
B1500 Van	5.2L V8 F/I	HPR0160	Ram 3500 Pickup	5.9L V8 F/I	HPR3901 +
B1500 Van	5.9L V8 F/I	HPR0160	Stratus	2.0L L4 F/I	HPR7432
B2500 Van	5.2L V8 F/I	HPR0160	Stratus	2.4L L4 F/I	HPR7432
B2500 Van	5.9L V8 F/I	HPR0160	Stratus	2.5L V6 F/I	HPR7432
B3500 Van	5.2L V8 F/I	HPR0160	1996 DODGE		
B3500 Van	5.9L V8 F/I	HPR0160	Avenger	2.0L L4 F/I	HPR7344
Caravan	2.4L L4 F/I	HPR3660	Avenger	2.5L V6 F/I	HPR7344
Caravan	3.0L V6 F/I	HPR3660	B1500 Van	3.9L V6 F/I	HPR0160
Caravan	3.3L V6 F/I	HPR3660	B1500 Van	5.2L V8 F/I	HPR0160
Caravan	3.8L V6 F/I	HPR3660	B2500 Van	3.9L V6 F/I	HPR0160
Dakota	2.5L L4 F/I	HPR3901	B2500 Van	5.2L V8 F/I	HPR0160
Dakota	3.9L V6 F/I	HPR3901	B2500 Van	5.9L V8 F/I	HPR0160
Dakota	5.2L V8 F/I	HPR3901	B3500 Van	5.2L V8 F/I	HPR0160
Dakota	5.9L V8 F/I	HPR3901	B3500 Van	5.9L V8 F/I	HPR0160
Durango	3.9L V6 F/I	HPR3901	Caravan	2.4L L4 F/I	HPR3660
Durango	5.2L V8 F/I	HPR3901	Caravan	3.0L V6 F/I	HPR3660
Durango	5.9L V8 F/I	HPR3901	Caravan	3.3L V6 F/I	HPR3660
Grand Caravan	3.0L V6 F/I	HPR3660	Caravan	3.8L V6 F/I	HPR3660
Grand Caravan	3.3L V6 F/I	HPR3660	Dakota	2.5L L4 F/I	HPR3559
Grand Caravan	3.8L V6 F/I	HPR3660	Dakota	3.9L V6 F/I	HPR0160
Intrepid	2.7L V6 F/I	HPR8606	Dakota	5.2L V8 F/I	HPR0160
Intrepid	3.2L V6 F/I	HPR8606	Grand Caravan	2.4L L4 F/I	HPR3660
Neon	2.0L L4 F/I	HPR3660	Grand Caravan	3.0L V6 F/I	HPR3660
Ram 1500 Pickup	3.9L V6 F/I	HPR3901 +	Grand Caravan	3.3L V6 F/I	HPR3660
Ram 1500 Pickup	5.2L V8 F/I	HPR3901 ♦+	Grand Caravan	3.8L V6 F/I	HPR3660
Ram 1500 Pickup	5.9L V8 F/I	HPR3901 ♦+	Neon	2.0L L4 F/I	HPR3660
Ram 2500	5.2L V8 F/I	HPR3901	Ram 1500 Pickup	3.9L V6 F/I	HPR3901 +
Ram 2500 Pickup	5.2L V8 F/I	HPR3901	Ram 1500 Pickup	5.2L V8 F/I	HPR3901 ♦+
Ram 2500 Pickup	5.9L L6 DSL	HPR7640 ♦	Ram 1500 Pickup	5.9L V8 F/I	HPR3901 ♦+
Ram 2500 Pickup	5.9L V8 F/I	HPR3901 ♦+	Ram 2500 Pickup	5.2L V8 F/I	HPR3901 ♦+
Ram 3500 Pickup	5.9L L6 DSL	HPR7640 ♦	Ram 2500 Pickup	5.9L L6 DSL	HPR7640 ♦
Ram 3500 Pickup	5.9L V8 F/I	HPR3901 +	Ram 2500 Pickup	5.9L V8 F/I	HPR3901 ♦+
Stratus	2.0L L4 F/I	HPR7432	Ram 3500 Pickup	5.9L L6 DSL	HPR7640 ♦
Stratus	2.4L L4 F/I	HPR7432	Ram 3500 Pickup	5.9L V8 F/I	HPR3901 +
Stratus	2.5L V6 F/I	HPR7432	Stealth	3.0L V6 F/I	HPR7142
1997 DODGE			Stratus	2.0L L4 F/I	HPR7432
Avenger	2.0L L4 F/I	HPR7344	Stratus	2.4L L4 F/I	HPR7432
Avenger	2.5L V6 F/I	HPR7344	Stratus	2.5L V6 F/I	HPR7432
B1500 Van	3.9L V6 F/I	HPR0160	1995 DODGE		
B1500 Van	5.2L V8 F/I	HPR0160	Avenger	2.0L L4 F/I	HPR7344
B2500 Van	3.9L V6 F/I	HPR0160	Avenger	2.5L V6 F/I	HPR7344
B2500 Van	5.2L V8 F/I	HPR0160	B1500 Van	3.9L V6 F/I	HPR0160
B2500 Van	5.9L V8 F/I	HPR0160	B1500 Van	5.2L V8 F/I	HPR0160
B3500 Van	5.2L V8 F/I	HPR0160	B2500 Van	3.9L V6 F/I	HPR0160
B3500 Van	5.9L V8 F/I	HPR0160	B2500 Van	5.2L V8 F/I	HPR0160
Caravan	2.4L L4 F/I	HPR3660	B2500 Van	5.9L V8 F/I	HPR0160
Caravan	3.0L V6 F/I	HPR3660	B3500 Van	5.2L V8 F/I	HPR0160
Caravan	3.3L V6 F/I	HPR3660	B3500 Van	5.9L V8 F/I	HPR0160
Caravan	3.8L V6 F/I	HPR3660	Caravan	2.5L L4 F/I	HPR3559
Dakota	2.5L L4 F/I	HPR3901	Caravan	3.0L V6 F/I	HPR3660
Dakota	3.9L V6 F/I	HPR3901	Caravan	3.3L V6 F/I	HPR3559
Dakota	5.2L V8 F/I	HPR3901	Dakota	2.5L L4 F/I	HPR3559
Grand Caravan	2.4L L4 F/I	HPR3660	Dakota	3.9L V6 F/I	HPR0160
Grand Caravan	3.0L V6 F/I	HPR3660	Dakota	5.2L V8 F/I	HPR0160
Grand Caravan	3.3L V6 F/I	HPR3660	Grand Caravan	3.0L V6 F/I	HPR3660
Grand Caravan	3.8L V6 F/I	HPR3660	Grand Caravan	3.3L V6 F/I	HPR3559
Neon	2.0L L4 F/I	HPR3660	Grand Caravan	3.8L V6 F/I	HPR3559
Ram 1500 Pickup	3.9L V6 F/I	HPR3901 +	Neon	2.0L L4 F/I	HPR3660

*Indicates 2 filters required ♦ Intake system available - see page 326 + throttle body spacer available - see page 20

HPR™ REPLACEMENT AIR FILTERS

DODGE

Vehicle	Engine Type	Air Filter	Vehicle	Engine Type	Air Filter
1995 DODGE			1993 DODGE		
Ram 1500 Pickup	3.9L V6 F/I	HPR3901 +	D250	5.9L V8 F/I	HPR0160
Ram 1500 Pickup	5.2L V8 F/I	HPR3901 ♦+	D350	5.9L V8 F/I	HPR0160
Ram 1500 Pickup	5.9L V8 F/I	HPR3901 ♦+	Dakota	2.5L L4 F/I	HPR3559
Ram 2500 Pickup	5.2L V8 F/I	HPR3901 ♦+	Dakota	3.9L V6 F/I	HPR0160
Ram 2500 Pickup	5.9L L6 DSL	HPR7640 ♦	Dakota	5.2L V8 F/I	HPR0160
Ram 2500 Pickup	5.9L V8 F/I	HPR3901 ♦+	Daytona	2.2L L4 F/I	HPR3660
Ram 3500 Pickup	5.9L L6 DSL	HPR7640 ♦	Daytona	3.0L V6 F/I	HPR3660
Ram 3500 Pickup	5.9L V8 F/I	HPR3901 +	Dynasty	3.0L V6 F/I	HPR3660
Spirit	3.0L V6 F/I	HPR3660	Dynasty	3.3L V6 F/I	HPR3559
Stealth	3.0L V6 F/I	HPR7142	Grand Caravan	3.0L V6 F/I	HPR3660
Stratus	2.0L L4 F/I	HPR7432	Grand Caravan	3.3L V6 F/I	HPR3559
Stratus	2.4L L4 F/I	HPR7432	Ram 50	2.4L L4 F/I	HPR7142
Stratus	2.5L V6 F/I	HPR7432	Ramcharger	5.2L V8 F/I	HPR0160
1994 DODGE			Ramcharger	5.9L V8 F/I	HPR0160
B150 Van	3.9L V6 F/I	HPR0160	Shadow	3.0L V6 F/I	HPR3660
B150 Van	5.2L V8 F/I	HPR0160	Spirit	2.5L L4 F/I	HPR3660
B250 Van	3.9L V6 F/I	HPR0160	Spirit	3.0L V6 F/I	HPR3660
B250 Van	5.2L V8 F/I	HPR0160	Stealth	3.0L V6 F/I	HPR7142
B250 Van	5.9L V8 F/I	HPR0160	W150	3.9L V6 F/I	HPR0160
B350 Van	5.2L V8 F/I	HPR0160	W150	5.2L V8 F/I	HPR0160
B350 Van	5.9L V8 F/I	HPR0160	W150	5.9L V8 F/I	HPR0160
Caravan	2.5L L4 F/I	HPR3559	W250	5.2L V8 F/I	HPR0160
Caravan	3.0L V6 F/I	HPR3660	W250	5.9L V8 F/I	HPR0160
Caravan	3.3L V6 F/I	HPR3559	W350	5.9L V8 F/I	HPR0160
Colt	1.8L L4 F/I	HPR7344	1992 DODGE		
Colt	2.4L L4 F/I	HPR7344	B150 Van	3.9L V6 F/I	HPR0160
Dakota	2.5L L4 F/I	HPR3559	B150 Van	5.2L V8 F/I	HPR0160
Dakota	3.9L V6 F/I	HPR0160	B250 Van	3.9L V6 F/I	HPR0160
Dakota	5.2L V8 F/I	HPR0160	B250 Van	5.2L V8 F/I	HPR0160
Grand Caravan	3.0L V6 F/I	HPR3660	B250 Van	5.9L V8 F/I	HPR0160
Grand Caravan	3.3L V6 F/I	HPR3559	B350 Van	5.2L V8 F/I	HPR0160
Grand Caravan	3.8L V6 F/I	HPR3559	B350 Van	5.9L V8 F/I	HPR0160
Ram 1500 Pickup	3.9L V6 F/I	HPR3901 +	Caravan	2.5L L4 F/I	HPR3559
Ram 1500 Pickup	5.2L V8 F/I	HPR3901 ♦+	Caravan	3.0L V6 F/I	HPR3660
Ram 1500 Pickup	5.9L V8 F/I	HPR3901 ♦+	Caravan	3.3L V6 F/I	HPR3559
Ram 2500 Pickup	5.2L V8 F/I	HPR3901 ♦+	Colt	1.8L L4 F/I	HPR7344
Ram 2500 Pickup	5.9L L6 DSL	HPR7640 ♦	D150	5.2L V8 F/I	HPR0160
Ram 2500 Pickup	5.9L V8 F/I	HPR3901 ♦+	D250	5.2L V8 F/I	HPR0160
Ram 3500 Pickup	5.9L L6 DSL	HPR7640 ♦	D250	5.9L V8 F/I	HPR0160
Ram 3500 Pickup	5.9L V8 F/I	HPR3901 +	D350	5.9L V8 F/I	HPR0160
Shadow	3.0L V6 F/I	HPR3660	Dakota	2.5L L4 F/I	HPR3559
Spirit	2.5L L4 F/I	HPR3660	Dakota	3.9L V6 F/I	HPR0160
Spirit	2.5L L4 F/I - VIN V	HPR3660	Dakota	5.2L V8 F/I	HPR0160
Spirit	3.0L V6 F/I	HPR3660	Daytona	2.2L L4 F/I	HPR3660
Stealth	3.0L V6 F/I	HPR7142	Daytona	3.0L V6 F/I	HPR3660
1993 DODGE			Dynasty	3.0L V6 F/I	HPR3660
B150 Van	3.9L V6 F/I	HPR0160	Dynasty	3.3L V6 F/I	HPR3559
B150 Van	5.2L V8 F/I	HPR0160	Grand Caravan	3.0L V6 F/I	HPR3660
B250 Van	3.9L V6 F/I	HPR0160	Grand Caravan	3.3L V6 F/I	HPR3559
B250 Van	5.2L V8 F/I	HPR0160	Monaco	3.0L V6 F/I	HPR3660
B250 Van	5.9L V8 F/I	HPR0160	Ram 50	2.4L L4 F/I	HPR7142
B350 Van	5.2L V8 F/I	HPR0160	Ramcharger	5.2L V8 F/I	HPR0160
B350 Van	5.9L V8 F/I	HPR0160	Ramcharger	5.9L V8 F/I	HPR0160
Caravan	2.5L L4 F/I	HPR3559	Shadow	3.0L V6 F/I	HPR3660
Caravan	3.0L V6 F/I	HPR3660	Spirit	2.2L L4 F/I	HPR3660
Caravan	3.3L V6 F/I	HPR3559	Spirit	3.0L V6 F/I	HPR3660
Colt	1.8L L4 F/I - w/Panel Filter	HPR7344	Stealth	3.0L V6 F/I	HPR7142
Colt	2.4L L4 F/I	HPR7344	W150	5.2L V8 F/I	HPR0160
D150	3.9L V6 F/I	HPR0160	W250	5.2L V8 F/I	HPR0160
D150	5.2L V8 F/I	HPR0160	W250	5.9L V8 F/I	HPR0160
D150	5.9L V8 F/I	HPR0160	W350	5.9L V8 F/I	HPR0160
D250	3.9L V6 F/I	HPR0160	1991 DODGE		
D250	5.2L V8 F/I	HPR0160	B150 Van	3.9L V6 F/I	HPR0160

*Indicates 2 filters required ♦ Intake system available - see page 326 + throttle body spacer available - see page 20

DODGE

HPR™ REPLACEMENT AIR FILTERS

Vehicle	Engine Type	Air Filter	Vehicle	Engine Type	Air Filter
1991 DODGE			1990 DODGE		
B150 Van	5.2L V8 F/I	HPR0160	W350	5.9L V8 F/I	HPR0160
B250 Van	3.9L V6 F/I	HPR0160	1989 DODGE		
B250 Van	5.2L V8 F/I	HPR0160	B150 Van	5.2L V8 F/I	HPR0160
B250 Van	5.9L V8 F/I	HPR0160	B250 Van	5.2L V8 F/I	HPR0160
B350 Van	5.2L V8 F/I	HPR0160	B250 Van	5.9L V8 F/I	HPR0160
B350 Van	5.9L V8 F/I	HPR0160	B350 Van	5.2L V8 F/I	HPR0160
Caravan	2.5L L4 F/I	HPR3559	B350 Van	5.9L V8 F/I	HPR0160
Caravan	3.0L V6 F/I	HPR3660	Caravan	2.5L L4 F/I	HPR3559
Caravan	3.3L V6 F/I	HPR3559	Caravan	3.0L V6 F/I	HPR3660
D150	5.2L V8 F/I	HPR0160	D100	5.2L V8 F/I	HPR0160
D150	5.9L V8 F/I	HPR0160	D150	5.2L V8 F/I	HPR0160
D250	5.2L V8 F/I	HPR0160	D150	5.9L V8 F/I	HPR0160
D250	5.9L V8 F/I	HPR0160	D250	5.2L V8 F/I	HPR0160
D350	5.9L V8 F/I	HPR0160	D250	5.9L V8 F/I	HPR0160
Dakota	2.5L L4 F/I	HPR3559	D350	5.9L V8 F/I	HPR0160
Dakota	3.9L V6 F/I	HPR0160	Dakota	2.5L L4 F/I	HPR3559
Dakota	5.2L V8 F/I	HPR0160	Dakota	5.2L V8 F/I	HPR0351
Daytona	3.0L V6 F/I	HPR3660	Daytona	2.2L L4 F/I	HPR3559
Dynasty	3.0L V6 F/I	HPR3660	Daytona	2.5L L4 F/I - Turbo	HPR3559
Dynasty	3.3L V6 F/I	HPR3559	Diplomat	5.2L V8 2 BBL.	HPR0160
Grand Caravan	3.3L V6 F/I	HPR3559	Dynasty	3.0L V6 F/I	HPR3660
Monaco	3.0L V6 F/I	HPR3660	Grand Caravan	2.5L L4 F/I	HPR3559
Ram 50	2.4L L4 F/I	HPR7142	Grand Caravan	3.0L V6 F/I	HPR3660
Ram 50	3.0L V6 F/I	HPR7142	Lancer	2.5L L4 F/I - Turbo	HPR3559
Ramcharger	5.2L V8 F/I	HPR0160	Omni	2.2L L4 F/I	HPR3660
Ramcharger	5.9L V8 F/I	HPR0160	Ramcharger	5.2L V8 F/I	HPR0160
Spirit	2.2L L4 F/I	HPR3660	Ramcharger	5.9L V8 F/I	HPR0160
Spirit	3.0L V6 F/I	HPR3660	Shadow	2.5L L4 F/I - Turbo	HPR3559
Stealth	3.0L V6 F/I	HPR7142	Spirit	2.5L L4 F/I - Turbo	HPR3559
W150	5.2L V8 F/I	HPR0160	Spirit	3.0L V6 F/I	HPR3660
W150	5.9L V8 F/I	HPR0160	W100	5.2L V8 F/I	HPR0160
W250	5.2L V8 F/I	HPR0160	W150	5.2L V8 F/I	HPR0160
W250	5.9L V8 F/I	HPR0160	W150	5.9L V8 F/I	HPR0160
W350	5.9L V8 F/I	HPR0160	W250	5.2L V8 F/I	HPR0160
1990 DODGE			W250	5.9L V8 F/I	HPR0160
B150 Van	3.9L V6 F/I	HPR0160	W350	5.9L V8 F/I	HPR0160
B150 Van	5.2L V8 F/I	HPR0160	1988 DODGE		
B250 Van	3.9L V6 F/I	HPR0160	600	2.2L L4 F/I - Exc. Turbo	HPR3660
B250 Van	5.2L V8 F/I	HPR0160	600	2.2L L4 F/I - Turbo	HPR3559
B250 Van	5.9L V8 F/I	HPR0160	B150 Van	3.9L V6 F/I	HPR0351
B350 Van	5.2L V8 F/I	HPR0160	B150 Van	5.2L V8 F/I	HPR0351
B350 Van	5.9L V8 F/I	HPR0160	B250 Van	5.9L V8 CARB	HPR0160
Caravan	2.5L L4 F/I	HPR3559	B350 Van	5.9L V8 CARB	HPR0160
Caravan	3.0L V6 F/I	HPR3660	Caravan	2.5L L4 F/I	HPR3559
Caravan	3.3L V6 F/I	HPR3559	Caravan	3.0L V6 F/I	HPR3660
D150	5.2L V8 F/I	HPR0160	D100	5.9L V8 CARB	HPR0160
D150	5.9L V8 F/I	HPR0160	D150	5.9L V8 CARB	HPR0160
D250	5.2L V8 F/I	HPR0160	D250	5.2L V8 F/I	HPR0351
D250	5.9L V8 F/I	HPR0160	D250	5.9L V8 CARB	HPR0160
D350	5.9L V8 F/I	HPR0160	D350	5.9L V8 CARB	HPR0160
Dakota	2.5L L4 F/I	HPR3559	Dakota	2.2L L4 CARB	HPR0184
Dakota	3.9L V6 F/I	HPR0160	Daytona	2.2L L4 F/I	HPR3559
Daytona	3.0L V6 F/I	HPR3660	Diplomat	5.2L V8 2 BBL.	HPR0160
Dynasty	3.0L V6 F/I	HPR3660	Dynasty	3.0L V6 F/I	HPR3660
Dynasty	3.3L V6 F/I	HPR3559	Grand Caravan	2.5L L4 F/I	HPR3559
Grand Caravan	3.3L V6 F/I	HPR3559	Grand Caravan	3.0L V6 F/I	HPR3660
Omni	2.2L L4 F/I	HPR3660	Lancer	2.2L L4 F/I - Turbo	HPR3559
Ramcharger	5.2L V8 F/I	HPR0160	Mini Ram	2.5L L4 F/I	HPR3559
Ramcharger	5.9L V8 F/I	HPR0160	Mini Ram	3.0L V6 F/I	HPR3660
Spirit	3.0L V6 F/I	HPR3660	Omni	2.2L L4 F/I	HPR3660
W150	5.2L V8 F/I	HPR0160	Ramcharger	5.9L V8 CARB	HPR0160
W150	5.9L V8 F/I	HPR0160	Shadow	2.2L L4 F/I - Turbo	HPR3559
W250	5.2L V8 F/I	HPR0160	W100	5.9L V8 CARB	HPR0160
W250	5.9L V8 F/I	HPR0160			

*Indicates 2 filters required ♦ Intake system available - see page 326 + throttle body spacer available - see page 20

HPR™ REPLACEMENT AIR FILTERS

DODGE

Vehicle	Engine Type	Air Filter	Vehicle	Engine Type	Air Filter
1988 DODGE			1986 DODGE		
W150	5.9L V8 CARB	HPR0160	Charger	1.6L L4 CARB	HPR3559
W250	5.9L V8 CARB	HPR0160	Charger	2.2L L4 CARB	HPR3559
W350	5.9L V8 CARB	HPR0160	Charger	2.2L L4 F/I	HPR3559
1987 DODGE			D100	3.7L L6 CARB	HPR0160
600	2.2L L4 F/I - Exc. Turbo	HPR3660	D100	5.2L V8 CARB	HPR0160
600	2.2L L4 F/I - Turbo	HPR3559	D100	5.9L V8 CARB	HPR0160
B150 Van	3.7L L6 CARB	HPR0184	D150	3.7L L6 CARB	HPR0160
B150 Van	5.2L V8 CARB	HPR0160	D150	5.2L V8 CARB	HPR0160
B250 Van	3.7L L6 CARB	HPR0184	D150	5.9L V8 CARB	HPR0160
B250 Van	5.2L V8 CARB	HPR0160	D250	3.7L L6 CARB	HPR0160
B250 Van	5.9L V8 CARB	HPR0160	D250	5.2L V8 CARB	HPR0160
B350 Van	5.2L V8 CARB	HPR0160	D250	5.9L V8 CARB	HPR0160
B350 Van	5.9L V8 CARB	HPR0160	D350	5.9L V8 CARB	HPR0160
Caravan	2.2L L4 CARB	HPR3559	Daytona	2.2L L4 F/I - Turbo	HPR3559
Caravan	3.0L V6 F/I	HPR3660	Diplomat	5.2L V8 2 BBL.	HPR0160
Charger	2.2L L4 F/I	HPR3559	Lancer	2.2L L4 F/I - Turbo	HPR3559
D100	3.7L L6 CARB	HPR0160	Mini Ram	2.2L L4 CARB	HPR3559
D100	5.2L V8 CARB	HPR0160	Omni	1.6L L4 CARB	HPR3559
D100	5.9L V8 CARB	HPR0160	Omni	2.2L L4 CARB	HPR3559
D150	3.7L L6 CARB	HPR0160	Omni	2.2L L4 F/I	HPR3559
D150	5.2L V8 CARB	HPR0160	Ramcharger	5.2L V8 CARB	HPR0160
D150	5.9L V8 CARB	HPR0160	Ramcharger	5.9L V8 CARB	HPR0160
D250	3.7L L6 CARB	HPR0160	Royal Mini Ram	2.2L L4 CARB	HPR3559
D250	5.2L V8 CARB	HPR0160	W100	3.7L L6 CARB	HPR0160
D250	5.9L V8 CARB	HPR0160	W100	5.2L V8 CARB	HPR0160
D350	5.9L V8 CARB	HPR0160	W100	5.9L V8 CARB	HPR0160
Dakota	2.2L L4 CARB	HPR0184	W150	3.7L L6 CARB	HPR0160
Dakota	3.9L V6 CARB	HPR0160	W150	5.2L V8 CARB	HPR0160
Daytona	2.2L L4 F/I	HPR3559	W150	5.9L V8 CARB	HPR0160
Diplomat	5.2L V8 2 BBL.	HPR0160	W250	5.2L V8 CARB	HPR0160
Grand Caravan	2.5L L4 F/I	HPR3559	W250	5.9L V8 CARB	HPR0160
Grand Caravan	3.0L V6 F/I	HPR3660	W350	5.9L V8 CARB	HPR0160
Lancer	2.2L L4 F/I - Turbo	HPR3559	1985 DODGE		
Mini Ram	2.2L L4 CARB	HPR3559	600	2.2L L4 F/I - Exc. Turbo	HPR3660
Mini Ram	2.5L L4 F/I	HPR3559	600	2.2L L4 F/I - Turbo	HPR3559
Mini Ram	3.0L V6 F/I	HPR3660	Aries	2.2L L4 CARB	HPR3559
Omni	2.2L L4 CARB	HPR3559	Aries	2.2L L4 F/I	HPR3660
Omni	2.2L L4 F/I	HPR3559	B150 Van	3.7L L6 CARB	HPR0184
Ramcharger	5.2L V8 CARB	HPR0160	B150 Van	5.2L V8 CARB	HPR0160
Ramcharger	5.9L V8 CARB	HPR0160	B250 Van	3.7L L6 CARB	HPR0184
Royal Mini Ram	2.2L L4 CARB	HPR3559	B250 Van	5.2L V8 CARB	HPR0160
Royal Mini Ram	3.0L V6 F/I	HPR3660	B350 Van	5.2L V8 CARB	HPR0160
Shadow	2.2L L4 F/I - Turbo	HPR3559	B350 Van	5.9L V8 CARB	HPR0160
W100	3.7L L6 CARB	HPR0160	Caravan	2.2L L4 CARB	HPR3559
W100	5.2L V8 CARB	HPR0160	Charger	1.6L L4 CARB	HPR3559
W100	5.9L V8 CARB	HPR0160	Charger	2.2L L4 CARB	HPR3559
W150	3.7L L6 CARB	HPR0160	Charger	2.2L L4 F/I	HPR3559
W150	5.2L V8 CARB	HPR0160	D100	3.7L L6 CARB	HPR0160
W150	5.9L V8 CARB	HPR0160	D100	5.2L V8 CARB	HPR0160
W250	5.2L V8 CARB	HPR0160	D100	5.9L V8 CARB	HPR0160
W250	5.9L V8 CARB	HPR0160	D150	3.7L L6 CARB	HPR0160
W350	5.9L V8 CARB	HPR0160	D150	5.2L V8 CARB	HPR0160
1986 DODGE			D150	5.9L V8 CARB	HPR0160
600	2.2L L4 F/I - Exc. Turbo	HPR3660	D250	3.7L L6 CARB	HPR0160
600	2.2L L4 F/I - Turbo	HPR3559	D250	5.2L V8 CARB	HPR0160
B150 Van	3.7L L6 CARB	HPR0184	D250	5.9L V8 CARB	HPR0160
B150 Van	5.2L V8 CARB	HPR0160	D350	5.9L V8 CARB	HPR0160
B250 Van	3.7L L6 CARB	HPR0184	Daytona	2.2L L4 F/I - Exc. Turbo	HPR3660
B250 Van	5.2L V8 CARB	HPR0160	Daytona	2.2L L4 F/I - Turbo	HPR3559
B250 Van	5.9L V8 CARB	HPR0160	Diplomat	5.2L V8 2 BBL.	HPR0160
B350 Van	5.2L V8 CARB	HPR0160	Lancer	2.2L L4 F/I - Exc. Turbo	HPR3660
B350 Van	5.9L V8 CARB	HPR0160	Lancer	2.2L L4 F/I - Turbo	HPR3559
Caravan	2.2L L4 CARB	HPR3559	Mini Ram	2.2L L4 CARB	HPR3559
			Omni	1.6L L4 CARB	HPR3559

*Indicates 2 filters required ♦ Intake system available - see page 326 + throttle body spacer available - see page 20

DODGE

HPR™ REPLACEMENT AIR FILTERS

Vehicle	Engine Type	Air Filter	Vehicle	Engine Type	Air Filter
1985 DODGE			1983 DODGE		
Omni	2.2L L4 CARB	HPR3559	B250 Van	3.7L L6 CARB	HPR0184
Omni	2.2L L4 F/I	HPR3559	Charger	1.6L L4 CARB	HPR3559
Ramcharger	5.2L V8 CARB	HPR0160	Charger	2.2L L4 CARB	HPR3559
Ramcharger	5.9L V8 CARB	HPR0160	D150	3.7L L6 CARB	HPR0160
Royal Mini Ram	2.2L L4 CARB	HPR3559	D150	5.2L V8 CARB	HPR0160
W100	3.7L L6 CARB	HPR0160	D250	3.7L L6 CARB	HPR0160
W100	5.2L V8 CARB	HPR0160	D250	5.2L V8 CARB	HPR0160
W100	5.9L V8 CARB	HPR0160	D350	5.2L V8 CARB	HPR0160
W150	3.7L L6 CARB	HPR0160	D350	5.9L V8 CARB	HPR0160
W150	5.2L V8 CARB	HPR0160	Diplomat	3.7L L6 CARB	HPR0160
W150	5.9L V8 CARB	HPR0160	Diplomat	5.2L V8 2 BBL.	HPR0160
W250	5.2L V8 CARB	HPR0160	Mirada	3.7L L6 CARB	HPR0160
W250	5.9L V8 CARB	HPR0160	Mirada	5.2L V8 CARB	HPR0160
W350	5.9L V8 CARB	HPR0160	Omni	1.6L L4 CARB	HPR3559
1984 DODGE			Omni	2.2L L4 CARB	HPR3559
600	2.2L L4 CARB	HPR3559	Ramcharger	5.2L V8 CARB	HPR0160
600	2.2L L4 F/I - Exc. Turbo	HPR3660	Rampage	2.2L L4 CARB	HPR3559
600	2.2L L4 F/I - Turbo	HPR3559	W150	3.7L L6 CARB	HPR0160
Aries	2.2L L4 CARB	HPR3559	W150	5.2L V8 CARB	HPR0160
B150 Van	3.7L L6 CARB	HPR0184	W250	5.2L V8 CARB	HPR0160
B150 Van	5.2L V8 CARB	HPR0160	W350	5.2L V8 CARB	HPR0160
B250 Van	3.7L L6 CARB	HPR0184	W350	5.9L V8 CARB	HPR0160
B250 Van	5.2L V8 CARB	HPR0160	1982 DODGE		
B250 Van	5.9L V8 CARB	HPR0160	400	2.2L L4 CARB	HPR3559
B350 Van	5.2L V8 CARB	HPR0160	Aries	2.2L L4 CARB	HPR3559
B350 Van	5.9L V8 CARB	HPR0160	B150 Van	3.7L L6 CARB	HPR0184
Caravan	2.2L L4 CARB	HPR3559	B250 Van	3.7L L6 CARB	HPR0184
Charger	1.6L L4 CARB	HPR3559	D150	3.7L L6 CARB	HPR0160
Charger	2.2L L4 CARB	HPR3559	D150	5.2L V8 CARB	HPR0160
D100	3.7L L6 CARB	HPR0160	D150	5.9L V8 CARB	HPR0160
D100	5.2L V8 CARB	HPR0160	D250	3.7L L6 CARB	HPR0160
D100	5.9L V8 CARB	HPR0160	D250	5.2L V8 CARB	HPR0160
D150	3.7L L6 CARB	HPR0160	D250	5.9L V8 CARB	HPR0160
D150	5.2L V8 CARB	HPR0160	D350	5.2L V8 CARB	HPR0160
D150	5.9L V8 CARB	HPR0160	D350	5.9L V8 CARB	HPR0160
D250	3.7L L6 CARB	HPR0160	Diplomat	3.7L L6 CARB	HPR0160
D250	5.2L V8 CARB	HPR0160	Diplomat	5.2L V8 2 BBL.	HPR0160
D250	5.9L V8 CARB	HPR0160	Mirada	3.7L L6 CARB	HPR0160
D350	5.9L V8 CARB	HPR0160	Mirada	5.2L V8 2 BBL.	HPR0160
Daytona	2.2L L4 F/I - Exc. Turbo	HPR3660	Omni	2.2L L4 CARB	HPR3559
Daytona	2.2L L4 F/I - Turbo	HPR3559	Ramcharger	5.2L V8 CARB	HPR0160
Diplomat	5.2L V8 2 BBL.	HPR0160	Rampage	2.2L L4 CARB	HPR3559
Mini Ram	2.2L L4 CARB	HPR3559	W150	3.7L L6 CARB	HPR0160
Omni	1.6L L4 CARB	HPR3559	W150	5.2L V8 CARB	HPR0160
Omni	2.2L L4 CARB	HPR3559	W250	5.2L V8 CARB	HPR0160
Ramcharger	5.2L V8 CARB	HPR0160	W250	5.9L V8 CARB	HPR0160
Ramcharger	5.9L V8 CARB	HPR0160	W350	5.2L V8 CARB	HPR0160
Rampage	2.2L L4 CARB	HPR3559	W350	5.9L V8 CARB	HPR0160
Royal Mini Ram	2.2L L4 CARB	HPR3559	1981 DODGE		
W100	3.7L L6 CARB	HPR0160	Aries	2.2L L4 CARB	HPR3559
W100	5.2L V8 CARB	HPR0160	B150 Van	3.7L L6 CARB	HPR0184
W100	5.9L V8 CARB	HPR0160	B250 Van	3.7L L6 CARB	HPR0184
W150	3.7L L6 CARB	HPR0160	D150	3.7L L6 CARB	HPR0160
W150	5.2L V8 CARB	HPR0160	D150	5.2L V8 CARB	HPR0160
W150	5.9L V8 CARB	HPR0160	D150	5.9L V8 CARB	HPR0160
W250	5.2L V8 CARB	HPR0160	D250	3.7L L6 CARB	HPR0160
W250	5.9L V8 CARB	HPR0160	D250	5.2L V8 CARB	HPR0160
W350	5.9L V8 CARB	HPR0160	D250	5.9L V8 CARB	HPR0160
1983 DODGE			D350	5.2L V8 CARB	HPR0160
400	2.2L L4 CARB	HPR3559	D350	5.9L V8 CARB	HPR0160
600	2.2L L4 CARB	HPR3559	D400	5.9L V8 CARB	HPR0160
Aries	2.2L L4 CARB	HPR3559	D450	5.9L V8 CARB	HPR0160
B150 Van	3.7L L6 CARB	HPR0184	Diplomat	3.7L L6 CARB	HPR0160

*Indicates 2 filters required ♦ Intake system available - see page 326 + throttle body spacer available - see page 20

HPR™ REPLACEMENT AIR FILTERS

DODGE

Vehicle	Engine Type	Air Filter	Vehicle	Engine Type	Air Filter
1981 DODGE			1979 DODGE		
Diplomat	5.2L V8 2 BBL.	HPR0160	D100	360 V8 CARB	HPR0160
Mirada	3.7L L6 CARB	HPR0160	D150	225 L6 CARB	HPR0184
Mirada	5.2L V8 2 BBL.	HPR0160	D150	318 V8 2 BBL.	HPR0160
Omni	2.2L L4 CARB	HPR3559	D150	360 V8 2 BBL.	HPR0160
Ramcharger	5.2L V8 CARB	HPR0160	D200	225 L6 CARB	HPR0184
Ramcharger	5.9L V8 CARB	HPR0160	D200	318 V8 2 BBL.	HPR0160
St. Regis	3.7L L6 CARB	HPR0160	D200	360 V8 2 BBL.	HPR0160
St. Regis	5.2L V8 2 BBL.	HPR0160	D300	318 V8 CARB	HPR0160
W150	3.7L L6 CARB	HPR0160	D300	360 V8 2 BBL.	HPR0160
W150	5.2L V8 CARB	HPR0160	Diplomat	225 L6 1 BBL. - w/10 in OD Filter	HPR0160
W150	5.9L V8 CARB	HPR0160	Diplomat	225 L6 2 BBL. - w/10 in OD Filter	HPR0160
W250	5.2L V8 CARB	HPR0160	Diplomat	318 V8 2 BBL.	HPR0160
W250	5.9L V8 CARB	HPR0160	Diplomat	360 V8 2 BBL.	HPR0160
W350	5.9L V8 CARB	HPR0160	Magnum	318 V8 2 BBL.	HPR0160
1980 DODGE			Ramcharger	225 L6 CARB	HPR0184
Aspen	225 L6 2 BBL.	HPR0160	Ramcharger	318 V8 2 BBL.	HPR0160
Aspen	318 V8 2 BBL.	HPR0160	Ramcharger	360 V8 2 BBL.	HPR0160
B100 Van	225 L6 CARB	HPR0160	St. Regis	225 L6 CARB	HPR0160
B100 Van	318 V8 CARB	HPR0160	St. Regis	318 V8 2 BBL.	HPR0160
B200 Van	225 L6 CARB	HPR0160	W150	225 L6 CARB	HPR0184
B200 Van	318 V8 CARB	HPR0160	W150	318 V8 2 BBL.	HPR0160
B300	225 L6 CARB	HPR0160	W150	360 V8 2 BBL.	HPR0160
B300	318 V8 CARB	HPR0160	W200	225 L6 CARB	HPR0184
Cb300	318 V8 CARB	HPR0160	W200	318 V8 2 BBL.	HPR0160
D150	225 L6 CARB	HPR0160	W200	360 V8 2 BBL.	HPR0160
D150	318 V8 CARB	HPR0160	1978 DODGE		
D150	360 V8 2 BBL.	HPR0160	Aspen	225 L6 2 BBL.	HPR0160
D200	225 L6 CARB	HPR0160	Aspen	318 V8 2 BBL.	HPR0160
D200	318 V8 CARB	HPR0160	B100 Van	318 V8 CARB	HPR0160
D200	360 V8 2 BBL.	HPR0160	B200 Van	318 V8 CARB	HPR0160
D300	318 V8 2 BBL.	HPR0160	B300	318 V8 CARB	HPR0160
D300	360 V8 2 BBL.	HPR0160	Cb300	225 L6 CARB	HPR0160
Diplomat	225 L6 1 BBL.	HPR0160	Cb300	318 V8 CARB	HPR0160
Diplomat	225 L6 2 BBL.	HPR0160	Charger	318 V8 2 BBL.	HPR0160
Diplomat	318 V8 2 BBL.	HPR0160	D100	225 L6 CARB	HPR0160
Mirada	225 L6 CARB	HPR0160	D100	318 V8 CARB	HPR0160
Mirada	318 V8 2 BBL.	HPR0160	D150	225 L6 CARB	HPR0160
Ramcharger	225 L6 CARB	HPR0160	D150	318 V8 CARB	HPR0160
Ramcharger	318 V8 CARB	HPR0160	D200	225 L6 CARB	HPR0160
RD200	318 V8 CARB	HPR0160	D200	318 V8 CARB	HPR0160
St. Regis	225 L6 CARB - w/10 in OD Filter	HPR0160	D300	318 V8 CARB	HPR0160
St. Regis	318 V8 2 BBL.	HPR0160	Diplomat	225 L6 2 BBL.	HPR0160
W150	225 L6 CARB	HPR0160	Diplomat	318 V8 2 BBL.	HPR0160
W150	318 V8 CARB	HPR0160	Magnum	318 V8 2 BBL.	HPR0160
W200	225 L6 CARB	HPR0160	Monaco	225 L6 2 BBL.	HPR0160
W200	318 V8 CARB	HPR0160	Monaco	318 V8 2 BBL.	HPR0160
W300	318 V8 CARB	HPR0160	Motorhome	318 V8 2 BBL. - Class C	HPR0160
1979 DODGE			Ramcharger	225 L6 CARB	HPR0160
Aspen	225 L6 CARB	HPR0160	Ramcharger	318 V8 CARB	HPR0160
Aspen	318 V8 2 BBL.	HPR0160	RD200	318 V8 CARB	HPR0160
B100 Van	225 L6 CARB	HPR0184	W150	225 L6 CARB	HPR0160
B100 Van	318 V8 2 BBL.	HPR0160	W150	318 V8 CARB	HPR0160
B200 Van	225 L6 CARB	HPR0184	W200	225 L6 CARB	HPR0160
B200 Van	318 V8 2 BBL.	HPR0160	W200	318 V8 CARB	HPR0160
B200 Van	360 V8 2 BBL.	HPR0160	W300	225 L6 CARB	HPR0160
B300	225 L6 CARB	HPR0160	W300	318 V8 CARB	HPR0160
B300	318 V8 2 BBL.	HPR0160	1977 DODGE		
B300	360 V8 2 BBL.	HPR0160	Aspen	225 L6 2 BBL.	HPR0160
Cb300	225 L6 CARB	HPR0184	Aspen	318 V8 CARB	HPR0160
Cb300	318 V8 2 BBL.	HPR0160	B100 Van	318 V8 CARB	HPR0160
Cb300	360 V8 2 BBL.	HPR0160	B200 Van	318 V8 CARB	HPR0160
D100	225 L6 CARB	HPR0184	B300	318 V8 CARB	HPR0160
D100	318 V8 2 BBL.	HPR0160	Cb300	225 L6 CARB	HPR0160

*Indicates 2 filters required ♦ Intake system available - see page 326 + throttle body spacer available - see page 20

DODGE

HPR™ REPLACEMENT AIR FILTERS

Vehicle	Engine Type	Air Filter	Vehicle	Engine Type	Air Filter
1977 DODGE			1974 DODGE		
Cb300	318 V8 CARB	HPR0160	B300 Van	318 V8 CARB	HPR0160
Charger	318 V8 CARB	HPR0160	Cb300	318 V8 CARB	HPR0160
D100	225 L6 CARB	HPR0160	Challenger	318 V8 CARB	HPR0160
D100	318 V8 CARB	HPR0160	Charger	318 V8 CARB	HPR0160
D150	225 L6 CARB	HPR0160	Coronet	318 V8 CARB	HPR0160
D150	318 V8 CARB	HPR0160	D100 Pickup	318 V8 CARB	HPR0160
D200	225 L6 CARB	HPR0160	D200 Pickup	318 V8 CARB	HPR0160
D200	318 V8 CARB	HPR0160	D300 Pickup	318 V8 CARB	HPR0160
D300	225 L6 1 BBL.	HPR0160	Dart	318 V8 CARB	HPR0160
D300	225 L6 2 BBL.	HPR0160	M300	318 V8 CARB	HPR0160
D300	318 V8 CARB	HPR0160	M350	318 V8 CARB	HPR0160
Diplomat	318 V8 CARB	HPR0160	Motorhome	318 V8 2 BBL. - Class A & C	HPR0160
Monaco	225 L6 2 BBL.	HPR0160	R300	318 V8 CARB	HPR0160
Monaco	318 V8 CARB	HPR0160	Ramcharger	318 V8 CARB	HPR0160
Motorhome	318 V8 2 BBL. - Class A & C	HPR0160	RM300	318 V8 CARB	HPR0160
Ramcharger	225 L6 CARB	HPR0160	RM350	318 V8 CARB	HPR0160
Ramcharger	318 V8 CARB	HPR0160	W100 Pickup	318 V8 CARB	HPR0160
W100	225 L6 CARB	HPR0160	W200 Pickup	318 V8 CARB	HPR0160
W100	318 V8 CARB	HPR0160	W300 Pickup	318 V8 CARB	HPR0160
W150	318 V8 CARB	HPR0160	1973 DODGE		
W200	225 L6 CARB	HPR0160	B100 Van	318 V8 CARB	HPR0160
W200	318 V8 CARB	HPR0160	B200 Van	318 V8 CARB	HPR0160
W300	225 L6 CARB	HPR0160	B300 Van	318 V8 CARB	HPR0160
W300	318 V8 CARB	HPR0160	Cb300	318 V8 CARB	HPR0160
1976 DODGE			Challenger	318 V8 CARB	HPR0160
Aspen	318 V8 CARB	HPR0160	Charger	318 V8 CARB	HPR0160
B100 Van	318 V8 CARB	HPR0160	Coronet	318 V8 CARB	HPR0160
B200 Van	318 V8 CARB	HPR0160	D100 Pickup	318 V8 CARB	HPR0160
B300	318 V8 CARB	HPR0160	D200 Pickup	318 V8 CARB	HPR0160
Cb300	318 V8 CARB	HPR0160	D300 Pickup	318 V8 CARB	HPR0160
Charger	318 V8 CARB	HPR0160	Dart	318 V8 CARB	HPR0160
Coronet	318 V8 CARB	HPR0160	Motorhome	318 V8 2 BBL. - Class A & C	HPR0160
D100	318 V8 CARB	HPR0160	Polara	318 V8 CARB	HPR0160
D200	318 V8 CARB	HPR0160	R300	318 V8 CARB	HPR0160
D300	318 V8 CARB	HPR0160	RM300	318 V8 CARB	HPR0160
Dart	318 V8 CARB	HPR0160	W100 Pickup	318 V8 CARB	HPR0160
Monaco	318 V8 CARB	HPR0160	W200 Pickup	318 V8 CARB	HPR0160
Motorhome	318 V8 2 BBL. - Class A & C	HPR0160	W300 Pickup	318 V8 CARB	HPR0160
Ramcharger	318 V8 CARB	HPR0160	1972 DODGE		
W100	318 V8 CARB	HPR0160	B100 Van	225 L6 CARB	HPR0160
W200	318 V8 CARB	HPR0160	B100 Van	318 V8 CARB	HPR0160
W300	318 V8 CARB	HPR0160	B200 Van	225 L6 CARB	HPR0160
1975 DODGE			B200 Van	318 V8 CARB	HPR0160
B100 Van	318 V8 CARB	HPR0160	B300 Van	225 L6 CARB	HPR0160
B200 Van	318 V8 CARB	HPR0160	B300 Van	318 V8 CARB	HPR0160
B300	318 V8 CARB	HPR0160	Challenger	318 V8 CARB	HPR0160
Cb300	318 V8 CARB	HPR0160	Charger	318 V8 CARB	HPR0160
Charger	318 V8 CARB	HPR0160	Coronet	318 V8 CARB	HPR0160
Coronet	318 V8 CARB	HPR0160	D100 Pickup	318 V8 CARB	HPR0160
D100	318 V8 CARB	HPR0160	D200 Pickup	318 V8 CARB	HPR0160
D200	318 V8 CARB	HPR0160	D300 Pickup	318 V8 CARB	HPR0160
D300	318 V8 CARB	HPR0160	Dart	318 V8 CARB	HPR0160
Dart	318 V8 CARB	HPR0160	Motorhome	318 V8 2 BBL. - Class A & C	HPR0160
Monaco	318 V8 CARB	HPR0160	P200	225 L6 CARB	HPR0160
Motorhome	318 V8 2 BBL. - Class A & C	HPR0160	P300	225 L6 CARB	HPR0160
Ramcharger	318 V8 CARB	HPR0160	Polara	318 V8 CARB	HPR0160
Royal Monaco	318 V8 CARB	HPR0160	R300	318 V8 CARB	HPR0160
W100	318 V8 CARB	HPR0160	W100 Pickup	318 V8 CARB	HPR0160
W200	318 V8 CARB	HPR0160	W200 Pickup	318 V8 CARB	HPR0160
W300	318 V8 CARB	HPR0160	W300 Pickup	318 V8 CARB	HPR0160
1974 DODGE			1971 DODGE		
B100 Van	318 V8 CARB	HPR0160	B100 Van	318 V8 CARB	HPR0160
B200 Van	318 V8 CARB	HPR0160	B100 Van	360 V8 CARB	HPR0160

*Indicates 2 filters required ♦ Intake system available - see page 326 + throttle body spacer available - see page 20

HPR™ REPLACEMENT AIR FILTERS

DODGE

Vehicle	Engine Type	Air Filter	Vehicle	Engine Type	Air Filter
1971 DODGE			1968 DODGE		
B200 Van	318 V8 CARB	HPR0160	Coronet	273 V8 CARB	HPR0160
B200 Van	360 V8 CARB	HPR0160	Coronet	318 V8 CARB	HPR0160
B300 Van	318 V8 CARB	HPR0160	D100 Pickup	318 V8 CARB	HPR0160
B300 Van	360 V8 CARB	HPR0160	D200 Pickup	318 V8 CARB	HPR0160
Challenger	318 V8 CARB	HPR0160	D300 Pickup	318 V8 CARB	HPR0160
Charger	318 V8 CARB	HPR0160	Dart	273 V8 CARB	HPR0160
Coronet	318 V8 CARB	HPR0160	Dart	318 V8 CARB	HPR0160
D100 Pickup	318 V8 CARB	HPR0160	Monaco	318 V8 CARB	HPR0160
D100 Pickup	360 V8 CARB	HPR0160	Motorhome	273 V8 2 BBL. - Class C	HPR0160
D200 Pickup	318 V8 CARB	HPR0160	Motorhome	318 V8 2 BBL. - Class A & C	HPR0160
D200 Pickup	360 V8 CARB	HPR0160	P375	360 V8 CARB	HPR0160
D300 Pickup	318 V8 CARB	HPR0160	P375	361 V8 CARB	HPR0160
D300 Pickup	360 V8 CARB	HPR0160	Polara	318 V8 CARB	HPR0160
Dart	318 V8 CARB	HPR0160	W100 Pickup	318 V8 CARB	HPR0160
Motorhome	318 V8 2 BBL. - Class A & C	HPR0160	W200 Pickup	318 V8 CARB	HPR0160
P200	360 V8 CARB	HPR0160	W300 Pickup	318 V8 CARB	HPR0160
P300	360 V8 CARB	HPR0160	1967 DODGE		
Polara	318 V8 CARB	HPR0160	A100	273 V8 CARB	HPR0160
RM300	318 V8 CARB	HPR0160	A100 Truck	273 V8 CARB - w/10 in OD Filter	HPR0160
RM350	318 V8 CARB	HPR0160	A100 Truck	318 V8 CARB	HPR0160
W100 Pickup	318 V8 CARB	HPR0160	Charger	318 V8 CARB	HPR0160
W200 Pickup	318 V8 CARB	HPR0160	Coronet	273 V8 CARB	HPR0160
W200 Pickup	360 V8 CARB	HPR0160	Coronet	318 V8 CARB	HPR0160
W300 Pickup	318 V8 CARB	HPR0160	D100 Series	318 V8 CARB	HPR0160
W300 Pickup	360 V8 CARB	HPR0160	D200 Series	318 V8 CARB	HPR0160
1970 DODGE			D300 Series	318 V8 CARB	HPR0160
A100	318 V8 CARB	HPR0160	Dart	273 V8 CARB	HPR0160
A100 Truck	318 V8 CARB	HPR0160	Dart	318 V8 CARB	HPR0160
Challenger	318 V8 CARB	HPR0160	Motorhome	273 V8 2 BBL. - Class C	HPR0160
Charger	318 V8 CARB	HPR0160	Polara	273 V8 CARB	HPR0160
Coronet	318 V8 CARB	HPR0160	Polara	318 V8 CARB	HPR0160
D100 Pickup	318 V8 CARB	HPR0160	W100 Series	318 V8 CARB	HPR0160
D200 Pickup	318 V8 CARB	HPR0160	W200 Series	318 V8 CARB	HPR0160
D300 Pickup	318 V8 CARB	HPR0160	W300 Series	318 V8 CARB	HPR0160
Dart	318 V8 CARB	HPR0160	1966 DODGE		
Monaco	318 V8 CARB	HPR0160	A100	273 V8 CARB	HPR0160
Motorhome	318 V8 2 BBL. - Class A & C	HPR0160	A100 Truck	273 V8 CARB - w/10 in OD Filter	HPR0160
P200	360 V8 CARB	HPR0160	Charger	273 V8 CARB	HPR0160
Polara	318 V8 CARB	HPR0160	Charger	318 V8 CARB	HPR0160
W100 Pickup	318 V8 CARB	HPR0160	Coronet	273 V8 CARB	HPR0160
W200 Pickup	318 V8 CARB	HPR0160	Coronet	318 V8 CARB	HPR0160
W300 Pickup	318 V8 CARB	HPR0160	D100 Series	318 V8 CARB	HPR0160
1969 DODGE			D200 Series	318 V8 CARB	HPR0160
A100	318 V8 CARB	HPR0160	D300 Series	318 V8 CARB	HPR0160
A100 Truck	318 V8 CARB	HPR0160	Dart	273 V8 CARB	HPR0160
Charger	318 V8 CARB	HPR0160	Motorhome	273 V8 2 BBL. - Class C	HPR0160
Charger	383 V8 CARB - w/air control	HPR0192	Polara	273 V8 CARB	HPR0160
Coronet	318 V8 CARB	HPR0160	Polara	318 V8 CARB	HPR0160
D100 Pickup	318 V8 CARB	HPR0160	W100 Series	318 V8 CARB	HPR0160
D200 Pickup	318 V8 CARB	HPR0160	W200 Series	318 V8 CARB	HPR0160
D300 Pickup	318 V8 CARB	HPR0160	W300 Series	318 V8 CARB	HPR0160
Dart	273 V8 CARB	HPR0160	1965 DODGE		
Dart	318 V8 CARB	HPR0160	A100	273 V8 CARB	HPR0160
Monaco	318 V8 CARB	HPR0160	A100 Truck	273 V8 CARB - w/10 in OD Filter	HPR0160
Motorhome	318 V8 2 BBL. - Class A & C	HPR0160	Coronet	273 V8 CARB	HPR0160
Polara	318 V8 CARB	HPR0160	Coronet	318 V8 CARB	HPR0160
W100 Pickup	318 V8 CARB	HPR0160	Custom	273 V8 CARB	HPR0160
W200 Pickup	318 V8 CARB	HPR0160	Custom	318 V8 CARB	HPR0160
W300 Pickup	318 V8 CARB	HPR0160	Dart	273 V8 CARB	HPR0160
1968 DODGE			Motorhome	273 V8 2 BBL. - Class C	HPR0160
A100	318 V8 CARB	HPR0160	Polara	273 V8 CARB	HPR0160
A100 Truck	318 V8 CARB	HPR0160	Polara	318 V8 CARB	HPR0160
Charger	318 V8 CARB	HPR0160			

*Indicates 2 filters required ♦ Intake system available - see page 326 + throttle body spacer available - see page 20

DODGE

HPR™ REPLACEMENT AIR FILTERS

Vehicle	Engine Type	Air Filter
1964 DODGE		
330	273 V8 CARB	HPR0160
330	361 V8 CARB - w/10 in OD Filter	HPR0160
440	273 V8 CARB	HPR0160
440	361 V8 CARB - w/10 in OD Filter	HPR0160
880	273 V8 CARB	HPR0160
880	361 V8 CARB - w/10 in OD Filter	HPR0160
A100	273 V8 CARB	HPR0160
A100 Truck	273 V8 CARB - w/10 in OD Filter	HPR0160
Custom	273 V8 CARB	HPR0160
Custom	361 V8 CARB - w/10 in OD Filter	HPR0160
Dart	273 V8 CARB	HPR0160
Motorhome	273 V8 2 BBL. - Class C	HPR0160
Polara	273 V8 CARB	HPR0160
Polara	361 V8 CARB - w/10 in OD Filter	HPR0160
1963 DODGE		
330	361 V8 CARB - w/10 in OD Filter	HPR0160
440	318 V8 CARB	HPR0160
880	318 V8 CARB	HPR0160
Custom	318 V8 CARB	HPR0160
Polara	318 V8 CARB	HPR0160
1962 DODGE		
Dart	361 V8 CARB - w/10 in OD Filter	HPR0160
Dart	383 V8 CARB - w/10 in OD Filter	HPR0160
Polara	318 V8 CARB - w/10 in OD Filter	HPR0160
Polara	361 V8 CARB - w/10 in OD Filter	HPR0160
1961 DODGE		
Custom	361 V8 CARB	HPR0160
Dart	361 V8 CARB - w/10 in OD Filter	HPR0160
Dart	383 V8 CARB - w/10 in OD Filter	HPR0160
Polara	318 V8 CARB	HPR0160
Polara	361 V8 CARB - w/10 in OD Filter	HPR0160
Polara	383 V8 CARB - w/10 in OD Filter	HPR0160
1960 DODGE		
Dart	361 V8 CARB - w/10 in OD Filter	HPR0160
Dart	383 V8 CARB - w/10 in OD Filter	HPR0160
Matador	361 V8 CARB - w/10 in OD Filter	HPR0160
Matador	383 V8 CARB - w/10 in OD Filter	HPR0160
Polara	318 V8 CARB	HPR0160
1959 DODGE		
Coronet	230 L6 CARB	HPR0160
Coronet	326 V8 CARB - w/10 in OD Filter	HPR0160
Royal	361 V8 2 BBL. - w/10 in OD Filter	HPR0160
Royal	361 V8 4 BBL. - w/10 in OD Filter	HPR0160
Sierra	361 V8 2 BBL. - w/10 in OD Filter	HPR0160
Sierra	361 V8 4 BBL. - w/10 in OD Filter	HPR0160
Sierra	361 V8 CARB - w/10 in OD Filter	HPR0160
1958 DODGE		
Coronet	230 L6 CARB	HPR0160
Coronet	361 V8 CARB - w/10 in OD Filter	HPR0160
1957 DODGE		
Coronet	230 L6 CARB	HPR0160
1956 DODGE		
Coronet	230 L6 CARB	HPR0160
1955 DODGE		
C-3	230 L6 CARB	HPR0160
Coronet	230 L6 CARB	HPR0160
1954 DODGE		
C-1	230 L6 CARB	HPR0160
Coronet	230 L6 CARB	HPR0160

Vehicle	Engine Type	Air Filter
1954 DODGE		
Meadowbrook	230 L6 CARB	HPR0160
1953 DODGE		
Coronet	230 L6 CARB	HPR0160
Meadowbrook	230 L6 CARB	HPR0160
1950 DODGE		
B-1	230 L6 CARB - w/10 in OD Filter	HPR0160
1998 EAGLE		
Talon	2.0L L4 F/I	HPR7344
Talon TSi	2.0L L4 F/I	HPR7344
1997 EAGLE		
Talon	2.0L L4 F/I	HPR7344
Talon TSi	2.0L L4 F/I	HPR7344
1996 EAGLE		
Summit Wagon	1.8L L4 F/I	HPR7344
Talon	2.0L L4 F/I	HPR7344
Talon TSi	2.0L L4 F/I	HPR7344
1995 EAGLE		
Summit Wagon	1.8L L4 F/I	HPR7344
Talon	2.0L L4 F/I	HPR7344
Talon TSi	2.0L L4 F/I	HPR7344
1994 EAGLE		
Summit	2.4L L4 F/I	HPR7344
Summit Wagon	1.8L L4 F/I	HPR7344
1993 EAGLE		
Summit	2.4L L4 F/I	HPR7344
Summit Wagon	1.8L L4 F/I	HPR7344
1992 EAGLE		
Premier	3.0L V6 F/I	HPR3660
Summit	1.8L L4 F/I	HPR7344
Summit	2.4L L4 F/I	HPR7344
1991 EAGLE		
Premier	3.0L V6 F/I	HPR3660
1990 EAGLE		
Premier	3.0L V6 F/I	HPR3660
2017 FORD		
Expedition	3.5L V6 F/I	HPR10262
Explorer	2.3L L4 F/I	HPR10242
Explorer	3.5L V6 F/I	HPR10242
F150	2.7L V6 F/I	HPR10262
F150	3.5L V6 F/I	HPR10262
F150	5.0L V8 F/I	HPR10262
2016 FORD		
E350 Super Duty	5.4L V8 F/I	HPR8039
E350 Super Duty	6.8L V10 F/I	HPR8039
E450 Super Duty	5.4L V8 F/I	HPR8039
Expedition	3.5L V6 F/I	HPR10262
Explorer	2.3L L4 F/I	HPR10242
Explorer	3.5L V6 F/I	HPR10242 ♦
F150	2.7L V6 F/I	HPR10262 ♦
F150	3.5L V6 F/I	HPR10262 ♦
F150	5.0L V8 F/I	HPR10262 ♦
F250 Super Duty	6.2L V8 F/I	HPR10262
F350 Super Duty	6.2L V8 F/I	HPR10262
Flex	3.5L V6 F/I	HPR10242
Taurus	2.0L L4 F/I	HPR10242
Taurus	3.5L V6 F/I	HPR10242
Taurus SHO	3.5L V6 F/I	HPR10242

*Indicates 2 filters required ♦ Intake system available - see page 326 + throttle body spacer available - see page 20

HPR™ REPLACEMENT AIR FILTERS

FORD

Vehicle	Engine Type	Air Filter	Vehicle	Engine Type	Air Filter
2015 FORD			2013 FORD		
E350 Super Duty	5.4L V8 F/I	HPR8039	Expedition	5.4L V8 F/I	HPR10262 ♦
E350 Super Duty	6.8L V10 F/I	HPR8039	Explorer	2.0L L4 F/I	HPR10242
E450 Super Duty	5.4L V8 F/I	HPR8039	Explorer	3.5L V6 F/I	HPR10242
E450 Super Duty	6.8L V10 F/I	HPR8039	Explorer Sport	3.5L V6 F/I	HPR10242 ♦
Expedition	3.5L V6 F/I	HPR10262	F150	3.5L V6 F/I	HPR10262 ♦
Explorer	2.0L L4 F/I	HPR10242 ♦	F150	3.7L V6 F/I	HPR10262
Explorer	3.5L V6 F/I	HPR10242	F150	5.0L V8 F/I	HPR10262 ♦
Explorer Sport	3.5L V6 F/I	HPR10242 ♦	F150	6.2L V8 F/I	HPR10262
F150	2.7L V6 F/I	HPR10262 ♦	F150 SVT Raptor	6.2L V8 F/I	HPR10262 ♦
F150	3.5L V6 F/I	HPR10262 ♦	F250 Super Duty	6.2L V8 F/I	HPR10262 ♦
F150	5.0L V8 F/I	HPR10262 ♦	F350 Super Duty	6.2L V8 F/I	HPR10262 ♦
F250 Super Duty	6.2L V8 F/I	HPR10262	F450 Super Duty	6.8L V10 F/I	HPR10262
F350 Super Duty	6.2L V8 F/I	HPR10262	F550 Super Duty	6.8L V10 F/I	HPR10262
F450 Super Duty	6.2L V8 F/I	HPR10262	F650	6.8L V10 F/I	HPR10262
F450 Super Duty	6.8L V10 F/I	HPR10262	Flex	3.5L V6 F/I	HPR10242
F550 Super Duty	6.8L V10 F/I	HPR10262	Mustang	3.7L V6 F/I	HPR10781 ♦
Flex	3.5L V6 F/I	HPR10242	Mustang Boss 302	5.0L V8 F/I	HPR10781 ♦
Taurus	2.0L L4 F/I	HPR10242	Mustang GT	5.0L V8 F/I	HPR10781 ♦
Taurus	3.5L V6 F/I	HPR10242	Taurus	2.0L L4 F/I	HPR10242
Taurus SHO	3.5L V6 F/I	HPR10242	Taurus	3.5L V6 F/I	HPR10242
2014 FORD			2012 FORD		
E150	4.6L V8 F/I	HPR8039	E150	4.6L V8 F/I	HPR8039
E150	5.4L V8 F/I	HPR8039	E150	5.4L V8 F/I	HPR8039
E250	4.6L V8 F/I	HPR8039	E150	6.8L V10 F/I	HPR8039
E250	5.4L V8 F/I	HPR8039	E250	4.6L V8 F/I	HPR8039
E350 Super Duty	5.4L V8 F/I	HPR8039	E250	5.4L V8 F/I	HPR8039
E350 Super Duty	6.8L V10 F/I	HPR8039	E250 Super Duty	6.8L V10 F/I	HPR8039
E450 Super Duty	5.4L V8 F/I	HPR8039	E350	4.6L V8 F/I	HPR8039
E450 Super Duty	6.8L V10 F/I	HPR8039	E350 Super Duty	5.4L V8 F/I	HPR8039
Edge	2.0L L4 F/I	HPR10242	E350 Super Duty	6.8L V10 F/I	HPR8039
Edge	3.5L V6 F/I	HPR10242 ♦	E450 Super Duty	5.4L V8 F/I	HPR8039
Edge	3.7L V6 F/I	HPR10242 ♦	E450 Super Duty	6.8L V10 F/I	HPR8039
Expedition	5.4L V8 F/I	HPR10262 ♦	Edge	2.0L L4 F/I	HPR10242
Explorer	2.0L L4 F/I	HPR10242 ♦	Edge	3.5L V6 F/I	HPR10242 ♦
Explorer	3.5L V6 F/I	HPR10242	Edge	3.7L V6 F/I	HPR10242 ♦
Explorer Sport	3.5L V6 F/I	HPR10242 ♦	Escape	2.5L L4 F/I	HPR8997
F150	3.5L V6 F/I	HPR10262 ♦	Expedition	5.4L V8 F/I	HPR10262 ♦
F150	3.7L V6 F/I	HPR10262	Explorer	2.0L L4 F/I	HPR10242
F150	5.0L V8 F/I	HPR10262 ♦	Explorer	3.5L V6 F/I	HPR10242
F150	6.2L V8 F/I	HPR10262	F150	3.5L V6 F/I	HPR10262 ♦
F150 SVT Raptor	6.2L V8 F/I	HPR10262 ♦	F150	3.7L V6 F/I	HPR10262
F250 Super Duty	6.2L V8 F/I	HPR10262 ♦	F150	5.0L V8 F/I	HPR10262 ♦
F350 Super Duty	6.2L V8 F/I	HPR10262 ♦	F150	6.2L V8 F/I	HPR10262
F450 Super Duty	6.8L V10 F/I	HPR10262	F150 SVT Raptor	6.2L V8 F/I	HPR10262 ♦
F550 Super Duty	6.8L V10 F/I	HPR10262	F250 Super Duty	6.2L V8 F/I	HPR10262 ♦
Flex	3.5L V6 F/I	HPR10242	F350 Super Duty	6.2L V8 F/I	HPR10262 ♦
Mustang	3.7L V6 F/I	HPR10781 ♦	F450 Super Duty	6.8L V10 F/I	HPR10262
Mustang GT	5.0L V8 F/I	HPR10781 ♦	F550 Super Duty	6.8L V10 F/I	HPR10262
Taurus	2.0L L4 F/I	HPR10242	F650	6.8L V10 F/I	HPR10262
Taurus	3.5L V6 F/I	HPR10242	Flex	3.5L V6 F/I	HPR10242
Taurus SHO	3.5L V6 F/I	HPR10242 ♦	Fusion	3.5L V6 F/I	HPR10242
2013 FORD			2011 FORD		
E150	4.6L V8 F/I	HPR8039	Crown Victoria	4.6L V8 F/I	HPR5056
E150	5.4L V8 F/I	HPR8039	Crown Victoria Police	4.6L V8 F/I	HPR5056
E250	4.6L V8 F/I	HPR8039	Interceptor		
E250	5.4L V8 F/I	HPR8039	E150	4.6L V8 F/I	HPR8039
E350 Super Duty	5.4L V8 F/I	HPR8039	E150	5.4L V8 F/I	HPR8039
E350 Super Duty	6.8L V10 F/I	HPR8039			
E450 Super Duty	5.4L V8 F/I	HPR8039			
E450 Super Duty	6.8L V10 F/I	HPR8039			
Edge	2.0L L4 F/I	HPR10242			
Edge	3.5L V6 F/I	HPR10242 ♦			
Edge	3.7L V6 F/I	HPR10242 ♦			

*Indicates 2 filters required ♦ Intake system available - see page 326 + throttle body spacer available - see page 20

Vehicle	Engine Type	Air Filter	Vehicle	Engine Type	Air Filter
2011 FORD			2010 FORD		
E250	4.6L V8 F/I	HPR8039	Fusion	3.5L V6 F/I	HPR10242
E250	5.4L V8 F/I	HPR8039	Mustang	4.0L V6 F/I	HPR9895
E350	4.6L V8 F/I	HPR8039	Mustang	4.6L V8 F/I	HPR10781
E350 Super Duty	5.4L V8 F/I	HPR8039	Mustang GT	4.6L V8 F/I	HPR10781
E350 Super Duty	6.8L V10 F/I	HPR8039	Ranger	2.3L L4 F/I	HPR8243
E450 Super Duty	5.4L V8 F/I	HPR8039	Ranger	4.0L V6 F/I	HPR8243
E450 Super Duty	6.8L V10 F/I	HPR8039	Taurus	3.5L V6 F/I	HPR10242
Edge	3.5L V6 F/I	HPR10242 ♦	Taurus SHO	3.5L V6 F/I	HPR10242
Edge	3.7L V6 F/I	HPR10242 ♦	2009 FORD		
Escape	2.5L L4 F/I	HPR8997	Crown Victoria	4.6L V8 F/I	HPR5056
Expedition	5.4L V8 F/I	HPR10262 ♦	Crown Victoria Police	4.6L V8 F/I	HPR5056
Explorer	3.5L V6 F/I	HPR10242	Interceptor		
F150	3.5L V6 F/I	HPR10262	E150	4.6L V8 F/I	HPR8039
F150	3.7L V6 F/I	HPR10262	E150	5.4L V8 F/I	HPR8039
F150	4.6L V8 F/I	HPR10262	E250	4.6L V8 F/I	HPR8039
F150	5.0L V8 F/I	HPR10262 ♦	E250	5.4L V8 F/I	HPR8039
F150	5.4L V8 F/I	HPR10262	E350	4.6L V8 F/I	HPR8039
F150	6.2L V8 F/I	HPR10262	E350 Super Duty	5.4L V8 F/I	HPR8039
F150 Platinum	6.2L V8 F/I	HPR10262 ♦	E350 Super Duty	6.8L V10 F/I	HPR8039
F150 SVT Raptor	6.2L V8 F/I	HPR10262 ♦	E450 Super Duty	5.4L V8 F/I	HPR8039
F250 Super Duty	6.2L V8 F/I	HPR10262 ♦	E450 Super Duty	6.8L V10 F/I	HPR8039
F250 Super Duty	6.8L V10 F/I	HPR10262	Edge	3.5L V6 F/I	HPR10242
F350 Super Duty	6.2L V8 F/I	HPR10262 ♦	Escape	2.5L L4 F/I	HPR8997
F350 Super Duty	6.8L V10 F/I	HPR10262	Expedition	5.4L V8 F/I	HPR10262 ♦+
F450 Super Duty	6.8L V10 F/I	HPR10262	Explorer	4.0L V6 F/I	HPR9332
F550 Super Duty	6.2L V8 F/I	HPR10262	Explorer Sport Trac	4.0L V6 F/I	HPR9332
F550 Super Duty	6.8L V10 F/I	HPR10262	F150	4.6L V8 F/I	HPR10262 ♦+
Flex	3.5L V6 F/I	HPR10242	F150	5.4L V8 F/I	HPR10262 ♦+
Fusion	3.5L V6 F/I	HPR10242	F250 Super Duty	5.4L V8 F/I	HPR10262
Mustang	3.7L V6 F/I	HPR10781 ♦	F250 Super Duty	6.8L V10 F/I	HPR10262
Mustang GT	5.0L V8 F/I	HPR10781 ♦	F350	5.4L V8 F/I	HPR10262
Ranger	2.3L L4 F/I	HPR8243	F350 Super Duty	5.4L V8 F/I	HPR10262
Ranger	4.0L V6 F/I	HPR8243	F350 Super Duty	6.8L V10 F/I	HPR10262
Taurus	3.5L V6 F/I	HPR10242	F450	6.8L V10 F/I	HPR10262
Taurus SHO	3.5L V6 F/I	HPR10242 ♦	F450 Super Duty	6.8L V10 F/I	HPR10262
2010 FORD			F550 Super Duty	6.8L V10 F/I	HPR10262
Crown Victoria	4.6L V8 F/I	HPR5056	Flex	3.5L V6 F/I	HPR10242
Crown Victoria Police	4.6L V8 F/I	HPR5056	Mustang	4.0L V6 F/I	HPR9895 ♦
Interceptor			Mustang	4.6L V8 F/I	HPR9895
E150	4.6L V8 F/I	HPR8039	Mustang Bullitt	4.6L V8 F/I	HPR9895
E150	5.4L V8 F/I	HPR8039	Mustang GT	4.6L V8 F/I	HPR9895 ♦
E250	4.6L V8 F/I	HPR8039	Ranger	2.3L L4 F/I	HPR8243
E250	5.4L V8 F/I	HPR8039	Ranger	4.0L V6 F/I	HPR8243
E350	4.6L V8 F/I	HPR8039	Taurus	3.5L V6 F/I	HPR10242
E350 Super Duty	5.4L V8 F/I	HPR8039	Taurus X	3.5L V6 F/I	HPR10242
E350 Super Duty	6.8L V10 F/I	HPR8039	2008 FORD		
E450 Super Duty	5.4L V8 F/I	HPR8039	Crown Victoria	4.6L V8 F/I	HPR5056
E450 Super Duty	6.8L V10 F/I	HPR8039	Crown Victoria Police	4.6L V8 F/I	HPR5056
Edge	3.5L V6 F/I	HPR10242	Interceptor		
Escape	2.5L L4 F/I	HPR8997	E150	4.6L V8 F/I	HPR8039
Expedition	5.4L V8 F/I	HPR10262 ♦	E150	5.4L V8 F/I	HPR8039
Explorer	4.0L V6 F/I	HPR9332	E250	4.6L V8 F/I	HPR8039
Explorer Sport Trac	4.0L V6 F/I	HPR9332	E250	5.4L V8 F/I	HPR8039
F150	4.6L V8 F/I	HPR10262 ♦+	E350	4.6L V8 F/I	HPR8039
F150	5.4L V8 F/I	HPR10262 ♦	E350 Super Duty	5.4L V8 F/I	HPR8039
F150 SVT Raptor	5.4L V8 F/I	HPR10262 ♦	E350 Super Duty	6.8L V10 F/I	HPR8039
F150 SVT Raptor	6.2L V8 F/I	HPR10262	E450 Super Duty	5.4L V8 F/I	HPR8039
F250 Super Duty	5.4L V8 F/I	HPR10262	E450 Super Duty	6.8L V10 F/I	HPR8039
F250 Super Duty	6.8L V10 F/I	HPR10262	Edge	3.5L V6 F/I	HPR10242
F350 Super Duty	5.4L V8 F/I	HPR10262	Escape	2.3L L4 F/I	HPR8997
F350 Super Duty	6.8L V10 F/I	HPR10262	Escape	3.0L V6 F/I	HPR8997
F450 Super Duty	6.8L V10 F/I	HPR10262	Expedition	5.4L V8 F/I	HPR10262 ♦+
F550 Super Duty	6.8L V10 F/I	HPR10262	Explorer	4.0L V6 F/I	HPR9332
Flex	3.5L V6 F/I	HPR10242			

*Indicates 2 filters required ♦ Intake system available - see page 326 + throttle body spacer available - see page 20

HPR™ REPLACEMENT AIR FILTERS

FORD

Vehicle	Engine Type	Air Filter	Vehicle	Engine Type	Air Filter
2008 FORD			2006 FORD		
Explorer Sport Trac	4.0L V6 F/I	HPR9332	Crown Victoria	4.6L V8 F/I	HPR5056
F150	4.2L V6 F/I	HPR8039	Crown Victoria Police	4.6L V8 F/I	HPR5056
F150	4.6L V8 F/I	HPR8039 +	Interceptor		
F150	5.4L V8 F/I	HPR9687 ♦+	E150	4.6L V8 F/I	HPR8039
F250 Super Duty	5.4L V8 F/I	HPR10262	E150	5.4L V8 F/I	HPR8039
F250 Super Duty	6.8L V10 F/I	HPR10262	E250	4.6L V8 F/I	HPR8039
F350	5.4L V8 F/I	HPR10262	E250	5.4L V8 F/I	HPR8039
F350 Super Duty	5.4L V8 F/I	HPR10262	E350	4.6L V8 F/I	HPR8039
F350 Super Duty	6.8L V10 F/I	HPR10262	E350 Cutaway	5.4L V8 F/I - Class C	HPR8039
F450	6.8L V10 F/I	HPR10262	E350 Cutaway	6.8L V10 F/I - Class C	HPR8039
F450 Super Duty	6.8L V10 F/I	HPR10262	E350 Super Duty	5.4L V8 F/I	HPR8039
F550 Super Duty	6.8L V10 F/I	HPR10262	E350 Super Duty	6.8L V10 F/I	HPR8039
FPV GT	5.4L V8 F/I - To 5/08	HPR8039	E450 Cutaway	6.8L V10 F/I - Class C	HPR8039
Ka	1.0L L4 F/I	HPR5058	E450 Super Duty	5.4L V8 F/I	HPR8039
Mustang	4.0L V6 F/I	HPR9895 ♦	E450 Super Duty	6.8L V10 F/I	HPR8039
Mustang	4.6L V8 F/I	HPR9895	Escape	2.3L L4 F/I	HPR8997
Mustang Bullitt	4.6L V8 F/I	HPR9895	Escape	3.0L V6 F/I	HPR8997
Mustang GT	4.6L V8 F/I	HPR9895 ♦	Expedition	5.4L V8 F/I	HPR9687 +
Ranger	2.3L L4 F/I	HPR8243	Explorer	4.0L V6 F/I	HPR9332
Ranger	3.0L V6 F/I	HPR8243	Explorer Sport Trac	4.0L V6 F/I	HPR9332
Ranger	4.0L V6 F/I	HPR8243	F150	4.2L V6 F/I	HPR8039
Taurus	3.5L V6 F/I	HPR10242	F150	4.6L V8 F/I	HPR8039 +
Taurus X	3.5L V6 F/I	HPR10242	F150	5.4L V8 F/I	HPR9687 ♦+
2007 FORD			F250 Super Duty	5.4L V8 F/I	HPR9687
Crown Victoria	4.6L V8 F/I	HPR5056	F350	5.4L V8 F/I	HPR9687
Crown Victoria Police	4.6L V8 F/I	HPR5056	F350 Cutaway	5.4L V8 F/I - Class C	HPR9687
Interceptor			F350 Super Duty	5.4L V8 F/I	HPR9687
E150	4.6L V8 F/I	HPR8039	FPV GT	5.4L V8 F/I	HPR8039
E150	5.4L V8 F/I	HPR8039	Freestar	3.9L V6 F/I	HPR8956
E250	4.6L V8 F/I	HPR8039	Freestar	4.2L V6 F/I	HPR8956
E250	5.4L V8 F/I	HPR8039	Ka	1.0L L4 F/I	HPR5058
E350	4.6L V8 F/I	HPR8039	Mustang	4.0L V6 F/I	HPR9895 ♦
E350 Cutaway	5.4L V8 F/I - Class C	HPR8039	Mustang GT	4.6L V8 F/I	HPR9895 ♦
E350 Cutaway	6.8L V10 F/I - Class C	HPR8039	Ranger	2.3L L4 F/I	HPR8243
E350 Super Duty	5.4L V8 F/I	HPR8039	Ranger	3.0L V6 F/I	HPR8243
E350 Super Duty	6.8L V10 F/I	HPR8039	Ranger	4.0L V6 F/I	HPR8243
E450 Cutaway	6.8L V10 F/I - Class C	HPR8039	Taurus	3.0L V6 F/I	HPR8997
E450 Super Duty	5.4L V8 F/I	HPR8039	2005 FORD		
E450 Super Duty	6.8L V10 F/I	HPR8039	Crown Victoria	4.6L V8 F/I	HPR5056
Edge	3.5L V6 F/I	HPR10242	Crown Victoria Police	4.6L V8 F/I	HPR5056
Escape	2.3L L4 F/I	HPR8997	Interceptor		
Escape	3.0L V6 F/I	HPR8997	E150	4.6L V8 F/I	HPR8039
Expedition	5.4L V8 F/I	HPR10262 ♦+	E150	5.4L V8 F/I	HPR8039
Explorer	4.0L V6 F/I	HPR9332	E150 Club Wagon	4.6L V8 F/I	HPR8039
Explorer Sport Trac	4.0L V6 F/I	HPR9332	E150 Club Wagon	5.4L V8 F/I	HPR8039
F150	4.2L V6 F/I	HPR8039	E250	4.6L V8 F/I	HPR8039
F150	4.6L V8 F/I	HPR8039 +	E250	5.4L V8 F/I	HPR8039
F150	5.4L V8 F/I	HPR9687 ♦+	E250 Club Wagon	5.4L V8 F/I	HPR8039
F250 Super Duty	5.4L V8 F/I	HPR9687	E350	4.6L V8 F/I	HPR8039
F350	5.4L V8 F/I	HPR9687	E350 Club Wagon	5.4L V8 F/I	HPR8039
F350 Cutaway	5.4L V8 F/I - Class C	HPR9687	E350 Club Wagon	6.8L V10 F/I	HPR8039
F350 Super Duty	5.4L V8 F/I	HPR9687	E350 Super Duty	5.4L V8 F/I	HPR8039
FPV GT	5.4L V8 F/I	HPR8039	E350 Super Duty	6.8L V10 F/I	HPR8039
Freestar	3.9L V6 F/I	HPR8956	E450 Super Duty	6.8L V10 F/I	HPR8039
Freestar	4.2L V6 F/I	HPR8956	Escape	2.3L L4 F/I	HPR8997
Ka	1.0L L4 F/I	HPR5058	Escape	3.0L V6 F/I	HPR8997
Mustang	4.0L V6 F/I	HPR9895 ♦	Excursion	5.4L V8 F/I - w/Panel Filter	HPR9687
Mustang	4.6L V8 F/I	HPR9895	Excursion	5.4L V8 F/I - w/Round Filter	HPR8039
Mustang GT	4.6L V8 F/I	HPR9895 ♦	Excursion	6.8L V10 F/I	HPR8039
Ranger	2.3L L4 F/I	HPR8243	Expedition	5.4L V8 F/I	HPR9687 +
Ranger	3.0L V6 F/I	HPR8243	Explorer	4.0L V6 F/I	HPR9332
Ranger	4.0L V6 F/I	HPR8243	Explorer	4.6L V8 F/I	HPR9332
Taurus	3.0L V6 F/I	HPR8997	Explorer Sport Trac	4.0L V6 F/I	HPR8243
			F150	4.2L V6 F/I	HPR8039

*Indicates 2 filters required ♦ Intake system available - see page 326 + throttle body spacer available - see page 20

FORD

HPR™ REPLACEMENT AIR FILTERS

Vehicle	Engine Type	Air Filter	Vehicle	Engine Type	Air Filter
2005 FORD			2004 FORD		
F150	4.6L V8 F/I	HPR8039 +	F450	6.8L V10 F/I	HPR8039
F150	5.4L V8 F/I	HPR9687 ♦+	F450 Super Duty	6.8L V10 F/I	HPR8039 +
F250 Super Duty	5.4L V8 F/I	HPR9687	F550 Super Duty	6.8L V10 F/I	HPR8039 +
F350	5.4L V8 F/I	HPR9687	Falcon	5.4L V8 F/I - DOHC	HPR8039
F350 Super Duty	5.4L V8 F/I	HPR9687	Focus RS	2.0L L4 F/I	HPR8956
F450 Super Duty	6.8L V10 F/I	HPR8039	FPV GT	5.4L V8 F/I	HPR8039
F550 Super Duty	6.8L V10 F/I	HPR8039	Freestar	3.9L V6 F/I	HPR8956
Falcon	5.4L V8 F/I - DOHC	HPR8039	Freestar	4.2L V6 F/I	HPR8956
FPV GT	5.4L V8 F/I	HPR8039	Ka	1.0L L4 F/I	HPR5058
Freestar	3.9L V6 F/I	HPR8956	Maverick	2.3L L4 F/I	HPR8997
Freestar	4.2L V6 F/I	HPR8956	Maverick	3.0L L4 F/I	HPR8997
Ka	1.0L L4 F/I	HPR5058	Motorhome	5.4L V8 F/I - Class C	HPR8039
Maverick	3.0L L4 F/I	HPR8997	Mustang	3.8L V6 F/I	HPR7730
Mustang	4.0L V6 F/I	HPR9895 ♦	Mustang	3.9L V6 F/I	HPR7730
Mustang GT	4.6L V8 F/I	HPR9895 ♦	Mustang GT	4.6L V8 F/I	HPR8039 ♦
Ranger	2.3L L4 F/I	HPR8243	Mustang Mach 1	4.6L V8 F/I	HPR8039
Ranger	3.0L V6 F/I	HPR8243	Mustang SVT Cobra	4.6L V8 F/I	HPR8039
Ranger	4.0L V6 F/I	HPR8243	Ranger	2.3L L4 F/I	HPR8243
Taurus	3.0L V6 F/I	HPR8997	Ranger	3.0L V6 F/I	HPR8243
Thunderbird	3.9L V8 F/I	HPR8956	Ranger	4.0L V6 F/I	HPR8243
2004 FORD			2003 FORD		
Crown Victoria	4.6L V8 F/I	HPR5056	Crown Victoria	4.6L V8 F/I	HPR5056
Crown Victoria Police Interceptor	4.6L V8 F/I	HPR5056	E150	4.2L V6 F/I	HPR8039
E150	4.6L V8 F/I	HPR8039	E150	4.6L V8 F/I	HPR8039
E150	5.4L V8 F/I	HPR8039	E150	5.4L V8 F/I	HPR8039
E150 Club Wagon	4.6L V8 F/I	HPR8039	E150 Club Wagon	4.2L V6 F/I	HPR8039
E150 Club Wagon	5.4L V8 F/I	HPR8039	E150 Club Wagon	4.6L V8 F/I	HPR8039
E250	4.6L V8 F/I	HPR8039	E150 Club Wagon	5.4L V8 F/I	HPR8039
E250	5.4L V8 F/I	HPR8039	E250	4.2L V6 F/I	HPR8039
E350	4.6L V8 F/I	HPR8039	E250	4.6L V8 F/I	HPR8039
E350 Club Wagon	5.4L V8 F/I	HPR8039	E250	5.4L V8 F/I	HPR8039
E350 Super Duty	5.4L V8 F/I	HPR8039	E350	4.2L V6 F/I	HPR8039
E350 Super Duty	6.8L V10 F/I	HPR8039	E350	4.6L V8 F/I	HPR8039
E450 Motorhome	6.8L V10 F/I - Class C	HPR8039	E350 Club Wagon	5.4L V8 F/I	HPR8039
E450 Super Duty	5.4L V8 F/I	HPR8039	E350 Club Wagon	6.8L V10 F/I	HPR8039
E450 Super Duty	6.8L V10 F/I	HPR8039	E350 Super Duty	5.4L V8 F/I	HPR8039
E550 Motorhome	6.8L V10 F/I - Class C	HPR8039	E350 Super Duty	6.8L V10 F/I	HPR8039
Escape	2.0L L4 F/I	HPR8997	E450 Motorhome	6.8L V10 F/I - Class C	HPR8039
Escape	3.0L V6 F/I	HPR8997	E450 Super Duty	5.4L V8 F/I	HPR8039
Excursion	5.4L V8 F/I	HPR8039	E450 Super Duty	6.8L V10 F/I	HPR8039
Excursion	6.8L V10 F/I	HPR8039 ♦+	E450 Super Duty Stripped Chassis	5.4L V8 F/I	HPR8039
Expedition	4.6L V8 F/I	HPR8039 ♦+	E450 Super Duty Stripped Chassis	6.8L V10 F/I	HPR8039
Expedition	5.4L V8 F/I	HPR8039 ♦+	E550 Motorhome	6.8L V10 F/I - Class C	HPR8039
Explorer	4.0L V6 F/I	HPR9332	E550 Super Duty	6.8L V10 F/I	HPR8039
Explorer	4.6L V8 F/I	HPR9332	Escape	2.0L L4 F/I	HPR8997
Explorer Sport	4.0L V6 F/I	HPR8243	Escape	3.0L V6 F/I	HPR8997
Explorer Sport Trac	4.0L V6 F/I	HPR8243	Escort ZX2	2.0L L4 F/I	HPR7774
F150	4.2L V6 F/I	HPR8039	Excursion	5.4L V8 F/I	HPR8039
F150	4.6L V8 F/I	HPR8039 +	Excursion	6.8L V10 F/I	HPR8039 ♦+
F150	5.4L V8 F/I	HPR9687 ♦+	Excursion	7.3L V8 DSL	HPR8925 ♦
F150 Heritage	4.2L V6 F/I	HPR8039	Expedition	4.6L V8 F/I	HPR8039 ♦+
F150 Heritage	4.6L V8 F/I	HPR8039	Expedition	5.4L V8 F/I	HPR8039 ♦+
F150 Heritage	5.4L V8 F/I	HPR8039	Explorer	4.0L V6 F/I	HPR9332
F150 Lightning	5.4L V8 F/I	HPR9687	Explorer	4.6L V8 F/I	HPR9332
F250 Harley Davidson Super Duty	6.8L V10 F/I	HPR8039	Explorer Sport	4.0L V6 F/I	HPR8243
F250 Super Duty	5.4L V8 F/I	HPR8039	Explorer Sport Trac	4.0L V6 F/I	HPR8243
F250 Super Duty	6.8L V10 F/I	HPR8039 +	F150	4.2L V6 F/I	HPR8039
F350	5.4L V8 F/I	HPR8039	F150	4.6L V8 F/I	HPR8039 ♦+
F350 Harley Davidson Super Duty	6.8L V10 F/I	HPR8039	F150	5.4L V8 F/I	HPR8039 ♦+
F350 Super Duty	5.4L V8 F/I	HPR8039			
F350 Super Duty	6.8L V10 F/I	HPR8039 +			

*Indicates 2 filters required ♦ Intake system available - see page 326 + throttle body spacer available - see page 20

HPR™ REPLACEMENT AIR FILTERS

FORD

Vehicle	Engine Type	Air Filter	Vehicle	Engine Type	Air Filter
2003 FORD			2002 FORD		
F150 Harley Davidson	5.4L V8 F/I	HPR8039	Escape	2.0L L4 F/I	HPR8997
F250 Super Duty	5.4L V8 F/I	HPR8039	Escape	3.0L V6 F/I	HPR8997
F250 Super Duty	6.8L V10 F/I	HPR8039 ♦+	Escort	2.0L L4 F/I	HPR7774
F250 Super Duty	7.3L V8 DSL	HPR8925 ♦	Escort ZX2	2.0L L4 F/I	HPR7774
F350 Super Duty	5.4L V8 F/I	HPR8039	Excursion	5.4L V8 F/I	HPR8039
F350 Super Duty	6.8L V10 F/I	HPR8039 ♦+	Excursion	6.8L V10 F/I	HPR8039 ♦+
F350 Super Duty	7.3L V8 DSL	HPR8925 ♦	Excursion	7.3L V8 DSL	HPR8925 ♦
F450	6.8L V10 F/I	HPR8039	Expedition	4.6L V8 F/I	HPR8039 ♦+
F450 Super Duty	6.8L V10 F/I	HPR8039 ♦+	Expedition	5.4L V8 F/I	HPR8039 ♦+
F450 Super Duty	7.3L V8 DSL	HPR8925	Explorer	4.0L V6 F/I	HPR9332
F550 Super Duty	6.8L V10 F/I	HPR8039 ♦+	Explorer	4.6L V8 F/I	HPR9332
F550 Super Duty	7.3L V8 DSL	HPR8925	Explorer Sport	4.0L V6 F/I	HPR8243
Falcon	5.4L V8 F/I - DOHC	HPR8039	Explorer Sport Trac	4.0L V6 F/I	HPR8243
Focus RS	2.0L L4 F/I	HPR8956	F150	4.2L V6 F/I	HPR8039
FPV GT	5.4L V8 F/I - from 3/03	HPR8039	F150	4.6L V8 F/I	HPR8039 ♦+
Ka	1.0L L4 F/I	HPR5058	F150	5.4L V8 F/I	HPR8039 ♦+
Maverick	3.0L L4 F/I	HPR8997	F150 Harley Davidson	5.4L V8 F/I	HPR8039
Motorhome	5.4L V8 F/I - Class C	HPR8039	F250 Super Duty	5.4L V8 F/I	HPR8039
Mustang	3.8L V6 F/I	HPR7730	F250 Super Duty	6.8L V10 F/I	HPR8039 ♦+
Mustang	4.6L V8 F/I	HPR8039	F250 Super Duty	7.3L V8 DSL	HPR8925 ♦
Mustang GT	4.6L V8 F/I	HPR8039 ♦	F350 Super Duty	5.4L V8 F/I	HPR8039
Mustang Mach 1	4.6L V8 F/I	HPR8039	F350 Super Duty	6.8L V10 F/I	HPR8039 ♦+
Mustang SVT Cobra	4.6L V8 F/I	HPR8039	F350 Super Duty	7.3L V8 DSL	HPR8925 ♦
Ranger	2.3L L4 F/I	HPR8243	F450	6.8L V10 F/I	HPR8039
Ranger	3.0L V6 F/I	HPR8243	F450 Super Duty	6.8L V10 F/I	HPR8039 ♦+
Ranger	4.0L V6 F/I	HPR8243	F450 Super Duty	7.3L V8 DSL	HPR8925
Taurus	3.0L V6 F/I	HPR8997	F550 Super Duty	6.8L V10 F/I	HPR8039 ♦+
Thunderbird	3.9L V8 F/I	HPR8956	F550 Super Duty	7.3L V8 DSL	HPR8925
Windstar	3.8L V6 F/I	HPR7774	Falcon	5.4L V8 F/I - DOHC	HPR8039
2002 FORD			Falcon	5.6L V8 F/I	HPR8039
Crown Victoria	4.6L V8 F/I	HPR5056	Focus RS	2.0L L4 F/I	HPR8956
E150	4.2L V6 F/I	HPR8039	Ka	1.0L L4 F/I	HPR5058
E150	5.4L V8 F/I	HPR8039	Ka	1.3L L4 F/I - Exc., 70BHP	HPR5058
E150 Econoline	4.2L V6 F/I	HPR8039	Maverick	3.0L L4 F/I	HPR8997
E150 Econoline	4.6L V8 F/I	HPR8039	Motorhome	5.4L V8 F/I - Class C	HPR8039
E150 Econoline	5.4L V8 F/I	HPR8039	Mustang	3.8L V6 F/I	HPR7730
E150 Econoline Club Wagon	4.2L V6 F/I	HPR8039	Mustang	4.6L V8 F/I	HPR8039
E150 Econoline Club Wagon	4.6L V8 F/I	HPR8039	Mustang GT	4.6L V8 F/I	HPR8039 ♦
E150 Econoline Club Wagon	5.4L V8 F/I	HPR8039	Ranger	2.3L L4 F/I	HPR8243
E250 Econoline	4.2L V6 F/I	HPR8039	Ranger	3.0L V6 F/I	HPR8243
E250 Econoline	5.4L V8 F/I	HPR8039	Ranger	4.0L V6 F/I	HPR8243
E350 Club Wagon	5.4L V8 F/I	HPR8039	Taurus	3.0L V6 F/I	HPR8997
E350 Econoline Club Wagon	5.4L V8 F/I	HPR8039	Thunderbird	3.9L V8 F/I	HPR8956
E350 Econoline Club Wagon	6.8L V10 F/I	HPR8039	Windstar	3.8L V6 F/I	HPR7774
E350 Super Duty	5.4L V8 F/I	HPR8039	2001 FORD		
E350 Super Duty	6.8L V10 F/I	HPR8039	Crown Victoria	4.6L V8 F/I	HPR5056
E450 Econoline Super Duty	5.4L V8 F/I	HPR8039	E150 Econoline	4.2L V6 F/I	HPR8039
E450 Econoline Super Duty	6.8L V10 F/I	HPR8039	E150 Econoline	4.6L V8 F/I	HPR8039
E450 Econoline Super Duty Stripped	5.4L V8 F/I	HPR8039	E150 Econoline	5.4L V8 F/I	HPR8039
E450 Econoline Super Duty Stripped	6.8L V10 F/I	HPR8039	E150 Econoline Club Wagon	4.2L V6 F/I	HPR8039
E450 Motorhome	6.8L V10 F/I - Class C	HPR8039	E150 Econoline Club Wagon	4.6L V8 F/I	HPR8039
E550 Econoline Super Duty	6.8L V10 F/I	HPR8039	E150 Econoline Club Wagon	5.4L V8 F/I	HPR8039
E550 Motorhome Econoline	6.8L V10 F/I - Class C	HPR8039	E250 Econoline	4.2L V6 F/I	HPR8039
	4.2L V6 F/I	HPR8039	E250 Econoline	5.4L V8 F/I	HPR8039
			E350 Econoline Club Wagon	5.4L V8 F/I	HPR8039
			E350 Econoline Club Wagon	6.8L V10 F/I	HPR8039
			E350 Super Duty	5.4L V8 F/I	HPR8039
			E350 Super Duty	6.8L V10 F/I	HPR8039

*Indicates 2 filters required ♦ Intake system available - see page 326 + throttle body spacer available - see page 20

FORD

HPR™ REPLACEMENT AIR FILTERS

Vehicle	Engine Type	Air Filter	Vehicle	Engine Type	Air Filter
2001 FORD			2000 FORD		
E450 Econoline Super Duty	5.4L V8 F/I	HPR8039	E150 Econoline Club Wagon	4.6L V8 F/I	HPR8039
E450 Econoline Super Duty	6.8L V10 F/I	HPR8039	E150 Econoline Club Wagon	5.4L V8 F/I	HPR8039
E450 Econoline Super Duty Stripped	5.4L V8 F/I	HPR8039	E250 Econoline	4.2L V6 F/I	HPR8039
E450 Econoline Super Duty Stripped	6.8L V10 F/I	HPR8039	E250 Econoline	5.4L V8 F/I	HPR8039
E450 Motorhome	6.8L V10 F/I - Class C	HPR8039	E350 Econoline	5.4L V8 F/I	HPR8039
E550 Motorhome	6.8L V10 F/I - Class C	HPR8039	E350 Econoline Club Wagon	5.4L V8 F/I	HPR8039
Econoline	4.2L V6 F/I	HPR8039	E350 Econoline Club Wagon	6.8L V10 F/I	HPR8039
Escape	2.0L L4 F/I	HPR8997	E350 Super Duty	5.4L V8 F/I	HPR8039
Escape	3.0L V6 F/I	HPR8997	E350 Super Duty	6.8L V10 F/I	HPR8039
Escort	2.0L L4 F/I	HPR7774	E450 Econoline Super Duty	5.4L V8 F/I	HPR8039
Escort ZX2	2.0L L4 F/I	HPR7774	E450 Econoline Super Duty	6.8L V10 F/I	HPR8039
Excursion	5.4L V8 F/I	HPR8039	E450 Econoline Super Duty Stripped	5.4L V8 F/I	HPR8039
Excursion	6.8L V10 F/I	HPR8039 ♦+	E450 Econoline Super Duty Stripped	6.8L V10 F/I	HPR8039
Excursion	7.3L V8 DSL	HPR8925 ♦	E450 Motorhome	6.8L V10 F/I - Class C	HPR8039
Expedition	4.6L V8 F/I	HPR8039 ♦+	E550 Motorhome	6.8L V10 F/I - Class C	HPR8039
Expedition	5.4L V8 F/I	HPR8039 ♦+	Econoline	4.2L V6 F/I	HPR8039
Explorer	4.0L V6 F/I	HPR8243	Escort	2.0L L4 F/I	HPR7774
Explorer	5.0L V8 F/I	HPR8243	Escort ZX2	2.0L L4 F/I	HPR7774
Explorer Sport	4.0L V6 F/I	HPR8243	Excursion	5.4L V8 F/I	HPR8039
Explorer Sport Trac	4.0L V6 F/I	HPR8243	Excursion	6.8L V10 F/I	HPR8039 ♦+
F150	4.2L V6 F/I	HPR8039	Excursion	7.3L V8 DSL	HPR8925 ♦
F150	4.6L V8 F/I	HPR8039 ♦+	Expedition	4.6L V8 F/I	HPR8039 ♦+
F150	5.4L V8 F/I	HPR8039 ♦+	Expedition	5.4L V8 F/I	HPR8039 ♦+
F150 Harley Davidson	5.4L V8 F/I	HPR8039	Explorer	4.0L V6 F/I	HPR8243
F250 Super Duty	5.4L V8 F/I	HPR8039	Explorer	5.0L V8 F/I	HPR8243
F250 Super Duty	6.8L V10 F/I	HPR8039 ♦+	Explorer Sport	4.0L V6 F/I	HPR8243
F250 Super Duty	7.3L V8 DSL	HPR8925 ♦	F150	4.2L V6 F/I	HPR8039
F350 Super Duty	5.4L V8 F/I	HPR8039	F150	4.6L V8 F/I	HPR8039 ♦+
F350 Super Duty	6.8L V10 F/I	HPR8039 ♦+	F150	5.4L V8 F/I	HPR8039 ♦+
F350 Super Duty	7.3L V8 DSL	HPR8925 ♦	F150 Harley Davidson	5.4L V8 F/I	HPR8039
F450	6.8L V10 F/I	HPR8039	F250 Super Duty	5.4L V8 F/I	HPR8039
F450 Super Duty	6.8L V10 F/I	HPR8039 ♦+	F250 Super Duty	6.8L V10 F/I	HPR8039 ♦+
F450 Super Duty	7.3L V8 DSL	HPR8925	F250 Super Duty	7.3L V8 DSL	HPR8925 ♦
F550 Super Duty	6.8L V10 F/I	HPR8039 ♦+	F350 Super Duty	5.4L V8 F/I	HPR8039
F550 Super Duty	7.3L V8 DSL	HPR8925	F350 Super Duty	6.8L V10 F/I	HPR8039 ♦+
Falcon	5.6L V8 F/I	HPR8039	F350 Super Duty	7.3L V8 DSL	HPR8925 ♦
Ka	1.0L L4 F/I	HPR5058	F450 Super Duty	6.8L V10 F/I	HPR8039 ♦+
Ka	1.3L L4 F/I	HPR5058	F450 Super Duty	7.3L V8 DSL	HPR8925
Maverick	3.0L L4 F/I	HPR8997	F550 Super Duty	6.8L V10 F/I	HPR8039 ♦+
Motorhome	5.4L V8 F/I - Class C	HPR8039	F550 Super Duty	7.3L V8 DSL	HPR8925
Mustang	3.8L V6 F/I	HPR7730	Ka	1.0L L4 F/I	HPR5058
Mustang	4.6L V8 F/I	HPR8039	Ka	1.3L L4 F/I	HPR5058
Mustang GT	4.6L V8 F/I	HPR8039 ♦	Motorhome	5.4L V8 F/I - Class C	HPR8039
Mustang GT Bullitt	4.6L V8 F/I	HPR8039	Mustang	3.8L V6 F/I	HPR7730
Mustang SVT Cobra	4.6L V8 F/I	HPR8039	Mustang	4.6L V8 F/I	HPR8039
Ranger	2.3L L4 F/I	HPR8243	Mustang GT	4.6L V8 F/I	HPR8039 ♦
Ranger	2.5L L4 F/I	HPR8243	Mustang SVT Cobra	4.6L V8 F/I	HPR8039
Ranger	3.0L V6 F/I	HPR8243	Ranger	2.5L L4 F/I	HPR8243
Ranger	4.0L V6 F/I	HPR8243	Ranger	3.0L V6 F/I	HPR8243
Taurus	3.0L V6 F/I	HPR8997	Ranger	4.0L V6 F/I	HPR8243
Windstar	3.8L V6 F/I	HPR7774	Taurus	3.0L V6 F/I	HPR8997
2000 FORD			1999 FORD		
Contour	2.5L V6 F/I	HPR7730	Contour	2.5L V6 F/I	HPR7730
Contour SVT	2.5L V6 F/I	HPR7730	Contour SVT	2.5L V6 F/I	HPR7730
Crown Victoria	4.6L V8 F/I	HPR5056			
E150 Econoline	4.2L V6 F/I	HPR8039			
E150 Econoline	4.6L V8 F/I	HPR8039			
E150 Econoline	5.4L V8 F/I	HPR8039			
E150 Econoline Club Wagon	4.2L V6 F/I	HPR8039			

*Indicates 2 filters required ♦ Intake system available - see page 326 + throttle body spacer available - see page 20

HPR™ REPLACEMENT AIR FILTERS

FORD

Vehicle	Engine Type	Air Filter	Vehicle	Engine Type	Air Filter
1999 FORD			1998 FORD		
Crown Victoria	4.6L V8 F/I	HPR5056	Contour SVT	2.5L V6 F/I	HPR7730
E150 Econoline	4.2L V6 F/I	HPR8039	Crown Victoria	4.6L V8 F/I	HPR5056
E150 Econoline	4.6L V8 F/I	HPR8039	E150 Econoline	4.2L V6 F/I	HPR8039
E150 Econoline	5.4L V8 F/I	HPR8039	E150 Econoline	4.6L V8 F/I	HPR8039
E150 Econoline Club Wagon	4.2L V6 F/I	HPR8039	E150 Econoline	5.4L V8 F/I	HPR8039
E150 Econoline Club Wagon	4.6L V8 F/I	HPR8039	E150 Econoline Club Wagon	4.2L V6 F/I	HPR8039
E150 Econoline Club Wagon	5.4L V8 F/I	HPR8039	E150 Econoline Club Wagon	4.6L V8 F/I	HPR8039
E250 Econoline	4.2L V6 F/I	HPR8039	E150 Econoline Club Wagon	5.4L V8 F/I	HPR8039
E250 Econoline	5.4L V8 F/I	HPR8039	E250 Econoline	4.2L V6 F/I	HPR8039
E350 Econoline	5.4L V8 F/I	HPR8039	E250 Econoline	5.4L V8 F/I	HPR8039
E350 Econoline Club Wagon	5.4L V8 F/I	HPR8039	E350 Econoline	5.4L V8 F/I	HPR8039
E350 Econoline Club Wagon	6.8L V10 F/I	HPR8039	E350 Econoline	6.8L V10 F/I	HPR8039
E350 Super Duty	5.4L V8 F/I	HPR8039	E350 Econoline Club Wagon	5.4L V8 F/I	HPR8039
E350 Super Duty	6.8L V10 F/I	HPR8039	E350 Econoline Club Wagon	6.8L V10 F/I	HPR8039
E450 Econoline Super Duty	6.8L V10 F/I	HPR8039	E450 Econoline Super Duty	6.8L V10 F/I	HPR8039
E450 Motorhome	6.8L V10 F/I - Class C	HPR8039	E450 Motorhome	6.8L V10 F/I - Class C	HPR8039
E550 Econoline Super Duty	6.8L V10 F/I	HPR8039	E550 Econoline Super Duty	6.8L V10 F/I	HPR8039
E550 Motorhome Econoline	6.8L V10 F/I - Class C	HPR8039	E550 Motorhome Econoline Super Duty	6.8L V10 F/I - Class C	HPR8039
Econoline Super Duty	4.2L V6 F/I	HPR8039	Econoline Super Duty	5.4L V8 F/I	HPR8039
Econoline Super Duty	5.4L V8 F/I	HPR8039	Econoline Super Duty	6.8L V10 F/I	HPR8039
Escort	2.0L L4 F/I	HPR7774	Escort	2.0L L4 F/I	HPR7774
Escort ZX2	2.0L L4 F/I	HPR7774	Escort ZX2	2.0L L4 F/I	HPR7774
Expedition	4.6L V8 F/I	HPR8039 ♦+	Expedition	4.6L V8 F/I	HPR8039 ♦+
Expedition	5.4L V8 F/I	HPR8039 ♦+	Expedition	5.4L V8 F/I	HPR8039 ♦+
Explorer	4.0L V6 F/I	HPR8243	Explorer	4.0L V6 F/I - w/Panel Filter	HPR8243
Explorer	5.0L V8 F/I	HPR8243	Explorer	4.0L V6 F/I - w/Round Filter	HPR7774
F150	4.2L V6 F/I	HPR8039	Explorer	5.0L V8 F/I - w/Panel Filter	HPR8243
F150	4.6L V8 F/I	HPR8039 ♦+	Explorer	5.0L V8 F/I - w/Round Filter	HPR7774
F150	5.4L V8 F/I	HPR8039 ♦+	F150	4.2L V6 F/I	HPR8039
F250	4.6L V8 F/I	HPR8039	F150	4.6L V8 F/I	HPR8039 ♦+
F250	5.4L V8 F/I	HPR8039	F150	5.4L V8 F/I	HPR8039 ♦+
F250 Super Duty	5.4L V8 F/I	HPR8039	F250	4.6L V8 F/I	HPR8039
F250 Super Duty	6.8L V10 F/I	HPR8039 ♦+	F250	5.4L V8 F/I	HPR8039
F250 Super Duty	7.3L V8 DSL - from 12/98	HPR8925 ♦	Ka	1.3L L4 F/I	HPR5058
F350 Super Duty	5.4L V8 F/I	HPR8039	Maverick	2.4L L4 F/I	HPR4309
F350 Super Duty	6.8L V10 F/I	HPR8039 ♦+	Motorhome	5.4L V8 F/I - Class C	HPR8039
F350 Super Duty	7.3L V8 DSL - from 12/98	HPR8925 ♦	Mustang	3.8L V6 F/I	HPR7730
F450	6.8L V10 F/I	HPR8039	Mustang	4.6L V8 F/I	HPR8039
F450 Super Duty	6.8L V10 F/I	HPR8039 ♦+	Mustang GT	4.6L V8 F/I	HPR8039 ♦
F450 Super Duty	7.3L V8 DSL - from 12/98	HPR8925	Mustang SVT Cobra	4.6L V8 F/I	HPR8039
F550 Super Duty	6.8L V10 F/I	HPR8039 ♦+	Ranger	2.5L L4 F/I	HPR8243
F550 Super Duty	7.3L V8 DSL - from 12/98	HPR8925	Ranger	3.0L V6 F/I	HPR8243
Ka	1.0L L4 F/I	HPR5058	Ranger	4.0L V6 F/I	HPR8243
Ka	1.3L L4 F/I	HPR5058	Taurus	3.0L V6 F/I	HPR7365
Motorhome	5.4L V8 F/I - Class C	HPR8039	Taurus	3.4L V8 F/I	HPR8997
Mustang	3.8L V6 F/I	HPR7730	Windstar	3.0L V6 F/I	HPR7774
Mustang	4.6L V8 F/I	HPR8039	Windstar	3.8L V6 F/I	HPR7774
Mustang GT	4.6L V8 F/I	HPR8039 ♦	1997 FORD		
Mustang SVT Cobra	4.6L V8 F/I	HPR8039	Aerostar	3.0L V6 F/I	HPR5058
Ranger	2.5L L4 F/I	HPR8243	Aerostar	4.0L V6 F/I	HPR5058
Ranger	3.0L V6 F/I	HPR8243	Crown Victoria	4.6L V8 F/I	HPR5056
Ranger	4.0L V6 F/I	HPR8243	E150 Econoline	4.2L V6 F/I	HPR8039
Taurus	3.0L V6 F/I	HPR7365	E150 Econoline	4.6L V8 F/I	HPR8039
Taurus	3.4L V8 F/I	HPR8997	E150 Econoline	5.4L V8 F/I	HPR8039
Windstar	3.0L V6 F/I	HPR7774	E150 Econoline Club Wagon	4.2L V6 F/I	HPR8039
Windstar	3.8L V6 F/I	HPR7774	E150 Econoline Club Wagon	4.6L V8 F/I	HPR8039
1998 FORD			1997 FORD		
Contour	2.5L V6 F/I	HPR7730	Aerostar	3.0L V6 F/I	HPR5058
			Aerostar	4.0L V6 F/I	HPR5058
			Crown Victoria	4.6L V8 F/I	HPR5056
			E150 Econoline	4.2L V6 F/I	HPR8039
			E150 Econoline	4.6L V8 F/I	HPR8039
			E150 Econoline	5.4L V8 F/I	HPR8039
			E150 Econoline Club Wagon	4.2L V6 F/I	HPR8039
			E150 Econoline Club Wagon	4.6L V8 F/I	HPR8039

*Indicates 2 filters required ♦ Intake system available - see page 326 + throttle body spacer available - see page 20

FORD

HPR™ REPLACEMENT AIR FILTERS

Vehicle	Engine Type	Air Filter	Vehicle	Engine Type	Air Filter
1997 FORD			1996 FORD		
E150 Econoline Club Wagon	5.4L V8 F/I	HPR8039	E150 Econoline Club Wagon	4.9L L6 F/I	HPR6366
E250	6.8L V10 F/I	HPR8039	E150 Econoline Club Wagon	5.0L V8 F/I	HPR6366
E250 Econoline	4.2L V6 F/I	HPR8039	E150 Econoline Club Wagon	5.8L V8 F/I	HPR6366
E250 Econoline	4.6L V8 F/I	HPR8039	E250 Econoline	4.9L L6 F/I	HPR6366
E250 Econoline	5.4L V8 F/I	HPR8039	E250 Econoline	5.8L V8 F/I	HPR6366
E350 Econoline	5.4L V8 F/I	HPR8039	E350 Econoline	4.9L L6 F/I	HPR6366
E350 Econoline	6.8L V10 F/I	HPR8039	E350 Econoline	5.8L V8 F/I	HPR6366
E350 Econoline Club Wagon	5.4L V8 F/I	HPR8039	E350 Econoline	7.5L V8 F/I	HPR6366
E350 Econoline Club Wagon	6.8L V10 F/I	HPR8039	E350 Econoline Club Wagon	4.9L L6 F/I	HPR6366
E450 Econoline Super Duty	6.8L V10 F/I	HPR8039	E350 Econoline Club Wagon	5.8L V8 F/I	HPR6366
E450 Motorhome	6.8L V10 F/I - Class C	HPR8039	E350 Econoline Club Wagon	7.5L V8 F/I	HPR6366
E550 Econoline Super Duty	6.8L V10 F/I	HPR8039	Econoline Super Duty	5.8L V8 F/I	HPR6366
E550 Motorhome	6.8L V10 F/I - Class C	HPR8039	Econoline Super Duty	7.5L V8 F/I	HPR6366
Econoline Super Duty	5.4L V8 F/I	HPR8039	Escort	1.9L L4 F/I	HPR3660
Escort	2.0L L4 F/I	HPR7774	Explorer	4.0L V6 F/I	HPR7774
Expedition	4.6L V8 F/I	HPR8039 ♦+	Explorer	5.0L V8 F/I	HPR7774
Expedition	5.4L V8 F/I	HPR8039 ♦+	F53	7.5L V8 F/I	HPR6366
Explorer	4.0L V6 F/I - w/Panel Filter	HPR8243	F150	4.9L L6 F/I	HPR6366
Explorer	4.0L V6 F/I - w/Round Filter	HPR7774	F150	5.0L V8 F/I	HPR6366
Explorer	5.0L V8 F/I - w/Panel Filter	HPR8243	F150	5.8L V8 F/I	HPR6366
Explorer	5.0L V8 F/I - w/Round Filter	HPR7774	F250	4.9L L6 F/I	HPR6366
F53	7.5L V8 F/I	HPR6366	F250	5.0L V8 F/I	HPR6366
F150	4.2L V6 F/I	HPR8039	F250	5.8L V8 F/I	HPR6366
F150	4.6L V8 F/I	HPR8039 ♦+	F250	7.5L V8 F/I	HPR6366
F150	5.4L V8 F/I	HPR8039 ♦+	F350	4.9L L6 F/I	HPR6366
F250	4.6L V8 F/I	HPR8039	F350	5.8L V8 F/I	HPR6366
F250	5.4L V8 F/I	HPR8039	F350	7.5L V8 F/I	HPR6366
F250	5.8L V8 F/I	HPR6366	F450	7.5L V8 F/I	HPR6366
F250	7.5L V8 F/I	HPR6366	Ka	1.3L L4 F/I	HPR5058
F350	5.8L V8 F/I	HPR6366	Maverick	2.4L L4 F/I	HPR4309
F350	7.5L V8 F/I	HPR6366	Mustang	3.8L V6 F/I	HPR7730
F450	7.5L V8 F/I	HPR6366	Mustang	4.6L V8 F/I	HPR8039
Ka	1.3L L4 F/I	HPR5058	Mustang GT	4.6L V8 F/I	HPR8039 ♦
Maverick	2.4L L4 F/I	HPR4309	Mustang SVT Cobra	4.6L V8 F/I	HPR8039
Motorhome	5.4L V8 F/I - Class C	HPR8039	Ranger	2.3L L4 F/I	HPR7774
Mustang	3.8L V6 F/I	HPR7730	Ranger	3.0L V6 F/I	HPR7774
Mustang	4.6L V8 F/I	HPR8039	Ranger	4.0L V6 F/I	HPR7774
Mustang GT	4.6L V8 F/I	HPR8039 ♦	Taurus	3.0L V6 F/I	HPR7365
Mustang SVT Cobra	4.6L V8 F/I	HPR8039	Taurus	3.4L V8 F/I	HPR7365
Ranger	2.3L L4 F/I	HPR7774	Taurus LX	3.0L V6 F/I	HPR7365
Ranger	3.0L V6 F/I	HPR7774	Thunderbird	3.8L V6 F/I	HPR6555
Ranger	4.0L V6 F/I - w/Panel Filter	HPR8243	Thunderbird	4.6L V8 F/I	HPR6555
Ranger	4.0L V6 F/I - w/Round Filter	HPR7774	Windstar	3.0L V6 F/I	HPR5058
Taurus	3.0L V6 F/I	HPR7365	Windstar	3.8L V6 F/I	HPR7774
Taurus	3.4L V8 F/I	HPR7365	1995 FORD		
Taurus LX	3.0L V6 F/I	HPR7365	Aerostar	3.0L V6 F/I	HPR5058
Thunderbird	3.8L V6 F/I	HPR6555	Aerostar	4.0L V6 F/I	HPR5058
Thunderbird	4.6L V8 F/I	HPR6555	Bronco	5.0L V8 F/I	HPR6366
Windstar	3.0L V6 F/I	HPR5058	Bronco	5.8L V8 F/I	HPR6366
Windstar	3.8L V6 F/I	HPR7774	Crown Victoria	4.6L V8 F/I	HPR5056
1996 FORD			E150 Econoline	4.9L L6 F/I	HPR6366
Aerostar	3.0L V6 F/I	HPR5058	E150 Econoline	5.0L V8 F/I	HPR6366
Aerostar	4.0L V6 F/I	HPR5058	E150 Econoline	5.8L V8 F/I	HPR6366
Bronco	5.0L V8 F/I	HPR6366	E150 Econoline Club Wagon	4.9L L6 F/I	HPR6366
Bronco	5.8L V8 F/I	HPR6366	E150 Econoline Club Wagon	5.0L V8 F/I	HPR6366
Crown Victoria	4.6L V8 F/I	HPR5056	E150 Econoline Club Wagon	5.8L V8 F/I	HPR6366
E150 Econoline	4.9L L6 F/I	HPR6366			
E150 Econoline	5.0L V8 F/I	HPR6366			
E150 Econoline	5.8L V8 F/I	HPR6366			

*Indicates 2 filters required ♦ Intake system available - see page 326 + throttle body spacer available - see page 20

HPR™ REPLACEMENT AIR FILTERS

FORD

Vehicle	Engine Type	Air Filter	Vehicle	Engine Type	Air Filter
1995 FORD			1994 FORD		
E250 Econoline	4.9L L6 F/I	HPR6366	E350 Econoline	7.5L V8 F/I	HPR6366
E250 Econoline	5.8L V8 F/I	HPR6366	E350 Econoline Club Wagon	4.9L L6 F/I	HPR6366
E350 Econoline	4.9L L6 F/I	HPR6366	E350 Econoline Club Wagon	5.8L V8 F/I	HPR6366
E350 Econoline	5.8L V8 F/I	HPR6366	E350 Econoline Club Wagon	7.5L V8 F/I	HPR6366
E350 Econoline	7.5L V8 F/I	HPR6366	Escort	1.9L L4 F/I	HPR3660
E350 Econoline Club Wagon	4.9L L6 F/I	HPR6366	Explorer	4.0L V6 F/I	HPR5058
E350 Econoline Club Wagon	5.8L V8 F/I	HPR6366	F53	7.5L V8 F/I	HPR6366
E350 Econoline Club Wagon	7.5L V8 F/I	HPR6366	F150	4.9L L6 F/I	HPR6366
Escort	1.9L L4 F/I	HPR3660	F150	5.0L V8 F/I	HPR6366
Explorer	4.0L V6 F/I	HPR7774	F150	5.8L V8 F/I	HPR6366
F53	7.5L V8 F/I	HPR6366	F150 Lightning	5.8L V8 F/I	HPR6366
F150	4.9L L6 F/I	HPR6366	F250	4.9L L6 F/I	HPR6366
F150	5.0L V8 F/I	HPR6366	F250	5.0L V8 F/I	HPR6366
F150	5.8L V8 F/I	HPR6366	F250	5.8L V8 F/I	HPR6366
F150 Lightning	5.8L V8 F/I	HPR6366	F250	7.5L V8 F/I	HPR6366
F250	4.9L L6 F/I	HPR6366	F350	4.9L L6 F/I	HPR6366
F250	4.9L V8 F/I	HPR6366	F350	5.8L V8 F/I	HPR6366
F250	5.0L V8 F/I	HPR6366	F350	7.5L V8 F/I	HPR6366
F250	5.8L V8 F/I	HPR6366	F450	7.5L V8 F/I	HPR6366
F250	7.5L V8 F/I	HPR6366	Maverick	2.4L L4 F/I	HPR4309
F350	4.9L L6 F/I	HPR6366	Motorhome	4.9L L6 F/I - Class C	HPR6366
F350	5.8L V8 F/I	HPR6366	Motorhome	5.0L V8 F/I - Class C	HPR6366
F350	7.5L V8 F/I	HPR6366	Motorhome	5.8L V8 F/I - Class C	HPR6366
F450	7.5L V8 F/I	HPR6366	Motorhome	7.5L V8 F/I - Class C	HPR6366
Maverick	2.4L L4 F/I	HPR4309	Mustang	3.8L V6 F/I	HPR7730
Motorhome	4.9L L6 F/I - Class C	HPR6366	Mustang	5.0L V8 F/I	HPR7730
Motorhome	5.0L V8 F/I - Class C	HPR6366	Mustang SVT Cobra	5.0L V8 F/I	HPR7730
Motorhome	5.8L V8 F/I - Class C	HPR6366	Ranger	2.3L L4 F/I	HPR5058
Motorhome	7.5L V8 F/I - Class C	HPR6366	Ranger	3.0L V6 F/I	HPR5058
Mustang	3.8L V6 F/I	HPR7730	Ranger	4.0L V6 F/I	HPR5058
Mustang	5.0L V8 F/I	HPR7730	Taurus	3.0L V6 F/I	HPR5058
Mustang	5.8L V8 F/I	HPR8039	Taurus	3.8L V6 F/I	HPR5058
Mustang SVT Cobra	5.0L V8 F/I	HPR7730	Taurus SHO	3.0L V6 F/I	HPR5058
Ranger	2.3L L4 F/I	HPR7774	Thunderbird	3.8L V6 F/I	HPR6555
Ranger	3.0L V6 F/I	HPR7774	Thunderbird	4.6L V8 F/I	HPR6555
Ranger	4.0L V6 F/I	HPR7774			
Taurus	3.0L V6 F/I	HPR5058	1993 FORD		
Taurus	3.8L V6 F/I	HPR5058	Aerostar	3.0L V6 F/I	HPR5058
Taurus SHO	3.0L V6 F/I	HPR5058	Aerostar	4.0L V6 F/I	HPR5058
Thunderbird	3.8L V6 F/I	HPR6555	Bronco	5.0L V8 F/I	HPR6366
Thunderbird	4.6L V8 F/I	HPR6555	Bronco	5.8L V8 F/I	HPR6366
Windstar	3.0L V6 F/I	HPR5058	Crown Victoria	4.6L V8 F/I	HPR5056
Windstar	3.8L V6 F/I	HPR5058	E150 Econoline	4.9L L6 F/I	HPR6366
1994 FORD			E150 Econoline	5.0L V8 F/I	HPR6366
Aerostar	3.0L V6 F/I	HPR5058	E150 Econoline	5.8L V8 F/I	HPR6366
Aerostar	4.0L V6 F/I	HPR5058	E150 Econoline Club Wagon	4.9L L6 F/I	HPR6366
Bronco	5.0L V8 F/I	HPR6366	E150 Econoline Club Wagon	5.0L V8 F/I	HPR6366
Bronco	5.8L V8 F/I	HPR6366	E150 Econoline Club Wagon	5.8L V8 F/I	HPR6366
Crown Victoria	4.6L V8 F/I	HPR5056	E250 Econoline	4.9L L6 F/I	HPR6366
E150 Econoline	4.9L L6 F/I	HPR6366	E250 Econoline	5.8L V8 F/I	HPR6366
E150 Econoline	5.0L V8 F/I	HPR6366	E350 Econoline	4.9L L6 F/I	HPR6366
E150 Econoline	5.8L V8 F/I	HPR6366	E350 Econoline	5.8L V8 F/I	HPR6366
E150 Econoline Club Wagon	4.9L L6 F/I	HPR6366	E350 Econoline	7.5L V8 F/I	HPR6366
E150 Econoline Club Wagon	5.0L V8 F/I	HPR6366	E350 Econoline Club Wagon	4.9L L6 F/I	HPR6366
E150 Econoline Club Wagon	5.8L V8 F/I	HPR6366	E350 Econoline Club Wagon	5.8L V8 F/I	HPR6366
E250 Econoline	4.9L L6 F/I	HPR6366			
E250 Econoline	5.8L V8 F/I	HPR6366			
E350 Econoline	4.9L L6 F/I	HPR6366			
E350 Econoline	5.8L V8 F/I	HPR6366			

*Indicates 2 filters required ♦ Intake system available - see page 326 + throttle body spacer available - see page 20

FORD

HPR™ REPLACEMENT AIR FILTERS

Vehicle	Engine Type	Air Filter	Vehicle	Engine Type	Air Filter
1993 FORD			1992 FORD		
E350 Econoline Club Wagon	7.5L V8 F/I	HPR6366	F150	5.0L V8 F/I	HPR6366
Escort	1.9L L4 F/I	HPR3660	F150	5.8L V8 F/I	HPR6366
Explorer	4.0L V6 F/I	HPR5058	F250	4.9L L6 F/I	HPR6366
F53	7.5L V8 F/I	HPR6366	F250	5.0L V8 F/I	HPR6366
F150	4.9L L6 F/I	HPR6366	F250	5.8L V8 F/I	HPR6366
F150	5.0L V8 F/I	HPR6366	F250	7.5L V8 F/I	HPR6366
F150	5.8L V8 F/I	HPR6366	F350	4.9L L6 F/I	HPR6366
F150 Lightning	5.8L V8 F/I	HPR6366	F350	5.8L V8 F/I	HPR6366
F250	4.9L L6 F/I	HPR6366	F350	7.5L V8 F/I	HPR6366
F250	5.0L V8 F/I	HPR6366	F450	7.5L V8 F/I	HPR6366
F250	5.8L V8 F/I	HPR6366	Motorhome	4.9L L6 F/I - Class C	HPR6366
F250	7.5L V8 F/I	HPR6366	Motorhome	5.0L V8 F/I - Class C	HPR6366
F350	4.9L L6 F/I	HPR6366	Motorhome	5.8L V8 F/I - Class C	HPR6366
F350	5.8L V8 F/I	HPR6366	Motorhome	7.5L V8 F/I - Class C	HPR6366
F350	7.5L V8 F/I	HPR6366	Ranger	2.3L L4 F/I	HPR5058
F450	7.5L V8 F/I	HPR6366	Ranger	2.9L V6 F/I	HPR5058
Maverick	2.4L L4 F/I	HPR4309	Ranger	3.0L V6 F/I	HPR5058
Motorhome	4.9L L6 F/I - Class C	HPR6366	Ranger	4.0L V6 F/I	HPR5058
Motorhome	5.0L V8 F/I - Class C	HPR6366	Scorpio	1.8L L4 CARB	HPR0192
Motorhome	5.8L V8 F/I - Class C	HPR6366	Sierra	1.6L L4 CARB - CV	HPR0184
Motorhome	7.5L V8 F/I - Class C	HPR6366	Sierra	1.8L L4 CARB - Exc., CVH	HPR0192
Ranger	2.3L L4 F/I	HPR5058	Taurus	3.0L V6 F/I	HPR5058
Ranger	3.0L V6 F/I	HPR5058	Taurus	3.8L V6 F/I	HPR5058
Ranger	4.0L V6 F/I	HPR5058	Taurus SHO	3.0L V6 F/I	HPR5058
Sierra	1.6L L4 CARB - CV	HPR0184	Tempo	2.3L L4 F/I	HPR7365
Sierra	1.8L L4 CARB - Exc., CVH	HPR0192	Tempo	3.0L V6 F/I	HPR7365
Taurus	3.0L V6 F/I	HPR5058	Thunderbird	3.8L V6 F/I	HPR6555
Taurus	3.8L V6 F/I	HPR5058	Thunderbird	5.0L V8 F/I	HPR6555
Taurus SHO	3.0L V6 F/I	HPR5058	1991 FORD		
Tempo	2.3L L4 F/I	HPR7365	Aerostar	3.0L V6 F/I	HPR5058
Tempo	3.0L V6 F/I	HPR7365	Aerostar	4.0L V6 F/I	HPR5058
Thunderbird	3.8L V6 F/I	HPR6555	Bronco	4.9L L6 F/I	HPR6366
Thunderbird	5.0L V8 F/I	HPR6555	Bronco	5.0L V8 F/I	HPR6366
1992 FORD			Bronco	5.8L V8 F/I	HPR6366
Aerostar	3.0L V6 F/I	HPR5058	Bronco	5.0L V8 F/I	HPR6366
Aerostar	4.0L V6 F/I	HPR5058	Bronco	5.8L V8 F/I	HPR6366
Bronco	4.9L L6 F/I	HPR6366	Country Squire	5.0L V8 F/I	HPR5056
Bronco	5.0L V8 F/I	HPR6366	E150 Econoline	4.9L L6 F/I	HPR6366
Bronco	5.8L V8 F/I	HPR6366	E150 Econoline	5.0L V8 F/I	HPR6366
Crown Victoria	4.6L V8 F/I	HPR5056	E150 Econoline	5.8L V8 F/I	HPR6366
E150 Econoline	4.9L L6 F/I	HPR6366	E150 Econoline Club Wagon	4.9L L6 F/I	HPR6366
E150 Econoline	5.0L V8 F/I	HPR6366	E150 Econoline Club Wagon	5.0L V8 F/I	HPR6366
E150 Econoline	5.8L V8 F/I	HPR6366	E150 Econoline Club Wagon	5.8L V8 F/I	HPR6366
E150 Econoline Club Wagon	4.9L L6 F/I	HPR6366	E250 Econoline	4.9L L6 F/I	HPR6366
E150 Econoline Club Wagon	5.0L V8 F/I	HPR6366	E250 Econoline	5.0L V8 F/I	HPR6366
E150 Econoline Club Wagon	5.8L V8 F/I	HPR6366	E250 Econoline	5.8L V8 F/I	HPR6366
E250 Econoline	4.9L L6 F/I	HPR6366	E250 Econoline Club Wagon	4.9L L6 F/I	HPR6366
E250 Econoline	5.8L V8 F/I	HPR6366	E250 Econoline Club Wagon	5.8L V8 F/I	HPR6366
E350 Econoline	4.9L L6 F/I	HPR6366	E250 Econoline Club Wagon	7.5L V8 F/I	HPR6366
E350 Econoline	5.8L V8 F/I	HPR6366	E350 Econoline	4.9L L6 F/I	HPR6366
E350 Econoline	7.5L V8 F/I	HPR6366	E350 Econoline	5.8L V8 F/I	HPR6366
E350 Econoline Club Wagon	4.9L L6 F/I	HPR6366	E350 Econoline	7.5L V8 F/I	HPR6366
E350 Econoline Club Wagon	5.8L V8 F/I	HPR6366	E350 Econoline Club Wagon	4.9L L6 F/I	HPR6366
E350 Econoline Club Wagon	7.5L V8 F/I	HPR6366	E350 Econoline Club Wagon	5.8L V8 F/I	HPR6366
Escort	1.9L L4 F/I	HPR3660	E350 Econoline Club Wagon	7.5L V8 F/I	HPR6366
Explorer	4.0L V6 F/I	HPR5058	Escort	1.9L L4 F/I	HPR3660
F53	7.5L V8 F/I	HPR6366	Explorer	4.0L V6 F/I	HPR5058
F150	4.9L L6 F/I	HPR6366	F53	7.5L V8 F/I	HPR6366

*Indicates 2 filters required ♦ Intake system available - see page 326 + throttle body spacer available - see page 20

HPR™ REPLACEMENT AIR FILTERS

FORD

Vehicle	Engine Type	Air Filter	Vehicle	Engine Type	Air Filter
1991 FORD			1990 FORD		
F150	4.9L L6 F/I	HPR6366	Escort	1.9L L4 F/I	HPR3660
F150	5.0L V8 F/I	HPR6366	F53	7.5L V8 F/I	HPR6366
F150	5.8L V8 F/I	HPR6366	F150	4.9L L6 F/I	HPR6366
F250	4.9L L6 F/I	HPR6366	F150	5.0L V8 F/I	HPR6366
F250	5.0L V8 F/I	HPR6366	F150	5.8L V8 F/I	HPR6366
F250	5.8L V8 F/I	HPR6366	F250	4.9L L6 F/I	HPR6366
F250	7.5L V8 F/I	HPR6366	F250	5.0L V8 F/I	HPR6366
F350	4.9L L6 F/I	HPR6366	F250	5.8L V8 F/I	HPR6366
F350	5.8L V8 F/I	HPR6366	F250	7.5L V8 F/I	HPR6366
F450	7.5L V8 F/I	HPR6366	F350	4.9L L6 F/I	HPR6366
LTD Crown Victoria	5.0L V8 F/I	HPR5056	F350	5.8L V8 F/I	HPR6366
LTD Crown Victoria	5.8L V8 CARB	HPR0351	F350	7.5L V8 F/I	HPR6366
Motorhome	4.9L L6 F/I - Class C	HPR6366	F450	7.5L V8 F/I	HPR6366
Motorhome	5.0L V8 F/I - Class C	HPR6366	LTD Crown Victoria	5.0L V8 F/I	HPR5056
Motorhome	5.8L V8 F/I - Class C	HPR6366	LTD Crown Victoria	5.8L V8 CARB	HPR0351
Motorhome	7.5L V8 F/I - Class C	HPR6366	Motorhome	4.9L L6 F/I - Class C	HPR6366
Ranger	2.3L L4 F/I	HPR5058	Motorhome	5.0L V8 F/I - Class C	HPR6366
Ranger	2.9L V6 F/I	HPR5058	Motorhome	5.8L V8 F/I - Class C	HPR6366
Ranger	3.0L V6 F/I	HPR5058	Motorhome	7.5L V8 F/I - Class C	HPR6366
Ranger	4.0L V6 F/I	HPR5058	Probe	2.2L L4 F/I - Cruise control	HPR5058
Scorpio	1.8L L4 CARB	HPR0192	Ranger	2.3L L4 F/I	HPR5058
Sierra	1.6L L4 CARB - CV	HPR0184	Ranger	2.9L V6 F/I	HPR5058
Sierra	1.8L L4 CARB - Exc., CVH	HPR0192	Ranger	4.0L V6 F/I	HPR5058
Taurus	2.5L L4 F/I	HPR5058	Scorpio	1.8L L4 CARB	HPR0192
Taurus	3.0L V6 F/I	HPR5058	Sierra	1.6L L4 CARB - CV	HPR0184
Taurus	3.8L V6 F/I	HPR5058	Sierra	1.8L L4 CARB - Exc., CVH	HPR0192
Taurus SHO	3.0L V6 F/I	HPR5058	Taurus	2.5L L4 F/I	HPR5058
Thunderbird	3.8L V6 F/I	HPR6555	Taurus	3.0L V6 F/I	HPR5058
Thunderbird	5.0L V8 F/I	HPR6555	Taurus	3.8L V6 F/I	HPR5058
1990 FORD			Taurus SHO	3.0L V6 F/I	HPR5058
Aerostar	3.0L V6 F/I	HPR5058	Thunderbird	3.8L V6 F/I	HPR6555
Aerostar	4.0L V6 F/I	HPR5058	1989 FORD		
Bronco	4.9L L6 F/I	HPR6366	Aerostar	3.0L V6 F/I	HPR5058
Bronco	5.0L V8 F/I	HPR6366	Bronco	4.9L L6 F/I	HPR6366
Bronco	5.8L V8 F/I	HPR6366	Bronco	5.0L V8 F/I	HPR6366
Bronco II	2.9L V6 F/I	HPR5058	Bronco	5.8L V8 F/I	HPR6366
Country Squire	5.0L V8 F/I	HPR5056	Bronco II	2.9L V6 F/I	HPR5058
E150 Econoline	4.9L L6 F/I	HPR6366	Country Squire	5.0L V8 F/I	HPR5056
E150 Econoline	5.0L V8 F/I	HPR6366	E150 Econoline	4.9L L6 F/I	HPR6366
E150 Econoline	5.8L V8 F/I	HPR6366	E150 Econoline	5.0L V8 F/I	HPR6366
E150 Econoline Club Wagon	4.9L L6 F/I	HPR6366	E150 Econoline	5.8L V8 F/I	HPR6366
E150 Econoline Club Wagon	5.0L V8 F/I	HPR6366	E150 Econoline Club Wagon	4.9L L6 F/I	HPR6366
E150 Econoline Club Wagon	5.8L V8 F/I	HPR6366	E150 Econoline Club Wagon	5.0L V8 F/I	HPR6366
E250 Econoline	4.9L L6 F/I	HPR6366	E150 Econoline Club Wagon	5.8L V8 F/I	HPR6366
E250 Econoline	5.0L V8 F/I	HPR6366	E250 Econoline	4.9L L6 F/I	HPR6366
E250 Econoline	5.8L V8 F/I	HPR6366	E250 Econoline	5.0L V8 F/I	HPR6366
E250 Econoline Club Wagon	4.9L L6 F/I	HPR6366	E250 Econoline	5.8L V8 F/I	HPR6366
E250 Econoline Club Wagon	5.8L V8 F/I	HPR6366	E250 Econoline Club Wagon	4.9L L6 F/I	HPR6366
E250 Econoline Club Wagon	7.5L V8 F/I	HPR6366	E250 Econoline Club Wagon	5.8L V8 F/I	HPR6366
E350 Econoline	4.9L L6 F/I	HPR6366	E250 Econoline Club Wagon	7.5L V8 F/I	HPR6366
E350 Econoline	5.8L V8 F/I	HPR6366	E350 Econoline	4.9L L6 F/I	HPR6366
E350 Econoline	7.5L V8 F/I	HPR6366	E350 Econoline	5.8L V8 F/I	HPR6366
E350 Econoline Club Wagon	4.9L L6 F/I	HPR6366	E350 Econoline	7.5L V8 F/I	HPR6366
E350 Econoline Club Wagon	5.8L V8 F/I	HPR6366	E350 Econoline Club Wagon	4.9L L6 F/I	HPR6366
E350 Econoline Club Wagon	7.5L V8 F/I	HPR6366	E350 Econoline Club Wagon	5.8L V8 F/I	HPR6366
			E350 Econoline Club Wagon	7.5L V8 F/I	HPR6366

*Indicates 2 filters required ♦ Intake system available - see page 326 + throttle body spacer available - see page 20

FORD

HPR™ REPLACEMENT AIR FILTERS

Vehicle	Engine Type	Air Filter	Vehicle	Engine Type	Air Filter
1989 FORD			1988 FORD		
Escort	1.9L L4 F/I	HPR3660	EXP	1.9L L4 F/I	HPR3660
Escort GT	1.9L L4 F/I	HPR3660	F Super Duty	7.5L V8 F/I	HPR6366
F Super Duty	7.5L V8 F/I	HPR6366	F53	7.5L V8 F/I	HPR6366
F53	7.5L V8 F/I	HPR6366	F150	4.9L L6 F/I	HPR6366
F150	4.9L L6 F/I	HPR6366	F150	5.0L V8 F/I	HPR6366
F150	5.0L V8 F/I	HPR6366	F150	5.8L V8 F/I	HPR6366
F150	5.8L V8 F/I	HPR6366	F250	4.9L L6 F/I	HPR6366
F250	4.9L L6 F/I	HPR6366	F250	5.0L V8 F/I	HPR6366
F250	5.0L V8 F/I	HPR6366	F250	5.8L V8 F/I	HPR6366
F250	5.8L V8 F/I	HPR6366	F250	7.5L V8 F/I	HPR6366
F250	7.5L V8 F/I	HPR6366	F350	4.9L L6 F/I	HPR6366
F350	4.9L L6 F/I	HPR6366	F350	5.8L V8 F/I	HPR6366
F350	5.8L V8 F/I	HPR6366	F350	7.5L V8 F/I	HPR6366
F350	7.5L V8 F/I	HPR6366	LTD Crown Victoria	5.0L V8 F/I	HPR5056
LTD Crown Victoria	5.0L V8 F/I	HPR5056	LTD Crown Victoria	5.8L V8 CARB	HPR0351
LTD Crown Victoria	5.8L V8 CARB	HPR0351	Motorhome	4.9L L6 F/I - Class C	HPR6366
Motorhome	4.9L L6 F/I - Class C	HPR6366	Motorhome	5.0L V8 F/I - Class C	HPR6366
Motorhome	5.0L V8 F/I - Class C	HPR6366	Motorhome	5.8L V8 F/I - Class C	HPR6366
Motorhome	5.8L V8 F/I - Class C	HPR6366	Motorhome	7.5L V8 F/I - Class C	HPR6366
Motorhome	7.5L V8 F/I - Class C	HPR6366	Ranger	2.3L L4 F/I	HPR3660
Ranger	2.3L L4 F/I	HPR5058	Ranger	2.9L V6 F/I	HPR5058
Ranger	2.9L V6 F/I	HPR5058	Scorpio	1.8L L4 CARB	HPR0192
Scorpio	1.8L L4 CARB	HPR0192	Sierra	1.6L L4 CARB - CV	HPR0184
Sierra	1.6L L4 CARB - CV	HPR0184	Sierra	1.8L L4 CARB - Exc., CVH	HPR0192
Sierra	1.8L L4 CARB - Exc., CVH	HPR0192	Taurus	2.5L L4 F/I	HPR5058
Taurus	2.5L L4 F/I	HPR5058	Taurus	3.0L V6 F/I	HPR5058
Taurus	3.0L V6 F/I	HPR5058	Taurus	3.8L V6 F/I	HPR5058
Taurus	3.8L V6 F/I	HPR5058	1987 FORD		
Taurus SHO	3.0L V6 F/I	HPR5058	Aerostar	2.3L L4 F/I	HPR3660
Thunderbird	3.8L V6 F/I	HPR6555	Aerostar	3.0L V6 F/I	HPR5058
1988 FORD			Bronco	4.9L L6 F/I	HPR6366
Aerostar	3.0L V6 F/I	HPR5058	Bronco	5.0L V8 F/I	HPR6366
Bronco	4.9L L6 F/I	HPR6366	Bronco II	2.9L V6 F/I	HPR3660
Bronco	5.0L V8 F/I	HPR6366	Capri III	1.6L L4 CARB	HPR0184
Bronco	5.8L V8 F/I	HPR6366	Country Squire	5.0L V8 F/I	HPR5056
Bronco II	2.9L V6 F/I	HPR5058	E150 Econoline	4.9L L6 F/I	HPR6366
Country Squire	5.0L V8 F/I	HPR5056	E150 Econoline	5.0L V8 F/I	HPR6366
E150 Econoline	4.9L L6 F/I	HPR6366	E150 Econoline Club	4.9L L6 F/I	HPR6366
E150 Econoline	5.0L V8 F/I	HPR6366	Wagon		
E150 Econoline	5.8L V8 F/I	HPR6366	E150 Econoline Club	5.0L V8 F/I	HPR6366
E150 Econoline Club	4.9L L6 F/I	HPR6366	Wagon		
Wagon			E250 Econoline	4.9L L6 F/I	HPR6366
E150 Econoline Club	5.0L V8 F/I	HPR6366	E250 Econoline	5.0L V8 F/I	HPR6366
Wagon			E250 Econoline Club	4.9L L6 F/I	HPR6366
E150 Econoline Club	5.8L V8 F/I	HPR6366	Wagon		
Wagon			E350 Econoline	4.9L L6 F/I	HPR6366
E250 Econoline	4.9L L6 F/I	HPR6366	E350 Econoline	7.5L V8 F/I	HPR6366
E250 Econoline	5.0L V8 F/I	HPR6366	E350 Econoline Club	4.9L L6 F/I	HPR6366
E250 Econoline	5.8L V8 F/I	HPR6366	Wagon		
E250 Econoline Club	4.9L L6 F/I	HPR6366	Escort	1.9L L4 F/I	HPR3660
Wagon			EXP	1.9L L4 F/I	HPR3660
E250 Econoline Club	5.8L V8 F/I	HPR6366	F150	4.9L L6 F/I	HPR6366
Wagon			F150	5.0L V8 F/I	HPR6366
E250 Econoline Club	7.5L V8 F/I	HPR6366	F250	4.9L L6 F/I	HPR6366
Wagon			F250	5.0L V8 F/I	HPR6366
E350 Econoline	4.9L L6 F/I	HPR6366	F350	4.9L L6 F/I	HPR6366
E350 Econoline	5.8L V8 F/I	HPR6366	LTD Crown Victoria	5.0L V8 F/I	HPR5056
E350 Econoline	7.5L V8 F/I	HPR6366	LTD Crown Victoria	5.8L V8 CARB	HPR0351
E350 Econoline Club	4.9L L6 F/I	HPR6366	Motorhome	4.9L L6 F/I - Class C	HPR6366
Wagon			Motorhome	5.0L V8 F/I - Class C	HPR6366
E350 Econoline Club	5.8L V8 F/I	HPR6366	Motorhome	5.8L V8 F/I - Class C	HPR6366
Wagon			Motorhome	7.5L V8 F/I - Class C	HPR6366
E350 Econoline Club	7.5L V8 F/I	HPR6366	Ranger	2.3L L4 F/I	HPR3660
Wagon			Ranger	2.9L V6 F/I	HPR3660
Escort	1.9L L4 F/I	HPR3660			

*Indicates 2 filters required ♦ Intake system available - see page 326 + throttle body spacer available - see page 20

HPR™ REPLACEMENT AIR FILTERS

FORD

Vehicle	Engine Type	Air Filter	Vehicle	Engine Type	Air Filter
1987 FORD			1985 FORD		
Scorpio	1.8L L4 CARB	HPR0192	F250	5.0L V8 CARB	HPR0351
Sierra	1.6L L4 CARB - CV	HPR0184	F250	5.0L V8 F/I	HPR5056
Taurus	2.5L L4 F/I	HPR5058	F250	5.8L V8 2 BBL.	HPR0351
Taurus	3.0L V6 F/I	HPR5058	F350	4.9L L6 CARB	HPR3300
1986 FORD			F350	5.8L V8 2 BBL.	HPR0351
Aerostar	2.3L L4 F/I	HPR3660	Granada	1.6L L4 CARB - to 8/85	HPR0184
Aerostar	3.0L V6 F/I	HPR5058	Granada	2.0L L4 CARB	HPR0184
Bronco	4.9L L6 CARB	HPR3300	LTD	5.0L V8 F/I	HPR0351
Bronco	5.0L V8 F/I	HPR5056	LTD	5.8L V8 CARB	HPR0351
Bronco II	2.9L V6 F/I	HPR3660	Motorhome	5.0L V8 2 BBL. - Class C	HPR0351
Capri III	1.6L L4 CARB	HPR0184	Motorhome	5.8L V8 2 BBL. - Class C	HPR0351
E150 Econoline	5.0L V8 F/I	HPR5056	Ranger	2.3L L4 F/I	HPR3660
E150 Econoline Club Wagon	5.0L V8 F/I	HPR5056	Scorpio	1.8L L4 CARB	HPR0192
E250 Econoline	5.0L V8 F/I	HPR5056	Sierra	1.3L L4 CARB	HPR0184
Escort	1.9L L4 CARB	HPR3660	Sierra	1.6L L4 CARB - CV	HPR0184
Escort	1.9L L4 F/I	HPR3660	Thunderbird	5.0L V8 F/I	HPR0351
EXP	1.9L L4 CARB	HPR3660	1984 FORD		
EXP	1.9L L4 F/I	HPR3660	Bronco	4.9L L6 CARB	HPR3300
F150	4.9L L6 CARB	HPR3300	Bronco	5.0L V8 CARB	HPR0351
F150	5.0L V8 F/I	HPR5056	Bronco	5.8L V8 2 BBL.	HPR0351
F250	4.9L L6 CARB	HPR3300	Capri III	1.6L L4 CARB	HPR0184
F250	5.0L V8 F/I	HPR5056	Capri III	2.0L V6 CARB	HPR0184
F350	4.9L L6 CARB	HPR3300	E150 Econoline	5.0L V8 CARB	HPR0351
LTD	5.0L V8 F/I	HPR5056	E150 Econoline	5.8L V8 2 BBL.	HPR0351
LTD	5.8L V8 CARB	HPR0351	E150 Econoline Club Wagon	5.0L V8 CARB	HPR0351
Motorhome	5.0L V8 2 BBL. - Class C	HPR5056	E150 Econoline Club Wagon	5.8L V8 2 BBL.	HPR0351
Motorhome	5.8L V8 2 BBL. - Class C	HPR0351	E250 Econoline	5.0L V8 CARB	HPR0351
Ranger	2.3L L4 F/I	HPR3660	E250 Econoline	5.8L V8 2 BBL.	HPR0351
Ranger	2.9L V6 F/I	HPR3660	E250 Econoline Club Wagon	5.8L V8 CARB	HPR0351
Scorpio	1.8L L4 CARB	HPR0192	E350 Econoline	5.8L V8 CARB	HPR0351
Sierra	1.3L L4 CARB	HPR0184	E350 Econoline Club Wagon	5.8L V8 CARB	HPR0351
Sierra	1.6L L4 CARB - CV	HPR0184	Escort	1.6L L4 CARB	HPR3660
Taurus	2.5L L4 F/I	HPR5058	Escort	1.6L L4 F/I	HPR3660
Taurus	3.0L V6 F/I	HPR5058	EXP	1.6L L4 CARB	HPR3660
1985 FORD			EXP	1.6L L4 F/I	HPR3660
Bronco	4.9L L6 CARB	HPR3300	EXP	1.6L L4 F/I - Turbo	HPR3660
Bronco	5.0L V8 F/I	HPR5056	F150	4.9L L6 CARB	HPR3300
Bronco	5.8L V8 2 BBL.	HPR0351	F150	5.0L V8 CARB	HPR0351
Capri III	1.6L L4 CARB	HPR0184	F150	5.8L V8 CARB	HPR0351
Capri III	2.0L V6 CARB	HPR0184	F250	4.9L L6 CARB	HPR3300
E150 Econoline	5.0L V8 CARB	HPR0351	F250	5.0L V8 CARB	HPR0351
E150 Econoline	5.8L V8 2 BBL.	HPR0351	F250	5.8L V8 2 BBL.	HPR0351
E150 Econoline Club Wagon	5.0L V8 CARB	HPR0351	F350	4.9L L6 CARB	HPR3300
E150 Econoline Club Wagon	5.8L V8 2 BBL.	HPR0351	F350	5.8L V8 2 BBL.	HPR0351
E250 Econoline	5.0L V8 CARB	HPR0351	Granada	1.6L L4 CARB	HPR0184
E250 Econoline	5.8L V8 2 BBL.	HPR0351	Granada	2.0L L4 CARB	HPR0184
E250 Econoline Club Wagon	5.8L V8 2 BBL.	HPR0351	LTD	5.0L V8 CARB	HPR0351
E350 Econoline	5.8L V8 2 BBL.	HPR0351	LTD	5.0L V8 F/I	HPR0351
E350 Econoline Club Wagon	5.8L V8 2 BBL.	HPR0351	LTD	5.8L V8 CARB	HPR0351
Escort	1.6L L4 CARB	HPR3660	Motorhome	5.0L V8 2 BBL. - Class C	HPR0351
Escort	1.6L L4 F/I	HPR3660	Motorhome	5.8L V8 2 BBL. - Class C	HPR0351
Escort	1.9L L4 CARB	HPR3660	Sierra	1.3L L4 CARB	HPR0184
EXP	1.6L L4 CARB	HPR3660	Sierra	1.6L L4 CARB - CV	HPR0184
EXP	1.6L L4 F/I	HPR3660	Sierra	2.0L L4 CARB - to 10/84	HPR0184
F150	4.9L L6 CARB	HPR3300	Thunderbird	5.0L V8 F/I	HPR0351
F150	5.0L V8 CARB	HPR0351	1983 FORD		
F150	5.0L V8 F/I	HPR5056	Bronco	4.9L L6 CARB	HPR3300
F150	5.8L V8 2 BBL.	HPR0351	Bronco	5.0L V8 CARB	HPR0351
F250	4.9L L6 CARB	HPR3300	Bronco	5.8L V8 CARB	HPR0351
			Capri III	1.6L L4 CARB	HPR0184

*Indicates 2 filters required ♦ Intake system available - see page 326 + throttle body spacer available - see page 20

FORD

HPR™ REPLACEMENT AIR FILTERS

Vehicle	Engine Type	Air Filter	Vehicle	Engine Type	Air Filter
1983 FORD			1982 FORD		
Capri III	2.0L V6 CARB	HPR0184	E250 Econoline	5.0L V8 CARB	HPR0351
E100 Econoline	5.0L V8 CARB	HPR0351	E250 Econoline	5.8L V8 CARB	HPR0351
E100 Econoline	5.8L V8 CARB	HPR0351	E250 Econoline Club Wagon	5.8L V8 CARB	HPR0351
E100 Econoline Club Wagon	5.0L V8 CARB	HPR0351	E250 Econoline Club Wagon	6.6L V8 CARB	HPR0351
E100 Econoline Club Wagon	5.8L V8 CARB	HPR0351	E350 Econoline	5.0L V8 CARB	HPR0351
E150 Econoline	5.0L V8 CARB	HPR0351	E350 Econoline	5.8L V8 CARB	HPR0351
E150 Econoline	5.8L V8 CARB	HPR0351	E350 Econoline	6.6L V8 CARB	HPR0351
E150 Econoline Club Wagon	5.0L V8 CARB	HPR0351	E350 Econoline Club Wagon	5.8L V8 CARB	HPR0351
E150 Econoline Club Wagon	5.8L V8 CARB	HPR0351	E350 Econoline Club Wagon	6.6L V8 CARB	HPR0351
E250 Econoline	5.0L V8 CARB	HPR0351	F100	4.2L V8 CARB	HPR0351
E250 Econoline	5.8L V8 CARB	HPR0351	F100	4.9L L6 CARB	HPR3300
E250 Econoline Club Wagon	5.8L V8 CARB	HPR0351	F100	5.0L V8 CARB	HPR0351
E350 Econoline	5.8L V8 CARB	HPR0351	F150	4.9L L6 CARB	HPR3300
E350 Econoline Club Wagon	5.8L V8 CARB	HPR0351	F150	5.0L V8 CARB	HPR0351
Escort	1.6L L4 F/I	HPR3660	F150	5.8L V8 CARB	HPR0351
F100	4.9L L6 CARB	HPR3300	F250	4.9L L6 CARB	HPR3300
F100	5.0L V8 CARB	HPR0351	F250	5.0L V8 CARB	HPR0351
F150	4.9L L6 CARB	HPR3300	F250	5.8L V8 CARB	HPR0351
F150	5.0L V8 CARB	HPR0351	F250	6.6L V8 CARB	HPR0351
F150	5.8L V8 CARB	HPR0351	F350	4.9L L6 CARB	HPR3300
F250	4.9L L6 CARB	HPR3300	F350	5.8L V8 CARB	HPR0351
F250	5.0L V8 CARB	HPR0351	F350	6.6L V8 CARB	HPR0351
F250	5.8L V8 CARB	HPR0351	Fairmont	3.3L L6 CARB	HPR3300
F350	4.9L L6 CARB	HPR3300	Granada	1.6L L4 CARB	HPR0184
F350	5.8L V8 CARB	HPR0351	Granada	2.0L L4 CARB	HPR0184
Fairmont	3.3L L6 CARB	HPR3300	Granada	3.3L L6 CARB	HPR3300
Granada	1.6L L4 CARB	HPR0184	LTD	4.2L V8 CARB	HPR0351
Granada	2.0L L4 CARB	HPR0184	LTD	5.0L V8 CARB	HPR0351
LTD	3.3L L6 CARB	HPR3300	LTD	5.8L V8 CARB	HPR0351
LTD	5.0L V8 F/I	HPR0351	Motorhome	5.8L V8 2 BBL. - Class C	HPR0351
LTD	5.8L V8 CARB	HPR0351	Motorhome	6.6L V8 2 BBL. - Class C	HPR0351
Motorhome	5.0L V8 2 BBL. - Class C	HPR0351	Mustang	3.3L L6 CARB	HPR3300
Motorhome	5.8L V8 2 BBL. - Class C	HPR0351	Mustang	5.0L V8 CARB	HPR0351
Motorhome	6.6L V8 2 BBL. - Class C	HPR0351	Sierra	1.3L L4 CARB	HPR0184
Sierra	1.3L L4 CARB	HPR0184	Sierra	1.6L L4 CARB - CV	HPR0184
Sierra	1.6L L4 CARB - CV	HPR0184	Sierra	2.0L L4 CARB	HPR0184
Sierra	2.0L L4 CARB	HPR0184	Taurus	1.3L L4 CARB	HPR0184
Thunderbird	5.0L V8 F/I	HPR0351	Taurus	1.6L L4 CARB - 88BHP	HPR0192
			Taurus	1.6L L4 CARB - Exc., 88BHP	HPR0184
			Thunderbird	3.3L L6 CARB	HPR3300
1982 FORD			1981 FORD		
Bronco	4.9L L6 CARB	HPR3300	Bronco	5.0L V8 CARB	HPR0351
Bronco	5.0L V8 CARB	HPR0351	Bronco	5.8L V8 CARB	HPR0351
Bronco	5.8L V8 CARB	HPR0351	Capri III	1.6L L4 CARB	HPR0184
Capri III	1.6L L4 CARB	HPR0184	Capri III	2.0L V6 CARB	HPR0184
Capri III	2.0L V6 CARB	HPR0184	Cortina	1.6L L4 CARB - OHC	HPR0184
Cortina	1.6L L4 CARB - OHC, to 9/82	HPR0184	Courier	2.0L L4 CARB	HPR0352
Courier	2.0L L4 CARB	HPR0352	Courier	2.3L L4 CARB	HPR0352
Courier	2.3L L4 CARB	HPR0352	E100 Econoline	5.0L V8 CARB	HPR0351
E100 Econoline	5.0L V8 CARB	HPR0351	E100 Econoline	5.8L V8 CARB	HPR0351
E100 Econoline	5.8L V8 CARB	HPR0351	E100 Econoline Club Wagon	5.0L V8 CARB	HPR0351
E100 Econoline Club Wagon	5.0L V8 CARB	HPR0351	E100 Econoline Club Wagon	5.8L V8 CARB	HPR0351
E100 Econoline Club Wagon	5.8L V8 CARB	HPR0351	E150 Econoline	5.0L V8 CARB	HPR0351
E150 Econoline	5.0L V8 CARB	HPR0351	E150 Econoline	5.8L V8 CARB	HPR0351
E150 Econoline	5.8L V8 CARB	HPR0351	E150 Econoline Club Wagon	5.0L V8 CARB	HPR0351
E150 Econoline Club Wagon	5.0L V8 CARB	HPR0351	E150 Econoline Club Wagon	5.8L V8 CARB	HPR0351
E150 Econoline Club Wagon	5.8L V8 CARB	HPR0351	E250 Econoline	5.0L V8 CARB	HPR0351

*Indicates 2 filters required ♦ Intake system available - see page 326 + throttle body spacer available - see page 20

HPR™ REPLACEMENT AIR FILTERS

FORD

Vehicle	Engine Type	Air Filter	Vehicle	Engine Type	Air Filter
1981 FORD			1980 FORD		
E250 Econoline	5.8L V8 CARB	HPR0351	E250 Econoline Club Wagon	400 V8 CARB	HPR0351
E250 Econoline Club Wagon	5.8L V8 CARB	HPR0351	E350 Econoline	302 V8 CARB	HPR0351
E250 Econoline Club Wagon	6.6L V8 CARB	HPR0351	E350 Econoline	351 V8 CARB	HPR0351
E350 Econoline	5.0L V8 CARB	HPR0351	E350 Econoline	400 V8 CARB	HPR0351
E350 Econoline	5.8L V8 CARB	HPR0351	E350 Econoline Club Wagon	302 V8 CARB	HPR0351
E350 Econoline	6.6L V8 CARB	HPR0351	E350 Econoline Club Wagon	351 V8 CARB	HPR0351
E350 Econoline Club Wagon	5.8L V8 CARB	HPR0351	E350 Econoline Club Wagon	400 V8 CARB	HPR0351
E350 Econoline Club Wagon	6.6L V8 CARB	HPR0351	F100	302 V8 CARB	HPR0351
F100	4.2L V8 CARB	HPR0351	F150	302 V8 CARB	HPR0351
F100	5.0L V8 CARB	HPR0351	F150	351 V8 CARB	HPR0351
F100	5.8L V8 CARB	HPR0351	F250	302 V8 CARB	HPR0351
F150	5.0L V8 CARB	HPR0351	F250	351 V8 CARB	HPR0351
F150	5.8L V8 CARB	HPR0351	F250	351 V8 CARB - w/Modified Eng.	HPR0351
F250	5.0L V8 CARB	HPR0351	F250	400 V8 CARB	HPR0351
F250	5.8L V8 CARB	HPR0351	F350	302 V8 CARB	HPR0351
F250	6.6L V8 CARB	HPR0351	F350	351 V8 CARB	HPR0351
F350	5.8L V8 CARB	HPR0351	F350	400 V8 CARB	HPR0351
F350	6.6L V8 CARB	HPR0351	Fairmont	3.3L L6 CARB	HPR3300
Fairmont	3.3L L6 CARB	HPR3300	Granada	2.0L L4 CARB	HPR0184
Granada	1.6L L4 CARB - from 7/81	HPR0184	Granada	255 V8 CARB	HPR0351
Granada	2.0L L4 CARB	HPR0184	Granada	302 V8 CARB	HPR0351
Granada	3.3L L6 CARB	HPR3300	LTD	302 V8 CARB	HPR0351
LTD	4.2L V8 CARB	HPR0351	LTD	351 V8 CARB	HPR0351
LTD	5.0L V8 CARB	HPR0351	Motorhome	5.0L V8 2 BBL. - Class C	HPR0351
LTD	5.8L V8 CARB	HPR0351	Motorhome	5.8L V8 2 BBL. - Class C	HPR0351
Motorhome	5.0L V8 2 BBL. - Class C	HPR0351	Motorhome	6.6L V8 2 BBL. - Class C	HPR0351
Motorhome	5.8L V8 2 BBL. - Class C	HPR0351	Mustang	200 L6 CARB	HPR3300
Motorhome	6.6L V8 2 BBL. - Class C	HPR0351	Taurus	1.3L L4 CARB	HPR0184
Mustang	3.3L L6 CARB	HPR3300	Taurus	1.6L L4 CARB - 88BHP	HPR0192
Taurus	1.3L L4 CARB	HPR0184	Taurus	1.6L L4 CARB - Exc., 88BHP	HPR0184
Taurus	1.6L L4 CARB - 88BHP	HPR0192	Thunderbird	200 L6 CARB	HPR3300
Taurus	1.6L L4 CARB - Exc., 88BHP	HPR0184	1979 FORD		
Thunderbird	3.3L L6 CARB	HPR3300	Bronco	351 V8 CARB	HPR0351
1980 FORD			Bronco	400 V8 CARB	HPR0351
Bronco	302 V8 CARB	HPR0351	Capri III	1.6L L4 CARB	HPR0184
Bronco	351 V8 CARB	HPR0351	Capri III	2.0L V6 CARB	HPR0184
Capri III	1.6L L4 CARB	HPR0184	Cortina	1.6L L4 CARB - OHC	HPR0184
Capri III	2.0L V6 CARB	HPR0184	Courier	122 L4 CARB	HPR2740
Cortina	1.6L L4 CARB - OHC	HPR0184	Courier	140 L4 CARB	HPR2740
Courier	122 L4 CARB	HPR0352	E100 Econoline	302 V8 CARB	HPR0351
Courier	140 L4 CARB	HPR2740	E100 Econoline	351 V8 CARB	HPR0351
E100 Econoline	302 V8 CARB	HPR0351	E100 Econoline Club Wagon	302 V8 CARB	HPR0351
E100 Econoline	351 V8 CARB	HPR0351	E100 Econoline Club Wagon	351 V8 CARB	HPR0351
E100 Econoline	400 V8 CARB	HPR0351	E150 Econoline	302 V8 CARB	HPR0351
E100 Econoline Club Wagon	302 V8 CARB	HPR0351	E150 Econoline	351 V8 CARB	HPR0351
E100 Econoline Club Wagon	351 V8 CARB	HPR0351	E150 Econoline Club Wagon	302 V8 CARB	HPR0351
E150 Econoline	302 V8 CARB	HPR0351	E150 Econoline Club Wagon	351 V8 CARB	HPR0351
E150 Econoline	351 V8 CARB	HPR0351	E250 Econoline	302 V8 CARB	HPR0351
E150 Econoline Club Wagon	302 V8 CARB	HPR0351	E250 Econoline	351 V8 CARB	HPR0351
E150 Econoline Club Wagon	351 V8 CARB	HPR0351	E250 Econoline Club Wagon	302 V8 CARB	HPR0351
E250 Econoline	302 V8 CARB	HPR0351	E250 Econoline Club Wagon	351 V8 CARB	HPR0351
E250 Econoline	351 V8 CARB	HPR0351	E350 Econoline	302 V8 CARB	HPR0351
E250 Econoline	400 V8 CARB	HPR0351	E350 Econoline	351 V8 CARB	HPR0351
E250 Econoline Club Wagon	302 V8 CARB	HPR0351	E350 Econoline Club Wagon	302 V8 CARB	HPR0351
E250 Econoline Club Wagon	351 V8 CARB	HPR0351			

*Indicates 2 filters required ♦ Intake system available - see page 326 + throttle body spacer available - see page 20

FORD

HPR™ REPLACEMENT AIR FILTERS

Vehicle	Engine Type	Air Filter	Vehicle	Engine Type	Air Filter
1979 FORD			1978 FORD		
E350 Econoline Club Wagon	351 V8 CARB	HPR0351	F350	400 V8 CARB	HPR0351
F100	302 V8 CARB	HPR0351	Fairmont	200 L6 CARB	HPR3300
F100	351 V8 CARB	HPR0351	Fairmont	200 L6 CARB - w/Auto Trans.	HPR3300
F100	400 V8 CARB	HPR0351	Granada	2.0L L4 CARB	HPR0184
F150	302 V8 CARB	HPR0351	Granada	302 V8 CARB	HPR0351
F150	351 V8 CARB	HPR0351	LTD	302 V8 CARB	HPR0351
F150	400 V8 CARB	HPR0351	LTD	351 V8 CARB	HPR0351
F250	302 V8 CARB	HPR0351	LTD	400 V8 CARB	HPR0351
F250	351 V8 CARB	HPR0351	LTD II	302 V8 CARB	HPR0351
F250	400 V8 CARB	HPR0351	LTD II	351 V8 CARB	HPR0351
F350	302 V8 CARB	HPR0351	LTD II	400 V8 CARB	HPR0351
F350	351 V8 CARB	HPR0351	Motorhome	302 V8 2 BBL. - Class C	HPR0351
F350	400 V8 CARB	HPR0351	Motorhome	351 V8 2 BBL. - Class C	HPR0351
Fairmont	200 L6 CARB	HPR3300	Ranchero	302 V8 CARB	HPR0351
Fairmont	200 L6 CARB - w/Auto Trans.	HPR3300	Ranchero	351 V8 CARB	HPR0351
Granada	2.0L L4 CARB	HPR0184	Ranchero	400 V8 CARB	HPR0351
Granada	302 V8 CARB	HPR0351	Ranchero	1.3L L4 CARB	HPR0184
LTD	302 V8 CARB	HPR0351	Taurus	1.6L L4 CARB - 88BHP	HPR0192
LTD	351 V8 CARB	HPR0351	Taurus	1.6L L4 CARB - Exc., 88BHP	HPR0184
LTD II	302 V8 CARB	HPR0351	Thunderbird	302 V8 CARB	HPR0351
LTD II	351 V8 CARB	HPR0351	Thunderbird	351 V8 CARB	HPR0351
Motorhome	302 V8 2 BBL. - Class C	HPR0351	Thunderbird	400 V8 CARB	HPR0351
Motorhome	360 V8 2 BBL. - Class C	HPR0351	1977 FORD		
Motorhome	400 V8 4 BBL. - Class C	HPR0351	Capri II	1.6L L4 CARB - Exc., 88BHP	HPR0184
Mustang	200 L6 CARB	HPR3300	Cortina	1.6L L4 CARB - OHC	HPR0184
Ranchero	302 V8 CARB	HPR0351	Courier	110 L4 CARB	HPR2740
Ranchero	351 V8 CARB	HPR0351	Courier	140 L4 CARB	HPR2740
Taurus	1.3L L4 CARB	HPR0184	Custom 500	351 V8 CARB	HPR0351
Taurus	1.6L L4 CARB - 88BHP	HPR0192	Custom 500	400 V8 CARB	HPR0351
Taurus	1.6L L4 CARB - Exc., 88BHP	HPR0184	E100 Econoline	351 V8 CARB	HPR0351
Thunderbird	302 V8 CARB	HPR0351	E100 Econoline Club Wagon	351 V8 CARB	HPR0351
Thunderbird	351 V8 CARB	HPR0351	E150 Econoline	351 V8 CARB	HPR0351
1978 FORD			E150 Econoline Club Wagon	351 V8 CARB	HPR0351
Bronco	351 V8 CARB	HPR0351	E250 Econoline	351 V8 CARB	HPR0351
Bronco	400 V8 CARB	HPR0351	E250 Econoline Club Wagon	351 V8 CARB	HPR0351
Capri III	1.6L L4 CARB	HPR0184	E350 Econoline	351 V8 CARB	HPR0351
Capri III	2.0L V6 CARB	HPR0184	E350 Econoline Club Wagon	351 V8 CARB	HPR0351
Cortina	1.6L L4 CARB - OHC	HPR0184	F100	302 V8 CARB	HPR0351
Courier	110 L4 CARB	HPR2740	F100	351 V8 CARB	HPR0351
Courier	140 L4 CARB	HPR2740	F100	400 V8 CARB	HPR0351
E100 Econoline	351 V8 CARB	HPR0351	F150	302 V8 CARB	HPR0351
E100 Econoline Club Wagon	351 V8 CARB	HPR0351	F150	351 V8 CARB	HPR0351
E150 Econoline	351 V8 CARB	HPR0351	F150	400 V8 CARB	HPR0351
E150 Econoline Club Wagon	351 V8 CARB	HPR0351	F250	302 V8 CARB	HPR0351
E250 Econoline	351 V8 CARB	HPR0351	F250	351 V8 CARB	HPR0351
E250 Econoline Club Wagon	351 V8 CARB	HPR0351	F250	400 V8 CARB	HPR0351
E350 Econoline	351 V8 CARB	HPR0351	F350	302 V8 CARB	HPR0351
E350 Econoline Club Wagon	351 V8 CARB	HPR0351	F350	351 V8 CARB	HPR0351
F100	302 V8 CARB	HPR0351	F350	400 V8 CARB	HPR0351
F100	351 V8 CARB	HPR0351	Granada	2.0L L4 CARB	HPR0184
F100	400 V8 CARB	HPR0351	Granada	302 V8 CARB	HPR0351
F150	302 V8 CARB	HPR0351	Granada	351 V8 CARB	HPR0351
F150	351 V8 CARB	HPR0351	LTD	302 V8 CARB	HPR0351
F150	400 V8 CARB	HPR0351	LTD	351 V8 CARB	HPR0351
F250	302 V8 CARB	HPR0351	LTD	400 V8 CARB	HPR0351
F250	351 V8 CARB	HPR0351	LTD II	302 V8 CARB	HPR0351
F250	400 V8 CARB	HPR0351	LTD II	351 V8 CARB	HPR0351
F350	302 V8 CARB	HPR0351	LTD II	400 V8 CARB	HPR0351
F350	351 V8 CARB	HPR0351	Motorhome	302 V8 2 BBL. - Class C	HPR0351
			Motorhome	360 V8 2 BBL. - Class C	HPR0351

*Indicates 2 filters required ♦ Intake system available - see page 326 + throttle body spacer available - see page 20

HPR™ REPLACEMENT AIR FILTERS

FORD

Vehicle	Engine Type	Air Filter	Vehicle	Engine Type	Air Filter
1977 FORD			1975 FORD		
P-500	400 V8 CARB	HPR0351	E150 Econoline	351 V8 CARB	HPR0351
Ranchero	302 V8 CARB	HPR0351	E150 Econoline Club Wagon	351 V8 CARB	HPR0351
Ranchero	351 V8 CARB	HPR0351	E250 Econoline	302 V8 CARB	HPR0351
Ranchero	400 V8 CARB	HPR0351	E250 Econoline	351 V8 CARB	HPR0351
Taurus	1.3L L4 CARB	HPR0184	E250 Econoline Club Wagon	351 V8 CARB	HPR0351
Taurus	1.6L L4 CARB - 88BHP	HPR0192	E350 Econoline	302 V8 CARB	HPR0351
Taurus	1.6L L4 CARB - Exc., 88BHP	HPR0184	E350 Econoline Elite	351 V8 CARB	HPR0351
Thunderbird	351 V8 CARB	HPR0351	F100	351 V8 CARB - 11 inch OD	HPR0351
Thunderbird	400 V8 CARB	HPR0351	F150	302 V8 CARB	HPR0351
1976 FORD			F150	302 V8 CARB	HPR0351
Capri II	1.6L L4 CARB - Exc., 88BHP	HPR0184	F250	302 V8 CARB	HPR0351
Cortina	1.6L L4 CARB - OHC	HPR0184	F350	302 V8 CARB	HPR0351
Custom 500	351 V8 CARB	HPR0351	Granada	2.0L L4 CARB	HPR0184
Custom 500	400 V8 CARB	HPR0351	Granada	302 V8 CARB	HPR0351
E100 Econoline	351 V8 CARB	HPR0351	Granada	351 V8 CARB	HPR0351
E100 Econoline Club Wagon	351 V8 CARB	HPR0351	LTD	351 V8 CARB	HPR0351
E150 Econoline	351 V8 CARB	HPR0351	Maverick	302 V8 CARB	HPR0351
E150 Econoline Club Wagon	351 V8 CARB	HPR0351	Motorhome	302 V8 2 BBL. - Class C	HPR0351
E250 Econoline	351 V8 CARB	HPR0351	Motorhome	351 V8 2 BBL. - Class C	HPR0351
E250 Econoline Club Wagon	351 V8 CARB	HPR0351	Mustang II	171 V6 CARB	HPR3300
E350 Econoline	351 V8 CARB	HPR0351	P-400	302 V8 CARB	HPR0351
Elite	351 V8 CARB	HPR0351	P-400	400 V8 CARB	HPR0351
Elite	400 V8 CARB	HPR0351	P-500	302 V8 CARB	HPR0351
F100	302 V8 CARB	HPR0351	P-500	400 V8 CARB	HPR0351
F150	302 V8 CARB	HPR0351	Pinto	171 V6 CARB	HPR3300
F250	302 V8 CARB	HPR0351	Ranchero	351 V8 CARB - 11 inch OD	HPR0351
F350	302 V8 CARB	HPR0351	Taurus	1.3L L4 CARB	HPR0184
Gran Torino	351 V8 CARB	HPR0351	Taurus	1.6L L4 CARB - 88BHP	HPR0192
Gran Torino	400 V8 CARB	HPR0351	Taurus	1.6L L4 CARB - Exc., 88BHP	HPR0184
Granada	2.0L L4 CARB	HPR0184	Torino	351 V8 CARB - 11 inch OD	HPR0351
Granada	302 V8 CARB - Early Prod.	HPR0351	1974 FORD		
Granada	351 V8 CARB	HPR0351	Capri	1.6L L4 CARB - Exc. 88BHP	HPR0184
LTD	351 V8 CARB	HPR0351	Capri II	1.6L L4 CARB - Exc., 88BHP	HPR0184
LTD	400 V8 CARB	HPR0351	Cortina	1.6L L4 CARB - OHC	HPR0184
Maverick	302 V8 CARB	HPR0351	Country Sedan	351 V8 2 BBL.	HPR0351
Motorhome	302 V8 2 BBL. - Class C	HPR0351	Country Sedan	351 V8 4 BBL.	HPR0351
Motorhome	360 V8 2 BBL. - Class C	HPR0351	Country Squire	351 V8 2 BBL.	HPR0351
Mustang II	171 V6 CARB	HPR3300	Country Squire	351 V8 4 BBL.	HPR0351
P-350	302 V8 CARB	HPR0351	Custom 500	351 V8 2 BBL.	HPR0351
P-350	400 V8 CARB	HPR0351	Custom 500	351 V8 4 BBL.	HPR0351
P-400	302 V8 CARB	HPR0351	E100 Econoline	302 V8 CARB	HPR0351
P-400	400 V8 CARB	HPR0351	E200 Econoline	302 V8 CARB	HPR0351
P-500	302 V8 CARB	HPR0351	E300 Econoline	302 V8 CARB	HPR0351
P-500	400 V8 CARB	HPR0351	F100 Pickup	302 V8 CARB	HPR0351
Pinto	171 V6 CARB	HPR3300	F250 Pickup	302 V8 CARB	HPR0351
Ranchero	351 V8 CARB	HPR0351	F350 Pickup	302 V8 CARB	HPR0351
Ranchero	400 V8 CARB	HPR0351	Falcon	250 L6 CARB	HPR3300
Taurus	1.3L L4 CARB	HPR0184	Galaxie 500	351 V8 2 BBL.	HPR0351
Taurus	1.6L L4 CARB - 88BHP	HPR0192	Galaxie 500	351 V8 4 BBL.	HPR0351
Taurus	1.6L L4 CARB - Exc., 88BHP	HPR0184	Gran Torino	250 L6 CARB	HPR3300
Torino	351 V8 CARB	HPR0351	Gran Torino	302 V8 CARB	HPR0351
Torino	400 V8 CARB	HPR0351	Gran Torino	351 V8 2 BBL.	HPR0351
1975 FORD			Gran Torino	351 V8 4 BBL.	HPR0351
Capri II	1.6L L4 CARB - Exc., 88BHP	HPR0184	Granada	2.0L L4 CARB	HPR0184
Cortina	1.6L L4 CARB - OHC	HPR0184	LTD	351 V8 2 BBL.	HPR0351
Custom 500	351 V8 CARB	HPR0351	LTD	351 V8 4 BBL.	HPR0351
E100 Econoline	302 V8 CARB	HPR0351	Maverick	250 L6 CARB	HPR3300
E100 Econoline	351 V8 CARB	HPR0351	Maverick	302 V8 CARB	HPR0351
E100 Econoline Club Wagon	351 V8 CARB	HPR0351	Motorhome	302 V8 2 BBL. - Class C	HPR0351
E150 Econoline	302 V8 CARB	HPR0351	Mustang II	171 V6 CARB	HPR3300
			Ranch Wagon	351 V8 2 BBL.	HPR0351
			Ranch Wagon	351 V8 4 BBL.	HPR0351

*Indicates 2 filters required ♦ Intake system available - see page 326 + throttle body spacer available - see page 20

FORD

HPR™ REPLACEMENT AIR FILTERS

Vehicle	Engine Type	Air Filter	Vehicle	Engine Type	Air Filter
1974 FORD			1972 FORD		
Ranchero	302 V8 CARB	HPR0351	Falcon	250 L6 CARB	HPR3300
Ranchero	351 V8 2 BBL.	HPR0351	Galaxie 500	302 V8 CARB	HPR0351
Taurus	1.3L L4 CARB	HPR0184	Galaxie 500	351 V8 2 BBL. - 11 inch OD	HPR0351
Taurus	1.6L L4 CARB - 88BHP	HPR0192	Galaxie 500	351 V8 4 BBL. - 11 inch OD	HPR0351
Taurus	1.6L L4 CARB - Exc., 88BHP	HPR0184	Gran Torino	250 L6 CARB	HPR3300
Torino	250 L6 CARB	HPR3300	Gran Torino	302 V8 CARB	HPR0351
Torino	302 V8 CARB	HPR0351	Gran Torino	351 V8 2 BBL.	HPR0351
Torino	351 V8 2 BBL.	HPR0351	Gran Torino	351 V8 4 BBL.	HPR0351
1973 FORD			Granada	2.0L L4 CARB	HPR0184
Capri	1.6L L4 CARB - Exc. 88BHP	HPR0184	LTD	302 V8 CARB	HPR0351
Cortina Mk3/4/5	1.6L L4 CARB - OHC, from 8/73	HPR0184	LTD	351 V8 2 BBL. - 11 inch OD	HPR0351
Country Sedan	351 V8 2 BBL.	HPR0351	LTD	351 V8 4 BBL. - 11 inch OD	HPR0351
Country Sedan	351 V8 4 BBL.	HPR0351	Maverick	250 L6 CARB	HPR3300
Country Squire	351 V8 2 BBL.	HPR0351	Maverick	302 V8 CARB	HPR0351
Country Squire	351 V8 4 BBL.	HPR0351	Mustang	250 L6 CARB	HPR3300
Custom 500	351 V8 2 BBL. - Exc. Police Package	HPR0351	Mustang	302 V8 CARB - w/10-3/4 inch Tall Filter	HPR0351
Custom 500	351 V8 4 BBL. - Exc. Police Package	HPR0351	Mustang	351 V8 CARB - w/o Ram Air	HPR0351
E100 Econoline	302 V8 CARB	HPR0351	Ranch Wagon	302 V8 CARB	HPR0351
E200 Econoline	302 V8 CARB	HPR0351	Ranch Wagon	351 V8 2 BBL.	HPR0351
E300 Econoline	302 V8 CARB	HPR0351	Ranch Wagon	351 V8 4 BBL.	HPR0351
F100 Pickup	302 V8 CARB	HPR0351	Ranchero	250 L6 CARB	HPR3300
F250 Pickup	302 V8 CARB	HPR0351	Ranchero	302 V8 CARB	HPR0351
F350 Pickup	302 V8 CARB	HPR0351	Ranchero	351 V8 2 BBL.	HPR0351
Falcon	250 L6 CARB	HPR3300	Taurus	1.3L L4 CARB	HPR0184
Galaxie 500	351 V8 2 BBL.	HPR0351	Taurus	1.6L L4 CARB - 88BHP	HPR0192
Galaxie 500	351 V8 4 BBL.	HPR0351	Taurus	1.6L L4 CARB - Exc., 88BHP	HPR0184
Gran Torino	250 L6 CARB	HPR3300	Torino	250 L6 CARB	HPR3300
Gran Torino	302 V8 CARB	HPR0351	Torino	302 V8 CARB	HPR0351
Gran Torino	351 V8 CARB	HPR0351	Torino	351 V8 2 BBL.	HPR0351
Granada	2.0L L4 CARB	HPR0184	1971 FORD		
LTD	351 V8 2 BBL. - Exc. Police Package	HPR0351	Cortina	2.0L L4 CARB	HPR0184
LTD	351 V8 4 BBL. - Exc. Police Package	HPR0351	Falcon	250 L6 CARB	HPR3300
Maverick	250 L6 CARB	HPR3300	Maverick	250 L6 CARB	HPR3300
Maverick	302 V8 CARB	HPR0351	Mustang	250 L6 CARB	HPR3300
Motorhome	302 V8 2 BBL. - Class C	HPR0351	Ranchero	250 L6 CARB	HPR3300
Mustang	250 L6 CARB	HPR3300	Taurus	1.3L L4 CARB	HPR0184
Ranch Wagon	351 V8 2 BBL.	HPR0351	Taurus	1.6L L4 CARB - 88BHP	HPR0192
Ranch Wagon	351 V8 4 BBL.	HPR0351	Taurus	1.6L L4 CARB - Exc., 88BHP	HPR0184
Ranchero	250 L6 CARB	HPR3300	Torino	250 L6 CARB	HPR3300
Ranchero	302 V8 CARB	HPR0351	1970 FORD		
Ranchero	351 V8 2 BBL.	HPR0351	Cortina	2.0L L4 CARB	HPR0184
Taurus	1.3L L4 CARB	HPR0184	Fairlane	250 L6 CARB	HPR3300
Taurus	1.6L L4 CARB - 88BHP	HPR0192	Falcon	250 L6 CARB	HPR3300
Taurus	1.6L L4 CARB - Exc., 88BHP	HPR0184	Maverick	250 L6 CARB	HPR3300
Torino	250 L6 CARB	HPR3300	Mustang	250 L6 CARB	HPR3300
Torino	302 V8 CARB	HPR0351	Ranchero	250 L6 CARB	HPR3300
Torino	351 V8 2 BBL.	HPR0351	Taurus	1.3L L4 CARB	HPR0184
1972 FORD			Taurus	1.6L L4 CARB - 88BHP	HPR0192
Capri	1.6L L4 CARB - Exc. 88BHP	HPR0184	Taurus	1.6L L4 CARB - Exc., 88BHP	HPR0184
Cortina	2.0L L4 CARB	HPR0184	Torino	250 L6 CARB	HPR3300
Country Sedan	302 V8 CARB	HPR0351	1969 FORD		
Country Sedan	351 V8 2 BBL.	HPR0351	Mustang	250 L6 CARB	HPR3300
Country Sedan	351 V8 4 BBL.	HPR0351	Taurus	1.3L L4 CARB	HPR0184
Country Squire	302 V8 CARB	HPR0351	1968 FORD		
Country Squire	351 V8 2 BBL.	HPR0351	Taurus	1.3L L4 CARB	HPR0184
Country Squire	351 V8 4 BBL.	HPR0351	1967 FORD		
Custom	302 V8 CARB	HPR0351	Bronco	170 L6 CARB	HPR0184
Custom	351 V8 CARB	HPR0351	Bronco	240 L6 CARB	HPR0184
Custom 500	302 V8 CARB	HPR0351	Club Wagon	170 L6 CARB	HPR0184
Custom 500	351 V8 2 BBL.	HPR0351	Club Wagon	240 L6 CARB	HPR0184
Custom 500	351 V8 4 BBL.	HPR0351	Country Sedan	170 L6 CARB	HPR0184

*Indicates 2 filters required ♦ Intake system available - see page 326 + throttle body spacer available - see page 20

HPR™ REPLACEMENT AIR FILTERS

FORD

Vehicle	Engine Type	Air Filter	Vehicle	Engine Type	Air Filter
1967 FORD			1965 FORD		
Country Sedan	200 L6 CARB	HPR0184	Club Wagon	170 L6 CARB	HPR0184
Country Sedan	240 L6 CARB	HPR0184	Country Sedan	170 L6 CARB	HPR0184
Country Squire	170 L6 CARB	HPR0184	Country Sedan	200 L6 CARB	HPR0184
Country Squire	200 L6 CARB	HPR0184	Country Sedan	240 L6 CARB	HPR0184
Country Squire	240 L6 CARB	HPR0184	Country Sedan	352 V8 CARB - Calif.	HPR0184
Custom	240 L6 CARB	HPR0184	Country Sedan	390 V8 CARB - Calif.	HPR0184
Custom 500	240 L6 CARB	HPR0184	Country Sedan	427 V8 CARB - Calif.	HPR0184
Econoline	170 L6 CARB	HPR0184	Country Squire	170 L6 CARB	HPR0184
Econoline	240 L6 CARB	HPR0184	Country Squire	200 L6 CARB	HPR0184
F100 Pickup	240 L6 CARB	HPR0184	Country Squire	240 L6 CARB	HPR0184
F250 Pickup	240 L6 CARB	HPR0184	Country Squire	352 V8 CARB - Calif.	HPR0184
F350 Pickup	240 L6 CARB	HPR0184	Custom	240 L6 CARB	HPR0184
Fairlane	200 L6 CARB	HPR0184	Custom	352 V8 CARB - Calif.	HPR0184
Falcon	170 L6 CARB	HPR0184	Custom	390 V8 CARB - Calif.	HPR0184
Falcon	200 L6 CARB	HPR0184	Custom	427 V8 CARB - Calif.	HPR0184
Galaxie	240 L6 CARB	HPR0184	Custom 500	240 L6 CARB	HPR0184
Galaxie 500	240 L6 CARB	HPR0184	Custom 500	352 V8 CARB - Calif.	HPR0184
Motorhome	240 L6 1 BBL. - Class C	HPR0184	Custom 500	427 V8 CARB - Calif.	HPR0184
Mustang	200 L6 CARB	HPR0184	Econoline	144 L6 CARB	HPR0184
P100	170 L6 CARB	HPR0184	Econoline	170 L6 CARB	HPR0184
P350	170 L6 CARB	HPR0184	Econoline	240 L6 CARB	HPR0184
P350	240 L6 CARB	HPR0184	F100 Pickup	240 L6 CARB	HPR0184
Ranch Wagon	170 L6 CARB	HPR0184	F250 Pickup	240 L6 CARB	HPR0184
Ranch Wagon	200 L6 CARB	HPR0184	F350 Pickup	240 L6 CARB	HPR0184
Ranch Wagon	240 L6 CARB	HPR0184	Fairlane	170 L6 CARB	HPR0184
Ranchero	200 L6 CARB	HPR0184	Fairlane	200 L6 CARB	HPR0184
Taurus	1.3L L4 CARB	HPR0184	Fairlane	352 V8 CARB	HPR0184
1966 FORD			Fairlane	390 V8 CARB	HPR0184
Bronco	170 L6 CARB	HPR0184	Falcon	170 L6 CARB	HPR0184
Club Wagon	144 L6 CARB	HPR0184	Falcon	200 L6 CARB	HPR0184
Club Wagon	170 L6 CARB	HPR0184	Falcon Sedan	170 L6 CARB	HPR0184
Country Sedan	170 L6 CARB	HPR0184	Delivery		
Country Sedan	200 L6 CARB	HPR0184	Falcon Sedan	200 L6 CARB	HPR0184
Country Sedan	240 L6 CARB	HPR0184	Delivery		
Country Squire	170 L6 CARB	HPR0184	Galaxie	240 L6 CARB	HPR0184
Country Squire	200 L6 CARB	HPR0184	Galaxie	352 V8 CARB	HPR0184
Country Squire	240 L6 CARB	HPR0184	Galaxie	390 V8 CARB	HPR0184
Custom	240 L6 CARB	HPR0184	Galaxie 500	240 L6 CARB	HPR0184
Custom 500	240 L6 CARB	HPR0184	Galaxie 500	352 V8 CARB	HPR0184
Econoline	144 L6 CARB	HPR0184	Galaxie 500	390 V8 CARB	HPR0184
Econoline	170 L6 CARB	HPR0184	LTD	352 V8 CARB - Hi Perf.	HPR0184
Econoline	240 L6 CARB	HPR0184	LTD	390 V8 CARB - Calif.	HPR0184
F100 Pickup	240 L6 CARB	HPR0184	Motorhome	200 L6 2 BBL. - Class C	HPR0184
F250 Pickup	240 L6 CARB	HPR0184	Mustang	170 L6 CARB	HPR0184
F350 Pickup	240 L6 CARB	HPR0184	Mustang	200 L6 CARB	HPR0184
Fairlane	170 L6 CARB	HPR0184	Mustang	289 V8 CARB	HPR0184
Fairlane	200 L6 CARB	HPR0184	P100	170 L6 CARB	HPR0184
Falcon	170 L6 CARB	HPR0184	P350	170 L6 CARB	HPR0184
Falcon	200 L6 CARB	HPR0184	P350	240 L6 CARB	HPR0184
Galaxie	240 L6 CARB	HPR0184	Ranch Wagon	240 L6 CARB	HPR0184
Galaxie 500	240 L6 CARB	HPR0184	Ranch Wagon	352 V8 CARB - Calif.	HPR0184
Motorhome	240 L6 1 BBL. - Class C	HPR0184	Ranch Wagon	390 V8 CARB - Calif.	HPR0184
Mustang	200 L6 CARB	HPR0184	Ranchero	170 L6 CARB	HPR0184
P100	170 L6 CARB	HPR0184	Ranchero	200 L6 CARB	HPR0184
P350	170 L6 CARB	HPR0184	Thunderbird	390 V8 CARB - Calif.	HPR0184
P350	240 L6 CARB	HPR0184	1964 FORD		
Ranch Wagon	170 L6 CARB	HPR0184	Club Wagon	144 L6 CARB	HPR0184
Ranch Wagon	200 L6 CARB	HPR0184	Club Wagon	170 L6 CARB	HPR0184
Ranch Wagon	240 L6 CARB	HPR0184	Club Wagon	223 L6 CARB	HPR0184
Ranchero	200 L6 CARB	HPR0184	Country Sedan	170 L6 CARB	HPR0184
Taurus	1.3L L4 CARB	HPR0184	Country Sedan	200 L6 CARB	HPR0184
1965 FORD			Country Sedan	223 L6 CARB	HPR0184
Club Wagon	144 L6 CARB	HPR0184	Country Squire	170 L6 CARB	HPR0184
			Country Squire	200 L6 CARB	HPR0184

*Indicates 2 filters required ♦ Intake system available - see page 326 + throttle body spacer available - see page 20

FORD

HPR™ REPLACEMENT AIR FILTERS

Vehicle	Engine Type	Air Filter	Vehicle	Engine Type	Air Filter
1964 FORD			1963 FORD		
Country Squire	223 L6 CARB	HPR0184	Galaxie	200 L6 CARB	HPR0184
Custom	223 L6 CARB	HPR0184	Galaxie	223 L6 CARB	HPR0184
Econoline	144 L6 CARB	HPR0184	Galaxie 500	200 L6 CARB	HPR0184
Econoline	170 L6 CARB	HPR0184	Galaxie 500	223 L6 CARB	HPR0184
F100 Pickup	223 L6 CARB	HPR0184	Motorhome	200 L6 2 BBL. - Class C	HPR0184
F250 Pickup	223 L6 CARB	HPR0184	P100	144 L6 CARB	HPR0184
F350 Pickup	223 L6 CARB	HPR0184	P100	170 L6 CARB	HPR0184
Fairlane	170 L6 CARB	HPR0184	P350	170 L6 CARB	HPR0184
Fairlane	200 L6 CARB	HPR0184	Ranch Wagon	200 L6 CARB	HPR0184
Falcon	144 L6 CARB	HPR0184	Ranch Wagon	221 V8 CARB	HPR0184
Falcon	170 L6 CARB	HPR0184	Ranch Wagon	223 L6 CARB	HPR0184
Falcon	200 L6 CARB	HPR0184	Ranchero	144 L6 CARB	HPR0184
Falcon Sedan	144 L6 CARB	HPR0184	Ranchero	170 L6 CARB	HPR0184
Delivery			Ranchero	260 V8 CARB	HPR0184
Falcon Sedan	170 L6 CARB	HPR0184	Sprint	170 L6 CARB	HPR0184
Delivery			Sunliner	200 L6 CARB	HPR0184
Falcon Sedan	200 L6 CARB	HPR0184	Sunliner	223 L6 CARB	HPR0184
Delivery			Victoria	200 L6 CARB	HPR0184
Galaxie	223 L6 CARB	HPR0184	Victoria	223 L6 CARB	HPR0184
Galaxie 500	223 L6 CARB	HPR0184	1962 FORD		
Motorhome	200 L6 2 BBL. - Class C	HPR0184	Club Wagon	221 V8 CARB	HPR0184
Mustang	170 L6 CARB	HPR0184	Club Wagon	223 L6 CARB	HPR0184
Mustang	200 L6 CARB	HPR0184	Country Sedan	144 L6 CARB	HPR0184
Mustang	260 V8 CARB	HPR0184	Country Sedan	170 L6 CARB	HPR0184
Mustang	289 V8 CARB - Exc. Hi Perf.	HPR0184	Country Sedan	221 V8 CARB	HPR0184
P100	144 L6 CARB	HPR0184	Country Sedan	223 L6 CARB	HPR0184
P100	170 L6 CARB	HPR0184	Country Squire	144 L6 CARB	HPR0184
P350	170 L6 CARB	HPR0184	Country Squire	170 L6 CARB	HPR0184
Ranch Wagon	170 L6 CARB	HPR0184	Country Squire	223 L6 CARB	HPR0184
Ranch Wagon	223 L6 CARB	HPR0184	Econoline	144 L6 CARB	HPR0184
Ranchero	144 L6 CARB	HPR0184	Econoline	170 L6 CARB	HPR0184
Ranchero	170 L6 CARB	HPR0184	F100 Pickup	223 L6 CARB	HPR0184
Ranchero	200 L6 CARB	HPR0184	F250 Pickup	223 L6 CARB	HPR0184
Ranchero	260 V8 CARB	HPR0184	F350 Pickup	223 L6 CARB	HPR0184
Sunliner	223 L6 CARB	HPR0184	F350 Pickup	262 L6 CARB	HPR0184
Victoria	223 L6 CARB	HPR0184	Fairlane	223 L6 CARB	HPR0184
1963 FORD			Falcon	144 L6 CARB	HPR0184
Club Wagon	144 L6 CARB	HPR0184	Falcon	170 L6 CARB	HPR0184
Club Wagon	170 L6 CARB	HPR0184	Falcon Sedan	144 L6 CARB	HPR0184
Club Wagon	200 L6 CARB	HPR0184	Delivery		
Club Wagon	221 V8 CARB	HPR0184	P100	144 L6 CARB	HPR0184
Club Wagon	223 L6 CARB	HPR0184	P100	170 L6 CARB	HPR0184
Country Sedan	170 L6 CARB	HPR0184	P350	170 L6 CARB	HPR0184
Country Sedan	200 L6 CARB	HPR0184	Ranchero	144 L6 CARB	HPR0184
Country Sedan	221 V8 CARB	HPR0184	1961 FORD		
Country Sedan	223 L6 CARB	HPR0184	Econoline	144 L6 CARB	HPR0184
Country Squire	170 L6 CARB	HPR0184	F100 Pickup	223 L6 CARB	HPR0184
Country Squire	200 L6 CARB	HPR0184	F250 Pickup	223 L6 CARB	HPR0184
Country Squire	221 V8 CARB	HPR0184	F350 Pickup	223 L6 CARB	HPR0184
Country Squire	223 L6 CARB	HPR0184	Falcon	144 L6 CARB	HPR0184
Econoline	144 L6 CARB	HPR0184	Falcon	170 L6 CARB	HPR0184
Econoline	170 L6 CARB	HPR0184	Falcon Sedan	144 L6 CARB	HPR0184
F100 Pickup	223 L6 CARB	HPR0184	Delivery		
F250 Pickup	223 L6 CARB	HPR0184	Falcon Sedan	170 L6 CARB	HPR0184
F350 Pickup	223 L6 CARB	HPR0184	Delivery		
F350 Pickup	262 L6 CARB	HPR0184	P100	144 L6 CARB	HPR0184
Fairlane	170 L6 CARB	HPR0184	Ranchero	144 L6 CARB	HPR0184
Falcon	144 L6 CARB	HPR0184	Ranchero	170 L6 CARB	HPR0184
Falcon	170 L6 CARB	HPR0184	1960 FORD		
Falcon	200 L6 CARB	HPR0184	Falcon	144 L6 CARB	HPR0184
Falcon Sedan	144 L6 CARB	HPR0184	Falcon	170 L6 CARB	HPR0184
Delivery			Ranchero	144 L6 CARB	HPR0184
Ford 300	200 L6 CARB	HPR0184			
Ford 300	223 L6 CARB	HPR0184			

*Indicates 2 filters required ♦ Intake system available - see page 326 + throttle body spacer available - see page 20

HPR™ REPLACEMENT AIR FILTERS

FORD

Vehicle	Engine Type	Air Filter
1957 FORD		
Courier Sedan Delivery	223 L6 CARB	HPR0184
Del Rio Wagon	223 L6 CARB	HPR0184
Ranch Wagon	223 L6 CARB	HPR0184
1956 FORD		
Country Sedan	223 L6 CARB	HPR0184
Country Squire	223 L6 CARB	HPR0184
Courier Sedan Delivery	223 L6 CARB	HPR0184
Customline	223 L6 CARB	HPR0184
F100 Pickup	223 L6 CARB	HPR0184
F250 Pickup	223 L6 CARB	HPR0184
F350 Pickup	223 L6 CARB	HPR0184
Fairlane	223 L6 CARB	HPR0184
Mainline	223 L6 CARB	HPR0184
Park Lane Wagon	223 L6 CARB	HPR0184
Ranch Wagon	223 L6 CARB	HPR0184
Skyliner	223 L6 CARB	HPR0184
Sunliner	223 L6 CARB	HPR0184
Victoria	223 L6 CARB	HPR0184
1997 GEO		
Prizm	1.6L L4 F/I	HPR5466
Prizm	1.8L L4 F/I	HPR5466
1996 GEO		
Prizm	1.6L L4 F/I	HPR5466
Prizm	1.8L L4 F/I	HPR5466
1995 GEO		
Prizm	1.6L L4 F/I	HPR5466
Prizm	1.8L L4 F/I	HPR5466
1994 GEO		
Prizm	1.6L L4 F/I	HPR5466
Prizm	1.8L L4 F/I	HPR5466
1993 GEO		
Storm	1.6L L4 F/I	HPR6690
Storm	1.8L L4 F/I	HPR6690
1992 GEO		
Storm	1.6L L4 F/I	HPR6690
Storm	1.8L L4 F/I	HPR6690
1991 GEO		
Storm	1.6L L4 F/I	HPR6690
1990 GEO		
Storm	1.6L L4 F/I	HPR6690
2017 GMC		
Sierra 1500	4.3L V6 F/I	HPR8755
Sierra 1500	5.3L V8 F/I	HPR8755
Sierra 1500	6.2L V8 F/I	HPR8755
2016 GMC		
Sierra 1500	5.3L V8 F/I	HPR8755
Sierra 1500	6.2L V8 F/I	HPR8755
Sierra 2500 HD	6.0L V8 F/I	HPR8755 ♦
Sierra 3500 HD	6.0L V8 F/I	HPR8755 ♦
Yukon	5.3L V8 F/I	HPR8755
Yukon Denali	6.2L V8 F/I	HPR8755
Yukon Denali XL	6.2L V8 F/I	HPR8755
2015 GMC		
Sierra	5.3L V8 F/I	HPR8755
Sierra 1500	4.3L V6 F/I	HPR8755
Sierra 1500	5.3L V8 F/I	HPR8755 ♦
Sierra 1500	6.2L V8 F/I	HPR8755 ♦

Vehicle	Engine Type	Air Filter
2015 GMC		
Sierra 2500 HD	6.0L V8 F/I	HPR8755 ♦
Sierra 3500 HD	6.0L V8 F/I	HPR8755 ♦
Yukon	5.3L V8 F/I	HPR8755 ♦
Yukon Denali	6.2L V8 F/I	HPR8755 ♦
Yukon Denali XL	6.2L V8 F/I	HPR8755 ♦
Yukon XL	5.3L V8 F/I	HPR8755 ♦
2014 GMC		
Sierra 1500	4.3L V6 F/I	HPR8755 ♦
Sierra 1500	5.3L V8 F/I	HPR8755 ♦
Sierra 1500	6.2L V8 F/I	HPR8755 ♦
Sierra 2500 HD	6.0L V8 F/I	HPR8755 ♦
Sierra 3500 HD	6.0L V8 F/I	HPR8755 ♦
Sierra Denali	6.2L V8 F/I	HPR8755
Yukon	5.3L V8 F/I	HPR8755 ♦
Yukon Denali	6.2L V8 F/I	HPR8755 ♦
Yukon Denali XL	6.2L V8 F/I	HPR8755 ♦
Yukon XL 1500	5.3L V8 F/I	HPR8755 ♦
Yukon XL 1500	6.2L V8 F/I	HPR8755
2013 GMC		
Sierra 1500	4.3L V6 F/I	HPR8755
Sierra 1500	4.8L V8 F/I	HPR8755 ♦♦
Sierra 1500	5.3L V8 F/I	HPR8755 ♦♦
Sierra 1500	6.2L V8 F/I	HPR8755 ♦♦
Sierra 1500 Hybrid	6.0L V8 F/I	HPR8755 +
Sierra 2500 HD	6.0L V8 F/I	HPR8755 ♦♦
Sierra 3500 HD	6.0L V8 F/I	HPR8755 ♦♦
Sierra Denali	6.2L V8 F/I	HPR8755 ♦
Yukon	5.3L V8 F/I	HPR8755 ♦♦
Yukon Denali	6.2L V8 F/I	HPR8755 ♦♦
Yukon Denali Hybrid	6.0L V8 F/I	HPR8755 +
Yukon Denali XL	6.2L V8 F/I	HPR8755 ♦♦
Yukon Hybrid	6.0L V8 F/I	HPR8755 +
Yukon XL 1500	5.3L V8 F/I	HPR8755 ♦♦
Yukon XL 1500	6.2L V8 F/I	HPR8755 ♦♦
Yukon XL 2500	6.0L V8 F/I	HPR8755 +
2012 GMC		
Sierra 1500	4.3L V6 F/I	HPR8755
Sierra 1500	4.8L V8 F/I	HPR8755 ♦♦
Sierra 1500	5.3L V8 F/I	HPR8755 ♦♦
Sierra 1500	6.2L V8 F/I	HPR8755 ♦♦
Sierra 1500 Hybrid	6.0L V8 F/I	HPR8755 +
Sierra 2500 HD	6.0L V8 F/I	HPR8755 ♦♦
Sierra 3500 HD	6.0L V8 F/I	HPR8755 ♦♦
Sierra Denali	6.2L V8 F/I	HPR8755 ♦
Yukon	5.3L V8 F/I	HPR8755 ♦♦
Yukon Denali	6.2L V8 F/I	HPR8755 ♦♦
Yukon Denali Hybrid	6.0L V8 F/I	HPR8755 +
Yukon Denali XL	6.2L V8 F/I	HPR8755 ♦♦
Yukon Hybrid	6.0L V8 F/I	HPR8755 +
Yukon XL 1500	5.3L V8 F/I	HPR8755 ♦♦
Yukon XL 2500	6.0L V8 F/I	HPR8755 +
2011 GMC		
Sierra 1500	4.3L V6 F/I	HPR8755
Sierra 1500	4.8L V8 F/I	HPR8755 ♦♦
Sierra 1500	5.3L V8 F/I	HPR8755 ♦♦
Sierra 1500	6.2L V8 F/I	HPR8755 ♦♦
Sierra 1500 Hybrid	6.0L V8 F/I	HPR8755 +
Sierra 2500 HD	6.0L V8 F/I	HPR8755 ♦♦
Sierra 3500 HD	6.0L V8 F/I	HPR8755 ♦♦
Sierra Denali	6.2L V8 F/I	HPR8755 ♦
Yukon	5.3L V8 F/I	HPR8755 ♦♦
Yukon	6.2L V8 F/I	HPR8755 ♦♦

*Indicates 2 filters required ♦ Intake system available - see page 326 + throttle body spacer available - see page 20

Vehicle	Engine Type	Air Filter
2011 GMC		
Yukon Denali	6.2L V8 F/I	HPR8755 ♦+
Yukon Denali Hybrid	6.0L V8 F/I	HPR8755 +
Yukon Denali XL	6.2L V8 F/I	HPR8755 ♦+
Yukon Hybrid	6.0L V8 F/I	HPR8755 +
Yukon XL 1500	5.3L V8 F/I	HPR8755 ♦+
Yukon XL 1500	6.2L V8 F/I	HPR8755 ♦+
Yukon XL 2500	6.0L V8 F/I	HPR8755 +

2010 GMC		
Sierra 1500	4.3L V6 F/I	HPR8755
Sierra 1500	4.8L V8 F/I	HPR8755 ♦+
Sierra 1500	5.3L V8 F/I	HPR8755 ♦+
Sierra 1500	6.2L V8 F/I	HPR8755 ♦+
Sierra 1500 Hybrid	6.0L V8 F/I	HPR8755 +
Sierra 2500 HD	6.0L V8 F/I	HPR8755 +
Sierra 3500 HD	6.0L V8 F/I	HPR8755 +
Sierra Denali	6.2L V8 F/I	HPR8755 ♦+
Yukon	4.8L V8 F/I	HPR8755 ♦
Yukon	5.3L V8 F/I	HPR8755 ♦+
Yukon Denali	6.2L V8 F/I	HPR8755 ♦+
Yukon Denali Hybrid	6.0L V8 F/I	HPR8755 +
Yukon Denali XL	6.2L V8 F/I	HPR8755 ♦+
Yukon Hybrid	6.0L V8 F/I	HPR8755 +
Yukon XL 1500	5.3L V8 F/I	HPR8755 ♦+
Yukon XL 1500	6.2L V8 F/I	HPR8755 ♦+
Yukon XL 2500	6.0L V8 F/I	HPR8755 +

2009 GMC		
Envoy	4.2L L6 F/I	HPR9345
Envoy	5.3L V8 F/I	HPR9345
Sierra 1500	4.3L V6 F/I	HPR8755
Sierra 1500	4.8L V8 F/I	HPR8755 ♦+
Sierra 1500	5.3L V8 F/I	HPR8755 ♦+
Sierra 1500	6.0L V8 F/I	HPR8755 ♦+
Sierra 1500	6.2L V8 F/I	HPR8755 ♦+
Sierra 1500 Hybrid	6.0L V8 F/I	HPR8755 +
Sierra 2500 HD	6.0L V8 F/I	HPR8755 +
Sierra 3500 HD	6.0L V8 F/I	HPR8755 +
Sierra Denali	6.2L V8 F/I	HPR8755 ♦+
Yukon	4.8L V8 F/I	HPR8755 ♦+
Yukon	5.3L V8 F/I	HPR8755 ♦+
Yukon Denali	6.2L V8 F/I	HPR8755 ♦+
Yukon Denali XL	6.2L V8 F/I	HPR8755 ♦+
Yukon Hybrid	6.0L V8 F/I	HPR8755 +
Yukon XL 1500	5.3L V8 F/I	HPR8755 ♦+
Yukon XL 1500	6.0L V8 F/I	HPR8755 ♦+
Yukon XL 1500	6.2L V8 F/I	HPR8755 ♦+
Yukon XL 2500	6.0L V8 F/I	HPR8755 +

2008 GMC		
Envoy	4.2L L6 F/I	HPR9345
Envoy Denali	5.3L V8 F/I	HPR9345
Sierra 1500	4.3L V6 F/I	HPR8755
Sierra 1500	4.8L V8 F/I	HPR8755 ♦+
Sierra 1500	5.3L V8 F/I	HPR8755 ♦+
Sierra 1500	6.0L V8 F/I	HPR8755 ♦+
Sierra 2500 HD	6.0L V8 F/I	HPR8755 +
Sierra 3500 HD	6.0L V8 F/I	HPR8755 +
Sierra Denali	6.2L V8 F/I	HPR8755 ♦+
Yukon	4.8L V8 F/I	HPR8755 ♦+
Yukon	5.3L V8 F/I	HPR8755 ♦+
Yukon Denali	6.2L V8 F/I	HPR8755 +
Yukon Hybrid	6.0L V8 F/I	HPR8755 ♦+
Yukon XL 1500	5.3L V8 F/I	HPR8755 ♦+
Yukon XL 1500	6.0L V8 F/I	HPR8755 ♦+

Vehicle	Engine Type	Air Filter
2008 GMC		
Yukon XL 1500 Denali	6.2L V8 F/I	HPR8755 +
Yukon XL 2500	6.0L V8 F/I	HPR8755 +

2007 GMC		
Canyon	2.9L L4 F/I	HPR9778
Canyon	3.7L L5 F/I	HPR9778
Envoy	4.2L L6 F/I	HPR9345
Envoy Denali	5.3L V8 F/I	HPR9345
Sierra	5.3L V8 F/I	HPR8755
Sierra 1500	4.3L V6 F/I	HPR8755
Sierra 1500	4.8L V8 F/I	HPR8755 ♦+
Sierra 1500	5.3L V8 F/I	HPR8755 ♦+
Sierra 1500	6.0L V8 F/I	HPR8755 ♦+
Sierra 1500 Classic	4.3L V6 F/I	HPR8755
Sierra 1500 Classic	4.8L V8 F/I	HPR8755 ♦+
Sierra 1500 Classic	5.3L V8 F/I	HPR8755 ♦+
Sierra 1500 HD	6.0L V8 F/I	HPR8755
Sierra 1500 HD Classic	6.0L V8 F/I	HPR8755 ♦+
Sierra 2500 HD	6.0L V8 F/I	HPR8755 ♦+
Sierra 2500 HD Classic	6.0L V8 F/I	HPR8755 ♦+
Sierra 2500 HD Classic	8.1L V8 F/I	HPR8755
Sierra 3500 Classic	6.0L V8 F/I	HPR8755 ♦+
Sierra 3500 Classic	8.1L V8 F/I	HPR8755
Sierra 3500 HD	6.0L V8 F/I	HPR8755 +
Sierra Denali	6.2L V8 F/I	HPR8755 +
Sierra Denali Classic	6.0L V8 F/I	HPR8755 ♦+
Yukon	4.8L V8 F/I	HPR8755 ♦+
Yukon	5.3L V8 F/I	HPR8755 ♦+
Yukon Denali	6.2L V8 F/I	HPR8755 +
Yukon XL 1500	5.3L V8 F/I	HPR8755 ♦+
Yukon XL 1500	6.0L V8 F/I	HPR8755 ♦+
Yukon XL 1500	6.2L V8 F/I	HPR8755 +
Yukon XL 2500	6.0L V8 F/I	HPR8755 +
Yukon XL 2500	8.1L V8 F/I	HPR8755

2006 GMC		
Canyon	2.8L L4 F/I	HPR9778
Canyon	3.5L L5 F/I	HPR9778
Envoy	4.2L L6 F/I	HPR9345
Envoy Denali	5.3L V8 F/I	HPR9345
Sierra 1500	4.3L V6 F/I	HPR8755
Sierra 1500	4.8L V8 F/I	HPR8755 ♦+
Sierra 1500	5.3L V8 F/I	HPR8755 ♦+
Sierra 1500	6.0L V8 F/I	HPR8755 ♦+
Sierra 1500 HD	6.0L V8 F/I	HPR8755 ♦+
Sierra 2500 HD	6.0L V8 F/I	HPR8755 ♦+
Sierra 2500 HD	8.1L V8 F/I	HPR8755
Sierra 3500	6.0L V8 F/I	HPR8755 ♦+
Sierra 3500	8.1L V8 F/I	HPR8755 +
Sierra Denali	6.0L V8 F/I	HPR8755 ♦
Yukon	4.8L V8 F/I	HPR8755 ♦+
Yukon	5.3L V8 F/I	HPR8755 ♦+
Yukon Denali	6.0L V8 F/I	HPR8755 +
Yukon Denali XL	6.0L V8 F/I	HPR8755 +
Yukon XL 1500	5.3L V8 F/I	HPR8755 ♦+
Yukon XL 2500	6.0L V8 F/I	HPR8755 ♦+
Yukon XL 2500	8.1L V8 F/I	HPR8755 +

2005 GMC		
Canyon	2.8L L4 F/I	HPR9778
Canyon	3.5L L5 F/I	HPR9778

*Indicates 2 filters required ♦ Intake system available - see page 326 + throttle body spacer available - see page 20

HPR™ REPLACEMENT AIR FILTERS

GMC

Vehicle	Engine Type	Air Filter	Vehicle	Engine Type	Air Filter
2005 GMC			2003 GMC		
Envoy	4.2L L6 F/I	HPR9345	Sierra 3500	6.6L V8 DSL	HPR8755 ♦
Envoy	5.3L V8 F/I	HPR9345	Sierra 3500	8.1L V8 F/I	HPR8755 +
Jimmy	4.3L V6 F/I	HPR7421	Sierra Denali	6.0L V8 F/I	HPR8755 ♦
Safari	4.3L V6 F/I	HPR7421	Sonoma	2.2L L4 F/I	HPR7421 ♦
Sierra 1500	4.3L V6 F/I	HPR8755	Sonoma	4.3L V6 F/I	HPR7421 ♦
Sierra 1500	4.8L V8 F/I	HPR8755 ♦+	Yukon	4.8L V8 F/I	HPR8755 ♦+
Sierra 1500	5.3L V8 F/I	HPR8755 ♦+	Yukon	5.3L V8 F/I	HPR8755 ♦+
Sierra 1500	6.0L V8 F/I	HPR8755 ♦+	Yukon Denali	6.0L V8 F/I	HPR8755 ♦+
Sierra 1500 HD	6.0L V8 F/I	HPR8755 ♦+	Yukon Denali XL	6.0L V8 F/I	HPR8755 ♦+
Sierra 2500 HD	6.0L V8 F/I	HPR8755 ♦+	Yukon XL 1500	5.3L V8 F/I	HPR8755 ♦+
Sierra 2500 HD	6.6L V8 DSL - w/Panel Filter	HPR8755	Yukon XL 2500	6.0L V8 F/I	HPR8755 ♦+
Sierra 2500 HD	8.1L V8 F/I	HPR8755	Yukon XL 2500	8.1L V8 F/I	HPR8755 +
Sierra 3500	6.0L V8 F/I	HPR8755 ♦+	2002 GMC		
Sierra 3500	6.6L V8 DSL - w/Panel Filter	HPR8755	C3500HD	6.5L V8 DSL	HPR8038
Sierra 3500	8.1L V8 F/I	HPR8755 +	C3500HD	8.1L V8 F/I	HPR8755
Sierra Denali	6.0L V8 F/I	HPR8755 ♦	Envoy	4.2L L6 F/I	HPR9345
Yukon	4.8L V8 F/I	HPR8755 ♦+	Jimmy	4.3L V6 F/I	HPR7421
Yukon	5.3L V8 F/I	HPR8755 ♦+	Safari	4.3L V6 F/I	HPR7421
Yukon Denali	6.0L V8 F/I	HPR8755 +	Savana 2500	6.5L V8 DSL	HPR3914
Yukon Denali XL	6.0L V8 F/I	HPR8755 +	Savana 3500	6.5L V8 DSL	HPR3914
Yukon XL 1500	5.3L V8 F/I	HPR8755 ♦+	Sierra 1500	4.3L V6 F/I	HPR8755
Yukon XL 2500	6.0L V8 F/I	HPR8755 ♦+	Sierra 1500	4.8L V8 F/I	HPR8755 ♦+
Yukon XL 2500	8.1L V8 F/I	HPR8755 +	Sierra 1500	5.3L V8 F/I	HPR8755 ♦+
2004 GMC			Sierra 1500 HD	6.0L V8 F/I	HPR8755 ♦+
Canyon	2.8L L4 F/I	HPR9778	Sierra 2500	6.0L V8 F/I	HPR8755 ♦+
Canyon	3.5L L5 F/I	HPR9778	Sierra 2500 HD	6.0L V8 F/I	HPR8755 ♦+
Envoy	4.2L L6 F/I	HPR9345	Sierra 2500 HD	6.6L V8 DSL	HPR8755 ♦
Envoy	5.3L V8 F/I	HPR9345	Sierra 2500 HD	8.1L V8 F/I	HPR8755
Jimmy	4.3L V6 F/I	HPR7421	Sierra 3500	6.0L V8 F/I	HPR8755 ♦+
Safari	4.3L V6 F/I	HPR7421	Sierra 3500	6.6L V8 DSL	HPR8755 ♦
Sierra 1500	4.3L V6 F/I	HPR8755	Sierra 3500	8.1L V8 F/I	HPR8755 +
Sierra 1500	4.8L V8 F/I	HPR8755 ♦+	Sierra Denali	6.0L V8 F/I	HPR8755 ♦
Sierra 1500	5.3L V8 F/I	HPR8755 ♦+	Sonoma	2.2L L4 F/I	HPR7421 ♦
Sierra 2500	6.0L V8 F/I	HPR8755 ♦+	Sonoma	4.3L V6 F/I	HPR7421 ♦
Sierra 2500 HD	6.0L V8 F/I	HPR8755 ♦+	Yukon	4.8L V8 F/I	HPR8755 ♦+
Sierra 2500 HD	6.6L V8 DSL	HPR8755 ♦	Yukon	5.3L V8 F/I	HPR8755 ♦+
Sierra 2500 HD	8.1L V8 F/I	HPR8755	Yukon Denali	6.0L V8 F/I	HPR8755 ♦+
Sierra 3500	6.0L V8 F/I	HPR8755 ♦+	Yukon Denali XL	6.0L V8 F/I	HPR8755 ♦+
Sierra 3500	6.6L V8 DSL	HPR8755 ♦	Yukon XL 1500	5.3L V8 F/I	HPR8755 ♦+
Sierra 3500	8.1L V8 F/I	HPR8755 +	Yukon XL 2500	6.0L V8 F/I	HPR8755 ♦+
Sierra Denali	6.0L V8 F/I	HPR8755 ♦	Yukon XL 2500	8.1L V8 F/I	HPR8755 +
Sonoma	4.3L V6 F/I	HPR7421 ♦	2001 GMC		
Yukon	4.8L V8 F/I	HPR8755 ♦+	C3500HD	6.5L V8 DSL	HPR8038
Yukon	5.3L V8 F/I	HPR8755 ♦+	C3500HD	8.1L V8 F/I	HPR8755
Yukon Denali	6.0L V8 F/I	HPR8755 ♦+	Jimmy	4.3L V6 F/I	HPR7421 ♦
Yukon Denali XL	6.0L V8 F/I	HPR8755 ♦+	Safari	4.3L V6 F/I	HPR7421
Yukon XL 1500	5.3L V8 F/I	HPR8755 ♦+	Savana 2500	6.5L V8 DSL	HPR3914
Yukon XL 2500	6.0L V8 F/I	HPR8755 ♦+	Savana 3500	6.5L V8 DSL	HPR3914
Yukon XL 2500	8.1L V8 F/I	HPR8755 +	Sierra 1500	4.3L V6 F/I	HPR8755
2003 GMC			Sierra 1500	4.8L V8 F/I	HPR8755 ♦+
Envoy	4.2L L6 F/I	HPR9345	Sierra 1500	5.3L V8 F/I	HPR8755 ♦+
Envoy	5.3L V8 F/I	HPR9345	Sierra 1500	6.0L V8 F/I	HPR8755 ♦+
Jimmy	4.3L V6 F/I	HPR7421	Sierra 1500 HD	6.0L V8 F/I	HPR8755 ♦+
Safari	4.3L V6 F/I	HPR7421	Sierra 2500	6.0L V8 F/I	HPR8755 ♦+
Sierra 1500	4.3L V6 F/I	HPR8755	Sierra 2500 HD	6.0L V8 F/I	HPR8755 ♦+
Sierra 1500	4.8L V8 F/I	HPR8755 ♦+	Sierra 2500 HD	6.6L V8 DSL	HPR8755 ♦
Sierra 1500	5.3L V8 F/I	HPR8755 ♦+	Sierra 2500 HD	8.1L V8 F/I	HPR8755
Sierra 1500 HD	6.0L V8 F/I	HPR8755 ♦+	Sierra 3500	6.0L V8 F/I	HPR8755 ♦+
Sierra 2500	6.0L V8 F/I	HPR8755 ♦+	Sierra 3500	6.6L V8 DSL	HPR8755 ♦
Sierra 2500 HD	6.0L V8 F/I	HPR8755 ♦+	Sierra 3500	8.1L V8 F/I	HPR8755 +
Sierra 2500 HD	6.6L V8 DSL	HPR8755 ♦	Sierra C3	6.0L V8 F/I	HPR8755
Sierra 2500 HD	8.1L V8 F/I	HPR8755	Sonoma	2.2L L4 F/I	HPR7421 ♦
Sierra 3500	6.0L V8 F/I	HPR8755 ♦+	Sonoma	4.3L V6 F/I	HPR7421 ♦

*Indicates 2 filters required ♦ Intake system available - see page 326 + throttle body spacer available - see page 20

Vehicle	Engine Type	Air Filter	Vehicle	Engine Type	Air Filter
2001 GMC			1999 GMC		
Yukon	4.8L V8 F/I	HPR8755 ♦+	K1500 Suburban	6.5L V8 DSL	HPR8038
Yukon	5.3L V8 F/I	HPR8755 ♦+	K2500	5.0L V8 F/I	HPR8038 ♦+
Yukon Denali	6.0L V8 F/I	HPR8755 ♦+	K2500	5.7L V8 F/I	HPR8038 ♦+
Yukon Denali XL	6.0L V8 F/I	HPR8755 ♦+	K2500	6.5L V8 DSL	HPR8038
Yukon XL 1500	5.3L V8 F/I	HPR8755 ♦+	K2500	7.4L V8 F/I	HPR8038
Yukon XL 2500	6.0L V8 F/I	HPR8755 ♦+	K2500 Suburban	5.7L V8 F/I	HPR8038 ♦+
Yukon XL 2500	8.1L V8 F/I	HPR8755 +	K2500 Suburban	6.5L V8 DSL	HPR8038
2000 GMC			K2500 Suburban	7.4L V8 F/I	HPR8038
C2500	5.7L V8 F/I	HPR8038 ♦+	K3500	5.7L V8 F/I	HPR8038 ♦+
C2500	6.5L V8 DSL	HPR8038	K3500	6.5L V8 DSL	HPR8038
C2500	7.4L V8 F/I	HPR8038	K3500	7.4L V8 F/I	HPR8038
C3500	5.7L V8 F/I	HPR8038 ♦+	P3500	4.3L V6 F/I	HPR3914
C3500	6.5L V8 DSL	HPR8038	P3500	5.7L V8 F/I	HPR3914
C3500	7.4L V8 F/I	HPR8038	P3500	7.4L V8 F/I	HPR3914
Jimmy	4.3L V6 F/I	HPR7421 ♦	Safari	4.3L V6 F/I	HPR7421
K2500	5.7L V8 F/I	HPR8038 ♦+	Savana 1500	4.3L V6 F/I	HPR3914
K2500	6.5L V8 DSL	HPR8038	Savana 1500	5.0L V8 F/I	HPR3914
K2500	7.4L V8 F/I	HPR8038	Savana 1500	5.7L V8 F/I	HPR3914
K3500	5.7L V8 F/I	HPR8038 ♦+	Savana 2500	4.3L V6 F/I	HPR3914
K3500	6.5L V8 DSL	HPR8038	Savana 2500	5.0L V8 F/I	HPR3914
K3500	7.4L V8 F/I	HPR8038	Savana 2500	5.7L V8 F/I	HPR3914
Safari	4.3L V6 F/I	HPR7421	Savana 2500	6.5L V8 DSL	HPR3914
Savana 1500	4.3L V6 F/I	HPR3914	Savana 2500	5.7L V8 F/I	HPR3914
Savana 1500	5.0L V8 F/I	HPR3914	Savana 3500	6.5L V8 DSL	HPR3914
Savana 1500	5.7L V8 F/I	HPR3914	Savana 3500	7.4L V8 F/I	HPR3914
Savana 2500	4.3L V6 F/I	HPR3914	Sierra 1500	4.3L V6 F/I	HPR8755
Savana 2500	5.0L V8 F/I	HPR3914	Sierra 1500	4.8L V8 F/I	HPR8755 ♦+
Savana 2500	5.7L V8 F/I	HPR3914	Sierra 1500	5.3L V8 F/I	HPR8755 ♦+
Savana 2500	6.5L V8 DSL	HPR3914	Sierra 2500	5.3L V8 F/I	HPR8755 ♦+
Savana 3500	5.7L V8 F/I	HPR3914	Sierra 2500	6.0L V8 F/I	HPR8755 ♦+
Savana 3500	6.5L V8 DSL	HPR3914	Sonoma	2.2L L4 F/I	HPR7421 ♦
Savana 3500	7.4L V8 F/I	HPR3914	Sonoma	4.3L V6 F/I	HPR7421 ♦
Sierra 1500	4.3L V6 F/I	HPR8755	Yukon	5.7L V8 F/I	HPR8038 ♦+
Sierra 1500	4.8L V8 F/I	HPR8755 ♦+	Yukon Denali	5.7L V8 F/I	HPR8038 ♦+
Sierra 1500	5.3L V8 F/I	HPR8755 ♦+	Yukon Denali	6.5L V8 DSL	HPR8038
Sierra 2500	5.3L V8 F/I	HPR8755 ♦+	1998 GMC		
Sierra 2500	6.0L V8 F/I	HPR8755 ♦+	C1500	4.3L V6 F/I	HPR8038
Sonoma	2.2L L4 F/I	HPR7421 ♦	C1500	5.0L V8 F/I	HPR8038 ♦+
Sonoma	4.3L V6 F/I	HPR7421 ♦	C1500	5.7L V8 F/I	HPR8038 ♦+
Yukon	4.8L V8 F/I	HPR8755 ♦+	C1500	6.5L V8 DSL	HPR8038
Yukon	5.3L V8 F/I	HPR8755 ♦+	C1500 Suburban	5.7L V8 F/I	HPR8038 ♦+
Yukon Denali	5.7L V8 F/I	HPR8038 ♦+	C1500 Suburban	6.5L V8 DSL	HPR8038
Yukon XL 1500	5.3L V8 F/I	HPR8755 ♦+	C2500	5.0L V8 F/I	HPR8038 ♦+
Yukon XL 2500	6.0L V8 F/I	HPR8755 ♦+	C2500	5.7L V8 F/I	HPR8038 ♦+
1999 GMC			C2500	6.5L V8 DSL	HPR8038
C1500	5.0L V8 F/I	HPR8038 ♦+	C2500	7.4L V8 F/I	HPR8038
C1500	5.7L V8 F/I	HPR8038 ♦+	C2500 Suburban	5.7L V8 F/I	HPR8038 ♦+
C1500 Suburban	5.7L V8 F/I	HPR8038 ♦+	C2500 Suburban	6.5L V8 DSL	HPR8038
C1500 Suburban	6.5L V8 DSL	HPR8038	C2500 Suburban	7.4L V8 F/I	HPR8038
C2500	5.0L V8 F/I	HPR8038 ♦+	C3500	5.7L V8 F/I	HPR8038 ♦+
C2500	5.7L V8 F/I	HPR8038 ♦+	C3500	6.5L V8 DSL	HPR8038
C2500	6.5L V8 DSL	HPR8038	C3500	7.4L V8 F/I	HPR8038
C2500	7.4L V8 F/I	HPR8038	Jimmy	4.3L V6 F/I	HPR7421 ♦
C2500 Suburban	5.7L V8 F/I	HPR8038 ♦+	K1500	4.3L V6 F/I	HPR8038
C2500 Suburban	6.5L V8 DSL	HPR8038	K1500	5.0L V8 F/I	HPR8038 ♦+
C2500 Suburban	7.4L V8 F/I	HPR8038	K1500	5.7L V8 F/I	HPR8038 ♦+
C3500	5.7L V8 F/I	HPR8038 ♦+	K1500	6.5L V8 DSL	HPR8038
C3500	6.5L V8 DSL	HPR8038	K1500 Suburban	5.7L V8 F/I	HPR8038 ♦+
C3500	7.4L V8 F/I	HPR8038	K1500 Suburban	6.5L V8 DSL	HPR8038
Jimmy	4.3L V6 F/I	HPR7421 ♦	K2500	5.0L V8 F/I	HPR8038 ♦+
K1500	5.0L V8 F/I	HPR8038 ♦+	K2500	5.7L V8 F/I	HPR8038 ♦+
K1500	5.7L V8 F/I	HPR8038 ♦+	K2500	6.5L V8 DSL	HPR8038
K1500 Suburban	5.7L V8 F/I	HPR8038 ♦+	K2500	7.4L V8 F/I	HPR8038
			K2500 Suburban	5.7L V8 F/I	HPR8038 ♦+

*Indicates 2 filters required ♦ Intake system available - see page 326 + throttle body spacer available - see page 20

HPR™ REPLACEMENT AIR FILTERS

GMC

Vehicle	Engine Type	Air Filter	Vehicle	Engine Type	Air Filter
1998 GMC			1997 GMC		
K2500 Suburban	6.5L V8 DSL	HPR8038	Savana 2500	5.7L V8 F/I	HPR3914
K2500 Suburban	7.4L V8 F/I	HPR8038	Savana 2500	6.5L V8 DSL	HPR3914
K3500	5.7L V8 F/I	HPR8038 ♦+	Savana 3500	5.7L V8 F/I	HPR3914
K3500	6.5L V8 DSL	HPR8038	Savana 3500	6.5L V8 DSL	HPR3914
K3500	7.4L V8 F/I	HPR8038	Savana 3500	7.4L V8 F/I	HPR3914
P3500	4.3L V6 F/I	HPR3914	Sonoma	2.2L L4 F/I	HPR7421
P3500	5.7L V8 F/I	HPR3914	Sonoma	4.3L V6 F/I	HPR7421 ♦
P3500	7.4L V8 F/I	HPR3914	Yukon	5.7L V8 F/I	HPR8038 ♦+
Safari	4.3L V6 F/I	HPR7421	Yukon	6.5L V8 DSL	HPR8038
Savana 1500	4.3L V6 F/I	HPR3914	1996 GMC		
Savana 1500	5.0L V8 F/I	HPR3914	C1500	4.3L V6 F/I	HPR8038
Savana 1500	5.7L V8 F/I	HPR3914	C1500	5.0L V8 F/I	HPR8038 ♦+
Savana 2500	4.3L V6 F/I	HPR3914	C1500	5.7L V8 F/I	HPR8038 ♦+
Savana 2500	5.0L V8 F/I	HPR3914	C1500 Suburban	5.7L V8 F/I	HPR8038 ♦+
Savana 2500	5.7L V8 F/I	HPR3914	C2500	5.0L V8 F/I	HPR8038 ♦+
Savana 2500	6.5L V8 DSL	HPR3914	C2500	5.7L V8 F/I	HPR8038 ♦+
Savana 3500	5.7L V8 F/I	HPR3914	C2500	7.4L V8 F/I	HPR8038
Savana 3500	6.5L V8 DSL	HPR3914	C2500 Suburban	5.7L V8 F/I	HPR8038 ♦+
Savana 3500	7.4L V8 F/I	HPR3914	C2500 Suburban	7.4L V8 F/I	HPR8038
Sonoma	2.2L L4 F/I	HPR7421 ♦	C3500	5.7L V8 F/I	HPR8038 ♦+
Sonoma	4.3L V6 F/I	HPR7421 ♦	C3500	6.5L V8 DSL	HPR8038
Yukon	5.7L V8 F/I	HPR8038 ♦+	C3500	7.4L V8 F/I	HPR8038
1997 GMC			C3500	4.3L V6 F/I	HPR0192
C1500	4.3L V6 F/I	HPR8038	G3500	5.7L V8 F/I	HPR0192
C1500	5.0L V8 F/I	HPR8038 ♦+	G3500	6.5L V8 DSL	HPR3914
C1500	5.7L V8 F/I	HPR8038 ♦+	G3500	7.4L V8 F/I	HPR0326
C1500	6.5L V8 DSL	HPR8038	Jimmy	4.3L V6 F/I	HPR7421 ♦
C1500 Suburban	5.7L V8 F/I	HPR8038 ♦+	K1500	4.3L V6 F/I	HPR8038
C1500 Suburban	6.5L V8 DSL	HPR8038	K1500	5.0L V8 F/I	HPR8038 ♦+
C2500	5.0L V8 F/I	HPR8038 ♦+	K1500	5.7L V8 F/I	HPR8038 ♦+
C2500	5.7L V8 F/I	HPR8038 ♦+	K1500	6.5L V8 DSL	HPR8038
C2500	6.5L V8 DSL	HPR8038	K1500 Suburban	5.7L V8 F/I	HPR8038 ♦+
C2500	7.4L V8 F/I	HPR8038	K2500	5.0L V8 F/I	HPR8038
C2500 Suburban	5.7L V8 F/I	HPR8038 ♦+	K2500	5.7L V8 F/I	HPR8038 ♦+
C2500 Suburban	6.5L V8 DSL	HPR8038	K2500	6.5L V8 DSL	HPR8038
C2500 Suburban	7.4L V8 F/I	HPR8038	K2500	7.4L V8 F/I	HPR8038
C3500	5.7L V8 F/I	HPR8038 ♦+	K2500 Suburban	5.7L V8 F/I	HPR8038 ♦+
C3500	6.5L V8 DSL	HPR8038	K2500 Suburban	7.4L V8 F/I	HPR8038
C3500	7.4L V8 F/I	HPR8038	K3500	5.7L V8 F/I	HPR8038 ♦+
Jimmy	4.3L V6 F/I	HPR7421 ♦	K3500	6.5L V8 DSL	HPR8038
K1500	4.3L V6 F/I	HPR8038	K3500	7.4L V8 F/I	HPR8038
K1500	5.0L V8 F/I	HPR8038 ♦+	P3500	4.3L V6 F/I	HPR3914
K1500	5.7L V8 F/I	HPR8038 ♦+	P3500	5.7L V8 F/I	HPR0326
K1500	6.5L V8 DSL	HPR8038	Safari	4.3L V6 F/I	HPR7421
K1500 Suburban	5.7L V8 F/I	HPR8038 ♦+	Savana 1500	4.3L V6 F/I	HPR3914
K1500 Suburban	6.5L V8 DSL	HPR8038	Savana 1500	5.0L V8 F/I	HPR0192
K2500	5.0L V8 F/I	HPR8038	Savana 1500	5.7L V8 F/I	HPR3914
K2500	5.7L V8 F/I	HPR8038 ♦+	Savana 2500	4.3L V6 F/I	HPR3914
K2500	6.5L V8 DSL	HPR8038	Savana 2500	5.0L V8 F/I	HPR0192
K2500	7.4L V8 F/I	HPR8038	Savana 2500	5.7L V8 F/I	HPR3914
K2500 Suburban	5.7L V8 F/I	HPR8038 ♦+	Savana 2500	7.4L V8 F/I	HPR3914
K2500 Suburban	6.5L V8 DSL	HPR8038	Sonoma	2.2L L4 F/I	HPR7421
K2500 Suburban	7.4L V8 F/I	HPR8038	Sonoma	4.3L V6 F/I	HPR7421 ♦
K3500	5.7L V8 F/I	HPR8038 ♦+	Yukon	5.7L V8 F/I	HPR8038 ♦+
K3500	6.5L V8 DSL	HPR8038	1995 GMC		
K3500	7.4L V8 F/I	HPR8038	C1500	4.3L V6 F/I	HPR0192 +
P3500	4.3L V6 F/I	HPR0192	C1500	5.0L V8 F/I	HPR0326 +
P3500	5.7L V8 F/I	HPR0326	C1500	5.7L V8 F/I	HPR0326 +
Safari	4.3L V6 F/I	HPR7421	C1500 Suburban	5.7L V8 F/I	HPR0326 +
Savana 1500	4.3L V6 F/I	HPR3914	C2500	4.3L V6 F/I	HPR0192 +
Savana 1500	5.0L V8 F/I	HPR0192	C2500	5.0L V8 F/I	HPR0326 +
Savana 1500	5.7L V8 F/I	HPR3914	C2500	5.7L V8 F/I	HPR0326 +
Savana 2500	4.3L V6 F/I	HPR3914			
Savana 2500	5.0L V8 F/I	HPR0192			

*Indicates 2 filters required ♦ Intake system available - see page 326 + throttle body spacer available - see page 20

Vehicle	Engine Type	Air Filter	Vehicle	Engine Type	Air Filter
1995 GMC			1994 GMC		
C2500	7.4L V8 F/I	HPR0326	G2500	5.0L V8 F/I	HPR0192
C2500 Suburban	5.7L V8 F/I	HPR0326 +	G2500	5.7L V8 F/I	HPR0192
C2500 Suburban	7.4L V8 F/I	HPR0326	G2500	6.5L V8 DSL	HPR3914
C3500	5.7L V8 F/I	HPR0326 +	G3500	4.3L V6 F/I	HPR0192
C3500	6.5L V8 DSL	HPR8038	G3500	5.7L V8 F/I	HPR0192
C3500	7.4L V8 F/I	HPR0326	G3500	6.5L V8 DSL	HPR3914
G1500	4.3L V6 F/I	HPR0192	G3500	7.4L V8 F/I	HPR0326
G1500	5.0L V8 F/I	HPR0192	Jimmy	4.3L V6 CPI	HPR7421 +
G2500	4.3L V6 F/I	HPR0192	Jimmy	4.3L V6 TBI	HPR3588 +
G2500	5.0L V8 F/I	HPR0192	K1500	4.3L V6 F/I	HPR0192 +
G2500	5.7L V8 F/I	HPR0192	K1500	5.0L V8 F/I	HPR0326 +
G2500	6.5L V8 DSL	HPR3914	K1500	5.7L V8 F/I	HPR0326 +
G3500	4.3L V6 F/I	HPR0192	K1500	6.5L V8 DSL	HPR8038
G3500	5.7L V8 F/I	HPR0192	K1500 Suburban	5.7L V8 F/I	HPR0326 +
G3500	6.5L V8 DSL	HPR3914	K2500	4.3L V6 F/I	HPR0192 +
G3500	7.4L V8 F/I	HPR0326	K2500	5.0L V8 F/I	HPR0326 +
Jimmy	4.3L V6 F/I	HPR7421 +	K2500	5.7L V8 F/I	HPR0326 +
K1500	4.3L V6 F/I	HPR0192 +	K2500	6.5L V8 DSL	HPR8038
K1500	5.0L V8 F/I	HPR0326 +	K2500	7.4L V8 F/I	HPR0326
K1500	5.7L V8 F/I	HPR0326 +	K2500 Suburban	5.7L V8 F/I	HPR0326 +
K1500	6.5L V8 DSL	HPR8038	K2500 Suburban	7.4L V8 F/I	HPR0326
K1500 Suburban	5.7L V8 F/I	HPR0326 +	K3500	5.7L V8 F/I	HPR0326 +
K2500	4.3L V6 F/I	HPR0192 +	K3500	6.5L V8 DSL	HPR8038
K2500	5.0L V8 F/I	HPR0326 +	K3500	7.4L V8 F/I	HPR0326
K2500	5.7L V8 F/I	HPR0326 +	Motorhome	4.3L V6 F/I - Class C	HPR0192
K2500	6.5L V8 DSL	HPR8038	Motorhome	5.0L V8 F/I - Class C	HPR0192
K2500	7.4L V8 F/I	HPR0326	Motorhome	5.7L V8 F/I - VIN K, Class C, Exc. Off-Road	HPR0192
K2500 Suburban	5.7L V8 F/I	HPR0326 +	Motorhome	5.7L V8 F/I - VIN K, Class C, P Series	HPR0326
K2500 Suburban	7.4L V8 F/I	HPR0326	Motorhome	7.4L V8 F/I - Class C, w/3-7/16 inch Tall Filter	HPR0326
K3500	5.7L V8 F/I	HPR0326 +	P3500	4.3L V6 F/I	HPR0192
K3500	6.5L V8 DSL	HPR8038	P3500	5.7L V8 F/I	HPR0326
K3500	7.4L V8 F/I	HPR0326	P3500	7.4L V8 F/I	HPR0326
Motorhome	4.3L V6 F/I - Class C	HPR0192	Safari	4.3L V6 CPI	HPR7421
Motorhome	5.0L V8 F/I - Class C	HPR0192	Safari	4.3L V6 TBI	HPR3588
Motorhome	5.7L V8 F/I - VIN K, Class C, Exc. Off-Road	HPR0192	Sonoma	2.2L L4 F/I	HPR7421
Motorhome	5.7L V8 F/I - VIN K, Class C, P Series	HPR0326	Sonoma	4.3L V6 CPI	HPR7421 +
Motorhome	7.4L V8 F/I - Class C, w/3-7/16 inch Tall Filter	HPR0326	Sonoma	4.3L V6 TBI	HPR3588 +
P3500	4.3L V6 F/I	HPR0192	Yukon	5.7L V8 F/I	HPR0326 +
P3500	5.7L V8 F/I	HPR0326			
P3500	7.4L V8 F/I	HPR0326	1993 GMC		
Safari	4.3L V6 F/I	HPR7421	C1500	4.3L V6 F/I	HPR0192 +
Sonoma	2.2L L4 F/I	HPR7421	C1500	5.0L V8 F/I	HPR0326 +
Sonoma	4.3L V6 CPI	HPR7421 +	C1500	5.7L V8 F/I	HPR0326 +
Sonoma	4.3L V6 TBI	HPR3588 +	C1500 Suburban	5.7L V8 F/I	HPR0326 +
Yukon	5.7L V8 F/I	HPR0326 +	C2500	4.3L V6 F/I	HPR0192 +
			C2500	5.0L V8 F/I	HPR0326 +
			C2500	5.7L V8 F/I	HPR0326 +
			C2500	7.4L V8 F/I	HPR0326
			C2500 Suburban	5.7L V8 F/I	HPR0326 +
			C2500 Suburban	7.4L V8 F/I	HPR0326
			C3500	5.7L V8 F/I	HPR0326 +
			C3500	6.5L V8 DSL	HPR8038
			C3500	7.4L V8 F/I	HPR0326
			G1500	4.3L V6 F/I	HPR0192
			G1500	5.0L V8 F/I	HPR0192
			G1500	5.7L V8 F/I	HPR0192
			G2500	4.3L V6 F/I	HPR0192
			G2500	5.0L V8 F/I	HPR0192
			G2500	5.7L V8 F/I	HPR0192
			G3500	4.3L V6 F/I	HPR0192
			G3500	5.7L V8 F/I	HPR0192
			G3500	7.4L V8 F/I	HPR0326
			Jimmy	4.3L V6 CPI	HPR7421 +

*Indicates 2 filters required ♦ Intake system available - see page 326 + throttle body spacer available - see page 20

HPR™ REPLACEMENT AIR FILTERS

GMC

Vehicle	Engine Type	Air Filter	Vehicle	Engine Type	Air Filter
1993 GMC			1992 GMC		
Jimmy	4.3L V6 TBI	HPR3588 +	K2500	5.7L V8 F/I	HPR0326 +
K1500	4.3L V6 F/I	HPR0192 +	K2500	6.5L V8 DSL	HPR8038
K1500	5.0L V8 F/I	HPR0326 +	K2500	7.4L V8 F/I	HPR0326
K1500	5.7L V8 F/I	HPR0326 +	K2500 Suburban	5.7L V8 F/I	HPR0326 +
K1500 Suburban	5.7L V8 F/I	HPR0326 +	K2500 Suburban	7.4L V8 F/I	HPR0326
K2500	4.3L V6 F/I	HPR0192 +	K3500	5.7L V8 F/I	HPR0326 +
K2500	5.0L V8 F/I	HPR0326 +	K3500	6.5L V8 DSL	HPR8038
K2500	5.7L V8 F/I	HPR0326 +	K3500	7.4L V8 F/I	HPR0326
K2500	6.5L V8 DSL	HPR8038	Motorhome	4.3L V6 F/I - Class C	HPR0192
K2500	7.4L V8 F/I	HPR0326	Motorhome	5.0L V8 F/I - Class C	HPR0192
K2500 Suburban	5.7L V8 F/I	HPR0326 +	Motorhome	5.7L V8 F/I - VIN K, Class C, Exc. Off-Road	HPR0192
K2500 Suburban	7.4L V8 F/I	HPR0326	Motorhome	5.7L V8 F/I - VIN K, Class C, P Series	HPR0326
K3500	5.7L V8 F/I	HPR0326 +	Motorhome	7.4L V8 F/I - Class A & C, w/3-7/16 inch Tall Filter	HPR0326
K3500	6.5L V8 DSL	HPR8038	P3500	4.3L V6 F/I	HPR0192
K3500	7.4L V8 F/I	HPR0326	P3500	5.7L V8 F/I	HPR0326
Motorhome	4.3L V6 F/I - Class C	HPR0192	P3500	7.4L V8 F/I	HPR0326
Motorhome	5.0L V8 F/I - Class C	HPR0192	Safari	4.3L V6 CPI	HPR7421
Motorhome	5.7L V8 F/I - VIN K, Class C, Exc. Off-Road	HPR0192	Safari	4.3L V6 TBI	HPR3588
Motorhome	5.7L V8 F/I - VIN K, Class C, P Series	HPR0326	Sonoma	2.5L L4 F/I	HPR3647
Motorhome	7.4L V8 F/I - Class A & C, w/3-7/16 inch Tall Filter	HPR0326	Sonoma	2.8L V6 F/I	HPR3588
P3500	4.3L V6 F/I	HPR0192	Sonoma	4.3L V6 CPI	HPR7421 +
P3500	5.7L V8 F/I	HPR0326	Sonoma	4.3L V6 TBI	HPR3588 +
P3500	7.4L V8 F/I	HPR0326	Typhoon	4.3L V6 F/I	HPR7421
Safari	4.3L V6 CPI	HPR7421	Yukon	5.7L V8 F/I	HPR0326 +
Safari	4.3L V6 TBI	HPR3588	1991 GMC		
Sonoma	2.5L L4 F/I	HPR3647	C1500	4.3L V6 F/I	HPR0192 +
Sonoma	2.8L V6 F/I	HPR3588	C1500	5.0L V8 F/I	HPR0326 +
Sonoma	4.3L V6 CPI	HPR7421 +	C1500	5.7L V8 F/I	HPR0326 +
Sonoma	4.3L V6 TBI	HPR3588 +	C2500	4.3L V6 F/I	HPR0192 +
Typhoon	4.3L V6 F/I	HPR7421	C2500	5.0L V8 F/I	HPR0326 +
Yukon	5.7L V8 F/I	HPR0326 +	C2500	5.7L V8 F/I	HPR0326 +
1992 GMC			C2500	7.4L V8 F/I - w/3-7/16 inch Tall Filter	HPR0326
C1500	4.3L V6 F/I	HPR0192 +	C3500	5.7L V8 F/I	HPR0326 +
C1500	5.0L V8 F/I	HPR0326 +	C3500	7.4L V8 F/I - w/3-7/16 inch Tall Filter	HPR0326
C1500	5.7L V8 F/I	HPR0326 +	G1500	4.3L V6 F/I	HPR0192
C1500 Suburban	5.7L V8 F/I	HPR0326 +	G1500	5.0L V8 F/I	HPR0192
C2500	4.3L V6 F/I	HPR0192 +	G1500	5.7L V8 F/I	HPR0192
C2500	5.0L V8 F/I	HPR0326 +	G2500	4.3L V6 F/I	HPR0192
C2500	5.7L V8 F/I	HPR0326 +	G2500	5.0L V8 F/I	HPR0192
C2500	7.4L V8 F/I	HPR0326	G2500	5.7L V8 F/I	HPR0192
C2500 Suburban	5.7L V8 F/I	HPR0326 +	G3500	4.3L V6 F/I	HPR0192
C2500 Suburban	7.4L V8 F/I	HPR0326	G3500	5.7L V8 F/I	HPR0192
C3500	5.7L V8 F/I	HPR0326 +	G3500	7.4L V8 F/I	HPR0326
C3500	6.5L V8 DSL	HPR8038	Jimmy	5.7L V8 F/I	HPR0326 +
C3500	7.4L V8 F/I	HPR0326	K1500	4.3L V6 F/I	HPR0192 +
G1500	4.3L V6 F/I	HPR0192	K1500	5.0L V8 F/I	HPR0326 +
G1500	5.0L V8 F/I	HPR0192	K1500	5.7L V8 F/I	HPR0326 +
G1500	5.7L V8 F/I	HPR0192	K2500	4.3L V6 F/I	HPR0192 +
G2500	4.3L V6 F/I	HPR0192	K2500	5.0L V8 F/I	HPR0326 +
G2500	5.0L V8 F/I	HPR0192	K2500	5.7L V8 F/I	HPR0326 +
G2500	5.7L V8 F/I	HPR0192	K2500	7.4L V8 F/I - w/3-7/16 inch Tall Filter	HPR0326
G3500	4.3L V6 F/I	HPR0192	K3500	5.7L V8 F/I	HPR0326 +
G3500	5.7L V8 F/I	HPR0192	K3500	7.4L V8 F/I - w/3-7/16 inch Tall Filter	HPR0326
G3500	7.4L V8 F/I	HPR0326	Motorhome	4.3L V6 F/I - Class C	HPR0192
Jimmy	4.3L V6 CPI	HPR7421 +	Motorhome	5.0L V8 F/I - Class C	HPR0192
Jimmy	4.3L V6 TBI	HPR3588 +	Motorhome	5.7L V8 F/I - Class C	HPR0192
K1500	4.3L V6 F/I	HPR0192 +	Motorhome	7.4L V8 F/I - Class A & C, w/3-7/16 inch Tall Filter	HPR0326
K1500	5.0L V8 F/I	HPR0326 +	P3500	4.3L V6 F/I	HPR0192
K1500	5.7L V8 F/I	HPR0326 +	P3500	5.7L V8 F/I	HPR0326
K1500 Suburban	5.7L V8 F/I	HPR0326 +	P3500	7.4L V8 F/I	HPR0326
K2500	4.3L V6 F/I	HPR0192 +	R1500 Suburban	5.7L V8 F/I	HPR0326 +
K2500	5.0L V8 F/I	HPR0326 +			

*Indicates 2 filters required ♦ Intake system available - see page 326 + throttle body spacer available - see page 20

Vehicle	Engine Type	Air Filter	Vehicle	Engine Type	Air Filter
1991 GMC			1989 GMC		
R2500 Suburban	5.7L V8 F/I	HPR0326 +	C1500	4.3L V6 F/I	HPR0192 +
R2500 Suburban	7.4L V8 F/I - w/3-7/16 inch Tall Filter	HPR0326	C1500	5.0L V8 F/I	HPR0326 +
R3500	5.7L V8 F/I	HPR0326 +	C1500	5.7L V8 F/I	HPR0326 +
R3500	7.4L V8 F/I - w/3-7/16 inch Tall Filter	HPR0326	C2500	4.3L V6 F/I	HPR0192 +
S15 Jimmy	4.3L V6 F/I	HPR3588 +	C2500	5.0L V8 F/I	HPR0326 +
Safari	4.3L V6 F/I	HPR3588	C2500	5.7L V8 F/I	HPR0326 +
Sonoma	2.5L L4 F/I	HPR3647	C3500	5.7L V8 F/I	HPR0326 +
Sonoma	2.8L V6 F/I	HPR3588	C3500	7.4L V8 F/I - w/3-7/16 inch Tall Filter	HPR0326 +
Sonoma	4.3L V6 F/I	HPR3588 +	G1500	4.3L V6 F/I	HPR0192
Syclone	4.3L V6 F/I	HPR7421	G1500	5.0L V8 F/I	HPR0192
V1500 Suburban	5.7L V8 F/I	HPR0326 +	G1500	5.7L V8 F/I	HPR0192
V2500 Suburban	5.7L V8 F/I	HPR0326 +	G2500	4.3L V6 F/I	HPR0192
V3500	5.7L V8 F/I	HPR0326 +	G2500	5.0L V8 F/I	HPR0192
V3500	7.4L V8 F/I - w/3-7/16 inch Tall Filter	HPR0326	G2500	5.7L V8 F/I	HPR0192
1990 GMC			G3500	4.3L V6 F/I	HPR0192
C1500	4.3L V6 F/I	HPR0192 +	G3500	5.7L V8 F/I	HPR0192
C1500	5.0L V8 F/I	HPR0326 +	G3500	7.4L V8 F/I	HPR0326
C1500	5.7L V8 F/I	HPR0326 +	Jimmy	5.7L V8 F/I	HPR0326 +
C2500	4.3L V6 F/I	HPR0192 +	K1500	4.3L V6 F/I	HPR0192 +
C2500	5.0L V8 F/I	HPR0326 +	K1500	5.0L V8 F/I	HPR0326 +
C2500	5.7L V8 F/I	HPR0326 +	K1500	5.7L V8 F/I	HPR0326 +
C3500	5.7L V8 F/I	HPR0326 +	K2500	4.3L V6 F/I	HPR0192 +
C3500	7.4L V8 F/I - w/3-7/16 inch Tall Filter	HPR0326 +	K2500	5.0L V8 F/I	HPR0326 +
G1500	4.3L V6 F/I	HPR0192	K2500	5.7L V8 F/I	HPR0326 +
G1500	5.0L V8 F/I	HPR0192	K3500	5.7L V8 F/I	HPR0326 +
G1500	5.7L V8 F/I	HPR0192	K3500	7.4L V8 F/I - w/3-7/16 inch Tall Filter	HPR0326 +
G2500	4.3L V6 F/I	HPR0192	Motorhome	4.3L V6 F/I - Class C	HPR0192
G2500	5.0L V8 F/I	HPR0192	Motorhome	5.0L V8 F/I - Class C	HPR0192
G2500	5.7L V8 F/I	HPR0192	Motorhome	5.7L V8 F/I - Class A & C	HPR0192
G3500	4.3L V6 F/I	HPR0192	Motorhome	7.4L V8 F/I - Class A & C, w/3-7/16 inch Tall Filter	HPR0326
G3500	5.7L V8 F/I	HPR0192	P2500	5.7L V8 F/I	HPR0326
G3500	7.4L V8 F/I	HPR0326	P3500	5.7L V8 F/I	HPR0326
Jimmy	5.7L V8 F/I	HPR0326 +	P3500	7.4L V8 CARB	HPR0326
K1500	4.3L V6 F/I	HPR0192 +	R1500 Suburban	5.7L V8 F/I	HPR0326 +
K1500	5.0L V8 F/I	HPR0326 +	R2500	5.7L V8 F/I	HPR0326 +
K1500	5.7L V8 F/I	HPR0326 +	R2500	7.4L V8 F/I - w/3-7/16 inch Tall Filter	HPR0326 +
K2500	4.3L V6 F/I	HPR0192 +	R2500 Suburban	5.7L V8 F/I	HPR0326 +
K2500	5.0L V8 F/I	HPR0326 +	R2500 Suburban	7.4L V8 F/I - w/3-7/16 inch Tall Filter	HPR0326 +
K2500	5.7L V8 F/I	HPR0326 +	R3500	5.7L V8 F/I	HPR0326 +
K3500	5.7L V8 F/I	HPR0326 +	R3500	7.4L V8 CARB - w/3-7/16 inch Tall Filter	HPR0326 +
K3500	7.4L V8 F/I - w/3-7/16 inch Tall Filter	HPR0326 +	R3500	7.4L V8 F/I - w/3-7/16 inch Tall Filter	HPR0326 +
Motorhome	4.3L V6 F/I - Class C	HPR0192	S15 Jimmy	2.8L V6 F/I	HPR3588
Motorhome	5.0L V8 F/I - Class C	HPR0192	S15 Jimmy	4.3L V6 TBI	HPR3588 +
Motorhome	5.7L V8 F/I - Class A & C	HPR0192	S15 Pickup	2.5L L4 F/I	HPR3647
Motorhome	7.4L V8 F/I - Class A & C, w/3-7/16 inch Tall Filter	HPR0326	S15 Pickup	2.8L V6 F/I	HPR3588
P3500	4.3L V6 F/I	HPR0192	S15 Pickup	4.3L V6 TBI	HPR3588 +
P3500	5.7L V8 F/I	HPR0326	Safari	2.5L L4 F/I	HPR3647
P3500	7.4L V8 F/I	HPR0326	Safari	4.3L V6 F/I	HPR3588
R1500 Suburban	5.7L V8 F/I	HPR0326 +	V1500 Suburban	5.7L V8 F/I	HPR0326 +
R2500 Suburban	5.7L V8 F/I	HPR0326 +	V2500 Suburban	5.7L V8 F/I	HPR0326 +
R2500 Suburban	7.4L V8 F/I - w/3-7/16 inch Tall Filter	HPR0326 +	V3500	5.7L V8 F/I	HPR0326 +
R3500	5.7L V8 F/I	HPR0326 +	V3500	7.4L V8 CARB - w/3-7/16 inch Tall Filter	HPR0326 +
R3500	7.4L V8 F/I - w/3-7/16 inch Tall Filter	HPR0326 +	V3500	7.4L V8 F/I - w/3-7/16 inch Tall Filter	HPR0326 +
S15 Jimmy	4.3L V6 TBI	HPR3588 +	1988 GMC		
S15 Pickup	2.5L L4 F/I	HPR3647	C1500	4.3L V6 F/I	HPR0192 +
S15 Pickup	2.8L V6 F/I	HPR3588	C1500	5.0L V8 F/I	HPR0326 +
S15 Pickup	4.3L V6 TBI	HPR3588 +	C1500	5.7L V8 F/I	HPR0326 +
Safari	2.5L L4 F/I	HPR3647	C2500	4.3L V6 F/I	HPR0192 +
Safari	4.3L V6 F/I	HPR3588	C2500	5.0L V8 F/I	HPR0326 +
V1500 Suburban	5.7L V8 F/I	HPR0326 +	C2500	5.7L V8 F/I	HPR0326 +
V2500 Suburban	5.7L V8 F/I	HPR0326 +	C2500	5.7L V8 F/I	HPR0326 +
V3500	5.7L V8 F/I	HPR0326 +	C3500	5.7L V8 F/I	HPR0326 +
V3500	7.4L V8 F/I - w/3-7/16 inch Tall Filter	HPR0326 +	C3500	7.4L V8 F/I - w/3-7/16 inch Tall Filter	HPR0326 +

*Indicates 2 filters required ♦ Intake system available - see page 326 + throttle body spacer available - see page 20

HPR™ REPLACEMENT AIR FILTERS

GMC

Vehicle	Engine Type	Air Filter	Vehicle	Engine Type	Air Filter
1988 GMC			1987 GMC		
G1500	4.3L V6 F/I	HPR0192	Jimmy	5.7L V8 F/I	HPR0326 +
G1500	5.0L V8 F/I	HPR0192	Motorhome	4.3L V6 F/I - Class C	HPR0192
G1500	5.7L V8 F/I	HPR0192	Motorhome	5.0L V8 F/I - Class C	HPR0192
G2500	4.3L V6 F/I	HPR0192	Motorhome	5.7L V8 F/I - Class A & C	HPR0192
G2500	5.0L V8 F/I	HPR0192	Motorhome	7.4L V8 F/I - Class A & C, w/3-7/16 inch Tall Filter	HPR0326
G2500	5.7L V8 F/I	HPR0192	P2500	5.7L V8 CARB	HPR0326
G3500	4.3L V6 F/I	HPR0192	P3500	5.7L V8 CARB	HPR0326
G3500	5.7L V8 CARB	HPR0192	P3500	5.7L V8 F/I	HPR0326
G3500	5.7L V8 F/I	HPR0192	P3500	7.4L V8 CARB	HPR0326
G3500	7.4L V8 F/I	HPR0326	R1500	4.3L V6 F/I	HPR0192 +
Jimmy	5.7L V8 F/I	HPR0326 +	R1500	5.0L V8 F/I	HPR0326 +
K1500	4.3L V6 F/I	HPR0192 +	R1500	5.7L V8 F/I	HPR0326 +
K1500	5.0L V8 F/I	HPR0326 +	R1500 Suburban	5.0L V8 F/I	HPR0326 +
K1500	5.7L V8 F/I	HPR0326 +	R1500 Suburban	5.7L V8 F/I	HPR0326 +
K2500	4.3L V6 F/I	HPR0192 +	R2500	4.3L V6 F/I	HPR0192 +
K2500	5.0L V8 F/I	HPR0326 +	R2500	5.0L V8 F/I	HPR0326 +
K2500	5.7L V8 F/I	HPR0326 +	R2500	5.7L V8 F/I	HPR0326 +
K3500	5.7L V8 F/I	HPR0326 +	R2500	7.4L V8 F/I - w/3-7/16 inch Tall Filter	HPR0326 +
K3500	7.4L V8 F/I - w/3-7/16 inch Tall Filter	HPR0326 +	R2500 Suburban	5.7L V8 F/I	HPR0326 +
Motorhome	4.3L V6 F/I - Class C	HPR0192	R2500 Suburban	7.4L V8 F/I - w/3-7/16 inch Tall Filter	HPR0326 +
Motorhome	5.0L V8 F/I - Class C	HPR0192	R3500	5.7L V8 CARB	HPR0326 +
Motorhome	5.7L V8 F/I - Class A & C	HPR0192	R3500	5.7L V8 F/I	HPR0326 +
Motorhome	7.4L V8 F/I - Class A & C, w/3-7/16 inch Tall Filter	HPR0326	R3500	7.4L V8 CARB - w/3-7/16 inch Tall Filter	HPR0326 +
P2500	5.7L V8 F/I	HPR0192	R3500	7.4L V8 F/I - w/3-7/16 inch Tall Filter	HPR0326 +
P3500	5.7L V8 F/I	HPR0326	S15 Jimmy	2.5L L4 F/I	HPR3647
P3500	7.4L V8 CARB	HPR0326	S15 Jimmy	2.8L V6 F/I	HPR3588
R1500 Suburban	5.7L V8 F/I	HPR0326 +	S15 Pickup	2.5L L4 F/I	HPR3647
R2500	5.7L V8 F/I	HPR0326 +	S15 Pickup	2.8L V6 F/I	HPR3588
R2500	7.4L V8 F/I - w/3-7/16 inch Tall Filter	HPR0326 +	Safari	2.5L L4 F/I	HPR3647
R2500 Suburban	5.7L V8 F/I	HPR0326 +	Safari	4.3L V6 F/I	HPR3588
R2500 Suburban	7.4L V8 F/I - w/3-7/16 inch Tall Filter	HPR0326 +	V1500	4.3L V6 F/I	HPR0192 +
R3500	5.7L V8 CARB	HPR0326 +	V1500	5.0L V8 F/I	HPR0326 +
R3500	5.7L V8 F/I	HPR0326 +	V1500	5.7L V8 F/I	HPR0326 +
R3500	7.4L V8 CARB - w/3-7/16 inch Tall Filter	HPR0326 +	V1500 Suburban	5.7L V8 F/I	HPR0326 +
R3500	7.4L V8 F/I - w/3-7/16 inch Tall Filter	HPR0326 +	V2500	5.7L V8 F/I	HPR0326 +
S15 Jimmy	2.5L L4 F/I	HPR3647	V2500 Suburban	5.7L V8 F/I	HPR0326 +
S15 Jimmy	2.8L V6 F/I	HPR3588	V3500	5.7L V8 CARB	HPR0326 +
S15 Jimmy	4.3L V6 F/I	HPR3588 +	V3500	5.7L V8 F/I	HPR0326 +
S15 Pickup	2.5L L4 F/I	HPR3647	V3500	7.4L V8 CARB - w/3-7/16 inch Tall Filter	HPR0326 +
S15 Pickup	2.8L V6 F/I	HPR3588	V3500	7.4L V8 F/I - w/3-7/16 inch Tall Filter	HPR0326 +
S15 Pickup	4.3L V6 F/I	HPR3588 +			
Safari	2.5L L4 F/I	HPR3647	1986 GMC		
Safari	4.3L V6 F/I	HPR3588	C1500	4.3L V6 CARB	HPR0326 +
V1500 Suburban	5.7L V8 F/I	HPR0326 +	C1500	5.0L V8 CARB - w/3-7/16 inch Tall Filter	HPR0326 +
V2500 Suburban	5.7L V8 F/I	HPR0326 +	C1500	5.7L V8 CARB	HPR0326 +
V3500	5.7L V8 CARB	HPR0326 +	C1500 Suburban	5.0L V8 CARB	HPR0326 +
V3500	5.7L V8 F/I	HPR0326 +	C1500 Suburban	5.7L V8 CARB	HPR0326 +
V3500	7.4L V8 CARB - w/3-7/16 inch Tall Filter	HPR0326 +	C2500	4.3L V6 CARB	HPR0326 +
V3500	7.4L V8 F/I - w/3-7/16 inch Tall Filter	HPR0326 +	C2500	5.0L V8 CARB - w/3-7/16 inch Tall Filter	HPR0326 +
			C2500	5.7L V8 CARB	HPR0326 +
			C2500	7.4L V8 CARB	HPR0326
			C2500 Suburban	5.0L V8 CARB	HPR0326 +
			C2500 Suburban	5.7L V8 CARB	HPR0326 +
			C2500 Suburban	7.4L V8 CARB - w/3-7/16 inch Tall Filter	HPR0326
			C3500	5.0L V8 CARB - w/3-7/16 inch Tall Filter	HPR0326 +
			C3500	5.7L V8 CARB	HPR0326 +
			C3500	7.4L V8 CARB	HPR0326
			Caballero	4.3L V6 F/I	HPR0192
			Caballero	5.0L V8 CARB	HPR0326
			G1500	4.3L V6 CARB	HPR0192
1987 GMC					
Caballero	4.3L V6 F/I	HPR0192			
Caballero	5.0L V8 CARB	HPR0326			
G1500	4.3L V6 F/I	HPR0192			
G1500	5.0L V8 F/I	HPR0192			
G1500	5.7L V8 F/I	HPR0192			
G2500	4.3L V6 F/I	HPR0192			
G2500	5.0L V8 F/I	HPR0192			
G2500	5.7L V8 F/I	HPR0192			
G3500	4.3L V6 F/I	HPR0192			
G3500	5.7L V8 CARB	HPR0192			
G3500	5.7L V8 F/I	HPR0192			
Jimmy	5.0L V8 F/I	HPR0326 +			

*Indicates 2 filters required ♦ Intake system available - see page 326 + throttle body spacer available - see page 20

Vehicle	Engine Type	Air Filter	Vehicle	Engine Type	Air Filter
1986 GMC			1985 GMC		
G1500	5.0L V8 CARB	HPR0192	Jimmy	5.7L V8 CARB - w/3-7/16 inch Tall Filter	HPR0326
G1500	5.7L V8 CARB	HPR0192	K1500	4.3L V6 CARB	HPR0326
G2500	4.3L V6 CARB	HPR0192	K1500	5.0L V8 CARB - w/3-7/16 inch Tall Filter	HPR0326
G2500	5.0L V8 CARB	HPR0192	K1500	5.7L V8 CARB - w/3-7/16 inch Tall Filter	HPR0326
G2500	5.7L V8 CARB	HPR0192	K1500 Suburban	5.0L V8 CARB	HPR0326
G3500	4.3L V6 CARB	HPR0192	K1500 Suburban	5.7L V8 CARB	HPR0326
G3500	5.7L V8 CARB	HPR0192	K2500	4.3L V6 CARB	HPR0326
Jimmy	5.0L V8 CARB	HPR0326 +	K2500	5.7L V8 CARB - w/3-7/16 inch Tall Filter	HPR0326
Jimmy	5.7L V8 CARB	HPR0326 +	K2500 Suburban	5.7L V8 CARB	HPR0326
K1500	4.3L V6 CARB	HPR0326 +	K3500	5.7L V8 CARB - w/3-7/16 inch Tall Filter	HPR0326
K1500	5.0L V8 CARB - w/3-7/16 inch Tall Filter	HPR0326 +	K3500	7.4L V8 CARB - w/3-7/16 inch Tall Filter	HPR0326
K1500	5.7L V8 CARB	HPR0326 +	Motorhome	4.3L V6 4 BBL. - Class C	HPR0192
K1500 Suburban	5.7L V8 CARB	HPR0326 +	Motorhome	5.0L V8 4 BBL. - Class C	HPR0192
K2500	5.7L V8 CARB	HPR0326 +	Motorhome	5.7L V8 4 BBL. - Class A & C	HPR0192
K2500 Suburban	5.7L V8 CARB	HPR0326 +	Motorhome	7.4L V8 4 BBL. - Class A & C, w/3-7/16 inch Tall Filter	HPR0326
K3500	5.7L V8 CARB	HPR0326 +	P2500	5.7L V8 CARB	HPR0326
K3500	7.4L V8 CARB	HPR0326	P3500	5.7L V8 CARB	HPR0326
Motorhome	4.3L V6 4 BBL. - Class C	HPR0192	P3500	7.4L V8 CARB	HPR0326
Motorhome	5.0L V8 4 BBL. - Class C	HPR0192	S15 Jimmy	2.5L L4 F/I	HPR3647
Motorhome	5.7L V8 4 BBL. - Class A & C	HPR0192	S15 Jimmy	2.8L V6 F/I	HPR3588
Motorhome	7.4L V8 4 BBL. - Class A & C, w/3-7/16 inch Tall Filter	HPR0326	S15 Pickup	2.5L L4 F/I	HPR3647
P2500	5.7L V8 CARB	HPR0326	S15 Pickup	2.8L V6 F/I	HPR3588
P3500	5.7L V8 CARB	HPR0326	Safari	2.5L L4 F/I	HPR3647
P3500	7.4L V8 CARB	HPR0326	Safari	4.3L V6 F/I	HPR3588
S15 Jimmy	2.5L L4 F/I	HPR3647	1984 GMC		
S15 Jimmy	2.8L V6 F/I	HPR3588	C1500	5.0L V8 CARB	HPR0326
S15 Pickup	2.5L L4 F/I	HPR3647	C1500	5.7L V8 CARB - w/3-7/16 inch Tall Filter	HPR0326
S15 Pickup	2.8L V6 F/I	HPR3588	C1500 Suburban	5.0L V8 CARB	HPR0326
Safari	2.5L L4 F/I	HPR3647	C1500 Suburban	5.7L V8 CARB	HPR0326
Safari	4.3L V6 F/I	HPR3588	C2500	5.0L V8 CARB	HPR0326
1985 GMC			C2500	5.7L V8 CARB - w/3-7/16 inch Tall Filter	HPR0326
C1500	4.3L V6 CARB	HPR0326	C2500	7.4L V8 CARB - w/3-7/16 inch Tall Filter	HPR0326
C1500	5.0L V8 CARB - w/3-7/16 inch Tall Filter	HPR0326	C2500 Suburban	5.0L V8 CARB	HPR0326
C1500	5.7L V8 CARB - w/3-7/16 inch Tall Filter	HPR0326	C2500 Suburban	5.7L V8 CARB	HPR0326
C1500 Suburban	5.0L V8 CARB	HPR0326	C2500 Suburban	7.4L V8 CARB - w/3-7/16 inch Tall Filter	HPR0326
C1500 Suburban	5.7L V8 CARB	HPR0326	C3500	5.7L V8 CARB - w/3-7/16 inch Tall Filter	HPR0326
C2500	4.3L V6 CARB	HPR0326	C3500	7.4L V8 CARB - w/3-7/16 inch Tall Filter	HPR0326
C2500	5.0L V8 CARB - w/3-7/16 inch Tall Filter	HPR0326	Caballero	3.8L V6 CARB - VIN 9	HPR3588
C2500	5.7L V8 CARB - w/3-7/16 inch Tall Filter	HPR0326	Caballero	3.8L V6 CARB - VIN A	HPR0192
C2500	7.4L V8 CARB - w/3-7/16 inch Tall Filter	HPR0326	Caballero	5.0L V8 CARB	HPR0326
C2500 Suburban	5.0L V8 CARB	HPR0326	G1500	5.0L V8 CARB	HPR0192
C2500 Suburban	5.7L V8 CARB	HPR0326	G1500	5.7L V8 CARB	HPR0192
C2500 Suburban	7.4L V8 CARB - w/3-7/16 inch Tall Filter	HPR0326	G2500	5.0L V8 CARB	HPR0192
C3500	5.7L V8 CARB - w/3-7/16 inch Tall Filter	HPR0326	G2500	5.7L V8 CARB	HPR0192
C3500	7.4L V8 CARB - w/3-7/16 inch Tall Filter	HPR0326	G3500	5.7L V8 CARB	HPR0192
Caballero	4.3L V6 F/I	HPR0192	Jimmy	5.0L V8 CARB	HPR0326
Caballero	5.0L V8 CARB	HPR0326	Jimmy	5.7L V8 CARB - w/3-7/16 inch Tall Filter	HPR0326
G1500	4.3L V6 CARB	HPR0192	K1500	5.0L V8 CARB	HPR0326
G1500	5.0L V8 CARB	HPR0192	K1500	5.7L V8 CARB - w/3-7/16 inch Tall Filter	HPR0326
G1500	5.7L V8 CARB	HPR0192	K1500 Suburban	5.0L V8 CARB	HPR0326
G2500	4.3L V6 CARB	HPR0192	K1500 Suburban	5.7L V8 CARB	HPR0326
G2500	5.0L V8 CARB	HPR0192	K2500	5.7L V8 CARB - w/3-7/16 inch Tall Filter	HPR0326
G2500	5.7L V8 CARB	HPR0192	K2500 Suburban	5.7L V8 CARB	HPR0326
G3500	4.3L V6 CARB	HPR0192			
G3500	5.7L V8 CARB	HPR0192			
G3500	5.0L V8 CARB - w/3-7/16 inch Tall Filter	HPR0326			
Jimmy	5.0L V8 CARB - w/3-7/16 inch Tall Filter	HPR0326			

*Indicates 2 filters required ♦ Intake system available - see page 326 + throttle body spacer available - see page 20

HPR™ REPLACEMENT AIR FILTERS

GMC

Vehicle	Engine Type	Air Filter	Vehicle	Engine Type	Air Filter
1984 GMC			1982 GMC		
K3500	5.7L V8 CARB - w/3-7/16 inch Tall Filter	HPR0326	C2500	5.7L V8 CARB	HPR0326
K3500	7.4L V8 CARB - w/3-7/16 inch Tall Filter	HPR0326	C2500 Suburban	5.0L V8 CARB	HPR0326
Motorhome	5.0L V8 4 BBL. - Class C	HPR0192	C2500 Suburban	5.7L V8 CARB	HPR0326
Motorhome	5.7L V8 4 BBL. - Class A & C	HPR0192	C2500 Suburban	7.4L V8 CARB - w/3-7/16 inch Tall Filter	HPR0326
Motorhome	7.4L V8 4 BBL. - Class A & C, w/3-7/16 inch Tall Filter	HPR0326	C3500	5.7L V8 CARB	HPR0326
P2500	5.7L V8 CARB	HPR0192	C3500	7.4L V8 CARB	HPR8038
P3500	5.7L V8 CARB	HPR0192	Caballero	3.8L V6 CARB - VIN A	HPR0192
S15 Jimmy	1.9L L4 CARB	HPR0352	Caballero	3.8L V6 CARB - VIN K	HPR3588
S15 Pickup	1.9L L4 CARB	HPR0352	Caballero	4.4L V8 CARB	HPR3588
S15 Pickup	2.2L L4 DSL	HPR0352	Caballero	5.0L V8 CARB	HPR0326
1983 GMC			G1500	5.0L V8 CARB	HPR0192
C1500	5.0L V8 CARB	HPR0326	G1500	5.7L V8 CARB	HPR0192
C1500	5.7L V8 CARB - w/3-7/16 inch Tall Filter	HPR0326	G1500	5.0L V8 CARB	HPR0192
C1500 Suburban	5.0L V8 CARB	HPR0326	G2500	5.0L V8 CARB	HPR0192
C1500 Suburban	5.7L V8 CARB	HPR0326	G2500	5.7L V8 CARB	HPR0192
C2500	5.0L V8 CARB	HPR0326	G3500	5.7L V8 CARB	HPR0192
C2500	5.7L V8 CARB - w/3-7/16 inch Tall Filter	HPR0326	Jimmy	5.0L V8 CARB	HPR0326
C2500	7.4L V8 CARB - w/3-7/16 inch Tall Filter	HPR0326	Jimmy	5.7L V8 CARB	HPR0326
C2500 Suburban	5.0L V8 CARB	HPR0326	K1500	5.0L V8 CARB	HPR0326
C2500 Suburban	5.7L V8 CARB	HPR0326	K1500	5.7L V8 CARB	HPR0326
C2500 Suburban	7.4L V8 CARB - w/3-7/16 inch Tall Filter	HPR0326	K1500 Suburban	5.0L V8 CARB	HPR0326
C3500	5.7L V8 CARB - w/3-7/16 inch Tall Filter	HPR0326	K1500 Suburban	5.7L V8 CARB	HPR0326
C3500	7.4L V8 CARB - w/3-7/16 inch Tall Filter	HPR0326	K2500	5.7L V8 CARB	HPR0326
Caballero	3.8L V6 CARB - VIN 9	HPR3588	K2500 Suburban	5.7L V8 CARB	HPR0326
Caballero	3.8L V6 CARB - VIN A	HPR0192	K3500	5.7L V8 CARB	HPR0326
Caballero	5.0L V8 CARB	HPR0326	K3500	7.4L V8 CARB	HPR8038
G1500	5.0L V8 CARB	HPR0192	Motorhome	5.0L V8 4 BBL. - Class C	HPR0192
G1500	5.7L V8 CARB	HPR0192	Motorhome	5.7L V8 4 BBL. - Class A & C	HPR0192
G2500	5.0L V8 CARB	HPR0192	Motorhome	7.4L V8 4 BBL. - Class A & C, w/3-7/16 inch Tall Filter	HPR0326
G2500	5.7L V8 CARB	HPR0192	P2500	5.7L V8 CARB	HPR0192
G3500	5.7L V8 CARB	HPR0192	P3500	5.7L V8 CARB	HPR0192
Jimmy	5.0L V8 CARB	HPR0326	S15 Pickup	1.9L L4 CARB	HPR0352
Jimmy	5.7L V8 CARB	HPR0326	1981 GMC		
K1500	5.0L V8 CARB	HPR0326	C1500	5.0L V8 2 BBL.	HPR0192 ♦
K1500	5.7L V8 CARB - w/3-7/16 inch Tall Filter	HPR0326	C1500	5.0L V8 4 BBL.	HPR0192 ♦
K1500 Suburban	5.0L V8 CARB	HPR0326	C1500	5.7L V8 CARB	HPR0326 ♦
K1500 Suburban	5.7L V8 CARB	HPR0326	C1500 Suburban	5.0L V8 2 BBL.	HPR0192 ♦
K2500	5.7L V8 CARB - w/3-7/16 inch Tall Filter	HPR0326	C1500 Suburban	5.0L V8 4 BBL.	HPR0192 ♦
K2500 Suburban	5.7L V8 CARB	HPR0326	C1500 Suburban	5.7L V8 CARB	HPR0326 ♦
K3500	5.7L V8 CARB - w/3-7/16 inch Tall Filter	HPR0326	C2500	5.0L V8 CARB	HPR0326 ♦
K3500	7.4L V8 CARB - w/3-7/16 inch Tall Filter	HPR0326	C2500 Suburban	7.4L V8 CARB - w/3-7/16 inch Tall Filter	HPR0326 ♦
Motorhome	5.0L V8 4 BBL. - Class C	HPR0192	C3500	5.7L V8 CARB	HPR0326 ♦
Motorhome	5.7L V8 4 BBL. - Class A & C	HPR0192	C3500	7.4L V8 CARB	HPR8038 ♦
Motorhome	7.4L V8 4 BBL. - Class A & C, w/3-7/16 inch Tall Filter	HPR0326	Caballero	3.8L V6 CARB - VIN A	HPR0192
P2500	5.7L V8 CARB	HPR0192	Caballero	3.8L V6 CARB - VIN K	HPR3588
P3500	5.7L V8 CARB	HPR0192	Caballero	4.4L V8 CARB	HPR3588
S15 Jimmy	1.9L L4 CARB	HPR0352	Caballero	5.0L V8 CARB	HPR0326
S15 Pickup	1.9L L4 CARB	HPR0352	G1500	5.0L V8 2 BBL.	HPR0192
1982 GMC			G1500	5.0L V8 4 BBL.	HPR0192
C1500	5.0L V8 CARB	HPR0326	G1500	5.7L V8 CARB	HPR0192
C1500	5.7L V8 CARB	HPR0326	G2500	5.0L V8 2 BBL.	HPR0192
C1500 Suburban	5.0L V8 CARB	HPR0326	G2500	5.7L V8 CARB	HPR0192
C1500 Suburban	5.7L V8 CARB	HPR0326	G3500	5.0L V8 CARB	HPR0326
C2500	5.0L V8 CARB	HPR0326	G3500	5.7L V8 CARB	HPR0192
			Jimmy	5.0L V8 CARB	HPR0192 ♦
			Jimmy	5.7L V8 CARB	HPR0326 ♦
			K1500	5.0L V8 CARB	HPR0326 ♦
			K1500	5.7L V8 CARB	HPR0326 ♦
			K1500 Suburban	5.7L V8 CARB	HPR0326 ♦
			K2500	5.7L V8 CARB	HPR0326 ♦
			K2500 Suburban	5.7L V8 CARB	HPR0326 ♦
			K3500	5.7L V8 CARB	HPR0326 ♦
			K3500	7.4L V8 CARB	HPR8038 ♦

*Indicates 2 filters required ♦ Intake system available - see page 326 + throttle body spacer available - see page 20

Vehicle	Engine Type	Air Filter	Vehicle	Engine Type	Air Filter
1981 GMC			1980 GMC		
Motorhome	5.0L V8 4 BBL. - Class C	HPR0192	Motorhome	454 V8 4 BBL. - Class A & C, w/3-7/16 inch Tall Filter	HPR0326
Motorhome	5.7L V8 4 BBL. - Class A & C	HPR0192	P2500	350 V8 CARB	HPR0192
Motorhome	7.4L V8 4 BBL. - Class A & C, w/3-7/16 inch Tall Filter	HPR0326	P3500	350 V8 CARB	HPR0192
P2500	5.7L V8 CARB	HPR0192	P3500	454 V8 CARB - w/3-7/16 inch Tall Filter	HPR0326
P3500	5.7L V8 CARB	HPR0192	1979 GMC		
1980 GMC			C1500	305 V8 CARB	HPR0192 ♦
C1500	350 V8 CARB - w/3-7/16 inch Tall Filter	HPR0326 ♦	C1500	350 V8 CARB	HPR0192 ♦
C1500	400 V8 CARB - w/3-7/16 inch Tall Filter	HPR0326 ♦	C1500	400 V8 CARB	HPR0326 ♦
C1500	454 V8 CARB - w/3-7/16 inch Tall Filter	HPR0326 ♦	C1500	454 V8 CARB	HPR0326 ♦
C1500 Suburban	305 V8 CARB	HPR0192 ♦	C1500 Suburban	305 V8 CARB	HPR0192 ♦
C1500 Suburban	350 V8 CARB - w/3-7/16 inch Tall Filter	HPR0326 ♦	C1500 Suburban	350 V8 CARB	HPR0326 ♦
C1500 Suburban	454 V8 CARB - w/3-7/16 inch Tall Filter	HPR0326 ♦	C1500 Suburban	454 V8 CARB	HPR0326 ♦
C2500	305 V8 CARB	HPR0192 ♦	C2500	305 V8 CARB	HPR0192 ♦
C2500	350 V8 CARB - w/3-7/16 inch Tall Filter	HPR0326 ♦	C2500	350 V8 CARB	HPR0326 ♦
C2500	454 V8 CARB - w/3-7/16 inch Tall Filter	HPR0326 ♦	C2500	400 V8 CARB	HPR0326 ♦
C2500 Suburban	305 V8 CARB	HPR0192 ♦	C2500	454 V8 CARB	HPR0326 ♦
C2500 Suburban	350 V8 CARB - w/3-7/16 inch Tall Filter	HPR0326 ♦	C2500 Suburban	350 V8 CARB	HPR0326 ♦
C2500 Suburban	454 V8 CARB - w/3-7/16 inch Tall Filter	HPR0326 ♦	C2500 Suburban	454 V8 CARB	HPR0326 ♦
C3500	350 V8 CARB - w/3-7/16 inch Tall Filter	HPR0326 ♦	C3500	350 V8 CARB	HPR0192 ♦
C3500	454 V8 CARB - w/3-7/16 inch Tall Filter	HPR0326 ♦	C3500	400 V8 CARB	HPR0326 ♦
Caballero	231 V6 CARB	HPR0192	C3500	454 V8 CARB	HPR0326 ♦
Caballero	267 V8 CARB	HPR0192	Caballero	200 V6 CARB	HPR0192
Caballero	305 V8 CARB	HPR0326	Caballero	231 V6 CARB - VIN A	HPR0192
G1500	305 V8 CARB	HPR0192	Caballero	267 V8 CARB	HPR0192
G1500	350 V8 CARB	HPR0192	Caballero	305 V8 CARB	HPR0326
G2500	305 V8 CARB	HPR0192	Caballero	350 V8 CARB	HPR0326
G2500	350 V8 CARB	HPR0192	G1500	305 V8 CARB	HPR0192
G2500	400 V8 CARB	HPR0192	G1500	350 V8 CARB	HPR0192
G3500	350 V8 CARB	HPR0192	G1500	400 V8 CARB	HPR0326
G3500	400 V8 CARB	HPR0192	G2500	305 V8 CARB	HPR0192
Jimmy	305 V8 CARB	HPR0192 ♦	G2500	350 V8 CARB	HPR0192
Jimmy	350 V8 CARB - w/3-7/16 inch Tall Filter	HPR0326 ♦	G2500	400 V8 CARB	HPR0192
K1500	350 V8 CARB - w/3-7/16 inch Tall Filter	HPR0326 ♦	G3500	350 V8 CARB	HPR0192
K1500	400 V8 CARB - w/3-7/16 inch Tall Filter	HPR0326 ♦	G3500	400 V8 CARB	HPR0192
K1500	454 V8 CARB - w/3-7/16 inch Tall Filter	HPR0326 ♦	G3500	454 V8 CARB	HPR0326
K1500 Suburban	350 V8 CARB - w/3-7/16 inch Tall Filter	HPR0326 ♦	G3500	305 V8 CARB	HPR0192 ♦
K1500 Suburban	400 V8 CARB	HPR0326 ♦	G3500	350 V8 CARB	HPR0326 ♦
K2500	350 V8 CARB - w/3-7/16 inch Tall Filter	HPR0326 ♦	G3500	400 V8 CARB	HPR0326 ♦
K2500	400 V8 CARB - w/3-7/16 inch Tall Filter	HPR0326 ♦	G3500	454 V8 CARB	HPR0326 ♦
K2500 Suburban	350 V8 CARB - w/3-7/16 inch Tall Filter	HPR0326 ♦	Jimmy	305 V8 CARB	HPR0192 ♦
K2500 Suburban	400 V8 CARB - w/3-7/16 inch Tall Filter	HPR0326 ♦	Jimmy	350 V8 CARB	HPR0326 ♦
K3500	350 V8 CARB - w/3-7/16 inch Tall Filter	HPR0326 ♦	Jimmy	400 V8 CARB	HPR0326 ♦
K3500	400 V8 CARB - w/3-7/16 inch Tall Filter	HPR0326 ♦	K1500	305 V8 CARB	HPR0192 ♦
K3500	454 V8 CARB - w/3-7/16 inch Tall Filter	HPR0326 ♦	K1500	400 V8 CARB	HPR0326 ♦
Motorhome	305 V8 4 BBL. - Class C	HPR0192	K1500	454 V8 CARB	HPR0326 ♦
Motorhome	350 V8 4 BBL. - Class A & C	HPR0192	K1500 Suburban	305 V8 CARB	HPR0192 ♦
Motorhome	400 V8 4 BBL. - Class C	HPR0192	K1500 Suburban	350 V8 CARB	HPR0326 ♦
			K1500 Suburban	400 V8 CARB	HPR0326 ♦
			K2500	400 V8 CARB	HPR0326 ♦
			K2500 Suburban	350 V8 CARB	HPR0326 ♦
			K2500 Suburban	400 V8 CARB	HPR0326 ♦
			K3500	400 V8 CARB	HPR0326 ♦
			K3500	454 V8 CARB	HPR0326 ♦
			Motorhome	305 V8 4 BBL. - Class C	HPR0192
			Motorhome	350 V8 4 BBL. - Class A & C	HPR0192
			Motorhome	400 V8 4 BBL. - Class C	HPR0192
			Motorhome	454 V8 4 BBL. - Class A, VIN N, w/3-7/16 inch Tall Filter	HPR0326
			P1500	454 V8 CARB	HPR0326
			P2500	350 V8 CARB	HPR0192
			P3500	350 V8 CARB	HPR0192
			P3500	454 V8 CARB	HPR0326
			1978 GMC		
			C15	305 V8 CARB	HPR0192 ♦
			C15	350 V8 CARB	HPR0326 ♦

*Indicates 2 filters required ♦ Intake system available - see page 326 + throttle body spacer available - see page 20

HPR™ REPLACEMENT AIR FILTERS

GMC

Vehicle	Engine Type	Air Filter	Vehicle	Engine Type	Air Filter
1978 GMC			1977 GMC		
C15	400 V8 CARB	HPR0326 ♦	C25	454 V8 CARB	HPR0326 ♦
C15	454 V8 CARB	HPR0326 ♦	C25 Suburban	305 V8 CARB	HPR0192 ♦
C15 Suburban	305 V8 CARB	HPR0192 ♦	C25 Suburban	350 V8 CARB	HPR0326 ♦
C15 Suburban	350 V8 CARB	HPR0326 ♦	C25 Suburban	454 V8 CARB	HPR0326 ♦
C15 Suburban	454 V8 CARB	HPR0326 ♦	C35	350 V8 CARB	HPR0326 ♦
C25	305 V8 CARB	HPR0192 ♦	C35	400 V8 CARB	HPR0326 ♦
C25	350 V8 CARB	HPR0326 ♦	C35	454 V8 CARB	HPR0326 ♦
C25	400 V8 CARB	HPR0326 ♦	G15	305 V8 CARB	HPR0192
C25	454 V8 CARB	HPR0326 ♦	G15	350 V8 CARB	HPR0192
C25 Suburban	305 V8 CARB	HPR0192 ♦	G25 Van	305 V8 CARB	HPR0192
C25 Suburban	350 V8 CARB	HPR0326 ♦	G25 Van	350 V8 CARB	HPR0192
C25 Suburban	400 V8 CARB	HPR0326 ♦	G25 Van	400 V8 CARB	HPR0192
C25 Suburban	454 V8 CARB	HPR0326 ♦	G35 Van	350 V8 CARB	HPR0192
C35	305 V8 CARB	HPR0192 ♦	G35 Van	400 V8 CARB	HPR0192
C35	350 V8 CARB	HPR0326 ♦	Jimmy	305 V8 CARB	HPR0192 ♦
C35	400 V8 CARB	HPR0326 ♦	Jimmy	350 V8 CARB	HPR0326 ♦
C35	454 V8 CARB	HPR0326 ♦	Jimmy	400 V8 CARB	HPR0326 ♦
Caballero	200 V6 CARB	HPR0192	K15	305 V8 CARB	HPR0192 ♦
Caballero	231 V6 CARB	HPR0192	K15	350 V8 CARB	HPR0326 ♦
Caballero	305 V8 CARB	HPR0192	K15	400 V8 CARB	HPR0326 ♦
Caballero	350 V8 CARB	HPR0326	K15 Suburban	305 V8 CARB	HPR0192 ♦
G15	305 V8 CARB	HPR0192	K15 Suburban	350 V8 CARB	HPR0326 ♦
G15	350 V8 CARB	HPR0192	K15 Suburban	400 V8 CARB	HPR0326 ♦
G25 Van	305 V8 CARB	HPR0192	K25	305 V8 CARB	HPR0192 ♦
G25 Van	350 V8 CARB	HPR0192	K25	350 V8 CARB	HPR0326 ♦
G25 Van	400 V8 CARB	HPR0192	K25	400 V8 CARB	HPR0326 ♦
G35 Van	350 V8 CARB	HPR0192	K25	454 V8 CARB	HPR0326 ♦
G35 Van	400 V8 CARB	HPR0192	K25 Suburban	305 V8 CARB	HPR0192 ♦
Jimmy	305 V8 CARB	HPR0192 ♦	K25 Suburban	350 V8 CARB	HPR0326 ♦
Jimmy	350 V8 CARB	HPR0326 ♦	K25 Suburban	400 V8 CARB	HPR0326 ♦
Jimmy	400 V8 CARB	HPR0326 ♦	K25 Suburban	454 V8 CARB	HPR0326 ♦
K15	305 V8 CARB	HPR0192 ♦	K35	350 V8 CARB	HPR0326 ♦
K15	350 V8 CARB	HPR0326 ♦	K35	400 V8 CARB	HPR0326 ♦
K15	400 V8 CARB	HPR0326 ♦	Motorhome	305 V8 4 BBL. - Class C	HPR0192
K15 Suburban	305 V8 CARB	HPR0192 ♦	Motorhome	350 V8 4 BBL. - Class A & C	HPR0192
K15 Suburban	350 V8 CARB	HPR0326 ♦	Motorhome	400 V8 4 BBL. - Class C	HPR0192
K15 Suburban	400 V8 CARB	HPR0326 ♦	Motorhome	454 V8 4 BBL. - Class A, VIN N, w/3-7/16 inch Tall Filter	HPR0326
K25	305 V8 CARB	HPR0192 ♦	P25	350 V8 CARB	HPR0192
K25	350 V8 CARB	HPR0326 ♦	P35	350 V8 CARB	HPR0192
K25	400 V8 CARB	HPR0326 ♦	P35	454 V8 CARB	HPR0326
K25	454 V8 CARB	HPR0326 ♦	Sprint Truck	305 V8 CARB	HPR0326
K25 Suburban	305 V8 CARB	HPR0192 ♦	Sprint Truck	350 V8 CARB	HPR0326
K25 Suburban	350 V8 CARB	HPR0326 ♦			
K25 Suburban	400 V8 CARB	HPR0326 ♦	1976 GMC		
K35	350 V8 CARB	HPR0326 ♦	C15	305 V8 CARB	HPR0192 ♦
K35	400 V8 CARB	HPR0326 ♦	C15	350 V8 CARB	HPR0326 ♦
Motorhome	305 V8 4 BBL. - Class C	HPR0192	C15	400 V8 CARB	HPR0326 ♦
Motorhome	350 V8 4 BBL. - Class A & C	HPR0192	C15	454 V8 CARB	HPR0326 ♦
Motorhome	400 V8 4 BBL. - Class C	HPR0192	C15 Suburban	305 V8 CARB	HPR0192 ♦
Motorhome	454 V8 4 BBL. - Class A, VIN N, w/3-7/16 inch Tall Filter	HPR0326	C15 Suburban	350 V8 CARB	HPR0326 ♦
P25	350 V8 CARB	HPR0192	C15 Suburban	454 V8 CARB	HPR0326 ♦
P35	350 V8 CARB	HPR0326	C25	350 V8 CARB	HPR0326 ♦
P35	454 V8 CARB	HPR0326	C25	400 V8 CARB	HPR0326 ♦
			C25	454 V8 CARB	HPR0326 ♦
			C25 Suburban	350 V8 CARB	HPR0326 ♦
			C25 Suburban	454 V8 CARB	HPR0326 ♦
			C35	350 V8 CARB	HPR0326 ♦
			C35	400 V8 CARB	HPR0326 ♦
			C35	454 V8 CARB	HPR0326 ♦
			C35	454 V8 CARB	HPR0326 ♦
			G15	350 V8 CARB	HPR0192
			G15	400 V8 CARB	HPR0192
			G25 Van	350 V8 CARB	HPR0192
			G25 Van	400 V8 CARB	HPR0192
			G25 Van	454 V8 CARB	HPR0326

*Indicates 2 filters required ♦ Intake system available - see page 326 + throttle body spacer available - see page 20

Vehicle	Engine Type	Air Filter	Vehicle	Engine Type	Air Filter
1976 GMC			1975 GMC		
G35 Van	350 V8 CARB	HPR0192	K25 Suburban	350 V8 4 BBL.	HPR0326 ♦
G35 Van	400 V8 CARB	HPR0192	K25 Suburban	400 V8 CARB	HPR0326 ♦
G35 Van	454 V8 CARB	HPR0326	Motorhome	350 V8 2 BBL. - Class C	HPR0192
Jimmy	350 V8 CARB	HPR0326 ♦	Motorhome	350 V8 4 BBL. - Class C	HPR0192
Jimmy	400 V8 CARB	HPR0326 ♦	Motorhome	400 V8 4 BBL. - Class C	HPR0192
Jimmy	454 V8 CARB	HPR0326 ♦	Motorhome	454 V8 4 BBL. - Class A, VIN N, w/3-7/16 inch Tall Filter	HPR0326
K15	305 V8 CARB	HPR0192 ♦		455 V8 4 BBL. - Class C	48026
K15	350 V8 CARB	HPR0326 ♦			HPR0136
K15	400 V8 CARB	HPR0326 ♦	P25	350 V8 CARB	HPR0192
K15	454 V8 CARB	HPR0326 ♦	P35	350 V8 CARB	HPR0192
K15 Suburban	305 V8 CARB	HPR0192 ♦	P35	454 V8 CARB	HPR0326
K15 Suburban	350 V8 CARB	HPR0326 ♦	Sprint	350 V8 CARB	HPR0326
K15 Suburban	400 V8 CARB	HPR0326 ♦	Sprint	454 V8 CARB	HPR0326
K25	350 V8 CARB	HPR0326 ♦	1974 GMC		
K25	400 V8 CARB	HPR0326 ♦	C15/C1500 Pickup	350 V8 2 BBL.	HPR0192
K25	454 V8 CARB	HPR0326 ♦	C15/C1500 Pickup	350 V8 4 BBL.	HPR0326
K25 Suburban	350 V8 CARB	HPR0326 ♦	C15/C1500 Pickup	454 V8 CARB	HPR0326
K25 Suburban	400 V8 CARB	HPR0326 ♦	C15/C1500 Suburban	350 V8 2 BBL.	HPR0192
Motorhome	305 V8 4 BBL. - Class C	HPR0192	C15/C1500 Suburban	350 V8 4 BBL.	HPR0326
Motorhome	350 V8 4 BBL. - Class A & C	HPR0192	C15/C1500 Suburban	454 V8 CARB	HPR0326
Motorhome	400 V8 4 BBL. - Class C	HPR0192	C25/C2500 Pickup	350 V8 2 BBL.	HPR0192
Motorhome	454 V8 4 BBL. - Class A, VIN N, w/3-7/16 inch Tall Filter	HPR0326	C25/C2500 Pickup	350 V8 4 BBL.	HPR0326
	455 V8 4 BBL. - Class C	48026	C25/C2500 Pickup	454 V8 CARB	HPR0326
P25	350 V8 CARB	HPR0136	C25/C2500 Pickup	350 V8 2 BBL.	HPR0192
P35	350 V8 CARB	HPR0192	C25/C2500 Suburban	350 V8 4 BBL.	HPR0326
P35	454 V8 CARB	HPR0326	C25/C2500 Suburban	454 V8 CARB	HPR0326
Sprint Truck	305 V8 CARB	HPR0326	C35/C3500 Pickup	350 V8 2 BBL.	HPR0192
Sprint Truck	350 V8 CARB	HPR0326	C35/C3500 Pickup	350 V8 4 BBL.	HPR0326
Sprint Truck	400 V8 CARB	HPR0326	C35/C3500 Pickup	454 V8 CARB	HPR0326
1975 GMC			G15/G1500 Van	350 V8 CARB	HPR0192
C15	350 V8 2 BBL.	HPR0192 ♦	G25/G2500 Van	292 L6 CARB	HPR0192
C15	350 V8 4 BBL.	HPR0326 ♦	G25/G2500 Van	350 V8 CARB	HPR0192
C15	454 V8 CARB	HPR0326 ♦	G35/G3500 Van	350 V8 CARB	HPR0192
C15 Suburban	350 V8 2 BBL.	HPR0192 ♦	G35/G3500 Van	454 V8 CARB	HPR0326
C15 Suburban	350 V8 4 BBL.	HPR0326 ♦	Jimmy	350 V8 2 BBL.	HPR0192
C15 Suburban	454 V8 CARB	HPR0326 ♦	Jimmy	350 V8 4 BBL.	HPR0192
C25	350 V8 2 BBL.	HPR0192 ♦	K15/K1500 Pickup	350 V8 2 BBL.	HPR0192
C25	350 V8 4 BBL.	HPR0326 ♦	K15/K1500 Pickup	350 V8 4 BBL.	HPR0326
C25	454 V8 CARB	HPR0326 ♦	K15/K1500 Pickup	454 V8 CARB	HPR0326
C25 Suburban	350 V8 2 BBL.	HPR0192 ♦	K15/K1500 Suburban	350 V8 2 BBL.	HPR0192
C25 Suburban	350 V8 4 BBL.	HPR0326 ♦	K15/K1500 Suburban	350 V8 4 BBL.	HPR0326
C25 Suburban	454 V8 CARB	HPR0326 ♦	K25/K2500 Pickup	350 V8 2 BBL.	HPR0192
C35	350 V8 2 BBL.	HPR0192 ♦	K25/K2500 Pickup	350 V8 4 BBL.	HPR0326
C35	350 V8 4 BBL.	HPR0326 ♦	K25/K2500 Pickup	454 V8 CARB	HPR0326
C35	454 V8 CARB	HPR0326 ♦	K25/K2500 Suburban	350 V8 2 BBL.	HPR0192
G15	350 V8 2 BBL.	HPR0192	K25/K2500 Suburban	350 V8 4 BBL.	HPR0326
G15	350 V8 4 BBL.	HPR0192	K35/K3500 Pickup	350 V8 2 BBL.	HPR0192 ♦
G25 Van	350 V8 2 BBL.	HPR0192	K35/K3500 Pickup	350 V8 4 BBL.	HPR0326 ♦
G25 Van	350 V8 4 BBL.	HPR0192	K35/K3500 Pickup	454 V8 CARB	HPR0326
G25 Van	400 V8 CARB	HPR0192	Motorhome	350 V8 4 BBL. - Class C	HPR0192
G25 Van	454 V8 CARB	HPR0326	Motorhome	400 V8 4 BBL. - Class C	HPR0326
G35 Van	350 V8 2 BBL.	HPR0192	Motorhome	454 V8 4 BBL. - Class A, VIN N, w/3-7/16 inch Tall Filter	HPR0326
G35 Van	350 V8 4 BBL.	HPR0192			
G35 Van	400 V8 CARB	HPR0192	P25/P2500 Van	350 V8 CARB	HPR0326
Jimmy	350 V8 4 BBL.	HPR0326 ♦	P35/P3500 Van	350 V8 CARB	HPR0326
Jimmy	400 V8 CARB	HPR0326 ♦	P35/P3500 Van	454 V8 CARB	HPR0326
K15	350 V8 4 BBL.	HPR0326 ♦	Sprint Truck	350 V8 CARB	HPR0326
K15	400 V8 CARB	HPR0326 ♦	Sprint Truck	400 V8 CARB	HPR0326
K15 Suburban	350 V8 4 BBL.	HPR0326 ♦	Sprint Truck	402 V8 CARB	HPR0326
K15 Suburban	400 V8 CARB	HPR0326 ♦	Sprint Truck	454 V8 CARB	HPR0326
K25	350 V8 4 BBL.	HPR0326 ♦	1973 GMC		
K25	400 V8 CARB	HPR0326 ♦	C15/C1500 Pickup	292 L6 CARB	HPR0192
			C15/C1500 Pickup	307 V8 CARB	HPR0192

*Indicates 2 filters required ♦ Intake system available - see page 326 + throttle body spacer available - see page 20

HPR™ REPLACEMENT AIR FILTERS

GMC

Vehicle	Engine Type	Air Filter
1973 GMC		
C15/C1500 Pickup	350 V8 CARB	HPR0326
C15/C1500 Pickup	454 V8 CARB	HPR0326
C15/C1500 Suburban	307 V8 CARB	HPR0192
C15/C1500 Suburban	350 V8 CARB	HPR0326
C15/C1500 Suburban	454 V8 CARB	HPR0326
C25/C2500 Pickup	292 L6 CARB	HPR0192
C25/C2500 Pickup	307 V8 CARB	HPR0192
C25/C2500 Pickup	350 V8 CARB	HPR0326
C25/C2500 Pickup	454 V8 CARB	HPR0326
C25/C2500 Suburban	307 V8 CARB	HPR0192
C25/C2500 Suburban	350 V8 CARB	HPR0326
C25/C2500 Suburban	454 V8 CARB	HPR0326
C35/C3500 Pickup	292 L6 CARB	HPR0192
C35/C3500 Pickup	307 V8 CARB	HPR0192
C35/C3500 Pickup	350 V8 CARB	HPR0326
C35/C3500 Pickup	454 V8 CARB	HPR0326
G15/G1500 Van	307 V8 CARB	HPR0192
G15/G1500 Van	350 V8 CARB - w/12 in OD Filter	HPR0326
G15/G1500 Van	350 V8 CARB - w/Std. Filter	HPR0192
G25/G2500 Van	307 V8 CARB	HPR0192
G25/G2500 Van	350 V8 CARB - w/12 in OD Filter	HPR0326
G25/G2500 Van	350 V8 CARB - w/Std. Filter	HPR0192
G35/G3500 Van	350 V8 CARB - w/12 in OD Filter	HPR0326
G35/G3500 Van	350 V8 CARB - w/Std. Filter	HPR0192
G35/G3500 Van	454 V8 CARB	HPR0326
Jimmy	350 V8 CARB	HPR0326
Jimmy	454 V8 CARB	HPR0326
K15/K1500 Pickup	292 L6 CARB	HPR0192
K15/K1500 Pickup	307 V8 CARB	HPR0192
K15/K1500 Pickup	350 V8 CARB	HPR0326 ♦
K15/K1500 Pickup	454 V8 CARB	HPR0326
K15/K1500 Suburban	307 V8 CARB	HPR0192
K15/K1500 Suburban	350 V8 2 BBL.	HPR0192 ♦
K15/K1500 Suburban	350 V8 4 BBL.	HPR0326 ♦
K15/K1500 Suburban	454 V8 CARB	HPR0326
K25/K2500 Pickup	292 L6 CARB	HPR0192
K25/K2500 Pickup	307 V8 CARB	HPR0192
K25/K2500 Pickup	350 V8 CARB	HPR0326
K25/K2500 Pickup	454 V8 CARB	HPR0326
K25/K2500 Suburban	307 V8 CARB	HPR0192
K25/K2500 Suburban	350 V8 2 BBL.	HPR0192 ♦
K25/K2500 Suburban	350 V8 4 BBL.	HPR0326 ♦
K25/K2500 Suburban	454 V8 CARB	HPR0326
K35/K3500 Pickup	292 L6 CARB	HPR0192
K35/K3500 Pickup	307 V8 CARB	HPR0192
K35/K3500 Pickup	350 V8 2 BBL.	HPR0192 ♦
K35/K3500 Pickup	350 V8 4 BBL.	HPR0326 ♦
K35/K3500 Pickup	454 V8 CARB	HPR0326
Motorhome	307 V8 4 BBL. - Class C	HPR0192
Motorhome	350 V8 4 BBL. - Class C, Heavy Duty Filter	HPR0326
Motorhome	350 V8 4 BBL. - Class C, w/Std. Filter	HPR0192
Motorhome	400 V8 4 BBL. - Class C	HPR0326
Motorhome	454 V8 4 BBL. - Class A, VIN N, w/3-7/16 inch Tall Filter	HPR0326
P25/P2500 Van	292 L6 CARB	HPR0192
P25/P2500 Van	350 V8 CARB - w/12 in OD Filter	HPR0326
P25/P2500 Van	350 V8 CARB - w/Std. Filter	HPR0192
P35/P3500 Van	292 L6 CARB	HPR0192
P35/P3500 Van	350 V8 CARB - w/12 in OD Filter	HPR0326
P35/P3500 Van	350 V8 CARB - w/Std. Filter	HPR0192
P35/P3500 Van	454 V8 CARB	HPR0326
Sprint Truck	307 V8 CARB	HPR0326
Sprint Truck	350 V8 CARB	HPR0326

Vehicle	Engine Type	Air Filter
1973 GMC		
Sprint Truck	454 V8 CARB	HPR0326
1972 GMC		
C15/C1500 Pickup	292 L6 CARB - w/o Power Brakes	HPR0192
C15/C1500 Pickup	307 V8 CARB	HPR0192
C15/C1500 Pickup	350 V8 4 BBL.	HPR0326
C15/C1500 Pickup	402 V8 CARB	HPR0192
C15/C1500 Suburban	292 L6 CARB	HPR0192
C15/C1500 Suburban	307 V8 CARB	HPR0192
C15/C1500 Suburban	350 V8 2 BBL.	HPR0192 ♦
C15/C1500 Suburban	350 V8 4 BBL.	HPR0326 ♦
C15/C1500 Suburban	402 V8 CARB	HPR0326
C25/C2500 Pickup	292 L6 CARB - w/o Power Brakes	HPR0192
C25/C2500 Pickup	307 V8 CARB	HPR0192
C25/C2500 Pickup	350 V8 CARB	HPR0326
C25/C2500 Pickup	402 V8 CARB	HPR0326
C25/C2500 Suburban	292 L6 CARB	HPR0192
C25/C2500 Suburban	307 V8 CARB	HPR0192
C25/C2500 Suburban	350 V8 2 BBL.	HPR0192 ♦
C25/C2500 Suburban	350 V8 4 BBL.	HPR0326 ♦
C25/C2500 Suburban	402 V8 CARB	HPR0326
C35/C3500 Pickup	292 L6 CARB - w/o Power Brakes	HPR0192
C35/C3500 Pickup	307 V8 CARB	HPR0192
C35/C3500 Pickup	350 V8 CARB	HPR0326
C35/C3500 Pickup	402 V8 CARB	HPR0326
G15/G1500 Van	307 V8 CARB	HPR0192
G15/G1500 Van	350 V8 CARB - w/12 in OD Filter	HPR0326
G15/G1500 Van	350 V8 CARB - w/Std. Filter	HPR0192
G25/G2500 Van	307 V8 CARB	HPR0192
G25/G2500 Van	350 V8 CARB - w/12 in OD Filter	HPR0326
G25/G2500 Van	350 V8 CARB - w/Std. Filter	HPR0192
G35/G3500 Van	307 V8 CARB	HPR0192
G35/G3500 Van	350 V8 CARB - w/12 in OD Filter	HPR0326
G35/G3500 Van	350 V8 CARB - w/Std. Filter	HPR0192
Heavy Duty Truck	396 V8 4 BBL. - 4000-8500	HPR0192
Heavy Duty Truck	402 V8 4 BBL. - 4000-8500	HPR0192
Jimmy	307 V8 CARB	HPR0192
Jimmy	350 V8 CARB	HPR0326
K15/K1500 Pickup	292 L6 CARB - w/o Power Brakes	HPR0192
K15/K1500 Pickup	350 V8 2 BBL.	HPR0192 ♦
K15/K1500 Pickup	350 V8 4 BBL.	HPR0326 ♦
K15/K1500 Pickup	402 V8 CARB	HPR0192
K15/K1500 Suburban	307 V8 CARB	HPR0192
K15/K1500 Suburban	350 V8 2 BBL.	HPR0192 ♦
K15/K1500 Suburban	350 V8 4 BBL.	HPR0326 ♦
K15/K1500 Suburban	402 V8 CARB	HPR0326
K25/K2500 Pickup	292 L6 CARB - w/o Power Brakes	HPR0192
K25/K2500 Pickup	350 V8 2 BBL.	HPR0192 ♦
K25/K2500 Pickup	350 V8 4 BBL.	HPR0326 ♦
K25/K2500 Pickup	402 V8 CARB	HPR0326
K25/K2500 Suburban	307 V8 CARB	HPR0192
K25/K2500 Suburban	350 V8 2 BBL.	HPR0192 ♦
K25/K2500 Suburban	350 V8 4 BBL.	HPR0326 ♦
K25/K2500 Suburban	402 V8 CARB	HPR0326
K35/K3500 Pickup	292 L6 CARB - w/o Power Brakes	HPR0192
K35/K3500 Pickup	307 V8 CARB	HPR0192
K35/K3500 Pickup	350 V8 2 BBL.	HPR0192 ♦
K35/K3500 Pickup	350 V8 4 BBL.	HPR0326 ♦
K35/K3500 Pickup	402 V8 CARB	HPR0326
Motorhome	307 V8 4 BBL. - Class A	HPR0192
Motorhome	350 V8 4 BBL. - Class C, Heavy Duty Filter	HPR0326
Motorhome	350 V8 4 BBL. - Class C, w/Std. Filter	HPR0192
Motorhome	400 V8 4 BBL. - Class C	HPR0326

*Indicates 2 filters required ♦ Intake system available - see page 326 + throttle body spacer available - see page 20

Vehicle	Engine Type	Air Filter	Vehicle	Engine Type	Air Filter
1972 GMC			1971 GMC		
Motorhome	402 V8 4 BBL. - Class C	HPR0192	K35/K3500 Pickup	307 V8 CARB	HPR0192
	403 V8 4 BBL. - Class A Olds, FWD	48026	K35/K3500 Pickup	350 V8 2 BBL.	HPR0192 ♦
		HPR0136	K35/K3500 Pickup	350 V8 4 BBL.	HPR0326 ♦
Motorhome	454 V8 4 BBL. - Class A, VIN N, w/3-7/16 inch Tall Filter	HPR0326	K35/K3500 Pickup	402 V8 CARB	HPR0192
P15/P1500 Van	307 V8 CARB	HPR0192	Motorhome	307 V8 4 BBL. - Class A	HPR0192
P25/P2500 Van	292 L6 CARB	HPR0192	Motorhome	350 V8 4 BBL. - Class C	HPR0192
P25/P2500 Van	307 V8 CARB	HPR0192	Motorhome	400 V8 4 BBL. - Class C	HPR0326
P25/P2500 Van	350 V8 CARB - w/12 in OD Filter	HPR0326	Motorhome	402 V8 4 BBL. - Class C	HPR0192
P25/P2500 Van	350 V8 CARB - w/Std. Filter	HPR0192		403 V8 4 BBL. - Class A Olds, FWD	48026
P35/P3500 Van	292 L6 CARB	HPR0192			HPR0136
P35/P3500 Van	307 V8 CARB	HPR0192	P25/P2500 Van	292 L6 CARB	HPR0192
P35/P3500 Van	350 V8 CARB - w/12 in OD Filter	HPR0326	P25/P2500 Van	350 V8 CARB	HPR0192
P35/P3500 Van	350 V8 CARB - w/Std. Filter	HPR0192	P35/P3500 Van	292 L6 CARB	HPR0192
Sprint Truck	307 V8 CARB	HPR0326	P35/P3500 Van	350 V8 CARB	HPR0192
Sprint Truck	350 V8 CARB	HPR0326	Sprint Truck	307 V8 CARB	HPR0326
Sprint Truck	402 V8 CARB	HPR0326	Sprint Truck	402 V8 CARB	HPR0326
Sprint Truck	454 V8 CARB	HPR0326	Sprint Truck	454 V8 CARB	HPR0326
1971 GMC			1970 GMC		
C15/C1500 Pickup	292 L6 CARB	HPR0192	C15/C1500 Pickup	292 L6 CARB	HPR0192
C15/C1500 Pickup	307 V8 CARB	HPR0192	C15/C1500 Pickup	307 V8 CARB	HPR0192
C15/C1500 Pickup	350 V8 4 BBL.	HPR0326	C15/C1500 Pickup	350 V8 CARB	HPR0192
C15/C1500 Suburban	350 V8 4 BBL.	HPR0326 ♦	C15/C1500 Suburban	292 L6 CARB	HPR0192
C15/C1500 Suburban	402 V8 CARB	HPR0326	C15/C1500 Suburban	307 V8 CARB	HPR0192
C25/C2500 Pickup	292 L6 CARB	HPR0192	C15/C1500 Suburban	350 V8 CARB	HPR0326
C25/C2500 Pickup	307 V8 CARB	HPR0192	C15/C1500 Suburban	402 V8 CARB	HPR0192
C25/C2500 Pickup	350 V8 2 BBL.	HPR0192	C25/C2500 Pickup	292 L6 CARB	HPR0192
C25/C2500 Pickup	350 V8 4 BBL.	HPR0326	C25/C2500 Pickup	307 V8 CARB	HPR0192
C25/C2500 Pickup	402 V8 CARB	HPR0326	C25/C2500 Suburban	292 L6 CARB	HPR0192
C25/C2500 Suburban	292 L6 CARB	HPR0192	C25/C2500 Suburban	307 V8 CARB	HPR0192
C25/C2500 Suburban	307 V8 CARB	HPR0192	C25/C2500 Suburban	350 V8 2 BBL.	HPR0192 ♦
C25/C2500 Suburban	350 V8 2 BBL.	HPR0192 ♦	C25/C2500 Suburban	350 V8 4 BBL.	HPR0326 ♦
C25/C2500 Suburban	350 V8 4 BBL.	HPR0326 ♦	C25/C2500 Suburban	402 V8 CARB	HPR0192
C25/C2500 Suburban	402 V8 CARB	HPR0326	C35/C3500 Pickup	292 L6 CARB	HPR0192
C35/C3500 Pickup	292 L6 CARB	HPR0192	C35/C3500 Pickup	307 V8 CARB	HPR0192
C35/C3500 Pickup	307 V8 CARB	HPR0192	G15/G1500 Van	307 V8 CARB	HPR0192
C35/C3500 Pickup	350 V8 4 BBL.	HPR0326	G25/G2500 Van	307 V8 CARB	HPR0192
C35/C3500 Pickup	402 V8 CARB	HPR0326	G25/G2500 Van	350 V8 CARB	HPR0192
G15/G1500 Van	307 V8 CARB	HPR0192	G35/G3500 Van	307 V8 CARB	HPR0192
G15/G1500 Van	350 V8 CARB	HPR0192	G35/G3500 Van	350 V8 CARB	HPR0192
G25/G2500 Van	307 V8 CARB	HPR0192	Heavy Duty Truck	396 V8 4 BBL. - 4000-8500	HPR0192
G25/G2500 Van	350 V8 CARB	HPR0192	Jimmy	307 V8 CARB	HPR0192
G35/G3500 Van	350 V8 CARB	HPR0192	Jimmy	350 V8 CARB	HPR0192
Heavy Duty Truck	396 V8 4 BBL. - 4000-8500	HPR0192	K15/K1500 Pickup	292 L6 CARB	HPR0192
Heavy Duty Truck	402 V8 4 BBL. - 4000-8500	HPR0192	K15/K1500 Pickup	307 V8 CARB	HPR0192
Jimmy	307 V8 CARB	HPR0192	K15/K1500 Suburban	292 L6 CARB	HPR0192
Jimmy	350 V8 CARB	HPR0326	K15/K1500 Suburban	307 V8 CARB	HPR0192
K15/K1500 Pickup	292 L6 CARB	HPR0192	K15/K1500 Suburban	350 V8 2 BBL.	HPR0192 ♦
K15/K1500 Pickup	350 V8 2 BBL.	HPR0192 ♦	K15/K1500 Suburban	350 V8 4 BBL.	HPR0326 ♦
K15/K1500 Pickup	350 V8 4 BBL.	HPR0326 ♦	K15/K1500 Suburban	402 V8 CARB	HPR0192
K15/K1500 Pickup	402 V8 CARB	HPR0192	K25/K2500 Pickup	292 L6 CARB	HPR0192
K15/K1500 Suburban	307 V8 CARB	HPR0192	K25/K2500 Pickup	307 V8 CARB	HPR0192
K15/K1500 Suburban	350 V8 2 BBL.	HPR0192 ♦	K25/K2500 Suburban	292 L6 CARB	HPR0192
K15/K1500 Suburban	350 V8 4 BBL.	HPR0326 ♦	K25/K2500 Suburban	307 V8 CARB	HPR0192
K15/K1500 Suburban	402 V8 CARB	HPR0326	K25/K2500 Suburban	350 V8 2 BBL.	HPR0192 ♦
K25/K2500 Pickup	292 L6 CARB	HPR0192	K25/K2500 Suburban	350 V8 4 BBL.	HPR0326 ♦
K25/K2500 Pickup	350 V8 2 BBL.	HPR0192 ♦	K25/K2500 Suburban	402 V8 CARB	HPR0192
K25/K2500 Pickup	350 V8 4 BBL.	HPR0326 ♦	K35/K3500 Pickup	292 L6 CARB	HPR0192
K25/K2500 Pickup	402 V8 CARB	HPR0192	K35/K3500 Pickup	307 V8 CARB	HPR0192
K25/K2500 Suburban	307 V8 CARB	HPR0192	Motorhome	307 V8 4 BBL. - Class C	HPR0192
K25/K2500 Suburban	350 V8 2 BBL.	HPR0192 ♦	Motorhome	350 V8 4 BBL. - Class C	HPR0192
K25/K2500 Suburban	350 V8 4 BBL.	HPR0326 ♦	P15/P1500 Van	307 V8 CARB	HPR0192
K25/K2500 Suburban	402 V8 CARB	HPR0326	P25/P2500 Van	292 L6 CARB	HPR0192
K35/K3500 Pickup	292 L6 CARB	HPR0192	P25/P2500 Van	307 V8 CARB	HPR0192
			P25/P2500 Van	350 V8 CARB	HPR0192

*Indicates 2 filters required ♦ Intake system available - see page 326 + throttle body spacer available - see page 20

HPR™ REPLACEMENT AIR FILTERS

GMC

Vehicle	Engine Type	Air Filter	Vehicle	Engine Type	Air Filter
1970 GMC			1968 GMC		
P35/P3500 Van	292 L6 CARB	HPR0192	C35/C3500 Pickup	396 V8 CARB - Hi Perf.	880136
P35/P3500 Van	307 V8 CARB	HPR0192			HPR0136
P35/P3500 Van	350 V8 CARB	HPR0192	G15/G1500 Van	230 L6 CARB	HPR0192
1969 GMC			G15/G1500 Van	250 L6 CARB	HPR0192
C15/C1500 Pickup	292 L6 CARB	HPR0192	G25/G2500 Van	230 L6 CARB	HPR0192
C15/C1500 Pickup	396 V8 CARB - Exc. Hi Perf.	HPR0192	G25/G2500 Van	250 L6 CARB	HPR0192
	396 V8 CARB - Hi Perf.	48026	Heavy Duty Truck	230 L6 2 BBL. - 4000-8500 HD	HPR0192
		880136	Heavy Duty Truck	327 V8 2 BBL. - 4000-8500	HPR0192
		HPR0136	Heavy Duty Truck	396 V8 4 BBL. - 4000-8500	HPR0192
C15/C1500 Suburban	292 L6 CARB	HPR0192	K15/K1500 Pickup	292 L6 CARB	HPR0192
C25/C2500 Pickup	292 L6 CARB	HPR0192	K15/K1500 Pickup	327 V8 CARB	HPR0192
C25/C2500 Pickup	396 V8 CARB - Exc. Hi Perf.	HPR0192	K15/K1500 Pickup	396 V8 CARB - Exc. Hi Perf.	HPR0192
	396 V8 CARB - Hi Perf.	48026		396 V8 CARB - Hi Perf.	48026
		880136			880136
		HPR0136			HPR0136
C25/C2500 Suburban	292 L6 CARB	HPR0192	K15/K1500 Suburban	292 L6 CARB	HPR0192
C35/C3500 Pickup	292 L6 CARB	HPR0192	K15/K1500 Suburban	327 V8 CARB	HPR0192
C35/C3500 Pickup	396 V8 CARB - Exc. Hi Perf.	HPR0192	K15/K1500 Suburban	396 V8 CARB - Exc. Hi Perf.	HPR0192
	396 V8 CARB - Hi Perf.	48026	K25/K2500 Pickup	292 L6 CARB	HPR0192
		880136	K25/K2500 Pickup	396 V8 CARB - Exc. Hi Perf.	HPR0192
		HPR0136		396 V8 CARB - Hi Perf.	48026
G15/G1500 Van	230 L6 CARB	HPR0192			880136
G25/G2500 Van	230 L6 CARB	HPR0192			HPR0136
Heavy Duty Truck	230 L6 2 BBL. - 4000-8500 HD	HPR0192	K25/K2500 Suburban	292 L6 CARB	HPR0192
Heavy Duty Truck	396 V8 4 BBL. - 4000-8500	HPR0192	K35/K3500 Pickup	292 L6 CARB	HPR0192
Heavy Duty Truck	396 V8 4 BBL. - 4000-8500	HPR0192	K35/K3500 Pickup	327 V8 CARB	HPR0192
K15/K1500 Pickup	292 L6 CARB	HPR0192	K35/K3500 Pickup	396 V8 CARB - Exc. Hi Perf.	HPR0192
K15/K1500 Pickup	307 V8 CARB	HPR0192		396 V8 CARB - Hi Perf.	48026
K15/K1500 Pickup	396 V8 CARB	48026			880136
		880136			HPR0136
		HPR0136	P15/P1500 Van	230 L6 CARB	HPR0192
K25/K2500 Pickup	292 L6 CARB	HPR0192	P15/P1500 Van	250 L6 CARB	HPR0192
	396 V8 CARB	48026	P25/P2500 Van	292 L6 CARB	HPR0192
		880136	P35/P3500 Van	292 L6 CARB	HPR0192
		HPR0136	1967 GMC		
K25/K2500 Suburban	292 L6 CARB	HPR0192	Heavy Duty Truck	230 L6 2 BBL. - 4000-8500 HD	HPR0192
K35/K3500 Pickup	292 L6 CARB	HPR0192	1966 GMC		
	396 V8 CARB	48026	Heavy Duty Truck	230 L6 2 BBL. - 4000-8500 HD	HPR0192
		880136	1965 GMC		
		HPR0136	1000 Series	230 L6 CARB - Heavy Duty Filter	HPR0192
Motorhome	350 V8 4 BBL. - Class C	HPR0192	1500 Series	230 L6 CARB - Heavy Duty Filter	HPR0192
P15/P1500 Van	230 L6 CARB	HPR0192	3000	230 L6 CARB - Heavy Duty Filter	HPR0192
P15/P1500 Van	250 L6 CARB	HPR0192	3500	230 L6 CARB - Heavy Duty Filter	HPR0192
P25/P2500 Van	292 L6 CARB	HPR0192	Heavy Duty Truck	230 L6 2 BBL. - 4000-8500 HD	HPR0192
P35/P3500 Van	292 L6 CARB	HPR0192	I1000	230 L6 CARB - Heavy Duty Filter	HPR0192
1968 GMC			I1500	230 L6 CARB - Heavy Duty Filter	HPR0192
C15/C1500 Pickup	292 L6 CARB	HPR0192	I2500	230 L6 CARB - Heavy Duty Filter	HPR0192
C15/C1500 Pickup	396 V8 CARB - Exc. Hi Perf.	HPR0192	PB1000 Series	230 L6 CARB - Heavy Duty Filter	HPR0192
	396 V8 CARB - Hi Perf.	48026	1964 GMC		
		880136	1000 Series	230 L6 CARB - Heavy Duty Filter	HPR0192
		HPR0136	1500 Series	230 L6 CARB - Heavy Duty Filter	HPR0192
C15/C1500 Suburban	292 L6 CARB	HPR0192	3000	230 L6 CARB - Heavy Duty Filter	HPR0192
C25/C2500 Pickup	292 L6 CARB	HPR0192	3500	230 L6 CARB - Heavy Duty Filter	HPR0192
C25/C2500 Pickup	327 V8 CARB	HPR0192	Heavy Duty Truck	230 L6 2 BBL. - 4000-8500 HD	HPR0192
C25/C2500 Pickup	396 V8 CARB - Exc. Hi Perf.	HPR0192	I1000	230 L6 CARB - Heavy Duty Filter	HPR0192
	396 V8 CARB - Hi Perf.	48026	PB1000 Series	230 L6 CARB - Heavy Duty Filter	HPR0192
		880136	1963 GMC		
		HPR0136	Heavy Duty Truck	230 L6 2 BBL. - 4000-8500 HD	HPR0192
C25/C2500 Suburban	292 L6 CARB	HPR0192	2011 HONDA		
C25/C2500 Suburban	327 V8 CARB	HPR0192	Civic	1.8L L4 F/I	HPR10165
C35/C3500 Pickup	292 L6 CARB	HPR0192	Civic GX	1.8L L4 F/I	HPR10165
C35/C3500 Pickup	327 V8 CARB	HPR0192			
C35/C3500 Pickup	396 V8 CARB - Exc. Hi Perf.	HPR0192			
	396 V8 CARB - Hi Perf.	48026			

*Indicates 2 filters required ♦ Intake system available - see page 326 + throttle body spacer available - see page 20

Vehicle	Engine Type	Air Filter	Vehicle	Engine Type	Air Filter
2011 HONDA			2005 HONDA		
Civic VIII	1.8L L4 F/I	HPR10165	Element	2.4L L4 F/I	HPR9493
2010 HONDA			FR-V	2.0L L4 F/I	HPR9493
Civic	1.8L L4 F/I	HPR10165	HRV	1.6L L4 F/I	HPR7764
Civic GX	1.8L L4 F/I	HPR10165	Pilot	3.5L V6 F/I	HPR9361
Civic VIII	1.8L L4 F/I	HPR10165	Stream	2.0L L4 F/I	HPR9493
FR-V	1.8L L4 F/I	HPR10165	2004 HONDA		
2009 HONDA			Accord	2.4L L4 F/I	HPR9564
Civic	1.8L L4 F/I	HPR10165	Accord VIII	2.0L L4 F/I - Non-US	HPR9564
Civic GX	1.8L L4 F/I	HPR10165	Accord VIII	2.4L L4 F/I - Non-US	HPR9564
Civic VIII	1.8L L4 F/I	HPR10165	Civic DX	1.7L L4 F/I	HPR8911
FR-V	1.8L L4 F/I	HPR10165	Civic EX	1.7L L4 F/I	HPR8911
2008 HONDA			Civic GX	1.7L L4 F/I	HPR8911
Accord VIII	2.0L L4 F/I - Non-US	HPR9564	Civic HX	1.7L L4 F/I	HPR8911
Accord VIII	2.4L L4 F/I - Non-US	HPR9564	Civic LX	1.7L L4 F/I	HPR8911
Civic	1.8L L4 F/I	HPR10165	Civic Si	1.7L L4 F/I	HPR8911
Civic GX	1.8L L4 F/I	HPR10165	Civic Si	2.0L L4 F/I	HPR9493
Civic VIII	1.8L L4 F/I	HPR10165	Civic Value Package	1.7L L4 F/I	HPR8911
FR-V	1.8L L4 F/I	HPR10165	Civic VI	1.7L L4 F/I	HPR8911
FR-V	2.0L L4 F/I	HPR9493	Civic VI	2.0L L4 F/I	HPR9493
Pilot	3.5L V6 F/I	HPR9361	CR-V	2.4L L4 F/I	HPR9493
2007 HONDA			CR-V II	2.0L L4 F/I	HPR9493
Accord	2.4L L4 F/I	HPR9564	Element	2.4L L4 F/I	HPR9493
Accord VIII	2.0L L4 F/I - Non-US	HPR9564	HRV	1.6L L4 F/I	HPR7764
Accord VIII	2.4L L4 F/I - Non-US	HPR9564	Pilot	3.5L V6 F/I	HPR9361
Civic	1.8L L4 F/I	HPR10165	Stream	2.0L L4 F/I	HPR9493
Civic GX	1.8L L4 F/I	HPR10165	2003 HONDA		
Civic VIII	1.8L L4 F/I	HPR10165	Accord	2.4L L4 F/I	HPR9564
FR-V	1.8L L4 F/I	HPR10165	Accord VII	1.8L L4 F/I	HPR8133
FR-V	2.0L L4 F/I	HPR9493	Accord VII	2.0L L4 F/I	HPR8133
Pilot	3.5L V6 F/I	HPR9361	Accord VII	3.0L V6 F/I	HPR8475
2006 HONDA			Accord VIII	2.0L L4 F/I - Non-US	HPR9564
Accord	2.4L L4 F/I	HPR9564	Accord VIII	2.4L L4 F/I - Non-US	HPR9564
Accord VIII	2.0L L4 F/I - Non-US	HPR9564	Civic DX	1.7L L4 F/I	HPR8911
Accord VIII	2.4L L4 F/I - Non-US	HPR9564	Civic EX	1.7L L4 F/I	HPR8911
Civic	1.8L L4 F/I	HPR10165	Civic GX	1.7L L4 F/I	HPR8911
Civic GX	1.8L L4 F/I	HPR10165	Civic HX	1.7L L4 F/I	HPR8911
Civic VII	2.0L L4 F/I	HPR9493	Civic LX	1.7L L4 F/I	HPR8911
Civic VIII	1.8L L4 F/I	HPR10165	Civic Si	1.7L L4 F/I	HPR8911
CR-V	2.4L L4 F/I	HPR9493	Civic Si	2.0L L4 F/I	HPR9493
CR-V II	2.0L L4 F/I	HPR9493	Civic VI	1.7L L4 F/I	HPR8911
Element	2.4L L4 F/I	HPR9493	Civic VI	2.0L L4 F/I	HPR9493
FR-V	2.0L L4 F/I	HPR9493	CR-V	2.4L L4 F/I	HPR9493
Pilot	3.5L V6 F/I	HPR9361	CR-V II	2.0L L4 F/I	HPR9493
2005 HONDA			Element	2.4L L4 F/I	HPR9493
Accord	2.4L L4 F/I	HPR9564	HRV	1.6L L4 F/I	HPR7764
Accord VIII	2.0L L4 F/I - Non-US	HPR9564	Pilot	3.5L V6 F/I	HPR9361
Accord VIII	2.4L L4 F/I - Non-US	HPR9564	Stream	2.0L L4 F/I	HPR9493
Civic DX	1.7L L4 F/I	HPR8911	2002 HONDA		
Civic EX	1.7L L4 F/I	HPR8911	Accord	2.3L L4 F/I	HPR8133
Civic GX	1.7L L4 F/I	HPR8911	Accord	3.0L V6 F/I	HPR8475
Civic HX	1.7L L4 F/I	HPR8911	Accord VII	1.6L L4 F/I	HPR8133
Civic LX	1.7L L4 F/I	HPR8911	Accord VII	1.8L L4 F/I	HPR8133
Civic Reverb	1.7L L4 F/I	HPR8911	Accord VII	2.0L L4 F/I	HPR8133
Civic Si	1.7L L4 F/I	HPR8911	Accord VII	2.2L L4 F/I	HPR8133
Civic Si	2.0L L4 F/I	HPR9493	Accord VII	3.0L V6 F/I	HPR8475
Civic Value Package	1.7L L4 F/I	HPR8911	Civic DX	1.7L L4 F/I	HPR8911
Civic VI	1.7L L4 F/I	HPR8911	Civic EX	1.7L L4 F/I	HPR8911
Civic VI	2.0L L4 F/I	HPR9493	Civic GX	1.7L L4 F/I	HPR8911
Civic VIII	1.8L L4 F/I	HPR10165	Civic HX	1.7L L4 F/I	HPR8911
CR-V	2.4L L4 F/I	HPR9493	Civic LX	1.7L L4 F/I	HPR8911
CR-V II	2.0L L4 F/I	HPR9493	Civic Si	1.7L L4 F/I	HPR8911
			Civic Si	2.0L L4 F/I	HPR9493
			Civic VI	1.7L L4 F/I	HPR8911

*Indicates 2 filters required ♦ Intake system available - see page 326 + throttle body spacer available - see page 20

HPR™ REPLACEMENT AIR FILTERS

HONDA

Vehicle	Engine Type	Air Filter
2002 HONDA		
Civic VI	2.0L L4 F/I	HPR9493
CR-V	2.4L L4 F/I	HPR9493
CR-V I	2.0L L4 F/I	HPR7764
CR-V II	2.0L L4 F/I	HPR9493
HRV	1.6L L4 F/I	HPR7764
Passport	3.2L V6 F/I	HPR7417
Stream	2.0L L4 F/I	HPR9493

2001 HONDA		
Accord	2.3L L4 F/I	HPR8133
Accord	3.0L V6 F/I	HPR8475
Accord VII	1.6L L4 F/I	HPR8133
Accord VII	1.8L L4 F/I	HPR8133
Accord VII	2.0L L4 F/I	HPR8133
Accord VII	2.2L L4 F/I	HPR8133
Accord VII	3.0L V6 F/I	HPR8475
Civic DX	1.7L L4 F/I	HPR8911
Civic EX	1.7L L4 F/I	HPR8911
Civic GX	1.7L L4 F/I	HPR8911
Civic HX	1.7L L4 F/I	HPR8911
Civic LX	1.7L L4 F/I	HPR8911
Civic V	1.5L L4 F/I - 3/4-Door	HPR7764
Civic V	1.6L L4 F/I - 114/160BHP	HPR7764
Civic VI	1.7L L4 F/I	HPR8911
Civic VI	2.0L L4 F/I	HPR9493
CR-V	2.0L L4 F/I	HPR7764
CR-V I	2.0L L4 F/I	HPR7764
HRV	1.6L L4 F/I	HPR7764
Passport	3.2L V6 F/I	HPR7417
Shuttle	2.3L L4 F/I	HPR7420
Stream	2.0L L4 F/I	HPR9493

2000 HONDA		
Accord	2.3L L4 F/I	HPR8133
Accord	3.0L V6 F/I	HPR8475
Accord VII	1.6L L4 F/I	HPR8133
Accord VII	1.8L L4 F/I	HPR8133
Accord VII	2.0L L4 F/I	HPR8133
Accord VII	2.2L L4 F/I	HPR8133
Accord VII	3.0L V6 F/I	HPR8475
Civic CX	1.6L L4 F/I	HPR8040 ♦
Civic DX	1.6L L4 F/I	HPR8040 ♦
Civic EX	1.6L L4 F/I	HPR7764 ♦
Civic GX	1.6L L4 F/I	HPR7764 ♦
Civic HX	1.6L L4 F/I	HPR7764 ♦
Civic LX	1.6L L4 F/I	HPR8040 ♦
Civic Si	1.6L L4 F/I	HPR7764
Civic V	1.5L L4 F/I - 3/4-Door	HPR7764
Civic V	1.6L L4 F/I - 114/160BHP	HPR7764
CR-V	2.0L L4 F/I	HPR7764
CR-V I	2.0L L4 F/I	HPR7764
HRV	1.6L L4 F/I	HPR7764
Passport	3.2L V6 F/I	HPR7417
Shuttle	2.3L L4 F/I	HPR7420

1999 HONDA		
Accord	2.3L L4 F/I	HPR8133
Accord	3.0L V6 F/I	HPR8475
Accord VII	1.6L L4 F/I	HPR8133
Accord VII	1.8L L4 F/I	HPR8133
Accord VII	2.0L L4 F/I	HPR8133
Accord VII	2.2L L4 F/I	HPR8133
Accord VII	3.0L V6 F/I	HPR8475
Civic CX	1.6L L4 F/I	HPR8040 ♦
Civic DX	1.6L L4 F/I	HPR8040 ♦
Civic EX	1.6L L4 F/I	HPR7764 ♦

Vehicle	Engine Type	Air Filter
1999 HONDA		
Civic GX	1.6L L4 F/I	HPR7764 ♦
Civic HX	1.6L L4 F/I	HPR7764 ♦
Civic LX	1.6L L4 F/I	HPR8040 ♦
Civic Si	1.6L L4 F/I	HPR7764
Civic V	1.5L L4 F/I - 3/4-Door	HPR7764
Civic V	1.6L L4 F/I - 114/160BHP	HPR7764
Civic Value Package	1.6L L4 F/I	HPR7764 ♦
CR-V	2.0L L4 F/I	HPR7764
CR-V I	2.0L L4 F/I	HPR7764
HRV	1.6L L4 F/I	HPR7764
Passport	3.2L V6 F/I	HPR7417
Shuttle	2.3L L4 F/I	HPR7420

1998 HONDA		
Accord	2.3L L4 F/I	HPR8133
Accord	2.3L L4 F/I - Non-US	HPR6807
Accord	2.3L L4 F/I - US	HPR8133
Accord	3.0L V6 F/I	HPR8475
Accord V	2.0L L4 F/I - F20B Eng.	HPR7420
Accord V	2.0L L4 F/I - F20Z Eng.	HPR6807
Accord V	2.2L L4 F/I	HPR7420
Accord VI	1.8L L4 F/I	HPR6807
Accord VI	2.0L L4 F/I	HPR6807
Accord VI	2.2L L4 F/I	HPR6807
Accord VII	1.6L L4 F/I	HPR8133
Accord VII	1.8L L4 F/I	HPR8133
Accord VII	2.0L L4 F/I	HPR8133
Accord VII	2.2L L4 F/I	HPR8133
Accord VII	3.0L V6 F/I	HPR8475
Civic CX	1.6L L4 F/I	HPR8040
Civic DX	1.6L L4 F/I	HPR8040
Civic EX	1.6L L4 F/I	HPR7764
Civic GX	1.6L L4 F/I	HPR7764
Civic HX	1.6L L4 F/I	HPR7764
Civic LX	1.6L L4 F/I	HPR8040
Civic Si	1.6L L4 F/I	HPR7764
Civic V	1.5L L4 F/I - 3/4-Door	HPR7764
Civic V	1.6L L4 F/I - 114/160BHP	HPR7764
CR-V	2.0L L4 F/I	HPR7764
CR-V I	2.0L L4 F/I	HPR7764
Odyssey	2.3L L4 F/I	HPR7420
Passport	3.2L V6 F/I	HPR7417
Shuttle	2.2L L4 F/I	HPR7420
Shuttle	2.3L L4 F/I	HPR7420

1997 HONDA		
Accord	2.2L L4 F/I - US	HPR7420
Accord	2.3L L4 F/I	HPR7420
Accord V	2.0L L4 F/I - F20B Eng.	HPR7420
Accord V	2.0L L4 F/I - F20Z Eng.	HPR6807
Accord V	2.2L L4 F/I	HPR7420
Accord VI	1.8L L4 F/I	HPR6807
Accord VI	2.0L L4 F/I	HPR6807
Accord VI	2.2L L4 F/I	HPR6807
Civic CX	1.6L L4 F/I	HPR8040
Civic DX	1.6L L4 F/I	HPR8040
Civic EX	1.6L L4 F/I	HPR7764
Civic HX	1.6L L4 F/I	HPR7764
Civic LX	1.6L L4 F/I	HPR8040
Civic Si	1.6L L4 F/I	HPR7764
Civic V	1.5L L4 F/I - 3/4-Door	HPR7764
Civic V	1.6L L4 F/I - 114/160BHP	HPR7764
CR-V	2.0L L4 F/I	HPR7764
CR-V I	2.0L L4 F/I	HPR7764
Odyssey	2.2L L4 F/I	HPR7420

*Indicates 2 filters required ♦ Intake system available - see page 326 + throttle body spacer available - see page 20

HONDA

HPR™ REPLACEMENT AIR FILTERS

Vehicle	Engine Type	Air Filter
1997 HONDA		
Passport	3.2L V6 F/I	HPR7417
Shuttle	2.2L L4 F/I	HPR7420
1996 HONDA		
Accord	2.2L L4 F/I - US	HPR7420
Accord V	2.0L L4 F/I - F20B Eng.	HPR7420
Accord V	2.0L L4 F/I - F20Z Eng.	HPR6807
Accord V	2.2L L4 F/I	HPR7420
Accord V	2.3L L4 F/I	HPR6807
Accord VI	1.8L L4 F/I	HPR6807
Accord VI	2.0L L4 F/I	HPR6807
Accord VI	2.2L L4 F/I	HPR6807
Civic CX	1.6L L4 F/I	HPR8040
Civic DX	1.6L L4 F/I	HPR8040
Civic EX	1.6L L4 F/I	HPR8040
Civic HX	1.6L L4 F/I	HPR7764
Civic LX	1.6L L4 F/I	HPR8040
Civic Si	1.6L L4 F/I	HPR7764
Civic V	1.5L L4 F/I	HPR7764
Civic V	1.6L L4 F/I - 114/160BHP	HPR7764
CR-V I	2.0L L4 F/I	HPR7764
Odyssey	2.2L L4 F/I	HPR7420
Passport	3.2L V6 F/I	HPR7417
Shuttle	2.2L L4 F/I	HPR7420
1995 HONDA		
Accord	2.2L L4 F/I	HPR7420
Accord EX	2.2L L4 F/I	HPR7420
Accord V	2.0L L4 F/I - F20B Eng.	HPR7420
Accord V	2.0L L4 F/I - F20Z Eng.	HPR6807
Accord V	2.2L L4 F/I	HPR7420
Accord V	2.3L L4 F/I	HPR6807
Civic V	1.5L L4 F/I	HPR7764
Civic V	1.6L L4 F/I - 114/160BHP	HPR7764
CR-V I	2.0L L4 F/I	HPR7764
Odyssey	2.2L L4 F/I	HPR7420
Passport	2.6L L4 F/I	HPR7417
Passport	3.2L V6 F/I	HPR7417
Shuttle	2.2L L4 F/I	HPR7420
1994 HONDA		
Accord	2.2L L4 F/I	HPR7420
Accord EX	2.2L L4 F/I	HPR7420
Accord V	2.0L L4 F/I - F20B Eng.	HPR7420
Accord V	2.0L L4 F/I - F20Z Eng.	HPR6807
Accord V	2.2L L4 F/I	HPR7420
Accord V	2.3L L4 F/I	HPR6807
Passport	2.6L L4 F/I	HPR7417
Passport	3.2L V6 F/I	HPR7417
1993 HONDA		
Accord	2.2L L4 F/I	HPR6807
Accord IV	2.0L L4 F/I - 133BHP	HPR6807
Accord IV	2.2L L4 F/I	HPR6807
Accord V	2.0L L4 F/I - F20B Eng.	HPR7420
Accord V	2.0L L4 F/I - F20Z Eng.	HPR6807
Accord V	2.2L L4 F/I	HPR7420
Accord V	2.3L L4 F/I	HPR6807
1992 HONDA		
Accord	2.2L L4 F/I	HPR6807
Accord IV	2.0L L4 F/I - 133BHP	HPR6807
Accord IV	2.2L L4 F/I	HPR6807
1991 HONDA		
Accord	2.2L L4 F/I	HPR6807
Accord IV	2.0L L4 F/I - 133BHP	HPR6807

Vehicle	Engine Type	Air Filter
1991 HONDA		
Accord IV	2.2L L4 F/I	HPR6807
1990 HONDA		
Accord	2.2L L4 F/I	HPR6807
Accord IV	2.0L L4 F/I - 133BHP	HPR6807
Accord IV	2.2L L4 F/I	HPR6807
1984 HONDA		
Quintet	1.6L L4 CARB	HPR2740
1983 HONDA		
Accord	1.8L L4 CARB	HPR2740
Accord I	1.6L L4 CARB	HPR2740
Quintet	1.6L L4 CARB	HPR2740
1982 HONDA		
Accord	1.8L L4 CARB	HPR2740
Accord I	1.6L L4 CARB	HPR2740
Prelude	1.8L L4 CARB	HPR2740
Prelude I	1.6L L4 CARB	HPR2740
Quintet	1.6L L4 CARB	HPR2740
1981 HONDA		
Accord	1.8L L4 CARB	HPR2740
Accord I	1.6L L4 CARB	HPR2740
Prelude	1.8L L4 CARB	HPR2740
Prelude I	1.6L L4 CARB	HPR2740
Quintet	1.6L L4 CARB	HPR2740
1980 HONDA		
Accord	1.8L L4 CARB	HPR2740
Accord I	1.6L L4 CARB	HPR2740
Prelude	1.8L L4 CARB	HPR2740
Prelude I	1.6L L4 CARB	HPR2740
1979 HONDA		
Accord	1.8L L4 CARB	HPR0352
Accord I	1.6L L4 CARB	HPR2740
Prelude	110 L4 CARB	HPR0352
Prelude I	1.6L L4 CARB	HPR2740
1978 HONDA		
Accord I	1.6L L4 CARB	HPR2740
Prelude I	1.6L L4 CARB	HPR2740
2010 HYUNDAI		
Tucson	2.0L L4 DSL	HPR9392
2009 HYUNDAI		
Coupe	2.0L L4 F/I	HPR9392
Coupe	2.7L V6 F/I	HPR9392
Tucson	2.0L L4 DSL	HPR9392
Tucson	2.0L L4 F/I	HPR9392
Tucson	2.7L V6 F/I	HPR9392
2008 HYUNDAI		
Coupe	2.0L L4 F/I	HPR9392
Coupe	2.7L V6 F/I	HPR9392
Getz	1.1L L4 F/I	HPR7167
Getz	1.4L L4 F/I	HPR7167
Getz	1.5L L4 F/I	HPR7167
Getz	1.6L L4 F/I	HPR7167
Tiburon	2.0L L4 F/I	HPR9392
Tiburon	2.7L V6 F/I	HPR9392
Tucson	2.0L L4 DSL	HPR9392
Tucson	2.0L L4 F/I	HPR9392
Tucson	2.7L V6 F/I	HPR9392
2007 HYUNDAI		
Coupe	2.0L L4 F/I	HPR9392

*Indicates 2 filters required ♦ Intake system available - see page 326 + throttle body spacer available - see page 20

HPR™ REPLACEMENT AIR FILTERS

HYUNDAI

Vehicle	Engine Type	Air Filter	Vehicle	Engine Type	Air Filter
2007 HYUNDAI			2004 HYUNDAI		
Coupe	2.7L V6 F/I	HPR9392	Tucson	2.0L L4 F/I	HPR9392
Elantra	1.6L L4 F/I	HPR9392	Tucson	2.7L V6 F/I	HPR9392
Elantra	2.0L L4 DSL	HPR9392	XG300	3.0L V6 F/I	HPR9055
Elantra	2.0L L4 F/I - Non-US	HPR9392	XG350	3.5L V6 F/I	HPR9055
Getz	1.1L L4 F/I	HPR7167	2003 HYUNDAI		
Getz	1.4L L4 F/I	HPR7167	Coupe	1.6L L4 F/I	HPR9392
Getz	1.5L L4 DSL	HPR7167	Coupe	2.0L L4 F/I	HPR9392
Getz	1.6L L4 F/I	HPR7167	Coupe	2.7L V6 F/I	HPR9392
Tiburon	2.0L L4 F/I	HPR9392	Elantra	1.6L L4 F/I	HPR9392
Tiburon	2.7L V6 F/I	HPR9392	Elantra	1.8L L4 F/I	HPR9392
Tucson	2.0L L4 DSL	HPR9392	Elantra	2.0L L4 DSL	HPR9392
Tucson	2.0L L4 F/I	HPR9392	Elantra	2.0L L4 F/I	HPR9392
Tucson	2.7L V6 F/I	HPR9392	Elantra	1.1L L4 F/I	HPR7167
2006 HYUNDAI			Getz	1.3L L4 F/I	HPR7167
Coupe	2.0L L4 F/I	HPR9392	Getz	1.5L L4 DSL	HPR7167
Coupe	2.7L V6 F/I	HPR9392	Getz	1.6L L4 F/I	HPR7167
Elantra	1.6L L4 F/I	HPR9392	Tiburon	2.0L L4 F/I	HPR9392
Elantra	2.0L L4 DSL	HPR9392	Tiburon GT	2.7L V6 F/I	HPR9392
Elantra	2.0L L4 F/I	HPR9392	XG300	3.0L V6 F/I	HPR9055
Getz	1.1L L4 F/I	HPR7167	XG350	3.5L V6 F/I	HPR9055
Getz	1.4L L4 F/I	HPR7167	2002 HYUNDAI		
Getz	1.5L L4 DSL	HPR7167	Coupe	1.6L L4 F/I	HPR9392
Getz	1.6L L4 F/I	HPR7167	Coupe	2.0L L4 F/I	HPR9392
Tiburon	2.0L L4 F/I	HPR9392	Coupe	2.7L V6 F/I	HPR9392
Tiburon	2.7L V6 F/I	HPR9392	Elantra	1.6L L4 F/I	HPR9392
Tucson	2.0L L4 DSL	HPR9392	Elantra	1.8L L4 F/I	HPR9392
Tucson	2.0L L4 F/I	HPR9392	Elantra	2.0L L4 DSL	HPR9392
Tucson	2.7L V6 F/I	HPR9392	Elantra	2.0L L4 F/I	HPR9392
2005 HYUNDAI			Getz	1.1L L4 F/I	HPR7167
Coupe	2.0L L4 F/I	HPR9392	Getz	1.3L L4 F/I	HPR7167
Coupe	2.7L V6 F/I	HPR9392	Getz	1.6L L4 F/I	HPR7167
Elantra	1.6L L4 F/I	HPR9392	XG300	3.0L V6 F/I	HPR9055
Elantra	1.8L L4 F/I	HPR9392	XG350	3.5L V6 F/I	HPR9055
Elantra	2.0L L4 DSL	HPR9392	2001 HYUNDAI		
Elantra	2.0L L4 F/I	HPR9392	Elantra	1.6L L4 F/I	HPR9392
Getz	1.1L L4 F/I	HPR7167	Elantra	1.8L L4 F/I	HPR9392
Getz	1.3L L4 F/I	HPR7167	Elantra	2.0L L4 DSL	HPR9392
Getz	1.4L L4 F/I	HPR7167	Elantra	2.0L L4 F/I	HPR9392
Getz	1.5L L4 DSL	HPR7167	XG300	3.0L V6 F/I	HPR9055
Getz	1.6L L4 F/I	HPR7167	2000 HYUNDAI		
Tiburon	2.0L L4 F/I	HPR9392	Elantra	1.6L L4 F/I	HPR9392
Tiburon GT	2.7L V6 F/I	HPR9392	Elantra	1.8L L4 F/I	HPR9392
Tiburon SE	2.7L V6 F/I	HPR9392	Elantra	2.0L L4 F/I - Non-US	HPR9392
Tucson	2.0L L4 DSL	HPR9392	XG300	3.0L V6 F/I	HPR9055
Tucson	2.0L L4 F/I	HPR9392	1999 HYUNDAI		
Tucson	2.7L V6 F/I	HPR9392	XG300	3.0L V6 F/I	HPR9055
XG300	3.0L V6 F/I	HPR9055	1998 HYUNDAI		
XG350	3.5L V6 F/I	HPR9055	XG300	3.0L V6 F/I	HPR9055
2004 HYUNDAI			2016 INFINITI		
Coupe	1.6L L4 F/I	HPR9392	QX60	3.5L V6 F/I	HPR4309
Coupe	2.0L L4 F/I	HPR9392	2015 INFINITI		
Coupe	2.7L V6 F/I	HPR9392	QX60	3.5L V6 F/I	HPR4309
Elantra	1.6L L4 F/I	HPR9392	2014 INFINITI		
Elantra	1.8L L4 F/I	HPR9392	QX60	3.5L V6 F/I	HPR4309
Elantra	2.0L L4 DSL	HPR9392	2013 INFINITI		
Elantra	2.0L L4 F/I	HPR9392	JX35	3.5L V6 F/I	HPR4309
Getz	1.1L L4 F/I	HPR7167	2010 INFINITI		
Getz	1.3L L4 F/I	HPR7167	QX56	5.6L V8 F/I	HPR7440 ♦
Getz	1.5L L4 DSL	HPR7167			
Getz	1.6L L4 F/I	HPR7167			
Tiburon	2.0L L4 F/I	HPR9392			
Tiburon GT	2.7L V6 F/I	HPR9392			
Tucson	2.0L L4 DSL	HPR9392			

*Indicates 2 filters required ♦ Intake system available - see page 326 + throttle body spacer available - see page 20

Vehicle	Engine Type	Air Filter
2009 INFINITI		
QX56	5.6L V8 F/I	HPR7440 ♦
2008 INFINITI		
FX35	3.5L V6 F/I	HPR4309
QX56	5.6L V8 F/I	HPR7440 ♦
2007 INFINITI		
FX35	3.5L V6 F/I	HPR4309
G35	3.5L V6 F/I - Coupe	HPR4309
QX56	5.6L V8 F/I	HPR7440 ♦
2006 INFINITI		
FX35	3.5L V6 F/I	HPR4309
G35	3.5L V6 F/I	HPR4309
QX56	5.6L V8 F/I	HPR7440 ♦
2005 INFINITI		
FX35	3.5L V6 F/I	HPR4309
G35	3.5L V6 F/I	HPR4309
QX56	5.6L V8 F/I	HPR7440 ♦
2004 INFINITI		
FX35	3.5L V6 F/I	HPR4309
G35	3.5L V6 F/I	HPR4309
I35	3.5L V6 F/I	HPR4309
QX56	5.6L V8 F/I	HPR7440 ♦
2003 INFINITI		
FX35	3.5L V6 F/I	HPR4309
G35	3.5L V6 F/I	HPR4309
I35	3.5L V6 F/I	HPR4309
QX4	3.5L V6 F/I	HPR4309
2002 INFINITI		
G20	2.0L L4 F/I	HPR4309
I35	3.5L V6 F/I	HPR4309
QX4	3.5L V6 F/I	HPR4309
2001 INFINITI		
G20	2.0L L4 F/I	HPR4309
I30	3.0L V6 F/I	HPR4309
Q45	4.1L V8 F/I	HPR4309
QX4	3.5L V6 F/I	HPR4309
2000 INFINITI		
G20	2.0L L4 F/I	HPR4309
I30	3.0L V6 F/I	HPR4309
QX4	3.3L V6 F/I	HPR4309
1999 INFINITI		
G20	2.0L L4 F/I	HPR4309
I30	3.0L V6 F/I	HPR4309
QX4	3.3L V6 F/I	HPR4309
1998 INFINITI		
I30	3.0L V6 F/I	HPR4309
QX4	3.3L V6 F/I	HPR4309
1997 INFINITI		
I30	3.0L V6 F/I	HPR4309
J30	3.0L V6 F/I	HPR4309
QX4	3.3L V6 F/I	HPR4309
1996 INFINITI		
G20	2.0L L4 F/I	HPR4309
I30	3.0L V6 F/I	HPR4309
J30	3.0L V6 F/I	HPR4309
1995 INFINITI		
G20	2.0L L4 F/I	HPR4309
J30	3.0L V6 F/I	HPR4309

Vehicle	Engine Type	Air Filter
1994 INFINITI		
G20	2.0L L4 F/I	HPR4309
J30	3.0L V6 F/I	HPR4309
1993 INFINITI		
G20	2.0L L4 F/I	HPR4309
J30	3.0L V6 F/I	HPR4309
1992 INFINITI		
G20	2.0L L4 F/I	HPR4309
M30	3.0L V6 F/I	HPR4309
1991 INFINITI		
G20	2.0L L4 F/I	HPR4309
M30	3.0L V6 F/I	HPR4309
1990 INFINITI		
M30	3.0L V6 F/I	HPR4309
2008 JAGUAR		
S-Type	3.0L V6 F/I - Non-US	HPR8956
2007 JAGUAR		
S-Type	3.0L V6 F/I - Non-US	HPR8956
2006 JAGUAR		
S-Type	3.0L V6 F/I - Non-US	HPR8956
2005 JAGUAR		
S-Type	3.0L V6 F/I - Non-US	HPR8956
2004 JAGUAR		
S-Type	3.0L V6 F/I - Non-US	HPR8956
2003 JAGUAR		
S-Type	3.0L V6 F/I - Non-US	HPR8956
2002 JAGUAR		
S-Type	3.0L V6 F/I	HPR8956
S-Type	4.0L V8 F/I	HPR8956
2001 JAGUAR		
S-Type	3.0L V6 F/I	HPR8956
S-Type	4.0L V8 F/I	HPR8956
2000 JAGUAR		
S-Type	3.0L V6 F/I	HPR8956
S-Type	4.0L V8 F/I	HPR8956
1999 JAGUAR		
S-Type	4.0L V8 F/I	HPR8956
2017 JEEP		
Grand Cherokee	3.6L V6 F/I	HPR10755
Grand Cherokee	5.7L V8 F/I	HPR10755
Grand Cherokee	6.4L V8 F/I	HPR10755
Wrangler	3.6L V6 F/I	HPR10348
2016 JEEP		
Grand Cherokee	3.6L V6 F/I	HPR10755
Grand Cherokee	5.7L V8 F/I	HPR10755 ♦
Grand Cherokee	6.4L V8 F/I	HPR10755
Wrangler	3.6L V6 F/I	HPR10348 ♦
2015 JEEP		
Grand Cherokee	3.6L V6 F/I	HPR10755 ♦
Grand Cherokee	5.7L V8 F/I	HPR10755 ♦
Grand Cherokee	6.4L V8 F/I	HPR10755 ♦
Wrangler	3.6L V6 F/I	HPR10348 ♦
2014 JEEP		
Grand Cherokee	3.6L V6 F/I	HPR10755 ♦
Grand Cherokee	5.7L V8 F/I	HPR10755 ♦
Grand Cherokee	6.4L V8 F/I	HPR10755 ♦

*Indicates 2 filters required ♦ Intake system available - see page 326 + throttle body spacer available - see page 20

HPR™ REPLACEMENT AIR FILTERS

JEEP

Vehicle	Engine Type	Air Filter
2014 JEEP		
Wrangler	3.6L V6 F/I	HPR10348 ♦
2013 JEEP		
Grand Cherokee	3.6L V6 F/I	HPR10755 ♦
Grand Cherokee	5.7L V8 F/I	HPR10755 ♦
Grand Cherokee	6.4L V8 F/I	HPR10755 ♦
Wrangler	3.6L V6 F/I	HPR10348 ♦
2012 JEEP		
Grand Cherokee	3.6L V6 F/I	HPR10755 ♦
Grand Cherokee	5.7L V8 F/I	HPR10755 ♦
Grand Cherokee	6.4L V8 F/I	HPR10755 ♦
Wrangler	3.6L V6 F/I	HPR10348 ♦
Wrangler	3.8L V6 F/I	HPR10348
2011 JEEP		
Grand Cherokee	3.6L V6 F/I	HPR10755 ♦
Grand Cherokee	5.7L V8 F/I	HPR10755 ♦
Wrangler	3.8L V6 F/I	HPR10348 ♦
2010 JEEP		
Commander	3.7L V6 F/I	HPR8817
Commander	5.7L V8 F/I	HPR8817
Grand Cherokee	3.7L V6 F/I	HPR8817
Grand Cherokee	5.7L V8 F/I	HPR8817
Grand Cherokee	6.1L V8 F/I	HPR8817
Wrangler	3.8L V6 F/I	HPR10348 ♦
2009 JEEP		
Commander	3.7L V6 F/I	HPR8817
Commander	4.7L V8 F/I	HPR8817
Commander	5.7L V8 F/I	HPR8817
Grand Cherokee	3.0L V6 DSL	HPR8817
Grand Cherokee	3.7L V6 F/I	HPR8817
Grand Cherokee	4.7L V8 F/I	HPR8817
Grand Cherokee	5.7L V8 F/I	HPR8817
Grand Cherokee	6.1L V8 F/I	HPR8817
Wrangler	3.8L V6 F/I	HPR10348 ♦
2008 JEEP		
Commander	3.7L V6 F/I	HPR8817
Commander	4.7L V8 F/I	HPR8817
Commander	5.7L V8 F/I	HPR8817
Grand Cherokee	3.0L V6 DSL	HPR8817
Grand Cherokee	3.7L V6 F/I	HPR8817
Grand Cherokee	4.7L V8 F/I	HPR8817
Grand Cherokee	5.7L V8 F/I	HPR8817
Grand Cherokee	6.1L V8 F/I	HPR8817
Grand Cherokee III	3.7L V6 F/I	HPR8817
Grand Cherokee III	4.7L V8 F/I	HPR8817
Grand Cherokee III	5.7L V8 F/I	HPR8817
Grand Cherokee III	6.1L V8 F/I	HPR8817
Wrangler	3.8L V6 F/I	HPR10348 ♦
Wrangler II	3.8L V6 F/I	HPR10348
2007 JEEP		
Commander	3.7L V6 F/I	HPR8817
Commander	4.7L V8 F/I	HPR8817
Commander	5.7L V8 F/I	HPR8817
Grand Cherokee	3.0L V6 DSL	HPR8817
Grand Cherokee	3.7L V6 F/I	HPR8817
Grand Cherokee	4.7L V8 F/I	HPR8817
Grand Cherokee	5.7L V8 F/I	HPR8817
Grand Cherokee	6.1L V8 F/I	HPR8817
Grand Cherokee III	3.0L V6 DSL	HPR8817
Grand Cherokee III	3.7L V6 F/I	HPR8817
Grand Cherokee III	4.7L V8 F/I	HPR8817
Grand Cherokee III	5.7L V8 F/I	HPR8817

Vehicle	Engine Type	Air Filter
2007 JEEP		
Grand Cherokee III	6.1L V8 F/I	HPR8817
Liberty	2.8L L4 DSL	HPR8817
Liberty	3.7L V6 F/I	HPR8817
Wrangler	3.8L V6 F/I	HPR10348 ♦
Wrangler II	3.8L V6 F/I	HPR10348
2006 JEEP		
Commander	3.7L V6 F/I	HPR8817
Commander	4.7L V8 F/I	HPR8817
Commander	5.7L V8 F/I	HPR8817
Grand Cherokee	3.7L V6 F/I	HPR8817
Grand Cherokee	4.7L V8 F/I	HPR8817
Grand Cherokee	5.7L V8 F/I	HPR8817
Grand Cherokee	6.1L V8 F/I	HPR8817
Grand Cherokee III	3.0L V6 DSL	HPR8817
Grand Cherokee III	3.7L V6 F/I	HPR8817
Grand Cherokee III	4.7L V8 F/I	HPR8817
Grand Cherokee III	5.7L V8 F/I	HPR8817
Grand Cherokee III	6.1L V8 F/I	HPR8817
Liberty	2.8L L4 DSL	HPR8817
Liberty	3.7L V6 F/I	HPR8817
TJ	4.0L L6 F/I	HPR8205
Wrangler	4.0L L6 F/I	HPR8205
Wrangler II	4.0L L6 F/I	HPR8205
2005 JEEP		
Cherokee	2.5L L4 DSL	HPR8817
Grand Cherokee	3.7L V6 F/I	HPR8817
Grand Cherokee	4.7L V8 F/I	HPR8817
Grand Cherokee	5.7L V8 F/I	HPR8817
Grand Cherokee II	2.7L L5 DSL	HPR7440
Grand Cherokee III	3.0L V6 DSL	HPR8817
Grand Cherokee III	3.7L V6 F/I	HPR8817
Grand Cherokee III	4.7L V8 F/I	HPR8817
Grand Cherokee III	5.7L V8 F/I	HPR8817
Liberty	2.8L L4 DSL	HPR8817
Liberty	3.7L V6 F/I	HPR8817
TJ	2.4L L4 F/I	HPR8205
TJ	4.0L L6 F/I	HPR8205
Wrangler	4.0L L6 F/I	HPR8205
Wrangler II	4.0L L6 F/I	HPR8205
2004 JEEP		
Cherokee	2.5L L4 DSL	HPR8817
Cherokee	2.8L L4 DSL - CRD	HPR8817
Cherokee	3.7L V6 F/I	HPR8817
Grand Cherokee	4.0L L6 F/I	HPR7440
Grand Cherokee	4.7L V8 F/I - w/o High Output	HPR7440
Grand Cherokee II	2.7L L5 DSL	HPR7440
Grand Cherokee II	4.0L L6 F/I	HPR7440
Grand Cherokee II	4.7L V8 F/I - w/o High Output	HPR7440
Liberty	2.8L L4 DSL	HPR8817
Liberty	3.7L V6 F/I	HPR8817
TJ	4.0L L6 F/I	HPR8205
Wrangler	4.0L L6 F/I	HPR8205
Wrangler II	4.0L L6 F/I	HPR8205
2003 JEEP		
Cherokee	2.5L L4 DSL	HPR8817
Cherokee	2.8L L4 DSL - CRD	HPR8817
Cherokee	3.7L V6 F/I	HPR8817
Grand Cherokee	4.0L L6 F/I	HPR7440
Grand Cherokee	4.7L V8 F/I - w/o High Output	HPR7440
Grand Cherokee II	2.7L L5 DSL	HPR7440
Grand Cherokee II	4.0L L6 F/I	HPR7440
Grand Cherokee II	4.7L V8 F/I - w/o High Output	HPR7440

*Indicates 2 filters required ♦ Intake system available - see page 326 + throttle body spacer available - see page 20

Vehicle	Engine Type	Air Filter	Vehicle	Engine Type	Air Filter
2003 JEEP			1999 JEEP		
Liberty	2.5L L4 DSL	HPR8817	Grand Cherokee I	4.0L L6 F/I - to 4/99	HPR7440
Liberty	2.8L L4 DSL	HPR8817	Grand Cherokee I	5.2L V8 F/I	HPR7440
Liberty	3.7L V6 F/I	HPR8817	Grand Cherokee I	5.9L V8 F/I	HPR7440
TJ	2.4L L4 F/I	HPR8205	Grand Cherokee II	3.1L V6 DSL	HPR7440
TJ	4.0L L6 F/I	HPR8205	Grand Cherokee II	4.0L L6 F/I - from 5/99	HPR7440
Wrangler	4.0L L6 F/I	HPR8205	Grand Cherokee II	4.7L V8 F/I - w/o High Output	HPR7440
Wrangler II	4.0L L6 F/I	HPR8205	TJ	2.5L L4 F/I	HPR8205 ♦
2002 JEEP			TJ	4.0L L6 F/I	HPR8205
Cherokee	2.5L L4 DSL	HPR8817	Wrangler	2.5L L4 F/I	HPR8205 ♦
Cherokee	2.8L L4 DSL - CRD	HPR8817	Wrangler	4.0L L6 F/I	HPR8205
Cherokee	3.7L V6 F/I	HPR8817	Wrangler II	2.5L L4 F/I	HPR8205
Grand Cherokee	4.0L L6 F/I	HPR7440	Wrangler II	4.0L L6 F/I	HPR8205
Grand Cherokee	4.7L V8 F/I - All, w/o High Output	HPR7440	1998 JEEP		
Grand Cherokee	4.7L V8 F/I - w/o High Output	HPR7440	Cherokee	2.5L L4 F/I - US	HPR3901
Grand Cherokee II	2.7L L5 DSL	HPR7440	Cherokee	4.0L L6 F/I	HPR3901 ♦
Grand Cherokee II	4.0L L6 F/I	HPR7440	Grand Cherokee	4.0L L6 F/I	HPR7440
Grand Cherokee II	4.7L V8 F/I - w/o High Output	HPR7440	Grand Cherokee	5.2L V8 F/I	HPR7440
Liberty	2.5L L4 DSL	HPR8817	Grand Cherokee	5.9L V8 F/I	HPR7440
Liberty	2.8L L4 DSL	HPR8817	Grand Cherokee I	2.5L L4 DSL	HPR7440
Liberty	3.7L V6 F/I	HPR8817	Grand Cherokee I	4.0L L6 F/I	HPR7440
TJ	2.5L L4 F/I	HPR8205 ♦	Grand Cherokee I	5.2L V8 F/I	HPR7440
TJ	4.0L L6 F/I	HPR8205	Grand Cherokee I	5.9L V8 F/I	HPR7440
Wrangler	2.5L L4 F/I	HPR8205 ♦	TJ	2.5L L4 F/I	HPR8205 ♦
Wrangler	4.0L L6 F/I	HPR8205	TJ	4.0L L6 F/I	HPR8205
Wrangler II	2.5L L4 F/I	HPR8205	Wrangler	2.5L L4 F/I	HPR8205 ♦
Wrangler II	4.0L L6 F/I	HPR8205	Wrangler	4.0L L6 F/I	HPR8205
2001 JEEP			Wrangler II	2.5L L4 F/I	HPR8205
Cherokee	4.0L L6 F/I	HPR3901 ♦	Wrangler II	4.0L L6 F/I	HPR8205
Grand Cherokee	4.0L L6 F/I	HPR7440	1997 JEEP		
Grand Cherokee	4.7L V8 F/I	HPR7440	Cherokee	2.5L L4 F/I - US	HPR3901
Grand Cherokee II	2.7L L5 DSL	HPR7440	Cherokee	4.0L L6 F/I	HPR3901 ♦
Grand Cherokee II	3.1L V6 DSL	HPR7440	Grand Cherokee	4.0L L6 F/I	HPR7440
Grand Cherokee II	4.0L L6 F/I	HPR7440	Grand Cherokee	5.2L V8 F/I	HPR7440
Grand Cherokee II	4.7L V8 F/I - w/o High Output	HPR7440	Grand Cherokee I	2.5L L4 DSL	HPR7440
Liberty	2.5L L4 DSL	HPR8817	Grand Cherokee I	4.0L L6 F/I	HPR7440
Liberty	3.7L V6 F/I	HPR8817	Grand Cherokee I	5.2L V8 F/I	HPR7440
TJ	2.5L L4 F/I	HPR8205 ♦	Grand Cherokee I	5.9L V8 F/I	HPR7440
TJ	4.0L L6 F/I	HPR8205	TJ	2.5L L4 F/I - OEM 4797777	HPR8205 ♦
Wrangler	2.5L L4 F/I	HPR8205 ♦	TJ	4.0L L6 F/I - OEM 4797777	HPR8205
Wrangler	4.0L L6 F/I	HPR8205	Wrangler	2.5L L4 F/I - OEM 4797777	HPR8205 ♦
Wrangler II	2.5L L4 F/I	HPR8205	Wrangler	4.0L L6 F/I - OEM 4797777	HPR8205
Wrangler II	4.0L L6 F/I	HPR8205	Wrangler II	2.5L L4 F/I	HPR8205
2000 JEEP			Wrangler II	4.0L L6 F/I	HPR8205
Cherokee	2.5L L4 F/I - US	HPR3901	1996 JEEP		
Cherokee	4.0L L6 F/I	HPR3901 ♦	Cherokee	2.5L L4 F/I - US	HPR3901
Grand Cherokee	4.0L L6 F/I	HPR7440	Cherokee	4.0L L6 F/I	HPR3901 ♦
Grand Cherokee	4.7L V8 F/I	HPR7440	Grand Cherokee	4.0L L6 F/I	HPR7440
Grand Cherokee II	3.1L V6 DSL	HPR7440	Grand Cherokee	5.2L V8 F/I	HPR7440
Grand Cherokee II	4.0L L6 F/I	HPR7440	Grand Cherokee I	2.5L L4 DSL	HPR7440
Grand Cherokee II	4.7L V8 F/I - w/o High Output	HPR7440	Grand Cherokee I	4.0L L6 F/I	HPR7440
TJ	2.5L L4 F/I	HPR8205 ♦	Grand Cherokee I	5.2L V8 F/I	HPR7440
TJ	4.0L L6 F/I	HPR8205	Wrangler II	2.5L L4 F/I - from 9/96	HPR8205
Wrangler	2.5L L4 F/I	HPR8205 ♦	Wrangler II	4.0L L6 F/I	HPR8205
Wrangler	4.0L L6 F/I	HPR8205	1995 JEEP		
Wrangler II	2.5L L4 F/I	HPR8205	Cherokee	2.5L L4 F/I	HPR3901
Wrangler II	4.0L L6 F/I	HPR8205	Cherokee	4.0L L6 F/I	HPR3901 ♦
1999 JEEP			Grand Cherokee	4.0L L6 F/I	HPR7440
Cherokee	2.5L L4 F/I - US	HPR3901	Grand Cherokee	5.2L V8 F/I	HPR7440
Cherokee	4.0L L6 F/I	HPR3901 ♦	Grand Cherokee I	2.5L L4 DSL	HPR7440
Grand Cherokee	4.0L L6 F/I	HPR7440	Grand Cherokee I	4.0L L6 F/I	HPR7440
Grand Cherokee	4.7L V8 F/I	HPR7440	Grand Cherokee I	5.2L V8 F/I	HPR7440
Grand Cherokee I	2.5L L4 DSL	HPR7440			

*Indicates 2 filters required ♦ Intake system available - see page 326 + throttle body spacer available - see page 20

HPR™ REPLACEMENT AIR FILTERS

JEEP

Vehicle	Engine Type	Air Filter	Vehicle	Engine Type	Air Filter
1994 JEEP			1987 JEEP		
Cherokee	2.5L L4 F/I	HPR3901	Brairwood	2.8L V6 F/I	HPR3901
Cherokee	4.0L L6 F/I	HPR3901 ♦	Cherokee	2.5L L4 F/I	HPR3901
Grand Cherokee	4.0L L6 F/I	HPR7440	Cherokee	2.8L F/I	HPR3901
Grand Cherokee	5.2L V8 F/I	HPR7440	Cherokee	4.0L L6 F/I	HPR3901
Grand Cherokee I	4.0L L6 F/I	HPR7440	CJ5	2.5L L4 CARB	HPR0184
Grand Cherokee I	5.2L V8 F/I	HPR7440	CJ6	2.5L L4 CARB	HPR0184
1993 JEEP			CJ6	4.2L L6 CARB	HPR0184
Cherokee	2.5L L4 F/I	HPR3901	CJ7	2.5L L4 CARB	HPR0184
Cherokee	4.0L L6 F/I	HPR3901 ♦	CJ7	4.2L L6 CARB	HPR0184
Grand Cherokee	4.0L L6 F/I	HPR7440	CJ8	2.5L L4 CARB	HPR0184
Grand Cherokee	5.2L V8 F/I	HPR7440	CJ8	4.2L L6 CARB	HPR0184
Grand Cherokee I	4.0L L6 F/I	HPR7440	Comanche	2.5L L4 F/I	HPR3901
Grand Cherokee I	5.2L V8 F/I	HPR7440	Comanche	2.8L F/I	HPR3901
Grand Wagoneer	5.2L V8 F/I	HPR7440	Comanche	4.0L L6 F/I	HPR3901
1992 JEEP			Grand Wagoneer	5.9L V8 CARB	HPR0160
Cherokee	2.5L L4 F/I	HPR3901	J10	4.2L L6 CARB	HPR0184
Cherokee	4.0L L6 F/I	HPR3901 ♦	J10	5.9L V8 CARB	HPR0160
Comanche	2.5L L4 F/I	HPR3901	Sportswagen	2.5L L4 CARB	HPR0184
Comanche	4.0L L6 F/I	HPR3901	Wagoneer	2.5L L4 F/I	HPR3901
Grand Cherokee I	4.0L L6 F/I	HPR7440	Wagoneer	4.0L L6 F/I	HPR3901
Grand Cherokee I	5.2L V8 F/I	HPR7440	Wrangler	4.2L L6 CARB	HPR0184
1991 JEEP			Wrangler I	4.2L L6 CARB	HPR0184
Cherokee	2.5L L4 F/I	HPR3901	1986 JEEP		
Cherokee	4.0L L6 F/I	HPR3901 ♦	Cherokee	2.8L V6 CARB	HPR0184
Comanche	2.5L L4 F/I	HPR3901	CJ5	2.5L L4 CARB	HPR0184
Comanche	4.0L L6 F/I	HPR3901	CJ6	2.5L L4 CARB	HPR0184
Grand Cherokee I	4.0L L6 F/I	HPR7440	CJ6	4.2L L6 CARB	HPR0184
Grand Wagoneer	5.9L V8 CARB	HPR0160	CJ7	2.5L L4 CARB	HPR0184
Wagoneer	2.5L L4 F/I	HPR3901	CJ7	4.2L L6 CARB	HPR0184
Wagoneer	4.2L L6 F/I	HPR0184	CJ8	2.5L L4 CARB	HPR0184
1990 JEEP			CJ8	4.2L L6 CARB	HPR0184
Cherokee	2.5L L4 F/I	HPR3901	Comanche	2.8L V6 CARB	HPR0184
Cherokee	4.0L L6 F/I	HPR3901	Grand Wagoneer	4.2L L6 CARB	HPR0184
Comanche	2.5L L4 F/I	HPR3901	Grand Wagoneer	5.9L V8 CARB	HPR0160
Comanche	4.0L L6 F/I	HPR3901	J10	4.2L L6 CARB	HPR0184
Grand Wagoneer	5.9L V8 CARB	HPR0160	J10	5.9L V8 CARB	HPR0160
Wagoneer	2.5L L4 F/I	HPR3901	Sportswagen	2.5L L4 CARB	HPR0184
Wagoneer	4.0L L6 F/I	HPR3901	Wagoneer	2.5L L4 F/I	HPR0184
Wrangler	4.2L L6 CARB	HPR0184	Wagoneer	2.8L V6 CARB	HPR0184
Wrangler I	4.2L L6 CARB	HPR0184	Wrangler I	4.2L L6 CARB	HPR0184
1989 JEEP			1985 JEEP		
Cherokee	2.5L L4 F/I	HPR3901	Cherokee	2.8L V6 CARB	HPR0184
Cherokee	4.0L L6 F/I	HPR3901	CJ5	2.5L L4 CARB	HPR0184
Comanche	2.5L L4 F/I	HPR3901	CJ6	2.5L L4 CARB	HPR0184
Comanche	4.0L L6 F/I	HPR3901	CJ6	4.2L L6 CARB	HPR0184
Grand Wagoneer	5.9L V8 CARB	HPR0160	CJ7	2.5L L4 CARB	HPR0184
Wagoneer	2.5L L4 F/I	HPR3901	CJ7	4.2L L6 CARB	HPR0184
Wagoneer	4.0L L6 F/I	HPR3901	CJ8	2.5L L4 CARB	HPR0184
Wrangler	4.2L L6 CARB	HPR0184	CJ8	4.2L L6 CARB	HPR0184
Wrangler I	4.2L L6 CARB	HPR0184	Comanche	2.5L	HPR0184
1988 JEEP			Grand Wagoneer	4.2L L6 CARB	HPR0184
Cherokee	2.5L L4 F/I	HPR3901	Grand Wagoneer	5.9L V8 CARB	HPR0160
Cherokee	4.0L L6 F/I	HPR3901	J10	4.2L L6 CARB	HPR0184
Comanche	2.5L L4 F/I	HPR3901	J10	5.9L V8 CARB	HPR0160
Comanche	4.0L L6 F/I	HPR3901	Scrambler	2.5L L4 CARB	HPR0184
Grand Wagoneer	5.9L V8 CARB	HPR0160	Scrambler	4.2L L6 CARB	HPR0184
Wagoneer	2.5L L4 F/I	HPR3901	Sportswagen	2.5L L4 CARB	HPR0184
Wagoneer	4.0L L6 F/I	HPR3901	Wagoneer	2.5L L4 CARB	HPR0184
Wrangler	4.2L L6 CARB	HPR0184	Wagoneer	2.8L V6 CARB	HPR0184
Wrangler I	4.2L L6 CARB	HPR0184	1984 JEEP		
			Cherokee	2.8L V6 CARB	HPR0184
			Cherokee	4.2L	HPR0160
			Cherokee	5.9L	HPR0160

*Indicates 2 filters required ♦ Intake system available - see page 326 + throttle body spacer available - see page 20

Vehicle	Engine Type	Air Filter	Vehicle	Engine Type	Air Filter
1984 JEEP			1982 JEEP		
CJ5	2.5L L4 CARB	HPR0184	Scrambler	4.0L L6 CARB	HPR0184
CJ6	2.5L L4 CARB	HPR0184	Scrambler	4.2L L6 CARB	HPR0184
CJ6	4.0L L6 CARB	HPR0184	Wagoneer	4.2L L6 CARB	HPR0184
CJ6	4.2L L6 CARB	HPR0184	Wagoneer	5.9L V8 CARB	HPR0160
CJ7	2.5L L4 CARB	HPR0184	1981 JEEP		
CJ7	4.2L L6 CARB	HPR0184	Cherokee	4.2L L6 CARB	HPR0184
CJ8	2.5L L4 CARB	HPR0184	Cherokee	5.9L V8 CARB	HPR0160
CJ8	4.0L L6 CARB	HPR0184	CJ5	2.5L L4 CARB	HPR0184
CJ8	4.2L L6 CARB	HPR0184	CJ5	4.2L L6 CARB	HPR0184
Comanche	2.5L	HPR0184	CJ5	5.0L V8 CARB	HPR0184
Grand Wagoneer	4.2L L6 CARB	HPR0184	CJ6	2.5L L4 CARB	HPR0184
Grand Wagoneer	5.9L V8 CARB	HPR0160	CJ6	4.0L L6 CARB	HPR0184
J10	4.2L L6 CARB	HPR0184	CJ6	4.2L L6 CARB	HPR0184
J10	5.9L V8 CARB	HPR0160	CJ6	5.0L V8 CARB	HPR0160
Renegade	2.5L L4 CARB	HPR0184	CJ7	2.5L L4 CARB	HPR0184
Renegade	4.0L L6 CARB	HPR0184	CJ7	4.2L L6 CARB	HPR0184
Scrambler	2.5L L4 CARB	HPR0184	CJ7	5.0L V8 CARB	HPR0184
Scrambler	4.0L L6 CARB	HPR0184	CJ8	2.5L L4 CARB	HPR0184
Scrambler	4.2L L6 CARB	HPR0184	CJ8	4.0L L6 CARB	HPR0184
Sportswagen	2.5L L4 CARB	HPR0184	CJ8	4.2L L6 CARB	HPR0184
Wagoneer	2.5L L4 CARB	HPR0184	CJ8	5.0L V8 CARB	HPR0160
Wagoneer	2.8L V6 CARB	HPR0184	J10	4.2L L6 CARB	HPR0184
1983 JEEP			J10	5.9L V8 CARB	HPR0160
Cherokee	2.5L L4 CARB	HPR0184	Renegade	2.5L L4 CARB	HPR0184
Cherokee	4.2L L6 CARB	HPR0184	Renegade	4.0L L6 CARB	HPR0184
Cherokee	5.9L V8 CARB	HPR0160	Scrambler	2.5L L4 CARB	HPR0184
CJ5	2.5L L4 CARB	HPR0184	Scrambler	4.0L L6 CARB	HPR0184
CJ5	4.2L L6 CARB	HPR0184	Scrambler	4.2L L6 CARB	HPR0184
CJ6	2.5L L4 CARB	HPR0184	Wagoneer	4.2L L6 CARB	HPR0184
CJ6	4.0L L6 CARB	HPR0184	Wagoneer	5.9L V8 CARB	HPR0160
CJ6	4.2L L6 CARB	HPR0184	1980 JEEP		
CJ7	2.5L L4 CARB	HPR0184	Cherokee	258 L6 CARB	HPR0184
CJ7	4.2L L6 CARB	HPR0184	Cherokee	360 V8 CARB	HPR0160
CJ8	2.5L L4 CARB	HPR0184	CJ5	2.5L L4 CARB	HPR0184
CJ8	4.0L L6 CARB	HPR0184	CJ5	4.2L L6 CARB	HPR0184
CJ8	4.2L L6 CARB	HPR0184	CJ5	5.0L V8 CARB	HPR0160
J10	4.2L L6 CARB	HPR0184	CJ6	2.5L L4 CARB	HPR0184
J10	5.9L V8 CARB	HPR0160	CJ6	4.2L L6 CARB	HPR0184
Renegade	2.5L L4 CARB	HPR0184	CJ6	5.0L V8 CARB	HPR0160
Renegade	4.0L L6 CARB	HPR0184	CJ7	151 L4 CARB	HPR0184
Scrambler	2.5L L4 CARB	HPR0184	CJ7	258 L6 CARB	HPR0184
Scrambler	4.0L L6 CARB	HPR0184	CJ7	5.0L V8 CARB	HPR0160
Scrambler	4.2L L6 CARB	HPR0184	CJ8	2.5L L4 CARB	HPR0184
Wagoneer	4.2L L6 CARB	HPR0184	CJ8	4.0L L6 CARB	HPR0184
Wagoneer	5.9L V8 CARB	HPR0160	CJ8	4.2L L6 CARB	HPR0184
1982 JEEP			CJ8	5.0L V8 CARB	HPR0160
Cherokee	4.2L L6 CARB	HPR0184	J10	258 L6 CARB	HPR0184
Cherokee	5.9L V8 CARB	HPR0160	J10	360 V8 CARB	HPR0160
CJ5	2.5L L4 CARB	HPR0184	Renegade	2.5L L4 CARB	HPR0184
CJ5	4.2L L6 CARB	HPR0184	Renegade	4.0L L6 CARB	HPR0184
CJ6	2.5L L4 CARB	HPR0184	Scrambler	150 L4 CARB	HPR0184
CJ6	4.0L L6 CARB	HPR0184	Scrambler	2.5L L4 CARB	HPR0184
CJ6	4.2L L6 CARB	HPR0184	Scrambler	258 L6 2 BBL.	HPR0184
CJ7	2.5L L4 CARB	HPR0184	Scrambler	304 V8 2 BBL.	HPR0160
CJ7	4.2L L6 CARB	HPR0184	Scrambler	360 V8 2 BBL.	HPR0160
CJ8	2.5L L4 CARB	HPR0184	Scrambler	360 V8 4 BBL.	HPR0160
CJ8	4.0L L6 CARB	HPR0184	Scrambler	4.0L L6 CARB	HPR0184
CJ8	4.2L L6 CARB	HPR0184	Wagoneer	258 L6 CARB	HPR0184
J10	4.2L L6 CARB	HPR0184	Wagoneer	360 V8 CARB	HPR0160
J10	5.9L V8 CARB	HPR0160	1979 JEEP		
Renegade	2.5L L4 CARB	HPR0184	Cherokee	258 L6 CARB	HPR0184
Renegade	4.0L L6 CARB	HPR0184	Cherokee	360 V8 CARB	HPR0160
Scrambler	2.5L L4 CARB	HPR0184	CJ5	258 L6 CARB	HPR0184

*Indicates 2 filters required ♦ Intake system available - see page 326 + throttle body spacer available - see page 20

HPR™ REPLACEMENT AIR FILTERS

JEEP

Vehicle	Engine Type	Air Filter	Vehicle	Engine Type	Air Filter
1979 JEEP			1977 JEEP		
CJ5	304 V8 CARB	HPR0160	Scrambler	360 V8 2 BBL.	HPR0160
CJ6	258 L6 CARB	HPR0184	Scrambler	360 V8 4 BBL.	HPR0160
CJ6	304 V8 CARB	HPR0160	Scrambler	401 V8 4 BBL.	HPR0160
CJ7	258 L6 CARB	HPR0184	Wagoneer	360 V8 CARB	HPR0160
CJ7	304 V8 CARB	HPR0160	Wagoneer	401 V8 CARB	HPR0160
CJ8	258 L6 CARB	HPR0184	1976 JEEP		
CJ8	304 V8 CARB	HPR0160	Cherokee	258 L6 CARB	HPR0184
J10	258 L6 CARB	HPR0184	Cherokee	360 V8 CARB	HPR0160
J10	360 V8 CARB	HPR0160	Cherokee	401 V8 CARB	HPR0160
Scrambler	258 L6 2 BBL.	HPR0184	CJ5	232 L6 CARB	HPR0184
Scrambler	304 V8 2 BBL.	HPR0160	CJ5	258 L6 CARB	HPR0184
Scrambler	360 V8 2 BBL.	HPR0160	CJ5	304 V8 CARB	HPR0160
Scrambler	360 V8 4 BBL.	HPR0160	CJ6	232 L6 CARB	HPR0184
Wagoneer	360 V8 CARB	HPR0160	CJ6	258 L6 CARB	HPR0184
1978 JEEP			CJ6	304 V8 CARB	HPR0160
Cherokee	258 L6 CARB	HPR0184	CJ7	232 L6 CARB	HPR0184
Cherokee	360 V8 2 BBL.	HPR0160	CJ7	258 L6 CARB	HPR0184
Cherokee	360 V8 4 BBL.	HPR0160	CJ7	304 V8 CARB	HPR0160
Cherokee	401 V8 CARB	HPR0160	CJ8	232 L6 CARB	HPR0184
CJ5	232 L6 CARB	HPR0184	CJ8	258 L6 CARB	HPR0184
CJ5	258 L6 CARB	HPR0184	CJ8	304 V8 CARB	HPR0160
CJ5	304 V8 CARB	HPR0160	J10	258 L6 CARB	HPR0184
CJ6	232 L6 CARB	HPR0184	J10	360 V8 CARB	HPR0160
CJ6	258 L6 CARB	HPR0184	J10	401 V8 CARB	HPR0160
CJ6	304 V8 CARB	HPR0160	J20	258 L6 CARB	HPR0184
CJ7	232 L6 CARB	HPR0184	J20	360 V8 CARB	HPR0160
CJ7	258 L6 CARB	HPR0184	J20	401 V8 CARB	HPR0160
CJ7	304 V8 CARB	HPR0160	Scrambler	232 L6 1 BBL.	HPR0184
CJ8	232 L6 CARB	HPR0184	Scrambler	258 L6 2 BBL.	HPR0184
CJ8	258 L6 CARB	HPR0184	Scrambler	304 V8 2 BBL.	HPR0160
CJ8	304 V8 CARB	HPR0160	Scrambler	360 V8 2 BBL.	HPR0160
J10	258 L6 CARB	HPR0184	Scrambler	360 V8 4 BBL.	HPR0160
J10	360 V8 CARB	HPR0160	Scrambler	401 V8 4 BBL.	HPR0160
J10	401 V8 CARB	HPR0160	Wagoneer	360 V8 CARB	HPR0160
Scrambler	232 L6 1 BBL.	HPR0184	Wagoneer	401 V8 CARB	HPR0160
Scrambler	258 L6 2 BBL.	HPR0184	1975 JEEP		
Scrambler	304 V8 2 BBL.	HPR0160	Cherokee	258 L6 CARB	HPR0184
Scrambler	360 V8 2 BBL.	HPR0160	Cherokee	360 V8 CARB	HPR0160
Scrambler	360 V8 4 BBL.	HPR0160	Cherokee	401 V8 CARB	HPR0160
Wagoneer	360 V8 CARB	HPR0160	CJ5	232 L6 CARB	HPR0184
Wagoneer	401 V8 CARB	HPR0160	CJ5	258 L6 CARB	HPR0184
1977 JEEP			CJ5	304 V8 CARB	HPR0160
Cherokee	258 L6 CARB	HPR0184	CJ6	232 L6 CARB	HPR0184
Cherokee	360 V8 CARB	HPR0160	CJ6	258 L6 CARB	HPR0184
Cherokee	401 V8 CARB	HPR0160	CJ6	304 V8 CARB	HPR0160
CJ5	232 L6 CARB	HPR0184	CJ7	232 L6 CARB	HPR0184
CJ5	258 L6 CARB	HPR0184	CJ7	258 L6 CARB	HPR0184
CJ5	304 V8 CARB	HPR0160	CJ7	304 V8 CARB	HPR0160
CJ6	232 L6 CARB	HPR0184	CJ8	232 L6 CARB	HPR0184
CJ6	258 L6 CARB	HPR0184	CJ8	258 L6 CARB	HPR0184
CJ6	304 V8 CARB	HPR0160	CJ8	304 V8 CARB	HPR0160
CJ7	232 L6 CARB	HPR0184	J10	258 L6 CARB	HPR0184
CJ7	258 L6 CARB	HPR0184	J10	360 V8 CARB	HPR0160
CJ7	304 V8 CARB	HPR0160	J10	401 V8 CARB	HPR0160
CJ8	232 L6 CARB	HPR0184	Scrambler	232 L6 1 BBL.	HPR0184
CJ8	258 L6 CARB	HPR0184	Scrambler	258 L6 2 BBL.	HPR0184
CJ8	304 V8 CARB	HPR0160	Scrambler	304 V8 2 BBL.	HPR0160
J10	258 L6 CARB	HPR0184	Scrambler	360 V8 2 BBL.	HPR0160
J10	360 V8 CARB	HPR0160	Scrambler	360 V8 4 BBL.	HPR0160
J10	401 V8 CARB	HPR0160	Scrambler	401 V8 4 BBL.	HPR0160
Scrambler	232 L6 1 BBL.	HPR0184	Wagoneer	360 V8 CARB	HPR0160
Scrambler	258 L6 2 BBL.	HPR0184	Wagoneer	401 V8 CARB	HPR0160
Scrambler	304 V8 2 BBL.	HPR0160			

*Indicates 2 filters required ♦ Intake system available - see page 326 + throttle body spacer available - see page 20

Vehicle	Engine Type	Air Filter	Vehicle	Engine Type	Air Filter
1974 JEEP			1972 JEEP		
Cherokee	258 L6 CARB	HPR0184	CJ7	232 L6 CARB	HPR0184
Cherokee	360 V8 CARB	HPR0160	CJ7	258 L6 CARB	HPR0184
Cherokee	401 V8 CARB	HPR0160	CJ8	232 L6 CARB	HPR0184
CJ5	232 L6 CARB	HPR0184	CJ8	258 L6 CARB	HPR0184
CJ5	258 L6 CARB	HPR0184	DJ5	232 L6 CARB	HPR0184
CJ5	304 V8 CARB	HPR0160	Jeepster	304 V8 CARB	HPR0160
CJ6	232 L6 CARB	HPR0184	Scrambler	232 L6 1 BBL.	HPR0184
CJ6	258 L6 CARB	HPR0184	Scrambler	258 L6 2 BBL.	HPR0184
CJ6	304 V8 CARB	HPR0160	Scrambler	304 V8 2 BBL.	HPR0160
CJ7	232 L6 CARB	HPR0184	Scrambler	360 V8 2 BBL.	HPR0160
CJ7	258 L6 CARB	HPR0184	Scrambler	360 V8 4 BBL.	HPR0160
CJ7	304 V8 CARB	HPR0160	Scrambler	401 V8 4 BBL.	HPR0160
CJ8	232 L6 CARB	HPR0184	Wagoneer	258 L6 CARB	HPR0184
CJ8	258 L6 CARB	HPR0184	Wagoneer	360 V8 CARB	HPR0160
CJ8	304 V8 CARB	HPR0160	1971 JEEP		
DJ5	232 L6 CARB	HPR0184	CJ5	225 V6 CARB	HPR0192
DJ5	304 V8 CARB	HPR0160	CJ6	225 V6 CARB	HPR0192
J10	360 V8 CARB	HPR0160	Commando	225 V6 CARB	HPR0192
J10	401 V8 CARB	HPR0160	DJ5	225 V6 CARB	HPR0192
J20	360 V8 CARB	HPR0160	Jeepster	225 V6 CARB	HPR0192
J20	401 V8 CARB	HPR0160	Scrambler	232 L6 1 BBL.	HPR0184
Scrambler	232 L6 1 BBL.	HPR0184	Scrambler	258 L6 2 BBL.	HPR0184
Scrambler	258 L6 2 BBL.	HPR0184	Scrambler	350 V8 2 BBL.	HPR0192
Scrambler	304 V8 2 BBL.	HPR0160	Scrambler	350 V8 4 BBL.	HPR0192
Scrambler	360 V8 2 BBL.	HPR0160	Scrambler	360 V8 2 BBL.	HPR0160
Scrambler	360 V8 4 BBL.	HPR0160	Scrambler	360 V8 4 BBL.	HPR0160
Scrambler	401 V8 4 BBL.	HPR0160	Wagoneer	232 L6 CARB	HPR0184
Wagoneer	360 V8 CARB	HPR0160	Wagoneer	350 V8 CARB	HPR0160
Wagoneer	401 V8 CARB	HPR0160	1970 JEEP		
1973 JEEP			CJ5	225 V6 CARB	HPR0192
CJ5	232 L6 CARB	HPR0184	CJ6	225 V6 CARB	HPR0192
CJ5	258 L6 CARB	HPR0184	Commando	225 V6 CARB	HPR0192
CJ5	304 V8 CARB	HPR0160	DJ5	225 V6 CARB	HPR0192
CJ6	232 L6 CARB	HPR0184	Jeepster	225 V6 CARB	HPR0192
CJ6	258 L6 CARB	HPR0184	Scrambler	232 L6 1 BBL.	HPR0184
CJ6	304 V8 CARB	HPR0160	Wagoneer	232 L6 CARB	HPR0184
CJ7	232 L6 CARB	HPR0184	Wagoneer	350 V8 CARB	HPR0160
CJ7	258 L6 CARB	HPR0184	1969 JEEP		
CJ7	304 V8 CARB	HPR0160	CJ5	225 V6 CARB	HPR0192
CJ8	232 L6 CARB	HPR0184	CJ6	225 V6 CARB	HPR0192
CJ8	258 L6 CARB	HPR0184	Commando	225 V6 CARB	HPR0192
CJ8	304 V8 CARB	HPR0160	DJ5	225 V6 CARB	HPR0192
Commando	232 L6 CARB	HPR0184	Jeepster	225 V6 CARB	HPR0192
Commando	258 L6 CARB	HPR0184	1968 JEEP		
Commando	304 V8 CARB	HPR0160	CJ5	225 V6 CARB	HPR0192
DJ5	232 L6 CARB	HPR0184	CJ6	225 V6 CARB	HPR0192
DJ5	258 L6 CARB	HPR0184	Commando	225 V6 CARB	HPR0192
Jeepster	304 V8 CARB	HPR0160	DJ5	225 V6 CARB	HPR0192
Scrambler	232 L6 1 BBL.	HPR0184	DJ6	225 V6 CARB	HPR0192
Scrambler	258 L6 2 BBL.	HPR0184	Jeepster	225 V6 CARB	HPR0192
Scrambler	304 V8 2 BBL.	HPR0160	Wagoneer	232 L6 CARB	HPR0192
Scrambler	360 V8 2 BBL.	HPR0160	2010 KIA		
Scrambler	360 V8 4 BBL.	HPR0160	Sportage	2.0L L4 DSL	HPR9392
Scrambler	401 V8 4 BBL.	HPR0160	Sportage	2.0L L4 F/I - US	HPR9392
Wagoneer	258 L6 CARB	HPR0184	Sportage	2.7L V6 F/I	HPR9392
Wagoneer	360 V8 CARB	HPR0160	2009 KIA		
1972 JEEP			Spectra	2.0L L4 F/I	HPR9392
CJ5	232 L6 CARB	HPR0184	Spectra5	2.0L L4 F/I	HPR9392
CJ5	258 L6 CARB	HPR0184	Sportage	2.0L L4 DSL	HPR9392
CJ5	304 V8 CARB	HPR0160	Sportage	2.0L L4 F/I	HPR9392
CJ6	232 L6 CARB	HPR0184	Sportage	2.7L V6 F/I	HPR9392
CJ6	258 L6 CARB	HPR0184			
CJ6	304 V8 CARB	HPR0160			

*Indicates 2 filters required ♦ Intake system available - see page 326 + throttle body spacer available - see page 20

HPR™ REPLACEMENT AIR FILTERS

KIA

Vehicle	Engine Type	Air Filter
2008 KIA		
Cerato	1.5L L4 DSL	HPR9392
Cerato	1.6L L4 F/I	HPR9392
Cerato	2.0L L4 DSL	HPR9392
Cerato	2.0L L4 F/I	HPR9392
Spectra	2.0L L4 F/I	HPR9392
Spectra5	2.0L L4 F/I	HPR9392
Sportage	2.0L L4 DSL	HPR9392
Sportage	2.0L L4 F/I	HPR9392
Sportage	2.7L V6 F/I	HPR9392

Vehicle	Engine Type	Air Filter
2007 KIA		
Cerato	1.5L L4 DSL	HPR9392
Cerato	1.6L L4 F/I	HPR9392
Cerato	2.0L L4 DSL	HPR9392
Cerato	2.0L L4 F/I	HPR9392
Spectra	2.0L L4 F/I	HPR9392
Spectra5	2.0L L4 F/I	HPR9392
Sportage	2.0L L4 DSL	HPR9392
Sportage	2.0L L4 F/I	HPR9392
Sportage	2.7L V6 F/I	HPR9392

Vehicle	Engine Type	Air Filter
2006 KIA		
Amanti	3.5L V6 F/I	HPR9055
Cerato	1.5L L4 DSL	HPR9392
Cerato	1.6L L4 F/I	HPR9392
Cerato	2.0L L4 DSL	HPR9392
Cerato	2.0L L4 F/I	HPR9392
Spectra	2.0L L4 F/I	HPR9392
Spectra5	2.0L L4 F/I	HPR9392
Sportage	2.0L L4 DSL	HPR9392
Sportage	2.0L L4 F/I	HPR9392
Sportage	2.7L V6 F/I	HPR9392

Vehicle	Engine Type	Air Filter
2005 KIA		
Amanti	3.5L V6 F/I	HPR9055
Cerato	1.5L L4 DSL	HPR9392
Cerato	1.6L L4 F/I	HPR9392
Cerato	2.0L L4 DSL	HPR9392
Cerato	2.0L L4 F/I	HPR9392
Spectra	2.0L L4 F/I	HPR9392
Spectra5	2.0L L4 F/I	HPR9392
Sportage	2.0L L4 DSL	HPR9392
Sportage	2.0L L4 F/I	HPR9392
Sportage	2.7L V6 F/I	HPR9392

Vehicle	Engine Type	Air Filter
2004 KIA		
Amanti	3.5L V6 F/I	HPR9055
Cerato	1.6L L4 F/I	HPR9392
Cerato	2.0L L4 DSL	HPR9392
Cerato	2.0L L4 F/I	HPR9392
Spectra	2.0L L4 F/I	HPR9392

Vehicle	Engine Type	Air Filter
2017 LEXUS		
RX450h	3.5L V6 F/I - Non-US	HPR9762

Vehicle	Engine Type	Air Filter
2016 LEXUS		
LX570	5.7L V8 F/I	HPR10343
RX450h	3.5L V6 F/I - Non-US	HPR9762

Vehicle	Engine Type	Air Filter
2015 LEXUS		
LX570	5.7L V8 F/I	HPR10343
RX450h	3.5L V6 F/I	HPR9762

Vehicle	Engine Type	Air Filter
2014 LEXUS		
LX570	5.7L V8 F/I	HPR10343
RX450h	3.5L V6 F/I	HPR9762

Vehicle	Engine Type	Air Filter
2013 LEXUS		
LX570	5.7L V8 F/I	HPR10343

Vehicle	Engine Type	Air Filter
2013 LEXUS		
RX450h	3.5L V6 F/I	HPR9762

Vehicle	Engine Type	Air Filter
2012 LEXUS		
ES350	3.5L V6 F/I	HPR10169
LX570	5.7L V8 F/I	HPR10343
RX450h	3.5L V6 F/I	HPR9762

Vehicle	Engine Type	Air Filter
2011 LEXUS		
ES350	3.5L V6 F/I	HPR10169
LX570	5.7L V8 F/I	HPR10343
RX450h	3.5L V6 F/I	HPR9762

Vehicle	Engine Type	Air Filter
2010 LEXUS		
ES350	3.5L V6 F/I	HPR10169
LX570	5.7L V8 F/I	HPR10343
RX450h	3.5L V6 F/I	HPR9762

Vehicle	Engine Type	Air Filter
2009 LEXUS		
ES350	3.5L V6 F/I	HPR10169
GX470	4.7L V8 F/I	HPR8918
LX570	5.7L V8 F/I	HPR10343
RX350	3.5L V6 F/I	HPR9360

Vehicle	Engine Type	Air Filter
2008 LEXUS		
ES350	3.5L V6 F/I	HPR10169
GX470	4.7L V8 F/I	HPR8918
LX470	4.7L V8 F/I	HPR8918
LX570	5.7L V8 F/I	HPR10343
RX350	3.5L V6 F/I	HPR9360

Vehicle	Engine Type	Air Filter
2007 LEXUS		
ES350	3.5L V6 F/I	HPR10169
GX470	4.7L V8 F/I	HPR8918
LX470	4.7L V8 F/I	HPR8918
RX350	3.5L V6 F/I	HPR9360

Vehicle	Engine Type	Air Filter
2006 LEXUS		
ES330	3.3L V6 F/I	HPR9360
GX470	4.7L V8 F/I	HPR8918
LX470	4.7L V8 F/I	HPR8918
RX330	3.3L V6 F/I	HPR9360

Vehicle	Engine Type	Air Filter
2005 LEXUS		
ES330	3.3L V6 F/I	HPR9360
GX470	4.7L V8 F/I	HPR8918
LX470	4.7L V8 F/I	HPR8918
RX330	3.3L V6 F/I	HPR9360

Vehicle	Engine Type	Air Filter
2004 LEXUS		
ES330	3.3L V6 F/I	HPR9360
GX470	4.7L V8 F/I	HPR8918
LX470	4.7L V8 F/I	HPR8918
RX330	3.3L V6 F/I	HPR9360

Vehicle	Engine Type	Air Filter
2003 LEXUS		
ES300	3.0L V6 F/I	HPR9360
GX470	4.7L V8 F/I	HPR8918
LX470	4.7L V8 F/I	HPR8918
RX300	3.0L V6 F/I	HPR7351
RX330	3.3L V6 F/I	HPR9360

Vehicle	Engine Type	Air Filter
2002 LEXUS		
ES300	3.0L V6 F/I	HPR9360
GX470	4.7L V8 F/I	HPR8918
LX470	4.7L V8 F/I	HPR8918
RX300	3.0L V6 F/I	HPR7351

Vehicle	Engine Type	Air Filter
2001 LEXUS		
ES300	3.0L V6 F/I	HPR7351
LX470	4.7L V8 F/I	HPR8918

*Indicates 2 filters required ♦ Intake system available - see page 326 + throttle body spacer available - see page 20

LEXUS

HPR™ REPLACEMENT AIR FILTERS

Vehicle	Engine Type	Air Filter	Vehicle	Engine Type	Air Filter
2001 LEXUS			2014 LINCOLN		
RX300	3.0L V6 F/I	HPR7351	MKX	3.7L V6 F/I	HPR10242
2000 LEXUS			Navigator	5.4L V8 F/I	HPR10262 ♦
ES300	3.0L V6 F/I	HPR7351	2013 LINCOLN		
LX470	4.7L V8 F/I	HPR8918	MKS	3.5L V6 F/I	HPR10242
RX300	3.0L V6 F/I	HPR7351	MKS	3.7L V6 F/I	HPR10242
SC300	3.0L L6 F/I	HPR7626	MKT	3.5L V6 F/I	HPR10242
SC400	4.0L V8 F/I	HPR7626	MKT	3.7L V6 F/I	HPR10242
1999 LEXUS			MKX	3.7L V6 F/I	HPR10242
ES300	3.0L V6 F/I	HPR7351	Navigator	5.4L V8 F/I	HPR10262 ♦
LX470	4.7L V8 F/I	HPR8918	2012 LINCOLN		
RX300	3.0L V6 F/I	HPR7351	MKS	3.5L V6 F/I	HPR10242
SC300	3.0L L6 F/I	HPR7626	MKS	3.7L V6 F/I	HPR10242
SC400	4.0L V8 F/I	HPR7626	MKT	3.5L V6 F/I	HPR10242
1998 LEXUS			MKT	3.7L V6 F/I	HPR10242
ES300	3.0L V6 F/I	HPR7351	MKT	3.7L V6 F/I	HPR10242
LX470	4.7L V8 F/I	HPR8918	MKX	3.7L V6 F/I	HPR10242
SC300	3.0L L6 F/I	HPR7626	MKZ	3.5L V6 F/I	HPR10242
SC400	4.0L V8 F/I	HPR7626	Navigator	5.4L V8 F/I	HPR10262 ♦
1997 LEXUS			2011 LINCOLN		
ES300	3.0L V6 F/I	HPR7351	MKS	3.5L V6 F/I	HPR10242
SC300	3.0L L6 F/I	HPR7626	MKS	3.7L V6 F/I	HPR10242
SC400	4.0L V8 F/I	HPR7626	MKT	3.5L V6 F/I	HPR10242
1996 LEXUS			MKT	3.7L V6 F/I	HPR10242
ES300	3.0L V6 F/I	HPR7351	MKX	3.7L V6 F/I	HPR10242
SC300	3.0L L6 F/I	HPR7626	MKZ	3.5L V6 F/I	HPR10242
SC400	4.0L V8 F/I	HPR7626	Navigator	5.4L V8 F/I	HPR10262 ♦
1995 LEXUS			Town Car	4.6L V8 F/I	HPR5056
ES300	3.0L V6 F/I	HPR7351	2010 LINCOLN		
SC300	3.0L L6 F/I	HPR7626	MKS	3.5L V6 F/I	HPR10242
SC400	4.0L V8 F/I	HPR7626	MKS	3.7L V6 F/I	HPR10242
1994 LEXUS			MKT	3.5L V6 F/I	HPR10242
ES300	3.0L V6 F/I	HPR7351	MKT	3.7L V6 F/I	HPR10242
SC300	3.0L L6 F/I	HPR7626	MKX	3.5L V6 F/I	HPR10242
SC400	4.0L V8 F/I	HPR7626	MKZ	3.5L V6 F/I	HPR10242
1993 LEXUS			Navigator	5.4L V8 F/I	HPR10262 ♦
ES300	3.0L V6 F/I	HPR7351	Town Car	4.6L V8 F/I	HPR5056
SC300	3.0L L6 F/I	HPR7626	2009 LINCOLN		
SC400	4.0L V8 F/I	HPR7626	MKS	3.7L V6 F/I	HPR10242
1992 LEXUS			MKX	3.5L V6 F/I	HPR10242
ES300	3.0L V6 F/I	HPR7351	MKZ	3.5L V6 F/I	HPR10242
SC300	3.0L L6 F/I	HPR7626	Navigator	5.4L V8 F/I	HPR10262 ♦
SC400	4.0L V8 F/I	HPR7626	Town Car	4.6L V8 F/I	HPR5056
2016 LINCOLN			2008 LINCOLN		
MKS	3.5L V6 F/I	HPR10242	Mark LT	5.4L V8 F/I	HPR9687
MKT	3.5L V6 F/I	HPR10242	MKX	3.5L V6 F/I	HPR10242
Navigator	3.5L V6 F/I	HPR10262	MKZ	3.5L V6 F/I	HPR10242
2015 LINCOLN			Navigator	5.4L V8 F/I	HPR10262 ♦
MKS	3.5L V6 F/I	HPR10242	Town Car	4.6L V8 F/I	HPR5056
MKS	3.7L V6 F/I	HPR10242	2007 LINCOLN		
MKT	3.5L V6 F/I	HPR10242	Mark LT	5.4L V8 F/I	HPR9687
MKT	3.7L V6 F/I	HPR10242	MKX	3.5L V6 F/I	HPR10242
MKX	3.7L V6 F/I	HPR10242	MKZ	3.5L V6 F/I	HPR10242
Navigator	3.5L V6 F/I	HPR10262	Navigator	5.4L V8 F/I	HPR10262 ♦
2014 LINCOLN			Town Car	4.6L V8 F/I	HPR5056
MKS	3.5L V6 F/I	HPR10242	2006 LINCOLN		
MKS	3.7L V6 F/I	HPR10242	LS	3.9L V8 F/I	HPR8956
MKT	3.5L V6 F/I	HPR10242	Mark LT	5.4L V8 F/I	HPR9687
MKT	3.7L V6 F/I	HPR10242	Navigator	5.4L V8 F/I	HPR9687
2014 LINCOLN			Town Car	4.6L V8 F/I	HPR5056
MKS	3.5L V6 F/I	HPR10242	2005 LINCOLN		
MKS	3.7L V6 F/I	HPR10242	Aviator	4.6L V8 F/I	HPR9332

*Indicates 2 filters required ♦ Intake system available - see page 326 + throttle body spacer available - see page 20

HPR™ REPLACEMENT AIR FILTERS

LINCOLN

Vehicle	Engine Type	Air Filter
2005 LINCOLN		
LS	3.0L V6 F/I	HPR8956
LS	3.9L V8 F/I	HPR8956
Navigator	5.4L V8 F/I	HPR9687
Town Car	4.6L V8 F/I	HPR5056
2004 LINCOLN		
Aviator	4.6L V8 F/I	HPR9332
LS	3.0L V6 F/I	HPR8956
LS	3.9L V8 F/I	HPR8956
Navigator	5.4L V8 F/I	HPR8039
Town Car	4.6L V8 F/I	HPR5056
2003 LINCOLN		
Aviator	4.6L V8 F/I	HPR9332
LS	3.0L V6 F/I	HPR8956
LS	3.9L V8 F/I	HPR8956
Navigator	5.4L V8 F/I	HPR8039
Town Car	4.6L V8 F/I	HPR5056
2002 LINCOLN		
Blackwood	5.4L V8 F/I	HPR8039
Continental	4.6L V8 F/I	HPR8039
LS	3.0L V6 F/I	HPR8956
LS	3.9L V8 F/I	HPR8956
Navigator	5.4L V8 F/I	HPR8039
Town Car	4.6L V8 F/I	HPR5056
2001 LINCOLN		
Continental	4.6L V8 F/I	HPR8039
LS	3.0L V6 F/I	HPR8956
LS	3.9L V8 F/I	HPR8956
Navigator	5.4L V8 F/I	HPR8039
Town Car	4.6L V8 F/I	HPR5056
2000 LINCOLN		
Continental	4.6L V8 F/I	HPR8039
LS	3.0L V6 F/I	HPR8956
LS	3.9L V8 F/I	HPR8956
Navigator	5.4L V8 F/I	HPR8039
Town Car	4.6L V8 F/I	HPR5056
1999 LINCOLN		
Continental	4.6L V8 F/I	HPR8039
Navigator	5.4L V8 F/I	HPR8039 ♦
Town Car	4.6L V8 F/I	HPR5056
1998 LINCOLN		
Continental	4.6L V8 F/I	HPR8039
Navigator	5.4L V8 F/I	HPR8039 ♦
Town Car	4.6L V8 F/I	HPR5056
1997 LINCOLN		
Continental	4.6L V8 F/I	HPR8039
Town Car	4.6L V8 F/I	HPR5056
1996 LINCOLN		
Continental	4.6L V8 F/I	HPR8039
Town Car	4.6L V8 F/I	HPR5056
1995 LINCOLN		
Continental	4.6L V8 F/I	HPR8039
Town Car	4.6L V8 F/I	HPR5056
1994 LINCOLN		
Continental	3.8L V6 F/I	HPR5058
Town Car	4.6L V8 F/I	HPR5056
1993 LINCOLN		
Continental	3.8L V6 F/I	HPR5058
Town Car	4.6L V8 F/I	HPR5056

Vehicle	Engine Type	Air Filter
1992 LINCOLN		
Continental	3.8L V6 F/I	HPR5058
Town Car	4.6L V8 F/I	HPR5056
1991 LINCOLN		
Continental	3.8L V6 F/I	HPR5058
Town Car	4.6L V8 F/I	HPR5056
1990 LINCOLN		
Continental	3.8L V6 F/I	HPR5058
Town Car	5.0L V8 F/I	HPR5056
1989 LINCOLN		
Continental	3.8L V6 F/I	HPR5058
Town Car	5.0L V8 F/I	HPR5056
1988 LINCOLN		
Continental	3.8L V6 F/I	HPR5058
Town Car	5.0L V8 F/I	HPR5056
1987 LINCOLN		
Town Car	5.0L V8 F/I	HPR5056
1986 LINCOLN		
Continental	5.0L V8 F/I	HPR5056
Town Car	5.0L V8 F/I	HPR5056
1985 LINCOLN		
Continental	5.0L V8 F/I	HPR0351
Mark VII	5.0L V8 F/I	HPR0351
Town Car	5.0L V8 F/I	HPR0351
1984 LINCOLN		
Continental	5.0L V8 F/I	HPR0351
Mark VII	5.0L V8 F/I	HPR0351
Town Car	5.0L V8 F/I	HPR0351
1983 LINCOLN		
Continental	5.0L V8 F/I	HPR0351
Mark VI	5.0L V8 F/I	HPR0351
Town Car	5.0L V8 F/I	HPR0351
1982 LINCOLN		
Mark VI	5.0L V8 F/I	HPR0351
Town Car	5.0L V8 F/I	HPR0351
1981 LINCOLN		
Mark VI	5.0L V8 F/I	HPR0351
Town Car	5.0L V8 F/I	HPR0351
1980 LINCOLN		
Continental	302 V8 CARB	HPR0351
Continental	351 V8 CARB	HPR0351
Mark VI	302 V8 F/I	HPR0351
Mark VI	351 V8 CARB	HPR0351
Versailles	302 V8 CARB	HPR0351
1979 LINCOLN		
Continental	400 V8 CARB	HPR0351
Mark V	400 V8 CARB	HPR0351
Versailles	302 V8 CARB	HPR0351
1978 LINCOLN		
Continental	400 V8 CARB	HPR0351
Mark V	400 V8 CARB	HPR0351
Versailles	302 V8 CARB	HPR0351
1977 LINCOLN		
Continental	400 V8 CARB	HPR0351
Mark V	400 V8 CARB	HPR0351
Versailles	351 V8 CARB	HPR0351

*Indicates 2 filters required ♦ Intake system available - see page 326 + throttle body spacer available - see page 20

MAZDA

HPR™ REPLACEMENT AIR FILTERS

Vehicle	Engine Type	Air Filter	Vehicle	Engine Type	Air Filter
2015 MAZDA			2006 MAZDA		
CX-9	3.7L V6 F/I	HPR10242	6	1.8L L4 F/I	HPR8922
2014 MAZDA			6	2.0L L4 DSL	HPR8922
CX-9	3.7L V6 F/I	HPR10242	6	2.0L L4 F/I	HPR8922
2013 MAZDA			6	2.3L L4 F/I	HPR8922
6	3.7L V6 F/I	HPR10242	B2300	2.3L L4 F/I	HPR8243
CX-9	3.7L V6 F/I	HPR10242	B3000	3.0L V6 F/I	HPR8243
2012 MAZDA			B4000	4.0L V6 F/I	HPR8243
6	1.8L L4 F/I	HPR8922	Mazdaspeed6	2.3L L4 F/I	HPR8922
6	2.0L L4 F/I	HPR8922	MPV	3.0L V6 F/I	HPR8922
6	3.7L V6 F/I	HPR10242	MPV II	3.0L V6 F/I	HPR8922
CX-9	3.7L V6 F/I	HPR10242	Tribute	2.3L L4 F/I	HPR8997
2011 MAZDA			Tribute	3.0L V6 F/I	HPR8997
6	1.8L L4 F/I	HPR8922	2005 MAZDA		
6	2.0L L4 F/I	HPR8922	6	1.8L L4 F/I	HPR8922
6	3.7L V6 F/I	HPR10242	6	2.0L L4 DSL	HPR8922
CX-9	3.7L V6 F/I	HPR10242	6	2.0L L4 F/I	HPR8922
Tribute	2.5L L4 F/I	HPR8997	6	2.3L L4 F/I	HPR8922
2010 MAZDA			B2300	2.3L L4 F/I	HPR8243
6	1.8L L4 F/I	HPR8922	B3000	3.0L V6 F/I	HPR8243
6	2.0L L4 F/I	HPR8922	B4000	4.0L V6 F/I	HPR8243
6	2.2L L4 DSL	HPR8922	MPV	3.0L V6 F/I	HPR8922
6	2.5L L4 F/I - Non-US	HPR8922	MPV II	3.0L V6 F/I	HPR8922
6	3.7L V6 F/I	HPR10242	Tribute	2.0L L4 F/I	HPR8997
CX-9	3.7L V6 F/I	HPR10242	Tribute	2.3L L4 F/I	HPR8997
Tribute	2.5L L4 F/I	HPR8997	Tribute	3.0L V6 F/I	HPR8997
2009 MAZDA			2004 MAZDA		
6	1.8L L4 F/I	HPR8922	6	1.8L L4 F/I	HPR8922
6	2.0L L4 DSL	HPR8922	6	2.0L L4 DSL	HPR8922
6	2.0L L4 F/I	HPR8922	6	2.0L L4 F/I	HPR8922
6	2.2L L4 DSL	HPR8922	6	2.3L L4 F/I	HPR8922
6	2.5L L4 F/I - Non-US	HPR8922	B2300	2.3L L4 F/I	HPR8243
6	3.7L V6 F/I	HPR10242	B3000	3.0L V6 F/I	HPR8243
B2300	2.3L L4 F/I	HPR8243	B4000	4.0L V6 F/I	HPR8243
B4000	4.0L V6 F/I	HPR8243	MPV	3.0L V6 F/I	HPR8922
CX-9	3.7L V6 F/I	HPR10242	MPV II	3.0L V6 F/I	HPR8922
Tribute	2.5L L4 F/I	HPR8997	Tribute	2.0L L4 F/I	HPR8997
2008 MAZDA			Tribute	3.0L V6 F/I	HPR8997
6	1.8L L4 F/I	HPR8922	2003 MAZDA		
6	2.0L L4 DSL	HPR8922	6	1.8L L4 F/I	HPR8922
6	2.0L L4 F/I	HPR8922	6	2.0L L4 DSL	HPR8922
6	2.3L L4 F/I - US	HPR8922	6	2.0L L4 F/I	HPR8922
6	2.5L L4 F/I	HPR8922	6	2.3L L4 F/I	HPR8922
B2300	2.3L L4 F/I	HPR8243	B2300	2.3L L4 F/I	HPR8243
B3000	3.0L V6 F/I	HPR8243	B3000	3.0L V6 F/I	HPR8243
B4000	4.0L V6 F/I	HPR8243	B4000	4.0L V6 F/I	HPR8243
CX-9	3.7L V6 F/I	HPR10242	MPV	3.0L V6 F/I	HPR8922
Tribute	2.3L L4 F/I	HPR8997	MPV II	3.0L V6 F/I	HPR8922
Tribute	3.0L V6 F/I	HPR8997	Tribute	2.0L L4 F/I	HPR8997
2007 MAZDA			Tribute	3.0L V6 F/I	HPR8997
6	1.8L L4 F/I	HPR8922	2002 MAZDA		
6	2.0L L4 DSL	HPR8922	6	1.8L L4 F/I	HPR8922
6	2.0L L4 F/I	HPR8922	6	2.0L L4 DSL	HPR8922
6	2.3L L4 F/I - US	HPR8922	6	2.0L L4 F/I	HPR8922
6	2.5L L4 F/I	HPR8922	6	2.3L L4 F/I	HPR8922
B2300	2.3L L4 F/I	HPR8243	626 V	2.0L L4 DSL	HPR8922
B3000	3.0L V6 F/I	HPR8243	B2300	2.3L L4 F/I	HPR8243
B4000	4.0L V6 F/I	HPR8243	B3000	3.0L V6 F/I	HPR8243
CX-9	3.5L V6 F/I	HPR10242	B4000	4.0L V6 F/I	HPR8243
Mazdaspeed6	2.3L L4 F/I	HPR8922	Millenia	2.3L V6 F/I	HPR5466
			Millenia	2.5L V6 F/I	HPR7344
			MPV	3.0L V6 F/I	HPR8922
			MPV II	2.0L L4 F/I	HPR8922

*Indicates 2 filters required ♦ Intake system available - see page 326 + throttle body spacer available - see page 20

HPR™ REPLACEMENT AIR FILTERS

MAZDA

Vehicle	Engine Type	Air Filter	Vehicle	Engine Type	Air Filter
2002 MAZDA			1997 MAZDA		
MPV II	2.5L V6 F/I	HPR8922	Xedos 9	2.0L V6 F/I	HPR7344
MPV II	3.0L V6 F/I	HPR8922	Xedos 9	2.3L V6 F/I	HPR2740
Tribute	2.0L L4 F/I	HPR8997	Xedos 9	2.5L V6 F/I	HPR7344
Tribute	3.0L V6 F/I	HPR8997	1996 MAZDA		
Xedos 9	2.5L V6 F/I	HPR7344	B-Series	2.0L L4 CARB	HPR2740
2001 MAZDA			B-Series	2.2L L4 CARB	HPR2740
626 V	2.0L L4 DSL	HPR8922	B2300	2.3L L4 F/I	HPR7774
B2300	2.3L L4 F/I	HPR8243	B3000	3.0L V6 F/I	HPR7774
B2500	2.5L L4 F/I	HPR8243	B4000	4.0L V6 F/I	HPR7774
B3000	3.0L V6 F/I	HPR8243	Millenia	2.3L V6 F/I	HPR5466
B4000	4.0L V6 F/I	HPR8243	Millenia	2.5L V6 F/I	HPR7344
Millenia	2.3L V6 F/I	HPR5466	Xedos 9	2.0L V6 F/I	HPR7344
Millenia	2.5L V6 F/I	HPR7344	Xedos 9	2.3L V6 F/I	HPR2740
MPV	2.5L V6 F/I	HPR8922	Xedos 9	2.5L V6 F/I	HPR7344
MPV II	2.0L L4 F/I	HPR8922	1995 MAZDA		
MPV II	2.5L V6 F/I	HPR8922	929	3.0L V6 F/I	HPR6690
Tribute	2.0L L4 F/I	HPR8997	B-Series	2.0L L4 CARB	HPR2740
Tribute	3.0L V6 F/I	HPR8997	B-Series	2.2L L4 CARB	HPR2740
Xedos 9	2.0L V6 F/I	HPR7344	B2300	2.3L L4 F/I	HPR7774
Xedos 9	2.3L V6 F/I	HPR2740	B3000	3.0L V6 F/I	HPR7774
Xedos 9	2.5L V6 F/I	HPR7344	B4000	4.0L V6 F/I	HPR7774
2000 MAZDA			Millenia	2.3L V6 F/I	HPR5466
626 V	2.0L L4 DSL	HPR8922	Millenia	2.5L V6 F/I	HPR7344
B2500	2.5L L4 F/I	HPR8243	Xedos 9	2.0L V6 F/I	HPR7344
B3000	3.0L V6 F/I	HPR8243	Xedos 9	2.3L V6 F/I	HPR2740
B4000	4.0L V6 F/I	HPR8243	Xedos 9	2.5L V6 F/I	HPR7344
Millenia	2.3L V6 F/I	HPR5466	1994 MAZDA		
Millenia	2.5L V6 F/I	HPR7344	929	3.0L V6 F/I	HPR6690
MPV	2.5L V6 F/I	HPR8922	B-Series	2.0L L4 CARB	HPR2740
MPV II	2.0L L4 F/I	HPR8922	B-Series	2.2L L4 CARB	HPR2740
MPV II	2.5L V6 F/I	HPR8922	B2300	2.3L L4 F/I	HPR5058
Xedos 9	2.0L V6 F/I	HPR7344	B3000	3.0L V6 F/I	HPR5058
Xedos 9	2.3L V6 F/I	HPR2740	B4000	4.0L V6 F/I	HPR5058
Xedos 9	2.5L V6 F/I	HPR7344	Navajo	4.0L V6 F/I	HPR5058
1999 MAZDA			Xedos 9	2.0L V6 F/I	HPR7344
626 V	2.0L L4 DSL	HPR8922	Xedos 9	2.5L V6 F/I	HPR7344
B2500	2.5L L4 F/I	HPR8243	1993 MAZDA		
B3000	3.0L V6 F/I	HPR8243	929	3.0L V6 F/I	HPR6690
B4000	4.0L V6 F/I	HPR8243	B-Series	2.0L L4 CARB	HPR2740
Millenia	2.3L V6 F/I	HPR5466	B-Series	2.2L L4 CARB	HPR2740
Millenia	2.5L V6 F/I	HPR7344	B2200	2.2L L4 CARB	HPR2740
MPV II	2.0L L4 F/I	HPR8922	B2200	2.2L L4 F/I	HPR0352
MPV II	2.5L V6 F/I	HPR8922	Navajo	4.0L V6 F/I	HPR5058
Xedos 9	2.0L V6 F/I	HPR7344	Xedos 9	2.0L V6 F/I	HPR7344
Xedos 9	2.3L V6 F/I	HPR2740	Xedos 9	2.5L V6 F/I	HPR7344
Xedos 9	2.5L V6 F/I	HPR7344	1992 MAZDA		
1998 MAZDA			626 III	1.8L L4 CARB	HPR2740
626 V	2.0L L4 DSL	HPR8922	929	3.0L V6 F/I	HPR6690
B2500	2.5L L4 F/I	HPR8243	B-Series	2.0L L4 CARB	HPR2740
B3000	3.0L V6 F/I	HPR8243	B-Series	2.2L L4 CARB	HPR2740
B4000	4.0L V6 F/I	HPR8243	B2200	2.2L L4 CARB	HPR2740
Millenia	2.3L V6 F/I	HPR5466	B2200	2.2L L4 F/I	HPR0352
Millenia	2.5L V6 F/I	HPR7344	Navajo	4.0L V6 F/I	HPR5058
Xedos 9	2.0L V6 F/I	HPR7344	Xedos 9	2.0L V6 F/I	HPR7344
Xedos 9	2.3L V6 F/I	HPR2740	1991 MAZDA		
Xedos 9	2.5L V6 F/I	HPR7344	626 III	1.8L L4 CARB	HPR2740
1997 MAZDA			626 III	2.0L L4 CARB	HPR2740
B2300	2.3L L4 F/I	HPR7774	929 III	2.2L L4 F/I	HPR6690
B3000	3.0L V6 F/I	HPR7774	B-Series	2.0L L4 CARB	HPR2740
B4000	4.0L V6 F/I	HPR7774	B-Series	2.2L L4 CARB	HPR2740
Millenia	2.3L V6 F/I	HPR5466	B2200	2.2L L4 CARB	HPR2740
Millenia	2.5L V6 F/I	HPR7344			

*Indicates 2 filters required ♦ Intake system available - see page 326 + throttle body spacer available - see page 20

Vehicle	Engine Type	Air Filter
1991 MAZDA		
B2200	2.2L L4 F/I	HPR0352
Navajo	4.0L V6 F/I	HPR5058
1990 MAZDA		
626 III	1.8L L4 CARB	HPR2740
626 III	2.0L L4 CARB	HPR2740
929 III	2.2L L4 F/I	HPR6690
B-Series	2.0L L4 CARB	HPR2740
B2200	2.2L L4 CARB	HPR2740
B2200	2.2L L4 F/I	HPR0352
1989 MAZDA		
626 III	1.8L L4 CARB	HPR2740
626 III	2.0L L4 CARB	HPR2740
929 III	2.2L L4 F/I	HPR6690
B-Series	2.0L L4 CARB	HPR2740
B2200	2.2L L4 CARB	HPR2740
1988 MAZDA		
626 III	1.8L L4 CARB	HPR2740
626 III	2.0L L4 CARB	HPR2740
929 III	2.0L L4 F/I	HPR6690
929 III	2.2L L4 F/I	HPR6690
B-Series	2.0L L4 CARB	HPR2740
B2200	2.2L L4 CARB	HPR2740
1987 MAZDA		
626	2.0L L4 F/I - Exc. Turbo	HPR2740
626 II	1.6L L4 CARB	HPR2740
626 II	2.0L L4 CARB	HPR2740
626 II	2.0L L4 F/I	HPR6690
626 III	1.8L L4 CARB	HPR2740
626 III	2.0L L4 CARB	HPR2740
929 II	2.0L L4 F/I - from 5/87	HPR6690
929 II	2.0L L4 F/I - to 4/87	HPR2740
929 III	2.0L L4 F/I - from 5/87	HPR6690
929 III	2.0L L4 F/I - to 4/87	HPR2740
929 III	2.2L L4 F/I	HPR6690
B-Series	2.0L L4 CARB	HPR2740
B2000	2.0L L4 CARB	HPR2740
B2200	2.2L L4 CARB	HPR2740
1986 MAZDA		
626	2.0L L4 F/I	HPR6690
626 II	1.6L L4 CARB	HPR2740
626 II	2.0L L4 CARB	HPR2740
626 II	2.0L L4 F/I	HPR6690
929 I	2.0L L4 F/I	HPR2740
929 II	2.0L L4 F/I	HPR2740
B-Series	2.0L L4 CARB	HPR2740
B2000	2.0L L4 CARB	HPR2740
1985 MAZDA		
626	2.0L L4 CARB	HPR2740
626 II	1.6L L4 CARB	HPR2740
626 II	2.0L L4 CARB	HPR2740
929 I	2.0L L4 F/I	HPR2740
929 II	2.0L L4 F/I	HPR2740
B-Series	1.8L L4 CARB	HPR2740
B-Series	2.0L L4 CARB	HPR2740
B1800	1.8L L4 CARB - VC Eng.	HPR2740
1984 MAZDA		
626	2.0L L4 CARB	HPR2740
626 II	1.6L L4 CARB	HPR2740
626 II	2.0L L4 CARB	HPR2740
929 I	2.0L L4 F/I	HPR2740
929 II	2.0L L4 F/I	HPR2740

Vehicle	Engine Type	Air Filter
1984 MAZDA		
B-Series	1.8L L4 CARB	HPR2740
B-Series	2.0L L4 CARB	HPR2740
B1800	1.8L L4 CARB - VC Eng.	HPR2740
B2000	2.0L L4 CARB	HPR2740
1983 MAZDA		
626	2.0L L4 CARB	HPR2740
626 II	1.6L L4 CARB	HPR2740
626 II	2.0L L4 CARB	HPR2740
929 I	2.0L L4 F/I	HPR2740
929 II	2.0L L4 F/I	HPR2740
B-Series	1.8L L4 CARB	HPR2740
B-Series	2.0L L4 CARB	HPR2740
B1800	1.8L L4 CARB - VC Eng.	HPR2740
B2000	2.0L L4 CARB	HPR2740
Montrose	1.6L - GL, GLS	HPR2740
Montrose	2.0L - GLS, Coupe	HPR2740
1982 MAZDA		
626	2.0L L4 CARB	HPR2740
626 I	1.6L L4 CARB	HPR2740
626 I	2.0L L4 CARB	HPR2740
626 II	1.6L L4 CARB	HPR2740
929 I	2.0L L4 F/I	HPR2740
929 II	2.0L L4 F/I	HPR2740
B-Series	1.8L L4 CARB	HPR2740
B-Series	2.0L L4 CARB	HPR2740
B1800	1.8L L4 CARB - VC Eng.	HPR2740
B2000	2.0L L4 CARB	HPR2740
Montrose	1.6L - GL, GLS	HPR2740
Montrose	2.0L - GLS, Coupe	HPR2740
1981 MAZDA		
626	2.0L L4 CARB	HPR2740
626 I	1.6L L4 CARB	HPR2740
626 I	2.0L L4 CARB	HPR2740
929 I	2.0L L4 F/I	HPR2740
B-Series	1.8L L4 CARB	HPR2740
B1800	1.8L L4 CARB - VC Eng.	HPR2740
B2000	2.0L L4 CARB	HPR2740
Montrose	1.6L - GL, GLS	HPR2740
Montrose	2.0L - GLS, Coupe	HPR2740
1980 MAZDA		
626	2.0L L4 CARB	HPR2740
626 I	1.6L L4 CARB	HPR2740
626 I	2.0L L4 CARB	HPR2740
929 I	2.0L L4 F/I	HPR2740
B-Series	1.8L L4 CARB	HPR2740
B1800	1.8L L4 CARB - VC Eng.	HPR2740
B2000	2.0L L4 CARB	HPR2740
Montrose	1.6L - GL, GLS	HPR2740
Montrose	2.0L - GLS, Coupe	HPR2740
1979 MAZDA		
626	2.0L L4 CARB	HPR2740
626 I	1.6L L4 CARB	HPR2740
626 I	2.0L L4 CARB	HPR2740
929 I	2.0L L4 F/I	HPR2740
B-Series	1.8L L4 CARB	HPR2740
B1800	1.8L L4 CARB - VC Eng.	HPR2740
B2000	2.0L L4 CARB	HPR2740
Montrose	1.6L - GL, GLS	HPR2740
Montrose	2.0L - GLS, Coupe	HPR2740
1978 MAZDA		
B-Series	1.8L L4 CARB	HPR2740

*Indicates 2 filters required ♦ Intake system available - see page 326 + throttle body spacer available - see page 20

HPR™ REPLACEMENT AIR FILTERS

MAZDA

Vehicle	Engine Type	Air Filter
1978 MAZDA		
B1800	110 L4 CARB	HPR2740
Montrose	1.6L - GL, GLS	HPR2740
Pickup	1.6L L4 2 BBL. - B1600, NA Eng.	HPR2740
1977 MAZDA		
808	1.6L L4 CARB	HPR0352
B-Series	1.8L L4 CARB	HPR2740
B1800	110 L4 CARB	HPR2740
Pickup	1.6L L4 2 BBL. - B1600, NA Eng.	HPR2740
1976 MAZDA		
808	1.6L L4 CARB	HPR0352
B1600	1.6L L4 CARB	HPR2740
Rotary Pickup	1.3L R2 CARB	HPR0352
1975 MAZDA		
808	1.6L L4 CARB	HPR0352
B1600	1.6L L4 CARB	HPR2740
1974 MAZDA		
808	97 L4 CARB	HPR0352
1973 MAZDA		
808	97 L4 CARB	HPR0352
1972 MAZDA		
808	97 L4 CARB	HPR0352
450SE	4.5L V8 F/I	48026
450SEL	4.5L V8 F/I	HPR0136
450SL	4.5L V8 F/I - US	48026
450SLC	4.5L V8 F/I - US	HPR0136
450SE	4.5L V8 F/I	48026
450SEL	4.5L V8 F/I	HPR0136
450SL	4.5L V8 F/I - US	48026
450SLC	4.5L V8 F/I - US	HPR0136
280SEL	4.5L V8 F/I	48026
300SEL	4.5L V8 F/I	HPR0136
450SE	4.5L V8 F/I	48026
450SEL	4.5L V8 F/I	HPR0136
450SL	4.5L V8 F/I - US	48026
450SLC	4.5L V8 F/I - US	HPR0136
280SEL	4.5L V8 F/I	48026
300SEL	3.5L V8 F/I	HPR0136
	4.5L V8 F/I	48026
	3.5L V8 F/I	HPR0136
280SE	3.5L V8 F/I	48026
300SEL	3.5L V8 F/I	HPR0136
		48026

Vehicle	Engine Type	Air Filter
1970 MERCEDES BENZ		
300SEL	3.5L V8 F/I	HPR0136
2011 MERCURY		
Grand Marquis	4.6L V8 F/I	HPR5056
Mariner	2.5L L4 F/I	HPR8997
2010 MERCURY		
Grand Marquis	4.6L V8 F/I	HPR5056
Mariner	2.5L L4 F/I	HPR8997
Mountaineer	4.0L V6 F/I	HPR9332
2009 MERCURY		
Grand Marquis	4.6L V8 F/I	HPR5056
Mariner	2.5L L4 F/I	HPR8997
Mountaineer	4.0L V6 F/I	HPR9332
2008 MERCURY		
Grand Marquis	4.6L V8 F/I	HPR5056
Mariner	2.3L L4 F/I	HPR8997
Mariner	3.0L V6 F/I	HPR8997
Mountaineer	4.0L V6 F/I	HPR9332
Sable	3.5L V6 F/I	HPR10242
2007 MERCURY		
Grand Marquis	4.6L V8 F/I	HPR5056
Mariner	2.3L L4 F/I	HPR8997
Mariner	3.0L V6 F/I	HPR8997
Monterey Van	4.2L V6 F/I	HPR8956
Mountaineer	4.0L V6 F/I	HPR9332
2006 MERCURY		
Grand Marquis	4.6L V8 F/I	HPR5056
Mariner	2.3L L4 F/I	HPR8997
Mariner	3.0L V6 F/I	HPR8997
Monterey Van	4.2L V6 F/I	HPR8956
Mountaineer	4.0L V6 F/I	HPR9332
2005 MERCURY		
Grand Marquis	4.6L V8 F/I	HPR5056
Mariner	2.3L L4 F/I	HPR8997
Mariner	3.0L V6 F/I	HPR8997
Monterey Van	4.2L V6 F/I	HPR8956
Mountaineer	4.0L V6 F/I	HPR9332
Mountaineer	4.6L V8 F/I	HPR9332
Sable	3.0L V6 F/I	HPR8997
2004 MERCURY		
Grand Marquis	4.6L V8 F/I	HPR5056
Marauder	4.6L V8 F/I	HPR5056
Monterey Van	4.2L V6 F/I	HPR8956
Mountaineer	4.0L V6 F/I	HPR9332
Mountaineer	4.6L V8 F/I	HPR9332
Sable	3.0L V6 F/I	HPR8997
2003 MERCURY		
Grand Marquis	4.6L V8 F/I	HPR5056
Marauder	4.6L V8 F/I	HPR5056
Mountaineer	4.0L V6 F/I	HPR9332
Mountaineer	4.6L V8 F/I	HPR9332
Sable	3.0L V6 F/I	HPR8997
2002 MERCURY		
Grand Marquis	4.6L V8 F/I	HPR5056
Mountaineer	4.0L V6 F/I	HPR9332
Mountaineer	4.6L V8 F/I	HPR9332
Sable	3.0L V6 F/I	HPR8997
2001 MERCURY		
Grand Marquis	4.6L V8 F/I	HPR5056
Mountaineer	4.0L V6 F/I	HPR8243

*Indicates 2 filters required ♦ Intake system available - see page 326 + throttle body spacer available - see page 20

MERCURY HPR™ REPLACEMENT AIR FILTERS

Vehicle	Engine Type	Air Filter	Vehicle	Engine Type	Air Filter
2001 MERCURY			1992 MERCURY		
Mountaineer	5.0L V8 F/I	HPR8243	Cougar	3.8L V6 F/I	HPR6555
Sable	3.0L V6 F/I	HPR8997	Cougar	5.0L V8 F/I	HPR6555
2000 MERCURY			Grand Marquis	4.6L V8 F/I	HPR5056
Grand Marquis	4.6L V8 F/I	HPR5056	Sable	3.0L V6 F/I	HPR5058
Mountaineer	4.0L V6 F/I	HPR8243	Sable	3.8L V6 F/I	HPR5058
Mountaineer	5.0L V8 F/I	HPR8243	Topaz	2.3L L4 F/I	HPR7365
Sable	3.0L V6 F/I	HPR8997	Topaz	3.0L V6 F/I	HPR7365
1999 MERCURY			Tracer	1.9L L4 F/I	HPR3660
Grand Marquis	4.6L V8 F/I	HPR5056	1991 MERCURY		
Mountaineer	4.0L V6 F/I	HPR8243	Colony Park	5.0L V8 F/I	HPR5056
Mountaineer	5.0L V8 F/I	HPR8243	Cougar	3.8L V6 F/I	HPR6555
Sable	3.0L V6 F/I	HPR7365	Cougar	5.0L V8 F/I	HPR6555
Tracer	2.0L L4 F/I	HPR7774	Grand Marquis	5.0L V8 F/I	HPR5056
1998 MERCURY			Sable	3.0L V6 F/I	HPR5058
Grand Marquis	4.6L V8 F/I	HPR5056	Sable	3.8L V6 F/I	HPR5058
Mountaineer	4.0L V6 F/I - w/Panel Filter	HPR8243	Tracer	1.9L L4 F/I	HPR3660
Mountaineer	4.0L V6 F/I - w/Round Filter	HPR7774	1990 MERCURY		
Mountaineer	5.0L V8 F/I - w/Panel Filter	HPR8243	Colony Park	5.0L V8 F/I	HPR5056
Mountaineer	5.0L V8 F/I - w/Round Filter	HPR7774	Cougar	3.8L V6 F/I	HPR6555
Sable	3.0L V6 F/I	HPR7365	Grand Marquis	5.0L V8 F/I	HPR5056
Tracer	2.0L L4 F/I	HPR7774	Sable	3.0L V6 F/I	HPR5058
1997 MERCURY			Sable	3.8L V6 F/I	HPR5058
Cougar	3.8L V6 F/I	HPR6555	1989 MERCURY		
Cougar	4.6L V8 F/I	HPR6555	Colony Park	5.0L V8 F/I	HPR5056
Grand Marquis	4.6L V8 F/I	HPR5056	Cougar	3.8L V6 F/I	HPR6555
Mountaineer	5.0L V8 F/I - w/Panel Filter	HPR8243	Grand Marquis	5.0L V8 F/I	HPR5056
Mountaineer	5.0L V8 F/I - w/Round Filter	HPR7774	Grand Marquis	5.8L V8 CARB	HPR0351
Sable	3.0L V6 F/I	HPR7365	Sable	3.0L V6 F/I	HPR5058
Tracer	2.0L L4 F/I	HPR7774	Sable	3.8L V6 F/I	HPR5058
1996 MERCURY			1988 MERCURY		
Cougar	3.8L V6 F/I	HPR6555	Colony Park	5.0L V8 F/I	HPR5056
Cougar	4.6L V8 F/I	HPR6555	Grand Marquis	5.0L V8 F/I	HPR5056
Grand Marquis	4.6L V8 F/I	HPR5056	Grand Marquis	5.8L V8 CARB	HPR0351
Sable	3.0L V6 F/I	HPR7365	Sable	3.0L V6 F/I	HPR5058
Tracer	1.9L L4 F/I	HPR3660	Sable	3.8L V6 F/I	HPR5058
1995 MERCURY			1987 MERCURY		
Cougar	3.8L V6 F/I	HPR6555	Colony Park	5.0L V8 F/I	HPR5056
Cougar	4.6L V8 F/I	HPR6555	Grand Marquis	5.0L V8 F/I	HPR5056
Grand Marquis	4.6L V8 F/I	HPR5056	Grand Marquis	5.8L V8 CARB	HPR0351
Sable	3.0L V6 F/I	HPR5058	Lynx	1.9L L4 F/I	HPR3660
Sable	3.8L V6 F/I	HPR5058	Sable	3.0L V6 F/I	HPR5058
Tracer	1.9L L4 F/I	HPR3660	1986 MERCURY		
1994 MERCURY			Grand Marquis	5.0L V8 F/I	HPR5056
Cougar	3.8L V6 F/I	HPR6555	Grand Marquis	5.8L V8 CARB	HPR0351
Cougar	4.6L V8 F/I	HPR6555	Lynx	1.9L L4 CARB	HPR3660
Grand Marquis	4.6L V8 F/I	HPR5056	Lynx	1.9L L4 F/I	HPR3660
Sable	3.0L V6 F/I	HPR5058	Sable	2.5L L4 F/I	HPR5058
Sable	3.8L V6 F/I	HPR5058	Sable	3.0L V6 F/I	HPR5058
Topaz	2.3L L4 F/I	HPR7365	1985 MERCURY		
Topaz	3.0L V6 F/I	HPR7365	Cougar	5.0L V8 F/I	HPR0351
Tracer	1.9L L4 F/I	HPR3660	Grand Marquis	5.0L V8 F/I	HPR0351
1993 MERCURY			Grand Marquis	5.8L V8 CARB	HPR0351
Cougar	3.8L V6 F/I	HPR6555	Lynx	1.6L L4 CARB	HPR3660
Cougar	5.0L V8 F/I	HPR6555	Lynx	1.9L L4 CARB	HPR3660
Grand Marquis	4.6L V8 F/I	HPR5056	Marquis	5.0L V8 F/I	HPR0351
Sable	3.0L V6 F/I	HPR5058	1984 MERCURY		
Sable	3.8L V6 F/I	HPR5058	Cougar	5.0L V8 F/I	HPR0351
Topaz	2.3L L4 F/I	HPR7365	Grand Marquis	5.0L V8 F/I	HPR0351
Topaz	3.0L V6 F/I	HPR7365	Grand Marquis	5.8L V8 CARB	HPR0351
Tracer	1.9L L4 F/I	HPR3660	Lynx	1.6L L4 CARB	HPR3660

*Indicates 2 filters required ♦ Intake system available - see page 326 + throttle body spacer available - see page 20

HPR™ REPLACEMENT AIR FILTERS

MERCURY

Vehicle	Engine Type	Air Filter
1984 MERCURY		
Lynx	1.6L L4 F/I	HPR3660
1983 MERCURY		
Cougar	5.0L V8 F/I	HPR0351
Grand Marquis	5.0L V8 CARB	HPR0351
Grand Marquis	5.0L V8 F/I	HPR0351
Grand Marquis	5.8L V8 CARB	HPR0351
Marquis	3.3L L6 CARB	HPR3300
Zephyr	3.3L L6 CARB	HPR3300
1982 MERCURY		
Capri	3.3L L6 CARB	HPR3300
Capri	5.0L V8 CARB	HPR0351
Cougar	3.3L L6 CARB	HPR3300
Grand Marquis	4.2L V8 CARB	HPR0351
Grand Marquis	5.0L V8 CARB	HPR0351
Marquis	4.2L V8 CARB	HPR0351
Marquis	5.0L V8 CARB	HPR0351
Marquis	5.8L V8 CARB	HPR0351
Zephyr	3.3L L6 CARB	HPR3300
Zephyr	4.2L V8 CARB	HPR0351
1981 MERCURY		
Capri	3.3L L6 CARB	HPR3300
Cougar	3.3L L6 CARB	HPR3300
Cougar	5.0L V8 CARB	HPR0351
Grand Marquis	4.2L V8 CARB	HPR0351
Grand Marquis	5.0L V8 CARB	HPR0351
Grand Marquis	5.8L V8 CARB	HPR0351
Marquis	4.2L V8 CARB	HPR0351
Marquis	5.0L V8 CARB	HPR0351
Marquis	5.8L V8 CARB	HPR0351
Zephyr	3.3L L6 CARB	HPR3300
1980 MERCURY		
Capri	200 L6 CARB	HPR3300
Cougar	3.3L L6 CARB	HPR3300
Cougar	5.0L V8 CARB	HPR0351
Grand Marquis	302 V8 CARB	HPR0351
Grand Marquis	351 V8 CARB	HPR0351
Marquis	302 V8 CARB	HPR0351
Marquis	351 V8 CARB	HPR0351
Monarch	255 V8 CARB	HPR0351
Monarch	302 V8 CARB	HPR0351
Zephyr	200 L6 CARB	HPR3300
1979 MERCURY		
Capri	200 L6 CARB	HPR3300
Capri	200 L6 CARB - w/Auto Trans.	HPR3300
Cougar	302 V8 CARB	HPR0351
Cougar	351 V8 CARB	HPR0351
Grand Marquis	302 V8 CARB	HPR0351
Grand Marquis	351 V8 CARB	HPR0351
Marquis	302 V8 CARB	HPR0351
Marquis	351 V8 CARB	HPR0351
Monarch	302 V8 CARB	HPR0351
Zephyr	200 L6 CARB	HPR3300
Zephyr	200 L6 CARB - w/Auto Trans.	HPR3300
1978 MERCURY		
Cougar	302 V8 CARB	HPR0351
Cougar	351 V8 CARB	HPR0351
Cougar	400 V8 CARB	HPR0351
Grand Marquis	351 V8 CARB	HPR0351
Grand Marquis	400 V8 CARB	HPR0351
Marquis	351 V8 CARB	HPR0351
Marquis	400 V8 CARB	HPR0351

Vehicle	Engine Type	Air Filter
1978 MERCURY		
Monarch	302 V8 CARB	HPR0351
Zephyr	200 L6 CARB	HPR3300
Zephyr	200 L6 CARB - w/Auto Trans.	HPR3300
1977 MERCURY		
Cougar	351 V8 CARB	HPR0351
Cougar	400 V8 CARB	HPR0351
Grand Marquis	400 V8 CARB	HPR0351
Marquis	400 V8 CARB	HPR0351
Monarch	302 V8 CARB	HPR0351
Monarch	351 V8 CARB	HPR0351
1976 MERCURY		
Bobcat	171 V6 CARB	HPR3300
Capri	171 V6 CARB	HPR3300
Capri	173 V6 2 BBL.	HPR3300
Comet	302 V8 CARB	HPR0351
Cougar	351 V8 CARB	HPR0351
Monarch	302 V8 CARB - Early Prod.	HPR0351
Monarch	351 V8 CARB	HPR0351
Montego	351 V8 CARB - w/Windsor Eng.	HPR0351
1975 MERCURY		
Bobcat	171 V6 CARB	HPR3300
Comet	302 V8 CARB	HPR0351
Cougar	351 V8 CARB - 11 inch OD	HPR0351
Monarch	302 V8 CARB	HPR0351
Monarch	351 V8 CARB	HPR0351
Montego	351 V8 CARB - w/Windsor Eng.	HPR0351
1974 MERCURY		
Capri	171 V6 CARB	HPR3300
Comet	250 L6 CARB	HPR3300
Comet	302 V8 CARB	HPR0351
Cougar	351 V8 2 BBL.	HPR0351
Montclair	351 V8 2 BBL.	HPR0351
Montego	250 L6 CARB	HPR3300
Montego	302 V8 CARB	HPR0351
Montego	351 V8 CARB	HPR0351
1973 MERCURY		
Colony Park	351 V8 CARB - w/Cleveland Eng.	HPR0351
Comet	250 L6 CARB	HPR3300
Comet	302 V8 CARB	HPR0351
Cougar	351 V8 2 BBL.	HPR0351
Marquis	351 V8 CARB - w/Cleveland Eng.	HPR0351
Montclair	351 V8 2 BBL.	HPR0351
Montego	250 L6 CARB	HPR3300
Montego	302 V8 CARB	HPR0351
Montego	351 V8 CARB - w/Windsor Eng.	HPR0351
1972 MERCURY		
Colony Park	351 V8 CARB - w/Cleveland Eng.	HPR0351
Comet	250 L6 CARB	HPR3300
Comet	302 V8 CARB	HPR0351
Cougar	351 V8 2 BBL.	HPR0351
Cougar	351 V8 2 BBL. - w/Cleveland Eng.	HPR0351
Marquis	351 V8 CARB - w/Cleveland Eng.	HPR0351
Montego	250 L6 CARB	HPR3300
Montego	302 V8 CARB	HPR0351
Montego	351 V8 2 BBL.	HPR0351
1971 MERCURY		
Comet	250 L6 CARB	HPR3300
Montego	250 L6 CARB	HPR3300
1970 MERCURY		
Comet	250 L6 CARB	HPR3300

*Indicates 2 filters required ♦ Intake system available - see page 326 + throttle body spacer available - see page 20

MERCURY HPR™ REPLACEMENT AIR FILTERS

Vehicle	Engine Type	Air Filter
1970 MERCURY		
Montego	250 L6 CARB	HPR3300
1967 MERCURY		
Caliente	200 L6 CARB	HPR0184
Comet	200 L6 CARB	HPR0184
Montclair	427 V8 CARB	HPR0184
Villager	200 L6 CARB	HPR0184
Voyager	200 L6 CARB	HPR0184
1966 MERCURY		
Breezeway	427 V8 CARB	HPR0184
Caliente	200 L6 CARB	HPR0184
Colony Park	427 V8 CARB	HPR0184
Comet	200 L6 CARB	HPR0184
Commuter	427 V8 CARB	HPR0184
Cyclone	390 V8 CARB	HPR0184
Monterey	427 V8 CARB	HPR0184
Park Lane	427 V8 CARB	HPR0184
Villager	200 L6 CARB	HPR0184
Voyager	200 L6 CARB	HPR0184
1965 MERCURY		
Breezeway	390 V8 CARB	HPR0184
Caliente	200 L6 CARB	HPR0184
Colony Park	390 V8 CARB	HPR0184
Comet	200 L6 CARB	HPR0184
Commuter	390 V8 CARB	HPR0184
Marauder	390 V8 CARB	HPR0184
Montclair	390 V8 CARB	HPR0184
Monterey	390 V8 CARB	HPR0184
Park Lane	390 V8 CARB	HPR0184
Villager	200 L6 CARB	HPR0184
1964 MERCURY		
Caliente	200 L6 CARB	HPR0184
Comet	170 L6 CARB	HPR0184
Comet	200 L6 CARB	HPR0184
Cyclone	200 L6 CARB	HPR0184
Villager	200 L6 CARB	HPR0184
1963 MERCURY		
Comet	144 L6 CARB	HPR0184
Comet	170 L6 CARB	HPR0184
Country Cruiser	200 L6 CARB	HPR0184
Meteor	170 L6 CARB	HPR0184
Meteor	200 L6 CARB	HPR0184
Villager	144 L6 CARB	HPR0184
1962 MERCURY		
Comet	144 L6 CARB	HPR0184
Comet	170 L6 CARB	HPR0184
Meteor	170 L6 CARB	HPR0184
1961 MERCURY		
Comet	144 L6 CARB	HPR0184
Comet	170 L6 CARB	HPR0184
Meteor	170 L6 CARB	HPR0184
2017 MITSUBISHI		
ASX	2.2L L4 DSL	HPR6690
Lancer VIII	1.8L L4 DSL	HPR6690
Outlander	2.2L L4 DSL	HPR6690
2016 MITSUBISHI		
ASX	2.2L L4 DSL	HPR6690
Lancer VIII	1.8L L4 DSL	HPR6690
Outlander	2.2L L4 DSL	HPR6690

Vehicle	Engine Type	Air Filter
2015 MITSUBISHI		
ASX	1.8L L4 DSL	HPR6690
ASX	2.2L L4 DSL	HPR6690
Lancer VIII	1.8L L4 DSL	HPR6690
Outlander	2.2L L4 DSL	HPR6690
2014 MITSUBISHI		
ASX	1.8L L4 DSL	HPR6690
ASX	2.2L L4 DSL	HPR6690
Lancer VIII	1.8L L4 DSL	HPR6690
Outlander	2.2L L4 DSL	HPR6690
2013 MITSUBISHI		
ASX	1.8L L4 DSL	HPR6690
ASX	2.2L L4 DSL	HPR6690
Lancer VIII	1.8L L4 DSL	HPR6690
Outlander	2.2L L4 DSL	HPR6690
2012 MITSUBISHI		
ASX	1.8L L4 DSL	HPR6690
Lancer VIII	1.8L L4 DSL	HPR6690
Outlander	2.2L L4 DSL - 177BHP	HPR6690
2011 MITSUBISHI		
ASX	1.8L L4 DSL	HPR6690
Lancer VIII	1.8L L4 DSL	HPR6690
Outlander	2.2L L4 DSL - 177BHP	HPR6690
2010 MITSUBISHI		
ASX	1.8L L4 DSL	HPR6690
Outlander	2.2L L4 DSL - 177BHP	HPR6690
Raider	3.7L V6 F/I	HPR3901
2009 MITSUBISHI		
Outlander	2.0L L4 F/I	HPR8208
Raider	3.7L V6 F/I	HPR3901
2008 MITSUBISHI		
Lancer	1.3L L4 F/I	HPR8208
Lancer	1.6L L4 F/I	HPR8208
Outlander	2.0L L4 F/I	HPR8208
Raider	3.7L V6 F/I	HPR3901
Raider	4.7L V8 F/I	HPR3901
2007 MITSUBISHI		
iO	1.8L L4 F/I	HPR7344
iO	2.0L L4 F/I	HPR7344
Lancer	1.3L L4 F/I	HPR8208
Lancer	1.6L L4 F/I	HPR8208
Lancer	2.0L L4 F/I	HPR8208
Lancer	2.4L L4 F/I	HPR8208
Lancer Evolution	2.0L L4 F/I	HPR8208
Outlander	2.0L L4 F/I	HPR8208
Outlander	2.4L L4 F/I - to 2/07	HPR8208
Raider	3.7L V6 F/I	HPR3901
Raider	4.7L V8 F/I	HPR3901
2006 MITSUBISHI		
iO	1.8L L4 F/I	HPR7344
iO	2.0L L4 F/I	HPR7344
Lancer	1.3L L4 F/I	HPR8208
Lancer	1.6L L4 F/I	HPR8208
Lancer	2.0L L4 F/I	HPR8208
Lancer	2.4L L4 F/I	HPR8208
Lancer Evolution	2.0L L4 F/I	HPR8208
Outlander	2.0L L4 F/I	HPR8208
Outlander	2.4L L4 F/I	HPR8208
Raider	3.7L V6 F/I	HPR3901
Raider	4.7L V8 F/I	HPR3901

*Indicates 2 filters required ♦ Intake system available - see page 326 + throttle body spacer available - see page 20

HPR™ REPLACEMENT AIR FILTERS MITSUBISHI

Vehicle	Engine Type	Air Filter	Vehicle	Engine Type	Air Filter
2005 MITSUBISHI			2003 MITSUBISHI		
Colt V	1.3L L4 F/I	HPR8208	Pajero Pinin	1.8L L4 DSL	HPR7344
Eclipse	2.4L L4 F/I	HPR7344	Pajero Pinin	1.8L L4 F/I	HPR7344
Eclipse	3.0L V6 F/I	HPR7344	Pajero Pinin	2.0L L4 F/I	HPR7344
Eclipse GT	3.0L V6 F/I	HPR7344	Pajero Sport	1.8L L4 F/I	HPR7344
Galloper	3.0L V6 F/I	HPR7142	Pajero Sport	3.0L V6 F/I	HPR7142
iO	1.8L L4 F/I	HPR7344	2002 MITSUBISHI		
iO	2.0L L4 F/I	HPR7344	Colt V	1.3L L4 F/I	HPR8208
Lancer	1.3L L4 F/I	HPR8208	Colt V	1.6L L4 F/I	HPR8208
Lancer	1.6L L4 F/I	HPR8208	Eclipse	2.4L L4 F/I	HPR7344
Lancer	2.0L L4 F/I	HPR8208	Eclipse	3.0L V6 F/I	HPR7344
Lancer Evolution	2.0L L4 F/I	HPR8208	Galant	2.4L L4 F/I	HPR7344
Lancer Ralliart	2.4L L4 F/I	HPR8208	Galant	3.0L V6 F/I	HPR7344
Outlander	2.0L L4 F/I	HPR8208	Galloper	3.0L V6 F/I	HPR7142
Outlander	2.4L L4 F/I	HPR8208	iO	1.8L L4 F/I	HPR7344
Pajero Sport	3.0L V6 F/I	HPR7142	iO	2.0L L4 F/I	HPR7344
2004 MITSUBISHI			Lancer	2.0L L4 F/I	HPR8208
Colt V	1.3L L4 F/I	HPR8208	Lancer VI	2.0L L4 F/I	HPR8208
Colt V	1.6L L4 F/I	HPR8208	Mirage	1.5L L4 F/I	HPR8208
Eclipse	2.4L L4 F/I	HPR7344	Mirage	1.8L L4 F/I	HPR8208
Eclipse	3.0L V6 F/I	HPR7344	Montero Sport	3.0L V6 F/I	HPR7142
Eclipse GT	3.0L V6 F/I	HPR7344	Pajero Pinin	1.8L L4 DSL	HPR7344
Galloper	3.0L V6 F/I	HPR7142	Pajero Pinin	1.8L L4 F/I	HPR7344
iO	1.8L L4 F/I	HPR7344	Pajero Pinin	2.0L L4 F/I	HPR7344
iO	2.0L L4 F/I	HPR7344	Pajero Sport	1.8L L4 F/I	HPR7344
Lancer	1.3L L4 F/I	HPR8208	Pajero Sport	3.0L V6 F/I	HPR7142
Lancer	1.6L L4 F/I	HPR8208	2001 MITSUBISHI		
Lancer	2.0L L4 F/I	HPR8208	Colt V	1.3L L4 F/I	HPR8208
Lancer Evolution	2.0L L4 F/I	HPR8208	Colt V	1.6L L4 F/I	HPR8208
Lancer Ralliart	2.4L L4 F/I	HPR8208	Eclipse	2.4L L4 F/I	HPR7344
Lancer Sportback	2.4L L4 F/I	HPR8208	Eclipse	3.0L V6 F/I	HPR7344
Mirage	1.5L L4 F/I	HPR8208	Galant	2.4L L4 F/I	HPR7344
Mirage	1.8L L4 F/I	HPR8208	Galant	3.0L V6 F/I	HPR7344
Outlander	2.0L L4 F/I	HPR8208	Galloper	3.0L V6 F/I	HPR7142
Outlander	2.4L L4 F/I	HPR8208	iO	1.8L L4 F/I	HPR7344
Pajero Pinin	1.8L L4 DSL	HPR7344	iO	2.0L L4 F/I	HPR7344
Pajero Pinin	1.8L L4 F/I	HPR7344	Lancer VI	2.0L L4 F/I	HPR8208
Pajero Pinin	2.0L L4 F/I	HPR7344	Mirage	1.5L L4 F/I	HPR8208
Pajero Sport	1.8L L4 F/I	HPR7344	Mirage	1.8L L4 F/I	HPR8208
Pajero Sport	3.0L V6 F/I	HPR7142	Montero Sport	3.0L V6 F/I	HPR7142
2003 MITSUBISHI			Pajero Pinin	1.8L L4 DSL	HPR7344
Colt V	1.3L L4 F/I	HPR8208	Pajero Pinin	1.8L L4 F/I	HPR7344
Colt V	1.6L L4 F/I	HPR8208	Pajero Pinin	2.0L L4 F/I	HPR7344
Eclipse	2.4L L4 F/I	HPR7344	Pajero Sport	1.8L L4 DSL	HPR7344
Eclipse	3.0L V6 F/I	HPR7344	Pajero Sport	1.8L L4 F/I	HPR7344
Eclipse GT	3.0L V6 F/I	HPR7344	Pajero Sport	3.0L V6 F/I	HPR7142
Galant	2.4L L4 F/I	HPR7344	2000 MITSUBISHI		
Galant	3.0L V6 F/I	HPR7344	Colt V	1.3L L4 F/I	HPR8208
Galloper	3.0L V6 F/I	HPR7142	Colt V	1.6L L4 F/I	HPR8208
iO	1.8L L4 F/I	HPR7344	Eclipse	2.4L L4 F/I	HPR7344
iO	2.0L L4 F/I	HPR7344	Eclipse	3.0L V6 F/I	HPR7344
Lancer	1.3L L4 F/I - From 10/03	HPR8208	Galant	2.4L L4 F/I	HPR7344
Lancer	1.6L L4 F/I - From 10/03	HPR8208	Galant	3.0L V6 F/I	HPR7344
Lancer	2.0L L4 F/I	HPR8208	Galloper	3.0L V6 F/I	HPR7142
Lancer Evolution	2.0L L4 F/I	HPR8208	iO	1.8L L4 F/I	HPR7344
Lancer V	1.6L L4 F/I - From 10/03	HPR8208	iO	2.0L L4 F/I	HPR7344
Lancer VI	1.3L L4 F/I - From 10/03	HPR8208	Lancer VI	2.0L L4 F/I	HPR8208
Lancer VI	1.6L L4 F/I - From 10/03	HPR8208	Mirage	1.5L L4 F/I	HPR8208
Lancer VI	2.0L L4 F/I	HPR8208	Mirage	1.8L L4 F/I	HPR8208
Mirage	1.5L L4 F/I	HPR8208	Montero Sport	3.0L V6 F/I	HPR7142
Mirage	1.8L L4 F/I	HPR8208	Pajero II	1.8L L4 DSL	HPR7344
Montero Sport	3.0L V6 F/I	HPR7142	Pajero Pinin	1.8L L4 DSL	HPR7344
Outlander	2.0L L4 F/I	HPR8208	Pajero Pinin	1.8L L4 F/I	HPR7344
Outlander	2.4L L4 F/I	HPR8208	Pajero Pinin	2.0L L4 F/I	HPR7344

*Indicates 2 filters required ♦ Intake system available - see page 326 + throttle body spacer available - see page 20

MITSUBISHI HPR™ REPLACEMENT AIR FILTERS

Vehicle	Engine Type	Air Filter	Vehicle	Engine Type	Air Filter
2000 MITSUBISHI			1996 MITSUBISHI		
Pajero Sport	1.8L L4 DSL	HPR7344	3000GT	3.0L V6 F/I	HPR7142
Pajero Sport	3.0L V6 F/I	HPR7142	Colt V	1.3L L4 F/I	HPR8208
1999 MITSUBISHI			Colt V	1.6L L4 F/I	HPR8208
3000GT	3.0L V6 F/I	HPR7142	Diamante	3.0L V6 F/I	HPR7142
Colt V	1.3L L4 F/I	HPR8208	Eclipse	2.0L L4 F/I	HPR7344
Colt V	1.6L L4 F/I	HPR8208	Eclipse	2.4L L4 F/I	HPR7344
Eclipse	2.0L L4 F/I	HPR7344	Eclipse II	2.0L L4 F/I	HPR7344
Eclipse	2.4L L4 F/I	HPR7344	Galant	2.4L L4 F/I	HPR7344
Eclipse II	2.0L L4 F/I	HPR7344	Galant V	1.8L L4 F/I	HPR7344
Eclipse II	2.4L L4 F/I	HPR7344	Galant V	2.0L L4 F/I	HPR7344
Galant	2.4L L4 F/I	HPR7344	Galant V	2.5L V6 F/I	HPR7344
Galant	3.0L V6 F/I	HPR7344	Magna	3.0L V6 F/I	HPR7142
Galopper	3.0L V6 F/I	HPR7142	Mighty Max	2.4L L4 F/I	HPR7142
iO	1.8L L4 F/I	HPR7344	Sigma	3.0L V6 F/I	HPR7142
Lancer VI	2.0L L4 F/I	HPR8208	Space Gear	2.0L L4 F/I	HPR7142
Mirage	1.5L L4 F/I	HPR8208	Space Gear	2.4L L4 F/I	HPR7142
Mirage	1.8L L4 F/I	HPR8208	Space Runner	1.8L L4 F/I	HPR7344
Montero Sport	2.4L L4 F/I	HPR7142	Space Wagon	2.0L L4 DSL	HPR7344
Montero Sport	3.0L V6 F/I	HPR7142	Space Wagon	2.0L L4 F/I	HPR7344
Pajero II	1.8L L4 DSL	HPR7344	1995 MITSUBISHI		
Pajero Pinin	1.8L L4 DSL	HPR7344	3000GT	3.0L V6 F/I	HPR7142
Pajero Pinin	1.8L L4 F/I	HPR7344	Diamante	3.0L V6 F/I	HPR7142
Pajero Sport	1.8L L4 DSL	HPR7344	Eclipse	2.0L L4 F/I	HPR7344
Pajero Sport	3.0L V6 F/I	HPR7142	Eclipse II	2.0L L4 F/I	HPR7344
Space Runner	1.8L L4 F/I	HPR7344	Expo	2.4L L4 F/I	HPR7344
1998 MITSUBISHI			Galant	2.4L L4 F/I	HPR7344
3000GT	3.0L V6 F/I	HPR7142	Galant V	1.8L L4 F/I	HPR7344
Colt V	1.3L L4 F/I	HPR8208	Galant V	2.0L L4 F/I	HPR7344
Colt V	1.6L L4 F/I	HPR8208	Galant V	2.5L V6 F/I	HPR7344
Eclipse	2.0L L4 F/I	HPR7344	Magna	3.0L V6 F/I	HPR7142
Eclipse	2.4L L4 F/I	HPR7344	Mighty Max	2.4L L4 F/I	HPR7142
Eclipse II	2.0L L4 F/I	HPR7344	Pajero II	3.0L V6 F/I - 150BHP	HPR7142
Eclipse II	2.4L L4 F/I	HPR7344	Sigma	3.0L V6 F/I	HPR7142
Galant	2.4L L4 F/I	HPR7344	Space Gear	2.0L L4 F/I	HPR7142
Mirage	1.5L L4 F/I	HPR8208	Space Gear	2.4L L4 F/I	HPR7142
Mirage	1.8L L4 F/I	HPR8208	Space Runner	1.8L L4 F/I	HPR7344
Montero Sport	2.4L L4 F/I	HPR7142	Space Wagon	2.0L L4 DSL	HPR7344
Montero Sport	3.0L V6 F/I	HPR7142	Space Wagon	2.0L L4 F/I	HPR7344
Pajero II	1.8L L4 DSL	HPR7344	1994 MITSUBISHI		
Pajero Sport	3.0L V6 F/I	HPR7142	3000GT	3.0L V6 F/I	HPR7142
Space Gear	2.0L L4 F/I	HPR7142	Diamante	3.0L V6 F/I	HPR7142
Space Gear	2.4L L4 F/I	HPR7142	Expo	2.4L L4 F/I	HPR7344
Space Runner	1.8L L4 F/I	HPR7344	Expo LRV	1.8L L4 F/I	HPR7344
Space Wagon	2.0L L4 DSL	HPR7344	Expo LRV	2.4L L4 F/I	HPR7344
Space Wagon	2.0L L4 F/I	HPR7344	Galant	2.4L L4 F/I	HPR7344
1997 MITSUBISHI			Galant V	1.8L L4 F/I	HPR7344
3000GT	3.0L V6 F/I	HPR7142	Galant V	2.0L L4 F/I	HPR7344
Colt V	1.3L L4 F/I	HPR8208	Galant V	2.5L V6 F/I	HPR7344
Colt V	1.6L L4 F/I	HPR8208	Magna	3.0L V6 F/I	HPR7142
Eclipse	2.0L L4 F/I	HPR7344	Mighty Max	2.4L L4 F/I	HPR7142
Eclipse	2.4L L4 F/I	HPR7344	Mighty Max	3.0L V6 F/I	HPR7142
Eclipse II	2.0L L4 F/I	HPR7344	Montero	3.0L V6 F/I	HPR7142
Galant	2.4L L4 F/I	HPR7344	Pajero II	3.0L V6 F/I - 150BHP	HPR7142
Mirage	1.5L L4 F/I	HPR8208	Sigma	3.0L V6 F/I	HPR7142
Mirage	1.8L L4 F/I	HPR8208	Space Runner	1.8L L4 F/I	HPR7344
Montero Sport	2.4L L4 F/I	HPR7142	Space Wagon	2.0L L4 DSL	HPR7344
Montero Sport	3.0L V6 F/I	HPR7142	Space Wagon	2.0L L4 F/I	HPR7344
Space Gear	2.0L L4 F/I	HPR7142	1993 MITSUBISHI		
Space Gear	2.4L L4 F/I	HPR7142	3000GT	3.0L V6 F/I	HPR7142
Space Runner	1.8L L4 F/I	HPR7344	Diamante	3.0L V6 F/I	HPR7142
Space Wagon	2.0L L4 DSL	HPR7344	Expo	2.4L L4 F/I	HPR7344
Space Wagon	2.0L L4 F/I	HPR7344	Expo LRV	1.8L L4 F/I	HPR7344
			Expo LRV	2.4L L4 F/I	HPR7344

*Indicates 2 filters required ♦ Intake system available - see page 326 + throttle body spacer available - see page 20

HPR™ REPLACEMENT AIR FILTERS MITSUBISHI

Vehicle	Engine Type	Air Filter	Vehicle	Engine Type	Air Filter
1993 MITSUBISHI			2017 NISSAN		
Galant V	1.8L L4 F/I	HPR7344	Altima	3.5L V6 F/I	HPR4309
Galant V	2.0L L4 F/I	HPR7344	Frontier	4.0L V6 F/I	HPR7440
Galant V	2.5L V6 F/I	HPR7344	Maxima	3.5L V6 F/I	HPR4309
Magna	3.0L V6 F/I	HPR7142	Murano	3.5L V6 F/I	HPR4309
Mighty Max	2.4L L4 F/I	HPR7142	NV1500	4.0L V6 F/I	HPR7440
Mighty Max	3.0L V6 F/I	HPR7142	NV2500	4.0L V6 F/I	HPR7440
Montero	3.0L V6 F/I	HPR7142	Pathfinder	3.5L V6 F/I	HPR4309
Pajero II	3.0L V6 F/I	HPR7142	Quest	3.5L V6 F/I	HPR4309
Sigma	3.0L V6 F/I	HPR7142	2016 NISSAN		
Space Runner	1.8L L4 F/I	HPR7344	Altima	3.5L V6 F/I	HPR4309
Space Wagon	2.0L L4 DSL	HPR7344	Frontier	4.0L V6 F/I	HPR7440
Space Wagon	2.0L L4 F/I	HPR7344	Maxima	3.5L V6 F/I	HPR4309
1992 MITSUBISHI			Murano	3.5L V6 F/I	HPR4309
3000GT	3.0L V6 F/I	HPR7142	NV1500	4.0L V6 F/I	HPR7440
Diamante	3.0L V6 F/I	HPR7142	NV2500	4.0L V6 F/I	HPR7440
Expo	2.4L L4 F/I	HPR7344	NV2500	5.6L V8 F/I	HPR7440
Expo LRV	1.8L L4 F/I	HPR7344	NV3500	5.6L V8 F/I	HPR7440
Galant V	1.8L L4 F/I	HPR7344	Pathfinder	3.5L V6 F/I	HPR4309
Galant V	2.0L L4 F/I	HPR7344	Quest	3.5L V6 F/I	HPR4309
Galant V	2.5L V6 F/I	HPR7344	2015 NISSAN		
Mighty Max	2.4L L4 F/I	HPR7142	Altima	3.5L V6 F/I	HPR4309
Mighty Max	3.0L V6 F/I	HPR7142	Armada	5.6L V8 F/I	HPR7440
Montero	3.0L V6 F/I	HPR7142	Frontier	4.0L V6 F/I	HPR7440
Pajero II	3.0L V6 F/I	HPR7142	Murano	3.5L V6 F/I	HPR4309
Shogun	3.0L V6 - w/Panel Filter, 12v	HPR7142	NV1500	4.0L V6 F/I	HPR7440
Sigma	3.0L V6 F/I	HPR7142	NV2500	4.0L V6 F/I	HPR7440
Space Runner	1.8L L4 F/I	HPR7344	NV2500	5.6L V8 F/I	HPR7440
Space Wagon	2.0L L4 DSL	HPR7344	NV3500	5.6L V8 F/I	HPR7440
Space Wagon	2.0L L4 F/I	HPR7344	Pathfinder	3.5L V6 F/I	HPR4309
1991 MITSUBISHI			Quest	3.5L V6 F/I	HPR4309
3000GT	3.0L V6 F/I	HPR7142	Titan	5.6L V8 F/I	HPR7440
Mighty Max	2.4L L4 F/I	HPR7142	Xterra	4.0L V6 F/I	HPR7440
Mighty Max	3.0L V6 F/I	HPR7142	2014 NISSAN		
Pajero II	3.0L V6 F/I	HPR7142	Altima	3.5L V6 F/I	HPR4309
Sigma	3.0L V6 F/I	HPR7142	Armada	5.6L V8 F/I	HPR7440 ♦
Space Runner	1.8L L4 F/I	HPR7344	Frontier	4.0L V6 F/I	HPR7440
1990 MITSUBISHI			Maxima	3.5L V6 F/I	HPR4309
Lancer IV	1.3L L4 F/I	HPR0352	Murano	3.5L V6 F/I	HPR4309
Pajero II	3.0L V6 F/I	HPR7142	NV1500	4.0L V6 F/I	HPR7440
Sigma	3.0L V6 F/I	HPR7142	NV2500	4.0L V6 F/I	HPR7440
1989 MITSUBISHI			NV2500	5.6L V8 F/I	HPR7440
Lancer IV	1.3L L4 F/I	HPR0352	NV3500	5.6L V8 F/I	HPR7440
1988 MITSUBISHI			Pathfinder	3.5L V6 F/I	HPR4309
Lancer IV	1.3L L4 F/I	HPR0352	Quest	3.5L V6 F/I	HPR4309
1981 MITSUBISHI			Titan	5.6L V8 F/I	HPR7440 ♦
Celeste	1.6L L4 CARB	HPR0352	Xterra	4.0L V6 F/I	HPR7440
1980 MITSUBISHI			2013 NISSAN		
Celeste	1.6L L4 CARB	HPR0352	Altima	3.5L V6 F/I	HPR4309
1979 MITSUBISHI			Armada	5.6L V8 F/I	HPR7440 ♦
Celeste	1.6L L4 CARB	HPR0352	Frontier	4.0L V6 F/I	HPR7440
1978 MITSUBISHI			Maxima	3.5L V6 F/I	HPR4309
Celeste	1.6L L4 CARB	HPR0352	Murano	3.5L V6 F/I	HPR4309
1977 MITSUBISHI			NV1500	4.0L V6 F/I	HPR7440
Celeste	1.6L L4 CARB	HPR0352	NV2500	4.0L V6 F/I	HPR7440
1976 MITSUBISHI			NV2500	5.6L V8 F/I	HPR7440
Celeste	1.6L L4 CARB	HPR0352	NV3500	5.6L V8 F/I	HPR7440
1975 MITSUBISHI			Pathfinder	3.5L V6 F/I	HPR4309
Celeste	1.6L L4 CARB	HPR0352	Quest	3.5L V6 F/I	HPR4309
			Titan	5.6L V8 F/I	HPR7440 ♦
			Xterra	4.0L V6 F/I	HPR7440
			2012 NISSAN		
			Altima	3.5L V6 F/I	HPR4309

*Indicates 2 filters required ♦ Intake system available - see page 326 + throttle body spacer available - see page 20

Vehicle	Engine Type	Air Filter	Vehicle	Engine Type	Air Filter
2012 NISSAN			2007 NISSAN		
Armada	5.6L V8 F/I	HPR7440 ♦	Armada	5.6L V8 F/I	HPR7440 ♦
Frontier	4.0L V6 F/I	HPR7440	Frontier	4.0L V6 F/I	HPR7440
Maxima	3.5L V6 F/I	HPR4309	Maxima	3.5L V6 F/I	HPR4309
Murano	3.5L V6 F/I	HPR4309	Murano	3.5L V6 F/I	HPR4309
NV1500	4.0L V6 F/I	HPR7440	Pathfinder	4.0L V6 F/I	HPR7440
NV2500	4.0L V6 F/I	HPR7440	Primera	1.8L L4 F/I	HPR4309
NV2500	5.6L V8 F/I	HPR7440	Primera	2.0L L4 F/I	HPR4309
NV3500	5.6L V8 F/I	HPR7440	Quest	3.5L V6 F/I	HPR4309
Pathfinder	4.0L V6 F/I	HPR7440	Titan	5.6L V8 F/I	HPR7440 ♦
Pathfinder	5.6L V8 F/I	HPR7440	Xterra	4.0L V6 F/I	HPR7440
Quest	3.5L V6 F/I	HPR4309	X-Trail	2.2L L4 DSL	HPR4309
Titan	5.6L V8 F/I	HPR7440 ♦	2006 NISSAN		
Xterra	4.0L V6 F/I	HPR7440	350Z	3.5L V6 F/I	HPR4309
2011 NISSAN			Almera II	1.5L L4 F/I	HPR4309
Altima	3.5L V6 F/I	HPR4309	Almera II	1.8L L4 F/I	HPR4309
Armada	5.6L V8 F/I	HPR7440 ♦	Almera II	2.2L L4 DSL	HPR4309
Frontier	4.0L V6 F/I	HPR7440	Almera Tino	1.8L L4 F/I	HPR4309
Maxima	3.5L V6 F/I	HPR4309	Almera Tino	2.2L L4 DSL	HPR4309
Murano	3.5L V6 F/I	HPR4309	Altima	2.5L L4 F/I	HPR4309
Pathfinder	4.0L V6 F/I	HPR7440	Altima	3.5L V6 F/I	HPR4309
Pathfinder	5.6L V8 F/I	HPR7440	Armada	5.6L V8 F/I	HPR7440 ♦
Quest	3.5L V6 F/I	HPR4309	Frontier	4.0L V6 F/I	HPR7440
Titan	5.6L V8 F/I	HPR7440 ♦	Maxima	3.5L V6 F/I	HPR4309
Xterra	4.0L V6 F/I	HPR7440	Murano	3.5L V6 F/I	HPR4309
2010 NISSAN			Pathfinder	4.0L V6 F/I	HPR7440
Altima	3.5L V6 F/I	HPR4309	Primera	1.6L L4 F/I	HPR4309
Armada	5.6L V8 F/I	HPR7440 ♦	Primera	1.8L L4 F/I	HPR4309
Frontier	4.0L V6 F/I	HPR7440	Primera	2.0L L4 F/I	HPR4309
Maxima	3.5L V6 F/I	HPR4309	Primera	2.2L L4 DSL	HPR4309
Murano	3.5L V6 F/I	HPR4309	Quest	3.5L V6 F/I	HPR4309
Pathfinder	4.0L V6 F/I	HPR7440	Sentra	1.8L L4 F/I	HPR4309
Pathfinder	5.6L V8 F/I	HPR7440	Sentra	2.5L L4 F/I	HPR4309
Quest	3.5L V6 F/I	HPR4309	Titan	5.6L V8 F/I	HPR7440 ♦
Titan	5.6L V8 F/I	HPR7440 ♦	Xterra	4.0L V6 F/I	HPR7440
Xterra	4.0L V6 F/I	HPR7440	X-Trail	2.0L L4 F/I	HPR4309
2009 NISSAN			X-Trail	2.2L L4 DSL	HPR4309
Altima	3.5L V6 F/I	HPR4309	X-Trail	2.5L L4 F/I	HPR4309
Armada	5.6L V8 F/I	HPR7440 ♦	2005 NISSAN		
Frontier	4.0L V6 F/I	HPR7440	350Z	3.5L V6 F/I	HPR4309
Maxima	3.5L V6 F/I	HPR4309	Almera II	1.5L L4 F/I	HPR4309
Murano	3.5L V6 F/I	HPR4309	Almera II	1.8L L4 F/I	HPR4309
Pathfinder	4.0L V6 F/I	HPR7440	Almera II	2.2L L4 DSL	HPR4309
Pathfinder	5.6L V8 F/I	HPR7440	Almera Tino	1.8L L4 F/I	HPR4309
Quest	3.5L V6 F/I	HPR4309	Almera Tino	2.0L L4 F/I	HPR4309
Titan	5.6L V8 F/I	HPR7440 ♦	Almera Tino	2.2L L4 DSL	HPR4309
Xterra	4.0L V6 F/I	HPR7440	Altima	2.5L L4 F/I	HPR4309
2008 NISSAN			Altima	3.5L V6 F/I	HPR4309
Altima	3.5L V6 F/I	HPR4309	Armada	5.6L V8 F/I	HPR7440 ♦
Armada	5.6L V8 F/I	HPR7440 ♦	Frontier	4.0L V6 F/I	HPR7440
Frontier	4.0L V6 F/I	HPR7440	Maxima	2.0L V6 F/I	HPR4309
Maxima	3.5L V6 F/I	HPR4309	Maxima	3.0L V6 F/I	HPR4309
Murano	3.5L V6 F/I	HPR4309	Maxima	3.5L V6 F/I	HPR4309
Pathfinder	4.0L V6 F/I	HPR7440	Murano	3.5L V6 F/I	HPR4309
Pathfinder	5.6L V8 F/I	HPR7440	Navara	3.0L L4 DSL	HPR4309
Primera	1.8L L4 F/I	HPR4309	Pathfinder	4.0L V6 F/I	HPR7440
Primera	2.0L L4 F/I	HPR4309	Primera	1.6L L4 F/I	HPR4309
Quest	3.5L V6 F/I	HPR4309	Primera	1.8L L4 F/I	HPR4309
Titan	5.6L V8 F/I	HPR7440 ♦	Primera	2.0L L4 F/I	HPR4309
Xterra	4.0L V6 F/I	HPR7440	Primera	2.2L L4 DSL	HPR4309
2007 NISSAN			Quest	3.5L V6 F/I	HPR4309
Almera II	1.5L L4 F/I	HPR4309	Sentra	1.8L L4 F/I	HPR4309
Altima	3.5L V6 F/I	HPR4309	Sentra	2.5L L4 F/I	HPR4309
			Terrano II	2.4L L4 F/I	HPR4309

*Indicates 2 filters required ♦ Intake system available - see page 326 + throttle body spacer available – see page 20

HPR™ REPLACEMENT AIR FILTERS

NISSAN

Vehicle	Engine Type	Air Filter	Vehicle	Engine Type	Air Filter
2005 NISSAN			2003 NISSAN		
Titan	5.6L V8 F/I	HPR7440 ♦	Pathfinder	3.5L V6 F/I	HPR4309
Xterra	4.0L V6 F/I	HPR7440	Primera	1.6L L4 F/I	HPR4309
X-Trail	2.0L L4 F/I	HPR4309	Primera	1.8L L4 F/I	HPR4309
X-Trail	2.2L L4 DSL	HPR4309	Primera	2.0L L4 F/I	HPR4309
X-Trail	2.5L L4 F/I	HPR4309	Primera	2.2L L4 DSL	HPR4309
2004 NISSAN			Sentra	1.8L L4 F/I	HPR4309
350Z	3.5L V6 F/I	HPR4309	Sentra	2.5L L4 F/I	HPR4309
Almera II	1.5L L4 F/I	HPR4309	Terrano II	2.4L L4 F/I	HPR4309
Almera II	1.8L L4 F/I	HPR4309	Xterra	2.4L L4 F/I	HPR6850
Almera II	2.2L L4 DSL	HPR4309	Xterra	3.3L V6 F/I	HPR4309
Almera Tino	1.8L L4 F/I	HPR4309	X-Trail	2.0L L4 F/I	HPR4309
Almera Tino	2.0L L4 F/I	HPR4309	X-Trail	2.2L L4 DSL	HPR4309
Almera Tino	2.2L L4 DSL	HPR4309	X-Trail	2.5L L4 F/I	HPR4309
Altima	2.5L L4 F/I	HPR4309	2002 NISSAN		
Altima	3.5L V6 F/I	HPR4309	Almera II	1.5L L4 F/I	HPR4309
D22 Pickup	2.4L L4 F/I	HPR6850	Almera II	1.8L L4 F/I	HPR4309
D22 Pickup	2.5L L4 DSL - Exc. Turbo	HPR0352	Almera II	2.2L L4 DSL	HPR4309
Frontier	2.4L L4 F/I	HPR6850	Almera Tino	1.8L L4 F/I	HPR4309
Frontier	3.3L V6 F/I	HPR4309	Almera Tino	2.0L L4 F/I	HPR4309
Maxima	2.0L V6 F/I	HPR4309	Almera Tino	2.2L L4 DSL	HPR4309
Maxima	3.0L V6 F/I	HPR4309	Altima	2.5L L4 F/I	HPR4309
Maxima	3.5L V6 F/I	HPR4309	Altima	3.5L V6 F/I	HPR4309
Murano	3.5L V6 F/I	HPR4309	D22 Pickup	2.4L L4 F/I	HPR6850
Navara	3.0L L4 DSL	HPR4309	D22 Pickup	2.5L L4 DSL - Exc. Turbo	HPR0352
Pathfinder	2.7L L6 DSL	HPR4309	Frontier	2.4L L4 F/I	HPR6850
Pathfinder	3.3L V6 F/I	HPR4309	Frontier	3.3L V6 F/I	HPR4309
Pathfinder	3.5L V6 F/I	HPR4309	Maxima	2.0L V6 F/I	HPR4309
Pathfinder	5.6L V8 F/I	HPR7440	Maxima	3.0L V6 F/I	HPR4309
Pathfinder Armada	5.6L V8 F/I	HPR7440	Maxima	3.5L V6 F/I	HPR4309
Primera	1.6L L4 F/I	HPR4309	Pathfinder	2.7L L6 DSL	HPR4309
Primera	1.8L L4 F/I	HPR4309	Pathfinder	3.3L V6 F/I	HPR4309
Primera	2.0L L4 F/I	HPR4309	Pathfinder	3.5L V6 F/I	HPR4309
Primera	2.2L L4 DSL	HPR4309	Primera	1.8L L4 F/I	HPR4309
Quest	3.5L V6 F/I	HPR4309	Primera	2.0L L4 DSL	HPR4309
Sentra	1.8L L4 F/I	HPR4309	Primera	2.0L L4 F/I	HPR4309
Sentra	2.5L L4 F/I	HPR4309	Primera	2.2L L4 DSL	HPR4309
Terrano II	2.4L L4 F/I	HPR4309	Sentra	1.8L L4 F/I	HPR4309
Titan	5.6L V8 F/I	HPR7440 ♦	Sentra	2.5L L4 F/I	HPR4309
Xterra	2.4L L4 F/I	HPR6850	Terrano II	2.4L L4 F/I	HPR4309
Xterra	3.3L V6 F/I	HPR4309	Xterra	2.4L L4 F/I	HPR6850
X-Trail	2.0L L4 F/I	HPR4309	Xterra	3.3L V6 F/I	HPR4309
X-Trail	2.2L L4 DSL	HPR4309	X-Trail	2.0L L4 F/I	HPR4309
X-Trail	2.5L L4 F/I	HPR4309	X-Trail	2.2L L4 DSL	HPR4309
2003 NISSAN			2001 NISSAN		
350Z	3.5L V6 F/I	HPR4309	Almera II	1.5L L4 F/I	HPR4309
Almera II	1.5L L4 F/I	HPR4309	Almera II	1.8L L4 F/I	HPR4309
Almera II	1.8L L4 F/I	HPR4309	Almera II	2.2L L4 DSL	HPR4309
Almera II	2.2L L4 DSL	HPR4309	Almera Tino	1.8L L4 F/I	HPR4309
Almera Tino	1.8L L4 F/I	HPR4309	Almera Tino	2.0L L4 F/I	HPR4309
Almera Tino	2.0L L4 F/I	HPR4309	Almera Tino	2.2L L4 DSL	HPR4309
Almera Tino	2.2L L4 DSL	HPR4309	Altima	2.4L L4 F/I	HPR4309
Altima	2.5L L4 F/I	HPR4309	D22 Pickup	2.4L L4 F/I	HPR6850
Altima	3.5L V6 F/I	HPR4309	D22 Pickup	2.5L L4 DSL - Exc. Turbo	HPR0352
D22 Pickup	2.4L L4 F/I	HPR6850	Frontier	2.4L L4 F/I	HPR6850
D22 Pickup	2.5L L4 DSL - Exc. Turbo	HPR0352	Frontier	3.3L V6 F/I	HPR4309
Frontier	2.4L L4 F/I	HPR6850	Maxima	2.0L V6 F/I	HPR4309
Frontier	3.3L V6 F/I	HPR4309	Maxima	3.0L V6 F/I	HPR4309
Maxima	2.0L V6 F/I	HPR4309	Pathfinder	2.7L L6 DSL	HPR4309
Maxima	3.0L V6 F/I	HPR4309	Pathfinder	3.3L V6 F/I	HPR4309
Maxima	3.5L V6 F/I	HPR4309	Pathfinder	3.5L V6 F/I	HPR4309
Murano	3.5L V6 F/I	HPR4309	Primera	1.8L L4 F/I	HPR4309
Pathfinder	2.7L L6 DSL	HPR4309	Primera	2.0L L4 DSL	HPR4309
Pathfinder	3.3L V6 F/I	HPR4309	Primera	2.0L L4 F/I	HPR4309

*Indicates 2 filters required ♦ Intake system available - see page 326 + throttle body spacer available - see page 20

Vehicle	Engine Type	Air Filter	Vehicle	Engine Type	Air Filter
2001 NISSAN			1999 NISSAN		
Sentra	1.8L L4 F/I	HPR4309	Serena	2.0L L4 F/I	HPR4309
Sentra	2.0L L4 F/I	HPR4309	Serena	2.3L L4 DSL	HPR4309
Serena	1.6L L4 F/I	HPR4309	Terrano II	2.4L L4 F/I	HPR4309
Serena	2.0L L4 DSL	HPR4309	1998 NISSAN		
Serena	2.0L L4 F/I	HPR4309	200SX	1.6L L4 F/I	HPR4309
Serena	2.3L L4 DSL	HPR4309	200SX	2.0L L4 F/I	HPR4309
Terrano II	2.4L L4 F/I	HPR4309	240SX	2.4L L4 F/I	HPR4309
Xterra	2.4L L4 F/I	HPR6850	Almera I	2.0L L4 DSL	HPR4309
Xterra	3.3L V6 F/I	HPR4309	Almera I	2.0L L4 F/I	HPR4309
X-Trail	2.0L L4 F/I	HPR4309	Altima	2.4L L4 F/I	HPR4309
X-Trail	2.2L L4 DSL	HPR4309	D21 Pickup	2.4L L4 F/I	HPR6850
2000 NISSAN			D21 Pickup	2.5L L4 DSL	HPR0352
Almera I	2.0L L4 DSL	HPR4309	D22 Pickup	2.4L L4 F/I	HPR6850
Almera I	2.0L L4 F/I	HPR4309	D22 Pickup	2.5L L4 DSL - Exc. Turbo	HPR0352
Almera II	1.5L L4 F/I	HPR4309	Frontier	2.4L L4 F/I	HPR6850
Almera II	1.8L L4 F/I	HPR4309	Maxima	2.0L V6 F/I	HPR4309
Almera II	2.2L L4 DSL	HPR4309	Maxima	3.0L V6 F/I	HPR4309
Almera Tino	1.8L L4 F/I	HPR4309	Pathfinder	2.7L L6 DSL	HPR4309
Almera Tino	2.0L L4 F/I	HPR4309	Pathfinder	3.3L V6 F/I	HPR4309
Almera Tino	2.2L L4 DSL	HPR4309	Pickup	2.4L L4 F/I	HPR6850
Altima	2.4L L4 F/I	HPR4309	Primera	2.0L L4 DSL	HPR4309
D22 Pickup	2.4L L4 F/I	HPR6850	Primera	2.0L L4 F/I	HPR4309
D22 Pickup	2.5L L4 DSL - Exc. Turbo	HPR0352	Sentra	1.6L L4 F/I	HPR4309
Frontier	2.4L L4 F/I	HPR6850	Sentra	2.0L L4 F/I	HPR4309
Frontier	3.3L V6 F/I	HPR4309	Serena	1.6L L4 F/I	HPR4309
Maxima	2.0L V6 F/I	HPR4309	Serena	2.0L L4 DSL	HPR4309
Maxima	3.0L V6 F/I	HPR4309	Serena	2.0L L4 F/I	HPR4309
Pathfinder	2.7L L6 DSL	HPR4309	Serena	2.3L L4 DSL	HPR4309
Pathfinder	3.3L V6 F/I	HPR4309	Terrano II	2.4L L4 F/I	HPR4309
Pathfinder	3.5L V6 F/I	HPR4309	1997 NISSAN		
Primera	1.8L L4 F/I	HPR4309	200SX	1.6L L4 F/I	HPR4309
Primera	2.0L L4 DSL	HPR4309	200SX	2.0L L4 F/I	HPR4309
Primera	2.0L L4 F/I	HPR4309	240SX	2.4L L4 F/I	HPR4309
Sentra	1.8L L4 F/I	HPR4309	Almera I	2.0L L4 DSL	HPR4309
Sentra	2.0L L4 F/I	HPR4309	Almera I	2.0L L4 F/I	HPR4309
Serena	1.6L L4 F/I	HPR4309	Altima	2.4L L4 F/I	HPR4309
Serena	2.0L L4 DSL	HPR4309	D21 Pickup	2.4L L4 F/I	HPR6850
Serena	2.0L L4 F/I	HPR4309	D21 Pickup	2.5L L4 DSL	HPR0352
Serena	2.3L L4 DSL	HPR4309	Maxima	2.0L V6 F/I	HPR4309
Terrano II	2.4L L4 F/I	HPR4309	Maxima	3.0L V6 F/I	HPR4309
Xterra	2.4L L4 F/I	HPR6850	Pathfinder	2.7L L6 DSL	HPR4309
Xterra	3.3L V6 F/I	HPR4309	Pathfinder	3.3L V6 F/I	HPR4309
1999 NISSAN			Patrol	4.2L L6 F/I	HPR4309
200SX	2.0L L4 F/I	HPR4309	Pickup	2.4L L4 F/I	HPR6850
Almera I	2.0L L4 DSL	HPR4309	Primera	2.0L L4 DSL	HPR4309
Almera I	2.0L L4 F/I	HPR4309	Primera	2.0L L4 F/I	HPR4309
Altima	2.4L L4 F/I	HPR4309	Sentra	1.6L L4 F/I	HPR4309
D22 Pickup	2.4L L4 F/I	HPR6850	Serena	1.6L L4 F/I	HPR4309
D22 Pickup	2.5L L4 DSL - Exc. Turbo	HPR0352	Serena	2.0L L4 DSL	HPR4309
Frontier	2.4L L4 F/I	HPR6850	Serena	2.0L L4 F/I	HPR4309
Frontier	3.3L V6 F/I	HPR4309	Serena	2.3L L4 DSL	HPR4309
Maxima	2.0L V6 F/I	HPR4309	Skyline	2.6L - GTR, 24v, Twin Turbo	HPR4309
Maxima	3.0L V6 F/I	HPR4309	Terrano II	2.4L L4 F/I	HPR4309
Pathfinder	2.7L L6 DSL	HPR4309	1996 NISSAN		
Pathfinder	3.3L V6 F/I	HPR4309	200SX	1.6L L4 F/I	HPR4309
Pickup	2.4L L4 F/I	HPR6850	200SX	2.0L L4 F/I	HPR4309
Primera	1.8L L4 F/I	HPR4309	240SX	2.4L L4 F/I	HPR4309
Primera	2.0L L4 DSL	HPR4309	Almera I	2.0L L4 DSL	HPR4309
Primera	2.0L L4 F/I	HPR4309	Almera I	2.0L L4 F/I	HPR4309
Sentra	1.6L L4 F/I	HPR4309	Altima	2.4L L4 F/I	HPR4309
Sentra	2.0L L4 F/I	HPR4309	D21 Pickup	2.4L L4 F/I - 124BHP	HPR6850
Serena	1.6L L4 F/I	HPR4309	D21 Pickup	2.5L L4 DSL	HPR0352
Serena	2.0L L4 DSL	HPR4309	Maxima	2.0L V6 F/I	HPR4309

*Indicates 2 filters required ♦ Intake system available - see page 326 + throttle body spacer available - see page 20

HPR™ REPLACEMENT AIR FILTERS

NISSAN

Vehicle	Engine Type	Air Filter	Vehicle	Engine Type	Air Filter
1996 NISSAN			1994 NISSAN		
Maxima	3.0L V6 F/I	HPR4309	Sunny III	2.0L L4 F/I	HPR4309
Pathfinder	3.3L V6 F/I	HPR4309	Terrano I	3.0L L4 F/I	HPR4309
Patrol	4.2L L6 F/I	HPR4309	Terrano II	2.4L L4 F/I	HPR4309
Pickup	2.4L L4 F/I	HPR6850	1993 NISSAN		
Pickup	3.0L V6 F/I	HPR4309	200SX	1.8L L4 F/I	HPR4309
Primera	2.0L L4 DSL	HPR4309	200SX	2.0L L4 F/I	HPR4309
Primera	2.0L L4 F/I	HPR4309	240SX	2.4L L4 F/I	HPR4309
Sentra	1.6L L4 F/I	HPR4309	Altima	2.4L L4 F/I	HPR4309
Serena	1.6L L4 F/I	HPR4309	Axxess	2.4L L4 F/I	HPR4309
Serena	2.0L L4 DSL	HPR4309	D21 Pickup	2.4L L4 F/I - Non-US, 124BHP	HPR6850
Serena	2.0L L4 F/I	HPR4309	D21 Pickup	2.4L L4 F/I - US	HPR6850
Serena	2.3L L4 DSL	HPR4309	D21 Pickup	2.5L L4 DSL	HPR0352
Terrano II	2.4L L4 F/I	HPR4309	D21 Pickup	3.0L V6 F/I	HPR4309
1995 NISSAN			Maxima	3.0L V6 F/I	HPR4309
200SX	1.6L L4 F/I	HPR4309	NX	1.6L L4 F/I	HPR4309
200SX	2.0L L4 F/I	HPR4309	NX	2.0L L4 F/I	HPR4309
240SX	2.4L L4 F/I	HPR4309	Pathfinder	3.0L V6 F/I	HPR4309
Almera I	2.0L L4 DSL	HPR4309	Patrol	4.2L L6 F/I	HPR4309
Altima	2.4L L4 F/I	HPR4309	Prairie	2.4L L4 F/I	HPR4309
Axxess	2.4L L4 F/I	HPR4309	Primera	2.0L L4 DSL	HPR4309
D21 Pickup	2.4L L4 F/I - 124BHP	HPR6850	Primera	2.0L L4 F/I	HPR4309
D21 Pickup	2.5L L4 DSL	HPR0352	Sentra	1.6L L4 F/I	HPR4309
Maxima	2.0L V6 F/I	HPR4309	Sentra	2.0L L4 F/I	HPR4309
Maxima	3.0L V6 F/I	HPR4309	Serena	1.6L L4 F/I	HPR4309
Pathfinder	3.0L V6 F/I	HPR4309	Serena	2.0L L4 DSL	HPR4309
Patrol	4.2L L6 F/I	HPR4309	Serena	2.0L L4 F/I	HPR4309
Pickup	2.4L L4 F/I	HPR6850	Silvia	2.0L L4 F/I	HPR4309
Pickup	3.0L V6 F/I	HPR4309	Skyline	2.0L L6 F/I	HPR4309
Primera	2.0L L4 DSL	HPR4309	Skyline	2.5L V6 - 24v, Turbo	HPR4309
Primera	2.0L L4 F/I	HPR4309	Sunny III	2.0L L4 DSL	HPR4309
QX	2.0L L4 F/I	HPR4309	Sunny III	2.0L L4 F/I	HPR4309
QX	3.0L V6 F/I	HPR4309	Terrano I	3.0L L4 F/I	HPR4309
Sentra	1.6L L4 F/I	HPR4309	Terrano II	2.4L L4 F/I	HPR4309
Serena	1.6L L4 F/I	HPR4309	1992 NISSAN		
Serena	2.0L L4 DSL	HPR4309	200SX	1.8L L4 F/I	HPR4309
Serena	2.0L L4 F/I	HPR4309	240SX	2.4L L4 F/I	HPR4309
Serena	2.3L L4 DSL	HPR4309	Axxess	2.4L L4 F/I	HPR4309
Sunny III	2.0L L4 DSL	HPR4309	D21 Pickup	2.4L L4 F/I - Non-US, 124BHP	HPR6850
Sunny III	2.0L L4 F/I	HPR4309	D21 Pickup	2.4L L4 F/I - US	HPR6850
Terrano I	3.0L L4 F/I	HPR4309	D21 Pickup	2.5L L4 DSL	HPR0352
Terrano II	2.4L L4 F/I	HPR4309	D21 Pickup	3.0L V6 F/I	HPR4309
1994 NISSAN			Maxima	3.0L V6 F/I	HPR4309
200SX	1.8L L4 F/I	HPR4309	NX	1.6L L4 F/I	HPR4309
200SX	2.0L L4 F/I	HPR4309	NX	2.0L L4 F/I	HPR4309
240SX	2.4L L4 F/I	HPR4309	Pathfinder	3.0L V6 F/I	HPR4309
Altima	2.4L L4 F/I	HPR4309	Patrol	4.2L L6 F/I	HPR4309
Axxess	2.4L L4 F/I	HPR4309	Prairie	2.0L L4 F/I	HPR4309
D21 Pickup	2.4L L4 F/I - Non-US, 124BHP	HPR6850	Prairie	2.4L L4 F/I	HPR4309
D21 Pickup	2.4L L4 F/I - US	HPR6850	Primera	2.0L L4 DSL	HPR4309
D21 Pickup	2.5L L4 DSL	HPR0352	Primera	2.0L L4 F/I	HPR4309
D21 Pickup	3.0L V6 F/I	HPR4309	Sentra	1.6L L4 F/I	HPR4309
Maxima	3.0L V6 F/I	HPR4309	Sentra	2.0L L4 F/I	HPR4309
Pathfinder	3.0L V6 F/I	HPR4309	Serena	2.0L L4 DSL	HPR4309
Patrol	4.2L L6 F/I	HPR4309	Serena	2.0L L4 F/I	HPR4309
Prairie	2.4L L4 F/I	HPR4309	Stanza	2.4L L4 F/I	HPR4309
Primera	2.0L L4 DSL	HPR4309	Sunny III	2.0L L4 DSL	HPR4309
Primera	2.0L L4 F/I	HPR4309	Sunny III	2.0L L4 F/I	HPR4309
Sentra	1.6L L4 F/I	HPR4309	Terrano I	3.0L L4 F/I	HPR4309
Sentra	2.0L L4 F/I	HPR4309	1991 NISSAN		
Serena	1.6L L4 F/I	HPR4309	200SX	1.8L L4 F/I	HPR4309
Serena	2.0L L4 DSL	HPR4309	240SX	2.4L L4 F/I	HPR4309
Serena	2.0L L4 F/I	HPR4309	Axxess	2.4L L4 F/I	HPR4309
Sunny III	2.0L L4 DSL	HPR4309	D21 Pickup	2.4L L4 F/I - US	HPR6850

*Indicates 2 filters required ♦ Intake system available - see page 326 + throttle body spacer available - see page 20

Vehicle	Engine Type	Air Filter	Vehicle	Engine Type	Air Filter
1991 NISSAN			1988 NISSAN		
D21 Pickup	2.5L L4 DSL	HPR0352	Laurel	2.8L L6 DSL	HPR4309
D21 Pickup	3.0L V6 F/I	HPR4309	Laurel	3.0L F/I	HPR4309
Maxima	3.0L V6 F/I	HPR4309	Maxima	3.0L V6 F/I - 170BHP	HPR4309
NX	1.6L L4 F/I	HPR4309	Pathfinder	2.4L L4 F/I	HPR3588
NX	2.0L L4 F/I	HPR4309	Patrol	2.8L V6 F/I	HPR0352
Pathfinder	3.0L V6 F/I	HPR4309	Patrol	4.2L L6 F/I	HPR4309
Patrol	4.2L L6 F/I	HPR4309	Pulsar NX	1.6L L4 F/I	HPR4309
Prairie	2.0L L4 F/I	HPR4309	Pulsar NX	1.8L L4 F/I	HPR4309
Primera	2.0L L4 DSL	HPR4309	Silvia	2.0L L4 F/I	HPR4309
Primera	2.0L L4 F/I	HPR4309	Sunny II	1.6L L4 F/I - 110BHP	HPR4309
Sentra	1.6L L4 F/I	HPR4309	Sunny II	1.7L L4 DSL	HPR4309
Sentra	2.0L L4 F/I	HPR4309	1987 NISSAN		
Stanza	2.4L L4 F/I	HPR4309	300ZX	3.0L V6 F/I - Exc. Turbo	HPR4309
Sunny II	1.7L L4 DSL	HPR4309	Bluebird	2.0L L4 DSL	HPR4309
Sunny II	1.8L L4 F/I	HPR4309	D21 Pickup	2.4L L4 F/I	HPR3588
Sunny III	2.0L L4 DSL	HPR4309	D21 Pickup	2.5L L4 DSL	HPR0352
Sunny III	2.0L L4 F/I	HPR4309	Laurel	2.4L L6 F/I	HPR4309
Terrano I	3.0L L4 F/I	HPR4309	Laurel	2.8L L6 DSL	HPR4309
1990 NISSAN			Laurel	3.0L F/I	HPR4309
200SX	1.8L L4 F/I	HPR4309	Pathfinder	2.4L L4 F/I	HPR3588
240SX	2.4L L4 F/I	HPR4309	Patrol	2.8L V6 F/I	HPR0352
300ZX	3.0L V6 F/I - Non-US, VG30 Eng.	HPR4309	Pulsar NX	1.6L L4 F/I - w/Panel Filter	HPR4309
Axxess	2.4L L4 F/I	HPR4309	Silvia	2.0L L4 F/I	HPR4309
Bluebird	2.0L L4 DSL	HPR4309	Sunny II	1.6L L4 F/I - 110BHP	HPR4309
D21 Pickup	2.4L L4 F/I - US	HPR6850	Sunny II	1.7L L4 DSL	HPR4309
D21 Pickup	2.5L L4 DSL	HPR0352	1986 NISSAN		
D21 Pickup	3.0L V6 F/I - w/Panel Filter	HPR4309	720	2.0L L4 CARB	HPR0352
Maxima	3.0L V6 F/I	HPR4309	720	2.2L L4 CARB	HPR0352
Pathfinder	3.0L V6 F/I - w/Panel Filter	HPR4309	720	2.4L L4 F/I	HPR3588
Patrol	2.8L V6 F/I	HPR0352	720	2.5L L4 DSL	HPR0352
Patrol	4.2L L6 F/I	HPR4309	Bluebird	2.0L L4 DSL	HPR4309
Prairie	2.0L L4 F/I	HPR4309	Cherry	1.5L - GTi	HPR7017
Primera	2.0L L4 F/I	HPR4309	D21 Pickup	2.4L L4 F/I	HPR3588
Stanza	2.4L L4 F/I	HPR4309	Laurel	2.4L L6 F/I	HPR4309
Sunny II	1.7L L4 DSL	HPR4309	Laurel	2.8L L6 DSL	HPR4309
Sunny II	1.8L L4 F/I	HPR4309	Laurel	3.0L F/I	HPR4309
Sunny III	2.0L L4 DSL	HPR4309	Patrol	2.8L V6 F/I	HPR0352
Sunny III	2.0L L4 F/I	HPR4309	Silvia	2.0L L4 F/I	HPR4309
Terrano I	3.0L L4 F/I	HPR4309	Sunny II	1.7L L4 DSL	HPR4309
1989 NISSAN			1985 NISSAN		
200SX	1.8L L4 F/I	HPR4309	720	2.0L L4 CARB	HPR0352
240SX	2.4L L4 F/I	HPR4309	720	2.2L L4 CARB	HPR0352
300ZX	3.0L V6 F/I	HPR4309	720	2.4L L4 CARB	HPR0352
Bluebird	2.0L L4 DSL	HPR4309	720	2.5L L4 DSL	HPR0352
D21 Pickup	2.4L L4 F/I	HPR3588	Bluebird	2.0L L4 DSL - Exc., Turbo, 58BHP	HPR4309
D21 Pickup	2.5L L4 DSL	HPR0352	Cherry	1.2L	HPR3647
Laurel	2.8L L6 DSL	HPR4309	Cherry	1.5L - GTi	HPR7017
Laurel	3.0L V6 F/I	HPR4309	Laurel	2.4L L6 F/I	HPR4309
Maxima	3.0L V6 F/I	HPR4309	Laurel	2.8L L6 DSL	HPR4309
Patrol	2.8L V6 F/I	HPR0352	Patrol	2.8L V6 F/I	HPR0352
Patrol	4.2L L6 F/I	HPR4309	Silvia	2.0L L4 F/I	HPR4309
Prairie	2.0L L4 F/I	HPR4309	1984 NISSAN		
Pulsar NX	1.8L L4 F/I	HPR4309	720	2.0L L4 CARB	HPR0352
Sunny II	1.6L L4 F/I - 110BHP	HPR4309	720	2.2L L4 CARB	HPR0352
Sunny II	1.7L L4 DSL	HPR4309	720	2.4L L4 CARB	HPR0352
Sunny II	1.8L L4 F/I	HPR4309	720	2.5L L4 DSL	HPR0352
1988 NISSAN			Bluebird	1.9L L4 F/I	HPR4309
200SX	1.8L L4 F/I	HPR4309	Bluebird	2.0L L4 DSL - Exc., Turbo, 58BHP	HPR4309
240SX	2.4L L4 F/I	HPR4309	Cherry	1.2L	HPR3647
300ZX	3.0L V6 F/I	HPR4309	Cherry	1.5L - GTi	HPR7017
Bluebird	2.0L L4 DSL	HPR4309	Laurel	2.0L L4 F/I	HPR0352
D21 Pickup	2.4L L4 F/I	HPR3588	Laurel	2.4L L6 F/I	HPR0352
D21 Pickup	2.5L L4 DSL	HPR0352			

*Indicates 2 filters required ♦ Intake system available - see page 326 + throttle body spacer available - see page 20

HPR™ REPLACEMENT AIR FILTERS

NISSAN

Vehicle	Engine Type	Air Filter
1984 NISSAN		
Laurel	2.8L L6 DSL	HPR4309
Maxima	2.4L L6 F/I	HPR4309
Patrol	2.8L V6 F/I	HPR0352
Silvia	2.0L L4 F/I	HPR4309
1983 NISSAN		
720	2.0L L4 CARB	HPR0352
720	2.2L L4 CARB - w/Round Filter	HPR0352
720	2.2L L4 DSL	HPR0352
720	2.4L L4 CARB	HPR0352
720	2.5L L4 DSL	HPR0352
Bluebird	1.9L L4 F/I	HPR4309
Bluebird	2.0L L4 F/I	HPR4309
Cedric	2.8L DSL	HPR4309
Cherry	1.2L	HPR3647
Cherry	1.5L L4 2 BBL. - GTi	HPR7017
Laurel	2.0L L4 F/I	HPR0352
Laurel	2.4L L6 F/I	HPR0352
Laurel	2.8L L6 DSL	HPR4309
Maxima	2.4L L6 F/I	HPR4309
Maxima	2.8L L6 DSL	HPR4309
Patrol	2.8L V6 F/I	HPR0352
1982 NISSAN		
510	1.9L L4 2 BBL.	HPR0352
510	2.0L L4 2 BBL.	HPR0352
720	2.2L L4 CARB	HPR0352
Bluebird	1.9L L4 F/I	HPR4309
Bluebird	2.0L L4 F/I	HPR4309
Laurel	2.0L L4 F/I	HPR0352
Laurel	2.4L L6 F/I	HPR0352
Laurel	2.8L L6 DSL	HPR4309
Maxima	2.4L L6 F/I	HPR4309
Maxima	2.8L L6 DSL	HPR4309
Patrol	2.8L V6 F/I	HPR0352
1981 NISSAN		
510	2.0L L4 CARB	HPR0352
720	2.2L L4 CARB	HPR0352
810	2.4L L6 F/I	HPR4309
810	2.8L L6 DSL	HPR4309
Laurel	2.0L L4 F/I	HPR0352
Laurel	2.4L L6 F/I	HPR0352
Laurel	2.8L L6 DSL	HPR4309
Maxima	2.4L L6 F/I	HPR4309
Maxima	2.8L L6 DSL	HPR4309
Patrol	2.8L V6 F/I	HPR0352
1980 NISSAN		
280C	2.8L - L28 Eng.	HPR0352
510	2.0L L4 CARB	HPR0352
720	2.0L L4 CARB	HPR0352
Laurel	2.4L L6 F/I	HPR0352
Patrol	2.8L V6 F/I	HPR0352
1979 NISSAN		
280C	2.8L - L28 Eng.	HPR0352
620	2.0L L4 CARB	HPR0352
1978 NISSAN		
280C	2.8L - L28 Eng.	HPR0352
620	2.0L L4 CARB	HPR0352
1977 NISSAN		
620	2.0L L4 CARB	HPR0352
710	2.0L L4 CARB	HPR0352
PL-710	1.8L L4 CARB	HPR0352

Vehicle	Engine Type	Air Filter
1977 NISSAN		
PL-710	2.0L L4 CARB	HPR0352
1976 NISSAN		
610	119 L4 CARB	HPR0352
620	2.0L L4 CARB	HPR0352
1975 NISSAN		
240C	2.4L - L24 Eng.	HPR0352
610	119 L4 CARB	HPR0352
620	2.0L L4 CARB	HPR0352
1974 NISSAN		
240C	2.4L - L24 Eng.	HPR0352
610	119 L4 CARB	HPR0352
620 Pickup	108 L4 CARB	HPR0352
PL-610	1.8L L4 CARB	HPR0352
PL-610	2.0L L4 CARB	HPR0352
1973 NISSAN		
240C	2.4L - L24 Eng.	HPR0352
510	97 L4 CARB	HPR0352
610	108 L4 CARB	HPR0352
620 Pickup	97 L4 CARB	HPR0352
1800	L4	HPR0352
PL-510	1.6L L4 CARB	HPR0352
PL-610	1.8L L4 CARB	HPR0352
PL-610	2.0L L4 CARB	HPR0352
1972 NISSAN		
240C	2.4L - L24 Eng.	HPR0352
510	97 L4 CARB	HPR0352
521 Pickup	97 L4 CARB	HPR0352
620 Pickup	97 L4 CARB	HPR0352
PL-510	1.6L L4 CARB	HPR0352
PL-610	1.8L L4 CARB	HPR0352
PL-610	2.0L L4 CARB	HPR0352
1971 NISSAN		
510	97 L4 CARB	HPR0352
521 Pickup	97 L4 CARB	HPR0352
PL-510	1.5L L4 CARB	HPR0352
1970 NISSAN		
521 Pickup	97 L4 CARB	HPR0352
1600	1.6L L4 CARB	HPR0352
PL-510	1.5L L4 CARB	HPR0352
1969 NISSAN		
1600	1.6L L4 CARB	HPR0352
2000	121 L4 CARB	HPR0352
PL-510	1.5L L4 CARB	HPR0352
1968 NISSAN		
1600	1.6L L4 CARB	HPR0352
2000	121 L4 CARB	HPR0352
PL-410	1.2L L4 CARB	HPR0352
PL-510	1.5L L4 CARB	HPR0352
1967 NISSAN		
411	79 L4 CARB	HPR0352
411	97 L4 CARB	HPR0352
1600	1.6L L4 CARB	HPR0352
2000	121 L4 CARB	HPR0352
PL-410	1.2L L4 CARB	HPR0352
1966 NISSAN		
411	79 L4 CARB	HPR0352
520 Pickup	79 L4 CARB	HPR0352

*Indicates 2 filters required ♦ Intake system available - see page 326 + throttle body spacer available - see page 20

Vehicle	Engine Type	Air Filter
1965 NISSAN		
320	73 L4 CARB	HPR0352
410	73 L4 CARB	HPR0352
410	79 L4 CARB	HPR0352
411	79 L4 CARB	HPR0352
520 Pickup	79 L4 CARB	HPR0352
SPL-310	1.6L L4 2 BBL.	HPR0352

Vehicle	Engine Type	Air Filter
1964 NISSAN		
320	73 L4 CARB	HPR0352
410	73 L4 CARB	HPR0352
410	79 L4 CARB	HPR0352
411	79 L4 CARB	HPR0352
PL-312	1.2L L4 CARB	HPR0352

Vehicle	Engine Type	Air Filter
1963 NISSAN		
320	73 L4 CARB	HPR0352
410	73 L4 CARB	HPR0352
410	79 L4 CARB	HPR0352
411	79 L4 CARB	HPR0352
PL-312	1.2L L4 CARB	HPR0352

Vehicle	Engine Type	Air Filter
1962 NISSAN		
320	73 L4 CARB	HPR0352
PL-312	1.2L L4 CARB	HPR0352

Vehicle	Engine Type	Air Filter
1961 NISSAN		
320	73 L4 CARB	HPR0352
PL-312	1.2L L4 CARB	HPR0352

Vehicle	Engine Type	Air Filter
2004 OLDSMOBILE		
Alero	2.2L L4 F/I	HPR8221
Alero	3.4L V6 F/I	HPR8221
Bravada	4.2L L6 F/I	HPR9345
Silhouette	3.4L V6 F/I	HPR7597

Vehicle	Engine Type	Air Filter
2003 OLDSMOBILE		
Alero	2.2L L4 F/I	HPR8221
Alero	3.4L V6 F/I	HPR8221
Aurora	4.0L V8 F/I	HPR7597
Bravada	4.2L L6 F/I	HPR9345
Silhouette	3.4L V6 F/I	HPR7597

Vehicle	Engine Type	Air Filter
2002 OLDSMOBILE		
Alero	2.2L L4 F/I	HPR8221
Alero	3.4L V6 F/I	HPR8221
Aurora	3.5L V6 F/I	HPR7597
Aurora	4.0L V8 F/I	HPR7597
Bravada	4.2L L6 F/I	HPR9345
Intrigue	3.5L V6 F/I	HPR6479
Silhouette	3.4L V6 F/I	HPR7597

Vehicle	Engine Type	Air Filter
2001 OLDSMOBILE		
Alero	2.4L L4 F/I	HPR8221
Alero	3.4L V6 F/I	HPR8221
Aurora	3.5L V6 F/I	HPR7597
Aurora	4.0L V8 F/I	HPR7597
Bravada	4.3L V6 F/I	HPR7421
Intrigue	3.5L V6 F/I	HPR6479
Silhouette	3.4L V6 F/I	HPR7597

Vehicle	Engine Type	Air Filter
2000 OLDSMOBILE		
Alero	2.4L L4 F/I	HPR8221
Alero	3.4L V6 F/I	HPR8221
Bravada	4.3L V6 F/I	HPR7421
Intrigue	3.5L V6 F/I	HPR6479
Silhouette	3.4L V6 F/I	HPR7597

Vehicle	Engine Type	Air Filter
1999 OLDSMOBILE		
88	3.8L V6 F/I	HPR6479

Vehicle	Engine Type	Air Filter
1999 OLDSMOBILE		
Alero	2.4L L4 F/I	HPR8221
Alero	3.4L V6 F/I	HPR8221
Aurora	4.0L V8 F/I	HPR6479
Bravada	4.3L V6 F/I	HPR7421
Cutlass	3.1L V6 F/I	HPR8221
Intrigue	3.5L V6 F/I	HPR6479
Intrigue	3.8L V6 F/I	HPR7597
LSS	3.8L V6 F/I	HPR6479
Silhouette	3.4L V6 F/I	HPR7597

Vehicle	Engine Type	Air Filter
1998 OLDSMOBILE		
88	3.8L V6 F/I	HPR6479
Achieva	2.4L L4 F/I	HPR7598
Achieva	3.1L V6 F/I	HPR7598
Aurora	4.0L V8 F/I	HPR6479
Bravada	4.3L V6 F/I	HPR7421
Cutlass	3.1L V6 F/I	HPR8221
Intrigue	3.8L V6 F/I	HPR7597
LSS	3.8L V6 F/I	HPR6479
Regency	3.8L V6 F/I	HPR6479
Silhouette	3.4L V6 F/I	HPR7597

Vehicle	Engine Type	Air Filter
1997 OLDSMOBILE		
88	3.8L V6 F/I	HPR6479
Achieva	2.4L L4 F/I	HPR7598
Achieva	3.1L V6 F/I	HPR7598
Aurora	4.0L V8 F/I	HPR6479
Bravada	4.3L V6 F/I	HPR7421
Cutlass	3.1L V6 F/I	HPR7597
Cutlass Supreme	3.1L V6 F/I	HPR7597
LSS	3.8L V6 F/I	HPR6479
Regency	3.8L V6 F/I	HPR6479
Silhouette	3.4L V6 F/I	HPR7597

Vehicle	Engine Type	Air Filter
1996 OLDSMOBILE		
88	3.8L V6 F/I	HPR6479
98	3.8L V6 F/I	HPR6479
Achieva	2.4L L4 F/I	HPR7598
Achieva	3.1L V6 F/I	HPR7598
Aurora	4.0L V8 F/I	HPR6479
Bravada	4.3L V6 F/I	HPR7421
Cutlass Ciera	3.1L V6 F/I	HPR3902
Cutlass Supreme	3.1L V6 F/I	HPR7597
Cutlass Supreme	3.4L V6 F/I	HPR7597
LSS	3.8L V6 F/I	HPR6479
Silhouette	3.4L V6 F/I	HPR3916

Vehicle	Engine Type	Air Filter
1995 OLDSMOBILE		
88	3.8L V6 F/I	HPR6479
98	3.8L V6 F/I	HPR6479
Achieva	2.3L L4 F/I	HPR7598
Achieva	3.1L V6 F/I	HPR7598
Aurora	4.0L V8 F/I	HPR6479
Cutlass Ciera	3.1L V6 F/I	HPR3902
Cutlass Supreme	3.1L V6 F/I	HPR7597
Cutlass Supreme	3.4L V6 F/I	HPR7597
Silhouette	3.8L V6 F/I	HPR3916

Vehicle	Engine Type	Air Filter
1994 OLDSMOBILE		
98	3.8L V6 F/I	HPR6479
Achieva	2.3L L4 F/I	HPR7598
Achieva	3.1L V6 F/I	HPR7598
Bravada	4.3L V6 F/I	HPR7421
Cutlass Ciera	3.1L V6 F/I	HPR3902
Cutlass Supreme	3.1L V6 F/I	HPR7597
Cutlass Supreme	3.4L V6 F/I	HPR7597
Silhouette	3.1L V6 F/I	HPR3588

*Indicates 2 filters required ♦ Intake system available - see page 326 + throttle body spacer available - see page 20

HPR™ REPLACEMENT AIR FILTERS OLDSMOBILE

Vehicle	Engine Type	Air Filter	Vehicle	Engine Type	Air Filter
1994 OLDSMOBILE			1989 OLDSMOBILE		
Silhouette	3.8L V6 F/I	HPR3916	Cutlass Calais	2.5L L4 F/I	HPR3647
1993 OLDSMOBILE			Cutlass Calais	3.3L V6 F/I	HPR3916
98	3.8L V6 F/I	HPR6479	Cutlass Ciera	2.5L L4 F/I	HPR3647
Achieva	2.3L L4 F/I	HPR3916	Cutlass Ciera	3.3L V6 F/I	HPR3916
Achieva	3.3L V6 F/I	HPR3916	Cutlass Supreme	2.8L V6 F/I	HPR6626
Bravada	4.3L V6 F/I	HPR7421	Cutlass Supreme	3.1L V6 F/I	HPR6626
Cutlass Ciera	3.3L V6 F/I	HPR3916	Delta 88	3.8L V6 F/I	HPR3916
Cutlass Supreme	3.1L V6 F/I - VIN M	HPR3902	Toronado	3.8L V6 F/I	HPR3916
Cutlass Supreme	3.1L V6 F/I - VIN T	HPR6626	1988 OLDSMOBILE		
Cutlass Supreme	3.4L V6 F/I	HPR6626	98	3.8L V6 F/I	HPR3916
Silhouette	3.1L V6 F/I	HPR3588	Custom Cruiser	5.0L V8 CARB	HPR0326
Silhouette	3.8L V6 F/I	HPR3916	Cutlass Calais	2.5L L4 F/I	HPR3647
1992 OLDSMOBILE			Cutlass Ciera	2.5L L4 F/I	HPR3647
98	3.8L V6 F/I	HPR6479	Cutlass Supreme	5.0L V8 CARB	HPR0326
Achieva	2.3L L4 F/I	HPR3916	Delta 88	3.8L V6 F/I	HPR3916
Achieva	3.3L V6 F/I	HPR3916	Firenza	2.0L L4 F/I	HPR3647
Bravada	4.3L V6 CPI	HPR7421	Toronado	3.8L V6 F/I	HPR3916
Bravada	4.3L V6 TBI	HPR3588	1987 OLDSMOBILE		
Custom Cruiser	5.0L V8 F/I	HPR7017	98	3.8L V6 F/I	HPR3916
Custom Cruiser	5.7L V8 F/I	HPR7017	Calais	2.5L L4 F/I	HPR3647
Cutlass	3.1L V6 F/I	HPR6626	Custom Cruiser	5.0L V8 CARB	HPR0326
Cutlass Ciera	2.5L L4 F/I	HPR3647	Cutlass	5.0L V8 CARB	HPR0326
Cutlass Ciera	3.3L V6 F/I	HPR3916	Cutlass Ciera	2.5L L4 F/I	HPR3647
Cutlass Supreme	3.1L V6 F/I	HPR6626	Cutlass Salon	5.0L V8 CARB	HPR0326
Cutlass Supreme	3.4L V6 F/I	HPR6626	Cutlass Supreme	3.8L V6 CARB	HPR0192
Silhouette	3.1L V6 F/I	HPR3588	Cutlass Supreme	5.0L V8 CARB	HPR0326
Silhouette	3.8L V6 F/I	HPR3916	Delta 88	3.8L V6 F/I	HPR3916
Toronado	3.8L V6 F/I	HPR3916	Firenza	2.0L L4 F/I	HPR3647
1991 OLDSMOBILE			Toronado	3.8L V6 F/I	HPR3916
98	3.8L V6 F/I	HPR6479	1986 OLDSMOBILE		
Bravada	4.3L V6 F/I	HPR3588	98	3.8L V6 F/I	HPR3916
Custom Cruiser	5.0L V8 F/I	HPR7017	Calais	2.5L L4 F/I	HPR3647
Cutlass	3.1L V6 F/I	HPR6626	Custom Cruiser	5.0L V8 CARB	HPR0326
Cutlass Calais	2.3L L4 F/I	HPR3916	Cutlass	5.0L V8 CARB	HPR0326
Cutlass Calais	2.5L L4 F/I	HPR3647	Cutlass Ciera	2.5L L4 F/I	HPR3647
Cutlass Calais	3.3L V6 F/I	HPR3916	Cutlass Salon	5.0L V8 CARB	HPR0326
Cutlass Ciera	2.5L L4 F/I	HPR3647	Cutlass Supreme	3.8L V6 CARB	HPR0192
Cutlass Ciera	3.3L V6 F/I	HPR3916	Cutlass Supreme	5.0L V8 CARB	HPR0326
Cutlass Supreme	2.3L L4 F/I	HPR3916	Delta 88	3.0L V6 F/I	HPR3916
Cutlass Supreme	3.1L V6 F/I	HPR6626	Delta 88	3.8L V6 F/I	HPR3916
Cutlass Supreme	3.4L V6 F/I	HPR6626	Firenza	1.8L L4 F/I	HPR3647
Delta 88	3.8L V6 F/I	HPR3916	Firenza	2.0L L4 F/I	HPR3647
Silhouette	3.1L V6 F/I	HPR3588	Toronado	3.8L V6 F/I	HPR3916
Toronado	3.8L V6 F/I	HPR3916	1985 OLDSMOBILE		
1990 OLDSMOBILE			Calais	2.5L L4 F/I	HPR3647
98	3.8L V6 F/I	HPR3916	Custom Cruiser	5.0L V8 CARB	HPR0326
Custom Cruiser	5.0L V8 CARB	HPR0326	Cutlass	5.0L V8 CARB	HPR0326
Cutlass Calais	2.3L L4 F/I	HPR3916	Cutlass Ciera	2.5L L4 F/I	HPR3647
Cutlass Calais	2.5L L4 F/I	HPR3647	Cutlass Ciera	3.0L V6 CARB	HPR0192
Cutlass Calais	3.3L V6 F/I	HPR3916	Cutlass Salon	5.0L V8 CARB	HPR0326
Cutlass Ciera	2.5L L4 F/I	HPR3647	Cutlass Supreme	3.8L V6 CARB	HPR0192
Cutlass Ciera	3.3L V6 F/I	HPR3916	Cutlass Supreme	5.0L V8 CARB	HPR0326
Cutlass Supreme	2.3L L4 F/I	HPR3916	Delta 88	3.8L V6 CARB	HPR0192
Cutlass Supreme	3.1L V6 F/I	HPR6626	Delta 88	5.0L V8 CARB	HPR0326
Delta 88	3.8L V6 F/I	HPR3916	Firenza	1.8L L4 F/I	HPR3647
Silhouette	3.1L V6 F/I	HPR3588	Firenza	2.0L L4 F/I	HPR3647
Toronado	3.8L V6 F/I	HPR3916	Toronado	5.0L V8 CARB	HPR0192
1989 OLDSMOBILE				5.7L V8 DSL	48026
98	3.8L V6 F/I	HPR3916			880136
Custom Cruiser	5.0L V8 CARB	HPR0326			HPR0136
Cutlass Calais	2.3L L4 F/I	HPR3916	1984 OLDSMOBILE		
Cutlass Calais	2.3L L4 F/I - w/High Output	HPR3916	98	5.0L V8 CARB	HPR0326

*Indicates 2 filters required ♦ Intake system available - see page 326 + throttle body spacer available - see page 20

OLDSMOBILE HPR™ REPLACEMENT AIR FILTERS

Vehicle	Engine Type	Air Filter	Vehicle	Engine Type	Air Filter
1984 OLDSMOBILE			1982 OLDSMOBILE		
Custom Cruiser	5.0L V8 CARB	HPR0326	Delta 88	4.4L V8 CARB	HPR3588
Cutlass Calais	3.8L V6 CARB	HPR0192	Delta 88	5.0L V8 CARB	HPR0326
Cutlass Calais	5.0L V8 CARB	HPR0326	Firenza	1.8L L4 CARB	HPR3647
Cutlass Ciera	2.5L L4 F/I	HPR3647	Firenza	1.8L L4 F/I	HPR3647
Cutlass Ciera	3.0L V6 CARB	HPR0192	Omega	2.5L L4 F/I	HPR3647
Cutlass Supreme	3.8L V6 CARB	HPR0192	Toronado	4.1L V6 CARB	HPR0192
Cutlass Supreme	5.0L V8 CARB	HPR0326	Toronado	5.0L V8 CARB	HPR0192
Delta 88	3.8L V6 CARB	HPR0192		5.7L V8 DSL	48026
Delta 88	5.0L V8 CARB	HPR0326			880136
Firenza	1.8L L4 F/I	HPR3647			HPR0136
Firenza	2.0L L4 F/I	HPR3647	1981 OLDSMOBILE		
Omega	2.5L L4 F/I	HPR3647	98	4.1L V6 CARB	HPR0192
Toronado	4.1L V6 CARB	HPR0192	98	5.0L V8 CARB	HPR0326
Toronado	5.0L V8 CARB	HPR0192	Custom Cruiser	5.0L V8 CARB	HPR0326
	5.7L V8 DSL	48026	Cutlass	3.8L V6 CARB	HPR0192
		880136	Cutlass	4.3L V8 CARB	HPR0326
		HPR0136	Cutlass	4.4L V8 CARB	HPR3588
1983 OLDSMOBILE			Cutlass Calais	3.8L V6 CARB	HPR0192
98	4.1L V6 CARB	HPR0192	Cutlass Calais	4.3L V8 CARB	HPR0326
98	5.0L V8 CARB	HPR0326	Cutlass Cruiser	3.8L V6 CARB	HPR0192
Custom Cruiser	5.0L V8 CARB	HPR0326	Cutlass Cruiser	4.3L V8 CARB	HPR0326
Cutlass Calais	3.8L V6 CARB	HPR0192	Cutlass Cruiser	5.0L V8 CARB	HPR0326
Cutlass Calais	5.0L V8 CARB	HPR0326	Cutlass Salon	3.8L V6 CARB	HPR0192
Cutlass Ciera	2.5L L4 F/I	HPR3647	Cutlass Supreme	3.8L V6 CARB	HPR0192
Cutlass Ciera	3.0L V6 CARB	HPR0192	Cutlass Supreme	4.3L V8 CARB	HPR0326
Cutlass Cruiser	3.8L V6 CARB	HPR0192		5.7L V8 DSL	48026
Cutlass Cruiser	5.0L V8 CARB	HPR0326			HPR0136
Cutlass Supreme	3.8L V6 CARB	HPR0192	Delta 88	3.8L V6 CARB	HPR0192
Cutlass Supreme	5.0L V8 CARB	HPR0326	Delta 88	4.3L V8 CARB	HPR0326
Delta 88	3.8L V6 CARB	HPR0192	Delta 88	4.4L V8 CARB	HPR3588
Delta 88	5.0L V8 CARB	HPR0326	Delta 88	5.0L V8 CARB	HPR0326
Firenza	1.8L L4 F/I	HPR3647	Toronado	4.1L V6 CARB	HPR0192
Firenza	2.0L L4 F/I	HPR3647	Toronado	5.0L V8 CARB	HPR0192
Omega	2.5L L4 CARB	HPR3647		5.7L V8 DSL	48026
Omega	2.5L L4 F/I	HPR3647			880136
Toronado	4.1L V6 CARB	HPR0192			HPR0136
Toronado	5.0L V8 CARB	HPR0192	1980 OLDSMOBILE		
	5.7L V8 DSL	48026	98	307 V8 CARB	HPR0326
		880136	98	350 V8 CARB	HPR0326
		HPR0136	Custom Cruiser	307 V8 CARB	HPR0326
1982 OLDSMOBILE			Custom Cruiser	350 V8 CARB	HPR0326
98	4.1L V6 CARB	HPR0192	Cutlass	231 V6 CARB	HPR0192
98	5.0L V8 CARB	HPR0326	Cutlass	260 V8 CARB	HPR0326
Custom Cruiser	5.0L V8 CARB	HPR0326	Cutlass	305 V8 CARB	HPR0326
Cutlass Calais	3.8L V6 CARB	HPR0192	Cutlass	350 V8 CARB	HPR0326
Cutlass Calais	4.3L V6 DSL - w/3-1/2 inch Tall Filter	HPR0326	Cutlass Calais	231 V6 CARB	HPR0192
Cutlass Calais	4.3L V8 CARB - w/3-1/2 inch Tall Filter	HPR0326	Cutlass Calais	260 V8 CARB	HPR0326
Cutlass Calais	4.4L V8 CARB	HPR3588	Cutlass Calais	305 V8 CARB	HPR0326
Cutlass Calais	5.0L V8 CARB	HPR0326	Cutlass Calais	350 V8 CARB	HPR0326
Cutlass Ciera	2.5L L4 CARB	HPR3647	Cutlass Cruiser	231 V6 CARB	HPR0192
Cutlass Ciera	2.5L L4 F/I	HPR3647	Cutlass Cruiser	260 V8 CARB	HPR0326
Cutlass Ciera	3.0L V6 CARB	HPR0192	Cutlass Cruiser	305 V8 CARB	HPR0326
Cutlass Cruiser	3.8L V6 CARB	HPR0192	Cutlass Cruiser	350 V8 CARB	HPR0326
Cutlass Cruiser	4.3L V8 CARB	HPR0326	Cutlass Salon	231 V6 CARB	HPR0192
Cutlass Cruiser	4.4L V8 CARB	HPR3588	Cutlass Salon	260 V8 CARB	HPR0326
Cutlass Cruiser	5.0L V8 CARB	HPR0326	Cutlass Salon	305 V8 CARB	HPR0326
Cutlass Supreme	3.8L V6 CARB	HPR0192	Cutlass Supreme	231 V6 CARB	HPR0192
Cutlass Supreme	4.3L V8 CARB	HPR0326	Cutlass Supreme	260 V8 CARB	HPR0326
Cutlass Supreme	4.4L V8 CARB	HPR3588	Cutlass Supreme	305 V8 CARB	HPR0326
Cutlass Supreme	5.0L V8 CARB	HPR0326	Cutlass Supreme	350 V8 CARB	HPR0326
Delta 88	3.8L V6 CARB	HPR0192	Delta 88	231 V6 CARB	HPR0192
Delta 88	4.3L V8 CARB	HPR0326	Delta 88	260 V8 CARB	HPR0326
			Delta 88	307 V8 CARB	HPR0326

*Indicates 2 filters required ♦ Intake system available - see page 326 + throttle body spacer available - see page 20

HPR™ REPLACEMENT AIR FILTERS OLDSMOBILE

Vehicle	Engine Type	Air Filter	Vehicle	Engine Type	Air Filter
1980 OLDSMOBILE			1978 OLDSMOBILE		
Delta 88	350 V8 CARB	HPR0326	Custom Cruiser	350 V8 CARB	HPR0136
Starfire	231 V6 CARB	HPR0192		403 V8 CARB	48026
Toronado	307 V8 CARB	HPR0192			HPR0136
Toronado	350 V8 CARB	HPR0192	Cutlass	231 V6 CARB	HPR0192
	350 V8 DSL	48026	Cutlass	260 V8 CARB	HPR0326
		880136	Cutlass	305 V8 4 BBL.	HPR0326
		HPR0136	Cutlass	350 V8 CARB	HPR0326
98	350 V8 CARB	48026	Cutlass Calais	260 V8 CARB	HPR0326
		HPR0136	Cutlass Calais	305 V8 CARB	HPR0326
	403 V8 CARB	48026	Cutlass Salon	260 V8 CARB	HPR0326
		HPR0136	Cutlass Salon	305 V8 CARB	HPR0326
Custom Cruiser	350 V8 CARB	48026	Cutlass Supreme	260 V8 CARB	HPR0326
		HPR0136	Cutlass Supreme	305 V8 4 BBL.	HPR0326
	403 V8 CARB	48026	Cutlass Supreme	350 V8 CARB	HPR0326
		HPR0136	Delta 88	231 V6 CARB	HPR0192
Cutlass	231 V6 CARB	HPR0192	Delta 88	260 V8 CARB	HPR0326
Cutlass	260 V8 CARB	HPR0326		350 V8 CARB	48026
Cutlass	305 V8 CARB	HPR0326			880136
	350 V8 CARB - w/Oldsmobile Eng.	48026			HPR0136
		880136		350 V8 DSL	48026
		HPR0136			880136
	350 V8 DSL	48026			HPR0136
		880136		403 V8 CARB	48026
		HPR0136			880136
Cutlass Calais	231 V6 CARB	HPR0192			HPR0136
Cutlass Calais	260 V8 CARB	HPR0326	Omega	231 V6 CARB	HPR0192
Cutlass Calais	260 V8 DSL	HPR0326	Omega	305 V8 CARB	HPR0192
Cutlass Calais	305 V8 CARB	HPR0326	Omega	350 V8 CARB	HPR0326
	350 V8 CARB	48026	Starfire	305 V8 CARB	HPR0192
		880136	Toronado	403 V8 CARB	48026
		HPR0136			HPR0136
Cutlass Salon	260 V8 CARB	HPR0326	98	350 V8 CARB	48026
Cutlass Salon	260 V8 DSL	HPR0326			HPR0136
Cutlass Salon	305 V8 CARB	HPR0326			HPR0326
Cutlass Supreme	231 V6 CARB	HPR0192		403 V8 CARB	48026
Cutlass Supreme	260 V8 CARB	HPR0326			HPR0136
Cutlass Supreme	260 V8 DSL	HPR0326	Custom Cruiser	350 V8 CARB - VIN L	HPR0326
Cutlass Supreme	305 V8 CARB	HPR0326		350 V8 CARB - VIN R	48026
Cutlass Supreme	350 V8 CARB	HPR0326			HPR0136
Delta 88	231 V6 CARB	HPR0192		403 V8 CARB	48026
Delta 88	260 V8 CARB	HPR0326			HPR0136
Delta 88	301 V8 CARB	HPR0192	Cutlass	231 V6 CARB	HPR0192
	350 V8 CARB	48026		260 V8 CARB	48026
		880136			HPR0136
		HPR0136		350 V8 CARB	48026
	350 V8 DSL	48026			880136
		880136			HPR0136
		HPR0136		403 V8 CARB	48026
	403 V8 CARB	48026			880136
		880136			HPR0136
		HPR0136	Cutlass Salon	260 V8 CARB	HPR0326
Omega	231 V6 CARB	HPR0192	Cutlass Supreme	231 V6 CARB	HPR0192
Omega	305 V8 CARB	HPR0192		260 V8 CARB	48026
Omega	350 V8 CARB	HPR0326			HPR0136
Starfire	231 V6 CARB	HPR0192		350 V8 CARB	48026
Toronado	350 V8 CARB	48026			HPR0136
		HPR0136		403 V8 CARB	48026
	350 V8 DSL	48026			HPR0136
		HPR0136	Delta 88	231 V6 CARB	HPR0192
98	350 V8 CARB	48026		260 V8 CARB	48026
		HPR0136			880136
	403 V8 CARB	48026			HPR0136
		HPR0136	Delta 88	350 V8 CARB - VIN G	HPR0326
Custom Cruiser	350 V8 CARB	48026	Delta 88	350 V8 CARB - VIN L	HPR0326

*Indicates 2 filters required ♦ Intake system available - see page 326 + throttle body spacer available - see page 20

OLDSMOBILE HPR™ REPLACEMENT AIR FILTERS

Vehicle	Engine Type	Air Filter	Vehicle	Engine Type	Air Filter
1977 OLDSMOBILE			1975 OLDSMOBILE		
Delta 88	350 V8 CARB - VIN R	48026	Cutlass Salon	350 V8 CARB	48026
		880136			HPR0136
		HPR0136		455 V8 CARB	48026
	403 V8 CARB	48026			HPR0136
		880136	Cutlass Supreme	260 V8 CARB	HPR0326
		HPR0136		350 V8 CARB	48026
Omega	231 V6 CARB	HPR0192			880136
	260 V8 CARB	48026		455 V8 CARB	HPR0136
		880136			48026
		HPR0136	Delta 88	350 V8 CARB	HPR0136
Omega	305 V8 CARB	HPR0192			48026
Omega	350 V8 CARB - VIN L	HPR0326		400 V8 CARB	HPR0136
	350 V8 CARB - VIN R	48026			48026
		880136		455 V8 CARB	HPR0136
		HPR0136			48026
Starfire	231 V6 CARB	HPR0192			HPR0136
Starfire	231 V6 CARB - w/3-1/2 inch Tall Filter	HPR0192	Omega	260 V8 CARB	HPR0326
Toronado	403 V8 CARB	48026	Omega	350 V8 CARB	HPR0192
		880136	Toronado	455 V8 CARB	48026
		HPR0136			HPR0136
98	455 V8 CARB	48026	Vista Cruiser	350 V8 CARB	48026
		HPR0136			HPR0136
Custom Cruiser	455 V8 CARB	48026		455 V8 CARB	48026
		HPR0136	98	455 V8 CARB	48026
Cutlass	260 V8 CARB	HPR0326			HPR0136
	350 V8 CARB	48026	Custom Cruiser	455 V8 CARB - w/o hood scoop	48026
		880136			HPR0136
		HPR0136	Cutlass	350 V8 CARB - Exc. W30	48026
	455 V8 CARB	48026			880136
		880136			HPR0136
		HPR0136		455 V8 CARB - Exc. W31	48026
Cutlass Salon	260 V8 CARB	HPR0326			880136
Cutlass Supreme	260 V8 CARB	HPR0326			HPR0136
	350 V8 CARB	48026	Cutlass Supreme	350 V8 CARB	48026
		880136			880136
		HPR0136			HPR0136
	455 V8 CARB	48026	Delta 88	350 V8 CARB - w/o hood scoop	48026
		HPR0136			880136
Cutlass Tiara	260 V8 CARB	HPR0326			HPR0136
Delta 88	350 V8 CARB	48026	Delta 88	455 V8 2 BBL.	48026
		HPR0136			880136
	455 V8 CARB	48026		455 V8 4 BBL. - w/o hood scoop	48026
		HPR0136			880136
Omega	260 V8 CARB	HPR0326			HPR0136
Omega	350 V8 CARB	HPR0192	Omega	350 V8 CARB - w/o Ram Air	48026
Toronado	455 V8 CARB	48026			880136
		HPR0136	Toronado	455 V8 CARB	HPR0136
98	400 V8 CARB	48026			48026
		HPR0136			880136
	455 V8 CARB	48026			HPR0136
		HPR0136	Vista Cruiser	350 V8 CARB - Exc. W30, W31	48026
Custom Cruiser	400 V8 CARB	48026			880136
		HPR0136		455 V8 CARB	HPR0136
	455 V8 CARB	48026			48026
		HPR0136			880136
Cutlass	260 V8 CARB	HPR0326			HPR0136
	350 V8 CARB	48026	1973 OLDSMOBILE		
		880136	98	350 V8 2 BBL.	48026
		HPR0136			880136
	455 V8 CARB	48026		350 V8 4 BBL.	48026
		880136			880136
		HPR0136			HPR0136
Cutlass Salon	260 V8 CARB	HPR0326			

*Indicates 2 filters required ♦ Intake system available - see page 326 + throttle body spacer available - see page 20

HPR™ REPLACEMENT AIR FILTERS OLDSMOBILE

Vehicle	Engine Type	Air Filter	Vehicle	Engine Type	Air Filter
1973 OLDSMOBILE			1972 OLDSMOBILE		
98	455 V8 CARB	48026 880136 HPR0136	Cutlass Supreme	350 V8 4 BBL. - w/o hood scoop 455 V8 CARB - w/o hood scoop	HPR0136 48026 HPR0136
Custom Cruiser	350 V8 CARB - w/o hood scoop	48026 880136 HPR0136	Delta 88	350 V8 2 BBL. 350 V8 4 BBL. - w/o hood scoop	48026 880136 HPR0136
Cutlass	455 V8 CARB 350 V8 2 BBL. 350 V8 4 BBL. - w/o hood scoop	48026 HPR0136 48026 880136 HPR0136		455 V8 CARB - w/o hood scoop	48026 880136 HPR0136
Cutlass Supreme	455 V8 CARB - Exc. W31 350 V8 2 BBL. 350 V8 4 BBL. - w/o hood scoop	48026 880136 HPR0136 48026 880136 HPR0136	F85	350 V8 2 BBL. 350 V8 4 BBL.	48026 880136 48026 880136 HPR0136
Delta 88	455 V8 CARB - w/o hood scoop 350 V8 2 BBL. 350 V8 4 BBL. - w/o hood scoop	48026 HPR0136 48026 880136 HPR0136	Toronado	455 V8 CARB	48026 880136 HPR0136
Omega	455 V8 CARB 350 V8 2 BBL. 350 V8 4 BBL.	48026 880136 HPR0136 48026 880136 HPR0136	Vista Cruiser	350 V8 2 BBL. 350 V8 4 BBL. 455 V8 CARB	48026 880136 48026 880136 HPR0136
Toronado	350 V8 2 BBL. 350 V8 4 BBL.	48026 880136 HPR0136	98	455 V8 4 BBL. - w/o Ram Air	48026 HPR0136
Vista Cruiser	455 V8 CARB 350 V8 2 BBL. 350 V8 4 BBL. - w/o hood scoop	48026 880136 HPR0136 48026 880136 HPR0136	442	455 V8 2 BBL. 455 V8 4 BBL. - w/o Ram Air	48026 880136 48026 880136 HPR0136
98	455 V8 CARB	48026 880136 HPR0136	Custom Cruiser	455 V8 4 BBL. - w/o Ram Air	48026 HPR0136
Custom Cruiser	350 V8 2 BBL. 350 V8 4 BBL. - w/o hood scoop	48026 880136 HPR0136	Cutlass	350 V8 2 BBL. 350 V8 4 BBL. - w/o Ram Air	48026 880136 48026 880136 HPR0136
Cutlass	455 V8 CARB - Exc. W31	48026 880136 HPR0136	Cutlass	455 V8 2 BBL. 455 V8 4 BBL. - w/o Ram Air	48026 880136 48026 880136 HPR0136
Cutlass Supreme	455 V8 CARB 350 V8 2 BBL. 350 V8 4 BBL. - w/o hood scoop	48026 880136 HPR0136 48026 880136 HPR0136	Cutlass Supreme	350 V8 4 BBL.	48026 880136 HPR0136
	455 V8 CARB - w/o hood scoop	48026 880136 HPR0136	Delta 88	350 V8 4 BBL. 455 V8 4 BBL.	48026 HPR0136 48026 HPR0136
	350 V8 2 BBL. 350 V8 4 BBL. - w/o hood scoop	48026 880136 HPR0136	F85	350 V8 2 BBL.	48026 880136 HPR0136
	455 V8 CARB - w/o hood scoop	48026 880136 HPR0136		350 V8 4 BBL. - w/o Ram Air	48026 880136 HPR0136
	350 V8 2 BBL. 350 V8 4 BBL. - w/o hood scoop	48026 880136 HPR0136	Toronado	455 V8 CARB	48026

*Indicates 2 filters required ♦ Intake system available - see page 326 + throttle body spacer available - see page 20

OLDSMOBILE HPR™ REPLACEMENT AIR FILTERS

Vehicle	Engine Type	Air Filter	Vehicle	Engine Type	Air Filter
1971 OLDSMOBILE			1969 OLDSMOBILE		
Toronado	455 V8 CARB	HPR0136	442	455 V8 4 BBL. - w/o Ram Air	48026
Vista Cruiser	350 V8 2 BBL.	48026			HPR0136
		880136	Cutlass	350 V8 2 BBL.	48026
	350 V8 4 BBL.	48026			880136
		880136		350 V8 4 BBL.	48026
		HPR0136			880136
Vista Cruiser	455 V8 2 BBL.	48026			HPR0136
		880136	Cutlass Supreme	350 V8 4 BBL.	48026
	455 V8 4 BBL.	48026			880136
		880136		350 V8 CARB - 4 BBL	HPR0136
		HPR0136			48026
98	455 V8 4 BBL. - w/o hood scoop	48026			880136
		HPR0136			HPR0136
442	350 V8 4 BBL. - w/o hood scoop	48026	Delta 88	350 V8 4 BBL.	48026
		HPR0136			HPR0136
	455 V8 4 BBL. - w/o hood scoop	48026		455 V8 4 BBL.	48026
		HPR0136			HPR0136
Cutlass	350 V8 2 BBL.	48026	F85	350 V8 2 BBL.	48026
		880136			880136
	350 V8 4 BBL. - w/o Ram Air	48026		350 V8 4 BBL.	48026
		880136			880136
		HPR0136			HPR0136
Cutlass	455 V8 2 BBL.	48026	Toronado	455 V8 CARB	48026
		880136			HPR0136
	455 V8 4 BBL. - w/o Ram Air	48026	Vista Cruiser	350 V8 2 BBL.	48026
		880136			880136
		HPR0136		350 V8 4 BBL.	48026
Cutlass Supreme	350 V8 2 BBL.	48026			880136
		880136			HPR0136
	350 V8 4 BBL.	48026		400 V8 CARB	48026
		880136			880136
		HPR0136			HPR0136
Delta 88	350 V8 4 BBL. - w/o hood scoop	48026	98	455 V8 4 BBL.	48026
		HPR0136			HPR0136
	455 V8 4 BBL. - w/o hood scoop	48026	442	350 V8 4 BBL.	48026
		HPR0136			HPR0136
F85	350 V8 2 BBL.	48026		400 V8 CARB	48026
		880136			HPR0136
	350 V8 4 BBL. - w/o Ram Air	48026		455 V8 4 BBL. - w/o Ram Air	48026
		880136			HPR0136
		HPR0136	Cutlass	350 V8 2 BBL.	48026
F85	455 V8 2 BBL.	48026			880136
		880136		350 V8 4 BBL.	48026
	455 V8 4 BBL. - w/o Ram Air	48026			880136
		880136			HPR0136
		HPR0136	Cutlass	400 V8 2 BBL.	48026
Toronado	455 V8 CARB	48026			880136
		HPR0136		400 V8 4 BBL.	48026
Vista Cruiser	350 V8 2 BBL.	48026			880136
		880136			HPR0136
	350 V8 4 BBL. - w/o hood scoop	48026	Cutlass Supreme	350 V8 2 BBL.	48026
		880136			880136
		HPR0136		350 V8 4 BBL.	48026
Vista Cruiser	455 V8 2 BBL.	48026			880136
		880136			HPR0136
	455 V8 4 BBL. - w/o hood scoop	48026	Delmont 88	350 V8 2 BBL.	48026
		880136			880136
		HPR0136		350 V8 4 BBL.	48026
98	455 V8 4 BBL.	48026			880136
		HPR0136			HPR0136
442	350 V8 4 BBL.	48026		455 V8 4 BBL.	48026
		HPR0136			HPR0136
	400 V8 CARB	48026	Delta 88	350 V8 2 BBL.	48026
		HPR0136			880136

*Indicates 2 filters required ♦ Intake system available - see page 326 + throttle body spacer available - see page 20

HPR™ REPLACEMENT AIR FILTERS OLDSMOBILE

Vehicle	Engine Type	Air Filter	Vehicle	Engine Type	Air Filter
1968 OLDSMOBILE			1966 OLDSMOBILE		
Delta 88	350 V8 4 BBL.	48026	Dynamic	425 V8 4 BBL.	HPR0136
		880136			48026
	455 V8 4 BBL.	HPR0136	F85	400 V8 CARB	880136
		48026			48026
F85	350 V8 2 BBL.	HPR0136	Starfire	425 V8 CARB	HPR0136
		48026			48026
	350 V8 4 BBL.	880136	Toronado	425 V8 CARB	HPR0136
		48026			48026
	400 V8 CARB	880136	2001 PLYMOUTH		
		HPR0136	Neon	2.0L L4 F/I	HPR8805
Toronado	455 V8 CARB	48026	Prowler	3.5L V6 F/I	HPR3660
		HPR0136	2000 PLYMOUTH		
Vista Cruiser	350 V8 2 BBL.	48026	Breeze	2.0L L4 F/I	HPR7432
		880136	Breeze	2.4L L4 F/I	HPR7432
	350 V8 4 BBL.	HPR0136	Grand Voyager	3.0L V6 F/I	HPR3660
		48026	Grand Voyager	3.3L V6 F/I	HPR3660
	400 V8 CARB	880136	Neon	2.0L L4 F/I	HPR8805
		HPR0136	Prowler	3.5L V6 F/I	HPR3660
98	425 V8 CARB - w/Manual Trans.	48026	Voyager Van	2.4L L4 F/I	HPR3660
		HPR0136	Voyager Van	3.0L V6 F/I	HPR3660
442	400 V8 CARB	48026	Voyager Van	3.3L V6 F/I	HPR3660
		HPR0136	Voyager Van	3.3L V6 F/I	HPR3660
Cutlass	330 V8 CARB	880136	1999 PLYMOUTH		
		HPR0136	Breeze	2.0L L4 F/I	HPR7432
	400 V8 CARB	48026	Breeze	2.4L L4 F/I	HPR7432
		880136	Grand Voyager	3.0L V6 F/I	HPR3660
Cutlass Supreme	330 V8 CARB - w/Manual Trans.	HPR0136	Grand Voyager	3.3L V6 F/I	HPR3660
		48026	Grand Voyager	3.8L V6 F/I	HPR3660
Delmont 88	330 V8 CARB - w/Manual Trans.	48026	Neon	2.0L L4 F/I	HPR3660
		HPR0136	Prowler	3.5L V6 F/I	HPR3660
	425 V8 CARB - w/Manual Trans.	48026	Voyager Van	2.4L L4 F/I	HPR3660
		HPR0136	Voyager Van	3.0L V6 F/I	HPR3660
Delta 88	330 V8 CARB - w/Manual Trans.	48026	Voyager Van	3.3L V6 F/I	HPR3660
		HPR0136	Voyager Van	3.8L V6 F/I	HPR3660
F85	330 V8 CARB	880136	1998 PLYMOUTH		
		HPR0136	Breeze	2.0L L4 F/I	HPR7432
Toronado	425 V8 CARB	48026	Breeze	2.4L L4 F/I	HPR7432
		HPR0136	Grand Voyager	3.0L V6 F/I	HPR3660
Vista Cruiser	330 V8 CARB	48026	Grand Voyager	3.3L V6 F/I	HPR3660
		880136	Grand Voyager	3.8L V6 F/I	HPR3660
98	425 V8 4 BBL.	HPR0136	Neon	2.0L L4 F/I	HPR3660
		48026	Prowler	3.5L V6 F/I	HPR3660
442	400 V8 CARB	HPR0136	Voyager Van	2.4L L4 F/I	HPR3660
		48026	Voyager Van	3.0L V6 F/I	HPR3660
Cutlass	400 V8 CARB	880136	Voyager Van	3.3L V6 F/I	HPR3660
		HPR0136	Voyager Van	3.8L V6 F/I	HPR3660
Delta 88	425 V8 2 BBL.	48026	1997 PLYMOUTH		
		HPR0136	Breeze	2.0L L4 F/I	HPR7432
Dynamic	425 V8 2 BBL.	48026	Breeze	2.4L L4 F/I	HPR7432
		HPR0136	Grand Voyager	2.4L L4 F/I	HPR7432
	425 V8 4 BBL.	48026	Grand Voyager	3.0L V6 F/I	HPR3660
		HPR0136	Grand Voyager	3.3L V6 F/I	HPR3660
	425 V8 4 BBL.	880136	Grand Voyager	3.8L V6 F/I	HPR3660
		HPR0136	Neon	2.0L L4 F/I	HPR3660
	425 V8 4 BBL.	48026	Prowler	3.5L V6 F/I	HPR3660
		HPR0136	Voyager Van	2.4L L4 F/I	HPR3660
	425 V8 4 BBL.	48026	Voyager Van	3.0L V6 F/I	HPR3660
		HPR0136	Voyager Van	3.3L V6 F/I	HPR3660
	425 V8 4 BBL.	880136	Voyager Van	3.8L V6 F/I	HPR3660
		HPR0136	1996 PLYMOUTH		
	425 V8 4 BBL.	48026	Breeze	2.0L L4 F/I	HPR7432
		HPR0136	Breeze	2.4L L4 F/I	HPR7432

*Indicates 2 filters required ♦ Intake system available - see page 326 + throttle body spacer available - see page 20

PLYMOUTH HPR™ REPLACEMENT AIR FILTERS

Vehicle	Engine Type	Air Filter	Vehicle	Engine Type	Air Filter
1996 PLYMOUTH			1990 PLYMOUTH		
Grand Voyager	2.4L L4 F/I	HPR3660	Grand Voyager	3.3L V6 F/I	HPR3559
Grand Voyager	3.0L V6 F/I	HPR3660	Horizon	2.2L L4 F/I	HPR3660
Grand Voyager	3.3L V6 F/I	HPR3660	Voyager Van	2.5L L4 F/I - Exc. Turbo	HPR3559
Grand Voyager	3.8L V6 F/I	HPR3660	Voyager Van	3.0L V6 F/I	HPR3660
Neon	2.0L L4 F/I	HPR3660	1989 PLYMOUTH		
Voyager	3.8L V6 F/I	HPR3660	Acclaim	2.5L L4 F/I - Turbo	HPR3559
Voyager Van	2.4L L4 F/I	HPR3660	Acclaim	3.0L V6 F/I	HPR3660
Voyager Van	3.0L V6 F/I	HPR3660	Expo	2.2L L4 F/I	HPR3660
Voyager Van	3.3L V6 F/I	HPR3660	Gran Fury	5.2L V8 2 BBL.	HPR0160
1995 PLYMOUTH			Grand Voyager	2.5L L4 F/I	HPR3559
Acclaim	3.0L V6 F/I	HPR3660	Grand Voyager	3.0L V6 F/I	HPR3660
Grand Voyager	3.0L V6 F/I	HPR3660	Horizon	2.2L L4 F/I	HPR3660
Grand Voyager	3.3L V6 F/I	HPR3559	Sundance	2.5L L4 F/I - Exc. Turbo	HPR3660
Grand Voyager	3.8L V6 F/I	HPR3559	Sundance	2.5L L4 F/I - Turbo	HPR3559
Neon	2.0L L4 F/I	HPR3660	Voyager Van	2.5L L4 F/I	HPR3559
Voyager Van	2.5L L4 F/I	HPR3559	Voyager Van	3.0L V6 F/I	HPR3660
Voyager Van	3.0L V6 F/I	HPR3660	1988 PLYMOUTH		
Voyager Van	3.3L V6 F/I	HPR3559	Caravelle	2.2L L4 CARB	HPR3660
1994 PLYMOUTH			Caravelle	2.2L L4 F/I - Exc. Turbo	HPR3660
Acclaim	2.5L L4 F/I	HPR3660	Caravelle	2.2L L4 F/I - Turbo	HPR3559
Acclaim	3.0L V6 F/I	HPR3660	Expo	2.2L L4 F/I	HPR3660
Colt	1.8L L4 F/I	HPR7344	Gran Fury	5.2L V8 2 BBL.	HPR0160
Colt	2.4L L4 F/I	HPR7344	Grand Voyager	2.5L L4 F/I	HPR3559
Colt Vista	1.8L L4 F/I	HPR7344	Grand Voyager	3.0L V6 F/I	HPR3660
Grand Voyager	3.0L V6 F/I	HPR3660	Horizon	2.2L L4 F/I	HPR3660
Grand Voyager	3.3L V6 F/I	HPR3559	Sundance	2.2L L4 F/I - Exc. Turbo	HPR3660
Grand Voyager	3.8L V6 F/I	HPR3559	Sundance	2.2L L4 F/I - Turbo	HPR3559
Sundance	3.0L V6 F/I	HPR3660	Voyager Van	2.5L L4 F/I	HPR3559
Voyager Van	2.5L L4 F/I	HPR3559	Voyager Van	3.0L V6 F/I	HPR3660
Voyager Van	3.0L V6 F/I	HPR3660	1987 PLYMOUTH		
Voyager Van	3.3L V6 F/I	HPR3559	Caravelle	2.2L L4 CARB - Exc. Turbo	HPR3660
1993 PLYMOUTH			Caravelle	2.2L L4 F/I - Exc. Turbo	HPR3660
Acclaim	2.5L L4 F/I	HPR3660	Caravelle	2.2L L4 F/I - Turbo	HPR3559
Acclaim	3.0L V6 F/I	HPR3660	Expo	2.2L L4 CARB	HPR3559
Colt	1.8L L4 F/I	HPR7344	Gran Fury	5.2L V8 2 BBL.	HPR0160
Colt	2.4L L4 F/I	HPR7344	Horizon	2.2L L4 CARB	HPR3559
Colt Vista	1.8L L4 F/I	HPR7344	Sundance	2.2L L4 F/I - Exc. Turbo	HPR3660
Grand Voyager	3.0L V6 F/I	HPR3660	Sundance	2.2L L4 F/I - Turbo	HPR3559
Grand Voyager	3.3L V6 F/I	HPR3559	Voyager Van	2.2L L4 CARB	HPR3559
Grand Voyager	3.8L V6 F/I	HPR3559	Voyager Van	2.5L L4 F/I	HPR3559
Sundance	3.0L V6 F/I	HPR3660	Voyager Van	3.0L V6 F/I	HPR3660
Voyager Van	2.5L L4 F/I	HPR3559	1986 PLYMOUTH		
Voyager Van	3.0L V6 F/I	HPR3660	Caravelle	2.2L L4 F/I - Exc. Turbo	HPR3660
Voyager Van	3.3L V6 F/I	HPR3559	Caravelle	2.2L L4 F/I - Turbo	HPR3559
1992 PLYMOUTH			Gran Fury	5.2L V8 2 BBL.	HPR0160
Acclaim	3.0L V6 F/I	HPR3660	Horizon	1.6L L4 CARB	HPR3559
Colt	1.8L L4 F/I	HPR7344	Horizon	2.2L L4 CARB	HPR3559
Colt	2.4L L4 F/I	HPR7344	Voyager Van	2.2L L4 CARB	HPR3559
Grand Voyager	3.0L V6 F/I	HPR3660	1985 PLYMOUTH		
Grand Voyager	3.3L V6 F/I	HPR3559	Caravelle	2.2L L4 F/I - Exc. Turbo	HPR3660
Sundance	3.0L V6 F/I	HPR3660	Caravelle	2.2L L4 F/I - Turbo	HPR3559
Voyager Van	2.5L L4 F/I	HPR3559	Gran Fury	5.2L V8 2 BBL.	HPR0160
Voyager Van	3.0L V6 F/I	HPR3660	Horizon	1.6L L4 CARB	HPR3559
Voyager Van	3.3L V6 F/I	HPR3559	Horizon	2.2L L4 CARB	HPR3559
1991 PLYMOUTH			Reliant	2.2L L4 CARB	HPR3559
Acclaim	3.0L V6 F/I	HPR3660	Reliant	2.2L L4 F/I	HPR3559
Grand Voyager	3.3L V6 F/I	HPR3559	Turismo	1.6L L4 CARB	HPR3559
Voyager Van	2.5L L4 F/I	HPR3559	Voyager Van	2.2L L4 CARB	HPR3559
Voyager Van	3.0L V6 F/I	HPR3660	1984 PLYMOUTH		
Voyager Van	3.3L V6 F/I	HPR3559	Caravelle	2.2L L4 CARB	HPR3559
1990 PLYMOUTH			Caravelle	2.2L L4 F/I	HPR3559
Acclaim	3.0L V6 F/I	HPR3660			

*Indicates 2 filters required ♦ Intake system available - see page 326 + throttle body spacer available - see page 20

HPR™ REPLACEMENT AIR FILTERS PLYMOUTH

Vehicle	Engine Type	Air Filter
1984 PLYMOUTH		
Gran Fury	5.2L V8 2 BBL.	HPR0160
Horizon	1.6L L4 CARB	HPR3559
Horizon	2.2L L4 CARB	HPR3559
Reliant	2.2L L4 CARB	HPR3559
Turismo	1.6L L4 CARB	HPR3559
Voyager Van	2.2L L4 CARB	HPR3559

1983 PLYMOUTH		
Caravelle	2.2L L4 CARB	HPR3559
Gran Fury	3.7L L6 CARB	HPR0160
Gran Fury	5.2L V8 2 BBL.	HPR0160
Horizon	1.6L L4 CARB	HPR3559
Horizon	2.2L L4 CARB	HPR3559
PB150 Van	3.7L L6 CARB	HPR0184
PB250 Van	3.7L L6 CARB	HPR0184
Reliant	2.2L L4 CARB	HPR3559
Scamp	2.2L L4 CARB	HPR3559

1982 PLYMOUTH		
Gran Fury	3.7L L6 CARB	HPR0160
Gran Fury	5.2L V8 2 BBL.	HPR0160
Horizon	2.2L L4 CARB	HPR3559
PB150 Van	3.7L L6 CARB	HPR0184
PB250 Van	3.7L L6 CARB	HPR0184
Reliant	2.2L L4 CARB	HPR3559

1981 PLYMOUTH		
Gran Fury	3.7L L6 CARB	HPR0160
Gran Fury	5.2L V8 2 BBL.	HPR0160
Horizon	2.2L L4 CARB	HPR3559
PB150 Van	3.7L L6 CARB	HPR0184
PB250 Van	3.7L L6 CARB	HPR0184
Reliant	2.2L L4 CARB	HPR3559

1980 PLYMOUTH		
Gran Fury	225 L6 1 BBL. - w/10 in OD Filter	HPR0160
Gran Fury	225 L6 2 BBL. - w/10 in OD Filter	HPR0160
Gran Fury	318 V8 2 BBL.	HPR0160
Gran Fury	360 V8 4 BBL.	HPR0160
PB100	225 L6 CARB	HPR0160
PB100	318 V8 CARB	HPR0160
PB200	225 L6 CARB	HPR0160
PB200	318 V8 2 BBL.	HPR0160
PB300	318 V8 CARB	HPR0160
Trailduster	318 V8 CARB	HPR0160
Trailduster	360 V8 CARB	HPR0160
Volare	225 L6 1 BBL. - w/10 in OD Filter	HPR0160
Volare	225 L6 2 BBL. - w/10 in OD Filter	HPR0160
Volare	318 V8 2 BBL.	HPR0160

1979 PLYMOUTH		
PB100	225 L6 CARB	HPR0184
PB100	318 V8 2 BBL.	HPR0160
PB200	318 V8 2 BBL.	HPR0160
PB300	318 V8 CARB	HPR0160
Trailduster	225 L6 CARB	HPR0160
Trailduster	318 V8 2 BBL.	HPR0160
Volare	225 L6 CARB	HPR0160
Volare	318 V8 2 BBL.	HPR0160

1978 PLYMOUTH		
Fury	225 L6 2 BBL.	HPR0160
Fury	318 V8 2 BBL.	HPR0160
PB100	318 V8 CARB	HPR0160
PB200	318 V8 CARB	HPR0160
PB300	318 V8 CARB	HPR0160
Trailduster	318 V8 CARB	HPR0160

Vehicle	Engine Type	Air Filter
1978 PLYMOUTH		
Volare	225 L6 2 BBL.	HPR0160
Volare	318 V8 2 BBL.	HPR0160

1977 PLYMOUTH		
Fury	225 L6 2 BBL.	HPR0160
Fury	318 V8 CARB	HPR0160
Gran Fury	318 V8 CARB	HPR0160
Trailduster	318 V8 CARB	HPR0160
Volare	225 L6 2 BBL.	HPR0160
Volare	318 V8 CARB	HPR0160

1976 PLYMOUTH		
Duster	318 V8 CARB	HPR0160
Fury	318 V8 CARB	HPR0160
Gran Fury	318 V8 CARB	HPR0160
Scamp	318 V8 CARB	HPR0160
Trailduster	318 V8 CARB	HPR0160
Valiant	318 V8 CARB	HPR0160
Volare	318 V8 CARB	HPR0160

1975 PLYMOUTH		
Duster	318 V8 CARB	HPR0160
Fury	318 V8 CARB	HPR0160
Gran Fury	318 V8 CARB	HPR0160
PB100	318 V8 CARB	HPR0160
PB200	318 V8 CARB	HPR0160
PB300	318 V8 CARB	HPR0160
Roadrunner	318 V8 CARB	HPR0160
Roadrunner	360 V8 2 BBL.	HPR0160
Scamp	318 V8 CARB	HPR0160
Trailduster	318 V8 CARB	HPR0160
Valiant	318 V8 CARB	HPR0160

1974 PLYMOUTH		
Barracuda	318 V8 CARB	HPR0160
Belvedere	318 V8 2 BBL.	HPR0160
Cricket	91 L4 CARB	HPR0352
Cuda	318 V8 CARB	HPR0160
Duster	318 V8 CARB	HPR0160
Gran Fury	360 V8 CARB	HPR0326
Gran Fury	400 V8 CARB	HPR0326
Gran Fury	440 V8 CARB	HPR0326
PB100 Van	318 V8 CARB	HPR0160
PB200 Van	318 V8 CARB	HPR0160
PB300 Van	318 V8 CARB	HPR0160
Roadrunner	318 V8 CARB	HPR0160
Satellite	318 V8 CARB	HPR0160
Satellite	360 V8 2 BBL.	HPR0160
Scamp	318 V8 CARB	HPR0160
Sebring	318 V8 2 BBL.	HPR0160
Trailduster	318 V8 CARB	HPR0160
Valiant	318 V8 CARB	HPR0160

1973 PLYMOUTH		
Barracuda	318 V8 CARB	HPR0160
Belvedere	318 V8 2 BBL.	HPR0160
Cuda	318 V8 CARB	HPR0160
Duster	318 V8 CARB	HPR0160
Fury	318 V8 CARB	HPR0160
Fury I	318 V8 CARB	HPR0160
Fury II	318 V8 CARB	HPR0160
Fury III	318 V8 CARB	HPR0160
Gran Fury	318 V8 CARB	HPR0160
Roadrunner	318 V8 CARB	HPR0160
Satellite	318 V8 CARB	HPR0160
Scamp	318 V8 CARB	HPR0160
Sedan	318 V8 2 BBL.	HPR0160

*Indicates 2 filters required ♦ Intake system available - see page 326 + throttle body spacer available - see page 20

PLYMOUTH HPR™ REPLACEMENT AIR FILTERS

Vehicle	Engine Type	Air Filter	Vehicle	Engine Type	Air Filter
1973 PLYMOUTH			1967 PLYMOUTH		
Valiant	318 V8 CARB	HPR0160	Barracuda	273 V8 CARB	HPR0160
1972 PLYMOUTH			Belvedere	273 V8 CARB	HPR0160
Barracuda	318 V8 CARB	HPR0160	Belvedere	318 V8 CARB	HPR0160
Belvedere	318 V8 2 BBL.	HPR0160	Belvedere II	273 V8 CARB	HPR0160
Cuda	318 V8 CARB	HPR0160	Belvedere II	318 V8 CARB	HPR0160
Duster	318 V8 CARB	HPR0160	Fury	318 V8 CARB	HPR0160
Fury	318 V8 CARB	HPR0160	Fury II	318 V8 CARB	HPR0160
Fury I	318 V8 CARB	HPR0160	Fury III	318 V8 CARB	HPR0160
Fury II	318 V8 CARB	HPR0160	GTX	273 V8 CARB	HPR0160
Fury III	318 V8 CARB	HPR0160	GTX	318 V8 CARB	HPR0160
Gran Fury	318 V8 CARB	HPR0160	Satellite	273 V8 CARB	HPR0160
Roadrunner	318 V8 CARB	HPR0160	Satellite	318 V8 CARB	HPR0160
Satellite	318 V8 CARB	HPR0160	Valiant	273 V8 CARB	HPR0160
Scamp	318 V8 CARB	HPR0160	VIP	318 V8 CARB	HPR0160
Valiant	318 V8 CARB	HPR0160	1966 PLYMOUTH		
1971 PLYMOUTH			Barracuda	273 V8 2 BBL.	HPR0160
Barracuda	318 V8 CARB	HPR0160	Belvedere	273 V8 CARB	HPR0160
Belvedere	318 V8 2 BBL.	HPR0160	Belvedere	318 V8 CARB	HPR0160
Duster	318 V8 CARB	HPR0160	Belvedere	440 V8 2 BBL.	HPR0160
Fury	318 V8 CARB	HPR0160	Belvedere II	273 V8 CARB	HPR0160
Fury I	318 V8 CARB	HPR0160	Belvedere II	318 V8 CARB	HPR0160
Fury II	318 V8 CARB	HPR0160	Fury	318 V8 CARB	HPR0160
Fury III	318 V8 CARB	HPR0160	Fury	361 V8 2 BBL.	HPR0160
Satellite	318 V8 CARB	HPR0160	Fury II	318 V8 CARB	HPR0160
Scamp	318 V8 CARB	HPR0160	Fury III	318 V8 CARB	HPR0160
Valiant	318 V8 CARB	HPR0160	Satellite	273 V8 CARB	HPR0160
1970 PLYMOUTH			Satellite	318 V8 CARB	HPR0160
Barracuda	318 V8 CARB	HPR0160	Satellite	440 V8 2 BBL.	HPR0160
Belvedere	318 V8 CARB	HPR0160	Valiant	273 V8 2 BBL.	HPR0160
Duster	318 V8 CARB	HPR0160	1965 PLYMOUTH		
Fury	318 V8 CARB	HPR0160	Barracuda	273 V8 2 BBL.	HPR0160
Fury I	318 V8 CARB	HPR0160	Belvedere	273 V8 2 BBL.	HPR0160
Fury II	318 V8 CARB	HPR0160	Belvedere	318 V8 CARB	HPR0160
Fury III	318 V8 CARB	HPR0160	Belvedere II	273 V8 2 BBL.	HPR0160
Satellite	318 V8 CARB	HPR0160	Belvedere II	318 V8 CARB	HPR0160
Valiant	318 V8 CARB	HPR0160	Fury	273 V8 2 BBL.	HPR0160
1969 PLYMOUTH			Fury	318 V8 CARB	HPR0160
Barracuda	318 V8 CARB	HPR0160	Fury II	273 V8 2 BBL.	HPR0160
Belvedere	318 V8 CARB	HPR0160	Fury II	318 V8 CARB	HPR0160
Fury	318 V8 CARB	HPR0160	Fury III	273 V8 2 BBL.	HPR0160
Fury I	318 V8 CARB	HPR0160	Fury III	318 V8 CARB	HPR0160
Fury II	318 V8 CARB	HPR0160	Satellite	273 V8 2 BBL.	HPR0160
Fury III	318 V8 CARB	HPR0160	Satellite	318 V8 CARB	HPR0160
Satellite	318 V8 CARB	HPR0160	Valiant	273 V8 CARB	HPR0160
Valiant	273 V8 CARB	HPR0160	1964 PLYMOUTH		
Valiant	318 V8 CARB	HPR0160	Barracuda	273 V8 CARB	HPR0160
1968 PLYMOUTH			Barracuda	361 V8 CARB - w/10 in OD Filter	HPR0160
Barracuda	318 V8 CARB	HPR0160	Belvedere	318 V8 CARB	HPR0160
Belvedere	273 V8 CARB	HPR0160	Belvedere	361 V8 CARB	HPR0160
Belvedere	318 V8 CARB	HPR0160	Belvedere	426 V8 CARB - w/10 in OD Filter	HPR0160
Fury	318 V8 CARB	HPR0160	Fury	273 V8 CARB	HPR0160
Fury I	318 V8 CARB	HPR0160	Fury	318 V8 CARB	HPR0160
Fury II	318 V8 CARB	HPR0160	Fury	361 V8 CARB	HPR0160
Fury III	318 V8 CARB	HPR0160	Fury	383 V8 CARB	HPR0160
GTX	318 V8 CARB	HPR0160	Fury	426 V8 CARB	HPR0160
Roadrunner	273 V8 CARB	HPR0160	Savoy	273 V8 CARB	HPR0160
Roadrunner	318 V8 CARB	HPR0160	Savoy	318 V8 CARB	HPR0160
Satellite	273 V8 CARB	HPR0160	Valiant	273 V8 CARB	HPR0160
Satellite	318 V8 CARB	HPR0160	1963 PLYMOUTH		
Valiant	273 V8 CARB	HPR0160	Belvedere	318 V8 CARB	HPR0160
Valiant	318 V8 CARB	HPR0160	Fleet Special	318 V8 CARB	HPR0160
			Fury	361 V8 CARB	HPR0160

*Indicates 2 filters required ♦ Intake system available - see page 326 + throttle body spacer available - see page 20

HPR™ REPLACEMENT AIR FILTERS PLYMOUTH

Vehicle	Engine Type	Air Filter	Vehicle	Engine Type	Air Filter
1963 PLYMOUTH			2009 PONTIAC		
Fury	383 V8 CARB - 2 BBL	HPR0160	G5	2.2L L4 F/I	HPR9969
Savoy	318 V8 CARB	HPR0160	G6	2.4L L4 F/I - OEM 22676970	HPR9492
1962 PLYMOUTH			G6	3.5L V6 F/I - OEM 22676970	HPR9492
Belvedere	318 V8 CARB	HPR0160	G6	3.6L V6 F/I	HPR9492
Belvedere	361 V8 CARB - w/10 in OD Filter	HPR0160	Montana	3.9L V6 F/I	HPR7597
Fury	361 V8 CARB - w/10 in OD Filter	HPR0160	Torrent	3.4L V6 F/I	HPR9492
Savoy	318 V8 CARB - w/10 in OD Filter	HPR0160	Vibe	2.4L L4 F/I	HPR10169
Savoy	361 V8 CARB - w/10 in OD Filter	HPR0160	2008 PONTIAC		
1961 PLYMOUTH			G5	2.2L L4 F/I	HPR9969
Belvedere	318 V8 CARB	HPR0160	G5	2.4L L4 F/I	HPR9969
Belvedere	361 V8 CARB	HPR0160	G6	2.4L L4 F/I - OEM 22676970	HPR9492
Belvedere	383 V8 CARB	HPR0160	G6	3.5L V6 F/I - OEM 22676970	HPR9492
Custom	361 V8 CARB	HPR0160	G6	3.6L V6 F/I	HPR9492
Fleet Special	318 V8 CARB	HPR0160	Grand Prix	3.8L V6 F/I	HPR6479
Fleet Special	361 V8 CARB	HPR0160	Grand Prix	5.3L V8 F/I	HPR10014
Fleet Special	383 V8 CARB	HPR0160	Montana	3.9L V6 F/I	HPR7597
Fury	318 V8 CARB	HPR0160	Torrent	3.4L V6 F/I	HPR9492
Fury	361 V8 CARB	HPR0160	Torrent	3.6L V6 F/I	HPR9492
Savoy	318 V8 CARB	HPR0160	Vibe	1.8L L4 F/I	HPR9482
Savoy	361 V8 CARB	HPR0160	2007 PONTIAC		
Sport Wagon	318 V8 CARB	HPR0160	G5	2.2L L4 F/I	HPR9969
Sport Wagon	361 V8 CARB	HPR0160	G5	2.4L L4 F/I	HPR9969
Sport Wagon	383 V8 CARB	HPR0160	G6	3.6L V6 F/I	HPR9492
Suburban	318 V8 CARB	HPR0160	Grand Prix	3.8L V6 F/I	HPR6479
Suburban	361 V8 CARB	HPR0160	Grand Prix	5.3L V8 F/I	HPR10014
Suburban	383 V8 CARB	HPR0160	Montana	3.9L V6 F/I	HPR7597
1960 PLYMOUTH			Torrent	3.4L V6 F/I	HPR9492
Belvedere	318 V8 CARB	HPR0160	Vibe	1.8L L4 F/I	HPR9482
Belvedere	361 V8 CARB	HPR0160	2006 PONTIAC		
Custom	361 V8 CARB	HPR0160	Grand Prix	3.8L V6 F/I	HPR6479
Fleet Special	318 V8 CARB	HPR0160	Grand Prix	5.3L V8 F/I	HPR10014
Fleet Special	361 V8 CARB	HPR0160	Montana	3.5L V6 F/I	HPR7597
Fury	318 V8 CARB	HPR0160	Montana	3.9L V6 F/I	HPR7597
Fury	361 V8 CARB	HPR0160	Pursuit	2.2L L4 F/I	HPR9969
Savoy	318 V8 CARB	HPR0160	Pursuit	2.4L L4 F/I	HPR9969
Savoy	361 V8 CARB	HPR0160	Torrent	3.4L V6 F/I	HPR9492
Sport Wagon	318 V8 CARB	HPR0160	Vibe	1.8L L4 F/I	HPR9482
Sport Wagon	361 V8 CARB	HPR0160	Vibe GT	1.8L L4 F/I	HPR9482
Suburban	318 V8 CARB	HPR0160	2005 PONTIAC		
Suburban	361 V8 CARB	HPR0160	Aztek	3.4L V6 F/I	HPR7597
Suburban	383 V8 CARB	HPR0160	Bonneville	3.8L V6 F/I	HPR6479
1959 PLYMOUTH			Bonneville	4.6L V8 F/I	HPR7597
Belvedere	318 V8 CARB	HPR0160	Grand Am	2.2L L4 F/I	HPR8221
Fury	318 V8 CARB	HPR0160	Grand Am	3.4L V6 F/I	HPR8221
Fury	361 V8 CARB	HPR0160	Grand Prix	3.8L V6 F/I	HPR6479
Savoy	318 V8 CARB	HPR0160	Grand Prix	5.3L V8 F/I	HPR10014
Suburban	318 V8 CARB	HPR0160	Montana	3.4L V6 F/I	HPR7597
1958 PLYMOUTH			Montana	3.5L V6 F/I	HPR7597
Belvedere	318 V8 CARB	HPR0160	Pursuit	2.2L L4 F/I	HPR9969
Belvedere	350 V8 CARB - w/10 in OD Filter	HPR0160	Sunfire	2.2L L4 F/I	HPR3916
Savoy	318 V8 CARB	HPR0160	Vibe	1.8L L4 F/I	HPR9482
Savoy	350 V8 CARB - w/10 in OD Filter	HPR0160	Vibe GT	1.8L L4 F/I	HPR9482
Suburban	318 V8 CARB	HPR0160	2004 PONTIAC		
Suburban	350 V8 CARB - w/10 in OD Filter	HPR0160	Aztek	3.4L V6 F/I	HPR7597
2010 PONTIAC			Bonneville	3.8L V6 F/I	HPR6479
G5	2.2L L4 F/I	HPR9969	Bonneville	4.6L V8 F/I	HPR7597
G6	2.4L L4 F/I - OEM 22676970	HPR9492	Grand Am	2.2L L4 F/I	HPR8221
G6	3.5L V6 F/I - OEM 22676970	HPR9492	Grand Am	3.4L V6 F/I	HPR8221
G6	3.6L V6 F/I	HPR9492	Grand Prix	3.8L V6 F/I	HPR6479
Vibe	2.4L L4 F/I	HPR10169	Montana	3.4L V6 F/I	HPR7597
			Sunfire	2.2L L4 F/I	HPR3916
			Vibe	1.8L L4 F/I	HPR9482

*Indicates 2 filters required ♦ Intake system available - see page 326 + throttle body spacer available - see page 20

PONTIAC

HPR™ REPLACEMENT AIR FILTERS

Vehicle	Engine Type	Air Filter	Vehicle	Engine Type	Air Filter
2004 PONTIAC			1999 PONTIAC		
Vibe GT	1.8L L4 F/I	HPR9482	Trans Sport	3.4L V6 F/I	HPR7597
2003 PONTIAC			1998 PONTIAC		
Aztek	3.4L V6 F/I	HPR7597	Bonneville	3.8L V6 F/I	HPR6479
Bonneville	3.8L V6 F/I	HPR6479	Firebird	3.8L V6 F/I	HPR3914
Grand Am	2.2L L4 F/I	HPR8221	Firebird	5.7L V8 F/I	HPR3914
Grand Am	3.4L V6 F/I	HPR8221	Firefly	1.0L L3 F/I	HPR7598
Grand Prix	3.1L V6 F/I	HPR6479	Firefly	1.3L L4 F/I	HPR7598
Grand Prix	3.8L V6 F/I	HPR6479	Grand Am	2.4L L4 F/I	HPR7598
Montana	3.4L V6 F/I	HPR7597	Grand Am	3.1L V6 F/I	HPR7598
Sunfire	2.2L L4 F/I	HPR3916	Grand Prix	3.1L V6 F/I	HPR7597
Vibe	1.8L L4 F/I	HPR9482	Grand Prix	3.8L V6 F/I	HPR7597
Vibe GT	1.8L L4 F/I	HPR9482	Sunfire	2.2L L4 F/I	HPR3916
2002 PONTIAC			Sunfire	2.4L L4 F/I	HPR3916
Aztek	3.4L V6 F/I	HPR7597	Trans Sport	3.4L V6 F/I	HPR7597
Bonneville	3.8L V6 F/I	HPR6479	1997 PONTIAC		
Firebird	3.8L V6 F/I	HPR3914	Bonneville	3.8L V6 F/I	HPR6479
Firebird	5.7L V8 F/I	HPR3914	Firebird	3.8L V6 F/I	HPR7421
Grand Am	2.2L L4 F/I	HPR8221	Firebird	5.7L V8 F/I - w/o Ram Air	HPR7421
Grand Am	3.4L V6 F/I	HPR8221	Firefly	1.0L L3 F/I	HPR7598
Grand Prix	3.1L V6 F/I	HPR6479	Firefly	1.3L L4 F/I	HPR7598
Grand Prix	3.8L V6 F/I	HPR6479	Grand Am	2.4L L4 F/I	HPR7598
Montana	3.4L V6 F/I	HPR7597	Grand Am	3.1L V6 F/I	HPR7598
Sunfire	2.2L L4 F/I	HPR3916	Grand Prix	3.1L V6 F/I	HPR7597
Sunfire	2.4L L4 F/I	HPR3916	Grand Prix	3.8L V6 F/I	HPR7597
2001 PONTIAC			Sunfire	2.2L L4 F/I	HPR3916
Aztek	3.4L V6 F/I	HPR7597	Sunfire	2.4L L4 F/I	HPR3916
Bonneville	3.8L V6 F/I	HPR6479	Trans Sport	3.4L V6 F/I	HPR7597
Firebird	3.8L V6 F/I	HPR3914	1996 PONTIAC		
Firebird	5.7L V8 F/I	HPR3914	Bonneville	3.8L V6 F/I	HPR6479
Grand Am	2.4L L4 F/I	HPR8221	Firebird	3.8L V6 F/I	HPR7421
Grand Am	3.4L V6 F/I	HPR8221	Firebird	5.7L V8 F/I - w/o Ram Air	HPR7421
Grand Prix	3.1L V6 F/I	HPR6479	Firefly	1.0L L3 F/I	HPR7598
Grand Prix	3.8L V6 F/I	HPR6479	Firefly	1.3L L4 F/I	HPR7598
Montana	3.4L V6 F/I	HPR7597	Grand Am	2.4L L4 F/I	HPR7598
Sunfire	2.2L L4 F/I	HPR3916	Grand Am	3.1L V6 F/I	HPR7598
Sunfire	2.4L L4 F/I	HPR3916	Grand Prix	3.1L V6 F/I	HPR7597
2000 PONTIAC			Grand Prix	3.4L V6 F/I	HPR7597
Bonneville	3.8L V6 F/I	HPR6479	Sunfire	2.2L L4 F/I	HPR3916
Firebird	3.8L V6 F/I	HPR3914	Sunfire	2.4L L4 F/I	HPR3916
Firebird	5.7L V8 F/I	HPR3914	Trans Sport	3.4L V6 F/I	HPR3916
Firefly	1.0L L3 F/I	HPR7598	1995 PONTIAC		
Firefly	1.3L L4 F/I	HPR7598	Bonneville	3.8L V6 F/I	HPR6479
Grand Am	2.4L L4 F/I	HPR8221	Firebird	3.4L V6 F/I	HPR7421
Grand Am	3.4L V6 F/I	HPR8221	Firebird	3.8L V6 F/I	HPR7421
Grand Prix	3.1L V6 F/I	HPR6479	Firebird	5.7L V8 F/I - w/o Ram Air	HPR7421
Grand Prix	3.8L V6 F/I	HPR6479	Firefly	1.0L L3 F/I	HPR7598
Montana	3.4L V6 F/I	HPR7597	Firefly	1.3L L4 F/I	HPR7598
Sunfire	2.2L L4 F/I	HPR3916	Grand Am	2.3L L4 F/I	HPR7598
Sunfire	2.4L L4 F/I	HPR3916	Grand Am	3.1L V6 F/I	HPR7598
1999 PONTIAC			Grand Prix	3.1L V6 F/I	HPR7597
Bonneville	3.8L V6 F/I	HPR6479	Grand Prix	3.4L V6 F/I	HPR7597
Firebird	3.8L V6 F/I	HPR3914	Sunfire	2.2L L4 F/I	HPR3916
Firebird	5.7L V8 F/I	HPR3914	Sunfire	2.3L L4 F/I	HPR3916
Firefly	1.0L L3 F/I	HPR7598	Trans Sport	3.1L V6 F/I	HPR3588
Firefly	1.3L L4 F/I	HPR7598	Trans Sport	3.8L V6 F/I	HPR3916
Grand Am	2.4L L4 F/I	HPR8221	1994 PONTIAC		
Grand Am	3.4L V6 F/I	HPR8221	Bonneville	3.8L V6 F/I	HPR6479
Grand Prix	3.1L V6 F/I	HPR6479	Firebird	3.4L V6 F/I	HPR7421
Grand Prix	3.8L V6 F/I	HPR6479	Firebird	5.7L V8 F/I - w/o Ram Air	HPR7421
Montana	3.4L V6 F/I	HPR7597	Firefly	1.3L L4 F/I	HPR7598
Sunfire	2.2L L4 F/I	HPR3916	Grand Am	2.3L L4 F/I	HPR7598
Sunfire	2.4L L4 F/I	HPR3916	Grand Am	3.1L V6 F/I	HPR7598

*Indicates 2 filters required ♦ Intake system available - see page 326 + throttle body spacer available - see page 20

HPR™ REPLACEMENT AIR FILTERS

PONTIAC

Vehicle	Engine Type	Air Filter	Vehicle	Engine Type	Air Filter
1994 PONTIAC			1989 PONTIAC		
Grand Prix	3.1L V6 F/I	HPR7597	6000	2.5L L4 F/I	HPR3647
Grand Prix	3.4L V6 F/I	HPR7597	Bonneville	3.8L V6 F/I	HPR3916
Sunbird	2.0L L4 F/I	HPR3916	Firebird	2.8L V6 F/I	HPR3902
Trans Sport	3.1L V6 F/I	HPR3588	Firebird	5.0L V8 MFI	HPR3902
Trans Sport	3.8L V6 F/I	HPR3916	Firebird	5.0L V8 TBI	HPR0192
1993 PONTIAC			Firebird	5.7L V8 F/I	HPR3902
Bonneville	3.8L V6 F/I	HPR6479	Grand Am	2.3L L4 F/I	HPR3916
Firebird	3.4L V6 F/I	HPR7421	Grand Am	2.3L L4 F/I - VIN A	HPR3916
Firebird	5.7L V8 F/I - w/o Ram Air	HPR7421	Grand Am	2.5L L4 F/I	HPR3647
Grand Am	2.3L L4 F/I	HPR3916	Grand Prix	2.8L V6 F/I	HPR6626
Grand Am	3.3L V6 F/I	HPR3916	Grand Prix	3.1L V6 F/I	HPR6626
Grand Prix	3.1L V6 F/I	HPR6626	LeMans	2.0L L4 F/I	HPR3647
Grand Prix	3.4L V6 F/I	HPR6626	Optima	2.0L L4 F/I	HPR3647
Sunbird	2.0L L4 F/I	HPR3916	Safari	5.0L V8 CARB	HPR0326
Trans Sport	3.1L V6 F/I	HPR3588	Sunbird	2.0L L4 F/I	HPR3647
Trans Sport	3.8L V6 F/I	HPR3916	1988 PONTIAC		
1992 PONTIAC			6000	2.5L L4 F/I	HPR3647
Bonneville	3.8L V6 F/I	HPR6479	Bonneville	3.8L V6 F/I	HPR3916
Firebird	3.1L V6 F/I	HPR3902	Fiero	2.5L L4 F/I	HPR3647
Firebird	5.0L V8 TBI	HPR0192	Fiero	2.8L V6 F/I	HPR3902
Firebird	5.0L V8 TPI	HPR3902	Firebird	2.8L V6 F/I	HPR3902
Firebird	5.7L V8 F/I	HPR3902	Firebird	5.0L V8 MFI	HPR3902
Grand Am	2.3L L4 F/I	HPR3916	Firebird	5.0L V8 TBI	HPR0192
Grand Am	3.3L V6 F/I	HPR3916	Firebird	5.7L V8 F/I	HPR3902
Grand Prix	3.1L V6 F/I	HPR6626	Grand Am	2.5L L4 F/I	HPR3647
Grand Prix	3.4L V6 F/I	HPR6626	Optima	2.0L L4 F/I	HPR3647
Sunbird	2.0L L4 F/I	HPR3916	Safari	5.0L V8 CARB	HPR0326
Trans Sport	3.1L V6 F/I	HPR3588	Sunbird	2.0L L4 F/I	HPR3647
Trans Sport	3.8L V6 F/I	HPR3916	1987 PONTIAC		
1991 PONTIAC			6000	2.5L L4 F/I	HPR3647
6000	2.5L L4 F/I	HPR3647	Bonneville	3.8L V6 F/I	HPR3916
Bonneville	3.8L V6 F/I	HPR3916	Fiero	2.5L L4 F/I	HPR3647
Firebird	3.1L V6 F/I	HPR3902	Fiero	2.8L V6 F/I	HPR3902
Firebird	5.0L V8 TBI	HPR0192	Firebird	2.8L V6 F/I	HPR3902
Firebird	5.0L V8 TPI	HPR3902	Firebird	5.0L V8 CARB	HPR0192
Firebird	5.7L V8 F/I	HPR3902	Firebird	5.0L V8 F/I	HPR3902
Grand Am	2.3L L4 F/I	HPR3916	Firebird	5.7L V8 F/I	HPR3902
Grand Am	2.5L L4 F/I	HPR3647	Grand Am	2.5L L4 F/I	HPR3647
Grand Prix	2.3L L4 F/I	HPR3916	Grand Prix	3.8L V6 CARB	HPR0192
Grand Prix	3.1L V6 F/I	HPR6626	Grand Prix	5.0L V8 CARB	HPR0326
Grand Prix	3.4L V6 F/I	HPR6626	Safari	5.0L V8 CARB	HPR0326
Sunbird	2.0L L4 F/I	HPR3647	Sunbird	2.0L L4 F/I	HPR3647
Tempest	2.2L L4 F/I	HPR3647	1986 PONTIAC		
Trans Sport	3.1L V6 F/I	HPR3588	6000	2.5L L4 F/I	HPR3647
1990 PONTIAC			Bonneville	3.8L V6 CARB	HPR0192
6000	2.5L L4 F/I	HPR3647	Bonneville	5.0L V8 CARB	HPR0326
Bonneville	3.8L V6 F/I	HPR3916	Fiero	2.5L L4 F/I	HPR3647
Firebird	3.1L V6 F/I	HPR3902	Fiero	2.8L V6 F/I	HPR3902
Firebird	5.0L V8 MFI	HPR0192	Firebird	2.5L L4 F/I	HPR3647
Firebird	5.0L V8 TBI	HPR3902	Firebird	2.8L V6 F/I	HPR3902
Firebird	5.7L V8 F/I	HPR3902	Firebird	5.0L V8 CARB	HPR0192
Grand Am	2.3L L4 F/I	HPR3916	Firebird	5.0L V8 F/I	HPR3902
Grand Am	2.5L L4 F/I	HPR3647	Grand Am	2.5L L4 F/I	HPR3647
Grand Prix	2.3L L4 F/I	HPR3916	Grand Prix	3.8L V6 CARB	HPR0192
Grand Prix	3.1L V6 F/I	HPR6626	Grand Prix	5.0L V8 CARB	HPR0326
Grand Prix	3.1L V6 F/I - Exc. Turbo	HPR6626	Parisienne	4.3L V6 F/I	HPR0192
LeMans	2.0L L4 F/I	HPR3647	Parisienne	5.0L V8 CARB	HPR0326
Optima	2.0L L4 F/I	HPR3647	Sunbird	1.8L L4 F/I	HPR3647
Sunbird	2.0L L4 F/I	HPR3647	Sunbird	2.0L L4 F/I	HPR3647
Tempest	2.2L L4 F/I	HPR3647	1985 PONTIAC		
Trans Sport	3.1L V6 F/I	HPR3588	6000	2.5L L4 F/I	HPR3647
			Bonneville	3.8L V6 CARB	HPR0192

*Indicates 2 filters required ♦ Intake system available - see page 326 + throttle body spacer available - see page 20

PONTIAC

HPR™ REPLACEMENT AIR FILTERS

Vehicle	Engine Type	Air Filter	Vehicle	Engine Type	Air Filter
1985 PONTIAC			1982 PONTIAC		
Bonneville	5.0L V8 CARB	HPR0326	Parisienne	5.0L V8 CARB	HPR0326
Fiero	2.5L L4 F/I	HPR3647	Phoenix	2.5L L4 CARB	HPR3647
Fiero	2.8L V6 F/I	HPR3902	Phoenix	2.5L L4 F/I	HPR3647
Firebird	2.5L L4 F/I	HPR3647	1981 PONTIAC		
Firebird	2.8L V6 F/I	HPR3902	Bonneville	3.8L V6 CARB	HPR0192
Firebird	5.0L V8 CARB	HPR0192	Bonneville	4.3L V8 CARB	HPR0326
Firebird	5.0L V8 F/I	HPR3902	Bonneville	5.0L V8 CARB	HPR0326
Grand Am	2.5L L4 F/I	HPR3647	Catalina	3.8L V6 CARB	HPR0192
Grand Prix	3.8L V6 CARB	HPR0192	Catalina	4.3L V8 CARB	HPR0326
Grand Prix	5.0L V8 CARB	HPR0326	Catalina	4.4L V8 CARB	HPR3588
J2000 Sunbird	1.8L L4 F/I	HPR3647	Catalina	5.0L V8 CARB - VIN H	HPR0326
J2000 Sunbird	1.8L L4 F/I - Exc. Turbo	HPR3647	Catalina	5.0L V8 CARB - VIN Y	HPR0326
J2000 Sunbird	2.0L L4 F/I	HPR3647	Firebird	3.8L V6 CARB	HPR0192
Parisienne	3.8L V6 CARB	HPR0192	Firebird	4.4L V8 CARB	HPR3588
Parisienne	4.3L V6 F/I	HPR0192	Firebird	5.0L V8 CARB	HPR0326
Parisienne	5.0L V8 CARB	HPR0326	Grand LeMans	3.8L V6 CARB	HPR0192
1984 PONTIAC			Grand LeMans	4.3L V8 CARB	HPR0326
6000	2.5L L4 F/I	HPR3647	Grand LeMans	4.4L V8 CARB	HPR3588
Bonneville	3.8L V6 CARB	HPR0192	Grand LeMans	5.0L V8 CARB	HPR0326
Bonneville	5.0L V8 CARB	HPR0326	Grand Prix	3.8L V6 CARB	HPR0192
Fiero	2.5L L4 F/I	HPR3647	Grand Prix	3.8L V6 CARB - VIN A	HPR0192
Firebird	2.5L L4 F/I	HPR3647	Grand Prix	3.8L V6 CARB - VIN K	HPR3588
Firebird	5.0L V8 CARB	HPR0192	Grand Prix	4.4L V8 CARB	HPR3588
Grand Prix	3.8L V6 CARB	HPR0192	Laurentian	4.4L V8 CARB	HPR3588
Grand Prix	5.0L V8 CARB	HPR0326	Laurentian	5.0L V8 CARB	HPR0326
J2000 Sunbird	1.8L L4 F/I	HPR3647	LeMans	3.8L V6 CARB	HPR0192
J2000 Sunbird	2.0L L4 F/I	HPR3647	LeMans	4.3L V8 CARB	HPR0326
Parisienne	3.8L V6 CARB	HPR0192	LeMans	4.4L V8 CARB	HPR3588
Parisienne	5.0L V8 CARB	HPR0326	LeMans	5.0L V8 CARB	HPR0326
Phoenix	2.5L L4 F/I	HPR3647	Parisienne	4.3L V8 CARB	HPR0192
1983 PONTIAC			Parisienne	4.4L V8 CARB	HPR3588
6000	2.5L L4 F/I	HPR3647	Parisienne	5.0L V8 CARB	HPR0326
Bonneville	3.8L V6 CARB	HPR0192	1980 PONTIAC		
Bonneville	5.0L V8 CARB	HPR0326	Bonneville	231 V6 CARB	HPR0192
Firebird	2.5L L4 TBI	HPR3647	Bonneville	265 V8 CARB	HPR0192
Firebird	5.0L V8 CARB	HPR0192	Bonneville	301 V8 CARB	HPR0192
Grand LeMans	3.8L V6 CARB	HPR0192	Bonneville	350 V8 CARB - w/Buick Eng.	HPR0326
Grand LeMans	5.0L V8 CARB	HPR0326	Bonneville	350 V8 CARB - w/Oldsmobile Eng.	HPR0326
Grand Prix	3.8L V6 CARB	HPR0192	Catalina	229 V6 CARB	HPR0192
Grand Prix	5.0L V8 CARB	HPR0326	Catalina	231 V6 CARB	HPR0192
J2000	1.8L L4 F/I	HPR3647	Catalina	265 V8 CARB	HPR0192
J2000	2.0L L4 F/I	HPR3647	Catalina	267 V8 CARB	HPR0192
Parisienne	3.8L V6 CARB	HPR0192	Catalina	301 V8 CARB	HPR0192
Parisienne	5.0L V8 CARB	HPR0326	Catalina	350 V8 CARB - VIN R	HPR0326
Phoenix	2.5L L4 F/I	HPR3647	Catalina	350 V8 CARB - VIN X	HPR0326
1982 PONTIAC			Firebird	231 V6 CARB	HPR0192
6000	2.5L L4 CARB	HPR3647	Firebird	265 V8 CARB	HPR0192
6000	2.5L L4 F/I	HPR3647	Firebird	301 V8 CARB - w/o Ram Air	HPR0192
Bonneville	3.8L V6 CARB	HPR0192	Firebird	301 V8 CARB - w/Ram Air	HPR0326
Bonneville	4.1L V6 CARB	HPR0192	Firebird	305 V8 CARB	HPR0326
Firebird	2.5L L4 CARB	HPR3647	Firebird Trans Am	305 V8 CARB	HPR0326
Firebird	2.5L L4 TBI	HPR3647	Grand Am	301 V8 CARB	HPR0192
Firebird	5.0L V8 CARB	HPR0192	Grand Am	305 V8 CARB	HPR0326
Grand LeMans	3.8L V6 CARB	HPR0192	Grand LeMans	229 V6 CARB	HPR0192
Grand LeMans	4.4L V8 CARB	HPR3588	Grand LeMans	231 V6 CARB	HPR0192
Grand LeMans	5.0L V8 CARB	HPR0326	Grand LeMans	265 V8 CARB	HPR0192
Grand Prix	3.8L V6 CARB	HPR0192	Grand LeMans	267 V8 CARB	HPR0192
Grand Prix	4.1L V6 CARB	HPR0192	Grand LeMans	301 V8 CARB	HPR0192
Grand Prix	4.4L V8 CARB	HPR3588	Grand LeMans	305 V8 CARB	HPR0326
J2000	1.8L L4 CARB	HPR3647	Grand Prix	231 V6 CARB	HPR0192
J2000	1.8L L4 F/I	HPR3647	Grand Prix	265 V8 CARB	HPR0192
Parisienne	3.8L V6 CARB	HPR0192	Grand Prix	301 V8 CARB	HPR0192
Parisienne	4.4L V8 CARB	HPR3588	Grand Prix	305 V8 CARB	HPR0326

*Indicates 2 filters required ♦ Intake system available - see page 326 + throttle body spacer available - see page 20

HPR™ REPLACEMENT AIR FILTERS

PONTIAC

Vehicle	Engine Type	Air Filter	Vehicle	Engine Type	Air Filter
1980 PONTIAC			1979 PONTIAC		
Laurentian	229 V6 CARB	HPR0192	LeMans	301 V8 CARB	HPR0192
Laurentian	267 V8 CARB	HPR0192	LeMans	305 V8 CARB	HPR0326
Laurentian	305 V8 CARB	HPR0326	LeMans	350 V8 CARB	HPR0326
Laurentian	350 V8 CARB	HPR0326	Parisienne	305 V8 CARB	HPR0326
Laurentian	350 V8 DSL	HPR0326	Parisienne	350 V8 CARB	HPR0326
LeMans	229 V6 CARB	HPR0192	Phoenix	231 V6 CARB	HPR0192
LeMans	231 V6 CARB	HPR0192	Phoenix	305 V8 CARB	HPR0192
LeMans	265 V8 CARB	HPR0192	Phoenix	350 V8 CARB	HPR0326
LeMans	267 V8 CARB	HPR0192	Sunbird	231 V6 CARB	HPR0192
LeMans	301 V8 CARB	HPR0192	1978 PONTIAC		
LeMans	305 V8 CARB	HPR0326	Bonneville	301 V8 2 BBL.	HPR0192
Parisienne	229 V6 CARB	HPR0192	Bonneville	301 V8 4 BBL.	HPR0192
Parisienne	267 V8 CARB	HPR0192	Bonneville	350 V8 CARB - w/Buick Eng.	HPR0326
Parisienne	305 V8 CARB	HPR0326		350 V8 CARB - w/Oldsmobile Eng.	48026
Parisienne	350 V8 CARB	HPR0326			880136
Parisienne	350 V8 DSL	HPR0326			HPR0136
Sunbird	3.8L V6 CARB	HPR0192		400 V8 CARB	48026
1979 PONTIAC					880136
Bonneville	301 V8 2 BBL.	HPR0192			HPR0136
Bonneville	301 V8 4 BBL.	HPR0192		403 V8 CARB	48026
Bonneville	350 V8 CARB - w/Buick Eng.	HPR0326			880136
	350 V8 CARB - w/Oldsmobile Eng.	48026			HPR0136
		880136	Catalina	231 V6 CARB	HPR0192
		HPR0136	Catalina	301 V8 CARB	HPR0192
	403 V8 CARB	48026		350 V8 CARB - VIN R	48026
		880136			880136
		HPR0136			HPR0136
Catalina	231 V6 CARB	HPR0192	Catalina	350 V8 CARB - VIN X	HPR0326
Catalina	301 V8 2 BBL.	HPR0192		400 V8 CARB	48026
Catalina	301 V8 4 BBL.	HPR0192			880136
	350 V8 CARB - VIN R	48026			HPR0136
		880136		403 V8 CARB	48026
		HPR0136			880136
Catalina	350 V8 CARB - VIN X	HPR0326			HPR0136
	403 V8 CARB	48026	Firebird	305 V8 CARB	HPR0192
		880136	Firebird	350 V8 CARB	HPR0326
		HPR0136		400 V8 CARB - w/o Ram Air	48026
Firebird	231 V6 CARB	HPR0192			880136
Firebird	301 V8 2 BBL.	HPR0192			HPR0136
Firebird	301 V8 4 BBL. - w/o Ram Air	HPR0192		403 V8 CARB - w/o Ram Air	48026
Firebird	305 V8 CARB	HPR0192			880136
Firebird	350 V8 CARB	HPR0326			HPR0136
	400 V8 CARB - w/o Ram Air	48026	Grand Am	301 V8 CARB	HPR0192
		880136	Grand Am	305 V8 CARB	HPR0192
		HPR0136	Grand LeMans	200 V6 CARB	HPR0192
	403 V8 CARB - w/o Ram Air	48026	Grand LeMans	231 V6 CARB	HPR0192
		880136	Grand LeMans	350 V8 CARB	HPR0326
		HPR0136	Grand Prix	231 V6 CARB	HPR0192
Grand Am	231 V6 CARB	HPR0192	Grand Prix	301 V8 CARB	HPR0192
Grand Am	301 V8 CARB	HPR0192	Grand Prix	305 V8 CARB	HPR0326
Grand Am	305 V8 CARB	HPR0326	Grand Safari	400 V8 CARB	48026
Grand LeMans	200 V6 CARB	HPR0192			HPR0136
Grand LeMans	231 V6 CARB	HPR0192		403 V8 CARB	48026
Grand LeMans	267 V8 CARB	HPR0192			HPR0136
Grand LeMans	305 V8 CARB	HPR0326	Laurentian	350 V8 CARB	HPR0326
Grand LeMans	350 V8 CARB	HPR0326	LeMans	200 V6 CARB	HPR0192
Grand Prix	231 V6 CARB	HPR0192	LeMans	231 V6 CARB	HPR0192
Grand Prix	301 V8 CARB	HPR0192	LeMans	305 V8 CARB	HPR0192
Grand Prix	305 V8 CARB	HPR0326	LeMans	350 V8 CARB	HPR0326
Laurentian	305 V8 CARB	HPR0326	Parisienne	350 V8 CARB	HPR0326
Laurentian	350 V8 CARB	HPR0326	Phoenix	231 V6 CARB	HPR0192
LeMans	200 V6 CARB	HPR0192	Phoenix	305 V8 CARB	HPR0192
LeMans	231 V6 CARB	HPR0192	Phoenix	350 V8 CARB	HPR0326
LeMans	267 V8 CARB	HPR0192	Safari	231 V6 2 BBL.	HPR0192

*Indicates 2 filters required ♦ Intake system available - see page 326 + throttle body spacer available - see page 20

PONTIAC

HPR™ REPLACEMENT AIR FILTERS

Vehicle	Engine Type	Air Filter	Vehicle	Engine Type	Air Filter
1978 PONTIAC			1977 PONTIAC		
Safari	301 V8 2 BBL.	HPR0192	Grand Safari	400 V8 CARB	HPR0136
Safari	301 V8 4 BBL.	HPR0192		403 V8 CARB	48026
	400 V8 4 BBL.	48026			880136
		HPR0136			HPR0136
	403 V8 4 BBL.	48026	Laurentian	305 V8 CARB	HPR0326
		HPR0136		350 V8 CARB	48026
					HPR0136
1977 PONTIAC			LeMans	231 V6 CARB	HPR0192
Bonneville	301 V8 CARB	HPR0192	LeMans	301 V8 CARB	HPR0192
	350 V8 CARB	48026	LeMans	305 V8 CARB	HPR0326
		880136		350 V8 CARB	48026
		HPR0136			880136
	400 V8 CARB	48026			HPR0136
		880136		400 V8 CARB	48026
		HPR0136			880136
	403 V8 CARB	48026			HPR0136
		880136		403 V8 CARB	48026
		HPR0136			880136
Catalina	231 V6 CARB	HPR0192			HPR0136
Catalina	301 V8 CARB	HPR0192	Parisienne	305 V8 CARB	HPR0326
	350 V8 CARB	48026		350 V8 CARB	48026
		880136			HPR0136
		HPR0136	Phoenix	231 V6 CARB	HPR0192
	400 V8 CARB	48026	Phoenix	305 V8 CARB	HPR0192
		880136	Phoenix	350 V8 CARB - w/Chevrolet Eng.	HPR0326
		HPR0136		350 V8 CARB - w/Oldsmobile Eng.	48026
	403 V8 CARB	48026			880136
		880136			HPR0136
		HPR0136	Ventura	231 V6 CARB	HPR0192
Firebird	301 V8 CARB	HPR0192	Ventura	301 V8 CARB	HPR0192
	350 V8 CARB	48026	Ventura	305 V8 CARB	HPR0192
		880136	Ventura	350 V8 CARB - VIN L	HPR0326
		HPR0136		350 V8 CARB - VIN R	48026
	400 V8 CARB - w/o Ram Air	48026			880136
		880136			HPR0136
		HPR0136	Bonneville	400 V8 4 BBL.	48026
	403 V8 CARB - w/o Ram Air	48026			HPR0136
		880136		455 V8 CARB	48026
		HPR0136			880136
Grand LeMans	231 V6 CARB	HPR0192			HPR0136
Grand LeMans	305 V8 CARB	HPR0326	Catalina	350 V8 CARB	48026
	350 V8 CARB	48026			880136
		880136			HPR0136
		HPR0136		400 V8 4 BBL.	48026
	400 V8 CARB	48026			HPR0136
		880136		455 V8 CARB	48026
		HPR0136			880136
	403 V8 CARB	48026	Firebird	350 V8 CARB	HPR0136
		880136			48026
		HPR0136			880136
Grand Prix	301 V8 CARB	HPR0192			HPR0136
	350 V8 CARB	48026		400 V8 CARB - w/o Ram Air	48026
		880136			880136
		HPR0136			HPR0136
	400 V8 CARB	48026		455 V8 CARB - w/o Ram Air	48026
		880136			880136
		HPR0136			HPR0136
	403 V8 CARB	48026	Grand LeMans	260 V8 CARB	HPR0326
		880136		350 V8 CARB	48026
		HPR0136			HPR0136
Grand Safari	350 V8 CARB	48026		400 V8 CARB	48026
		880136			HPR0136
		HPR0136		455 V8 CARB	48026
	400 V8 CARB	48026			880136
		880136			

*Indicates 2 filters required ♦ Intake system available - see page 326 + throttle body spacer available - see page 20

HPR™ REPLACEMENT AIR FILTERS

PONTIAC

Vehicle	Engine Type	Air Filter	Vehicle	Engine Type	Air Filter
1976 PONTIAC			1975 PONTIAC		
Grand LeMans	455 V8 CARB	HPR0136	Grand Safari	400 V8 CARB	48026
Grand Prix	350 V8 4 BBL.	48026			HPR0136
		HPR0136		455 V8 CARB	48026
	400 V8 4 BBL.	48026			HPR0136
		HPR0136	Grandville	400 V8 CARB	48026
	455 V8 CARB	48026			HPR0136
		880136		455 V8 CARB	48026
		HPR0136			880136
Grand Safari	400 V8 CARB	48026			HPR0136
		HPR0136	LeMans	350 V8 4 BBL.	48026
	455 V8 CARB	48026			HPR0136
		HPR0136		400 V8 CARB - w/o Ram Air	48026
Laurentian	350 V8 CARB	HPR0326			HPR0136
	400 V8 CARB	48026	Safari	400 V8 4 BBL.	48026
		HPR0136			HPR0136
LeMans	260 V8 CARB	HPR0326		455 V8 4 BBL.	48026
LeMans	305 V8 CARB	HPR0326			HPR0136
	350 V8 4 BBL.	48026	Ventura	260 V8 CARB	HPR0326
		HPR0136	Ventura	350 V8 CARB	HPR0192
	350 V8 CARB	48026	Bonneville	350 V8 CARB	48026
		HPR0136			HPR0136
	400 V8 4 BBL.	48026		400 V8 2 BBL.	48026
		HPR0136			HPR0136
	455 V8 CARB	48026		400 V8 4 BBL.	48026
		880136			880136
		HPR0136			HPR0136
Parisienne	350 V8 CARB	HPR0326		455 V8 CARB	48026
	400 V8 CARB	48026			880136
		HPR0136			HPR0136
Ventura	260 V8 CARB	HPR0326	Catalina	400 V8 4 BBL.	48026
Ventura	350 V8 CARB	HPR0192			880136
Bonneville	400 V8 CARB - VIN S	48026			HPR0136
		HPR0136		455 V8 CARB	48026
	455 V8 CARB	48026			880136
		880136			HPR0136
		HPR0136	Firebird	350 V8 CARB	48026
Catalina	400 V8 CARB - VIN S	48026			880136
		HPR0136			HPR0136
	455 V8 CARB	48026		400 V8 CARB - w/o Ram Air	48026
		880136			880136
		HPR0136			HPR0136
Firebird	350 V8 CARB	48026		455 V8 CARB - w/o Ram Air	48026
		HPR0136			880136
	400 V8 CARB - w/o Ram Air	48026			HPR0136
		880136	Grand Am	400 V8 4 BBL.	48026
		HPR0136			HPR0136
	455 V8 CARB	48026		455 V8 CARB	48026
		880136			880136
		HPR0136			HPR0136
Grand Am	400 V8 CARB	48026	Grand Prix	400 V8 CARB	48026
		HPR0136			880136
	455 V8 CARB	48026			HPR0136
		880136		455 V8 CARB	48026
		HPR0136			880136
Grand LeMans	350 V8 CARB - w/o Ram Air	48026			HPR0136
		HPR0136	Grand Safari	400 V8 CARB	48026
	455 V8 CARB	48026			880136
		880136			HPR0136
		HPR0136		455 V8 CARB	48026
Grand Prix	400 V8 CARB - w/o Ram Air	48026			880136
		HPR0136			HPR0136
	455 V8 CARB	48026	Grandville	455 V8 CARB	48026
		880136			880136
		HPR0136			HPR0136

*Indicates 2 filters required ♦ Intake system available - see page 326 + throttle body spacer available - see page 20

PONTIAC

HPR™ REPLACEMENT AIR FILTERS

Vehicle	Engine Type	Air Filter	Vehicle	Engine Type	Air Filter	
1974 PONTIAC			1973 PONTIAC			
GT	350 V8 4 BBL.	48026	Grandville	400 V8 CARB	48026	
		HPR0136				880136
	400 V8 4 BBL.	48026				HPR0136
		HPR0136		455 V8 CARB	48026	
LeMans	455 V8 4 BBL.	48026	GTO	400 V8 CARB	48026	
		HPR0136				880136
	350 V8 4 BBL.	48026				HPR0136
		HPR0136		455 V8 CARB	48026	
LeMans	350 V8 CARB - 4 BBL	48026	LeMans	400 V8 4 BBL.	48026	
		HPR0136				880136
	400 V8 4 BBL.	48026				HPR0136
		HPR0136		455 V8 CARB	48026	
Safari	455 V8 CARB	880136	Safari	400 V8 4 BBL.	48026	
		HPR0136				HPR0136
	400 V8 4 BBL.	48026				HPR0136
		HPR0136		455 V8 4 BBL.	48026	
Safari	455 V8 4 BBL.	48026	SJ	400 V8 4 BBL.	48026	
		HPR0136				HPR0136
	350 V8 2 BBL.	48026				HPR0136
		HPR0136		455 V8 4 BBL.	48026	
Sprint	400 V8 4 BBL. - w/o Ram Air	48026	Ventura	307 V8 CARB	HPR0192	
		HPR0136				48026
	350 V8 2 BBL.	48026				880136
		HPR0136		350 V8 CARB	48026	
Ventura	400 V8 4 BBL. - w/o Ram Air	48026	Ventura			
		HPR0136				HPR0136
	350 V8 CARB - w/o Ram Air	880136				HPR0192
		HPR0136				48026
Bonneville	400 V8 4 BBL.	48026	Bonneville	400 V8 4 BBL. - w/o Ram Air	48026	
		880136				880136
	455 V8 CARB	48026				HPR0136
		HPR0136		455 V8 CARB	48026	
Catalina	400 V8 4 BBL.	48026	Catalina	400 V8 4 BBL.	48026	
		880136				880136
	455 V8 CARB	48026				HPR0136
		HPR0136		455 V8 CARB	48026	
Firebird	455 V8 CARB	880136	Firebird	350 V8 CARB	48026	
		HPR0136				880136
	350 V8 CARB	48026				HPR0136
		HPR0136		400 V8 CARB - w/o Ram Air	48026	
Firebird	400 V8 CARB - w/o Ram Air	48026	Firebird			
		880136				880136
	455 V8 CARB - w/o Ram Air	48026				HPR0136
		HPR0136		455 V8 CARB - w/o Ram Air	48026	
Grand Am	400 V8 4 BBL.	48026	Grand Prix	400 V8 CARB	48026	
		HPR0136				880136
	455 V8 CARB	48026				HPR0136
		HPR0136		455 V8 CARB	48026	
Grand Prix	400 V8 CARB	48026	Grand Prix			
		880136				880136
	455 V8 CARB	48026				HPR0136
		HPR0136		455 V8 2 BBL. - w/o Ram Air	48026	
Grand Prix	455 V8 CARB	880136	Grand Safari			
		HPR0136				HPR0136
	400 V8 CARB	48026				HPR0136
		HPR0136		455 V8 CARB	48026	
Grand Safari	455 V8 CARB	880136	Grandville	455 V8 CARB	48026	
		HPR0136				880136
	400 V8 CARB	48026				HPR0136
		HPR0136		400 V8 CARB - w/o Ram Air	48026	
Grand Safari	455 V8 CARB	880136	GTO			
		HPR0136				880136
	400 V8 CARB	48026				HPR0136
		HPR0136		400 V8 CARB - w/Ram Air	HPR0326	
Grand Safari	455 V8 CARB	880136	GTO			
		HPR0136				48026
	400 V8 CARB	48026				HPR0136
		HPR0136		455 V8 CARB - w/o Ram Air	48026	

*Indicates 2 filters required ♦ Intake system available - see page 326 + throttle body spacer available - see page 20

HPR™ REPLACEMENT AIR FILTERS

PONTIAC

Vehicle	Engine Type	Air Filter	Vehicle	Engine Type	Air Filter
1972 PONTIAC			1971 PONTIAC		
GTO	455 V8 CARB - w/o Ram Air	880136	Tempest	400 V8 4 BBL. - w/o Ram Air	HPR0136
		HPR0136		455 V8 4 BBL. - w/o Ram Air	48026
GTO	455 V8 CARB - w/Ram Air	HPR0326			HPR0136
LeMans	400 V8 4 BBL. - w/o Ram Air	48026	Bonneville	400 V8 2 BBL.	48026
		880136			HPR0136
		HPR0136		400 V8 4 BBL.	48026
LeMans	400 V8 4 BBL. - w/Ram Air	HPR0326			HPR0136
	455 V8 CARB - w/o Ram Air	48026		455 V8 CARB	48026
		880136			880136
		HPR0136			HPR0136
LeMans	455 V8 CARB - w/Ram Air	HPR0326	Catalina	400 V8 2 BBL.	48026
Tempest	400 V8 4 BBL. - w/o Ram Air	48026			HPR0136
		HPR0136		400 V8 4 BBL.	48026
Tempest	400 V8 4 BBL. - w/Ram Air	HPR0326			HPR0136
	455 V8 4 BBL. - w/o Ram Air	48026		455 V8 CARB	48026
		HPR0136			880136
Tempest	455 V8 4 BBL. - w/Ram Air	HPR0326			HPR0136
Ventura	307 V8 CARB	HPR0192	Executive	400 V8 2 BBL.	48026
	350 V8 CARB	48026			HPR0136
		880136		400 V8 4 BBL.	48026
		HPR0136			HPR0136
Bonneville	400 V8 4 BBL.	48026		455 V8 CARB	48026
		HPR0136			880136
	455 V8 CARB	48026			HPR0136
		880136	Firebird	350 V8 CARB	48026
		HPR0136			880136
Catalina	400 V8 4 BBL.	48026			HPR0136
		HPR0136		400 V8 CARB - w/o Ram Air	48026
	455 V8 CARB	48026			880136
		880136			HPR0136
		HPR0136	Grand Prix	400 V8 4 BBL.	48026
Firebird	350 V8 CARB	48026			HPR0136
		880136		455 V8 CARB	48026
		HPR0136			880136
	400 V8 CARB - w/o Ram Air	48026			HPR0136
		880136	GTO	400 V8 4 BBL. - w/o Ram Air	48026
		HPR0136			HPR0136
	455 V8 CARB	48026		455 V8 CARB - w/o Ram Air	48026
		880136			880136
		HPR0136			HPR0136
Grand Prix	400 V8 4 BBL.	48026	LeMans	400 V8 4 BBL.	48026
		HPR0136			HPR0136
	455 V8 CARB	48026		455 V8 CARB	48026
		HPR0136			880136
Grand Safari	400 V8 4 BBL.	48026			HPR0136
		880136	Safari	400 V8 4 BBL.	48026
		HPR0136			HPR0136
	455 V8 CARB - w/o Ram Air	48026	Tempest	400 V8 4 BBL.	48026
		880136			HPR0136
		HPR0136	Acadian	396 V8 CARB	48026
Grandville	400 V8 4 BBL.	48026			HPR0136
		HPR0136	Beaumont	307 V8 CARB	HPR0326
	455 V8 CARB	48026	Beaumont	350 V8 CARB	HPR0326
		HPR0136		396 V8 CARB	48026
GTO	400 V8 CARB	48026			HPR0136
		HPR0136	Bonneville	400 V8 CARB - w/o Ram Air	48026
	455 V8 CARB - w/o Ram Air	48026			HPR0136
		HPR0136		428 V8 CARB - w/o Ram Air	48026
LeMans	400 V8 4 BBL. - w/o Ram Air	48026			880136
		HPR0136			HPR0136
	455 V8 CARB - w/o Ram Air	48026	Catalina	400 V8 CARB - w/o Ram Air	48026
		880136			HPR0136
		HPR0136		428 V8 CARB - w/o Ram Air	48026
Tempest	400 V8 4 BBL. - w/o Ram Air	48026			880136

*Indicates 2 filters required ♦ Intake system available - see page 326 + throttle body spacer available - see page 20

PONTIAC

HPR™ REPLACEMENT AIR FILTERS

Vehicle	Engine Type	Air Filter	Vehicle	Engine Type	Air Filter		
1969 PONTIAC			1968 PONTIAC				
Catalina	428 V8 CARB - w/o Ram Air	HPR0136	Executive	428 V8 CARB	880136		
Executive	400 V8 2 BBL.	48026	Firebird	350 V8 2 BBL.	48026		
	400 V8 4 BBL.	HPR0136		350 V8 4 BBL.	HPR0136		
Firebird	428 V8 CARB - w/o Ram Air	48026	Grand Prix	400 V8 2 BBL.	48026		
	350 V8 CARB - w/o Ram Air	HPR0136		400 V8 4 BBL.	HPR0136		
	400 V8 CARB - w/o Ram Air	48026		400 V8 4 BBL.	48026		
	400 V8 2 BBL.	HPR0136		428 V8 CARB	880136		
Grand Prix	400 V8 2 BBL. - w/o Ram Air	48026	GTO	400 V8 CARB	48026		
	400 V8 4 BBL.	HPR0136		LeMans	350 V8 2 BBL.	48026	
	428 V8 CARB - w/o Ram Air	880136			350 V8 4 BBL.	HPR0136	
	400 V8 2 BBL.	HPR0136			400 V8 2 BBL.	48026	
400 V8 4 BBL. - w/o Ram Air	48026	400 V8 4 BBL.	HPR0136				
GTO	400 V8 2 BBL.	HPR0136	Safari	350 V8 2 BBL.	48026		
	400 V8 4 BBL. - w/o Ram Air	48026		350 V8 4 BBL.	HPR0136		
LeMans	350 V8 CARB - w/o Ram Air	HPR0136	Tempest	400 V8 2 BBL.	48026		
	400 V8 CARB - w/o Ram Air	48026		400 V8 4 BBL.	HPR0136		
Safari	428 V8 CARB - w/o Ram Air	48026	Tempest	428 V8 CARB - w/o Ram Air	880136		
	350 V8 CARB - w/o Ram Air	HPR0136		48026	HPR0136		
Tempest	400 V8 CARB - w/o Ram Air	48026	Tempest	350 V8 2 BBL.	48026		
	428 V8 CARB - w/o Ram Air	880136		350 V8 4 BBL.	HPR0136		
1968 PONTIAC			Bonneville	400 V8 2 BBL.	HPR0136		
Acadian	327 V8 CARB	HPR0326		400 V8 4 BBL.	48026		
Beaumont	307 V8 CARB	HPR0326	Bonneville	428 V8 CARB	48026		
	396 V8 CARB	48026		428 V8 CARB	880136		
Bonneville	400 V8 2 BBL.	HPR0136	Catalina	428 V8 CARB	HPR0136		
	400 V8 4 BBL.	48026		Executive	428 V8 CARB	48026	
	428 V8 CARB	HPR0136			Firebird	400 V8 CARB	48026
	400 V8 4 BBL.	48026				Grand Prix	428 V8 CARB
428 V8 CARB	880136	GTO	400 V8 CARB				HPR0136
400 V8 2 BBL.	HPR0136		GTO	400 V8 CARB			48026
400 V8 4 BBL.	48026			GTO	400 V8 CARB		48026
428 V8 CARB	HPR0136				GTO	400 V8 CARB	48026
400 V8 2 BBL.	48026	GTO				400 V8 CARB	48026
400 V8 4 BBL.	HPR0136		GTO			400 V8 CARB	48026
428 V8 CARB	48026			GTO		400 V8 CARB	48026
400 V8 2 BBL.	HPR0136				GTO	400 V8 CARB	48026
400 V8 4 BBL.	48026	GTO				400 V8 CARB	48026
428 V8 CARB	HPR0136		GTO			400 V8 CARB	48026
400 V8 2 BBL.	48026			GTO		400 V8 CARB	48026
400 V8 4 BBL.	HPR0136				GTO	400 V8 CARB	48026
428 V8 CARB	48026	GTO				400 V8 CARB	48026

*Indicates 2 filters required ♦ Intake system available - see page 326 + throttle body spacer available - see page 20

HPR™ REPLACEMENT AIR FILTERS

PONTIAC

Vehicle	Engine Type	Air Filter
1967 PONTIAC		
GTO	400 V8 CARB	HPR0136
Beaumont	327 V8 CARB	48026
		HPR0136
	396 V8 CARB	48026
		HPR0136
		48026
		HPR0136
LeMans	215 L6 CARB - Heavy Duty Filter	HPR0192
Tempest	215 L6 CARB - Heavy Duty Filter	HPR0192

1964 PONTIAC		
GTO	215 L6 CARB - Heavy Duty Filter	HPR0192
LeMans	215 L6 CARB - Heavy Duty Filter	HPR0192
Tempest	215 L6 CARB - Heavy Duty Filter	HPR0192

1965 PORSCHE		
356C	97 H4 CARB	HPR3300

1964 PORSCHE		
356C	97 H4 CARB	HPR3300

1959 PORSCHE		
356A	92 H4 CARB	HPR3300

1958 PORSCHE		
356A	92 H4 CARB	HPR3300

2017 RAM		
1500	3.0L V6 DSL	HPR9401
1500	3.6L V6 F/I	HPR9401
1500	5.7L V8 F/I	HPR9401
2500	5.7L V8 F/I	HPR9401
2500	6.4L V8 F/I	HPR9401
3500	5.7L V8 F/I	HPR9401
3500	6.4L V8 F/I	HPR9401

2016 RAM		
1500	3.0L V6 DSL	HPR9401 ♦
1500	3.6L V6 F/I	HPR9401
1500	5.7L V8 F/I	HPR9401
2500	5.7L V8 F/I	HPR9401
2500	6.4L V8 F/I	HPR9401
3500	5.7L V8 F/I	HPR9401
3500	6.4L V8 F/I	HPR9401
4500	6.4L V8 F/I	HPR9401
5500	6.4L V8 F/I	HPR9401

2015 RAM		
1500	3.0L V6 DSL	HPR9401 ♦
1500	3.6L V6 F/I	HPR9401
1500	5.7L V8 F/I	HPR9401 ♦
2500	5.7L V8 F/I	HPR9401 ♦
2500	6.4L V8 F/I	HPR9401
3500	5.7L V8 F/I	HPR9401
3500	6.4L V8 F/I	HPR9401
4500	6.4L V8 F/I	HPR9401
5500	6.4L V8 F/I	HPR9401

2014 RAM		
1500	3.0L V6 DSL	HPR9401 ♦
1500	3.6L V6 F/I	HPR9401 ♦
1500	5.7L V8 F/I	HPR9401 ♦
2500	5.7L V8 F/I	HPR9401 ♦
2500	6.4L V8 F/I	HPR9401
3500	5.7L V8 F/I	HPR9401
3500	6.4L V8 F/I	HPR9401
4500	6.4L V8 F/I	HPR9401
5500	6.4L V8 F/I	HPR9401

Vehicle	Engine Type	Air Filter
2014 RAM		
Ram	5.7L V8 F/I	HPR9401
Ram Pickup	3.6L V6 F/I	HPR9401
Ram Pickup	5.7L V8 F/I	HPR9401

2013 RAM		
1500	3.6L V6 F/I	HPR9401 ♦
1500	4.7L V8 F/I	HPR9401
1500	5.7L V8 F/I	HPR9401 ♦
2500	5.7L V8 F/I	HPR9401 ♦
3500	5.7L V8 F/I	HPR9401
Ram	5.7L V8 F/I	HPR9401
Ram Pickup	4.7L V8 F/I	HPR9401
Ram Pickup	5.7L V8 F/I	HPR9401

2012 RAM		
1500	3.7L V6 F/I	HPR9401
1500	4.7L V8 F/I	HPR9401
1500	5.7L V8 F/I	HPR9401 ♦
2500	5.7L V8 F/I	HPR9401
2500	6.7L L6 DSL	HPR10261 ♦
3500	5.7L V8 F/I	HPR9401
3500	6.7L L6 DSL	HPR10261 ♦
4500	6.7L L6 DSL	HPR10261
5500	6.7L L6 DSL	HPR10261
Ram	5.7L V8 F/I	HPR9401
Ram	6.7L L6 DSL	HPR10261
Ram Pickup	3.7L V6 F/I	HPR9401
Ram Pickup	4.7L V8 F/I	HPR9401
Ram Pickup	5.7L V8 F/I	HPR9401
Ram Pickup	6.7L L6 DSL	HPR10261

2011 RAM		
1500	3.7L V6 F/I	HPR9401
1500	4.7L V8 F/I	HPR9401
1500	5.7L V8 F/I	HPR9401 ♦
2500	5.7L V8 F/I	HPR9401 ♦
2500	6.7L L6 DSL	HPR10261 ♦
3500	5.7L V8 F/I	HPR9401 ♦
3500	6.7L L6 DSL	HPR10261 ♦
4500	6.7L L6 DSL	HPR10261
5500	6.7L L6 DSL	HPR10261
Dakota	3.7L V6 F/I	HPR3901
Dakota	4.7L V8 F/I	HPR3901
Ram Pickup	3.7L V6 F/I	HPR9401
Ram Pickup	4.7L V8 F/I	HPR9401
Ram Pickup	5.7L V8 F/I	HPR9401 ♦
Ram Pickup	6.7L L6 DSL	HPR10261 ♦

2010 RAM		
1500	3.7L V6 F/I	HPR9401
2500	5.7L V8 F/I	HPR9401 ♦
2500	6.7L L6 DSL	HPR10261 ♦
Dakota	3.7L V6 F/I	HPR3901
Ram Pickup	5.7L V8 F/I	HPR9401 ♦
Ram Pickup	6.7L L6 DSL	HPR10261 ♦

2009 SAAB		
9-7x	4.2L L6 F/I	HPR9345
9-7x	5.3L V8 F/I	HPR9345
9-7x	6.0L V8 F/I	HPR9345

2008 SAAB		
9-7x	4.2L L6 F/I	HPR9345
9-7x	5.3L V8 F/I	HPR9345
9-7x	6.0L V8 F/I	HPR9345

2007 SAAB		
9-7x	4.2L L6 F/I	HPR9345

*Indicates 2 filters required ♦ Intake system available - see page 326 + throttle body spacer available - see page 20

Vehicle	Engine Type	Air Filter	Vehicle	Engine Type	Air Filter
2007 SAAB			1998 SATURN		
9-7x	5.3L V8 F/I	HPR9345	SW2	1.9L L4 F/I	HPR7094
2006 SAAB			1997 SATURN		
9-2X	2.5L H4 F/I	HPR4309	SC1	1.9L L4 F/I	HPR7094
9-7x	4.2L L6 F/I	HPR9345	SC2	1.9L L4 F/I	HPR7094
9-7x	5.3L V8 F/I	HPR9345	SL	1.9L L4 F/I	HPR7094
2005 SAAB			SL1	1.9L L4 F/I	HPR7094
9-2X	2.0L H4 F/I	HPR4309	SL2	1.9L L4 F/I	HPR7094
9-2X	2.5L H4 F/I	HPR4309	SW1	1.9L L4 F/I	HPR7094
9-7x	4.2L L6 F/I	HPR9345	SW2	1.9L L4 F/I	HPR7094
9-7x	5.3L V8 F/I	HPR9345	1996 SATURN		
2007 SATURN			SC1	1.9L L4 F/I	HPR7094
Relay	3.9L V6 F/I	HPR7597	SC2	1.9L L4 F/I	HPR7094
2006 SATURN			SL	1.9L L4 F/I	HPR7094
Ion	2.0L L4 F/I	HPR9345	SL1	1.9L L4 F/I	HPR7094
Relay	3.5L V6 F/I	HPR7597	SL2	1.9L L4 F/I	HPR7094
Relay	3.9L V6 F/I	HPR7597	SW1	1.9L L4 F/I	HPR7094
2005 SATURN			SW2	1.9L L4 F/I	HPR7094
Ion	2.0L L4 F/I	HPR9345	1995 SATURN		
Relay	3.5L V6 F/I	HPR7597	SC1	1.9L L4 F/I	HPR7094
2004 SATURN			SC2	1.9L L4 F/I	HPR7094
Ion	2.0L L4 F/I	HPR9345	SL	1.9L L4 F/I	HPR7094
2002 SATURN			SL1	1.9L L4 F/I	HPR7094
SC1	1.9L L4 F/I	HPR7094	SL2	1.9L L4 F/I	HPR7094
SC2	1.9L L4 F/I	HPR7094	SW1	1.9L L4 F/I	HPR7094
SL	1.9L L4 F/I	HPR7094	SW2	1.9L L4 F/I	HPR7094
SL1	1.9L L4 F/I	HPR7094	1994 SATURN		
SL2	1.9L L4 F/I	HPR7094	SC1	1.9L L4 F/I	HPR7094
2001 SATURN			SC2	1.9L L4 F/I	HPR7094
SC1	1.9L L4 F/I	HPR7094	SL	1.9L L4 F/I	HPR7094
SC2	1.9L L4 F/I	HPR7094	SL1	1.9L L4 F/I	HPR7094
SL	1.9L L4 F/I	HPR7094	SL2	1.9L L4 F/I	HPR7094
SL1	1.9L L4 F/I	HPR7094	SW1	1.9L L4 F/I	HPR7094
SL2	1.9L L4 F/I	HPR7094	SW2	1.9L L4 F/I	HPR7094
SW1	1.9L L4 F/I	HPR7094	1993 SATURN		
SW2	1.9L L4 F/I	HPR7094	SC1	1.9L L4 F/I	HPR7094
2000 SATURN			SC2	1.9L L4 F/I	HPR7094
SC1	1.9L L4 F/I	HPR7094	SL	1.9L L4 F/I	HPR7094
SC2	1.9L L4 F/I	HPR7094	SL1	1.9L L4 F/I	HPR7094
SL	1.9L L4 F/I	HPR7094	SL2	1.9L L4 F/I	HPR7094
SL1	1.9L L4 F/I	HPR7094	SW1	1.9L L4 F/I	HPR7094
SL2	1.9L L4 F/I	HPR7094	SW2	1.9L L4 F/I	HPR7094
SW1	1.9L L4 F/I	HPR7094	1992 SATURN		
SW2	1.9L L4 F/I	HPR7094	SC	1.9L L4 F/I - DOHC	HPR7094
1999 SATURN			SL	1.9L L4 F/I	HPR7094
SC1	1.9L L4 F/I	HPR7094	SL1	1.9L L4 F/I	HPR7094
SC2	1.9L L4 F/I	HPR7094	SL2	1.9L L4 F/I	HPR7094
SL	1.9L L4 F/I	HPR7094	1991 SATURN		
SL1	1.9L L4 F/I	HPR7094	SC	1.9L L4 F/I - DOHC	HPR7094
SL2	1.9L L4 F/I	HPR7094	SL	1.9L L4 F/I	HPR7094
SW1	1.9L L4 F/I	HPR7094	SL1	1.9L L4 F/I	HPR7094
SW2	1.9L L4 F/I	HPR7094	SL2	1.9L L4 F/I	HPR7094
1998 SATURN			2016 SCION		
SC1	1.9L L4 F/I	HPR7094	tC	2.5L L4 F/I	HPR10169
SC2	1.9L L4 F/I	HPR7094	2015 SCION		
SL	1.9L L4 F/I	HPR7094	tC	2.5L L4 F/I	HPR10169
SL1	1.9L L4 F/I	HPR7094	xB	2.4L L4 F/I	HPR10169
SL2	1.9L L4 F/I	HPR7094	2014 SCION		
SW1	1.9L L4 F/I	HPR7094	tC	2.5L L4 F/I	HPR10169
			xB	2.4L L4 F/I	HPR10169

*Indicates 2 filters required ♦ Intake system available - see page 326 + throttle body spacer available - see page 20

HPR™ REPLACEMENT AIR FILTERS

SCION

Vehicle	Engine Type	Air Filter	Vehicle	Engine Type	Air Filter
2013 SCION			2016 SUBARU		
tC	2.5L L4 F/I	HPR10169	Legacy	2.5L H4 F/I	HPR9997
xB	2.4L L4 F/I	HPR10169	Legacy	3.6L H6 F/I	HPR9997
2012 SCION			Levorg	1.6L H4 F/I	HPR9997
tC	2.5L L4 F/I	HPR10169	Outback	2.0L H4 DSL	HPR9997
xB	2.4L L4 F/I	HPR10169	Outback	2.5L H4 F/I	HPR9997
2011 SCION			Outback	3.6L H6 F/I	HPR9997
tC	2.5L L4 F/I	HPR10169	WRX	2.0L H4 F/I	HPR9997
xB	2.4L L4 F/I	HPR10169	WRX STI	2.5L H4 F/I	HPR9997
2010 SCION			XV	1.6L H4 F/I	HPR9997
tC	2.4L L4 F/I	HPR9482	XV	2.0L H4 DSL	HPR9997
xB	2.4L L4 F/I	HPR10169	XV	2.0L H4 F/I - Non-US	HPR9997
2009 SCION			XV Crosstrek	2.0L H4 F/I - Exc. Hybrid	HPR9997
tC	2.4L L4 F/I	HPR9482	2015 SUBARU		
xB	2.4L L4 F/I	HPR10169	Forester	2.0L H4 DSL	HPR9997
2008 SCION			Forester	2.0L H4 F/I	HPR9997
tC	2.4L L4 F/I	HPR9482	Forester	2.5L H4 F/I	HPR9997
xB	2.4L L4 F/I	HPR10169	Impreza	1.6L H4 F/I	HPR9997
2007 SCION			Impreza	2.0L H4 F/I	HPR9997
tC	2.4L L4 F/I	HPR9482	Impreza WRX STi	2.5L H4 F/I	HPR9997
xA	1.5L L4 F/I	HPR9115	Legacy	2.5L H4 F/I	HPR9997
xB	1.5L L4 F/I	HPR9115	Legacy	3.6L H6 F/I	HPR9997
2006 SCION			Levorg	1.6L H4 F/I	HPR9997
tC	2.4L L4 F/I	HPR9482	Outback	2.0L H4 DSL	HPR9997
xA	1.5L L4 F/I	HPR9115	Outback	2.5L H4 F/I	HPR9997
xB	1.5L L4 F/I	HPR9115	Outback	3.6L H6 F/I	HPR9997
2005 SCION			WRX	2.0L H4 F/I	HPR9997
xA	1.5L L4 F/I	HPR9115	WRX STI	2.5L H4 F/I	HPR9997
xB	1.5L L4 F/I	HPR9115	XV	1.6L H4 F/I	HPR9997
2004 SCION			XV	2.0L H4 DSL	HPR9997
xA	1.5L L4 F/I	HPR9115	XV	2.0L H4 F/I - Non-US	HPR9997
xB	1.5L L4 F/I	HPR9115	XV Crosstrek	2.0L H4 F/I - Exc. Hybrid	HPR9997
2003 SCION			2014 SUBARU		
xA	1.5L L4 F/I	HPR9115	Forester	2.0L H4 DSL	HPR9997
xB	1.5L L4 F/I	HPR9115	Forester	2.0L H4 F/I	HPR9997
2017 SUBARU			Forester	2.5L H4 F/I	HPR9997
Forester	2.0L H4 DSL	HPR9997	Impreza	1.6L H4 F/I	HPR9997
Forester	2.0L H4 F/I	HPR9997	Impreza	2.0L H4 F/I	HPR9997
Forester	2.5L H4 F/I	HPR9997	Impreza WRX	2.5L H4 F/I	HPR9997
Impreza	2.0L H4 F/I - US	HPR9997	Impreza WRX STi	2.5L H4 F/I	HPR9997
Legacy	2.5L H4 F/I	HPR9997	Legacy	2.5L H4 F/I	HPR9997
Legacy	3.6L H6 F/I	HPR9997	Legacy	3.6L H6 F/I	HPR9997
Levorg	1.6L H4 F/I	HPR9997	Legacy IV	2.0L H4 DSL	HPR9997
Outback	2.0L H4 DSL	HPR9997	Legacy IV	2.0L H4 F/I	HPR9997
Outback	2.5L H4 F/I	HPR9997	Legacy IV	2.5L H4 F/I	HPR9997
Outback	3.6L H6 F/I	HPR9997	Outback	2.0L H4 DSL	HPR9997
WRX	2.0L H4 F/I	HPR9997	Outback	2.5L H4 F/I	HPR9997
WRX STI	2.5L H4 F/I	HPR9997	Outback	3.6L H6 F/I	HPR9997
XV	1.6L H4 F/I	HPR9997	Trezia	1.3L L4 F/I	HPR9115
XV	2.0L H4 DSL	HPR9997	Tribeca	3.6L H6 F/I	HPR9997
XV	2.0L H4 F/I - Non-US	HPR9997	WRX	2.5L H4 F/I	HPR9997
2016 SUBARU			WRX STI	2.5L H4 F/I	HPR9997
Forester	2.0L H4 DSL	HPR9997	XV	1.6L H4 F/I	HPR9997
Forester	2.0L H4 F/I	HPR9997	XV	2.0L H4 DSL	HPR9997
Forester	2.5L H4 F/I	HPR9997	XV	2.0L H4 F/I - Non-US	HPR9997
Impreza	1.6L H4 F/I - To 9/16	HPR9997	XV Crosstrek	2.0L H4 F/I - Exc. Hybrid	HPR9997
Impreza	2.0L H4 F/I - Non-US, To 9/16	HPR9997	2013 SUBARU		
Impreza	2.0L H4 F/I - US	HPR9997	Forester	2.0L H4 DSL	HPR9997
Impreza WRX STi	2.5L H4 F/I	HPR9997	Forester	2.0L H4 F/I	HPR9997
			Forester	2.5L H4 F/I	HPR9997
			Impreza	1.6L H4 F/I	HPR9997
			Impreza	2.0L H4 F/I	HPR9997
			Impreza WRX	2.5L H4 F/I	HPR9997
			Impreza WRX STi	2.5L H4 F/I	HPR9997

*Indicates 2 filters required ♦ Intake system available - see page 326 + throttle body spacer available – see page 20

SUBARU

HPR™ REPLACEMENT AIR FILTERS

Vehicle	Engine Type	Air Filter	Vehicle	Engine Type	Air Filter
2013 SUBARU			2010 SUBARU		
Legacy	2.5L H4 F/I	HPR9997	Forester	2.0L H4 DSL	HPR9997
Legacy	3.6L H6 F/I	HPR9997	Forester	2.0L H4 F/I	HPR9997
Legacy IV	2.0L H4 DSL	HPR9997	Forester	2.5L H4 F/I	HPR9997
Legacy IV	2.0L H4 F/I	HPR9997	Impreza	1.5L H4 F/I	HPR9997
Legacy IV	2.5L H4 F/I	HPR9997	Impreza	2.0L H4 DSL	HPR9997
Outback	2.0L H4 DSL	HPR9997	Impreza	2.0L H4 F/I	HPR9997
Outback	2.5L H4 F/I	HPR9997	Impreza	2.5L H4 F/I	HPR9997
Outback	3.6L H6 F/I	HPR9997	Impreza WRX	2.5L H4 F/I	HPR9997
Trezia	1.3L L4 F/I	HPR9115	Impreza WRX STi	2.5L H4 F/I	HPR9997
Tribeca	3.6L H6 F/I	HPR9997	Legacy	2.5L H4 F/I	HPR9997
WRX	2.5L H4 F/I	HPR9997	Legacy	3.6L H6 F/I	HPR9997
WRX STi	2.5L H4 F/I	HPR9997	Legacy IV	2.0L H4 DSL	HPR9997
XV	1.6L H4 F/I	HPR9997	Legacy IV	2.0L H4 F/I	HPR9997
XV	2.0L H4 DSL	HPR9997	Legacy IV	2.5L H4 F/I	HPR9997
XV	2.0L H4 F/I	HPR9997	Outback	2.0L H4 DSL	HPR9997
XV Crosstrek	2.0L H4 F/I	HPR9997	Outback	2.5L H4 F/I	HPR9997
2012 SUBARU			Outback	3.6L H6 F/I	HPR9997
Forester	2.0L H4 DSL	HPR9997	Tribeca	3.0L H6 F/I	HPR9997
Forester	2.0L H4 F/I	HPR9997	Tribeca	3.6L H6 F/I	HPR9997
Forester	2.5L H4 F/I	HPR9997	2009 SUBARU		
Forester Turbo	2.5L H4 F/I	HPR9997	Forester	2.0L H4 DSL	HPR9997
Impreza	1.5L H4 F/I	HPR9997	Forester	2.0L H4 F/I	HPR9997
Impreza	2.0L H4 DSL	HPR9997	Forester	2.5L H4 F/I	HPR9997
Impreza	2.0L H4 F/I	HPR9997	Impreza	1.5L H4 F/I	HPR9997
Impreza	2.0L H4 F/I	HPR9997	Impreza	2.0L H4 DSL	HPR9997
Impreza WRX	2.5L H4 F/I	HPR9997	Impreza	2.0L H4 F/I	HPR9997
Impreza WRX STi	2.5L H4 F/I	HPR9997	Impreza	2.5L H4 F/I	HPR9997
Legacy	2.5L H4 F/I	HPR9997	Impreza WRX	2.0L H4 F/I	HPR9997
Legacy	3.6L H6 F/I	HPR9997	Impreza WRX	2.5L H4 F/I	HPR9997
Legacy IV	2.0L H4 DSL	HPR9997	Impreza WRX STi	2.0L H4 F/I	HPR9997
Legacy IV	2.0L H4 F/I	HPR9997	Impreza WRX STi	2.5L H4 F/I	HPR9997
Legacy IV	2.5L H4 F/I	HPR9997	Legacy	2.5L H4 F/I	HPR9997
Outback	2.0L H4 DSL	HPR9997	Legacy	3.0L H6 F/I	HPR9997
Outback	2.5L H4 F/I	HPR9997	Legacy GT	2.5L H4 F/I	HPR9997
Outback	3.6L H6 F/I	HPR9997	Legacy IV	2.0L H4 DSL	HPR9997
Trezia	1.3L L4 F/I	HPR9115	Legacy IV	2.0L H4 F/I	HPR9997
Tribeca	3.6L H6 F/I	HPR9997	Legacy IV	2.5L H4 F/I - 165BHP	HPR9997
WRX	2.5L H4 F/I	HPR9997	Legacy IV	3.0L H6 F/I	HPR9997
WRX STi	2.5L H4 F/I	HPR9997	Outback	2.0L H4 DSL	HPR9997
XV	1.6L H4 F/I	HPR9997	Outback	2.5L H4 F/I	HPR9997
XV	2.0L H4 DSL	HPR9997	Outback	3.0L H6 F/I	HPR9997
XV	2.0L H4 F/I	HPR9997	Tribeca	3.0L H6 F/I	HPR9997
2011 SUBARU			Tribeca	3.6L H6 F/I	HPR9997
Forester	2.0L H4 DSL	HPR9997	2008 SUBARU		
Forester	2.0L H4 F/I	HPR9997	Forester	2.0L H4 DSL	HPR9997
Forester	2.5L H4 F/I	HPR9997	Forester	2.0L H4 F/I - From 4/08	HPR9997
Forester Turbo	2.5L H4 F/I	HPR9997	Forester	2.5L H4 F/I	HPR4309
Impreza	1.5L H4 F/I	HPR9997	Impreza	1.5L H4 F/I	HPR9997
Impreza	2.0L H4 DSL	HPR9997	Impreza	2.0L H4 DSL	HPR9997
Impreza	2.0L H4 F/I	HPR9997	Impreza	2.0L H4 F/I	HPR9997
Impreza	2.5L H4 F/I	HPR9997	Impreza	2.5L H4 F/I	HPR9997
Impreza WRX	2.5L H4 F/I	HPR9997	Impreza WRX	2.0L H4 F/I	HPR9997
Impreza WRX STi	2.5L H4 F/I	HPR9997	Impreza WRX	2.5L H4 F/I	HPR9997
Legacy	2.5L H4 F/I	HPR9997	Impreza WRX STi	2.0L H4 F/I	HPR9997
Legacy	3.6L H6 F/I	HPR9997	Impreza WRX STi	2.5L H4 F/I	HPR9997
Legacy IV	2.0L H4 DSL	HPR9997	Legacy	2.5L H4 F/I	HPR9997
Legacy IV	2.0L H4 F/I	HPR9997	Legacy	3.0L H6 F/I	HPR9997
Legacy IV	2.5L H4 F/I	HPR9997	Legacy GT	2.5L H4 F/I	HPR9997
Outback	2.0L H4 DSL	HPR9997	Legacy IV	2.0L H4 DSL	HPR9997
Outback	2.5L H4 F/I	HPR9997	Legacy IV	2.0L H4 F/I	HPR9997
Outback	3.6L H6 F/I	HPR9997	Legacy IV	2.5L H4 F/I - 165BHP	HPR9997
Trezia	1.3L L4 F/I	HPR9115	Legacy IV	3.0L H6 F/I	HPR9997
Tribeca	3.0L H6 F/I	HPR9997	Outback	2.0L H4 DSL	HPR9997
Tribeca	3.6L H6 F/I	HPR9997	Outback	2.5L H4 F/I	HPR9997

*Indicates 2 filters required ♦ Intake system available - see page 326 + throttle body spacer available - see page 20

HPR™ REPLACEMENT AIR FILTERS

SUBARU

Vehicle	Engine Type	Air Filter
---------	-------------	------------

2008 SUBARU

Outback	2.5L H4 F/I	HPR9997
Outback	3.0L H6 F/I	HPR9997
Tribeca	3.0L H6 F/I	HPR9997
Tribeca	3.6L H6 F/I	HPR9997

2007 SUBARU

B9 Tribeca	3.0L H6 F/I	HPR9997
Forester	2.5L H4 F/I	HPR4309
Impreza	1.5L H4 F/I	HPR9997
Impreza	2.0L H4 F/I	HPR9997
Impreza	2.5L H4 F/I	HPR4309
Impreza WRX	2.0L H4 F/I	HPR9997
Impreza WRX	2.5L H4 F/I	HPR4309
Impreza WRX STi	2.0L H4 F/I	HPR9997
Impreza WRX STi	2.5L H4 F/I	HPR4309
Legacy	2.5L H4 F/I	HPR9997
Legacy GT	2.5L H4 F/I	HPR9997
Legacy IV	2.0L H4 F/I	HPR9997
Legacy IV	2.5L H4 F/I - 165BHP	HPR9997
Legacy IV	3.0L H6 F/I	HPR9997
Outback	2.5L H4 F/I	HPR9997
Outback	3.0L H6 F/I	HPR9997
Tribeca	3.0L H6 F/I	HPR9997

2006 SUBARU

B9 Tribeca	3.0L H6 F/I	HPR9997
Baja	2.5L H4 F/I	HPR4309
Forester	2.5L H4 F/I	HPR4309
Forester	2.5L H4 F/I - Non-US, Turbo	HPR4309
Forester Turbo	2.5L H4 F/I	HPR4309
Impreza	2.5L H4 F/I	HPR4309
Impreza WRX	2.5L H4 F/I	HPR4309
Impreza WRX STi	2.5L H4 F/I	HPR4309
Legacy	2.5L H4 F/I	HPR9997
Legacy GT	2.5L H4 F/I	HPR9997
Legacy IV	2.0L H4 F/I	HPR9997
Legacy IV	2.5L H4 F/I - 165BHP	HPR9997
Legacy IV	3.0L H6 F/I	HPR9997
Outback	2.5L H4 F/I	HPR9997
Outback	3.0L H6 F/I	HPR9997
Outback XT	2.5L H4 F/I	HPR9997
Tribeca	3.0L H6 F/I	HPR9997

2005 SUBARU

Baja	2.5L H4 F/I	HPR4309
Forester	2.0L H4 F/I - Turbo	HPR4309
Forester	2.5L H4 F/I	HPR4309
Forester	2.5L H4 F/I - Non-US, Turbo	HPR4309
Forester Turbo	2.5L H4 F/I	HPR4309
Impreza	2.0L H4 F/I - Turbo	HPR4309
Impreza	2.5L H4 F/I	HPR4309
Impreza WRX	2.0L H4 F/I - US	HPR4309
Impreza WRX STi	2.0L H4 F/I	HPR4309
Impreza WRX STi	2.5L H4 F/I	HPR4309
Legacy	2.5L H4 F/I	HPR9997
Legacy GT	2.5L H4 F/I	HPR9997
Legacy IV	2.0L H4 F/I - 138/165BHP	HPR9997
Legacy IV	2.5L H4 F/I - 165BHP	HPR9997
Legacy IV	3.0L H6 F/I	HPR9997
Outback	2.5L H4 F/I	HPR9997
Outback	3.0L H6 F/I	HPR9997
Outback XT	2.5L H4 F/I	HPR9997
Tribeca	3.0L H6 F/I	HPR9997

2004 SUBARU

Baja	2.5L H4 F/I	HPR4309
------	-------------	---------

Vehicle	Engine Type	Air Filter
---------	-------------	------------

2004 SUBARU

Forester	2.0L H4 F/I - Turbo	HPR4309
Forester Turbo	2.5L H4 F/I - Turbo	HPR4309
Impreza	2.0L H4 F/I - Turbo	HPR4309
Impreza WRX	2.0L H4 F/I - US	HPR4309
Legacy	2.5L H4 F/I - OEM 16546AA020	HPR4309
Legacy IV	2.0L H4 F/I - 138BHP	HPR9997
Legacy IV	2.5L H4 F/I - 165BHP	HPR9997
Legacy IV	3.0L H6 F/I	HPR9997
Outback	2.5L H4 F/I - Calif.	HPR4309
Outback	2.5L H4 F/I - Non-US	HPR9997
Outback	3.0L H6 F/I	HPR4309
Outback	3.0L H6 F/I - Non-US, 245BHP	HPR9997
Outback	3.0L H6 F/I - VDC	HPR4309

2003 SUBARU

Forester	2.0L H4 F/I - Turbo	HPR4309
Forester	2.5L H4 F/I - Non-US, Turbo	HPR4309
Impreza	2.0L H4 F/I - Turbo	HPR4309
Impreza WRX	2.0L H4 F/I	HPR4309
Legacy	2.5L H4 F/I - OEM 16546AA020	HPR4309
Legacy IV	2.0L H4 F/I - 138BHP	HPR9997
Legacy IV	2.5L H4 F/I - 165BHP	HPR9997
Legacy IV	3.0L H6 F/I	HPR9997
Outback	2.5L H4 F/I - Non-US, 165BHP	HPR9997
Outback	3.0L H6 F/I	HPR4309
Outback	3.0L H6 F/I - Non-US, 209BHP	HPR4309
Outback	3.0L H6 F/I - Non-US, 245BHP	HPR9997

2002 SUBARU

Forester	2.0L H4 F/I - Turbo	HPR4309
Forester	2.5L H4 F/I - Non-US, Turbo	HPR4309
Impreza	2.0L H4 F/I - Turbo	HPR4309
Impreza WRX	2.0L H4 F/I	HPR4309
Impreza WRX STi	2.0L H4 F/I	HPR4309
Legacy	2.5L H4 F/I - OEM 16546AA020	HPR4309
Outback	3.0L H6 F/I	HPR4309

2001 SUBARU

Forester	2.0L H4 F/I - Turbo	HPR4309
Impreza	2.0L H4 F/I - Turbo	HPR4309
Impreza WRX	2.0L H4 F/I	HPR4309
Legacy	2.5L H4 F/I - OEM 16546AA020	HPR4309
Outback	3.0L H6 F/I	HPR4309

2000 SUBARU

Forester	2.0L H4 F/I - Turbo	HPR4309
Impreza	1.6L H4 F/I - 90BHP	HPR4309
Impreza	1.8L H4 F/I	HPR4309
Impreza	2.0L H4 F/I	HPR4309
Impreza WRX	2.0L H4 F/I	HPR4309
Legacy	2.5L H4 F/I - OEM 16546AA020	HPR4309
Outback	3.0L H6 F/I	HPR4309

1999 SUBARU

Forester	2.0L H4 F/I - Turbo	HPR4309
Forester	2.5L H4 F/I - OEM 16546AA020	HPR4309
Impreza	1.6L H4 F/I - 90BHP	HPR4309
Impreza	1.8L H4 F/I	HPR4309
Impreza	2.0L H4 F/I	HPR4309
Impreza	2.2L H4 F/I - OEM 16546AA020	HPR4309
Impreza	2.5L H4 F/I - OEM 16546AA020	HPR4309
Legacy	2.2L H4 F/I - OEM 16546AA020	HPR4309
Legacy	2.5L H4 F/I - OEM 16546AA020	HPR4309
Legacy II	2.0L H4 F/I	HPR4309
Legacy II	2.2L H4 F/I	HPR4309
Legacy II	2.5L H4 F/I	HPR4309

*Indicates 2 filters required ♦ Intake system available - see page 326 + throttle body spacer available - see page 20

Vehicle	Engine Type	Air Filter	Vehicle	Engine Type	Air Filter
1998 SUBARU			1993 SUBARU		
Forester	2.0L H4 F/ - Turbo	HPR4309	Impreza	1.6L H4 F/ - 90BHP	HPR4309
Forester	2.5L H4 F/	HPR4309	Impreza	1.8L H4 F/	HPR4309
Impreza	1.6L H4 F/ - 90BHP	HPR4309	Legacy	2.2L H4 F/	HPR4309
Impreza	1.8L H4 F/	HPR4309	Legacy	2.2L H4 F/ - Turbo	HPR4309
Impreza	2.0L H4 F/	HPR4309	Legacy I	1.8L H4 F/	HPR4309
Impreza	2.2L H4 F/	HPR4309	Legacy I	2.0L H4 F/	HPR4309
Impreza	2.5L H4 F/	HPR4309	Legacy I	2.2L H4 F/	HPR4309
Legacy	2.2L H4 F/	HPR4309	Legacy I	2.2L H4 F/	HPR4309
Legacy	2.5L H4 F/ - OEM 16546AA020	HPR4309	Loyale	1.8L H4 F/	HPR4309
Legacy II	2.0L H4 F/	HPR4309	SVX	3.3L H6 F/	HPR4309
Legacy II	2.2L H4 F/	HPR4309	1992 SUBARU		
Legacy II	2.5L H4 F/	HPR4309	Impreza	1.6L H4 F/ - 90BHP	HPR4309
Legacy Outback	2.5L H4 F/	HPR4309	Legacy	2.2L H4 F/	HPR4309
1997 SUBARU			Legacy I	1.8L H4 F/	HPR4309
Forester	2.0L H4 F/ - Turbo	HPR4309	Legacy I	2.0L H4 F/	HPR4309
Forester	2.5L H4 F/	HPR4309	Legacy I	2.2L H4 F/	HPR4309
Impreza	1.6L H4 F/ - 90BHP	HPR4309	Loyale	1.8L H4 F/	HPR4309
Impreza	1.8L H4 F/	HPR4309	SVX	3.3L H6 F/	HPR4309
Impreza	2.0L H4 F/	HPR4309	1991 SUBARU		
Impreza	2.2L H4 F/	HPR4309	Legacy	2.2L H4 F/	HPR4309
Legacy	2.2L H4 F/	HPR4309	Legacy I	1.8L H4 F/	HPR4309
Legacy	2.5L H4 F/ - OEM 16546AA020	HPR4309	Legacy I	2.0L H4 F/	HPR4309
Legacy II	2.0L H4 F/	HPR4309	Legacy I	2.2L H4 F/	HPR4309
Legacy II	2.2L H4 F/	HPR4309	Loyale	1.8L H4 F/	HPR4309
Legacy II	2.5L H4 F/	HPR4309	1990 SUBARU		
Legacy Outback	2.5L H4 F/	HPR4309	Legacy	2.2L H4 F/	HPR4309
SVX	3.3L H6 F/	HPR4309	Legacy I	1.8L H4 F/	HPR4309
1996 SUBARU			Legacy I	2.2L H4 F/	HPR4309
Impreza	1.6L H4 F/ - 90BHP	HPR4309	Loyale	1.8L H4 F/	HPR4309
Impreza	1.8L H4 F/	HPR4309	1989 SUBARU		
Impreza	2.0L H4 F/	HPR4309	Legacy I	1.8L H4 F/	HPR4309
Impreza	2.2L H4 F/	HPR4309	Legacy I	2.2L H4 F/	HPR4309
Legacy	2.2L H4 F/	HPR4309	RX	1.8L H4 F/	HPR4309
Legacy	2.5L H4 F/ - OEM 16546AA020	HPR4309	1988 SUBARU		
Legacy II	2.0L H4 F/	HPR4309	RX	1.8L H4 F/	HPR4309
Legacy II	2.2L H4 F/	HPR4309	1987 SUBARU		
Legacy II	2.5L H4 F/	HPR4309	RX	1.8L H4 F/	HPR4309
Legacy Outback	2.5L H4 F/	HPR4309	1986 SUBARU		
SVX	3.3L H6 F/	HPR4309	RX	1.8L H4 F/	HPR4309
1995 SUBARU			2016 SUZUKI		
Impreza	1.6L H4 F/ - 90BHP	HPR4309	SX4 S-Cross	1.6L L4 F/	HPR4309
Impreza	1.8L H4 F/	HPR4309	2015 SUZUKI		
Impreza	2.0L H4 F/	HPR4309	SX4 S-Cross	1.6L L4 F/	HPR4309
Impreza	2.2L H4 F/	HPR4309	2014 SUZUKI		
Legacy	2.2L H4 F/	HPR4309	Swift IV	1.6L L4 F/	HPR4309
Legacy II	2.0L H4 F/	HPR4309	SX4 S-Cross	1.6L L4 F/	HPR4309
Legacy II	2.2L H4 F/	HPR4309	2013 SUZUKI		
SVX	3.3L H6 F/	HPR4309	Swift IV	1.6L L4 F/	HPR4309
1994 SUBARU			SX4	1.6L L4 F/	HPR4309
Impreza	1.6L H4 F/ - 90BHP	HPR4309	SX4 S-Cross	1.6L L4 F/	HPR4309
Impreza	1.8L H4 F/	HPR4309	2012 SUZUKI		
Impreza	2.0L H4 F/	HPR4309	Equator	4.0L V6 F/	HPR7440
Legacy	2.2L H4 F/	HPR4309	Swift IV	1.6L L4 F/	HPR4309
Legacy	2.2L H4 F/ - Turbo	HPR4309	SX4	1.6L L4 F/	HPR4309
Legacy I	1.8L H4 F/	HPR4309	2011 SUZUKI		
Legacy I	2.0L H4 F/	HPR4309	Equator	4.0L V6 F/	HPR7440
Legacy I	2.2L H4 F/	HPR4309	Swift IV	1.6L L4 F/	HPR4309
Legacy II	2.0L H4 F/	HPR4309	SX4	1.6L L4 F/	HPR4309
Legacy II	2.2L H4 F/	HPR4309	2010 SUZUKI		
Loyale	1.8L H4 F/	HPR4309	Equator	4.0L V6 F/	HPR7440
SVX	3.3L H6 F/	HPR4309	Swift IV	1.6L L4 F/	HPR4309
			SX4	1.6L L4 F/	HPR4309

*Indicates 2 filters required ♦ Intake system available - see page 326 + throttle body spacer available - see page 20

HPR™ REPLACEMENT AIR FILTERS

SUZUKI

Vehicle	Engine Type	Air Filter	Vehicle	Engine Type	Air Filter
2010 SUZUKI			1998 SUZUKI		
Equator	4.0L V6 F/I	HPR7440	Grand Vitara	2.0L L4 DSL	HPR8069
SX4	1.6L L4 F/I - 120BHP	HPR4309	Grand Vitara	2.0L L4 F/I	HPR8069
2009 SUZUKI			Grand Vitara	2.5L V6 F/I	HPR8069
Equator	4.0L V6 F/I	HPR7440	Sidekick	1.8L L4 F/I	HPR8069
SX4	1.6L L4 F/I - 120BHP	HPR4309	Vitara	1.9L L4 DSL	HPR8069
2005 SUZUKI			Vitara	2.0L L4 DSL	HPR8069
Grand Vitara	1.6L L4 F/I - to 9/05	HPR8069	Vitara	2.0L L4 F/I	HPR8069
Grand Vitara	2.0L L4 DSL	HPR8069	Vitara	2.0L V6 F/I	HPR8069
Grand Vitara	2.0L L4 F/I - to 9/05	HPR8069	Vitara	2.5L V6 F/I	HPR8069
Grand Vitara	2.5L V6 F/I	HPR8069	1997 SUZUKI		
Grand Vitara	2.7L V6 F/I - to 9/05	HPR8069	Sidekick	1.8L L4 F/I	HPR8069
2004 SUZUKI			Vitara	1.9L L4 DSL	HPR8069
Grand Vitara	1.6L L4 F/I	HPR8069	Vitara	2.0L L4 DSL	HPR8069
Grand Vitara	2.0L L4 DSL	HPR8069	Vitara	2.0L L4 F/I	HPR8069
Grand Vitara	2.0L L4 F/I	HPR8069	Vitara	2.0L V6 F/I	HPR8069
Grand Vitara	2.5L V6 F/I	HPR8069	Vitara	2.5L V6 F/I	HPR8069
Grand Vitara	2.7L V6 F/I	HPR8069	1996 SUZUKI		
Vitara	2.5L V6 F/I	HPR8069	Sidekick	1.8L L4 F/I	HPR8069
2003 SUZUKI			Vitara	1.9L L4 DSL	HPR8069
Grand Vitara	1.6L L4 F/I	HPR8069	Vitara	2.0L L4 DSL	HPR8069
Grand Vitara	2.0L L4 DSL	HPR8069	Vitara	2.0L L4 F/I	HPR8069
Grand Vitara	2.0L L4 F/I	HPR8069	Vitara	2.0L V6 F/I	HPR8069
Grand Vitara	2.5L V6 F/I	HPR8069	Vitara	2.5L V6 F/I	HPR8069
Grand Vitara	2.7L V6 F/I	HPR8069	1995 SUZUKI		
Vitara	2.0L L4 F/I	HPR8069	Vitara	1.9L L4 DSL	HPR8069
XL-7	2.7L V6 F/I	HPR8069	Vitara	2.0L V6 F/I	HPR8069
2002 SUZUKI			Vitara	2.5L V6 F/I	HPR8069
Grand Vitara	1.6L L4 F/I	HPR8069	1994 SUZUKI		
Grand Vitara	2.0L L4 DSL	HPR8069	Vitara	2.0L V6 F/I	HPR8069
Grand Vitara	2.0L L4 F/I	HPR8069	2017 TOYOTA		
Grand Vitara	2.5L V6 F/I	HPR8069	Camry	2.5L L4 F/I	HPR10171
Grand Vitara	2.7L V6 F/I	HPR8069	Land Cruiser	5.7L V8 F/I	HPR10343
Vitara	1.6L L4 F/I	HPR8069	Yaris	1.3L L4 F/I	HPR9115
Vitara	2.0L L4 F/I	HPR8069	2016 TOYOTA		
XL-7	2.7L V6 F/I	HPR8069	Camry	2.5L L4 F/I	HPR10171
2001 SUZUKI			Highlander Hybrid	3.5L V6 F/I	HPR9762
Grand Vitara	1.6L L4 F/I	HPR8069	Land Cruiser	5.7L V8 F/I	HPR10343
Grand Vitara	2.0L L4 DSL	HPR8069	Verso S	1.3L L4 F/I	HPR9115
Grand Vitara	2.0L L4 F/I	HPR8069	Yaris	1.3L L4 F/I	HPR9115
Grand Vitara	2.5L V6 F/I	HPR8069	2015 TOYOTA		
Grand Vitara	2.7L V6 F/I	HPR8069	Camry	2.5L L4 F/I	HPR10171
Vitara	1.6L L4 F/I	HPR8069	Highlander Hybrid	3.5L V6 F/I	HPR9762
Vitara	2.0L L4 F/I	HPR8069	Land Cruiser	5.7L V8 F/I	HPR10343
2000 SUZUKI			Land Cruiser Prado	3.0L V6 DSL	HPR8918
Grand Vitara	1.6L L4 F/I	HPR8069	Rukus	2.4L L4 F/I	HPR10169
Grand Vitara	2.0L L4 DSL	HPR8069	Tacoma	4.0L V6 F/I	HPR9683 ♦
Grand Vitara	2.0L L4 F/I	HPR8069	Venza	2.7L L4 F/I	HPR10171
Grand Vitara	2.5L V6 F/I	HPR8069	Venza	3.5L V6 F/I	HPR10169
Vitara	1.6L L4 F/I	HPR8069	Verso S	1.3L L4 F/I	HPR9115
Vitara	2.0L L4 F/I	HPR8069	Yaris	1.3L L4 F/I	HPR9115
1999 SUZUKI			2014 TOYOTA		
Grand Vitara	1.6L L4 F/I	HPR8069	Camry	2.5L L4 F/I	HPR10171
Grand Vitara	2.0L L4 DSL	HPR8069	Highlander Hybrid	3.5L V6 F/I	HPR9762
Grand Vitara	2.0L L4 F/I	HPR8069	Kluger	3.5L V6 F/I	HPR9360
Grand Vitara	2.5L V6 F/I	HPR8069	Land Cruiser	3.0L L4 DSL	HPR8918
Vitara	1.6L L4 F/I	HPR8069	Land Cruiser	4.5L V8 DSL - Exc. 70 & 200 Series	HPR10343
Vitara	1.9L L4 DSL	HPR8069	Land Cruiser	5.7L V8 F/I	HPR10343
Vitara	2.0L L4 F/I	HPR8069	Land Cruiser Prado	3.0L V6 DSL	HPR8918
1998 SUZUKI			Rukus	2.4L L4 F/I	HPR10169
Grand Vitara	1.6L L4 F/I	HPR8069	Tacoma	4.0L V6 F/I	HPR9683 ♦

*Indicates 2 filters required ♦ Intake system available - see page 326 + throttle body spacer available - see page 20

TOYOTA

HPR™ REPLACEMENT AIR FILTERS

Vehicle	Engine Type	Air Filter	Vehicle	Engine Type	Air Filter
2014 TOYOTA			2011 TOYOTA		
Tundra	4.0L V6 F/I	HPR10343	Highlander Hybrid	3.5L V6 F/I	HPR9762
Urban Cruiser	1.3L L4 F/I	HPR9115	Kluger	3.5L V6 F/I	HPR9360
Venza	2.7L L4 F/I	HPR10171	Land Cruiser	3.0L L4 DSL	HPR8918
Venza	3.5L V6 F/I	HPR10169	Land Cruiser	4.5L V8 DSL - Exc. 70 & 200 Series	HPR10343
Verso S	1.3L L4 F/I	HPR9115	Land Cruiser	5.7L V8 F/I	HPR10343
Yaris	1.3L L4 F/I	HPR9115	Land Cruiser Prado	3.0L V6 DSL	HPR8918
2013 TOYOTA			Matrix	2.4L L4 F/I	HPR10169
Camry	2.5L L4 F/I	HPR10171	RAV4	2.5L L4 F/I	HPR10169
Corolla	2.4L L4 F/I	HPR10169	RAV4	3.5L V6 F/I	HPR10169
Highlander	2.7L L4 F/I	HPR9360	Rukus	2.4L L4 F/I	HPR10169
Highlander	3.5L V6 F/I	HPR9360	Sequoia	4.6L V8 F/I	HPR10343
Highlander Hybrid	3.5L V6 F/I	HPR9762	Sequoia	5.7L V8 F/I	HPR10343 ♦
Kluger	3.5L V6 F/I	HPR9360	Tacoma	4.0L V6 F/I	HPR9683 ♦
Land Cruiser	3.0L L4 DSL	HPR8918	Tundra	4.0L V6 F/I	HPR10343
Land Cruiser	4.5L V8 DSL - Exc. 70 & 200 Series	HPR10343	Tundra	4.6L V8 F/I	HPR10343 ♦
Land Cruiser	5.7L V8 F/I	HPR10343	Tundra	5.7L V8 F/I	HPR10343 ♦
Land Cruiser Prado	3.0L V6 DSL	HPR8918	Urban Cruiser	1.3L L4 F/I	HPR9115
Matrix	2.4L L4 F/I	HPR10169	Venza	2.7L L4 F/I	HPR10171
Rukus	2.4L L4 F/I	HPR10169	Venza	3.5L V6 F/I	HPR10169
Sequoia	5.7L V8 F/I	HPR10343	Verso S	1.3L L4 F/I	HPR9115
Tacoma	4.0L V6 F/I	HPR9683 ♦	Yaris	1.3L L4 F/I	HPR9115
Tundra	4.0L V6 F/I	HPR10343	2010 TOYOTA		
Tundra	4.6L V8 F/I	HPR10343 ♦	Avalon	3.5L V6 F/I	HPR10169
Tundra	5.7L V8 F/I	HPR10343 ♦	Camry	2.5L L4 F/I	HPR10171
Urban Cruiser	1.3L L4 F/I	HPR9115	Camry	3.5L V6 F/I	HPR10169
Venza	2.7L L4 F/I	HPR10171	Camry Hybrid	2.4L L4 F/I	HPR9360
Venza	3.5L V6 F/I	HPR10169	Corolla	2.4L L4 F/I	HPR10169
Verso S	1.3L L4 F/I	HPR9115	Highlander	2.7L L4 F/I	HPR9360
Yaris	1.3L L4 F/I	HPR9115	Highlander	3.5L V6 F/I	HPR9360
2012 TOYOTA			Kluger	3.5L V6 F/I	HPR9360
Avalon	3.5L V6 F/I	HPR10169	Land Cruiser	3.0L L4 DSL	HPR8918
Camry	2.5L L4 F/I	HPR10171	Land Cruiser	4.5L V8 DSL - Exc. 70 & 200 Series	HPR10343
Corolla	2.4L L4 F/I	HPR10169	Land Cruiser	5.7L V8 F/I	HPR10343
Highlander	2.7L L4 F/I	HPR9360	Land Cruiser Prado	3.0L V6 DSL	HPR8918
Highlander	3.5L V6 F/I	HPR9360	Matrix	2.4L L4 F/I	HPR10169
Highlander Hybrid	3.5L V6 F/I	HPR9762	RAV4	2.5L L4 F/I	HPR10169
Kluger	3.5L V6 F/I	HPR9360	RAV4	3.5L V6 F/I	HPR10169
Land Cruiser	3.0L L4 DSL	HPR8918	Rukus	2.4L L4 F/I	HPR10169
Land Cruiser	4.5L V8 DSL - Exc. 70 & 200 Series	HPR10343	Sequoia	4.6L V8 F/I	HPR10343
Land Cruiser Prado	3.0L V6 DSL	HPR8918	Sequoia	5.7L V8 F/I	HPR10343
Matrix	2.4L L4 F/I	HPR10169	Tacoma	4.0L V6 F/I	HPR9683 ♦
RAV4	2.5L L4 F/I	HPR10169	Tundra	4.0L V6 F/I	HPR10343
RAV4	3.5L V6 F/I	HPR10169	Tundra	4.6L V8 F/I	HPR10343 ♦
Rukus	2.4L L4 F/I	HPR10169	Tundra	5.7L V8 F/I	HPR10343 ♦
Sequoia	4.6L V8 F/I	HPR10343	Urban Cruiser	1.3L L4 F/I	HPR9115
Sequoia	5.7L V8 F/I	HPR10343	Venza	2.7L L4 F/I	HPR10171
Tacoma	4.0L V6 F/I	HPR9683 ♦	Venza	3.5L V6 F/I	HPR10169
Tundra	4.0L V6 F/I	HPR10343	Yaris	1.3L L4 F/I	HPR9115
Tundra	4.6L V8 F/I	HPR10343 ♦	2009 TOYOTA		
Tundra	5.7L V8 F/I	HPR10343 ♦	4 Runner	4.0L V6 F/I	HPR9683
Urban Cruiser	1.3L L4 F/I	HPR9115	4 Runner	4.7L V8 F/I	HPR8918
Venza	2.7L L4 F/I	HPR10171	Avalon	3.5L V6 F/I	HPR10169
Venza	3.5L V6 F/I	HPR10169	Avensis	2.4L L4 F/I	HPR9482
Verso S	1.3L L4 F/I	HPR9115	Camry	2.4L L4 F/I	HPR10171
Yaris	1.3L L4 F/I	HPR9115	Camry	3.5L V6 F/I	HPR10169
2011 TOYOTA			Camry Hybrid	2.4L L4 F/I	HPR9360
Avalon	3.5L V6 F/I	HPR10169	Corolla	2.4L L4 F/I	HPR10169
Camry	2.5L L4 F/I	HPR10171	FJ Cruiser	4.0L V6 F/I	HPR9683 ♦
Camry	3.5L V6 F/I	HPR10169	Highlander	2.7L L4 F/I	HPR9360
Camry Hybrid	2.4L L4 F/I	HPR9360	Highlander	3.5L V6 F/I	HPR9360
Corolla	2.4L L4 F/I	HPR10169	Kluger	3.5L V6 F/I	HPR9360
Highlander	2.7L L4 F/I	HPR9360			
Highlander	3.5L V6 F/I	HPR9360			

*Indicates 2 filters required ♦ Intake system available - see page 326 + throttle body spacer available - see page 20

HPR™ REPLACEMENT AIR FILTERS

TOYOTA

Vehicle	Engine Type	Air Filter	Vehicle	Engine Type	Air Filter
2009 TOYOTA			2007 TOYOTA		
Land Cruiser	3.0L L4 DSL	HPR8918	Avalon	3.5L V6 F/I	HPR10169
Land Cruiser	4.5L V8 DSL - Exc. 70 & 200 Series	HPR10343	Avensis	1.6L L4 F/I	HPR9482
Land Cruiser	5.7L V8 F/I	HPR10343	Avensis	1.8L L4 F/I	HPR9482
Land Cruiser Prado	3.0L V6 DSL	HPR8918	Avensis	2.0L L4 F/I	HPR9482
Land Cruiser Prado	4.0L V6 F/I	HPR9683	Avensis	2.4L L4 F/I	HPR9482
Matrix	2.4L L4 F/I	HPR10169	Avensis Verso	2.0L L4 F/I - 1AZ-FE Eng.	HPR9482
RAV4	2.5L L4 F/I	HPR10169	Camry	2.4L L4 F/I	HPR10171
RAV4	3.5L V6 F/I	HPR10169	Camry	3.5L V6 F/I	HPR10169
RAV4 III	2.0L L4 F/I - 152BHP	HPR10169	Camry Hybrid	2.4L L4 F/I	HPR9360
RAV4 III	3.5L V6 F/I	HPR10169	Corolla	1.6L L4 F/I - to 3/07	HPR9482
Sequoia	4.7L V8 F/I	HPR10343	Corolla	1.8L L4 F/I	HPR9482
Sequoia	5.7L V8 F/I	HPR10343 ♦	FJ Cruiser	4.0L V6 F/I	HPR9683 ♦
Sienna	3.5L V6 F/I	HPR9360	Highlander	2.4L L4 F/I	HPR9360
Solara	2.4L L4 F/I	HPR9360	Highlander	3.3L V6 F/I	HPR9360
Tacoma	4.0L V6 F/I	HPR9683 ♦	Kluger	3.3L V6 F/I	HPR9360
Tundra	4.0L V6 F/I	HPR9683	Kluger	3.5L V6 F/I	HPR9360
Tundra	4.7L V8 F/I	HPR10343	Land Cruiser	4.7L V8 F/I	HPR8918
Tundra	5.7L V8 F/I	HPR10343 ♦	Land Cruiser Prado	3.0L L4 DSL	HPR8918
Urban Cruiser	1.3L L4 F/I	HPR9115	Land Cruiser Prado	4.0L V6 F/I	HPR9683
Venza	2.7L L4 F/I	HPR10171	Matrix	1.8L L4 F/I	HPR9482
Venza	3.5L V6 F/I	HPR10169	RAV4	2.4L L4 F/I	HPR10169
Verso	1.6L L4 F/I	HPR9482	RAV4	3.5L V6 F/I	HPR10169
Verso	1.8L L4 F/I	HPR9482	RAV4 III	2.0L L4 F/I	HPR10169
Yaris	1.3L L4 F/I - 101BHP	HPR9115	RAV4 III	2.4L L4 F/I	HPR10169
2008 TOYOTA			2006 TOYOTA		
4 Runner	4.0L V6 F/I	HPR9683	4 Runner	4.0L V6 F/I	HPR9683
4 Runner	4.7L V8 F/I	HPR8918	4 Runner	4.7L V8 F/I	HPR8918
Avalon	3.5L V6 F/I	HPR10169	Avalon	3.5L V6 F/I	HPR10169
Avensis	1.6L L4 F/I	HPR9482	Avensis	1.6L L4 F/I	HPR9482
Avensis	1.8L L4 F/I	HPR9482	Avensis	1.8L L4 F/I	HPR9482
Avensis	2.0L L4 F/I	HPR9482	Avensis	2.0L L4 F/I	HPR9482
Avensis	2.4L L4 F/I	HPR9482	Avensis	2.4L L4 F/I	HPR9482
Camry	2.4L L4 F/I	HPR10171	Avensis Verso	2.0L L4 F/I - 1AZ-FE Eng.	HPR9482
Camry	3.5L V6 F/I	HPR10169	Camry	2.4L L4 F/I	HPR9360
Camry Hybrid	2.4L L4 F/I	HPR9360	Camry	3.0L V6 F/I	HPR9360
Corolla	1.8L L4 F/I	HPR9482	Camry	3.3L V6 F/I	HPR9360
FJ Cruiser	4.0L V6 F/I	HPR9683 ♦	Corolla	1.4L L4 F/I	HPR9482
Highlander	3.5L V6 F/I	HPR9360	Corolla	1.6L L4 F/I	HPR9482
Kluger	3.5L V6 F/I	HPR9360	Corolla	1.8L L4 F/I	HPR9482
Land Cruiser	4.5L V8 DSL - Exc. 70 & 200 Series	HPR10343	Highlander	2.4L L4 F/I	HPR9360
Land Cruiser	5.7L V8 F/I	HPR10343	Highlander	3.3L V6 F/I	HPR9360
Land Cruiser Prado	3.0L L4 DSL	HPR8918	Kluger	3.3L V6 F/I	HPR9360
Land Cruiser Prado	4.0L V6 F/I	HPR9683	Land Cruiser	4.7L V8 F/I	HPR8918
Matrix	1.8L L4 F/I	HPR9482	Land Cruiser Prado	3.0L L4 DSL	HPR8918
RAV4	2.4L L4 F/I	HPR10169	Land Cruiser Prado	4.0L V6 F/I	HPR9683
RAV4	3.5L V6 F/I	HPR10169	Matrix	1.8L L4 F/I	HPR9482
RAV4 III	2.0L L4 F/I	HPR10169	Matrix XR	1.8L L4 F/I	HPR9482
RAV4 III	2.4L L4 F/I	HPR10169	Matrix XRS	1.8L L4 F/I	HPR9482
RAV4 III	3.5L V6 F/I	HPR10169	RAV4	2.4L L4 F/I	HPR10169
Sequoia	4.7L V8 F/I	HPR10343	RAV4	3.5L V6 F/I	HPR10169
Sequoia	5.7L V8 F/I	HPR10343 ♦	RAV4 III	2.0L L4 F/I	HPR10169
Sienna	3.5L V6 F/I	HPR9360	RAV4 III	2.4L L4 F/I	HPR10169
Solara	2.4L L4 F/I	HPR9360	RAV4 III	3.5L V6 F/I	HPR10169
Solara	3.3L V6 F/I	HPR9360			
Tacoma	4.0L V6 F/I	HPR9683 ♦			
Tundra	4.0L V6 F/I	HPR9683			
Tundra	4.7L V8 F/I	HPR10343			
Tundra	5.7L V8 F/I	HPR10343 ♦			
Verso	1.6L L4 F/I	HPR9482			
Verso	1.8L L4 F/I	HPR9482			
2007 TOYOTA					
4 Runner	4.0L V6 F/I	HPR9683			
4 Runner	4.7L V8 F/I	HPR8918			

*Indicates 2 filters required ♦ Intake system available - see page 326 + throttle body spacer available - see page 20

Vehicle	Engine Type	Air Filter	Vehicle	Engine Type	Air Filter
2006 TOYOTA			2004 TOYOTA		
Sequoia	4.7L V8 F/I	HPR8918 ♦	Matrix XR	1.8L L4 F/I	HPR9482
Sienna	3.3L V6 F/I	HPR9360	Matrix XRS	1.8L L4 F/I	HPR9482
Solara	2.4L L4 F/I	HPR9360	Sequoia	4.7L V8 F/I	HPR8918 ♦
Solara	3.3L V6 F/I	HPR9360	Sienna	3.3L V6 F/I	HPR9360
Tacoma	4.0L V6 F/I	HPR9683 ♦	Solara	2.4L L4 F/I	HPR9360
Tundra	4.0L V6 F/I	HPR9683	Solara	3.3L V6 F/I	HPR9360
Tundra	4.7L V8 F/I	HPR8918 ♦	Tacoma	2.4L L4 F/I	HPR6690
2005 TOYOTA			Tacoma	2.7L L4 F/I	HPR6690
4 Runner	4.0L V6 F/I	HPR9683	Tacoma	3.4L V6 F/I	HPR7626 ♦
4 Runner	4.7L V8 F/I	HPR8918	Tundra	3.4L V6 F/I	HPR8918
Avalon	3.5L V6 F/I	HPR10169	Tundra	4.7L V8 F/I	HPR8918 ♦
Avenis	1.6L L4 F/I	HPR9482	Yaris	1.5L L4 F/I	HPR9115
Avenis	1.8L L4 F/I	HPR9482	2003 TOYOTA		
Avenis	2.0L L4 F/I	HPR9482	4 Runner	4.0L V6 F/I	HPR9683
Avenis	2.4L L4 F/I	HPR9482	4 Runner	4.7L V8 F/I	HPR8918
Avenis Verso	2.0L L4 F/I - 1AZ-FE Eng.	HPR9482	Avalon	3.0L V6 F/I	HPR7351
Camry	2.4L L4 F/I	HPR9360	Avenis	1.6L L4 F/I - from 3/03	HPR9482
Camry	3.0L V6 F/I	HPR9360	Avenis	1.8L L4 F/I - From 4/03	HPR9482
Camry	3.3L V6 F/I	HPR9360	Avenis	2.0L L4 F/I - from 3/03	HPR9482
Corolla	1.4L L4 F/I	HPR9482	Avenis	2.4L L4 F/I	HPR9482
Corolla	1.6L L4 F/I	HPR9482	Avenis Verso	2.0L L4 F/I - 1AZ-FE Eng.	HPR9482
Corolla	1.8L L4 F/I	HPR9482	Camry	2.4L L4 F/I	HPR9360
Echo	1.5L L4 F/I	HPR9115	Camry	3.0L V6 F/I	HPR9360
Highlander	2.4L L4 F/I	HPR9360	Corolla	1.4L L4 F/I	HPR9482
Highlander	3.3L V6 F/I	HPR9360	Corolla	1.6L L4 F/I	HPR9482
Kluger	3.3L V6 F/I	HPR9360	Corolla	1.8L L4 F/I	HPR9482
Land Cruiser	4.7L V8 F/I	HPR8918	Echo	1.5L L4 F/I	HPR9115
Land Cruiser Prado	3.0L V6 DSL	HPR8918	Highlander	2.4L L4 F/I	HPR9360
Land Cruiser Prado	4.0L V6 F/I	HPR9683	Highlander	3.0L V6 F/I	HPR9360
Matrix	1.8L L4 F/I	HPR9482	Kluger	3.3L V6 F/I	HPR9360
Matrix XR	1.8L L4 F/I	HPR9482	Land Cruiser	3.4L L4 F/I	HPR7626
Matrix XRS	1.8L L4 F/I	HPR9482	Land Cruiser	4.7L V8 F/I	HPR8918
Sequoia	4.7L V8 F/I	HPR8918 ♦	Land Cruiser Prado	3.0L L4 DSL	HPR8918
Sienna	3.3L V6 F/I	HPR9360	Land Cruiser Prado	4.0L V6 F/I	HPR9683
Solara	2.4L L4 F/I	HPR9360	Matrix	1.8L L4 F/I	HPR9482
Solara	3.3L V6 F/I	HPR9360	Matrix XR	1.8L L4 F/I	HPR9482
Tacoma	4.0L V6 F/I	HPR9683 ♦	Matrix XRS	1.8L L4 F/I	HPR9482
Tundra	4.0L V6 F/I	HPR9683	Sequoia	4.7L V8 F/I	HPR8918 ♦
Tundra	4.7L V8 F/I	HPR8918 ♦	Sienna	3.0L V6 F/I	HPR7351
2004 TOYOTA			Solara	2.4L L4 F/I	HPR7351
4 Runner	4.0L V6 F/I	HPR9683	Solara	3.0L V6 F/I	HPR7351
4 Runner	4.7L V8 F/I	HPR8918	Tacoma	2.4L L4 F/I	HPR6690
Avalon	3.0L V6 F/I	HPR7351	Tacoma	2.7L L4 F/I	HPR6690
Avenis	1.6L L4 F/I	HPR9482	Tacoma	3.4L V6 F/I	HPR7626 ♦
Avenis	1.8L L4 F/I	HPR9482	Tundra	3.4L V6 F/I	HPR8918
Avenis	2.0L L4 F/I	HPR9482	Tundra	4.7L V8 F/I	HPR8918 ♦
Avenis	2.4L L4 F/I	HPR9482	Yaris	1.5L L4 F/I	HPR9115
Avenis Verso	2.0L L4 F/I - 1AZ-FE Eng.	HPR9482	2002 TOYOTA		
Camry	2.4L L4 F/I	HPR9360	4 Runner	3.4L V6 F/I	HPR7626 ♦
Camry	3.0L V6 F/I	HPR9360	4 Runner	4.0L V6 F/I	HPR9683
Camry	3.3L V6 F/I	HPR9360	4 Runner	4.7L V8 F/I	HPR8918
Corolla	1.4L L4 F/I	HPR9482	Avalon	3.0L V6 F/I	HPR7351
Corolla	1.6L L4 F/I	HPR9482	Avenis Verso	2.0L L4 F/I - 1AZ-FE Eng.	HPR9482
Corolla	1.8L L4 F/I	HPR9482	Camry	2.4L L4 F/I	HPR9360
Echo	1.5L L4 F/I	HPR9115	Camry	3.0L V6 F/I	HPR9360
Highlander	2.4L L4 F/I	HPR9360	Corolla	1.4L L4 F/I	HPR9482
Highlander	3.3L V6 F/I	HPR9360	Corolla	1.6L L4 F/I	HPR9482
Kluger	3.3L V6 F/I	HPR9360	Corolla	1.8L L4 F/I - Non-US	HPR9482
Land Cruiser	3.4L V6 F/I	HPR7626	Corolla	1.8L L4 F/I - US	HPR5466
Land Cruiser	4.7L V8 F/I	HPR8918	Echo	1.5L L4 F/I	HPR9115
Land Cruiser Prado	3.0L L4 DSL	HPR8918	Highlander	2.4L L4 F/I	HPR9360
Land Cruiser Prado	4.0L V6 F/I	HPR9683	Highlander	3.0L V6 F/I	HPR9360
Matrix	1.8L L4 F/I	HPR9482	Land Cruiser	3.4L L4 F/I	HPR7626

*Indicates 2 filters required ♦ Intake system available - see page 326 + throttle body spacer available - see page 20

HPR™ REPLACEMENT AIR FILTERS

TOYOTA

Vehicle	Engine Type	Air Filter	Vehicle	Engine Type	Air Filter
2002 TOYOTA			1999 TOYOTA		
Land Cruiser	4.7L V8 F/I	HPR8918	4 Runner	3.4L V6 F/I	HPR7626 ♦
Sequoia	4.7L V8 F/I	HPR8918 ♦	Avalon	3.0L V6 F/I	HPR7351
Sienna	3.0L V6 F/I	HPR7351	Camry	2.2L L4 F/I	HPR7351
Solara	2.4L L4 F/I	HPR7351	Camry	3.0L V6 F/I	HPR7351
Solara	3.0L V6 F/I	HPR7351	Celica	1.8L L4 F/I - to 10/99	HPR7351
Tacoma	2.4L L4 F/I	HPR6690	Celica	2.0L L4 F/I	HPR7351
Tacoma	2.7L L4 F/I	HPR6690	Celica	2.2L L4 F/I	HPR7351
Tacoma	3.4L V6 F/I	HPR7626 ♦	Corolla	1.6L L4 F/I	HPR5466
Tundra	3.4L V6 F/I	HPR8918	Corolla	1.8L L4 F/I - US	HPR5466
Tundra	4.7L V8 F/I	HPR8918 ♦	Land Cruiser	3.4L L4 F/I	HPR7626
Yaris	1.5L L4 F/I	HPR9115	Land Cruiser	4.7L V8 F/I	HPR8918
2001 TOYOTA			Paseo	1.5L L4 F/I	HPR7167
4 Runner	3.4L V6 F/I	HPR7626 ♦	Previa	2.4L L4 F/I	HPR6690
Avalon	3.0L V6 F/I	HPR7351	Sienna	3.0L V6 F/I	HPR7351
Avensis Verso	2.0L L4 F/I - 1AZ-FE Eng.	HPR9482	Solara	2.2L L4 F/I	HPR7351
Camry	2.2L L4 F/I	HPR7351	Solara	3.0L V6 F/I	HPR7351
Camry	2.4L L4 F/I	HPR9360	Starlet	1.3L L4 F/I	HPR7167
Camry	3.0L V6 F/I	HPR7351	Tacoma	2.4L L4 F/I	HPR6690
Corolla	1.4L L4 F/I	HPR9482	Tacoma	2.7L L4 F/I	HPR6690
Corolla	1.6L L4 F/I	HPR9482	Tacoma	3.4L V6 F/I	HPR7626 ♦
Corolla	1.8L L4 F/I - Non-US	HPR9482	Tercel	1.5L L4 F/I	HPR7167
Corolla	1.8L L4 F/I - US	HPR5466	Yaris	1.3L L4 F/I	HPR9115
Corolla	2.0L L4 F/I	HPR9482	Yaris	1.5L L4 F/I	HPR9115
Echo	1.5L L4 F/I	HPR9115	1998 TOYOTA		
Highlander	2.4L L4 F/I	HPR9360	4 Runner	2.7L L4 F/I	HPR6690
Highlander	3.0L V6 F/I	HPR9360	4 Runner	3.4L V6 F/I	HPR7626
Land Cruiser	3.4L L4 F/I	HPR7626	Avalon	3.0L V6 F/I	HPR7351
Land Cruiser	4.7L V8 F/I	HPR8918	Camry	2.2L L4 F/I	HPR7351
Sequoia	4.7L V8 F/I	HPR8918 ♦	Camry	3.0L V6 F/I	HPR7351
Sienna	3.0L V6 F/I	HPR7351	Celica	1.8L L4 F/I	HPR7351
Solara	2.2L L4 F/I	HPR7351	Celica	2.0L L4 F/I	HPR7351
Solara	3.0L V6 F/I	HPR7351	Celica	2.2L L4 F/I	HPR7351
Tacoma	2.4L L4 F/I	HPR6690	Corolla	1.6L L4 F/I	HPR5466
Tacoma	2.7L L4 F/I	HPR6690	Corolla	1.8L L4 F/I - US	HPR5466
Tacoma	3.4L V6 F/I	HPR7626 ♦	Land Cruiser	3.4L L4 F/I	HPR7626
Tundra	3.4L V6 F/I	HPR8918	Land Cruiser	4.7L V8 F/I	HPR8918
Tundra	4.7L V8 F/I	HPR8918 ♦	Paseo	1.5L L4 F/I	HPR7167
Yaris	1.5L L4 F/I	HPR9115	Previa	2.4L L4 F/I	HPR6690
2000 TOYOTA			Sienna	3.0L V6 F/I	HPR7351
4 Runner	2.7L L4 F/I	HPR6690	Starlet	1.3L L4 F/I	HPR7167
4 Runner	3.4L V6 F/I	HPR7626 ♦	Supra	3.0L L6 F/I	HPR7626
Avalon	3.0L V6 F/I	HPR7351	T100	2.7L L4 F/I	HPR7417
Camry	2.2L L4 F/I	HPR7351	T100	3.4L V6 F/I	HPR7417
Camry	3.0L V6 F/I	HPR7351	Tacoma	2.4L L4 F/I	HPR6690
Corolla	1.4L L4 F/I - 97BHP	HPR9482	Tacoma	2.7L L4 F/I	HPR6690
Corolla	1.8L L4 F/I - US	HPR5466	Tacoma	3.4L V6 F/I	HPR7626
Echo	1.5L L4 F/I	HPR9115	Tercel	1.5L L4 F/I	HPR7167
Hilux	2.4L L4 F/I	HPR6690	1997 TOYOTA		
Land Cruiser	3.4L L4 F/I	HPR7626	4 Runner	2.7L L4 F/I	HPR6690
Land Cruiser	4.7L V8 F/I	HPR8918	4 Runner	3.4L V6 F/I	HPR7626
Previa	2.4L L4 F/I - to 7/00	HPR6690	Avalon	3.0L V6 F/I	HPR7351
Sienna	3.0L V6 F/I	HPR7351	Camry	2.2L L4 F/I	HPR7351
Solara	2.2L L4 F/I	HPR7351	Camry	3.0L V6 F/I	HPR7351
Solara	3.0L V6 F/I	HPR7351	Celica	1.8L L4 F/I - US	HPR7351
Tacoma	2.4L L4 F/I	HPR6690	Celica	2.0L L4 F/I	HPR7351
Tacoma	2.7L L4 F/I	HPR6690	Celica	2.2L L4 F/I	HPR7351
Tacoma	3.4L V6 F/I	HPR7626 ♦	Corolla	1.6L L4 F/I	HPR5466
Tundra	3.4L V6 F/I	HPR8918	Corolla	1.8L L4 F/I - Non-US, to 4/97	HPR5466
Tundra	4.7L V8 F/I	HPR8918 ♦	Corolla	1.8L L4 F/I - US	HPR5466
Yaris	1.3L L4 F/I	HPR9115	Land Cruiser	3.4L L4 F/I	HPR7626
Yaris	1.5L L4 F/I	HPR9115	Lexcen	3.8L V6 F/I	HPR4309
1999 TOYOTA			Paseo	1.5L L4 F/I	HPR7167
4 Runner	2.7L L4 F/I	HPR6690	Previa	2.4L L4 F/I	HPR6690

*Indicates 2 filters required ♦ Intake system available - see page 326 + throttle body spacer available - see page 20

TOYOTA

HPR™ REPLACEMENT AIR FILTERS

Vehicle	Engine Type	Air Filter	Vehicle	Engine Type	Air Filter
1997 TOYOTA			1994 TOYOTA		
Starlet	1.3L L4 F/I	HPR7167	Camry	3.0L V6 F/I	HPR7351
Supra	3.0L L6 F/I	HPR7626	Celica	1.8L L4 F/I - US	HPR7351
T100	2.7L L4 F/I	HPR7417	Celica	2.0L L4 F/I - from 3/94	HPR7351
T100	3.4L V6 F/I	HPR7417	Celica	2.2L L4 F/I	HPR7351
Tacoma	2.4L L4 F/I	HPR6690	Corolla	1.6L L4 F/I	HPR5466
Tacoma	2.7L L4 F/I	HPR6690	Corolla	1.8L L4 F/I	HPR5466
Tacoma	3.4L V6 F/I	HPR7626	Hilux	2.4L L4 F/I	HPR6690
Tercel	1.5L L4 F/I	HPR7167	Lexcen	3.8L V6 F/I	HPR4309
1996 TOYOTA			1993 TOYOTA		
4 Runner	2.7L L4 F/I	HPR6690	4 Runner	2.4L L4 F/I	HPR6690
4 Runner	3.4L V6 F/I	HPR7626	4 Runner	3.0L V6 DSL	HPR4939
Avalon	3.0L V6 F/I	HPR7351	4 Runner	3.0L V6 F/I	HPR4939
Camry	2.2L L4 F/I	HPR7351	Camry	2.2L L4 F/I	HPR7351
Camry	3.0L V6 F/I	HPR7351	Camry	3.0L V6 F/I	HPR7351
Celica	1.8L L4 F/I - US	HPR7351	Corolla	1.6L L4 F/I	HPR5466
Celica	2.0L L4 F/I	HPR7351	Corolla	1.6L L4 F/I - 114/115BHP	HPR5466
Celica	2.2L L4 F/I	HPR7351	Corolla	1.8L L4 DSL	HPR5466
Corolla	1.6L L4 F/I	HPR5466	Corolla	1.8L L4 F/I	HPR5466
Corolla	1.8L L4 F/I	HPR5466	Hilux	2.4L L4 F/I	HPR6690
Land Cruiser	3.4L L4 F/I	HPR7626	Lexcen	3.8L V6 F/I	HPR4309
Lexcen	3.8L V6 F/I	HPR4309	Paseo	1.5L L4 F/I	HPR7167
Paseo	1.5L L4 F/I	HPR7167	Pickup	2.4L L4 F/I	HPR6690
Previa	2.4L L4 F/I	HPR6690	Pickup	3.0L V6 F/I	HPR4939
Starlet	1.3L L4 F/I - From 4/96	HPR7167	Previa	2.4L L4 F/I	HPR6690
Supra	3.0L L6 F/I	HPR7626	Supra	3.0L L6 F/I	HPR7626
T100	2.7L L4 F/I	HPR7417	Supra	3.0L L6 F/I - From 5/93	HPR7626
T100	3.4L V6 F/I	HPR7417	Supra	3.0L L6 F/I - to 4/93	HPR4939
Tacoma	2.4L L4 F/I	HPR6690	T100	3.0L V6 F/I	HPR7417
Tacoma	2.7L L4 F/I	HPR6690	Tercel	1.5L L4 F/I	HPR7167
Tacoma	3.4L V6 F/I	HPR7626	1992 TOYOTA		
Tercel	1.5L L4 F/I	HPR7167	4 Runner	2.4L L4 F/I	HPR6690
1995 TOYOTA			4 Runner	3.0L V6 F/I	HPR4939
4 Runner	2.4L L4 F/I	HPR6690	Camry	2.2L L4 F/I	HPR7351
4 Runner	2.7L L4 F/I	HPR6690	Camry	3.0L V6 F/I	HPR7351
4 Runner	3.0L V6 DSL	HPR4939	Corolla	1.6L L4 F/I - 114/115BHP	HPR5466
4 Runner	3.0L V6 F/I	HPR4939	Corolla	1.8L L4 F/I	HPR5466
4 Runner	3.4L V6 F/I	HPR7626	Cressida	3.0L L6 F/I	HPR4939
Avalon	3.0L V6 F/I	HPR7351	Hilux	2.4L L4 F/I	HPR6690
Camry	2.2L L4 F/I	HPR7351	Lexcen	3.8L V6 F/I	HPR4309
Camry	3.0L V6 F/I	HPR7351	Paseo	1.5L L4 F/I	HPR7167
Celica	1.8L L4 F/I - US	HPR7351	Pickup	2.4L L4 F/I	HPR6690
Celica	2.0L L4 F/I	HPR7351	Pickup	3.0L V6 F/I	HPR4939
Celica	2.2L L4 F/I	HPR7351	Previa	2.4L L4 F/I	HPR6690
Corolla	1.6L L4 F/I	HPR5466	Supra	3.0L L6 F/I	HPR4939
Corolla	1.8L L4 F/I	HPR5466	T100	2.7L L4 F/I	HPR7417
Hilux	2.4L L4 F/I	HPR6690	T100	3.4L V6 F/I	HPR7417
Lexcen	3.8L V6 F/I	HPR4309	Tacoma	2.4L L4 F/I	HPR6690
Paseo	1.5L L4 F/I	HPR7167	Tacoma	2.7L L4 F/I	HPR6690
Pickup	2.4L L4 F/I	HPR6690	Tacoma	3.4L V6 F/I	HPR7626
Pickup	3.0L V6 F/I	HPR4939	Tercel	1.5L L4 F/I	HPR7167
Previa	2.4L L4 F/I	HPR6690	1991 TOYOTA		
Supra	3.0L L6 F/I	HPR7626	4 Runner	2.4L L4 F/I	HPR6690
T100	2.7L L4 F/I	HPR7417	4 Runner	3.0L V6 F/I	HPR4939
T100	3.4L V6 F/I	HPR7417	Camry	2.2L L4 F/I	HPR7351
Tacoma	2.4L L4 F/I	HPR6690	Camry	3.0L V6 F/I	HPR7351
Tacoma	2.7L L4 F/I	HPR6690	Cressida	3.0L L6 F/I	HPR4939
Tacoma	3.4L V6 F/I	HPR7626	Hilux	2.4L L4 F/I	HPR6690
Tercel	1.5L L4 F/I	HPR7167	Lexcen	3.8L V6 F/I	HPR4309
1994 TOYOTA			Paseo	1.5L L4 F/I	HPR7167
4 Runner	2.4L L4 F/I	HPR6690	Pickup	2.4L L4 F/I	HPR6690
4 Runner	3.0L V6 DSL	HPR4939	Pickup	3.0L V6 F/I	HPR4939
4 Runner	3.0L V6 F/I	HPR4939	Previa	2.4L L4 F/I	HPR6690
Camry	2.2L L4 F/I	HPR7351	Supra	3.0L L6 F/I	HPR4939
			Tercel	1.5L L4 F/I	HPR7167

*Indicates 2 filters required ♦ Intake system available - see page 326 + throttle body spacer available - see page 20

HPR™ REPLACEMENT AIR FILTERS

TOYOTA

Vehicle	Engine Type	Air Filter
1991 TOYOTA		
Pickup	3.0L V6 F/I	HPR4939
Previa	2.4L L4 F/I	HPR6690
Supra	3.0L L6 F/I	HPR4939
Tercel	1.5L L4 F/I	HPR7167
1990 TOYOTA		
4 Runner	2.4L L4 F/I	HPR6690
4 Runner	3.0L V6 F/I	HPR4939
Cressida	3.0L L6 F/I	HPR4939
Hilux	2.4L L4 F/I	HPR6690
Lexcen	3.8L V6 F/I	HPR4309
MR2	1.6L L4 F/I	HPR4939
Pickup	2.4L L4 CARB	HPR6690
Pickup	2.4L L4 F/I	HPR6690
Pickup	3.0L V6 F/I	HPR4939
Previa	2.4L L4 F/I	HPR6690
Supra	3.0L L6 F/I	HPR4939
1989 TOYOTA		
4 Runner	2.4L L4 F/I	HPR6690
4 Runner	3.0L V6 F/I	HPR4939
Cressida	3.0L L6 F/I	HPR4939
Hilux	2.4L L4 F/I	HPR6690
Lexcen	3.8L V6 F/I	HPR4309
MR2	1.6L L4 F/I	HPR4939
Pickup	2.4L L4 CARB	HPR6690
Pickup	2.4L L4 F/I	HPR6690
Pickup	3.0L V6 F/I	HPR4939
Supra	3.0L L6 F/I	HPR4939
1988 TOYOTA		
4 Runner	3.0L V6 F/I	HPR4939
Cressida	2.8L L6 F/I	HPR4939
MR2	1.6L L4 F/I	HPR4939
Pickup	3.0L V6 F/I	HPR4939
Supra	3.0L L6 F/I	HPR4939
1987 TOYOTA		
Cressida	2.8L L6 F/I	HPR4939
MR2	1.6L L4 F/I	HPR4939
Supra	3.0L L6 F/I	HPR4939
1986 TOYOTA		
Cressida	2.8L L6 F/I	HPR4939
MR2	1.6L L4 F/I - Non-US, from 4/86	HPR4939
Supra	3.0L L6 F/I	HPR4939
1985 TOYOTA		
Cressida	2.0L L4 CARB - 105BHP	HPR4939
Cressida	2.8L L6 F/I	HPR4939
1984 TOYOTA		
Cressida	2.0L L4 CARB - 105BHP	HPR4939
1983 TOYOTA		
Cressida	2.0L L4 CARB - 105BHP	HPR4939
1982 TOYOTA		
Corolla	1.8L L4 CARB	HPR0352
Cressida	2.0L L4 CARB - 105BHP	HPR4939
1981 TOYOTA		
Corolla	1.8L L4 CARB	HPR0352
Cressida	2.0L L4 CARB - 105BHP	HPR4939
1976 TOYOTA		
Celica	2.0L L4 CARB	HPR0352
1975 TOYOTA		
Celica	2.0L L4 CARB	HPR0352

Vehicle	Engine Type	Air Filter
1974 TOYOTA		
Celica	120 L4 CARB	HPR0352
1973 TOYOTA		
Celica	120 L4 CARB	HPR0352
1972 TOYOTA		
Celica	120 L4 CARB	HPR0352
Mark II	120 L4 CARB	HPR0352
Mark II	138 L6 CARB	HPR0352
1971 TOYOTA		
Celica	113 L4 CARB	HPR0352
2011 VOLKSWAGEN		
Lavida	2.0L L4 F/I	HPR8602
2010 VOLKSWAGEN		
Beetle	1.6L L4 F/I	HPR8602
Beetle	1.8L L4 F/I	HPR8602
Beetle	1.9L L4 DSL	HPR8602
Beetle	2.0L L4 F/I	HPR8602
Beetle	2.5L L5 F/I	HPR8602
Beetle Cabrio	2.5L L5 F/I	HPR8602
Lavida	2.0L L4 F/I	HPR8602
Routan	3.8L V6 F/I	HPR9054
Routan	4.0L V6 F/I	HPR9054
2009 VOLKSWAGEN		
Beetle	1.6L L4 F/I	HPR8602
Beetle	1.8L L4 F/I	HPR8602
Beetle	1.9L L4 DSL	HPR8602
Beetle	2.0L L4 F/I	HPR8602
Beetle	2.5L L5 F/I	HPR8602
Jetta City	2.0L L4 F/I	HPR8602
Lavida	2.0L L4 F/I	HPR8602
Routan	3.8L V6 F/I	HPR9054
Routan	4.0L V6 F/I	HPR9054
2008 VOLKSWAGEN		
Beetle	1.6L L4 F/I	HPR8602
Beetle	1.8L L4 F/I	HPR8602
Beetle	1.9L L4 DSL	HPR8602
Beetle	2.0L L4 F/I	HPR8602
Beetle	2.5L L5 F/I	HPR8602
Golf City	2.0L L4 F/I	HPR8602
Jetta City	2.0L L4 F/I	HPR8602
Lavida	2.0L L4 F/I	HPR8602
2007 VOLKSWAGEN		
Beetle	1.6L L4 F/I	HPR8602
Beetle	1.8L L4 F/I	HPR8602
Beetle	1.9L L4 DSL	HPR8602
Beetle	2.0L L4 F/I	HPR8602
Beetle	2.5L L5 F/I	HPR8602
Golf City	2.0L L4 F/I	HPR8602
Jetta City	2.0L L4 F/I	HPR8602
2006 VOLKSWAGEN		
Beetle	1.6L L4 F/I	HPR8602
Beetle	1.8L L4 F/I	HPR8602
Beetle	1.9L L4 DSL	HPR8602
Beetle	2.0L L4 F/I	HPR8602
Beetle	2.5L L5 F/I	HPR8602
Golf	1.9L L4 DSL - US	HPR8602
Golf	2.0L L4 F/I	HPR8602
Golf GTI	1.8L L4 F/I	HPR8602
2005 VOLKSWAGEN		
Beetle	1.6L L4 F/I	HPR8602

*Indicates 2 filters required ♦ Intake system available - see page 326 + throttle body spacer available - see page 20

VOLKSWAGEN HPR™ REPLACEMENT AIR FILTERS

Vehicle	Engine Type	Air Filter	Vehicle	Engine Type	Air Filter
2005 VOLKSWAGEN			2004 VOLKSWAGEN		
Beetle	1.8L L4 F/I	HPR8602	Passat	2.8L V6 F/I	HPR8080
Beetle	1.9L L4 DSL	HPR8602	Passat	4.0L W8 F/I	HPR8080
Beetle	2.0L L4 F/I	HPR8602	2003 VOLKSWAGEN		
Beetle	2.3L V5 F/I	HPR8602	Beetle	1.6L L4 F/I	HPR8602
Beetle	2.5L L5 F/I	HPR8602	Beetle	1.8L L4 F/I	HPR8602
Bora	1.6L L4 F/I - 101/110BHP	HPR8602	Beetle	1.9L L4 DSL	HPR8602
Bora	1.8L L4 F/I	HPR8602	Beetle	2.0L L4 F/I	HPR8602
Bora	1.9L L4 DSL	HPR8602	Beetle	2.3L V5 F/I	HPR8602
Bora	2.0L L4 F/I	HPR8602	Bora	1.6L L4 F/I - 101/110BHP	HPR8602
Bora	2.8L V6 F/I	HPR8602	Bora	1.8L L4 F/I	HPR8602
Golf	1.9L L4 DSL - US	HPR8602	Bora	1.9L L4 DSL	HPR8602
Golf	2.0L L4 F/I	HPR8602	Bora	2.0L L4 F/I	HPR8602
Golf GTI	1.8L L4 F/I	HPR8602	Bora	2.3L V5 F/I	HPR8602
Golf GTI	2.8L V6 F/I	HPR8602	Bora	2.8L V6 F/I	HPR8602
Golf IV	1.6L L4 F/I - 8v	HPR8602	Golf	1.9L L4 DSL	HPR8602
Golf IV	1.8L L4 F/I	HPR8602	Golf	2.0L L4 F/I - US	HPR8602
Golf IV GTI	1.8L L4 F/I	HPR8602	Golf GTI	1.8L L4 F/I	HPR8602
Jetta	1.8L L4 F/I	HPR8602	Golf GTI	2.8L V6 F/I	HPR8602
Jetta	1.9L L4 DSL	HPR8602	Golf IV	1.6L L4 F/I - 8v	HPR8602
Jetta	1.9L L4 DSL - BEW Eng.	HPR8602	Golf IV	1.8L L4 F/I	HPR8602
Jetta	2.0L L4 F/I	HPR8602	Golf IV	1.9L L4 DSL	HPR8602
Jetta	2.8L V6 F/I	HPR8602	Golf IV	2.0L L4 F/I	HPR8602
Passat	1.6L L4 F/I - To 2/05	HPR8080	Golf IV	2.3L L5 F/I	HPR8602
Passat	1.8L L4 F/I	HPR8080	Golf IV	2.8L V6 F/I	HPR8602
Passat	1.9L L4 DSL - 3B Model	HPR8080	Golf IV	3.2L V6 F/I	HPR8602
Passat	2.0L L4 DSL	HPR8080	Golf IV GTI	1.8L L4 F/I	HPR8602
Passat	2.0L L4 DSL - 3B Model	HPR8080	Golf IV GTI	1.9L L4 DSL	HPR8602
Passat	2.0L L4 F/I - 3B Model	HPR8080	Jetta	1.8L L4 F/I	HPR8602
Passat	2.3L V5 F/I	HPR8080	Jetta	1.9L L4 DSL	HPR8602
Passat	2.5L V6 DSL	HPR8080	Jetta	2.0L L4 F/I	HPR8602
Passat	2.8L V6 F/I	HPR8080	Jetta	2.8L V6 F/I	HPR8602
2004 VOLKSWAGEN			Passat	1.6L L4 F/I	HPR8080
Beetle	1.6L L4 F/I	HPR8602	Passat	1.8L L4 F/I	HPR8080
Beetle	1.8L L4 F/I	HPR8602	Passat	1.9L L4 DSL	HPR8080
Beetle	1.9L L4 DSL	HPR8602	Passat	2.0L L4 DSL	HPR8080
Beetle	2.0L L4 F/I	HPR8602	Passat	2.0L L4 F/I	HPR8080
Beetle	2.3L V5 F/I	HPR8602	Passat	2.3L V5 F/I	HPR8080
Bora	1.6L L4 F/I - 101/110BHP	HPR8602	Passat	2.5L V6 DSL	HPR8080
Bora	1.8L L4 F/I	HPR8602	Passat	2.8L V6 F/I	HPR8080
Bora	1.9L L4 DSL	HPR8602	Passat	4.0L W8 F/I	HPR8080
Bora	2.0L L4 F/I	HPR8602	2002 VOLKSWAGEN		
Bora	2.8L V6 F/I	HPR8602	Beetle	1.6L L4 F/I	HPR8602
Golf	1.9L L4 DSL	HPR8602	Beetle	1.8L L4 F/I	HPR8602
Golf	2.0L L4 F/I	HPR8602	Beetle	1.9L L4 DSL	HPR8602
Golf GTI	1.8L L4 F/I - US	HPR8602	Beetle	2.0L L4 F/I	HPR8602
Golf GTI	2.8L V6 F/I	HPR8602	Beetle	2.3L V5 F/I	HPR8602
Golf IV	1.8L L4 F/I	HPR8602	Bora	1.6L L4 F/I - 101/110BHP	HPR8602
Golf IV	1.9L L4 DSL	HPR8602	Bora	1.8L L4 F/I	HPR8602
Golf IV	2.0L L4 F/I	HPR8602	Bora	1.9L L4 DSL	HPR8602
Golf IV	3.2L V6 F/I	HPR8602	Bora	2.0L L4 F/I	HPR8602
Golf IV GTI	1.8L L4 F/I	HPR8602	Bora	2.3L V5 F/I	HPR8602
Golf IV GTI	1.9L L4 DSL	HPR8602	Bora	2.8L V6 F/I	HPR8602
Golf R32	3.2L V6 F/I	HPR8602	Golf	1.9L L4 DSL	HPR8602
Jetta	1.8L L4 F/I	HPR8602	Golf	2.0L L4 F/I - US	HPR8602
Jetta	1.9L L4 DSL	HPR8602	Golf GTI	1.8L L4 F/I - US	HPR8602
Jetta	2.0L L4 F/I	HPR8602	Golf GTI	2.0L L4 F/I	HPR8602
Jetta	2.8L V6 F/I	HPR8602	Golf GTI	2.8L V6 F/I	HPR8602
Passat	1.6L L4 F/I	HPR8080	Golf IV	1.6L L4 F/I - 8v	HPR8602
Passat	1.8L L4 F/I	HPR8080	Golf IV	1.8L L4 F/I	HPR8602
Passat	1.9L L4 DSL	HPR8080	Golf IV	1.9L L4 DSL	HPR8602
Passat	2.0L L4 DSL - Non-US	HPR8080	Golf IV	2.0L L4 F/I	HPR8602
Passat	2.0L L4 F/I	HPR8080	Golf IV	2.3L L5 F/I	HPR8602
Passat	2.3L V5 F/I	HPR8080	Golf IV	2.8L V6 F/I	HPR8602
Passat	2.5L V6 DSL	HPR8080			

*Indicates 2 filters required ♦ Intake system available - see page 326 + throttle body spacer available - see page 20

HPR™ REPLACEMENT AIR FILTERS VOLKSWAGEN

Vehicle	Engine Type	Air Filter	Vehicle	Engine Type	Air Filter
2002 VOLKSWAGEN			2000 VOLKSWAGEN		
Golf IV	3.2L V6 F/I	HPR8602	Bora	1.9L L4 DSL	HPR8602
Golf IV GTI	1.8L L4 F/I	HPR8602	Bora	2.0L L4 F/I	HPR8602
Golf IV GTI	1.9L L4 DSL	HPR8602	Bora	2.3L V5 F/I	HPR8602
Jetta	1.8L L4 F/I	HPR8602	Bora	2.8L V6 F/I	HPR8602
Jetta	1.9L L4 DSL	HPR8602	Golf	1.8L L4 F/I	HPR8602
Jetta	2.0L L4 F/I	HPR8602	Golf	1.9L L4 DSL	HPR8602
Jetta	2.8L V6 F/I	HPR8602	Golf	2.0L L4 F/I	HPR8602
Passat	1.6L L4 F/I	HPR8080	Golf GTI	1.8L L4 F/I	HPR8602
Passat	1.8L L4 F/I	HPR8080	Golf GTI	2.0L L4 F/I	HPR8602
Passat	1.9L L4 DSL	HPR8080	Golf GTI	2.8L V6 F/I	HPR8602
Passat	2.0L L4 F/I	HPR8080	Golf IV	1.6L L4 F/I - 8v	HPR8602
Passat	2.3L V5 F/I	HPR8080	Golf IV	1.8L L4 F/I	HPR8602
Passat	2.5L V6 DSL	HPR8080	Golf IV	1.9L L4 DSL	HPR8602
Passat	2.8L V6 F/I	HPR8080	Golf IV	2.0L L4 F/I	HPR8602
Passat	4.0L W8 F/I	HPR8080	Golf IV	2.3L L5 F/I	HPR8602
2001 VOLKSWAGEN			Golf IV	2.8L V6 F/I	HPR8602
Beetle	1.6L L4 F/I	HPR8602	Golf IV GTI	1.8L L4 F/I	HPR8602
Beetle	1.8L L4 F/I	HPR8602	Jetta	1.8L L4 F/I	HPR8602
Beetle	1.9L L4 DSL	HPR8602	Jetta	1.9L L4 DSL	HPR8602
Beetle	2.0L L4 F/I	HPR8602	Jetta	2.0L L4 F/I	HPR8602
Beetle	2.3L V5 F/I	HPR8602	Jetta	2.8L V6 F/I	HPR8602
Beetle	3.2L V6 F/I	HPR8602	Passat	1.6L L4 F/I	HPR8080
Bora	1.6L L4 F/I - 101/110BHP	HPR8602	Passat	1.8L L4 F/I	HPR8080
Bora	1.8L L4 F/I	HPR8602	Passat	1.9L L4 DSL	HPR8080
Bora	1.9L L4 DSL	HPR8602	Passat	2.0L L4 F/I	HPR8080
Bora	2.0L L4 F/I	HPR8602	Passat	2.3L V5 F/I	HPR8080
Bora	2.3L V5 F/I	HPR8602	Passat	2.5L V6 DSL	HPR8080
Bora	2.8L V6 F/I	HPR8602	Passat	2.8L V6 F/I	HPR8080
Golf	1.8L L4 F/I - US	HPR8602	1999 VOLKSWAGEN		
Golf	1.9L L4 DSL	HPR8602	Beetle	1.6L L4 F/I	HPR8602
Golf	2.0L L4 F/I	HPR8602	Beetle	1.8L L4 F/I	HPR8602
Golf GTI	1.8L L4 F/I - US	HPR8602	Beetle	1.9L L4 DSL	HPR8602
Golf GTI	2.0L L4 F/I	HPR8602	Beetle	2.0L L4 F/I	HPR8602
Golf GTI	2.8L V6 F/I	HPR8602	Bora	1.6L L4 F/I	HPR8602
Golf IV	1.6L L4 F/I - 8v	HPR8602	Bora	1.8L L4 F/I	HPR8602
Golf IV	1.8L L4 F/I	HPR8602	Bora	1.9L L4 DSL	HPR8602
Golf IV	1.9L L4 DSL	HPR8602	Bora	2.0L L4 F/I	HPR8602
Golf IV	2.0L L4 F/I	HPR8602	Bora	2.3L V5 F/I	HPR8602
Golf IV	2.3L L5 F/I	HPR8602	Bora	2.8L V6 F/I	HPR8602
Golf IV	2.8L V6 F/I	HPR8602	Golf	1.9L L4 DSL	HPR8602
Golf IV GTI	1.8L L4 F/I	HPR8602	Golf	2.0L L4 F/I	HPR8602
Golf IV GTI	1.9L L4 DSL	HPR8602	Golf GTI	2.0L L4 F/I	HPR8602
Jetta	1.8L L4 F/I	HPR8602	Golf GTI	2.8L V6 F/I	HPR8602
Jetta	1.9L L4 DSL	HPR8602	Golf IV	1.6L L4 F/I	HPR8602
Jetta	2.0L L4 F/I	HPR8602	Golf IV	1.8L L4 F/I	HPR8602
Jetta	2.8L V6 F/I	HPR8602	Golf IV	1.9L L4 DSL	HPR8602
Passat	1.6L L4 F/I	HPR8080	Golf IV	2.0L L4 F/I	HPR8602
Passat	1.8L L4 F/I	HPR8080	Golf IV	2.3L L5 F/I	HPR8602
Passat	1.9L L4 DSL	HPR8080	Golf IV	2.8L V6 F/I	HPR8602
Passat	2.0L L4 F/I	HPR8080	Golf IV GTI	1.8L L4 F/I	HPR8602
Passat	2.3L V5 F/I	HPR8080	Jetta	1.9L L4 DSL	HPR8602
Passat	2.5L V6 DSL	HPR8080	Jetta	2.0L L4 F/I - AEG Eng.	HPR8602
Passat	2.8L V6 F/I	HPR8080	Jetta	2.8L V6 F/I - AFP Eng.	HPR8602
Passat	4.0L W8 F/I	HPR8080	Passat	1.6L L4 F/I	HPR8080
2000 VOLKSWAGEN			Passat	1.8L L4 F/I	HPR8080
Beetle	1.6L L4 F/I	HPR8602	Passat	1.9L L4 DSL	HPR8080
Beetle	1.8L L4 F/I	HPR8602	Passat	2.3L V5 F/I	HPR8080
Beetle	1.9L L4 DSL	HPR8602	Passat	2.5L V6 DSL	HPR8080
Beetle	2.0L L4 F/I	HPR8602	Passat	2.8L V6 F/I	HPR8080
Beetle	2.3L V5 F/I	HPR8602	1998 VOLKSWAGEN		
Beetle	3.2L V6 F/I	HPR8602	Beetle	1.9L L4 DSL	HPR8602
Bora	1.6L L4 F/I - 101/110BHP	HPR8602	Beetle	2.0L L4 F/I	HPR8602
Bora	1.8L L4 F/I	HPR8602	Bora	1.6L L4 F/I	HPR8602

*Indicates 2 filters required ♦ Intake system available - see page 326 + throttle body spacer available - see page 20

VOLKSWAGEN HPR™ REPLACEMENT AIR FILTERS

Vehicle	Engine Type	Air Filter	Vehicle	Engine Type	Air Filter
1998 VOLKSWAGEN			1990 VOLKSWAGEN		
Bora	1.8L L4 F/I	HPR8602	Fox	1.8L L4 F/I	HPR3660
Bora	1.9L L4 DSL	HPR8602	Golf I	1.8L L4 F/I	HPR3660
Bora	2.0L L4 F/I	HPR8602	Jetta II	1.8L L4 F/I - 129/140BHP	HPR6366
Bora	2.3L V5 F/I	HPR8602	Scirocco	1.8L L4 F/I - Exc., 90BHP	HPR3660
Golf	1.8L L4 F/I	HPR8602	Taro	2.4L L4 F/I	HPR6690
Golf IV	1.6L L4 F/I	HPR8602	1989 VOLKSWAGEN		
Golf IV	1.8L L4 F/I	HPR8602	Cabriolet	1.8L L4 F/I	HPR3660
Golf IV	1.9L L4 DSL	HPR8602	Caddy I	1.8L L4 F/I	HPR3660
Golf IV	2.0L L4 F/I	HPR8602	Fox	1.8L L4 F/I	HPR3660
Golf IV	2.3L L5 F/I	HPR8602	Golf I	1.8L L4 F/I	HPR3660
Golf IV GTI	1.8L L4 F/I	HPR8602	Jetta II	1.8L L4 F/I - from 9/89, 129/140BHP	HPR6366
Passat	1.6L L4 F/I	HPR8080	Scirocco	1.8L L4 F/I	HPR3660
Passat	1.8L L4 F/I	HPR8080	Scirocco	1.8L L4 F/I - Exc., 90BHP	HPR3660
Passat	1.9L L4 DSL	HPR8080	Taro	2.4L L4 F/I	HPR6690
Passat	2.3L V5 F/I	HPR8080	1988 VOLKSWAGEN		
Passat	2.5L V6 DSL	HPR8080	Cabriolet	1.8L L4 F/I	HPR3660
Passat	2.8L V6 F/I	HPR8080	Caddy I	1.8L L4 F/I	HPR3660
1997 VOLKSWAGEN			Fox	1.8L L4 F/I	HPR3660
Golf IV	1.6L L4 F/I	HPR8602	Golf I	1.8L L4 F/I	HPR3660
Golf IV	1.8L L4 F/I	HPR8602	Scirocco	1.8L L4 F/I	HPR3660
Golf IV	1.9L L4 DSL	HPR8602	Scirocco	1.8L L4 F/I - Exc., 90BHP	HPR3660
Golf IV	2.3L L5 F/I	HPR8602	1987 VOLKSWAGEN		
Golf IV GTI	1.8L L4 F/I	HPR8602	Cabriolet	1.8L L4 F/I	HPR3660
Passat	1.6L L4 F/I	HPR8080	Caddy I	1.8L L4 F/I	HPR3660
Passat	1.8L L4 F/I - 3B Model	HPR8080	Fox	1.8L L4 F/I	HPR3660
Passat	1.9L L4 DSL - 3B Model	HPR8080	Golf I	1.8L L4 F/I	HPR3660
Passat	2.3L V5 F/I	HPR8080	Scirocco	1.8L L4 F/I	HPR3660
Passat	2.8L V6 F/I - Exc., 174BHP	HPR8080	Scirocco	1.8L L4 F/I - Exc., 90BHP	HPR3660
Taro	2.4L L4 F/I	HPR6690	1986 VOLKSWAGEN		
1996 VOLKSWAGEN			Cabriolet	1.8L L4 F/I	HPR3660
Passat	1.6L L4 F/I - from 9/96	HPR8080	Caddy I	1.8L L4 F/I	HPR3660
Passat	1.8L L4 F/I - 3B Model	HPR8080	Golf I	1.8L L4 F/I	HPR3660
Passat	1.9L L4 DSL - 3B Model	HPR8080	Scirocco	1.8L L4 F/I	HPR3660
Passat	2.3L V5 F/I	HPR8080	Scirocco	1.8L L4 F/I - Exc., 90BHP	HPR3660
Passat	2.8L V6 F/I - Exc., 174BHP	HPR8080	1985 VOLKSWAGEN		
Taro	2.4L L4 F/I	HPR6690	Cabriolet	1.8L L4 F/I	HPR3660
1995 VOLKSWAGEN			Caddy I	1.8L L4 F/I	HPR3660
Taro	2.4L L4 F/I	HPR6690	Golf I	1.8L L4 F/I	HPR3660
1994 VOLKSWAGEN			Scirocco	1.8L L4 F/I	HPR3660
Taro	2.4L L4 F/I	HPR6690	Scirocco	1.8L L4 F/I - Exc., 90BHP	HPR3660
1993 VOLKSWAGEN			1984 VOLKSWAGEN		
Cabriolet	1.8L L4 F/I	HPR3660	Golf I	1.8L L4 F/I	HPR3660
Golf I	1.8L L4 F/I	HPR3660	Jetta	1.7L L4 F/I	HPR3660
Taro	2.4L L4 F/I	HPR6690	Rabbit	1.7L L4 CARB	HPR3660
1992 VOLKSWAGEN			Rabbit	1.7L L4 F/I	HPR3660
Cabriolet	1.8L L4 F/I	HPR3660	Rabbit	1.8L L4 F/I	HPR3660
Caddy I	1.8L L4 F/I	HPR3660	Rabbit Convertible	1.8L L4 F/I	HPR3660
Golf I	1.8L L4 F/I	HPR3660	Scirocco	1.8L L4 F/I	HPR3660
Scirocco	1.8L L4 F/I - Exc., 90BHP	HPR3660	Scirocco	1.8L L4 F/I - Exc., 90BHP	HPR3660
Taro	2.4L L4 F/I	HPR6690	1983 VOLKSWAGEN		
1991 VOLKSWAGEN			Golf I	1.8L L4 F/I	HPR3660
Cabriolet	1.8L L4 F/I	HPR3660	Golf I GTI	1.8L L4 F/I	HPR3660
Caddy I	1.8L L4 F/I	HPR3660	Jetta	1.7L L4 F/I	HPR3660
Golf I	1.8L L4 F/I	HPR3660	Jetta I	1.8L L4 F/I	HPR3660
Jetta II	1.8L L4 F/I - 129/140BHP	HPR6366	Quantum	1.7L L4 F/I	HPR3660
Scirocco	1.8L L4 F/I - Exc., 90BHP	HPR3660	Rabbit	1.7L L4 CARB	HPR3660
Taro	2.4L L4 F/I	HPR6690	Rabbit	1.7L L4 F/I	HPR3660
1990 VOLKSWAGEN			Rabbit	1.8L L4 F/I	HPR3660
Cabriolet	1.8L L4 F/I	HPR3660	Rabbit Convertible	1.7L L4 F/I	HPR3660
Caddy I	1.8L L4 F/I	HPR3660	Rabbit Pickup	1.7L L4 F/I	HPR3660
			Scirocco	1.7L L4 F/I	HPR3660

*Indicates 2 filters required ♦ Intake system available - see page 326 + throttle body spacer available - see page 20

HPR™ REPLACEMENT AIR FILTERS VOLKSWAGEN

Vehicle	Engine Type	Air Filter	Vehicle	Engine Type	Air Filter
1983 VOLKSWAGEN			1976 VOLKSWAGEN		
Scirocco	1.8L L4 F/I	HPR3660	Dasher	1.6L L4 F/I	HPR3660
Scirocco	1.8L L4 F/I - Exc., 90BHP	HPR3660	Golf I	1.6L L4 F/I - 110BHP	HPR3660
1982 VOLKSWAGEN			Golf I GTI	1.6L L4 F/I	HPR3660
Golf I	1.6L L4 F/I - 110BHP	HPR3660	Scirocco	1.6L L4 F/I	HPR3660
Golf I	1.8L L4 CARB	HPR3660	1972 VOLKSWAGEN		
Golf I	1.8L L4 F/I	HPR3660	Transporter	97 H4 CARB	HPR3660
Golf I GTI	1.6L L4 F/I	HPR3660			
Golf I GTI	1.8L L4 CARB	HPR3660			
Jetta	1.6L L4 F/I	HPR3660			
Jetta	1.7L L4 F/I	HPR3660			
Jetta I	1.8L L4 F/I	HPR3660			
Quantum	1.7L L4 F/I	HPR3660			
Rabbit	1.7L L4 CARB	HPR3660			
Rabbit	1.7L L4 F/I	HPR3660			
Rabbit Convertible	1.7L L4 F/I	HPR3660			
Rabbit Pickup	1.7L L4 F/I	HPR3660			
Scirocco	1.6L L4 F/I	HPR3660			
Scirocco	1.7L L4 F/I	HPR3660			
Scirocco	1.8L L4 F/I - Exc., 90BHP	HPR3660			
1981 VOLKSWAGEN					
Golf I	1.6L L4 F/I - 110BHP	HPR3660			
Golf I GTI	1.6L L4 F/I	HPR3660			
Jetta	1.7L L4 F/I	HPR3660			
Rabbit	1.7L L4 F/I	HPR3660			
Rabbit Convertible	1.7L L4 F/I	HPR3660			
Rabbit Pickup	1.7L L4 F/I	HPR3660			
Scirocco	1.6L L4 F/I	HPR3660			
Scirocco	1.7L L4 F/I	HPR3660			
1980 VOLKSWAGEN					
Dasher	1.6L L4 F/I	HPR3660			
Golf I	1.6L L4 F/I - 110BHP	HPR3660			
Golf I GTI	1.6L L4 F/I	HPR3660			
Jetta	1.6L L4 F/I	HPR3660			
Passat	1.6L L4 F/I	HPR3660			
Rabbit	1.6L L4 F/I	HPR3660			
Rabbit Convertible	1.6L L4 F/I	HPR3660			
Rabbit Pickup	1.5L L4 F/I	HPR3660			
Rabbit Pickup	1.6L L4 F/I	HPR3660			
Scirocco	1.6L L4 F/I	HPR3660			
1979 VOLKSWAGEN					
Dasher	1.6L L4 F/I	HPR3660			
Golf I	1.6L L4 F/I - 110BHP	HPR3660			
Golf I GTI	1.6L L4 F/I	HPR3660			
Passat	1.6L L4 F/I	HPR3660			
Rabbit	1.5L L4 F/I	HPR3660			
Scirocco	1.6L L4 F/I	HPR3660			
1978 VOLKSWAGEN					
Dasher	1.6L L4 F/I	HPR3660			
Golf I	1.6L L4 F/I - 110BHP	HPR3660			
Golf I GTI	1.6L L4 F/I	HPR3660			
Passat	1.6L L4 F/I	HPR3660			
Rabbit	1.5L L4 F/I	HPR3660			
Scirocco	1.5L L4 F/I	HPR3660			
Scirocco	1.6L L4 F/I	HPR3660			
1977 VOLKSWAGEN					
Dasher	1.6L L4 F/I	HPR3660			
Golf I	1.6L L4 F/I - 110BHP	HPR3660			
Golf I GTI	1.6L L4 F/I	HPR3660			
Rabbit	1.6L L4 F/I	HPR3660			
Scirocco	1.6L L4 F/I	HPR3660			

*Indicates 2 filters required ♦ Intake system available - see page 326 + throttle body spacer available – see page 20

CADILLAC

AIR INTAKE SYSTEMS

Vehicle	Engine Type	Red Filter Part #	Blue Filter Part #	Black Filter Part #	Vehicle	Engine Type	Red Filter Part #	Blue Filter Part #	Black Filter Part #
2015 CADILLAC					2005 CADILLAC				
CTS-V	6.2L V8 F/I	9914 ²	9914B ²	9914K ²	Escalade	5.3L V8 F/I	9900 ¹	9900B ¹	9900K ¹
Escalade	6.2L V8 F/I	9015 ¹			Escalade	6.0L V8 F/I	9900 ¹	9900B ¹	9900K ¹
Escalade ESV	6.2L V8 F/I	9015 ¹			Escalade ESV	6.0L V8 F/I	9900 ¹	9900B ¹	9900K ¹
2014 CADILLAC					2004 CADILLAC				
CTS-V	6.2L V8 F/I	9914 ²	9914B ²	9914K ²	Escalade EXT	6.0L V8 F/I	9900 ¹	9900B ¹	9900K ¹
Escalade	6.2L V8 F/I	9918 ¹	9918B ¹	9918K ¹	2003 CADILLAC				
Escalade ESV	6.2L V8 F/I	9918 ¹	9918B ¹	9918K ¹	Escalade	5.3L V8 F/I	9900 ¹	9900B ¹	9900K ¹
2013 CADILLAC					Escalade	6.0L V8 F/I	9900 ¹	9900B ¹	9900K ¹
CTS-V	6.2L V8 F/I	9914 ²	9914B ²	9914K ²	Escalade ESV	6.0L V8 F/I	9900 ¹	9900B ¹	9900K ¹
Escalade	6.2L V8 F/I	9918 ¹	9918B ¹	9918K ¹	Escalade EXT	6.0L V8 F/I	9900 ¹	9900B ¹	9900K ¹
Escalade ESV	6.2L V8 F/I	9918 ¹	9918B ¹	9918K ¹	2002 CADILLAC				
Escalade EXT	6.2L V8 F/I	9918 ¹	9918B ¹	9918K ¹	Escalade	5.3L V8 F/I	9900 ¹	9900B ¹	9900K ¹
2012 CADILLAC					Escalade	6.0L V8 F/I	9900 ¹	9900B ¹	9900K ¹
CTS-V	6.2L V8 F/I	9914 ²	9914B ²	9914K ²	2016 CHEVROLET				
Escalade	6.2L V8 F/I	9918 ¹	9918B ¹	9918K ¹	Colorado	3.6L V6 F/I	9030 ²		
Escalade ESV	6.2L V8 F/I	9918 ¹	9918B ¹	9918K ¹	2015 CHEVROLET				
Escalade EXT	6.2L V8 F/I	9918 ¹	9918B ¹	9918K ¹	Camaro	3.6L V6 F/I	9981 ²	9981B ²	9981K ²
2011 CADILLAC					Camaro SS	6.2L V8 F/I	9908 ²	9908B ²	9908K ²
CTS-V	6.2L V8 F/I	9914 ²	9914B ²	9914K ²	Colorado	3.6L V6 F/I	9030 ¹		
Escalade	6.2L V8 F/I	9918 ¹	9918B ¹	9918K ¹	Cruze	1.4L L4 F/I	9044 ²		
Escalade ESV	6.2L V8 F/I	9918 ¹	9918B ¹	9918K ¹	Silverado 1500	5.3L V8 F/I	9006 ¹		
Escalade EXT	6.2L V8 F/I	9918 ¹	9918B ¹	9918K ¹	Silverado 1500	6.2L V8 F/I	9015 ¹		
2010 CADILLAC					Silverado 2500 HD	6.0L V8 F/I	9040 ¹		
CTS	3.6L V6 F/I	9912 ²	9912B ²	9912K ²	Silverado 3500 HD	6.0L V8 F/I	9040 ¹		
CTS-V	6.2L V8 F/I	9914 ²	9914B ²	9914K ²	Suburban	5.3L V8 F/I	9006 ¹		
Escalade	6.2L V8 F/I	9918 ¹	9918B ¹	9918K ¹	Tahoe	5.3L V8 F/I	9006 ¹		
Escalade ESV	6.2L V8 F/I	9918 ¹	9918B ¹	9918K ¹	2014 CHEVROLET				
Escalade EXT	6.2L V8 F/I	9918 ¹	9918B ¹	9918K ¹	Camaro	3.6L V6 F/I	9981 ²	9981B ²	9981K ²
2009 CADILLAC					Camaro SS	6.2L V8 F/I	9908 ²	9908B ²	9908K ²
CTS	3.6L V6 F/I	9912 ²	9912B ²	9912K ²	Cruze	1.4L L4 F/I	9044 ²		
CTS-V	6.2L V8 F/I	9914 ²	9914B ²	9914K ²	Silverado 1500	4.3L V6 F/I	9026 ¹		
Escalade	6.2L V8 F/I	9918 ¹	9918B ¹	9918K ¹	Silverado 1500	5.3L V8 F/I	9006 ¹		
Escalade ESV	6.2L V8 F/I	9918 ¹	9918B ¹	9918K ¹	Silverado 1500	6.2L V8 F/I	9015 ¹		
Escalade EXT	6.2L V8 F/I	9918 ¹	9918B ¹	9918K ¹	Silverado 2500 HD	6.0L V8 F/I	9040 ¹		
STS-V	4.4L V8 F/I	9917 ²	9917B ²	9917K ²	Silverado 2500 HD	6.6L V8 DSL	9986 ¹		
2008 CADILLAC					Silverado 3500 HD	6.0L V8 F/I	9040 ¹		
CTS	3.6L V6 F/I	9912 ²	9912B ²	9912K ²	Silverado 3500 HD	6.6L V8 DSL	9986 ¹		
Escalade	6.2L V8 F/I	9910 ¹	9910B ¹	9910K ¹	SS	6.2L V8 F/I	9017 ²		
Escalade ESV	6.2L V8 F/I	9910 ¹	9910B ¹	9910K ¹	Suburban 1500	5.3L V8 F/I	9918 ¹	9918B ¹	9918K ¹
Escalade EXT	6.2L V8 F/I	9910 ¹	9910B ¹	9910K ¹	Tahoe	5.3L V8 F/I	9918 ¹	9918B ¹	9918K ¹
STS-V	4.4L V8 F/I	9917 ²	9917B ²	9917K ²	2013 CHEVROLET				
2007 CADILLAC					Avalanche	5.3L V8 F/I	9918 ¹	9918B ¹	9918K ¹
CTS-V	6.0L V8 F/I	9913 ²	9913B ²	9913K ²	Camaro	3.6L V6 F/I	9981 ²	9981B ²	9981K ²
Escalade	6.2L V8 F/I	9910 ¹	9910B ¹	9910K ¹	Camaro SS	6.2L V8 F/I	9908 ²	9908B ²	9908K ²
Escalade ESV	6.2L V8 F/I	9910 ¹	9910B ¹	9910K ¹	Cruze	1.4L L4 F/I	9044 ²		
Escalade EXT	6.2L V8 F/I	9910 ¹	9910B ¹	9910K ¹	Silverado 1500	4.8L V8 F/I	9918 ¹	9918B ¹	9918K ¹
STS-V	4.4L V8 F/I	9917 ²	9917B ²	9917K ²	Silverado 1500	5.3L V8 F/I	9918 ¹	9918B ¹	9918K ¹
2006 CADILLAC					Silverado 1500	6.2L V8 F/I	9918 ¹	9918B ¹	9918K ¹
CTS-V	6.0L V8 F/I	9913 ²	9913B ²	9913K ²	Silverado 2500 HD	6.0L V8 F/I	9004 ¹	9004B ¹	9004K ¹
Escalade	6.0L V8 F/I	9900 ¹	9900B ¹	9900K ¹	Silverado 2500 HD	6.6L V8 DSL	9986 ¹		
Escalade ESV	6.0L V8 F/I	9900 ¹	9900B ¹	9900K ¹					
Escalade EXT	6.0L V8 F/I	9900 ¹	9900B ¹	9900K ¹					
STS-V	4.4L V8 F/I	9917 ²	9917B ²	9917K ²					

1) Street legal in all US states. 2) Not legal for sale or use on any pollution controlled motor vehicle in California or states adopting California emission procedures.

AIR INTAKE SYSTEMS

CHEVROLET

Vehicle	Engine Type	Red Filter Part #	Blue Filter Part #	Black Filter Part #
2013 CHEVROLET				
Silverado 3500 HD	6.0L V8 F/I	9004 ¹	9004B ¹	9004K ¹
Silverado 3500 HD	6.6L V8 DSL	9986 ¹		
Suburban 1500	5.3L V8 F/I	9918 ¹	9918B ¹	9918K ¹
Tahoe	5.3L V8 F/I	9918 ¹	9918B ¹	9918K ¹
2012 CHEVROLET				
Avalanche	5.3L V8 F/I	9918 ¹	9918B ¹	9918K ¹
Camaro	3.6L V6 F/I	9981 ²	9981B ²	9981K ²
Camaro SS	6.2L V8 F/I	9908 ²	9908B ²	9908K ²
Cruze	1.4L L4 F/I	9044 ²		
Silverado 1500	4.8L V8 F/I	9918 ¹	9918B ¹	9918K ¹
Silverado 1500	5.3L V8 F/I	9918 ¹	9918B ¹	9918K ¹
Silverado 1500	6.2L V8 F/I	9918 ¹	9918B ¹	9918K ¹
Silverado 2500 HD	6.0L V8 F/I	9004 ¹	9004B ¹	9004K ¹
Silverado 2500 HD	6.6L V8 DSL	9985 ¹		
Silverado 3500 HD	6.0L V8 F/I	9004 ¹	9004B ¹	9004K ¹
Silverado 3500 HD	6.6L V8 DSL	9985 ¹		
Suburban 1500	5.3L V8 F/I	9918 ¹	9918B ¹	9918K ¹
Suburban 2500	6.0L V8 F/I	9918 ¹	9918B ¹	9918K ¹
Tahoe	5.3L V8 F/I	9918 ¹	9918B ¹	9918K ¹
2011 CHEVROLET				
Avalanche	5.3L V8 F/I	9918 ¹	9918B ¹	9918K ¹
Camaro	3.6L V6 F/I	9909 ²	9909B ²	9909K ²
Camaro SS	6.2L V8 F/I	9908 ²	9908B ²	9908K ²
Cruze	1.4L L4 F/I	9044 ²		
Silverado 1500	4.8L V8 F/I	9918 ¹	9918B ¹	9918K ¹
Silverado 1500	5.3L V8 F/I	9918 ¹	9918B ¹	9918K ¹
Silverado 1500	6.2L V8 F/I	9918 ¹	9918B ¹	9918K ¹
Silverado 2500 HD	6.0L V8 F/I	9004 ¹	9004B ¹	9004K ¹
Silverado 2500 HD	6.6L V8 DSL	9985 ¹		
Silverado 3500 HD	6.0L V8 F/I	9004 ¹	9004B ¹	9004K ¹
Silverado 3500 HD	6.6L V8 DSL	9985 ¹		
Suburban 1500	5.3L V8 F/I	9918 ¹	9918B ¹	9918K ¹
Suburban 2500	6.0L V8 F/I	9918 ¹	9918B ¹	9918K ¹
Tahoe	5.3L V8 F/I	9918 ¹	9918B ¹	9918K ¹
2010 CHEVROLET				
Avalanche	5.3L V8 F/I	9918 ¹	9918B ¹	9918K ¹
Camaro	3.6L V6 F/I	9909 ²	9909B ²	9909K ²
Camaro SS	6.2L V8 F/I	9908 ²	9908B ²	9908K ²
Silverado 1500	4.8L V8 F/I	9918 ¹	9918B ¹	9918K ¹
Silverado 1500	5.3L V8 F/I	9918 ¹	9918B ¹	9918K ¹
Silverado 1500	6.2L V8 F/I	9918 ¹	9918B ¹	9918K ¹
Silverado 2500 HD	6.6L V8 DSL	9982 ¹		
Silverado 3500 HD	6.6L V8 DSL	9982 ¹		
Suburban 1500	5.3L V8 F/I	9918 ¹	9918B ¹	9918K ¹
Suburban 2500	6.0L V8 F/I	9918 ¹	9918B ¹	9918K ¹
Tahoe	5.3L V8 F/I	9918 ¹	9918B ¹	9918K ¹
2009 CHEVROLET				
Avalanche	5.3L V8 F/I	9918 ¹	9918B ¹	9918K ¹
Avalanche	6.0L V8 F/I	9918 ¹	9918B ¹	9918K ¹
Silverado 1500	4.8L V8 F/I	9918 ¹	9918B ¹	9918K ¹
Silverado 1500	5.3L V8 F/I	9918 ¹	9918B ¹	9918K ¹
Silverado 1500	6.0L V8 F/I	9918 ¹	9918B ¹	9918K ¹
Silverado 1500	6.2L V8 F/I	9918 ¹	9918B ¹	9918K ¹
Silverado 2500 HD	6.6L V8 DSL	9982 ¹		
Silverado 3500 HD	6.6L V8 DSL	9982 ¹		

Vehicle	Engine Type	Red Filter Part #	Blue Filter Part #	Black Filter Part #
2009 CHEVROLET				
Suburban 1500	5.3L V8 F/I	9918 ¹	9918B ¹	9918K ¹
Suburban 1500	6.0L V8 F/I	9918 ¹	9918B ¹	9918K ¹
Tahoe	4.8L V8 F/I	9918 ¹	9918B ¹	9918K ¹
Tahoe	5.3L V8 F/I	9918 ¹	9918B ¹	9918K ¹
Tahoe	6.2L V8 F/I	9918 ¹	9918B ¹	9918K ¹
2008 CHEVROLET				
Avalanche	5.3L V8 F/I	9910 ¹	9910B ¹	9910K ¹
Avalanche	6.0L V8 F/I	9910 ¹	9910B ¹	9910K ¹
Silverado 1500	4.8L V8 F/I	9910 ¹	9910B ¹	9910K ¹
Silverado 1500	5.3L V8 F/I	9910 ¹	9910B ¹	9910K ¹
Silverado 1500	6.0L V8 F/I	9910 ¹	9910B ¹	9910K ¹
Silverado 2500 HD	6.6L V8 DSL	9982 ¹		
Silverado 3500 HD	6.6L V8 DSL	9982 ¹		
Suburban 1500	5.3L V8 F/I	9910 ¹	9910B ¹	9910K ¹
Suburban 1500	6.0L V8 F/I	9910 ¹	9910B ¹	9910K ¹
Tahoe	4.8L V8 F/I	9910 ¹	9910B ¹	9910K ¹
Tahoe	5.3L V8 F/I	9910 ¹	9910B ¹	9910K ¹
Tahoe Hybrid	6.0L V8 F/I	9910 ¹	9910B ¹	9910K ¹
2007 CHEVROLET				
Avalanche	5.3L V8 F/I	9910 ¹	9910B ¹	9910K ¹
Avalanche	6.0L V8 F/I	9910 ¹	9910B ¹	9910K ¹
Silverado 1500	4.8L V8 F/I	9910 ¹	9910B ¹	9910K ¹
Silverado 1500	5.3L V8 F/I	9910 ¹	9910B ¹	9910K ¹
Silverado 1500	6.0L V8 F/I	9910 ¹	9910B ¹	9910K ¹
Silverado 1500	4.8L V8 F/I	9900 ¹	9900B ¹	9900K ¹
Classic				
Silverado 1500	5.3L V8 F/I	9900 ¹	9900B ¹	9900K ¹
Classic				
Silverado 1500	6.0L V8 F/I	9900 ¹	9900B ¹	9900K ¹
Classic				
Silverado 1500 HD	6.0L V8 F/I	9900 ¹	9900B ¹	9900K ¹
Classic				
Silverado 2500 HD	6.6L V8 DSL	9982 ¹		
Silverado 2500 HD	6.0L V8 F/I	9900 ¹	9900B ¹	9900K ¹
Classic				
Silverado 3500	6.0L V8 F/I	9900 ²	9900B ²	9900K ²
Classic				
Silverado 3500 HD	6.6L V8 DSL	9982 ¹		
Silverado SS	6.0L V8 F/I	9910 ¹	9910B ¹	9910K ¹
Silverado SS	6.0L V8 F/I	9900 ²	9900B ²	9900K ²
Classic				
Suburban 1500	5.3L V8 F/I	9910 ¹	9910B ¹	9910K ¹
Suburban 1500	6.0L V8 F/I	9910 ¹	9910B ¹	9910K ¹
Tahoe	4.8L V8 F/I	9910 ¹	9910B ¹	9910K ¹
Tahoe	5.3L V8 F/I	9910 ¹	9910B ¹	9910K ¹
TrailBlazer	6.0L V8 F/I	9911 ²	9911B ²	9911K ²
2006 CHEVROLET				
Avalanche 1500	5.3L V8 F/I	9900 ¹	9900B ¹	9900K ¹
Silverado 1500	4.8L V8 F/I	9900 ¹	9900B ¹	9900K ¹
Silverado 1500	5.3L V8 F/I	9900 ¹	9900B ¹	9900K ¹
Silverado 1500	6.0L V8 F/I	9900 ¹	9900B ¹	9900K ¹
Silverado 1500 HD	6.0L V8 F/I	9900 ²	9900B ²	9900K ²
Silverado 2500 HD	6.0L V8 F/I	9900 ²	9900B ²	9900K ²
Silverado 3500	6.0L V8 F/I	9900 ²	9900B ²	9900K ²
Silverado SS	6.0L V8 F/I	9900 ¹	9900B ¹	9900K ¹
Suburban 1500	5.3L V8 F/I	9900 ¹	9900B ¹	9900K ¹

1) Street legal in all US states. 2) Not legal for sale or use on any pollution controlled motor vehicle in California or states adopting California emission procedures.

CHEVROLET

AIR INTAKE SYSTEMS

Vehicle	Engine Type	Red Filter Part #	Blue Filter Part #	Black Filter Part #	Vehicle	Engine Type	Red Filter Part #	Blue Filter Part #	Black Filter Part #
2006 CHEVROLET					2002 CHEVROLET				
Suburban 1500	6.0L V8 F/I	9900 ¹	9900B ¹	9900K ¹	S10 Pickup	2.2L L4 F/I	9902 ¹	9902B ¹	9902K ¹
Suburban 2500	6.0L V8 F/I	9900 ¹	9900B ¹	9900K ¹	S10 Pickup	4.3L V6 F/I	9901 ¹	9901B ¹	9901K ¹
Tahoe	4.8L V8 F/I	9900 ¹	9900B ¹	9900K ¹	Silverado 1500	4.8L V8 F/I	9900 ¹	9900B ¹	9900K ¹
Tahoe	5.3L V8 F/I	9900 ¹	9900B ¹	9900K ¹	Silverado 1500	5.3L V8 F/I	9900 ¹	9900B ¹	9900K ¹
TrailBlazer	6.0L V8 F/I	9911 ²	9911B ²	9911K ²	Silverado 1500 HD	6.0L V8 F/I	9900 ¹	9900B ¹	9900K ¹
2005 CHEVROLET					Silverado 2500				
Avalanche 1500	5.3L V8 F/I	9900 ¹	9900B ¹	9900K ¹	Silverado 2500	5.3L V8 F/I	9900 ¹	9900B ¹	9900K ¹
Silverado 1500	4.8L V8 F/I	9900 ¹	9900B ¹	9900K ¹	Silverado 2500	6.0L V8 F/I	9900 ¹	9900B ¹	9900K ¹
Silverado 1500	5.3L V8 F/I	9900 ¹	9900B ¹	9900K ¹	Silverado 2500 HD	6.0L V8 F/I	9900 ¹	9900B ¹	9900K ¹
Silverado 1500 HD	6.0L V8 F/I	9900 ¹	9900B ¹	9900K ¹	Silverado 2500 HD	6.6L V8 DSL	9904 ¹	9904B ¹	9904K ¹
Silverado 2500 HD	6.0L V8 F/I	9900 ¹	9900B ¹	9900K ¹	Silverado 3500	5.3L V8 F/I	9900 ¹	9900B ¹	9900K ¹
Silverado 3500	6.0L V8 F/I	9900 ²	9900B ²	9900K ²	Silverado 3500	6.0L V8 F/I	9900 ²	9900B ²	9900K ²
Silverado SS	6.0L V8 F/I	9900 ¹	9900B ¹	9900K ¹	Silverado 3500	6.6L V8 DSL	9904 ¹	9904B ¹	9904K ¹
Suburban 1500	5.3L V8 F/I	9900 ¹	9900B ¹	9900K ¹	Suburban 1500	5.3L V8 F/I	9900 ¹	9900B ¹	9900K ¹
Suburban 2500	6.0L V8 F/I	9900 ¹	9900B ¹	9900K ¹	Suburban 2500	6.0L V8 F/I	9900 ¹	9900B ¹	9900K ¹
Tahoe	4.8L V8 F/I	9900 ¹	9900B ¹	9900K ¹	Tahoe	4.8L V8 F/I	9900 ¹	9900B ¹	9900K ¹
Tahoe	5.3L V8 F/I	9900 ¹	9900B ¹	9900K ¹	Tahoe	5.3L V8 F/I	9900 ¹	9900B ¹	9900K ¹
2004 CHEVROLET					2001 CHEVROLET				
Avalanche 1500	5.3L V8 F/I	9900 ¹	9900B ¹	9900K ¹	Blazer	4.3L V6 F/I	9901 ¹	9901B ¹	9901K ¹
Blazer	4.3L V6 F/I	9901 ¹	9901B ¹	9901K ¹	S10 Pickup	2.2L L4 F/I	9902 ¹	9902B ¹	9902K ¹
S10 Pickup	4.3L V6 F/I	9901 ¹	9901B ¹	9901K ¹	S10 Pickup	4.3L V6 F/I	9901 ¹	9901B ¹	9901K ¹
Silverado 1500	4.8L V8 F/I	9900 ¹	9900B ¹	9900K ¹	Silverado 1500	4.8L V8 F/I	9900 ¹	9900B ¹	9900K ¹
Silverado 1500	5.3L V8 F/I	9900 ¹	9900B ¹	9900K ¹	Silverado 1500	5.3L V8 F/I	9900 ¹	9900B ¹	9900K ¹
Silverado 2500	6.0L V8 F/I	9900 ¹	9900B ¹	9900K ¹	Silverado 1500 HD	6.0L V8 F/I	9900 ¹	9900B ¹	9900K ¹
Silverado 2500 HD	6.0L V8 F/I	9900 ¹	9900B ¹	9900K ¹	Silverado 2500	6.0L V8 F/I	9900 ¹	9900B ¹	9900K ¹
Silverado 2500 HD	6.6L V8 DSL - LB7	9904 ¹	9904B ¹	9904K ¹	Silverado 2500 HD	6.0L V8 F/I	9900 ¹	9900B ¹	9900K ¹
Silverado 3500	6.0L V8 F/I	9900 ²	9900B ²	9900K ²	Silverado 2500 HD	6.6L V8 DSL	9904 ¹	9904B ¹	9904K ¹
Silverado 3500	6.6L V8 DSL - LB7	9904 ¹	9904B ¹	9904K ¹	Silverado 3500	6.0L V8 F/I	9900 ²	9900B ²	9900K ²
Silverado SS	6.0L V8 F/I	9900 ¹	9900B ¹	9900K ¹	Silverado 3500	6.6L V8 DSL	9904 ¹	9904B ¹	9904K ¹
Suburban 1500	5.3L V8 F/I	9900 ¹	9900B ¹	9900K ¹	Suburban 1500	5.3L V8 F/I	9900 ¹	9900B ¹	9900K ¹
Suburban 2500	6.0L V8 F/I	9900 ¹	9900B ¹	9900K ¹	Suburban 2500	6.0L V8 F/I	9900 ¹	9900B ¹	9900K ¹
Tahoe	4.8L V8 F/I	9900 ¹	9900B ¹	9900K ¹	Tahoe	4.8L V8 F/I	9900 ¹	9900B ¹	9900K ¹
Tahoe	5.3L V8 F/I	9900 ¹	9900B ¹	9900K ¹	Tahoe	5.3L V8 F/I	9900 ¹	9900B ¹	9900K ¹
2003 CHEVROLET					2000 CHEVROLET				
Avalanche 1500	5.3L V8 F/I	9900 ¹	9900B ¹	9900K ¹	Blazer	4.3L V6 F/I	9901 ¹	9901B ¹	9901K ¹
Blazer	4.3L V6 F/I	9901 ¹	9901B ¹	9901K ¹	C2500	5.7L V8 F/I	9903 ¹	9903B ¹	9903K ¹
S10 Pickup	2.2L L4 F/I	9902 ¹	9902B ¹	9902K ¹	C3500	5.7L V8 F/I	9903 ¹	9903B ¹	9903K ¹
S10 Pickup	4.3L V6 F/I	9901 ¹	9901B ¹	9901K ¹	K2500	5.7L V8 F/I	9903 ¹	9903B ¹	9903K ¹
Silverado 1500	4.8L V8 F/I	9900 ¹	9900B ¹	9900K ¹	K3500	5.7L V8 F/I	9903 ¹	9903B ¹	9903K ¹
Silverado 1500	5.3L V8 F/I	9900 ¹	9900B ¹	9900K ¹	S10 Pickup	2.2L L4 F/I	9902 ¹	9902B ¹	9902K ¹
Silverado 1500 HD	6.0L V8 F/I	9900 ¹	9900B ¹	9900K ¹	S10 Pickup	4.3L V6 F/I	9901 ¹	9901B ¹	9901K ¹
Silverado 2500	6.0L V8 F/I	9900 ¹	9900B ¹	9900K ¹	Silverado 1500	4.8L V8 F/I	9900 ¹	9900B ¹	9900K ¹
Silverado 2500 HD	6.0L V8 F/I	9900 ¹	9900B ¹	9900K ¹	Silverado 1500	5.3L V8 F/I	9900 ¹	9900B ¹	9900K ¹
Silverado 2500 HD	6.6L V8 DSL	9904 ¹	9904B ¹	9904K ¹	Silverado 2500	5.3L V8 F/I	9900 ¹	9900B ¹	9900K ¹
Silverado 3500	6.0L V8 F/I	9900 ²	9900B ²	9900K ²	Silverado 2500	6.0L V8 F/I	9900 ¹	9900B ¹	9900K ¹
Silverado 3500	6.6L V8 DSL	9904 ¹	9904B ¹	9904K ¹	Suburban 1500	5.3L V8 F/I	9900 ¹	9900B ¹	9900K ¹
Silverado SS	6.0L V8 F/I	9900 ¹	9900B ¹	9900K ¹	Suburban 2500	6.0L V8 F/I	9900 ¹	9900B ¹	9900K ¹
Suburban 1500	5.3L V8 F/I	9900 ¹	9900B ¹	9900K ¹	Tahoe	4.8L V8 F/I	9900 ¹	9900B ¹	9900K ¹
Suburban 2500	6.0L V8 F/I	9900 ¹	9900B ¹	9900K ¹	Tahoe	5.3L V8 F/I	9900 ¹	9900B ¹	9900K ¹
Tahoe	4.8L V8 F/I	9900 ¹	9900B ¹	9900K ¹	Tahoe	5.7L V8 F/I	9903 ¹	9903B ¹	9903K ¹
Tahoe	5.3L V8 F/I	9900 ¹	9900B ¹	9900K ¹	1999 CHEVROLET				
2002 CHEVROLET					Blazer				
Avalanche 1500	5.3L V8 F/I	9900 ¹	9900B ¹	9900K ¹	Blazer	4.3L V6 F/I	9901 ¹	9901B ¹	9901K ¹
Blazer	4.3L V6 F/I	9901 ¹	9901B ¹	9901K ¹	C1500	5.0L V8 F/I	9903 ¹	9903B ¹	9903K ¹
					C1500				
					C1500 Suburban				
					C2500				

1) Street legal in all US states. 2) Not legal for sale or use on any pollution controlled motor vehicle in California or states adopting California emission procedures.

AIR INTAKE SYSTEMS

CHEVROLET

Vehicle	Engine Type	Red Filter Part #	Blue Filter Part #	Black Filter Part #	Vehicle	Engine Type	Red Filter Part #	Blue Filter Part #	Black Filter Part #
1999 CHEVROLET					1996 CHEVROLET				
C2500 Suburban	5.7L V8 F/I	9903 ¹	9903B ¹	9903K ¹	C1500	5.7L V8 F/I	9903 ¹	9903B ¹	9903K ¹
C3500	5.7L V8 F/I	9903 ¹	9903B ¹	9903K ¹	C1500 Suburban	5.7L V8 F/I	9903 ¹	9903B ¹	9903K ¹
K1500	5.0L V8 F/I	9903 ¹	9903B ¹	9903K ¹	C2500	5.0L V8 F/I	9903 ¹	9903B ¹	9903K ¹
K1500	5.7L V8 F/I	9903 ¹	9903B ¹	9903K ¹	C2500	5.7L V8 F/I	9903 ¹	9903B ¹	9903K ¹
K1500 Suburban	5.7L V8 F/I	9903 ¹	9903B ¹	9903K ¹	C2500 Suburban	5.7L V8 F/I	9903 ¹	9903B ¹	9903K ¹
K2500	5.7L V8 F/I	9903 ¹	9903B ¹	9903K ¹	C3500	5.7L V8 F/I	9903 ¹	9903B ¹	9903K ¹
K2500 Suburban	5.7L V8 F/I	9903 ¹	9903B ¹	9903K ¹	Impala SS	5.7L V8 F/I	9983 ²		
K3500	5.7L V8 F/I	9903 ¹	9903B ¹	9903K ¹	K1500	5.0L V8 F/I	9903 ¹	9903B ¹	9903K ¹
S10 Pickup	2.2L L4 F/I	9902 ¹	9902B ¹	9902K ¹	K1500	5.7L V8 F/I	9903 ¹	9903B ¹	9903K ¹
S10 Pickup	4.3L V6 F/I	9901 ¹	9901B ¹	9901K ¹	K1500 Suburban	5.7L V8 F/I	9903 ¹	9903B ¹	9903K ¹
Silverado 1500	4.8L V8 F/I	9900 ¹	9900B ¹	9900K ¹	K2500	5.0L V8 F/I	9903 ¹	9903B ¹	9903K ¹
Silverado 1500	5.3L V8 F/I	9900 ¹	9900B ¹	9900K ¹	K2500	5.7L V8 F/I	9903 ¹	9903B ¹	9903K ¹
Silverado 2500	5.3L V8 F/I	9900 ¹	9900B ¹	9900K ¹	K2500 Suburban	5.7L V8 F/I	9903 ¹	9903B ¹	9903K ¹
Silverado 2500	6.0L V8 F/I	9900 ¹	9900B ¹	9900K ¹	K3500	5.7L V8 F/I	9903 ¹	9903B ¹	9903K ¹
Tahoe	5.7L V8 F/I	9903 ¹	9903B ¹	9903K ¹	S10 Pickup	4.3L V6 F/I	9901 ¹	9901B ¹	9901K ¹
1998 CHEVROLET					1995 CHEVROLET				
Blazer	4.3L V6 F/I	9901 ¹	9901B ¹	9901K ¹	Impala SS	5.7L V8 F/I	9983 ²		
C1500	5.0L V8 F/I	9903 ¹	9903B ¹	9903K ¹	1994 CHEVROLET				
C1500	5.7L V8 F/I	9903 ¹	9903B ¹	9903K ¹	Impala SS 5.7L V8 F/I 9983 ²				
C1500 Suburban	5.7L V8 F/I	9903 ¹	9903B ¹	9903K ¹	2016 CHRYSLER				
C2500	5.0L V8 F/I	9903 ¹	9903B ¹	9903K ¹	300 3.6L V6 F/I 9028 ²				
C2500	5.7L V8 F/I	9903 ¹	9903B ¹	9903K ¹	2015 CHRYSLER				
C2500 Suburban	5.7L V8 F/I	9903 ¹	9903B ¹	9903K ¹	300 3.6L V6 F/I 9028 ²				
C3500	5.7L V8 F/I	9903 ¹	9903B ¹	9903K ¹	300 6.4L V8 F/I 9003 ² 9003B ² 9003K ²				
K1500	5.0L V8 F/I	9903 ¹	9903B ¹	9903K ¹	300C 3.6L V6 F/I 9028 ²				
K1500	5.7L V8 F/I	9903 ¹	9903B ¹	9903K ¹	300C 5.7L V8 F/I 9036 ²				
K1500 Suburban	5.7L V8 F/I	9903 ¹	9903B ¹	9903K ¹	300S 5.7L V8 F/I 9036 ²				
K2500	5.0L V8 F/I	9903 ¹	9903B ¹	9903K ¹	2014 CHRYSLER				
K2500	5.7L V8 F/I	9903 ¹	9903B ¹	9903K ¹	300 3.6L V6 F/I 9028 ²				
K2500 Suburban	5.7L V8 F/I	9903 ¹	9903B ¹	9903K ¹	300 6.4L V8 F/I 9003 ² 9003B ² 9003K ²				
K3500	5.7L V8 F/I	9903 ¹	9903B ¹	9903K ¹	300C 3.6L V6 F/I 9028 ²				
S10 Pickup	2.2L L4 F/I	9902 ¹	9902B ¹	9902K ¹	300C 5.7L V8 F/I 9036 ²				
S10 Pickup	4.3L V6 F/I	9901 ¹	9901B ¹	9901K ¹	300S 5.7L V8 F/I 9036 ²				
Tahoe	5.7L V8 F/I	9903 ¹	9903B ¹	9903K ¹	2013 CHRYSLER				
1997 CHEVROLET					300 3.6L V6 F/I 9028 ²				
Blazer	4.3L V6 F/I	9901 ¹	9901B ¹	9901K ¹	300 6.4L V8 F/I 9003 ² 9003B ² 9003K ²				
C1500	5.0L V8 F/I	9903 ¹	9903B ¹	9903K ¹	300C 5.7L V8 F/I 9036 ²				
C1500	5.7L V8 F/I	9903 ¹	9903B ¹	9903K ¹	300S 5.7L V8 F/I 9036 ²				
C1500 Suburban	5.7L V8 F/I	9903 ¹	9903B ¹	9903K ¹	2012 CHRYSLER				
C2500	5.0L V8 F/I	9903 ¹	9903B ¹	9903K ¹	300 3.6L V6 F/I 9028 ²				
C2500	5.7L V8 F/I	9903 ¹	9903B ¹	9903K ¹	300 6.4L V8 F/I 9003 ² 9003B ² 9003K ²				
C2500 Suburban	5.7L V8 F/I	9903 ¹	9903B ¹	9903K ¹	300C 5.7L V8 F/I 9036 ²				
C3500	5.7L V8 F/I	9903 ¹	9903B ¹	9903K ¹	300S 5.7L V8 F/I 9036 ²				
K1500	5.0L V8 F/I	9903 ¹	9903B ¹	9903K ¹	2011 CHRYSLER				
K1500	5.7L V8 F/I	9903 ¹	9903B ¹	9903K ¹	300 3.6L V6 F/I 9028 ²				
K1500 Suburban	5.7L V8 F/I	9903 ¹	9903B ¹	9903K ¹	300C 5.7L V8 F/I 9036 ²				
K2500	5.0L V8 F/I	9903 ¹	9903B ¹	9903K ¹	2010 CHRYSLER				
K2500	5.7L V8 F/I	9903 ¹	9903B ¹	9903K ¹	300C 5.7L V8 F/I 9935 ² 9935B ² 9935K ²				
K2500 Suburban	5.7L V8 F/I	9903 ¹	9903B ¹	9903K ¹	300C 6.1L V8 F/I 9935 ² 9935B ² 9935K ²				
K3500	5.7L V8 F/I	9903 ¹	9903B ¹	9903K ¹	2009 CHRYSLER				
S10 Pickup	4.3L V6 F/I	9901 ¹	9901B ¹	9901K ¹	300C 5.7L V8 F/I 9935 ² 9935B ² 9935K ²				
Tahoe	5.7L V8 F/I	9903 ¹	9903B ¹	9903K ¹					
1996 CHEVROLET									
Blazer	4.3L V6 F/I	9901 ¹	9901B ¹	9901K ¹					
C1500	5.0L V8 F/I	9903 ¹	9903B ¹	9903K ¹					

1) Street legal in all US states. 2) Not legal for sale or use on any pollution controlled motor vehicle in California or states adopting California emission procedures.

CHRYSLER

AIR INTAKE SYSTEMS

Vehicle	Engine Type	Red Filter Part #	Blue Filter Part #	Black Filter Part #
2009 CHRYSLER				
300C	6.1L V8 F/I	9935 ²	9935B ²	9935K ²
2008 CHRYSLER				
300C	5.7L V8 F/I	9935 ²	9935B ²	9935K ²
300C	6.1L V8 F/I	9935 ²	9935B ²	9935K ²
2007 CHRYSLER				
300C	5.7L V8 F/I	9935 ²	9935B ²	9935K ²
300C	6.1L V8 F/I	9935 ²	9935B ²	9935K ²
2006 CHRYSLER				
300C	5.7L V8 F/I	9935 ²	9935B ²	9935K ²
300C	6.1L V8 F/I	9935 ²	9935B ²	9935K ²
2005 CHRYSLER				
300C	5.7L V8 F/I	9935 ²	9935B ²	9935K ²
300C	6.1L V8 F/I	9935 ²	9935B ²	9935K ²
2016 DODGE				
1500	3.0L V6 DSL	9035 ²		
Challenger	3.6L V6 F/I	9028 ²		
Charger	3.6L V6 F/I	9028 ²		
2015 DODGE				
1500	3.0L V6 DSL	9035 ²		
1500	5.7L V8 F/I	9934 ²	9934B ²	9934K ²
2500	5.7L V8 F/I	9934 ²	9934B ²	9934K ²
Challenger	3.6L V6 F/I	9028 ²		
Challenger	5.7L V8 F/I	9036 ²		
Challenger	6.4L V8 F/I	9003 ²	9003B ²	9003K ²
Charger	3.6L V6 F/I	9028 ²		
Charger	5.7L V8 F/I	9036 ²		
Charger	6.4L V8 F/I	9003 ²	9003B ²	9003K ²
2014 DODGE				
Challenger	3.6L V6 F/I	9028 ²		
Challenger	5.7L V8 F/I	9036 ²		
Challenger	6.4L V8 F/I	9003 ²	9003B ²	9003K ²
Charger	3.6L V6 F/I	9028 ²		
Charger	5.7L V8 F/I	9036 ²		
Charger	6.4L V8 F/I	9003 ²	9003B ²	9003K ²
Durango	3.6L V6 F/I	9020 ²		
Durango	5.7L V8 F/I	9021 ²	9021B ²	9021K ²
Ram 1500	5.7L V8 F/I	9934 ²	9934B ²	9934K ²
Ram 1500 Pickup	3.0L V6 DSL	9035 ²		
Ram 1500 Pickup	3.6L V6 F/I	9016 ²	9016B ²	9016K ²
Ram 2500	5.7L V8 F/I	9934 ²	9934B ²	9934K ²
Ram 2500 Pickup	6.7L L6 DSL	9005 ²		
Ram 3500 Pickup	6.7L L6 DSL	9005 ²		
2013 DODGE				
Challenger	3.6L V6 F/I	9028 ²		
Challenger	5.7L V8 F/I	9036 ²		
Challenger	6.4L V8 F/I	9003 ²	9003B ²	9003K ²
Charger	3.6L V6 F/I	9028 ²		
Charger	5.7L V8 F/I	9036 ²		
Charger	6.4L V8 F/I	9003 ²	9003B ²	9003K ²
Durango	3.6L V6 F/I	9020 ²		
Durango	5.7L V8 F/I	9021 ²	9021B ²	9021K ²
Ram 1500	5.7L V8 F/I	9934 ²	9934B ²	9934K ²
Ram 1500 Pickup	3.6L V6 F/I	9016 ²	9016B ²	9016K ²

Vehicle	Engine Type	Red Filter Part #	Blue Filter Part #	Black Filter Part #
2013 DODGE				
Ram 2500	5.7L V8 F/I	9934 ²	9934B ²	9934K ²
Ram 2500 Pickup	6.7L L6 DSL	9005 ²		
Ram 3500 Pickup	6.7L L6 DSL	9005 ²		
2012 DODGE				
Challenger	3.6L V6 F/I	9028 ²		
Challenger	5.7L V8 F/I	9036 ²		
Challenger	6.4L V8 F/I	9003 ²	9003B ²	9003K ²
Charger	3.6L V6 F/I	9028 ²		
Charger	5.7L V8 F/I	9036 ²		
Charger	6.4L V8 F/I	9003 ²	9003B ²	9003K ²
Durango	3.6L V6 F/I	9020 ²		
Durango	5.7L V8 F/I	9021 ²	9021B ²	9021K ²
Ram 1500	5.7L V8 F/I	9934 ²	9934B ²	9934K ²
Ram 2500 Pickup	6.7L L6 DSL	9991 ²		
Ram 3500 Pickup	6.7L L6 DSL	9991 ²		
2011 DODGE				
Challenger	3.6L V6 F/I	9028 ²		
Challenger	5.7L V8 F/I	9036 ²		
Challenger	6.4L V8 F/I	9003 ²	9003B ²	9003K ²
Charger	3.6L V6 F/I	9028 ²		
Charger	5.7L V8 F/I	9036 ²		
Durango	3.6L V6 F/I	9020 ²		
Durango	5.7L V8 F/I	9021 ²	9021B ²	9021K ²
Ram 1500	5.7L V8 F/I	9934 ²	9934B ²	9934K ²
Ram 2500 Pickup	5.7L V8 F/I	9934 ²	9934B ²	9934K ²
Ram 2500 Pickup	6.7L L6 DSL	9991 ²		
Ram 3500 Pickup	5.7L V8 F/I	9934 ²	9934B ²	9934K ²
Ram 3500 Pickup	6.7L L6 DSL	9991 ²		
2010 DODGE				
Challenger	5.7L V8 F/I	9935 ²	9935B ²	9935K ²
Challenger	6.1L V8 F/I	9935 ²	9935B ²	9935K ²
Charger	5.7L V8 F/I	9935 ²	9935B ²	9935K ²
Charger	6.1L V8 F/I	9935 ²	9935B ²	9935K ²
Ram 1500 Pickup	5.7L V8 F/I	9934 ²	9934B ²	9934K ²
Ram 2500 Pickup	5.7L V8 F/I	9934 ²	9934B ²	9934K ²
Ram 2500 Pickup	6.7L L6 DSL	9991 ²		
Ram 3500 Pickup	6.7L L6 DSL	9991 ²		
2009 DODGE				
Challenger	5.7L V8 F/I	9935 ²	9935B ²	9935K ²
Challenger	6.1L V8 F/I	9935 ²	9935B ²	9935K ²
Charger	5.7L V8 F/I	9935 ²	9935B ²	9935K ²
Charger	6.1L V8 F/I	9935 ²	9935B ²	9935K ²
Ram 1500 Pickup	5.7L V8 F/I	9934 ²	9934B ²	9934K ²
Ram 2500 Pickup	5.7L V8 F/I	9934 ²	9934B ²	9934K ²
Ram 2500 Pickup	6.7L L6 DSL	9990 ²		
Ram 3500 Pickup	5.7L V8 F/I	9934 ²	9934B ²	9934K ²
Ram 3500 Pickup	6.7L L6 DSL	9990 ²		
2008 DODGE				
Challenger	6.1L V8 F/I	9935 ²	9935B ²	9935K ²
Charger	5.7L V8 F/I	9935 ²	9935B ²	9935K ²
Charger	6.1L V8 F/I	9935 ²	9935B ²	9935K ²
Magnum	5.7L V8 F/I	9935 ²	9935B ²	9935K ²
Magnum	6.1L V8 F/I	9935 ²	9935B ²	9935K ²

1) Street legal in all US states. 2) Not legal for sale or use on any pollution controlled motor vehicle in California or states adopting California emission procedures.

AIR INTAKE SYSTEMS

DODGE

Vehicle	Engine Type	Red Filter Part #	Blue Filter Part #	Black Filter Part #	Vehicle	Engine Type	Red Filter Part #	Blue Filter Part #	Black Filter Part #
2008 DODGE					2001 DODGE				
Ram 1500 Pickup	4.7L V8 F/I - Exc. 8CRXT0287P80	9932 ¹	9932B ¹	9932K ¹	Ram 1500 Pickup	5.2L V8 F/I	9931 ¹	9931B ¹	9931K ¹
Ram 1500 Pickup	5.7L V8 F/I	9932 ¹	9932B ¹	9932K ¹	Ram 1500 Pickup	5.9L V8 F/I	9931 ¹	9931B ¹	9931K ¹
Ram 2500 Pickup	5.7L V8 F/I	9932 ¹	9932B ¹	9932K ¹	Ram 2500 Pickup	5.9L L6 DSL	9939 ²	9939B ²	9939K ²
Ram 2500 Pickup	6.7L L6 DSL	9990 ²			Ram 2500 Pickup	5.9L V8 F/I	9931 ¹	9931B ¹	9931K ¹
Ram 3500 Pickup	6.7L L6 DSL	9990 ²			Ram 3500 Pickup	5.9L L6 DSL	9939 ²	9939B ²	9939K ²
2007 DODGE					2000 DODGE				
Charger	5.7L V8 F/I	9935 ²	9935B ²	9935K ²	Ram 1500 Pickup	5.2L V8 F/I	9931 ¹	9931B ¹	9931K ¹
Charger	6.1L V8 F/I	9935 ²	9935B ²	9935K ²	Ram 1500 Pickup	5.9L V8 F/I	9931 ¹	9931B ¹	9931K ¹
Magnum	5.7L V8 F/I	9935 ²	9935B ²	9935K ²	Ram 2500 Pickup	5.9L L6 DSL	9939 ²	9939B ²	9939K ²
Magnum	6.1L V8 F/I	9935 ²	9935B ²	9935K ²	Ram 2500 Pickup	5.9L V8 F/I	9931 ¹	9931B ¹	9931K ¹
Ram 1500 Pickup	4.7L V8 F/I - Exc. 7CRXT0287P80	9932 ¹	9932B ¹	9932K ¹	Ram 3500 Pickup	5.9L L6 DSL	9939 ²	9939B ²	9939K ²
Ram 1500 Pickup	5.7L V8 F/I	9932 ¹	9932B ¹	9932K ¹	1999 DODGE				
Ram 2500 Pickup	5.7L V8 F/I	9932 ¹	9932B ¹	9932K ¹	Ram 1500 Pickup	5.2L V8 F/I	9931 ¹	9931B ¹	9931K ¹
Ram 2500 Pickup	5.9L L6 DSL	9938 ²	9938B ²	9938K ²	Ram 1500 Pickup	5.9L V8 F/I	9931 ¹	9931B ¹	9931K ¹
Ram 2500 Pickup	6.7L L6 DSL	9990 ²			Ram 2500 Pickup	5.9L L6 DSL	9939 ²	9939B ²	9939K ²
Ram 2500 Pickup	6.7L L6 DSL	9990 ²			Ram 2500 Pickup	5.9L V8 F/I	9931 ¹	9931B ¹	9931K ¹
Ram 3500 Pickup	5.9L L6 DSL	9938 ²	9938B ²	9938K ²	Ram 3500 Pickup	5.9L L6 DSL	9939 ²	9939B ²	9939K ²
Ram 3500 Pickup	6.7L L6 DSL	9990 ²			1998 DODGE				
2006 DODGE					Ram 1500 Pickup	5.2L V8 F/I	9931 ¹	9931B ¹	9931K ¹
Charger	5.7L V8 F/I	9935 ²	9935B ²	9935K ²	Ram 1500 Pickup	5.9L V8 F/I	9931 ¹	9931B ¹	9931K ¹
Charger	6.1L V8 F/I	9935 ²	9935B ²	9935K ²	Ram 2500 Pickup	5.9L L6 DSL	9939 ²	9939B ²	9939K ²
Magnum	5.7L V8 F/I	9935 ²	9935B ²	9935K ²	Ram 2500 Pickup	5.9L V8 F/I	9931 ¹	9931B ¹	9931K ¹
Magnum	6.1L V8 F/I	9935 ²	9935B ²	9935K ²	Ram 3500 Pickup	5.9L L6 DSL	9939 ²	9939B ²	9939K ²
Ram 1500 Pickup	4.7L V8 F/I	9932 ¹	9932B ¹	9932K ¹	1997 DODGE				
Ram 1500 Pickup	5.7L V8 F/I	9932 ¹	9932B ¹	9932K ¹	Ram 1500 Pickup	5.2L V8 F/I	9931 ¹	9931B ¹	9931K ¹
Ram 2500 Pickup	5.7L V8 F/I	9932 ¹	9932B ¹	9932K ¹	Ram 1500 Pickup	5.9L V8 F/I	9931 ¹	9931B ¹	9931K ¹
Ram 2500 Pickup	5.9L L6 DSL	9938 ²	9938B ²	9938K ²	Ram 2500 Pickup	5.9L L6 DSL	9939 ²	9939B ²	9939K ²
Ram 2500 Pickup	5.9L L6 DSL	9938 ²	9938B ²	9938K ²	Ram 2500 Pickup	5.9L V8 F/I	9931 ¹	9931B ¹	9931K ¹
Ram 3500 Pickup	5.9L L6 DSL	9938 ²	9938B ²	9938K ²	Ram 3500 Pickup	5.9L L6 DSL	9939 ²	9939B ²	9939K ²
2005 DODGE					1996 DODGE				
Magnum	5.7L V8 F/I	9935 ²	9935B ²	9935K ²	Ram 1500 Pickup	5.2L V8 F/I	9931 ¹	9931B ¹	9931K ¹
Ram 1500 Pickup	4.7L V8 F/I	9932 ¹	9932B ¹	9932K ¹	Ram 1500 Pickup	5.9L V8 F/I	9931 ¹	9931B ¹	9931K ¹
Ram 1500 Pickup	5.7L V8 F/I	9932 ¹	9932B ¹	9932K ¹	Ram 2500 Pickup	5.2L V8 F/I	9931 ¹	9931B ¹	9931K ¹
Ram 2500 Pickup	5.7L V8 F/I	9932 ¹	9932B ¹	9932K ¹	Ram 2500 Pickup	5.9L L6 DSL	9939 ²	9939B ²	9939K ²
Ram 2500 Pickup	5.9L L6 DSL	9938 ²	9938B ²	9938K ²	Ram 2500 Pickup	5.9L V8 F/I	9931 ¹	9931B ¹	9931K ¹
Ram 3500 Pickup	5.9L L6 DSL	9938 ²	9938B ²	9938K ²	Ram 3500 Pickup	5.9L L6 DSL	9939 ²	9939B ²	9939K ²
2004 DODGE					1995 DODGE				
Ram 1500 Pickup	4.7L V8 F/I	9932 ¹	9932B ¹	9932K ¹	Ram 1500 Pickup	5.2L V8 F/I	9931 ¹	9931B ¹	9931K ¹
Ram 1500 Pickup	5.7L V8 F/I	9932 ¹	9932B ¹	9932K ¹	Ram 1500 Pickup	5.9L V8 F/I	9931 ¹	9931B ¹	9931K ¹
Ram 2500 Pickup	5.7L V8 F/I	9932 ¹	9932B ¹	9932K ¹	Ram 2500 Pickup	5.2L V8 F/I	9931 ¹	9931B ¹	9931K ¹
Ram 2500 Pickup	5.9L L6 DSL	9938 ²	9938B ²	9938K ²	Ram 2500 Pickup	5.9L L6 DSL	9939 ²	9939B ²	9939K ²
Ram 3500 Pickup	5.9L L6 DSL	9938 ²	9938B ²	9938K ²	Ram 2500 Pickup	5.9L V8 F/I	9931 ¹	9931B ¹	9931K ¹
2003 DODGE					1994 DODGE				
Ram 1500 Pickup	4.7L V8 F/I	9932 ¹	9932B ¹	9932K ¹	Ram 1500 Pickup	5.2L V8 F/I	9931 ¹	9931B ¹	9931K ¹
Ram 1500 Pickup	5.7L V8 F/I	9932 ¹	9932B ¹	9932K ¹	Ram 1500 Pickup	5.9L V8 F/I	9931 ¹	9931B ¹	9931K ¹
Ram 2500 Pickup	5.7L V8 F/I	9932 ¹	9932B ¹	9932K ¹	Ram 2500 Pickup	5.2L V8 F/I	9931 ¹	9931B ¹	9931K ¹
Ram 2500 Pickup	5.9L L6 DSL	9938 ²	9938B ²	9938K ²	Ram 2500 Pickup	5.9L L6 DSL	9939 ²	9939B ²	9939K ²
Ram 3500 Pickup	5.9L L6 DSL	9938 ²	9938B ²	9938K ²	Ram 2500 Pickup	5.9L V8 F/I	9931 ¹	9931B ¹	9931K ¹
2002 DODGE					2017 FORD				
Ram 1500 Pickup	4.7L V8 F/I	9932 ²	9932B ²	9932K ²	Mustang GT	5.0L V8 F/I	9031 ²		
Ram 2500 Pickup	5.9L L6 DSL	9939 ²	9939B ²	9939K ²	2016 FORD				
Ram 3500 Pickup	5.9L L6 DSL	9939 ²	9939B ²	9939K ²	Explorer	3.5L V6 F/I - Turbo	9022 ²		
					F150	2.7L V6 F/I	9034 ²		
					F150	3.5L V6 F/I	9034 ²		
					F150	5.0L V8 F/I	9033 ²		
					F250 Super Duty	6.7L V8 DSL	9979 ²		
					F350 Super Duty	6.7L V8 DSL	9979 ²		
					F450 Super Duty	6.7L V8 DSL	9979 ²		

1) Street legal in all US states. 2) Not legal for sale or use on any pollution controlled motor vehicle in California or states adopting California emission procedures.

FORD

AIR INTAKE SYSTEMS

Vehicle	Engine Type	Red Filter Part #	Blue Filter Part #	Black Filter Part #	Vehicle	Engine Type	Red Filter Part #	Blue Filter Part #	Black Filter Part #
2016 FORD					2012 FORD				
F550 Super Duty	6.7L V8 DSL	9979 ²			Edge	3.5L V6 F/I	9019 ¹		
Mustang	2.3L L4 F/I	9029 ²			Edge	3.7L V6 F/I	9019 ¹		
Mustang	3.7L V6 F/I	9041 ²			Expedition	5.4L V8 F/I	9970 ¹	9970B ¹	9970K ¹
Mustang GT	5.0L V8 F/I	9031 ²			F150	3.5L V6 F/I	9978 ¹	9978B ¹	9978K ¹
2015 FORD					F150	5.0L V8 F/I	9976 ¹	9976B ¹	9976K ¹
Explorer Sport	3.5L V6 F/I - Turbo	9022 ²			F150 SVT Raptor	6.2L V8 F/I	9977 ¹		
F150	2.7L V6 F/I	9034 ¹			F250 Super Duty	6.2L V8 F/I	9001 ¹		
F150	3.5L V6 F/I	9034 ¹			F250 Super Duty	6.7L V8 DSL	9979 ²		
F150	5.0L V8 F/I	9033 ¹			F350 Super Duty	6.2L V8 F/I	9001 ¹		
F250 Super Duty	6.7L V8 DSL	9979 ²			F350 Super Duty	6.7L V8 DSL	9979 ²		
F350 Super Duty	6.7L V8 DSL	9979 ²			F450 Super Duty	6.7L V8 DSL	9979 ²		
F450 Super Duty	6.7L V8 DSL	9979 ²			F550 Super Duty	6.7L V8 DSL	9979 ²		
F550 Super Duty	6.7L V8 DSL	9979 ²			Mustang	3.7L V6 F/I	9929 ¹	9929B ¹	9929K ¹
Mustang	2.3L L4 F/I	9029 ¹			Mustang Boss 302	5.0L V8 F/I	9928 ²	9928B ²	9928K ²
Mustang	3.7L V6 F/I	9041 ¹			Mustang GT	5.0L V8 F/I	9928 ²	9928B ²	9928K ²
Mustang GT	5.0L V8 F/I	9031 ²			Taurus SHO	3.5L V6 F/I - Turbo	9022 ¹		
2014 FORD					2011 FORD				
Edge	3.5L V6 F/I	9019 ¹			Edge	3.5L V6 F/I	9019 ¹		
Edge	3.7L V6 F/I	9019 ¹			Edge	3.7L V6 F/I	9019 ¹		
Expedition	5.4L V8 F/I	9970 ¹	9970B ¹	9970K ¹	Expedition	5.4L V8 F/I	9970 ¹	9970B ¹	9970K ¹
Explorer Sport	3.5L V6 F/I - Turbo	9022 ¹			F150	5.0L V8 F/I	9976 ¹	9976B ¹	9976K ¹
F150	3.5L V6 F/I	9978 ¹	9978B ¹	9978K ¹	F150 Platinum	6.2L V8 F/I	9977 ¹		
F150	5.0L V8 F/I	9976 ¹	9976B ¹	9976K ¹	F150 SVT Raptor	6.2L V8 F/I	9977 ¹		
F150 SVT Raptor	6.2L V8 F/I	9977 ¹			F250 Super Duty	6.2L V8 F/I	9001 ¹		
F250 Super Duty	6.2L V8 F/I	9001 ¹			F250 Super Duty	6.7L V8 DSL	9979 ²		
F250 Super Duty	6.7L V8 DSL	9979 ²			F250 Super Duty	6.2L V8 F/I	9001 ¹		
F350 Super Duty	6.2L V8 F/I	9001 ¹			F350 Super Duty	6.7L V8 DSL	9979 ²		
F350 Super Duty	6.7L V8 DSL	9979 ²			F450 Super Duty	6.7L V8 DSL	9979 ²		
F450 Super Duty	6.7L V8 DSL	9979 ²			F550 Super Duty	6.7L V8 DSL	9979 ²		
F550 Super Duty	6.7L V8 DSL	9979 ²			Mustang	3.7L V6 F/I	9929 ¹	9929B ¹	9929K ¹
Mustang	3.7L V6 F/I	9929 ¹	9929B ¹	9929K ¹	Mustang GT	5.0L V8 F/I	9928 ²	9928B ²	9928K ²
Mustang GT	5.0L V8 F/I	9928 ²	9928B ²	9928K ²	Taurus SHO	3.5L V6 F/I - Turbo	9022 ¹		
Taurus SHO	3.5L V6 F/I - Turbo	9022 ¹			2010 FORD				
2013 FORD					Expedition	5.4L V8 F/I	9970 ¹	9970B ¹	9970K ¹
Edge	3.5L V6 F/I	9019 ¹			F150	4.6L V8 F/I - w/39975 ¹ Valve VIN 8	9975 ¹	9975B ¹	9975K ¹
Edge	3.7L V6 F/I	9019 ¹			F150	5.4L V8 F/I	9970 ¹	9970B ¹	9970K ¹
Expedition	5.4L V8 F/I	9970 ¹	9970B ¹	9970K ¹	F150 SVT Raptor	5.4L V8 F/I	9970 ¹	9970B ¹	9970K ¹
Explorer Sport	3.5L V6 F/I - Turbo	9022 ¹			F250 Super Duty	6.4L V8 DSL	9972 ¹	9972B ¹	9972K ¹
F150	3.5L V6 F/I	9978 ¹	9978B ¹	9978K ¹	F350 Super Duty	6.4L V8 DSL	9972 ¹	9972B ¹	9972K ¹
F150	5.0L V8 F/I	9976 ¹	9976B ¹	9976K ¹	F450 Super Duty	6.4L V8 DSL	9972 ¹	9972B ¹	9972K ¹
F150 SVT Raptor	6.2L V8 F/I	9977 ¹			F550 Super Duty	6.4L V8 DSL	9972 ¹	9972B ¹	9972K ¹
F250 Super Duty	6.2L V8 F/I	9001 ¹			2009 FORD				
F250 Super Duty	6.7L V8 DSL	9979 ²			Expedition	5.4L V8 F/I	9970 ¹	9970B ¹	9970K ¹
F350 Super Duty	6.2L V8 F/I	9001 ¹			F150	4.6L V8 F/I - w/39975 ¹ Valve VIN 8	9975 ¹	9975B ¹	9975K ¹
F350 Super Duty	6.7L V8 DSL	9979 ²			F150	5.4L V8 F/I	9970 ¹	9970B ¹	9970K ¹
F450 Super Duty	6.7L V8 DSL	9979 ²			F250 Super Duty	6.4L V8 DSL	9972 ¹	9972B ¹	9972K ¹
F550 Super Duty	6.7L V8 DSL	9979 ²			F350 Super Duty	6.4L V8 DSL	9972 ¹	9972B ¹	9972K ¹
Mustang	3.7L V6 F/I	9929 ¹	9929B ¹	9929K ¹	F450 Super Duty	6.4L V8 DSL	9972 ¹	9972B ¹	9972K ¹
Mustang Boss 302	5.0L V8 F/I	9928 ²	9928B ²	9928K ²	F550 Super Duty	6.4L V8 DSL	9972 ¹	9972B ¹	9972K ¹
Mustang GT	5.0L V8 F/I	9928 ²	9928B ²	9928K ²	Mustang	4.0L V6 F/I	9926 ¹	9926B ¹	9926K ¹
Taurus SHO	3.5L V6 F/I - Turbo	9022 ¹			Mustang GT	4.6L V8 F/I	9924 ²	9924B ²	9924K ²

1) Street legal in all US states. 2) Not legal for sale or use on any pollution controlled motor vehicle in California or states adopting California emission procedures.

AIR INTAKE SYSTEMS

FORD

Vehicle	Engine Type	Red Filter Part #	Blue Filter Part #	Black Filter Part #	Vehicle	Engine Type	Red Filter Part #	Blue Filter Part #	Black Filter Part #
2008 FORD					2004 FORD				
Expedition	5.4L V8 F/I	9970 ¹	9970B ¹	9970K ¹	Excursion	6.8L V10 F/I	9921 ¹	9921B ¹	9921K ¹
F150	5.4L V8 F/I	9925 ²	9925B ²	9925K ²	Expedition	4.6L V8 F/I	9920 ¹	9920B ¹	9920K ¹
F250 Super Duty	6.4L V8 DSL	9972 ¹	9972B ¹	9972K ¹	Expedition	5.4L V8 F/I	9920 ¹	9920B ¹	9920K ¹
F350 Super Duty	6.4L V8 DSL	9972 ¹	9972B ¹	9972K ¹	F150	5.4L V8 F/I	9925 ¹	9925B ¹	9925K ¹
F450 Super Duty	6.4L V8 DSL	9972 ¹	9972B ¹	9972K ¹	F250 Harley Davidson Super Duty	6.0L V8 DSL	9973 ¹	9973B ¹	9973K ¹
F550 Super Duty	6.4L V8 DSL	9972 ¹	9972B ¹	9972K ¹	F250 Super Duty	6.0L V8 DSL	9973 ¹	9973B ¹	9973K ¹
Mustang	4.0L V6 F/I	9926 ¹	9926B ¹	9926K ¹	F350 Super Duty	6.0L V8 DSL	9973 ¹	9973B ¹	9973K ¹
Mustang GT	4.6L V8 F/I	9924 ²	9924B ²	9924K ²	F450 Super Duty	6.0L V8 DSL	9973 ¹	9973B ¹	9973K ¹
2007 FORD					2003 FORD				
Expedition	5.4L V8 F/I	9970 ¹	9970B ¹	9970K ¹	Excursion	6.0L V8 DSL	9973 ¹	9973B ¹	9973K ¹
F150	5.4L V8 F/I - Exc. FMXT05.44D7	9925 ¹	9925B ¹	9925K ¹	Excursion	6.8L V10 F/I	9921 ¹	9921B ¹	9921K ¹
F250 Harley Davidson Super Duty	6.0L V8 DSL	9973 ¹	9973B ¹	9973K ¹	Excursion	7.3L V8 DSL	9922 ¹	9922B ¹	9922K ¹
F250 Super Duty	6.0L V8 DSL	9973 ¹	9973B ¹	9973K ¹	Expedition	4.6L V8 F/I	9920 ¹	9920B ¹	9920K ¹
F350 Cutaway	6.0L V8 DSL	9973 ¹	9973B ¹	9973K ¹	Expedition	5.4L V8 F/I	9920 ¹	9920B ¹	9920K ¹
F350 Harley Davidson Super Duty	6.0L V8 DSL	9973 ¹	9973B ¹	9973K ¹	F150	4.6L V8 F/I	9920 ¹	9920B ¹	9920K ¹
F350 Super Duty	6.0L V8 DSL	9973 ¹	9973B ¹	9973K ¹	F150	5.4L V8 F/I	9920 ¹	9920B ¹	9920K ¹
F450 Super Duty	6.0L V8 DSL	9973 ¹	9973B ¹	9973K ¹	F250 Super Duty	6.0L V8 DSL	9973 ¹	9973B ¹	9973K ¹
Mustang	4.0L V6 F/I	9926 ¹	9926B ¹	9926K ¹	F250 Super Duty	6.8L V10 F/I	9921 ¹	9921B ¹	9921K ¹
Mustang GT	4.6L V8 F/I	9924 ²	9924B ²	9924K ²	F250 Super Duty	7.3L V8 DSL	9922 ¹	9922B ¹	9922K ¹
2006 FORD					F350 Super Duty				
F150	5.4L V8 F/I	9925 ¹	9925B ¹	9925K ¹	F350 Super Duty	6.0L V8 DSL	9973 ¹	9973B ¹	9973K ¹
F250 Harley Davidson Super Duty	6.0L V8 DSL	9973 ¹	9973B ¹	9973K ¹	F350 Super Duty	6.8L V10 F/I	9921 ¹	9921B ¹	9921K ¹
F250 Super Duty	6.0L V8 DSL	9973 ¹	9973B ¹	9973K ¹	F350 Super Duty	7.3L V8 DSL	9922 ¹	9922B ¹	9922K ¹
F350 Cutaway	6.0L V8 DSL	9973 ¹	9973B ¹	9973K ¹	F450 Super Duty	6.0L V8 DSL	9973 ¹	9973B ¹	9973K ¹
F350 Harley Davidson Super Duty	6.0L V8 DSL	9973 ¹	9973B ¹	9973K ¹	F450 Super Duty	6.8L V10 F/I	9921 ¹	9921B ¹	9921K ¹
F350 Super Duty	6.0L V8 DSL	9973 ¹	9973B ¹	9973K ¹	F550 Super Duty	6.0L V8 DSL	9973 ¹	9973B ¹	9973K ¹
F450 Super Duty	6.0L V8 DSL	9973 ¹	9973B ¹	9973K ¹	F550 Super Duty	6.8L V10 F/I	9921 ¹	9921B ¹	9921K ¹
F550 Super Duty	6.0L V8 DSL	9973 ¹	9973B ¹	9973K ¹	Mustang GT	4.6L V8 F/I	9923 ¹	9923B ¹	9923K ¹
Mustang	4.0L V6 F/I	9926 ¹	9926B ¹	9926K ¹	2002 FORD				
Mustang GT	4.6L V8 F/I	9924 ²	9924B ²	9924K ²	Excursion	6.8L V10 F/I	9921 ¹	9921B ¹	9921K ¹
2005 FORD					Excursion				
Excursion	6.0L V8 DSL	9973 ¹	9973B ¹	9973K ¹	Excursion	7.3L V8 DSL	9922 ¹	9922B ¹	9922K ¹
F150	5.4L V8 F/I	9925 ¹	9925B ¹	9925K ¹	Expedition	4.6L V8 F/I	9920 ¹	9920B ¹	9920K ¹
F250 Harley Davidson Super Duty	6.0L V8 DSL	9973 ¹	9973B ¹	9973K ¹	Expedition	5.4L V8 F/I	9920 ¹	9920B ¹	9920K ¹
F250 Super Duty	6.0L V8 DSL	9973 ¹	9973B ¹	9973K ¹	F150	4.6L V8 F/I	9920 ¹	9920B ¹	9920K ¹
F350 Harley Davidson Super Duty	6.0L V8 DSL	9973 ¹	9973B ¹	9973K ¹	F150	5.4L V8 F/I	9920 ¹	9920B ¹	9920K ¹
F350 Super Duty	6.0L V8 DSL	9973 ¹	9973B ¹	9973K ¹	F250 Super Duty	6.8L V10 F/I	9921 ¹	9921B ¹	9921K ¹
F450 Super Duty	6.0L V8 DSL	9973 ¹	9973B ¹	9973K ¹	F250 Super Duty	7.3L V8 DSL	9922 ¹	9922B ¹	9922K ¹
F550 Super Duty	6.0L V8 DSL	9973 ¹	9973B ¹	9973K ¹	F350 Super Duty	6.8L V10 F/I	9921 ¹	9921B ¹	9921K ¹
Mustang	4.0L V6 F/I	9926 ¹	9926B ¹	9926K ¹	F350 Super Duty	7.3L V8 DSL	9922 ¹	9922B ¹	9922K ¹
Mustang GT	4.6L V8 F/I - From 4/30/05	9924 ¹	9924B ¹	9924K ¹	F450 Super Duty	6.8L V10 F/I	9921 ¹	9921B ¹	9921K ¹
2004 FORD					F550 Super Duty				
Excursion	6.0L V8 DSL	9973 ¹	9973B ¹	9973K ¹	F550 Super Duty	6.8L V10 F/I	9921 ¹	9921B ¹	9921K ¹
					Mustang GT				
					4.6L V8 F/I 9923 ¹ 9923B ¹ 9923K ¹				
					2001 FORD				
					Excursion				
					6.8L V10 F/I 9921 ¹ 9921B ¹ 9921K ¹				
					Excursion				
					7.3L V8 DSL 9922 ¹ 9922B ¹ 9922K ¹				
					Expedition				
					4.6L V8 F/I 9920 ¹ 9920B ¹ 9920K ¹				
					Expedition				
					5.4L V8 F/I 9920 ¹ 9920B ¹ 9920K ¹				
					F150				
					4.6L V8 F/I 9920 ¹ 9920B ¹ 9920K ¹				
					F150				
					5.4L V8 F/I 9920 ¹ 9920B ¹ 9920K ¹				
					F250 Super Duty				
					6.8L V10 F/I 9921 ¹ 9921B ¹ 9921K ¹				
					F250 Super Duty				
					7.3L V8 DSL 9922 ¹ 9922B ¹ 9922K ¹				
					F350 Super Duty				
					6.8L V10 F/I 9921 ¹ 9921B ¹ 9921K ¹				

1) Street legal in all US states. 2) Not legal for sale or use on any pollution controlled motor vehicle in California or states adopting California emission procedures.

FORD

AIR INTAKE SYSTEMS

Vehicle	Engine Type	Red Filter Part #	Blue Filter Part #	Black Filter Part #	Vehicle	Engine Type	Red Filter Part #	Blue Filter Part #	Black Filter Part #
2001 FORD					1990 FORD				
F350 Super Duty	7.3L V8 DSL	9922 ¹	9922B ¹	9922K ¹	Mustang	5.0L V8 F/I	9974 ¹		
F450 Super Duty	6.8L V10 F/I	9921 ¹	9921B ¹	9921K ¹	1989 FORD				
F550 Super Duty	6.8L V10 F/I	9921 ¹	9921B ¹	9921K ¹	Mustang	5.0L V8 F/I	9974 ¹		
Mustang GT	4.6L V8 F/I	9923 ¹	9923B ¹	9923K ¹	1988 FORD				
2000 FORD					Mustang	5.0L V8 F/I	9974 ¹		
Excursion	6.8L V10 F/I	9921 ¹	9921B ¹	9921K ¹	1987 FORD				
Excursion	7.3L V8 DSL	9922 ¹	9922B ¹	9922K ¹	Mustang	5.0L V8 F/I	9974 ¹		
Expedition	4.6L V8 F/I	9920 ¹	9920B ¹	9920K ¹	1986 FORD				
Expedition	5.4L V8 F/I	9920 ¹	9920B ¹	9920K ¹	Mustang	5.0L V8 F/I	9974 ¹		
F150	4.6L V8 F/I	9920 ¹	9920B ¹	9920K ¹	2016 GMC				
F150	5.4L V8 F/I	9920 ¹	9920B ¹	9920K ¹	Canyon	3.6L V6 F/I	9030 ²		
F250 Super Duty	6.8L V10 F/I	9921 ¹	9921B ¹	9921K ¹	2015 GMC				
F250 Super Duty	7.3L V8 DSL	9922 ¹	9922B ¹	9922K ¹	Canyon	3.6L V6 F/I	9030 ¹		
F350 Super Duty	6.8L V10 F/I	9921 ¹	9921B ¹	9921K ¹	Sierra 1500	5.3L V8 F/I	9006 ¹		
F350 Super Duty	7.3L V8 DSL	9922 ¹	9922B ¹	9922K ¹	Sierra 1500	6.2L V8 F/I	9015 ¹		
F450 Super Duty	6.8L V10 F/I	9921 ¹	9921B ¹	9921K ¹	Sierra 2500 HD	6.0L V8 F/I	9040 ¹		
F550 Super Duty	6.8L V10 F/I	9921 ¹	9921B ¹	9921K ¹	Sierra 3500 HD	6.0L V8 F/I	9040 ¹		
Mustang GT	4.6L V8 F/I	9923 ¹	9923B ¹	9923K ¹	Yukon	5.3L V8 F/I	9006 ¹		
1999 FORD					Yukon Denali	6.2L V8 F/I	9015 ¹		
Expedition	4.6L V8 F/I	9920 ¹	9920B ¹	9920K ¹	Yukon Denali XL	6.2L V8 F/I	9015 ¹		
Expedition	5.4L V8 F/I	9920 ¹	9920B ¹	9920K ¹	Yukon XL	5.3L V8 F/I	9006 ¹		
F150	4.6L V8 F/I	9920 ¹	9920B ¹	9920K ¹	2014 GMC				
F150	5.4L V8 F/I	9920 ¹	9920B ¹	9920K ¹	Sierra 1500	4.3L V6 F/I	9026 ¹		
F250 Super Duty	6.8L V10 F/I	9921 ¹	9921B ¹	9921K ¹	Sierra 1500	5.3L V8 F/I	9006 ¹		
F250 Super Duty	7.3L V8 DSL - from 12/98	9922 ¹	9922B ¹	9922K ¹	Sierra 1500	6.2L V8 F/I	9015 ¹		
F350 Super Duty	6.8L V10 F/I	9921 ¹	9921B ¹	9921K ¹	Sierra 2500 HD	6.0L V8 F/I	9040 ¹		
F350 Super Duty	7.3L V8 DSL - from 12/98	9922 ¹	9922B ¹	9922K ¹	Sierra 2500 HD	6.6L V8 DSL	9986 ¹		
F450 Super Duty	6.8L V10 F/I	9921 ¹	9921B ¹	9921K ¹	Sierra 3500 HD	6.0L V8 F/I	9040 ¹		
F550 Super Duty	6.8L V10 F/I	9921 ¹	9921B ¹	9921K ¹	Sierra 3500 HD	6.6L V8 DSL	9986 ¹		
Mustang GT	4.6L V8 F/I	9923 ¹	9923B ¹	9923K ¹	Yukon	5.3L V8 F/I	9918 ¹	9918B ¹	9918K ¹
1998 FORD					Yukon Denali	6.2L V8 F/I	9918 ¹	9918B ¹	9918K ¹
Expedition	4.6L V8 F/I	9920 ¹	9920B ¹	9920K ¹	Yukon Denali XL	6.2L V8 F/I	9918 ¹	9918B ¹	9918K ¹
Expedition	5.4L V8 F/I	9920 ¹	9920B ¹	9920K ¹	Yukon XL 1500	5.3L V8 F/I	9918 ¹	9918B ¹	9918K ¹
F150	4.6L V8 F/I	9920 ¹	9920B ¹	9920K ¹	2013 GMC				
F150	5.4L V8 F/I	9920 ¹	9920B ¹	9920K ¹	Sierra 1500	4.8L V8 F/I	9918 ¹	9918B ¹	9918K ¹
Mustang GT	4.6L V8 F/I	9923 ¹	9923B ¹	9923K ¹	Sierra 1500	5.3L V8 F/I	9918 ¹	9918B ¹	9918K ¹
1997 FORD					Sierra 1500	6.2L V8 F/I	9918 ¹	9918B ¹	9918K ¹
Expedition	4.6L V8 F/I	9920 ¹	9920B ¹	9920K ¹	Sierra 2500 HD	6.0L V8 F/I	9004 ¹	9004B ¹	9004K ¹
Expedition	5.4L V8 F/I	9920 ¹	9920B ¹	9920K ¹	Sierra 2500 HD	6.6L V8 DSL	9986 ¹		
F150	4.6L V8 F/I	9920 ¹	9920B ¹	9920K ¹	Sierra 3500 HD	6.0L V8 F/I	9004 ¹	9004B ¹	9004K ¹
F150	5.4L V8 F/I	9920 ¹	9920B ¹	9920K ¹	Sierra 3500 HD	6.6L V8 DSL	9986 ¹		
Mustang GT	4.6L V8 F/I	9923 ¹	9923B ¹	9923K ¹	Sierra Denali	6.2L V8 F/I	9918 ¹	9918B ¹	9918K ¹
1996 FORD					Yukon	5.3L V8 F/I	9918 ¹	9918B ¹	9918K ¹
Mustang GT	4.6L V8 F/I	9923 ¹	9923B ¹	9923K ¹	Yukon Denali	6.2L V8 F/I	9918 ¹	9918B ¹	9918K ¹
1993 FORD					Yukon Denali XL	6.2L V8 F/I	9918 ¹	9918B ¹	9918K ¹
Mustang	5.0L V8 F/I	9974 ¹			Yukon XL 1500	5.3L V8 F/I	9918 ¹	9918B ¹	9918K ¹
1992 FORD					Yukon XL 1500	6.2L V8 F/I	9918 ¹	9918B ¹	9918K ¹
Mustang	5.0L V8 F/I	9974 ¹			2012 GMC				
1991 FORD					Sierra 1500	4.8L V8 F/I	9918 ¹	9918B ¹	9918K ¹
Mustang	5.0L V8 F/I	9974 ¹			Sierra 1500	5.3L V8 F/I	9918 ¹	9918B ¹	9918K ¹
					Sierra 1500	6.2L V8 F/I	9918 ¹	9918B ¹	9918K ¹
					Sierra 2500 HD	6.0L V8 F/I	9004 ¹	9004B ¹	9004K ¹
					Sierra 2500 HD	6.6L V8 DSL	9985 ¹		

1) Street legal in all US states. 2) Not legal for sale or use on any pollution controlled motor vehicle in California or states adopting California emission procedures.

AIR INTAKE SYSTEMS

GMC

Vehicle	Engine Type	Red Filter Part #	Blue Filter Part #	Black Filter Part #	Vehicle	Engine Type	Red Filter Part #	Blue Filter Part #	Black Filter Part #
2012 GMC					2008 GMC				
Sierra 3500 HD	6.0L V8 F/I	9004 ¹	9004B ¹	9004K ¹	Sierra 2500 HD	6.6L V8 DSL	9982 ¹		
Sierra 3500 HD	6.6L V8 DSL	9985 ¹			Sierra 3500 HD	6.6L V8 DSL	9982 ¹		
Sierra Denali	6.2L V8 F/I	9918 ¹	9918B ¹	9918K ¹	Yukon	4.8L V8 F/I	9910 ¹	9910B ¹	9910K ¹
Yukon	5.3L V8 F/I	9918 ¹	9918B ¹	9918K ¹	Yukon	5.3L V8 F/I	9910 ¹	9910B ¹	9910K ¹
Yukon Denali	6.2L V8 F/I	9918 ¹	9918B ¹	9918K ¹	Yukon Hybrid	6.0L V8 F/I	9910 ¹	9910B ¹	9910K ¹
Yukon Denali XL	6.2L V8 F/I	9918 ¹	9918B ¹	9918K ¹	Yukon XL 1500	5.3L V8 F/I	9910 ¹	9910B ¹	9910K ¹
Yukon XL 1500	5.3L V8 F/I	9918 ¹	9918B ¹	9918K ¹	Yukon XL 1500	6.0L V8 F/I	9910 ¹	9910B ¹	9910K ¹
2011 GMC					2007 GMC				
Sierra 1500	4.8L V8 F/I	9918 ¹	9918B ¹	9918K ¹	Sierra 1500	4.8L V8 F/I	9910 ¹	9910B ¹	9910K ¹
Sierra 1500	5.3L V8 F/I	9918 ¹	9918B ¹	9918K ¹	Sierra 1500	5.3L V8 F/I	9910 ¹	9910B ¹	9910K ¹
Sierra 1500	6.2L V8 F/I	9918 ¹	9918B ¹	9918K ¹	Sierra 1500	6.0L V8 F/I	9910 ¹	9910B ¹	9910K ¹
Sierra 2500 HD	6.0L V8 F/I	9004 ¹	9004B ¹	9004K ¹	Sierra 1500 Classic	4.8L V8 F/I	9900 ¹	9900B ¹	9900K ¹
Sierra 2500 HD	6.6L V8 DSL	9985 ¹			Sierra 1500 Classic	5.3L V8 F/I	9900 ¹	9900B ¹	9900K ¹
Sierra 3500 HD	6.0L V8 F/I	9004 ¹	9004B ¹	9004K ¹	Sierra 1500 HD Classic	6.0L V8 F/I	9900 ¹	9900B ¹	9900K ¹
Sierra 3500 HD	6.6L V8 DSL	9985 ¹			Sierra 2500 HD	6.0L V8 F/I	9910 ¹	9910B ¹	9910K ¹
Sierra Denali	6.2L V8 F/I	9918 ¹	9918B ¹	9918K ¹	Sierra 2500 HD	6.6L V8 DSL	9982 ¹		
Yukon	4.8L V8 F/I	9918 ¹	9918B ¹	9918K ¹	Sierra 2500 HD Classic	6.0L V8 F/I	9900 ¹	9900B ¹	9900K ¹
Yukon	5.3L V8 F/I	9918 ¹	9918B ¹	9918K ¹	Sierra 3500 Classic	6.0L V8 F/I	9900 ²	9900B ²	9900K ²
Yukon	6.2L V8 F/I	9918 ¹	9918B ¹	9918K ¹	Sierra 3500 HD	6.6L V8 DSL	9982 ¹		
Yukon Denali	6.2L V8 F/I	9918 ¹	9918B ¹	9918K ¹	Sierra Denali Classic	6.0L V8 F/I	9900 ²	9900B ²	9900K ²
Yukon Denali XL	6.2L V8 F/I	9918 ¹	9918B ¹	9918K ¹	Yukon	4.8L V8 F/I	9910 ¹	9910B ¹	9910K ¹
Yukon XL 1500	5.3L V8 F/I	9918 ¹	9918B ¹	9918K ¹	Yukon	5.3L V8 F/I	9910 ¹	9910B ¹	9910K ¹
Yukon XL 1500	6.2L V8 F/I	9918 ¹	9918B ¹	9918K ¹	Yukon XL 1500	5.3L V8 F/I	9910 ¹	9910B ¹	9910K ¹
2010 GMC					2006 GMC				
Sierra 1500	4.8L V8 F/I	9918 ¹	9918B ¹	9918K ¹	Sierra 1500	4.8L V8 F/I	9900 ¹	9900B ¹	9900K ¹
Sierra 1500	5.3L V8 F/I	9918 ¹	9918B ¹	9918K ¹	Sierra 1500	5.3L V8 F/I	9900 ¹	9900B ¹	9900K ¹
Sierra 1500	6.2L V8 F/I	9918 ¹	9918B ¹	9918K ¹	Sierra 1500	6.0L V8 F/I	9900 ¹	9900B ¹	9900K ¹
Sierra 2500 HD	6.6L V8 DSL	9982 ¹			Sierra 1500 HD	6.0L V8 F/I	9900 ²	9900B ²	9900K ²
Sierra 3500 HD	6.6L V8 DSL	9982 ¹			Sierra 2500 HD	6.0L V8 F/I	9900 ²	9900B ²	9900K ²
Sierra Denali	6.2L V8 F/I	9918 ¹	9918B ¹	9918K ¹	Sierra 3500	6.0L V8 F/I	9900 ²	9900B ²	9900K ²
Yukon	4.8L V8 F/I	9918 ¹	9918B ¹	9918K ¹	Sierra Denali	6.0L V8 F/I	9900 ²	9900B ²	9900K ²
Yukon	5.3L V8 F/I	9918 ¹	9918B ¹	9918K ¹	Yukon	4.8L V8 F/I	9900 ¹	9900B ¹	9900K ¹
Yukon Denali	6.2L V8 F/I	9918 ¹	9918B ¹	9918K ¹	Yukon	5.3L V8 F/I	9900 ¹	9900B ¹	9900K ¹
Yukon Denali XL	6.2L V8 F/I	9918 ¹	9918B ¹	9918K ¹	Yukon XL 1500	5.3L V8 F/I	9900 ¹	9900B ¹	9900K ¹
Yukon XL 1500	5.3L V8 F/I	9918 ¹	9918B ¹	9918K ¹	Yukon XL 2500	6.0L V8 F/I	9900 ¹	9900B ¹	9900K ¹
Yukon XL 1500	6.2L V8 F/I	9918 ¹	9918B ¹	9918K ¹	2005 GMC				
2009 GMC					Sierra 1500	4.8L V8 F/I	9900 ¹	9900B ¹	9900K ¹
Sierra 1500	4.8L V8 F/I	9918 ¹	9918B ¹	9918K ¹	Sierra 1500	5.3L V8 F/I	9900 ¹	9900B ¹	9900K ¹
Sierra 1500	5.3L V8 F/I	9918 ¹	9918B ¹	9918K ¹	Sierra 1500	6.0L V8 F/I	9900 ¹	9900B ¹	9900K ¹
Sierra 1500	6.0L V8 F/I	9918 ¹	9918B ¹	9918K ¹	Sierra 1500 HD	6.0L V8 F/I	9900 ¹	9900B ¹	9900K ¹
Sierra 1500	6.2L V8 F/I	9918 ¹	9918B ¹	9918K ¹	Sierra 2500 HD	6.0L V8 F/I	9900 ¹	9900B ¹	9900K ¹
Sierra 2500 HD	6.6L V8 DSL	9982 ¹			Sierra 3500	6.0L V8 F/I	9900 ²	9900B ²	9900K ²
Sierra 3500 HD	6.6L V8 DSL	9982 ¹			Sierra Denali	6.0L V8 F/I	9900 ²	9900B ²	9900K ²
Sierra Denali	6.2L V8 F/I	9918 ¹	9918B ¹	9918K ¹	Yukon	4.8L V8 F/I	9900 ¹	9900B ¹	9900K ¹
Yukon	4.8L V8 F/I	9918 ¹	9918B ¹	9918K ¹	Yukon	5.3L V8 F/I	9900 ¹	9900B ¹	9900K ¹
Yukon	5.3L V8 F/I	9918 ¹	9918B ¹	9918K ¹	Yukon XL 1500	5.3L V8 F/I	9900 ¹	9900B ¹	9900K ¹
Yukon Denali	6.2L V8 F/I	9918 ¹	9918B ¹	9918K ¹	Yukon XL 2500	6.0L V8 F/I	9900 ¹	9900B ¹	9900K ¹
Yukon Denali XL	6.2L V8 F/I	9918 ¹	9918B ¹	9918K ¹	2004 GMC				
Yukon XL 1500	5.3L V8 F/I	9918 ¹	9918B ¹	9918K ¹	Sierra 1500	4.8L V8 F/I	9900 ¹	9900B ¹	9900K ¹
Yukon XL 1500	6.0L V8 F/I	9918 ¹	9918B ¹	9918K ¹	Sierra 1500	5.3L V8 F/I	9900 ¹	9900B ¹	9900K ¹
Yukon XL 1500	6.2L V8 F/I	9918 ¹	9918B ¹	9918K ¹	Sierra 2500	6.0L V8 F/I	9900 ¹	9900B ¹	9900K ¹

1) Street legal in all US states. 2) Not legal for sale or use on any pollution controlled motor vehicle in California or states adopting California emission procedures.

GMC

AIR INTAKE SYSTEMS

Vehicle	Engine Type	Red Filter Part #	Blue Filter Part #	Black Filter Part #	Vehicle	Engine Type	Red Filter Part #	Blue Filter Part #	Black Filter Part #
2004 GMC					2001 GMC				
Sierra 2500 HD	6.0L V8 F/I	9900 ¹	9900B ¹	9900K ¹	Sierra 2500	6.0L V8 F/I	9900 ¹	9900B ¹	9900K ¹
Sierra 2500 HD	6.6L V8 DSL - LB7	9904 ¹	9904B ¹	9904K ¹	Sierra 2500 HD	6.0L V8 F/I	9900 ¹	9900B ¹	9900K ¹
Sierra 3500	6.0L V8 F/I	9900 ²	9900B ²	9900K ²	Sierra 2500 HD	6.6L V8 DSL	9904 ¹	9904B ¹	9904K ¹
Sierra 3500	6.6L V8 DSL - LB7	9904 ¹	9904B ¹	9904K ¹	Sierra 3500	6.0L V8 F/I	9900 ²	9900B ²	9900K ²
Sierra Denali	6.0L V8 F/I	9900 ²	9900B ²	9900K ²	Sierra 3500	6.6L V8 DSL	9904 ¹	9904B ¹	9904K ¹
Sonoma	4.3L V6 F/I	9901 ¹	9901B ¹	9901K ¹	Sonoma	2.2L L4 F/I	9902 ¹	9902B ¹	9902K ¹
Yukon	4.8L V8 F/I	9900 ¹	9900B ¹	9900K ¹	Sonoma	4.3L V6 F/I	9901 ¹	9901B ¹	9901K ¹
Yukon	5.3L V8 F/I	9900 ¹	9900B ¹	9900K ¹	Yukon	4.8L V8 F/I	9900 ¹	9900B ¹	9900K ¹
Yukon Denali	6.0L V8 F/I	9900 ¹	9900B ¹	9900K ¹	Yukon	5.3L V8 F/I	9900 ¹	9900B ¹	9900K ¹
Yukon Denali XL	6.0L V8 F/I	9900 ¹	9900B ¹	9900K ¹	Yukon Denali	6.0L V8 F/I	9900 ¹	9900B ¹	9900K ¹
Yukon XL 1500	5.3L V8 F/I	9900 ¹	9900B ¹	9900K ¹	Yukon Denali XL	6.0L V8 F/I	9900 ¹	9900B ¹	9900K ¹
Yukon XL 2500	6.0L V8 F/I	9900 ¹	9900B ¹	9900K ¹	Yukon XL 1500	5.3L V8 F/I	9900 ¹	9900B ¹	9900K ¹
2003 GMC					2000 GMC				
Sierra 1500	4.8L V8 F/I	9900 ¹	9900B ¹	9900K ¹	C2500	5.7L V8 F/I	9903 ¹	9903B ¹	9903K ¹
Sierra 1500	5.3L V8 F/I	9900 ¹	9900B ¹	9900K ¹	C3500	5.7L V8 F/I	9903 ¹	9903B ¹	9903K ¹
Sierra 1500 HD	6.0L V8 F/I	9900 ¹	9900B ¹	9900K ¹	Jimmy	4.3L V6 F/I	9901 ¹	9901B ¹	9901K ¹
Sierra 2500	6.0L V8 F/I	9900 ¹	9900B ¹	9900K ¹	K2500	5.7L V8 F/I	9903 ¹	9903B ¹	9903K ¹
Sierra 2500 HD	6.0L V8 F/I	9900 ¹	9900B ¹	9900K ¹	K3500	5.7L V8 F/I	9903 ¹	9903B ¹	9903K ¹
Sierra 2500 HD	6.6L V8 DSL	9904 ¹	9904B ¹	9904K ¹	Sierra 1500	4.8L V8 F/I	9900 ¹	9900B ¹	9900K ¹
Sierra 3500	6.0L V8 F/I	9900 ²	9900B ²	9900K ²	Sierra 1500	5.3L V8 F/I	9900 ¹	9900B ¹	9900K ¹
Sierra 3500	6.6L V8 DSL	9904 ¹	9904B ¹	9904K ¹	Sierra 2500	5.3L V8 F/I	9900 ¹	9900B ¹	9900K ¹
Sierra Denali	6.0L V8 F/I	9900 ²	9900B ²	9900K ²	Sierra 2500	6.0L V8 F/I	9900 ¹	9900B ¹	9900K ¹
Sonoma	2.2L L4 F/I	9902 ¹	9902B ¹	9902K ¹	Sonoma	2.2L L4 F/I	9902 ¹	9902B ¹	9902K ¹
Sonoma	4.3L V6 F/I	9901 ¹	9901B ¹	9901K ¹	Sonoma	4.3L V6 F/I	9901 ¹	9901B ¹	9901K ¹
Yukon	4.8L V8 F/I	9900 ¹	9900B ¹	9900K ¹	Yukon	4.8L V8 F/I	9900 ¹	9900B ¹	9900K ¹
Yukon	5.3L V8 F/I	9900 ¹	9900B ¹	9900K ¹	Yukon	5.3L V8 F/I	9900 ¹	9900B ¹	9900K ¹
Yukon Denali	6.0L V8 F/I	9900 ¹	9900B ¹	9900K ¹	Yukon Denali	5.7L V8 F/I	9903 ¹	9903B ¹	9903K ¹
Yukon Denali XL	6.0L V8 F/I	9900 ¹	9900B ¹	9900K ¹	Yukon XL 1500	5.3L V8 F/I	9900 ¹	9900B ¹	9900K ¹
Yukon XL 1500	5.3L V8 F/I	9900 ¹	9900B ¹	9900K ¹	Yukon XL 2500	6.0L V8 F/I	9900 ¹	9900B ¹	9900K ¹
Yukon XL 2500	6.0L V8 F/I	9900 ¹	9900B ¹	9900K ¹	1999 GMC				
2002 GMC					C1500	5.0L V8 F/I	9903 ¹	9903B ¹	9903K ¹
Sierra 1500	4.8L V8 F/I	9900 ¹	9900B ¹	9900K ¹	C1500	5.7L V8 F/I	9903 ¹	9903B ¹	9903K ¹
Sierra 1500	5.3L V8 F/I	9900 ¹	9900B ¹	9900K ¹	C1500 Suburban	5.7L V8 F/I	9903 ¹	9903B ¹	9903K ¹
Sierra 1500 HD	6.0L V8 F/I	9900 ¹	9900B ¹	9900K ¹	C2500	5.0L V8 F/I	9903 ¹	9903B ¹	9903K ¹
Sierra 2500	6.0L V8 F/I	9900 ¹	9900B ¹	9900K ¹	C2500	5.7L V8 F/I	9903 ¹	9903B ¹	9903K ¹
Sierra 2500 HD	6.0L V8 F/I	9900 ¹	9900B ¹	9900K ¹	C2500 Suburban	5.7L V8 F/I	9903 ¹	9903B ¹	9903K ¹
Sierra 2500 HD	6.6L V8 DSL	9904 ¹	9904B ¹	9904K ¹	C3500	5.7L V8 F/I	9903 ¹	9903B ¹	9903K ¹
Sierra 3500	6.0L V8 F/I	9900 ²	9900B ²	9900K ²	Jimmy	4.3L V6 F/I	9901 ¹	9901B ¹	9901K ¹
Sierra 3500	6.6L V8 DSL	9904 ¹	9904B ¹	9904K ¹	K1500	5.0L V8 F/I	9903 ¹	9903B ¹	9903K ¹
Sierra Denali	6.0L V8 F/I	9900 ²	9900B ²	9900K ²	K1500	5.7L V8 F/I	9903 ¹	9903B ¹	9903K ¹
Sonoma	2.2L L4 F/I	9902 ¹	9902B ¹	9902K ¹	K1500 Suburban	5.7L V8 F/I	9903 ¹	9903B ¹	9903K ¹
Sonoma	4.3L V6 F/I	9901 ¹	9901B ¹	9901K ¹	K2500	5.0L V8 F/I	9903 ¹	9903B ¹	9903K ¹
Yukon	4.8L V8 F/I	9900 ¹	9900B ¹	9900K ¹	K2500	5.7L V8 F/I	9903 ¹	9903B ¹	9903K ¹
Yukon	5.3L V8 F/I	9900 ¹	9900B ¹	9900K ¹	K2500 Suburban	5.7L V8 F/I	9903 ¹	9903B ¹	9903K ¹
Yukon Denali	6.0L V8 F/I	9900 ¹	9900B ¹	9900K ¹	K3500	5.7L V8 F/I	9903 ¹	9903B ¹	9903K ¹
Yukon Denali XL	6.0L V8 F/I	9900 ¹	9900B ¹	9900K ¹	Sierra 1500	4.8L V8 F/I	9900 ¹	9900B ¹	9900K ¹
Yukon XL 1500	5.3L V8 F/I	9900 ¹	9900B ¹	9900K ¹	Sierra 1500	5.3L V8 F/I	9900 ¹	9900B ¹	9900K ¹
Yukon XL 2500	6.0L V8 F/I	9900 ¹	9900B ¹	9900K ¹	Sierra 2500	5.3L V8 F/I	9900 ¹	9900B ¹	9900K ¹
2001 GMC					Sierra 2500	6.0L V8 F/I	9900 ¹	9900B ¹	9900K ¹
Jimmy	4.3L V6 F/I	9901 ¹	9901B ¹	9901K ¹	Sonoma	2.2L L4 F/I	9902 ¹	9902B ¹	9902K ¹
Sierra 1500	4.8L V8 F/I	9900 ¹	9900B ¹	9900K ¹	Sonoma	4.3L V6 F/I	9901 ¹	9901B ¹	9901K ¹
Sierra 1500	5.3L V8 F/I	9900 ¹	9900B ¹	9900K ¹	Yukon	5.7L V8 F/I	9903 ¹	9903B ¹	9903K ¹
Sierra 1500	6.0L V8 F/I	9900 ¹	9900B ¹	9900K ¹	Yukon Denali	5.7L V8 F/I	9903 ¹	9903B ¹	9903K ¹
Sierra 1500 HD	6.0L V8 F/I	9900 ¹	9900B ¹	9900K ¹					

1) Street legal in all US states. 2) Not legal for sale or use on any pollution controlled motor vehicle in California or states adopting California emission procedures.

AIR INTAKE SYSTEMS

GMC

Vehicle	Engine Type	Red Filter Part #	Blue Filter Part #	Black Filter Part #	Vehicle	Engine Type	Red Filter Part #	Blue Filter Part #	Black Filter Part #
1998 GMC					2000 HONDA				
C1500	5.0L V8 F/I	9903 ¹	9903B ¹	9903K ¹	Civic EX	1.6L L4 F/I	10146 ¹		
C1500	5.7L V8 F/I	9903 ¹	9903B ¹	9903K ¹	Civic GX	1.6L L4 F/I	10146 ²		
C1500 Suburban	5.7L V8 F/I	9903 ¹	9903B ¹	9903K ¹	Civic HX	1.6L L4 F/I	10146 ¹		
C2500	5.0L V8 F/I	9903 ¹	9903B ¹	9903K ¹	Civic LX	1.6L L4 F/I	10146 ²		
C2500	5.7L V8 F/I	9903 ¹	9903B ¹	9903K ¹	1999 HONDA				
C2500 Suburban	5.7L V8 F/I	9903 ¹	9903B ¹	9903K ¹	Civic CX	1.6L L4 F/I	10146 ²		
C3500	5.7L V8 F/I	9903 ¹	9903B ¹	9903K ¹	Civic DX	1.6L L4 F/I	10146 ²		
Jimmy	4.3L V6 F/I	9901 ¹	9901B ¹	9901K ¹	Civic EX	1.6L L4 F/I	10146 ¹		
K1500	5.0L V8 F/I	9903 ²	9903B ²	9903K ²	Civic GX	1.6L L4 F/I	10146 ²		
K1500	5.7L V8 F/I	9903 ¹	9903B ¹	9903K ¹	Civic HX	1.6L L4 F/I	10146 ¹		
K1500 Suburban	5.7L V8 F/I	9903 ¹	9903B ¹	9903K ¹	Civic LX	1.6L L4 F/I	10146 ²		
K2500	5.0L V8 F/I	9903 ²	9903B ²	9903K ²	Civic Value Package	1.6L L4 F/I	10146 ²		
K2500	5.7L V8 F/I	9903 ¹	9903B ¹	9903K ¹	1997 HONDA				
K2500 Suburban	5.7L V8 F/I	9903 ¹	9903B ¹	9903K ¹	Civic del Sol	1.6L L4 F/I	10146 ¹		
K3500	5.7L V8 F/I	9903 ¹	9903B ¹	9903K ¹	1996 HONDA				
Sonoma	2.2L L4 F/I	9902 ¹	9902B ¹	9902K ¹	Civic del Sol	1.6L L4 F/I	10146 ¹		
Sonoma	4.3L V6 F/I	9901 ¹	9901B ¹	9901K ¹	2010 INFINITI				
Yukon	5.7L V8 F/I	9903 ¹	9903B ¹	9903K ¹	QX56	5.6L V8 F/I	9951 ¹	9951B ¹	9951K ¹
1997 GMC					2009 INFINITI				
C1500	5.0L V8 F/I	9903 ¹	9903B ¹	9903K ¹	QX56	5.6L V8 F/I	9951 ¹	9951B ¹	9951K ¹
C1500	5.7L V8 F/I	9903 ¹	9903B ¹	9903K ¹	2008 INFINITI				
C1500 Suburban	5.7L V8 F/I	9903 ¹	9903B ¹	9903K ¹	QX56	5.6L V8 F/I	9951 ¹	9951B ¹	9951K ¹
C2500	5.0L V8 F/I	9903 ¹	9903B ¹	9903K ¹	2007 INFINITI				
C2500	5.7L V8 F/I	9903 ¹	9903B ¹	9903K ¹	QX56	5.6L V8 F/I	9951 ¹	9951B ¹	9951K ¹
C2500 Suburban	5.7L V8 F/I	9903 ¹	9903B ¹	9903K ¹	2006 INFINITI				
C3500	5.7L V8 F/I	9903 ¹	9903B ¹	9903K ¹	QX56	5.6L V8 F/I	9951 ¹	9951B ¹	9951K ¹
Jimmy	4.3L V6 F/I	9901 ¹	9901B ¹	9901K ¹	2005 INFINITI				
K1500	5.0L V8 F/I	9903 ²	9903B ²	9903K ²	QX56	5.6L V8 F/I	9951 ¹	9951B ¹	9951K ¹
K1500	5.7L V8 F/I	9903 ¹	9903B ¹	9903K ¹	2004 INFINITI				
K1500 Suburban	5.7L V8 F/I	9903 ¹	9903B ¹	9903K ¹	QX56	5.6L V8 F/I	9951 ¹	9951B ¹	9951K ¹
K2500	5.7L V8 F/I	9903 ¹	9903B ¹	9903K ¹	2017 JEEP				
K2500 Suburban	5.7L V8 F/I	9903 ¹	9903B ¹	9903K ¹	Compass	2.0L L4 F/I	9053 ²		
K3500	5.7L V8 F/I	9903 ¹	9903B ¹	9903K ¹	Compass	2.4L L4 F/I	9053 ²		
Sonoma	4.3L V6 F/I	9901 ¹	9901B ¹	9901K ¹	Patriot	2.0L L4 F/I	9053 ²		
Yukon	5.7L V8 F/I	9903 ¹	9903B ¹	9903K ¹	Patriot	2.4L L4 F/I	9053 ²		
1996 GMC					2016 JEEP				
C1500	5.0L V8 F/I	9903 ¹	9903B ¹	9903K ¹	Cherokee	3.2L V6 F/I	9014 ²		
C1500	5.7L V8 F/I	9903 ¹	9903B ¹	9903K ¹	Compass	2.0L L4 F/I	9053 ²		
C1500 Suburban	5.7L V8 F/I	9903 ¹	9903B ¹	9903K ¹	Compass	2.4L L4 F/I	9053 ²		
C2500	5.0L V8 F/I	9903 ¹	9903B ¹	9903K ¹	Grand Cherokee	5.7L V8 F/I	9021 ²	9021B ²	9021K ²
C2500	5.7L V8 F/I	9903 ¹	9903B ¹	9903K ¹	Patriot	2.0L L4 F/I	9053 ²		
C2500 Suburban	5.7L V8 F/I	9903 ¹	9903B ¹	9903K ¹	Patriot	2.4L L4 F/I	9053 ²		
C3500	5.7L V8 F/I	9903 ¹	9903B ¹	9903K ¹	Wrangler	3.6L V6 F/I	9007 ²		
Jimmy	4.3L V6 F/I	9901 ¹	9901B ¹	9901K ¹	2015 JEEP				
K1500	5.0L V8 F/I	9903 ²	9903B ²	9903K ²	Cherokee	3.2L V6 F/I	9014 ²		
K1500	5.7L V8 F/I	9903 ¹	9903B ¹	9903K ¹	Compass	2.0L L4 F/I	9053 ²		
K1500 Suburban	5.7L V8 F/I	9903 ¹	9903B ¹	9903K ¹	Compass	2.4L L4 F/I	9053 ²		
K2500	5.7L V8 F/I	9903 ¹	9903B ¹	9903K ¹	Grand Cherokee	3.0L V6 DSL	9024 ²		
K2500 Suburban	5.7L V8 F/I	9903 ¹	9903B ¹	9903K ¹	Grand Cherokee	3.6L V6 F/I	9020 ²		
K3500	5.7L V8 F/I	9903 ¹	9903B ¹	9903K ¹	Grand Cherokee	5.7L V8 F/I	9021 ²	9021B ²	9021K ²
Sonoma	4.3L V6 F/I	9901 ¹	9901B ¹	9901K ¹	Grand Cherokee	6.4L V8 F/I	9039 ²		
Yukon	5.7L V8 F/I	9903 ¹	9903B ¹	9903K ¹	2000 HONDA				
2000 HONDA					Civic CX	1.6L L4 F/I	10146 ²		
Civic CX	1.6L L4 F/I	10146 ²			Civic DX	1.6L L4 F/I	10146 ²		
Civic DX	1.6L L4 F/I	10146 ²							

1) Street legal in all US states. 2) Not legal for sale or use on any pollution controlled motor vehicle in California or states adopting California emission procedures.

JEEP

AIR INTAKE SYSTEMS

Vehicle	Engine Type	Red Filter Part #	Blue Filter Part #	Black Filter Part #	Vehicle	Engine Type	Red Filter Part #	Blue Filter Part #	Black Filter Part #
2015 JEEP					2001 JEEP				
Patriot	2.0L L4 F/I	9053 ²			Cherokee	4.0L L6 F/I	9051 ²		
Patriot	2.4L L4 F/I	9053 ²			TJ	2.5L L4 F/I	9940 ²	9940B ²	9940K ²
Wrangler	3.6L V6 F/I	9007 ²			Wrangler	2.5L L4 F/I	9940 ¹	9940B ¹	9940K ¹
2014 JEEP					2000 JEEP				
Cherokee	3.2L V6 F/I	9014 ²			Cherokee	4.0L L6 F/I	9051 ²		
Compass	2.0L L4 F/I	9053 ²			TJ	2.5L L4 F/I	9940 ²	9940B ²	9940K ²
Compass	2.4L L4 F/I	9053 ²			Wrangler	2.5L L4 F/I	9940 ¹	9940B ¹	9940K ¹
Grand Cherokee	3.0L V6 DSL	9024 ²			1999 JEEP				
Grand Cherokee	3.6L V6 F/I	9020 ²			Cherokee	4.0L L6 F/I	9051 ²		
Grand Cherokee	5.7L V8 F/I	9021 ²	9021B ²	9021K ²	TJ	2.5L L4 F/I	9940 ²	9940B ²	9940K ²
Grand Cherokee	6.4L V8 F/I	9039 ²			Wrangler	2.5L L4 F/I	9940 ¹	9940B ¹	9940K ¹
Patriot	2.0L L4 F/I	9053 ²			1998 JEEP				
Patriot	2.4L L4 F/I	9053 ²			Cherokee	4.0L L6 F/I	9051 ²		
Wrangler	3.6L V6 F/I	9007 ²			TJ	2.5L L4 F/I	9940 ²	9940B ²	9940K ²
2013 JEEP					1997 JEEP				
Compass	2.0L L4 F/I	9053 ²			Cherokee	4.0L L6 F/I	9051 ²		
Compass	2.4L L4 F/I	9053 ²			TJ	2.5L L4 F/I	9940 ²	9940B ²	9940K ²
Grand Cherokee	3.6L V6 F/I	9020 ²			Wrangler	2.5L L4 F/I	9940 ¹	9940B ¹	9940K ¹
Grand Cherokee	5.7L V8 F/I	9021 ²	9021B ²	9021K ²	1996 JEEP				
Grand Cherokee	6.4L V8 F/I	9039 ²			Cherokee	4.0L L6 F/I	9051 ²		
Patriot	2.0L L4 F/I	9053 ²			1995 JEEP				
Patriot	2.4L L4 F/I	9053 ²			Cherokee	4.0L L6 F/I	9051 ²		
Wrangler	3.6L V6 F/I	9007 ²			1994 JEEP				
2012 JEEP					1993 JEEP				
Compass	2.0L L4 F/I	9053 ²			Cherokee	4.0L L6 F/I	9051 ²		
Compass	2.4L L4 F/I	9053 ²			1992 JEEP				
Grand Cherokee	3.6L V6 F/I	9020 ²			Cherokee	4.0L L6 F/I	9051 ²		
Grand Cherokee	5.7L V8 F/I	9021 ²	9021B ²	9021K ²	1991 JEEP				
Grand Cherokee	6.4L V8 F/I	9039 ²			Cherokee	4.0L L6 F/I	9051 ²		
Patriot	2.0L L4 F/I	9053 ²			2012 LEXUS				
Patriot	2.4L L4 F/I	9053 ²			IS250	2.5L V6 F/I	10190 ²		
Wrangler	3.6L V6 F/I	9007 ²			2011 LEXUS				
2011 JEEP					2010 LEXUS				
Compass	2.0L L4 F/I	9053 ²			IS250	2.5L V6 F/I	10190 ²		
Compass	2.4L L4 F/I	9053 ²			IS350	3.5L V6 F/I	10190 ²		
Grand Cherokee	3.6L V6 F/I	9020 ²			2009 LEXUS				
Grand Cherokee	5.7L V8 F/I	9021 ²	9021B ²	9021K ²	IS250	2.5L V6 F/I	10190 ²		
Patriot	2.0L L4 F/I	9053 ²			IS350	3.5L V6 F/I	10190 ²		
Patriot	2.4L L4 F/I	9053 ²			2008 LEXUS				
Wrangler	3.8L V6 F/I	9944 ²	9944B ²	9944K ²	IS250	2.5L V6 F/I	10190 ²		
2010 JEEP					2007 LEXUS				
Wrangler	3.8L V6 F/I	9944 ²	9944B ²	9944K ²	IS250	2.5L V6 F/I	10190 ²		
2009 JEEP					2006 LEXUS				
Wrangler	3.8L V6 F/I	9944 ²	9944B ²	9944K ²	IS250	2.5L V6 F/I	10190 ²		
2008 JEEP					2005 LEXUS				
Wrangler	3.8L V6 F/I	9944 ²	9944B ²	9944K ²	IS250	2.5L V6 F/I	10190 ²		
2007 JEEP					2004 LEXUS				
Wrangler	3.8L V6 F/I	9944 ²	9944B ²	9944K ²	IS250	2.5L V6 F/I	10190 ²		
2006 JEEP					2003 LEXUS				
TJ	2.5L L4 F/I	9940 ²	9940B ²	9940K ²	IS250	2.5L V6 F/I	10190 ²		
Wrangler	2.5L L4 F/I	9940 ¹	9940B ¹	9940K ¹	IS350	3.5L V6 F/I	10190 ²		
2005 JEEP					2002 LEXUS				
Wrangler	3.8L V6 F/I	9944 ²	9944B ²	9944K ²	IS250	2.5L V6 F/I	10190 ²		
2004 JEEP					2001 LEXUS				
Wrangler	3.8L V6 F/I	9944 ²	9944B ²	9944K ²	IS250	2.5L V6 F/I	10190 ²		
2003 JEEP					2000 LEXUS				
TJ	2.5L L4 F/I	9940 ²	9940B ²	9940K ²	IS250	2.5L V6 F/I	10190 ²		
Wrangler	2.5L L4 F/I	9940 ¹	9940B ¹	9940K ¹	IS350	3.5L V6 F/I	10190 ²		
2002 JEEP					1999 LEXUS				
TJ	2.5L L4 F/I	9940 ²	9940B ²	9940K ²	IS250	2.5L V6 F/I	10190 ²		
Wrangler	2.5L L4 F/I	9940 ¹	9940B ¹	9940K ¹	IS350	3.5L V6 F/I	10190 ²		
2001 JEEP					1998 LEXUS				
Cherokee	4.0L L6 F/I	9051 ²			IS250	2.5L V6 F/I	10190 ²		
TJ	2.5L L4 F/I	9940 ²	9940B ²	9940K ²	IS350	3.5L V6 F/I	10190 ²		
Wrangler	2.5L L4 F/I	9940 ¹	9940B ¹	9940K ¹	1997 LEXUS				
2000 JEEP					1996 LEXUS				
Cherokee	4.0L L6 F/I	9051 ²			IS250	2.5L V6 F/I	10190 ²		
TJ	2.5L L4 F/I	9940 ²	9940B ²	9940K ²	IS350	3.5L V6 F/I	10190 ²		
Wrangler	2.5L L4 F/I	9940 ¹	9940B ¹	9940K ¹	1995 LEXUS				
1999 JEEP					1994 LEXUS				
Cherokee	4.0L L6 F/I	9051 ²			IS250	2.5L V6 F/I	10190 ²		
TJ	2.5L L4 F/I	9940 ²	9940B ²	9940K ²	IS350	3.5L V6 F/I	10190 ²		
Wrangler	2.5L L4 F/I	9940 ¹	9940B ¹	9940K ¹	1993 LEXUS				
1998 JEEP					1992 LEXUS				
Cherokee	4.0L L6 F/I	9051 ²			IS250	2.5L V6 F/I	10190 ²		
TJ	2.5L L4 F/I	9940 ²	9940B ²	9940K ²	IS350	3.5L V6 F/I	10190 ²		
Wrangler	2.5L L4 F/I	9940 ¹	9940B ¹	9940K ¹	1991 LEXUS				
1997 JEEP					1990 LEXUS				
Cherokee	4.0L L6 F/I	9051 ²			IS250	2.5L V6 F/I	10190 ²		
TJ	2.5L L4 F/I	9940 ²	9940B ²	9940K ²	1989 LEXUS				
Wrangler	2.5L L4 F/I	9940 ¹	9940B ¹	9940K ¹	IS250	2.5L V6 F/I	10190 ²		
1996 JEEP					1988 LEXUS				
Cherokee	4.0L L6 F/I	9051 ²			IS250	2.5L V6 F/I	10190 ²		
TJ	2.5L L4 F/I	9940 ²	9940B ²	9940K ²	1987 LEXUS				
Wrangler	2.5L L4 F/I	9940 ¹	9940B ¹	9940K ¹	IS250	2.5L V6 F/I	10190 ²		
1995 JEEP					1986 LEXUS				
Cherokee	4.0L L6 F/I	9051 ²			IS250	2.5L V6 F/I	10190 ²		
TJ	2.5L L4 F/I	9940 ²	9940B ²	9940K ²	1985 LEXUS				
Wrangler	2.5L L4 F/I	9940 ¹	9940B ¹	9940K ¹	IS250	2.5L V6 F/I	10190 ²		
1994 JEEP					1984 LEXUS				
Cherokee	4.0L L6 F/I	9051 ²			IS250	2.5L V6 F/I	10190 ²		
TJ	2.5L L4 F/I	9940 ²	9940B ²	9940K ²	1983 LEXUS				
Wrangler	2.5L L4 F/I	9940 ¹	9940B ¹	9940K ¹	IS250	2.5L V6 F/I	10190 ²		
1993 JEEP					1982 LEXUS				
Cherokee	4.0L L6 F/I	9051 ²			IS250	2.5L V6 F/I	10190 ²		
TJ	2.5L L4 F/I	9940 ²	9940B ²	9940K ²	1981 LEXUS				
Wrangler	2.5L L4 F/I	9940 ¹	9940B ¹	9940K ¹	IS250	2.5L V6 F/I	10190 ²		
1992 JEEP					1980 LEXUS				
Cherokee	4.0L L6 F/I	9051 ²			IS250	2.5L V6 F/I	10190 ²		
TJ	2.5L L4 F/I	9940 ²	9940B ²	9940K ²	1979 LEXUS				
Wrangler	2.5L L4 F/I	9940 ¹	9940B ¹	9940K ¹	IS250	2.5L V6 F/I	10190 ²		
1991 JEEP					1978 LEXUS				
Cherokee	4.0L L6 F/I	9051 ²			IS250	2.5L V6 F/I	10190 ²		
TJ	2.5L L4 F/I	9940 ²	9940B ²	9940K ²	1977 LEXUS				
Wrangler	2.5L L4 F/I	9940 ¹	9940B ¹	9940K ¹	IS250	2.5L V6 F/I	10190 ²		
1990 JEEP					1976 LEXUS				
Cherokee	4.0L L6 F/I	9051 ²			IS250	2.5L V6 F/I	10190 ²		
TJ	2.5L L4 F/I	9940 ²	9940B ²	9940K ²	1975 LEXUS				
Wrangler	2.5L L4 F/I	9940 ¹	9940B ¹	9940K ¹	IS250	2.5L V6 F/I	10190 ²		
1989 JEEP					1974 LEXUS				
Cherokee	4.0L L6 F/I	9051 ²			IS250	2.5L V6 F/I	10190 ²		
TJ	2.5L L4 F/I	9940 ²	9940B ²	9940K ²	1973 LEXUS				
Wrangler	2.5L L4 F/I	9940 ¹	9940B ¹	9940K ¹	IS250	2.5L V6 F/I	10190 ²		
1988 JEEP					1972 LEXUS				
Cherokee	4.0L L6 F/I	9051 ²			IS250	2.5L V6 F/I	10190 ²		
TJ	2.5L L4 F/I	9940 ²	9940B ²	9940K ²	1971 LEXUS				
Wrangler	2.5L L4 F/I	9940 ¹	9940B ¹	9940K ¹	IS250	2.5L V6 F/I	10190 ²		
1987 JEEP					1970 LEXUS				
Cherokee	4.0L L6 F/I	9051 ²			IS250	2.5L V6 F/I	10190 ²		
TJ	2.5L L4 F/I	9940 ²	9940B ²	9940K ²	1969 LEXUS				
Wrangler	2.5L L4 F/I	9940 ¹	9940B ¹	9940K ¹	IS250	2.5L V6 F/I	10190 ²		
1986 JEEP					1968 LEXUS				
Cherokee	4.0L L6 F/I	9051 ²			IS250	2.5L V6 F/I	10190 ²		
TJ	2.5L L4 F/I	9940 ²	9940B ²	9940K ²	1967 LEXUS				
Wrangler	2.5L L4 F/I	9940 ¹	9940B ¹	9940K ¹	IS250	2.5L V6 F/I	10190 ²		
1985 JEEP					1966 LEXUS				
Cherokee	4.0L L6 F/I	9051 ²			IS250	2.5L V6 F/I	10190 ²		

AIR INTAKE SYSTEMS

LEXUS

Vehicle	Engine Type	Red Filter Part #	Blue Filter Part #	Black Filter Part #
2006 LEXUS				
IS350	3.5L V6 F/I	10190 ²		
2014 LINCOLN				
Navigator	5.4L V8 F/I	9970 ²	9970B ²	9970K ²
2013 LINCOLN				
Navigator	5.4L V8 F/I	9970 ²	9970B ²	9970K ²
2012 LINCOLN				
Navigator	5.4L V8 F/I	9970 ¹	9970B ¹	9970K ¹
2011 LINCOLN				
Navigator	5.4L V8 F/I	9970 ¹	9970B ¹	9970K ¹
2010 LINCOLN				
Navigator	5.4L V8 F/I	9970 ¹	9970B ¹	9970K ¹
2009 LINCOLN				
Navigator	5.4L V8 F/I	9970 ¹	9970B ¹	9970K ¹
2008 LINCOLN				
Navigator	5.4L V8 F/I	9970 ¹	9970B ¹	9970K ¹
2007 LINCOLN				
Navigator	5.4L V8 F/I	9970 ¹	9970B ¹	9970K ¹
1999 LINCOLN				
Navigator	5.4L V8 F/I	9920 ¹	9920B ¹	9920K ¹
1998 LINCOLN				
Navigator	5.4L V8 F/I	9920 ¹	9920B ¹	9920K ¹
2014 NISSAN				
Armada	5.6L V8 F/I	9951 ¹	9951B ¹	9951K ¹
Titan	5.6L V8 F/I	9951 ¹	9951B ¹	9951K ¹
2013 NISSAN				
Armada	5.6L V8 F/I	9951 ¹	9951B ¹	9951K ¹
Titan	5.6L V8 F/I	9951 ¹	9951B ¹	9951K ¹
2012 NISSAN				
Altima	2.5L L4 F/I	10233 ¹		
Armada	5.6L V8 F/I	9951 ¹	9951B ¹	9951K ¹
Titan	5.6L V8 F/I	9951 ¹	9951B ¹	9951K ¹
2011 NISSAN				
Altima	2.5L L4 F/I	10233 ¹		
Armada	5.6L V8 F/I	9951 ¹	9951B ¹	9951K ¹
Titan	5.6L V8 F/I	9951 ¹	9951B ¹	9951K ¹
2010 NISSAN				
Altima	2.5L L4 F/I	10233 ¹		
Armada	5.6L V8 F/I	9951 ¹	9951B ¹	9951K ¹
Titan	5.6L V8 F/I	9951 ¹	9951B ¹	9951K ¹
2009 NISSAN				
Altima	2.5L L4 F/I - Exc. PZEV	10233 ¹		
Armada	5.6L V8 F/I	9951 ¹	9951B ¹	9951K ¹
Titan	5.6L V8 F/I	9951 ¹	9951B ¹	9951K ¹
2008 NISSAN				
Altima	2.5L L4 F/I	10233 ¹		
Armada	5.6L V8 F/I	9951 ¹	9951B ¹	9951K ¹
Titan	5.6L V8 F/I	9951 ¹	9951B ¹	9951K ¹
2007 NISSAN				
Altima	2.5L L4 F/I	10233 ¹		
2007 NISSAN				
Armada	5.6L V8 F/I	9951 ¹	9951B ¹	9951K ¹
Titan	5.6L V8 F/I	9951 ¹	9951B ¹	9951K ¹
2006 NISSAN				
Armada	5.6L V8 F/I	9951 ¹	9951B ¹	9951K ¹
Titan	5.6L V8 F/I	9951 ¹	9951B ¹	9951K ¹
2005 NISSAN				
Armada	5.6L V8 F/I	9951 ¹	9951B ¹	9951K ¹
Titan	5.6L V8 F/I	9951 ¹	9951B ¹	9951K ¹
2004 NISSAN				
Titan	5.6L V8 F/I	9951 ¹	9951B ¹	9951K ¹
2009 PONTIAC				
G8	6.0L V8 F/I	9907 ²	9907B ²	9907K ²
		9017 ²		
G8	6.2L V8 F/I	9907 ²	9907B ²	9907K ²
		9017 ²		
2008 PONTIAC				
G8	6.0L V8 F/I	9907 ²	9907B ²	9907K ²
		9017 ²		
2006 PONTIAC				
GTO	6.0L V8 F/I	9906 ²	9906B ²	9906K ²
2005 PONTIAC				
GTO	6.0L V8 F/I	9906 ²	9906B ²	9906K ²
2016 RAM				
1500	3.0L V6 DSL	9035 ²		
2015 RAM				
1500	3.0L V6 DSL	9035 ²		
1500	5.7L V8 F/I	9934 ²	9934B ²	9934K ²
2500	5.7L V8 F/I	9934 ²	9934B ²	9934K ²
2014 RAM				
1500	3.0L V6 DSL	9035 ²		
1500	3.6L V6 F/I	9016 ²	9016B ²	9016K ²
1500	5.7L V8 F/I	9934 ²	9934B ²	9934K ²
2500	5.7L V8 F/I	9934 ²	9934B ²	9934K ²
2500	6.7L L6 DSL	9005 ²		
3500	6.7L L6 DSL	9005 ²		
2013 RAM				
1500	3.6L V6 F/I	9016 ²	9016B ²	9016K ²
1500	5.7L V8 F/I	9934 ²	9934B ²	9934K ²
2500	5.7L V8 F/I	9934 ²	9934B ²	9934K ²
2500	6.7L L6 DSL	9005 ²		
3500	6.7L L6 DSL	9005 ²		
2012 RAM				
1500	5.7L V8 F/I	9934 ²	9934B ²	9934K ²
2500	6.7L L6 DSL	9991 ²		
3500	6.7L L6 DSL	9991 ²		
2011 RAM				
1500	5.7L V8 F/I	9934 ²	9934B ²	9934K ²
2500	5.7L V8 F/I	9934 ²	9934B ²	9934K ²
2500	6.7L L6 DSL	9991 ²		
3500	5.7L V8 F/I	9934 ²	9934B ²	9934K ²
3500	6.7L L6 DSL	9991 ²		

1) Street legal in all US states. 2) Not legal for sale or use on any pollution controlled motor vehicle in California or states adopting California emission procedures.

RAM

AIR INTAKE SYSTEMS

Vehicle	Engine Type	Red Filter Part #	Blue Filter Part #	Black Filter Part #
2011 RAM				
Ram Pickup	5.7L V8 F/I	9934 ²	9934B ²	9934K ²
Ram Pickup	6.7L L6 DSL	9991 ²		
2010 RAM				
2500	5.7L V8 F/I	9934 ²	9934B ²	9934K ²
2500	6.7L L6 DSL	9991 ²		
Ram Pickup	5.7L V8 F/I	9934 ²	9934B ²	9934K ²
Ram Pickup	6.7L L6 DSL	9991 ²		
2016 TOYOTA				
Tundra	4.6L V8 F/I	9055 ²		
Tundra	5.7L V8 F/I	9055 ²		
2015 TOYOTA				
4 Runner	4.0L V6 F/I	9002 ²	9002B ²	9002K ²
FJ Cruiser	4.0L V6 F/I	9002 ²	9002B ²	9002K ²
Tacoma	4.0L V6 F/I	9013 ²		
Tundra	4.6L V8 F/I	9055 ²		
Tundra	5.7L V8 F/I	9055 ²		
2014 TOYOTA				
Corolla	1.8L L4 F/I	10268 ²		
FJ Cruiser	4.0L V6 F/I	9002 ²	9002B ²	9002K ²
Tacoma	4.0L V6 F/I	9013 ¹		
Tundra	4.6L V8 F/I	9055 ²		
Tundra	5.7L V8 F/I	9055 ²		
2013 TOYOTA				
4 Runner	4.0L V6 F/I	9002 ²	9002B ²	9002K ²
Corolla	1.8L L4 F/I	10268 ²		
FJ Cruiser	4.0L V6 F/I	9002 ²	9002B ²	9002K ²
Tacoma	4.0L V6 F/I	9013 ¹		
Tundra	4.6L V8 F/I	9055 ²		
Tundra	5.7L V8 F/I	9055 ²		
2012 TOYOTA				
4 Runner	4.0L V6 F/I	9002 ²	9002B ²	9002K ²
Corolla	1.8L L4 F/I	10268 ²		
FJ Cruiser	4.0L V6 F/I	9002 ²	9002B ²	9002K ²
Tacoma	4.0L V6 F/I	9013 ¹		
Tundra	4.6L V8 F/I	9055 ²		
Tundra	5.7L V8 F/I	9055 ²		
2011 TOYOTA				
4 Runner	4.0L V6 F/I	9002 ²	9002B ²	9002K ²
Corolla	1.8L L4 F/I	10268 ²		
FJ Cruiser	4.0L V6 F/I	9002 ²	9002B ²	9002K ²
Sequoia	5.7L V8 F/I	9963 ²	9963B ²	9963K ²
Tacoma	4.0L V6 F/I	9962 ²	9962B ²	9962K ²
		9009 ¹		
Tundra	5.7L V8 F/I	9963 ²	9963B ²	9963K ²
2010 TOYOTA				
4 Runner	4.0L V6 F/I	9002 ²	9002B ²	9002K ²
Corolla	1.8L L4 F/I	10268 ²		
FJ Cruiser	4.0L V6 F/I	9002 ²	9002B ²	9002K ²
Sequoia	5.7L V8 F/I	9963 ²	9963B ²	9963K ²
Tacoma	4.0L V6 F/I	9962 ²	9962B ²	9962K ²
		9009 ¹		
Tundra	5.7L V8 F/I	9963 ²	9963B ²	9963K ²

Vehicle	Engine Type	Red Filter Part #	Blue Filter Part #	Black Filter Part #
2009 TOYOTA				
Corolla	1.8L L4 F/I	10268 ²		
FJ Cruiser	4.0L V6 F/I	9009 ¹		
Sequoia	5.7L V8 F/I	9963 ²	9963B ²	9963K ²
Tacoma	4.0L V6 F/I	9962 ²	9962B ²	9962K ²
		9009 ¹		
Tundra	5.7L V8 F/I	9963 ²	9963B ²	9963K ²
2008 TOYOTA				
FJ Cruiser	4.0L V6 F/I	9009 ¹		
Sequoia	5.7L V8 F/I	9963 ²	9963B ²	9963K ²
Tacoma	4.0L V6 F/I	9962 ²	9962B ²	9962K ²
		9009 ¹		
Tundra	5.7L V8 F/I	9963 ²	9963B ²	9963K ²
2007 TOYOTA				
FJ Cruiser	4.0L V6 F/I	9009 ¹		
Sequoia	4.7L V8 F/I	9964 ²	9964B ²	9964K ²
Tacoma	4.0L V6 F/I	9962 ²	9962B ²	9962K ²
		9009 ¹		
Tundra	5.7L V8 F/I	9963 ²	9963B ²	9963K ²
2006 TOYOTA				
Sequoia	4.7L V8 F/I	9964 ²	9964B ²	9964K ²
Tacoma	4.0L V6 F/I	9962 ²	9962B ²	9962K ²
		9009 ¹		
Tundra	4.7L V8 F/I	9964 ²	9964B ²	9964K ²
2005 TOYOTA				
Sequoia	4.7L V8 F/I	9964 ²	9964B ²	9964K ²
Tacoma	4.0L V6 F/I	9962 ²	9962B ²	9962K ²
		9009 ¹		
Tundra	4.7L V8 F/I	9964 ²	9964B ²	9964K ²
2004 TOYOTA				
Sequoia	4.7L V8 F/I	9961 ²	9961B ²	9961K ²
Tacoma	3.4L V6 F/I	9960 ¹	9960B ¹	9960K ¹
Tundra	4.7L V8 F/I	9961 ²	9961B ²	9961K ²
2003 TOYOTA				
Sequoia	4.7L V8 F/I	9961 ¹	9961B ¹	9961K ¹
Tacoma	3.4L V6 F/I	9960 ¹	9960B ¹	9960K ¹
Tundra	4.7L V8 F/I	9961 ²	9961B ²	9961K ²
2002 TOYOTA				
4 Runner	3.4L V6 F/I	9960 ¹	9960B ¹	9960K ¹
Sequoia	4.7L V8 F/I	9961 ¹	9961B ¹	9961K ¹
Tacoma	3.4L V6 F/I	9960 ¹	9960B ¹	9960K ¹
Tundra	4.7L V8 F/I	9961 ¹	9961B ¹	9961K ¹
2001 TOYOTA				
4 Runner	3.4L V6 F/I	9960 ¹	9960B ¹	9960K ¹
Sequoia	4.7L V8 F/I	9961 ¹	9961B ¹	9961K ¹
Tacoma	3.4L V6 F/I	9960 ¹	9960B ¹	9960K ¹
Tundra	4.7L V8 F/I	9961 ¹	9961B ¹	9961K ¹
2000 TOYOTA				
4 Runner	3.4L V6 F/I	9960 ¹	9960B ¹	9960K ¹
Tacoma	3.4L V6 F/I	9960 ¹	9960B ¹	9960K ¹
Tundra	4.7L V8 F/I	9961 ¹	9961B ¹	9961K ¹
1999 TOYOTA				
4 Runner	3.4L V6 F/I	9960 ¹	9960B ¹	9960K ¹

1) Street legal in all US states. 2) Not legal for sale or use on any pollution controlled motor vehicle in California or states adopting California emission procedures.

APPLICATION LISTINGS

OE REPLACEMENT PERFORMANCE AIR FILTERS

**ENGINEERED TO
ADD PERFORMANCE**

**WASHABLE AND
REUSABLE**

**PRE-OILED AND
READY TO USE**

**WILL NOT VOID
NEW CAR WARRANTY**



*SEE PAGE 162 FOR COMPLETE
APPLICATION LISTINGS*

PERFORMANCE AIR INTAKE SYSTEMS

**ENGINEERED TO ADD
HORSEPOWER
AND TORQUE**

**HIGH PERFORMANCE
AIR FILTER**

**HIGH QUALITY
ALUMINUM TUBING**

**MANY AVAILABLE
WITH MULTIPLE
AIR FILTER COLORS**



*SEE PAGE 326 FOR COMPLETE
APPLICATION LISTINGS*

Some intake systems are not legal for sale or use on any pollution controlled motor vehicle in California or states adopting California emission procedures.

EMISSIONS STANDARDS AND SMOG TESTING

Some intake systems are not legal for use on certain vehicles in California or other states adopting CA emission standards. See the application section of this catalog for information on a particular vehicle. For an intake system to be legally used on the street in California or states adopting California emission standards, the intake must receive an EO number from The California Air Resources Board (CARB) that is specific to a particular part on a specific vehicle. This means a specific part number can be CARB exempt for some vehicles and not others. Intake system/vehicle combinations that do not have a CARB EO are not legal for highway use in California and several other states. They will not pass a state regulated visual inspection test if they do not have a valid CARB EO decal clearly displayed on the vehicle. You can check with your local motor vehicle or emissions agency to determine if your state requires CARB exemption.

INTAKE HORSEPOWER ESTIMATES AND DYNO TESTING

Spectre® performs tests to measure vehicle power on a dynamometer before and after an air intake is installed. Our air intake horsepower estimates are based on the results of specific or similar vehicle testing. Sometimes an air intake will fit several vehicles or different years of the same model. In these cases it is not practical to test every application so our horsepower estimates are based on similar vehicles where we believe the horsepower estimates are reliable.

Horsepower measurements can vary some from day to day due to environmental conditions, the dynamometer used, and the vehicle's on-board computer adjusting to changing airflow or environmental conditions.