

Vision

Global Lighting Systems



LIGHTING EVOLVED

2016 CATALOG



INDUSTRIAL CONTENTS

HEAVY DUTY

18 PitMaster
20 Ripper
22 Solstice Prime
24 Shockwave
26 Protex [ATEX]

MEDIUM DUTY

30 Utility Market Xtreme
32 Duralux

MARITIME

37 Maritime PitMaster
38 Maritime Ripper
39 Maritime Explorer

NEXT-GEN STRUCTURAL

43 Cube LED PitMaster
44 Cube LED Shockwave

INDUSTRIAL ACCESSORIES

47 Utility Flood
47 Video Extreme Light
48 Heavy Duty Strobe Beacon
48 36 LED Strobe Beacon
49 LED Vehicle ID Board
49 Mini Incident Response



AUTOMOTIVE/OFFROAD CONTENTS

LED LIGHTS

Cannon Series 56
Transporter Series 58
Optimus Series 60
Solo Pod Series 62

LIGHT BARS

PX [Prime Xtreme] 70
XPR 71
LPX [Lo-Pro Prime Xtreme] 72
Xmitter 73

LED HEADLIGHTS

Vortex 80
--------	----------

VEHICLE SPECIFIC KITS

Jeep JK 83
Ford Raptor/F-Series 84
Dodge, Toyota, GMC, Chevrolet 85

MOTORCYCLE

XMC LED Headlights 87
--------------------	----------

AUTOMOTIVE LIGHT ACCESSORIES

Polycarbonate Light Covers 96
Accent Lighting 98
Mounting/Parts 100



VISION X LIGHTING

WHAT WE'RE MADE OF



Design, Manufacture and Deliver
THE ULTIMATE LIGHTING SOLUTION.

Worldwide Facilities

Vision X Lighting operates state-of-the-art facilities. Our factory has received multiple awards for environmental sustainability as well as certifications for meeting ISO certifications of 9001 and 14001. At Vision X we ensure that both the products we deliver and the workers who manufacture the products are safe and up to standard.



Vision X USA - Seattle, USA
Global Sales and Marketing
Worldwide Distribution
Product Design
Engineering



Vision X Asia - Seoul, S. Korea
Product Development
Product Engineering
Manufacturing
Testing

Since the beginning in 1997, Vision X has been growing at the speed of light. The most recent addition in 2016 to Vision X facilities is the brand new production facility located in South Korea, that increased from 40,000 sq. ft. to over 200,000 sq. ft. of state-of-the-art testing and manufacturing technology worldwide. Commitment to customer service, quality product manufacturing, and innovative development have all contributed to this success. We are dedicated to maintaining the highest quality standards in engineering, manufacturing, and testing to ensure delivery of the highest quality products.

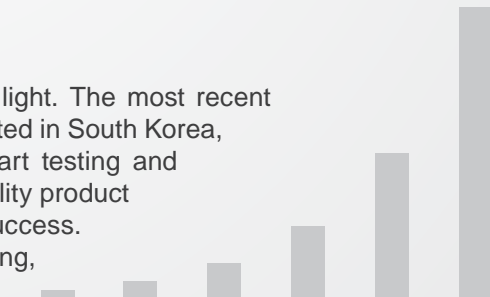

VISION X LIGHTING

PRODUCT EVOLUTION

Product Innovation
Imagining and Engineering



1997 Foul Weather Lighting



2000 HID Headlight Replacements



2005 HID Offroad Lights



2008 Xmitter LED Light Bar



2009 Solstice Solo LED Pod



2010 Heavy Duty LED Series



2013 25 Watt Single Source LED



2015 LED Headlight Upgrade

Inventing the Next Solution

Since 1997, Vision X has been providing the lighting solutions demanded by the market as well as innovating the next step for lighting. With the release of the HID series in late 2005, Vision X was the first to provide an HID internal ballast and starter to the mass market, simplifying installation and reducing external components. Again in 2008, Vision X revolutionized lighting with the LED bar originally produced for NASA's Back to the Moon Mission. Since then, Vision X has continued innovation with the Solo Pod - which gives as many lumens as a headlight from a single 2" x 2" housing - and heavy duty LED lighting for use in mining, industrial, and commercial

applications. The newest addition to the Vision X product line, the LED Light Cannon, transforms a single LED into 1 kilometer (1,000 meters) of usable light. At Vision X, we are constantly striving to live up to our company motto of "Lighting Evolved".

Vision X works with our customers around the world, our sponsorship partners, and the world's leading LED manufacturers continuously to imagine new products for use in many applications. We strive to be the solution provider for any lighting need by continuously improving existing product and imagining new product.

VISION X LIGHTING

ONLY THE HIGHEST QUALITY

QUALITY AS A PRIORITY

Our Customers Demand the Highest Quality. That's What We Deliver.



PRODUCT TESTING



Consumption
All products are put on a digital power meter to test that it is consuming the correct amount of power, checking for any electrical faults.



EMI
Products are tested in a sealed chamber to ensure that they don't introduce RF noise into electronics/radios.



Submersion/Aging
Once products are assembled every product is run through a submersion (water dunk test), then placed onto an aging rack and powered up for 30 minutes to ensure proper operation.



Thermal Impact Rapid Temperature Change
Products are placed in a -40°C chamber for 30 minutes, and then placed in a 80°C chamber for an additional 30 minutes. Products are then run for 72 hours to ensure full operational status.



Photometric Isolux Beam Pattern
Lights are tested in the Goniophotometer to model the beam pattern and depict the overall light output.



High Temperature & High Humidity Operational
Products are placed in a 60°C, 94% humidity chamber and left operational for 72 hours. Afterwards, products are inspected for moisture, water drops, damaged LEDs, flickering LEDs, and more.



Ingress High Pressure IP69K
Products are sprayed from close distances with 80~100 BAR water pressure to verify the Ingress Protection rating, ensuring they are sealed properly.



Vibration 15.6 G rms Rating
Products are placed on the vibration shock table with a vibration range of 25.6G for 4 hours to test that they can withstand the rated vibration standard. Products tested at 60 G rms are performed off-site.



Long Term Durability
Products are then switched on and off 20,000 times repeatedly to ensure that they remain functional after all testing.

VISION X LIGHTING

HIGH QUALITY GUARANTEED



Here at Vision X, we pride ourselves on raising the standards for the quality and durability of our lights, assuring a long lifespan and reliable illumination for years to come. In the US we offer a Lifetime Warranty on many of our products for Consumer use and a 3 year warranty on an assortment of our Commercial use products. Ask your local dealer about the provided warranty available for your products.

High Level Certifications

IEC 62471 **Photo Biological**
Ensures that light output has safe levels of UV exposure for both skin and eyes.

RoHS **ROHS**
Ensures no use of restricted hazardous materials in products such as lead, mercury, cadmium, PBB, PBDE, and Phthalate.

DOT
US Department of Transportation certified for on road use.

UL
UL Certification is recognized around the world as a way to ensure standards.

EX **ATEX 95 (94/9/EC)**
The APEX 95 certification is given to electronic equipment that is resistant to flame and explosion.

E **E-mark**
European Regulatory certification for on highway use.

ADR **ADR 13/00**
Products which are in compliance with the Australian Design Rules (ADR).

IP-69K **IP Rating**
Ingress Protection rates protection against outside elements. First number is solids, second is liquids.

CE **CE**
CE is a mandatory conformity mark for products in the European Economic Area.

emc **EMC**
EMC and EMI certifies that a product does not interfere with other electrical products. This includes CISPR 25 Certifications

VISION X LIGHTING

NOTHING BUT THE BEST

Development Process

After consulting with industry leaders, Vision X works to develop market-changing products to advance lighting technology forward. Our team of engineers is capable of transforming an idea to a prototype in just 60 days.

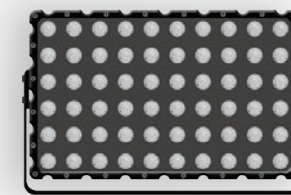

CONCEPT

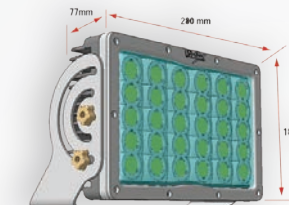

RENDERING

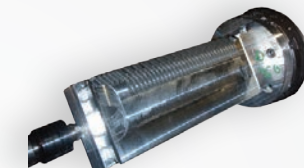

PROTOTYPE



PRODUCTION

Trademarks and Patents

Vision X ensures the protection of our products by acquiring patents and trademarks worldwide.

This gives us the ability to fight "knockoff" products worldwide so that our customers can be assured they are buying Vision X Genuine products.

Vision X currently holds 141 total patents and pending patents.

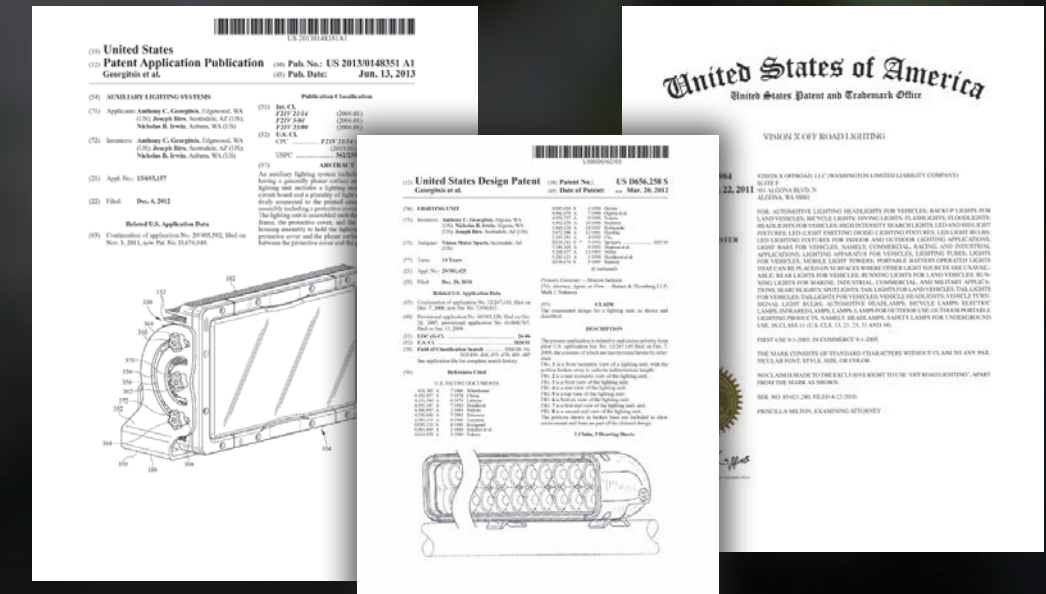

VISION X LIGHTING

LED, HID, HALOGEN TECHNOLOGY

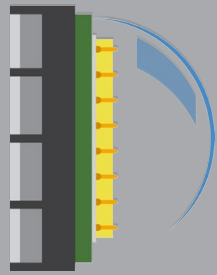

Lighting-Emitting Diode (LED)

Vision X offers a variety of LEDs in different color temperatures based on applications. LED Lights do not use a bulb, making them much more durable and require less energy.

INTENSITY



AMP DRAW



LUMENS PER WATT

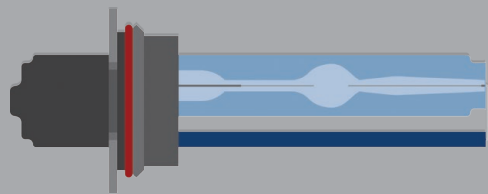

High Intensity Discharge (HID)

Vision X HID Lighting runs at a 5000k temperature for a super white beam color. HID lights require a bulb, starter and ballast to operate. They have a higher output per wattage than Halogen bulbs.

INTENSITY



AMP DRAW



LUMENS PER WATT

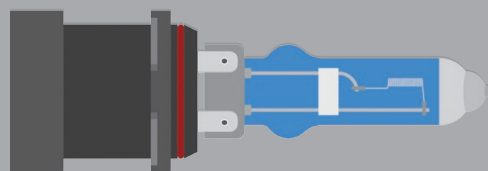

Halogen

Vision X offers a number of different Halogen Lighting options. The Tungsten-Halogen series uses an oversized globe and specially engineered filament to enhance light output. Vision X offers many headlight replacements.

INTENSITY



AMP DRAW



LUMENS PER WATT



VISION X LIGHTING

LIGHTING EXPLAINED

Beam Patterns Explained

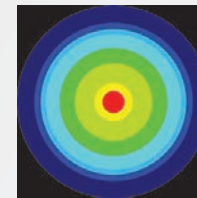

10°/20° Narrow Beam

The spot beam pattern is used primarily as a driving light. The narrow beam creates a focal point accompanied by a "halo effect" which adds peripheral lighting. Best for high speed travel requiring distance.

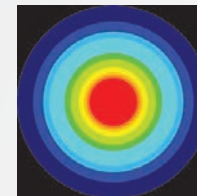

40° Wide Beam

The wide beam pattern is the intermediate beam well suited as a multi-purpose light. This beam pattern is recommended as a driving beam at lower speeds when you need more peripheral lighting.

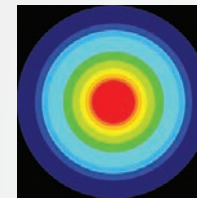

60°/90° Extra Wide Beam

The extra wide beam pattern is typically used as backup and area lighting and for slow-speed applications. Please note that 60°/90° beam is not listed on each product page, but is available in most products.

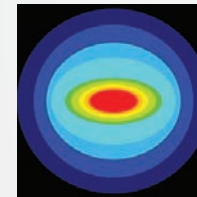

30°/65° Elliptical Beam

The elliptical beam is a specialty beam pattern that is designed for driving with oncoming traffic. The beam itself is 30° tall and 65° wide, good for all speeds. Ideal for use in fog or heavy particulate conditions.

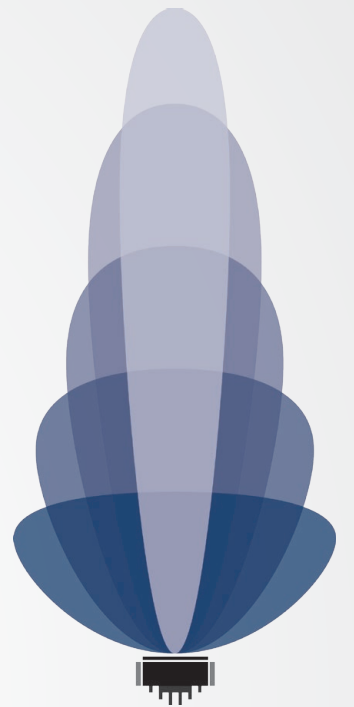

- 10° Narrow Beam
- 20° Narrow Beam
- 40° Wide Beam
- 60° Extra Wide
- 90° Extra Wide

Lighting Terms Explained

Lumen

Lumens measure the overall output of a light source. **Raw Lumens** account for the rated output of the LED from the source. By contrast, the **Effective Lumens** rating accounts for thermal, optical, and electrical losses which reduce total output.

Lux

Lux measures the amount of light per square meter. Unlike lumens which measures light at the source, lux is measured at a specific distance. This helps better determine whether those effective lumens are lighting up the environment with the necessary light.

Measuring Lux

On Vision X lux charts, the different colors within a light's beam on the lux chart correlates to a different lux level at that distance from the source, according to the colors shown below.

Lux Chart

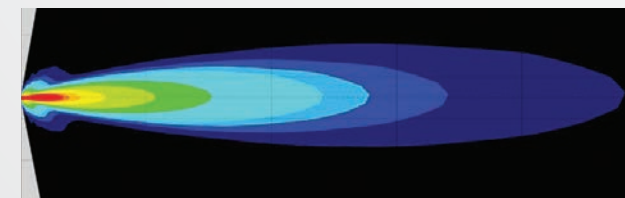

- 100.00 lux
- 75.00 lux
- 50.00 lux
- 25.00 lux
- 10.00 lux
- 5.000 lux
- 20.0 lux
- 1.500 lux
- 1.000 lux
- .5000 lux

TAKE CONTROL OF YOUR LIGHTING

INTRODUCING BORG TECHNOLOGY FROM VISION X



Available on the App Store

ST
life.augmented

ITEM #: XIL-PXB36M Shown
PART #: 9893266

BLUETOOTH CONNECTION FOR PRIME DRIVE LIGHTS

THE NEXT STEP IN LED LIGHTING IS ONE TAP AWAY.



PATENT PENDING

ABOUT THE BORG

Vision X is constantly leading the LED Lighting industry by taking the "next-step" in technology and products. The Borg is just that. A simple adaption for any Vision X Light that is equipped with Prime Drive Technology can be transformed from a simple on/off product, to an experience in itself.

Everything from strobing intervals to light intensity can be controlled by your smartphone via bluetooth connection. Additionally, you'll have the power to see valuable data relayed from your LED Light such as humidity, temperature, voltage, RSSI, and elevation. Even further, you can track your g-force level and acceleration with only a few taps.

Unlock the full potential of your Vision X LED by equipping it with Borg!

KEY FEATURES

- Take control of your Vision X Prime Drive Lights via bluetooth connection
- Monitor humidity, temperature, voltage, and other valuable data
- Remotely set strobing and power levels via mobile device
- Currently available for Apple devices
- Simple On-Off Power Function
- Real Time Two-Way Data
- 32 Bit Processing

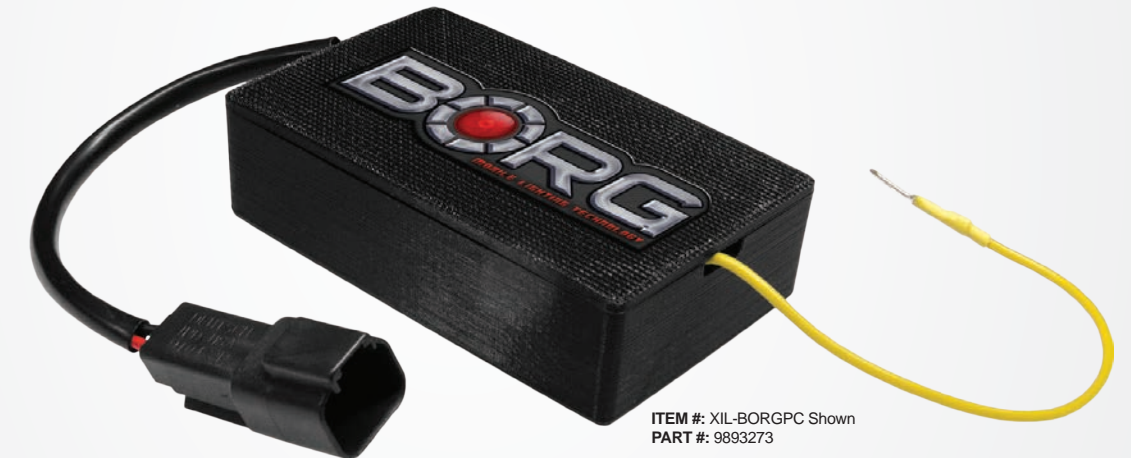

ITEM #: XIL-BORGPC Shown
PART #: 9893273

CONNECTING THE BORG

The Borg is sold as an accessory for Vision X LED Lights that are equipped with our exclusive Prime Drive Technology. Simply attach the Borg to the same power source as the LED Light and then connect the output wire to the Prime Drive wire on the back of the fixture.

We've also created a special 26 inch Xmitter Prime Xtreme (36 LED) Light Bar with the Borg pre-installed in the center of the bar. Simply connect the bar to a power source and the Borg will become operational. Enjoy the powerful output of the Xmitter Prime Xtreme series while also having access to Borg features in the palm of your hand. Item #: XIL-PXB36M - Part #: 9893266

EXAMPLE APPLICATIONS

The Borg is the perfect accessory for both Industrial and Automotive/Offroad applications. With so many additional features and information unlocked in the app, there's bound to be something for everyone.

Borg is a powerful ally in both industries thanks to the ability to accurately display information such as humidity and internal temperature in real-time. The proximity alert function turns the LED Light on or off depending on the range of the smartphone from the light. Imagine your LED Light turning on as you approach your vehicle or building. The potential of Borg Technology is unlimited with software updates and enhancements easily downloadable.



INDUSTRIAL SOLUTIONS

HEAVY DUTY | MEDIUM DUTY | MARITIME | STRUCTURAL | INDUSTRIAL ACCESSORIES



HEAVY DUTY SOLUTIONS

Engineered for high-vibration and harsh environments, our Heavy Duty range features advanced specifications including specialized brackets and electrical components for unmatched illumination on a large scale.



SOLUTION PROCESS

Vision X offers complete lighting solutions tailored to the exact needs of your location. This allows you to know prior to purchasing exactly what each light package will do for you. Letting you know in confidence that the lights will meet all the OSHA/MSHA and any other requirements that you may need.

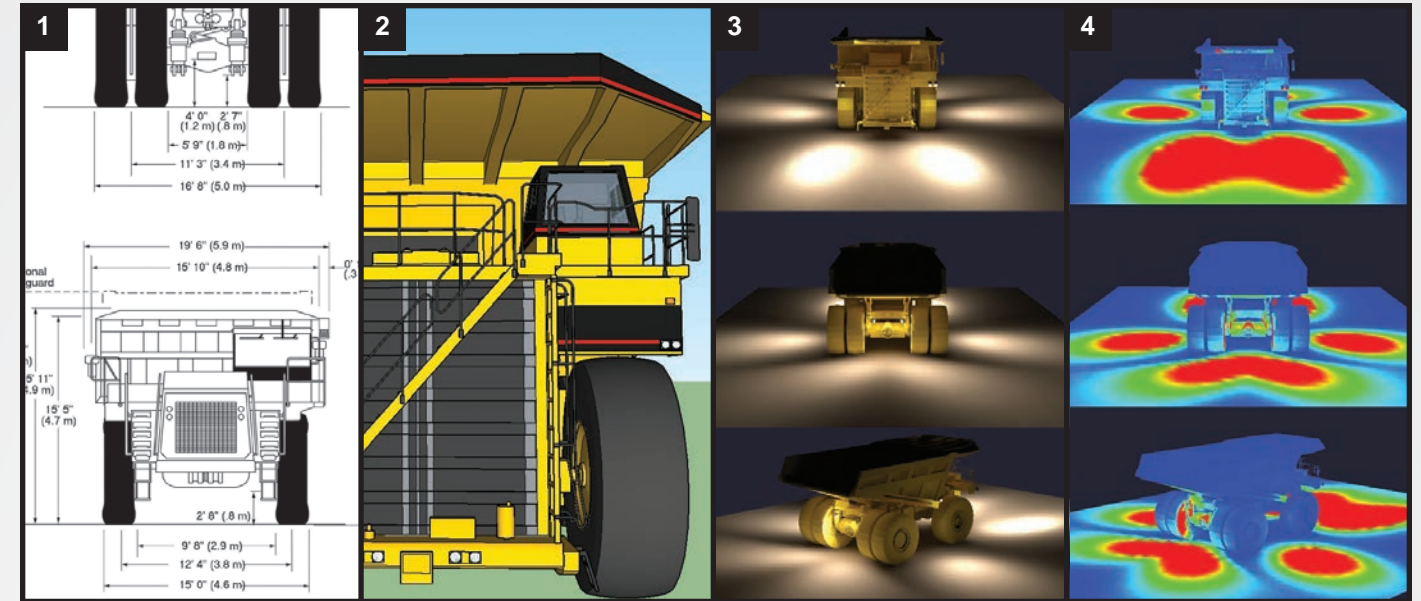

2D BLUEPRINT

Vision X begins a project by requesting the list of machines that will be needed to be retrofitted. Then gathering the technical information for those machines.

3D MODEL

A 3D Model is then built to match the customer exact specifications. This model is then carried over into the rendering.

SIMULATION RENDER

Prior to implementing a lighting solution, Vision X creates a simulation rendering of the intended result to help envision if the final product will meet lighting requirements.

SOLUTION

Vision X creates a complete breakdown of what the customer needs to meet their specific requirements for safety.

FIT OUT GUIDES AVAILABLE

CAT D11 DOZER	CATERPILLAR 994F WHEEL LOADER	CATERPILLAR 797F DUMP TRUCK
<ul style="list-style-type: none"> MIL-RPX1240T 4.5" x 2" Rectangle 60W Flood LED Work Light MIL-RPX1260T 4.5" x 2" Rectangle 60W Flood LED Work Light 	<ul style="list-style-type: none"> MIL-SP520 4" Square Flood LED Work Light MIL-SP540 4" Square Flood LED Work Light MIL-SP140 2" Round Flood LED Flood Light 	<ul style="list-style-type: none"> MIL-SP520 4" Square Flood LED Work Light MIL-SP540 4" Square Flood LED Work Light MIL-SP140 2" Round Flood LED Flood Light
<p>Vision X Lighting Mining Services P: 1-800-994-4460 E: mining@visionxusa.com Copyright 2014 Vision X Lighting</p>	<p>Vision X Lighting Mining Services P: 1-800-994-4460 E: mining@visionxusa.com Copyright 2010 Vision X Lighting</p>	<p>Vision X Lighting Mining Services P: 1-800-994-4460 E: mining@visionxusa.com Copyright 2010 Vision X Lighting</p>

INDUSTRIAL PITMASTER SERIES

ABOUT THE PITMASTER

HARSH ENVIRONMENT 500 & 1000 WATT HPS REPLACEMENT

The PitMaster has earned its reputation for being the ultimate Heavy Duty LED light from the combination of its die-cast aluminum housing, unbreakable polycarbonate lens, integrated deutsch connector, reinforced gasketed bezel, and a strengthened trunnion mounting bracket.

Designed to outshine and outlast the competition, the PitMaster features advanced electronic technology like Pulse Width Modulation, Electronic Thermal Management, and a Redundant Circuit Design (60 LED) that allows the fixture to function even if half of the light should fail for unknown reasons. This is part of the effort by Vision X to ensure that the PitMaster exceeds half engine life on mining vehicles.

FOR USE WITH

- UNDERGROUND JUMBOS & DRILL RIGS
- HARSH ENVIRONMENT STRUCTURAL
- HYDRAULIC AND ROPE SHOVELS
- WORKOVER DRILL RIGS
- LIGHT PLANT RETROFIT
- LIGHT POLES
- WASH BAYS

PACKAGES & MOUNTS

ADAPTIVE MOUNTING

Multiple mounting options are available for the PitMaster 30 and PitMaster 60 such as hanging mounts, flush mounts, and application specific mounts crafted from hardened steel. Also, Vision X can create custom brackets or mounting for your specific needs. Give us a call for further information.



ITEM #: P-PMX30HANGINGMOUNT Shown
PART #: 9131085



ITEM #: P-PMX30COBRAHEADMOUNT Shown
PART #: 9130996



ITEM #: P-PMX30HANGINGMOUNT Shown
PART #: 9131177

AC PACKAGES

Packages are also available for purchase and include the fixture, a power supply, necessary mounting, and a junction box to protect the wiring from weather. The AC Power Inverter changes the PitMaster Input Voltage from 11-65V DC to 90-277V AC for a wider range.

ITEM #	PART #	APPLICATION	PACKAGE INCLUDES	VOLTAGE
CXA-PMX3060HPS	9887388	High Bay	MIL-PMX3060, XPC-PS150-24, P-PMX30HANGINGMOUNT, P-JBOXAC	90-277V AC
CXA-PMX3060FPS	9887395	Low Bay	MIL-PMX3060, XPC-PS150-24, P-PMX30FLUSHMOUNT, P-JBOXAC	90-277V AC
CXA-PMX3060CPS	9887401	Street Lighting	MIL-PMX3060, XPC-PS150-24, P-PMX30COBRAHEADMOUNT, P-JBOXAC	90-277V AC
CXA-PMX3060PS	9887418	Structural	MIL-PMX3060, XPC-PS150-24, P-JBOXAC	90-277V AC
CXA-PMX6060HPS	9887425	High Bay	MIL-PMX6060, [2] XPC-PS150-24, P-PMX60HPLATE, [2] P-JBOXAC	90-277V AC
CXA-PMX6060PS	9887432	Structural	MIL-PMX6060, [2] XPC-PS150-24, [2] P-JBOXAC	90-277V AC
CXA-PMX3090WPS	9893280	Wall Pack	MIL-PMX6090, [2] XPC-PS150-24, P-PMX30WALLPACK, [2] P-JBOXAC	90-277V AC

REDUNDANT CIRCUIT DESIGN

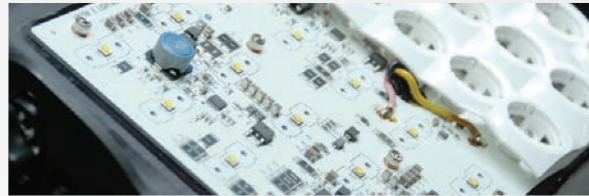

FAILSAFE FIXTURE

The PitMaster 30 & 60 each have five and ten internal circuits respectively for redundancy. If one circuit fails, other circuits continue to function allowing equipment to operate until preventive maintenance eliminating unscheduled maintenance and downtime.

INCREASED PERFORMANCE OVER HPS



Each PitMaster delivers 30% more light to effective work area over high-pressure sodium and metal-halide fixtures, while consuming only 30% of the energy.

PITMASTER 60



ITEM #: MIL-PMX6060 Shown
PART #: 9113357

1000-WATT METAL HALIDE REPLACEMENT LIGHT
Increases Operator Safety | 360° Fully Adjustable Mounting System | Prime Drive Equipped

BEAM PATTERNS	WARRANTY	DIMENSIONS
10°,25°, 40°, 60°, 90°, 30°x65°	Extended	14.28" x 11.68" x 6.87"
RAW LUMENS	EFFECTIVE LUMENS	METRIC
31,680 lm (ea)	22,200 lm (ea)	362.7mm x 296.7mm x 174.5mm
WATTAGE / AMPS	VIBRATION RATING	WEIGHT
300W / 25A @12V	15.6 G rms	26.46 lb / 12.0 kg



ITEM #	PART #	QTY	BEAM
MIL-PMX6010	9113081	1	10°
MIL-PMX6040	9113265	1	40°

ITEM #	PART #	QTY	BEAM
MIL-PMX6060	9113357	1	60°
MIL-PMX6090	9139906	1	90°

BEAM PATTERN

MIL-PMX6060 | 9113357 - 60° Beam

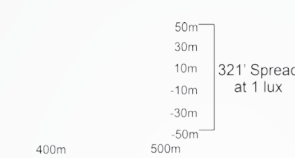
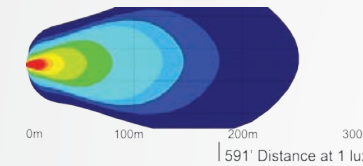

2D VIEW

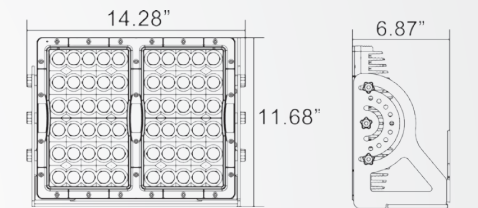

PITMASTER 30



ITEM #: MIL-PMX3060 Shown
PART #: 9112909

500-WATT METAL HALIDE REPLACEMENT LIGHT
Increases Operator Safety | 360° Fully Adjustable Mounting System | Prime Drive Equipped

BEAM PATTERNS	WARRANTY	DIMENSIONS
10°,25°, 40°, 60°, 90°, 30°x65°	Extended	11.75" x 7.54" x 4.94"
RAW LUMENS	EFFECTIVE LUMENS	METRIC
15,840 lm (ea)	11,100 lm (ea)	298.5mm x 191.5mm x 125.5mm
WATTAGE / AMPS	VIBRATION RATING	WEIGHT
150W / 12.5A @12V	15.6 G rms	12.34 lb / 5.6 kg



ITEM #	PART #	QTY	BEAM
MIL-PMX3010	9112633	1	10°
MIL-PMX3040	9112817	1	40°

ITEM #	PART #	QTY	BEAM
MIL-PMX3060	9112909	1	60°
MIL-PMX3090	9138107	1	90°

BEAM PATTERN

MIL-PMX3060 | 9112909 - 60° Beam

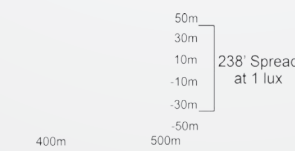
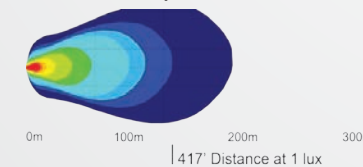

2D VIEW

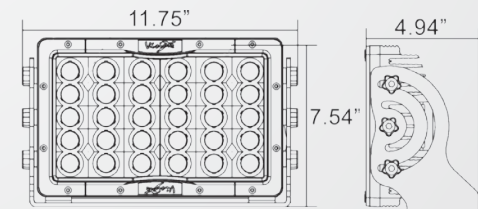

INDUSTRIAL RIPPER SERIES

ABOUT THE RIPPER

DESIGNED SPECIFICALLY FOR TRACKED DOZERS, WILL LAST IN ANY APPLICATION.

Built to last. The Ripper Series from Vision X is the hardest working LED fixture you'll find on the market. Rated at 60G rms, the Ripper is capable of standing up to intense amounts of vibration and still perform like it is its first day on the job.

The Ripper is a direct replacement for HID and Halogen fixtures on heavy vibration commercial and industrial machinery. It features Prime Drive ETM (Electronic Thermal Management) that controls the LED temperature to ensure a prolonged LED lifespan. Additionally, the unique vertical and horizontal channeled heat sink increases heat dissipation and further prolongs the lifespan of the light.

FOR USE WITH

- HARSH ENVIRONMENT STRUCTURAL RUBBER TIRE & TRACK DOZERS
- STANCHION LIGHT POLES
- WORKOVER DRILL RIGS
- HYDRAULIC SHOVELS
- WASH BAYS

RIPPER SERIES MOUNTING



DUAL MOUNTING

Each Ripper comes packaged with a fully-adjustable Trunnion mount with isolated rubber shock absorbers. Combined with the standard Suspension mount, the Ripper can operate in intense vibration applications.

VARIETY OF OPTICS



BEAM PATTERNS

The Ripper 12 and 20 LED lights are available in a large variety of beam patterns, each excelling in specific applications. Currently, 10, 25, 40, 60, and 90° beam patterns are available.

RIPPER 20 LED



ITEM #: MIL-RXP2060T Shown
PART #: 9114439

60 G rms RATED FOR HIGH VIBRATION 100-WATT WORK LIGHT
Dual Mounting System | High Vibration Light | OE Upgrade

BEAM PATTERNS 10°, 25°, 40°, 60°, 90°, 30°x65°	WARRANTY Extended	DIMENSIONS 6.97" x 6.61" x 4.05"
RAW LUMENS 10,560 lm (ea)	EFFECTIVE LUMENS 7,400 lm (ea)	METRIC 177mm x 168mm x 102.9mm
WATTAGE / AMPS 100W / 8.34A @12V	VIBRATION RATING 60 G rms	WEIGHT 7.50 lb / 3.4 kg



ITEM #	PART #	QTY	BEAM
MIL-RXP2010T	9114163	1	10°
MIL-RXP2040T	9114347	1	40°

ITEM #	PART #	QTY	BEAM
MIL-RXP2060T	9114439	1	60°
MIL-RXP2090T	9138640	1	90°

BEAM PATTERN

MIL-RXP2060T | 9114439 - 60° Beam

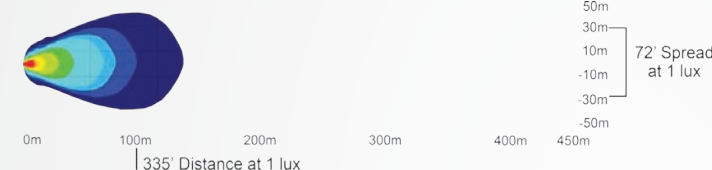

2D VIEW

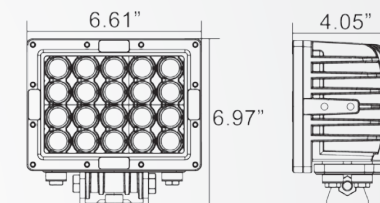

RIPPER 12 LED



ITEM #: MIL-RXP1260T Shown
PART #: 4009998

60 G rms RATED FOR HIGH VIBRATION 60-WATT WORK LIGHT
Dual Mounting System | High Vibration Light | OE Upgrade

BEAM PATTERNS 10°, 25°, 40°, 60°, 90°, 30°x65°	WARRANTY Extended	DIMENSIONS 6.94" x 4.72" x 4.05"
RAW LUMENS 6,336 lm (ea)	EFFECTIVE LUMENS 4,440 lm (ea)	METRIC 176.2mm x 120mm x 102.9mm
WATTAGE / AMPS 60W / 5.0A @12V	VIBRATION RATING 60 G rms	WEIGHT 5.51 lb / 2.5 kg



ITEM #	PART #	QTY	BEAM
MIL-RXP1210T	4009974	1	10°
MIL-RXP1240T	4009981	1	40°

ITEM #	PART #	QTY	BEAM
MIL-RXP1260T	4009998	1	60°
MIL-RXP1290T	9138558	1	90°

BEAM PATTERN

MIL-RXP1260T | 4009998 - 60° Beam

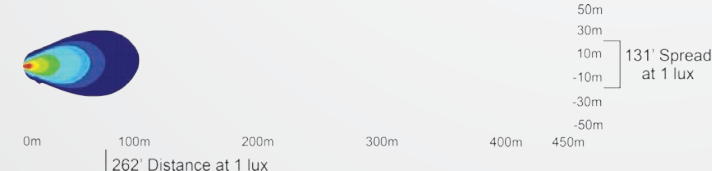

2D VIEW

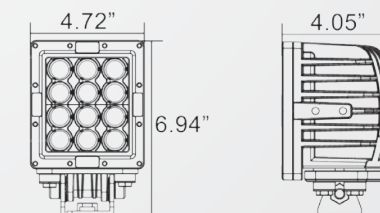

INDUSTRIAL SOLSTICE PRIME SERIES

ABOUT THE SOLSTICE PRIME

DESIGNED FOR HEAVY DUTY FLEETS, OE FITMENT DESIGN

The Solstice Prime Series from Vision X combines traditional form factor and single-bolt mounting with the energy-efficient benefits of LED for the ultimate OE upgrade option for commercial and industrial vehicles that use HID and Halogen fixtures.

The Solstice Prime Series is available in 5 LED or 7 LED models, and each feature Prime Drive ETM (Electronic Thermal Management) that controls the LED temperature to ensure a prolonged LED lifespan. Additionally, the unique vertical and horizontal channeled heat sink increases heat dissipation and further prolongs the lifespan.

FOR USE WITH

- UNDERGROUND HAUL TRUCKS
- OPEN PIT HAUL TRUCKS
- MISC WHITE IRON
- WATER TRUCKS
- EXCAVATORS
- GRADERS
- LOADERS
- MUCKER

SOLSTICE PRIME MOUNTING



TRUNNION BRACKET

The Vision X Solstice Prime comes equipped with a full-adjustable 105° Trunnion Bracket that can be easily tuned with a 5mm allen wrench for the optical angle for the most direct and efficient light. Additionally, each bolt on the bracket uses isolated rubber shock absorbers to minimize vibration.

ETM & REDUNDANT CIRCUITRY



ETM & PRIME DRIVE

Integrated Electronic Thermal Management helps prolong the life of the LEDs by regulating heat levels. Redundant circuit design allows partial light operation until preventative maintenance.

SOLSTICE PRIME 7 LED



ITEM #: XIL-SP740 Shown
PART #: 4009875

OE UPGRADE FOR HEAVY DUTY COMMERCIAL & INDUSTRIAL APPLICATIONS
105° Adjustable Trunnion Bracket | PWM Integrated Dimming | Vertical Fins Maximize Heat Dissipation

BEAM PATTERNS 20°, 40°	WARRANTY Extended	DIMENSIONS 7.14" x 6.53" x 3.13"
RAW LUMENS 7,364 lm (ea)	EFFECTIVE LUMENS 5,155 lm (ea)	METRIC 181.4mm x 165.9mm x 79.5mm
WATTAGE / AMPS 70W / 5.84A @12V	VIBRATION RATING 15.6 G rms	WEIGHT 4.52 lb / 2.05 kg



ITEM #	PART #	QTY	BEAM
XIL-SP720	4009868	1	20°

ITEM #	PART #	QTY	BEAM
XIL-SP740	4009875	1	40°

BEAM PATTERN

XIL-SP740 | 4009875 - 40° Beam



2D VIEW

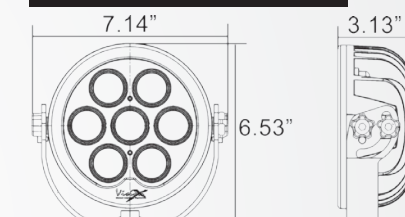

SOLSTICE PRIME 5 LED



ITEM #: XIL-SP540 Shown
PART #: 4009851

OE UPGRADE FOR HEAVY DUTY COMMERCIAL & INDUSTRIAL APPLICATIONS
105° Adjustable Trunnion Bracket | PWM Integrated Dimming | Vertical Fins Maximize Heat Dissipation

BEAM PATTERNS 20°, 40°	WARRANTY Extended	DIMENSIONS 6.00" x 5.17" x 3.13"
RAW LUMENS 5,260 lm (ea)	EFFECTIVE LUMENS 3,682 lm (ea)	METRIC 152.4mm x 131.3mm x 79.5mm
WATTAGE / AMPS 50W / 4.17A @12V	VIBRATION RATING 15.6 G rms	WEIGHT 3.09 lb / 1.4 kg



ITEM #	PART #	QTY	BEAM
XIL-SP520	4009844	1	20°

ITEM #	PART #	QTY	BEAM
XIL-SP540	4009851	1	40°

BEAM PATTERN

XIL-SP540 | 4009851 - 40° Beam

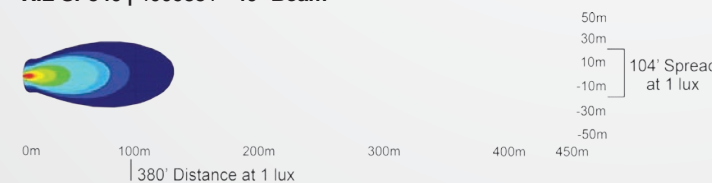

2D VIEW

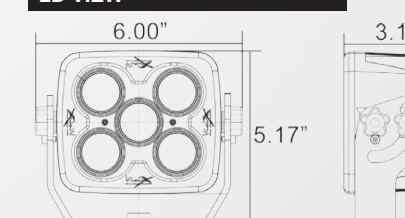

INDUSTRIAL SHOCKWAVE SERIES

ABOUT THE SHOCKWAVE

REPLACES FLUORESCENT FIXTURES IN HARSH ENVIRONMENTS

The Vision X Shockwave excels at being a durable fluorescent upgrade for flat mount applications. The Shockwave was designed to replace fluorescent tubes in heavy commercial and industrial work environments.

Each Shockwave has the option of using a Frosted lens that diffuse the light to help reduce shadow areas. Additionally, multiple mounting options are available, including a Flush, and standard brackets.

Fluorescent tubes often break and need replacement. With the Shockwave Series, you can save on unscheduled maintenance with 50,000 hours of LED life for a brighter, longer-lasting light.



Shown above: P&H Factory Fixture Replacement
CXA-SWD2440FPH

FLOURESCENT REPLACEMENT



FOR HARSH CONDITION MACHINERY
We designed the Shockwave Series to replace ineffective fluorescent fixtures on heavy duty machinery. With the Shockwave, you get more output for much less power.

AC SHOCKWAVE PACKAGES

AC PACKAGE

The Vision X Shockwave fixture can be purchased in a complete package with a power supply for up to 480V of AC input. Brackets and Junction Boxes are also included in these packages to help you get the most out of your shockwave.



ITEM #: CXA-SWD4880FPS Shown
PART #: 9887593

ITEM #	PART #	LENGTH	LENS
CXA-SWD1220PS	9887449	Dual 12"	Clear
CXA-SWD2440PS	9887463	Dual 24"	Clear
CXA-SWD3660PS	9887487	Dual 36"	Clear
CXA-SWD4880PS	9887500	Dual 48"	Clear
CXA-SWS1210PS	9887524	Single 12"	Clear
CXA-SWS2420PS	9887548	Single 24"	Clear
CXA-SWS3630PS	9887562	Single 36"	Clear
CXA-SWS4840PS	9887586	Single 48"	Clear

ITEM #	PART #	LENGTH	LENS
CXA-SWD1220FPS	9887456	Dual 12"	Frosted
CXA-SWD2440FPS	9887470	Dual 24"	Frosted
CXA-SWD3660FPS	9887494	Dual 36"	Frosted
CXA-SWD4880FPS	9887517	Dual 48"	Frosted
CXA-SWS1210FPS	9887531	Single 12"	Frosted
CXA-SWS2420FPS	9887555	Single 24"	Frosted
CXA-SWS3630FPS	9887579	Single 36"	Frosted
CXA-SWS4840FPS	9887593	Single 48"	Frosted

DC SHOCKWAVE DUAL



ITEM #: MIL-SWD2440 Shown
PART #: 9126043

2D VIEW

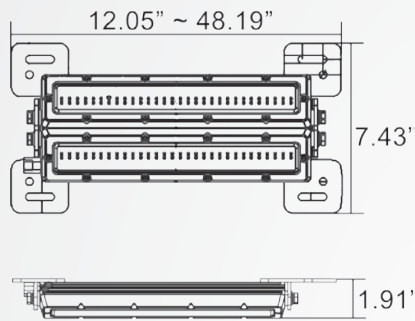

MODULAR LED UPGRADE FOR FLUORESCENT LIGHTS
Power Supply & Mounts Available | Frosted or Clear Lens | Direct Fluorescent Replacement

BEAM PATTERNS	WARRANTY	DIMENSIONS
Ultra Wide 150°	Extended	12" 24" 36" 48"
RAW LUMENS	EFFECTIVE LUMENS	METRIC
1,750 3,500 5,250 7,000	1,225 2,450 3,675 4,900	304mm 608mm 912mm 1216mm
WATTAGE / AMPS	VIBRATION RATING	WEIGHT
20-80W / 1.67-6.67A @12V	15.6 G rms	5.8 11.6 17.0 22.6



ITEM #	PART #	LENGTH	LENS	RAW LUMENS	WATTS	AMP DRAW	WEIGHT
MIL-SWD1220	9125954	Dual 12"	Clear	1,750 lm	20	1.67A	5.8 lb
MIL-SWD2440	9126043	Dual 24"	Clear	3,500 lm	40	3.34A	11.6 lb
MIL-SWD3660	9126135	Dual 36"	Clear	5,250 lm	60	5.0A	17.0 lb
MIL-SWD4880	9126227	Dual 48"	Clear	7,000 lm	80	6.67A	22.6 lb

ITEM #	PART #	LENGTH	LENS	RAW LUMENS	WATTS	AMP DRAW	WEIGHT
MIL-SWD1220F	9150253	Dual 12"	Frost	1,750 lm	20	1.67A	5.8 lb
MIL-SWD2440F	9150345	Dual 24"	Frost	3,500 lm	40	3.34A	11.6 lb
MIL-SWD3660F	9150437	Dual 36"	Frost	5,250 lm	60	5.0A	17.0 lb
MIL-SWD4880F	9150529	Dual 48"	Frost	7,000 lm	80	6.67A	22.6 lb

DC SHOCKWAVE SINGLE



ITEM #: MIL-SWS1220F Shown
PART #: 9150611

2D VIEW

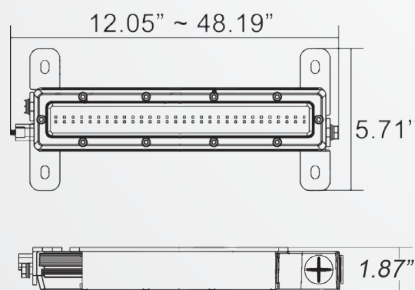

MODULAR LED UPGRADE FOR FLUORESCENT LIGHTS
Power Supply & Mounts Available | Frosted or Clear Lens | Direct Fluorescent Replacement

BEAM PATTERNS	WARRANTY	DIMENSIONS
Ultra Wide 120°	Extended	12" 24" 36" 48"
RAW LUMENS	EFFECTIVE LUMENS	METRIC
875 1,750 2,625 3,500	613 1,225 1,838 2,450	304mm 608mm 912mm 1216mm
WATTAGE / AMPS	VIBRATION RATING	WEIGHT
10-40W / 0.42-1.67A @12V	15.6 G rms	3.1 6.2 9.2 12.2



ITEM #	PART #	LENGTH	LENS	RAW LUMENS	WATTS	AMP DRAW	WEIGHT
MIL-SWS1210	9125596	Single 12"	Clear	875 lm	10	0.42A	3.1 lb
MIL-SWS2420	9125688	Single 24"	Clear	1,750 lm	20	0.83A	6.2 lb
MIL-SWS3630	9125770	Single 36"	Clear	2,625 lm	30	1.25A	9.2 lb
MIL-SWS4840	9125862	Single 48"	Clear	3,500 lm	40	1.67A	12.2 lb

ITEM #	PART #	LENGTH	LENS	RAW LUMENS	WATTS	AMP DRAW	WEIGHT
MIL-SWS1210F	9150611	Single 12"	Frost	875 lm	10	0.42A	3.1 lb
MIL-SWS2420F	9150703	Single 24"	Frost	1,750 lm	20	0.83A	6.2 lb
MIL-SWS3630F	9150796	Single 36"	Frost	2,625 lm	30	1.25A	9.2 lb
MIL-SWS4840F	9150888	Single 48"	Frost	3,500 lm	40	1.67A	12.2 lb

INDUSTRIAL PROTEX LIGHT

ABOUT THE PROTEX

ATEX APPROVED FOR FLAMMABLE ENVIRONMENTS

The Protex Flameproof Light fixture from Vision X provides you with a powerful and energy efficient alternative to traditional hazardous lights. The Protex offers a compact design making it the perfect replacement for older fixtures that are too bulky or require high maintenance. The Protex is designed to be mounted on the interior or exterior for area illumination.

This fixture features 18 High Output 3-Watt LEDs for a total of forty watts, and has an integrated 85-264V AC input range. The Die-Cast Aluminum Housing combined with a soda-lime glass lens allow the light to operate in any environment.

FOR USE WITH

- FUEL DELIVERY SYSTEMS
- FRACKING DRILL RIGS
- OIL PLATFORMS
- OIL REFINERIES
- TANK FARMS

ATEX 95 APPROVAL



DIRECTIVE 94/9/EC

The Vision X Protex fixture has undergone extensive product testing and has earned the ATEX 95 certification to become a flameproof electrical equipment.

FLAME/EXPLOSION CERTIFICATIONS



CE 0575 EX II 2G Ex d II B T5 Gb
 Zone 1 – Gases, Mists, Vapors. Occasional, Present
 Zone 2 – Gases, Mists, Vapors. Only present for a short period
 EX d – Prevents transmission of the explosion outside
 II B – For Complete list of explosion group examples see ATEX 94/9/EC



PROTEX FLAMEPROOF LIGHT



ITEM #: MIL-EXP1860 Shown
 PART #: 9895956

18-WATT FLAMEPROOF ATEX 95 CERTIFIED LED FIXTURE
 Soda-Lime Glass (15.0t) Lens | Integrated 85-264V AC Power Input | Single Stud Mounting System

BEAM PATTERNS 10°, 25°, 60°	WARRANTY Extended	DIMENSIONS 11.38" x 6.88" x 8.46"
RAW LUMENS 3,500 lm (ea)	EFFECTIVE LUMENS 2,450 lm (ea)	METRIC 289mm x 174.8mm x 215mm
WATTAGE / AMPS 40W / 8.43A @12V	VIBRATION RATING 15.6 G rms	WEIGHT 21.16 lb / 9.16 kg



ITEM #	PART #	QTY	BEAM
MIL-EXP1810	9895925	1	10°

ITEM #	PART #	QTY	BEAM
MIL-EXP1860	9895956	1	60°

BEAM PATTERN

MIL-EXP1860 | 9895956 - 60° Beam

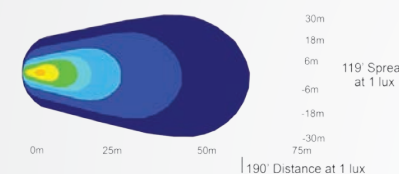

2D VIEW

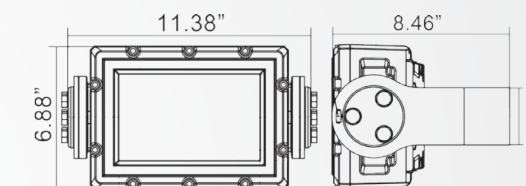



MEDIUM DUTY SOLUTIONS

Like the Heavy Duty lighting options, Medium Duty lights have passed rigorous quality tests to confirm consistent durability and lighting excellence. Medium Duty is tailored towards smaller scale lighting needs.



SOLUTION PROCESS

Vision X offers complete lighting solutions tailored to the exact needs of your Vehicle. This allows you to know prior to purchasing exactly what each light package will do for that specific vehicle. Letting you know in confidence that the lights will meet all the OSHA/MSHA and any other requirements that you may need.

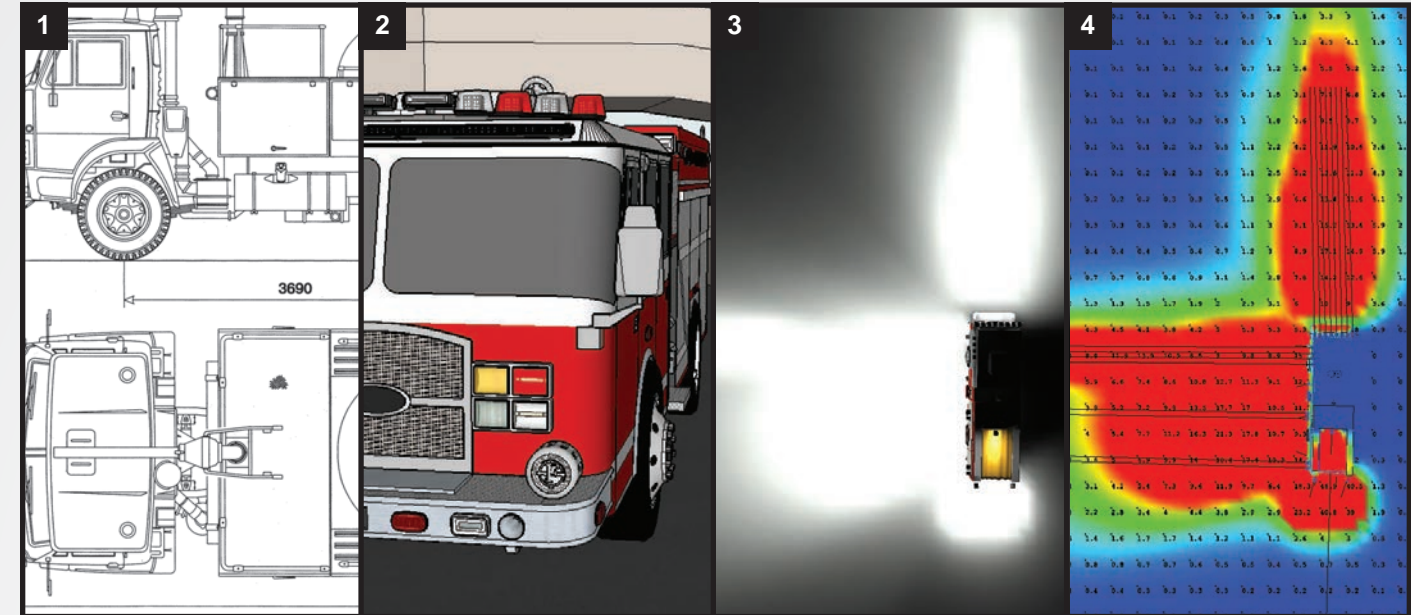

2D BLUEPRINT

Vision X begins a project by requesting the exact vehicle information that they need to be retrofitted.

3D MODEL

A 3D Model is then built to match the customer exact specifications. This model is then carried over into the rendering.

SIMULATION RENDER

Prior to implementing a lighting solution, Vision X creates a simulation rendering of the intended result to help envision if the final product will meet lighting requirements.

SOLUTION

Vision X creates a complete breakdown of what the customer needs to meet their specific requirements for safety.

FIT OUT GUIDES AVAILABLE

 <p>KOMATSU PC35-1</p> <p>DURA-400 4.0" Square 60° Flood Work Light</p> <p>1 x Front Facing (Blower Mounted) 2 x Front Facing (Blower Canted)</p> <p>Vision X Lighting Mining Services P: 1-800-994-4460 E: mining@visionxusa.com Copyright 2014 Vision X Lighting</p>	 <p>KOMATSU D85EX</p> <p>XIL-UMX4400 4.0" Square 60° Flood Work Light</p> <p>2 x Front Facing (Work Light Pods) 2 x Rear Facing (Blower Mount)</p> <p>Vision X Lighting Mining Services P: 1-800-994-4460 E: mining@visionxusa.com Copyright 2014 Vision X Lighting</p>	 <p>TEREX MHL380</p> <p>XIL-UMX4440 4.7" Square 60° Flood Beam LED Work Light</p> <p>1 x Front Facing (Blower in Cabin Front) 2 x Front Facing (Blower in Blower Mount) 2 x Rear Facing (Blower in Blower Mount) 2 x Rear Facing (Blower in Blower Mount)</p> <p>Vision X Lighting Mining Services P: 1-888-489-9920 E: info@visionxusa.com Copyright 2015 Vision X Lighting</p>
---	--	---

INDUSTRIAL UTILITY MARKET XTREME

ABOUT THE UMX SERIES

OEM/AFTERMARKET REPLACEMENT LIGHTING FOR HALOGEN/HID

The UMX Series excels in a multitude of applications and is a premium OE upgrade for commercial and industrial applications. Both the UMX Round and the UMX Square are capable of delivering greatly increased output and a smoother beam pattern than comparable halogen fixtures.

The UMX is used everywhere from large-scale mining sites to commercial fog light applications that take advantage of the available 10° beam pattern.

Over 528 raw lumens come out of each LED inside the UMX, making it a leader in the 5-Watt LED field.

FOR USE WITH

- AGRICULTURAL EQUIPMENT
- AIRPORT EQUIPMENT
- GARBAGE TRUCKS
- FLEET VEHICLES
- SERVICE BODIES
- EXCAVATORS
- SWEEPERS
- WRECKERS

REDUCED ENERGY CONSUMPTION



3-WATT MODEL AVAILABLE

For those looking for less power draw, the less powerful UM Series is available in the same housings as the UMX. The UM Series utilizes 3-watt LEDs to draw less power.

FACTORY REPLACEMENT LED FIXTURE



REPLACES OEM HALOGEN & HID

The UMX Series features a single stud mount allowing it to replace OEM fixtures with ease, including integrated deutsch plug mated to factory wiring on most equipment manufacturers.

ROUND UTILITY MARKET XTREME



ITEM #: XIL-UMX4060 Shown
PART #: 9118307

BEAM PATTERN

XIL-UMX4060 | 9118307 - 60° Beam

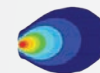

0m 100m 200m 300m 400m 450m
195' Distance at 1 lux

XTREME LIGHT OUTPUT OE UPGRADE FOR COMMERCIAL & INDUSTRIAL
Die-Cast Aluminum Housing | Reduced Energy Consumption | 3-Watt Model Available

BEAM PATTERNS 10°, 25°, 40°, 60°, 90°, 30°x65°	WARRANTY Extended	DIMENSIONS 4.49" x 5.47" x 3.14"
RAW LUMENS 3,696 lm (ea)	EFFECTIVE LUMENS 2,590 lm (ea)	METRIC 114mm x 139mm x 79.7mm
WATTAGE / AMPS 70W / 3.8A @12V	VIBRATION RATING 15.6 G rms	WEIGHT 2.43 lb / 1.1 kg



ITEM #	PART #	QTY	BEAM
XIL-UMX4010	4004719	SINGLE	10°
XIL-UMX4040	9118215	SINGLE	40°
XIL-UMX4060	9118307	SINGLE	60°

2D VIEW

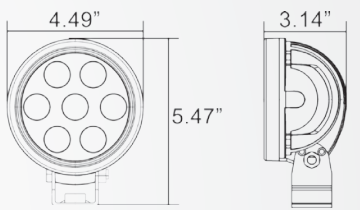

SQUARE UTILITY MARKET XTREME



ITEM #: XIL-UMX4460 Shown
PART #: 9118482

BEAM PATTERN

XIL-UMX4460 | 9118482 - 60° Beam

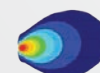

0m 100m 200m 300m 400m 450m
195' Distance at 1 lux

XTREME LIGHT OUTPUT OE UPGRADE FOR COMMERCIAL & INDUSTRIAL
Die-Cast Aluminum Housing | Reduced Energy Consumption | 3-Watt Model Available

BEAM PATTERNS 10°, 25°, 40°, 60°, 90°, 30°x65°	WARRANTY Extended	DIMENSIONS 4.71" x 6.28" x 3.14"
RAW LUMENS 3,696 lm (ea)	EFFECTIVE LUMENS 2,590 lm (ea)	METRIC 119.6mm x 159.5mm x 79.7mm
WATTAGE / AMPS 70W / 3.8A @12V	VIBRATION RATING 15.6 G rms	WEIGHT 2.63 lb / 1.2 kg



ITEM #	PART #	QTY	BEAM
XIL-UMX4410	4004726	SINGLE	10°
XIL-UMX4440	9118390	SINGLE	40°
XIL-UMX4460	9118482	SINGLE	60°

2D VIEW

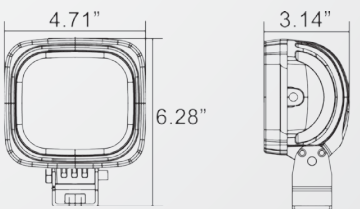

INDUSTRIAL DURALUX SERIES

ABOUT THE DURALUX SERIES

OEM/AFTERMARKET REPLACEMENT LIGHTING FOR HALOGEN/HID

The Duralux Series gives more output than 100-Watt Halogen lights while drawing much less power and reducing wear on associated components. Additionally, the Duralux was designed with fleet vehicles in mind, reducing cost, energy consumption, and boosting output at an attractive price.

Available in three different housing sizes and three different beam patterns, the Duralux Series is one of the most adaptive fixtures made by Vision X. The Die-Cast Aluminum housing combines durability with afford-ability for a wide variety of applications.

For those with limited space, the 12-Watt DURA Mini (DURA-M460) produces 2,000 raw lumens while only drawing 1.0 ampere at 12V.

FOR USE WITH

- AGRICULTURAL EQUIPMENT
- AIRPORT EQUIPMENT
- GARBAGE TRUCKS
- FLEET VEHICLES
- SERVICE BODIES
- EXCAVATORS
- SWEEPERS
- WRECKERS

DURA MINI



ITEM #: DURA-M460 Shown
PART #: 9895499

ULTIMATE COMPACT FIXTURE FOR UNIVERSAL APPLICATIONS

60° Flood Beam Pattern | IP-69K Waterproof/High Pressure Spray | 1.0 Amp Draw At 12V

BEAM PATTERNS 60°	WARRANTY Extended	DIMENSIONS 2.75" x 3.62" x 1.94"
RAW LUMENS 2,000 lm (ea)	EFFECTIVE LUMENS 950 lm (ea)	METRIC 70mm x 92mm x 49.4mm
WATTAGE / AMPS 12W / 1.0A	VIBRATION RATING 15.6 G rms	WEIGHT 0.88 lb / 0.40 kg



ITEM #	PART #	QTY	BEAM
DURA-M460	9895499	1	60°

BEAM PATTERN

DURA-M460 | 9895499 - 60° Beam



2D VIEW

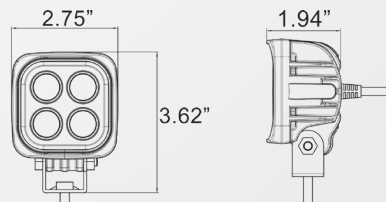

TWO LIGHT KITS



AVAILABLE DURALUX KITS

Currently, the Dura 6 LED and Dura 4 LED are available in two light kits with a dual wiring harness with 10°, 40°, or 60° optics at an affordable price.

FLUSH BRACKETS AVAILABLE



PROFESSIONAL MOUNTING SOLUTION

Extend the application range of the DURA with the addition of a Flush Mounting Bracket.

DURA-660FLUSH | 9893006
DURA-460FLUSH | 9892993

DURALUX 6 LED



ITEM #: DURA-660 Shown
PART #: 9888385

30-WATT HIGH PERFORMANCE UNIVERSAL LED LIGHT

Minimal Amperage Draw | 150-Watt Halogen Comparable Fixture | Durable Die-Cast Housing

BEAM PATTERNS 10°,25°, 40°, 60°, 90°, 30°x65°	WARRANTY Extended	DIMENSIONS 4.71" x 6.28" x 3.14"
RAW LUMENS 3,696 lm (ea)	EFFECTIVE LUMENS 2,590 lm (ea)	METRIC 119.6mm x 159.5mm x 79.7mm
WATTAGE / AMPS 30W / 2.5A @12V	VIBRATION RATING 15.6 G rms	WEIGHT 2.63 lb / 1.2 kg



ITEM #	PART #	QTY	BEAM
DURA-610	9891125	1	10°
DURA-610KIT	9891309	2	10°

ITEM #	PART #	QTY	BEAM
DURA-640	9888378	1	40°
DURA-660	9888385	1	60°

BEAM PATTERN

DURA-610 | 9891125 - 10° Beam

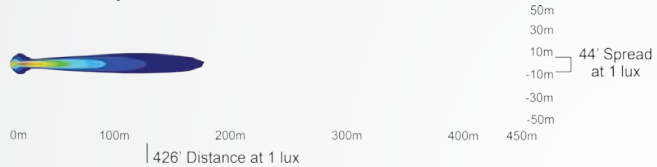

2D VIEW

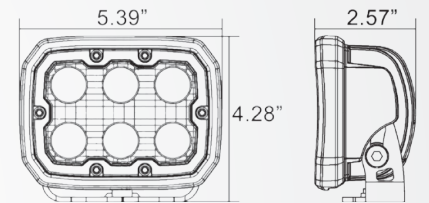

DURALUX 4 LED



ITEM #: DURA-460 Shown
PART #: 9141527

30-WATT HIGH PERFORMANCE UNIVERSAL LED LIGHT

Minimal Amperage Draw | 100-Watt Halogen Comparable Fixture | Durable Die-Cast Housing

BEAM PATTERNS 10°,25°, 40°, 60°, 90°, 30°x65°	WARRANTY Extended	DIMENSIONS 4.71" x 6.28" x 3.14"
RAW LUMENS 2,112 lm (ea)	EFFECTIVE LUMENS 1,480 lm (ea)	METRIC 119.6mm x 159.5mm x 79.7mm
WATTAGE / AMPS 20W / 1.6A @12V	VIBRATION RATING 15.6 G rms	WEIGHT 1.50 lb / 0.68 kg



ITEM #	PART #	QTY	BEAM
DURA-410	9891132	1	10°
DURA-410KIT	9891187	2	10°

ITEM #	PART #	QTY	BEAM
DURA-440	9141619	1	40°
DURA-460	9141527	1	60°

BEAM PATTERN

DURA-410 | 9141132 - 10° Beam

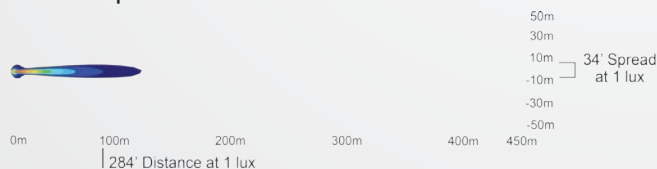

2D VIEW

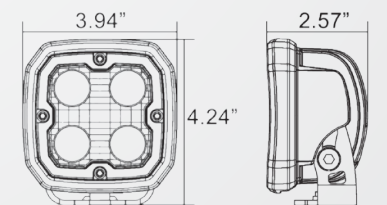

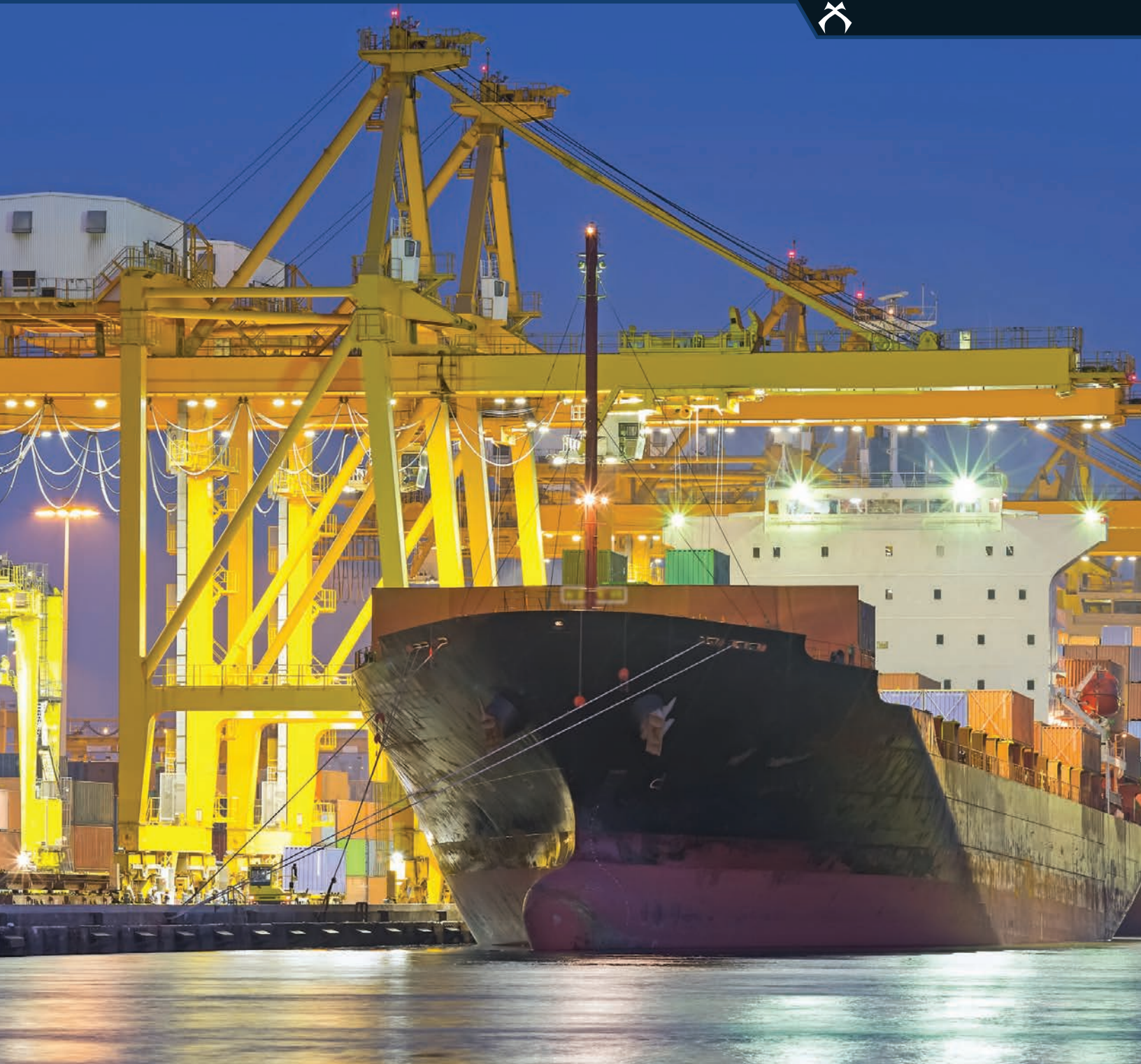

MARITIME SOLUTIONS

Vision X Marine lighting is specially manufactured to prevent effects of corrosion caused by close proximity to saltwater, along with special electronics for use in or near saltwater.



SOLUTION PROCESS

Vision X creates a solution for your ship or shore lighting needs while using a product specific range designed for the harsh environment of saltwater. This is done through above ground copper plated circuit boards, stainless steel brackets, and a marine grade coating. Using this environment specific range to create a complete proven solution.

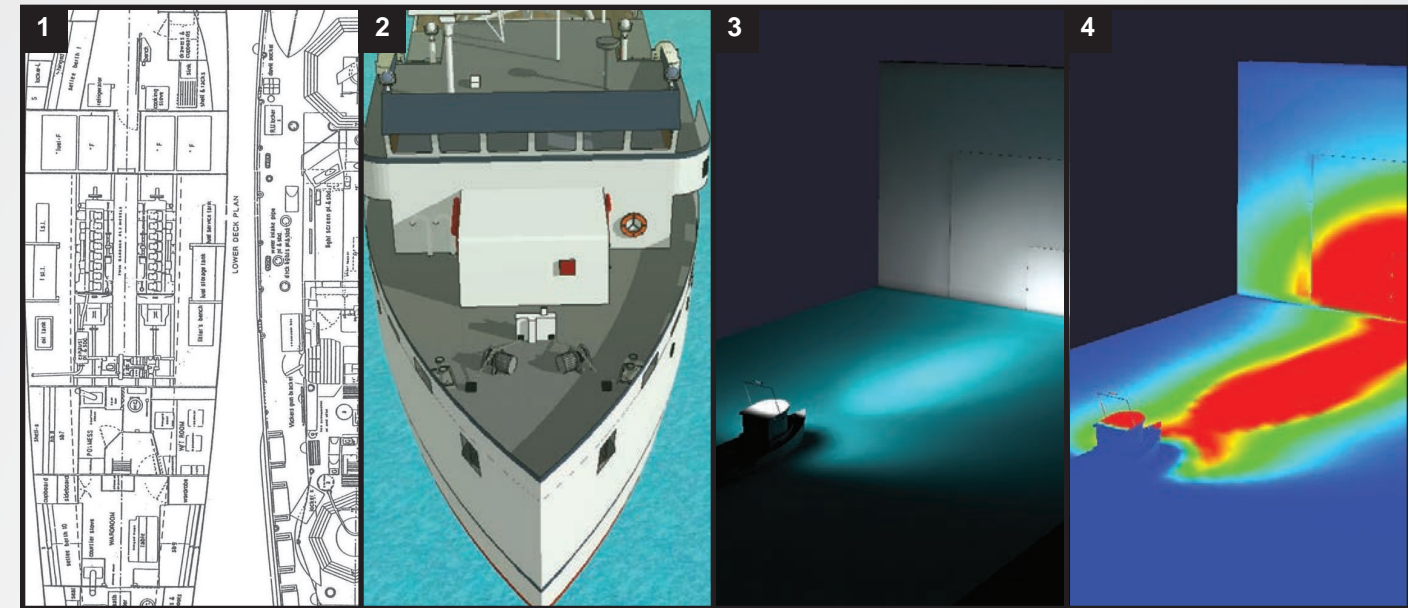

2D BLUEPRINT

Vision X begins a project by gathering information from the customer and the exact areas of the boat that need to be illuminated to what Lux/FC requirements.

3D MODEL

A 3D Model is then built to match the requirements requested and dropped into a realistic aquatic or port environment to ensure the light is where you need it.

SIMULATION RENDER

Prior to implementing a lighting solution, Vision X creates a simulation rendering of the intended result to help envision if the final product will resolve the problem.

SOLUTION

Vision X is able to create a solution that proves our lights are able to get you the spread and distance you need on the shore or on the ship.

CASE STUDIES / FIT OUT GUIDES AVAILABLE

Case Study - Port Lighting
Innovative LED Lighting Helps Shipping Port Increase Energy Efficiency and Light Output

Vision X Lighting helped shipping port to increase energy efficiency and reduce environmental impact at their large container ship docking terminal by upgrading their existing inefficient lighting fixtures to premium LED technology.

By switching to Vision X LED lighting shipping and we able to increase energy efficiency by about 85% while also increasing light output by 20%. This upgrade is actively helping reduce the shipping port footprint while also ensuring a safe, well-lit workplace.

About The Port Project
Shipping port, headquartered in Houston, Texas is the operator of a large preprint manufacturing plant located just outside of Miami, Georgia. A preprint is a material that is used in the oil industry to keep induced hydraulic fractures open. The preprinting Port Miller facility produces cement-lined preprint material for a wide variety of oil drilling and hydraulic fracturing ("fracking") operations. Shipping port was interested in reducing their facility's energy inefficient lights with Vision X Lighting's premium LED lighting fixtures.

The Project at Hand
The job containing the large Port Miller preprint plant covers over 80 acres. A large proportion of the site, as well as the interior of all plant structures, need to be kept well lit at all times to ensure a safe and productive work environment. Previously this task was accomplished by large amounts of inefficient, older technology fixtures. Not only did these fixtures waste large amounts of energy, they also provided less lighting output and poor coverage compared to their intended by newer Vision X LED technologies.

Developing A Solution
In order to fulfill Port Ceramics' desire to reduce the high energy consumption of their preprint plant's lighting systems while also increasing light output, Vision X developed a plug and play retrofit solution for existing fixtures. In this way all lighting fixtures were easily replaced while continuing to utilize existing hardware and wiring. This applied to all previously existing light fixtures, from large 1000-watt high bay lights in the facility's cranes shed to 400-watt wall packs to smaller, lower-wattage fixtures inside of plant structures.

Smaller lights were easily replaced with the small 50-watt output of the higher output, maintain light output at any size workplace.

www.visionx.com

RTG CRANE

4x Outside of North Arm (Aiming Straight Down)
4x Outside of South Arm (Aiming Straight Down)

4x One on the Outside of Each Leg (12" High Aiming Straight Down)

4x ML-FR3000P/19V55 180 Watt P/N-Motor 60 60° Beam Pattern 200-400V AC Power Supply Soft Start

4x ML-FR3000P/19V55 180 Watt P/N-Motor 60 60° Beam Pattern 200-400V AC Power Supply Soft Start

TXLC-976

2x Rear Facing (Backlog)
2x Facing Inboard Twist Lock

4x XIL-UM4440 3.9" x 4.7" Rectangle Flood LED Work Light

4x XIL-SP520 4.13" x 6" Rectangle Spot LED Work Light
2x Forward Facing at 45° Out Board

INDUSTRIAL MARITIME SOLUTIONS

ABOUT THE MARITIME SERIES

The Vision X Marine line provides the ideal solution for watercraft of all sizes. From commercial freight ships to fishing vessels for hobbyists, we carry the perfect LED fixtures. Each electronics board used in the Maritime line is constructed from copper to remove corrosion issues typically common in saltwater applications.

Additionally, the gloss coating reduces wear from constant barrage of saltwater while at sea, ensuring the light performs day in and day out. The heavy duty stainless steel bracket combines maximum strength with a bracket that won't deteriorate over time.

Maritime products operate at a 5000K color temperature, giving the light a warmer feel.

ABOVE GROUND MARITIME



SALTWATER PROTECTION

The unique gloss coating used on Maritime products from Vision X greatly reduces the dramatic impact that saltwater has on traditional lighting fixture housings.

STAINLESS STEEL BRACKET

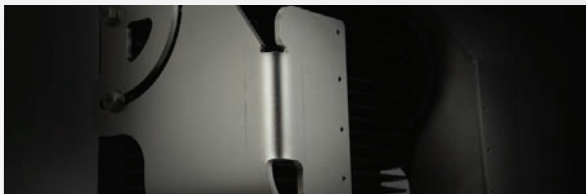

INCLUDED MOUNTING

The each fixture in the MAR Series from Vision X comes equipped with a high-strength stainless steel bracket that gives the light extra protection against saltwater corrosion.

COPPER PLATED BOARD

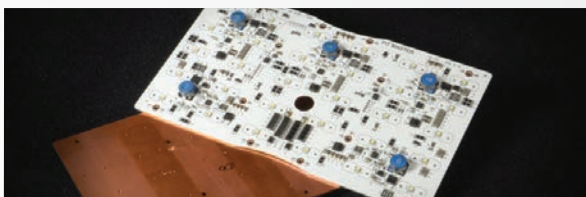

ANTI-CORROSION

The Maritime products from Vision X feature a copper electronic board to eliminate any chance of corrosion. Additionally, the copper board helps reduce above-ground CISPR.

MARITIME PITMASTER 60



ITEM #: MAR-PMX6060 Shown
PART #: 9892078

1000-WATT METAL HALIDE REPLACEMENT LIGHT FOR MARINE APPLICATIONS
Stainless Steel Bracket | 360° Fully Adjustable Mounting System | Prime Drive Technology

BEAM PATTERNS 10°, 25°, 40°, 60°, 90°, 30°x65°	WARRANTY Extended	DIMENSIONS 14.28" x 11.68" x 6.87"
RAW LUMENS 31,680 lm (ea)	EFFECTIVE LUMENS 22,200 lm (ea)	METRIC 362.7mm x 296.7mm x 174.5mm
WATTAGE / AMPS 300W / 25A @12V	VIBRATION RATING 15.6 G rms	WEIGHT 32.4 lb / 14.7 kg



ITEM #	PART #	QTY	BEAM
MAR-PMX6040	9892382	1	40°
MAR-PMX6060	9892078	1	60°
MAR-PMX6090	9893013	1	90°

BEAM PATTERN

MAR-PMX6060 | 9892078 - 60° Beam

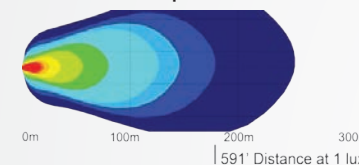

2D VIEW

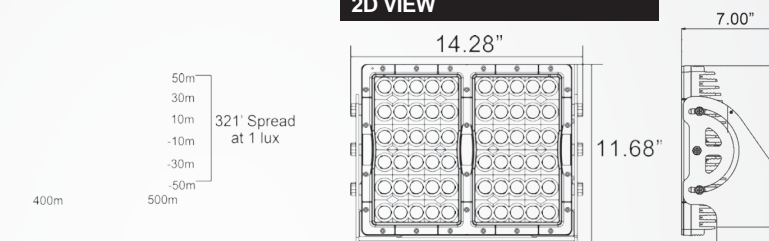

MARITIME PITMASTER 30



ITEM #: MAR-PMX3060 Shown
PART #: 9892085

500-WATT METAL HALIDE REPLACEMENT LIGHT FOR MARINE APPLICATIONS
Stainless Steel Bracket | 360° Fully Adjustable Mounting System | Prime Drive Technology

BEAM PATTERNS 10°, 25°, 40°, 60°, 90°, 30°x65°	WARRANTY Extended	DIMENSIONS 11.75" x 7.54" x 4.94"
RAW LUMENS 15,840 lm (ea)	EFFECTIVE LUMENS 11,100 lm (ea)	METRIC 298.5mm x 191.5mm x 125.5mm
WATTAGE / AMPS 150W / 12.5A @12V	VIBRATION RATING 15.6 G rms	WEIGHT 16.1 lb / 7.3 kg



ITEM #	PART #	QTY	BEAM
MAR-PMX3040	9892412	1	40°
MAR-PMX3060	9892085	1	60°
MAR-PMX3090	9892573	1	90°

BEAM PATTERN

MAR-PMX3060 | 9892085 - 60° Beam

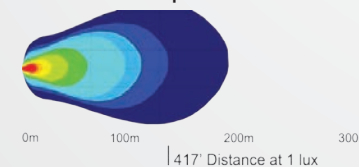

2D VIEW

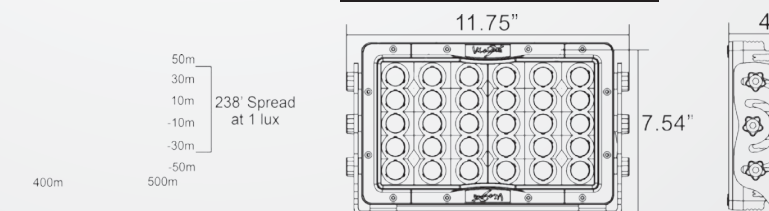

MARITIME RIPPER 20



ITEM #: MAR-RXP2060 Shown
PART #: 9892108

STAINLESS STEEL BRACKET WITH UPGRADED ELECTRONICS FOR MARINE USE
60 G rms High Vibration Rating | Single Bolt Mounting | Stainless Steel Trunnion Bracket

BEAM PATTERNS 10°, 25°, 40°, 60°, 90°, 30°x65°	WARRANTY Extended	DIMENSIONS 6.97" x 6.61" x 4.05"
RAW LUMENS 10,560 lm (ea)	EFFECTIVE LUMENS 7,400 lm (ea)	METRIC 177mm x 168mm x 102.9mm
WATTAGE / AMPS 100W / 8.34A @12V	VIBRATION RATING 60 G rms	WEIGHT 8.4 lb / 38 kg



ITEM #	PART #	QTY	BEAM
MAR-RXP2040	9893020	1	40°
MAR-RXP2060	9892108	1	60°

BEAM PATTERN

MAR-RXP2060 | 9892108 - 60° Beam

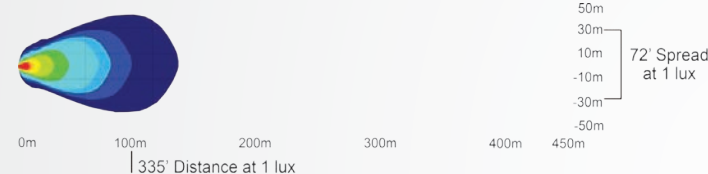

2D VIEW

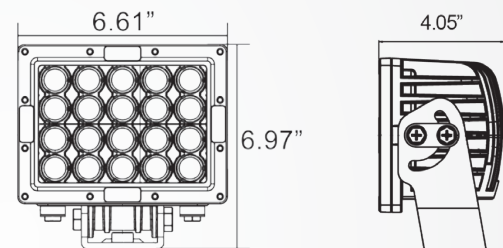

MARITIME RIPPER 12



ITEM #: MAR-RXP1260 Shown
PART #: 9892092

STAINLESS STEEL BRACKET WITH UPGRADED ELECTRONICS FOR MARINE USE
60 G rms High Vibration Rating | Single Bolt Mounting | Stainless Steel Trunnion Bracket

BEAM PATTERNS 10°, 25°, 40°, 60°, 90°, 30°x65°	WARRANTY Extended	DIMENSIONS 6.94" x 4.72" x 4.05"
RAW LUMENS 6,336 lm (ea)	EFFECTIVE LUMENS 4,440 lm (ea)	METRIC 176.2mm x 120mm x 102.9mm
WATTAGE / AMPS 60W / 5.0A @12V	VIBRATION RATING 60 G rms	WEIGHT 5.51 lb / 2.5 kg



ITEM #	PART #	QTY	BEAM
MAR-RXP1240	9893037	1	40°
MAR-RXP1260	9892092	1	60°

BEAM PATTERN

MAR-RXP1260 | 9892092 - 60° Beam

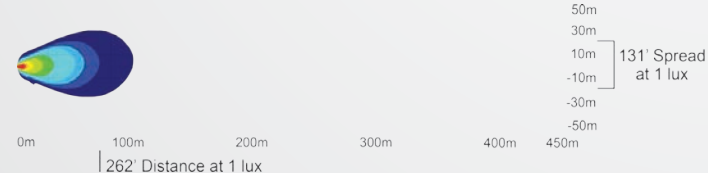

2D VIEW

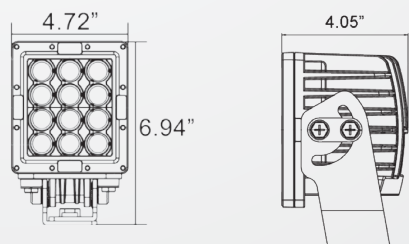

MARINE EXPLORER 7



ITEM #: MIL-EPX760 Shown
PART #: 9892115

STAINLESS STEEL BRACKET WITH UPGRADED ELECTRONICS FOR MARINE USE
Stainless Steel Trunnion Bracket | Single Bolt Mounting | CISPR 25 Rated For Marine Use

BEAM PATTERNS 40°, 60°, 90°	WARRANTY Extended	DIMENSIONS 4.71" x 6.28" x 3.14"
RAW LUMENS 3,696 lm (ea)	EFFECTIVE LUMENS 2,590 lm (ea)	METRIC 120mm x 159.5mm x 79.7mm
WATTAGE / AMPS 35W / 2.9A @12V	VIBRATION RATING 15.6 G rms	WEIGHT 4.0 lb / 1.81 kg



ITEM #	PART #	QTY	BEAM
MAR-EPX740	9893044	1	40°
MAR-EPX760	9892115	1	60°

BEAM PATTERN

MAR-EPX760 | 9892115 - 60° Beam

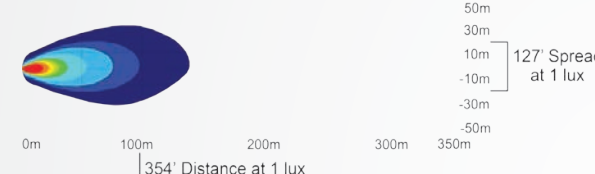

2D VIEW

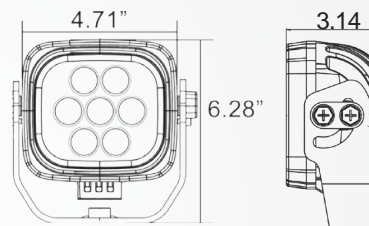

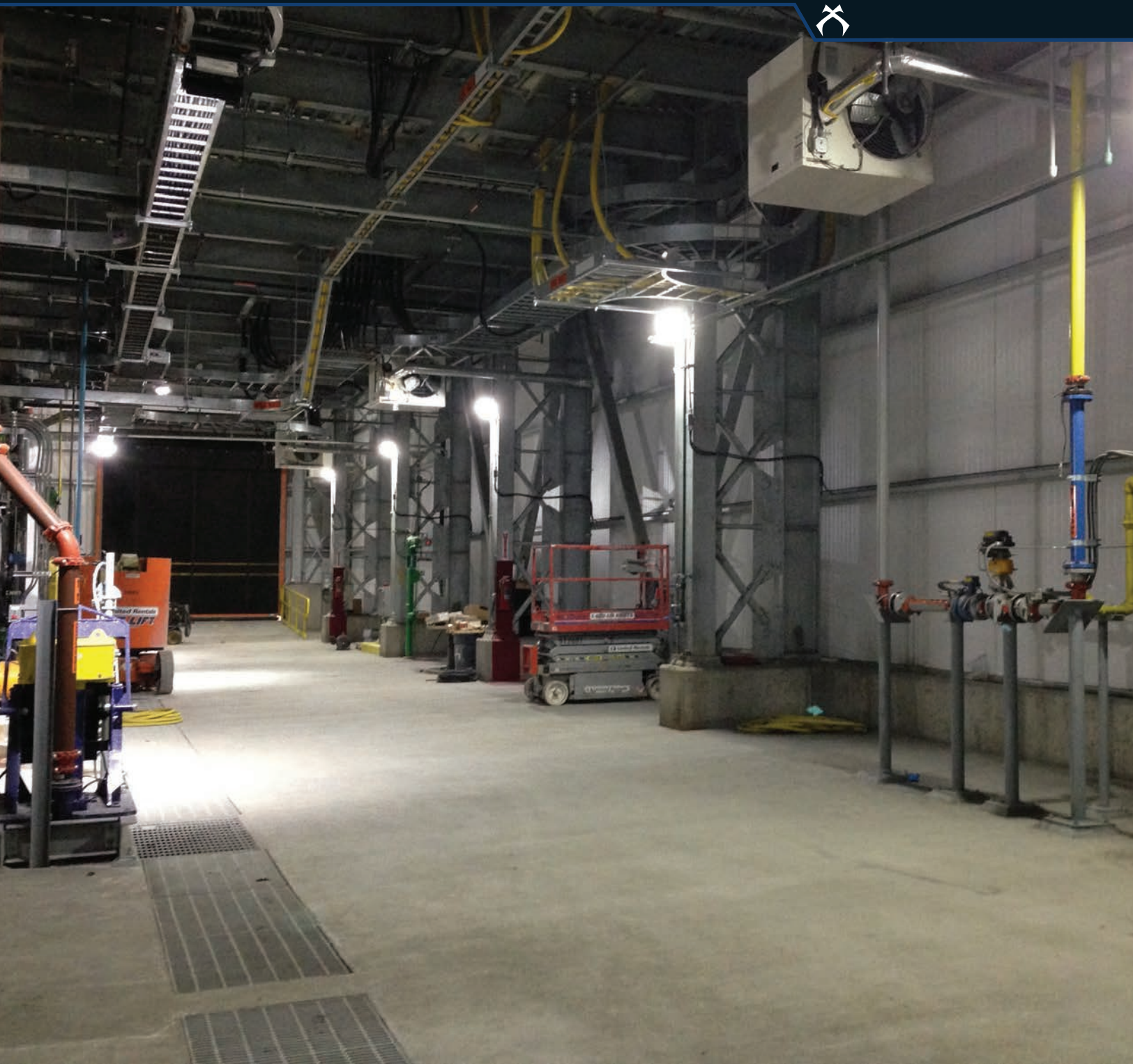

STRUCTURAL SOLUTIONS

LED lighting for harsh environments with greatly lower annual power consumption and increased efficiency to provide more light output for a more eco-friendly alternative to HPS and metal halide lighting.

SOLUTION PROCESS

Vision X goes above the expectation to create a solution for the specific needs of its customers. A digital rendering of accurate light output can be requested for specific projects to help demonstrate the effectiveness of our products and help you visualize the solution before purchasing.

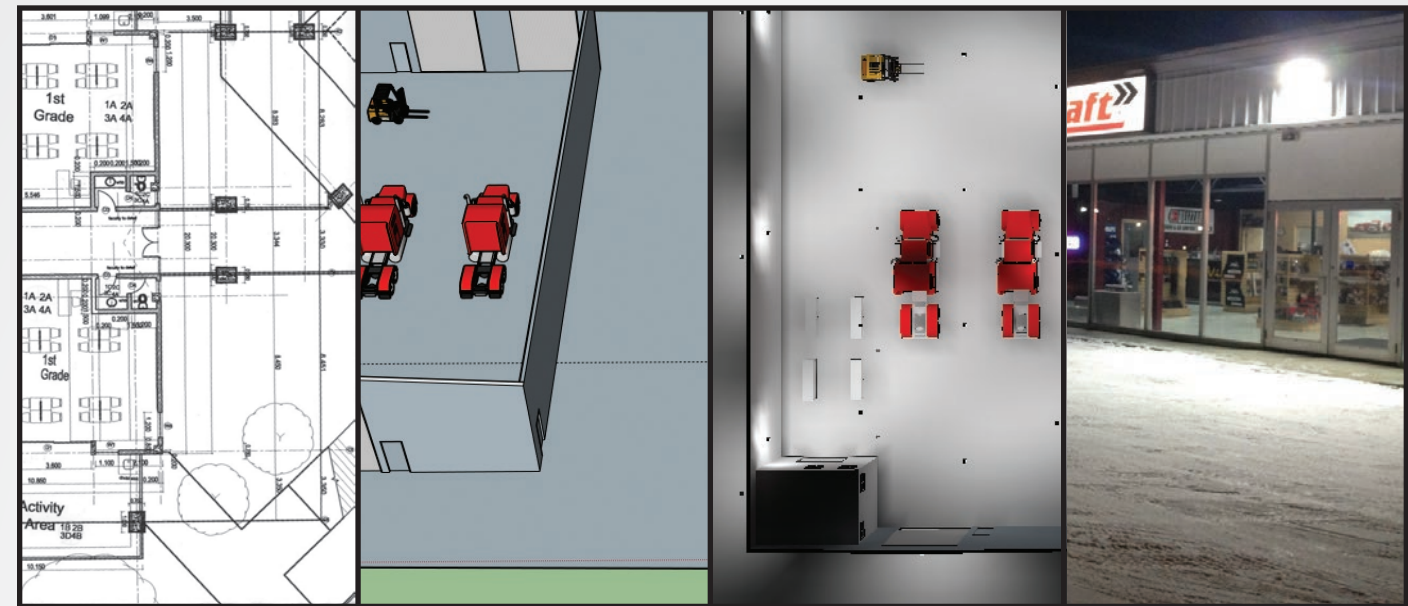

2D BLUEPRINT

Vision X begins a project by gathering information and details that will be used to digitally create the project in order to accurately portray the solution.

3D MODEL

A 3D Model is then built to-scale in order for lighting fixtures to be rendered and placed accordingly. This model is then carried over into the rendering.

SIMULATION RENDER

Prior to implementing a lighting solution, Vision X creates a simulation rendering of the intended result to help envision if the final product will resolve the problem.

SOLUTION

Vision X creates a cost effective solution that provides ample light output while saving energy and valuable time.

CASE STUDIES AVAILABLE

Case Study - Affordable Used Cars Lot

Innovative LED Lighting Technology Helps Alaskan Car Dealer Reduce Costs and Eliminate Light Pollution

Vision X Lighting solutions helped Affordable Used Cars to increase their energy efficiency and reduce light pollution onto neighboring city streets at one of their largest used car lots in Fairbanks, Alaska.

By switching from old inefficient lighting technologies to Vision X premium LED lighting technology in 131 of its lot lighting fixtures, Affordable Used Cars was able to save 136,500 kWh and \$5,500 a year while increasing light output by 50%. The increase in energy efficiency is also preventing the release of 9 metric tons of greenhouse gas emissions from Alaskan coal-fired power plants every year.

About The Project
The Affordable Used Cars lot is located in Fairbanks, Alaska. In an effort to improve light output in the lot, reduce energy efficiency and cut costs, Affordable Used Cars was interested in replacing its other fixtures with Vision X's LED technology.

The Project At Hand
The Affordable Used Cars lot covers nearly 170,000 square feet, almost all of which is required to be well lit for long periods of time. Lighting requirements are even higher in the winter, when it is dark most during normal day hours. Previously, the lot was accomplished by a set of 120 old inefficient fixtures - that represented a significant problem, including projecting light onto city streets, which represented a safety hazard to passing drivers. All together the old fixtures consumed about 218,500 kWh of electricity per year, which translates to Alaskan high energy costs totaling to an expense of \$5,500 a year.

Developing A Solution
To address the problems and alleviate the unnecessary costs being incurred at the Affordable Used Cars lot, Vision X developed a comprehensive lighting solution. All 131 of the old 400-watt fixtures were removed and replaced with new to install modern LED systems that could be simply bolted onto existing hardware present on the lighting poles. The problem of light being projected onto city streets was also solved by utilizing special Vision X LED fixtures equipped with digital lenses over the poles adjacent to the road. Special fixtures that used power supplies also helped guarantee worry-free operation in the harsh Alaskan climate.

Energy and Cost Savings
In total the upgrade to Vision X's LED technology increased energy efficiency by 40% and reduced electrical consumption at the lot by 136,500 kWh a year, which in turn will reduce utility costs by about \$4,800 a year. The reduction of energy costs alone will result in the cost of the upgrade being recouped in under two years, as well as a 140,000% of electricity savings in 5 years. Affordable Used Cars also received a rebate from the local power utility for going through with this upgrade, amounting to \$20,000 and a new surplus of nearly 1,600 kWh in 5 years.

Case Study - Van Cours Automotive

Innovative LED Lighting Technology Helps a Washington State Auto Dealer Cut Costs and Improve Light Output

Vision X Lighting solutions is looking into helping Van Cours Automotive increase their energy efficiency, reduce utility costs and improve light coverage at their shop location in South Hill, WA just outside of Tacoma.

By switching from old inefficient lighting technologies to Vision X premium LED lighting technology in 12 of its existing lighting fixtures, Van Cours will be able to save 13,100 kWh and \$4,800 a year. The increase in energy efficiency will also prevent the release of 9 metric tons of greenhouse gas emissions every year. Vision X LED technology also outperforms 30% more light and provides better lighting coverage than the older technology currently in use.

About The Project
The Van Cours Automotive location is an auto detailing workshop located just outside of Tacoma, WA. In an effort to reduce energy inefficiency as well as improve light output and light coverage around the shop, Van Cours is interested in upgrading to older fixtures with Vision X's LED technology.

The Project At Hand
The lot for which the Van Cours Automotive store is situated covers nearly 4,400 square feet, a result amount of which needs to be kept during nighttime hours for security purposes. Currently the lot is being performed by inefficient 400-watt fixtures mounted to walls in or on light poles adjacent to the street. All together the current fixtures consume about 21,000 kWh of electricity per year, which is typical Washington energy values to be about \$2,500 a year.

Developing A Solution
To increase light output and the security throughout the lot and alleviate the unnecessary costs being incurred at the Van Cours Automotive store, Vision X developed a comprehensive lighting solution. All 12 of the old 400-watt fixtures will be removed and replaced with new to install 100-watt LED systems. These will be removed and replaced with new to install 100-watt LED systems. These will be removed and replaced with new to install 100-watt LED systems. These will be removed and replaced with new to install 100-watt LED systems.

Energy and Cost Savings
All told the upgrade to Vision X's LED technology will increase energy efficiency by 60% and reduce electrical consumption at the store by 13,100 kWh a year, which in turn will reduce utility costs by about \$4,800 a year. The reduction of energy costs alone will result in the cost of the upgrade being recouped in just under one year, as well as producing 22,000 kWh of savings in 5 years.

Case Study - Intermountain Medical Center

Innovative LED Lighting Technology Helps Leading Medical Center Improve Efficiency

Vision X Lighting helped Utah's leading medical campus reduce their carbon footprint by 207 metric tons every year with premium LED lighting.

Intermountain Medical Center reduced their annual energy cost by switching to LED lighting saving \$40,200.00 annually just from retrofitting 276 parking lot light fixture fixtures alone. Other projects included walkway lighting and a complete parking garage retrofit.

About The Project
Intermountain Medical Center in Sandy, Utah is regarded as one of the nation's leading medical centers providing top of the line medical care to individuals from all over the nation. Prior to being retrofitted with LED lighting fixtures, IMC had high consumption on 400-Watt Halogen and Metal Halide fixtures for their parking lot lighting. Interested in lowering their energy consumption and reducing their carbon footprint, the medical center looked toward Vision X LED lighting to replace their existing fixtures with premium LED lighting technology.

The Project At Hand
Over 900,000 square feet of parking space was using inefficient lighting technology that was increasing the facility's annual energy cost. The Medical Center already had lighting fixtures in place in the form of light poles and parking garage units, and wanted to replace the existing fixtures with a more sustainable, in addition to saving on operating costs, Intermountain Medical Center was concerned about their carbon footprint and to reduce. The existing 400-watt light fixtures had a daily operation cost of \$11,510 for the medical center left unnecessary with today's lighting options.

Developing A Solution
In order to still be able to demonstrate that the Intermountain Medical Center IMC was able to develop a long and profitable solution that reduced the "light" of their existing pole-mounted color bowl and replace them with white lenses, reducing the energy consumption from 400-watts to 100-watts, in addition to the parking lot lighting walk way lighting was upgraded in the same fashion as well as the walkway lighting was upgraded from track fluorescent to LED fixtures. All applications received light of the ground by near 50% compared to the fluorescent and metal halide fixtures, and a saved energy consumption by near 60%.

The LED Fixtures Implemented by Vision X saved the Intermountain Medical Center \$40,200.00 for each building in annual energy costs. Over the average life of the LED fixtures, Intermountain Medical Center will save \$1,000,730 in energy expenses required to power their light poles.

In addition to more light output, the "harsh" color of systems of lighting between fixtures was improved while reducing light pollution into the atmosphere.

INDUSTRIAL STRUCTURAL SOLUTIONS

ABOUT CUBE LED TECHNOLOGY

Vision X is able to provide professional solutions due to the effectiveness of CUBE LED Technology. CUBE LEDs differ from standard diodes primarily in size and output per watt. A CUBE LED has a larger surface area, allowing more light to be emitted per individual watt. Additionally, having a larger surface area gives the LED a much wider beam pattern, allowing more lux to illuminate a more wide-spread area.

Currently, Vision X CUBE LEDs output an impressive 117 lumens per watt, making them the ideal LED for structural applications.

HIGH TEMP GLASS



HEAT RESISTANT

The optional Soda-Lime Glass lens helps protect the LEDs, as well as internal components, from extreme heat. Vision X recommends Soda-Lime Glass for applications that require intense heat.

117 LUMENS PER WATT

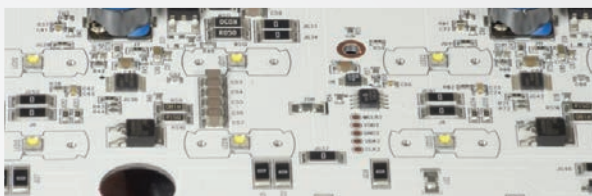

HIGH EFFICACY

CUBE LEDs from Vision X are ideal for structural applications because of the 117 lumen per watt ratio. We're able to get more light output for a lower cost than standard LEDs.

PACKAGES



INTEGRATED POWER SUPPLIES

Structural solutions from Vision X are bundled with power supplies that allow for a 110V-277V AC Power input range, as well as junction boxes to protect the electrical connections.



CUBE PITMASTER 320 LED



ITEM #: CPM320PE Shown
PART #: 9893051

320 CUBE LEDs FOR 37,440 LUMENS & UNMATCHED BEAM SPREAD
High Efficacy CUBE LEDs | Power Supply Packages Available | High-Temp Glass Lens Option

BEAM PATTERNS 180°	WARRANTY Extended	DIMENSIONS 14.28" x 11.68" x 6.87"
TESTED LUMENS 37,440 lm (ea)	VIBRATION RATING 15.6 G rms	METRIC 363mm x 297mm x 174.5mm
WATTAGE / AMPS 320W / 6.66A	INPUT VOLTAGE 110-277V AC	WEIGHT 29.17 lb / 13.23 kg



ITEM #	PART #	LEDS	LENS	WEIGHT
CPM320PE	9893051	320	Polycarbonate	26.46 lb / 12 kg
CPM320GPE	9893068	320	High-Temp Glass	26.46 lb / 12 kg

BEAM PATTERN

CPM320PE | 9893051 - 180° Beam



2D VIEW

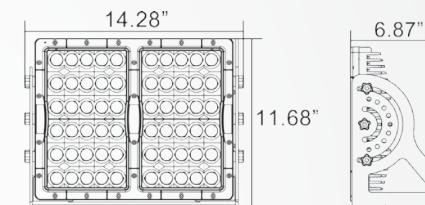

CUBE PITMASTER 160 LED



ITEM #: CPM160PE Shown
PART #: 9893075

160 CUBE LEDs FOR 18,720 LUMENS & UNMATCHED BEAM SPREAD
High Efficacy CUBE LEDs | Power Supply Packages Available | High-Temp Glass Lens Option

BEAM PATTERNS 180°	WARRANTY Extended	DIMENSIONS 11.75" x 7.54" x 4.94"
TESTED LUMENS 18,720 lm (ea)	VIBRATION RATING 15.6 G rms	METRIC 298.5mm x 191.5mm x 125.5mm
WATTAGE / AMPS 160W / 3.33A	INPUT VOLTAGE 110-277V AC	WEIGHT 15.05 lb / 6.82 kg



ITEM #	PART #	LEDS	LENS	WEIGHT
CPM160PE	9893075	160	Polycarbonate	12.34 lb / 5.6 kg
CPM160GPE	9893082	160	High-Temp Glass	12.34 lb / 5.6 kg

BEAM PATTERN

CPM160PE | 9893075 - 180° Beam

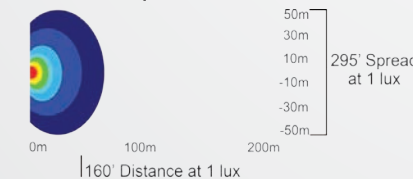

2D VIEW

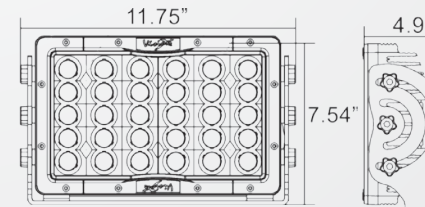

CUBE SHOCKWAVE DUAL



ITEM #: CSWD192PE Shown
PART #: 9893105

2D VIEW

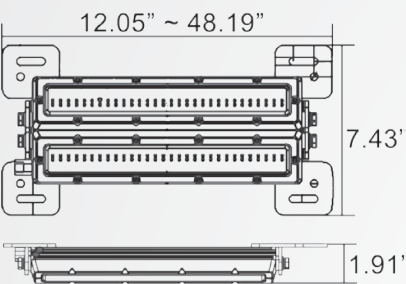

PREMIUM FLUORESCENT REPLACEMENT WITH 210° FULL-SPREAD BEAM PATTERN
High Efficacy CUBE LEDs | Power Supply Packages Available | Clear Bezel For Wider Dispersion

BEAM PATTERNS 210°	WARRANTY Extended	DIMENSIONS 12" 24"
TESTED LUMENS 10,848 lm 21,696 lm	INPUT VOLTAGE 110-277V AC	METRIC 304mm 608mm
WATTAGE / AMPS 96W / 2A 192W / 4A	VIBRATION RATING 15.6 G rms	WEIGHT 5.8 lb 11.6 lb



ITEM #	PART #	LENGTH	LEDS	RAW LUMENS	WATTS	AMP DRAW	WEIGHT
CSWD96PE	9893099	Dual 12"	96	10,848 lm	96	2A	5.80 lb
CSWD192PE	9893105	Dual 24"	192	21,696 lm	192	4A	11.60 lb

CUBE SHOCKWAVE SINGLE



ITEM #: CSWS48 Shown
PART #: 9893112

2D VIEW

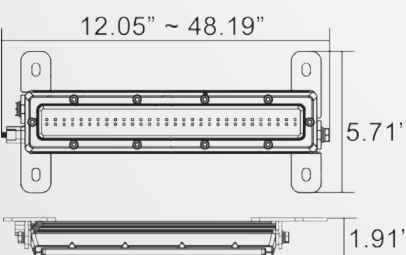

PREMIUM FLUORESCENT REPLACEMENT WITH 180° FULL-SPREAD BEAM PATTERN
High Efficacy CUBE LEDs | Power Supply Packages Available | Clear Bezel For Wider Dispersion

BEAM PATTERNS 180°	WARRANTY Extended	DIMENSIONS 12" 24" 36" 48"
TESTED LUMENS 5,424 10,848 16,272 21,696	INPUT VOLTAGE 110-277V AC	METRIC 304mm 608mm 912mm 1216mm
WATTAGE / AMPS 92-371W / 1.67-6.67A	VIBRATION RATING 15.6 G rms	WEIGHT 3.1 lb 6.2 lb 9.2 lb 12.2 lb



ITEM #	PART #	LENGTH	LEDS	RAW LUMENS	WATTS	AMP DRAW	WEIGHT
CSWS48PE	9893112	Single 12"	48	5,424 lm	48	1A	3.1 lb
CSWS96PE	9893129	Single 24"	96	10,848 lm	96	2A	6.2 lb
CSWS144PE	9893136	Single 36"	144	16,272 lm	144	3A	9.2 lb
CSWS192PE	9893143	Single 48"	192	21,696 lm	192	4A	12.2 lb

MOUNTING SOLUTIONS

Multiple mounting solutions have been created for a variety of applications in which the CUBE LED technology excels.

Additionally, Vision X can create custom mounting to suit your applications and help lower the cost of retrofitting a project with LED Lighting.

Flush Mount



Hanging Mount



Cobra Head Mount



Wall Mount



ITEM #	PART #	FITS	APPLICATION	MATERIAL
P-PMX30FLUSHMOUNT	9131085	PitMaster 30	For Use In Low Bay Applications	Steel
P-PMX30HANGINGMOUNT	9131177	PitMaster 30	For Hanging Mount Applications	Steel
P-PMX30COBRAHEADMOUNT	9130996	PitMaster 30	For Street Lighting Or Light Pole Applications	Steel
P-PMX60HPLATE	9893150	PitMaster 60	For Hanging Mount Applications	Steel





INDUSTRIAL ACCESSORIES

Vision X offers various accessories including vehicle ID boards, LED reflector utility lights, and the new addition of our video extreme LED light.

UTILITY FLOOD



ITEM #: XIL-UF32 Shown
PART #: 4001824

LIGHTWEIGHT UTILITY LED LIGHT WITH 120° FLOOD PATTERN
0.5A Amp Draw At 12V | Available In White, Amber, Blue, Green, Red | Universal Applications

BEAM PATTERNS 120°	WARRANTY Extended	DIMENSIONS 3.4" x 1.9" x 0.9"
RAW LUMENS 500 lm (ea)	EFFECTIVE LUMENS 456 lm (ea)	METRIC 86mm x 48mm x 23mm
WATTAGE / AMPS 6W / 0.5A	VIBRATION RATING 8.6 G rms	WEIGHT 0.41 lb / 0.19 kg



ITEM #	PART #	COLOR	ITEM #	PART #	COLOR
XIL-UF32	4001824	White	XIL-UF32G	9121277	Green
XIL-UF32A	9119298	Amber	XIL-UF32R	9121369	Red
XIL-UF32B	9121185	Blue	XIL-UF32P	9893297	Purple

AVAILABLE COLORS



VIDEO EXTREME LIGHT



ITEM #: VEL-4460CA72SS0 Shown
PART #: 9899856

ILLUMINATES AREA WHILE SIMULTANEOUSLY PROVIDING LIVE VIDEO FEED
Kit Available With 7" Monitor (VEL-CAMMON7KIT) | Glare Blocking Shield | Infrared Model Available

BEAM PATTERNS 60°, Infrared	WARRANTY Extended	DIMENSIONS 4.71" x 6.28" x 3.14"
RAW LUMENS 3,168 lm (ea)	EFFECTIVE LUMENS 2,590 lm (ea)	METRIC 119.6mm x 159.5mm x 79.7mm
WATTAGE / AMPS 30W / 2.5A	VIBRATION RATING 15.6 G rms	WEIGHT 2.43 lb / 1.1 kg



ITEM #	PART #	LED TYPE	ITEM #	PART #	LED TYPE
VEL-4460CA72SS0	9899856	5-Watt	VEL-4460CA72SS.IR850	9889863	Infrared
VEL-CAMMON7KIT	9892863	5-Watt	VEL-M7 (7" Monitor)	9889870	-

BEAM PATTERN



2D VIEW

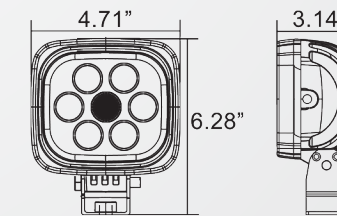

ITEM #: VEL-M7 Shown
PART #: 9889870

HEAVY DUTY LED BEACON



ITEM #: MIL-HDBA Shown
PART #: 9895123

180 LED HEAVY DUTY STROBING SAFETY BEACON

360° Visibility | Rugged Die-Cast Aluminum Housing | Shatterproof Polycarbonate Lens

LEDS 180	WARRANTY Extended	DIMENSIONS 5.31" x 5.12" x 5.31"
AREA OF EFFECT Full 360° Visibility	FLASH TYPE Dual	METRIC 135mm x 130mm x 135mm
WATTAGE / AMPS 36W / 3.0A	VIBRATION RATING 15.6 G rms	WEIGHT 2.96 lb / 1.34 kg



ITEM #	PART #	COLOR	ITEM #	PART #	COLOR
MIL-HDBA	9895123	Amber	MIL-HDBR	9893174	Red
MIL-HDBB	9893167	Blue	MIL-HDBW	9895130	White
MIL-HDBG	9895314	Green			

36 LED STROBE BEACON (9V)



ITEM #: XIL-UBB36A Shown
PART #: 9895147

3 TIMES THE OUTPUT OVER STANDARD LED BEACONS

Powered By 2x 9V Batteries | Wide Reflectors Increase Visibility | Available In Five Colors

LEDS 36	WARRANTY Extended	DIMENSIONS 5.25" x 3.81" x 2.86"
AREA OF EFFECT Full 360° Visibility	FLASH TYPE Dual	METRIC 133mm x 97mm x 73mm
WATTAGE / AMPS 7.2W / 0.8A @9V	VIBRATION RATING 15.6 G rms	WEIGHT 0.44 lb / 0.2 kg



ITEM #	PART #	COLOR	POWER
XIL-UBB36A	9895147	Amber	2x 9V
XIL-UBB36B	9895185	Green	2x 9V
XIL-UBB36W	9895345	Red	2x 9V

36 LED STROBE BEACON



ITEM #: XIL-UB36A Shown
PART #: 9895321

3 TIMES THE OUTPUT OVER STANDARD LED BEACONS

Weatherproof Deutsch Connector | Wide Reflectors Increase Visibility | Available In Five Colors

LEDS 36	WARRANTY Extended	DIMENSIONS 5.25" x 3.81" x 2.86"
AREA OF EFFECT Full 360° Visibility	FLASH TYPE Dual	METRIC 133mm x 97mm x 73mm
WATTAGE / AMPS 7.2W / 0.6A @12V	VIBRATION RATING 15.6 G rms	WEIGHT 0.44 lb / 0.2 kg



ITEM #	PART #	COLOR	POWER
XIL-UB36A	9895321	Amber	Wired
XIL-UB36B	9895178	Green	Wired
XIL-UB36W	9895338	Red	Wired

LED VEHICLE ID BOARD



ITEM #: MIL-ID03R & MIL-ID02A Shown
PART #: 9892184 & 9892207

ALLOWS FOR QUICK VEHICLE IDENTIFICATION IN ANY WEATHER CONDITION
195 Crisp LEDs Per Digit | Magnetic Sensor To Change Digits | Engineered For 24/7 Operation

ITEM #	PART #	DIGITS	COLOR	ITEM #	PART #	DIGITS	COLOR
MIL-ID03A	9892719	3	Amber	MIL-ID02A	9892207	2	Amber
MIL-ID03R	9892184	3	Red	MIL-ID02R	9892191	2	Red

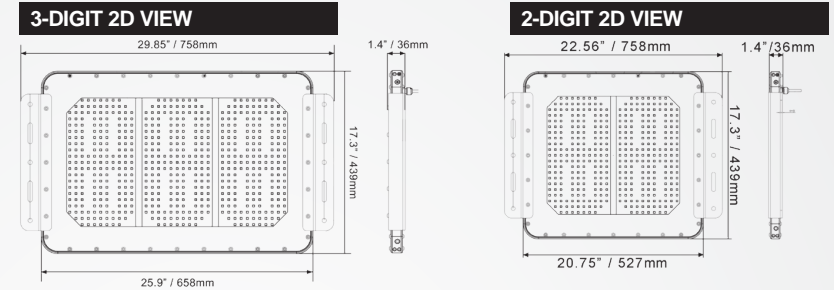

MINI INCIDENT RESPONSE CASE



ITEM #: XLS-M2DURA460BP Shown
PART #: 9891026

PORTABLE EMERGENCY SCENE LIGHTING

Deploys In 30 Seconds Without Tools | Self-Contained Power Cell | 12 Hour Run Time

POLE LENGTH 96" / 2.44m	WARRANTY Standard	DIMENSIONS 17.5" x 25" x 8"
RUN TIME Up To 12 Hours	CHARGE TIME 10 Hours	METRIC 445mm x 635mm x 203mm

ITEM #	PART #	LIGHTS INCLUDED	RAW LUMENS	RUN TIME
XLS-M2DURA460BP	9891026	2x DURA-460	5,916 lm	12 Hours
XLS-M4S1160BP	9891033	4x XIL-S1160	1,720 lm	12 Hours
XLS-M2UMX4460BP	9891040	2x XIL-UMX4460	6,902 lm	7.5 Hours





AUTOMOTIVE & OFFROAD SOLUTIONS

LED LIGHTS | LED LIGHT BARS | LED HEADLIGHTS | VEHICLE SPECIFIC | MOTORCYCLE | HID | HALOGEN | VEHICLE ACCESSORIES

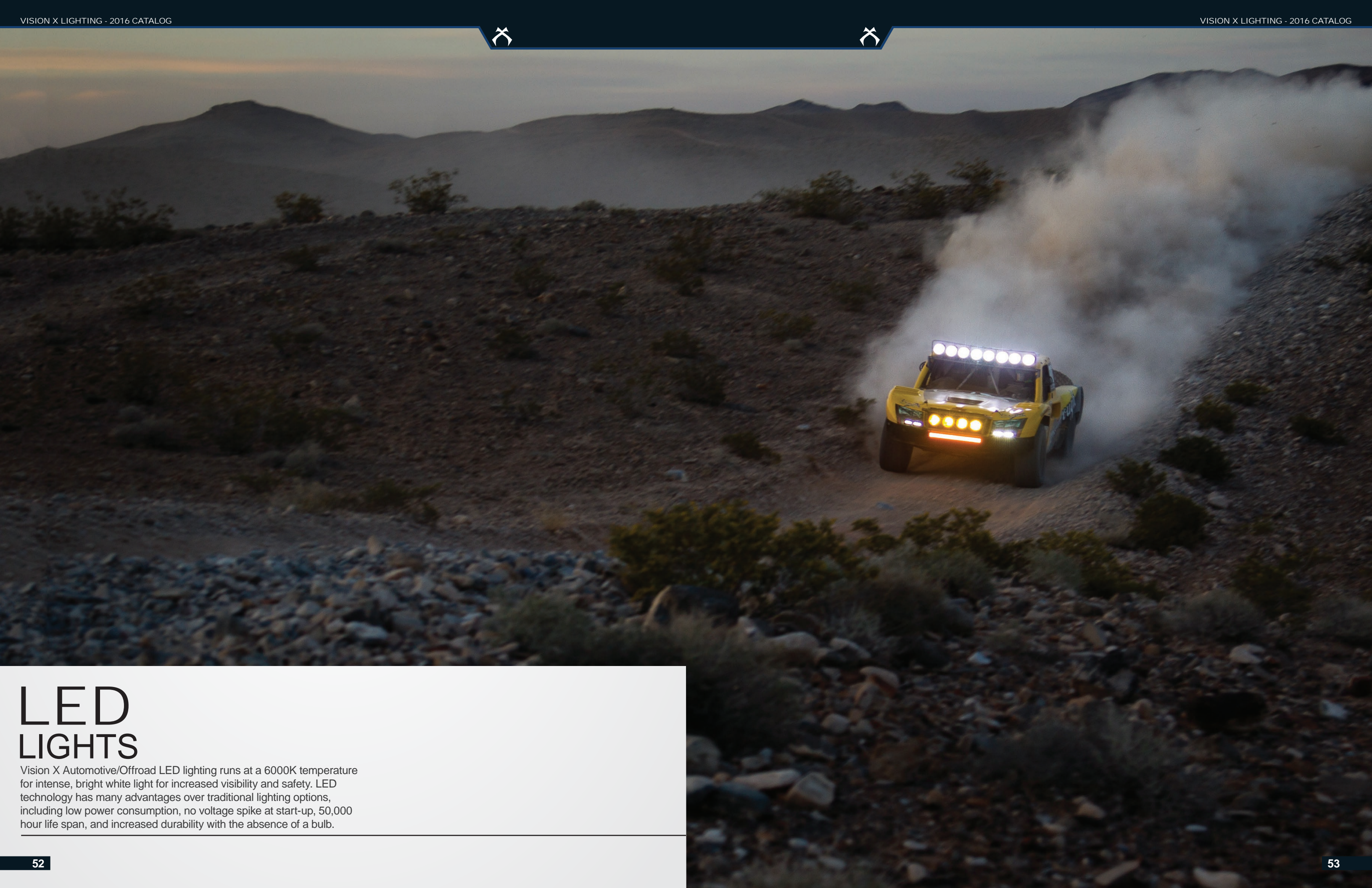

LED LIGHTS

Vision X Automotive/Offroad LED lighting runs at a 6000K temperature for intense, bright white light for increased visibility and safety. LED technology has many advantages over traditional lighting options, including low power consumption, no voltage spike at start-up, 50,000 hour life span, and increased durability with the absence of a bulb.



UNMATCHED

DISTANCE + VERSATILITY + VALUE

When we released the 25 watt 4.5" LED Light Cannon, no one expected us to double the size shortly after being on the market for one year. Enter the 8.7" LED Light Cannon. This massive single source LED excels at long range distances, shining up to 3,280 feet of usable light all from a 90 watt Luminus Premium LED. With the addition of the 50 watt 6.7" Cannon, that boasts a respectable 2,500 feet of usable light, there's a Light Cannon option for everyone. With the available snap-on covers, you can easily turn any Cannon into 25 different lights.



**25 LIGHTS
IN ONE!**



With Snap-On Covers

AUTOMOTIVE/OFFROAD LED LIGHT CANNONS

ABOUT THE CANNON SERIES

The LED Light Cannon Series from Vision X is unmatched by any other fixture on the market. By utilizing Vision X's IRIS Reflector Technology and top binned Single-Source Luminous LEDs, the Cannon Series can produce up to 3,280 feet of usable light.

Each Light Cannon is 25 Lights In One with the help of the available polycarbonate snap-on covers that can alter the beam pattern and change the color of the Cannon. Tackle any weather condition with the proper color cover, or quickly change your spot cover to a flood cover for a wider beam when necessary.

The Light Cannon Series is sold as single fixtures, or as a complete Light Kit consisting of two lights and a dual wiring harness with toggle switch.



25 LIGHTS IN ONE

CLEAR COVERS

Unbreakable, dust resistant protection to protect the light from debris and particulate. Recommended for users who wish to maintain original light color.

RED COVERS

Reduces light temperature and glare back in order to enhance penetration in dust and air particulate. Ideal for vehicles in extreme dust conditions.

BLUE COVERS

Increases lighting distance when used in snow conditions by reflecting the blue light off the snow. Recommended for vehicles in heavy winter conditions.

AMBER COVERS

Battles fog conditions by reducing the amount of blue light. Mimics classic Halogen color temperature. Great for driving in dust at high speeds.

BLACKOUT COVERS

Covers the fixture with a solid black protective cover with a high contrast "X" logo. Required in select states for on-road use.

SPOT	COMBO	EURO	ELLIPTICAL	FLOOD	WIDE FLOOD
------	-------	------	------------	-------	------------



VIEW ALL COVERS - PAGE 67

BIG-CHIP SINGLE SOURCE LEDs

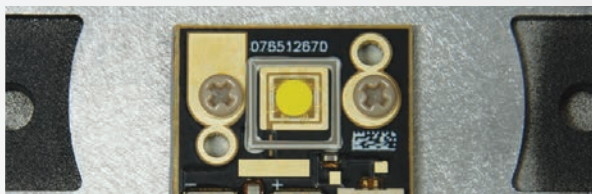

Luminous LEDs

Most LEDs on the market today are composed of smaller LEDs combined together to make one large unit. With the LED Light Cannon Series, Vision X uses larger Single Source LEDs that are one diode, capable of producing more light and a brighter source.

Light Kits Available

Each size of LED Light Cannon is available in a two light kit that includes a dual wiring harness and a toggle switch.



8.7" 90-WATT LIGHT CANNON



ITEM #: CTL-CPZ810 Shown
PART #: 9890852

90-WATT SINGLE SOURCE LED PRODUCES 3,280' OF USABLE LIGHT

Lightweight Hybrid Housing | Long Range IRIS Reflectors | Snap-On Covers Change Beam Pattern

BEAM PATTERNS	WEIGHT	DIMENSIONS
10°	10.36 lb / 4.7 kg	8.70" x 7.93" x 10.57"
RAW LUMENS	DISTANCE TO 1 LUX	METRIC
5,800 lm (ea)	3,280'	223mm x 201.4mm x 268.5mm



ITEM #	PART #	QTY	BEAM
CTL-CPZ810	9890852	1	10°
CTL-CPZ810KIT	9890074	2	10°

*Additional Part Numbers & Technical Information On Page 64

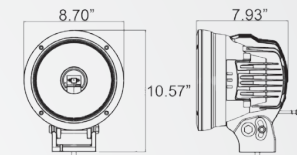

6.7" 50-WATT LIGHT CANNON



ITEM #: CTL-CPZ610 Shown
PART #: 9888538

50-WATT SINGLE SOURCE LED PRODUCES 2,500' OF USABLE LIGHT

Lightweight Hybrid Housing | Long Range IRIS Reflectors | Snap-On Covers Change Beam Pattern

BEAM PATTERNS	WEIGHT	DIMENSIONS
10°, 20°	5.51 lb / 2.5 kg	6.70" x 6.30" x 8.82"
RAW LUMENS	DISTANCE TO 1 LUX	METRIC
3,200 lm (ea)	2,500'	170mm x 91.4mm x 224mm

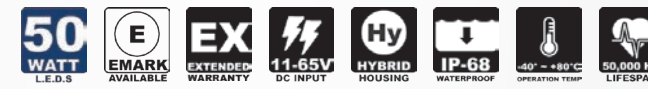

ITEM #	PART #	QTY	BEAM
CTL-CPZ610	9888538	1	10°
CTL-CPZ610KIT	9888545	2	10°
CTL-CPZ620	9891736	1	20°
CTL-CPZ620KIT	9891743	2	20°

*Additional Part Numbers & Technical Information On Page 64

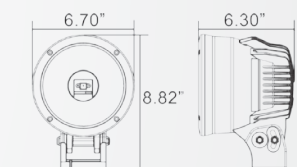

4.5" 25-WATT LIGHT CANNON



ITEM #: CTL-CPZ110 Shown
PART #: 9150970

25-WATT SINGLE SOURCE LED PRODUCES 1,000' OF USABLE LIGHT

Lightweight Hybrid Housing | Long Range IRIS Reflectors | Snap-On Covers Change Beam Pattern

BEAM PATTERNS	WEIGHT	DIMENSIONS
10°	2.02 lb / 0.92 kg	4.72" x 4.36" x 5.75"
RAW LUMENS	DISTANCE TO 1 LUX	METRIC
2,500 lm (ea)	1,000'	2.02mm x 110.7mm x 146mm

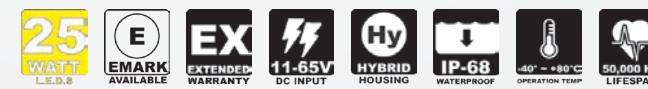

ITEM #	PART #	QTY	BEAM
CTL-CPZ110	9150970	1	10°
CTL-CPZ110KIT	9151069	2	10°

*Additional Part Numbers & Technical Information On Page 64

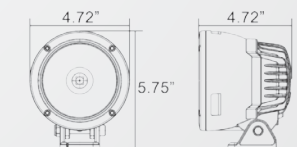

AUTOMOTIVE/OFFROAD TRANSPORTER SERIES

ABOUT THE TRANSPORTER SERIES

The Transporter Series utilizes high powered 5-watt LEDs to provide intense light output for commercial applications. The Transporter Series is ideal for long-haul Trucking and Transport applications because the 50,000 hour lifespan takes away from unscheduled fleet maintenance like bulb replacement, etc.

Additionally, brighter driving conditions for operators ensures greater safety and reliability for drivers on the road. Proper lighting can reduce the amount of time it takes for a load to be delivered and can also reduce the chances for an accident on roadways affected by harsh conditions.

ADVANCED MOUNTING



KNURLED AIMING KNOBS

The Transporter Series can be precisely adjusted to any angle within 15° thanks to the knurled adjustment knobs located at the base of the fixture.

HEAVY DUTY HARNESS



INCLUDED HARNESS

The Transporter Series comes packaged with a single light wiring harness with toggle switch for activation and a weatherproof deutsch connector, ensuring the longevity of the light. Mounting and wiring is a breeze so you'll be out on the road in no time.

RECESSED REFLECTORS



SMOOTH BEAM PATTERN

Each Transporter produces a smooth and even beam pattern due to the recessed reflectors that are precisely angled to achieve an effective beam pattern for on-road driving.



TRANSPORTER 18 LED



ITEM #: CTL-TPX1810 Shown
PART #: 9111018

90-WATT LED LIGHT FOR LONG-HAUL TRUCK AND TRANSPORT
Eighteen 5-Watt LEDs | Protective Polycarbonate Covers Available | Truck and Transport Ready

BEAM PATTERNS 10°, 40°	WEIGHT 6.17 lb / 2.8 kg	DIMENSIONS 6.71" x 7.19" x 4.57"
RAW LUMENS 9,504 lm (ea)	DISTANCE TO 1 LUX 840'	METRIC 171mm x 182.5mm x 116mm



ITEM #	PART #	QTY	BEAM
CTL-TPX1810	9111018	1	10°
CTL-TPX1840	9111193	1	40°

*Additional Part Numbers & Technical Information On Page 64

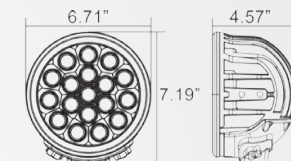

TRANSPORTER 12 LED



ITEM #: CTL-TPX1210 Shown
PART #: 9110561

60-WATT LED LIGHT FOR LONG-HAUL TRUCK AND TRANSPORT
Twelve 5-Watt LEDs | Protective Polycarbonate Covers Available | Truck and Transport Ready

BEAM PATTERNS 10°, 40°	WEIGHT 5.95 lb / 2.7 kg	DIMENSIONS 6.71" x 7.19" x 4.57"
RAW LUMENS 6,336 lm (ea)	DISTANCE TO 1 LUX 778'	METRIC 171mm x 182.5mm x 116mm



ITEM #	PART #	QTY	BEAM
CTL-TPX1210	9110561	1	10°
CTL-TPX1240	9110745	1	40°

*Additional Part Numbers & Technical Information On Page 64

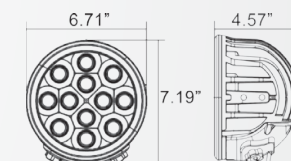

TRANSPORTER 9 LED



ITEM #: CTL-TPX910 Shown
PART #: 9110110

45-WATT LED LIGHT FOR LONG-HAUL TRUCK AND TRANSPORT
Nine 5-Watt LEDs | Protective Polycarbonate Covers Available | E-Mark Approved Fixture

BEAM PATTERNS 10°, 40°	WEIGHT 5.95 lb / 2.7 kg	DIMENSIONS 6.71" x 7.19" x 4.57"
RAW LUMENS 4,752 lm (ea)	DISTANCE TO 1 LUX 656'	METRIC 171mm x 182.5mm x 116mm



ITEM #	PART #	QTY	BEAM
CTL-TPX910	9110110	1	10°
CTL-TPX940	9110295	1	40°

*Additional Part Numbers & Technical Information On Page 64

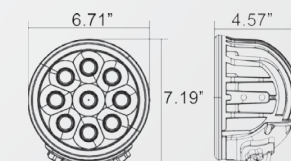

AUTOMOTIVE/OFFROAD OPTIMUS SERIES

ABOUT THE OPTIMUS SERIES

By combining Single-Source LEDs with Vision X's IRIS Reflector Technology, the Optimus Series is capable of reaching powerful distances from a small housing. The Optimus is available in three different beam patterns, allowing users to choose between distance or spread.

Kits consisting of two lights and a wiring harness are available for each member of the Optimus family, and each is also available in Black, Chrome or White housing colors.

The Optimus Series is often used in Vision X Vehicle Specific Kits, to see the available options and to learn more please see page 82.

TWO LIGHT KIT



- Black
- White
- Chrome

COMPLETE KIT

Each model in the Optimus Series can be purchased in a complete lighting kit consisting of two fixtures, a dual-wiring harness, and necessary mounting. Everything you need to explore the night.



OPTIMUS SINGLE



ITEM #: XIL-OP110 Shown
PART #: 9123882

10-WATT UNIVERSAL LED DRIVING LIGHT PRODUCES ULTIMATE DISTANCE
Compact 3.0" Housing | High-Strength Adjustable Trunnion Mount | Two Light Kits Available

BEAM PATTERNS 10°, 20°, 60°	WEIGHT 1.37 lb / 0.62 kg	DIMENSIONS 2.99" x 3.17" x 3.79"
RAW LUMENS 1,052 lm (ea)	DISTANCE TO 1 LUX 883'	METRIC 76mm x 80.5mm x 96.2mm



ITEM #	PART #	QTY	BEAM	ITEM #	PART #	QTY	BEAM
XIL-OP110	9123882	1	10°	XIL-OP110KIT	9124421	2	10°
XIL-OP120	9124605	1	20°	XIL-OP120KIT	9138015	2	20°
XIL-OP160	9124063	1	60°	XIL-OP160KIT	9137926	2	60°

*Additional Part Numbers & Technical Information On Page 65

OPTIMUS ROUND



ITEM #: XIL-OPR110 Shown
PART #: 9140896



VIEW COVERS
Page 96

10-WATT UNIVERSAL LED DRIVING LIGHT PRODUCES ULTIMATE DISTANCE
Compact 3.0" Housing | Snap-On Color & Beam Changing Covers | Two Light Kits Available

BEAM PATTERNS 10°, 20°, 60°	WEIGHT 1.53 lb / 0.69 kg	DIMENSIONS 3.74" x 3.74" x 3.79"
RAW LUMENS 1,052 lm (ea)	DISTANCE TO 1 LUX 883'	METRIC 95mm x 95mm x 96.2mm



ITEM #	PART #	QTY	BEAM	ITEM #	PART #	QTY	BEAM
XIL-OPR110	9140896	1	10°	XIL-OPR110KIT	9141251	2	10°
XIL-OPR120	9141077	1	20°	XIL-OPR120KIT	9141343	2	20°
XIL-OPR160	9141169	1	60°	XIL-OPR160KIT	9141435	2	60°

*Additional Part Numbers & Technical Information On Page 65

OPTIMUS HALO



Round
ITEM #: XIL-OPRH115 Shown
PART #: 9891712

Square
ITEM #: XIL-OPH115 Shown
PART #: 9891699

LONG-RANGE 10-WATT LED WITH BRIGHT LED HALO RING
15° Beam Pattern | Polycarbonate Covers Available (Round) | Two Light Kits Available

BEAM PATTERNS 15°	WEIGHT 1.37 lb / 0.62 kg	DIMENSIONS 3.74" x 3.74" x 3.79"
RAW LUMENS 1,052 lm (ea)	DISTANCE TO 1 LUX 680'	METRIC 95mm x 95mm x 96.2mm

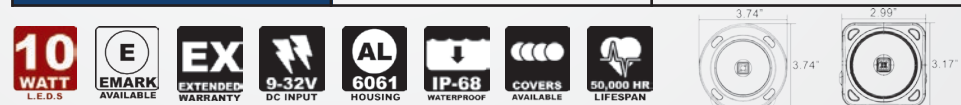

ITEM #	PART #	QTY	HOUSING	ITEM #	PART #	QTY	HOUSING
XIL-OPRH115	9891712	1	ROUND	XIL-OPRH115KIT	9891729	2	ROUND
XIL-OPH115	9891699	1	SQUARE	XIL-OPH115KIT	9891705	2	SQUARE

*Additional Part Numbers & Technical Information On Page 65

OPTIMUS DUAL



ITEM #: XIL-OP210 Shown
PART #: 9123882

20-WATT UNIVERSAL LED DRIVING LIGHT PRODUCES ULTIMATE DISTANCE
Power Of Two Optimus In One | Available In Kits | High-Strength Adjustable Trunnion Mount

BEAM PATTERNS 10°, 20°, 60°	WEIGHT 2.25 lb / 1.02 kg	DIMENSIONS 5.83" x 4.80" x 3.81"
RAW LUMENS 2,104 lm (ea)	DISTANCE TO 1 LUX 1,240'	METRIC 148mm x 122mm x 96.8mm



ITEM #	PART #	QTY	BEAM	ITEM #	PART #	QTY	BEAM
XIL-OP210	9123882	1	10°	XIL-OP210KIT	9125053	2	10°
XIL-OP220	9139548	1	20°	XIL-OP220KIT	9137834	2	20°
XIL-OP260	9136660	1	60°	XIL-OP260KIT	9137742	2	60°

*Additional Part Numbers & Technical Information On Page 65

AUTOMOTIVE/OFFROAD SOLO POD SERIES

ABOUT THE SOLO SERIES

Compact yet powerful, the Solo Pod Series from Vision X provides intense light output from a small housing. Each Solo produces the equal light output of a pair of headlights from a modern vehicle.

The Solstice Solo excels at multiple applications thanks to the wide selection of different beam patterns. Perfect for dirt bikes, reverse lights, marine lights, or rock lights - the applications are endless.

Additionally, there are multiple accessories that can further extend the versatility of the Solstice Solo.

FLEXIBLE MOUNTING



SINGLE-BOLT MOUNTING SYSTEM

The Solstice Solo uses a single-bolt mounting system with an adjustable aiming system allowing for precision aiming in hard to reach spots.

OMNI-LINK CONNECTORS



ENDLESS CONFIGURATIONS

With the Omni-Link Connector, simply connect Solstice Solo Pods together to create unique lengths and configurations, as well as add numerous accessories for various applications.

ACCESSORIES



SEE PAGE 103

Multiple accessories are available that further enhance the diversity of the Solstice Solo, including handlebar clamps, pistol-grips for flashlight applications, and flush mounts.

SOLO PRIME POD



ITEM #: XIL-SP110 Shown
PART #: 4008830

ULTIMATE 10-WATT LED POD FOR UNIVERSAL APPLICATIONS
Omni-Link Interlocking System | Electronic Thermal Management | Flush Mount Bracket Available

BEAM PATTERNS 10°, 20°, 40°	WEIGHT 0.70 lb / 0.32 kg	DIMENSIONS 2.16" x 3.25" x 2.36"
RAW LUMENS 1,052 lm (ea)	DISTANCE TO 1 LUX 279'	METRIC 55mm x 82.5mm x 60mm

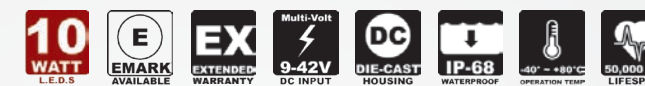

ITEM #	PART #	BEAM
XIL-SP110	4008830	10°
XIL-SP120	4009882	20°
XIL-SP140	4009899	40°

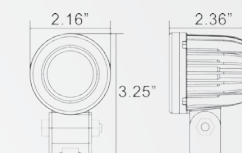

*Additional Part Numbers & Technical Information On Page 66

SOLSTICE SOLO



ITEM #: XIL-S1110 Shown
PART #: 9888156

COMPACT 10-WATT LED FOR UNIVERSAL APPLICATIONS
Omni-Link Interlocking System | Small 2" Die-Cast Housing | Flush Mount Bracket Available

BEAM PATTERNS 10°, 30°, 60°, 30°x65°	WEIGHT 0.76 lb / 0.34 kg	DIMENSIONS 2.05" x 3.25" x 2.44"
RAW LUMENS 1,052 lm (ea)	DISTANCE TO 1 LUX 255'	METRIC 52.1mm x 82.5mm x 62mm



ITEM #	PART #	BEAM
XIL-S1110	9888156	10°
XIL-S1130	9888163	30°
XIL-S1160	9888170	60°

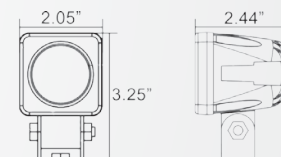

*Additional Part Numbers & Technical Information On Page 66

MINI SOLO POD



ITEM #: XIL-MX110 Shown
PART #: 9113531

COMPACT 5-WATT LED PERFECT FOR TIGHT SPOTS
Omni-Link Interlocking System | Ultra Compact Housing | Mounting Accessories

BEAM PATTERNS 10°, 25°, 40°, 60°, 90°, 30°x65°	WEIGHT 0.40 lb / 0.18 kg	DIMENSIONS 1.69" x 2.56" x 2.38"
RAW LUMENS 528 lm (ea)	DISTANCE TO 1 LUX 195'	METRIC 43mm x 65mm x 60.5mm



ITEM #	PART #	BEAM
XIL-MX110	9113531	10°
XIL-MX140	9113715	40°
XIL-MX160	9113807	60°

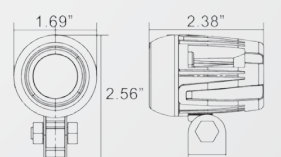

*Additional Part Numbers & Technical Information On Page 66



LED LIGHT CANNON

ITEM #	PART #	QTY	BEAM	WEIGHT	RAW LUMENS	EFFECTIVE LUMENS	INPUT VOLTS	WATTS	AMP DRAW
CTL-CPZ110	9150970	1	10°	2.02 lb	2,500 lm	1,750 lm	9-32V	25	2.08A
CTL-CPZ110KIT	9151069	2		4.04 lb	5,000 lm	3,500 lm			4.17A
CTL-CPZ610	9888538	1	10°	5.51 lb	3,200 lm	2,240 lm	9-32V	50	4.17A
CTL-CPZ610KIT	9888545	2		11.02 lb	6,400 lm	4,480 lm			8.34A
CTL-CPZ620	9891736	1	20°	5.51 lb	3,200 lm	2,240 lm	9-32V	50	4.17A
CTL-CPZ620KIT	9891743	2		11.02 lb	6,400 lm	4,480 lm			8.34A
CTL-CPZ810	9890852	1	10°	10.36 lb	5,800 lm	4,060 lm	9-32V	90	7.5A
CTL-CPZ810KIT	9890074	2		20.72 lb	11,600 lm	8,120 lm			15A

CTL-CPZ110 | 9150970 - 10° BEAM

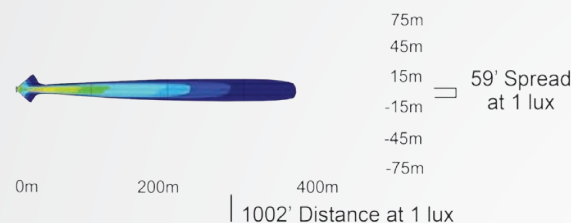

CTL-CPZ610 | 9888538 - 10° BEAM

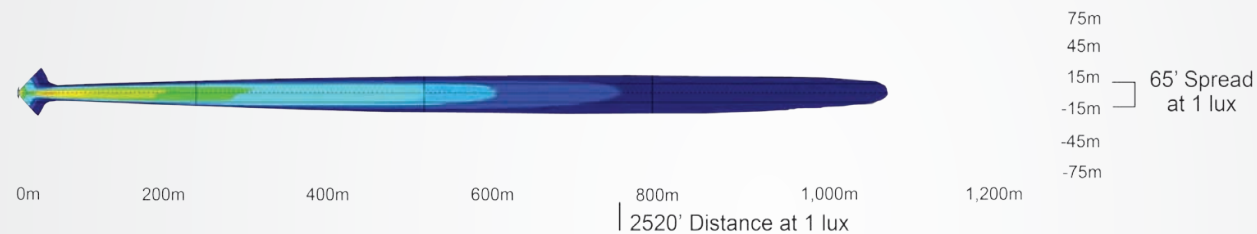

CTL-CPZ810 | 9890852 - 10° BEAM

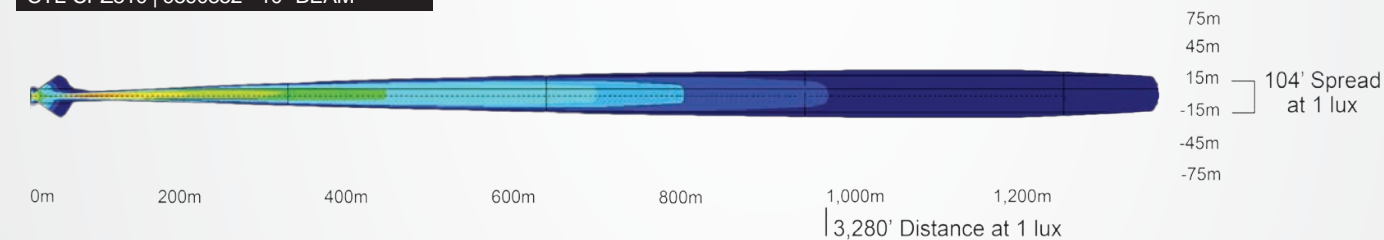

TRANSPORTER

ITEM #	PART #	# OF LEDS	BEAM	WEIGHT	RAW LUMENS	EFFECTIVE LUMENS	INPUT VOLTS	WATTS	AMP DRAW
CTL-TPX910	9110110	9	10°	5.95 lb	4,752 lm	3,330 lm	11-65V	45	3.75A
CTL-TPX940	9110295	9	40°	5.95 lb	4,752 lm	3,330 lm	11-65V	45	3.75A
CTL-TPX1210	9110561	12	10°	5.95 lb	6,336 lm	4,440 lm	11-65V	60	5A
CTL-TPX1240	9110745	12	40°	5.95 lb	6,336 lm	4,440 lm	11-65V	60	5A
CTL-TPX1810	9111018	18	10°	6.17 lb	9,504 lm	6,660 lm	11-65V	90	7.5A
CTL-TPX1840	9111193	18	40°	6.17 lb	9,504 lm	6,660 lm	11-65V	90	7.5A

CTL-TPX1810 | 9111018 - 10° BEAM

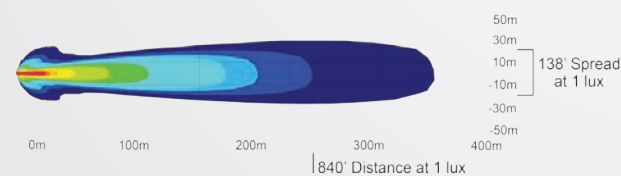

CTL-TPX1840 | 9111193 - 40° BEAM



OPTIMUS

ITEM #	PART #	QTY	HOUSING	BEAM	WEIGHT	RAW LUMENS	EFFECTIVE LUMENS	INPUT VOLTS	WATTS	AMP DRAW
XIL-OPH115	9891699	1	Black	10°	2.02 lb	2,500 lm	1,750 lm	9-32V	25	2.08A
XIL-OPH115KIT	9891705	2			4.04 lb	5,000 lm	3,500 lm			4.17A
XIL-OPRH115	9891712	1	Black	10°	5.51 lb	3,200 lm	2,240 lm	9-32V	50	4.17A
XIL-OPRH115KIT	9891729	2			11.02 lb	6,400 lm	4,480 lm			8.34A
XIL-OP110	9123882	1	Black	20°	5.51 lb	3,200 lm	2,240 lm	9-32V	50	4.17A
XIL-OP110KIT	9124421	2			11.02 lb	6,400 lm	4,480 lm			8.34A
XIL-OP120	9124605	1	Black	10°	10.36 lb	5,800 lm	4,060 lm	9-32V	90	7.5A
XIL-OP120KIT	9138015	2			20.72 lb	11,600 lm	8,120 lm			15A
XIL-OP160	9124063	1	Black	10°	10.36 lb	5,800 lm	4,060 lm	9-32V	90	7.5A
XIL-OP160KIT	9137926	2			20.72 lb	11,600 lm	8,120 lm			15A
XIL-OP110W	9124513	1	White	10°	10.36 lb	5,800 lm	4,060 lm	9-32V	90	7.5A
XIL-OP110C	9124247	1	Chrome	10°	20.72 lb	11,600 lm	8,120 lm			15A
XIL-OP120W	9149356	1	White	20°	10.36 lb	5,800 lm	4,060 lm	9-32V	90	7.5A
XIL-OP120C	9139098	1	Chrome	20°	20.72 lb	11,600 lm	8,120 lm			15A
XIL-OP160W	9139364	1	White	60°	10.36 lb	5,800 lm	4,060 lm	9-32V	90	7.5A
XIL-OP160C	9139272	1	Chrome	60°	20.72 lb	11,600 lm	8,120 lm			15A
XIL-OPR110	9140896	1	Black	10°	10.36 lb	5,800 lm	4,060 lm	9-32V	90	7.5A
XIL-OPR110KIT	9141251	2			20.72 lb	11,600 lm	8,120 lm			15A
XIL-OPR120	9141077	1	Black	10°	10.36 lb	5,800 lm	4,060 lm	9-32V	90	7.5A
XIL-OPR120KIT	9141343	2			20.72 lb	11,600 lm	8,120 lm			15A
XIL-OPR160	9141169	1	Black	10°	10.36 lb	5,800 lm	4,060 lm	9-32V	90	7.5A
XIL-OPR160KIT	9141435	2			20.72 lb	11,600 lm	8,120 lm			15A
XIL-OPR110W	9149172	1	White	10°	10.36 lb	5,800 lm	4,060 lm	9-32V	90	7.5A
XIL-OPR110C	9149080	1	Chrome	10°	20.72 lb	11,600 lm	8,120 lm			15A
XIL-OPR120W	9149172	1	White	20°	10.36 lb	5,800 lm	4,060 lm	9-32V	90	7.5A
XIL-OPR120C	9149264	1	Chrome	20°	20.72 lb	11,600 lm	8,120 lm			15A
XIL-OPR160W	9149530	1	White	60°	10.36 lb	5,800 lm	4,060 lm	9-32V	90	7.5A
XIL-OPR160C	9149448	1	Chrome	60°	20.72 lb	11,600 lm	8,120 lm			15A
XIL-OP210	9124605	1	Black	10°	10.36 lb	5,800 lm	4,060 lm	9-32V	90	7.5A
XIL-OP210KIT	9125053	2			20.72 lb	11,600 lm	8,120 lm			15A
XIL-OP220	9139548	1	Black	20°	10.36 lb	5,800 lm	4,060 lm	9-32V	90	7.5A
XIL-OP220KIT	9137834	2			20.72 lb	11,600 lm	8,120 lm			15A
XIL-OP260	9136660	1	Black	60°	10.36 lb	5,800 lm	4,060 lm	9-32V	90	7.5A
XIL-OP260KIT	9137742	2			20.72 lb	11,600 lm	8,120 lm			15A
XIL-OP210W	9124964	1	White	10°	10.36 lb	5,800 lm	4,060 lm	9-32V	90	7.5A
XIL-OP210C	9124698	1	Chrome	10°	20.72 lb	11,600 lm	8,120 lm			15A
XIL-OP220W	9139630	1	White	20°	10.36 lb	5,800 lm	4,060 lm	9-32V	90	7.5A
XIL-OP220C	9166636	1	Chrome	20°	20.72 lb	11,600 lm	8,120 lm			15A
XIL-OP260W	9139722	1	White	60°	10.36 lb	5,800 lm	4,060 lm	9-32V	90	7.5A
XIL-OP260C	9159348	1	Chrome	60°	20.72 lb	11,600 lm	8,120 lm			15A

XIL-OP110 | 9123882 - 10° BEAM



XIL-OP160 | 9124063 - 60° BEAM



XIL-OP210 | 9124605 - 10° BEAM

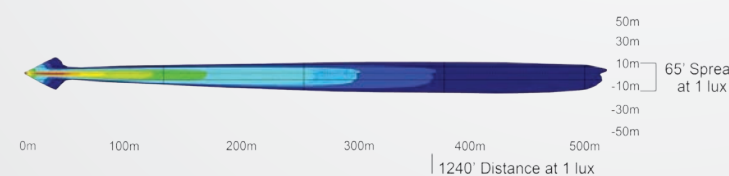

XIL-OP260 | 9139548 - 60° BEAM



SOLO PRIME

ITEM #	PART #	HOUSING	BEAM	WEIGHT	RAW LUMENS	EFFECTIVE LUMENS	INPUT VOLTS	WATTS	AMP DRAW
XIL-SP110	4008830	Black	10°	0.70 lb	1,052 lm	736 lm	9-48V	10	0.83A
XIL-SP110W	4008847	White	10°	0.70 lb	1,052 lm	736 lm	9-48V	10	0.83A
XIL-SP120	4009882	Black	20°	0.70 lb	1,052 lm	736 lm	9-48V	10	0.83A
XIL-SP120W	4008854	White	20°	0.70 lb	1,052 lm	736 lm	9-48V	10	0.83A
XIL-SP140	4009899	Black	40°	0.70 lb	1,052 lm	736 lm	9-48V	10	0.83A
XIL-SP140W	4008861	White	40°	0.70 lb	1,052 lm	736 lm	9-48V	10	0.83A

XIL-SP110 | 4008830 - 10° BEAM

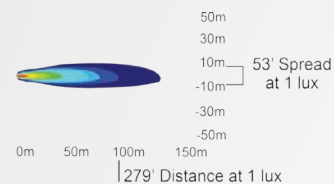

XIL-SP120 | 4009882 - 20° BEAM

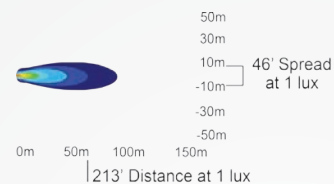

XIL-SP140 | 4009899 - 40° BEAM



SOLSTICE SOLO

ITEM #	PART #	HOUSING	BEAM	WEIGHT	RAW LUMENS	EFFECTIVE LUMENS	INPUT VOLTS	WATTS	AMP DRAW
XIL-S1110	9888156	Black	10°	0.76 lb	1,052 lm	736 lm	9-48V	10	0.83A
XIL-S1110W	9888194	White	10°	0.76 lb	1,052 lm	736 lm	9-48V	10	0.83A
XIL-S1130	9888163	Black	30°	0.76 lb	1,052 lm	736 lm	9-48V	10	0.83A
XIL-S1130W	9888200	White	30°	0.76 lb	1,052 lm	736 lm	9-48V	10	0.83A
XIL-S1160	9888170	Black	60°	0.76 lb	1,052 lm	736 lm	9-48V	10	0.83A
XIL-S1160W	9888217	White	60°	0.76 lb	1,052 lm	736 lm	9-48V	10	0.83A
XIL-S11e3065	9888187	Black	30°x65°	0.76 lb	1,052 lm	736 lm	9-48V	10	0.83A
XIL-S11e3065W	9888224	White	30°x65°	0.76 lb	1,052 lm	736 lm	9-48V	10	0.83A

XIL-S1110 | 9888156 - 10° BEAM



XIL-S1130 | 9888163 - 30° BEAM

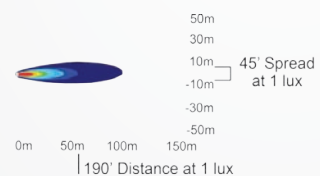

XIL-S1160 | 9888170 - 60° BEAM



MINI SOLO

ITEM #	PART #	HOUSING	BEAM	WEIGHT	RAW LUMENS	EFFECTIVE LUMENS	INPUT VOLTS	WATTS	AMP DRAW
XIL-MX110	9113531	Black	10°	0.40 lb	528 lm	368 lm	9-32V	5	0.42A
XIL-MX140	9113715	Black	40°	0.40 lb	528 lm	368 lm	9-32V	5	0.42A
XIL-MX160	9113807	Black	60°	0.40 lb	528 lm	368 lm	9-32V	5	0.42A

XIL-MX110 | 9113531 - 10° BEAM

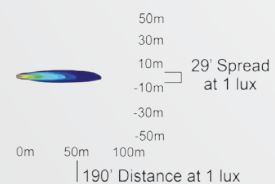

XIL-MX140 | 9113715 - 40° BEAM



XIL-MX160 | 9113807 - 60° BEAM



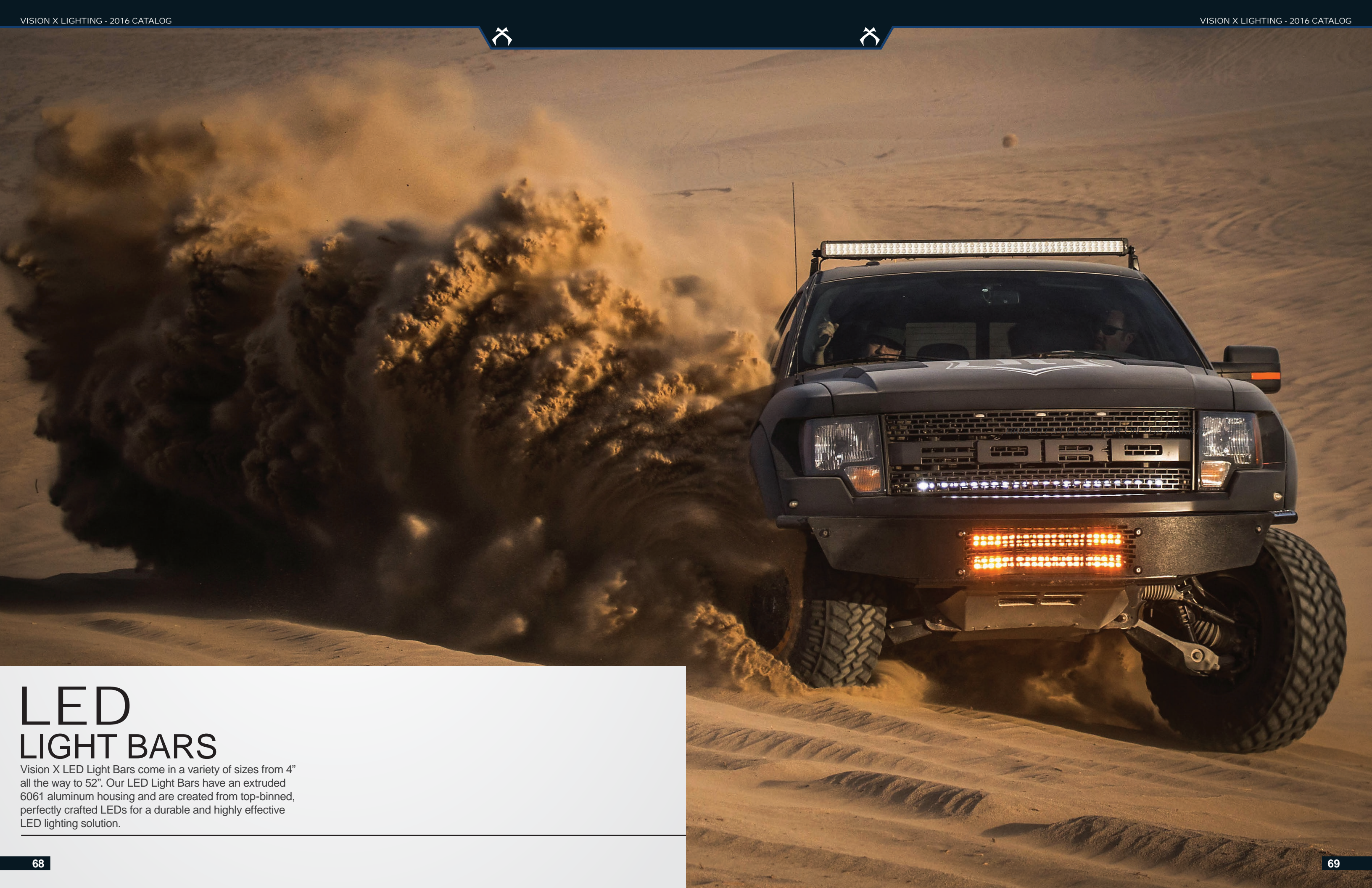

LED LIGHT BARS

Vision X LED Light Bars come in a variety of sizes from 4" all the way to 52". Our LED Light Bars have an extruded 6061 aluminum housing and are created from top-binned, perfectly crafted LEDs for a durable and highly effective LED lighting solution.

XMITTER PRIME XTREME

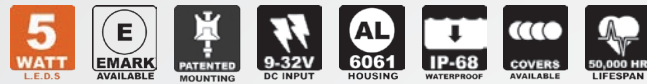

BEAM PATTERNS 10°, 40°, Mixed	WARRANTY Extended
HEIGHT 3.75" / 95.25mm	WIDTH 3.31" / 84.1mm

BRIGHTEST LIGHT BAR ON THE MARKET

- Full Range Fills In Road Way
- Plug And Play Harness Included
- PWM Integrated Dimming Circuitry
- 90% Efficiency Next Generation LED
- Electronic Thermal Management & Dimming

END CAP MOUNTS



ITEM #: XIL-PECM Shown
PART #: 9889191

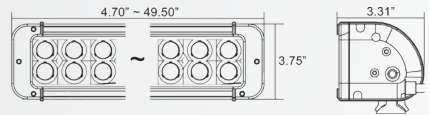

ITEM #	PART #	LENGTH	BEAM
XIL-PX610	9117409	4.70" / 120mm	10° Spot
XIL-PX1210	9115603	7.90" / 201mm	10° Spot
XIL-PX1810	9115788	11.10" / 282mm	10° Spot
XIL-PX3010	9116860	17.50" / 444mm	10° Spot
XIL-PX3610	9117041	20.60" / 525mm	10° Spot
XIL-PX5410	9117225	30.20" / 768mm	10° Spot
XIL-PX7210	9117584	39.80" / 1,011mm	10° Spot
XIL-PX9010	9887036	49.37" / 1,254mm	10° Spot

ITEM #	PART #	LENGTH	BEAM
XIL-PX640	9117492	4.70" / 120mm	40° Flood
XIL-PX1240	9115696	7.90" / 201mm	40° Flood
XIL-PX1840	9115870	11.10" / 282mm	40° Flood
XIL-PX3040	9116952	17.50" / 444mm	40° Flood
XIL-PX3640	9117133	20.60" / 525mm	40° Flood
XIL-PX5440	9117317	30.20" / 768mm	40° Flood
XIL-PX7240	9117676	39.80" / 1,011mm	40° Flood
XIL-PX9040	9887043	49.37" / 1,254mm	40° Flood

*Additional Part Numbers & Technical Information On Page 74

XPR

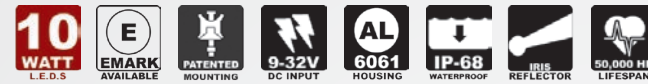

BEAM PATTERNS Straight, Tilted	WARRANTY Extended
HEIGHT 3.15" / 80.01mm	WIDTH 3.19" / 81.02mm

IRIS REFLECTORS FOR ULTIMATE DISTANCE

- Dual Mounting Standard
- 5-Watt XPI Light Bar Available
- Plug And Play Harness Included
- IRIS Reflector Technology With 10 Watt LED
- New Lifespan-Boosting Heat Sink Technology

END CAP MOUNTS



ITEM #: XPI-EM Shown
PART #: 9892917

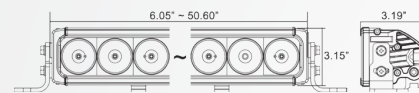

ITEM #	PART #	LENGTH	BEAM
XPR-3	9891606	6.05" / 153.7mm	Straight
XPR-6	9891613	11.50" / 292.1mm	Straight
XPR-12M	9891637	24.00" / 609.6mm	Tilted
XPR-15M	9891644	29.40" / 746.76mm	Tilted
XPR-18M	9891651	34.70" / 881.38mm	Tilted
XPR-21M	9891668	40.00" / 1,016mm	Tilted
XPR-24M	9891675	45.30" / 1,150.62mm	Tilted
XPR-27M	9891682	50.60" / 1,285.24mm	Tilted

SIDE WING MOUNTS INCLUDED



DUAL MOUNTING INCLUDED

Each XPR comes packaged with dual side-wing mounts as well as patented feet mounts. Amount of feet mounts vary by length of the light bar.

*Additional Part Numbers & Technical Information On Page 74

XMITTER LOW PRO XTREME



BEAM PATTERNS 10°, 40°, Mixed	WARRANTY Extended
HEIGHT 2.06" / 52.4mm	WIDTH 2.45" / 62.3mm

END CAP MOUNTS



ITEM #: XIL-LPECM Shown
PART #: 9888811

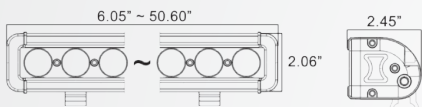

XTREME OUTPUT IN A COMPACT LIGHT BAR

- Sleek Low Profile Design
- 90% Efficiency Next Gen LED
- Plug And Play Harness Included
- PWM Integrated Dimming Circuitry
- Electronic Thermal Management & Dimming



ITEM #	PART #	LENGTH	BEAM
XIL-LPX310	4000759	4.65" / 118mm	10° Spot
XIL-LPX610	9118758	8.43" / 214mm	10° Spot
XIL-LPX910	4000773	12.21" / 310mm	10° Spot
XIL-LPX1510	9114613	19.77" / 502mm	10° Spot
XIL-LPX2410	9121901	31.11" / 790mm	10° Spot
XIL-LPX2710	9114972	34.89" / 886mm	10° Spot
XIL-LPX3310	9115153	42.44" / 1,078mm	10° Spot
XIL-LPX3910	9128115	52.00" / 1,270mm	10° Spot

ITEM #	PART #	LENGTH	BEAM
XIL-LPX340	4000766	4.65" / 118mm	40° Flood
XIL-LPX640	9120737	8.43" / 214mm	40° Flood
XIL-LPX940	4000780	12.21" / 310mm	40° Flood
XIL-LPX1540	9114705	19.77" / 502mm	40° Flood
XIL-LPX2440	9132884	31.11" / 790mm	40° Flood
XIL-LPX2740	9115061	34.89" / 886mm	40° Flood
XIL-LPX3340	9115245	42.44" / 1,078mm	40° Flood
XIL-LPX3940	9132976	52.00" / 1,270mm	40° Flood

*Additional Part Numbers & Technical Information On Page 75

XMITTER

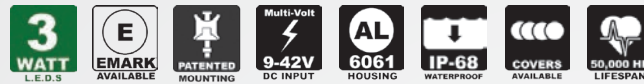

BEAM PATTERNS Euro, Flood	WARRANTY Extended
HEIGHT 2.76" / 69mm	WIDTH 3.00" / 76.25mm

END CAP MOUNTS



ITEM #: XIL-ECM Shown
PART #: 9888781

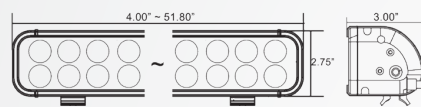

ITEM #	PART #	LENGTH	BEAM
XIL-40	4006270	4.00" / 101.6mm	Euro
XIL-80	4006287	5.80" / 147.6mm	Euro
XIL-120	4006294	7.80" / 198.4mm	Euro
XIL-200	4006300	11.80" / 300mm	Euro
XIL-320	4006317	17.60" / 446mm	Euro
XIL-400	4006324	21.70" / 550mm	Euro
XIL-600	4006331	31.80" / 808mm	Euro
XIL-800	4006348	41.80" / 1,062mm	Euro
XIL-1000	4006355	51.80" / 1,316mm	Euro

ORIGINAL LIGHT BAR WITH SEAMLESS BEAM

- Seamless Beam Pattern
- Plug and Play Harness Included
- Weatherproof Deutsch Connector
- Used by NASA, Border Patrol, and Pro Racers
- Infrared, Amber, Red Blue, and Green Available

ITEM #	PART #	LENGTH	BEAM
XIL-41	4007529	4.00" / 101.6mm	Flood
XIL-81	4007581	5.80" / 147.6mm	Flood
XIL-121	4007369	7.80" / 198.4mm	Flood
XIL-201	4006300	11.80" / 300mm	Flood
XIL-321	4007482	17.60" / 446mm	Flood
XIL-401	4007505	21.70" / 550mm	Flood
XIL-601	4007543	31.80" / 808mm	Flood
XIL-801	4007567	41.80" / 1,062mm	Flood
XIL-1001	4007345	51.80" / 1,316mm	Flood

*Additional Part Numbers & Technical Information On Page 75

XMITTER PRIME XTREME

ITEM #	PART #	LEDS	BEAM	LENGTH	WEIGHT	RAW LUMENS	EFFECTIVE LUMENS	INPUT VOLTS	WATTS	AMP DRAW
XIL-PX610 XIL-PX640	9117409 9117492	6	10° 40°	4.70"/120mm	2.65lb/1.2kg	3,168 lm	2,220 lm	9-32V	30	2.5A
XIL-PX1210 XIL-PX1240	9115603 9115696	12	10° 40°	7.90"/201mm	5.29lb/2.4kg	6,336 lm	4,440 lm	9-32V	60	5A
XIL-PX1810 XIL-PX1840	9115788 9115870	18	10° 40°	11.10"/282mm	6.61lb/3.0kg	9,504 lm	6,660 lm	9-32V	90	7.5A
XIL-PX3010 XIL-PX3040	9116860 9116952	30	10° 40°	17.50"/444mm	9.25lb/4.5kg	15,840 lm	11,100 lm	9-32V	150	12.5A
XIL-PX3610 XIL-PX3640	9117041 9117133	36	10° 40°	20.60"/525mm	10.58lb/4.8kg	19,008 lm	13,320 lm	9-32V	180	15A
XIL-PX5410 XIL-PX5440	9117225 9117317	54	10° 40°	30.20"/768mm	14.55lb/6.6kg	28,512 lm	19,980 lm	9-32V	270	22.5A
XIL-PX7210 XIL-PX7240	9117584 9117676	72	10° 40°	39.80"/1,011mm	18.51lb/8.4kg	38,016 lm	26,640 lm	9-32V	360	30A
XIL-PX9010 XIL-PX9040	9887036 9887043	90	10° 40°	49.37"/1,254mm	22.49lb/10.2kg	47,520 lm	33,300 lm	9-32V	450	37.5A

XIL-PX1810 | 9115788 - 10° BEAM

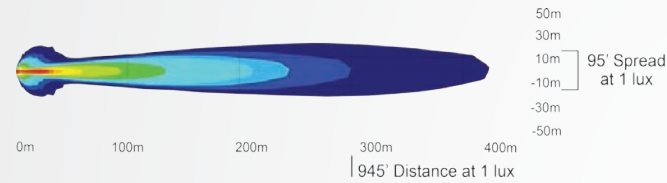

XIL-PX1840 | 9115870 - 40° BEAM



XPR

ITEM #	PART #	LEDS	BEAM	LENGTH	WEIGHT	RAW LUMENS	EFFECTIVE LUMENS	INPUT VOLTS	WATTS	AMP DRAW
XPR-3	9891606	3	Straight	8.75"/222.2mm	1.80lb/0.82kg	3,237 lm	2,266 lm	11-32V	30	2.5A
XPR-6	9891613	6	Straight	11.50"/292.2mm	3.40lb/1.54kg	6,474 lm	4,531 lm	11-32V	60	5A
XPR-12M	9891637	12	Tilted	24.01"/609.6mm	6.90lb/3.13kg	12,948 lm	9,064 lm	11-32V	90	10A
XPR-15M	9891644	15	Tilted	29.40"/746.76mm	8.70lb/3.95kg	16,185 lm	11,330 lm	11-32V	150	12.5A
XPR-18M	9891651	18	Tilted	34.70"/881.38mm	9.80lb/4.45kg	19,422 lm	13,595 lm	11-32V	180	15A
XPR-21M	9891668	21	Tilted	40.00"/1,016.02mm	11.60lb/5.26kg	22,659 lm	15,861 lm	11-32V	210	17.5A
XPR-24M	9891675	24	Tilted	45.30"/1,150.62mm	13.40lb/6.07kg	25,896 lm	18,127 lm	11-32V	240	20A
XPR-27M	9891682	27	Tilted	50.60"/1,285.24mm	15.22lb/6.90kg	29,133 lm	20,393 lm	11-32V	270	22.5A

XPR-27M | 9891682 - Tilted Beam

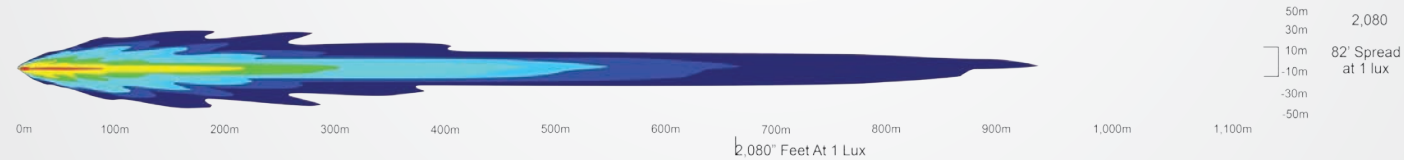

XMITTER LOW PROFILE XTREME

ITEM #	PART #	LEDS	BEAM	LENGTH	WEIGHT	RAW LUMENS	EFFECTIVE LUMENS	INPUT VOLTS	WATTS	AMP DRAW
XIL-LPX310 XIL-LPX340	4000759 4000766	3	10° 40°	4.65"/118mm	1.21lb/0.5kg	1,584 lm	1,110 lm	9-32V	15	1.25A
XIL-LPX610 XIL-LPX640	9118758 9120737	6	10° 40°	8.43"/214mm	2.00lb/0.9kg	3,168 lm	2,220 lm	9-32V	30	2.5A
XIL-LPX910 XIL-LPX940	4000773 4000780	9	10° 40°	12.21"/310mm	2.84lb/1.3kg	4,752 lm	3,330 lm	9-32V	45	3.75A
XIL-LPX1510 XIL-LPX1540	9114613 9114705	15	10° 40°	19.77"/502mm	4.45lb/2.0kg	7,920 lm	5,550 lm	9-32V	75	6.25A
XIL-LPX2410 XIL-LPX2440	9121901 9132884	24	10° 40°	31.11"/790mm	6.05lb/2.7kg	12,672 lm	8,880 lm	9-32V	120	10A
XIL-LPX2710 XIL-LPX2740	9114972 9115061	27	10° 40°	34.89"/886mm	7.67lb/3.5kg	14,256 lm	9,990 lm	9-32V	135	11.25A
XIL-LPX3310 XIL-LPX3340	9115153 9115245	33	10° 40°	42.44"/1,078mm	9.26lb/4.2kg	17,424 lm	12,210 lm	9-32V	165	13.75A
XIL-LPX3910 XIL-LPX3940	9128115 9132976	39	10° 40°	50.00"/1,270mm	10.9lb/4.9kg	20,592 lm	14,430 lm	9-32V	195	16.25A

XIL-LPX910 | 4000773 - 10° BEAM

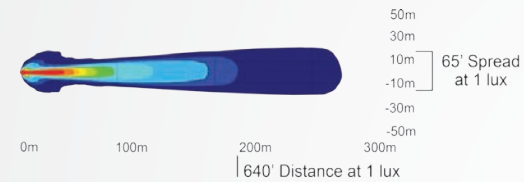

XIL-LPX940 | 4000780 - 40° BEAM



XMITTER

ITEM #	PART #	LEDS	BEAM	LENGTH	WEIGHT	RAW LUMENS	EFFECTIVE LUMENS	INPUT VOLTS	WATTS	AMP DRAW
XIL-40 XIL-41	4006270 4007529	4	Euro Flood	4.00"/101.6mm	1.26lb/0.57kg	720 lm	396 lm	9-42V	12	1.25A
XIL-80 XIL-81	4006287 4007581	8	Euro Flood	5.80"/147.6mm	2.09lb/0.95kg	1,440 lm	792 lm	9-42V	24	2.5A
XIL-120 XIL-121	4006294 4007369	12	Euro Flood	7.80"/198.4mm	2.65lb/1.2kg	2,160 lm	1,188 lm	9-42V	36	3.75A
XIL-200 XIL-201	4006317 4007468	20	Euro Flood	11.80"/300mm	3.64lb/1.65kg	3,600 lm	1,980 lm	9-42V	60	6.25A
XIL-320 XIL-321	4006317 4007482	32	Euro Flood	17.60"/446mm	5.51lb/2.5kg	5,760 lm	3,168 lm	9-42V	96	10A
XIL-400 XIL-401	4006324 4007505	40	Euro Flood	21.70"/550mm	6.61lb/3.0kg	7,200 lm	3,960 lm	9-42V	120	11.25A
XIL-600 XIL-601	4006331 4007543	60	Euro Flood	31.80"/808mm	9.59lb/4.35kg	10,800 lm	5,940 lm	9-42V	180	13.75A
XIL-800 XIL-801	4006348 4007567	80	Euro Flood	41.80"/1,062mm	12.46lb/5.65kg	14,400 lm	7,920 lm	9-42V	240	16.25A
XIL-1000 XIL-1001	4006355 4007345	100	Euro Flood	51.80"/1,316mm	14.55lb/6.60kg	18,000 lm	9,900 lm	9-42V	300	16.25A

XIL-200 | 4006317 - EURO BEAM

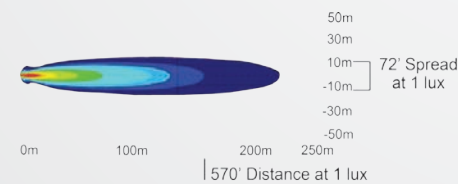

XIL-201 | 4007468 - FLOOD BEAM

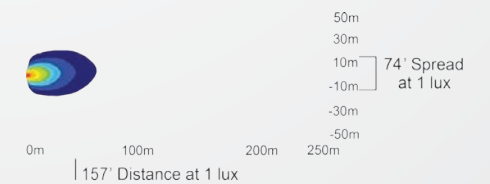

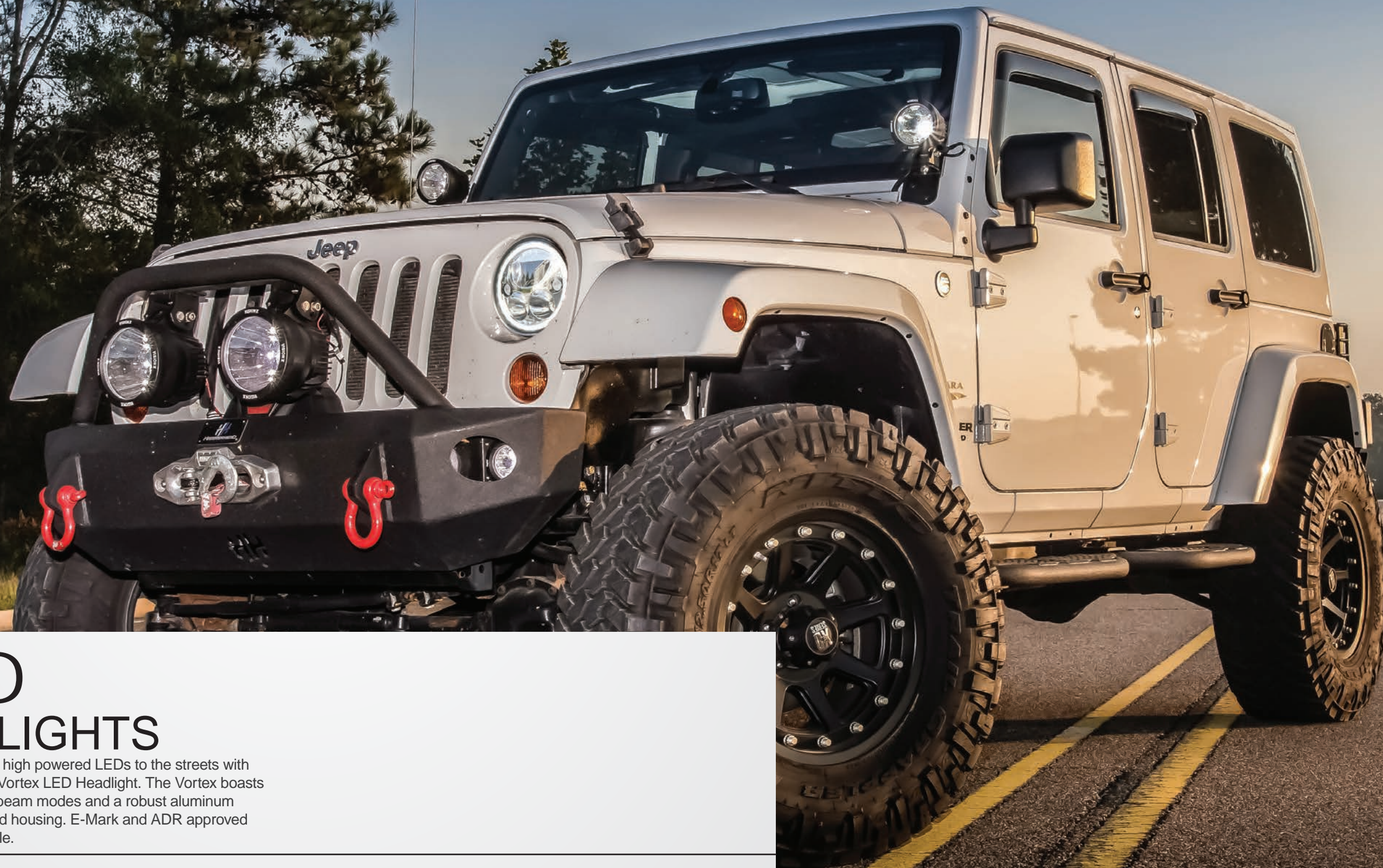

LED HEADLIGHTS

Take your desire for high powered LEDs to the streets with the DOT Approved Vortex LED Headlight. The Vortex boasts halo, low, and high beam modes and a robust aluminum polycarbonate hybrid housing. E-Mark and ADR approved models also available.

NEXT LEVEL

STYLE + OUTPUT + RELIABILITY



HALO



LOW



HIGH



ALSO AVAILABLE IN
BLACK CHROME



E-MARK & ADR MODELS AVAILABLE

WIDE SPREAD
LOW BEAM

BRIGHT LED
HALO RING

LONG RANGE
HIGH BEAMS

MULTIPLE LEDS
FILL IN ROADWAY

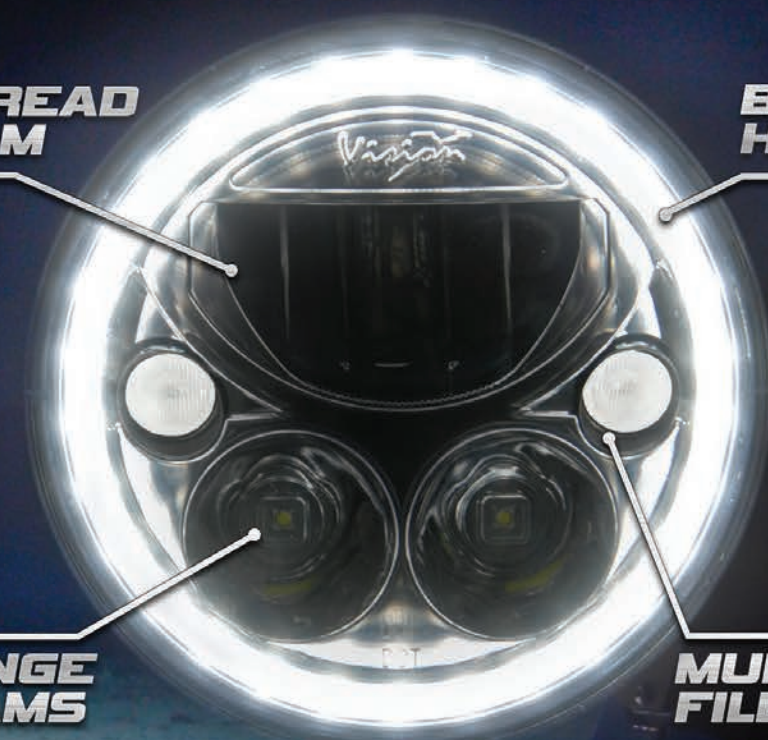

AUTOMOTIVE/OFFROAD VORTEX LED HEADLIGHTS

ABOUT THE VORTEX

The DOT Approved Vortex LED Headlight leads the LED Headlight industry in both style and performance. With an integrated LED Halo Ring, the Vortex is sure to turn heads while also delivering a dramatically improved night driving experience over factory headlights. The Vortex is currently available in 7" Round and 5.75" Round with more models on the way, each available with a Polished Chrome finish or a Black Chrome finish.

ADR and E-MARK Approved models are available for those who live in Australia and Europe. We spent the time to get the certification and pass all regulations so that you can enjoy your Vortex LED Headlight regardless of location.

Multiple direct plug-and-play accessories are available that help give you the most out of your Vortex LED Headlight.

7" E-MARK APPROVED MODELS



XIL-7RELKIT
Special models for Left-hand and Right-hand driving regulations are available with E-Mark Approval in the 7" Round housing..

MULTIPLE LEDs

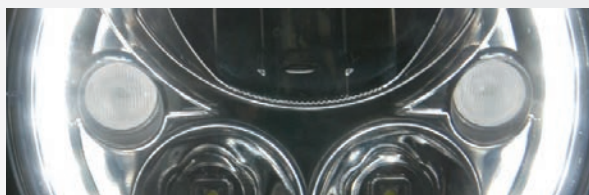

MULTIPLE LEDs FILL IN ROADWAY
Vision X integrated two LEDs with flood optics into the sides of the fixture in order to provide ample peripheral lighting by filling in the sides of the roadway in between the vehicle and the low beam.

BEAM MODES



HALO / LOW / HIGH
The Vortex has three beam modes that each serve a different purpose. The Halo works as a daytime running light while the Low and High beams handle the job of providing you with light output.



ACCESSORIES

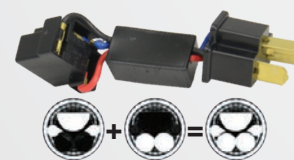

ITEM #: P-HLH4 Shown
PART #: 9895475
For Offroad Vehicles Only



ITEM #: P-HLCBA Shown
PART #: 9892757

IMPROVE PERFORMANCE
For those looking to take their Vortex LED Headlight to the next level we recommend the following accessories.

ITEM #	PART #	PURPOSE	QTY
P-HLH4	9895475	Engages all three beam modes simultaneously to dramatically increase visibility and light output	1
P-HLCBA	9892757	Levels electrical current to remove electrical interference from vehicle and eliminate flickering in the light	1

7" ROUND LED HEADLIGHT



ITEM #: XIL-7RD Shown
PART #: 9891217

DOT APPROVED LED HEADLIGHT WITH BRIGHT LED HALO RING

Multiple LEDs Fill In Roadway | Polycarbonate Lens | E-Mark & ADR Models Available

BEAM MODES	WEIGHT	DIMENSIONS
Halo, Low, High	2.20 lb / 1.00 kg	6.96" x 6.96" x 3.85"
RAW LUMENS	REFLECTOR FINISH	METRIC
4,210 lm (ea)	Polished Chrome, Black Chrome	177mm x 177mm x 97.8mm



ITEM #	PART #	FINISH	QTY
XIL-7RD	9891217	Polished Chrome	1
XIL-7RDKIT	9891224	Black Chrome	2
XIL-7RDB	9892436	Polished Chrome	1
XIL-7RDBKIT	9892443	Black Chrome	2

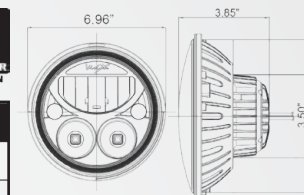

5.75" ROUND LED HEADLIGHT



ITEM #: XIL-575RD Shown
PART #: 9895604

DOT APPROVED LED HEADLIGHT WITH BRIGHT LED HALO RING

Multiple LEDs Fill In Roadway | Polycarbonate Lens | Perfect For Classic Cars

BEAM MODES	WEIGHT	DIMENSIONS
Halo, Low, High	1.95 lb / 0.88 kg	5.75" x 5.75" x 3.85"
RAW LUMENS	REFLECTOR FINISH	METRIC
4,210 lm (ea)	Polished Chrome, Black Chrome	146mm x 146mm x 97.8mm



ITEM #	PART #	FINISH	QTY
XIL-575RD	9895604	Polished Chrome	1
XIL-575RDKIT	9895611	Black Chrome	2
XIL-575RDB	9895635	Polished Chrome	1
XIL-575RDBKIT	9895642	Black Chrome	2

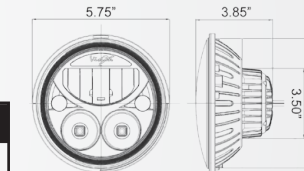

JEEP JK SPECIFIC KIT



ITEM #: XIL-7RDKITJK Shown
PART #: 9892733

DIRECT REPLACEMENT LED HEADLIGHT KIT FOR JEEP JK

Two Canbus Adapters Included | Simple Installation | Multiple LEDs Fill In Roadway

BEAM MODES	WEIGHT	DIMENSIONS
Halo, Low, High	4.40 lb / 2.00 kg	6.96" x 6.96" x 3.85"
RAW LUMENS	REFLECTOR FINISH	METRIC
8,420 lm	Polished Chrome, Black Chrome	177mm x 177mm x 97.8mm



ITEM #	PART #	FINISH	QTY
XIL-7RDKITJK	9892733	Polished Chrome	2
XIL-7RDBKITJK	9892825	Black Chrome	2

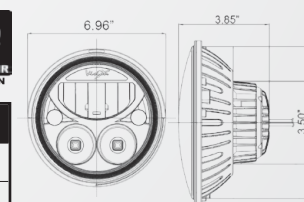



VEHICLE SPECIFIC KITS

Vision X offers vehicle specific lighting application and mounting options for most truck makes and models, allowing for effortless installation with our direct replacement fitting.



JEEP KITS

ABOUT JEEP JK KITS

Adding custom lighting takes any Jeep to the next level. Vision X makes easy to install custom kits for Jeep JK vehicles. All custom kits feature no-drilling requirements, and are easily installed in a matter of minutes. Each kit can be purchased with Vision X Light products, ultimately brightening your Jeep JK.



VORTEX 7" LED HEADLIGHT

PAGE 80

Check out the Vortex 7" LED Headlight featuring an intense halo ring on page 80 and 81. This powerful headlight is the perfect addition to any Jeep. Exclusive Jeep JK LED headlight kit includes 2 canbus adapters to eliminate electrical interference between vehicle and light.



AVAILABLE JEEP LED KITS



Factory Fog Light Upgrade Kit
 - 883 Feet Of Usable Light
 - 7x Brighter Than Factory
 - Direct Replacement

ITEM #: XIL-OE1012JKV2OPR Shown
 PART #: 9154756



Windshield Mount for Light Bars
 - Mount 50" LED Light Bars
 - Easy Installation
 - No Drilling

ITEM #: XIL-OEW0713JKV2 Shown
 PART #: 9888422



Hood Mount for Light Bars
 - Maintains Factory Appearance
 - For Up To 20" LED Light Bar
 - Adds Up To 17,748 Lumens

ITEM #: XIL-OEH0713JKPX36 Shown
 PART #: 9891002



A-Pillar Light Mount
 - Perfect For Cannon Or Optimus
 - Long Range Projection
 - No Drilling Required

ITEM #: XIL-OEA0713JKCPZ1 Shown
 PART #: 9888415

VORTEX HEADLIGHT UPGRADE

DOT Approved Lighting Fixture | Bright LED Halo Ring | Multiple LEDs Fill In Roadway

ITEM #	PART #	REPLACES	KIT INCLUDES	REFERENCE
XIL-7RDKITJK	9892733	7" ROUND HEADLIGHT	CHROME LED HEADLIGHTS (2), CANBUS ADAPTER (2)	PAGE 81
XIL-7RDBKITJK	9892825	7" ROUND HEADLIGHTS	BLACK CHROME LED HEADLIGHTS (2), CANBUS ADAPTER (2)	PAGE 81

DIRECT REPLACEMENT LED UPGRADES

No Drilling Necessary | Direct Plug-And-Play With Factory Wiring | Dramatically Increase Visibility

ITEM #	PART #	APPLICATION	YEAR FITS	KIT INCLUDES	REFERENCE
XIL-OE0709JKV2	9145662	LED FOG LIGHTS	07-09 JEEP JK	BRACKETS, CONNECTORS	-
XIL-OE1012JKV2	9154664	LED FOG LIGHTS	10-13 JEEP JK	BRACKETS, CONNECTORS	-
XIL-OE0709JKV2OPR	9145754	LED FOG LIGHTS	07-09 JEEP JK	BRACKETS, (2) XIL-OPR110, CONNECTORS	PAGE 61
XIL-OE1012JKV2OPR	9154756	LED FOG LIGHTS	10-13 JEEP JK	BRACKETS, (2) XIL-OPR110, CONNECTORS	PAGE 61
XIL-OE13JKX	9891064	LED FOG LIGHTS	13-14 JEEP JK-X	BRACKETS, CONNECTORS	-
XIL-OEW0713JKV2	9888422	WINDSHIELD MOUNT	07-14 JEEP JK	BRACKETS	-
XIL-OEH0713PX36	9891002	BUMPER LIGHT BAR	07-14 JEEP JK	BRACKETS, (1) XIL-PX3610, HARNESS	PAGE 70
XIL-OEH0713JKXP112	9891019	BUMPER LIGHT BAR	07-14 JEEP JK	BRACKETS, (1) XPI-12M	PAGE 71
XIL-OEA0713JK	9888392	A-PILLAR FOG LIGHT	07-14 JEEP JK	BRACKETS	-
XIL-OEA0713JKOP1	9888408	A-PILLAR FOG LIGHT	07-14 JEEP JK	BRACKETS, (2) XIL-OPR110, HARNESS	PAGE 61
XIL-OEA0713JKCPZ1	9888415	A-PILLAR FOG LIGHT	07-14 JEEP JK	BRACKETS, (2) CTL-CPZ110, HARNESS	PAGE 57
XIL-OEA9706TJCPZ1	9892795	A-PILLAR FOG LIGHT	97-06 JEEP TJ	BRACKETS, (2) CTL-CPZ110, HARNESS	PAGE 57
XIL-OEA9706TJOPH	9892818	A-PILLAR FOG LIGHT	97-06 JEEP TJ	BRACKETS, (2) XIL-OPH115, HARNESS	PAGE 60

FORD RAPTOR KITS

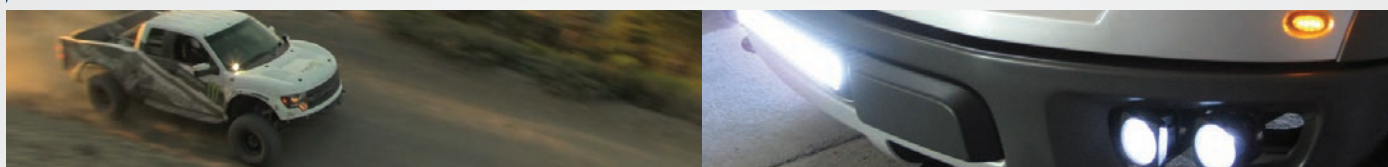

Factory Fog Light Upgrade Kit
ITEM #: XIL-OE10FROP Shown
PART #: 9160870



Bumper Mount for Light Bars
ITEM #: XIL-OEB10FRX3610 Shown
PART #: 9887357

FACTORY FOG LIGHT UPGRADE KIT

Lights, Mounts, Wiring | 7x Brighter Than Headlight | Direct Fit In Factory Opening

ITEM #	PART #	FITS	KIT INCLUDES	REFERENCE
XIL-OE10FR	9160870	07-09 FORD RAPTOR	BRACKET, FACTORY INTEGRATION HARNESS	-
XIL-OE10FROP	9133515	10-13 FORD RAPTOR	BRACKETS, (4) XIL-OP110, INTEGRATED HARNESS	PAGE 61

BUMPER MOUNT FOR LIGHT BARS

Lights, Mounts, Wiring | Fits Directly into Factory Bumper | Add Up to 17,748 Lumens

ITEM #	PART #	FITS	KIT INCLUDES	REFERENCE
XIL-OEB10FR	9887340	10-14 FORD RAPTOR	BRACKET*, FACTORY INTEGRATION HARNESS	-
XIL-OEB10FRPX3610	9887357	10-14 FORD RAPTOR	BRACKETS, (1) XIL-PX3610, INTEGRATED HARNESS	PAGE 70

FORD F SERIES KITS



Factory Fog Light Upgrade Kit
ITEM #: XIL-OE9913FSDDURA Shown
PART #: 9891200



Bumper Mount for Light Bars
ITEM #: XIL-OEB09F150PX36 Shown
PART #: 9891156

FACTORY FOG LIGHT UPGRADE KIT

Drastically Increase Light Output | 99-14 Ford Super Duty Models | Direct Fit In Factory Bumper

ITEM #	PART #	FITS	KIT INCLUDES	REFERENCE
XIL-OE9913FSD	9891194	99-14 FORD SUPER DUTY	BRACKET, CONNECTORS	-
XIL-OE9913FSDDURA	9891200	99-14 FORD SUPER DUTY	BRACKETS, (2) DURA-410, CONNECTORS	PAGE 33

BUMPER MOUNT FOR LIGHT BARS

EcoBoost Edition Available | Add Up To 17,748 Lumens | Direct Fit In Factory Bumper

ITEM #	PART #	FITS	KIT INCLUDES	REFERENCE
XIL-OEB09F150	9891057	09-14 FORD F150	BRACKET	-
XIL-OEB09F150PX36	9891156	09-14 FORD F150	BRACKET, XIL-PX3610, WIRING HARNESS	PAGE 70
XIL-OEB09F150LPX15	9891163	09-14 FORD F150	BRACKET, XIL-LPX1510, WIRING HARNESS	PAGE 72
XIL-OEB09F150ECO	9891170	09-14 FORD F150	BRACKET, (2) XIL-PX610, WIRING HARNESS	PAGE 70

DODGE RAM KITS



ITEM #: XIL-OE0913DROP1MX2 Shown
PART #: 9133065

FACTORY FOG LIGHT UPGRADE KIT

Lights, Mounts, Wiring | Available for 02-14 Dodge Ram Models | Direct Fog Light Replacement

ITEM #	PART #	FITS	KIT INCLUDES
XIL-OE0210DR	4002333	02-08 DODGE RAM	BRACKETS, PLUG & PLAY CONNECTORS
XIL-OE0210DRUMX	9133065	02-08 DODGE RAM	BRACKETS, (2) XIL-UMX4010, CONNECTORS
XIL-OE0913DR	9889221	09-14 DODGE RAM	BRACKETS, CONNECTORS
XIL-OE0913DROP	9888552	09-14 DODGE RAM	BRACKETS, (2) XIL-OP110, CONNECTORS
XIL-OE0913DROP1MX2	9890685	09-14 DODGE RAM	BRACKETS, (2) XIL-OP110, CONNECTORS

BUMPER MOUNT FOR LIGHT BARS

Lights, Mounts, Wiring | Add Up to 17,748 Lumens | Direct Fit In Factory Bumper



ITEM #: XIL-OEB0913DRPX3610 Shown
PART #: 9889245

ITEM #	PART #	FITS	KIT INCLUDES
XIL-OEB0913DR	9889238	10-14 DODGE RAM	BRACKETS, CONNECTORS
XIL-OEB0913DRPX3610	9889245	10-14 DODGE RAM	BRACKETS, XIL-PX3610, WIRING HARNESS

TOYOTA TUNDRA KITS



ITEM #: XIL-OE0711TTUMX Shown
PART #: 9133249

FACTORY FOG LIGHT UPGRADE KIT

Lights, Mounts, Wiring | 7x Brighter Than Headlight | Direct Fog Light Replacement

ITEM #	PART #	FITS	KIT INCLUDES
XIL-OE0711TT	4002296	07-13 TUNDRA	BRACKET, CONNECTORS
XIL-OE0711TTUMX	9133249	07-13 TUNDRA	BRACKETS, (2) XIL-UMX4010, CONNECTORS

GMC SIERRA KITS



ITEM #: XIL-OE0111GSUMX Shown
PART #: 9133157

FACTORY FOG LIGHT UPGRADE KIT

Lights, Mounts, Wiring | Bolts Directly To Factory Mounting | 7x Brighter Than Headlight

ITEM #	PART #	FITS	KIT INCLUDES
XIL-OE0711GS	4002388	07-13 GMC SIERRA	BRACKET
XIL-OE0711GSUMX	9133157	07-13 GMC SIERRA	BRACKETS, (2) XIL-UMX4010, INTEGRATED HARNESS

CHEVROLET SILVERADO KITS



ITEM #: XIL-OE0711CSS1100 Shown
PART #: 9120829

FACTORY FOG LIGHT UPGRADE KIT

Lights, Mounts, Wiring | Bolts Directly To Factory Mounting | 7x Brighter Than Headlight

ITEM #	PART #	FITS	KIT INCLUDES
XIL-OE0711CS	4002340	07-13 SILVERADO	BRACKETS*, T-TAP CONNECTORS
XIL-OE0711CSS1100	9120829	07-13 SILVERADO	BRACKETS, (4) XIL-S1100, T-TAP CONNECTORS



MOTORCYCLE LED LIGHTING

With the addition of the DOT approved XMC Vortex LED headlight, Vision X now offers lighting solutions to illuminate your evening rides with halo, low, and high beam lighting all in one.

MOTORCYCLE XMC LED HEADLIGHT

ABOUT THE XMC SERIES

The XMC DOT Approved Vortex LED Headlight leads the Motorcycle Headlight industry in both style and performance. With an integrated LED Halo Ring, the Vortex is sure to turn heads while also delivering a dramatically improved night driving experience over factory headlights. The XMC Vortex is currently available in 7" Round, 5.75" Round and 5.75" Oval for Road Glides, each available with a Polished Chrome finish or a Black Chrome finish.

The XMC LED Headlight dramatically improves riding safety on the road thanks to the bright beam modes and LED halo ring. Be seen and see more.

This headlight is compatible with most bikes that use a 7" round, 5.75" round, or 5.75" oval headlight.

ROAD GLIDE SPECIFIC



DUAL OVAL HEADLIGHTS

A direct-replacement model specifically created for the Harley Davidson Road Glide is available that features the same specifications and output as the other XMC LED Headlights.

MULTIPLE LEDS



ENHANCED SAFETY

Thanks to multiple LEDs in the Vortex LED Headlight, your on-road safety and visibility is dramatically enhanced. Additionally, the Vortex is compatible with most headlight modulators.

BEAM MODES



HALO / LOW / HIGH

The Vortex has three beam modes that each serve a different purpose. The Halo works as a daytime running light while the Low and High beams handle the job of providing you with light output.



ACCESSORIES



ITEM #: P-HLH14 Shown
PART #: 9895475



ITEM #: XMC-H42H9H11 Shown
PART #: 9892900



ITEM #: XMC-H42DELPHI Shown
PART #: 9892894



ITEM #: P-HARNES.2XIL Shown
PART #: 4006201

7" ROUND LED HEADLIGHT



ITEM #: XMC-7RD Shown
PART #: 9892061

DOT APPROVED LED HEADLIGHT WITH BRIGHT LED HALO RING
Multiple LEDs Fill In Roadway | Polycarbonate Lens | Dramatically Improves Safety

BEAM MODES Halo, Low, High	WEIGHT 2.20 lb / 1.00 kg	DIMENSIONS 6.96" x 6.96" x 3.85"
RAW LUMENS 4,210 lm (ea)	REFLECTOR FINISH Polished Chrome, Black Chrome	METRIC 177mm x 177mm x 97.8mm



ITEM #	PART #	FINISH	QTY
XMC-7RD	9892061	Polished Chrome	Single
XMC-7RDB	9895291	Black Chrome	Single

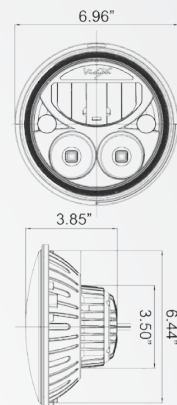

5.75" ROUND LED HEADLIGHT



ITEM #: XMC-575RD Shown
PART #: 9895628

DOT APPROVED LED HEADLIGHT WITH BRIGHT LED HALO RING
Multiple LEDs Fill In Roadway | Polycarbonate Lens | Dramatically Improves Safety

BEAM MODES Halo, Low, High	WEIGHT 2.20 lb / 1.00 kg	DIMENSIONS 5.75" x 5.75" x 3.85"
RAW LUMENS 4,210 lm (ea)	REFLECTOR FINISH Polished Chrome, Black Chrome	METRIC 146mm x 146mm x 97.8mm



ITEM #	PART #	FINISH	QTY
XMC-575RD	9895628	Polished Chrome	Single
XMC-575RDB	9895659	Black Chrome	Single

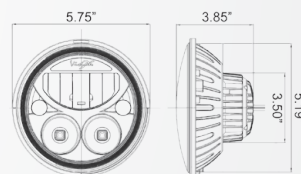

5.75" OVAL ROAD GLIDE



ITEM #: XMC-575ODKIT Shown
PART #: 9895673

HARLEY-DAVIDSON ROAD GLIDE DIRECT REPLACEMENT
Multiple LEDs Fill In Roadway | Polycarbonate Lens | Dramatically Improves Safety

BEAM MODES Halo, Low, High	WEIGHT 2.20 lb / 1.00 kg (ea)	DIMENSIONS 6.96" x 6.96" x 3.85"
RAW LUMENS 8,420 lm	REFLECTOR FINISH Polished Chrome, Black Chrome	METRIC 177mm x 177mm x 97.8mm



ITEM #	PART #	FINISH	QTY
XMC-575ODKIT	9895673	Polished Chrome	Kit
XMC-575OGBKIT	9895697	Black Chrome	Kit

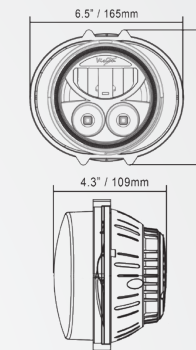

LED BAGGER LIGHT KIT



ITEM #: XMC-BKW2 Shown
PART #: 9895246

LOW CONSUMPTION COMPARTMENT LIGHTING FOR TRUNKS, BAGS, SADDLES
Two Light Kit | 40 Inch Power Cord With Flush Switch Included | Water & Dust Proof

BEAM PATTERNS 210°	WARRANTY Extended	DIMENSIONS 2.7" x 2.7" x 0.87"
RAW LUMENS 280 lm	WEIGHT 0.20 lb / 0.09 kg (ea)	METRIC 68.5mm x 68.5mm x 21mm



ITEM #	PART #	WIRING	QTY
XMC-BKW2	9895246	40" Cord With Switch	Two Pods

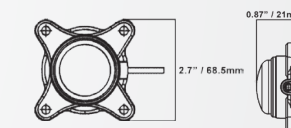



HID LIGHTING

Vision X continues to offer high quality HID lighting solutions, providing over 2,500 hours of intense illumination and a die-cast 6061 aluminum housing for a reliable and durable lighting solution.



ABOUT THE XP SERIES

The Xtreme Performance HID was engineered with input from Baja 1000 winning racers to further enhance the race proven Vision X HID series. Each light includes a weatherproof Deutsch Connector with Plug-and-Play Harness and features a durable lightweight polycarbonate lens.

The HID XP Series is currently trusted by professional rally teams in the United States and Canada.

Internal Ballast & Starter

The ballast takes the standard 12V input power and increases this to the 32,000V that the bulb operates at and the starter is used to ignite the bulb. Vision X uses all internal components for an all-in-one package

LONG RANGE PROJECTION

The XP Series is capable of producing long range distances of up to 1,200 meters of usable light from the 8.7" model and 1,000 meters from the 6.7" housing.



8.7" HID XP



ITEM #: HID-8550XP Shown
PART #: 9119922

1200 METERS OF LIGHT FOR UNMATCHED DISTANCE

Polycarbonate Lens | Die-Cast Aluminum Housing | Internal Ballast & Starter

BEAM PATTERNS Spot, Euro	WARRANTY 50W	DIMENSIONS 8.7" x 9.09" x 5.55"
RAW LUMENS 5,000 lm (ea)	EFFECTIVE LUMENS 3,500 lm	METRIC 221mm x 231mm x 141mm
WATTAGE / AMPS 50W / 4.17A	VIBRATION RATING 8.6 G rms	WEIGHT 6.20 lb / 2.81 kg

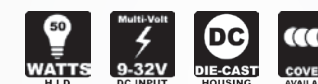

ITEM #	PART #	FINISH
HID-8550XP	9119922	Euro
HID-8552XP	4000490	Spot

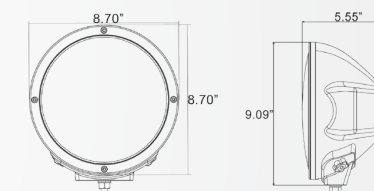

6.7" HID XP



ITEM #: HID-6552XP Shown
PART #: 4000483

1000 METERS OF USABLE LIGHT

Polycarbonate Lens | Die-Cast Aluminum Housing | Internal Ballast & Starter

BEAM PATTERNS Spot	WARRANTY 50W	DIMENSIONS 6.7" x 7.00" x 6.30"
RAW LUMENS 5,000 lm (ea)	EFFECTIVE LUMENS 3,500 lm (ea)	METRIC 170mm x 178mm x 160mm
WATTAGE / AMPS 50W / 4.17A	VIBRATION RATING 8.6 G rms	WEIGHT 4.00 lb / 1.81 kg



ITEM #	PART #	BEAM
HID-6552XP	4000483	Spot

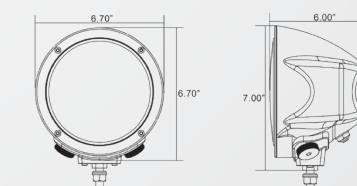



HALOGEN LIGHTING

With various bulbs and headlight products, Vision X caters to your needs when upgrading or replacing your bulbs or headlights.



AUTOMOTIVE/OFFROAD HALOGEN HEADLIGHT BULBS

DIRECT REPLACEMENT

Increase brightness by up to 50% with the Vision X headlight bulbs. Vision X headlight bulbs provide a super white, more natural light for increased visibility and safety. With three lines to chose from, we offer the perfect mix of cost and performance for any driver.

DOT APPROVED

Unlike other Halogen Bulbs on the market, Vision X D Series bulbs are DOT Approved. Enhance your night time driving experience while cooperating with all laws and regulations.



D SERIES HALOGEN BULBS



VX-D9004
4001527



VX-D9005
4001534



VX-D9006
4001558

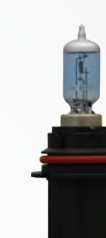

VX-D9007
4001572



VX-DH1
4001589



VX-DH3
4001596



VX-DH4
4001602



VX-DH7
4001619



VX-DH10
4001633



VX-DH11
4001657



VX-DH13
4001664



ITEM #	PART #	REPLACES	WATTS	FILAMENT
VX-D9004	4001527	9004	65/45	DUAL
VX-D9005	4001534	9005	65	SINGLE
VX-D9006	4001558	9006	55	SINGLE
VX-D9007	4001572	9007	65/55	DUAL
VX-DH1	4001589	H1	55	SINGLE
VX-DH3	4001596	H3	66	SINGLE
VX-DH4	4001602	H4	60/55	DUAL
VX-DH7	4001619	H7	55	SINGLE
VX-DH10	4001633	H10	42	SINGLE
VX-DH11	4001657	H11	55	SINGLE
VX-DH13	4001664	H13	55/60	DUAL

7" SEALED BEAM



ITEM #: VX-7RD Shown
PART #: 4004047

OEM REPLACEMENT HEADLIGHT
Hardened Borosilicate Glass Lens | High/Low Beam | DOT Certified

BULB TYPE H4 (Not Included)	WARRANTY Standard	DIMENSIONS 5.00" x 7.00" x 4.50"
VISION X BULB AVAILABLE VX-DH4 / VX-LH4 / VX-HH4	OEM CROSS REFERENCE H6017 / H6024	METRIC 127mm x 178mm x 114mm
CERTIFICATION DOT Approved	BEAM MODE High/Low	WEIGHT 3.40 lb / 1.54 kg

ITEM #	PART #	QUANTITY
VX-7RD	4004047	PAIR

5.75" SEALED BEAM



ITEM #: VX-575 Shown
PART #: 4004030

OEM REPLACEMENT HEADLIGHT
Hardened Borosilicate Glass Lens | High/Low Beam | DOT Certified

BULB TYPE 9007 (Not Included)	WARRANTY Standard	DIMENSIONS 5.75" x 5.75" x 3.13"
VISION X BULB AVAILABLE VX-D9007/VX-L9007/VX-H9007	OEM CROSS REFERENCE H5001 / H5006	METRIC 146mm x 146mm x 80mm
CERTIFICATION DOT Approved	BEAM MODE High/Low	WEIGHT 1.50 lb / 0.68 kg

ITEM #	PART #	QUANTITY
VX-575	4004030	PAIR

5" X 7" SEALED BEAM



ITEM #: VX-57 Shown
PART #: 4004023

OEM REPLACEMENT HEADLIGHT
Hardened Borosilicate Glass Lens | High/Low Beam | DOT Certified

BULB TYPE H4 (Not Included)	WARRANTY Standard	DIMENSIONS 5.00" x 7.00" x 4.50"
VISION X BULB AVAILABLE VX-DH4 / VX-LH4 / VX-HH4	OEM CROSS REFERENCE H6054	METRIC 127mm x 178mm x 114mm
CERTIFICATION DOT Approved	BEAM MODE High/Low	WEIGHT 3.40 lb / 1.54 kg

ITEM #	PART #	QUANTITY
VX-57	4004023	PAIR

4" X 6" SEALED BEAM



ITEM #: VX-46 Shown
PART #: 4004016

OEM REPLACEMENT HEADLIGHT
Hardened Borosilicate Glass Lens | High/Low Beam | DOT Certified

BULB TYPE 9007 (Not Included)	WARRANTY Standard	DIMENSIONS 4.00" x 6.00" x 4.25"
VISION X BULB AVAILABLE VX-D9007/VX-L9007/VX-H9007	OEM CROSS REFERENCE H5001/H5006	METRIC 102mm x 152mm x 108mm
CERTIFICATION DOT Approved	BEAM MODE High/Low	WEIGHT 2.00 lb / 0.91 kg

ITEM #	PART #	QUANTITY
VX-46	4004016	PAIR



AUTOMOTIVE ACCESSORIES

Vision X provides an assortment of automotive accessories including accent lights, mounting solutions, and light covers for that extra detail you've been looking for.

POLYCARBONATE LIGHT COVERS

ABOUT POLYCARBONATE LIGHT COVERS

Vision X polycarbonate translucent covers not only protect your light, but they also improving vision in dust, fog, or snow. Another benefit of adding a cover is the capability to change your beam pattern. Each cover is finished with a glow in the dark printed "X" for a unique look at night when the lights are off.

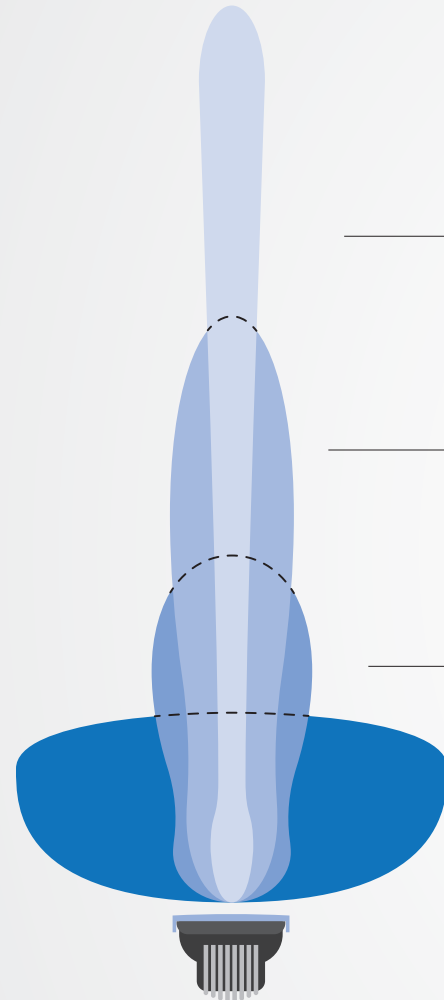

SPOT
Spot covers maintain original lighting beam pattern while protecting the lens from harmful debris.



COMBO
Combo covers combine the distance of a spot cover with the peripheral illumination of a euro cover.



EURO *ELLIPTICAL
Euro covers illuminate peripherals while losing some distance effectiveness.
*Reduces left peripheral illumination for oncoming traffic.



FLOOD *WIDE FLOOD
Wide Flood covers illuminate a wide field of view in exchange for distance effectiveness.
* Flood covers is the vertical beam equivalent to flood covers.



OPTIMUS ROUND & OPTIMUS HALO ROUND

ITEM #	PART #	COLOR	BEAM
PCV-OPR1	9889528	CLEAR	SPOT
PCV-OPR1B	9889559	BLUE	SPOT
PCV-OPR1Y	9889740	YELLOW	SPOT
PCV-OPR1R	9889719	RED	SPOT
PCV-OPR1EU	9889535	CLEAR	EURO
PCV-OPR1BEU	9889566	BLUE	EURO
PCV-OPR1YEU	9889757	YELLOW	EURO
PCV-OPR1REU	9889726	RED	EURO
PCV-OPR1FL	9889542	CLEAR	FLOOD
PCV-OPR1BFL	9889573	BLUE	FLOOD
PCV-OPR1YFL	9889764	YELLOW	FLOOD
PCV-OPR1RFL	9889733	RED	FLOOD
PCV-OPR1WF	9890944	CLEAR	WIDE FLOOD
PCV-OPR1BWF	9890906	BLUE	WIDE FLOOD
PCV-OPR1YWF	9890968	YELLOW	WIDE FLOOD
PCV-OPR1RWF	9890937	RED	WIDE FLOOD
PCV-OPR1EL	9890913	CLEAR	ELLIPTICAL
PCV-OPR1BEL	9890890	BLUE	ELLIPTICAL
PCV-OPR1YEL	9890951	YELLOW	ELLIPTICAL
PCV-OPR1REL	9890920	RED	ELLIPTICAL
PCV-OPR1BL	9889580	BLACK	PROTECTIVE

* Compatible with all beam patterns

6.7 LED LIGHT CANNON

ITEM #	PART #	COLOR	BEAM
PCV-6500	4003248	CLEAR	SPOT
PCV-6500B	4003569	BLUE	SPOT
PCV-6500Y	4002784	YELLOW	SPOT
PCV-6500R	4004689	RED	SPOT
PCV-6500CB	9895703	CLEAR	COMBO
PCV-6500BCB	9895710	BLUE	COMBO
PCV-6500YCB	9895734	YELLOW	COMBO
PCV-6500RCB	9893198	RED	COMBO
PCV-6500EU	9888453	CLEAR	EURO
PCV-6500BEU	9888460	BLUE	EURO
PCV-6500YEU	9888484	YELLOW	EURO
PCV-6500REU	9888477	RED	EURO
PCV-6500FL	9888491	CLEAR	FLOOD
PCV-6500BFL	9888507	BLUE	FLOOD
PCV-6500YFL	9888521	YELLOW	FLOOD
PCV-6500RFL	9888514	RED	FLOOD
PCV-6500WF	9888771	CLEAR	WIDE FLOOD
PCV-6500BWF	9889788	BLUE	WIDE FLOOD
PCV-6500YWF	9889801	YELLOW	WIDE FLOOD
PCV-6500RWF	9889795	RED	WIDE FLOOD
PCV-6500EL	9890616	CLEAR	ELLIPTICAL
PCV-6500BEL	9890609	BLUE	ELLIPTICAL
PCV-6500YEL	9890630	YELLOW	ELLIPTICAL
PCV-6500REL	9890623	RED	ELLIPTICAL
PCV-6500BL	9160245	BLACK	PROTECTIVE

LOW PROFILE XTREME

ITEM #	PART #	FITS	COLOR	BEAM
PCV-LP3BL	9155296	XIL-LPX3*	BLACK	PROTECTIVE
PCV-LP6BL	9155388	XIL-LPX6*	BLACK	PROTECTIVE
PCV-LP9BL	9135946	XIL-LPX9*	BLACK	PROTECTIVE
PCV-LP15BL	9155470	XIL-LPX15*	BLACK	PROTECTIVE
PCV-LP18BL	9135762	XIL-LPX18*	BLACK	PROTECTIVE
PCV-LP24BL	9155654	XIL-LPX24*	BLACK	PROTECTIVE
PCV-LP33BL	9155838	XIL-LPX33*	BLACK	PROTECTIVE
PCV-LP36BL	9155920	XIL-LPX36*	BLACK	PROTECTIVE
PCV-LP3Y	9165103	XIL-LPX3*	YELLOW	SPOT
PCV-LP6Y	9165196	XIL-LPX6*	YELLOW	SPOT
PCV-LP9Y	9136035	XIL-LPX9*	YELLOW	SPOT
PCV-LP15Y	9164564	XIL-LPX15*	YELLOW	SPOT
PCV-LP18Y	9135854	XIL-LPX18*	YELLOW	SPOT
PCV-LP24Y	9164748	XIL-LPX24*	YELLOW	SPOT
PCV-LP33Y	9164922	XIL-LPX33*	YELLOW	SPOT
PCV-LP36Y	9165011	XIL-LPX36*	YELLOW	SPOT

* Compatible with all beam patterns

4.5 LED LIGHT CANNON

ITEM #	PART #	COLOR	BEAM
PCV-CP1	9151151	CLEAR	SPOT
PCV-CP1B	9157184	BLUE	SPOT
PCV-CP1Y	9157726	YELLOW	SPOT
PCV-CP1R	9162492	RED	SPOT
PCV-CP1CB	9893228	CLEAR	COMBO
PCV-CP1BCB	9893242	BLUE	COMBO
PCV-CP1YCB	9893259	YELLOW	COMBO
PCV-CP1RCB	9893235	RED	COMBO
PCV-CP1EU	9151243	CLEAR	EURO
PCV-CP1BEU	9157276	BLUE	EURO
PCV-CP1YEU	9157818	YELLOW	EURO
PCV-CP1REU	9157542	RED	EURO
PCV-CP1FL	9151335	CLEAR	FLOOD
PCV-CP1BFL	9157368	BLUE	FLOOD
PCV-CP1YFL	9157900	YELLOW	FLOOD
PCV-CP1RFL	9157634	RED	FLOOD
PCV-CP1WF	9890562	CLEAR	WIDE FLOOD
PCV-CP1BWF	9890654	BLUE	WIDE FLOOD
PCV-CP1YWF	9890586	YELLOW	WIDE FLOOD
PCV-CP1RWF	9890883	RED	WIDE FLOOD
PCV-CP1EL	9890661	CLEAR	ELLIPTICAL
PCV-CP1BEL	9890647	BLUE	ELLIPTICAL
PCV-CP1YEL	9890579	YELLOW	ELLIPTICAL
PCV-CP1REL	9890678	RED	ELLIPTICAL
PCV-CP1BL	9157450	BLACK	PROTECTIVE

* Also compatible with Transporter and HID-6500

8.7 LED LIGHT CANNON

ITEM #	PART #	COLOR	BEAM
PCV-8500	4003255	CLEAR	SPOT
PCV-8500B	4003583	BLUE	SPOT
PCV-8500Y	4002791	YELLOW	SPOT
PCV-8500R	4003576	RED	SPOT
PCV-8500CB	9893182	CLEAR	COMBO
PCV-8500BCB	9893204	BLUE	COMBO
PCV-8500YCB	9893211	YELLOW	COMBO
PCV-8500RCB	9893198	RED	COMBO
PCV-8500EU	9890128	CLEAR	EURO
PCV-8500BEU	9890098	BLUE	EURO
PCV-8500YEU	9890470	YELLOW	EURO
PCV-8500REU	9890432	RED	EURO
PCV-8500FL	9890135	CLEAR	FLOOD
PCV-8500BFL	9890104	BLUE	FLOOD
PCV-8500YFL	9890487	YELLOW	FLOOD
PCV-8500RFL	9890449	RED	FLOOD
PCV-8500WF	9890463	CLEAR	WIDE FLOOD
PCV-8500BWF	9890111	BLUE	WIDE FLOOD
PCV-8500YWF	9890142	YELLOW	WIDE FLOOD
PCV-8500RWF	9890456	RED	WIDE FLOOD
PCV-8500EL	9890081	CLEAR	ELLIPTICAL
PCV-8500BEL	9890869	BLUE	ELLIPTICAL
PCV-8500YEL	9890159	YELLOW	ELLIPTICAL
PCV-8500REL	9890425	RED	ELLIPTICAL
PCV-8500BL	9890876	BLACK	PROTECTIVE

* Also compatible with HID-8500

XMITTER PRIME XTREME

ITEM #	PART #	FITS	COLOR	BEAM
PCV-P6BL	9156019	XIL-PX6*	BLACK	PROTECTIVE
PCV-P12BL	9156101	XIL-PX12*	BLACK	PROTECTIVE
PCV-P18BL	9156194	XIL-PX18*	BLACK	PROTECTIVE
PCV-P30BL	9156378	XIL-PX30*	BLACK	PROTECTIVE
PCV-P36BL	9156460	XIL-PX36*	BLACK	PROTECTIVE
PCV-P54BL	9156736	XIL-PX54*	BLACK	PROTECTIVE
PCV-P72BL	9157009	XIL-PX72*	BLACK	PROTECTIVE
PCV-P90BL	9888064	XIL-PX90*	BLACK	PROTECTIVE
PCV-P6Y	9166186	XIL-PX6*	YELLOW	SPOT
PCV-P12Y	9165288	XIL-PX12*	YELLOW	SPOT
PCV-P18Y	9165370	XIL-PX18*	YELLOW	SPOT
PCV-P30Y	9165554	XIL-PX30*	YELLOW	SPOT
PCV-P36Y	9165646	XIL-PX36*	YELLOW	SPOT
PCV-P54Y	9165912	XIL-PX54*	YELLOW	SPOT
PCV-P72Y	9166278	XIL-PX72*	YELLOW	SPOT
PCV-P90Y	9887883	XIL-PX90*	YELLOW	SPOT

* Compatible with all beam patterns

LED POD ACCENT LIGHTING

ABOUT ACCENT LIGHTING

Vision X offers a diverse line of accent pod lighting. Easily attract attention to your vehicle with the wide variety of colors. Each durable pod weighs in at one pound and features a strong black housing. Ideal for professional grade applications and weekend enthusiasts alike.

Solid-State Kits

Vision X Pro Pods are available in kits, featuring four universal pods each attached to a 10' cord. Pro Pods feature solid-state electronics, giving you a durable long lasting product.



Reinforced Mounting

Vision X Pro Pod LEDs each feature four equally distant mounting holes, allowing the light to be securely fastened to a large variety of surfaces and letting you put the light where it needs to be.

UNIVERSAL PRO PODS

LED POD PERFECT FOR ROCK LIGHTING OR COMPARTMENT LIGHTING

Impact Resistant Lens | Weatherproof Housing for All Conditions | 10' Cord

COLORS Amber, Blue, Green, Red, White	WARRANTY Extended	DIMENSIONS 1.76" Diameter
RAW LUMENS 140 lm (ea)	HOUSING Aluminum	METRIC 44.7mm Diameter

ITEM #	PART #	COLOR
XIL-PDA	9136219	AMBER
XIL-PDB	9136301	BLUE
XIL-PDG	9136394	GREEN

ITEM #	PART #	COLOR
XIL-PDR	9136486	RED
XIL-PDW	9136127	WHITE



ITEM #: XIL-PDW Shown
PART #: 9136127

UNIVERSAL PODS

COLORED LED LIGHTING FOR ANY APPLICATION

Impact Resistant Acrylic Lens | Weatherproof Housing for All Conditions | 10' Cord

COLORS Amber, Blue, Green, Red, White	WARRANTY Standard	DIMENSIONS 1.25" Diameter
HOUSING Aluminum	HOUSING Aluminum	METRIC 31.75mm Diameter

ITEM #	PART #	COLOR
HIL-DA	4004078	AMBER
HIL-DB	4004139	BLUE
HIL-DG	4004146	GREEN

ITEM #	PART #	COLOR
HIL-DR	4004061	RED
HIL-DW	4004054	WHITE



ITEM #: HIL-DW Shown
PART #: 4004054

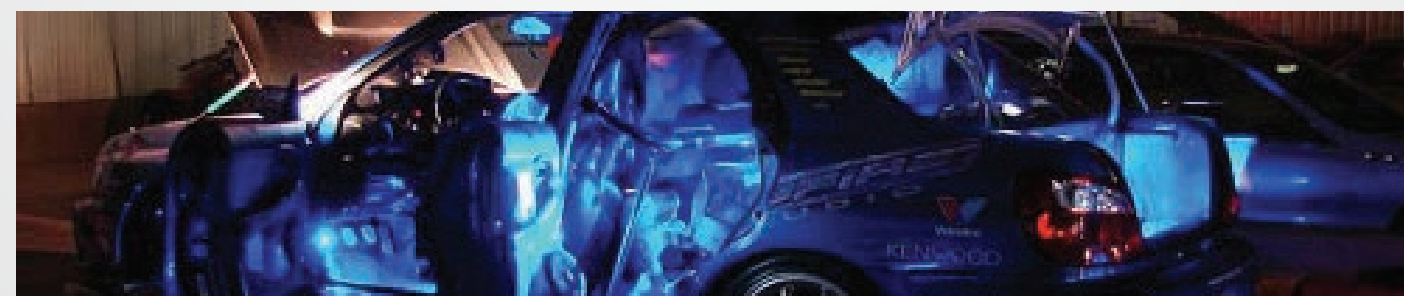

SUBAQUA



ITEM #: XIL-U40W Shown
PART #: 4008687

UNDERWATER LED MODULE FOR OE TRANSOM INTEGRATION

Transom LED Light | Submersible To 100 Feet | Multiple Colors Available

SUBMERSIBLE 100 Feet	WARRANTY Extended	DIMENSIONS 1.76" Diameter
RAW LUMENS 720 lm (ea)	COLORS White, Amber, Blue, Green, Red	METRIC 44.7mm Diameter
WEIGHT 0.41lb / 0.19kg		

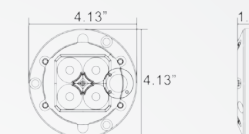
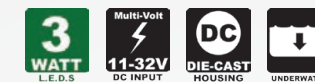

ITEM #	PART #	COLOR	BEAM	ITEM #	PART #	COLOR	BEAM
XIL-U40A	4008724	Amber	Euro	XIL-U41A	4008731	Amber	Flood
XIL-U40B	4008649	Blue	Euro	XIL-U41B	4008656	Blue	Flood
XIL-U40G	4008700	Green	Euro	XIL-U41G	4008717	Green	Flood
XIL-U40R	4008663	Red	Euro	XIL-U41R	4008670	Red	Flood
XIL-U40W	4008687	White	Euro	XIL-U41W	4008694	White	Flood

STRIP LIGHT



ITEM #: XIL-ST7.5 Shown
PART #: 9167626



ITEM #: XIL-ST12 Shown
PART #: 9141701

TOUCH ACTIVATED OR STANDARD COMMERCIAL DESIGN

Universal Application | Touch Activated Model Available | Compact Design

ACTIVATION MODES Touch On/Off, Hard-wired	WARRANTY Standard	HEIGHT 0.92"/23mm
RAW LUMENS 141-328lm (ea)	LENGTH 7.4", 11.9"	DEPTH 0.59"/15mm

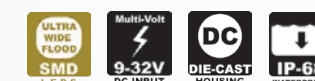

ITEM #	PART #	MODE	LENGTH	ITEM #	PART #	MODE	LENGTH
XIL-ST7.5	9167626	Touch	7.4"/189 mm	XIL-SL7.5	9167534	Standard	7.4"/189 mm
XIL-ST12	9141701	Touch	11.9"/303 mm	XIL-SL12	9141794	Standard	11.9"/303 mm



LED MOUNTING SOLUTIONS

Vision X offers a variety of mounts and adapters to help you put lights in more places. Each adapter allows you to add lights to spots that are normally out-of-bounds, and can bring light to clutch areas around your vehicle. For extra mounting options with light bars, pods and more, we've got the right solution for you.

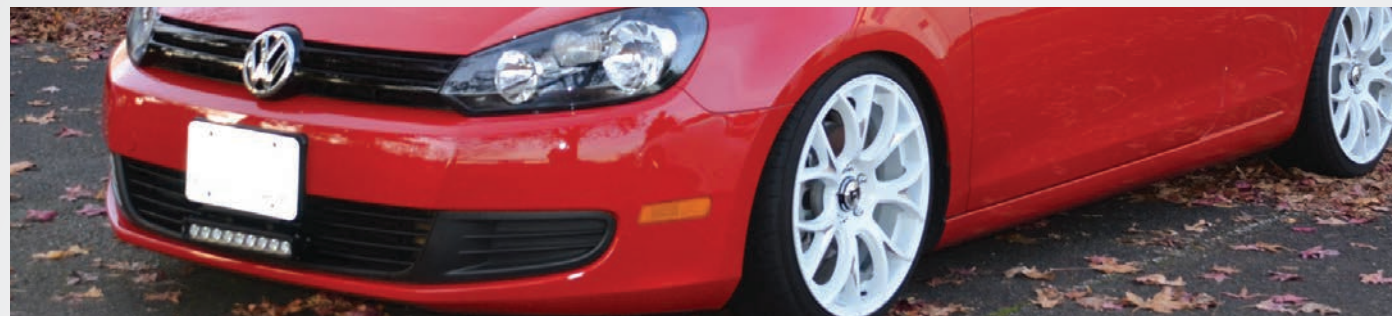

LICENSE PLATE MOUNT



ITEM #: XIL-LICENSEPLPX910 Shown
PART #: 9887012

LICENSE PLATE MOUNT

Holds Any LED Bar Up To 20" | Easily Installs Behind License Plate | Powder Coated

ITEM #	PART #	INCLUDED
XIL-LICENSEP	4000315	Bracket
XIL-LICENSEPLPX910	9887012	Bracket, XIL-LPX910 LED Bar & Harness

TOW HITCH MOUNT



ITEM #: XIL-SRECEIVER Shown
PART #: 4000322
Lights Not Included

TOW HITCH MOUNT

Machined 6061 Aluminum | 2 Bolt Mount for Class 1 or 2 Hitches | Use With Solo Pods

ITEM #	PART #	COLOR
XIL-SRECEIVER	4000322	Black

BACKUP LIGHT RECEIVER ADAPTER

Attaches to tow hitch for no-drill installation with Solo Pods for a combined 1800 lumens.



BILLET TUBE MOUNTS



Various Billet Mounts Shown

360° TUBE FRAME MOUNT SYSTEM

Includes All Hardware | Machined Billet 6061 Aluminum | Sold in Pairs

ITEM #	PART #	DIAMETER
XIL-B075	4006584	Dial 0.75" Tubing
XIL-B100	4006591	1.0" Tubing
XIL-B125	4006577	1.25" Tubing
XIL-B150	4006522	1.5" Tubing
XIL-B168	4006560	1 11/16" Tubing
XIL-B175	4006539	1.75" Tubing
XIL-B200	4006546	2.0" Tubing

SOLO FLUSH MOUNT



ITEM #: XIL-SFLUSHV2 Shown
PART #: 9887777

4" FLUSH MOUNT FOR SOLSTICE SOLO POD

Install Flush Into A 2.75" Hole | Ideal for Ceiling Mounts | Black Anodized Finish

ITEM #	PART #	DIAMETER
XIL-SFLUSH	4000315	3.68"/93.47 mm
XIL-SFLUSHV2	9887777	3.68"/93.47 mm
XIL-SFLUSH4	4008243	4.00"/101.6 mm

MAGNETIC BASE



ITEM #: P-UMB Shown
PART #: 4006225
Lights Not Included

UNIVERSAL TEMPORARY LIGHT MOUNT

Secure Light Temporarily | Multiple to Support Large Lights | Protective Rubber Boot

ITEM #	PART #	DIAMETER	INCLUDED
P-UMB.95	4009127	95 lb/43.09 kg	Magnet & Sleeve
P-UMB.65	4009110	65 lb/29.48 kg	Magnet & Sleeve
P-UMB	4006225	75 lb/34.02 kg	Magnet & Rubber Boot

END CAP MOUNTS



ITEM #: XIL-PECM Shown
PART #: 9889191

END CAP MOUNTS FOR LIGHT BARS

M10x1.5P 20mm Thread | Sold In Pairs | Ideal For Roof Mounting

ITEM #	PART #	DESIGNED FOR
XIL-LPECM	9888811	Xmitter Low Profile
XIL-PECM	9889191	Xmitter Prime
XPI-EM	9892917	XPR & XPI
XIL-ECM	9888781	Xmitter

PRIME DIMMER



ITEM #: XIL-PDIMMER Shown
PART #: 4009257

PUSH BUTTON OR DIAL DIMMER FOR PRIME LIGHTS
Push Button Dimmer | Designed for Prime Drive Lights | Dial Knob Dimmer

ITEM #	PART #	CONTROL	DIMMER RANGE	CORD LENGTH
XIL-PDIMMER	4009257	Dial Knob	50%-100%	5.50"/139.7mm
XIL-PDIMMERB	4009264	Button Knob	50% & 100%	5.50"/139.7mm

BATTERY PACKS

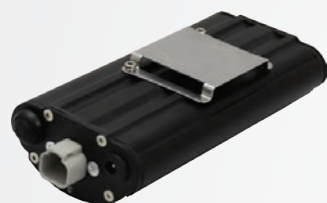

ITEM #: XPC-B30 Shown
PART #: 9130095

RECHARGEABLE POWER SOURCE FOR VISION X LIGHTS
Long Life Battery | Compatible with 12V Lights | Compact & Lightweight

ITEM #	PART #	MAX LOAD	CAPACITY	SOLO RUN TIME	WEIGHT
XPC-B22	4009080	5A	2.2Ah	3 Hours	1.15 lb
XPC-B30	9130095	5A	3.1Ah	5 Hours	1.15 lb
XPC-B65	4009097	8A	6.5Ah	6 Hours	1.00 lb
XPC-B86	4003392	10A	8.6Ah	13 Hours	2.00 lb

12V SMART CHARGER



ITEM #: XPC-C120 Shown
PART #: 4009073

BATTERY MAINTENANCE PULSE CHARGER
Quick Charge | Can Charge Battery Via Cigarette Lighter | Spark & Polarity Protection

ITEM #	PART #	MAX LOAD	SOLO RUN TIME	WEIGHT
XPC-C120	4009073	110V AC	12V DC	1.00 lb
XPC-C120.220V	9130187	220V AC	12V DC	1.00 lb

UNIVERSAL HARNESS



ITEM #: P-HARNESS.2XIL Shown
PART #: 4006201

UNIVERSAL WIRING HARNESS
30A 12V Relay Included | Heavy Duty Toggle Switch | Weatherproof Deutsch Connectors

ITEM #	PART #	CONNECTORS	APPLICATION	LENGTH
P-HARNESS.2XIL	4006201	Terminals	2 Light Harness	3 Hours
P-HARNESS.XIL	4006195	Terminals	1 Light Harness	5 Hours
P-HARNESS.HO	9888354	Terminals	High Amp 1 Light Harness	6 Hours
P-DY2M1F	4006263	Deutsch DT Series	Y Adapter	13 Hours
P-UCA	4006218	Cigarette Adapter	Cigarette Power Cord	10'/3.05 m

OPTIMUS HANDLE



ITEM #: XIL-OP2HANDLE Shown
PART #: 9887098

OPTIMUS HANDLE FOR PORTABLE APPLICATIONS
Sure-Grip form | Convenient Handle for use with Optimus Series | Portable Application

ITEM #	PART #	FITS	COLOR
XIL-OP1HANDLE	9890173	Optimus Single & Optimus Round	Black
XIL-OP2HANDLE	9887098	Optimus Dual	Black

XIL-UM HANDLE



ITEM #: P-UM40HANDLE Shown
PART #: 9144498

UTILITY MARKET LIGHT ACCESSORY FOR ADDITIONAL APPLICATIONS
Sure-Grip form | Convenient Handle for use with UM Series | Portable Application

ITEM #	PART #	FITS
P-UM40HANDLE	9888361	UM40 & UMX40
P-UMHANDLE	9887111	UM44 & UMX44

SOLO MOUNTS



Various Solo Mounts Shown

SOLO MOUNTS
Combine with Vision X Battery Packs | Portable On-The-Go Lighting | Extends Applications

ITEM #	PART #	USE
XIL-SHANDLE	4002685	Pistol Grip Handle
XIL-SHELMET	4002753	Helmets
XIL-SHANDLEBAR	4002746	Handlebars
XIL-SCLAMP	9117942	Tube Mounting 0.75"-1.25"
XIL-SCOMBO	4002739	Helmets + Handlebars

MINI SOLO MOUNTS



Various Mini Solo Mounts Shown

MINI SOLO MOUNTS
Combine with Vision X Battery Packs | Portable On-The-Go Lighting | Extends Applications

ITEM #	PART #	USE
XIL-MXHANDLEBAR	9145570	Handlebars
XIL-MXHELMET	9145488	Helmets
XIL-MXCOMBO	9145396	Helmets + Handlebars
XIL-MXCLAMP	9119205	Tube Mounting 0.75"-1.25"