



WGP MX2
TEAM SUZUKI
JEREMY SEEWER

2018

ZETA
HIGH PERFORMANCE PRODUCTS

DRC
HARDWARE

CATALOG



YOSHIMURA SUZUKI MOTUL RACING
Photo credit: Yoshimura Japan

JAPAN MOTOCROSS



YAMAHA FACTORY RACING TEAM



Kawasaki Team GREEN



TEAM SUZUKI



UZUSHIO RACING

WORLD MOTOCROSS



WMXGP 24MX HONDA RACING



WMXGP SUZUKI EUROPE

WMXGP
KEMEA RACING YAMAHA
SUZUKI REINECKE

MX NATIONALS
PENRITE HONDA RACING
DPH YAMAHA RACING

Photo by **HITOSHI KAJINO**



FMX Taka Higashino Brody Wilson **TEAM MX-VIRUS**
 Clinton Moore Keith Sayers **TEAM THUGWAY**



SUPER MOTARD Tomoyoshi Masuda
 Ikki Morita
 Naoto Takayama

ENDURO

Kenji Suzuki
 Yutaro Uchiyama
 Kyohei Hoshino
 Masahiro Kobayashi
 Tadashi Kugimura
 Hiroshi Yamamoto
 Seiji Numata



RALLY CRF250L Patric Trahan



MOTO AMERICA
YOSHIMURA SUZUKI FACTORY RACING



Photo credit: Yoshimura Japan

SUZUKA 8h
YOSHIMURA SUZUKI MOTUL RACING



MOTO AMERICA
YAMALUBE / WESTBY RACING TEAM



SUZUKA 8h
Kawasaki Team GREEN

Z ZETA	OFF
CONTROL	5-10
BARCLAMP	11-15
LEVER	16-21
FOOT PARTS	22-25
HAND GUARD	26-31
SUSPENSION	32-35
BODY GUARD	36-40
BODY	41-53
ACCESSORIES	54
Z CARBON	OFF
CARBON	55-58
Z WHEEL	OFF
STICKER	59
WHEEL	60-69
BRAKE DISC	70
BRAKE HOSE	71
STAND	OFF
STAND	72-73
TRANSPORT	74-77
TOOL	78-93
CONTROL	94-95
EXHAUST	96-97
ELECTRICAL	98-105
DRIVE	106-110
BODY	111-118
ACCESSORIES	119
DELTA	OFF
EXHAUST	120-121
COVER DECAL	OFF
COVER DECAL	122-123
MUDOFF	OFF
MUD PARTS	124-125
INNER WEAR	OFF
INNER WEAR	126-129
Z ZETA	STREET
CONTROL	130-135
LEVER	136-141
BODY	142-149
ELECTRICAL	150
Z ZETA	OFF/STREET
TITANIUM	151-162

WR250R Retro



* Graphic decals are not included.

* Graphic decals are not included.

- WR250R/X retro kit available from Dirt Freak Japan.
- Kit comes with classic style tank, seat, side cover, radiator covers, front fender and head light unit.
- No need to make any modifications, just bolt on these products and transform your WR250R/X into a 1970's mx classic.

PRODUCT DETAILS



DM56-0100

WR-Retro Tank / Seat / Side Cover Kit

This kit comes with aluminium tank, complete seat, side cover and radiator cover.



DM56-0102

WR-Retro Front Fender / Light Kit

Kit comes with UFO vintage front fender and speedometer brackets and UFO head light kit.

SX-3

TAPER TUBE HANDLEBAR

7075-T6 ALUMINUM

ZETA
HIGH PERFORMANCE PRODUCTS
DIRT

YAMAHA FACTORY RACING TEAM
YUU HIRATA
JMX

ZETA SX-3 HANDLEBAR 1 1/8 in (28.6 mm)

- ZETA revolutionary over-sized handlebar.
- Tested and developed by Japanese factory riders.
- Made of A7075-T6 aluminum for strength and durability.
- Knurled grip area to resist slippage.
- Many bends available for MX racers, ED, Mini racer, Free style, Super Motard, and Trial.
- Includes large size foam bar pad.
- Available in black, red and blue colors.

- 1 Black
- 2 Blue
- 3 Red

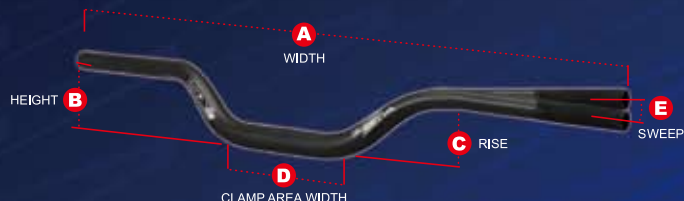

Model	Part #	Handlebar dimensions					Color			Approximate bend
		A	B	C	D	E	1	2	3	
MX-111	ZE06-111 #	806	83	49	215	53	1	2	3	CR/CRF-Low, KXF-Low
MX-123	ZE06-123 #	806	98	64	215	53	1	2	3	CR125R/250R'04-07, CRF250R'04-17, CRF450R'04-18, CRF450RX'17-18, KX125/250/250F/450F'06-18, KLX450R'08-09
MX-214	ZE06-214 #	803	95	57	213	54	1	2	3	KX125/250'03-05, RM125/250'02-05, RMZ250'04-06, KX250F'04-05
MX-313	ZE06-313 #	805	80	52	205	60	1	2	3	RM125/250'06-, RMZ250'07-18, RMZ450'05-17, RMX450Z'10-17, DRZ400SM, 125/150SX'08-12, 250SX'08-12, 250/350/450SX-F'08-12, 250XC-F'11-12, 350XC-F'12
MX-414	ZE06-414 #	803	84	55	209	49	1	2	3	YZ125/250'06-18, YZ250F'06-18, YZ450F'06-17, YZ125X'17-18, YZ250X'16-18, YZ250FX'15-18, YZ450FX'16-18, WR250F'13-18, WR450F'13-18
MX-542	ZE06-542 #	811	79	42	195	50	1			KTM SX/SX-F/XC-F'16-18
MX-543	ZE06-543 #	805	88	61	205	40	1			KTM EXC/EXC TPI/EXC-F/XC-W'16-18
Super-Low	ZE06-602 #	805	65	29	200	48	1			
ED-Medium	ZE06-635 #	815	88	68	205	72	1			
ED-High	ZE06-638 #	825	103	83	215	72	1			
Motard-High	ZE06-658 #	825	107	79	215	64	1			
Super Moto-Low	ZE06-661 #	800	80	45	200	62	1			
Super Moto-Medium	ZE06-665 #	800	95	60	200	62	1			
FMX	ZE06-671 #	802	108	70	220	54	1			EIGO SATO MODEL
FMX-TAKA	ZE06-674 #	777	123	70	228	56	1			TAKA HIGASHINO MODEL
Trial Competition	ZE06-754 #	797	99	62	178	45	1			FUMITAKA NOZAKI MODEL
Mini Racer-Low	ZE06-922 #	740	95	62	190	55	1			RM85, KX85
Mini Racer-Medium	ZE06-931 #	750	110	77	195	55	1			CR85, CRF150R, YZ85
Mini Racer-HIGH	ZE06-942 #	760	125	92	205	55	1			

#Add color number to complete number for ordering.



Tapered handlebar provides high rigidity and shock absorption.



Comes with large foam SX Bar pad.



Plastic bar end caps installed.

CONTROL

BARCLAMP

LEVER

FOOT PARTS

HAND GUARD

SUSPENSION

BODY GUARD

BODY

ACCESSORIES

CARBON

UZUSHIO RACING JMX

YUUI HOSHINO

7075-T6
ALUMINUM

CX
COMP-X HANDLEBAR

CONTROL

BARCLAMP

LEVER

FOOT PARTS

HAND GUARD

SUSPENSION

BODY GUARD

BODY

ACCESSORIES

CARBON



- 1 Black
- 2 Blue
- 3 Red

**ZETA
CX HANDLEBAR 7/8 in (22.2 mm)**

- ZETA 22.2 mm handlebar for top riders.
- Made of durable 7075 - T6 aluminum with brace on the handlebar to provide direct control.
- Laser printed logos and handlebar positioning gauge for accurate handlebar position setting.
- Knurled grip area to resist slippage.
- Comes with plastic bar end cap and comp handlebar pad.
- Many bends available for MX racers, ED, Mini racers, Super motard and Trial.
- Available in black, red and blue colors.



Laser printed logos and handlebar positioning gauge for accurate handlebar position setting.



Comes with high gloss bar pad.



Plastic bar end caps installed.

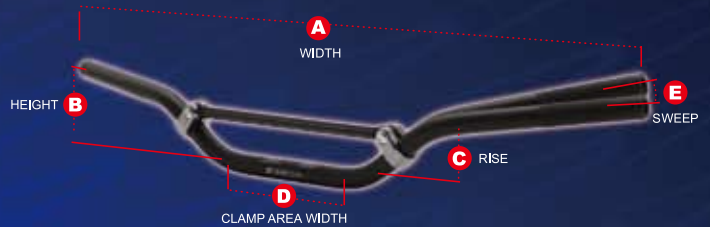

Model	Part #	Handlebar dimensions					Color	Approximate bend
		A	B	C	D	E		
MX-111	ZE09-111 #	806	83	49	215	53	1 2 3	CR/CRF-Low, KXF-Low
MX-121	ZE09-121 #	797	87	49	210	55	1	CR125R/250R'02-03, CRF450R'02-03
MX-123	ZE09-123 #	806	98	64	215	53	1 2 3	CR125R/250R'04-07, CRF250R'04-17, CRF450R'04-18, CRF450R'17-18, KX125/250/250F/450F'06-17, KLX450R'08-09
MX-214	ZE09-214 #	803	95	57	213	54	1 2 3	KX125/250'03-05, RM125/250'02-05, RMZ250'04-06, KX250F'04-05
MX-412	ZE09-412 #	800	90	63	213	58	1 2 3	YZ125/250/250F/450F'03-05, WR250F/450F03-05
Dual Sport-Low	ZE09-641 #	800	75	46	200	78	1 2 3	XR250/Baja/Motard, XR230/Motard, SEROW225
Dual Sport-Medium	ZE09-645 #	800	90	61	200	78	1 2 3	DRZ400S/SM, KLX250'07, D-TRACKER'07, CRF250L/M
Super Moto-Low	ZE09-661 #	800	80	45	200	62	1 2 3	SEROW250
Super Moto-Medium	ZE09-665 #	800	95	60	200	62	1 2 3	KLX250'08-15, D-TRACKER'08-15, WR250R/X
Mini Racer-Low	ZE09-922 #	740	95	62	190	55	1	RM85, KX85
Mini Racer-Medium	ZE09-931 #	750	110	77	195	55	1	CR85, CRF150R, YZ85
Mini Racer-HIGH	ZE09-942 #	760	125	92	205	55	1	

#Add color number to complete number for ordering.



ZETA
COMP HANDLEBAR 7/8 in (22.2 mm)

- Upgrade comp handlebar for all riders.
- Made of a strong and durable material.
- Available in titanium, red and blue anodized colors.
- Knurled grip area to resist slippage.
- Comes with plastic bar end caps.
- Laser printed position grid.

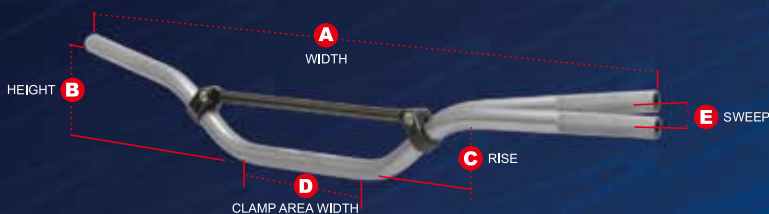

Model	Part #	Handlebar dimensions					Color	Approximate bend
		A	B	C	D	E		
Dual Sport-Low	ZE07-641#	800	75	46	200	78	2 3 8	XR250/Baja/Motard, XR230/Motard, SEROW225
Dual Sport-Medium	ZE07-645#	800	90	61	200	78	2 3 8	DRZ400S/SM, KLX250-'07, D-TRACKER-'07, CRF250L/M
Motard-Low	ZE07-661#	800	80	45	200	62	2 3 8	SEROW250
Motard-Medium	ZE07-665#	800	95	60	200	62	2 3 8	KLX250'08-16, D-TRACKER'08-16, WR250R/X
50-Mini	ZE07-902#	715	215	193	145	40	8	CRF50, TTR50, DRZ50/70
110-Mini	ZE07-904#	743	173	144	190	45	8	KLX110/L
Mini-Trail	ZE07-993#	775	106	80	181	60	2 3 8	KLX125, D-TRACKER125, KLX150S, XTZ125

#Add color number to complete number for ordering.



ZETA
COMP BAR PAD

- Provides rider protection while padding the bar mount area.
- Graphics resistant to power washers and stains.
- Available in 4 colors.

Standard size	254 mm (10")	Mini size	220 mm (8.8")
Part number	ZE47-9131	Color	Blue
	ZE47-9132	Color	Black
	ZE47-9133	Color	Red
	ZE47-9136	Color	White



Plastic bar end caps installed.



Laser printed logos and handlebar positioning gauge for accurate handlebar position setting.

CONTROL

BARCLAMP

LEVER

FOOT PARTS

HAND GUARD

SUSPENSION

BODY GUARD

BODY

ACCESSORIES

CARBON

RACE GRIPS



ZETA RACE GRIPS

- Dual compound motocross and enduro racing grip available from ZETA.
- Grip body in gray is made of soft compound to reduce shock, while durable inner layer and grip end improve bar adhesion and give longer grip life.
- The upper half anti-slip diamond pattern provides greater grip, while the waffle pattern on the lower half provides excellent finger grip.
- Incorporates 3 safety wire grooves to allow accurate and secure grip placement.
- Available in 4 different colors.
- Length 119 mm

CONTROL



BARCLAMP



LEVER



FOOT PARTS



HAND GUARD



SUSPENSION



BODY GUARD



BODY



ACCESSORIES



CARBON



CLOSED END

Part number	Color
ZE47-5000	Black / Gray
ZE47-5002	Red / Gray



OPEN END

Part number	Color
ZE47-5100	Black / Gray
ZE47-5102	Red / Gray
ZE47-5103	Orange / Gray
ZE47-5106	Blue / Gray



Twist half waffle pattern
Lower twist half waffle pattern for better finger grip.

Bar end cutting line
Easy to cut grip bar end for installing aluminum hand guards.

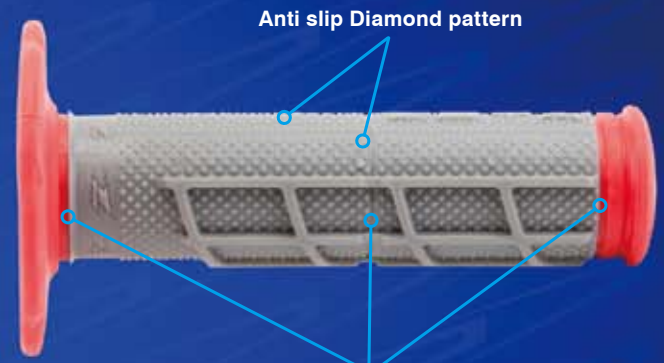

Anti slip Diamond pattern

3 safety wire grooves

	Year	Standard	Quick	Closed	
HONDA	CRF150R	07-18	ZE45-5015	-	
	CRF250R/X	04-17	ZE45-5007	ZE45-5207	
	CRF450R	04-18	ZE45-5007	ZE45-5207	
	CRF450RX	17-18	ZE45-5007	ZE45-5207	
	CRF450X	05-17	ZE45-5007	ZE45-5207	
	CRF250L/M	12-17	ZE45-5024	-	
	CRF250RALLY	17	ZE45-5024	-	
	CRF1000L	16-17	ZE45-5024	-	
	YAMAHA	YZ250F	98-11	ZE45-5001	ZE45-5101
		YZ250F	12-18	ZE45-5014	ZE45-5214
YZ400F-450F		98-13	ZE45-5001	ZE45-5101	
YZ450F		14-15	ZE45-5014	ZE45-5214	
YZ450F		16-18	ZE45-5001	ZE45-5201	
YZ250FX		15-18	ZE45-5014	ZE45-5214	
YZ450FX		16-18	ZE45-5014	ZE45-5214	
WR250F		01-14	ZE45-5001	ZE45-5101	
WR250F		15-18	ZE45-5014	ZE45-5214	
WR400F-450F		98-15	ZE45-5001	ZE45-5101	
KAWASAKI	SEROW225/250,TRICKER	16-18	ZE45-5014	ZE45-5214	
	SEROW225/250,TRICKER	00-17	ZE45-5001	ZE45-5101	
	XT250X	06-17	ZE45-5001	ZE45-5101	
	WR250R/X	07-17	ZE45-5001	ZE45-5101	
	KX250F	04-18	ZE45-5001	ZE45-5101	
	KX450F	06-18	ZE45-5001	ZE45-5101	
	KLX450R	08-09	ZE45-5001	ZE45-5101	
	KLX125	10-16	ZE45-5001	ZE45-5101	
	D-TRACKER125	09-13	ZE45-5001	ZE45-5101	
	KLX150S	93-03	ZE45-5001	ZE45-5101	
SUZUKI	KLX250	04-16	ZE45-5001	ZE45-5101	
	D-TRACKER/X	04-06	ZE45-5001	ZE45-5101	
	RMZ250	07-18	ZE45-5014	ZE45-5214	
	RMZ250	05-06	ZE45-5001	ZE45-5101	
	RMZ450	07	ZE45-5014	ZE45-5214	
	RMZ450	08-18	ZE45-5001	ZE45-5101	
	RMX450Z	10-17	ZE45-5001	ZE45-5101	
	DRZ400R/S/M	00-17	-	ZE45-5111	
	DR250S/R	92-04	-	ZE45-5111	
	250SB	02-03	-	ZE45-5111	
KTM	85SX	04-06	ZE45-5001	ZE45-5101	
	125SX/XC-W	17-18	-	ZE45-5225	
	150SX/XC-W	17-18	-	ZE45-5225	
	250SX/EXC/XC/XC-W	17-18	-	ZE45-5225	
	300EXC/XC/XC-W	17-18	-	ZE45-5225	
	250SX-F/XC-F	06-15	ZE45-5021	-	
	250SX-F/XC-F	17-18	-	ZE45-5225	
	250EXC-FIXCF-W	06-16	ZE45-5021	-	
	250EXC-FIXCF-W	17-18	-	ZE45-5225	
	350SX-F/XC-F	11-15	ZE45-5021	-	
DUCATI	350SX-F/XC-F	17-18	-	ZE45-5225	
	350EXC-F/XCF-W	12-16	ZE45-5021	-	
	350EXC-F/XCF-W	17-18	-	ZE45-5225	
	450SX-F/XC-F	06-15	ZE45-5021	-	
	450SX-F/XC-F	17-18	-	ZE45-5225	
	450EXC/XC-W	06-16	ZE45-5021	-	
	450EXC/XC-W	17-18	-	ZE45-5225	
	400-530SX-R/EXC	04-16	ZE45-5021	-	
	400-530SX-R/EXC	17-18	-	ZE45-5225	
	FREERIDE250F	18	-	ZE45-5225	
FREERIDE350	13-17	ZE45-5021	-		
PULVERIZER	TC85	18	-	ZE45-5225	
	TC/TE/TX125-300	17-18	-	ZE45-5225	
	FC250-450	14-15	ZE45-5021	-	
	FC250-450	17-18	-	ZE45-5225	
	FE250-501	14-16	ZE45-5021	-	
	FE250-501	17-18	-	ZE45-5225	
	FX350-450	17-18	-	ZE45-5225	



Closed End

* Can not be removed end cap.
Replacement end cap is not available.

ZETA ALUMINIUM THROTTLE TUBE

- Made of A6061 aluminum with hard anodized finish.
- Removable end cap design allows the use with bar end plugs or aluminum hand guards.
- Quick turn throttle tubes available for dual sport models for better acceleration.
- Special tapered inside tube design keeps the distance between the throttle tube and handlebar, greatly reducing frictional resistance which allows for smoother acceleration.

Aluminum throttle tube cutaway view

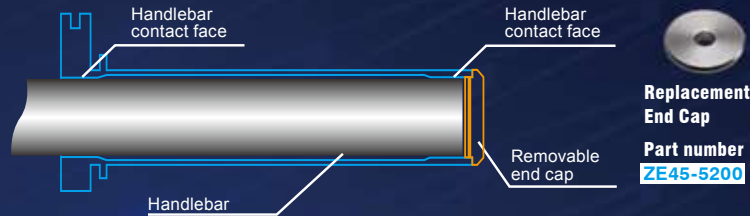

Replacement End Cap

Part number
ZE45-5200

	Year	Closed End	Open End
KAWASAKI	KX60/65/80/85/100	89-18	ZE45-8104
	KX125/250	92-02	ZE45-8008
	KX125/250	03-08	ZE45-8008
	KX250F	04-12	ZE45-8001
	KX250F	13	ZE45-8023
	KX450F	14-18	ZE45-8001
	KX450F	06-12	ZE45-8001
	KX450F	13	ZE45-8023
	KLX450R	14-18	ZE45-8001
	KLX450R	08-14	ZE45-8001
SUZUKI	KDX125/200/220/250	89-	-
	KLX110	10-17	ZE45-8104
	KLX125, D-TRACKER125	10-16	ZE45-8023
	KLX140	08-16	ZE45-8023
	KLX150S	09-13	ZE45-8002
	KLX150S	93-03	ZE45-8002
	KLX250, D-TRACKER	04-16	ZE45-8023
	RM80/85	95-17	ZE45-8008
	RM125/250	95-08	ZE45-8008
	RMZ250	04-06	ZE45-8001
YAMAHA	RMZ250	07-18	ZE45-8014
	RMZ250	05-06	ZE45-8001
	RMZ450	07	ZE45-8014
	RMZ450	08-18	ZE45-8001
	RMX450Z	10-17	ZE45-8001
	TS125/200/R	89-97	-
	RMX250S/R	89-98	-
	DRZ125	01-16	ZE45-8104
	DR250S/R	92-04	ZE45-8011
	DRZ400S/R/SM	00-17	ZE45-8011
KTM	250SB	02-03	ZE45-8002
	250SB	04-06	ZE45-8023
	50SX	12-18	ZE45-8022
	65SX	09-18	ZE45-8022
	85SX	04-17	ZE45-8020
	125-300SX/EXC/XC/XC-W	04-16	ZE45-8020
	250SX-F/XC-F	16-18	ZE45-8025
	250EXC-FIXCF-W	06-16	ZE45-8021
	350SX-FIXCF-W	17-18	ZE45-8025
	350SX-FIXCF-W	11-15	ZE45-8021
DUCATI	450SX-FIXCF-W	16-18	ZE45-8025
	450EXC/XC-W	12-16	ZE45-8021
	450EXC/XC-W	17-18	ZE45-8025
	450SX-FIXCF-W	06-15	ZE45-8021
	450EXC/XC-W	06-16	ZE45-8021
	500EXC-F	17-18	ZE45-8025
	400-530SX-R/EXC/XC-W	04-16	ZE45-8021
	FREERIDE250F	18	ZE45-8025
	FREERIDE250R	14-17	ZE45-8020
	FREERIDE350	13-17	ZE45-8021
PULVERIZER	TC85	14-17	ZE45-8025
	TC85	18	ZE45-8025
	TC125/250	14-16	ZE45-8020
	TC125/250	17-18	ZE45-8025
	TE125-300	14-16	ZE45-8020
	TE125-300	17-18	ZE45-8025
	FC250-450	14-15	ZE45-8021
	FC250-450	16-18	ZE45-8025
	TX/FX125-450	17-18	ZE45-8025
	FE250-501	14-16	ZE45-8021
domino	17-18	ZE45-8031	



ZETA THROTTLE TUBE

- Replaces stock throttle tube.
- Teflon coated nylon fabric provides smooth acceleration.
- Open end type available for use with aluminum hand guards and bar ends.

	Bike	Year	Closed End	Open End
HONDA	CR80R/85R	90-07	ZE45-8006	ZE45-8106
	CRF150R	07-18	ZE45-8015	ZE45-8115
	CRF250R	04-17	ZE45-8007	ZE45-8107
	CRF450R	02-18	ZE45-8007	ZE45-8107
	CRF450RX	17-18	ZE45-8007	ZE45-8107
	CRF250X	04-17	ZE45-8007	ZE45-8107
	CRF450X	05-17	ZE45-8007	ZE45-8107
	CRM250	91-96	ZE45-8010	ZE45-8110
	CRM250	97-99	ZE45-8002	ZE45-8102
	CRF250L/M	12-17	ZE45-8024	ZE45-8124
YAMAHA	CRF250RALLY	17	ZE45-8024	ZE45-8124
	CRF1000L	16-17	-	ZE45-8124
	XR250/BAJA/MOTARD	95-07	ZE45-8013	-
	XR230/MOTARD	05-12	ZE45-8002	ZE45-8102
	XR400/MOTARD	05-07	ZE45-8002	ZE45-8102
	XR250R, XLR250	-94	ZE45-8002	ZE45-8102
	XR650R	00-07	ZE45-8002	ZE45-8102
	YZ80/85	93-18	ZE45-8012	-
	YZ125/250	96	ZE45-8008	ZE45-8103
	YZ125/250	97-18	ZE45-8009	ZE45-8109
YZ250F	01-11	ZE45-8001	ZE45-8101	
YZ400F-450F	12-18	ZE45-8014	ZE45-8114	
Y2450F	98-13	ZE45-8001	ZE45-8101	
Y2450F	14-15	ZE45-8014	ZE45-8114	
Y2125X	16-18	ZE45-8001	ZE45-8101	
Y2250X	17-18	ZE45-8009	ZE45-8109	
Y2250FX	16-18	ZE45-8009	ZE45-8109	
Y2450FX	15-18	ZE45-8014	ZE45-8114	
WR250F	01-14	ZE45-8001	ZE45-8101	
WR250F	15-18	ZE45-8014	ZE45-8114	
WR400F-450F	98-15	ZE45-8001	ZE45-8101	
WR400F-450F	16-18	ZE45-8014	ZE45-8114	
DT230 LANZA	97-	ZE45-8012	-	
SEROW225/250,TRICKER	00-17	ZE45-8001	ZE45-8101	
XT250X	06-17	ZE45-8001	ZE45-8101	
WR250R/X	07-17	ZE45-8001	ZE45-8101	



ZETA BAR END PLUGS SWIVEL

- Fits throttle tube and allows smoother throttle movement than standard bar end plug. (Installation on the clutch side is the same as the standard bar end plug.)
- Made of 6061-T6 aluminum. Diameter : 29 mm (1.15 inch)
- Comes in pairs.

29 mm

Part number	Color
ZE48-8101	Silver
ZE48-8103	Titanium
ZE48-8104	Gold
ZE48-8105	Black
ZE48-8106	Red
ZE48-8107	Blue

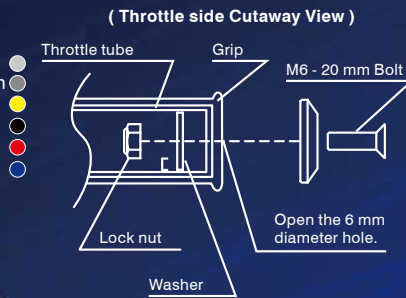

ZETA BAR END PLUGS 29 mm / 35 mm

- Prevents grip damage in the event of a fall.
- Light weight aluminum hardware.
- Available in 7 different colors for each size. (35 mm and 29 mm)
- Replacement parts available.

29 mm

Part number	Color
ZE48-7001	Silver
ZE48-7003	Titanium
ZE48-7004	Gold
ZE48-7005	Black
ZE48-7006	Red
ZE48-7007	Blue
ZE48-7009	Orange

35 mm

Part number	Color
ZE48-7101	Silver
ZE48-7103	Titanium
ZE48-7104	Gold
ZE48-7105	Black
ZE48-7106	Red
ZE48-7107	Blue
ZE48-7109	Orange

CONTROL

BARCLAMP

LEVER

FOOT PARTS

HAND GUARD

SUSPENSION

BODY GUARD

BODY

ACCESSORIES

CARBON

ZETA BAR END SLIDER

- Bar end slider made of durable POM material.
- Protects your throttle tube and grips from damages in a crash.
- Can be used on handlebar inner diameter sizes from 13.5 mm to 19 mm

Part number	Color
ZE48-0010	Black



ZETA ROTATING BAR CLAMP UN

- Universal rotating bar clamp. Bolts on to your existing perch.
- Includes nylon sleeve to insert between the clamp and your bar allowing the perch to rotate upon impact.
- Made of A7009-T6 aluminum.

Part number	Color	Part number	Color
ZE40-9111	Titanium	ZE40-9098	Replacement Nylon sleeve 180°
ZE40-9112	Red		
ZE40-9113	Blue		
ZE40-9114	Orange		

ZETA ROTATING BAR CLAMP MH

- Universal rotating bar clamp with mirror hole (10 mm). Bolts on to your existing perch.
- Includes nylon sleeve to insert between the clamp and your bar allowing the perch to rotate upon impact.
- Made of A7009-T6 aluminum.

Part number	Color	Part number	Color
ZE40-9411	Titanium	ZE40-9098	Replacement Nylon sleeve 180°
ZE40-9412	Red		
ZE40-9413	Blue		

ZETA ROTATING BAR CLAMP HS

- Universal hot starter lever with rotating bar clamp.
- Bolts on to your existing brake master cylinder or clutch perch.
- Re-locates the stock hot start lever over to the right or left side perch for easy access.
- Includes nylon sleeve to insert between the clamp and your bar allowing the lever perch to rotate upon impact.

Part number	Color	Part number	Color
ZE40-9211	Titanium	ZE40-9098	Replacement nylon sleeve 180°
ZE40-9212	Red		
ZE40-9213	Blue		

ZETA GRIP PADS

- Made of Neoprene rubber, installed at base of grips.
- Prevents blisters on your thumbs.

Part number	Color
ZE49-9303	Black / Red



ZETA KILL SWITCH

- Engine kill switch with bar clamp, bolt on to clutch Perch.
- Saves space on your handlebar.
- Bar clamp body is made of aluminum with titanium-color anodized finish.
- Comes with plug type terminals for installation.
- Made of A7009-T6 aluminum CNC machined.

Part number	Description
ZE51-1201	YZ / YZF (-08) , KX / KXF , RMZ





**Bar Rise Kit 7/8 in (28.6 mm)
H 19 mm**



**Bar Rise Kit 7/8 in (22.2 mm)
H 30 mm**

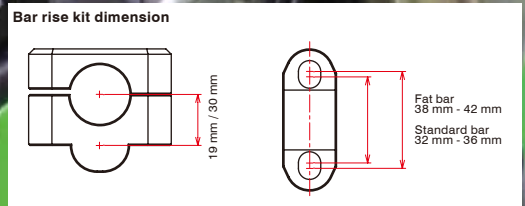

**Bar Rise Kit Offset 7/8 in (22.2 mm)
H 26 mm**



KX85/100



H : 19 mm H : 30 mm

ZETA
BAR RISE KIT 1 1/8 in (28.6 mm)

- Universal bar riser kit for over sized (28.6 mm, 1 1/8") bar mount.
- Provides 19 mm and 30 mm higher bar position than stock bar position.
- For use on dirt bikes and ATVs.
- Comes with bar clamp bolts.
- Made of A7009-T6 aluminum.

Part number	Size
ZE53-0219	H : 19 mm
ZE53-0230	H : 30 mm



H : 19 mm H : 30 mm

ZETA
BAR RISE KIT 7/8 in (22.2 mm)

- Universal bar riser kit for standard sized (22.2 mm, 7/8") bar mount.
- Provides 19 mm and 30 mm higher bar position than stock bar position.
- For use on dirt bikes and ATVs.
- Comes with bar clamp bolts.
- Made of A7009-T6 aluminum.

Part number	Size
ZE53-0119	H : 19 mm
ZE53-0130	H : 30 mm



ZETA
BAR RISE KIT OFFSET 7/8 in (22.2 mm)

- Handlebar rise and offset kit.
- Provides 26 mm higher, 20 mm back and forth positions from stock handlebar position.
- Great to use for 85 / 150 cc tall rider with 20 mm forward position.
- Can be used with 22.2 mm OE bar clamp models with bar clamp width in between 32 mm to 36 mm.

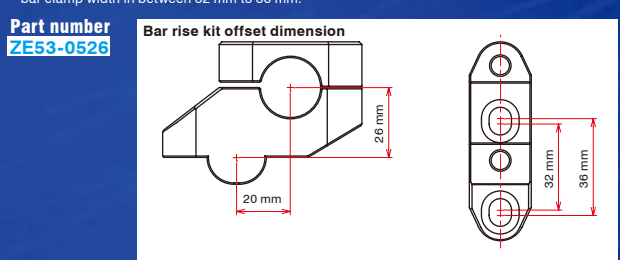

CONTROL

BARCLAMP

LEVER

FOOT PARTS

HAND GUARD

SUSPENSION

BODY GUARD

BODY

ACCESSORIES

CARBON

HANDLEBAR CLAMP KIT

- Adjustment system to fit each rider's size, style and type of riding .
- The innovative adjusting system gives you the option of 8 different " back and forth " positions . (Maximum)
- The optional lower clamp enables a total of 4 different heights .
- Provides 32 different positions to fit anyone's needs . (Maximum)
- Made of CNC machined A7009-T6 aluminum.
- Available for SX over-sized bars and Comp standard-sized bars as well .



CRF250R/450R
ZE11-1125



CRF250R/450R
ZE11-1124



Specially designed lower bar clamp provides the option of 8 different back and forth positions in 5 mm increments. (Maximum)



One piece stabilizer is set by 4 special bolts. To securely mount handlebar, the clamp is designed to be tightened first with the 2 front side bolts, then the 2 rear side bolts.



Reinforcing ribs are positioned for maximized strength and minimized weight.



The one-piece upper bar clamp helps stabilize handlebar and prevents bar twist when falling down.



The two holes allow 2 back and forth positions of the handlebar clamp on the top clamp. Utilizing the optional lower clamp enables different handlebar height positions.



Front fork clamp area designed to securely clamp the front fork. Specially designed Front fork bolts are made of stainless to prevent corrosion.

Bike (Competition)	Year	Part #		Bar Clamp Size (mm)		
		SX	COMP	Upper	Lower	
HONDA	CR85R	03-07	ZE11-1081	ZE12-1081	80	50
	CRF150R	07-18	ZE11-1081	ZE12-1081	80	50
	CR125R/250R	00-07	ZE11-1122	ZE12-1122	90	35
		04-07	ZE11-1122	ZE12-1122	90	35
	CRF250R	08-09	ZE11-1123	ZE12-1123	90	35
		10-17	ZE11-1124	-	90	35
	CRF250R(Red)	10-17	ZE11-1125	-	90	35
		02-07	ZE11-1122	ZE12-1122	90	35
	CRF450R	08	ZE11-1123	ZE12-1123	90	35
		09-16	ZE11-1124	-	90	35
	CRF450R(Red)	09-16	ZE11-1125	-	90	35
	CRF110F(Red)	13-16	ZE11-1102	ZE12-1102	80	35
	CRF125F(Red)	14-18	ZE11-1102	ZE12-1102	80	35
	CRF230F	03-15	ZE11-1235	ZE12-1235	90	35
YAMAHA	YZ80/85	93-18	ZE11-4081	ZE12-4081	80	50
	YZ125/250	06-18	ZE11-4124	ZE12-4124	90	35
	YZ125X	17-18	ZE11-4124	ZE12-4124	90	35
	YZ250X	16-18	ZE11-4124	ZE12-4124	90	35
	YZ250F	06-08	ZE11-4124	ZE12-4124	90	35
		09-11	ZE11-4127	-	90	40
	YZ450F	06-08	ZE11-4124	ZE12-4124	90	35
		09	ZE11-4127	-	90	40
		05	-	ZE12-4123	90	35
	WR250F	07-14	ZE11-4126	ZE12-4126	90	35
WR450F	05	-	ZE12-4123	90	35	
	07-11	ZE11-4126	ZE12-4126	90	35	
KAWASAKI	KX80/85/100(Black)	98-18	ZE11-2082	ZE12-2082	80	50
		06-08	ZE11-2125	ZE12-2125	90	35
	KX250F	09-10	ZE11-2129	-	90	35
		06-08	ZE11-2126	ZE12-2126	90	35
SUZUKI		09-12	ZE11-2128	-	90	35
	RM85	02-17	ZE11-3081	ZE12-3081	80	50
	RM125	05-08	ZE11-3122	ZE12-3122	90	40
	RM250	04-08	ZE11-3122	ZE12-3122	90	40
	RMZ250	07-15	ZE11-3123	ZE12-3123	90	40
RMZ450	05-09	ZE11-3123	ZE12-3123	90	40	

Bike (Competition)	Year	Part #		Bar Clamp Size (mm)		
		SX	COMP	Upper	Lower	
HONDA	CRM250R/AR	94-98	ZE11-1252	ZE12-1252	90	35
	CRF250L/M(Red)	12-16	ZE11-1255	-	90	35
	CRF250L/M/RALLY(Red)	17	ZE11-1256	ZE12-1256	90	35
	XR50/100 MOTARD	05-07	-	ZE12-1053	80	35
	XR250/MOTARD	03-07	ZE11-1252	ZE12-1252	90	35
	XR400 MOTARD	05-08	ZE11-1252	ZE12-1252	90	35
	TRICKER	04-17	ZE11-4232	ZE12-4232	80	35
YAMAHA	SEROW250	05-17	-	ZE12-4233	80	35
	XT250X	06-17	-	ZE12-4233	80	35
	WR250R/X(Blue)	07-17	ZE11-4252	ZE12-4252	90	35
KAWASAKI	KLX250/D-TRACKER	98-07	ZE11-2253	ZE12-2253	90	35
		08-16	ZE11-2254	ZE12-2254	90	35
SUZUKI	250SB	02-06	ZE11-2253	ZE12-2253	90	35
	DRZ400SM(Black)	04-17	ZE11-3403	-	90	40

Bike (Competition)	Year	Part #	Bar Clamp Size (mm)		
		COMP	Upper	Lower	
HONDA	CRF50F	04-17	ZE12-1052	-	-
YAMAHA	TT-R50E	06-15	ZE12-4051	-	-
KAWASAKI	KLX110/L	02-18	ZE12-2101	80	35
SUZUKI	DRZ50/70	08-15	ZE12-3051	-	-



KX80/85/100(COMP)
ZE11-2082

CONTROL

BARCLAMP

LEVER

FOOT PARTS

HAND GUARD

SUSPENSION

BODY GUARD

BODY

ACCESSORIES

CARBON

ZETA TRIPLE CLAMP KIT

- Complete triple clamp kits for CRF250L/M/RALLY, WR250R/X and DRZ400SM.
- Clamp body is made of CNC machined durable aluminum with beautiful anodized finish.
- Comes with upper and lower clamps, stem shaft, stem nuts and SX bar size (28.6 mm) clamp.

Part number	Bike	Year	Color
ZE14-1255	CRF250L/M	12-16	Red
ZE14-1256	CRF250L/M/RALLY	17	Red
ZE14-3403	DRZ400SM	07-17	Black
ZE14-4252	WR250R/X	07-17	Blue
ZE14-4253	WR250X (3 mm offset)	04-17	Black

CAUTION

- This kit does not come with stem bearings.
- OE lower clamp bearing, dust seal and 2 of main switch mount bolts may be required for installing this top triple clamp kit.
- Press fit machine or special bearing installation tool would be required for lower clamp bearing installation.



WR250X
BLACK(3MM OFFSET)

WR250R/X
BLUE

DRZ400SM
BLACK

CRF250L/M
RALLY
RED

WR250X 3 mm OFFSET CLAMP

3 mm front fork offset clamp increases trail amount, provides quicker and more stable handling for super moto riding.

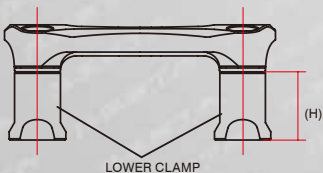

LOWER CLAMP



H 50 mm SX

H 35 mm SX

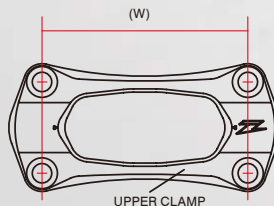

UPPER CLAMP



80 mm

90 mm

ZETA OPTION LOWER CLAMP

- Optional lower clamps for adjusting the height of handlebar.
- Available in 4 different heights.
- Set-ups range from 35 mm to 65 mm in 10 mm increments.

SX (For 28.6 mm / 1 1/8" bars)

Part number	Height
ZE31-4235	35 mm (1.2")
ZE31-4240	40 mm (1.6")
ZE31-4250	50 mm (2.0")
ZE31-4265	65 mm (2.6")

COMP (For 22.2 mm / 7/8" bars)

Part number	Height
ZE31-4135	35 mm (1.2")
ZE31-4140	40 mm (1.6")
ZE31-4150	50 mm (2.0")
ZE31-4165	65 mm (2.6")

ZETA OPTION UPPER CLAMP

- Replacement stabilizer for ZETA handlebar clamp kit.
- Use with optional lower bar clamp when changing bar size.

SX (For 28.6 mm / 1 1/8" bars)

Part number	Wide
ZE31-3180	80 mm (3.2")
ZE31-3190	90 mm (3.5")

COMP (For 22.2 mm / 7/8" bars)

Part number	Wide
ZE31-2180	80 mm (3.2")
ZE31-2190	90 mm (3.5")

CONTROL

BARCLAMP

LEVER

FOOT PARTS

HAND GUARD

SUSPENSION

BODY GUARD

BODY

ACCESSORIES

CARBON



ZE32-4011

ZETA
RX CLAMP KIT

- Designed for easy installation of over-sized bars (1 1/8") to stock rubber-mounted top clamp.
- Accepts 28.6 mm (1 1/8") handlebars with OEM triple clamps.
- The one-piece top bar mount helps stabilize rubber-mounted bars.
- Made of CNC machined A7009-T6 aluminum.

	Bike	Year	Part number
HONDA	CR125R	00-07	ZE32-4011
	CR250R	99-07	
	CRF250R	04-17	
	CRF450R	02-18	
	CRF450RX	17-18	
	CRF250X	04-17	
YAMAHA	WR250R/X	07-17	ZE32-4045
	KX125	06-08	ZE32-4051
KX250	05-08		
KAWASAKI	KX250F*1	05-12	
		15-18	
	KX450F*2	06-16	
SUZUKI	RMZ250	05-06	ZE32-4051

*1 2012-2015 model can set only near side.
*2 2015-2018 model can set only near side.



CRF450R



CONTROL

BARCLAMP

LEVER

FOOT PARTS

HAND GUARD

SUSPENSION

BODY GUARD

BODY

ACCESSORIES

CARBON



ZE32-4201

ZE32-4245

ZETA
RX2 CLAMP KIT

- Two-piece handlebar clamp kit developed for easy installation of over-sized bars (1 1/8") to stock rubber-mounted top clamp.
- Specially designed bolts enable three different back and forth positions (stock , stock + / - 4 mm)
- Available for CR, CRF, KX, KXF and WR250R / X .
The height is not adjustable.
- WR250R / X clamp is 10 mm higher than stock bar position.

WR250R

	Bike	Year	Part #
HONDA	CR125R	00-07	ZE32-4201
	CR250R	99-07	ZE32-4201
	CRF250R	04-17	ZE32-4201
	CRF450R	02-18	ZE32-4201
	CRF450RX	17-18	ZE32-4201
	CRF250X	04-17	ZE32-4201
	CRF450X	05-17	ZE32-4201
YAMAHA	WR250R/X #	07-17	ZE32-4245
KAWASAKI	KX125	06-08	ZE32-4201
	KX250	05-08	ZE32-4201
	KX250F	05-18	ZE32-4201
	KX450F	06-18	ZE32-4201
SUZUKI	RMZ250	05-06	ZE32-4201



ZE37-0311

ZE37-0322

ZE37-0352

ZETA
RUBBER KILLER

- Solid cones for rubber bar mounted stock triple top clamps.
- Provides direct control and prevents bar twist when falling down.
- Finished in anodized red and blue colors.
- Comes in a set of 4 solid cones.
- Made of A7009-T6 aluminum.

	Bike	Color	Part #
HONDA	CR125R '00-, CR250R '99-, CRF250R '04-, CRF450R '02-, CRF450RX '17-	Red	ZE37-0311
YAMAHA	YZ250F '14-, YZ450F '14-, YZ250FX '15-, YZ450FX '16-, WR250F '15-, WR450F '16-	Blue	ZE37-0341
KAWASAKI	KX125 '02-, KX250 '96-, KX250F '04-14, KX450F '06-11, RMZ250 '04-'06, KLX125 '10-, KLX150S '09-, D-TRACKER125 '10-	Red	ZE37-0321
	KX250F '15-, KX450F '12-	Blue	ZE37-0322
SUZUKI	RM125 '05-, RM250 '02-, RMZ250 '07-, RMZ450 '05-, RMX450Z '10-, DRZ400SM '05-	Red	ZE37-0331
HUSQVARNA	TC125 '16-, TC250 '16-, FC250 '16-, FC350 '16-, FC450 '16-	Blue	ZE37-0351
KTM	125SX '16-, 150SX '16-, 250SX '16-, 250SX-F '16-, 350SX-F '16-, 450SX-F '16-	Orange	ZE37-0352



ZE33-3100

YZ250F



ZETA
SX STABILIZER 1 1/8 in (28.6 mm)

- One-piece top bar mount for oversized 1/18" bars.
- Improves steering control and rigidity.
- Comes with bar clamp bolts.
- Made of CNC machined A7009-T6 aluminum.

Bike	Year	SX	Size
YAMAHA			
YZ125/250	07-18	ZE33-3100	100
YZ125X	17-18	ZE33-3100	100
YZ250X	16-18	ZE33-3100	100
YZ250F	06-08	ZE33-3100	100
	14-18	ZE33-3103	103
	06-08	ZE33-3100	100
YZ400F-450F	14-17	ZE33-3103	103
	15-18	ZE33-3103	103
YZ450FX	16-18	ZE33-3103	103
WR250F	07-09	ZE33-3100	100
	15-18	ZE33-3103	103
WR400F-450F	07-09	ZE33-3100	100
	16-18	ZE33-3103	103

Bike	Year	SX	Size
SUZUKI			
RM125	06-08	ZE33-3096	96
RM250	06-08	ZE33-3096	96
RMZ250	07-15	ZE33-3096	96
RMZ450	05-18	ZE33-3096	96
RMX450Z	10-17	ZE33-3096	96
KTM			
125-450 SX/SX-F/XC/XC-F	00-18	ZE33-3091	90
125-530 EXC/EXC-F/XC-W/XCF-W	00-18	ZE33-3091	90
HUSQVARNA			
TC/FC 125-450	14-18	ZE33-3091	90
TE/FE/TX/FX 125-501	14-18	ZE33-3091	90



ZE33-2085

ZETA
COMP STABILIZER 7/8 in (22.2 mm)

- One-piece top bar mount for standard 7/8" bars.
- Improves steering control and rigidity.
- Install with stock handlebar clamp bolts.
- Made of CNC machined A7009-T6 aluminum.

Bike	Year	Comp	Size
HONDA			
CR125R	95-99	ZE33-2100	100
	00-07	ZE33-2106	106
CR250R	95-98	ZE33-2100	100
	99-07	ZE33-2106	106
CRF250R	04-17	ZE33-2106	106
CRF450R	02-18	ZE33-2106	106
CRF450RX	17-18	ZE33-2106	106
CRF250X	04-17	ZE33-2106	106
CRF450X	05-17	ZE33-2106	106
CRM250R/AR	89-98	ZE33-2100	100
CRF250L	12-17	ZE33-2100	100
CRF250RALLY	17	ZE33-2100	100
XLR125R/200R	93-00	ZE33-2100	100
XLR250/XR250, BAJA	-94	ZE33-2100	100
XR230	05-12	ZE33-2100	100
XR250/BAJA/MOTARD	95-07	ZE33-2100	100
XR250R/400R	96-04	ZE33-2100	100
XR600R/650R	88-06	ZE33-2100	100
FTR223, SL230	97-08	ZE33-2100	100
YAMAHA			
YZ80/85	93-14	ZE33-2085	85
YZ125/250	90-06	ZE33-2100	100
YZ250F	01-05	ZE33-2100	100
YZ400F-450F	98-05	ZE33-2100	100
WR250F	99-06	ZE33-2100	100
WR400F-450F	99-06	ZE33-2100	100
DT125/200	88-92	ZE33-2100	100
DT200WR	91-96	ZE33-2100	100
DT230 LANZA	97-98	ZE33-2085	85
TTR125	00-04	ZE33-2085	85
TTR250R/RAID	93-07	ZE33-2100	100
TW200	91-04	ZE33-2085	85
SEROW225WE/250, XT225	93-17	ZE33-2085	85
TRICKER	04-17	ZE33-2085	85
XTZ125	03-17	ZE33-2085	85
XT250X	06-17	ZE33-2085	85
WR250R/X	07-17	ZE33-2100	100

Bike	Year	Comp	Size
KAWASAKI			
KX60/65	94-18	ZE33-2085	85
KX80/85/100	96-18	ZE33-2085	85
KX125	96-05	ZE33-2090	90
	06-08	ZE33-2098	98
KX250	92-04	ZE33-2090	90
	05-08	ZE33-2098	98
KX250F #1	04	ZE33-2090	90
	05-18	ZE33-2098	98
KX450F #2	06-16	ZE33-2098	98
KDX125-250	88-99	ZE33-2090	90
KLX250/D-TRACKER	98-16	ZE33-2090	90
SUZUKI			
RM125	96-05	ZE33-2098	98
	96-00	ZE33-2098	98
RM250	01	ZE33-2100	100
	02-05	ZE33-2098	98
	04	ZE33-2090	90
	05-06	ZE33-2098	98
RMZ250			
DRZ250, DR250R, DJEBEL250XC	95-07	ZE33-2100	100
DRZ400S/R/SM	00-17	ZE33-2098	98
TS125R/200R		ZE33-2100	100
SX/DR/DF125/200		ZE33-2100	100
RMX250S/R	96-98	ZE33-2100	100
250SB	02-06	ZE33-2090	90

#1 2015-2018 model can set only near side.
#2 2012-2016 model can set only near side.

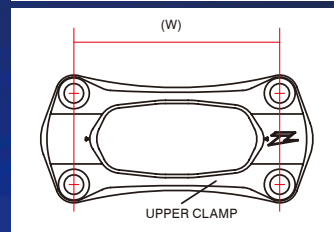

ZETA
UX3 CLAMP KIT

- Adapts stock 22.2 mm (7/8") bar mounts to accept 28.6 mm (1 1/8") handlebars.
- Adds 20 mm (4/5") to bar height. Please take this into consideration when selecting bars.

Part number
ZE32-1200



CRF450R

CONTROL

BARCLAMP

LEVER

FOOT PARTS

HAND GUARD

SUSPENSION

BODY GUARD

BODY

ACCESSORIES

CARBON

ZETA PIVOT LEVER SET FP

- Pivot FP clutch and brake lever set for MX racing models.
- Comes with durable forged color anodized lever arm.
- Lever folds outward to prevent breakage in the event of a crash.
- Lever adapter is Ultraprecise CNC machined out of high grade aluminum for super light weight design.
- Available in red, blue, orange and black colors for specific models.
- Function consistent with style.



Clutch

Red

Orange

Blue

H-Blue

Black

Brake

Red

Orange

Blue

H-Blue

Black

#Add color number to complete number for ordering.

Bike	Year	Part #	Bik	Blu	Red	Bike	Year	Part #	Bik	Org	
HONDA						KTM					
CRF250R	07-17	ZE44-010	1	-	3	65/85SX	14-18	ZE44-415	#	7	
CRF450R	07-18	ZE44-010	1	-	3	125EXC (SIX DAYS)	09-13	*2 ZE44-411	#	7	
CRF450RX	17-18	ZE44-010	1	-	3		14-16	*4 ZE44-413	#	7	
YAMAHA						KTM					
YZ125/250	01-07	ZE44-110	1	2	3	125SX/XC-W/144SX	14-15	*2 ZE44-411	#	7	
	08-14	ZE44-111	1	2	3		14-15	*4 ZE44-413	#	7	
	15-12	ZE44-310	1	2	3		16-18	*3 ZE44-412	#	7	
YZ250F	01-06	ZE44-110	1	2	3	150SX/XC/XC-W	09-13	*2 ZE44-411	#	7	
	07-08	ZE44-111	1	2	3		14-15	*4 ZE44-413	#	7	
	09-18	ZE44-310	1	2	-		16-18	*3 ZE44-412	#	7	
YZ426F/450F	01-07	ZE44-110	1	2	3	200XC-W	09-13	*2 ZE44-411	#	7	
	08	ZE44-111	1	2	3		14-16	*4 ZE44-413	#	7	
	09-18	ZE44-310	1	2	-	200EXC/XC	09-13	*2 ZE44-411	#	7	
YZ125X	17-18	ZE44-310	1	2	-		14-15	*4 ZE44-413	#	7	
YZ250X	16-18	ZE44-310	1	2	-	250EXC/EXC-F (SIX DAYS)	06-13	*3 ZE44-412	#	7	
YZ250FX	15-18	ZE44-311	1	2	-		14-18	*3 ZE44-412	#	7	
YZ450FX	16-18	ZE44-311	1	2	-	250SX-F	07-13	*1 ZE44-410	#	7	
KAWASAKI						KTM					
KX65	00-18	ZE44-210	1	2	3	450XC-F/SIX DAYS	14-18	*3 ZE44-412	#	7	
KX80/85/100	01-18	ZE44-210	1	2	3	250SX	06-13	*1 ZE44-410	#	7	
KX125	00-05	ZE44-210	1	2	3	250XC	14-18	*3 ZE44-413	#	7	
	06-08	ZE44-110	1	2	3		06-13	*1 ZE44-410	#	7	
KX250	00-04	ZE44-210	1	2	3	250XC-F/XCF-W	14-18	*3 ZE44-413	#	7	
	05-08	ZE44-110	1	2	3		07-13	*1 ZE44-410	#	7	
	04	ZE44-210	1	2	3	250/300XC-W	14-18	*3 ZE44-413	#	7	
KX250F	05-12	ZE44-110	1	2	3		06-13	*1 ZE44-410	#	7	
	13-18	ZE44-111	1	2	3	250/300XC-W	14-18	*3 ZE44-413	#	7	
	06-12	ZE44-110	1	2	3	300EXC (SIX DAYS)	06-13	*1 ZE44-410	#	7	
KX450F	06-12	ZE44-111	1	2	3		14-18	*3 ZE44-413	#	7	
	13-18	ZE44-111	1	2	3	300XC	06-13	*1 ZE44-410	#	7	
SUZUKI						KTM					
RMZ250	04	ZE44-210	1	2	3	350EXC-F/SIX DAYS	11-13	*1 ZE44-410	#	7	
	05-06	ZE44-110	1	2	3	350SX-F/XC-F/XCF-W	14-18	*3 ZE44-413	#	7	
RMZ450	07-18	ZE44-210	1	2	3	400EXC	09-11	*1 ZE44-410	#	7	
	05-18	ZE44-210	1	2	3	400XC-W	09-10	*1 ZE44-410	#	7	
BETA						KTM					
RR2T	13-17	ZE44-414	-	-	3	450EXC/R/EXC-F (SIX DAYS)	07-13	*1 ZE44-410	#	7	
RR4T/RS4T	12-18	ZE44-414	-	-	3	450RALLY REPLICA	14-18	*3 ZE44-413	#	7	
X-TRAINER	15-18	ZE44-414	-	-	3		15-16	*3 ZE44-413	#	7	
Clutch						Brake					
*1	Brembo		Brembo -'13								
*2	New MAGURA		Brembo -'13								
*3	Brembo		Brembo '14-								
*4	New MAGURA		Brembo '14-								

Pivot lever FP Replacement

Brake Lever Arm

ZE41-36001	Black	ZE41-36007	Orange
ZE41-36002	Blue	ZE41-36009	H-Blue
ZE41-36003	Red		

Clutch Lever Arm

ZE42-36001	Black	ZE42-36007	Orange
ZE42-36002	Blue	ZE42-36009	H-Blue
ZE42-36003	Red		

ZETA PIVOT LEVER SET CP

- Pivot CP clutch and brake lever set for Trail models.
- Lever folds outward to prevent breakage in the event of a crash.
- Lever adapter is Ultraprecise CNC machined out of high grade aluminum for super light weight design.
- Available in red, blue and black colors for specific models.

Bike	Year	Black	Blue	Red
HONDA				
CRF250L/M	12-17	ZE44-5011	-	ZE44-5013
CRF250RALLY	17	ZE44-5011	-	ZE44-5013
YAMAHA				
WR250R/X	07-17	ZE44-8011	ZE44-8012	-
SEROW225/250	86-17	ZE44-8011	ZE44-8012	-
TTR250	93-97	ZE44-8011	ZE44-8012	-
XT250X	06-17	ZE44-8011	ZE44-8012	-
TRICKER	04-17	ZE44-8011	ZE44-8012	-
DT230LANZA	97-99	ZE44-8011	ZE44-8012	-
KAWASAKI				
KLX125,D-TRACKER125	10-16	ZE44-6011	ZE44-6012	-
KLX250,D-TRACKER/X	08-16	ZE44-6011	ZE44-6012	-
VERSYS-X250	17	ZE44-6011	ZE44-6012	-
VERSYS-X300	17	ZE44-6011	ZE44-6012	-
SUZUKI				
DRZ400S/SM	00-17	ZE44-7011	ZE44-7012	ZE44-7013
DR250R	97-00	ZE44-7011	ZE44-7012	ZE44-7013

Pivot lever CP Replacement

Brake Lever Arm

ZE41-31001	Black	ZE41-31003	Red
ZE41-31002	Blue		

Clutch Lever Arm

ZE42-31001	Black	ZE42-31003	Red
ZE42-31002	Blue		



CONTROL

BARCLAMP

LEVER

FOOT PARTS

HAND GUARD

SUSPENSION

BODY GUARD

BODY

ACCESSORIES

CARBON

- Original pivot lever design, in a durable forged lever body.
- Lever arm holder and lever body M type designed for racing use.
- Laser printed ZETA logo on the front of the lever.
- Titanium anodized finish.



APPRICATION P18



Replacement parts



Mount Kit	Clutch Lever Arm	Brake Lever Arm
ZE41-0190 Brake	ZE42-3600 3 Finger	ZE41-3600 3 Finger
ZE42-0190 Clutch	ZE42-4600 4 Finger	

- CNC Machined aluminum folding levers.
- The pivot design allows the lever to fold outward to prevent bending or breaking in the event of a crash.
- Hard anodized finish, made of CNC machined aircraft grade aluminum.
- M-type rectilinear lever available for more competitive use.
- Exclusively designed for each bike, available 3 and 4 finger lever lengths.



APPRICATION P19



Replacement parts



Mount Kit	Brake Lever Arm K-Type	Brake Lever Arm M-Type
ZE41-0190 Brake	ZE41-3100 3 Finger	ZE41-3200 3 Finger
ZE42-0190 Clutch	ZE41-4100 4 Finger	ZE41-4200 4 Finger
	Clutch Lever Arm K-Type	Clutch Lever Arm M-Type
	ZE42-3100 3 Finger	ZE42-3200 3 Finger
	ZE42-4100 4 Finger	ZE42-4200 4 Finger



PIVOT LEVER FP
Forged lever arm

Smooth surface forged lever arm with laser printed logo.

PIVOT LEVER CP
PIVOT LEVER FP
Pivot

Pivot design with return spring allows the lever to fold outward to prevent bending or breaking.

Adjustable

Adjustable reach system provides the perfect lever position for all riders.

CNC Machined lever arm

Machined ZETA logo provides better lever grip.

K Type
For street bikes with switch boxes on the handlebar.

M Type
For racing bikes without switch boxes on the handlebar.

CONTROL

BARCLAMP

LEVER

FOOT PARTS

HAND GUARD

SUSPENSION

BODY GUARD

BODY

ACCESSORIES

CARBON



CONTROL

BARCLAMP

LEVER

FOOT PARTS

HAND GUARD

SUSPENSION

BODY GUARD

BODY

ACCESSORIES

CARBON

CLUTCH				
	Bike	Year	4 Finger	3 Finger
HONDA	CR125R/250R	04-07	ZE42-4610	ZE42-3610
	CRF250R	04-18	ZE42-4610	ZE42-3610
	CRF450R	04-18	ZE42-4610	ZE42-3610
	CRF450RX	17-18	ZE42-4610	ZE42-3610
	CRF250X	04-17	ZE42-4610	ZE42-3610
	CRF450X	05-17	ZE42-4610	ZE42-3610
YAMAHA	YZ280/85	15-18	ZE42-4666	ZE42-3666
	YZ125/250	00-14	ZE42-4661	ZE42-3661
	YZ250F	15-18	ZE42-4666	ZE42-3666
	YZ250F	00-08	ZE42-4661	ZE42-3661
	YZ250FX	09-18	ZE42-4666	ZE42-3666
	YZ450FX	00-08	ZE42-4661	ZE42-3661
	YZ426F/450F	09-18	ZE42-4666	ZE42-3666
	YZ125X	17-18	ZE42-4666	ZE42-3666
	YZ250X	16-18	ZE42-4666	ZE42-3666
	YZ250FX	15-18	ZE42-4667	ZE42-3667
KAWASAKI	KX65	00-18	ZE42-4620	ZE42-3620
	KX80/85	98-18	ZE42-4620	ZE42-3620
	KX125	90-05	ZE42-4620	ZE42-3620
	KX250	06-08	ZE42-4661	ZE42-3661
		90-04	ZE42-4620	ZE42-3620
	KX250F	05-08	ZE42-4661	ZE42-3661
		04	ZE42-4620	ZE42-3620
	KX450F	05-18	ZE42-4661	ZE42-3661
		06-18	ZE42-4661	ZE42-3661
	SUZUKI	RMZ250	04	ZE42-4620
RMZ450		05-06	ZE42-4661	ZE42-3661
		07-18	ZE42-4620	ZE42-3620
65SX/XC		05-18	ZE42-4620	ZE42-3620
85SX		14-18	-	ZE42-3687
125EXC (SIX DAYS)		09-16 #2	ZE42-4684	ZE42-3684
125SX/XC-W/144SX		09-15 #2	ZE42-4684	ZE42-3684
150SX/XC/XC-W		16-18 #3	ZE42-4683	ZE42-3683
200XC-W		09-15 #2	ZE42-4684	ZE42-3684
200EXC/XC		09-15 #2	ZE42-4684	ZE42-3684
KTM	250EXC/EXC-F (SIX DAYS)	16 #3	ZE42-4683	ZE42-3683
	250SX	06-18 #3	ZE42-4683	ZE42-3683
	250XC	06-18 #3	ZE42-4683	ZE42-3683
	250XC-F/XCF-W	07-18 #3	ZE42-4683	ZE42-3683
	250/300XC-W	06-18 #3	ZE42-4683	ZE42-3683
	300EXC (SIX DAYS)	06-18 #3	ZE42-4683	ZE42-3683
	300XC	06-18 #3	ZE42-4683	ZE42-3683
	350EXC-F/SIX DAYS	11-18 #3	ZE42-4683	ZE42-3683
	350SX-F/XC-F/XCF-W	09-11 #3	ZE42-4683	ZE42-3683
	400EXC	09-10 #3	ZE42-4683	ZE42-3683
	400XC-W	07-18 #3	ZE42-4683	ZE42-3683
	450EXC/R/EXC-F (SIX DAYS)	15-17 #3	ZE42-4683	ZE42-3683
	450RALLY	09 #2	ZE42-4684	ZE42-3684
	450SMR	13-14 #3	ZE42-4683	ZE42-3683
	450SX/SX-F/SX-R	09-12 #2	ZE42-4684	ZE42-3684
		13-18 #3	ZE42-4683	ZE42-3683
	450XC-F	08 #3	ZE42-4683	ZE42-3683
	450XC-W/XCR-W (SIX DAYS)	13-18 #3	ZE42-4683	ZE42-3683
	500EXC/EXC-F/XC-W (SIX DAYS)	12-18 #3	ZE42-4683	ZE42-3683
	505XC-F	08 #3	ZE42-4683	ZE42-3683
525XC-R	07 #3	ZE42-4683	ZE42-3683	
530EXC-/EXC-R/XCR-W/XC-W (SIX DAYS)	08-11 #3	ZE42-4683	ZE42-3683	
250FREERIDE R	14-17	-	ZE42-3687	
350FREERIDE	14-17	-	ZE42-3687	
HUSQVARNA	TC/TE250-511	-13 #3	ZE42-4683	ZE42-3683
	CR/WR125-300	-13 #3	ZE42-4683	ZE42-3683
	TC65	17-18 #4	-	ZE42-3687
	TC85	14-18 #4	-	ZE42-3687
	TC125	14-18 #2	ZE42-4684	ZE42-3684
	TC250	14-18 #2	ZE42-4684	ZE42-3684
	TE125	14-16 #2	ZE42-4684	ZE42-3684
	TE150	17-18 #2	ZE42-4684	ZE42-3684
	TE250/300	14-16 #3	ZE42-4683	ZE42-3683
		17-18 #2	ZE42-4684	ZE42-3684
	FC250-450	14-15 #3	ZE42-4683	ZE42-3683
		16-18 #2	ZE42-4684	ZE42-3684
	FE250-501/S	14-16 #3	ZE42-4683	ZE42-3683
	FR450RALLY	17-18 #2	ZE42-4684	ZE42-3684
	FR450RALLY	16-17 #3	ZE42-4683	ZE42-3683
FS450	15 #3	ZE42-4683	ZE42-3683	
TX125-300	16-18 #2	ZE42-4684	ZE42-3684	
FX350-450	17-18 #2	ZE42-4684	ZE42-3684	
BETA	RR 2T	13-17 #3	ZE42-4683	ZE42-3683
	RR/RS 4T	12-17 #3	ZE42-4683	ZE42-3683
	X-TRAINER	15-17 #3	ZE42-4683	ZE42-3683
GASGAS	EC250E4/300E4	17 #2	ZE42-4684	ZE42-3684
	XC250/300	17 #2	ZE42-4684	ZE42-3684

BRAKE			
	Bike	Year	3 Finger
HONDA	CR80R/85R	98-07	ZE41-3606
	CRF150R	07-18	ZE41-3606
	CR125R/250R	92-07	ZE41-3606
	CRF250R	04-06	ZE41-3606
		07-18	ZE41-3607
	CRF450R	02-06	ZE41-3606
		07-18	ZE41-3607
	CRF450RX	17-18	ZE41-3607
	CRF250X	04-17	ZE41-3606
	CRF450X	05-17	ZE41-3606
CRF125F	14-18	ZE41-3606	
CRF150F/230F	03-17	ZE41-3606	
YAMAHA	YZ280/85	01-18	ZE41-3662
	YZ125/250	01-07	ZE41-3662
		08-18	ZE41-3665
	YZ250F	01-06	ZE41-3662
		07-18	ZE41-3665
	YZ426F/450F	01-07	ZE41-3662
		08-18	ZE41-3665
	YZ125X	17-18	ZE41-3665
	YZ250X	16-18	ZE41-3665
	YZ250FX	15-18	ZE41-3665
YZ450FX	16-18	ZE41-3665	
WR250F	01-16	ZE41-3662	
WR450F	17-18	ZE41-3665	
	01-15	ZE41-3662	
KAWASAKI	KX65	00-18	ZE41-3662
	KX85/100	01-18	ZE41-3662
KX125/250	00-08	ZE41-3662	
	04-12	ZE41-3662	
KX250F/450F	13-18	ZE41-3665	
	08-15	ZE41-3662	
SUZUKI	KLX450R	08-15	ZE41-3662
	RM85	05-17	ZE41-3662
RM125/250	96-03	ZE41-3606	
	04-08	ZE41-3662	
RMZ250	04-18	ZE41-3662	
	04-18	ZE41-3662	
RMZ450	10-17	ZE41-3662	
	10-17	ZE41-3662	
RMX450Z	04-11	ZE41-3682	
	14-18	ZE41-3684	
65SX/XC	03-11	ZE41-3682	
	14-18	ZE41-3684	
85/150SX/XC	03-11	ZE41-3682	
	14-18	ZE41-3684	
85SX	05-13	ZE41-3681	
	14-18	ZE41-3684	
125SX/XC-W/EXC(SIX DAYS)	05-13	ZE41-3681	
	14-18	ZE41-3684	
144/150SX/150XC/150XC-W	05-13	ZE41-3681	
	14-18	ZE41-3684	
200XC-W/EXC	05-13	ZE41-3681	
	14-18	ZE41-3684	
250SX/SX-F/XC/XC-F	05-13	ZE41-3681	
	14-18	ZE41-3684	
250XC-W/XCF-W	05-13	ZE41-3681	
	14-18	ZE41-3684	
250EXC/EXC-R/EXC-F (SIX DAYS)	14-18	ZE41-3683	
	11-13	ZE41-3681	
300XC/XC-W/EXC(SIX DAYS)	11-13	ZE41-3681	
	14-18	ZE41-3683	
350EXC-F/XC-F/XCF-W	14-18	ZE41-3683	
	05-11	ZE41-3681	
400XC-W/EXC(XC-R)	05-11	ZE41-3681	
	14-18	ZE41-3683	
450SX/SX-R/SX-F	05-13	ZE41-3681	
	14-18	ZE41-3683	
450XC/XC-F/XCR-W , XC-W	05-13	ZE41-3681	
	14-18	ZE41-3683	
450EXC-R/EXC/EXC-F (SIX DAYS)	12-13	ZE41-3681	
	14-18	ZE41-3683	
500XC-W/EXC/EXC-F (SIX DAYS)	14-18	ZE41-3683	
	08-09	ZE41-3681	
505SX-F/XC-F	05-07	ZE41-3681	
	08-11	ZE41-3681	
525SX/SX-R/XC/XC-W/EXC-R	05-07	ZE41-3681	
	08-11	ZE41-3681	
530XC-W/XCR-W/EXC-R/EXC	13	ZE41-3681	
	18	ZE41-3684	
450SMR	14-17	ZE41-3684	
	14-17	ZE41-3684	
FREERIDE250 F	14-17	ZE41-3684	
	14-17	ZE41-3684	
FREERIDE250 R	14-17	ZE41-3684	
	14-17	ZE41-3684	
FREERIDE350	17-18	ZE41-3684	
	14-18	ZE41-3684	
TC65	-13	ZE41-3681	
	-13	ZE41-3681	
CR/WR125-300	-13	ZE41-3681	
	-13	ZE41-3681	
TC125/250	14-17	ZE41-3683	
	18	ZE41-3683	
FC/FE/FX250-501	18	ZE41-3683	
	14-17	ZE41-3683	
FC250/350/450	18	ZE41-3683	
	14-17	ZE41-3683	
RR 2T	13-17	ZE41-3606	
	08-17	ZE41-3606	
RR/RS 4T	08-17	ZE41-3606	
	15-17	ZE41-3606	
X-TRAINER	00-16	ZE41-3606	
	10-15	ZE41-3606	
EC 2T	10-15	ZE41-3606	
	17	ZE41-3606	
EC250E4/300E4	17	ZE41-3606	
	03-09	ZE41-3606	
XC250/300	17	ZE41-3606	
	17	ZE41-3606	
FSE/FSR	03-09	ZE41-3606	
	03-09	ZE41-3606	

#2 New MAGURA #3 Brembo #4 Formula



HIGH PERFORMANCE PRODUCTS

DIRT

CONTROL

BARCLAMP

LEVER

FOOT PARTS

HAND GUARD

SUSPENSION

BODY GUARD

BODY

ACCESSORIES

CARBON

Bike	CLUTCH			
	Year	4 Finger	3 Finger	Type
CR80R/85R	83-07	ZE42-4101	ZE42-3101	K
CRF150R	07-18	ZE42-4101	ZE42-3101	K
CR125R/250R	02-03	ZE42-4101	ZE42-3101	K
CRF250R	04-07	ZE42-4210	ZE42-3210	M
CRF450R	04-17	ZE42-4210	ZE42-3210	M
CRF450R	02-03	ZE42-4101	ZE42-3101	K
CRF450R	04-18	ZE42-4210	ZE42-3210	M
CRF450RX	17-18	ZE42-4210	ZE42-3210	M
CRF250X	04-17	ZE42-4210	ZE42-3210	M
CRF450X	05-17	ZE42-4210	ZE42-3210	M
CRF150F	03-17	ZE42-4103	ZE42-3103	K
CRF230F	03-17	ZE42-4103	ZE42-3103	K
CRF250L/M	12-17	ZE42-4104	ZE42-3104	K
CRF250RALLY	17	ZE42-4104	ZE42-3104	K
CRF1000L	16-17	ZE42-4105	ZE42-3105	K
SL230	97-04	ZE42-4103	ZE42-3103	K
XR230/MOTARD	05-12	ZE42-4103	ZE42-3103	K
XR250/BAJA/MOTARD	95-07	ZE42-4101	ZE42-3101	K
XR400MOTARD	05-08	ZE42-4101	ZE42-3101	K
CRM250R/AR	94-98	ZE42-4101	ZE42-3101	K
XR650R	00-06	ZE42-4101	ZE42-3101	K
YZ80/85	95-14	ZE42-4160	ZE42-3160	K
YZ125/250	15-18	ZE42-4266	ZE42-3266	M
YZ125/250	00-14	ZE42-4261	ZE42-3261	M
YZ250F	00-08	ZE42-4261	ZE42-3261	M
YZ250F	09-18	ZE42-4266	ZE42-3266	M
YZ246F/450F	00-08	ZE42-4261	ZE42-3261	M
YZ125X	09-18	ZE42-4266	ZE42-3266	M
YZ250X	17-18	ZE42-4266	ZE42-3266	M
YZ250FX	15-18	ZE42-4267	ZE42-3267	M
YZ450FX	16-18	ZE42-4267	ZE42-3267	M
WR250F	05-18	ZE42-4165	ZE42-3165	K
WR450F	05-18	ZE42-4165	ZE42-3165	K
WR250R/X	07-17	ZE42-4160	ZE42-3160	K
SEROW225/250	86-17	ZE42-4160	ZE42-3160	K
TTR125/LW/E	00-08	ZE42-4160	ZE42-3160	K
TTR250	93-97	ZE42-4160	ZE42-3160	K
TTR600	98-02	ZE42-4186	-	K
XT250X	06-17	ZE42-4160	ZE42-3160	K
XT125	03-12	ZE42-4160	ZE42-3160	K
TRICKER	04-17	ZE42-4160	ZE42-3160	K
DT230LANZA	97-99	ZE42-4160	ZE42-3160	K
KX65	00-18	ZE42-4220	ZE42-3220	M
KX80/85	98-18	ZE42-4220	ZE42-3220	M
KX125	90-05	ZE42-4220	ZE42-3220	M
KX125	06-08	ZE42-4261	ZE42-3261	M
KX250	90-04	ZE42-4220	ZE42-3220	M
KX250	05-08	ZE42-4261	ZE42-3261	M
KX250F	04	ZE42-4220	ZE42-3220	M
KX450F	05-18	ZE42-4261	ZE42-3261	M
KLX450R	06-18	ZE42-4261	ZE42-3261	M
KDX125-250	88-99	ZE42-4160	ZE42-3160	K
KLX125	10-16	ZE42-4127	ZE42-3127	K
D-TRACKER125	09-13	ZE42-4127	ZE42-3127	K
KLX150S	93-97	ZE42-4160	ZE42-3160	K
KLX250	98-07	ZE42-4125	ZE42-3125	K
D-TRACKER	08-16	ZE42-4127	ZE42-3127	M
SUPER SHERPA	97-07	ZE42-4125	ZE42-3125	K
VERSYS-X250	17	ZE42-4127	ZE42-3127	K
VERSYS-X300	17	ZE42-4127	ZE42-3127	K
RM85	05-17	ZE42-4160	ZE42-3160	K
RM125/250	92-08	ZE42-4160	ZE42-3160	K
RMZ250	04	ZE42-4220	ZE42-3220	M
RMZ250	05-06	ZE42-4261	ZE42-3261	M
RMZ250	07-18	ZE42-4220	ZE42-3220	M
RMZ450	05-18	ZE42-4220	ZE42-3220	M
RMX250R/S	93-98	ZE42-4160	ZE42-3160	K
DRZ400R	00-04	ZE42-4160	ZE42-3160	K
DRZ400S/SM	00-17	ZE42-4140	ZE42-3140	K
DRZ50R	97-00	ZE42-4140	ZE42-3140	K
DJEBEL250XC	98-06	ZE42-4140	ZE42-3140	K
250SB	02-06	ZE42-4125	ZE42-3125	K

* Is not compatible wit stock hand guard.

Bike	CLUTCH			
	Year	4 Finger	3 Finger	Type
65SX/XC	04-13	#1 ZE42-4182	ZE42-3182	K
65SX/XC	14-18	-	ZE42-3287	M
85SX/XC	03-12	#1 ZE42-4182	ZE42-3182	K
85SX	14-18	-	ZE42-3287	M
105SX/XC	07-11	#1 ZE42-4182	ZE42-3182	K
125EXC (SIX DAYS)	04-08	#1 ZE42-4182	ZE42-3182	K
125EXC (SIX DAYS)	09-16	#2 ZE42-4284	ZE42-3284	M
125EXC (SIX DAYS)	05-08	#1 ZE42-4182	ZE42-3182	K
125SX/XC-W/144SX	09-15	#2 ZE42-4284	ZE42-3284	M
125SX/XC-W/144SX	16-18	#3 ZE42-4283	ZE42-3283	M
150SX/XC/XC-W	09-15	#2 ZE42-4284	ZE42-3284	M
150SX/XC/XC-W	16-18	#3 ZE42-4283	ZE42-3283	M
200XC-W	03-08	#1 ZE42-4182	ZE42-3182	K
200XC-W	09-16	#2 ZE42-4284	ZE42-3284	M
200XC-W	03-08	#1 ZE42-4182	ZE42-3182	K
200XC-W	09-15	#2 ZE42-4284	ZE42-3284	M
200EXC/XC	16	#3 ZE42-4283	ZE42-3283	M
250EXC/EXC-F (SIX DAYS)	03-05	#1 ZE42-4182	ZE42-3182	K
250EXC/EXC-F (SIX DAYS)	03-05	#3 ZE42-4283	ZE42-3283	M
250EXC-F	05-06	#1 ZE42-4182	ZE42-3182	K
250SX-F	07-18	#3 ZE42-4283	ZE42-3283	M
250SX-F	03-05	#1 ZE42-4182	ZE42-3182	K
250SX	06-18	#3 ZE42-4283	ZE42-3283	M
250XC	06-18	#3 ZE42-4283	ZE42-3283	M
250XC-F/XCF-W	07-18	#3 ZE42-4283	ZE42-3283	M
250/300XC-W	06-18	#3 ZE42-4283	ZE42-3283	M
300EXC (SIX DAYS)	03-05	#1 ZE42-4182	ZE42-3182	K
300EXC (SIX DAYS)	06-18	#3 ZE42-4283	ZE42-3283	M
300XC	06-18	#3 ZE42-4283	ZE42-3283	M
350EXC-F/SIX DAYS	11-18	#3 ZE42-4283	ZE42-3283	M
350EXC-F/SIX DAYS	09-11	#3 ZE42-4283	ZE42-3283	M
350SX-F/XCF/XCF-W	03-07	#1 ZE42-4182	ZE42-3182	K
400EXC-R	07	#1 ZE42-4182	ZE42-3182	K
400XC-W	09-10	#3 ZE42-4283	ZE42-3283	M
400XC-W	04-06	#3 ZE42-4283	ZE42-3283	M
450EXC/R/EXC-F (SIX DAYS)	07-18	#3 ZE42-4283	ZE42-3283	M
450RALLY	13-14	#1 ZE42-4182	ZE42-3182	K
450RALLY	15-17	#3 ZE42-4283	ZE42-3283	M
450RALLY	06-08	#1 ZE42-4182	ZE42-3182	K
450SMR	09	#2 ZE42-4284	ZE42-3284	M
450SMR	13-14	#3 ZE42-4283	ZE42-3283	M
450SMR	03-08	#1 ZE42-4182	ZE42-3182	K
450SMR	09-12	#2 ZE42-4284	ZE42-3284	M
450SMR	13-18	#3 ZE42-4283	ZE42-3283	M
450SX/SX-F/SX-R	06-07	#1 ZE42-4182	ZE42-3182	K
450SX/SX-F/SX-R	08	#3 ZE42-4283	ZE42-3283	M
450XC-F	09	#1 ZE42-4182	ZE42-3182	K
450XC-F	13-18	#3 ZE42-4283	ZE42-3283	M
450XC-F	07	#1 ZE42-4182	ZE42-3182	K
450XC-F	08-16	#3 ZE42-4283	ZE42-3283	M
450XC-W/XCR-W (SIX DAYS)	12-18	#3 ZE42-4283	ZE42-3283	M
500EXC/EXC-F/XC-W (SIX DAYS)	08	#1 ZE42-4182	ZE42-3182	K
505SX-F	08	#3 ZE42-4283	ZE42-3283	M
505XC-F	09	#1 ZE42-4182	ZE42-3182	K
505XC-F	03-06	#1 ZE42-4182	ZE42-3182	K
525EXC-R	07	#3 ZE42-4283	ZE42-3283	M
525EXC-R	03-07	#1 ZE42-4182	ZE42-3182	K
525SX/SX-R/XC/XC-W	08-11	#3 ZE42-4283	ZE42-3283	M
530EXC-R/XC-W (SIX DAYS)	14-17	-	ZE42-3287	M
530EXC-R/XC-W (SIX DAYS)	14-17	-	ZE42-3287	M
250FREERIDE R	14-17	-	ZE42-3287	M
350FREERIDE	14-17	-	ZE42-3287	M
TC/TE250-511	-13	#3 ZE42-4283	ZE42-3283	M
CR/WR125-300	-13	#3 ZE42-4283	ZE42-3283	M
TC65	17-18	#4 -	ZE42-3287	M
TC85	14-18	#4 -	ZE42-3287	M
TC125	14-18	#2 ZE42-4284	ZE42-3284	M
TC250	14-18	#2 ZE42-4284	ZE42-3284	M
TE125	14-16	#2 ZE42-4284	ZE42-3284	M
TE150	17-18	#2 ZE42-4284	ZE42-3284	M
TE250/300	14-16	#3 ZE42-4283	ZE42-3283	M
FE250-450	17-18	#2 ZE42-4284	ZE42-3284	M
FE250-450	14-16	#3 ZE42-4283	ZE42-3283	M
FR450RALLY	17-18	#2 ZE42-4284	ZE42-3284	M
FR450RALLY	16-17	#3 ZE42-4283	ZE42-3283	M
FS450	15	#3 ZE42-4283	ZE42-3283	M
FS450	16-18	#2 ZE42-4284	ZE42-3284	M
TX125-300	17-18	#2 ZE42-4284	ZE42-3284	M
FX350-450	17-18	#2 ZE42-4284	ZE42-3284	M

Bike	CLUTCH				
	Year	4 Finger	3 Finger	Type	
BETA	RR 2T	13-17	#3 ZE42-4283	ZE42-3283	M
BETA	RR/RS 4T	08-11	-	ZE42-3185	K
BETA	RR/RS 4T	12-17	#3 ZE42-4283	ZE42-3283	M
BETA	X-Trainer	15-17	#3 ZE42-4283	ZE42-3283	M
BETA	EC 2T	00-16	-	ZE42-3185	K
BETA	EC 4T	10-13	-	ZE42-3185	K
GAS GAS	EC250E4/300E4	17	#2 ZE42-4284	ZE42-3284	M
GAS GAS	XC250/300	17	#2 ZE42-4284	ZE42-3284	M
GAS GAS	FSE/FSR	03-09	-	ZE42-3185	K
TRIAL	AJP	-	-	ZE42-3185	K

- #1 MAGURA
- #2 New MAGURA
- #3 Brembo
- #4 Formula

Bike	BRAKE				
	Year	4 Finger	3 Finger	Type	
BETA	RR 2T	13-17	-	ZE41-3206	M
BETA	RR/RS 4T	08-17	-	ZE41-3206	M
BETA	X-TRAINER	15-17	-	ZE41-3206	M
BETA	EC 2T	00-16	-	ZE41-3206	M
BETA	EC 4T	10-15	-	ZE41-3206	M
GAS GAS	EC250E4/300E4	17	-	ZE41-3206	M
GAS GAS	XC250/300	17	-	ZE41-3206	M
GAS GAS	FSE/FSR	03-09	-	ZE41-3206	M
TRIAL	AJP	-	-	ZE41-3185	K
MOTARD	BREMBO RADIAL SHORT	-	-	ZE41-3275	M
MOTARD	MAGURA 195.5 SHORT	-	-	ZE41-3271	M
MOTARD	NISSIN RS-TYPE	-	-	ZE41-4299	M

Bike	BRAKE			
	Year	4 Finger	3 Finger	Type
CR80R/85R	86-07	-	ZE41-3206	M
CRF150R	07-18	-	ZE41-3206	M
CR125R/250R	02-07	-	ZE41-3206	M
CRF250R	04-06	-	ZE41-3206	M
CRF250R	07-17	-	ZE41-3207	M
CRF450R	02-06	-	ZE41-3206	M
CRF450R	07-18	-	ZE41-3207	M
CRF450RX	17-18	-	ZE41-3207	M
CRF250X	04-17	-	ZE41-3206	M
CRF450X	05-17	-	ZE41-3206	M
CRF125F	14-18	-	ZE41-3206	M
CRF150F/230F	03-17	-	ZE41-3206	M
SL230	97-04	ZE41-4105	ZE41-3105	K
XR230/MOTARD	05-12	ZE41-4105	ZE41-3105	K
XR250/MOTARD	95-07	ZE41-4105	ZE41-3105	K
CRM250R/AR	94-99	ZE41-4105	ZE41-3105	K
XR400MOTARD	05-08	ZE41-4105	ZE41-3105	K
CRF250L/M	12-17	ZE41-4145	ZE41-3145	K
CRF250RALLY	17	ZE41-4145	ZE41-3145	K
CRF1000L	16-17	ZE41-4298	-	M
YZ80/85	01-18	-	ZE41-3262	M
YZ125/250	10-07	-	ZE41-3262	M
YZ125/250	08-18	-	ZE41-3265	M
YZ250F	01-0			



4 Finger
Titanium / Blue



3 Finger
Titanium / Red

ZETA
PIVOT PERCH CP

- High quality CNC machined rotating clutch perch with Pivot Lever CP Clutch K-Type.
- Clutch perch is made of CNC machined A7009 aluminum. Lever is made of CNC machined aluminum for durable construction.
- Provides 2 different lever ratios, light pulling and accurate clutch control by changing position of Ratio Device (**PATENT PENDING**).
- Best to use with PIVOT LEVER CP BRAKE.
- 3 finger and 4 finger lever arm models are available.
- Clutch wire adjuster available in blue and red colors.
- Optional hot starter lever is available.

Part number	Description
ZE43-1310	3 Finger Titanium / Red
ZE43-1311	3 Finger Titanium / Blue
ZE43-1410	4 Finger Titanium / Red
ZE43-1411	4 Finger Titanium / Blue



CP K-Type lever is designed to avoid interference with switch assembly.

Optional parts

Part number	Description
ZE43-9080	Hot Starter lever Red

Pivot Perch CP Replacement parts

Part number	Description	Part number	Description	Part number	Description	Part number	Description	Part number	Description
ZE42-3100	3 Finger	ZE43-9393	Red	ZE43-9289	Adapter Assy	ZE43-9396	Perch Assy	ZE43-9292	Dust cover
ZE42-4100	4 Finger	ZE43-9394	Blue					ZE43-9399	Bolt set

PIVOT PERCH CP & FP FUNCTION

Ratio Device PATENT PENDING

ACCURATE RATIO

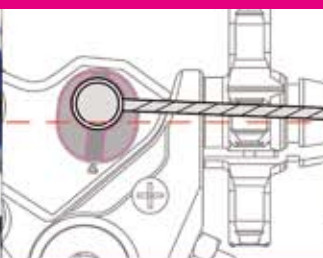

LIGHT RATIO

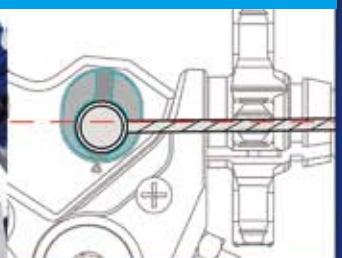

Provides 2 different lever ratios, light pulling and accurate clutch control, by changing position of Ratio Device.



TEAM SRM JMX
RYOTA IKEMOTO

4 Finger
Titanium / Blue



3 Finger
Titanium / Red

ZETA PIVOT PERCH FP

- High quality CNC machined rotating clutch perch with PIVOT LEVER FP CLUTCH.
- Clutch perch is made of CNC machined A7009 aluminum. Lever arm is made of forged aluminum for durable construction, more competitive use for MX or ED.
- Provides 2 different lever ratios, light pulling and accurate clutch control, by changing position of Ratio Device (*PATENT PENDING*).
- Best to use with PIVOT LEVER FP BRAKE.
- 3 finger and 4 finger lever arm models are available.
- Clutch wire adjuster available in red and blue colors.
- Optional hot starter lever is available.

Part number	Description
ZE43-2310	3 Finger Titanium / Red
ZE43-2311	3 Finger Titanium / Blue
ZE43-2410	4 Finger Titanium / Red
ZE43-2411	4 Finger Titanium / Blue

< Caution > Can not be used if lever interferes with switch box on your handlebar.



Optional parts

PIVOT PERCH FP Replacement parts



Part number [ZE43-9080](#)
Description Hot Starter lever Red



Lever Arm
[ZE42-3600](#) 3 Finger
[ZE42-4600](#) 4 Finger



Adjuster Assy
[ZE43-9393](#) Red
[ZE43-9394](#) Blue



Adapter Assy
[ZE43-9389](#)



Perch Assy
[ZE43-9396](#)



Dust cover
[ZE43-9392](#)



Bolt set
[ZE43-9399](#)

Adjust bolt & Quick cable adjuster

Quick clamp system & Nylon Sleeve

Flex outward



- Quick and easy to adjust clutch play even during the ride.
- Provides the best lever position for any hand size.

- Hinge style clamp for easy and quick maintenance.
- Nylon sleeve placed between the clamp and handlebar allows the perch to rotate upon impact.

- Built-in return spring in the Pivot lever allows the lever to swing forward in the event of crash and prevents lever breakage.

CONTROL



BARCLAMP



LEVER



FOOT PARTS



HAND GUARD



SUSPENSION



BODY GUARD



BODY



ACCESSORIES



CARBON



REVOLVER SHIFT

Rotating shift tip provides 6 different positions!

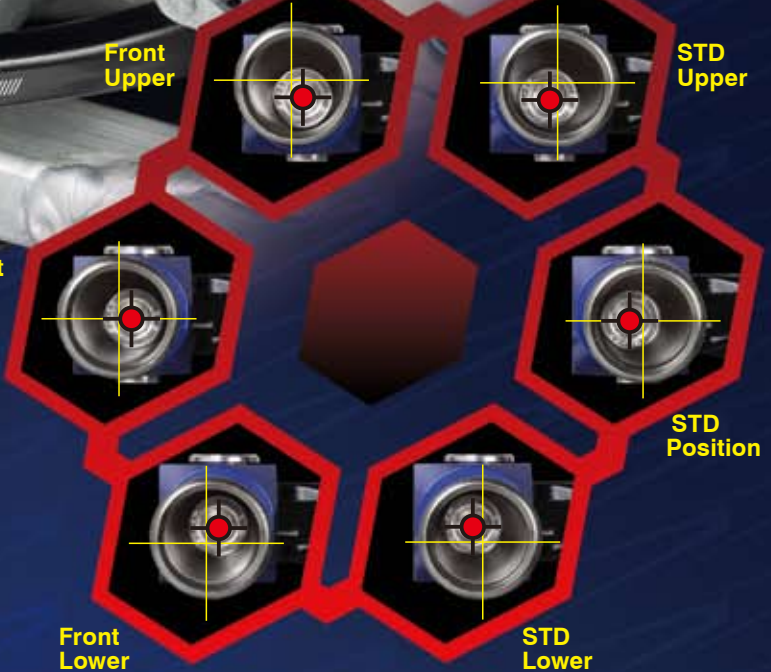

ZETA REVOLVER SHIFT LEVER

- Revolving shift tip design provides best shift positions for all riders.
- Rotating shift tip provides 6 different positions, offer more sensitive shift position adjustment.
- Shift arm is made of A2014 forged aluminum for durability.
- Forged arm is black anodized finish with laser print logo.
- Foldable shift tip is made of CNC aluminum with knurled finish for better shift grip.
- Shift tip is color anodized with ZETA laser print logo.
- Replacement shift tips and tip mounts are available.



Shift tip is color anodized with ZETA laser print logo.

Forged arm is black anodized finish with laser print logo.

REVOLVER SHIFT RACER Application

Bike	Year	Color	Part #	Rep Shift Tip	Rep Tip Mount
HONDA	CR80R/85R	96-07	ZE90-3042	ZE90-3920	ZE90-3902
	CRF150R	07-18	ZE90-3012	ZE90-3920	ZE90-3902
	CRF250R	04-09	ZE90-3052	ZE90-3920	ZE90-3902
	CRF450R	10-17	ZE90-3022	ZE90-3920	ZE90-3902
	CRF450R	07-16	ZE90-3032	ZE90-3930	ZE90-3912
	CRF450R	17-18	ZE90-3062	ZE90-3930	ZE90-3912
	CRF250X	04-17	ZE90-3052	ZE90-3920	ZE90-3902
	CRF450RX	17-18	ZE90-3062	ZE90-3930	ZE90-3912
	CRF50F/70F(Standard)	04-17	ZE90-3502	ZE90-3930	ZE90-3902
	CRF50F/70F(10 mm Long)	04-17	ZE90-3512	ZE90-3930	ZE90-3912
	CRF125F	14-18	ZE90-3512	ZE90-3930	ZE90-3912
	XR250R(ME06/ME08)	93-04	ZE90-3532	ZE90-3920	ZE90-3902
XR400R	96-04	ZE90-3532	ZE90-3920	ZE90-3902	
YAMAHA	YZ85	07-18	ZE90-3306	ZE90-3920	ZE90-3906
	YZ125/250	06-18	ZE90-3316	ZE90-3920	ZE90-3906
	YZ250F	06-13	ZE90-3336	ZE90-3920	ZE90-3916
	YZ450F(10 mm Long)	14-18	ZE90-3326	ZE90-3930	ZE90-3916
	YZ450F	06-13	ZE90-3336	ZE90-3930	ZE90-3916
	YZ125X	17-18	ZE90-3316	ZE90-3920	ZE90-3906
	YZ250X	16-18	ZE90-3316	ZE90-3920	ZE90-3906
	YZ250FX	15-18	ZE90-3356	ZE90-3920	ZE90-3916
	YZ450FX	16-18	ZE90-3326	ZE90-3930	ZE90-3916
	WR250F	07-13	ZE90-3336	ZE90-3920	ZE90-3916
	WR250F	15-18	ZE90-3356	ZE90-3920	ZE90-3916
	WR450F	07-15	ZE90-3336	ZE90-3920	ZE90-3916
TTR50E(Standard)	06-16	ZE90-3506	ZE90-3930	ZE90-3906	
TTR50E(10 mm Long)	06-16	ZE90-3516	ZE90-3930	ZE90-3916	
KAWASAKI	KX250F	09-18	ZE90-3112	ZE90-3920	ZE90-3912
	KX450F	09-18	ZE90-3122	ZE90-3920	ZE90-3902
SUZUKI	RMZ250	07-18	ZE90-3212	ZE90-3930	ZE90-3902
	RMZ450	08-18	ZE90-3222	ZE90-3920	ZE90-3902
	RMX250R	89-98	ZE90-3242	ZE90-3920	ZE90-3902
	RMX450Z	10-17	ZE90-3222	ZE90-3920	ZE90-3902

NOTE : After selecting the tip position. Always coat with a screw locking agent, and tighten firmly.

Bike	Year	Color	Part #	Rep Shift Tip	Rep Tip Mount
KTM	85SX	03-17	ZE90-3403	ZE90-3920	ZE90-3913
	125SX/EXC	01-15	ZE90-3413	ZE90-3920	ZE90-3913
	125SX	16	ZE90-3433	ZE90-3920	ZE90-3913
	125SX/EXC/XC-W	17-18	ZE90-3443	ZE90-3920	ZE90-3913
	150SX/XC	09-15	ZE90-3413	ZE90-3920	ZE90-3913
	150SX	16	ZE90-3433	ZE90-3920	ZE90-3913
	150SX/XC-W	17-18	ZE90-3443	ZE90-3920	ZE90-3913
	200EXC	01-16	ZE90-3413	ZE90-3920	ZE90-3913
	200SX/MXC	01-04	ZE90-3413	ZE90-3920	ZE90-3913
	200XC/XC-W	06-15	ZE90-3413	ZE90-3920	ZE90-3913
	250SX/EXC/EXC TPI/XC-W	17-18	ZE90-3413	ZE90-3920	ZE90-3913
	250SX-F/XC-F	11-12	ZE90-3423	ZE90-3930	ZE90-3913
	250SX-F/XC-F	13-18	ZE90-3413	ZE90-3920	ZE90-3913
	250EXC-F/XCF-W	09-11	ZE90-3413	ZE90-3920	ZE90-3913
	250EXC-F	12-16	ZE90-3423	ZE90-3930	ZE90-3913
	300XC/EXC/EXC TPI/XC-W	17-18	ZE90-3413	ZE90-3920	ZE90-3913
	350SX-F/XC-F	11-18	ZE90-3413	ZE90-3920	ZE90-3913
	350EXC-F/XCF-W	12-16	ZE90-3423	ZE90-3930	ZE90-3913
	350EXC-F	17-18	ZE90-3413	ZE90-3920	ZE90-3913
	450SX	03-06	ZE90-3413	ZE90-3920	ZE90-3913
450SX-S-F	07-08	ZE90-3413	ZE90-3920	ZE90-3913	
450SX-F	07-12	ZE90-3413	ZE90-3920	ZE90-3913	
450XC-F	08-09	ZE90-3413	ZE90-3920	ZE90-3913	
450SX-F/XC-F	13-15	ZE90-3423	ZE90-3930	ZE90-3913	
450EXC	16-18	ZE90-3433	ZE90-3920	ZE90-3913	
450XC-F	03-16	ZE90-3423	ZE90-3930	ZE90-3913	
450XC-W	17-18	ZE90-3433	ZE90-3920	ZE90-3913	
500EXC	07-16	ZE90-3423	ZE90-3930	ZE90-3913	
500EXC-F	12-16	ZE90-3423	ZE90-3930	ZE90-3913	
500XC-W	17-18	ZE90-3433	ZE90-3920	ZE90-3913	
500XC-W	12-16	ZE90-3423	ZE90-3930	ZE90-3913	
505SX-F	07-08	ZE90-3413	ZE90-3920	ZE90-3913	
505XC-F	08-09	ZE90-3413	ZE90-3920	ZE90-3913	
HUSQVARNA	TC85	15-17	ZE90-3406	ZE90-3920	ZE90-3916
	TE125	14-16	ZE90-3416	ZE90-3920	ZE90-3916
	TC125	14-15	ZE90-3416	ZE90-3920	ZE90-3916
	TC/TX125	16	ZE90-3436	ZE90-3920	ZE90-3916
	TE150	17-18	ZE90-3446	ZE90-3920	ZE90-3916
	TE250/300/250i/300i	17-18	ZE90-3416	ZE90-3920	ZE90-3916
	TC250	17-18	ZE90-3416	ZE90-3920	ZE90-3916
	TX300	17-18	ZE90-3416	ZE90-3920	ZE90-3916
	FC250/350	14-18	ZE90-3416	ZE90-3920	ZE90-3916
	FC450	14-15	ZE90-3426	ZE90-3930	ZE90-3916
	FE250-501	16-18	ZE90-3436	ZE90-3920	ZE90-3916
	FE250/350	14-16	ZE90-3426	ZE90-3930	ZE90-3916
	FE450/501	17-18	ZE90-3416	ZE90-3920	ZE90-3916
	FX350/450	17-18	ZE90-3436	ZE90-3920	ZE90-3916

CONTROL

BARCLAMP

LEVER

FOOT PARTS

HAND GUARD

SUSPENSION

BODY GUARD

BODY

ACCESSORIES

CARBON



Replacement Tip Mount

Part #	Color	Description
ZE90-3900	Black	Straight type
ZE90-3902	Red	
ZE90-3906	Blue	
ZE90-3912	Red	Offset type
ZE90-3913	Orange	
ZE90-3916	Blue	

Note replacement tip mount, please use the same shape as shown on the compatibility table. If you install a different shape it may interfere with the engine case cover.



Replacement Shift tip

Part #	Description
ZE90-3920	23 mm
ZE90-3930	28 mm

	Bike	Year	Color	Part #	Rep Shift Tip	Rep Tip Mount		
HONDA	CRM50/80	93-97	Red	ZE90-3512	ZE90-3930	ZE90-3912		
		93-97	Blue	ZE90-3516	ZE90-3930	ZE90-3916		
		89-00		ZE90-3522	ZE90-3930	ZE90-3902		
		87-94		ZE90-3532	ZE90-3920	ZE90-3902		
		95-07	Red	ZE90-3532	ZE90-3920	ZE90-3902		
		12-17		ZE90-3042	ZE90-3920	ZE90-3902		
		17		ZE90-3042	ZE90-3920	ZE90-3902		
YAMAHA	XT200	82-84	Red	ZE90-3502	ZE90-3930	ZE90-3902		
		82-84	Blue	ZE90-3506	ZE90-3930	ZE90-3906		
		91-94	Red	ZE90-3502	ZE90-3930	ZE90-3902		
		91-94	Blue	ZE90-3506	ZE90-3930	ZE90-3906		
		97-00	Red	ZE90-3512	ZE90-3930	ZE90-3912		
		97-00	Blue	ZE90-3516	ZE90-3930	ZE90-3916		
		07-17		ZE90-3346	ZE90-3930	ZE90-3906		
		05-17		ZE90-3360	ZE90-3930	ZE90-3900		
		04-17		ZE90-3360	ZE90-3930	ZE90-3900		
		06-17	Black	ZE90-3360	ZE90-3930	ZE90-3900		
KAWASAKI	KDX125SR	10-16		ZE90-3532	ZE90-3920	ZE90-3902		
		92-99	Red	ZE90-3602	#	ZE90-3920		
		90-93		ZE90-3602	#	ZE90-3920		
		94-99		ZE90-3602	#	ZE90-3920		
		92-94		ZE90-3602	#	ZE90-3920		
		97-07		ZE90-3502	ZE90-3930	ZE90-3902		
		97-07	Blue	ZE90-3506	ZE90-3930	ZE90-3906		
		01-16	Red	ZE90-3142	ZE90-3920	ZE90-3902		
		SUZUKI	RMX250S	96-98		ZE90-3242	ZE90-3920	ZE90-3902
				02-06	Red	ZE90-3142	ZE90-3920	ZE90-3902
00-17				ZE90-3242	ZE90-3920	ZE90-3902		

ZE90-3062 (KDX125SR / 200SR / 220SR / 250SR) up and down shift position is with the use of only genuine position. After selecting the tip position, always coat with a screw locking agent, please tighten firmly.



KTM250SX-F



ZETA FORGED SHIFT LEVER

- Forged lever arm shift lever available from ZETA.
- Shift arm is made of A2014 forged aluminum for durability.
- Forged arm is black anodized finish.
- Foldable shift tip is made of CNC aluminum with knurled finish for better shift grip.
- Shift tip is color anodized with ZETA laser print logo.
- Available for most motocross and dual sport models.

RACER Application

Bike	Year	Color	Part #
HONDA			
CR80R/85R	96-07		ZE90-4042
CRF150R	07-18		ZE90-4012
CRF250R	04-09		ZE90-4052
	10-17		ZE90-4022
	07-16		ZE90-4032
CRF450R	17-18		ZE90-4062
	17-18	Red	ZE90-4062
CRF450RX	04-17		ZE90-4052
CRF250X	04-17		ZE90-4502
CRF50F/70F(Standard)	04-17		ZE90-4512
CRF50F/70F (10 mm Long)	04-17		ZE90-4512
CRF125F	14-18		ZE90-4512
XR250R(ME06/ME08)	93-04		ZE90-4532
XR400R	96-04		ZE90-4532
YAMAHA			
YZ85	07-18		ZE90-4306
YZ125/250	06-18		ZE90-4316
YZ125X	17-18		ZE90-4316
YZ250X	16-18		ZE90-4316
YZ250F	06-13		ZE90-4336
YZ250FX	14-18		ZE90-4326
YZ250FX	15-18		ZE90-4356
YZ450F(10 mm Long)	06-13	Blue	ZE90-4336
YZ450F	14-18		ZE90-4326
YZ450FX	16-18		ZE90-4326
WR250F	07-13		ZE90-4336
	15-18		ZE90-4356
WR450F	07-15		ZE90-4336
	16-18		ZE90-4326
TTR50E(Standard)	06-16		ZE90-4506
TTR50E(10 mm Long)	06-16		ZE90-4516
KAWASAKI			
KX250F	09-18	Red	ZE90-4112
KX450F	09-18		ZE90-4122
SUZUKI			
RMZ250	07-18		ZE90-4212
RMZ450	08-18		ZE90-4222
RMX450Z	10-17	Red	ZE90-4222
RMX250R	89-98		ZE90-4242

DUAL SPORTS Application

Bike	Year	Color	Part #
HONDA			
CRM50/80	93-97	Red	ZE90-4512
	93-97	Blue	ZE90-4516
CRM250R/AR	89-00		ZE90-4522
XLR250R/BAJA	87-94	Red	ZE90-4532
XR250/BAJA/MOTARD	95-07		ZE90-4532
CRF250L/M	12-17		ZE90-4042
CRF250RALLY	17		ZE90-4042
YAMAHA			
XT200	82-84	Red	ZE90-4502
	82-84	Blue	ZE90-4506
DT200WR	91-94	Red	ZE90-4502
	91-94	Blue	ZE90-4506
DT230LANZA	97-00	Red	ZE90-4512
	97-00	Blue	ZE90-4516
WR250R/X	07-17	Blue	ZE90-4346
KAWASAKI			
KLX125,D-TRACKER125	10-16		ZE90-4532
KDX125SR	92-99	Red	ZE90-4602 #
KDX200SR	90-93		ZE90-4602 #
KDX220SR	94-99		ZE90-4602 #
KDX250SR	92-94		ZE90-4602 #
KL250 SUPER SHERPA	97-07	Blue	ZE90-4502
KLX250,D-TRACKER	01-16	Red	ZE90-4142
SUZUKI			
RMX250S	96-98		ZE90-4242
250SB	02-06	Red	ZE90-4142
DR-Z400S/SM	00-17		ZE90-4242

ZE90-4062 (KDX125SR / 200SR / 220SR / 250SR) up and down shift position is with the use of only genuine position.

RACER Application

Bike	Year	Color	Part #
HUSQVARNA			
FC250/350	14-18		ZE90-4416
FC450	14-15		ZE90-4426
FC450	16-18		ZE90-4436
FE250-501	14-16	Blue	ZE90-4426
FE250/350	17-18		ZE90-4416
FE450/501	17-18		ZE90-4436
FX350/450	17-18		ZE90-4416

TRIGGER



ZE90-7423
KTM

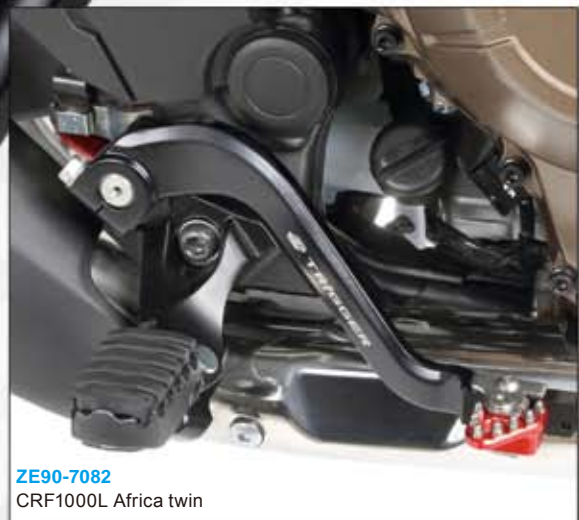

ZE90-7082
CRF1000L Africa twin

CONTROL

BARCLAMP

LEVER

FOOT PARTS

HAND GUARD

SUSPENSION

BODY GUARD

BODY

ACCESSORIES

CARBON



ZE90-7012
CRF250R/450R

ZE90-7416
Husqvarna

ZE90-7350
SEROW250
TRICKER
XT250X
XT250

ZETA TRIGGER BRAKE PEDAL

- Brake arm is made of forged A2014 aluminum for durability.
- Black anodized finish with laser print logo.
- Brake tip is made of CNC machined A7079 aluminum with anodized finish.
- Bolt, pin and spring are made of stainless steel for less corrosion.
- Comes with brake saver.



Black anodized finish with laser print logo.



Thin tip design to prevent it from hitting the ground. Designed to prevent sand and mud from entering the tip folding area from front and side of brake tips. Pins are designed for sensitive pedal control and traction.



Designed to prevent sand and mud from entering tip folding area from front and side of brake tips.



Provides 2 different positions.

	Bike	Year	Color	Part #
HONDA	CRF250R	04-17	Red	ZE90-7012
	CRF450R	05-18		ZE90-7012
	CRF450RX	17-18		ZE90-7012
	CRF250L/M	12-17		ZE90-7022
	CRF250RALLY	17		ZE90-7022
	CRF1000L/DCT	16-17		ZE90-7082
YAMAHA	YZ125	05-18	Blue	ZE90-7316
	YZ250	05-18		ZE90-7316
	YZ250F	10-18		ZE90-7326
	YZ450F	10-18		ZE90-7336
	YZ125X	17-18		ZE90-7316
	YZ250X	16-18		ZE90-7316
	YZ250FX	15-18		ZE90-7326
	YZ450FX	16-18		ZE90-7336
	WR250F	15-18		ZE90-7326
	WR450F	12-18		ZE90-7336
	WR250R/X	07-17		ZE90-7346
	SEROW250	05-17		Black
TRICKER	04-17	ZE90-7350		
XT250X	06-17	ZE90-7350		
XT250	08-18	ZE90-7350		
KAWASAKI	KX250F	06-18	Red	ZE90-7112
	KX450F	16-18		ZE90-7122
	KLX250/ D-TRACKER	01-16		ZE90-7182
SUZUKI	RMZ250	13-18	Red	ZE90-7212
	RMX450	08-18		ZE90-7222
	RMX450Z	10-17		ZE90-7222
	250SB	02-06		ZE90-7182
DRZ400S/SM	00-17	ZE90-7282		
KTM	125EXC	11-16	Orange	ZE90-7413
	125SX	11-15		ZE90-7413
	125SX-W	16-18		ZE90-7423
	125XC-W	17		ZE90-7423
	150SX/XC	11-15		ZE90-7413
	150SX/XC-W	16-18		ZE90-7423
	200EXC/XC/XC-W	01-16		ZE90-7413
	250SX	11-16		ZE90-7413
	250SX-F/XC-F	11-15		ZE90-7413
	250SX-F/XC-F	16-18		ZE90-7423
	250EXC-F/XCF-W	11-16		ZE90-7413
	250EXC-F	17-18		ZE90-7423
	300XC/XC-W	11-16		ZE90-7413
	350SX-F/XC-F	11-15		ZE90-7413
	350SX-F/XC-F	16-18		ZE90-7423
	350EXC-F/XCF-W	11-16		ZE90-7413
	350EXC-F	17-18		ZE90-7423
	450SX-F/XC-F	11-15		ZE90-7413
	450SX-F	16-18		ZE90-7423
	450EXC/XC-W	12-16		ZE90-7413
450EXC-F	17-18	ZE90-7423		
500EXC/XC-W	12-16	ZE90-7413		
500EXC-F	17-18	ZE90-7423		
HUSQVARNA	TE150	17-18	Blue	ZE90-7426
	TE250/300	14-16		ZE90-7416
	FE250-501	14-16		ZE90-7416
	FE250/350	17-18		ZE90-7426
	FE450/501	17-18		ZE90-7426
	TC125	16-18		ZE90-7426
	TC250	14-16		ZE90-7416
	FC250/350/450	14-15		ZE90-7416
	TX125	16-18		ZE90-7426
	FX350/450	17-18		ZE90-7426

Replacement Tip Mount



ZE90-7900
Black

ZE90-7902
Red

ZE90-7903
Orange

ZE90-7906
Blue

Replacement Pin Set



ZE90-7929

ALUMINUM FOOTPEG



	Bike	Year	Black	Red	Blue	Orange	
HONDA	CR125R/250R	02-07	ZE93-1020	ZE93-1022	-	-	
	CRF150R	07-18	ZE93-1020	ZE93-1022	-	-	
	CRF250R	04-17	ZE93-1020	ZE93-1022	-	-	
	CRF450R	02-18	ZE93-1020	ZE93-1022	-	-	
	CRF450RX	17-18	ZE93-1020	ZE93-1022	-	-	
	CRF250X	04-17	ZE93-1020	ZE93-1022	-	-	
	CRF450X	05-17	ZE93-1020	ZE93-1022	-	-	
	CRF250L/M	12-17	ZE93-1020	ZE93-1022	-	-	
	CRF250RALLY	17	ZE93-1020	ZE93-1022	-	-	
	YZ85	02-18	ZE93-1620	-	ZE93-1623	-	
YAMAHA	YZ125	97-18	ZE93-1620	-	ZE93-1623	-	
	YZ250	98-18	ZE93-1620	-	ZE93-1623	-	
	YZ250F	01-16	ZE93-1620	-	ZE93-1623	-	
		17-18	ZE93-1620	-	ZE93-1623	#1	
	YZ450F	03-15	ZE93-1620	-	ZE93-1623	-	
		16-18	ZE93-1620	-	ZE93-1623	#1	
	YZ125X	17-18	ZE93-1620	-	ZE93-1623	-	
	YZ250X	16-18	ZE93-1620	-	ZE93-1623	-	
	YZ250FX	15-18	ZE93-1620	-	ZE93-1623	#1	
	YZ450FX	16-18	ZE93-1620	-	ZE93-1623	#1	
KAWASAKI	WR250F	01-06	ZE93-1620	-	ZE93-1623	-	
		07-18	ZE93-1620	-	ZE93-1623	#1	
	WR450F	03-15	ZE93-1620	-	ZE93-1623	-	
		16-18	ZE93-1620	-	ZE93-1623	#1	
	WR250R/X	07-17	-	-	ZE93-1663	-	
	SUZUKI	KX250F	09-18	ZE93-1220	-	-	-
		KX450F	09-18	ZE93-1220	-	-	-
		RMZ250	10-18	ZE93-1420	-	-	-
		RMZ450	08-18	ZE93-1420	-	-	-
		RMX450Z	10-17	ZE93-1420	-	-	-
65SX		09-18	ZE93-1810	-	-	ZE93-1817	
		03-17	ZE93-1810	-	-	ZE93-1817	
85SX		18	ZE93-1820	-	ZE93-1823	ZE93-1827	
		98-15	ZE93-1810	-	-	ZE93-1817	
125SX/250-450SX-F		16-18	ZE93-1820	-	ZE93-1823	ZE93-1827	
SUZUKI	250SX	98-16	ZE93-1810	-	-	ZE93-1817	
		17-18	ZE93-1820	-	ZE93-1823	ZE93-1827	
	125-530 EXC/EXC-F	98-16	ZE93-1810	-	-	ZE93-1817	
		17-18	ZE93-1820	-	ZE93-1823	ZE93-1827 #2	
	150-300XC/250XC-F	06-16	ZE93-1810	-	-	ZE93-1817	
		17-18	ZE93-1820	-	ZE93-1823	ZE93-1827	
	350-450XC-F	08-15	ZE93-1810	-	-	ZE93-1817	
		16-18	ZE93-1820	-	ZE93-1823	ZE93-1827	
	200-530XC-W/XCF-W	06-16	ZE93-1810	-	-	ZE93-1817	
	125-300XC-W	17-18	ZE93-1820	-	ZE93-1823	ZE93-1827 #2	
SUZUKI	FREERIDE250F	18	ZE93-1810	-	-	ZE93-1817	
	FREERIDE250R	14-17	ZE93-1810	-	-	ZE93-1817	
	FREERIDE350	12-17	ZE93-1810	-	-	ZE93-1817	
	690ENDURO/R	08-17	ZE93-1810	-	-	ZE93-1817	
	690SMC/R	08-17	ZE93-1810	-	-	ZE93-1817	
	690SUPER MOTO/R	07-09	ZE93-1810	-	-	ZE93-1817	
	950ADVENTURE/S	03-06	ZE93-1810	-	-	ZE93-1817	
	950SUPER ENDURO/R	ALL	ZE93-1810	-	-	ZE93-1817	
	950SUPER MOTO/R	05-08	ZE93-1810	-	-	ZE93-1817	
	990ADVENTURE/R/S	ALL	ZE93-1810	-	-	ZE93-1817	
SUZUKI	990SUPER MOTO/R/T	09-13	ZE93-1810	-	-	ZE93-1817	
	1050ADVENTURE	15-16	ZE93-1810	-	-	ZE93-1817	
	1090ADVENTURE/R	17	ZE93-1810	-	-	ZE93-1817	
	1190ADVENTURE/R	13-16	ZE93-1810	-	-	ZE93-1817	
	1290SUPER ADVENTUR/R/S/T	15-17	ZE93-1810	-	-	ZE93-1817	
	SUZUKI	TC65	17-18	ZE93-1810	-	-	ZE93-1817
			14-17	ZE93-1810	-	-	ZE93-1817
		TC85	18	ZE93-1820	-	ZE93-1823	ZE93-1827
			14-15	ZE93-1810	-	-	ZE93-1817
		TC125/FC250-450	16-18	ZE93-1820	-	ZE93-1823	ZE93-1827
		14-16	ZE93-1810	-	-	ZE93-1817	
TC250		17-18	ZE93-1820	-	ZE93-1823	ZE93-1827	
		14-16	ZE93-1810	-	-	ZE93-1817	
TE/FE150-501		17-18	ZE93-1820	-	ZE93-1823	ZE93-1827 #2	
		17-18	ZE93-1820	-	ZE93-1823	ZE93-1827 #2	
SUZUKI	TX125	17-18	ZE93-1820	-	ZE93-1823	ZE93-1827	
	TX/FX300-450	17-18	ZE93-1820	-	ZE93-1823	ZE93-1827	
	701ENDURO	16-18	ZE93-1810	-	-	ZE93-1817	
	701SUPER MOTO	16-18	ZE93-1810	-	-	ZE93-1817	
		15	ZE93-1810	-	-	ZE93-1817	
	FS450	16-18	ZE93-1820	-	ZE93-1823	ZE93-1827 #2	

#1 Stock +5 mm
#2 Stock -5 mm

ZETA ALUMINUM FOOT PEGS

- CNC machined A2014 forged aluminum foot peg.
- 57 mm width foot pegs provides better foot peg traction and control.
- Light weight design comes with beautiful anodized finish and zeta laser print logo.
- SUS 304 stainless pins provides better grip.
- Available for recent MX bikes.



Black
HONDA, YAMAHA,
KAWASAKI, SUZUKI,
KTM, HUSQVARNA



Red
HONDA



Blue
YAMAHA,
KTM
HUSQVARNA



Orange
KTM
HUSQVARNA



Replacement Pin Set
ZE93-1997

CONTROL

BARCLAMP

LEVER

FOOT PARTS

HAND GUARD

SUSPENSION

BODY GUARD

BODY

ACCESSORIES

CARBON

IMPACT X3

ZETA

IMPACT X3 HAND GUARD

- Aerodynamic design new hand guard.
- Ideal hand guard size and design requested by top riders and factory teams.
- Comes with master cylinder guard, can be adjusted to 2 different positions.
- Can be used at various track or race conditions and bikes, protect your hands and master cylinders from mud and rocks
- Available in black and white colors.

Part #	Color
ZE74-4101	Black
ZE74-4110	White

Replacement Shields

ZE74-4201	Black
ZE74-4210	White



Available in 2 colors



Master-Cylinder Guard

2 adjustable master cylinder guard positions to protect your master cylinder. It can be removed for lighter weight.



Master cylinder guard



Hand guard without guard.

Handguard Mount TYPE-2

Clamp on style universal hand guard mounts, made of light weight plastic.



Comes with special hand guard mount spacers.

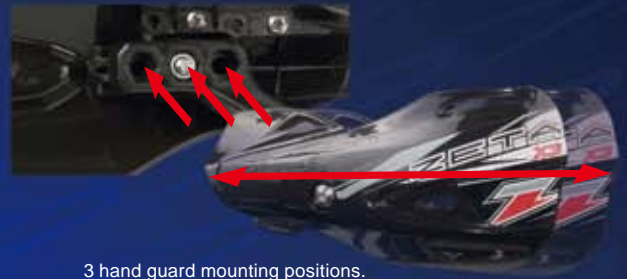

3 hand guard mounting positions.

Clamp Position

Hand guard mount is designed to install hand guard mount inside of switches or brake / clutch master cylinder on handlebar without any position adjustment on handlebar. Great to use on recent MX bikes come with mapping switch and electric start button, which do not have space on handlebar straight area.



Handlebar Clamp

Can be mount even on handlebar curved area.

Mount Spacer

Adjust hand guard angle with mounting spacer when hand guard clamp is installed on handlebar curved area.



Standard 0°

Slant 10°



Turn over spacers to change hand guard angle.

* Can be used taper handlebar size from 22.2 mm to 23.5 mm.

Stingray Vented

Kawasaki Team GREEN
JMX

ZETA

STINGRAY VENT HAND GUARD

- ZETA vented Stingray hand guards, used by Japanese Factory Kawasaki Team Green and Factory Suzuki.
- Vented design cools your hand during hard riding, yet it protects your hand from brush, roots and the elements. Light weight design.
- Handlebar clamp style hand guards fits almost all dirt bikes and ATVs.
- Available in 7 factory colors, replacement shields available.

Part #	Color	Part #	Color	Part #	Color
ZE74-3101	Black	ZE74-3107	Yellow	ZE74-3109	Orange
ZE74-3104	Blue	ZE74-3108	Green	ZE74-3110	White
ZE74-3105	Red				

Replacement Shields

Part #	Color	Part #	Color	Part #	Color
ZE74-3201	Black	ZE74-3207	Yellow	ZE74-3209	Orange
ZE74-3204	Blue	ZE74-3208	Green	ZE74-3210	White
ZE74-3205	Red				



Available in 7 colors

Stingray

ZETA

STINGRAY HAND GUARD

- Handlebar clamp style hand guard.
- Protect your hand from brush, roots and the elements.
- Fits almost all dirt bikes, ATVs and more. Universal fit.
- Colors available : Black, Red, Blue, Yellow, Orange and White.
- Comes complete with all mounting hardware.
- Replacement shields available.

Part #	Color	Part #	Color	Part #	Color
ZE74-2101	Black	ZE74-2107	Yellow	ZE74-2110	White
ZE74-2104	Blue	ZE74-2109	Orange		
ZE74-2105	Red				

Replacement Shields

Part #	Color	Part #	Color	Part #	Color
ZE74-2201	Black	ZE74-2207	Yellow	ZE74-2210	White
ZE74-2204	Blue	ZE74-2209	Orange		
ZE74-2205	Red				



Available in 6 colors

IMPACT X2

ZETA

IMPACT X2 HAND GUARD

- 2nd generation of impact hand guards.
- New compact hand guard shells with aero dynamic design. Fits most dirt bikes and ATVs.
- Compact shells design for riders looking for small hand guard shells. Mini mx racing models and ATVs.
- Available in 7 factory colors, replacement shields available.

Part #	Color	Part #	Color	Part #	Color
ZE74-0201	Black	ZE74-0207	Yellow	ZE74-0209	Orange
ZE74-0204	Blue	ZE74-0208	Green	ZE74-0210	White
ZE74-0205	Red				

Replacement Shields

Part #	Color	Part #	Color	Part #	Color
ZE74-1201	Black	ZE74-1207	Yellow	ZE74-1209	Orange
ZE74-1204	Blue	ZE74-1208	Green	ZE74-1210	White
ZE74-1205	Red				



Available in 7 colors

Replacement Mounting Kit



TYPE -1
ZE74-0910

Fit Protector -----
STINGRAY VENT
STINGRAY
IMPACT X2

TYPE -2
ZE74-0911

Fit Protector -----
STINGRAY VENT
STINGRAY
IMPACT X2
IMPACT X3

TYPE - 1 Mounting Kit



Provides 3 different guard positions
Fit Protector -----
STINGRAY VENT, STINGRAY
IMPACT X2

Hand guard attachment fits above or below lever
Fit Protector -----
STINGRAY VENT, STINGRAY
IMPACT X2

CONTROL

BARCLAMP

LEVER

FOOT PARTS

HAND GUARD

SUSPENSION

BODY GUARD

BODY

ACCESSORIES

CARBON

ZETA
PRO ARMOR HAND GUARD

- Upgraded armor hand guards for pro rider use.
- Comes with durable plastic bumpers to protect the armor hand guard body.
- Comes with durable longer bar end adapters which holds the handlebars tighter.
- Matching design between hand guard body and bar end adapter prevents rotation of hand guards in the event of a fall.
- Can be used with Zeta hand guard mount kits: side, front and BC type, for durable fitting.
- Available in Titanium, black and orange anodized colors.
- Replacement hand guard bumpers and bar end adapters are available.

Part #	Color
ZE71-8001	Black
ZE71-8003	Titanium
ZE71-8006	Orange

Replacement ProBar End Adapter
Part number **ZE71-8921**

Replacement bumper
Part number **ZE71-8911**

Matching design

Plastic bumper

ZETA
ARMOR HAND GUARDS Bend 28.6 mm U-clamp

- Armor hand guard comes with U clamp bar mount.
- The best to use this hand guard for KTM and HUSQVARNA or other models which uses hydraulic clutch master cylinder.
- U shape handlebar clamp provides more space for hydraulic oil line or cables.
- Made of durable aluminum, Drop down design provides better control.
- Available for 28.6 mm handlebars.
- Can be used with ZETA hand guard protectors.

Part #	Color
ZE72-0151	Black
ZE72-0153	Titanium

ZETA
U-CLAMP KIT

- U shape armor hand guard bar mount kit.
- Unique U shape design clamp does not touch clutch cable and, oil line or brake line.
- Made of durable aluminum, available in 2 different size clamps, 28.6 mm and 22.2 mm.
- Comes in pairs.

Part #	Size
ZE71-1618	1-1/8" (28.6 mm)
ZE71-1718	7/8" (22.2 mm)

ZE71-1618

ZE71-1718

ZETA
HAND GUARD BC - MOUNT
KTM / HUSQVARNA

- Armor hand guard mount kit developed for KTM and HUSQVARNA.
- Bar clamp mount style does not interfere with brake and clutch hoses.
- Provides more durable fitting of ZETA armor hand guards.
- Prevents rotation of hand guards, protects your control levers and throttle in the event of fall.
- Made of CNC machined A7009 aluminum, hard anodized titanium color with laser printed logo.
- Comes with special installation bolts.

Part #	Color
ZE71-1831	Titanium

CONTROL

BARCLAMP

LEVER

FOOT PARTS

HAND GUARD

SUSPENSION

BODY GUARD

BODY

ACCESSORIES

CARBON

ZETA
ARMOR HAND GUARD BEND

- Durable aluminum hand guards.
- Made of A7009-T6 aluminum for extreme strength.
- Drop down design provides better control.
- Holes are pre-drilled for mounting of ZETA protector shields.
- All mounting hardware included, replacement hardware available.
- Hand guards available for 7/8" (22.2 mm) bars and 1-1/8" (28.6 mm) bars.
- Available in 4 colors : Black, Titanium-color, Red and Blue.

for 7/8" (22.2 mm) bars	
Part #	Color
ZE72-0001	Black
ZE72-0003	Titanium
ZE72-0004	Red
ZE72-0005	Blue

for 1-1/8" (28.6 mm) bars	
Part #	Color
ZE72-0101	Black
ZE72-0103	Titanium
ZE72-0104	Red
ZE72-0105	Blue



ZETA
ARMOR HAND GUARD STRAIGHT

- Standard straight end design aluminum hand guards.
- Made of A7009-T6 aluminum for extreme durability.
- Holes are pre-drilled for mounting of ZETA protector shields.
- All mounting hardware included, replacement hardware available.
- Hand guards available for 7/8" (22.2 mm) bars and 1-1/8" (28.6 mm) bars.
- Available in 2 colors : Titanium-color and Black

for 7/8" (22.2 mm) bars	
Part #	Color
ZE72-0011	Black
ZE72-0013	Titanium

for 1-1/8" (28.6 mm) bars	
Part #	Color
ZE72-0111	Black
ZE72-0113	Titanium



ZETA
HAND GUARD MOUNT
SIDE TYPE & FRONT TYPE

- Top triple clamp rigid mount kit for Armor hand guards provides more durable fitting.
- Prevents rotation of hand guards, protects your control levers and throttle in the event of a fall.
- Can be used on motorcycles with the top clamp fork bolts attached from the side or front.
- Made of CNC machined A7009 aluminum, hard anodized titanium color with laser printed logo.
- Comes with special installation bolts.

* Can not be used on top clamps with the fork bolts attached from the back.
* Hand guard modification may be needed to attach some handlebar bends.

SIDE TYPE
Can be used on motorcycles with the top clamp fork bolts attached from the side.

Part #	Color	Bolt center pitch
ZE71-1822	Titanium	16 - 30 mm

FRONT TYPE
Can be used on motorcycles with the top clamp fork bolts attached from the front.

Part #	Color	Bolt center pitch
ZE71-1821	Titanium	16 - 30 mm

Replacement Bar End Adapter
Bar inner diameter : 13.5 mm - 19.0 mm
ZE71-7911

Replacement Clamp
1-1/8" (28.6 mm) **ZE71-1612**
7/8" (22.2 mm) **ZE71-1712**

Replacement Clamp (long)
1-1/8" (28.6 mm) **ZE71-1613**
7/8" (22.2 mm) **ZE71-1713**

CONTROL

BARCLAMP

LEVER

FOOT PARTS

HAND GUARD

SUSPENSION

BODY GUARD

BODY

ACCESSORIES

CARBON



ZETA X3 PROTECTOR

- Protector comes with master cylinder guard.
- Master cylinder guard can be adjusted 2 different positions.
- Also can be removed for lighter weight.
- Protects your hand from brush, roots and the elements.
- Available black and white shell colors.

Part #	Color
ZE72-0406	Black
ZE72-0410	White



Adjusted 2 different positions

X3 PROTECTOR



ZETA X2 PROTECTOR

- Compact deflector-shields for Armor hand guards.
- Light weight design for better handling and more space for your hands.
- Great to use for Super moto and ED race.
- Comes with mounting screws for armor hand guards.
- Available in 7 colors.

Part #	Color	Part #	Color	Part #	Color
ZE72-0304	Blue	ZE72-0307	Yellow	ZE72-0310	White
ZE72-0305	Red	ZE72-0308	Green		
ZE72-0306	Black	ZE72-0309	Orange		

X2 PROTECTOR



ZETA XC PROTECTOR

- Larger deflector-shields for Armor hand guards.
- Suitable for ENDURO race.
- Larger shields protect hands from brush, roots and the elements.
- Slit holes on the shells reduce air resistance.
- Comes with mounting screws for armor hand guards.
- Optional XC flashers can be mounted.
- Available in 7 colors.

Part #	Color	Part #	Color	Part #	Color
ZE72-3104	Blue	ZE72-3107	Yellow	ZE72-3110	White
ZE72-3105	Red	ZE72-3108	Green		
ZE72-3106	Black	ZE72-3109	Orange		

XC Optional Flasher



Part #	Color
ZE72-3991	Orange
ZE72-3992	Smoke

XC PROTECTOR



ZETA XC FLASHER PROTECTOR

- XC protector with flasher.
- Allows removal of stock flashers for reduced weight and better handling.
- Comes with mounting screws for armor hand guards.
- Available in 3 colors.



Orange Lens

Part #	Color
ZE72-3406	Black
ZE72-3409	Orange
ZE72-3410	White

Smoke Lens

Part #	Color
ZE72-3506	Black
ZE72-3509	Orange
ZE72-3510	White

XC FLASHER PROTECTOR

XC Optional Flasher



Part #	Color
ZE72-3991	Orange
ZE72-3992	Smoke

XC-PRO PROTECTOR

ZETA XC-PRO PROTECTOR

- Largest deflector-shields for Armor hand guards.
- Protect your hands from brush, roots and the elements.
- Best to use for Extreme, hard Enduro racing.
- Comes with mounting screws for armor hand guards.
- Can be mounted with optional XC flashers.
- Available in 2 colors, white and black.

Part #	Color
ZE72-4106	Black
ZE72-4110	White





ZETA CW HAND WARMER

- Hand warmer designed for ZETA armor hand guard.
 - Prevents your hands from freezing in the cold wind of deep winter.
 - The main fabric is tough and durable 300 D oxford fabric with water repellent treatment on outside and PVC coating on inside to make it cold protective and water resistant.
 - Cuff part made of soft and elastic Neoprene fabric to retain fine mobility.
 - Inside pocket ideal for tiny stuffs such as instant heat pad is included.
- Black / Black [ZE72-8001](#) Black / Red [ZE72-8002](#)
 Size : W 34 cm x H 15 cm x D 32 cm
 Material : 60 % Chloroprene, 40% Polyester



Easy installation without tools

Wind and water resistance

Use of tough and durable fabric



**ZETA
FOR ARMOR HAND GUARD**



Reflector
Reflector piping to improve visibility at night.

Black / Red

Black / Black



Fine controlling while rider standing

Using soft and elastic Neoprene fabric around cuff to for no loss in mobility.



Enough clearance around switches



Convenient inside pocket

Inside pocket, good to put a tiny stuff such as instant heat pad.



ZETA DEFLECTOR MOUNT KIT

- Deflector mount attached by using rear view mirrors.
 - Can be used on motorcycle that have mirror holes on the right and left side.
 - All ZETA armor hand guard shells can be installed to protect your hands from cold wind, brush, roots and the elements.
 - Comes with protector attaching nuts.
- Black [ZS72-0590](#)

CONTROL

BARCLAMP

LEVER

FOOT PARTS

HAND GUARD

SUSPENSION

BODY GUARD

BODY

ACCESSORIES

CARBON



ZE56-10020
KYB AOS
YZ250FX



ZE56-10082
SHOWA SFF-AIR



ZE56-10026
KYB AOS

ZE56-10016
WR250R/X

ZETA
FRONT FORK TOP CAP

- Made of CNC machined 7000 grade aluminum, durable and light weight design.
- Top cap integrated damping adjuster allow you to adjust damping ratio without any tool, quick and easy to adjust.
- Integrated air bleeder on top cap provide more space, no need to worry about air bleeder breakage by hitting handlebar.

Bike	Year	Black	Red	Blue
HONDA				
CR80/85	96-07	-	ZE56-10042	-
CRF150R	07-18	-	ZE56-10042	-
CRF250R	15-17	-	ZE56-10082	-
CRF450R	09-12	ZE56-10020	-	ZE56-10026
	13-14	-	ZE56-10062	-
	15-16	-	ZE56-10152	-
	17-18	-	ZE56-10172	-
CRF450RX	17-18	-	ZE56-10172	-
XR250	03-07	ZE56-10110	ZE56-10112	-
CRM250R/AR	91-98	-	ZE56-10122	-
CRF250L/M	13-17	-	ZE56-10132	-
CRF250RALLY	17	-	ZE56-10132	-
YAMAHA				
YZ80/85	93-18	-	-	ZE56-10056
YZ125	04	ZE56-10030	-	ZE56-10036
	06-18	ZE56-10020	-	ZE56-10026
YZ250	04	ZE56-10030	-	ZE56-10036
	06-18	ZE56-10020	-	ZE56-10026
YZ250F	04	ZE56-10030	-	ZE56-10036
	06-18	ZE56-10020	-	ZE56-10026
YZ450F	04	ZE56-10030	-	ZE56-10036
	06-17	ZE56-10020	-	ZE56-10026
YZ125X	17-18	ZE56-10020	-	ZE56-10186
	17-18	ZE56-10020	-	ZE56-10026
YZ250X	16-18	ZE56-10020	-	ZE56-10026
YZ250FX	15-18	ZE56-10020	-	ZE56-10026
YZ450FX	16-18	ZE56-10020	-	ZE56-10026
WR250F	06-14	ZE56-10030	-	ZE56-10036
	15-18	ZE56-10020	-	ZE56-10026
WR450F	06-11	ZE56-10030	-	ZE56-10036
WR250R/X	12-18	ZE56-10020	-	ZE56-10026
	07-17	-	-	ZE56-10016
DT200WR	91	ZE56-10140	-	-

Bike	Year	Black	Red	Blue
KAWASAKI				
KX80/85	92-18	ZE56-10100	-	-
KX100	95-18	ZE56-10100	-	-
KX125	03-08	ZE56-10030	-	ZE56-10036
KX250	03-04	ZE56-10030	-	ZE56-10036
KX250F	04-05	ZE56-10030	-	ZE56-10036
	06-12	ZE56-10020	-	ZE56-10026
KX450F	13-14	ZE56-10070	-	-
	15-18	ZE56-10090	-	-
KLX450R	07-15	ZE56-10020	-	ZE56-10026
KDX250SR	91-94	ZE56-10110	ZE56-10112	-
KDX250R	91-94	ZE56-10110	ZE56-10112	-
KLX250SR	93-97	ZE56-10110	ZE56-10112	-
KLX250R	93-95	ZE56-10110	ZE56-10112	-
KLX250	98-16	ZE56-10110	ZE56-10112	-
SUZUKI				
RM85	02-17	-	ZE56-10042	-
RM-Z250	04-06	ZE56-10030	-	ZE56-10036
	16-18	ZE56-10160	-	-
RM-Z450	15-17	ZE56-10090	-	-
	18	-	ZE56-10172	-
HUSQVARNA				
CR150	11	ZE56-10020	-	ZE56-10026
TC250	10-13	ZE56-10020	-	ZE56-10026
TC449	11-13	ZE56-10020	-	ZE56-10026
CR125	10-13	ZE56-10020	-	ZE56-10026
CR450	10	ZE56-10020	-	ZE56-10026
TXC250	10-13	ZE56-10020	-	ZE56-10026
TXC449	11-13	ZE56-10020	-	ZE56-10026
TXC450	10	ZE56-10020	-	ZE56-10026
TXC510	10	ZE56-10020	-	ZE56-10026
TXC511	11-13	ZE56-10020	-	ZE56-10026



ZETA
FORK BOTTOM PROTECTOR

- Lower bracket fork protector for KYB front forks.
- Fits inside of lower bracket adjuster area to prevent breakage of bracket edge due to hard rocks hitting edge.
- Made of durable 7000 grade aluminum, blue hard anodized finish.
- Comes in pairs.

Part number
ZE93-7016

	Bike	Year
H	CRF450R	09-14
	YZ125	05-18
	YZ250	05-18
	YZ250F	05-18
	YZ450F	05-18
	YZ125X	17-18
Y	YZ250X	16-18
	YZ250FX	15-18
	YZ450FX	16-18
K	KX450F	08-14

FREE PISTON		
Bike	Year	
HONDA		
CRF450R	09-12	
YAMAHA		
YZ125/250	06-18	
YZ250F/450F	06-18	
YZ125X	17-18	
YZ250X	16-18	
YZ250FX	15-18	
YZ450FX	16-18	
WR250F	15-18	
WR450F	12-18	
KAWASAKI		
KX450F	07-12	
KLX450R	07-16	
HUSQVARNA		
CR125	10-13	
CR150	11	
TC250	10-13	
TC449	11-13	
CR450	10	
TXC250	10-13	
TXC449	11-13	
TXC450	10	
TXC510	10	
TXC511	11-13	



ZETA FREE PISTON for KYB Twin Chamber

- Replacement free piston kit for KYB AOS (Twin chamber) front forks.
- Made of light weight aluminum, more durable than OE free piston.
- Great to use for enduro racing.
- Suspension stiffness can be changed, and to provide progressive suspension feel by changing oil level.

Part number	Size	Description
ZE56-40010	STD	Provides OE suspension feeling.
ZE56-40012	LT	Light weight and less friction design, provides softer and smooth front fork moving.

CONTROL

BARCLAMP

LEVER

FOOT PARTS

HAND GUARD

SUSPENSION

BODY GUARD

BODY

ACCESSORIES

CARBON

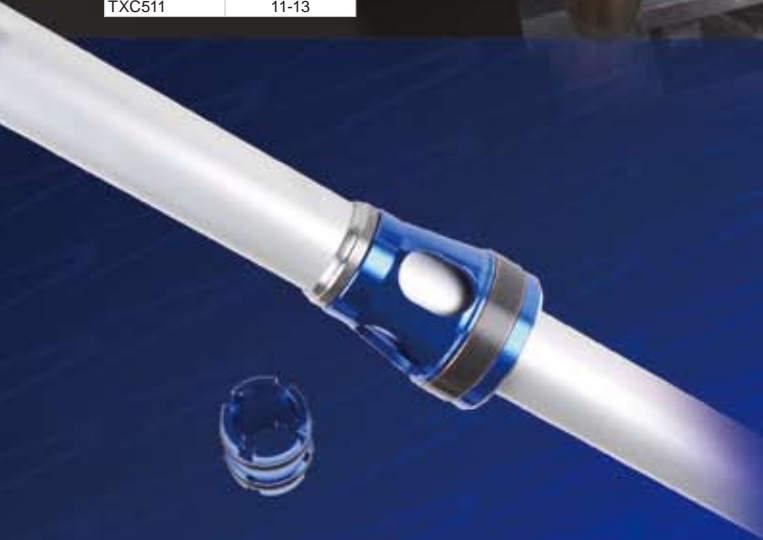

KYB AOS -30 mm

KYB AOS -50 mm



WP AOS -30 mm

SHOWA AOS -30 mm

LOWERING INNER KIT			
Bike	Year	-30 mm	
		-30 mm	-50 mm
HONDA			
CRF250R	10-14	ZE56-31010	ZE56-31030
CRF450R	09-12		
CRF450R	17-18	ZE56-31050	-
CRF450RX	17-18		
YAMAHA			
YZ125/250	06-18		
YZ250F	06-18		
YZ450F	06		
	14-17		
YZ125X	17-18	ZE56-31010	ZE56-31030
YZ250X	16-18		
YZ250FX	15-18		
YZ450FX	16-18		
WR250F	15-18		
WR450F	12-18		
KAWASAKI			
KX250	05-08		
KX450F	07-12	ZE56-31010	ZE56-31030
KLX450R	07-16		
KTM			
250/300EXC	17-18		
250/350/450/500EXC-F	17-18	ZE56-31070	-
125/150/250/300XC-W	17-18		
HUQVARNA			
CR125	10-13		
CR150	11		
TC250	10-13		
TC449	11-13		
TC450	10		
TXC250	10-13	ZE56-31010	ZE56-31030
TXC449	11-13		
TXC450	10		
TXC510	10		
TXC511	11-13		
TE150/250/300	17-18		
FE250/350/450/501	17-18	ZE56-31070	-

ZETA LOWERING INNER KIT

- Front fork lowering inner kit for KYB, SHOWA and WP front fork suspensions.
- Replace front fork inner parts with this kit. It provides 30 mm and 50 mm lower height.
- Replacing SHOWA and WP front fork spring seat and fits inner collar to make your suspension 30 mm lower than stock height.
- Make front fork fully extended length shorter, but no change length when the fork is shortened.
- Keep clearance between wheel and under fender, even on lowering.

Part number	Size	Part number	Size
ZE56-31010	KYB AOS - 30 mm	ZE56-31050	SHOWA AOS - 30 mm
ZE56-31030	KYB AOS - 50 mm	ZE56-31070	WP XPlor 48 - 30 mm

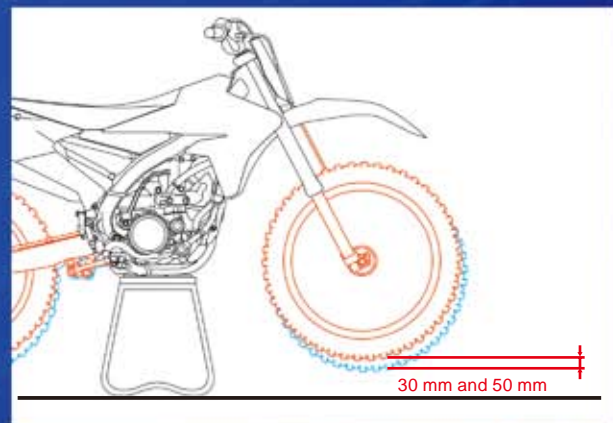



ZETA

ADJUSTABLE LOWERING LINK KIT

- Adjustable seat height by rotating the attachment to change link rod length. (Reference : About + 5 mm ~ - 25 mm. Vary by models.)
- Also adjustable operation of the rear suspension according to the situation, such as off-road course by changing the lever link ratio.
- 5 clips to lower. A standard position and 1 clip to lift up. Total 7 clips range adjustment.
- Bolt on design, pre-installed bearings and dust seal, only changing a stock link rod.
- 7000 - series aluminum alloy, high level laser finish.



ADJUSTABLE

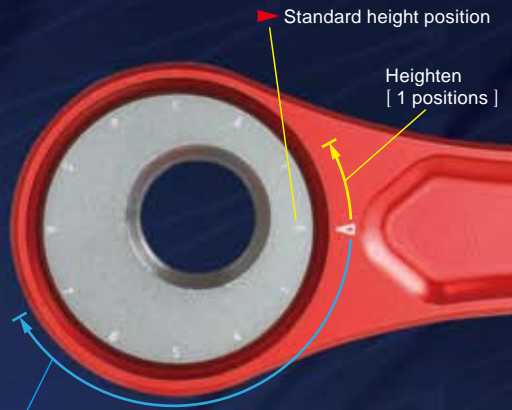

Adjust cam counter-clockwise from standard height position.

ZETA

LOWERING LINK KIT

- Improving ground touch.
- Able to lower with adjustable link. (Reference : About - 30 mm. Vary by models.)
- Bolt on design, only changing a stock link rod.
- 7000 - series aluminum alloy, high level laser finish.

* Applicable stock stand.



Normal

With ZETA lowering link kit

Bike	Year	Adjustable	Lowering
HONDA(Red)			
CRF150R	07-18	-	ZE56-05012
CRF250R	13-17	ZE56-01032	ZE56-05032
CRF450R	16	ZE56-01032	ZE56-05032
	17-18	ZE56-01042	ZE56-05042
CRF450RX	17-18	ZE56-01042	ZE56-05042
CRF250X	07-17	ZE56-01062	ZE56-05062
CRF450X	08-17	ZE56-01082	ZE56-05082
CRF250L	12-17	ZE56-01132	ZE56-05132 #1
CRF250L LD	17	ZE56-01132	ZE56-05132 #1
CRF250RALLY	17	ZE56-01132	ZE56-05132 #1
CRF250RALLY LD	17	ZE56-01132	ZE56-05132 #1
XR250/MOTARD	03-07	-	ZE56-05142
YAMAHA(Blue)			
YZ85	94-18	-	ZE56-05606
YZ125	06-18	ZE56-01616	ZE56-05616
YZ250	06-18	ZE56-01616	ZE56-05616
YZ250F	14-18	ZE56-01656	ZE56-05656
YZ450F	10-18	ZE56-01656	ZE56-05656
YZ125X	17-18	ZE56-01616	ZE56-05616
YZ250X	16-18	ZE56-01616	ZE56-05616
YZ250FX	15-18	ZE56-01656	ZE56-05656
YZ450FX	16-18	ZE56-01656	ZE56-05656
WR250F	07-14	ZE56-01636	ZE56-05636
WR250F	15-18	ZE56-01656	ZE56-05656
WR450F	07-15	ZE56-01636	ZE56-05636
WR450F	16-18	ZE56-01656	ZE56-05656
WR250R/X	07-17	ZE56-01736	ZE56-05736
KAWASAKI(Black)			
KX85 #2	91-18	-	ZE56-05210
KX250F	17-18	ZE56-01230	ZE56-05230
KX450F	17-18	ZE56-01270	ZE56-05270
SUZUKI(Red)			
RM85	05-17	-	ZE56-05412
RMZ250	13-18	ZE56-01432	ZE56-05432
RMZ450	13-17	ZE56-01472	ZE56-05472
DRZ400/E/S/SM	00-17	ZE56-01582	ZE56-05582
KTM(Orange)			
125SX	16-18	-	ZE56-05843
150SX	16-18	-	ZE56-05843
250SXF	16-18	-	ZE56-05843
350SXF	16-18	-	ZE56-05843
450SXF	16-18	-	ZE56-05843
HUSQVARNA(Blue)			
FC250	16-18	-	ZE56-05846
FC350	16-18	-	ZE56-05846
FC450	16-18	-	ZE56-05846
TC125	16-18	-	ZE56-05846
TC250	17-18	-	ZE56-05846
TX300	17-18	-	ZE56-05846
FX350	17-18	-	ZE56-05846
FX450	17-18	-	ZE56-05846

#1 Bearing dust seal does not come with this kit, reuse stock dust seal or purchase new dust seals.

#2 KX85 does not include bearings and seals. Please prepare stock products diverted or separately.



HUSQVARNA



KTM



ZETA BUMP RUBBER HOLDER

- Rear suspension bump rubber holder for KTM / HUSQVARNA 85 cc.
- Make your bump rubber have a longer life than OEM rubber holder due to its special bump rubber holding cup design.
- CNC machined aluminum with orange and blue anodized finish.
- * Disassembling shock unit is required for installation.

Part number	Color	Bike	Year
ZE56-50013	Orange	KTM 85SX	-17
ZE56-50016	H-Blue	HUSQVARNA TE85	-17

Before

After

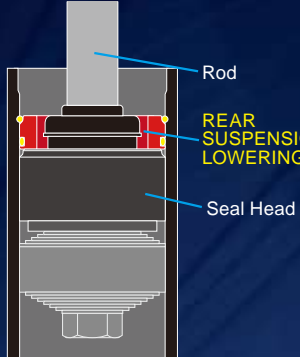

Rod
REAR SUSPENSION LOWERING KIT
Seal Head

Bike	Year	Cylinder type			
		46 mm	50 mm		
HODDA	CR125R	93-07	ZE56-32246	-	
	CR250R	93-99	ZE56-32246	-	
	CR250R	00-07	-	ZE56-32250	
	CR500R	95-02	ZE56-32246	-	
	CRF250R	04-17	-	ZE56-32250	
	CRF450R	02-18	-	ZE56-32250	
YAMAHA	CRF250X	04-17	-	ZE56-32250	
	CRF450X	05-17	-	ZE56-32250	
	CRF450RX	17-18	-	ZE56-32250	
	YZ125	93-18	ZE56-32246	-	
	YZ250	93-18	ZE56-32246	-	
	YZ250F	01-13	ZE56-32246	-	
SUZUKI	YZ2400-450F	14-18	-	ZE56-32250	
	WR250F	98-09	ZE56-32246	-	
	WR250F	10-18	-	ZE56-32250	
	WR250F	15-18	-	ZE56-32250	
	WR400-450F	98-15	ZE56-32246	-	
	WR400-450F	16-18	-	ZE56-32250	
KAWASAKI	KX125	93-08	ZE56-32246	-	
	KX250	93-08	ZE56-32246	-	
	KX500	93-04	ZE56-32246	-	
	KX250F	04-05	ZE56-32246	-	
	KX250F	06-18	-	ZE56-32250	
	KX450F	06-08	ZE56-32246	-	
SUZUKI	KX450F	09-18	-	ZE56-32250	
	KLX450R	07-15	ZE56-32246	-	
	KLX450R	92-97	ZE56-32246	-	
	RM125	98-08	-	ZE56-32250	
	RM125	92-97	ZE56-32246	-	
	RM125	98-00	-	ZE56-32250	
SUZUKI	RM250	01-03	ZE56-32246	-	
	RM250	04-09	-	ZE56-32250	
	RM-Z250	04-06	ZE56-32246	-	
	RM-Z250	07-18	-	ZE56-32250	
	RM-Z450	05-17	-	ZE56-32250	
	RM-Z450	08-18	-	ZE56-32250	
KTM	125SX	09-18	-	ZE56-32250	
	150SX	09-18	-	ZE56-32250	
	250SX	08-18	-	ZE56-32250	
	250SX-F	08-18	-	ZE56-32250	
	350SX-F	11-18	-	ZE56-32250	
	450SX-F	08-18	-	ZE56-32250	
	125EXC	08-13	-	ZE56-32250	
	125EXC	08-14	-	ZE56-32250	
	SIXDAYS	08-14	-	ZE56-32250	
	200EXC	08-14	-	ZE56-32250	
	HUSQVARNA	250EXC/SIXDAYS	08-13	-	ZE56-32250
		250EXC-F/SIXDAYS	08-16	-	ZE56-32246
250EXC-F/SIXDAYS		17-18	-	ZE56-32250	
300EXC		09-13	-	ZE56-32250	
300EXC SIXDAYS		17-18	ZE56-32246	-	
300EXC SIXDAYS		17-18	ZE56-32246	-	
350EXC-F/SIXDAYS		12-16	-	ZE56-32250	
350EXC-F/SIXDAYS		17-18	ZE56-32246	-	
450EXC-F/SIXDAYS		08-16	-	ZE56-32250	
450EXC-F/SIXDAYS		17-18	ZE56-32246	-	
500EXC-F		12-16	-	ZE56-32250	
500EXC-F		17-18	ZE56-32246	-	
HUSQVARNA	500EXC-F/SIXDAYS	12-16	-	ZE56-32250	
	150XC	10-14	-	ZE56-32250	
	250/300XC	08-18	-	ZE56-32250	
	250/350XC-F	11-18	-	ZE56-32250	
	450XC-F	13-18	-	ZE56-32250	
	125/150/250/300XC-W	17-18	ZE56-32246	-	
	300XC-W/SIXDAYS	17-18	ZE56-32246	-	
	TC125/250	14-18	-	ZE56-32250	
	FC250/350/450	14-18	-	ZE56-32250	
	TE125	14-16	-	ZE56-32250	
	TE150	17-18	-	ZE56-32250	
	TE250/300	14-18	-	ZE56-32250	
FE250/350/450/501	14-18	-	ZE56-32250		
TX125/300	17-18	-	ZE56-32250		
FX350/450	17-18	-	ZE56-32250		

ZETA REAR SUSPENSION LOWERING KIT

- Low down your rear suspension without disassemble rear shock unit.
- Push down seal head from out side of damper, and install this kit to make 30 mm lowering your suspension with keeping its function.
- Make rear suspension fully extended length shorter, but not change length when the shock is shortened. Keep clearance between wheel and under fender even on lowering.
- Can be used with lowering link.
- Available 46 mm size for KYB / WP and 50 mm size for KYB / SHOWA / WP rear suspension.

Part number	Description	Size	Color
ZE56-32246	KYB / WP	46 mm	Blue
ZE56-32250	SHOWA / KYB / WP	50 mm	Red

CONTROL

BARCLAMP

LEVER

FOOT PARTS

HAND GUARD

SUSPENSION

BODY GUARD

BODY

ACCESSORIES

CARBON



ZE80-7002

ZE80-7102

ZE80-7306

ZE80-7326

ZETA CASE SAVER

- Made of CNC 6061 aluminum for durability.
- 6 mm case saver body for durability, protects your engine case better than stock OEM 3 mm case saver.
- Available in Blue and Red Colors.

ZETA CASE SAVER

Bike	Year	Red	Blue
H	CRF250R	10-17	ZE80-7002
		10-16	ZE80-7002
	CRF450R	17-18	ZE80-7012
		17-18	ZE80-7012
Y	YZ125	06-18	-
	YZ250	06-18	-
	YZ250F	14-18	-
	YZ450F	14-18	-
	YZ125X	17-18	-
	YZ250X	16-18	-
	YZ250FX	15-18	-
	YZ450FX	16-18	-
	WR250F	15-18	-
	WR450F	16-18	-
K	KX250F	17-18	ZE80-7102
	KX450F	16-18	ZE80-7102
S	RMZ250/450	11-18	ZE80-7202

CONTROL

BARCLAMP

LEVER

FOOT PARTS

HAND GUARD

SUSPENSION

BODY GUARD

BODY

ACCESSORIES

CARBON

ZETA DRIVE COVER

- CNC machined front sprocket cover.
- Designed to keep mud out of the front sprocket area.
- Available in red, blue and titanium anodized colors.
- Made of A7009-T6 aluminum.

Drive Cover (RACER)

Bike	Year	Red	Blue
H	CRF150R	07-18	ZE80-9045
	CR250R	02-07	ZE80-9015
	CRF250R	04-09	ZE80-9015
		10-17	ZE80-9355
		05-07	ZE80-9045
	CRF450R	08	ZE80-9015
		09-16	ZE80-9355
	CRF250X	04-17	ZE80-9015
	CRF450X	05-17	ZE80-9045
	CRF250L/M	12-17	ZE80-9315
CRF250RALLY	17	ZE80-9315	
Y	YZ125	05-18	ZE80-9015
	YZ250	99-18	ZE80-9025
	YZ250F	01-13	ZE80-9025
		14-18	-
	YZ450F	03-13	ZE80-9075
		14-18	-
	YZ125X	17-18	ZE80-9015
	YZ250X	16-18	ZE80-9025
	YZ250FX	15-18	-
	YZ450FX	16-18	-
WR250F	01-14	ZE80-9025	
K	WR450F	15-18	-
		03-15	ZE80-9075
	WR250R/X	16-18	-
		07-17	ZE80-9614
	KX125	03-08	ZE80-9055
	KX250	05-08	ZE80-9055
	KX250F	04-16	ZE80-9035
		17-18	ZE80-9055
	KX450F	06-18	ZE80-9055
	S	RMZ250	04-06
		07-18	ZE80-9025
RMZ450		05-18	ZE80-9025

Drive Cover (TRAIL)

Bike	Year	Silver
H	XR250/BAJA	95-02
	XR250/MOTARD	03-07
Y	TRICKER	04-17
	SEROW250	05-17
K	XT250X	06-17
	KLX125, D-TRACKER125	10-16
K	KLX150S	09-13
	KLX250/ES/SR	93-16
K	D-TRACKER	98-16
	DRZ400S/SM	00-17
S	250SB	00-17

ZE80-9374

ZE80-9015

ZE80-9606

ZETA HEEL GUARD

- Protects your heel from the chain and the rear sprocket.
- Made of CNC machined A7009-T6 aluminum.
- Finished in anodized titanium-color.

Part #	Bike
ZE81-2008	XR250/BAJA '95-/CRF250L/M/RALLY/CRM250R/AR/SEROW225 , TW200/225
ZE81-2041	SEROW250
ZE81-2042	WR250R/X
ZE81-2003	DRZ125/400S/400SM

ZETA REAR DISC GUARD

- Protects your rear disc from rocks and roots.
- Simple bolt-on application.
- Made of CNC machined A7009-T6 aluminum.
- Finished in anodized titanium-color.

Part number Bike

ZE84-0141 WR250R/X

ZETA CHAIN GUARD BRACE

- Protects your chain guide from rocks and other debris.
- Made of CNC machined A7009-T6 aluminum.
- Finished in anodized titanium-color.
- Simple bolt-on application.

Part #	Bike
ZE82-0211	XR250/BAJA/MOTARD '95-/CRF250L/M/RALLY
ZE82-0241	SEROW250 , TRICKER , XT250X/XTZ125 '03-12

Clutch slave Cylinder cover

Reinforce rib design
for extreme durability

Case saver

Case saver protects engine
case and clutch slave cylinder

Drive cover

Covers sprocket
area for safety

Mud Out

Keep mud out of the
front sprocket area

Chain Roller

Chain roller for less
friction loss

ZE80-8403

ZE80-8423

ZE80-8519

	Bike	Year	Part #
KTM (Orange)	125/150SX	16-18	ZE80-8413
	125/150EXC/XC-W	17-18	ZE80-8413
	250/300SX/E XC/EXC TPI/XC/XC-W	17-18	ZE80-8403
	250/350SX-F/XC-F	16-18	ZE80-8403
	250/350EXC-F	17-18	ZE80-8403
	450SX-F/XC-F	16-18	ZE80-8423
Husqvarna (H-Blue)	450/500EXC-F	17-18	ZE80-8423
	TC125	16-18	ZE80-8519
	TX125	17-18	ZE80-8519
	TE150	17-18	ZE80-8519
	TC/TE/TX250/300	17-18	ZE80-8509
	TE250i/300i	18	ZE80-8509
	FC250/350	16-18	ZE80-8509
	FE/FX250/350	17-18	ZE80-8509
	FC450	16-18	ZE80-8529
	FE/FX450/501	17-18	ZE80-8529

ZETA

CASE SAVER KIT KTM / HUSQVARNA

KTM / Husqvarna case saver kit comes with clutch slave cylinder protector, drive cover and chain roller.

CASE SAVER :

Light weight aluminum case saver protects not only clutch slave cylinder, but also banjo bolt and air bleeder bolt.

Orange and blue case saver colors available.

DRIVE COVER :

Comes with black anodized aluminum drive cover plate protects clutch slave cylinder, banjo bolt and air bleeder bolt.

CHAIN SLIDER :

Replace OE chain slider to chain roller for less friction loss.

Spec

CASE SAVER :

Made of A7009 Aluminum, available in orange and blue anodized finish with laser printed logo.

DRIVE COVER :

Made of A6061 shot peened and black anodized surface finish with laser printed logo.

Replacement

DRC Chain roller

M size Black

D47-41-641

Covers sprocket area for safety.

Drive cover designed to keep mud out of the front sprocket area.

	Bike	Year	Red	Blue
HONDA	CRF250R	10-17	ZE80-8002	-
	CRF450R	10-16	ZE80-8002	-
	CRF450R/RX	17-18	ZE80-8012	-
YAMAHA	YZ125	06-18	-	ZE80-8306
	YZ250	06-18	-	ZE80-8316
	YZ250F/450F	14-18	-	ZE80-8326
	YZ125X	17	-	ZE80-8306
	YZ250X	16-18	-	ZE80-8316
	YZ250FX	15-18	-	ZE80-8326
KAWASAKI	YR250F	16-18	-	ZE80-8326
	WR250F	15-18	-	ZE80-8326
SUZUKI	WR450F	16-18	-	ZE80-8326
	KX250F	17-18	ZE80-8102	ZE80-8106
	KX450F	16-18	ZE80-8102	ZE80-8106
	RMZ250/450	11-18	ZE80-8202	ZE80-8206



ZETA

CASE SAVER with COVER

- Case saver comes with light weight and durable drive cover.
- Drive cover is made of A6061 laser cut aluminum.
- Sand blasted black anodized finish with laser print logo.
- Made of 2 mm aluminum with pressed construction for extreme durability and light weight.
- Available in Blue and Red case saver colors.

CONTROL

BARCLAMP

LEVER

FOOT PARTS

HAND GUARD

SUSPENSION

BODY GUARD

BODY

ACCESSORIES

CARBON



YZ250FX Right



YZ250FX Left

ZETA
FRAME GUARD

- Provides a flat surface on the motorcycle frame for better foot grips and bike control.
- Prevents frame scratches during your ride.
- Made of 5000 grade aluminum with ZETA embossed logo

Bike	Year	Part #
HONDA		
CRF150R	07-18	ZE52-0032
CRF250R	14-17	ZE52-0042
CRF450R	13-16	ZE52-0042
CRF125F	14-18	ZE52-0003
CRF150F/230F	03-18	ZE52-0011
CRM50/80	88-92	ZE52-0001
	93-98	ZE52-0002
CRM250R/AR	89-98	ZE52-0008
XR230	05-13	ZE52-0010
XR250R	86-95	ZE52-0013
	96-04	ZE52-0015
XR250	95-07	ZE52-0015
XLR250	88-94	ZE52-0013
CRF250L	12-17	ZE52-0018
CRF250RALLY	17	ZE52-0019
CRF1000L	16-17	ZE52-0022
YAMAHA		
YZ85	02-18	ZE52-0332
YZ125/250	05-18	ZE52-0336
YZ250F	14-16	ZE52-0341
YZ125X	17-18	ZE52-0336
YZ250X	16-18	ZE52-0336
YZ250FX	15-16	ZE52-0341
SEROW225W	93-96	ZE52-0311
SEROW250	05-17	ZE52-0313
TRICKER	04-17	ZE52-0313
TTR125/LW	00-06	ZE52-0304
TT250R/RAID	93-97	ZE52-0309
WR250R/X	07-17	ZE52-0322
DT200WR	91-94	ZE52-0302
DT230LANZA	97-98	ZE52-0303
KAWASAKI		
KX65	00-18	ZE52-0130
KX85/100	01-18	ZE52-0132
KX250F	13-18	ZE52-0142
KX450F	12-18	ZE52-0152
KDX125SR	90-99	ZE52-0110
KDX200SR	89-93	ZE52-0112
KDX220SR	94-99	ZE52-0114
KDX250SR	91-94	ZE52-0116
KLX125, D-TRACKER125	10-16	ZE52-0103
KLX250, D-TRACKER/X	98-16	ZE52-0106
SUPER SHERPA	97-08	ZE52-0105
SUZUKI		
RM85	02-18	ZE52-0232
RMZ250	10-15	ZE52-0242
	16-18	ZE52-0243
RMX250R	96-98	ZE52-0206
RMX250S	96-98	ZE52-0206
DR250S	90-94	ZE52-0211
DR250R/DJEBEL	95-06	ZE52-0213
DRZ400S/SM	00-18	ZE52-0215
KTM		
65SX	09-15	ZE52-0401
85SX	13-17	ZE52-0403



WR250R/X

YZ250F/FX



KX450F

DRZ400S/SM



CRF250R/450R

KTM 85SX



CRF1000L AFRICA TWIN



YZ250F



CRF250R

Bike	Year	Part #
HONDA		
CRF250R	10-13	ZE55-3112
	14-17	ZE55-3113
	09-14	ZE55-3132
CRF450R	15	ZE55-3133
YAMAHA		
YZ250F	07-09	ZE55-3411
	10-13	ZE55-3412
	06-09	ZE55-3431
YZ450F	10-13	ZE55-3432

Bike	Year	Part #
KAWASAKI		
KX450F	09-14	ZE55-3232
	16	ZE55-3233
RMZ250	SUZUKI	ZE55-3311
450SX-F	07-12	ZE55-3311
	07-10	ZE55-3561

ZETA MX GLIDE PLATE

- Glide plate made of 5000 grade durable aluminum for MX racing bikes.
- Model specific applications.
- Oil drain hole allows easy oil changes without removing the glide plate.
- All mounting hardware included.



YZ250FX



ZETA ED SKID PLATE

- Made of 5000 grade durable aluminum.
- Protects the area under engine, water pump cover and crankcase from stones and rocks.
- Oil drain hole allows easy oil changes without removing the skid plate.
- All mounting hardware included.



DRZ400



KLX250, D-Tracker250



WR250R/X

Bike	Year	Part #
H	XR230/MOTARD	05-12 ZE55-2120
	XR250/BAJA/MOTARD	95-07 ZE55-2100
	CRF250L	12-17 ZE55-2130
YAMAHA	YZ125/250	05-18 ZE55-2460
	YZ125X	17-18 ZE55-2460
	YZ250X	16-18 ZE55-2440
	YZ250FX, WR250F	15-16 ZE55-2430
	WR250R/X	07-17 ZE55-2400
	TRICKER	04-17 ZE55-2420
	XT250X	06-17 ZE55-2420
SEROW250	05-17 ZE55-2420	

Bike	Year	Part #
K	KLX125, D-TRACKER125	10-16 ZE55-2220
	KLX250, D-TRACKER	93-16 ZE55-2200
S	DRZ400S/SM	00-17 ZE55-2300
K	250SB	02-06 ZE55-2200
	250SX-F	07-10 ZE55-2250
	250EXC-F/XC-F	08-10 ZE55-2520



CRF250L



Installation outside

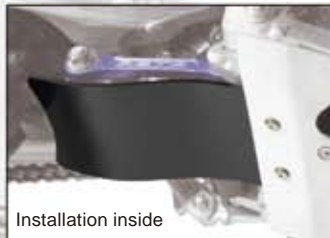

Installation inside



ZETA LINKAGE GUARD

Part number **ZE55-4010** Thickness **5 mm**

- Universal rear suspension linkage guard.
- Made of durable and thick polyethylene to protect linkage from being hit with rock and stones.
- Attach this guard to OE skid plate or your aftermarket skid plate.
- Drill holes on your OE skid plate or aftermarket kid plate to attach.
- Comes with mounting hardware, bolts, nuts and washers.

CONTROL

BARCLAMP

LEVER

FOOT PARTS

HAND GUARD

SUSPENSION

BODY GUARD

BODY

ACCESSORIES

CARBON

ZETA

PRO FRONT DISC GUARD

- Developed with factory Kawasaki racing team and Yamaha racing team in Japan, and used on their race bikes.
- Protect your front disc and brake caliper from rocks, bushes and debris during your ride.
- 270 mm disc guard size accepts most dirt bike's front brake disc.
- Model specific mount kit is required to install the disc guards on your bike.
- Available black and white color.

Part number	Color
ZE52-1041	Black
ZE52-1046	White

JMX
Kawasaki Team GREEN
MAKOTO OGATA



*Disc guard mount sold separately



ZETA

FRONT DISC GUARD MOUNTING KIT

- Model specific mounting kit. (Required for disc guard installation.)
- Mount bracket is integrated with wheel spacer.
- Comes with disc guard mounting stainless bolts.

	Bike	Year	Part #
HONDA	CR125R/250R	04-07	ZE52-1120
	CRF250R	04-17	ZE52-1120
	CRF450R	04-18	ZE52-1120
	CRF450RX	17-18	ZE52-1120
	CRF250X/450X	04-17	ZE52-1120
	CRF250L	12-16	ZE52-1180
		17	ZE52-1190
YAMAHA	YZ125/250	08-18	ZE52-1420
	YZ250F	07-13	ZE52-1420
		14-18	ZE52-1430
	YZ450F	07-13	ZE52-1420
		14-18	ZE52-1430
	YZ125X	17-18	ZE52-1420
	YZ250X	16-18	ZE52-1420
	YZ250FX	15-18	ZE52-1430
	YZ450FX	16-18	ZE52-1430
WR250F	06-18	ZE52-1420	
WR450F	06-18	ZE52-1420	
WR250R	07-17	ZE52-1470	
KAWASAKI	KX125/250	06-08	ZE52-1220
	KX250F	06-18	ZE52-1220
	KX450F	06-18	ZE52-1220
	KLX450R	08-09	ZE52-1220
	KLX125	10-16	ZE52-1280
	KLX150S	09-13	ZE52-1280
KLX250	08-16	ZE52-1270	
SUZUKI	RM-Z250	07-18	ZE52-1320
	RM-Z450	05-18	ZE52-1320
	RMX450Z	10-17	ZE52-1320
KTM	125-530SX/SX-F/XC/XC-F	03-14	ZE52-1520
		15-18	ZE52-1530
		03-15	ZE52-1520
		16-18	ZE52-1530
HUSQVARNA	CR/WR 125-300	09-11	ZE52-1610
	TC/TE 250-511	09-11	ZE52-1610
	TC/FC 125-450	14	ZE52-1520
		15-18	ZE52-1530
	TE/FE 125-501	14-15	ZE52-1520
	TX/FX125-450	16-18	ZE52-1530
	17-18	ZE52-1530	

CONTROL



BARCLAMP



LEVER



FOOT PARTS



HAND GUARD



SUSPENSION



BODY GUARD



BODY



ACCESSORIES



CARBON



YAMAHA FACTORY RACING TEAM

YU HIRATA

JMX

Take the holeshot!



SUZUKI EUROPE WORD MX2

FUNCTION



Integrated lower fork guard and lock pin for rigidity and reduced weight.



Nylon sleeve prevents scratches on the front fork. (Excluded on some models.)



Lock pin is made of light weight aluminum A7075-T6.



Hinge style aluminum clamp body for easy installation. Hinge pin is made of light weight, extremely durable titanium, Ti-6AL-4V.

Light weight 7075-T6 aluminum lock pin

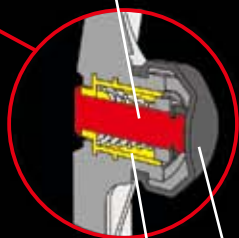

Dust cover

Aluminum sleeve



Easy installation!

Hinge clamp body and Integration of the lower fork guard and lock pin unit for easy installation with no modifications.

ZETA

LAUNCH CONTROL

- A hinge style aluminum clamp body for easy installation.
- The front fork does not need to be removed to install this kit.
- Comes with clamp body and integral lower fork guard. One side only.
- Hinge pin is constructed of high strength Ti-6AL-4V titanium.
- Nylon sleeve prevents front fork scratches.
- Light weight 7075-T6 aluminum lock pin.
- The integration of the lower fork guards and lock pin unit creates a rigid light weight body.
- Currently not available in the US.

* Usable front fork diameter is 53 mm to 56 mm
Usable front fork size is up to 57.5 mm without using nylon sleeve.

Replacement lower fork guard

Bike	Color	Part #
CR125R/250R, CRF250R '04-17	Natural	ZE89-7901
CRF450R '04-18	White	ZE89-7902
KX250F/450F '07-	Black	ZE89-7911
	White	ZE89-7921
RMZ250 '07-, RMZ450 '08-	Black	ZE89-7922
YZ125/250, YZ250F/450F '08-	White	ZE89-7931
	Black	ZE89-7941
KTM 125-450SX/SX-F '07-14	White	ZE89-7942
KTM 125-450SX/SX-F '15-17	White	ZE89-7943
	Black	ZE89-7975
Mini Motocrosser	Natural	ZE89-7979

	Bike	Year	Natural	Black	White
HONDA	CR85R	03-07	ZE89-7709	ZE89-7705	-
	CR125R/250R	04-07	ZE89-7019	-	ZE89-7018
	CRF150R	07-18	ZE89-7709	ZE89-7705	-
	CRF250R	04-17	ZE89-7019	-	ZE89-7018
	CRF450R	04-18	ZE89-7019	-	ZE89-7018
YAMAHA	YZ85	02-18	ZE89-7709	ZE89-7705	-
	YZ125/250	08-18	-	-	ZE89-7318
	YZ250F	08-18	-	-	ZE89-7318
	YZ450F	08-18	-	-	ZE89-7318
KAWASAKI	KX85	01-13	ZE89-7709	ZE89-7705	-
	KX250F/450F	07-18	-	ZE89-7111	-
SUZUKI	RM85	02-17	ZE89-7709	ZE89-7705	-
	RM-Z250	07-18	-	ZE89-7221	ZE89-7218
	RM-Z450	08-18	-	ZE89-7221	ZE89-7218
KTM	85/105SX	03-17	ZE89-7709	ZE89-7705	-
	125-450SX/SX-F	07-14 15-17	-	-	ZE89-7421 ZE89-7433

Dust cover
Part number
[ZE89-7999](#)

YAMAHA FACTORY RACING TEAM

JMX



ZETA

LAUNCH CONTROL UNIVERSAL

- Universal launch control kit to fit most MX racing bikes.
- A hinge style aluminum clamp body for easy installation, no need to remove front fork to install.
- Nylon sleeve on clamp body prevents front fork scratches.
- Hinge pin used on clamp body is made of light weight and durable Ti-6AL-4V.
- Lock pin body is fitted by 4 screws for secure installation on your lower fork guard.
- You can install the lock pin body at your desired position on your lower fork guard.
- Replacement rubber for lock pin is available.
- Currently not available in the US.

* Usable front fork diameter is 53 mm to 56 mm
Usable front fork size is up to 57.5 mm without using nylon sleeve.

Color Part #
Red [ZE89-7000](#)

Color Part #
Orange [ZE89-7003](#)

Color Part #
Blue [ZE89-7006](#)

CONTROL

BARCLAMP

LEVER

FOOT PARTS

HAND GUARD

SUSPENSION

BODY GUARD

BODY

ACCESSORIES

CARBON

ZETA BILLET KIT

- Aluminum billet kit for MX bikes.
- Buying one kit gives your bike factory look.
- Available in red, blue and orange anodized parts kits.



Brak resevoir cover



Engine plugs



Brake line clamp

Contents of kit

HONDA, YAMAHA KAWASAKI, SUZUKI	YZ125/250/125X/250X	DRZ400SM	KTM, HUSQVARNA
F/R Brak resevoir cover	F/R Brak resevoir cover	F/R Brak resevoir cover	F/R Brak resevoir cover
Brake line clamp	Brake line clamp	Brake line clamp	F Clutch resevoir cover
Oil filler plugs	Oil filler plugs	Engine plugs	Oil filler plugs
Engine plugs	Axle block	Axle block	Axle block
Axle block	Air valve caps	Air valve caps	Air valve caps
Air valve caps	Rim lock nuts	Rim lock nuts	Rim lock nuts
Rim lock nuts	Rim lock spacers	Rim lock spacers	Rim lock spacers
Rim lock spacers			

Bike	Year	Red	Blue
		ZE51-2032	ZE51-2346
HONDA	CRF250R	10-17	-
	CRF450R	02-16	-
	CRF450RX	17-18	-
	CRF250L/M	17-18	-
	CRF250RALLY	17	-
YAMAHA	YZ125/250	09-18	ZE51-2326
	YZ250F/450F	14-18	ZE51-2346
	YZ125X	17-18	ZE51-2326
	YZ250X	16-18	ZE51-2326
	YZ250FX	15-18	ZE51-2366
	YZ450FX	16-18	ZE51-2366
	WR250F	17-18	ZE51-2366
KAWASAKI	KX250F	11-16	ZE51-2132
	KX450F	09-15	ZE51-2132
SUZUKI	RMZ250	07-18	ZE51-2232
	RMZ450	05-18	ZE51-2232
	DRZ400SM	05-17	ZE51-2272
HUSQVARNA	FC250(US)	14	ZE51-2546
	FC250	14-15	ZE51-2546
	FC350	16-17	ZE51-2556
	FC450(US)	14-15	ZE51-2546
	FC450	16-17	ZE51-2556
	FC250/350/450 <i>breombo type only</i>	18	ZE51-2556
	TC85	15-18	ZE51-2526
	TC125	16-17	ZE51-2556
	TC250	17	ZE51-2556
	TC125/250 <i>breombo type only</i>	18	ZE51-2556
	FE250-501	14-16	ZE51-2546
	FE250-501	17	ZE51-2566
	TE125	14-16	ZE51-2566
	TE250/300	14-16	ZE51-2546
	TX125/300	17	ZE51-2566
FX350/450	17	ZE51-2566	

• Only ABS type brake line clamp can be installed.



HONDA : ZE51-2032



YAMAHA : ZE51-2346



HUSQVARNA : ZE51-2546



KTM : ZE51-2443

Bike	Year	Orange
85SX	15-18	ZE51-2423
125SX	16-18	ZE51-2443
125XC-W	17-18	ZE51-2433
150SX	16-18	ZE51-2443
150XC-W	17-18	ZE51-2433
250SX/XC	06-12	ZE51-2433
250SX	13-18	ZE51-2443
250XC	13-18	ZE51-2443
250SX-F/XC-F	07-12	ZE51-2433
250SX-F/XC-F	13-18	ZE51-2443
250XC-W	06-18	ZE51-2433
250XCF-W	07-16	ZE51-2433
250EXC/EXC-F (SIX DAYS)	06-18	ZE51-2433
300XC	13-18	ZE51-2443
300EXC	06-18	ZE51-2433
300XC-W	06-18	ZE51-2433
350SX-F/XC-F	11-12	ZE51-2433
350SX-F/XC-F	13-18	ZE51-2443
350EXC-F/XCF-W	12-18	ZE51-2433
400XC-W/EXC/EXC-R	09-11	ZE51-2433
450SX-F/XC-F	13-18	ZE51-2443
450EXC/EXC-F	07-18	ZE51-2433
450XC-W	08-16	ZE51-2433
500XC-W/EXC/EXC-F (SIX DAYS)	12-18	ZE51-2433
530XC-W/XCR-W/EXC-R/EXC	08-11	ZE51-2433
FREERIDE 250R	14-17	ZE51-2423
FREERIDE 350	13-17	ZE51-2423

CONTROL

BARCLAMP

LEVER

FOOT PARTS

HAND GUARD

SUSPENSION

BODY GUARD

BODY

ACCESSORIES

CARBON

ZETA ALUMINUM BOLT KIT

- Aluminum bolt kit for MX and dual sport bike plastics.
 - Made of A7009 T-6 Aluminum, around 50% lighter than stock plastic fastener bolts.
 - Kit comes with front number plate, lower fork guards, radiator shrouds and side panel bolts.
 - Color anodized finish for corrosion resistance, laser printed logo on flange area.
 - Available for most mx racing models and dual sport models.
- * Comes with illustrated installations.

CRF250R 14-17
CRF450R 13-16
ZE88-5042

YZ250F/450F/
250FX/450FX
ZE88-5666

KTM 250SX
ZE88-5843



	Bike	Year	Red	Blue	Orange
HONDA	CRF250R	14-17	ZE88-5042	-	-
	CRF450R	13-16	ZE88-5042	-	-
		17-18	ZE88-5052	-	-
	CRF250L/M	12-17	ZE88-5142	-	-
	CRF250RALLY	17	ZE88-5152	-	-
YAMAHA	YZ125/250	08-18	-	ZE88-5646	-
	YZ250F	14-18	-	ZE88-5666	-
	YZ450F	14-17	-	ZE88-5666	-
		18	-	ZE88-5676	-
	YZ125X	17-18	-	ZE88-5646	-
KAWASAKI	YZ250X	16-18	-	ZE88-5646	-
	YZ250FX	15-18	-	ZE88-5666	-
	YZ450FX	16-18	-	ZE88-5666	-
	KX250F	05-16	ZE88-5242	ZE88-5246	-
		17-18	ZE88-5262	ZE88-5266	-
SUZUKI	KX450F	12-15	ZE88-5242	ZE88-5246	-
		16-18	ZE88-5252	ZE88-5256	-
	KLX250/ D-TRACKER	08-16	ZE88-5342	ZE88-5346	-
	RMZ250	10-17	ZE88-5442	ZE88-5446	-
	RMZ450	11-17	ZE88-5442	ZE88-5446	-
KTM	DRZ400SM	05-17	ZE88-5542	ZE88-5546	-
	125/150SX	16-18	-	-	ZE88-5843
	250SX	17-18	-	-	ZE88-5843
	250-450SX-F/XC-F	16-18	-	-	ZE88-5843
	125-500EXC/EXC TPI/ EXC-F/XC/XC-W	17-18	-	-	ZE88-5843



FRONT NUMBER PLATE



SHROUD COVER



SHROUD COVER



LOWER FORK GUARD



SIDE COVER



BRAKE LINE

* KTM only There is a bolt of the brake line.

ZETA KTM TAPPING SCREW BOLT SET

- Tapping bolt screw set for KTM.
- Made of A7009 T-6 Aluminum.
- Orange anodized finish for corrosion resistance.
- Comes in 10pcs tapping screw bolts.

* The same bolt size with KTM OE bolts. (Part no 0017060206)

Orange **ZE88-5893**

CONTROL



BARCLAMP



LEVER



FOOT PARTS



HAND GUARD



SUSPENSION



BODY GUARD



BODY



ACCESSORIES



CARBON





Kawasaki
ZE88-9202

KTM
ZE88-9503



YAMAHA
ZE88-9406

YAMAHA
ZE88-9416
Does not come with laser print logo

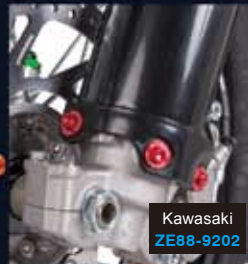

Kawasaki
ZE88-9202



YAMAHA
ZE88-9406



KTM
ZE88-9503

ZETA FORK GUARD BOLT

- Made of light weight aluminum to make front fork bottom area lighter.
- Beautiful anodized color with ZETA laser print logo. (Excluding some part numbers.)
- Available for specific models, not only Japanese, but also KTM and Husqvarna.

*1 CRF bolt kit, ZE88-9102 comes with disc guard bolts.
*2 Does not come with laser print logo.

Fork Guard Bolt	Year	Red	Blue
CR85R/RII	97-07	ZE88-9112	-
CRF150R	07-18	ZE88-9112	-
CR125R/250R	97-07	ZE88-9102 *1	-
CRF250R/X	04-17	ZE88-9102 *1	-
CRF450R	02-18	ZE88-9102 *1	-
CRF450RX	17-18	ZE88-9102 *1	-
CRF450X	05-17	ZE88-9102 *1	-
CRF250R/R	97-98	ZE88-9112	-
CRF250L/M	12-17	ZE88-9112	-
CRF250RALLY	17	ZE88-9112	-
XR250/MOTARD	03-07	ZE88-9112	-
XR400MOTARD	05-08	ZE88-9112	-
YZ125	91-07	-	ZE88-9416 *2
YZ250	91-07	-	ZE88-9416 *2
YZ250F	08-18	-	ZE88-9406
YZ250F	01-07	-	ZE88-9416 *2
YZ450F	08-18	-	ZE88-9406
YZ125X	03-07	-	ZE88-9416 *2
YZ250X	17-18	-	ZE88-9406
YZ250FX	16-18	-	ZE88-9406
YZ250FX	15-18	-	ZE88-9406
YZ450FX	16-18	-	ZE88-9406
WR250F	01-18	-	ZE88-9416 *2
WR450F	04-18	-	ZE88-9416 *2
WR250R/X	07-17	-	ZE88-9416 *2
KX80/85	98-13		
KX125/250	05-08		
KX250F	05-18		
KX450F	06-18	ZE88-9202	ZE88-9206
KLX450R	08-15		
KLX250/D-TRACKER	98-16		
RMZ250	05-06	ZE88-9202	ZE88-9206
RMZ450	08-18	ZE88-9302 *2	ZE88-9306 *2
RMX450Z	10-17	ZE88-9302 *2	ZE88-9306 *2
250SB	02-06	ZE88-9202	ZE88-9206
DRZ400SM	05-17	-	ZE88-9416 *2
TC50/65	17-18		
TC95	14-18		
TC125/250	14-18		
TE125-300/250i/300i	14-18		
TX125/300	17-18	-	ZE88-9506
FC250-450	14-18		
FE250-501	14-18		
FX350/450	17-18		
Fork Guard Bolt	Year	Orange	
50SX	12-18		
65SX	02-18		
85SX	03-18		
125-530SX/SX-F/XC-F/XC-F/EXC/EXC TPI/EXC-F/XC-W/XCF-W	00-18		ZE88-9503
FREERIDE 250F	18		
FREERIDE 250R	14-17		
FREERIDE 350	12-17		

Oil Filter Cover (Recer)	Year	Red
CRF150R	07-18	ZE90-1033
CRF250R	04-09	ZE90-1053
CRF250R	10-17	ZE90-1063
CRF450R	02-08	ZE90-1073
CRF450R	09-16	ZE90-1083
CRF450R	17-18	ZE90-1093
CRF450RX	17-18	ZE90-1093
CRF250X	04-17	ZE90-1053
CRF450X	05-17	ZE90-1073
CRF250L/M	12-17	ZE90-1023
CRF250RALLY	17	ZE90-1023
KX250F	05-18	ZE90-1153
KX450F	06-15	ZE90-1173
KLX450R	16-18	ZE90-1183
KLX450R	08-15	ZE90-1173
KLX125-D-TRACKER125	10-16	ZE90-1193
KLX150S	09-13	ZE90-1193
RMZ250	05-06	ZE90-1153
RMZ450	07-18	ZE90-1253
RMX450Z	05-18	ZE90-1253
RMX450Z	10-17	ZE90-1253

Oil Filter Cover (Recer)	Year	Blue
YZ250F	03-13	ZE90-1352
YZ250F	14-18	ZE90-1362
YZ450F	03-09	ZE90-1352
YZ450F	10-18	ZE90-1362
YZ250FX	15-18	ZE90-1362
YZ450FX	16-18	ZE90-1362
WR250F	03-14	ZE90-1352
WR450F	15-18	ZE90-1362
WR450F	03-15	ZE90-1352
WR450F	16-18	ZE90-1362
WR250R/X	07-17	ZE90-1312

Oil Filter Cover (Recer)	Year	Orange
250SX-F	05-12	ZE90-1417
250XC-F	13-18	ZE90-1447
250XC-F	07-12	ZE90-1417
250XC-F	13-18	ZE90-1447
250XC-F/XCF-W	07-13	ZE90-1417
250XC-F	14-18	ZE90-1447
250XCF-W	14-16	ZE90-1447
250EXC-R/EXC-G	00-06	ZE90-1417
350SX-F/EXC-F	11-18	ZE90-1447
350XC-F	11-18	ZE90-1447
350XCF-W	11-16	ZE90-1447
400SX/XC-W/EXC-R	03-07	ZE90-1417
400XC-W	09-10	ZE90-1447
450SX/EXC-R/EXC-G/XC/XC-W	03-07	ZE90-1417
450EXC/XC-W/XC-F	09-11	ZE90-1447
450SX-F	09-12	ZE90-1447
450SX-F	13-15	ZE90-1457
450XC-F	16-18	ZE90-1447
450XC-F	13-15	ZE90-1457
450XC-F	16-18	ZE90-1447
450XC	12-16	ZE90-1457
450XC-F	17-18	ZE90-1447
500XC-W	12-16	ZE90-1457
500XC	12-16	ZE90-1457
500XC-F	17-18	ZE90-1447
520SX/SXS-R	00-02	ZE90-1417
525SX/SX-R	02-06	ZE90-1417
525EXC-R/XC/XC-W	03-07	ZE90-1417
530EXC/XC-W	09-11	ZE90-1447
450SMR	04-06	ZE90-1417
450SMR	09-10	ZE90-1447
FREERIDE 250F	18	ZE90-1447
FREERIDE 350	12-17	ZE90-1447
525SMR	04-05	ZE90-1417
540SX/SXS-R	00-06	ZE90-1417
950ADVENTURE	03-06	ZE90-1417
990SUPERDUKE	04-06	ZE90-1417

Oil Filter Cover (Trail)	Year	Titanium
HR250/BAJA/MOTARD	95-07	ZE90-1010
KLX250/D-TRACKER	98-16	ZE90-1110
250SB	03-06	ZE90-1110
DRZ400S/SM	00-17	ZE90-1210



SUZUKI EUROPE WORD MX2

JEREMY SEEWER



Cooling fins

Installed on CRF250L

ZETA OIL FILTER COVER

- CNC machined aluminum oil filter covers.
- Made of A7009-T6 aluminum with a beautiful anodized finish and machined " ZETA " logo.
- Lighter than stock oil filter covers.
- Comes with cooling fins for heat dissipation.

Bike	Year	Size	Black	Blue	Red
HONDA					
CR85R/RII	03-07	M24 x 30-P1.0 H12	ZE58-2121	-	ZE58-2123
CR125R/250R	01-07	M26 x 32-P1.0 H10	-	-	ZE58-2323
CRF150R/RII	07-18	M24 x 30-P1.0 H12	ZE58-2121	-	ZE58-2123
CRF250R	04-17	M26 x 32-P1.0 H10	-	-	ZE58-2323
CRF450R	02-18	M26 x 32-P1.0 H10	-	-	ZE58-2323
CRF450RX	17-18	M26 x 32-P1.0 H10	-	-	ZE58-2323
CRF250X	04-17	M26 x 32-P1.0 H10	-	-	ZE58-2323
CRF450X	05-17	M26 x 32-P1.0 H10	-	-	ZE58-2323
XR50R/CRF50F	99-17	M22 x 30-P1.0 H12	-	ZE58-2032	ZE58-2033
CRM50/80	88-99	M24 x 30-P1.0 H12	ZE58-2121	-	ZE58-2123
CRM250R	89-96	M24 x 30-P1.0 H12	ZE58-2121	-	ZE58-2123
CRM250AR	97-00	M24 x 30-P1.0 H12	ZE58-2121	-	ZE58-2123
CRF250L/M	12-17	M24 x 30-P1.0 H12	ZE58-2121	-	ZE58-2123
CRF250RALLY	17	M24 x 30-P1.0 H12	ZE58-2121	-	ZE58-2123
CRF1000L	16-17	M24 x 30-P1.0 H12	ZE58-2121	-	ZE58-2123
XR230/MOTARD	05-12	M24 x 30-P1.0 H12	ZE58-2121	-	ZE58-2123
XR250/BAJA	95-07	M24 x 30-P1.0 H12	ZE58-2121	-	ZE58-2123
XR250MOTARD	03-07	M24 x 30-P1.0 H12	ZE58-2121	-	ZE58-2123
XR400MOTARD	05-08	M24 x 30-P1.0 H12	ZE58-2121	-	ZE58-2123
YAMAHA					
YZ85	02-18	M22 x 27-P1.0 H12	-	ZE58-2022	ZE58-2023
YZ125/250	94-18	M24 x 32-P1.0 H12	-	ZE58-2222	ZE58-2223
YZ250F	01-18	M24 x 32-P1.0 H12	-	ZE58-2222	ZE58-2223
YZ450F	03-18	M24 x 32-P1.0 H12	-	ZE58-2222	ZE58-2223
YZ400/426F	98-02	M24 x 32-P1.0 H12	-	ZE58-2222	ZE58-2223
YZ125X	17-18	M24 x 32-P1.0 H12	-	ZE58-2222	ZE58-2223
YZ250X	16-18	M24 x 32-P1.0 H12	-	ZE58-2222	ZE58-2223
YZ250FX	15-18	M24 x 32-P1.0 H12	-	ZE58-2222	ZE58-2223
YZ450FX	16-18	M24 x 32-P1.0 H12	-	ZE58-2222	ZE58-2223
WR250F	01-18	M24 x 32-P1.0 H12	-	ZE58-2222	ZE58-2223
WR450F	04-18	M24 x 32-P1.0 H12	-	ZE58-2222	ZE58-2223
TTR50	07-17	M22 x 27-P1.0 H12	-	ZE58-2022	ZE58-2023
TTR110	08-17	M22 x 27-P1.0 H12	-	ZE58-2022	ZE58-2023
TTR125	02-17	M22 x 27-P1.0 H12	-	ZE58-2022	ZE58-2023
TT250R	93-97	M24 x 30-P1.5 H14	ZE58-2151	ZE58-2152	ZE58-2153
TRICKER	04-17	M22 X 27-P1.0 H12	-	ZE58-2022	ZE58-2023
SEROW250	05-17	M22 X 27-P1.0 H12	-	ZE58-2022	ZE58-2023
XT250X	06-17	M22 X 27-P1.0 H12	-	ZE58-2022	ZE58-2023
XTZ125	03-17	M22 X 27-P1.0 H12	-	ZE58-2022	ZE58-2023
WR250R/X	07-17	M24 X 30-P1.5 H14	ZE58-2151	ZE58-2152	ZE58-2153
KAWASAKI					
KX65	00-18	M22 x 30-P1.0 H12	-	ZE58-2032	ZE58-2033
KX85/100	01-18	M22 x 30-P1.0 H12	-	ZE58-2032	ZE58-2033
KX125/250	88-91	M22 x 30-P1.0 H12	-	ZE58-2032	ZE58-2033
KX250F	04-08	M24 x 32-P1.5 H10	ZE58-2251	ZE58-2252	ZE58-2253
KX450F	04-18	M24 x 32-P1.5 H10	ZE58-2251	ZE58-2252	ZE58-2253
KX450F	06-18	M24 x 32-P1.5 H10	ZE58-2251	ZE58-2252	ZE58-2253
KLX450R	08-09	M24 x 32-P1.5 H10	ZE58-2251	ZE58-2252	ZE58-2253
KLX110/L	02-17	M22 x 30-P1.0 H12	-	ZE58-2032	ZE58-2033
KLX125	10-16	M22 x 30-P1.0 H12	-	ZE58-2032	ZE58-2033
D-TRACKER125	09-	M22 x 30-P1.0 H12	-	ZE58-2032	ZE58-2033
KLX150S	09-	M22 x 30-P1.0 H12	-	ZE58-2032	ZE58-2033
KLX250	98-16	M22 x 30-P1.0 H12	-	ZE58-2032	ZE58-2033
/D-TRACKER					
SUZUKI					
RM85/L	02-17	M22 x 30-P1.0 H12	-	ZE58-2032	ZE58-2033
RM125/250	04-13	M24 x 32-P1.0 H12	-	ZE58-2222	ZE58-2223
RMZ250	04-06	M24 x 32-P1.5 H10	ZE58-2251	ZE58-2252	ZE58-2253
	07-18	M24 x 32-P1.0 H12	-	ZE58-2222	ZE58-2223
RMZ450	05-18	M24 x 32-P1.0 H12	-	ZE58-2222	ZE58-2223
RMX450Z	10-17	M24 x 32-P1.0 H12	-	ZE58-2222	ZE58-2223
RMX250/S	92-98	M24 x 32-P1.5 H10	ZE58-2251	ZE58-2252	ZE58-2253
DJEBEL250XC	95-06	M24 x 32-P1.5 H10	ZE58-2251	ZE58-2252	ZE58-2253
250SB	02-06	M22 x 30-P1.0 H12	-	ZE58-2032	ZE58-2033
DRZ400S/E	00-17	M24 x 32-P1.5 H10	ZE58-2251	ZE58-2252	ZE58-2253
DRZ400SM	05-17	M24 x 32-P1.5 H10	ZE58-2251	ZE58-2252	ZE58-2253
V-STROM250	17	M22 x 30-P1.0 H12	-	ZE58-2032	ZE58-2033
V-STROM650/XT	07-17	M24 x 32-P1.5 H10	ZE58-2251	ZE58-2252	ZE58-2253
V-STROM1000/XT	02-17	M24 x 32-P1.5 H10	ZE58-2251	ZE58-2252	ZE58-2253



ZETA STEERING STEM NUT & BOLT

- CNC Machined steering stem nut and bolt.
- Made of A7009-T6 aluminum, light weight design.
- Available in red, blue, black and orange anodized colors.
- Bolt type for KTM in and Husqvarna.

Steering stem nut



Steering stem bolt

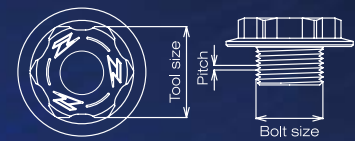

Nut/Bolt size Tool size Pitch Height
M26 x 32-P1.0 H10

Bike	Year	Size	Orange
KTM			
125-530	-	M20 x 27-P1.5 L=11.5 *	ZE58-2817
SX/SX-F/EXC/EXC-F/EXC-R/XC/XC-W/XC-F	-		
450-690	-		
SMR/SMC/ENDURO/R/ADVENTURE/SUPERMOTO/R/DUKE	-		
ATV SX/XC	-		
FREERIDE250F	18		
FREERIDE250R	14-17		
FREERIDE350	12-17		

Bike	Year	Size	Blue	Red
HUSQVARNA				
WR125	08-13	M26 x 32-P1.0 H10	-	ZE58-2323
TC125	14-18	M20 x 27-P1.5 L=11.5 *	ZE58-2812	-
TC250	09-13	M26 x 32-P1.0 H10	-	ZE58-2323
	14-18	M20 x 27-P1.5 L=11.5 *	ZE58-2812	-
TE125	14-16	M20 x 27-P1.5 L=11.5 *	ZE58-2812	-
TE150	17-18	M20 x 27-P1.5 L=11.5 *	ZE58-2812	-
TE250	09-13	M26 x 32-P1.0 H10	-	ZE58-2323
	14-18	M20 x 27-P1.5 L=11.5 *	ZE58-2812	-
TE300	14-18	M20 x 27-P1.5 L=11.5 *	ZE58-2812	-
FC250-450	14-18	M20 x 27-P1.5 L=11.5 *	ZE58-2812	-
FE250-501	14-18	M20 x 27-P1.5 L=11.5 *	ZE58-2812	-
TX/FX125-450	17-18	M20 x 27-P1.5 L=11.5 *	ZE58-2812	-
SM250R	09	M26 x 32-P1.0 H10	-	ZE58-2323

Verify stock bolt size before purchas

ZETA STEM CAP

- Aluminum stem shaft cap keeps dirt and mud out to prevent rust inside of the stem shaft.
- Made of A7009-T6 aluminum and light weight design.
- Available in titanium, black, blue and red anodized colors with cool laser print Zeta logo.
- Leaf springs hold inside of stem shaft and won't come off even in hard riding.
- Fits shaft inner diameter from 13 mm to 17.5 mm, fits almost all of dirt, super moto and dual sport bikes.

Part number	Color	Part number	Color
ZE58-4130	Titanium	ZE58-4132	Blue
ZE58-4131	Black	ZE58-4133	Red

CONTROL

BARCLAMP

LEVER

FOOT PARTS

HAND GUARD

SUSPENSION

BODY GUARD

BODY

ACCESSORIES

CARBON

Installed on KTM

ZE87-4208

ZE87-4202

ZE87-4108

ZE87-4102

ZE87-0600

ZE87-7106

ZE87-5101

Installed on WR250X

ZETA GAS CAP [RACER]

- CNC machined aluminum gas cap.
- Beautiful anodized colors makes your bike have the Factory look.
- Comes with uni flow cap which prevents fuel back flow from the fuel tank in the event of a fall.
- Made of A7009-T6 aluminum.
- Available in Blue, Red, Orange and Black colors.

ZETA GAS CAP [DUAL SPORTS]

- CNC machined aluminum gas cap for dual sport and trail models.
- Easy to install, just replace the stock fuel outer caps.
- KLX and D-TRACKER can be installed with factory key lock. Other models come with uni flow caps.
- Available in Blue and Titanium colors.

ZETA UNI - FLOW CAP

- One way valve to prevent fuel back flow from the fuel tank in the event of a fall.
- Keeps the fuel tank air ventilated but does not let fuel flow out.
- Available in 5 beautiful anodized colors.
- Cap is made of A7009-T6 aluminum.

Color	Part #
Blue	ZE93-1001
Red	ZE93-1003
Titanium	ZE93-1006
Gold	ZE93-1007
Orange	ZE93-1010

GAS CAP [Racer]		Year	Red	Blue	Black
HONDA	CRF250R	04-17	ZE87-0603	-	ZE87-0600
	CRF450R	02-16	ZE87-0603	-	ZE87-0600
	CRF450RX	17-18	ZE87-0603	-	ZE87-0600
	XR250R	96-	ZE87-0603	-	ZE87-0600
YAMAHA	YZ85	04-18	ZE87-1503	ZE87-1501	-
	YZ125/250	04-18	ZE87-1503	ZE87-1501	-
	YZ250F	04-13	ZE87-1503	ZE87-1501	-
	YZ450F	04-13	ZE87-1503	ZE87-1501	-
	YZ125X	17-18	ZE87-1503	ZE87-1501	-
	YZ250X	16-18	ZE87-1503	ZE87-1501	-
	TTR50	06-17	ZE87-2303	ZE87-2301	-
	TTR90	00-07	ZE87-2303	ZE87-2301	-
KAWASAKI	KX85/100	14-18	ZE87-1503	ZE87-1501	-
	KX250	05-08	ZE87-1503	ZE87-1501	-
	KLX110L	10-17	ZE87-1503	ZE87-1501	-
	KX250F	06-18	ZE87-1503	ZE87-1501	-
	KX450F	06-18	ZE87-1503	ZE87-1501	-
	KLX450R	08-15	ZE87-1503	ZE87-1501	-
	KFX450R	08-	ZE87-1503	ZE87-1501	-
	RM85	02-17	ZE87-2303	ZE87-2301	-
SUZUKI	RM125/250	04-08	ZE87-2303	ZE87-2301	-
	RMZ250	07-09	ZE87-2503	ZE87-2501	-
	RMZ250	10-18	ZE87-2303	ZE87-2301	-
		05-17	ZE87-2303	ZE87-2301	-
	RMZ450	18	ZE87-1503	ZE87-1501	-
	RMX450Z	10-17	ZE87-2303	ZE87-2301	-
	DR-Z50/70	08-13	ZE87-2503	ZE87-2501	-
	LT-R450	06-09	ZE87-2503	ZE87-2501	-
HUSAVARNA	LT-Z400/Z	03-09	ZE87-2503	ZE87-2501	-
	LT-Z250	04-09	ZE87-2503	ZE87-2501	-
	TC65	17-18	-	ZE87-4202	-
	TC85	14-17	-	ZE87-4102	-
	WR125	08-12	ZE87-2503	-	-
	TC125	14-15	-	ZE87-4102	-
	TC250	09-13	ZE87-2503	-	-
		14-16	-	ZE87-4102	-
TE250	09-13	ZE87-2503	-	-	
FC250-450	14-15	-	ZE87-4102	-	
TE/FE125-501	14-18	-	ZE87-4202	-	
TX/FX125-450	17-18	-	ZE87-4202	-	
SM250R	09	ZE87-2503	-	-	
IMS ALL	-	ZE87-0603	-	ZE87-0600	

GAS CAP [Racer]		Year	Orange
KTM	65SX	10-18	ZE87-4208
	125-450SX/SX-F	11-12	ZE87-4208
	85-450SX/SX-F	13-18	ZE87-4108
	125-530EXC/EXC-F/ XC/XC-F/XC-W/ XC-F-W	11-18	ZE87-4208

GAS CAP [Dual Sports]		Year	Blue	Titanium
HONDA	CRM50/80	88-99	ZE87-5101	ZE87-5106
	CRM250R/AR	89-00	ZE87-5101	ZE87-5106
	XR230/MOTARD	05-12	ZE87-5101	ZE87-5106
	XR250/MOTARD	95-07	ZE87-5101	ZE87-5106
	XR400/MOTARD	05-08	ZE87-5101	ZE87-5106
	XLR250R/BAJA	87-94	ZE87-5101	ZE87-5106
YAMAHA	DT200WR	91-94	ZE87-6101	ZE87-6106
	DT230LANZA	97-99	ZE87-6101	ZE87-6106
	SEROW225	93-04	ZE87-6101	ZE87-6106
	TT250R	93-97	ZE87-6101	ZE87-6106
KAWASAKI	WR250R/X	07-17	ZE87-6101	ZE87-6106
	KSR110	03-08	ZE87-7101	ZE87-7106
	KLX125,D- TRACKER125	10-16	ZE87-7101	ZE87-7106
	KLX150S	09-13	ZE87-7101	ZE87-7106
	KLX250,D-TRACKER	01-16	ZE87-7101	ZE87-7106
	SUPER SHERPA	97-07	ZE87-7101	ZE87-7106
	250SB	02-06	ZE87-7101	ZE87-7106
	RMX250S	92-95	ZE87-6101	ZE87-6106
DRZ400S/SM #	00-17	ZE87-6101	ZE87-6106	

* Can not be used for US Californian models.

CONTROL

BARCLAMP

LEVER

FOOT PARTS

HAND GUARD

SUSPENSION

BODY GUARD

BODY

ACCESSORIES

CARBON



ZETA CLUTCH CABLE GUIDE

- CNC machined aluminum clutch cable guide eliminates the flex on stock cable guide.
- Made of A7009-T6 aluminum and light weight design.
- Lighter weight than stock cable guides but stronger than stock guide.
- Exactly the same products used by , SUZUKI Europe, SRM.

Bike	Year	Part #
HONDA (Red)		
CRF250R	10-13	ZE94-0111
	09-14	ZE94-0141
CRF450R	15-16	ZE94-0151
	17-18	ZE94-0161
CRF450RX	17-18	ZE94-0161
CRF250L/M	12-17	ZE94-0181
YAMAHA (Blue)		
YZ450F	10-13	ZE94-0662
	18	ZE94-0632
WR250R/X	07-17	ZE94-0682
KAWASAKI (Red)		
KLX250/D-TRACKER	98-16	ZE94-0381
SUZUKI (Red)		
250SB	02-06	ZE94-0381



ZETA TANK HOLD WASHER KIT

- Aluminum washer for holding fuel tank.
- Available colors : titanium, gold, blue and red.
- Installed on your bike with OE bolt and aluminum collar that is contained in the kit.
- Washer is made of A7009-T6 aluminum.

Bike	Year	Blue	Red	Titanium	Gold
HONDA					
CR125R/250R	00-07	ZE88-0004	ZE88-0005	-	-
CRF250R	04-17	ZE88-0004	ZE88-0005	-	-
CRF450R	02-18	ZE88-0004	ZE88-0005	-	-
CRF450RX	17-18	ZE88-0004	ZE88-0005	-	-
CRF250X	04-17	ZE88-0004	ZE88-0005	-	-
CRF450X	05-17	ZE88-0004	ZE88-0005	-	-
YAMAHA					
YZ250F	06-09	ZE88-2004	ZE88-2005	ZE88-2006	ZE88-2007
	10-13	ZE88-0004	ZE88-0005	-	-
YZ450F	06-09	ZE88-2004	ZE88-2005	ZE88-2006	ZE88-2007
WR250F	07-14	ZE88-2004	ZE88-2005	ZE88-2006	ZE88-2007
WR450F	07-15	ZE88-2004	ZE88-2005	ZE88-2006	ZE88-2007
WR250R/X	07-17	ZE88-1004	ZE88-1005	-	ZE88-1007
KAWASAKI					
KX65	01-18	ZE88-1004	ZE88-1005	-	ZE88-1007
KX85/100	00-18	ZE88-1004	ZE88-1005	-	ZE88-1007
KX125/250	00-08	ZE88-1004	ZE88-1005	-	ZE88-1007
KX250F	04-18	ZE88-1004	ZE88-1005	-	ZE88-1007
KX450F	06-18	ZE88-1004	ZE88-1005	-	ZE88-1007
KLX450R	08-15	ZE88-1004	ZE88-1005	-	ZE88-1007
KLX110	02-17	ZE88-1004	ZE88-1005	-	ZE88-1007
SUZUKI					
RMZ250	04-06	ZE88-1004	ZE88-1005	-	ZE88-1007
	07-18	ZE88-3004	ZE88-3005	ZE88-3006	ZE88-3007
	05-06	ZE88-1004	ZE88-1005	-	ZE88-1007
RMZ450	07	ZE88-2004	ZE88-2005	ZE88-2006	ZE88-2007
	08-17	ZE88-3004	ZE88-3005	ZE88-3006	ZE88-3007
RMX450Z	10-17	ZE88-3004	ZE88-3005	ZE88-3006	ZE88-3007

ZETA AIR FILTER BOLT

- CNC aluminum air filter bolts.
- Larger rounded head, with finger grooves, makes it easy to spin the filter bolt.
- Red anodized finish with laser printed logo on filter bolt head.
- Bolt shaft is made of durable stainless steel.

Bike	Year	Part #
HONDA		
CR80R	96-02	ZE59-0102
CR85R	03-07	ZE59-0102
CR125R	85-07	ZE59-0202
CR250R	85-07	ZE59-0202
CR500R	85-01	ZE59-0202
CRF150R	07-18	ZE59-0102
CRF250R	04-17	ZE59-0102
CRF450R	02-18	ZE59-0102
CRF450RX	17-18	ZE59-0102
CRF250X	04-17	ZE59-0102
CRF450X	05-17	ZE59-0102
YAMAHA		
YZ85	02-18	ZE59-0202
YZ125	93-18	ZE59-0302
YZ250	93-18	ZE59-0302
YZ250F	01-13	ZE59-0302
	14-18	ZE59-0402
YZ450F	03-09	ZE59-0302
	14-17	ZE59-0402
YZ125X	17-18	ZE59-0302
YZ250X	16-18	ZE59-0302
YZ250FX	15-18	ZE59-0402
YZ450FX	16-18	ZE59-0402
WR250F	15-18	ZE59-0402
WR450F	16-18	ZE59-0402

Bike	Year	Part #
KAWASAKI		
KX65	00-18	ZE59-0202
KX80/85	91-18	ZE59-0202
KX100	95-18	ZE59-0202
KX125	92-05	ZE59-0202
KX250	92-08	ZE59-0202
KX250F	04-18	ZE59-0302
KX450F	06-18	ZE59-0302
SUZUKI		
RM125	96-08	ZE59-0302
RM250	93-08	ZE59-0302
RM-Z250	07-18	ZE59-0302
RM-Z450	05-18	ZE59-0302

ZETA BRAKE RESERVOIR COVER

- Made of CNC machined A7009-T6 aluminum.
- Anodized finish colors. Available in red, blue, orange for KTM.
- Available for MX, ED and dual sport bikes.

- Brake Reservoir Cover Front
- Clutch Reservoir Cover Front
- Brake Reservoir Cover Rear



SRM JMX

RYOTA IKEMOTO

Brake Reservoir Cover Front	Year	Red	Blue
CR80R/85R	98-07	ZE86-1103	-
CR125/250R	96-07	ZE86-1103	-
CRF150R	07-18	ZE86-1103	-
CRF250R	04-17	ZE86-1103	-
CRF450R	02-18	ZE86-1103	-
CRF450RX	17-18	ZE86-1103	-
CRF250X	04-17	ZE86-1103	-
CRF450X	05-17	ZE86-1103	-
CRF125F	14-18	ZE86-1103	-
CRF150F	03-17	ZE86-1103	-
CRF230F	07-17	ZE86-1103	-
XR50/XR100MOTARD	05-08	ZE86-1503	ZE86-1501
CRM50/80	88-98	ZE86-1503	ZE86-1501
FTR2723	00-08	ZE86-1503	ZE86-1501
SL230	97-05	ZE86-1503	ZE86-1501
XR230/MOTARD	05-12	ZE86-1503	ZE86-1501
CRM250R/AR	89-98	ZE86-1503	ZE86-1501
CRF250L/M	12-17	ZE86-1503	ZE86-1501
CRF250RALLY	17	ZE86-1503	ZE86-1501
XR250/MOTARD	95-07	ZE86-1503	ZE86-1501
XR400MOTARD	05-07	ZE86-1503	ZE86-1501
TRX450R	04-09	ZE86-1503	ZE86-1501
TRX450ER	06-09	ZE86-1503	ZE86-1501
TRX400EX	99-08	ZE86-1503	ZE86-1501
TRX300EX	93-08	ZE86-1503	ZE86-1501
YZ85	03-18	ZE86-2103	ZE86-2101
YZ125/250	02-07	ZE86-2103	ZE86-2101
YZ250F	02-06	ZE86-2103	ZE86-2101
YZ250F	07-18	ZE86-2303	ZE86-2301
YZ2426F-450F	02-07	ZE86-2103	ZE86-2101
YZ125X	08-18	ZE86-2303	ZE86-2301
YZ250X	17-18	ZE86-2303	ZE86-2301
YZ250FX	16-18	ZE86-2303	ZE86-2301
YZ250FX	15-18	ZE86-2303	ZE86-2301
YZ450FX	16-18	ZE86-2303	ZE86-2301
WR250F	02-16	ZE86-2103	ZE86-2101
WR450F	17-18	ZE86-2303	ZE86-2301
WR450F	04-15	ZE86-2103	ZE86-2101
TRICKER	16-18	ZE86-2303	ZE86-2301
SEROW250	04-17	ZE86-1503	ZE86-1501
XTZ125	05-17	ZE86-1503	ZE86-1501
XTZ150X	03-17	ZE86-1503	ZE86-1501
WR250R/X	09-17	ZE86-1503	ZE86-1501
YZ2450	07-10	ZE86-1503	ZE86-1501
RAPTOR250	08	ZE86-1503	ZE86-1501
RAPTOR750	07-10	ZE86-1503	ZE86-1501
KX65	01-18	ZE86-2103	ZE86-2101
KX80/85/100	98-18	ZE86-2103	ZE86-2101
KX125	92-08	ZE86-2103	ZE86-2101
KX250	93-08	ZE86-2103	ZE86-2101
KX250F	04-18	ZE86-2103	ZE86-2101
KX450F	06-18	ZE86-2103	ZE86-2101
KSR50/80/110	94-08	ZE86-1503	ZE86-1501
KDX125	92-99	ZE86-1503	ZE86-1501
KDX220	94-99	ZE86-1503	ZE86-1501
KDX250	92-94	ZE86-1503	ZE86-1501
KLX125	10-16	ZE86-1503	ZE86-1501
KLX150S	09-13	ZE86-1503	ZE86-1501
KLX250/300	93-18	ZE86-1503	ZE86-1501
KLX450R	08-15	ZE86-2103	ZE86-2101
D-TRACKER125	10-16	ZE86-1503	ZE86-1501
D-TRACKER	98-16	ZE86-1503	ZE86-1501
VERSYS-X250/300	17	ZE86-1503	ZE86-1501
KFX450R	08-09	ZE86-1503	ZE86-1501
KFX700	04-09	ZE86-1503	ZE86-1501
RM80/85	94-17	ZE86-2103	ZE86-2101
RM125/250	04-08	ZE86-2103	ZE86-2101
RMZ250	04-18	ZE86-2103	ZE86-2101
RMZ450	05-18	ZE86-2103	ZE86-2101
RMX450Z	10-17	ZE86-2103	ZE86-2101
RMX250S	89-98	ZE86-1503	ZE86-1501
DRZ250R/DJEBEL250XC	95-06	ZE86-1503	ZE86-1501
250SB	02-06	ZE86-1503	ZE86-1501
DRZ400S/SM	00-17	ZE86-1503	ZE86-1501
LT-R450	06-09	ZE86-1503	ZE86-1501
LT-2400/Z	03-08	ZE86-1503	ZE86-1501
LT-2250	04-08	ZE86-1503	ZE86-1501
TC65	17-18	ZE86-3202	-
TC85	14-18	ZE86-3202	-
TC/TE/TX	14-17	ZE86-1302	-
/FC/FE/FX125-501/S	18	ZE86-1302	-
TC/FC125-450 bremsbo type only	18	ZE86-1302	-
FR450RALLY	16-17	ZE86-1302	-

Brake Reservoir Cover Front	Year	Orange
65SX	14-18	ZE86-3210
85SX	13-18	ZE86-3210
125SX/XC-W/EXC(SIX DAYS)	05-18	ZE86-1310
144/150SX/150XC/150XC-W	05-18	ZE86-1310
200XC-W/EXC	05-16	ZE86-1310
250SX/SX-F/XC-F	05-18	ZE86-1310
250XC/XC-W/XCF-W	05-18	ZE86-1310
250EXC/EXC-R/EXC-F (SIX DAYS)	05-18	ZE86-1310
300XC/XC-W/EXC(SIX DAYS)	05-18	ZE86-1310
350SX-F/XC-F/XCF-W	11-18	ZE86-1310
350EXC-F(SIX DAYS)	11-18	ZE86-1310
400XC-W/EXC/EXC-R	05-11	ZE86-1310
450SX/SX-R/SX-F	05-18	ZE86-1310
450XC/XC-F/XCF-W	05-18	ZE86-1310
450XC-W/EXC-R/EXC/EXC-F	05-18	ZE86-1310
500XC-W/EXC/EXC-F (SIX DAYS)	12-18	ZE86-1310
505SX-F/XC-F	08-09	ZE86-1310
525SX/SX-R/XC/XC-W/EXC-R	05-07	ZE86-1310
530XC-W/XCR-W/EXC-R/EXC	08-11	ZE86-1310
450SMR	13	ZE86-3210
FREERIDE 250F	18	ZE86-3210
FREERIDE 250R	14-17	ZE86-3210
FREERIDE 350	12-17	ZE86-3210
FREERIDE E-SX/XC/SM	15-16	ZE86-3210
450RALLY	13-17	ZE86-1310

Clutch Reservoir Cover Front	Year	Orange
65SX	14-18	ZE86-3110
85SX	13-18	ZE86-3110
125EXC (SIX DAYS)	09-16	ZE86-1410
125/144SX	09-15	ZE86-1410
125SX/XC-W	16-18	ZE86-1310
150SX/XC	09-15	ZE86-1410
150SX/XC-W	16-18	ZE86-1310
200EXC/XC/XC-W	09-15	ZE86-1410
200EXC	16	ZE86-1310
250EXC/EXC-F (SIX DAYS)	06-18	ZE86-1310
250SX-F	07-18	ZE86-1310
250SX	06-18	ZE86-1310
250XC	06-18	ZE86-1310
250XC-F	07-18	ZE86-1310
250XCF-W	07-16	ZE86-1310
250/300XC-W	06-18	ZE86-1310
300EXC (SIX DAYS)	06-18	ZE86-1310
300XC	06-18	ZE86-1310
350EXC-F/SIX DAYS	11-18	ZE86-1310
350SX-F/XC-F/XCF-W	11-18	ZE86-1310
400EXC	09-10	ZE86-1310
400XC-W	07-18	ZE86-1310
450EXC/R/EXC-F (SIX DAYS)	09	ZE86-1410
450SMR	13-14	ZE86-1310
450SX/SX-F/SX-R	09-12	ZE86-1410
450XC-F	13-18	ZE86-1310
450XC-W/XCR-W (SIX DAYS)	08-16	ZE86-1310
500EXC/XC-W/EXC-F (SIX DAYS)	12-18	ZE86-1310
505XC-F	08	ZE86-1310
525EXC-R	07	ZE86-1310
530EXC-J/EXC-R/XCR-W/XC-W	08-11	ZE86-1310
FREERIDE 250F	18	ZE86-3110
FREERIDE 250R	14-17	ZE86-3110
FREERIDE 350	12-17	ZE86-3110
FREERIDE E-SX/XC/SM	15-16	ZE86-3110
450RALLY	15-17	ZE86-1310

Clutch Reservoir Cover Front	Year	Blue
TC65	17-18	ZE86-3102
TC85	14-18	ZE86-3102
TC125	14-18	ZE86-1402
TC250	14-18	ZE86-1402
TE125	14-16	ZE86-1402
TE150	17-18	ZE86-1402
TE250/300	14-16	ZE86-1302
TE250-450	17-18	ZE86-1402
FC250-450	14-15	ZE86-1302
FE250-501/S	16-18	ZE86-1402
FE250-501/S	14-16	ZE86-1302
FR450RALLY	17-18	ZE86-1402
FS450	16-18	ZE86-1402
TX125-300	17-18	ZE86-1402
FX350-450	17-18	ZE86-1402

Brake Reservoir Cover Rear	Year	Red	Blue
CR125R/250R	02-07	ZE86-4103	-
CRF150R	07-18	ZE86-4103	-
CRF250R	04-17	ZE86-4103	-
CRF450R	02-18	ZE86-4103	-
CRF450RX	17-18	ZE86-4103	-
CRF250X	04-17	ZE86-4103	-
CRF450X	05-17	ZE86-4103	-
CRF250L/M	12-17	ZE86-1103	-
TRX300EX	93-08	ZE86-1503	ZE86-1501
YZ125/250	03-18	ZE86-5103	ZE86-5101
YZ250F	03-18	ZE86-5103	ZE86-5101
YZ250F	03-18	ZE86-5103	ZE86-5101
YZ125X	17-18	ZE86-5103	ZE86-5101
YZ250X	16-18	ZE86-5103	ZE86-5101
YZ250FX	15-18	ZE86-5103	ZE86-5101
YZ450FX	16-18	ZE86-5103	ZE86-5101
WR250F	03-18	ZE86-5103	ZE86-5101
WR450F	04-18	ZE86-5103	ZE86-5101
WR250R/X	07-17	ZE86-5103	ZE86-5101
TRICKER	04-17	ZE86-5103	ZE86-5101
SEROW250	05-17	ZE86-5103	ZE86-5101
XT250X	06-17	ZE86-5103	ZE86-5101
KX125/250	03-08	ZE86-6103	ZE86-6101
KX250F	04-18	ZE86-6103	ZE86-6101
KX450F	06-18	ZE86-6103	ZE86-6101
KLX125-D-TRACKER125	10-16	ZE86-2103	ZE86-2101
KLX150S	09-13	ZE86-2103	ZE86-2101
KLX250/300	93-16	ZE86-2103	ZE86-2101
KLX450R	08-15	ZE86-6103	ZE86-6101
D-TRACKER/X	98-16	ZE86-2103	ZE86-2101
KFX450R	08-10	ZE86-6103	ZE86-6101
RM125/RM250	04-08	ZE86-6103	ZE86-6101
RMZ250	04-18	ZE86-6103	ZE86-6101
RMZ450	05-18	ZE86-6103	ZE86-6101
RMX450Z	10-17	ZE86-6103	ZE86-6101
DRZ400S/SM	00-17	ZE86-2103	ZE86-2101
TC65	17-18	-	ZE86-7202
TC85	14-17	-	ZE86-7202
TC125/250	14-17	-	ZE86-7102
TC125/250 bremsbo type only	18	-	ZE86-7102
TE125-300	14-17	-	ZE86-7102
TX125/300	17	-	ZE86-7102
FC250-450	14-17	-	ZE86-7102
FC250-450 bremsbo type only	18	-	ZE86-7102
FE250-501	14-17	-	ZE86-7102
FX350/450	17	-	ZE86-7102

Brake Reservoir Cover Rear	Year	Orange
85SX/SXS/XC	03-17	ZE86-7210
65SX/SXS/XC	04-17	ZE86-7210
505XS	11-13	ZE86-7210
505SX/SXS/SM	06-17	ZE86-7210
105SX/XC	04-11	ZE86-7210
125-530 SX/SX-F/EXC/EXC	04-18	ZE86-7110
TR/EXC-F/XC/F/XC-W/		
XCF-W/SMR		
FREERIDE 250F	18	ZE86-7210
FREERIDE 250R	14-17	ZE86-7210
FREERIDE 350	12-17	ZE86-7210



ZETA FORK TOP BLEEDER

- Allows bleeding of air pressure without additional tools.
- Easy to install. Replace the OEM bleeder screw with the Fork Top Bleeder.
- Fits most KAYABA and Showa upside-down forks. (Excluding KX250F '11- , YZ85 , RMZ250/450 '13-)
- Available bleeder for KTM / HUSKY / WP Suspension.
- Colors available (Anodized) : Blue, Red and Titanium. Blue, Orange and titanium for KTM / HUSKY / WP.
- Comes in pairs.

Description	Color	Part #
SHOWA / KYB	Titanium	ZE91-1103
SHOWA / KYB	Red	ZE91-1106
SHOWA / KYB	Blue	ZE91-1107
KTM / HUSKY / WP	Blue	ZE91-4102
KTM / HUSKY / WP	Titanium	ZE91-4103
KTM / HUSKY / WP	Orange	ZE91-4107

ACCESSORIES

CARBON



	Engine Plug	Year	Red	Blue
HONDA	CRF150R	07-18	ZE89-1120	-
	CRF250R	04-09	ZE89-1110	-
	CRF450R	10-17	ZE89-1120	-
	CRF450R	02-16	ZE89-1120	-
	CRF450R	17-18	ZE89-1130	-
	CRF450RX	17-18	ZE89-1130	-
	CRF250X	04-17	ZE89-1110	-
	CRF450X	05-17	ZE89-1120	-
	CRF250L/M	12-17	ZE89-1150	-
	CRF250RALLY	17	ZE89-1150	-
	XR250/BAJA/MOTARD	95-07	ZE89-1120	-
	XR400MOTARD	05-08	ZE89-1120	-
TRX400EX	00-08	ZE89-1120	-	
TRX450R/ER	04-09	ZE89-1120	-	
YAMAHA	YZ250F	01-13	ZE89-1410	ZE89-1412
		14-18	ZE89-1440	ZE89-1442
		06-09	ZE89-1420	ZE89-1422
	YZ450F	10-13	ZE89-1430	ZE89-1432
		14-18	ZE89-1440	ZE89-1442
	YZ400F/426F/450F	98-05	ZE89-1410	ZE89-1412
	YZ250FX	15-18	ZE89-1440	ZE89-1442
	YZ450FX	16-18	ZE89-1440	ZE89-1442
		01-02	ZE89-1410	ZE89-1412
	WR250F	03-14	ZE89-1420	ZE89-1422
		15-18	ZE89-1440	ZE89-1442
	WR400F/426F	98-02	ZE89-1410	ZE89-1412
WR450F	03-15	ZE89-1420	ZE89-1422	
	16-18	ZE89-1440	ZE89-1442	
TT-R50	06-15	ZE89-1410	ZE89-1412	
SEROW250	05-17	ZE89-1410	ZE89-1412	
TRICKER	04-17	ZE89-1410	ZE89-1412	
XT250X	06-17	ZE89-1410	ZE89-1412	
XTZ125	03-12	ZE89-1410	ZE89-1412	
WR250R/X	07-17	ZE89-1410	ZE89-1412	
YFZ450	04-09	ZE89-1420	ZE89-1422	
KAWASAKI	KX250F	04-10	ZE89-1210	ZE89-1212
		11-18	ZE89-1230	ZE89-1232
	KX450F	09-18	ZE89-1230	ZE89-1232
	KLX450R	08-15	ZE89-1230	ZE89-1232
	KLX125,D-TRACKER125	10-16	ZE89-1280	ZE89-1282
	KLX150S	09-13	ZE89-1280	-
	KLX250,D-TRACKER	98-16	ZE89-1250	ZE89-1252
KFX400	03-06	ZE89-1350	ZE89-1352	
SUZUKI	RMZ250	04-06	ZE89-1210	ZE89-1212
		07-18	ZE89-1310	ZE89-1312
	RMZ450	05-18	ZE89-1310	ZE89-1312
	RMX450Z	10-17	ZE89-1310	ZE89-1312
HUSQ	DR-Z400R/S/SM	00-17	ZE89-1350	ZE89-1352
	250SB	02-06	ZE89-1250	ZE89-1252
	FC250/350, FE250/350	14-18	ZE89-1612	-
FX350	17-18	ZE89-1612	-	

	Engine Plug	Year	Orange
KTM	250SX-F	11-18	ZE89-1617
	350SX-F	11-18	
	450SX-F	07-12	
	505SX-F/XC-F	08-09	
	250XC-F	11-18	
	350XC-F	12-18	
	450XC-F	08-09	
	250XC-F-W	12-16	
	350XC-F-W	12-16	
	250XC-F	12-18	
	350XC-F	12-18	
	FREERIDE 250F	18	
FREERIDE 350	14-17		
450SMR	08-10		

	Oil Filler Plug	Year	Red	Blue
HONDA	CR125R/250R	90-07		
	CRF150R	07-18		
	CRF250R	04-17		
	CRF450R	02-16		
	CRF450X	05-17	ZE89-2110	ZE89-2112
	CRM250R/AR	89-98		
	CRF250L/M	12-17		
YAMAHA	YZ80/85	98-18	ZE89-2110	ZE89-2112
	YZ125	97-18	ZE89-2110	ZE89-2112
	YZ250	99-18	ZE89-2110	ZE89-2112
	YZ250F	01-18	ZE89-2110	ZE89-2112
	YZ450F	03-18	ZE89-2110	ZE89-2112
	YZ125X	17-18	ZE89-2110	ZE89-2112
	YZ250X	16-18	ZE89-2110	ZE89-2112
	YZ250FX	15-18	ZE89-2110	ZE89-2112
	YZ450FX	16-18	ZE89-2110	ZE89-2112
	WR250F	03-18	ZE89-2110	ZE89-2112
	WR450F	03-18	ZE89-2110	ZE89-2112
	SEROW225	99-04	ZE89-2110	ZE89-2112
KAWASAKI	SEROW250	05-17	ZE89-2210	ZE89-2212
	TRICKER	04-17	ZE89-2210	ZE89-2212
	WR250R/X	07-17	ZE89-2110	ZE89-2112
	XT250X	06-17	ZE89-2210	ZE89-2212
	YFZ450	04-09	ZE89-2110	ZE89-2112
	KX250	05-08	ZE89-2310	ZE89-2312
	KX250F	04-18	ZE89-2310	ZE89-2312
	KX450F	06-18	ZE89-2310	ZE89-2312
	KLX450R	08-15	ZE89-2310	ZE89-2312
	D-TRACKER	98-16	ZE89-2110	ZE89-2112
	KLX250	93-16	ZE89-2110	ZE89-2112
	VERSYS650	07-17	ZE89-2110	ZE89-2112
SUZUKI	VERSYS1000	12-17	ZE89-2110	ZE89-2112
	KFX450R	08-09	ZE89-2310	ZE89-2312
	RM80/85	01-17	ZE89-2210	ZE89-2212
	RM125/250	01-08	ZE89-2210	ZE89-2212
	RM-Z250	04-06	ZE89-2310	ZE89-2312
	RM-Z450	07-18	ZE89-2210	ZE89-2212
	RM-Z450	05-18	ZE89-2210	ZE89-2212
RMX450Z	10-17	ZE89-2210	ZE89-2212	
HUSQ	250SB	02-06	ZE89-2110	ZE89-2112
	V-STORM250	17	ZE89-2110	ZE89-2112
	V-STORM650/1000/XT	04-17	ZE89-2110	ZE89-2112
	LT-R450	06-09	ZE89-2210	ZE89-2212
	TC50/65	17-18	-	ZE89-2412
	TC85	14-17	-	ZE89-2412
	TC125	14-18	-	ZE89-2412
	TC250	09-13	ZE89-2310	ZE89-2312
		14-18	-	ZE89-2412
	TE125	14-16	-	ZE89-2412
	TE150	17-18	-	ZE89-2412
	TE250/250i	09-13	ZE89-2310	ZE89-2312
	14-18	-	ZE89-2412	
TE300/300i	14-18	-	ZE89-2412	
TX125/300	17-18	-	ZE89-2412	
FC250-450	14-18	-	ZE89-2412	
FE250-501	14-18	-	ZE89-2412	
FX350/450	17-18	-	ZE89-2412	
SM250R	09	ZE89-2310	ZE89-2312	

	Oil Filler Plug	Year	Orange
KTM	50/65SX	-	
	65/100SX/SXS/XC	03-17	ZE89-2416
	50-300 2st	-	
	250-690 4st	-	



ZETA ENGINE PLUG

- CNC machined engine plugs.
- Replaces stock plugs to give a factory bike look.
- Available in anodized colors of red, blue and orange for KTM.
- Laser printed ZETA logo.



ZETA OIL FILLER PLUG

- CNC machined oil filler cap.
- 14 mm hex head design for easy operation with a wrench.
- Includes safety wire holes to prevent mispaced part.
- Available in anodized colors of red, blue and orange for KTM.
- Laser printed ZETA logo.



ZETA OIL DIP STICK

- CNC machined oil filler cap with aluminum oil dipstick.
- Includes safety wire holes to prevent mispaced part.
- Available in anodized colors of red.
- Laser printed ZETA logo.

	Oil Dip Stick	Year	Red	Blue
HONDA	CRF150R	07-17	ZE89-3050	-
	CRF250R	04-09	ZE89-3020	-
		10-17	ZE89-3040	-
	CRF450R	09-16	ZE89-3030	-
		17-18	ZE89-3060	-
	CRF450RX	17-18	ZE89-3060	-
SUZUKI	CRF250X	04-17	ZE89-3020	-
	CRF450X	05-17	ZE89-3020	-
	DR-Z400R/S/SM	00-17	ZE89-3210	ZE89-3212

- CONTROL
- BARCLAMP
- LEVER
- FOOT PARTS
- HAND GUARD
- SUSPENSION
- BODY GUARD
- BODY
- ACCESSORIES
- CARBON

ZETA

REAR BRAKE CLEVIS

- The high rigid and light weight design, provides better control of the rear brake.
- Clevis body is made of A7009-T6 aluminum.
- Comes with a specially designed stainless steel pin.
- Available in red and blue anodized colors.



ZETA

BRAKE LINE CLAMP

- Light weight and durable brake line clamp.
- Strongly clamp your brake line while reducing bike weight.
- Available in red and blue anodized colors.
- Made of A7009-T6 aluminum.



Rear Brake Clevis	Year	Red	Blue
HONDA			
CR80R/85R	96-07	ZE89-5045	-
CR125/250R	02-07	ZE89-5015	ZE89-5014
CRF150R	07-18	ZE89-5015	ZE89-5014
CRF250R	04-17	ZE89-5015	ZE89-5014
CRF450R	02-18	ZE89-5015	ZE89-5014
CRF450RX	17-18	ZE89-5015	ZE89-5014
CRF250X	04-17	ZE89-5015	ZE89-5014
CRF450X	05-17	ZE89-5015	ZE89-5014
CRM250R/AR	89-98	ZE89-5045	-
CRF250L/M	12-17	ZE89-5045	-
CRF250RALLY	17	ZE89-5045	-
XR50/XR100MOTARD	05-07	ZE89-5045	-
XR230/MOTARD	05-12	ZE89-5045	-
XR250/MOTARD	95-07	ZE89-5045	-
XR400MOTARD	05-08	ZE89-5045	-
XR650R	00-07	ZE89-5045	-
TRX450R/ER	04-09	ZE89-5045	-
TRX400EX	00-08	ZE89-5045	-
YAMAHA			
YZ80/85	94-18	ZE89-5035	ZE89-5034
YZ125/250	03-18	ZE89-5135	ZE89-5134
YZ250F	03-18	ZE89-5135	ZE89-5134
YZ450F	03-18	ZE89-5135	ZE89-5134
YZ125X	17-18	ZE89-5135	ZE89-5134
YZ250X	16-18	ZE89-5135	ZE89-5134
YZ250FX	15-18	ZE89-5135	ZE89-5134
YZ450FX	16-18	ZE89-5135	ZE89-5134
WR250F	03-18	ZE89-5135	ZE89-5134
WR450F	03-18	ZE89-5135	ZE89-5134
SEROW225/W/WE	93-04	ZE89-5035	ZE89-5034
SEROW250	05-17	ZE89-5035	ZE89-5034
TRICKER	04-17	ZE89-5035	ZE89-5034
WR250R/X	07-17	ZE89-5155	ZE89-5154
XT250X	06-17	ZE89-5035	ZE89-5034
YFZ450	04-10	ZE89-5035	ZE89-5034
RAPTER700R	06-09	ZE89-5035	ZE89-5034
RAPTER660R	01-05	ZE89-5035	ZE89-5034
RAPTER350	04-09	ZE89-5035	ZE89-5034
KAWASAKI			
KX65	03-18	ZE89-5125	ZE89-5124
KX80/85/100	98-18	ZE89-5115	ZE89-5114
KX125	02	ZE89-5125	ZE89-5124
	03-08	ZE89-5115	ZE89-5114
KX250	03-04	ZE89-5115	ZE89-5114
	05-08	ZE89-5125	ZE89-5124
KX250F	04-18	ZE89-5125	ZE89-5124
KX450F	06-18	ZE89-5125	ZE89-5124
KLX450R	08-15	ZE89-5125	ZE89-5124
D-TRACKER125	10-16	ZE89-5115	ZE89-5114
KLX125	10-16	ZE89-5115	ZE89-5114
KLX150S	09-13	ZE89-5115	ZE89-5114
D-TRACKER	98-16	ZE89-5115	ZE89-5114
KLX250	93-16	ZE89-5115	ZE89-5114
KFX450R	08-10	ZE89-5125	ZE89-5124
SUZUKI			
RM80/85	98-17	ZE89-5115	ZE89-5114
RM125/250	01-13	ZE89-5115	ZE89-5114
RMZ250	04-06	ZE89-5125	ZE89-5124
RMZ450	07-18	ZE89-5135	ZE89-5134
RMZ450	05-17	ZE89-5135	ZE89-5134
RMX450Z	10-17	ZE89-5135	ZE89-5134
RMX250S/R	93-98	ZE89-5115	ZE89-5114
DRZ400S/R	00-09	ZE89-5115	ZE89-5114
DRZ400SM	04-17	ZE89-5115	ZE89-5114
250SB	02-06	ZE89-5115	ZE89-5114
LT-R450	06-09	ZE89-5115	ZE89-5114

Brake Line Clamp	Year	Red	Blue
HONDA			
CR80R/85R	96-07	ZE92-0106	ZE92-0107
CR125/250R	90-03	ZE92-0106	ZE92-0107
CRF150R	04-07	ZE92-0206	ZE92-0207
CRF250R	07-18	ZE92-0106	ZE92-0107
CRF450R	04-17	ZE92-0206	ZE92-0207
CRF450R	02-03	ZE92-0106	ZE92-0107
CRF450R	04-18	ZE92-0206	ZE92-0207
CRF450RX	17-18	ZE92-0206	ZE92-0207
CRF250X	06-17	ZE92-0206	ZE92-0207
CRF450X	05-17	ZE92-0206	ZE92-0207
CRM250R/AR	91-98	ZE92-0106	ZE92-0107
CRF250L/M *	12-17	ZE92-0206	ZE92-0207
CRF250RALLY *	17	ZE92-0206	ZE92-0207
XR250/BAJA/MOTARD	95-07	ZE92-0106	ZE92-0107
XR400MOTARD	05-08	ZE92-0106	ZE92-0107
YAMAHA			
YZ125/250	05-08	ZE92-4106	ZE92-4107
YZ250F	09-18	ZE92-0206	ZE92-0207
	05-08	ZE92-4106	ZE92-4107
YZ450F	09-18	ZE92-0206	ZE92-0207
	05-08	ZE92-4106	ZE92-4107
YZ125X	17-18	ZE92-0206	ZE92-0207
YZ250X	16-18	ZE92-0206	ZE92-0207
YZ250FX	15-18	ZE92-0206	ZE92-0207
YZ450FX	16-18	ZE92-0206	ZE92-0207
WR250F	05-18	ZE92-4106	ZE92-4107
WR450F	05-18	ZE92-4106	ZE92-4107
WR250R/X	07-17	ZE92-4106	ZE92-4107
KAWASAKI			
KX65	00-18	ZE92-2106	ZE92-2107
KX80/85/100	98-18	ZE92-2106	ZE92-2107
KX125/250	92-08	ZE92-2106	ZE92-2107
KX250F	04-18	ZE92-2106	ZE92-2107
KX450F	06-18	ZE92-2106	ZE92-2107
KLX450R	08-15	ZE92-2106	ZE92-2107
KLX125.D-TRACKER125	10-16	ZE92-2106	ZE92-2107
SUZUKI			
RM85	02-17	ZE92-2106	ZE92-2107
RM125/250	01-13	ZE92-2106	ZE92-2107
RMZ250	04-18	ZE92-2106	ZE92-2107
RMZ450	05-18	ZE92-2106	ZE92-2107
RMX450Z	10-17	ZE92-2106	ZE92-2107
DRZ400SM	04-17	ZE92-2106	ZE92-2107

ABS not available.

CONTROL

BARCLAMP

LEVER

FOOT PARTS

HAND GUARD

SUSPENSION

BODY GUARD

BODY

ACCESSORIES

CARBON

Wheel Spacer Racer	Year	Color	Front	Rear
HONDA	CR125R/250R	02-03	-	ZE93-3151
		04-07	ZE93-3071 #1	ZE93-3151
	CRF250R	04-08	ZE93-3071 #1	ZE93-3151
		09-12	ZE93-3071 #2	ZE93-3151
		13-17	ZE93-3071 #1	ZE93-3151
	02-03	ZE93-3071 #1	ZE93-3151	
	CRF450R	04-08	ZE93-3071 #1	ZE93-3151
09-12		ZE93-3071 #2	ZE93-3151	
13-18	ZE93-3071 #1	ZE93-3151		
CRF450RX	17-18	ZE93-3071 #1	ZE93-3151	
CRF250X/450X	04-17	ZE93-3051	ZE93-3151	
YAMAHA	YZ85	02-18	ZE93-3652	-
	YZ125/250	02-07	ZE93-3642	ZE93-3712 #1
		08-18	ZE93-3612	ZE93-3712 #1
	02	ZE93-3642	-	
	YZ250F	03-06	ZE93-3642	ZE93-3712 #1
		07-08	ZE93-3612	ZE93-3712 #1
		09-13	ZE93-3612	ZE93-3752 #1
		14-18	ZE93-3672	ZE93-3752 #1
	YZ450F	03-07	ZE93-3642	ZE93-3712 #1
		08	ZE93-3612	ZE93-3712 #1
	09-13	ZE93-3612	ZE93-3752 #1	
	14-18	ZE93-3672	ZE93-3752 #1	
	YZ125X	17-18	ZE93-3612	ZE93-3712 #1
	YZ250X	16-18	ZE93-3612	ZE93-3712 #1
	YZ250FX	15-18	ZE93-3672	ZE93-3712 #1
	YZ450FX	16-18	ZE93-3672	ZE93-3712 #1
	WR250F	03	-	ZE93-3712 #1
	WR450F	06-18	-	ZE93-3712 #1
	YZ85	02-17	ZE93-3651	-
	YZ250F	09-13	-	ZE93-3751 #1
		14-18	-	ZE93-3751 #1
		09-13	-	ZE93-3751 #1
		14-18	-	ZE93-3751 #1
06-18		ZE93-3661	-	
WR250F	06-18	ZE93-3661	-	
KAWASAKI	KX85/100	01-18	ZE93-3261 #1	-
	KX125/250	03-05	-	ZE93-3311
		06-08	ZE93-3211	ZE93-3311
	KX250F	04-05	-	ZE93-3311
	KX450F	06-18	ZE93-3211	ZE93-3311
KLX450R	06-18	ZE93-3211	ZE93-3311	
SUZUKI	RM85	02-17	ZE93-3441 #1	-
	RMZ250	04-06	-	ZE93-3311
		07-12	ZE93-3411	ZE93-3511
	13-18	ZE93-3411	ZE93-3511 #1	
	05-12	ZE93-3411	ZE93-3511	
13-18	ZE93-3411	ZE93-3511 #1		
RMX450Z	10-17	ZE93-3411	ZE93-3511	
KTM	125-530 SX/SX-F/XC-F	03-12	ZE93-3814	ZE93-3864
	125-450 SX/SX-F/XC-F	13-14	ZE93-3814	ZE93-3884
	125-450SX/SX-F	15-18	ZE93-3824	ZE93-3884
	125-530EXC/EXC-F/EXC-W/XC-W/SMR	03-15	ZE93-3814	ZE93-3864
	125-500EXC/EXC-F/EXC-W/XC-W	16-18	ZE93-3824	ZE93-3864

#1 Model can not be used with stock dust cover
 #2 Model can not be used with stock disk cover

Wheel Spacer Dual Sports	Year	Color	Front	Rear
H	CRF250L/M	12-16	ZE93-3081	ZE93-3161
	17	Red	-	ZE93-3161
Y	CRF250RALLY	17	-	ZE93-3161
	XR50MOTARD/100MOTARD	05-08	ZE93-3041	ZE93-3131
Y	TRICKER	04-17	-	ZE93-3732 #1
	XT250X	06-17	Blue	-
K	SEROW250	05-17	-	ZE93-3321 #1
	KLX250/D-TRACKER/X	98-07	Red	ZE93-3321 #1
S	KLX300R	08-16	Red	ZE93-3321 #1
	96	-	ZE93-3321 #1	
S	RMX250	96-98	Red	ZE93-3531 #1
	250SB	02-06	-	ZE93-3321 #1
S	DRZ400S(JAPAN)	00-03	Red	ZE93-3531
	DRZ400S/DRZ400SM(JAPAN)	04-09	-	ZE93-3521

#1 Model can not be used with stock dust cover

Fast Rear Wheel Spacer	Year	Color	Part #
H	CR125R/250R	05-07	ZE93-2102
	CRF250R	05-17	
	CRF450R	05-17	
	CRF450RX	17	
	CRF250X	06-17	
	CRF450X	05-17	
YAMAHA	YZ125/250	99-18	ZE93-2416
	YZ250F	06-08	ZE93-2416
		09-18	ZE93-2406
	06-08	ZE93-2416	
	YZ450F	09-18	ZE93-2406
	YZ125X	17-18	ZE93-2416
	YZ250X	16-18	ZE93-2416
	YZ250FX	15-18	ZE93-2416
	YZ450FX	16-18	ZE93-2416
	WR250F	05-18	ZE93-2416
WR450F	05-18	ZE93-2416	
K	KX125/250	03-08	ZE93-2202
	KX250F	04-18	
	KX450F	06-18	
S	RMZ250	04-18	ZE93-2302
	RMZ450	08-18	
KTM	125-250SX/XC	13-18	ZE93-2503
	250-450SX-F/XC-F	13-18	ZE93-2503
	125-530SX/SX-F/XC/XC-F	08-12	ZE93-2513
	125-530EXC/EXC-TPI/EXC-F/XC-W/XC-F-W	08-18	ZE93-2513



ZETA WHEEL SPACER

- Anodized wheel spacers, available in blue, red and orange.
- Ribs keeps spacer on the wheels for easy maintenance. (Excluding some models)
- Made of A7009 aluminum with hard anodized finish.
- Lighter and more durable than stock spacers.
- Spacers available for MX racers, Mini-Moto and trail models.
- Front and rear spacers sold separately.
- Left and right side spacers sold in pairs. (Excluding some models)



ZETA FAST REAR WHEEL SPACER

- Unique tapered design rear wheel spacers.
- Wheel spacers do not come off the hub during wheel installation because of its tapered design.
- Protects wheel dust seals and bearings from mud and dirt.
- Made of aircraft grade aluminum and anodized finish.
- ZETA laser etching logo on side body, comes in pairs.



CONTROL

BARCLAMP

LEVER

FOOT PARTS

HAND GUARD

SUSPENSION

BODY GUARD

BODY

ACCESSORIES

CARBON

CONTROL

BARCLAMP

LEVER

FOOT PARTS

HAND GUARD

SUSPENSION

BODY GUARD

BODY

ACCESSORIES

CARBON



ZETA MAGNETIC DRAIN BOLT

- Magnetic drain bolts designed to pick up excess bits of metal in your engine oil.
- Made of A7009-T6 aluminum. Light weight design.
- Press fit magnet on the drain plugs.
- Includes safety wire holes to prevent mispaced part.
- Available in blue, red and orange anodized colors.

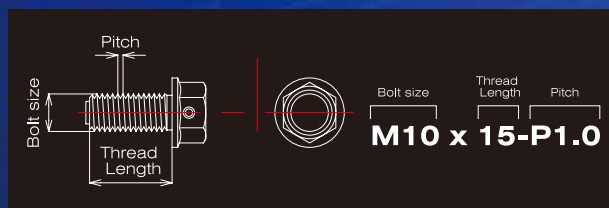

Magnetic Drain Bolt	Year	Size	Blue	Red
CR85R/R11	03-07	M12X15-P1.5	ZE58-1522	ZE58-1523
CR125R/250R	02-07	M12X15-P1.5	ZE58-1522	ZE58-1523
CRM250R	89-96	M12X15-P1.5	ZE58-1522	ZE58-1523
CRM250AR	97-00	M12X15-P1.5	ZE58-1522	ZE58-1523
CRF250L/M	12-17	M12X15-P1.5	ZE58-1522	ZE58-1523
CRF250RALLY	17	M12X15-P1.5	ZE58-1522	ZE58-1523
CRF1000L	16-17	M12X15-P1.5	ZE58-1522	ZE58-1523
XR50R/CRF50F	99-17	M12X15-P1.5	ZE58-1522	ZE58-1523
XR70R/CRF70F	97-11	M12X15-P1.5	ZE58-1522	ZE58-1523
XR100R/CRF100F	90-13	M12X15-P1.5	ZE58-1522	ZE58-1523
XR250/BAJA	95-07	M12X15-P1.5	ZE58-1522	ZE58-1523
XR250MOTARD	03-07	M12X15-P1.5	ZE58-1522	ZE58-1523
XR400MOTARD	05-08	M12X15-P1.5	ZE58-1522	ZE58-1523
XR250R	90-04	M12X15-P1.5	ZE58-1522	ZE58-1523
XR400R	96-04	M12X15-P1.5	ZE58-1522	ZE58-1523
XR600R	90-00	M12X15-P1.5	ZE58-1522	ZE58-1523
XR650R	00-06	M12X15-P1.5	ZE58-1522	ZE58-1523
YZ125	05-18	M10X15-P1.25	ZE58-1222	ZE58-1223
YZ250	97-18	M12X15-P1.5	ZE58-1522	ZE58-1523
YZ250F	01-18	M10X15-P1.25	ZE58-1222	ZE58-1223
YZ450F	03-09	M10X15-P1.25	ZE58-1222	ZE58-1223
YZ125X	14-18	M10X15-P1.25	ZE58-1222	ZE58-1223
YZ250X	17-18	M10X15-P1.25	ZE58-1222	ZE58-1223
YZ250FX	16-18	M12X15-P1.5	ZE58-1522	ZE58-1523
YZ250FX	15-18	M10X15-P1.25	ZE58-1222	ZE58-1223
YZ450FX	16-18	M10X15-P1.25	ZE58-1222	ZE58-1223
WR250F	01-18	M10X15-P1.25	ZE58-1222	ZE58-1223
WR450F	04-11	M10X15-P1.25	ZE58-1222	ZE58-1223
WR450F	16-18	M10X15-P1.25	ZE58-1222	ZE58-1223
TRICKER	04-17	M12X15-P1.5	ZE58-1522	ZE58-1523
SEROW250	05-17	M12X15-P1.5	ZE58-1522	ZE58-1523
XT250X	06-17	M12X15-P1.5	ZE58-1522	ZE58-1523
WR250R/X	07-17	M12X15-P1.5	ZE58-1522	ZE58-1523
KX65	00-18	M10X15-P1.5	ZE58-1322	ZE58-1323
KX85/100	01-18	M10X15-P1.5	ZE58-1322	ZE58-1323
KX125	96-08	M10X15-P1.5	ZE58-1322	ZE58-1323
KX250	96-08	M10X15-P1.5	ZE58-1322	ZE58-1323
KX250F	04-18	M10X15-P1.5	ZE58-1322	ZE58-1323
KX450F	06-15	M10X22-P1.5	ZE58-1342	ZE58-1343
KX450F	16-18	M10X15-P1.5	ZE58-1322	ZE58-1323
KLX450R	08-09	M10X22-P1.5	ZE58-1342	ZE58-1343
KLX110/L	02-17	M12X15-P1.5	ZE58-1522	ZE58-1523
KLX125, D-TRACKER125	10-16	M12X15-P1.5	ZE58-1522	ZE58-1523
KLX150S	09-13	M12X15-P1.5	ZE58-1522	ZE58-1523
KLX250/D-TRACKER	98-16	M10X15-P1.5	ZE58-1322	ZE58-1323
VERSYS-X250	17	M12X15-P1.5	ZE58-1522	ZE58-1523
VERSYS-X300	17	M12X15-P1.5	ZE58-1522	ZE58-1523
VERSYS 650	10-17	M12X15-P1.5	ZE58-1522	ZE58-1523
VERSYS1000	12-17	M12X15-P1.5	ZE58-1522	ZE58-1523
RMZ250	07-18	M12X10-P1.25	ZE58-1412	ZE58-1413
250SB	02-06	M10X15-P1.5	ZE58-1322	ZE58-1323
DRZ400S/E/SM(CRANKCASE)	00-17	M12X10-P1.25	ZE58-1412	ZE58-1413
DRZ400S/E/SM(FRAME)	00-17	M10X15-P1.25	ZE58-1222	ZE58-1223
V-STROM250	17	M14X10-P1.25	ZE58-1612	ZE58-1613
V-STROM650/XT	04-17	M12X10-P1.25	ZE58-1412	ZE58-1413
V-STROM1000/XT	02-17	M14X10-P1.25	ZE58-1612	ZE58-1613
TC125/250	14-18			
TE125-300	14-18			
FC250-450	14-18	M12X12-P1.5 *	ZE58-1512	-
FE250-501	14-18			
TX/FX125-450	17-18			

Magnetic Drain Bolt	Year	Size	Orange
125-530 SX/SX-F/EXC/EXC-F/EXC-R/XC/XC-W/XC-F	-		
450-690 SMR/SMC/Enduro/R	-		
/Adventure/Supermoto/R/Duke	-		
ATV SX/XC	-	M12X12-P1.5	ZE58-1517
FREERIDE250F	18		
FREERIDE250R	14-17		
FREERIDE350	12-17		

Verify stock bolt size before purchas



ZETA SPEED METER GEAR CANCELLER

- Speedometer cable gear cancelling spacer for Yamaha WRF.
- Useful when removing speed meter from the front wheel.
- Blue anodized finish.

WR250F/450F '06- Blue **ZE93-4626**

	Bike	Year	Red	Blue	Ti-color	
HONDA	CR125R/CR250R	02-07	ZE93-5013	-	-	
	CRF250R	04-17	ZE93-5013	-	-	
	CRF450R	02-18	ZE93-5013	-	-	
	CRF450RX	17-18	ZE93-5013	-	-	
	CRF250X	04-17	ZE93-5013	-	-	
	CRF450X	05-17	ZE93-5013	-	-	
	CRF250L/M	12-17	ZE93-5063	-	-	
	CRF250RALLY	17	ZE93-5063	-	-	
	YZ125/250	02-18	ZE93-5313	ZE93-5312	-	
	YAMAHA	YZ250F	02-08	ZE93-5313	ZE93-5312	-
		09-11	ZE93-5333	ZE93-5332	-	
		12-18	ZE93-5343	ZE93-5342	-	
		03-08	ZE93-5313	ZE93-5312	-	
YZ450F		09	ZE93-5333	ZE93-5332	-	
		10-18	ZE93-5343	ZE93-5342	-	
YZ125X		17-18	ZE93-5313	ZE93-5312	-	
YZ250X		16-18	ZE93-5313	ZE93-5312	-	
YZ250FX		15-18	ZE93-5313	ZE93-5312	-	
YZ450FX		16-18	ZE93-5313	ZE93-5312	-	
KAWASAKI	WR250F	02-18	ZE93-5313	ZE93-5312	-	
	WR450F	04-18	ZE93-5313	ZE93-5312	-	
	WR250R/X	07-17	ZE93-5313	ZE93-5312	-	
	KX85/100	01-18	ZE93-5133	ZE93-5132	-	
	KX125/250	03-08	ZE93-5113	ZE93-5112	-	
		04-16	ZE93-5113	ZE93-5112	ZE93-5120 *	
	KX250F	17-18	ZE93-5143 *	ZE93-5142 *	ZE93-5140 *	
		06-15	ZE93-5113	ZE93-5112	ZE93-5120 *	
	KX450F	16-18	ZE93-5143 *	ZE93-5142 *	ZE93-5140 *	
		08-15	ZE93-5113	ZE93-5112	-	
SUZUKI	RMZ250	04-17	ZE93-5113	ZE93-5112	-	
	RMZ450	05-18	ZE93-5113	ZE93-5112	-	
	RMX450Z	10-18	ZE93-5113	ZE93-5112	-	
	DRZ400SM	05-17	ZE93-5253	ZE93-5252	-	
	HUSQVARNA	TC85	14	-	ZE93-5422	-
			15-18	-	ZE93-5442	-
		TC125	14-15	-	ZE93-5422	-
			16-18	-	ZE93-5412	-
		TC250	14-16	-	ZE93-5422	-
			17-18	-	ZE93-5412	-
TE125-300		14-17	-	ZE93-5422	-	
TX125		17-18	-	ZE93-5422	-	
TX300		17-18	-	ZE93-5412	-	
FC350		14-15	-	ZE93-5422	-	
	16-18	-	ZE93-5412	-		
	14-15	-	ZE93-5422	-		
FC250/450	15(US)	-	ZE93-5412	-		
	16-18	-	ZE93-5412	-		
FE250-501	14-18	-	ZE93-5422	-		
FX350-450	17-18	-	ZE93-5412	-		

	Bike	Year	Orange
KTM	65SX	98-15	ZE93-5437
		16-18	ZE93-5457
	85SX	03-14	ZE93-5427
		15-18	ZE93-5447
	125-450SX/SX-F/XC/XC-F	-12	ZE93-5427
	125-530EXC/EXC-F/XC-W/XCF-W	00-18	ZE93-5427
	125-450SX/SX-F/XC/XC-F	13-18	ZE93-5417
	FREERIDE250F	18	ZE93-5447
	FREERIDE 250R	14-17	ZE93-5447
	FREERIDE 350	12-17	ZE93-5447

* Different shape from conventional products (KTM shape)



ZETA REAR AXLE BLOCKS

- CNC machined anodized axle blocks.
- Rotate using the forward and reverse positions, able to offset axle shaft 13 mm in reverse position. (Mini size is 11 mm)
- Scales on both sides of axle block for easy adjusting.

- CONTROL
- BARCLAMP
- LEVER
- FOOT PARTS
- HAND GUARD
- SUSPENSION
- BODY GUARD



ZETA REAR AXLE SLIDER

- Protects rear axle shaft and nut from damage when falling down.
- Made of A7009 aluminum with color anodized finish, covered by POM material.

	Bike	Year	Part #		
			Black	Red	Blue
HONDA	CRF250L/M	12-17	ZE93-6150	ZE93-6152	-
	CRF250RALLY	17	ZE93-6150	ZE93-6152	-
YAMAHA	WR250R/X	07-17	ZE93-6750	-	ZE93-6753
KAWASAKI	KLX250/D-TRACKER	08-16	ZE93-6350	-	-
SUZUKI	DRZ400SM	05-17	ZE93-6550	-	-

Replacement Slider
Part number **ZE93-6990**

- BODY
- ACCESSORIES
- CARBON



Red/Black
DK241-Z11

Blue/Black
DK241-Z12

Green/Black
DK241-Z13

Yellow/Black
DK241-Z14

Orange/Black
DK241-Z15



ZETA RACING FLOOR MAT

- Motorcycle floor mat made of high absorption polyester and PVC oil resistant rubber mat.
- 1.6 mm PVC rubber is oil and gasoline resistant, will not infiltrate oil or gasoline to ground.
- Dimple back side rubber design prevents slippage. Great to use for motorcycle display at shop or garage.
- Polyester carpet surface can be washed by high pressure water.
- This type of mat required for the event under FIM regulations.

100 x 220 cm (39" x 86")



Kawasaki Team GREEN
JMX

ZETA STAND MAT

- Mat that prevents the floor from being damaged by the stand.
- Carpet is also excellent in water absorption, durability and wear resistance. Nylon material.
- Mat can be used not only as a stand mat, but also for various uses such as tool mats, clothes changing mats, entrance mats and so on.
- Incombustible material used.

Part number Size
DK242-Z01 65 x 45 cm (25" x 17")



ZETA STICKER KIT 2 pcs

Part number Size
ZE50-0103 47 x 20 mm
(1.85" x 0.7")

ZETA STICKERS

Part number Size
ZE50-2111 65 x 35 mm
ZE50-2113 100 x 20 mm
ZE50-2115 150 x 30 mm



ZE50-2115



ZE50-2113



ZE50-2111



ZETA FRONT FENDER DECAL

Part number Color
MO33-0701 ZETA Racing Black
MO33-0702 ZETA Racing White



ZETA UMBRELLA

Part number Size
ZE29-1001 130 cm (51")



ZETA SNAP BACK CAP

ZE20-1101



ZETA DISPLAY RACK

Part number Size
D39-11-111 70 X 190 cm
(2.3" x 6.2")



ZETA LOGO BANNER

Part number Size
ZE65-0501 30 x 90 cm (1" x 3")



ZETA TRACK TAPE

- Track tape for MX and Ed track use.
- Available DF Yellow, ZETA Blue.

Size W 75 mm x L 200m per roll
Part number Description
DF29-7021 DIRTBREAK
DF29-7081 ZETA

	Bike	Year	Part #
H	CRF150R	07-18	ZC31-3130
	CRF250R	10-13	ZC31-3180
		14-17	ZC31-3150
	CRF450R	05-08	ZC31-3170
		09-14	ZC31-3150
XR	XR250/BAJA/MOTARD	95-07	ZC31-3120
	XR230/MOTARD	08-12	ZC31-3170
Y	YZ250F	10-12	ZC31-3440
	YZ450F	08-09	ZC31-3450
	WR250R/X	07-17	ZC31-3410
K	KX250F	04-09	ZC31-3150
		10-12	ZC31-3241
	KX450F	09	ZC31-3250
	KLX125,D-TRACKER125	10-16	ZC31-3230
	KLX150S	09-13	ZC31-3230
KLX250, D-TRACKER/X	01-16	ZC31-3210	
S	RMZ250	04-18	ZC31-3330
	RMZ450	08-09	ZC31-3350
	250SB	02-06	ZC31-3210
	DRZ400S/R/SM	00-17	ZC31-3310



Z-CARBON EX PIPE GUARD

- Carbon head pipe guards.
- Guards for specific models and universal type are available.
- Universal type exhaust pipe fitting diameter is from 26 mm to 50 mm.

Universal type
ZC31-3000



Replacement Mount kit
ZC31-3901

CONTROL

BARCLAMP

LEVER

FOOT PARTS

HAND GUARD

SUSPENSION

BODY GUARD

BODY

ACCESSORIES

CARBON



Z-CARBON MX HANDGUARD ZC

- Super light weight carbon fiber MX hand guards.
- Protect your hands from brush and water during your ride.
- Handlebar clamp style hand guards fit almost all dirt bikes and ATVs.
- Comes complete with installation hardware.
- Replacement mount kit available.

Part number
ZC41-2311

Replacement mount kit
ZE74-0910



Z-CARBON ARMOR HANDGUARD ZC

- Light weight carbon fiber deflector shields for ZETA Armor hand guards (sold separately).
- Protect your hands from brush and water during your ride.
- Includes mounting screws to attach armor hand guards.

Part number
ZC41-2310



ZETA Armor hand guards P 28 - 29



Z-CARBON
FRONT DISC GUARD

- Light weight carbon fiber brake disc guard.
- Protect your front brake disc from rocks, brush and debris during your ride.
- Prevents mud and dirt from getting on the disc, so your brakes function properly in a muddy race.
- Slim and light weight design will not affect the handling of the bike.
- Disc guard and bracket sold separately to allow larger range of combinations.

Model specific mounting kit required for installation.

Modification may be needed for some models.

Part number	Description
ZC35-1201	Up to 240 mm brake disc
ZC35-1202	Up to 270 mm brake disc

Z-CARBON
AIR SCOOP

- Carbon fiber front brake caliper air scoop for super moto bikes.
- Efficiently directs cool air to brake caliper to keep it cool and prevent brake fade.
- Can be used on up to 320 mm brake disc.
- # Model specific mounting kit required for installation.
- # Modification may be needed for some models.

Part number
ZC35-1203

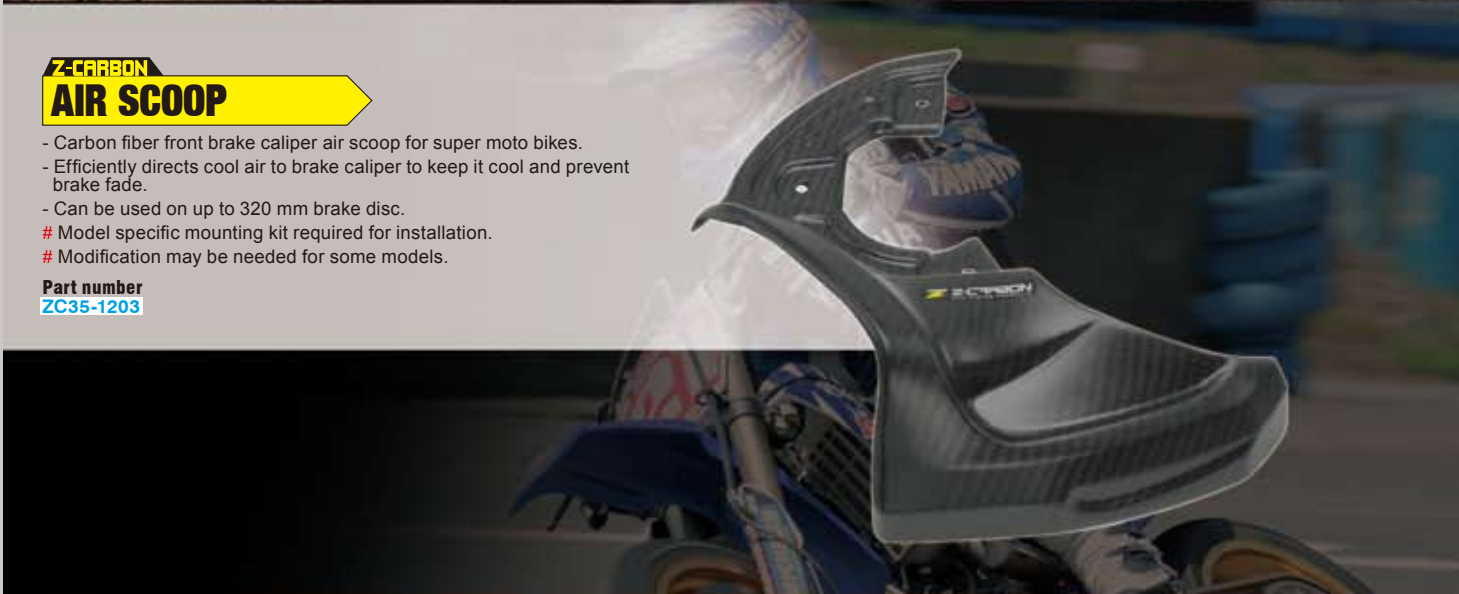

ZETA
FRONT DISC GUARD MOUNTING KIT

- Model specific mounting kit. (Required for installation)
- Mount bracket is integrated with wheel spacer.



Bike	Year	Mounting kit	Air scoop/ Disc guard
HONDA			
CRF150R	07-18	ZE52-1100	ZC35-1201
CR125R/250R	04-07	ZE52-1120	ZC35-1202
CRF250R	04-17	ZE52-1120	ZC35-1202
CRF450R	04-18	ZE52-1120	ZC35-1202
CRF450RX	17-18	ZE52-1120	ZC35-1202
CRF250X/450X	04-17	ZE52-1120	ZC35-1202
CRF250L	12-16	ZE52-1180	ZC35-1202
	17	ZE52-1190	ZC35-1202
CRF250M	12-16	ZE52-1180	ZC35-1203
	17	ZE52-1190	ZC35-1203
YAMAHA			
YZ125/250	08-18	ZE52-1420	ZC35-1202
YZ250F	07-13	ZE52-1420	ZC35-1202
	14-18	ZE52-1430	ZC35-1202
YZ450F	07-13	ZE52-1420	ZC35-1202
	14-18	ZE52-1430	ZC35-1202
YZ125X	17-18	ZE52-1420	ZC35-1202
YZ250X	16-18	ZE52-1420	ZC35-1202
YZ250FX	15-18	ZE52-1430	ZC35-1202
YZ450FX	16-18	ZE52-1430	ZC35-1202
WR250F	06-18	ZE52-1420	ZC35-1202
WR450F	06-18	ZE52-1420	ZC35-1202
WR250R	07-17	ZE52-1470	ZC35-1202
WR250X	07-17	ZE52-1470	ZC35-1203
KAWASAKI			
KX125/250	06-08	ZE52-1220	ZC35-1202
KX250F	06-18	ZE52-1220	ZC35-1202
KX450F	06-18	ZE52-1220	ZC35-1202
KLX450R	08-09	ZE52-1220	ZC35-1202
KLX125	10-16	ZE52-1280	ZC35-1201
KLX150S	09-13	ZE52-1280	ZC35-1201
D-TRACKER/X	08-16	ZE52-1270	ZC35-1203
KLX250	08-16	ZE52-1270	ZC35-1202

Bike	Year	Mounting kit	Air scoop/ Disc guard
SUZUKI			
RM85	02-17	ZE52-1300	ZC35-1201
RM-Z250	07-18	ZE52-1320	ZC35-1202
RM-Z450	05-18	ZE52-1320	ZC35-1202
RMX450Z	10-17	ZE52-1320	ZC35-1202
DRZ400SM	05-17	ZE52-1380	ZC35-1203
KTM			
85/105 SX/XC	03-11	ZE52-1500	ZC35-1201
125-530SX/SX-F/XC/	03-14	ZE52-1520	ZC35-1202
XC-F	15-18	ZE52-1530	ZC35-1202
125-530EXC/EXC-F	03-15	ZE52-1520	ZC35-1202
	16-18	ZE52-1530	ZC35-1202
450-525SMR	04-10	ZE52-1520	ZC35-1203
HUSQVARNA			
CR/WR 125-300	09-11	ZE52-1610	ZC35-1202
TC/TE 250-511	09-11	ZE52-1610	ZC35-1202
SM 450-510	09	ZE52-1610	ZC35-1203
TC/FC 125-450	14	ZE52-1520	ZC35-1202
	15-18	ZE52-1530	ZC35-1202
TE/FE 125-501	14-15	ZE52-1520	ZC35-1202
	16-18	ZE52-1530	ZC35-1202
TX/FX125-450	17-18	ZE52-1530	ZC35-1202

Z-CARBON FORK WRAPS

- Carbon front fork wrap for dirt bikes.
- Made of aircraft grade durable dry carbon fiber.
- Protect your front fork outer tube from brush and water during your ride.
- Easy to install, just attach on to front forks.
- Lower and upper fork guards available, comes in a pair.

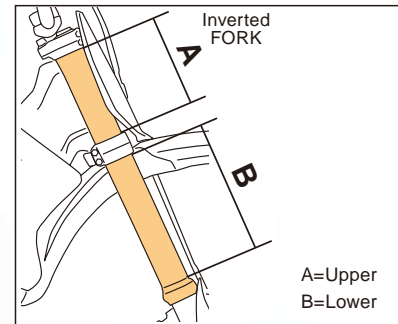

Please measure the length of A and B in the picture above and refer to list below for your fork wrap part number.

FORK WRAPS SIZE CHART

Description	Part #	Size (mm)	
		Length	Diameter
UPR	ZC35-4312	140	45
	ZC35-4314	164	45
	ZC35-4332	160	52
	ZC35-4334	178	52

Description	Part #	Size (mm)	
		Length	Diameter
LWR	ZC35-4316	220	45
	ZC35-4318	240	45
	ZC35-4336	225	52
	ZC35-4338	248	52

Bike	Year	UPR	LWR
HONDA			
CR85R	03-07	ZC35-4312	ZC35-4318
CRF150R	07-18	ZC35-4312	ZC35-4318
CRF250R	04-17	ZC35-4334	ZC35-4338
CRF450R	02-18	ZC35-4334	ZC35-4338
CRF450RX	17-18	ZC35-4334	ZC35-4338
CRF250X/450X	04-17	ZC35-4334	ZC35-4338
XR250/MOTARD	03-07	ZC35-4332	ZC35-4336
CRF250/LM	12-17	ZC35-4332	ZC35-4336
CRF250RALLY	17	ZC35-4332	ZC35-4336
YAMAHA			
YZ85	02-18	ZC35-4312	ZC35-4318
YZ125/250	08-18	ZC35-4334	ZC35-4338
YZ250F	08-18	ZC35-4334	ZC35-4338
YZ450F	08-18	ZC35-4334	ZC35-4338
YZ125X	17-18	ZC35-4334	ZC35-4338
YZ250X	16-18	ZC35-4334	ZC35-4338
YZ250FX	15-18	ZC35-4334	ZC35-4338
YZ450FX	16-18	ZC35-4334	ZC35-4338
WR250F	07-18	ZC35-4334	ZC35-4338
WR450F	07-18	ZC35-4334	ZC35-4338
WR250R/X	07-17	ZC35-4332	ZC35-4336

Bike	Year	UPR	LWR
KAWASAKI			
KX85/100	01-18	ZC35-4312	ZC35-4316
KX250F	07-18	ZC35-4334	ZC35-4336
KX450F	07-18	ZC35-4334	ZC35-4338
KLX450R	08-15	ZC35-4334	ZC35-4338
KLX250/ D-TRACKER/X	98-16	ZC35-4332	ZC35-4336
SUZUKI			
RM85	02-17	ZC35-4314	ZC35-4318
RM-Z250	07-18	ZC35-4332	ZC35-4338
RM-Z450	08-18	ZC35-4332	ZC35-4338
RMX450Z	10-15	ZC35-4332	ZC35-4338
250SB	02-06	ZC35-4332	ZC35-4336
DR-Z400SM	04-17	ZC35-4332	ZC35-4336
KTM			
85SX	03-09	ZC35-4314	ZC35-4316
125-450SX/SXF/ EXC/EXCF/XCF/ XCW	08-18	ZC35-4332	ZC35-4338
HUSQVARNA			
FC/FE 250-450	14-18	ZC35-4332	ZC35-4338

Z-CARBON HEAD LIGHT ELIMINATOR

- Carbon head light eliminator to replace stock head light unit for reduced weight.
- Prevents mud from entering the head light shell.
- Designed for use in Enduro racing.

Bike	Year	Part #
CRF250X/450X	07-17	ZC45-1301
125-530EXC/EXC-F/XCF-W/XC-W(Six Days)	08-12	ZC45-1341



Z-CARBON FRONT BRAKE LINE CLAMP

- Universal front brake line guide on your number plate.
- Bolts and nuts included.
- * Holes need to be drilled on your front number plate for installation.

Part number
ZC47-3390

Z-CARBON STICKER



Part number Size
ZC50-0110 100 x 16 mm



Part number Size
ZC50-0120 60 x 36 mm

CONTROL

BARCLAMP

LEVER

FOOT PARTS

HAND GUARD

SUSPENSION

BODY GUARD

BODY

ACCESSORIES

CARBON



Z-CARBON FRAME GUARD

- Carbon frame guards prevent scratches and chipping of your bike.
- Flat surface provides better grip and control.
- Designed specifically for each model.
- Made of aircraft grade dry carbon fiber for light weight and durable construction.

	Bike	Year	Part #
H	CRF250L/M	12-17	ZC35-5106
	CRF250RALLY	17	ZC35-5106
	XR250/Baja/Motard	95-07	ZC35-5105
Y	WR250R/X	07-17	ZC35-5134
	KLX125, D-Tracker125	10-16	ZC35-5112
K	KLX150S	09-13	ZC35-5112
	KLX250, D-Tracker	93-16	ZC35-5115
S	DRZ400S/R/SM	00-17	ZC35-5125



CRF250L



KLX250



Z-CARBON DRIVE COVER

- Light weight durable carbon drive cover.
- Designed to keep mud out of the front sprocket area.

	Bike	Year	Part #
H	CRF250R	04-17	ZC35-3102
	CRF450R	08-16	ZC35-3102
	CRF250X	04-17	ZC35-3102
	XR250/Baja/Motard	95-07	ZC35-3105
Y	YZ250F	01-13	ZC35-3132
	YZ450F	06-13	ZC35-3132
	WR250F	01-14	ZC35-3132
	WR450F	07-15	ZC35-3132
	WR250R/X	07-17	ZC35-3135
	KX250F	04-16	ZC35-3112
K	KX450F	17-18	ZC35-3113
	KLX125, D-Tracker125	09-18	ZC35-3113
	KLX150S	10-16	ZC35-3117
	KLX250, D-Tracker/X	09-13	ZC35-3117
	KLX250, D-Tracker/X	93-16	ZC35-3115
S	RMZ250	04-06	ZC35-3112
	RMZ450	07-18	ZC35-3122
	250SB	05-18	ZC35-3122
	DRZ400S/R/SM	02-06	ZC35-3115
		00-17	ZC35-3125



CRF250R/450R



WR250R/X



Z-CARBON CHAIN COVER

- Carbon chain cover for dual sport bikes.
- Install with OE chain cover bracket on swing arm.
- Light weight protection for your heels from the drive chain and sprocket.

	Bike	Year	Part #
H	XR250/Baja	95-07	ZC35-2206
	Serow250	05-17	ZC35-2206
Y	WR250R/X	07-17	ZC35-2206
	KLX125, D-Tracker125	10-16	ZC35-2217
K	KLX150S	09-13	ZC35-2217
	KLX250, D-Tracker	93-16	ZC35-2215 #
S	250SB	02-06	ZC35-2215
	DR250R	95-	ZC35-2215
	DRZ400S/SM	00-17	ZC35-2225

#Can not be used for the US models.



WR250R/X



KLX125



Z-CARBON CHAIN GUIDE

- Carbon chain guide.
- Lighter than stock aluminum chain guides.

	Bike	Year	Part #
H	CR125R/250R	05-07	ZC35-2102
	CRF150R *	07-18	ZC35-2100
	CRF250R	05-17	ZC35-2102
	CRF450R	05-18	ZC35-2102
	CRF450RX	17-18	ZC35-2102
	CRF250X	06-17	ZC35-2102
	CRF450X	05-17	ZC35-2102
	CRF250L/M	12-17	ZC35-2105
	CRF250RALLY	17	ZC35-2105
	XR250/BAJA/MOTARD *	95-07	ZC35-2105
	YZ125/250	08-18	ZC35-2132
	YZ250F	07-18	ZC35-2132
Y	YZ450F	07-18	ZC35-2132
	YZ125X	17-18	ZC35-2132
	YZ250X	16-18	ZC35-2132
	YZ250FX	15-18	ZC35-2132
	YZ450FX	16-18	ZC35-2132
	WR250F	07-18	ZC35-2132
	WR450F	07-18	ZC35-2132
	WR250R/X	07-17	ZC35-2135
	KX250F/450F	09-18	ZC35-2112
	KLX140	08-14	ZC35-2117
	KLX150S *	09-13	ZC35-2117
	KLX250, D-TRACKER/X *	93-16	ZC35-2115
S	RM125/250	99-08	ZC35-2122
	RMZ250	07-18	ZC35-2122
	RMZ450	05-17	ZC35-2122
	RMX450Z	10-15	ZC35-2122
	250SB *	02-06	ZC35-2115
	DRZ400S/R/SM	00-17	ZC35-2122



WR250R/X



WR250R/X

* It becomes a guide brace attached on the chain guide.

Z-CARBON REAR CALIPER GUARD

- Durable and beautiful light weight carbon rear brake caliper guards.
- Protect rear brake caliper from rocks.

	Bike	Year	Part #
H	CR85R *	03-07	ZC35-0104
	CR125R/250R	02-07	ZC35-0102
	CRF150R	07-18	ZC35-0102
	CRF250R	04-17	ZC35-0102
	CRF450R	02-18	ZC35-0102
	CRF450RX	17-18	ZC35-0102
	CRF250X	04-17	ZC35-0102
	CRF450X	05-17	ZC35-0102
	XR250/Baja/Motard *	95-07	ZC35-0104
	YZ125/250	06-18	ZC35-0133
Y	YZ250F/450F	06-18	ZC35-0133
	YZ125X	17-18	ZC35-0133
	YZ250X	16-18	ZC35-0133
	WR250F/450F	06-18	ZC35-0133
	WR250R/X	07-17	ZC35-0133
	KX250F	04-18	ZC35-0112
	KX450F	06-18	ZC35-0112
	KLX250, D-Tracker	98-16	ZC35-0114
	RM125/250	05-08	ZC35-0122
	RMZ250	04-06	ZC35-0112
S	RMZ450	07-18	ZC35-0122
	RMX450Z	10-15	ZC35-0122
	250SB	02-06	ZC35-0114
	DRZ400SM	04-17	ZC35-0122

* Aluminum bolt is attached.



YZ250F



WR250R/X

Z-CARBON REAR DISC GUARD

- Light weight and durable carbon disc guard.
- Protect your rear disc from rocks and roots.

	Bike	Year	Part #
H	CR125R/250R	02-07	ZC35-1102
	CRF250R	04-17	ZC35-1102
	CRF450R	02-18	ZC35-1102
	CRF450RX	17-18	ZC35-1102
	CRF250X	04-17	ZC35-1102
	CRF450X	05-17	ZC35-1102
	XR250/Baja	95-07	ZC35-1105
	YZ125/250	06-18	ZC35-1132
	YZ250F	06-18	ZC35-1132
	YZ450F	06-18	ZC35-1132
Y	YZ125X	17-18	ZC35-1132
	YZ250X	16-18	ZC35-1132
	WR250F	06-18	ZC35-1132
	WR450F	06-18	ZC35-1132
	WR250R/X	07-17	ZC35-1132
	KX250F	04-18	ZC35-1112
	KX450F	06-18	ZC35-1112
	RM125/250	05-08	ZC35-1122
	RMZ250	04-06	ZC35-1112
	RMZ450	07-18	ZC35-1122
S	RMX450Z	10-15	ZC35-1122
	250SB	02-06	ZC35-1122
	DRZ400SM	00-17	ZC35-1122



YZ250F



DRZ400SM



Red



Blue



Green



Yellow



Orange

STICKER



WHEEL



BRAKE DISC



BRAKE HOSE



Z-WHEEL RIM STICKER KIT 21 inch / 17-19 inch

- Z-Wheel rim sticker kit.
- Available for 21 inch and 17-19 inch wheels. A sheet covers one wheel.
- Available in 5 different colors.

21inch

Part number	Color	Part number	Color
W50-1202	Blue	W50-1205	Yellow
W50-1203	Red	W50-1206	Orange
W50-1204	Green		

17-19inch

Part number	Color	Part number	Color
W50-1302	Blue	W50-1305	Yellow
W50-1303	Red	W50-1306	Orange

Z-WHEEL STICKER



LOGO (Swingarm)

Part number	Size
W50-0120	200 X 31 mm ("7.9 X "1.2)



LOGO

Part number	Size
W50-0110	100 X 16 mm ("3.9 X "0.6)



LOGO

Part number	Size
W50-0115	150 X 22 mm ("5.9 X "0.8)

CORP - LOGO

Part number	Size
W50-0211	110 X 38 mm ("4.3 X "1.5)

ASTELIGHT HUB

Z-WHEEL

ASTELIGHT HUB

- Racing spec hubs for real MX and ED racing.
- Compatible hubs, designed to use with OE spokes, rims and wheel spacers.
- CNC machined from durable forged aluminum.
- Light weight construction yet strong.
- Slant holes on the hubs to keep mud out from the hub body.
- Available in Black, Blue, H-Blue, Yellow, Green, Red and Orange colors.
- # Use OE or ZETA Wheel Spacers (P51) for installation.

BLACK

BLUE

H - BLUE

GREEN

YELLOW

ORANGE

RED

STICKER

WHEEL

BRAKE DISC

BRAKE HOSE

HONDA

FRONT HUB				
Bike	Year	Black	Red	
CR125R	95-07	W41-1111	W41-1113	
CR250R	95-07	W41-1111	W41-1113	
CRF250R	04-17	W41-1111	W41-1113	
CRF450R	02-18	W41-1111	W41-1113	
CRF250X #	04-17	W41-1111	W41-1113	
CRF450X #	05-17	W41-1111	W41-1113	
CRF450RX	17-18	W41-1111	W41-1113	
REAR HUB				
Bike	Year	Black	Red	
CR125R	02-07	W41-1121	W41-1123	
CR250R	00-07	W41-1121	W41-1123	
CRF250R	04-13	W41-1121	W41-1123	
CRF250R 36H #	14-17	W41-1121	W41-1123	
CRF450R	02-12	W41-1121	W41-1123	
CRF450R 36H #	13-17	W41-1121	W41-1123	
CRF250X	04-17	W41-1121	W41-1123	
CRF450X	05-17	W41-1121	W41-1123	
CRF450RX	17-18	W41-1121	W41-1123	
CRF450RX 36H #	17-18	W41-1121	W41-1123	

Meter gear cancel

KAWASAKI

FRONT HUB				
Bike	Year	Black	Green	
KX125	06-08	W41-2111	W41-2114	
KX250	06-08	W41-2111	W41-2114	
KX250F	06-18	W41-2111	W41-2114	
KX450F	06-18	W41-2111	W41-2114	
KLX450R #	08-15	W41-2111	W41-2114	
REAR HUB				
Bike	Year	Black	Green	
KX125	03-08	W41-2121	W41-2124	
KX250	03-08	W41-2121	W41-2124	
KX250F	04-18	W41-2121	W41-2124	
KX450F	06-18	W41-2121	W41-2124	
KLX450R	08-15	W41-2121	W41-2124	

Meter gear cancel

SUZUKI

FRONT HUB				
Bike	Year	Black	Yellow	
RMZ250	07-18	W41-3111	W41-3115	
RMZ450	05-18	W41-3111	W41-3115	
RMX450Z	10-17	W41-3111	W41-3115	
REAR HUB				
Bike	Year	Black	Yellow	
RMZ250	04-06	W41-3121	-	
RMZ450	07-18	W41-3121	W41-3125	
RMZ450	05-18	W41-3121	W41-3125	
RMX450Z	10-17	W41-3121	W41-3125	

HUSABERG

FRONT HUB				
Bike	Year	Black	H-Blue	
TE/FE125-650	08-14	W41-5111	W41-5119	
REAR HUB				
Bike	Year	Black	H-Blue	
TE/FE125-650	08-14	W41-5121	W41-5129	

YAMAHA

FRONT HUB				
Bike	Year	Black	Blue	
YZ125	02-18	W41-4111	W41-4112	
YZ250	02-18	W41-4111	W41-4112	
YZ250F	02-13	W41-4111	W41-4112	
YZ250F	14-18	W41-4112	W41-4112	
YZ426F	02	W41-4111	W41-4112	
YZ450F	03-13	W41-4111	W41-4112	
YZ125X	14-18	W41-4112	W41-4112	
YZ250X	17-18	W41-4111	W41-4112	
YZ250FX	16-18	W41-4111	W41-4112	
YZ450FX	15-18	W41-4112	W41-4112	
YZ450FX	16-18	W41-4112	W41-4112	
WR250F #	02-18	W41-4111	W41-4112	
WR426F #	02	W41-4111	W41-4112	
WR450F #	03-18	W41-4111	W41-4112	
REAR HUB				
Bike	Year	Black	Blue	
YZ125	02-18	W41-4120	W41-4120	
YZ250	02-18	W41-4120	W41-4120	
YZ250F	02-08	W41-4120	W41-4120	
YZ250F	09-18	W41-4121	W41-4121	
YZ426F	02	W41-4120	W41-4120	
YZ450F	03-08	W41-4120	W41-4120	
YZ450F	09-18	W41-4121	W41-4121	
YZ125X	17-18	W41-4120	W41-4120	
YZ250X	16-18	W41-4120	W41-4120	
YZ250FX	15-18	W41-4120	W41-4120	
YZ450FX	16-18	W41-4120	W41-4120	
WR250F	02-18	W41-4120	W41-4120	
WR426F	02	W41-4120	W41-4120	
WR450F	03-18	W41-4120	W41-4120	

Meter gear cancel

KTM

FRONT HUB				
Bike	Year	Black	Orange	
SX/SX-F 125-505	03-18	W41-5111	W41-5117	
XC/XC-F 150-525	08-18	W41-5111	W41-5117	
EXC/EXC-F 125-530	03-18	W41-5111	W41-5117	
XC-W/XCF-W 125-530	08-18	W41-5111	W41-5117	
450SMR	06-14	W41-5111	W41-5117	
REAR HUB				
Bike	Year	Black	Orange	
SX/SX-F 125-505	03-18	W41-5121	W41-5127	
XC/XC-F 150-525	08-18	W41-5121	W41-5127	
EXC/EXC-F 125-530	03-18	W41-5121	W41-5127	
XC-W/XCF-W 125-530	08-18	W41-5121	W41-5127	
450SMR	06-14	W41-5121	W41-5127	

HUSQVARNA

FRONT HUB				
Bike	Year	Black	H-Blue	
TE/FE125-501/S	14-18	W41-5111	W41-5119	
TC/FC125-450	14-18	W41-5111	W41-5119	
TX/FX125-450	17-18	W41-5111	W41-5119	
FS450	15-18	W41-5111	W41-5119	
REAR HUB				
Bike	Year	Black	H-Blue	
TE/FE125-501/S	14-18	W41-5121	W41-5129	
TC/FC125-450	14-18	W41-5121	W41-5129	
TX/FX125-450	17-18	W41-5121	W41-5129	
FS450	15-18	W41-5121	W41-5129	

R50 SERIES

Z-WHEEL

R50 RIM FRONT / REAR



- Real racing specification rim for ED and MX Racers.
- Made of A7050-T6 aluminum with special rim design for durability.
- Durable constructions yet light weight.
- Available wide rim lineup, latest competition bikes to older and dual sport models.
- Rims available for dual sport models, upgrade to high specification rims used by latest MX racing models.
- Available in Black, Silver, Burgundy Red, Prussian Blue and Green.

For the models with OE steel nipples, please replace them with Z-Wheel aluminum nipples.

Replace OE steel nipples with aluminum nipples to make our front and rear wheels weigh 150 g lighter than OE wheels.

One hole each for rim lock and air valve on the rim.

STICKER



WHEEL



BRAKE DISC



BRAKE HOSE



BLACK

SILVER

BURGUNDY RED

PRUSSIAN BLUE

GREEN



R50 SERIES



1 Black 8 Silver 2 Prussian Blue 3 Burgundy Red 4 Green

Color Nipple lineup P66

Z-WHEEL R50 RIM FRONT [HONDA]

Bike	Year	Part.#	Rim Color. No #				Silver Nipple		
			Black	Silver	Red	Green			
CR125R	*1 84-01	W01-9241	#	1	8	3	4	W31-P3368	*2
	02-07	W01-9241	#	1	8	3	4	W31-P3368	*2
CR250R	*1 84-01	W01-9241	#	1	8	3	4	W31-P3368	*2
	02-07	W01-9241	#	1	8	3	4	W31-P3368	*2
CR500R(US)	*1 84-01	W01-9241	#	1	8	3	4	W31-P3368	*2
CRF250R	04-17	W01-9241	#	1	8	3	4	W31-P3368	*2
CRF250X	04-17	W01-9241	#	1	8	3	4	W31-P3368	*2
CRF450R	02-18	W01-9241	#	1	8	3	4	W31-P3368	*2
CRF450RX	17-18	W01-9241	#	1	8	3	4	W31-P3368	*2
CRF450X	05-17	W01-9241	#	1	8	3	4	W31-P3368	*2
CRF230F(US)	*1 03-09	W01-9243	#	1	8			W31-P3368	
CRF250L	*1 12-17	W01-9241	#	1	8	3	4	W31-P3368	*2
CRF250RALLY	*1 17	W01-9241	#	1	8	3	4	W31-P3368	*2
CRM250R/AR	*1 89-98	W01-9243	#	1	8			W31-P3368	
SL230	*1 97-01	W01-9243	#	1	8			W31-P3368	
XL250 Degree	*1 91-95	W01-9243	#	1	8			W31-P3368	
XLR125R	*1 93-94	W01-9243	#	1	8			W31-P3368	
XLR200R	*1 93	W01-9243	#	1	8			W31-P3368	
XLR250R/BAJA	*1 88-94	W01-9243	#	1	8			W31-P3368	
XR230	*1 05-13	W01-9243	#	1	8			W31-P3368	
XR250L(USA)	*1 91-96	W01-9243	#	1	8			W31-P3368	
XR250R(USA)	*1 84-89	W01-9241	#	1	8	3	4	W31-P3368	*2
XR250S/BAJA	*1 90-04	W01-9243	#	1	8			W31-P3368	*2
XR250S(US)	*1 95-07	W01-9243	#	1	8			W31-P3368	
XR350R(US)	*1 84-85	W01-9241	#	1	8	3	4	W31-P3368	*2
XR400R(US)	*1 96-04	W01-9241	#	1	8	3	4	W31-P3368	*2
XR500R(US)	*1 83-84	W01-9241	#	1	8	3	4	W31-P3368	*2
XR600R(US)	*1 85-87	W01-9241	#	1	8	3	4	W31-P3368	*2
XR650R(US)	*1 88-00	W01-9243	#	1	8			W31-P3368	
XR650R(US)	*1 00-07	W01-9243	#	1	8			W31-P3368	

Z-WHEEL R50 RIM REAR [HONDA]

Bike	Year	Part.#	Rim Color. No #					Silver Nipple	
			Black	Silver	Blue	Red	Green		
CR125R	95-96	W01-7331	#	1	8			3	W31-Q6328
	*1 97-01	W01-7331	#	1	8			3	W31-Q6328
	02-07	W01-7331	#	1	8			3	W31-Q6328
CR125R(Wide)	*1 87-88	W01-6441	#	1	8	2	3	4	W31-Q4368
	*1 89-93	W01-6431	#	1	8			3	W31-Q4328
CR250R	94	W01-6431	#	1	8			3	W31-Q6328
	*1 87-88	W01-6441	#	1	8	2	3	4	W31-Q4368
	*1 89-94	W01-6431	#	1	8			3	W31-Q4328
	95-96	W01-7431	#	1	8			3	W31-Q6328
	*1 97-01	W01-7431	#	1	8			3	W31-Q6328
	02-07	W01-7431	#	1	8			3	W31-Q6328
CR500R	*1 87-88	W01-6441	#	1	8	2	3	4	W31-Q4368
	89-01	W01-6431	#	1	8			3	W31-Q4328
CRF250R	04-17	W01-7331	#	1	8			3	W31-Q6328
CRF250R 36H	14-17	W01-7341	#	1	8			3	W31-Q6368
CRF250X	04-17	W01-6431	#	1	8			3	W31-Q6328
CRF450R	02-18	W01-7431	#	1	8			3	W31-Q6328
CRF450R 36H	13-18	W01-7441	#	1	8			3	W31-Q6368
CRF450RX	17-18	W01-6431	#	1	8			3	W31-Q6328
CRF450RX 36H	17-18	W01-6441	#	1	8			3	W31-Q6368
CRF450X	05-17	W01-6431	#	1	8			3	W31-Q6328
CRF250L	*1 12-17	W01-6431	#	1	8			3	W31-P2328
CRF250RALLY	*1 17	W01-6431	#	1	8			3	W31-P2328
CRM250R/AR	*1 89-98	W01-6432	#	1	8				W31-P2328
XR230	*1 05-13	W01-6432	#	1	8				W31-P2328
XR250R(US)	*1 90-04	W01-6432	#	1	8				W31-P2328
XR250S/BAJA	*1 95-07	W01-6432	#	1	8				W31-P2328
XR400R(US)	*1 96-04	W01-6432	#	1	8				W31-P3328
XR600R(US)	*1 91-00	W01-6432	#	1	8				W31-P3328
XR650R(US)	*1 00-07	W01-6432	#	1	8				W31-P3328

#Add rim color number to complete number for ordering.
*1 Z-WHEEL aluminum nipple set is required for installation.
*2 Color nipple available

Z-WHEEL R50 RIM FRONT [YAMAHA]

Bike	Year	Part.#	Rim Color. No #				Silver Nipple		
			Black	Silver	Red	Green			
YZ125	86-18	W01-9241	#	1	8	3	4	W31-P3368	*2
YZ250	86-18	W01-9241	#	1	8	3	4	W31-P3368	*2
YZ250F	01-18	W01-9241	#	1	8	3	4	W31-P3368	*2
YZ250WR	89-90	W01-9241	#	1	8	3	4	W31-P3368	*2
YZ400F	98-99	W01-9241	#	1	8	3	4	W31-P3368	*2
YZ426F	00-02	W01-9241	#	1	8	3	4	W31-P3368	*2
YZ450F	03-18	W01-9241	#	1	8	3	4	W31-P3368	*2
YZ125X	17-18	W01-9241	#	1	8	3	4	W31-P3368	*2
YZ250X	16-18	W01-9241	#	1	8	3	4	W31-P3368	*2
YZ250FX	15-18	W01-9241	#	1	8	3	4	W31-P3368	*2
YZ450FX	16-18	W01-9241	#	1	8	3	4	W31-P3368	*2
YZ490	89	W01-9241	#	1	8	3	4	W31-P3368	*2
DT125R	*1 85-97	W01-9241	#	1	8	3	4	W31-P2368	
DT200R	*1 84-90	W01-9241	#	1	8	3	4	W31-P2368	
DT200WR	*1 91-94	W01-9241	#	1	8	3	4	W31-P3368	*2
DT230 Lanza	*1 97-98	W01-9241	#	1	8	3	4	W31-P3368	*2
IT200(US)	*1 86	W01-9241	#	1	8	3	4	W31-P3368	*2
SEROW225	*1 85-04	W01-9241	#	1	8	3	4	W31-P2368	
SEROW250	*1 05-17	W01-9241	#	1	8	3	4	W31-P2368	
TT225(US)	*1 86-87	W01-9241	#	1	8	3	4	W31-P2368	
TT350(US)	*1 86-87	W01-9241	#	1	8	3	4	W31-P3368	*2
TT600(US)	*1 85-86	W01-9241	#	1	8	3	4	W31-P3368	*2
TTR230(US)	*1 05-12	W01-9241	#	1	8	3	4	W31-P2368	
TTR250/RAID	*1 93-97	W01-9241	#	1	8	3	4	W31-P3368	*2
TTR250(US)	*1 99-06	W01-9241	#	1	8	3	4	W31-P3368	*2
WR200R(US)	*1 92	W01-9241	#	1	8	3	4	W31-P3368	*2
WR250F	01-18	W01-9241	#	1	8	3	4	W31-P3368	*2
WR250R	*1 07-17	W01-9241	#	1	8	3	4	W31-P3368	*2
WR250Z	91-98	W01-9241	#	1	8	3	4	W31-P3368	*2
WR400F	98-00	W01-9241	#	1	8	3	4	W31-P3368	*2
WR426F	01-02	W01-9241	#	1	8	3	4	W31-P3368	*2
WR450F	03-18	W01-9241	#	1	8	3	4	W31-P3368	*2
WR500Z	92-93	W01-9241	#	1	8	3	4	W31-P3368	*2
XT225 Serow(US)	*1 92-07	W01-9241	#	1	8	3	4	W31-P2368	
XT250(US)	*1 08-12	W01-9241	#	1	8	3	4	W31-P2368	
XT250T	*1 85	W01-9241	#	1	8	3	4	W31-P2368	
XT350(US)	*1 85-00	W01-9241	#	1	8	3	4	W31-P2368	

Z-WHEEL R50 RIM REAR [YAMAHA]

Bike	Year	Part.#	Rim Color. No #					Silver Nipple	
			Black	Silver	Blue	Red	Green		
YZ125	*1 89-98	W01-7341	#	1	8	2	3	4	W31-Q4368
	*1 99-18	W01-7341	#	1	8	2	3	4	W31-Q4368
YZ125(Wide)	*1 88	W01-6441	#	1	8	2	3	4	W31-Q4368
	*1 88	W01-6441	#	1	8	2	3	4	W31-Q4368
YZ250	*1 89-98	W01-7441	#	1	8	2	3	4	W31-Q4368
	99-18	W01-7441	#	1	8	2	3	4	W31-Q4368
YZ250F	01-18	W01-7341	#	1	8	2	3	4	W31-Q4368
YZ250WR	*1 89	W01-7441	#	1	8	2	3	4	W31-Q4368
YZ250WR(US)	*1 90	W01-6441	#	1	8	2	3	4	W31-Q4368
YZ400F	*1 98	W01-7441	#	1	8	2	3	4	W31-Q4368
	99	W01-7441	#	1	8	2	3	4	W31-Q4368
YZ426F	00-02	W01-7441	#	1	8	2	3	4	W31-Q4368
YZ450F	03-18	W01-7441	#	1	8	2	3	4	W31-Q4368
YZ125X	17-18	W01-6441	#	1	8	2	3	4	W31-Q4368
YZ250X	16-18	W01-6441	#	1	8	2	3	4	W31-Q4368
YZ250FX	15-18	W01-6441	#	1	8	2	3	4	W31-Q4368
YZ450FX	16-18	W01-6441	#	1	8	2	3	4	W31-Q4368
DT200R	*1 88-90	W01-6441							

Z-WHEEL
R50 RIM FRONT [KAWASAKI]

Bike	Year	Part #	Rim color No #				Silver Nipple		
			Black	Silver	Red	Green			
KX125	*1 82-83	W01-9241	#	1	8	3	4	W31-P3368	*2
	*1 90-98	W01-9241	#	1	8	3	4	W31-P3368	*2
	*1 99-05	W01-9241	#	1	8	3	4	W31-P4368	*2
KX250	*1 06-08	W01-9241	#	1	8	3	4	W31-P3368	*2
	*1 82-83	W01-9241	#	1	8	3	4	W31-P3368	*2
	*1 90-98	W01-9241	#	1	8	3	4	W31-P3368	*2
KX250F	*1 05-08	W01-9241	#	1	8	3	4	W31-P3368	*2
	*1 04-18	W01-9241	#	1	8	3	4	W31-P3368	*2
	*1 06-18	W01-9241	#	1	8	3	4	W31-P3368	*2
Super Sherpa	*1 97-07	W01-9241	#	1	8	3	4	W31-P3368	*2
Super Sherpa(US)	*1 00-09	W01-9241	#	1	8	3	4	W31-P3368	*2
KX500(US)	*1 83-04	W01-9241	#	1	8	3	4	W31-P3368	*2
KDX200(US)	*1 86-06	W01-9241	#	1	8	3	4	W31-P3368	*2
KDX200R	*1 89-90	W01-9241	#	1	8	3	4	W31-P3368	*2
KDX200SR	*1 89-93	W01-9241	#	1	8	3	4	W31-P3368	*2
KDX220R	*1 94-05	W01-9241	#	1	8	3	4	W31-P3368	*2
KDX220SR	*1 94-99	W01-9241	#	1	8	3	4	W31-P3368	*2
KDX250(US)	*1 91-94	W01-9241	#	1	8	3	4	W31-P3368	*2
KDX250R	*1 91-94	W01-9241	#	1	8	3	4	W31-P3368	*2
KDX250SR	*1 91-94	W01-9241	#	1	8	3	4	W31-P3368	*2
KLX250	*1 98-16	W01-9241	#	1	8	3	4	W31-P4368	*2
KLX250ES	*1 94-97	W01-9241	#	1	8	3	4	W31-P4368	*2
KLX250R	*1 93-95	W01-9241	#	1	8	3	4	W31-P3368	*2
KLX250S(US)	*1 06-16	W01-9241	#	1	8	3	4	W31-P4368	*2
KLX250SR	*1 93-94	W01-9241	#	1	8	3	4	W31-P3368	*2
KLX300R	*1 95-97	W01-9241	#	1	8	3	4	W31-P4368	*2
KLX450R	*1 96-07	W01-9241	#	1	8	3	4	W31-P3368	*2
KLX650R(US)	*1 08-15	W01-9241	#	1	8	3	4	W31-P3368	*2
KLX650SR(US)	*1 93-96	W01-9241	#	1	8	3	4	W31-P3368	*2

#Add rim color number to complete number for ordering.
*1 Z-WHEEL aluminum nipple set is required for installation.
*2 Color nipple available

Z-WHEEL
R50 RIM REAR [KAWASAKI]

Bike	Year	Part #	Rim color No #					Silver Nipple		
			Black	Silver	Blue	Red	Green			
KX125	03-08	W01-7341	#	1	8	2	3	4	W31-Q4368	*2
KX125(Wide)	*1 86-87	W01-6441	#	1	8	2	3	4	W31-Q3368	*2
	*1 88	W01-6441	#	1	8	2	3	4	W31-Q4368	*2
KX250	*1 86-87	W01-6441	#	1	8	2	3	4	W31-Q3368	*2
	*1 88	W01-6441	#	1	8	2	3	4	W31-Q4368	*2
KX250F	03-08	W01-7441	#	1	8	2	3	4	W31-Q4368	*2
	04-18	W01-7341	#	1	8	2	3	4	W31-Q4368	*2
KX500(US)	06-18	W01-7441	#	1	8	2	3	4	W31-Q4368	*2
	*1 86-87	W01-6441	#	1	8	2	3	4	W31-Q3368	*2
Super Sherpa	*1 97-07	W01-6441	#	1	8	2	3	4	W31-Q3368	*2
Super Sherpa(US)	*1 00-09	W01-6441	#	1	8	2	3	4	W31-Q3368	*2
KDX200(US)	*1 95-06	W01-6443	#	1	8			4	W31-Q3368	*2
KDX220R	*1 94-05	W01-6443	#	1	8			4	W31-Q3368	*2
KDX220SR	*1 94-99	W01-6443	#	1	8			4	W31-Q3368	*2
KDX250(US)	*1 91-94	W01-6443	#	1	8			4	W31-Q4368	*2
KDX250R	*1 91-94	W01-6443	#	1	8			4	W31-Q4368	*2
KLX250SR	*1 91	W01-6443	#	1	8			4	W31-Q3368	*2
	*1 92-94	W01-6443	#	1	8			4	W31-Q3368	*2
KLX250	*1 98-07	W01-6443	#	1	8			4	W31-Q3368	*2
	*1 08-16	W01-6443	#	1	8			4	W31-Q4368	*2
KLX250ES	*1 94-97	W01-6443	#	1	8			4	W31-Q3368	*2
KLX250R	*1 93-95	W01-6443	#	1	8			4	W31-Q3368	*2
KLX250R(US)	*1 94-96	W01-6443	#	1	8			4	W31-Q3368	*2
KLX250S(US)	*1 06-08	W01-6443	#	1	8			4	W31-Q3368	*2
KLX250SR	*1 09-16	W01-6443	#	1	8			4	W31-Q4368	*2
	*1 93-97	W01-6443	#	1	8			4	W31-Q3368	*2
KLX300R	*1 96-07	W01-6443	#	1	8			4	W31-Q3368	*2
KLX450R	*1 08-15	W01-6441	#	1	8	2	3	4	W31-Q4368	*2
KLX650R(US)	*1 93	W01-6443	#	1	8			4	W31-Q4368	*2

Z-WHEEL
R50 RIM FRONT [SUZUKI]

Bike	Year	Part #	Rim color No #				Silver Nipple		
			Black	Silver	Red	Green			
RM125	86-08	W01-9241	#	1	8	3	4	W31-P3368	*2
RM250	86-08	W01-9241	#	1	8	3	4	W31-P3368	*2
RMZ250	04-18	W01-9241	#	1	8	3	4	W31-P3368	*2
RMZ450	05-18	W01-9241	#	1	8	3	4	W31-P3368	*2
RMX250(US)	89-98	W01-9241	#	1	8	3	4	W31-P3368	*2
RMX250R	93-98	W01-9241	#	1	8	3	4	W31-P3368	*2
RMX250S	*1 92-98	W01-9241	#	1	8	3	4	W31-P3368	*2
RMX450Z	10-17	W01-9241	#	1	8	3	4	W31-P3368	*2
SP200(US)	*1 86-88	W01-9241	#	1	8	3	4	W31-P3368	*2
SP250(US)	*1 85	W01-9241	#	1	8	3	4	W31-P3368	*2
SX125R	*1 85-91	W01-9241	#	1	8	3	4	W31-P3368	*2
SX200R	*1 85-91	W01-9241	#	1	8	3	4	W31-P3368	*2
TS125R	*1 89-97	W01-9241	#	1	8	3	4	W31-P3368	*2
TS200R	*1 89-96	W01-9241	#	1	8	3	4	W31-P3368	*2
DF200E	*1 97	W01-9241	#	1	8	3	4	W31-P3368	*2
DR125	*1 86-88	W01-9241	#	1	8	3	4	W31-P2368	*2
DR125SE	*1 93-99	W01-9241	#	1	8	3	4	W31-P2368	*2
DR200	*1 86-87	W01-9241	#	1	8	3	4	W31-P2368	*2
DR200SE	*1 93-09	W01-9241	#	1	8	3	4	W31-P2368	*2
DR250	*1 85	W01-9241	#	1	8	3	4	W31-P3368	*2
DR250R	95-00	W01-9241	#	1	8	3	4	W31-P3368	*2
DR250RX	96-00	W01-9241	#	1	8	3	4	W31-P3368	*2
DR250S	*1 90-93	W01-9241	#	1	8	3	4	W31-P3368	*2
DR250SES	*1 90-95	W01-9241	#	1	8	3	4	W31-P3368	*2
DR350SE	*1 90-99	W01-9241	#	1	8	3	4	W31-P3368	*2
DRZ250(US)	01-07	W01-9241	#	1	8	3	4	W31-P3368	*2
DRZ400(US)	00-04	W01-9241	#	1	8	3	4	W31-P3368	*2
DRZ400E	00-07	W01-9241	#	1	8	3	4	W31-P3368	*2
DRZ400S(US)	00-17	W01-9241	#	1	8	3	4	W31-P3368	*2
RA125	*1 84-88	W01-9241	#	1	8	3	4	W31-P2368	*2
RH250	*1 84-88	W01-9241	#	1	8	3	4	W31-P3368	*2

Z-WHEEL
R50 RIM FRONT [HUSQVARNA]

Bike	Year	Part #	Rim color No #				Silver Nipple		
			Black	Silver	Red	Green			
TC/FC 125-450	14-18	W01-9241	#	1	8	3	4	W31-P5368	
TE/FE 250-501	14-18	W01-9241	#	1	8	3	4	W31-P5368	
TX/FX125-450	17-18	W01-9241	#	1	8	3	4	W31-P5368	

#Add rim color number to complete number for ordering.

Z-WHEEL
R50 RIM REAR [SUZUKI]

Bike	Year	Part #	Rim color No #					Silver Nipple		
			Black	Silver	Blue	Red	Green			
RM125	90-06	W01-7341	#	1	8	2	3	4	W31-Q4368	*2
	07-08	W01-7341	#	1	8	2	3	4	W31-Q6368	*2
RM250	90-06	W01-7441	#	1	8	2	3	4	W31-Q4368	*2
	07-08	W01-7441	#	1	8	2	3	4	W31-Q6368	*2
RMZ250	04-06	W01-7341	#	1	8	2	3	4	W31-Q4368	*2
	07-18	W01-7341	#	1	8	2	3	4	W31-Q6368	*2
RMZ450	05	W01-7441	#	1	8	2	3	4	W31-Q4368	*2
	06-18	W01-7441	#	1	8	2	3	4	W31-Q6368	*2
RMX250(US)	89-98	W01-6441	#	1	8	2	3	4	W31-Q4368	*2
RMX250R	89-98	W01-6441	#	1	8	2	3	4	W31-Q4368	*2
RMX250S	*1 92-98	W01-6441	#	1	8	2	3	4	W31-Q3368	*2
RMX450Z	10-17	W01-6441	#	1	8	2	3	4	W31-Q6368	*2
TS125R	*1 89-97	W01-6441	#	1	8	2	3	4	W31-Q3368	*2
TS200R	*1 89-96	W01-6441	#	1	8	2	3	4	W31-Q3368	*2
DR250R	95-00	W01-6441	#	1	8	2	3	4	W31-Q4368	*2
DR250RX	96-00	W01-6441	#	1	8	2	3	4	W31-Q3368	*2
DR350SE	*1 96-99	W01-6441	#	1	8	2	3	4	W31-Q3368	*2

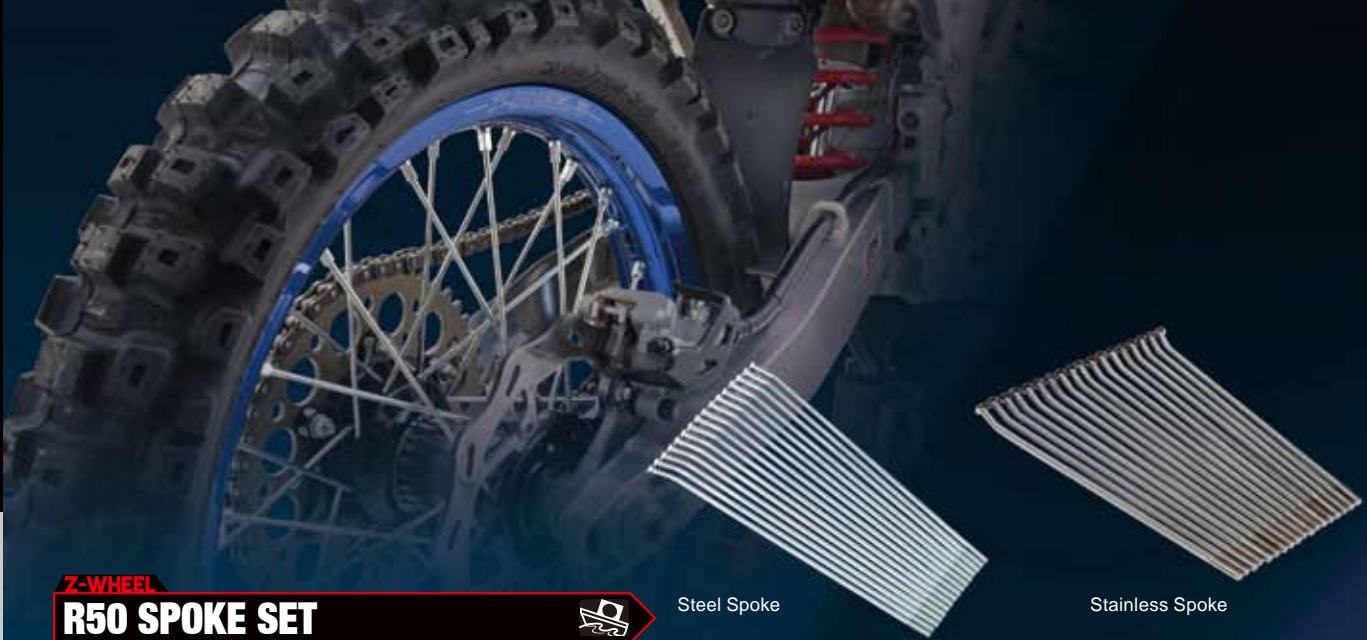

Z-WHEEL

R50 SPOKE SET



Steel Spoke

Stainless Spoke

- Spoke set designed for Z-wheel rims.

HONDA FRONT

Bike	Year	Steel Spoke	Nipple	SUS Spoke	Nipple	#2		
CR125R	84-87	-	-	W10-21110	W31-P3368	#2		
	88-91	-	-	W10-21112	W31-P3368	#2		
	92-94	-	-	W10-21114	W31-P3368	#2		
	95-07	W10-11140	W31-P3368	#2	W10-21140	W31-P3368	#2	
CR250R	84-87	-	-	W10-21110	W31-P3368	#2		
	88-91	-	-	W10-21112	W31-P3368	#2		
	92-94	-	-	W10-21114	W31-P3368	#2		
	95-07	W10-11140	W31-P3368	#2	W10-21140	W31-P3368	#2	
CR500R(USA)	84-87	-	-	W10-21110	W31-P3368	#2		
	88-91	-	-	W10-21112	W31-P3368	#2		
	92-94	-	-	W10-21114	W31-P3368	#2		
	95-01	W10-11140	W31-P3368	#2	W10-21140	W31-P3368	#2	
CRF250R	04-17	W10-11140	W31-P3368	#2	W10-21140	W31-P3368	#2	
	CRF250X	04-17	W10-11140	W31-P3368	#2	W10-21140	W31-P3368	#2
	CRF450R	02-18	W10-11140	W31-P3368	#2	W10-21140	W31-P3368	#2
	CRF450X	05-17	W10-11140	W31-P3368	#2	W10-21140	W31-P3368	#2
CRF450RX	17-18	W10-11140	W31-P3368	#2	W10-21140	W31-P3368	#2	
	CRF230F(US)	03-09	-	-	W10-21260	W31-P2368	-	
	CRF250L	12-17	W10-11340	W31-P2368	W10-21340	W31-P3368	#2	
	CRF250RALLY	17	W10-11340	W31-P2368	W10-21340	W31-P3368	#2	
CRM250R/AR	89-98	W10-11319	W31-P2368	W10-21320	W31-P3368	#2		
	SL230	97-04	W10-11319	W31-P2368	W10-21320	W31-P3368	#2	
	XL250 Degree	91-95	W10-11319	W31-P2368	W10-21320	W31-P3368	#2	
	XR125R	93-96	W10-11319	W31-P2368	W10-21320	W31-P3368	#2	
XR200R	93-94	W10-11319	W31-P2368	W10-21320	W31-P3368	#2		
	88-94	W10-11319	W31-P2368	W10-21320	W31-P3368	#2		
	XR230	05-12	W10-11319	W31-P2368	W10-21320	W31-P3368	#2	
	XR250L(US)	92-96	W10-11319	W31-P2368	W10-21320	W31-P3368	#2	
XR250R(US)	84-89	-	-	W10-21240	W31-P3368	#2		
	90-04	W10-11320	W31-P3368	#2	W10-21320	W31-P3368	#2	
	XR250S/BAJA	95-07	W10-11319	W31-P2368	W10-21320	W31-P3368	#2	
	XR350R(US)	84-85	-	-	W10-21240	W31-P3368	#2	
XR400R(US)	96-04	W10-11320	W31-P3368	#2	W10-21320	W31-P3368	#2	
	XR500R(US)	83-84	-	-	W10-21240	W31-P3368	#2	
	85-87	-	-	W10-21240	W31-P3368	#2		
	XR600R(US)	88-00	W10-11320	W31-P3368	#2	W10-21320	W31-P3368	#2
XR650R(US)	00-07	W10-11320	W31-P3368	#2	W10-21320	W31-P3368	#2	

HONDA REAR

Bike	Year	Steel Spoke	Nipple	SUS Spoke	Nipple	#2		
CR125R	95-01	-	-	W10-21518	W31-Q4328	#2		
	02-07	W10-11540	W31-Q4328	#2	W10-21540	W31-Q4328	#2	
	87-88	-	-	W10-21510	W31-Q4328	#2		
	89	-	-	W10-21512	W31-Q4328	#2		
CR125R(Wide)	90-91	-	-	W10-21514	W31-Q4328	#2		
	92-93	-	-	W10-21516	W31-Q4328	#2		
	94	-	-	W10-21516	W31-Q4328	#2		
	87-88	-	-	W10-21510	W31-Q4328	#2		
CR250R	89	-	-	W10-21512	W31-Q4328	#2		
	90-91	-	-	W10-21514	W31-Q4328	#2		
	92-94	-	-	W10-21516	W31-Q4328	#2		
	95-01	-	-	W10-21518	W31-Q4328	#2		
CR500R	02-07	W10-11540	W31-Q4328	#2	W10-21540	W31-Q4328	#2	
	87	-	-	W10-21510	W31-Q4328	#2		
	88	-	-	W10-21511	W31-Q4328	#2		
	91	-	-	W10-21514	W31-Q4328	#2		
CRF250R	92-01	-	-	W10-21516	W31-Q4328	#2		
	04-17	W10-11540	W31-Q4328	#2	W10-21540	W31-Q4328	#2	
	CRF250R 36H	14-17	W10-11541	W31-Q4368	#2	W10-21541	W31-Q4368	#2
	CRF250X	04-17	W10-11610	W31-Q4328	#2	W10-21610	W31-Q4328	#2
CRF450R	02-18	W10-11540	W31-Q4328	#2	W10-21540	W31-Q4328	#2	
	CRF450R 36H	13-18	W10-11541	W31-Q4368	#2	W10-21541	W31-Q4368	#2
	CRF450X	05-17	W10-11610	W31-Q4328	#2	W10-21610	W31-Q4328	#2
	CRF450RX	17-18	W10-11610	W31-Q4328	#2	W10-21610	W31-Q4328	#2
CRF450RX 36H	17-18	W10-11611	W31-Q4368	#2	W10-21611	W31-Q4368	#2	
	CRF250L	12-17	W10-11740	W31-P2328	W10-21740	W31-P3328	#2	
	CRF250RALLY	17	W10-11740	W31-P2328	W10-21740	W31-P3328	#2	
	CRM250R/AR	89-98	W10-11719	W31-P2328	W10-21720	W31-P3328	#2	
XR230	05-12	W10-11719	W31-P2328	W10-21720	W31-P3328	#2		
	XR250R(US)	90-04	W10-11719	W31-P2328	W10-21720	W31-P3328	#2	
	XR250S/BAJA	95-07	W10-11719	W31-P2328	W10-21720	W31-P3328	#2	
	XR400R(US)	96-06	W10-11720	W31-P3328	W10-21720	W31-P3328	#2	
XR600R(US)	91-00	W10-11720	W31-P3328	W10-21720	W31-P3328	#2		
	XR650R(US)	00-07	W10-11720	W31-P3328	W10-21720	W31-P3328	#2	
	XR650L	93-12	W10-11720	W31-P3328	W10-21720	W31-P3328	#2	

YAMAHA FRONT

Bike	Year	Steel Spoke	Nipple	SUS Spoke	Nipple	#2		
YZ125	86-91	-	-	W10-27110	W31-P3336	#2		
	92-18	W10-15140	W31-P3336	#2	W10-25140	W31-P3336	#2	
	86-91	-	-	W10-27110	W31-P3336	#2		
YZ250	92-18	W10-15140	W31-P3336	#2	W10-25140	W31-P3336	#2	
	01-18	W10-15140	W31-P3336	#2	W10-25140	W31-P3336	#2	
	89-90	-	-	W10-27110	W31-P3336	#2		
YZ250F	98-99	W10-15140	W31-P3336	#2	W10-25140	W31-P3336	#2	
	YZ400F	00-02	W10-15140	W31-P3336	#2	W10-25140	W31-P3336	#2
	YZ426F	03-18	W10-15140	W31-P3336	#2	W10-25140	W31-P3336	#2
	YZ450F	15-18	W10-15140	W31-P3336	#2	W10-25140	W31-P3336	#2
YZ250FX	16-18	W10-15140	W31-P3336	#2	W10-25140	W31-P3336	#2	
	YZ125X	17-18	W10-15140	W31-P3336	#2	W10-25140	W31-P3336	#2
	YZ250X	16-18	W10-15140	W31-P3336	#2	W10-25140	W31-P3336	#2
	YZ490	89-90	-	-	W10-27110	W31-P3336	#2	
DT125R	85-87	-	-	W10-27320	W31-P2336	#2		
	88-98	-	-	W10-27360	W31-P2336	#2		
	84-87	-	-	W10-27320	W31-P2336	#2		
	88-90	-	-	W10-27360	W31-P2336	#2		
DT200R	91-94	-	-	W10-27321	W31-P3336	#2		
	DT200WR	97-98	W10-11140	W31-P3336	#2	W10-21140	W31-P3336	#2
	IT200(US)	86	-	-	W10-27321	W31-P3336	#2	
	SEROW225	85-04	-	-	W10-27360	W31-P3336	#2	
SEROW250	05-16	-	-	W10-27360	W31-P3336	#2		
	TT225(US)	86-87	-	-	W10-27360	W31-P3336	#2	
	TT250	86-87	-	-	W10-27321	W31-P3336	#2	
	TT350(US)	86-87	-	-	W10-27321	W31-P3336	#2	
TT600(US)	85-86	-	-	W10-27321	W31-P3336	#2		
	05-07	-	-	W10-27320	W31-P3336	#2		
	08-12	-	-	W10-27360	W31-P3336	#2		
	TTR230(US)	03-97	W10-11140	W31-P3336	#2	W10-21140	W31-P3336	#2
TTR250/RAID	TTR250(US)	99-06	W10-11140	W31-P3336	#2	W10-21140	W31-P3336	#2
	WR200R(US)	92	-	-	W10-27321	W31-P3336	#2	
	WR250F	01-18	W10-15140	W31-P3336	#2	W10-25140	W31-P3336	#2
	WR250R	07-17	W10-17340	W31-P3336	#2	W10-27340	W31-P3336	#2
WR250Z	91	-	-	W10-27110	W31-P3336	#2		
	92-98	W10-15140	W31-P3336	#2	W10-25140	W31-P3336	#2	
	98-00	W10-15140	W31-P3336	#2	W10-25140	W31-P3336	#2	
	WR426F	01-02	W10-15140	W31-P3336	#2	W10-25140	W31-P3336	#2
WR450F	03-18	W10-15140	W31-P3336	#2	W10-25140	W31-P3336	#2	
	WR500Z	92-93	-	-	W10-27110	W31-P3336	#2	
	XT225	92-07	-	-	W10-27360	W31-P3336	#2	
	SEROW(US)	08-16	-	-	W10-27360	W31-P3336	#2	
XT250(US)	85	-	-	W10-27360	W31-P3336	#2		
	XT250T	85	-	-	W10-27360	W31-P3336	#2	
	XT350(US)	85-00	-	-	W10-27360	W31-P3336	#2	

YAMAHA REAR

Bike	Year	Steel Spoke	Nipple	SUS Spoke	Nipple	#2		
YZ125	89-98	-	-	W10-27510	W31-Q4368	#2		
	99-18	W10-17512	W31-Q4368	#2	W10-27512	W31-Q4368	#2	
	88	-	-	W10-27721	W31-Q4368	#2		
YZ250	88	-	-	W10-27710	W31-Q4368	#2		
	89-98	-	-	W10-27510	W31-Q4368	#2		
	99-18	W10-17512	W31-Q4368	#2	W10-27512	W31-Q4368	#2	
	01-08	W10-17512	W31-Q4368	#2	W10-27512	W31-Q4368	#2	
YZ250F	09-18	W10-17540	W31-Q4368	#2	W10-27540	W31-Q4368	#2	
	89	-	-	W10-27510	W31-Q4368	#2		
	90	-	-	W10-27721	W31-Q4368	#2		
	98	-	-	W10-27510	W31-Q4368	#2		
YZ400F	99	W10-17512	W31-Q4368	#2	W10-27512	W31-Q4368	#2	
	YZ426F	00-02	W10-17512	W31-Q4368	#2	W10-27512	W31-Q4368	#2
	YZ450F	03-08	W10-17512	W31-Q4368	#2	W10-27512	W31-Q4368	#2
	09-18	W10-17540	W31-Q4368	#2	W10-27540	W31-Q4368	#2	
YZ250FX	15-18	W10-17610	W31-Q4368	#2	W10-27610	W31-Q4368	#2	
	YZ450FX	16-18	W10-17610	W31-Q4368	#2	W10-27610	W31-Q4368	#2
	YZ125X	17-18	W10-17610	W31-Q4368	#2	W10-27610	W31-Q4368	#2
	YZ250X	16-18	W10-17610	W31-Q4368	#2	W10-27610	W31-Q4368	#2
DT125R	91-98	-	-	W10-27720	W31-Q3368	#2		
	DT200R	88-90	-	-	W10-27720	W31-Q3368	#2	
	DT200WR	91-94	-	-	W10-27721	W31-Q4368	#2	
	DT230LANZA	97-98	-	-	W10-27722	W31-Q4368	#2	
TTR250/RAID	TTR250(US)	93-97	-	-	W10-27721	W31-Q4368	#2	
	92	-	-	W10-27721	W31-Q4368	#2		
	WR250F	01-18	W10-17610	W31-Q4368	#2	W10-27610	W31-Q4368	#2
	WR250R</							

KAWASAKI FRONT

Bike	Year	Steel Spoke	Nipple	SUS Spoke	Nipple
KX125	82	-	-	W10-23110	W31-P3368 #2
	83	-	-	W10-23112	W31-P3368 #2
	84	-	-	W10-23115	W31-P3368 #2
	85	-	-	W10-23118	W31-P3368 #2
	86-88	-	-	W10-23121	W31-P3368 #2
	89-98	-	-	W10-23123	W31-P3368 #2
	99-05	-	-	W10-23125	W31-P3368 #2
	06-08	W10-19110	W31-P3368 #2	W10-29110	W31-P3368 #2
	82	-	-	W10-23110	W31-P3368 #2
	83	-	-	W10-23112	W31-P3368 #2
KX250	84	-	-	W10-23115	W31-P3368 #2
	85	-	-	W10-23118	W31-P3368 #2
	86-88	-	-	W10-23121	W31-P3368 #2
	89-98	-	-	W10-23123	W31-P3368 #2
	99-04	-	-	W10-23125	W31-P3368 #2
	05	-	-	W10-23140	W31-P3368 #2
	06-08	W10-19110	W31-P3368 #2	W10-29110	W31-P3368 #2
	82	-	-	W10-23110	W31-P3368 #2
	83	-	-	W10-23112	W31-P3368 #2
	84	-	-	W10-23115	W31-P3368 #2
KX250F	85	-	-	W10-23118	W31-P3368 #2
	86-88	-	-	W10-23121	W31-P3368 #2
	89-98	-	-	W10-23123	W31-P3368 #2
	99-04	-	-	W10-23125	W31-P3368 #2
	05	-	-	W10-23140	W31-P3368 #2
	06-08	W10-19110	W31-P3368 #2	W10-29110	W31-P3368 #2
	82	-	-	W10-23110	W31-P3368 #2
	83	-	-	W10-23112	W31-P3368 #2
	84	-	-	W10-23115	W31-P3368 #2
	85	-	-	W10-23118	W31-P3368 #2
KX450F	86-88	-	-	W10-23121	W31-P3368 #2
	89-98	-	-	W10-23123	W31-P3368 #2
	99-04	-	-	W10-23125	W31-P3368 #2
	05	-	-	W10-23140	W31-P3368 #2
	06-08	W10-19110	W31-P3368 #2	W10-29110	W31-P3368 #2
	82	-	-	W10-23110	W31-P3368 #2
	83	-	-	W10-23112	W31-P3368 #2
	84	-	-	W10-23115	W31-P3368 #2
	85	-	-	W10-23118	W31-P3368 #2
	86-88	-	-	W10-23121	W31-P3368 #2
KX500(US)	89-94	-	-	W10-23123	W31-P3368 #2
	97-08	-	-	W10-23360	W31-P3368 #2
	00-09	-	-	W10-23360	W31-P3368 #2
	90-99	-	-	W10-23320	W31-P3368 #2
	86-92	-	-	W10-23121	W31-P3368 #2
	93-06	-	-	W10-23320	W31-P3368 #2
	89	-	-	W10-23121	W31-P3368 #2
	90	-	-	W10-23320	W31-P3368 #2
	89	-	-	W10-23121	W31-P3368 #2
	90-93	-	-	W10-23320	W31-P3368 #2
Super Sherpa	94-05	-	-	W10-23320	W31-P3368 #2
	94-99	-	-	W10-23320	W31-P3368 #2
	91-94	-	-	W10-23320	W31-P3368 #2
	91-95	-	-	W10-23320	W31-P3368 #2
	91-94	-	-	W10-23320	W31-P3368 #2
	98-16	W10-13340	W31-P4368 #2	W10-23340	W31-P4368 #2
	94-97	W10-13340	W31-P4368 #2	W10-23340	W31-P4368 #2
	93-95	-	-	W10-23320	W31-P3368 #2
	06-16	W10-13340	W31-P4368 #2	W10-23340	W31-P4368 #2
	93-94	-	-	W10-23320	W31-P3368 #2
Super Sherpa Super Sherpa(US)	95-97	W10-13340	W31-P4368 #2	W10-23340	W31-P4368 #2
	96-07	-	-	W10-23320	W31-P3368 #2
	08-15	W10-19110	W31-P3368 #2	W10-29110	W31-P3368 #2
	93-96	-	-	W10-23320	W31-P3368 #2

KAWASAKI REAR

Bike	Year	Steel Spoke	Nipple	SUS Spoke	Nipple
KX125	03-08	W10-13540	W31-Q4368 #2	W10-23540	W31-Q4368 #2
	86-87	-	-	W10-23510	W31-Q3368 #2
KX125(wide)	88	-	-	W10-23511	W31-Q3368 #2
	86-87	-	-	W10-23510	W31-Q3368 #2
KX250	88	-	-	W10-23511	W31-Q4368 #2
	03-08	W10-13540	W31-Q4368 #2	W10-23540	W31-Q4368 #2
KX250F	04-18	W10-13540	W31-Q4368 #2	W10-23540	W31-Q4368 #2
	06-18	W10-13540	W31-Q4368 #2	W10-23540	W31-Q4368 #2
KX450F	86-87	-	-	W10-23510	W31-Q3368 #2
	97-08	-	-	W10-23760	W31-Q3368 #2
KX500(US)	00-09	-	-	W10-23760	W31-Q3368 #2
	90-99	-	-	W10-23722	W31-Q3368 #2
Super Sherpa Super Sherpa(US)	90-99	-	-	W10-23722	W31-Q3368 #2
	89-06	-	-	W10-23722	W31-Q3368 #2
KDX125SR	94-05	-	-	W10-23722	W31-Q3368 #2
	94-99	-	-	W10-23722	W31-Q3368 #2
KDX200(US)	85-94	-	-	W10-23720	W31-Q4368 #2
	91-95	-	-	W10-23720	W31-Q4368 #2
KDX220R	91-95	-	-	W10-23720	W31-Q4368 #2
	91-94	-	-	W10-23720	W31-Q4368 #2
KDX250SR	92-94	-	-	W10-23722	W31-Q3368 #2
	98-07	W10-13739	W31-Q3368 #2	W10-23740	W31-Q4368 #2 #1
KLX250	08-16	W10-13740	W31-Q4368 #2	W10-23740	W31-Q4368 #2
	94-97	W10-13739	W31-Q3368 #2	W10-23740	W31-Q4368 #2 #1
KLX250R	93-95	W10-13739	W31-Q3368 #2	W10-23740	W31-Q4368 #2 #1
	06-08	W10-13739	W31-Q3368 #2	W10-23740	W31-Q4368 #2 #1
KLX250S(US)	09-16	W10-13740	W31-Q4368 #2	W10-23740	W31-Q4368 #2
	93-97	W10-13739	W31-Q3368 #2	W10-23740	W31-Q4368 #2 #1
KLX300R	96-07	W10-13739	W31-Q3368 #2	W10-23740	W31-Q4368 #2 #1
	08-15	W10-13610	W31-Q4368 #2	W10-23610	W31-Q4368 #2
KLX450R	91	-	-	W10-23722	W31-Q3368 #2
	93	W10-13740	W31-Q4368 #2	W10-23740	W31-Q4368 #2

#1 Listed nipple set is required for installation of Z-Wheel spoke set.
#2 Color nipple available (Black, Blue, Red, Green, Gold)

SUZUKI FRONT

Bike	Year	Steel Spoke	Nipple	SUS Spoke	Nipple
RM125	86-96	W10-19110	W31-P3368 #2	W10-29110	W31-P3368 #2
	97-00	W10-19110	W31-P3368 #2	W10-29110	W31-P3368 #2
	01-08	W10-19110	W31-P3368 #2	W10-29110	W31-P3368 #2
RM250	86-96	W10-19110	W31-P3368 #2	W10-29110	W31-P3368 #2
	97-00	W10-15110	W31-P3368 #2	W10-25110	W31-P3368 #2
	01-08	W10-19110	W31-P3368 #2	W10-29110	W31-P3368 #2
RMZ250	04-06	-	-	W10-23140	W31-P3368 #2
	07-18	W10-15140	W31-P3368 #2	W10-25140	W31-P3368 #2
	05-18	W10-15140	W31-P3368 #2	W10-25140	W31-P3368 #2
RMZ450	89-98	W10-19110	W31-P3368 #2	W10-29110	W31-P3368 #2
	99-08	W10-19110	W31-P3368 #2	W10-29110	W31-P3368 #2
	99-08	W10-19110	W31-P3368 #2	W10-29110	W31-P3368 #2
RMX250R	93-98	W10-19110	W31-P3368 #2	W10-29110	W31-P3368 #2
	93-98	W10-19110	W31-P3368 #2	W10-29110	W31-P3368 #2
	93-98	W10-19110	W31-P3368 #2	W10-29110	W31-P3368 #2
RMX450Z	10-17	W10-15140	W31-P3368 #2	W10-25140	W31-P3368 #2
	82-88	-	-	W10-25360	W31-P2368 #2
	86-88	-	-	W10-25360	W31-P2368 #2
SP200(US)	85	W10-19110	W31-P3368 #2	W10-29110	W31-P3368 #2
	85-91	-	-	W10-25360	W31-P2368 #2
	90-97	-	-	W10-25360	W31-P2368 #2
TS125R	89	W10-19110	W31-P3368 #2	W10-29110	W31-P3368 #2
	90-97	-	-	W10-25323	W31-P3368 #2
	89	W10-19110	W31-P3368 #2	W10-29110	W31-P3368 #2
TS200R	90-96	-	-	W10-25323	W31-P3368 #2
	97	-	-	W10-25360	W31-P2368 #2
	86-88	-	-	W10-25360	W31-P2368 #2
DF200E	86-88	-	-	W10-25360	W31-P2368 #2
	89-99	-	-	W10-25360	W31-P2368 #2
	86-88	-	-	W10-25360	W31-P2368 #2
DR125SE	86-88	-	-	W10-25360	W31-P2368 #2
	89-99	-	-	W10-25360	W31-P2368 #2
	86-88	-	-	W10-25360	W31-P2368 #2
DR200SE	83-09	-	-	W10-25360	W31-P2368 #2
	85	W10-19110	W31-P3368 #2	W10-29110	W31-P3368 #2
	95-00	W10-19110	W31-P3368 #2	W10-29110	W31-P3368 #2
DR250R	96-05	W10-19110	W31-P3368 #2	W10-29110	W31-P3368 #2
	90-94	-	-	W10-25323	W31-P3368 #2
	90-95	-	-	W10-25323	W31-P3368 #2
DR250S/SH/SH	90-99	-	-	W10-25323	W31-P3368 #2
	90-91	-	-	W10-25323	W31-P3368 #2
	90-91	-	-	W10-25323	W31-P3368 #2
DR650S	01-07	W10-19110	W31-P3368 #2	W10-29110	W31-P3368 #2
	00-04	W10-15110	W31-P3368 #2	W10-25110	W31-P3368 #2
	00-07	W10-15110	W31-P3368 #2	W10-25110	W31-P3368 #2
DR2400(US)	00-07	W10-15110	W31-P3368 #2	W10-25110	W31-P3368 #2
	00-17	W10-15110	W31-P3368 #2	W10-25110	W31-P3368 #2
	84-88	-	-	W10-25320	W31-P2368 #2
RH250	84-88	W10-19110	W31-P3368 #2	W10-29110	W31-P3368 #2

SUZUKI REAR

Bike	Year	Steel Spoke	Nipple	SUS Spoke	Nipple
RM125	88	W10-15625	W31-Q4368 #2	W10-25625	W31-Q4368 #2
	90-06	W10-15510	W31-Q4368 #2	W10-25510	W31-Q4368 #2
	07-08	W10-15510	W31-Q4368 #2	W10-25510	W31-Q4368 #2
RM250	88-89	W10-15625	W31-Q4368 #2	W10-25625	W31-Q4368 #2
	90-06	W10-15510	W31-Q4368 #2	W10-25510	W31-Q4368 #2
	07-08	W10-15510	W31-Q4368 #2	W10-25510	W31-Q4368 #2
RMZ250	04-06	W10-13540	W31-Q4368 #2	W10-23540	W31-Q4368 #2
	07-18	W10-15540	W31-Q4368 #2	W10-25540	W31-Q4368 #2
	05	W10-15540	W31-Q4368 #2	W10-25540	W31-Q4368 #2
RMZ450	06-18	W10-15540	W31-Q4368 #2	W10-25540	W31-Q4368 #2
	89-98	W10-15625	W31-Q4368 #2	W10-25625	W31-Q4368 #2
	93-98	W10-15625	W31-Q4368 #2	W10-25625	W31-Q4368 #2
RMX250R	92-98	W10-15721	W31-Q3368 #2	W10-25721	W31-Q3368 #2
	92-98	W10-15721	W31-Q3368 #2	W10-25721	W31-Q3368 #2
	92-98	W10-15721	W31-Q3368 #2	W10-25721	W31-Q3368 #2
RMX450Z	10-17	W10-15610	W31-Q4368 #2	W10-25610	W31-Q4368 #2
	89-97	-	-	W10-25720	W31-Q3368 #2
	89-96	-	-	W10-25720	W31-Q3368 #2
TS125R	89-96	-	-	W10-25720	W31-Q3368 #2
	89-96	-	-	W10-25720	W31-Q3368 #2
	89-96	-	-	W10-25720	W31-Q3368 #2
DR250R	95-00	-	-	W10-25740	W31-Q3368 #2
	95-05	-	-	W10-25740	W31-Q3368 #2
	96-99	-	-	W10-25720	W31-Q3368 #2
DR250SX	01-07	-	-	W10-25740	W31-Q3368 #2
	00-04	-	-	W10-25745	W31-Q4368 #2
	00-07	-	-	W10-25745	W31-Q4368 #2
DR350SE	00-17	-	-	W10-25745	W31-Q4368 #2

#1 Listed nipple set is required for installation of Z-Wheel spoke set.
#2 Color nipple available (Black, Blue, Red, Green, Gold)

KTM FRONT

Bike	Year	Steel Spoke	Nipple	SUS Spoke	Nipple
SX/SX-F 125-505	05-18	W10-19110	W31-P3368 #2 #1	W10-29110	W31-P3368 #2 #1
XC/XC-F 150-525	05-18	W10-19110	W31-P3368 #2 #1	W10-29110	W31-P3368 #2 #1
EXC/EXC-F 125-530	05-18	W10-19110	W31-P3368 #2 #1	W10-29110	W31-P3368 #2 #1
XC-W/XCF-W 125-530	05-18				



BLACK

SILVER

BLUE

RED

GREEN

GOLD

Z-WHEEL

ALUMINIUM NIPPLE SET



- OE replacement aluminum nipple set, available in silver, black, blue, red, green and gold anodized nipples.
- Many application available for MX and ED bikes.

Aluminium Nipple Set (Front)

Bike	Year	Part #	Color No. #					
			Black	Silver	Blue	Red	Green	Gold
HONDA								
CR125R	02-07	W31-P336	# 1	8	2	3	4	5
CR250R	02-07	W31-P336	# 1	8	2	3	4	5
CRF250R	04-17	W31-P336	# 1	8	2	3	4	5
CRF250X	04-17	W31-P336	# 1	8	2	3	4	5
CRF450R	02-18	W31-P336	# 1	8	2	3	4	5
CRF450RX	17-18	W31-P336	# 1	8	2	3	4	5
CRF450X	05-17	W31-P336	# 1	8	2	3	4	5
YAMAHA								
WR250F	01-18	W31-P336	# 1	8	2	3	4	5
WR250Z	91-98	W31-P336	# 1	8	2	3	4	5
WR400F	98-00	W31-P336	# 1	8	2	3	4	5
WR426F	01-02	W31-P336	# 1	8	2	3	4	5
WR450F	03-18	W31-P336	# 1	8	2	3	4	5
WR500Z	92-93	W31-P336	# 1	8	2	3	4	5
YZ125	86-18	W31-P336	# 1	8	2	3	4	5
YZ250	86-18	W31-P336	# 1	8	2	3	4	5
YZ250F	01-18	W31-P336	# 1	8	2	3	4	5
YZ250WR	89-90	W31-P336	# 1	8	2	3	4	5
YZ400F	98-99	W31-P336	# 1	8	2	3	4	5
YZ426F	00-02	W31-P336	# 1	8	2	3	4	5
YZ450F	03-18	W31-P336	# 1	8	2	3	4	5
YZ125X	17-18	W31-P336	# 1	8	2	3	4	5
YZ250X	16-18	W31-P336	# 1	8	2	3	4	5
YZ250FX	15-18	W31-P336	# 1	8	2	3	4	5
YZ450FX	16-18	W31-P336	# 1	8	2	3	4	5
YZ490	86-90	W31-P336	# 1	8	2	3	4	5
KAWASAKI								
KX125	99-05	W31-Q436	# 1	8	2	3	4	5
KX250	05-08	W31-P336	# 1	8	2	3	4	5
KX250F	04-18	W31-P336	# 1	8	2	3	4	5
KX450F	06-18	W31-P336	# 1	8	2	3	4	5
KLX450R	08-15	W31-P336	# 1	8	2	3	4	5
SUZUKI								
DRZ400S(US)	00-17	W31-P336	# 1	8	2	3	4	5
DRZ400SM	05-08	W31-P336	# 1	8	2	3	4	5
DRZ400SM(US)	05-17	W31-P336	# 1	8	2	3	4	5
DRZ400(US)	00-04	W31-P336	# 1	8	2	3	4	5
DRZ400E(US)	00-07	W31-P336	# 1	8	2	3	4	5
DRZ400E	07	W31-P336	# 1	8	2	3	4	5
DR250R	95-00	W31-P336	# 1	8	2	3	4	5
DR250RX	96-00	W31-P336	# 1	8	2	3	4	5
DRZ250(US)	01-07	W31-P336	# 1	8	2	3	4	5
RMX250R	93-98	W31-P336	# 1	8	2	3	4	5
RMX250R(US)	89-98	W31-P336	# 1	8	2	3	4	5
RMX450Z	10-17	W31-P336	# 1	8	2	3	4	5
RM125	86-08	W31-P336	# 1	8	2	3	4	5
RM250	86-08	W31-P336	# 1	8	2	3	4	5
RMZ250	04-18	W31-P336	# 1	8	2	3	4	5
RMZ450	05-18	W31-P336	# 1	8	2	3	4	5

Aluminium Nipple Set (Front)

Bike	Year	Silver nipple
KTM		
SX/SX-F 125-505	05-18	W31-P5368
XC/XC-F 150-525	05-18	W31-P5368
EXC/EXC-F 125-530	05-18	W31-P5368
XC-W/XCF-W 125-530	05-18	W31-P5368
HUSQVARNA		
TC/FC 125-450/S	14-18	W31-P5368
TE/FE 125-501	14-18	W31-P5368
TX/FX125-450	17-18	W31-P5368
HUSABERG		
FE250-650	07-14	W31-P536
TE125-300	11-14	W31-P536

Aluminium Nipple Set (Rear)

Bike	Year	Part #	Color No. #					
			Black	Silver	Blue	Red	Green	Gold
HONDA								
CR125R	94-96	W31-Q632	#	8				
	02-07	W31-Q632	#	8				
	95-96	W31-Q632	#	8				
CR250R	02-07	W31-Q632	#	8				
CRF250R	04-17	W31-Q632	#	8				
CRF250X	04-17	W31-Q632	#	8				
CRF450R	02-18	W31-Q632	#	8				
CRF450RX	17-18	W31-Q632	#	8				
CRF450X	05-17	W31-Q632	#	8				
YAMAHA								
WR250F	01-18	W31-Q436	# 1	8	2	3	4	5
WR400F	99-00	W31-Q436	# 1	8	2	3	4	5
WR426F	01-02	W31-Q436	# 1	8	2	3	4	5
WR450F	03-18	W31-Q436	# 1	8	2	3	4	5
WR450F	03-18	W31-Q436	# 1	8	2	3	4	5
YZ125	99-18	W31-Q436	# 1	8	2	3	4	5
YZ250	99-18	W31-Q436	# 1	8	2	3	4	5
YZ250F	01-18	W31-Q436	# 1	8	2	3	4	5
YZ2400F	99	W31-Q436	# 1	8	2	3	4	5
YZ426F	00-02	W31-Q436	# 1	8	2	3	4	5
YZ450F	03-18	W31-Q436	# 1	8	2	3	4	5
YZ125X	17-18	W31-Q436	# 1	8	2	3	4	5
YZ250X	16-18	W31-Q436	# 1	8	2	3	4	5
YZ250FX	15-18	W31-Q436	# 1	8	2	3	4	5
YZ450FX	16-18	W31-Q436	# 1	8	2	3	4	5
KAWASAKI								
KX125	99-08	W31-Q436	# 1	8	2	3	4	5
KX250	99-08	W31-Q436	# 1	8	2	3	4	5
KX250F	04-18	W31-Q436	# 1	8	2	3	4	5
KX450F	06-18	W31-Q436	# 1	8	2	3	4	5
KLX450R	08-15	W31-Q436	# 1	8	2	3	4	5
SUZUKI								
DRZ400S(US)	00-16	W31-Q436	# 1	8	2	3	4	5
DRZ400SM	05-08	W31-Q436	# 1	8	2	3	4	5
DRZ400E(US)	00-04	W31-Q436	# 1	8	2	3	4	5
DRZ400E	07	W31-Q436	# 1	8	2	3	4	5
DR250R	95-00	W31-P336	# 1	8	2	3	4	5
DR250RX	96-00	W31-P336	# 1	8	2	3	4	5
DRZ250(US)	01-07	W31-P336	# 1	8	2	3	4	5
RMX250R	90-98	W31-Q436	# 1	8	2	3	4	5
RMX250R(US)	89-98	W31-Q436	# 1	8	2	3	4	5
RMX450Z	10-17	W31-Q636	# 1	8				
RM125	86-06	W31-Q436	# 1	8	2	3	4	5
RM250	07-08	W31-Q636	# 1	8				
	86-06	W31-Q436	# 1	8	2	3	4	5
RMZ250	04-06	W31-Q436	# 1	8	2	3	4	5
	07-18	W31-Q636	# 1	8				
RMZ450	05	W31-Q436	# 1	8	2	3	4	5
	06-18	W31-Q636	# 1	8				

Aluminium Nipple Set (Rear)

Bike	Year	Silver nipple
KTM		
SX/SX-F 125-505	05-10	W31-Q7368
	11-18	W31-Q5368
XC/XC-F 150-525	05-10	W31-Q7368
	11-18	W31-Q5368
EXC/EXC-F 125-530	05-11	W31-Q7368
	12-18	W31-Q5368
XC-W/XCF-W 125-530	05-11	W31-Q7368
	12-18	W31-Q5368
HUSQVARNA		
TC/FC 125-450/S	14-18	W31-Q5368
TE/FE 125-501	14-18	W31-Q5368
TX/FX125-450	17-18	W31-Q5368
HUSABERG		
FE250-550/650	07-11	W31-Q7368
	12-14	W31-Q5368
FE570	09-10	W31-Q7368
	11-12	W31-Q5368
TE125-300	11	W31-Q7368
	12-14	W31-Q5368



S30 SERIES

Z-WHEEL

WHEEL/DISC

STICKER



WHEEL



BRAKE DISC



BRAKE HOSE



Z-WHEEL S30 SPOKE SET

- Spoke sets for small mx racing bikes.- Available steel replacement nipples.

S30 SPOKE SET (Front)					
Bike	Year	Steel Spoke	SUS Spoke	Nipple	
HONDA	CR80R2/85R2	96-07	W10-11410	W10-21410	W38-D236M
	CRF150R2	07-18	W10-11411	W10-21411	W38-D236M
	CRF125F	14-18	-	W10-21435	W38-D136M
YAMAHA	CRM50/80	93-97	-	W10-21420	W38-D236M
	YZ80LW/85LW	94-18	W10-17810	W10-27410	W38-D236M
	TT-R125LW	00-11	-	W10-27435	W38-D136M
KAWASAKI	KX80II/85II/100	98-18	W10-13410	W10-23410	W38-F336M
	KLX125/150S	09-16	W10-13410	W10-23435	W38-F336M
SUZUKI	RM85L	04-17	W10-15409	W10-25410	W38-D236M
KTM	85SX 19/16	12-18	-	W10-29410	W31-P332 #
HUSQVARNA	TC85 19/16	14-18	-	W10-29410	W31-P332 #

S30 SPOKE SET (Rear)					
Bike	Year	Steel Spoke	SUS Spoke	Nipple	
HONDA	CR80R2/85R2	96-07	W10-11810	W10-21810	W38-D236M
	CRF150R2	07-18	W10-11811	W10-21811	W38-D236M
	CRF125F	14-18	-	W10-21835	-
YAMAHA	CRM50/80	93-97	-	W10-21820	W38-D236M
	YZ80LW/85LW	94-18	W10-17810	W10-27810	W38-D236M
	TT-R125LW	00-11	-	W10-27835	-
KAWASAKI	KX80II/85II/100	98-18	W10-13810	W10-23810	W38-F336M
	KLX125/150S	09-16	-	W10-23835	W38-F336M
SUZUKI	RM85L	04-17	W10-15810	W10-25810	W38-D236M
KTM	85SX 19/16	12-18	-	W10-29810	W31-P332 #
HUSQVARNA	TC85 19/16	14-18	-	W10-29810	W31-P332 #

* Listed nipple set is required for installation of Z-Wheel spoke set.
Color nipple available Black(1), Blue (2), Red (3), Green (4), Gold (5), Silver (8)

Z-WHEEL S30 RIM FRONT / REAR

- Real racing specification rims for small wheel bikes.
- Made of 7000 grade aluminum with special rim design for durability.
- Durable construction yet lightweight.
- Available in wide rim line up, recent competition bikes to older and dual sport models.
- Rims available for dual sport models to upgrade the rims.
- Can be used with OE nipples.
- One each of rim lock and air valve holes on the rim.
- Available in Black color.

S30 RIM (Front)				
Bike	Year	17inch	19inch	
HONDA	CR80R/85R/R2	96-07	W02-51211	W02-71211
	CRF150R/R2	07-18	W02-51211	W02-71211
	CRF125F	14-18	-	W02-71411
YAMAHA	CRM50/80	93-97	W02-51211	-
	YZ80/85/LW	94-18	W02-51311	W02-71311
KAWASAKI	TT-R125LW	00-11	-	W02-71411
	KX80/85/II/100	98-18	W02-51211	W02-71211
SUZUKI	KLX125/150S	09-16	-	W02-71211
KTM	RM85/L	04-17	W02-51311	W02-71311
KTM	85/105SX	03-18	-	W02-72311
HUSQVARNA	TC85	14-18	-	W02-72311

S30 RIM (Rear)				
Bike	Year	14inch	16inch	
HONDA	CR80R/85R/R2	96-07	W02-23321	W02-43331
	CRF150R/R2	07-18	W02-23311	W02-43321
	CRF125F	14-18	-	W02-43411
YAMAHA	CRM50/80	93-97	W02-23321	-
	YZ80/85/LW	94-18	W02-23331	W02-43311
KAWASAKI	TT-R125LW	00-11	-	W02-43411
	KX80/85/II/100	98-18	W02-23211	W02-43211
SUZUKI	KLX125/150S	09-16	-	W02-43211
KTM	RM85/L	04-17	W02-23331	W02-43311
KTM	85/105SX	03-18	-	W02-43341
HUSQVARNA	TC85	14-18	-	W02-43341

Front Rear

Front			Rear		
Bike	Year	Part #	Bike	Year	Part #
HONDA			YAMAHA		
CR125M	#1 73-78	W04-92458	MX125	72-73	W04-92468
CR125R	79	W04-A2498		74	W04-92458
CR125R	83	W04-92478	YZ125	74-75	W04-92458
CR250M	73-74	W04-92458	DT1MX	70-71	W04-92478
CR250R	82-83	W04-92478	DT2MX	72	W04-92478
CR80R2	85	W04-92478	YZ250	74-83	W04-92478
XR200R (ME)	83-02	W04-92478	MX250	73-74	W04-92478
XR250 (ME)	79-80	W04-A2498	DT125	#2 74-75	W04-92468
MT125	74-76	W04-92458	DT125M	#2 76-77	W04-92468
MTX125R	83	W04-92478	TY125	#2 83-84	W04-92478
TL125	#1 73-76	W04-92458	DT125M	#2 78-82	W04-92478
XL125R (JD04)	#1 75-78	W04-92458	TY125 (1T)	75-78	W04-92458
MTX200R (MD)	83-84	W04-92478	XT125	#2 82	W04-92478
XL200R (MD)	83-84	W04-92478	IT175	77-83	W04-92478
CT250S	81-83	W04-72468	TY175	75-80	W04-92458
MT250	74-76	W04-92498	XT200	#2 82-84	W04-92478
TL250	#1 75-76	W04-92458	DT1	68-72	W04-72468
SL250	72-74	W04-92498	DT250	72-73	W04-72468
XL250S	79-82	W04-A2498	DT250M	74-76	W04-92468
XL250R/PARIS DAKAR/DECCOSTA	82-83	W04-92478	IT250	77-78	W04-92498
XR350R	83	W04-92478	TY250	74-76	W04-92458
XL400R	82	W04-92478	XT250	80-82	W04-92478
XL500S	79-80	W04-A2498	XT250T	83-84	W04-92478
XR500 (PE01)	79-80	W04-A2498	RT1	70-71	W04-72468
KAWASAKI			RT360	72-73	W04-72468
KX250A	74	W04-92468	DT360	73	W04-72468
KE125	#2 76-82	W04-92478	DT400	74	W04-92468
KS125 (125TR)	#2 74-75	W04-92478	DT400	75-76	W04-92468
	78-79	W04-92488	XT400	82	W04-92478
KL250	#2 80-83	W04-92478	TT500	76-81	W04-92478
F9 (350TR)	72-74	W04-92468	XT500 (US)	76-80	W04-92488
			XT500 (US)	81	W04-92488
SUZUKI			SUZUKI		
			RM125	75-76	W04-92478
				79-80	W04-92458
				81-82	W04-92478
			RM250	79-80	W04-92468
				81-82	W04-92478
			TM250	72-74	W04-92458
				75	W04-92478
			TM400	71-72	W04-92458
			TS50	#2 83-97	W04-92478
			TS125	#2 73-75	W04-92458
				#2 76-79	W04-92478
			TS250	71-73	W04-72468
				74-76	W04-92468
				72-73	W04-72468
				74-77	W04-92468
			SP500	81-84	W04-92468
HONDA			KAWASAKI		
CR125R	79	W04-63478	KL250	78-79	W04-64468
CR250M	73-77	W04-64468	KL250	80-83	W04-54468
XR200R	81-83	W04-64458	KLR250	84-90	W04-54468
XR250 (ME)	79-80	W04-64458	F11 (250TR)	74-76	W04-64488
TLM50	84	W04-64458			
MT125	74-76	W04-64458			
MTX125R	83	W04-64458			
TL125/S	73-76	W04-64458			
TL125	81	W04-64458			
XL125	83-88	W04-64458			
XL125S	75-78	W04-64458			
	79-80	W04-64458			
	81-	W04-64458			
	85-	W04-64458			
MTX200R (MD)	83-84	W04-64458			
MTX200R2 (MT)	85-88	W04-64458			
TLR200 (MD)	83-	W04-64458			
XL200R (MD)	83-84	W04-64458			
XL230	02-04	W04-64468			
MT250	74-76	W04-64468			
TL250	75-76	W04-64458			
TLR250R (MD18)	86-	W04-64458			
SL250	72-74	W04-64468			
XL250S	79-80	W04-64468			
XL250R/PARIS DAKAR/DECCOSTA	81-82	W04-64468			
XL250R/PARIS DAKAR/DECCOSTA	82-83	W04-54468			
XL400R	82	W04-54468			
XL500S	79-80	W04-64468			
XR500 (PE01)	79-80	W04-64468			
YAMAHA			SUZUKI		
AT1M	#2 69-70	W04-63478	RM125	78-80	W04-64458
AT1MX	#2 71	W04-63478	TM250	72, 74	W04-64488
MX125	72-74	W04-63478	DR250S	82	W04-54468
YZ125	74-83	W04-63478		71-79	W04-64488
DT1MX	71	W04-64488	TS250	#2 80	W04-64488
DT2MX	72	W04-64488		81-83	W04-64488
MX250	73-74	W04-64488		78	W04-64488
YZ250	74-79	W04-64488		80	W04-64488
DT125	75-78	W04-64458		72-77	W04-64488
TY125	#2 69-71	W04-63478			
CT1	#2 72-73	W04-63478			
CT175	#2 77-83	W04-63478			
IT175	75-80	W04-64458			
AG200	85	W04-64458			
DT1	71-72	W04-64488			
DT250	72-76	W04-64488			
DT250M	77-78	W04-63478			
IT250	77-80	W04-64488			
TY250	75-76	W04-64458			
XT250	80-82	W04-54468			
DT360	73-74	W04-64488			
RT1	70-71	W04-64488			
RT360	72-73	W04-64488			
DT400	75-76	W04-64488			
TT500	76-81	W04-64488			
XT500	76-80	W04-64468			
XT500 (US)	81	W04-64468			



S16 SERIES

Z-WHEEL S16 RIM

- Aluminum rims for vintage off road bikes, make your vintage bike wheel look new.
- Available for many applications.
- Made of 7000 grade aluminum for durability and light weight.
- Silver anodized finish to match the vintage old style.
- Can be used with stock hubs, nipples and spokes.
- 1 X Rim lock hole on the rim.



*#1 and #2 models require to use with below Z wheel steel nipple sets.
#1 W38-D136M
#2 W38-D236M

M50 SERIES

Convertible Super motard rim kit into 16.5 / 17 inch



The front wheel uses cross-spoke (excluding trail). Minimizing the interference of the caliper and spoke.



Compatible with genuine hub

Z-WHEEL

M50 MOTARD RIM



- Kit to convert motocross bike into motard front 16.5 inch, rear 17 inch.
- Line up of 17 inch standard front and rear wheels for the trail.
- Designed for a high-rigidity rim "M50 series" Super motard.
- The front rim adopts cross spokes (excluding trails), minimized interference caliper and spoke.
- Minimum required parts.

Kit : M50 Rim Black (one side 1 wheel minute) / Stainless spoke set / Aluminium nipple set (Silver)

Bike	Year	Motard Rim Set Front		Front Replacement parts			Motard Rim Set Rear		Rear Replacement parts		
		Size	Part #	Rim	Spoke set	Nipple set (Silver) *1	Size	Part #	Rim	Spoke set	Nipple set (Silver) *1
HONDA											
CR125R	95-07	16.5x3.50	W26-11011	W03-47411	W13-11011	W31-P3368	-	-	-	-	-
CR250R	95-07	16.5x3.50	W26-11011	W03-47411	W13-11011	W31-P3368	-	-	-	-	-
CRF250R	04-17	16.5x3.50	W26-11011	W03-47411	W13-11011	W31-P3368	-	-	-	-	-
CRF450R	02-18	16.5x3.50	W26-11011	W03-47411	W13-11011	W31-P3368	-	-	-	-	-
CRF450RX	17-18	16.5x3.50	W26-11011	W03-47411	W13-11011	W31-P3368	-	-	-	-	-
CRF250X	04-17	16.5x3.50	W26-11011	W03-47411	W13-11011	W31-P3368	-	-	-	-	-
CRF450X	05-17	16.5x3.50	W26-11011	W03-47411	W13-11011	W31-P3368	-	-	-	-	-
YAMAHA											
YZ125	02-18	16.5x3.50	W26-17011	W03-47411	W13-17011	W31-P3368	17x5.00	W26-27111	W03-5A411	W13-27111	W31-Q4368
YZ250	02-18	16.5x3.50	W26-17011	W03-47411	W13-17011	W31-P3368	17x5.00	W26-27111	W03-5A411	W13-27111	W31-Q4368
YZ250F	02-08	16.5x3.50	W26-17011	W03-47411	W13-17011	W31-P3368	17x5.00	W26-27111	W03-5A411	W13-27111	W31-Q4368
YZ250F	09-18	16.5x3.50	W26-17011	W03-47411	W13-17011	W31-P3368	17x5.00	W26-27011	W03-5A411	W13-27011	W31-Q4368
YZ426F	02	16.5x3.50	W26-17011	W03-47411	W13-17011	W31-P3368	17x5.00	W26-27111	W03-5A411	W13-27111	W31-Q4368
YZ450F	03-08	16.5x3.50	W26-17011	W03-47411	W13-17011	W31-P3368	17x5.00	W26-27111	W03-5A411	W13-27111	W31-Q4368
YZ450F	09-18	16.5x3.50	W26-17011	W03-47411	W13-17011	W31-P3368	17x5.00	W26-27011	W03-5A411	W13-27011	W31-Q4368
YZ250FX	15-18	16.5x3.50	W26-17011	W03-47411	W13-17011	W31-P3368	17x5.00	W26-27111	W03-5A411	W13-27111	W31-Q4368
YZ450FX	16-18	16.5x3.50	W26-17011	W03-47411	W13-17011	W31-P3368	17x5.00	W26-27111	W03-5A411	W13-27111	W31-Q4368
YZ125X	17-18	16.5x3.50	W26-17011	W03-47411	W13-17011	W31-P3368	17x5.00	W26-27111	W03-5A411	W13-27111	W31-Q4368
YZ250X	16-18	16.5x3.50	W26-17011	W03-47411	W13-17011	W31-P3368	17x5.00	W26-27111	W03-5A411	W13-27111	W31-Q4368
WR250F	02-18	16.5x3.50	W26-17011	W03-47411	W13-17011	W31-P3368	17x5.00	W26-27111	W03-5A411	W13-27111	W31-Q4368
WR426F	02	16.5x3.50	W26-17011	W03-47411	W13-17011	W31-P3368	17x5.00	W26-27111	W03-5A411	W13-27111	W31-Q4368
WR450F	03-18	16.5x3.50	W26-17011	W03-47411	W13-17011	W31-P3368	17x5.00	W26-27111	W03-5A411	W13-27111	W31-Q4368
WR250R	07-17	17x3.50	W26-17511	W03-57411	W13-17511	W31-P3368	17x4.50	W26-27511	W03-59411	W13-27511	W31-Q4368
WR250X	07-17	-	-	-	-	-	17x4.50	W26-27511	W03-59411	W13-27511	W31-Q4368
KAWASAKI											
KLX250	98-16	17x3.50	W26-13511	W03-57411	W13-13511	W31-P3368	17x4.50	W26-23511	W03-59421	W13-23511	W31-Q4368
KLX250ES	94-97	17x3.50	W26-13511	W03-57411	W13-13511	W31-P3368	17x4.50	W26-23511	W03-59421	W13-23511	W31-Q4368
KLX250R	93-95	17x3.50	W26-13511	W03-57411	W13-13511	W31-P3368	17x4.50	W26-23511	W03-59421	W13-23511	W31-Q4368
KLX250SR	93-97	17x3.50	W26-13511	W03-57411	W13-13511	W31-P3368	17x4.50	W26-23511	W03-59421	W13-23511	W31-Q4368
KLX300R	96-07	17x3.50	W26-13511	W03-57411	W13-13511	W31-P3368	17x4.50	W26-23511	W03-59421	W13-23511	W31-Q4368
KLX650R	93-96	17x3.50	W26-13511	W03-57411	W13-13511	W31-P3368	17x4.50	W26-23511	W03-59421	W13-23511	W31-Q4368
D-TRACKER/X	98-16	17x3.50	W26-13511	W03-57411	W13-13511	W31-P3368	17x4.50	W26-23511	W03-59421	W13-23511	W31-Q4368
SUZUKI											
RMZ250	07-18	16.5x3.50	W26-15011	W03-47411	W13-15011	W31-P3368	17x5.00	W26-25011	W03-5A411	W13-25011	W31-Q4368
RMZ450	05-18	16.5x3.50	W26-15011	W03-47411	W13-15011	W31-P3368	17x5.00	W26-25011	W03-5A411	W13-25011	W31-Q4368
RMX450Z	10-17	16.5x3.50	W26-15011	W03-47411	W13-15011	W31-P3368	17x5.00	W26-25011	W03-5A411	W13-25011	W31-Q4368
KTM											
SX/SX-F 125-505	03-18	16.5x3.50	W26-19011	W03-47411	W13-19011	W31-P3368	17x5.00	W26-29031	W03-5A411	W13-29031	W31-Q4368
XC/XC-F 150-525	08-18	16.5x3.50	W26-19011	W03-47411	W13-19011	W31-P3368	17x5.00	W26-29031	W03-5A411	W13-29031	W31-Q4368
EXC/-F 125-530	03-18	16.5x3.50	W26-19011	W03-47411	W13-19011	W31-P3368	17x5.00	W26-29031	W03-5A411	W13-29031	W31-Q4368
XC/F-W 200-530	08-18	16.5x3.50	W26-19011	W03-47411	W13-19011	W31-P3368	17x5.00	W26-29031	W03-5A411	W13-29031	W31-Q4368
450SMR	08-14	16.5x3.50	W26-19011	W03-47411	W13-19011	W31-P3368	17x5.00	W26-29031	W03-5A411	W13-29031	W31-Q4368
HUSABERG											
TE/FE125-650	08-14	16.5x3.50	W26-19011	W03-47411	W13-19011	W31-P3368	17x5.00	W26-29031	W03-5A411	W13-29031	W31-Q4368
HUSQVARNA											
TE/FE125-501/S	14-18	16.5x3.50	W26-19011	W03-47411	W13-19011	W31-P3368	17x5.00	W26-29031	W03-5A411	W13-29031	W31-Q4368
TC/FC125-450	14-18	16.5x3.50	W26-19011	W03-47411	W13-19011	W31-P3368	17x5.00	W26-29031	W03-5A411	W13-29031	W31-Q4368
TX/FX125-450	17-18	16.5x3.50	W26-19011	W03-47411	W13-19011	W31-P3368	17x5.00	W26-29031	W03-5A411	W13-29031	W31-Q4368
FS450	15-18	16.5x3.50	W26-19011	W03-47411	W13-19011	W31-P3368	17x5.00	W26-29031	W03-5A411	W13-29031	W31-Q4368

Rim set comes with Silver aluminum nipples.

*1 Optional color nipples are available.

STICKER



WHEEL



BRAKE DISC



BRAKE HOSE



Bike	Year	Part #
HONDA		
CRF250L/M/RALLY	12-17	W16-31011
CRM250R/AR	89-98	W16-31021
XR230/MOTARD	05-12	W16-31021
XR250S/BAJA/MOTARD	95-07	W16-31021
XR400MOTARD	05-08	W16-31021
XR250R	90-04	W16-31021
XR400R	96-04	W16-31021
XR650R	00-07	W16-31021
YAMAHA		
DT200WR	91-94	W16-37011
DT230LANZA	97-98	W16-37021
TT250R/RAID	93-97	W16-37021
WR250R	07-17	W16-37031
WR250X	07-17	W16-37041
SUZUKI		
RMX250S	92-98	W16-35011
DR-Z400S	00-03	W16-35031
DR-Z400SM	04-08	W16-35041

Bike	Year	Part #
KAWASAKI		
KDX125SR	90-99	W16-33011
KDX200R	89-90	W16-33011
KDX200SR	90-93	W16-33011
KDX220R	94-05	W16-33011
KDX220SR	94-99	W16-33011
KDX250R	91-94	W16-33011
KDX250SR	91-94	W16-33011
KLX250	98-16	W16-33021
KLX250ES	94-97	W16-33021
KLX250R	93-95	W16-33021
KLX250SR	93-97	W16-33021
KLX300R	96-07	W16-33021
KLX650R	93-96	W16-33021
D-TRACKER/X	98-16	W16-33021

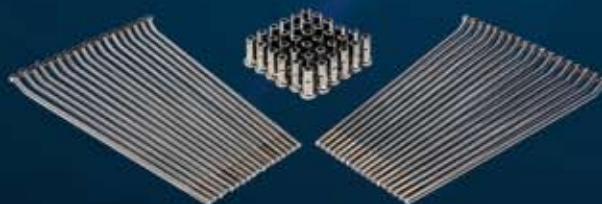

Z-WHEEL

**GENUINE / EXCEL / D.I.D RIM
CORRESPONDING MOTARD SPOKE SET
17 INCHES**



- Replacement line up to be used on motorcycles with Excel / D.I.D rim and 17-inch wheels.
- Stainless steel (except for some models) spoke and stainless nipple used for excellent corrosion resistance.
- 72 lines / nipple 72 pieces for both front and rear spoke set
- * both front and rear set for 68 lines / 68 pcs CRF250L / M, XR system models.
- Non applicable for M50 rim



ZIGRAM ROTOR

ジグラムローター

Bike	Year	Rear		
		Front STD	STD	MUD
HONDA				
CR125R	95-01	W51-10025	-	-
	02-07	W51-10025	W51-20026	W51-22026
CR250R	92-94	W51-10024	-	-
	95-01	W51-10025	-	-
CR500R	02-07	W51-10025	W51-20026	W51-22026
	92-94	W51-10024	-	-
CRF250R	04-14	W51-10025	W51-20026	W51-22026
	15-17	W51-10026	W51-20026	W51-22026
CRF450R	02-14	W51-10025	W51-20026	W51-22026
	15-18	W51-10026	W51-20026	W51-22026
CRF450RX	17-18	W51-10026	W51-20026	W51-22026
CRF250X	04-17	W51-10025	W51-20026	W51-22026
CRF450X	05-17	W51-10025	W51-20026	W51-22026
CRF150F/230F	03-17	W51-10024	-	-
CRM250R/AR	89-90	W51-10024	-	-
	91-99	W51-10024	W51-20033	-
CRF250L	12-17	W51-10035	W51-20033	-
CRF250M	13-17	-	W51-20033	-
CRF250RALLY	17	-	W51-20033	-
SL230	97-01	W51-10024	W51-20033	-
XLR125R/200R	93-97	W51-10024	-	-
	89-90	W51-10024	-	-
XLR250R/BAJA	91-94	W51-10024	W51-20033	-
XR230	05-12	W51-10024	W51-20033	-
XR250/BAJA/MOTARD	95-07	W51-10024	W51-20033	-
XR250R	91-04	W51-10024	W51-20033	-
XR400R	96-04	W51-10024	W51-20033	-
XR600R	91-06	W51-10024	W51-20033	-
XR650R	00-11	W51-10024	-	-
YAMAHA				
YZ125/250	01	W51-10326	-	-
	02-16	W51-10326	W51-20326	W51-22326
	17-18	W51-10327	W51-20326	W51-22326
YZ250F	01	W51-10326	-	-
	02-15	W51-10326	W51-20326	W51-22326
	16-18	W51-10327	W51-20326	W51-22326
YZ450F	02	-	W51-20326	W51-22326
	03-15	W51-10326	W51-20326	W51-22326
	16-17	W51-10327	W51-20326	W51-22326
YZ125X	18	W51-10327	-	-
	17-18	W51-10327	W51-20326	W51-22326
	16	W51-10326	W51-20326	W51-22326
YZ250X	17-18	W51-10327	W51-20326	W51-22326
	15-16	W51-10326	W51-20326	W51-22326
YZ250FX	17-18	W51-10327	W51-20326	W51-22326
	16-18	W51-10327	W51-20326	W51-22326
YZ450FX	02-16	W51-10326	W51-20326	W51-22326
	17-18	W51-10327	W51-20326	W51-22326
WR250F	02-15	W51-10326	W51-20326	W51-22326
	17-18	W51-10327	W51-20326	W51-22326
WR450F	02-15	W51-10326	W51-20326	W51-22326
	16-18	W51-10327	W51-20326	W51-22326
BRONCO	97-99	W51-10333	-	-
SEROW/225	85-04	W51-10333	W51-20336	-
SEROW/250	05-17	W51-10336	W51-20336	-
TRICKER	04-17	W51-10333	W51-20336	-
TW225	02-07	W51-10333	-	-
WR250R	07-17	W51-10335	W51-20335	-
WR250X	07-17	-	W51-20335	-
XT250X	06-17	W51-10336	W51-20336	-
XTZ125	03-17	W51-10333	-	-
KAWASAKI				
KX125/250	03-05	-	-	W51-22125
	06-08	W51-10126	-	W51-22125
KX250F	04-05	-	-	W51-22125
	06-14	W51-10126	-	W51-22125
	15-18	W51-10127	-	W51-22125
KX450F	06-14	W51-10126	-	W51-22125
	15-18	W51-10127	-	W51-22125
KLX450R	08-15	W51-10126	-	W51-22125
KDX125SR	90-99	W51-10141	W51-20140	-
KDX200R	95-06	-	W51-20140	-
KDX200SR	90-93	W51-10141	W51-20140	-
KDX220R	94-05	W51-10141	W51-20140	-
KDX220SR	94-99	W51-10141	W51-20140	-
KDX250R/SR	91	W51-10141	W51-20140	-
	92-94	-	W51-20140	-
KLX250/SR/ES	93-97	W51-10141	-	-
	98-07	W51-10141	W51-20140	-
	08-16	W51-10141	W51-20141	-
D-TRACKER	98-07	W51-10141	W51-20140	-
D-TRACKER X	08-16	-	W51-20141	-
SUZUKI				
RM125	88	-	W51-20225	-
	89-98	W51-10326	W51-20225	-
	99-05	W51-10326	-	-
RM250	06-08	W51-10326	-	-
	87-88	-	W51-20225	-
	89-98	W51-10326	W51-20225	-
RMZ250	99-05	W51-10326	-	-
	06-08	W51-10326	-	-
	04-06	-	-	W51-22125
RMZ450	07-18	W51-10226	W51-20227	W51-22227
	05-17	W51-10226	W51-20227	W51-22227
RMX450Z	18	-	W51-20227	W51-22227
	10-17	W51-10226	W51-20227	W51-22227
RMX250R	89-98	W51-10326	W51-20225	-
RMX250S	92-98	W51-10326	W51-20225	-
DJEBEL250/XC	96-00	W51-10326	-	-
DRZ400S/R	00-09	W51-10326	W51-20225	-
DR250R	95-00	W51-10326	-	-
250SB	02-06	W51-10141	W51-20140	-
KTM				
125-450SX/XC	98-18	W51-10525	W51-20525	W51-22525
125-530EXC/XC-W	98-18	W51-10525	W51-20525	W51-22525
450SMR	04-14	-	W51-20525	W51-22525
HUSQVARNA				
TC/FC/TX/FX125-450	14-18	W51-10525	W51-20525	W51-22525
TE/FE125-501	14-18	W51-10525	W51-20525	W51-22525
FS450	15-18	-	W51-20525	W51-22525

Z-WHEEL ZIGRAM ROTOR

- Standard sized brake rotor developed for use under extreme conditions with off road riding.
- Thick design for improved strength.
- Made of high carbon stainless steel (SUS420) for better brake feel and corrosion resistance.
- Standard type is a light weight design with holes placed based on strength analysis.
- Mud type has a solid design to keep the mud away from the rotor and prevent frictional wear of brake pads in a muddy race.

STD ROTOR

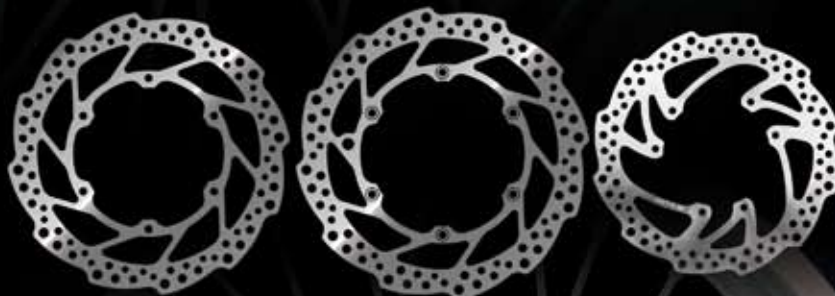

MUD ROTOR

MUD SPECIAL

Reduce wear and tear on the brake pads.





Z-WHEEL BRAKE HOSE



- PTFE inner brake hose covered stainless mesh provides better stopping power and sensitive control.
- PVC red and blue colored brake hose cover protects stainless mesh from rock and mud.
- Chrome plate coated brake banjo. Nut fitting design provides flexible brake hose installation.



Bike	Year	FRONT			REAR				
		C-Black	Blue	Red	C-Black	Blue	Red		
HONDA	CR125R/250R	02-07	W61-12011	W61-12012	W61-12013	W61-25051	W61-25052	W61-25053	
	CRF250R	04-17	W61-12011	W61-12012	W61-12013	W61-25051	W61-25052	W61-25053	
	CRF450R	02-16	W61-12011	W61-12012	W61-12013	W61-25051	W61-25052	W61-25053	
	CRF450R	17-18	W61-12011	W61-12012	W61-12013	W61-25071	-	W61-25073	
	CRF450RX	17-18	W61-12011	W61-12012	W61-12013	W61-25071	-	W61-25073	
	CRF450RX	04-05	W61-14011	-	W61-14013	W61-25051	W61-25052	W61-25053	
	CRF250X	06	-	-	-	W61-25051	W61-25052	W61-25053	
	CRF250X	07-17	W61-14011	-	W61-14013	W61-25051	W61-25052	W61-25053	
	CRF250X	05-07	-	-	-	W61-25051	W61-25052	W61-25053	
	CRF450X	08-17	W61-14011	-	W61-14013	W61-25051	W61-25052	W61-25053	
	CRM250R/AR	91-98	W61-14021	W61-14022	-	-	-	-	
	CRF250L	12-17	# W61-14011	-	W61-14013	W61-25051	W61-25052	W61-25053	
	CRF250M	13-17	W61-14511	-	W61-14513	W61-25051	W61-25052	W61-25053	
	CRF250RALLY	17	# W61-14011	-	W61-14013	W61-25051	W61-25052	W61-25053	
YAMAHA	XR250	95-96	-	-	-	W61-25061	-	W61-25063	
	XR250	00-02	-	-	-	W61-25061	-	W61-25063	
	XR230M	03-07	W61-13011	W61-13012	W61-13013	W61-25061	-	W61-25063	
	XR230M	08-12	W61-10011	-	-	-	-	-	
	YZ125/250	05-07	-	-	-	W61-25011	W61-25012	-	
	YZ125/250	08-18	W61-12011	W61-12012	W61-12013	W61-25011	W61-25012	-	
	YZ250F/450F	08-18	W61-12011	W61-12012	W61-12013	W61-25011	W61-25012	-	
	YZ125X	17-18	W61-12011	W61-12012	W61-12013	W61-25011	W61-25012	-	
	YZ250X	16-18	W61-12011	W61-12012	W61-12013	W61-25011	W61-25012	-	
	YZ250FX	15-18	W61-12011	W61-12012	W61-12013	W61-25011	W61-25012	-	
	YZ250FX	16-18	W61-12011	W61-12012	W61-12013	W61-25011	W61-25012	-	
	WR250F	07-18	-	-	-	W61-25011	W61-25012	-	
	WR250F	07-11	-	-	-	W61-25011	W61-25012	-	
	WR450F	16-18	-	-	-	W61-25011	W61-25012	-	
KAWASAKI	WR250R	08-17	W61-13011	W61-13012	W61-13013	W61-25011	W61-25012	-	
	TRICKER	04-17	W61-10011	-	-	W61-25031	-	-	
	SEROW225/XT225	92-04	W61-10011	-	-	-	-	-	
	SEROW250/XT250	05-17	W61-10011	-	-	W61-25031	-	-	
	WR250X	08-17	W61-14021	W61-14022	-	W61-25011	W61-25012	-	
	XT250X	06-17	W61-10011	-	-	W61-25031	-	-	
	XTZ125	03-17	W61-10011	-	-	-	-	-	
	SUZUKI	KX125/250	04-08	W61-12021	W61-12022	W61-12023	-	-	-
		KX125/250	04-05	W61-12021	W61-12022	W61-12023	-	-	-
		KX250F	06	-	-	-	W61-25021	W61-25022	W61-25023
		KX250F	07-18	W61-12021	W61-12022	W61-12023	W61-25021	W61-25022	W61-25023
		KX450F	07-09	W61-12021	W61-12022	W61-12023	-	-	-
		KDX220SR	10-18	W61-12021	W61-12022	W61-12023	W61-25021	W61-25022	W61-25023
		KDX125SR	94-99	W61-14021	W61-14022	-	W61-25051	W61-25052	W61-25053
KLX125		90-99	-	-	-	W61-25051	W61-25052	W61-25053	
KLX125		10-16	W61-13011	W61-13012	W61-13013	-	-	-	
KLX250		98-07	-	-	-	W61-25041	W61-25042	-	
D-TRACKER/X		08-16	W61-13021	W61-13022	-	W61-25041	W61-25042	-	
KLX125		98-16	-	-	-	W61-25041	W61-25042	-	
RM125/250		10-16	W61-13011	W61-13012	W61-13013	-	-	-	
SUZUKI		RM125/250	04-08	W61-12021	W61-12022	W61-12023	-	-	-
	RM125/250	04-06	W61-12021	W61-12022	W61-12023	-	-	-	
	RMZ250	09-15	W61-12021	W61-12022	W61-12023	W61-25021	W61-25022	W61-25023	
	RMZ250	16-18	W61-12021	W61-12022	W61-12023	-	-	-	
	RMZ250	08-15	W61-12021	W61-12022	W61-12023	W61-25021	W61-25022	W61-25023	
	RMZ450Z	16-18	W61-12021	W61-12022	W61-12023	-	-	-	
	RMX450Z	10-17	-	-	-	W61-25021	W61-25022	W61-25023	
	RMX250S	96-98	W61-14021	W61-14022	-	W61-28011	-	-	
	DRZ400S	00-08	W61-14021	W61-14022	-	W61-28011	-	-	
	DRZ400E	00-07	-	-	-	W61-28011	-	-	
DRZ400SM	05-17	W61-14011	-	W61-14013	W61-25061	-	W61-25063		

ABS not available.

WR250R WHEEL



Z-WHEEL BRAKE ROTOR CARRIER



- Brake rotor mount kit designed for WR250R hubs.
- Allow your WR250R hub to use WR250X larger brake discs for more stopping power.
- Made of durable aluminum with black anodized finish.

W41-83110

HC2

Height Control System

LIFT STAND



BLACK

RED

DRC
HC2 LIFT STAND

- Height adjustable lift stand for dirt bikes.
- Top plate is height-adjustable to fit under most dirt bikes.
- Easily operated durable double long-levered jack-pedal.
- Available red and black colors.
- Maximum lifting weight is 150 kgs. (330 lbs)

Part number	Color	PAT. 200520100979.6
D36-38-311	Black	
D36-38-312	Red	



Fits under most dirt bikes.
Adjustable range : 250 mm - 350 mm
(10 to 14 inches)



Damper shock eliminates the sudden drop, and provides a smooth, safe landing.



Designed for small to full size dirt bikes.



Easily operated durable double long-levered jack-pedal.



Height-adjustable top plate can be secured with the lock nut.



The Top Plate has a thick, non slip rubber surface.



" Safety Hold Hook " system prevents any accidents after lifting the bike.

STAND



TRANSPORT



TOOL



CONTROL



EXHAUST



ELECTRICAL



DRIVE



BODY



ACCESSORIES





Used by
JMX *Kawasaki Team GREEN*

DRC
RACER STAND

- Light weight aluminum box style racer stand.
- Weighs less than 3 kgs (105 oz) and is very stable.
- Stand available with or without panel.
- Made of aluminum. Stand height : 420 mm

.With panel **.Without panel**
Part number **Part number**
D36-31-011 **D36-31-021**



D36-31-011



D36-31-021

STAND



TRANSPORT



TOOL



CONTROL



EXHAUST



ELECTRICAL



DRIVE



BODY



ACCESSORIES



DRC
GARAGE STAND

- Box garage stand made of durable steel.
- Lower height, great to use with super Moto and dual sport bikes.

Part number
D36-31-102
Height : 375 mm



D36-31-102



REPLACEMENT TOP PLATE
Part number
D36-31-910



OPTION TRAY
Part number
D36-31-900

DRC
TRIANGLE STAND

- Quick and easy side stand, hooks into rear axle.
- For use on bikes with rear axles of inner diameters 18 mm, 14.5 mm, and 11 mm.
- When you need to move your bike, just hang it on the foot peg.

.MX type A 365 mm B 335 mm
Part number **Color**
D36-39-011 Gunmetal

.Super Motard type A 325 mm B 295 mm
- For SuperMoto bikes with 17 " wheels.

Part number **Color**
D36-39-021 Gunmetal

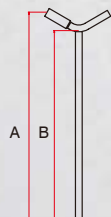

18 mm	Year	11 mm	Year	14.5 mm	Year
CR125R/250R	00-07	DT200WR	ALL	YZ125/250	99-18
CRF250R	04-17	KX125/250	90-02	YZ400F-450F	99-08
CRF450R	02-18	KDX200-250	ALL	YZ250F	01-08
CRF450RX	17-18	KLX250R/300R	ALL	YZ250FX	15-18
YZ250F	09-18	RM85L	ALL	YZ450FX	16-18
YZ450F	09-18	DR250R	ALL	YZ125X	17-18
RMZ450	05-18	DRZ400S/SM	00-16	YZ250X	16-18
RMZ250	04-18	125-530SX/SX-F	-12	WR250R/X	ALL
KX125/250	03-08	125-530EXC/EXC-F	ALL	RM125/250	02-08
KX250F	04-18	TC125	14-15		
KX450F	06-18	TC250	14-16		
125-530SX/SX-F	13-18	FC250/350/450	14-15		
TC125	16-18	TE/FE125-501	14-18		
TC250	17-18	TX125	17-18		
FC250/350/450	16-18				
FC250/450(US)	15-18				
TX300	17-18				
FX350/450	17-18				



DRC
HYBRID RAMP

Light weight construction

- Aluminum alloy, and nylon tube / plate construction.
- Tongue for attaching to truck bed.
- Nylon supports, lightweight, yet strong.
- Very compact when folded. (Folding type)
- 4 different sizes to suit any need.
- 20 cm width (8")

PAT. 200520100997.4



Non-slip rubber under the tongue to prevent slippage and protect your truck bed.



ABS constructed foot caps for stability.



4 different style ramps to fit your needs.



Folding type takes less space in your van or truck.

Straight type



D36-41-115

Folding type



D36-41-618

D36-41-621

D36-41-624

Straight type

Part number	Width × Length	Weight Capacity
D36-41-115	20 cm × 150 cm (8" × 5')	up to 210 kgs (463 lbs)

Folding type

Part number	Width × Length	Weight Capacity
D36-41-618	20 cm × 180 cm (8" × 6')	up to 190 kgs (419 lbs)
D36-41-621	20 cm × 210 cm (8" × 7')	up to 175 kgs (386 lbs)
D36-41-624	20 cm × 240 cm (8" × 8')	up to 165 kgs (364 lbs)



DRC
MOTO BINDING

- 2 way innovative style tire chock can be used for pit bikes to full size dirt bikes. (Accepts 8 to 21 inch wheels.)
- Maximum tire width : 130 mm / 5.2 inch
- Folding design saves space. Height is 135 mm / 5.4 inch when folded.
- Accepts mini wheels (Up to 12 inch) even while it is folded.
- Self lock function prevents arm from opening up unexpectedly from folded position.
- Using the wheel chock fitting kit (**D36-51-391**) makes it easy to attach and remove.

Part number
D36-51-101



DRC
WHEEL CHOCK

- Standard tire chock for your van or truck.
- Made of 22 mm diameter pipe.
- Maximum tire width : 130 mm (5.2 inch)
- Using the wheel chock fitting kit (**D36-51-391**) makes it easy to attach and remove.

Part number
D36-51-014



DRC
WHEEL CHOCK FITTING KIT

- Wheel Chock Fitting Kit makes it easy to attach and remove the DRC Moto Binding or Wheel Chock.
- 6.2 mm diameter x 10 mm. 2 pcs.

Part number
D36-51-391



DRC
TIE-DOWN HOOK STD

- Tie-down hook for your van or truck.
- Provides an additional hook point for tie downs.
- Clamp bolt : M8. 2 pcs.

Part number
D36-11-110

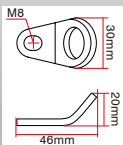

DRC
TIE-DOWN HOOK SWIVEL

- Swivel-style tie-down hook for your van or truck.
- Provides an additional hook point for tie downs.
- Clamp bolt : M8. 2 pcs.

Part number
D36-11-120

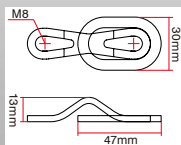

DRC
TRANSPORTER CLAMP HOOK

- Clamp hook for your van or truck.
- Provides an additional hook point for tie downs.
- Clamp diameter : 22 - 26 mm

Part number
D36-11-221



DRC
TIE-DOWN SOFT HOOK

- Designed to compensate for attachment points not accessible with hooks.
- Wrap around handle bars, sub frame etc and insert flat loop through twisted loop and attach tiedown hook.
- Comes in pairs.

Part number **Color**
D36-05-010 Blue
D36-05-020 Black
D36-05-030 Red

DRC
T2 RATCHET TIE-DOWNS

- Ratchet buckle tiedown for greater tensioning power.
- Vinyl coated hooks with 25 mm wide, thick and durable strap.
- Rubber covers on ratchet handle and release levers.
- Easy to operate even in narrow and small spaces.
- Comes in pairs.
- Comes with loop strap to prevent damaging your bike.
- Safety hook included to prevent from coming off.

Part number **Color**
D36-05-510 Blue
D36-05-520 Black
D36-05-530 Red

DRC
T2 CAM BUCKLE TIE-DOWNS

- Standard cambuckle tiedown.
- Vinyl coated hooks with 25 mm wide, thick and durable strap.
- Comes in pairs.
- Comes with loop strap to prevent damaging your bike.
- Safety hook included to prevent from coming off.

Part number **Color**
D36-05-410 Blue
D36-05-420 Black
D36-05-430 Red



Comes with karabiner secure hook.



Comes with loop strap to prevent damaging your bike.

STAND



TRANSPORT



TOOL



CONTROL



EXHAUST



ELECTRICAL



DRIVE



BODY



ACCESSORIES



Water repellent
finish



**Best for use with
pick up truck**

RACER COVER

DRC
RACER COVER

- Specially designed for MX and ED race bikes. (Over 125 cc)
- The bike can be moved with the cover on by opening the front and rear zippers.
- Secure adjustment of tie down belts by opening upper zipper.
- Protect your bike during transportation.
- Bike cover can be used in pits to keep your bike clean and protect the bike from night dew.

Part number
D57-01-505

Size
223 cm (87.8 inch) Height : 140 cm (55 inch)



Able to load the racing bike with covers on.



Usable with ZETA hand guards.



Belt loops on front and center of bike cover to prevent wind flap during transport.



Convenient double sliders of the zippers for handlebar provide a wide range of adjustment.

- STAND
- TRANSPORT
- TOOL
- CONTROL
- EXHAUST
- ELECTRICAL
- DRIVE
- BODY
- ACCESSORIES

How to load the racing bike on a truck with the cover on.



Remove the hook and loop fastener and open the zipper on the front wheel.



Lace the hook and loop fastener into the loop on the front fender and secure.



Loosen the hem adjusting cord at bottom center on the bike cover.



Now the front tire is free to move.



Lace the hook and loop fastener into the loop on the rear fender and secure.



The state after the flaps secured.



Now the rear tire is free to move.



Wrap a tie-down soft hooks around the handlebar then load on a truck.



DRC

OFF ROAD MOTORCYCLE COVER



- Off-road cover, all-weather type.
- Oxford fabric with excellent strength and durability.
- Front side colored in blue to easily find cover direction.
- Slit openings in front and back for security lock.
- Set the belt in the center to prevent rattling by wind.
- Comes with a storage bag (Convenient belt to hook at the bottom).

Part number	Medium Size	Size	
		Length	Height
D57-01-101	Medium Size	225 cm (88.58 inch)	160 cm (62.99 inch)
D57-01-112	Dual Sport Model	Length	250 cm (98.43 inch)
		Height	175 cm (68.9 inch)



Storage bag has a mesh panel to drain water from wet bike cover.

Dual sport model



Medium Size



Dual Sport Model



Slit openings on front and back for security lock.
Lock diameter : 6 cm / 2.4 inch



Reduce flapping by wind. Easy to install with buckle type.



Ventilation on the both sides.



Rubber shirring provided for secure installation.

Medium Size



Hem adjusting cord provides tight cover fit on your bike to prevent flapping of the cover.



Slit openings on front and back for security lock.
Lock diameter : 6 cm / 2.4 inch



2 adjustable belts prevent bike cover wind flap. Easy to use with buckles on the belts.



Storage bag has a mesh panel to drain water from wet bike cover. Loop for easy storage and drying.

Fitting application

Size	HONDA	YAMAHA	SUZUKI	KAWASAKI	KTM	HUSQVARNA	GASGAS	etc.
Dual Sport Model	CRM250/R/AR XR250/400Motard XR250/R/Baja XR400R/600R/650R XLR125R/200R XLR250/R/Baja CRF250L/M CRF250RALLY	DT125R/200R DT200WR DT230 Lanza TTR250R/Raid WR250R/X Serow250 XT400E Artesia	Djebel125/200/250 Djebel250XC DR250/S/R DR350 DRZ400/S/SM/R RMX250S/R DF125E/200E TS125R/200R SX125R/200R Van Van200 250SB V-strom250	KDX125SR/200SR KDX220SR KDX250SR KLX250/S/R/SR/ES/SF KLX300R/450R D-Tracker/X KLE250/400 250TR VERSYS-X 250	125EXC/ 200EXC 250EXC/-R/-F 300EXC 400LC-4 400EXC/-R 450EXC/-R 525EXC-R 530EXC/-R 690 Enduro/ SMC	TE250/310 TE450/630 WR125/250/360 SM125/250R SM400R/450R SM450RR/510R SM570/610 SMS630	Halley125R EC125/250 EC450	Husaberg TE250 Husaberg FE390/450 Husaberg FE570 Husaberg FS570 tm EN250
M	CRM50/80 XR50/100 Motard XR230/Motard FTR223/TLM220R SL230 XL230 Degree AX-1	DT50 XTZ125E TT-R125LW/LEW TW200/E TW25/E Serow225/W/WE XT250X Tricker/Bronco	TS50R GrassTracker BigBoy	D-Tracker125 Super Sherpa KLX125/150S			Pampera125	

DRC
HARDWARE

STAND



TRANSPORT



TOOL



CONTROL



EXHAUST



ELECTRICAL



DRIVE



BODY



ACCESSORIES



DRC

PRO SPOON TIRE IRON WITH WRENCH

- One end fits the axle nut, the other end is a tire tool.
- Made of heat treated steel.
- 25 cm (10") to 26.5 cm (10.6") wrench length.
- Wrench available in 6 sizes.

Part number	Wrench Size	Part number	Wrench Size
D59-10-917	17 mm	D59-10-924	24 mm
D59-10-919	19 mm	D59-10-927	27 mm
D59-10-922	22 mm	D59-10-932	32 mm



AXLE SHAFT NUT CHART

Bike	Year	Front	Rear
HONDA			
CR80R/85R		19mm	22mm
CR125R/250R		22mm	32mm
CRF150R	07-18	22mm	24mm
CRF250R/450R	02-18	22mm	32mm
CRF450RX	17-18	22mm	32mm
CRF250X/450X	04-17	22mm	32mm
CRM50/80		19mm	22mm
CRM250/R/AR		19mm	24mm
CRF250L/M	12-16	17mm	24mm
	17	-	24mm
CRF250RALLY	17	-	24mm
XR230		17mm	24mm
SUPER XR250/BAJA		17mm	24mm
YAMAHA			
YZ125/250	-18	22mm	27mm
	-08	22mm	27mm
YZ250F	09	22mm	32mm
	10-18	22mm	30mm
	-08	22mm	27mm
YZ450F	09	22mm	32mm
	10-18	22mm	30mm
YZ125X	17-18	22mm	27mm
YZ250X	16-18	22mm	27mm
YZ250FX	15-18	22mm	27mm
YZ450FX	16-18	22mm	27mm
WR250F/450F	-18	22mm	27mm
DT230LANZA		17mm	27mm
SEROW225		22mm	22mm
SEROW225WE		22mm	19mm
XT250/SEROW250	05-17	19mm	19mm
TT250R/RAID		17mm	24mm
WR250R/X	07-17	22mm	27mm
KAWASAKI			
KX65		17mm	17mm
KX85/100	-18	17mm	18mm
KX125/250	-08	22mm	32mm
KX250F/450F	04-	22mm	32mm
KLX450R	08-	22mm	32mm
KLX125	10-16	17mm	22mm
D-TRACKER125	10-16	17mm	22mm
KLX250	98-07	17mm	27mm
D-TRACKER	98-07	17mm	27mm
KLX250	08-16	19mm	27mm
D-TRACEKR X	08-16	19mm	27mm
SUPER SHERPA		17mm	22mm



Bike	Year	Front	Rear
SUZUKI			
RM125/250	-08	21mm	32mm
RMZ250	04-06	22mm	32mm
	07-18	21mm	32mm
RMZ450	05-18	21mm	32mm
RMX250S/R		19mm	24mm
DJEBEL125/200		17mm	19mm
DJEBEL250		19mm	19mm
DR250S		17mm	24mm
DR250R		19mm	24mm
DRZ400S/SM	00-17	24mm	24mm
250SB		17mm	27mm
KTM			
85SX		14mm	27mm
125-450SX/SX-F/XC-F	-12	27mm	27mm
	13-	27mm	32mm
125-450EXC/EXC-F/XC-W		27mm	27mm
FREERIDE250R/350		14mm	27mm
HUSQVARNA			
TC85	14-18	14mm	27mm
	14-15	27mm	27mm
TC125	16-18	27mm	32mm
	14-16	27mm	27mm
	17-18	27mm	32mm
TC250	14-15	27mm	27mm
	16-18	27mm	32mm
FC250/350/450	15-18	27mm	32mm
FC250/450(US)	15-18	27mm	32mm
TE/FE125-501	14-18	27mm	27mm
TX125	17-18	27mm	27mm
TX300	17-18	27mm	32mm
FX350/450	17-18	27mm	32mm

DRC

BEAD HOLDER

- Keeps the tire bead down during the tire change.
- Hooks over the spoke and pushes down on the bead for easy tire installation.
- Durable rubber grip for easy operation.

Part number
D59-11-071



1. Insert the tire bead into the wheel rim after installing the tube.



2. Insert lever part of the bead holder into the wheel rim and hook over spoke as shown above picture.



3. Keep the tool inserted and insert the tire bead into the wheel rim.



4. Tire bead won't come off with bead keeper. Smooth and easy operation.



DRC AIR VALVE CORE DRIVER

- Valve core remover designed for quick operation.
- Remover tip is made of chrome molybdenum steel for durability.
- Aluminum knurled grip.
- Length : 45 mm

Part number Color
D59-04-100 Titanium
D59-04-103 Red



DRC PRO SPOON TIRE IRON

- Designed for all types of tire changing needs.
- The bend of the lever and wide spoon area is designed for quick and easy tire removal.
- The durable rubber grip provides better grip.
- Available in 2 different lengths.

Part number Color
D59-10-113 230 mm (9.2")
D59-10-012 260 mm (10.4")



DRC TIRE IRON 400 mm

- Standard tire lever.
- Long length for easy operation for hard tire removal.
- Made of durable heat treated steel.

Part number
D59-10-005



DRC BEAD CREAM

- Compact bead cream fits any tool box.
- Comes in a compact plastic case. (Net : 40 g)
- Includes application sponge.

Part number
D51-50-120

STAND



TRANSPORT



TOOL



CONTROL



EXHAUST



ELECTRICAL



DRIVE



BODY



ACCESSORIES



NO REQUIRES TOOL!

Before

Hard to approach with tool and to pump air in.



DRC
AIR VALVE BIG NUT

- Nut for valve stem that can be used without a wrench.
- Also for use as a tool to help pull off the air valve stem when changing the tire and keep the valve stem out when pumping the air in.
- Knurled surface is easy to turn.

Part number Color Size
D59-04-220 Red W 20 mm x T 6 mm

After



STEP1: Pass air valve puller head through the valve hole.



STEP2: Install valve puller head on air valve on the tube.



STEP3: Replace air valve in the tire.



STEP4: Pull on the air valve wire. The air valve will appear.



MXA RATING



This simple little tool is worth its weight in gold when it comes time to go valve stem fishing.

DRC
AIR VALVE PULLER

- Easy to pull the air valve stem through the hole on the rim.
- Useful during tire changes and flat repairs.
- Air valve puller head may also be used for air valve core removal.

Part number Color
D59-38-201 Black
D59-38-202 Red
D59-38-203 Blue



DRC
AIR VALVE CORE DRIVER

- Valve core remover designed for quick operation.
- Remover tip is made of chrome molybdenum steel.
- Aluminum knurled grip.
- Length : 45 mm

Part number Color
D59-04-100 Ti-Color
D59-04-103 Red

STAND



TRANSPORT



TOOL



CONTROL



EXHAUST



ELECTRICAL



DRIVE



BODY



ACCESSORIES





Presta / Schrader
Motorcycle / MTB
Dual stroke

DRC
C301 MINI PUMP

- Dual stroke internal parts, pumps on both pushing and pulling motion.
- Light weight and compact 6063 aluminum barrel.
- T-handle for easier inflation.
- Reversible adapter fits Presta and Schrader valves.

Part number : **D59-35-301**
Maximum Pressur : 820 kPa / 120 psi
Body size : L 270 x W 40 x H 25 mm
Weight : 110 g

Folding position



Presta / Schrader
Motorcycle / MTB
Anti-Air Loss valve

DRC
C303 MINI PUMP

- Portable mini pump made of CNC machined aluminum.
- Integrated extendable hose for portability.
- One touch switchover valve system fits Presta and Schrader valves.
- Anti air loss valve attachment prevents air from leaking during pumping.

Part number : **D59-35-303**
Maximum Pressur : 550 kPa / 80 psi
Body size : L 240 x W 25 x H 25 mm
Weight : 135 g

Folding position

One touch switchover valve system



Presta / Schrader
Motorcycle / MTB
Floor type

DRC
C302 MINI FLOOR PUMP

- Floor pump style for stable air pumping.
- Compact design for portability.
- T-handle for easier inflation.
- Rotating and extendable hose for easy operation.

Part number : **D59-35-302**
Maximum pressur : 960 kPa / 140 psi
Body size : L 275 x W 50 x H 30 mm
(Folded position)
Hose length : 300 mm
Weight : 153 g

Folding position

360 degree rotating hose



Presta / Schrader
Motorcycle / MTB

DRC
G101 AIR GAUGE

- Air gauge specially designed for motorcycle and mountain bike.
- Micro adjust button for sensitive air reduction adjustment.

Part number : **D59-36-101**
Pressur range : 0 - 400 kPa (58 psi)
Body size : L 105 x W 50 x H 30 mm
Weight : 95 g

Micro adjust button

Schrader

Presta



Presta / Schrader
Motorcycle / MTB

DRC
F501 FLOOR PUMP

- Pump body is made of durable aluminum tube for lighter weight and durability.
- High pressure with minimum pumping power.
- Smart head air valve head automatically adjusts to fit Presta and Schrader valves.

Part number : **D59-35-501**
Maximum pressur : 1079 kPa (11 kgf / cm²)
Body size : H 610 mm x W 240 mm
Weight : 1.0 kg

Smart head



Presta / Schrader
Motorcycle / MTB

DRC
F503 FLOOR PUMP

- Pump body is made of durable aluminum tube for lighter weight and durability.
- High pressure with minimum pumping power.
- Smart head air valve head automatically adjusts to fit Presta and Schrader valves.
- Micro adjust button on Smart head for precise air adjustment.

Part number : **D59-35-503**
Maximum pressur : 1079 kPa (11 kgf / cm²)
Body size : H 650 mm x W 260 mm
Weight : 1.1 kg



Gauge



Micro adjust button

Smart head

Digital SHOCK PUMP

DRC DIGITAL SHOCK PUMP 2000 kpa (300 psi)

- Comes with maximum 300 psi high accuracy digital gauge for sensitive air adjustment.
- Pressure unit is switchable to psi, bar, Kg and cm².
- Swivel valve is easy to connect even in limited spaces.
- Micro adjust button for sensitive air pressure adjustment.
- Pump cylinder is made of A6063 aluminum alloy.
- 207 g light weight body.
- Long stroke air pump design for more air pumping and less pumping time for big bore front fork on MX bikes.
- 290 mm rotating long air hose.
- LCD display is clear and easy to see.

Body Size L 365 mm x W 30 mm x H 35 mm
Body Weight 233 g

Part number [D59-35-105](#)

2000kPa
300psi



360° rotating long air hose



Swivel Head

LONG BARREL

SHOCK PUMP

DRC SHOCK PUMP 1500 kpa (220 psi)

- Suspension air pump developed for front air suspension equipped models.
- Specially designed gauge for the new air suspension shows accurate air pressure. Max 15 bar (220 psi)
- Long stroke pump body designed for fewer pumps.
- Swivel valve is easy to connect even in limited spaces.
- Micro adjust button for precise air pressure adjustment.

Body Size L 365 mm x W 82 mm x H 37 mm
Body Weight 240 g

Part number [D59-35-102](#)

Replace swivel hose
Part number [D59-35-189](#)

Replace gauge
Part number [D59-35-182](#)

1500kPa
220psi



Big panel display



Swivel Head

LONG BARREL

SHOCK PUMP

DRC SHOCK PUMP 350 kpa (50 psi)

- Suspension air pump developed for front air suspension equipped models.
- Specially designed gauge for the new air suspension shows accurate air pressure. Max 3.5 bar (50 psi)
- Long stroke pump body designed for fewer pumps. (Approximately 60 pumps per fork leg.)
- Swivel valve is easy to connect even in limited spaces.
- Micro adjust button for precise air pressure adjustment.

Body Size L 365 mm x W 82 mm x H 37 mm
Body Weight 240 g

Part number [D59-35-101](#)

Replace swivel hose
Part number [D59-35-189](#)

Replace gauge
Part number [D59-35-181](#)

350kPa
50psi



Big panel display



Swivel Head

LONG BARREL

DRC AIR VALVE ADAPTER 69 mm

- Easy access to the air valve in the back place where shock pump was difficult to access.
- * Please be sure to install it on the shock pump and then set it on the bike. Part number [D59-37-162](#)

STAND



TRANSPORT



TOOL



CONTROL



EXHAUST



ELECTRICAL



DRIVE



BODY



ACCESSORIES



DRC

FORK CAP WRENCH

- Wrench for removing front fork cap.
- 2 wrench sizes available, 49 mm for KYB and 50 mm for SHOWA and 50 mm KTM WP front fork .
- Open wrench design for easy operation in small spaces.
- Opposite end of the wrench is a rod stopper to hold piston rod when removing piston inner cartridge.
- Socket hole available for torque wrench. (Socket size is 9.5 sq = 3 / 8 inch)
- Made of durable steel, electro coating finish with DRC sticker.



KYB 49 mm

SHOWA 50 mm

WP 50 mm

Bike	Year	F-Fork	Part #
CRF450R	09-14	KYB (49 mm)	D59-24-001
YZ125/250	06-18		
YZ250F	06-18		
YZ450F	06-18		
YZ250X	16-18		
YZ250FX	15-18		
YZ125X	17-18		
YZ450FX	16-18		
WR250F	15-18		
WR450F	13-18		
KX450F	06-14	SHOWA (50 mm)	D59-24-002
RMZ250	16-18		
CRF250R	04-17		
CRF450R	04-08		
CRF450RX	17-18		
CRF250X	06-17		
CRF450X	05-17		
KX250F	06-16		
KX450F	15-18		
RM125	08-08		
RM250	07-08		
RMZ250	07-15		
RMZ450	05-18		
RMX450Z	10-17		
DRZ400SM	05-17	WP (50 mm)	D59-24-003
125-150SX	07-15		
125-150SX(AIR)	16-18		
250SX/SX-F	07-15		
250SX/SX-F(AIR)	16-18		
350SX-F	11-15		
350SX-F(AIR)	16-18		
450SX-F	07-15		
450SX-F(AIR)	16-18		
150XC	10-13		
250/300XC	08-13		
250-450XC-F	08-13		



STAND



TRANSPORT



TOOL



CONTROL



EXHAUST



ELECTRICAL



DRIVE



BODY



ACCESSORIES



DRC

FORK COMPRESSION VALVE REMOVAL TOOL

- Fork compression valve removal tool for KYB, SHOWA, and KTM WP front forks.
- Use this tool with DRC fork cap wrench for removing compression valve from the inner cartridge.
- Made of aluminum, anodized finish with DRC laser printed logo and wrench size.



KYB

WP

4CS



Bike	Year	F-Fork	Part #	Bike	Year	F-Fork	Part #	Bike	Year	F-Fork	Part #		
YZ125/250	05-18	KYB	D59-24-016	CRF450R	09-12	KYB	D59-24-016	KX250F	13-18	SHOWA	D59-24-020		
YZ250F/450F	05-18												
YZ125X	17-18												
YZ250X	16-18												
YZ250FX	15-18					KX450F	05-08			RM-Z450	15-18	WP	D59-24-026
YZ450FX	16-18					KLX450R	06-12				15-17		
WR250F	17-18									KTM	-	WP(4CS)	D59-24-027
WR450F	12-18												

DRC

SEALING BOLT ATTACHMENT

- Removable tool for SHOWA SFF air fork bottom sealing bolt.
- Specially designed for SHOWA SFF Air fork.
- Sealing bolt size = Allen key 22 mm
- Can be used front suspension equipped on CRF250R, KXF450, RMZ450'15-

Part number
D59-37-120 SHOWA SFF-AIR



FORK SEAL DRIVER

FORK DIAMETER
Φ40 - Φ50



CAN BE USED FOR FULL SIZE MX, ED AND DUAL SPORTS BIKES



DRC FORK SEAL DRIVER 40-50

- Specially designed fork seal driving tools for front forks.
- Comes with 5 different size plastic adapters. Can be used for almost all of conventional and up side down front forks.
- Flange shape design of steel body for accurate operation with less power.

Body : Steel Body
 adapter size (mm):40/41,42/43,45/46,47/48,49/50
 Part number **D59-26-005**
 Replacement adapter set **D59-26-909**



■ Fork diameter 40 mm - 50 mm

Use the best size from 5 adapters.
 Won't damage seals.
 Fitting angle of the seals will always be correct.

■ Ergonomic flange body shape

Flange body shape for accurate operation.
 Best body weight to drive seals.



■ Plastic adapters to prevent damage to inner tube

Plastic adapters won't damage inner tube during seal driving.



DRC FRONT FORK SEAL INSERT GUIDE

- Front fork dust and oil seal insert guide.
- Prevents damaged seals during installation.
- Made of smooth surface stainless steel for easy installation of your dust and oil seals.
- Available many sizes to fit most motorcycle front forks.

Part number	Size	Part number	Size
D59-37-141	41 mm	D59-37-148	48 mm
D59-37-143	43 mm		
D59-37-145	45 mm		
D59-37-146	46 mm		

STAND



TRANSPORT



TOOL



CONTROL



EXHAUST



ELECTRICAL



DRIVE



BODY



ACCESSORIES



REAR SUSPENSION TOOL



KYB

SHOWA 1

SHOWA 2

WP



BLEEDING BOLT TYPE

Use only cup for the suspension equipped air bleeding bolt.

DRC RCU BLEED CUP

- Air bleed cup for KYB, SHOWA and WP rear suspensions.
- Make your rear suspension air bleeding easy.
- Titanium anodized with DRC laser printed logo on cup body.
- Can be used with suspension comes with bleeding bolt hole.

Part number	Suspension	Color
D59-37-157	WP	Orange / Blue
D59-37-158	SHOWA 1	Blue
D59-37-159	SHOWA 2	Gold
D59-37-160	KYB	Red

Bike	Year	Part #
CR250R	00-07	
CRF250R	04-17	
	02-08	
CRF450R	09-16	D59-37-158
	17-18	
CRF450RX	17-18	
CRF250X	04-17	
CRF450X	05-17	
YZ125	00-18	
YZ250	00-18	
YZ250F	01-18	
YZ426F/450F	00-18	
YZ125X	17-18	D59-37-160
YZ250X	16-18	
YZ250FX	15-18	
YZ450FX	16-18	
WR250F	03-18	
WR450F	03-18	
KX80/85	89-13	D59-37-160
KX125	00-08	D59-37-160
KX250	00-08	D59-37-160
KX250F	04-05	D59-37-160
	06-18	D59-37-158
KX450F	06-14	D59-37-160
	15-18	D59-37-158
KLX450R	07-16	D59-37-160
RM250	01-02	D59-37-160
	04-06	D59-37-160
RM-Z250	07-15	D59-37-159
	16-18	D59-37-160
RM-Z450	08-17	D59-37-159

Bike	Year	Part #
TC85	14-18	D59-37-157
TC125	14-18	D59-37-157
TC250	12-13	D59-37-160
	14-18	D59-37-157
TC449	11-13	D59-37-160
FC250	14-18	D59-37-157
FC350	14-18	D59-37-157
FC450	14-18	D59-37-157
TE125	14-16	D59-37-157
TE150	17-18	D59-37-157
TE250	12-13	D59-37-160
	14-18	D59-37-157
TE300	14-18	D59-37-157
TE310	12-13	D59-37-160
TE449	11-13	D59-37-160
TE511	11-13	D59-37-160
FE250	14-18	D59-37-157
FE350	14-18	D59-37-157
FE350S	15-16	D59-37-157
FE450	14-18	D59-37-157
FE501	14-18	D59-37-157
FE501S	15-16	D59-37-157
TX125	17-18	D59-37-157
TX300	17-18	D59-37-157
TXC449	11-13	D59-37-160
TXC511	11-13	D59-37-160
FX350	17-18	D59-37-157
FX450	17-18	D59-37-157

Bike	Year	Part #
85SX	04-18	
125SX	01-18	
150SX	09-18	
250SX	02-18	
250SX-F	06-18	
350SX-F	11-18	
450SX-F	03-18	
125EXC	05-16	D59-37-157
200EXC	05-16	
250EXC/TPI	05-18	
300EXC/TPI	05-18	
250EXC-F	06-18	
350EXC-F	12-18	
450EXC-F	08-18	
500EXC	12-18	

Bike	Year	Part #
150XC	10-14	
250XC	06-18	
300XC	06-18	
250XC-F	11-18	
350XC-F	11-18	
450XC-F	08-18	
125XC-W	17-18	
150XC-W	17-18	D59-37-157
200XC-W	06-16	
250XC-W	06-18	
300XC-W	06-18	
250XCF-W	06-16	
350XCF-W	12-16	
450XC-W	07-16	
500XC-W	12-16	



Rotating bleed cup to change its angle for better air bleeding.

OIL STOPPER

Oil stopper in cup prevents sudden oil spit.

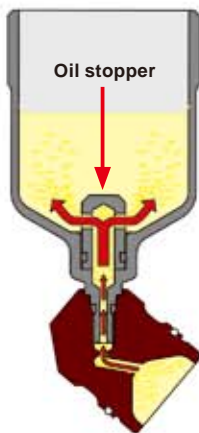

DRC GAS CAP EXTRACTOR

- Special tool for removing rear suspension gas cap.
- Does not damage gas cap valve thread.

Part number **D59-37-110**



Also useful to pull out the top cap of the air front suspension.

STAND



TRANSPORT



TOOL



CONTROL



EXHAUST



ELECTRICAL



DRIVE



BODY



ACCESSORIES



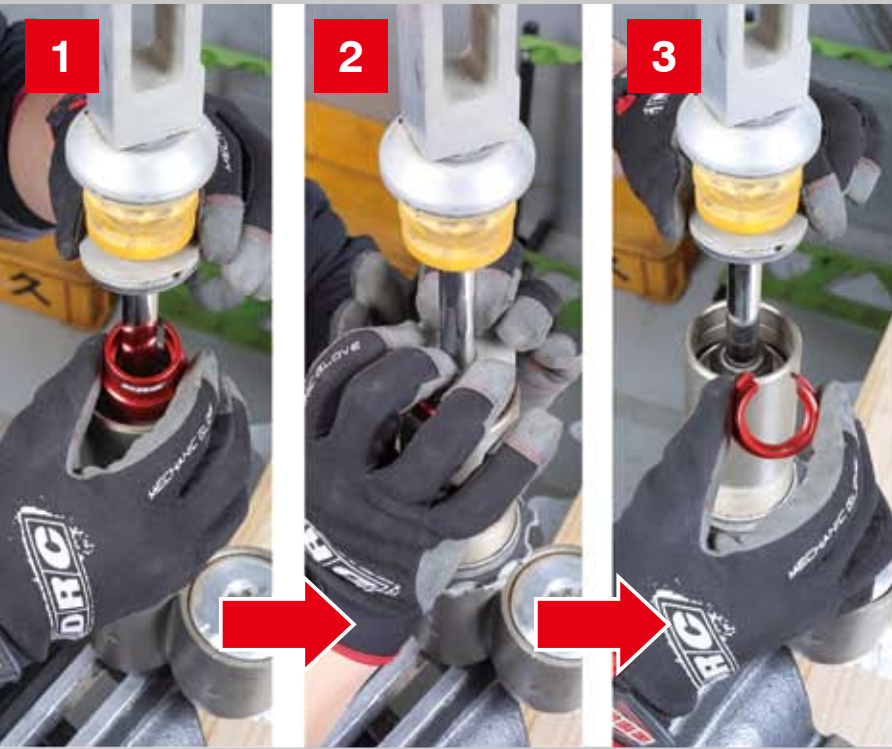

DRC
SEAL HEAD PUSH TOOL

- A useful tool for disassembling rear shock.
- It can be easily pushed down without damaging the seal head when detaching the circlip of the shock body.

Part number **D59-37-166**

STAND



TRANSPORT



TOOL



CONTROL



EXHAUST



ELECTRICAL



DRIVE



BODY



ACCESSORIES



DRC
COMP ADJUSTER SOCKET 24 mm

- A special tool to remove the compression adjuster of the rear shock.
- It is possible to easily remove the shock body of a shape which doesn't allow to be approached by the spanner or the monkey wrench for 24 mm width.
- By providing a square hole of 3/8 inch socket, you can use the ratchet wrench to increase work efficiency and use torque wrench to control tightening torque.

Part number **D59-37-164**



DRC
RCU SEAL HEAD INSERT KIT

- Seal guide for Rear suspension seal head.
- Does not damage oil seal during installing suspension seal.
- Comes with 3 different sizes, 14 mm, 16 mm and 18 mm.

Part number **D59-37-135**



DRG
SAG CHECKER

- Allows you to measure suspension sag by yourselves easily.
- Compact design, it does not take much space in your tool box.
- Measure front and rear suspension sag easily with this kit.
- Clamp comes with rubber and will not damage your plastic fenders or side panels.
- Clamp anywhere on side panels, rear fender or sub frames, to measure suspension sags.

Part number **D59-37-180**

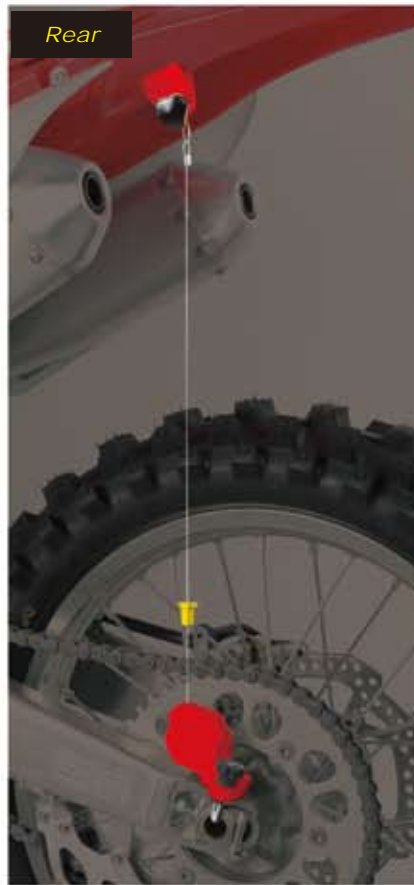

Rear



Front



DRG
LINK LUBE INJECTOR

- Linkage bearing grease tool.
- Allows placing bearing needles on bearing race while greasing linkage bearing.
- Will fill enough grease on your suspension linkage bearing.
- Clean linkage grease work with this tool.

Part number **D59-18-301**

Remove injector body slowly and place remaining bearing needle on bearing race.

5

* Can not place all bearing needle on injection body.



1

Fill grease and push grease out.



2

Place your bearing needles on injector body.



3

Insert injector into linkage carefully.



4

Inject grease and push down sleeve to place bearing on bearing race.



DRC
SPRING COMPRESSOR

- Spring removal tool for twin shock motorcycles.
- 2 spring hooks hold the springs secure while compressing the springs, making it easy to remove the springs from the shock bodies.

Part number **D59-29-101**

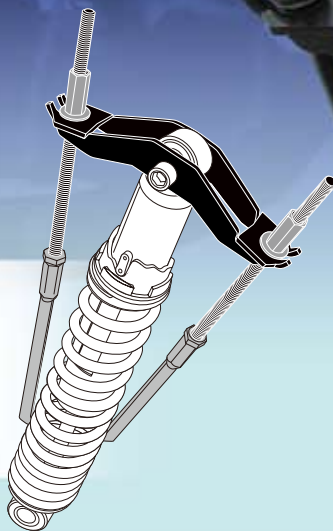

STAND



TRANSPORT



TOOL



CONTROL



EXHAUST



ELECTRICAL



DRIVE



BODY



ACCESSORIES



DRC
FORK OIL SEAL REMOVER

- Using the principle of leverage, the fork seal removal tool makes removing fork seals easy.
- Won't scratch your front fork body. * Do not reuse oil seal.

Part number **D59-28-010**

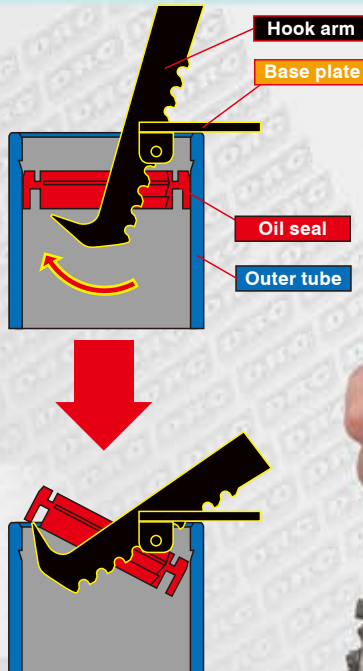

DRC
STEERING STEM TOOL

- Wrench for steering stem nut.
- Can be used for all off-road and road bikes.
- Precision laser cut for accurate fit on most steering stem nut.
- 6 mm thickness to access stem nut without removing top triple clamp.
- Made of durable steel, electro coated finish with DRC sticker.

Part number **D59-12-112**

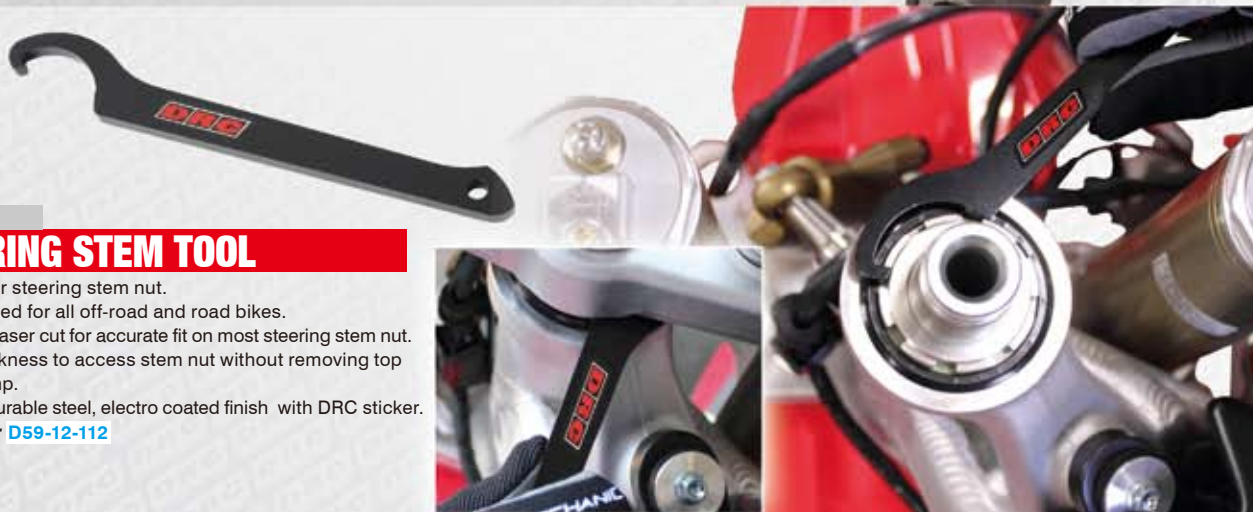

GYROSTAND

SERIES

STAND



TRANSPORT



TOOL



CONTROL



EXHAUST



ELECTRICAL



DRIVE



BODY



ACCESSORIES



This special wheel tool makes your wheel truing and balancing easy. Build your own wheels with GYROSTAND.



DRC
GYRO STAND

- One stand works for truing, balancing wheels and checking bearings.
- Durable frame provides stability for accurate wheel truing and balancing.
- Accepts rim widths up to 5.0 inches, rim sizes up to 23 inches.
- Foldable design saves space.
- Use on wheels with bearing inner diameter of more than 15mm.

Part number **D36-52-110**

* Optional shaft set is required for bearing diameters less than 15 mm.

MXA RATING



Given its reasonable price, the DRC Gyro stand could pay for itself in a couple of do-it-yourself wheels-truing sessions.

**Wheel Truing
Bearing Check**

Wheel Balance



Lock wheel rod for wheel truing and bearing check.



Double bearing roller for wheel balancing.



Can be folded to a very compact size for storage.

DRC
OPTIONAL 10 mm SHAFT SET

- For wheel bearings with inner diameters from 10 mm to 15 mm.

Part number **D36-52-191**



**Wheel Truing
Bearing Check**

Wheel Balance

DRC
GYRO EASY

- Simple wheel balancing, truing and bearing check kit.
- Light weight and compact design.
- Can be used on all motorcycle wheels.
- Can be used on wheels with bearing diameter of more than 15 mm.

Part number **D36-52-120**

* Optional shaft set is required for bearing diameters less than 15 mm.



STAND



TRANSPORT



TOOL



CONTROL



EXHAUST



ELECTRICAL



DRIVE



BODY



ACCESSORIES



DRC PRO CHAIN TOOL

- Designed to break, press side plates and rivet most 420, 428, 520, 525 and 530 standard and O-ring chains.
- Light weight aluminum body.
- Straight forward parts construction.
- Conveniently store cut and rivet pins in the handle.
- Fits nicely in the tool box and no loose parts.
- Replacement cut pins and rivet pin available.

Part number
D59-16-112



Stored in handle



STAND



TRANSPORT



TOOL



REPLACEMENT PARTS

Replacement anvil set
Part number D59-16-142

Replacement cut pin set
Part number D59-16-143

Replacement rivet pin
Part number D59-16-144

DRC ALUMINUM CHAIN CUTTER

- Very compact chain cutter for 420 to 520 size chains.
- Compact design for easy storage.
- Chain cutter body is made of light weight aluminum.
- Cutting pin is made of durable chromoly.
- Available in 3 anodized colors, silver, black and blue.

Part number **Color**
D59-16-340 Silver
D59-16-351 Black
D59-16-352 Blue



Replacement pin
Part number D59-16-333

DRC CHAIN BRUSH

- Drive chain cleaning brush.
- " L " shaped brush easily cleans the chain.
- Aluminum tube handle designed for comfortable operation.
- Available in blue, red and titanium anodized handle colors.
- Replacement brushes available.

Part number **Color**
D59-22-001 Blue
D59-22-002 Red
D59-22-003 Titanium

Replacement brushes set

Part number
D59-22-990



CONTROL



EXHAUST



ELECTRICAL



DRIVE



BODY



ACCESSORIES





Extension ratio shown by percentage.

DRG
CHAIN CHECKER

- Chain extension ratio checker. Very easy to check chain extension on your bike.
- Chain sizes from 420,428,520,525 and 530 can be checked.
- Chain play gauge is printed on the body.

Part number
D59-16-801



Can be used as gauge for chain play.



A. Lightly attach Chain Checker on the chain roller.



B. Lower the measuring nib. Extension rate will be shown on measuring nib where it touches the chain roller.



DRG
PRO SPOKE WRENCH

- Interchangeable tips to fit 8 sizes of spoke nipples.
- Main shaft is CNC precision machined from 7075A aluminum and designed for optimum grip.
- Tips are made of heat treated steel for strength.
- Available in 3 hard anodized colors.
- Standard and mini sizes available.



Tips Size 5.6 - 7.0 (Standard)
(5.6 / 5.8 / 6.0 / 6.2 / 6.4 / 6.6 / 6.8 / 7.0 mm)

Part number **Color**
D59-15-060 Titanium
D59-15-061 Red
D59-15-062 Blue

Tips Size 4.0 - 6.2 (Mini)
(4.0 / 4.4 / 5.0 / 5.2 / 5.6 / 5.8 / 6.0 / 6.2 mm)

Part number **Color**
D59-15-160 Titanium
D59-15-161 Red
D59-15-162 Blue

DRG
SPOKE WRENCH CRF50/DRZ50

- Spoke wrench for CRF/XR50, DRZ50/70 and KX65
- Tip size is 4.0 mm for stock CRF/XR50, DRZ50/70 and KX65 spoke nipples, 5.0mm size for after market spoke nipples.
- Made of durable steel.

Part number **Tips Size**
D59-15-900 4.0 mm & 5.0 mm



STAND



TRANSPORT



TOOL



CONTROL



EXHAUST



ELECTRICAL



DRIVE



BODY



ACCESSORIES



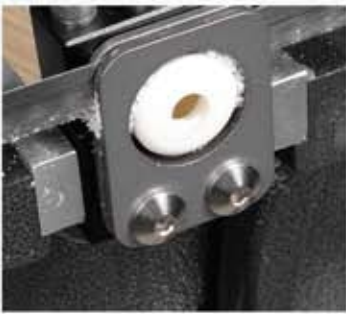

Throttle tube cut



Handlebar cut 1



Comes with 5 mm hole drilling guide for handlebar.



Handlebar cut 2



DRC HANDLEBAR SAW GUIDE

- Saw guide designed to easily cut handlebar and throttle tube.
- Make your handlebar cut easy and vertically.
- Comes with 5 mm hole drilling guide for handlebar.
- *Do not over tighten when you set this saw guide on throttle tube.
- *Do not use electric saw with this kit.

Part number Cutting pipe size
D59-45-211 From 22.2 mm to 26 mm



DRC AIR VALVE EXTENSION with HOSE

- Air valve extension with a hose.
- Easy to operate with flexible rubber hose.
- Hose length : 150 mm

Part number **D58-12-110**



DRC AIR VALVE EXTENSION

- Extension air valve changes the valve angle.
- Great for use on small wheel motorcycle, motard wheels with a big brake disc.
- For use with straight type air pump hose.

Part number **D58-12-100**



DRC TIMING PLUG WRENCH

- Wrench can be used for most motorcycle engine plugs.
- Comes with 4 different wrench sizes.
- Made of durable steel with black electro coating finish for less corrosion.
- Can be used for helmet viser screws.

Part number **D59-45-101**
Size W : 76 mm x H : 70 mm



DRC RELEASE TIE WRAP

- Releasable tie wrap, can be re-used.
- Length : 150 mm
- 6 pcs per pack.

Part number **D58-10-101**

STAND



TRANSPORT



TOOL



CONTROL



EXHAUST



ELECTRICAL



DRIVE



BODY



ACCESSORIES



ENDURO

KENJI SUZUKI

DRC PLUG PROTECTOR

- Protects the plugs in your tool box.
- Available in 3 sizes.
- The clear cap allows you to identify the plug without opening.
- High-impact plastic construction

B-Type(14mm) Color
D58-14-016 Clear / Red

C-Type(10mm) Color
D58-14-215 Clear / Blue
D58-14-216 Clear / Red

D-Type(12mm) Color
D58-14-116 Clear / Red
D58-14-117 Clear / Black

Bike	Type
HONDA	
CR85R/125R/250R	B
CRF150R	C
CRF250R/X	C
CRF450R/X	B
CRF250L/M	C
XR50/100MOTARD	C
XR230	D
XR250/MOTARD	C
XR400MOTARD	D
XR650R	B
YAMAHA	
YZ85/125/250	B
YZ250F/450F	C
YZ250FX	C
WR250F/450F	C
TT-R50E/125LWE	C
WR250R/X	C
SEROW225/250	D

Bike	Type
KAWASAKI	
KX65/85/125/250	B
KX250F/450F	C
KLX110	C
KLX250/450R	C
SUPER SHERPA	C
SUZUKI	
RM85/125/250	B
RMZ250/450	C
DJEBEL250	C
DRZ400	C
KTM	
SX65/85/125/250	B
SX-F250/450	C
EXC125/200/250	B
EXC-F250	C
EXC-R400/450/525	D
950SER	C

Bike	Type
HUSQVARNA	
TE250/450	C
GASGAS	
EC125/200/250	B
APRILIA	
RXV450	C

STAND



TRANSPORT



TOOL



CONTROL



EXHAUST



ELECTRICAL



DRIVE



BODY



ACCESSORIES



DRC OIL BOTTLE

- Portable 2stroke oil bottle.
- Easy to mix fuel for your 2 stroke at gas station.
- Measures 5cc and 30cc.
- Small enough to fit almost anywhere.

Part number
D59-44-020



DRC SPRING HOOK

- Easy exhaust spring removal.
- Excellent grip with the PVC coated handle.

Part number
D59-08-020



DRC WIRE OILER

- To inject lubricant into cable housing.
- Available in 3 hard anodized colors.

Part number Color
D59-18-131 Titanium
D59-18-132 Red
D59-18-133 Black



Replacement
inner rubber
Part number
D59-18-199

DRC STOCK REPLACEMENT LEVER

- Stock replacement brake and clutch levers.
- Available in standard and short length.
- MX, ED and dual sports models available.
- Sold Separately.



CLUTCH LEVER

Bike	Year	Std	Short
CR80R/85R	83-07	D40-01-102	D40-03-102
CRF150R	07-18	D40-01-102	D40-03-102
CR125R	86-03	D40-01-102	D40-03-102
	04-07	D40-01-101	-
CR250R	83-03	D40-01-102	D40-03-102
	04-07	D40-01-101	-
CRF250R	04-17	D40-01-101	-
CRF450R	02-03	D40-01-102	D40-03-102
	04-18	D40-01-101	-
CRF450RX	17-18	D40-01-101	-
CRF250X	04-17	D40-01-101	-
CRF450X	05-17	D40-01-101	-
CRF230F	03-09	D40-01-103	D40-03-103
CRM50/80	94-01	D40-01-102	D40-03-102
CRM250R/AR	94-98	D40-01-102	D40-03-102
CRF250LM	12-17	-	D40-03-125
CRF250RALLY	17	-	D40-03-125
SL230	97-04	D40-01-103	D40-03-103
FTR	00-08	D40-01-103	D40-03-103
XL250	91-01	D40-01-103	D40-03-103
XLR125R	93-01	D40-01-103	D40-03-103
XLR200R	93-94	D40-01-103	D40-03-103
XR230/MOTARD	05-12	D40-01-103	D40-03-103
XR250/MOTARD/BAJA	95-07	D40-01-102	D40-03-102
XR400MOTARD	05-08	D40-01-102	D40-03-102
XR250RCM	96-99	D40-01-102	D40-03-102
XR250RDK	96-04	D40-01-102	D40-03-102
XR400RCM/DK	96-04	D40-01-102	D40-03-102
XR650RCM/DK	00-07	D40-01-102	D40-03-102
YZ80/85	80-14	D40-01-706	D40-03-706
	15-18	D40-01-709	-
	80-99	D40-01-706	D40-03-706
YZ125/250	00-14	D40-01-708	D40-03-708
	15-18	D40-01-709	-
YZ250F	01-08	D40-01-708	D40-03-708
	09-18	D40-01-709	-
YZ400F	98-99	D40-01-706	D40-03-706
YZ426F/450F	00-08	D40-01-708	D40-03-708
	09-18	D40-01-709	-
YZ125X	17-18	D40-01-709	-
YZ250X	16-18	D40-01-709	-
YZ250FX	15-18	D40-01-707	D40-03-707
YZ450FX	16-18	D40-01-707	D40-03-707
WR250F	05-18	D40-01-707	D40-03-707
WR450F	05-18	D40-01-707	D40-03-707
WR250Z	90-99	D40-01-706	D40-03-706
WR250R/X	07-17	D40-01-706	D40-03-706
TTR125/LW/E	00-08	D40-01-706	D40-03-706
TTR250/RAID	93-07	D40-01-706	D40-03-706
DT230LANZA	97-98	D40-01-706	D40-03-706
DT50	88-96	D40-01-706	D40-03-706
DT125	88-99	D40-01-706	D40-03-706
DT200	87	D40-01-706	D40-03-706
DT200R	88-90	D40-01-706	D40-03-706
SEROW225S/W/W/WE/250	86-17	D40-01-706	D40-03-706
TRICKER	04-17	D40-01-706	D40-03-706
TY250ZS	97	D40-01-706	D40-03-706
TY250Z	93-96	D40-01-706	D40-03-706
TW200/E/225E	91-08	D40-01-706	D40-03-706
XT250X	06-17	D40-01-706	D40-03-706
XTZ125	03-12	D40-01-706	D40-03-706

Bike	Year	Std	Short
KX65	00-18	D40-01-509	-
	88-97	D40-01-706	D40-03-706
KX80/85/100	98-18	D40-01-509	-
	88-89	D40-01-706	D40-03-706
KX125	90-05	D40-01-509	-
	06-08	D40-01-708	D40-03-708
KX250	90-04	D40-01-509	-
	05-08	D40-01-708	D40-03-708
KX250F	04	D40-01-509	-
	05-18	D40-01-708	D40-03-708
KX450F	06-18	D40-01-708	D40-03-708
KLX450R	08-15	D40-01-707	D40-03-707
KDX125	90-99	D40-01-706	D40-03-706
KDX200	86-88	D40-01-706	D40-03-706
KDX200R	89-90	D40-01-706	D40-03-706
KDX200SR	89-93	D40-01-706	D40-03-706
KDX220R	94-95	D40-01-706	D40-03-706
KDX250R/SR	91-94	D40-01-706	D40-03-706
KLX125	10-16	D40-01-311	D40-03-311
/D-TRACKER125			
KLX150S	09-13	D40-01-311	D40-03-311
KLX250ES	94-97	D40-01-310	D40-03-310
KLX250R	93-95	D40-01-706	D40-03-706
KLX250SR	93-97	D40-01-706	D40-03-706
KLX300R	96	D40-01-706	D40-03-706
KLX250	98-07	D40-01-310	D40-03-310
/D-TRACKER			
KLX250	08-16	D40-01-311	D40-03-311
/D-TRACKER X			
SUPER SHERPA	97-07	D40-01-310	D40-03-310
RM85	05-17	D40-01-706	D40-03-706
RM125/250	89-08	D40-01-706	D40-03-706
	04	D40-01-509	-
RMZ250	05-06	D40-01-708	D40-03-708
	07-18	D40-01-509	-
RMZ450	05-18	D40-01-509	-
RMX250R/S	93-98	D40-01-706	D40-03-706
SX125/200	87	D40-01-706	D40-03-706
TS50/125R/200R	89-97	D40-01-706	D40-03-706
DRZ400R	00-04	D40-01-706	D40-03-706
DRZ400S/SM	00-17	D40-01-508	D40-03-508
DR250R	97-00	D40-01-508	D40-03-508
DR250S	90-94	D40-01-706	D40-03-706
	96-97	D40-01-706	D40-03-706
DJEBEL250XC	98-07	D40-01-508	D40-03-508
250SB	02-06	D40-01-310	D40-03-310
TC65	17-18	D40-01-913	-
TC85	14-18	D40-01-913	-
TC/WR125-300/TE250-511	-13	D40-01-912	-
brebo type only			
TE250/300	14-16	D40-01-912	-
FC250-450	14-15	D40-01-912	-
FE250-501/S	14-16	D40-01-912	-
FR450RALLY	16-17	D40-01-912	-
FS450	15	D40-01-912	-

Bike	Year	Std	Short
65SX/XC	04-13	D40-01-911	D40-03-911
	14-18	D40-01-913	-
85SX/XC	04-12	D40-01-911	D40-03-911
	13-18	D40-01-913	-
105SX/XC	07-11	D40-01-911	D40-03-911
125EXC (SIX DAYS)	04-08	D40-01-911	D40-03-911
125SX/XC-W/144SX	05-08	D40-01-911	D40-03-911
	16-18	D40-01-912	-
150SX/XC/XC-W	16-18	D40-01-912	-
200EXC	03-08	D40-01-911	D40-03-911
	16	D40-01-912	-
200XC/XC-W	03-08	D40-01-911	D40-03-911
250EXC/EXC-F (SIX DAYS)	03-05	D40-01-911	D40-03-911
	06-18	D40-01-912	-
250EXC-R	03-05	D40-01-911	D40-03-911
	05-06	D40-01-911	D40-03-911
250SX-F	07-18	D40-01-912	-
	03-05	D40-01-911	D40-03-911
250SX	06-18	D40-01-912	-
250XC	06-18	D40-01-912	-
250XC-F/XCF-W	07-18	D40-01-912	-
250/300XC-W	06-18	D40-01-912	-
300EXC (SIX DAYS)	03-05	D40-01-911	D40-03-911
	06-18	D40-01-912	-
300XC	06-18	D40-01-912	-
350EXC-F/SIX DAYS	11-18	D40-01-912	-
350SX-F/XC-F/XCF-W	09-11	D40-01-912	-
400EXC	03-07	D40-01-911	D40-03-911
400EXC-R	07	D40-01-911	D40-03-911
400XC-W	09-10	D40-01-912	-
	04-06	D40-01-911	D40-03-911
450EXC/R/EXC-F (SIX DAYS)	07-18	D40-01-912	-
450RALLY REPLICA	13-14	D40-01-911	D40-03-911
	15-17	D40-01-912	-
450SMR	06-08	D40-01-911	D40-03-911
	13-14	D40-01-912	-
450SX/SX-F/SX-R	03-08	D40-01-911	D40-03-911
	13-18	D40-01-912	-
450XC	06-07	D40-01-911	D40-03-911
	08	D40-01-912	-
450XC-F	09	D40-01-911	D40-03-911
	13-18	D40-01-912	-
450XC-W/XCR-W (SIX DAYS)	07	D40-01-911	D40-03-911
	08-16	D40-01-912	-
500EXC/EXC-F/XC-W (SIX DAYS)	12-18	D40-01-912	-
505SX-F	08	D40-01-911	D40-03-911
	08	D40-01-912	-
505XC-F	09	D40-01-911	D40-03-911
	03-06	D40-01-911	D40-03-911
525EXC-R	07	D40-01-912	-
	03-07	D40-01-911	D40-03-911
525SX/SX-R/XC/XC-W	08-11	D40-01-912	-
530EXC-/EXC-R/XCR-W/XC-W (SIX DAYS)	14-18	D40-01-913	-
FREERIDE 250F	14-17	D40-01-913	-
FREERIDE 250R	14-17	D40-01-913	-
FREERIDE 350	12-17	D40-01-913	-
FREERIDE E-SX/XC/SM	15-16	D40-01-913	-

STAND



TRANSPORT



TOOL



CONTROL



EXHAUST



ELECTRICAL



DRIVE



BODY



ACCESSORIES



CLOSED type



OPEN type



DRC TEAM GRIP

- Standard MX grip.
- 3 groove wiring system allows secure fastening.
- Closed and open end design are available.
- Open end design for easy installation of hand guards.
- Colors available: Black, Gray, Red and Blue.

Color
Black
Gray
Red
Blue

CLOSED type
D41-04-101
D41-04-102
D41-04-103
D41-04-104

OPEN type
D41-04-201
D41-04-202
D41-04-203
D41-04-204

Color
Orange
Green

CLOSED type
D41-04-106
D41-04-105

OPEN type
D41-04-206
D41-04-205



D40-11-607

D40-11-811

D40-11-005

BRAKE LEVER

Bike	Year	Std	Short
CR80R/85R	98-07	D40-11-002	-
CR125R/250R	92-07	D40-11-002	-
CRF150R	07-18	D40-11-002	-
CRF250R	04-06	D40-11-002	-
	07-17	D40-11-005	-
CRF450R	02-06	D40-11-002	-
	07-18	D40-11-005	-
CRF450RX	17-18	D40-11-005	-
CRF250X	04-17	D40-11-002	-
CRF450X	05-17	D40-11-002	-
CRF125F	14-18	D40-11-002	-
CRF150F/230F	03-17	D40-11-002	-
CRM250R/AR	89-98	D40-11-003	D40-13-003
CRM50/80	93-01	D40-11-003	D40-13-003
CRF250L/M	12-17	D40-11-410	D40-13-410
CRF250RALLY	17	D40-11-410	D40-13-410
FTR	00-08	D40-11-003	D40-13-003
SL230	97-05	D40-11-003	D40-13-003
XR230	05-12	D40-11-003	D40-13-003
XR250/MOTARD/BAJA	95-07	D40-11-003	D40-13-003
XR400MOTARD	05-08	D40-11-003	D40-13-003
XR250RCM	96-99	D40-11-002	-
XR250RDK	89-92	D40-11-003	D40-13-003
	96-04	D40-11-003	D40-13-003
XR400RCM	96-04	D40-11-002	-
XR400RDK	96-04	D40-11-003	D40-13-003
XR650RCM	00-07	D40-11-002	-
XR650RDK	00-07	D40-11-003	D40-13-003
XL250	91-01	D40-11-003	D40-13-003
XLR125R	93-01	D40-11-003	D40-13-003
XLR200R	93-94	D40-11-003	D40-13-003
XLR250/BAJA	85-94	D40-11-003	D40-13-003
YZ80/85	87-96	D40-11-606	D40-13-606
	01-18	D40-11-607	-
	85-88	D40-11-606	D40-13-606
YZ125	01-07	D40-11-607	-
	08-18	D40-11-608	-
	85-87	D40-11-606	D40-13-606
YZ250	01-07	D40-11-607	-
	08-18	D40-11-608	-
YZ250F	01-06	D40-11-607	-
	07-18	D40-11-608	-
YZ450F	01-07	D40-11-607	-
	08-18	D40-11-608	-
YZ125X	17-18	D40-11-608	-
YZ250X	16-18	D40-11-608	-
YZ250FX	15-18	D40-11-608	-
YZ450FX	16-18	D40-11-608	-
	01-16	D40-11-607	-
WR250F	17-18	D40-11-608	-
WR450F	01-16	D40-11-607	-
	17-18	D40-11-608	-
WR250R/X	07-17	D40-11-606	D40-13-606
DT125R	88-97	D40-11-606	D40-13-606
DT200	87	D40-11-606	D40-13-606
DT200R	88-90	D40-11-606	D40-13-606
DT230LANZA	97-98	D40-11-606	D40-13-606
BRONCO	97-04	D40-11-606	D40-13-606
SEROW225/S/W/WE/250	86-17	D40-11-606	D40-13-606
TTR250/RAID	93-07	D40-11-606	D40-13-606
TRICKER	04-17	D40-11-606	D40-13-606
TW200/E/225E	91-08	D40-11-606	D40-13-606
XT250X	06-17	D40-11-606	D40-13-606
XTZ125	02-12	D40-11-410	D40-13-410

Bike	Year	Std	Short
KX85	00-18	D40-11-607	-
KX80	94-97	D40-11-002	-
KX85/100	00-18	D40-11-607	-
KX125	94-96	D40-11-002	-
	00-08	D40-11-607	-
	93-96	D40-11-002	-
KX250	00-08	D40-11-607	-
	04-12	D40-11-607	-
KX250F	13-18	D40-11-608	-
	06-12	D40-11-607	-
KX450F	13-18	D40-11-608	-
	08-17	D40-11-607	-
KLX450R	90-99	D40-11-410	D40-13-410
KDX125SR	94-99	D40-11-003	D40-13-003
KDX220SR	92-94	D40-11-409	D40-13-409
KDX250SR	10-16	D40-11-410	D40-13-410
KLX125/D-TRACKER125	09-13	D40-11-410	D40-13-410
KLX150S	93-07	D40-11-409	D40-13-409
KLX250/ES/SR/D-TRACKER	08-16	D40-11-410	D40-13-410
KLX250/D-TRACKER X	96	D40-11-002	-
KLX300R	05-17	D40-11-607	-
RM85	96-03	D40-11-002	-
	04-08	D40-11-607	-
RM125/250	04-18	D40-11-607	-
RMZ250	05-18	D40-11-607	-
RMZ450	10-17	D40-11-607	-
RMX450Z	93-95	D40-11-409	D40-13-409
RMX250S	96-98	D40-11-408	D40-13-408
	89-97	D40-11-409	D40-13-409
TS125/200	02-06	D40-11-409	D40-13-409
250SB	93-99	D40-11-409	D40-13-409
DR125SE	97	D40-11-409	D40-13-409
DF200E	93-00	D40-11-409	D40-13-409
DR200SE	96-07	D40-11-408	D40-13-408
DJEBEL250XC	96-00	D40-11-408	D40-13-408
DR250R	90-94	D40-11-409	D40-13-409
DR250S	00-17	D40-11-408	D40-13-408
DRZ400S/SM	14-18	D40-01-913	-
65SX	13-18	D40-01-913	-
85SX	05-13	D40-11-811	-
125SX/XC-W/EXC(SIX DAYS)			
144/150SX/150XC/XC-W			
200XC-W/EXC			
250SX/SX-F/XC/XC-F			
250XC-W/XCF-W	14-18	D40-11-812	-
250EXC/EXC-R/EXC-F (SIX DAYS)			
300XC/XC-W/EXC(SIX DAYS)			
350SX-F/XC-F/XCF-W	11-13	D40-11-811	-
350EXC-F(SIX DAYS)	14-18	D40-11-812	-
400XC-W/EXC/EXC-R	05-11	D40-11-811	-
450SX/SX-R/SX-F	05-13	D40-11-811	-
450XC/XC-F/XCR-W	14-18	D40-11-812	-
450XC-W/EXC-F/EXC/R (SIX DAYS)			
500XC-W/EXC/EXC-F (SIX DAYS)	12-13	D40-11-811	-
	14-18	D40-11-812	-
505SX-F/XC-F	08-09	D40-11-811	-
525SX/SX-R/XC/XC-W/EXC-R	05-07	D40-11-811	-
530XC-W/XCR-W/EXC-R/EXC	08-11	D40-11-811	-
450SMR	13	D40-11-811	-
FREERIDE 250F	18	D40-01-913	-
FREERIDE 250R	14-17	D40-01-913	-
FREERIDE 350	12-17	D40-01-913	-
FREERIDE E-SX/XC/SM	15-16	D40-01-913	-
TC/WR125-300, TE250-511	-13	D40-11-811	-
TC65	17-18	D40-01-913	-
TC85	14-18	D40-01-913	-
TC/TE/TX125-300	14-17	D40-11-812	-
FC/FE/FX250-501	14-17	D40-11-812	-
TC/FC125-450 <i>brembo type only</i>	18	D40-11-812	-

STAND



TRANSPORT



TOOL



CONTROL



EXHAUST



ELECTRICAL



DRIVE



BODY



ACCESSORIES



DRC GRIP WIRE

- Wire for motorcycle grips.
- Made of SUS304 stainless steel for strength and corrosion prevention.
- Length : 2.5 m

Part number
D58-11-120



DRC HANDLEBAR EXTENSION

- Attach this extension on both sides of your handlebar to make your handlebar wider.
- Provides wider handlebar position without changing whole handlebar.
- One extension offers 10 mm or 15 mm of handlebar extended lengths.
- Can be used as bar end plug.
- Designed for aluminum handlebars.
- For use on handlebars with inside diameter of 13.5 mm to 14.5 mm .
- Comes in pairs.

Part number
D41-01-001



DRC
EX PIPE GUARD 4 ST

- Universal exhaust pipe guard for 4 stroke bikes.
- Protect head pipe from stones and rocks.
- Guard body is made of A 5052 aluminum with titanium anodized finish.
- Easy to install with enclosed stainless pipe bands.
- Fits pipe diameter : 26 mm to 50 mm
- Flexible guard design, applicable on most recent 4 stroke dirt bikes.

Part number **Color**
D31-01-110 Titanium



STAND



TRANSPORT



TOOL



CONTROL



EXHAUST



ELECTRICAL



DRIVE



BODY



ACCESSORIES



DRC
EX PIPE GUARD 2 ST

- Universal exhaust pipe guards for 2 stroke bikes.
- Protect pipe from stones and rocks.
- Guard body is made of A 5052 aluminum with titanium anodized finish.
- Easy to install with enclosed stainless pipe bands.
- Flexible guard design, applicable on most recent 2 stroke dirt bikes.

Part number **Color**
D31-01-130 Titanium



DRC
HEAT PROTECTOR

- Oval design universal heat protector for 4 stroke exhaust head pipe.
- Made of stainless steel.
- Fits exhaust pipe diameters from 26 mm to 50 mm.
- Comes complete with all mounting hardware needed.

Part number **Replaced mount kit**
D31-02-201 **ZC31-3000**



DRC
HEAT SHIELD

- Protects plastic side panels, gas tank, radiator hoses, etc. from heat damage from exhaust or other hot parts.
- Flexible, cut to fit.
- Adhesive on one side and aluminum shielding on the other.

Part number
D31-03-112

Size
250 mm x 245 mm (10 " x 9.8 ") Thickness : 0.35 mm



Bike	Year	Part #
HONDA		
CRF150R	07-18	D31-41-010
CRF250R	04-13	D31-41-010
CRF250R(F)	14-17	D31-41-010
CRF250X	04-17	D31-41-010
CRF450R	09-12	D31-41-020
CRF450R(F)	13-16	D31-41-020
CRF250L/M	12-16	D31-41-060
	17	D31-41-650
CRF250RALLY	17	D31-41-650
XR250R	95-00	D31-41-010
XR400R	96-04	D31-41-010
XLR250/BAJA	89-94	D31-41-040
XR250/MOTARD/BAJA	95-07	D31-41-050
XR400MOTARD	05-08	D31-41-050
YAMAHA		
YZ250F	06-13	D31-41-610
YZ450F	07-09	D31-41-620
YZ450F(F)	10-13	D31-41-630
	14-18	D31-41-610
YZ450F(R)	10-13	D31-41-640
YZ450FX(F)	16-18	D31-41-610
WR250F	01-14	D31-41-630
	04-06	D31-41-610
WR450F	07-11	D31-41-630
	12-15	D31-41-610
WR450F(F)	16-18	D31-41-610
WR250R/X	07-17	D31-41-650
SEROW225/S/W/WE/250	86-17	D31-41-660
TTR250/RAID	93-07	D31-41-040
XT250X	06-17	D31-41-660
TRICKER	04-17	D31-41-660
TW200/E/225E	91-08	D31-41-660

Bike	Year	Part #
KAWASAKI		
KX250F	09-18	D31-41-210
KX450F	06-11	D31-41-220
	12-18	D31-41-210
KLX125/D-TRACKER125	10-16	D31-41-230
KLX150S	09-13	D31-41-230
KLX250/ES/SR/D-TRACKER	93-99	D31-41-240
KLX250/D-TRACKER	00-16	D31-41-250
SUZUKI		
RMZ250	07-09	D31-41-410
	10-18	D31-41-420
RMZ450	08-18	D31-41-430
DRZ400S/SM	00-17	D31-41-010
DR250R	96-00	D31-41-440
250SB	02-06	D31-41-250
DR125SE/DF125	93-99	D31-41-440



DRC EXHAUST JOINT GASKET

- Replacement exhaust joint gasket.
- Available for most Japanese dirt bikes.
- The same quality as OEM exhaust joint gasket.



DRC STAINLESS EXHAUST CLAMP

- Stainless heavy duty exhaust clamp for 4 stroke bikes.
- Made of stainless steel for less corrosion than steel clamps.
- Available in 3 different sizes to fit most exhaust pipes.

Part number	Length
D31-32-360	Diameter 36 - 39 mm
D31-32-400	Diameter 40 - 43 mm
D31-32-440	Diameter 44 - 47 mm



DRC SILENCER PLUG

- Double soft rubber ribs provides an excellent fit to keep water, bugs and dirt out of your exhaust system.
- Available in 2 different sizes, Black and Red handle colors.

L size	Color	Part number
(Exhaust opening size from 15 mm to 30 mm)	Black	D31-14-302
	Red	D31-14-304

L size	Color	Part number
(Exhaust opening size from 30 mm to 50 mm)	Black	D31-14-402
	Red	D31-14-404



DRC PRO EXHAUST SPRING

- Quality replacement spring for your exhaust.
- One end of the spring swivels for a perfect fit.
- Available in 4 different lengths.
- Galvanized to prevent corrosion.
- 4 springs per pack.

Part number	Length
D31-31-157	57 mm (2.28 ")
D31-31-175	75 mm (3 ")
D31-31-183	83 mm (3.32 ")
D31-31-190	90 mm (3.6 ")



DRC STANDARD EXHAUST SPRING

- Replacement exhaust springs.
- Available in 4 lengths.
- Galvanized to prevent corrosion.
- 5 springs per pack.

Part number	Length
D31-31-057	57 mm (2.28 ")
D31-31-075	75 mm (3 ")
D31-31-083	83 mm (3.32 ")
D31-31-090	90 mm (3.6 ")

DRC SILENCER REPACK KIT

- Silencer re-pack kit for all silencers.
- For both 2 strokes and 4 strokes.
- Size : 55 x 33 cm t = 12 mm
- Heat proof to 770 °C

Part number
D31-21-120



DRC MAIN JET HOLDER

- Keep your main jets in your tool box.
- Made of PVC.
- Holds 12 pcs main jets.
- Compact size to fit in your tool box. (5 cm x 9 cm)
- Available in Black and Blue colors.

Part number	Color
D58-18-602	Blue



STAND



TRANSPORT



TOOL



CONTROL



EXHAUST



ELECTRICAL



DRIVE



BODY



ACCESSORIES



This series achieves ideal performance for off road models in all situations, making the most of LED characteristics in compact, energy-conserving and durable forms.

CRF250L/M



Red

Smoke

DRC MOTO LED **EDGE-2 TAIL LIGHT HOLDER**
Steel for CRF250L/M

- Edge tail light holder kit designed for HONDA CRF250L/M.
- Comes with a bracket for the tail light, license plate and flashers.
- Has a compact design for sport riding.
- Tail light bracket is made of steel for extreme durability.
- Special oval bolt holes to easily adjust tail light upwards and downwards.
- Two different flasher holes for both OEM and 8 mm flashers.
- * Can not be use with OEM flasher from 2017 models. Can be used with OEM flasher up to 2016 models.

Part number	Lens color
D45-18-507	Smoke
D45-18-707	Red

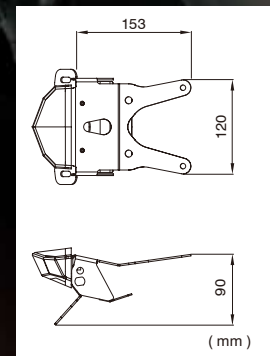

Red

Smoke

WR250R/X

DRC MOTO LED **EDGE-2 TAIL LIGHT HOLDER**
Aluminum for WR250R/X

- Edge tail light holder kit designed for YAMAHA WR250R / X.
- Comes with tail light bracket, license plate bracket and flasher brackets.
- Shorter than OEM license brackets, provides cool looks and good center of mass.
- Special screw holes to enable proper setting of the tail lights.
- Flasher stay hole size : 8 mm

Part number	Lens color
D45-18-531	Smoke
D45-18-731	Red

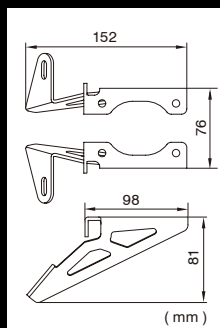

WR250R / X REPLACEMENT PARTS - - - - -



Tail light bracket
Part number
[D45-18-130](#)



License plate stay
(With 8 mm hole flashers stay)
Part number
[D45-18-131](#)

STAND



TRANSPORT



TOOL



CONTROL



EXHAUST



ELECTRICAL



DRIVE



BODY



ACCESSORIES



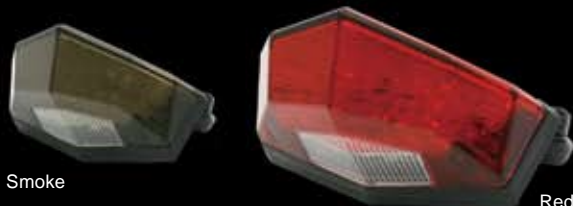

Smoke

Red

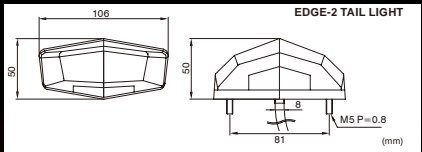

DRC
MOTO LED **EDGE-2 TAIL LIGHT**

- 16 high-intensity red LEDs are used for the tail / stop light, and 3 white LEDs for illuminating the license plate.
- Reduces electric power consumption. Offers a longer operating life.
- Detachable lens.
- Lens colors available: red and smoke.
- Plug type terminals are included for installation.
- Works on 12 V AC/DC.

Part number	Color	REPLACEMENT LENS	Part number	Color
D45-29-347	Red		D45-29-487	Red
D45-29-348	Smoke		D45-29-488	Smoke

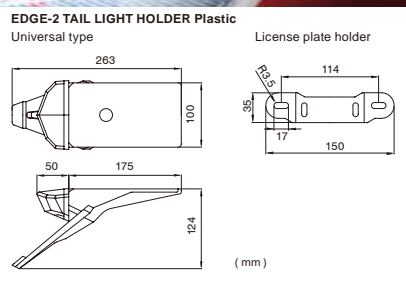
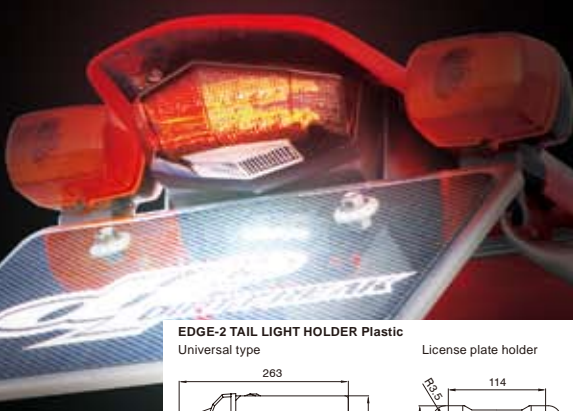

Red

Smoke

DRC
MOTO LED **EDGE-2 TAIL LIGHT HOLDER**
Plastic

- Universal plastic tail light holder with Edge tail light.
- Tail light holder is made of high quality, pliable plastic.
- Plastic material allows for quick and easy installation.
- Flashers can be placed on the flat side of this holder.
- License plate bracket (Japan specification) and plug type terminal included.
- Works on 12 V AC / DC.

Type	Part number	Lens color
Universal	D45-14-001	Red
	D45-14-002	Smoke

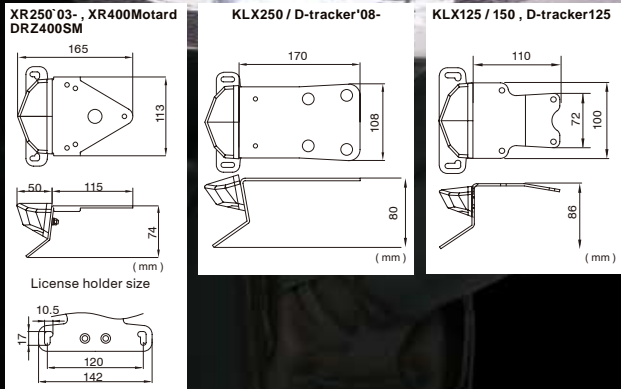

Red

Smoke

DRC
MOTO LED **EDGE-2 TAIL LIGHT HOLDER**
Aluminum

- Edge tail light with aluminum tail light holder designed for specific models.
- 16 high-intensity red LEDs are used for the tail / stop light, and 3 white LEDs for illuminating the license plate.
- Detachable lens.
- Comes with Flasher stays for DRC LED flashers.
- Plug type terminal included.
- Works on 12 V AC/DC.
- Reflector available. (Parts No [D45-07-899](#))

Type	Part number	Lens color
XR250'03- , XR400Motard	D45-18-704	Red
	D45-18-504	Smoke
DRZ400SM	D45-18-706	Red
	D45-18-506	Smoke
KLX250 / D-tracker-X '08-	D45-18-714	Red
	D45-18-514	Smoke
KLX125 / 150,D-tracker125	D45-18-715	Red
	D45-18-515	Smoke

DRC
MOTO LED **REFLECTOR**

- Universal reflector kit, especially perfect for DRC Edge tail light holders.
- Easily viewable, durable construction.
- Replacement reflector available.

Part number	Description
D45-07-899	(Kit)
D45-07-001	(Replacement reflector only)

STAND



TRANSPORT



TOOL



CONTROL



EXHAUST



ELECTRICAL



DRIVE



BODY



ACCESSORIES





DRC
MOTO LED ANATO ED REAR FENDER KIT

- Universal Enduro rear fender conversion kit with LED tail light.
- Fits on most MX type stock fenders.
- License plate bracket and plug type terminal included.
- Works on 12 V AC / DC.

Part number
D45-40-101

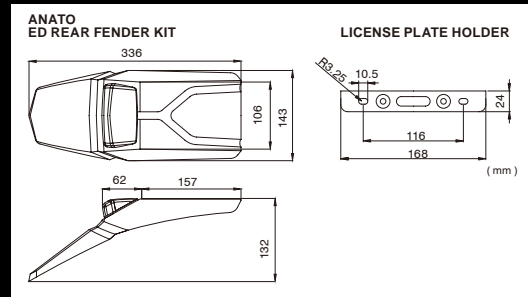

DRC
MOTO LED CRF-X TAIL LIGHT

- Fits CRF 250X / 450X.
- Tail light and stop light in this compact-sized product.
- Smaller and lighter than stock LED light.
- 8 high-intensity LEDs are used.
- Long operating life. Reduced electrical consumption.
- High impact, waterproofed, shock resistant.
- Lens colors available: red.
- Plug type terminals are included for installation.
- Works on 12 V AC / DC.

Part number Color
D45-29-330 Red

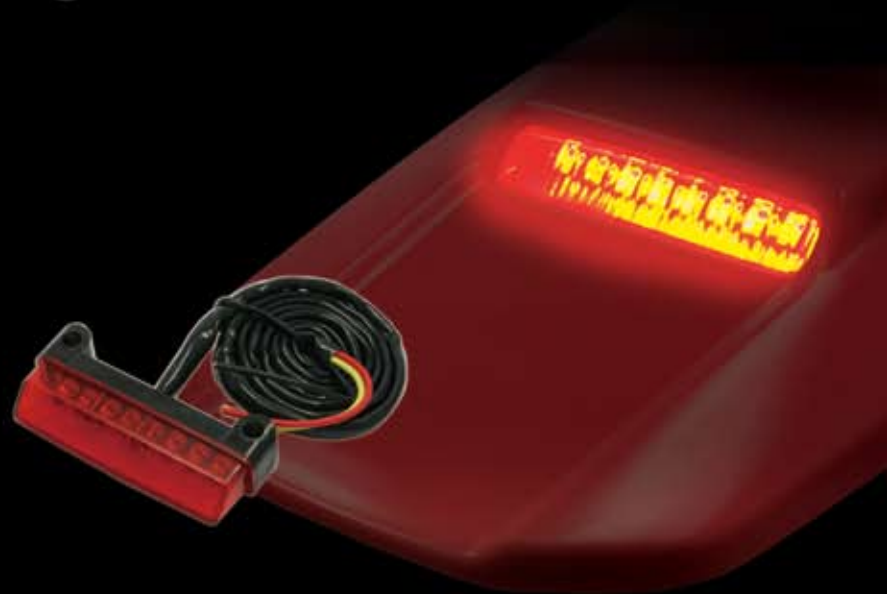

DRC
MOTO LED FLEX TAIL LIGHT

- Flex-1**
- Flex fit shell and body with 16 high quality chip LEDs.
- Even fits curved surfaces.
- Tail light and stop light in this compact-sized product.
- High impact, water and shock resistant.
- Includes aluminum bolts/nuts.
- Plug type terminals are included for installation.
- Works on 12 V AC / DC.
- Dimensions : L 109 mm x W 19 mm x H 9 mm.

Part number
D45-29-310

- Flex-3**
- Universal LED tail light.
- 12 pcs oval LEDs.
- Tail light and stop light in this compact-sized product.
- Reduced electric power consumption
- Works on 12 V AC / DC.
- Dimensions : L 109 mm x W 19 mm x H 19 mm

Part number
D45-29-316

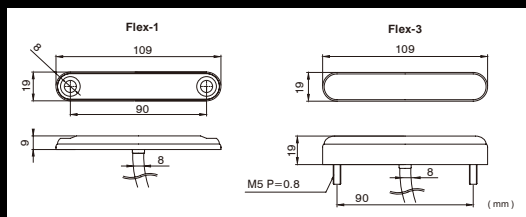



RALLY **PATRIC TRAHAN** CRF250L RALLY

DRC
MOTO LED **PHANTOM TAIL LIGHT**

- High intensity LED light for the rear fender.
- Tail light base is made of flex rubber. Enables a great fit on all shapes of rear fenders with M 5 bolts.
- 8 high-intensity LEDs are used.
- Tail light and stop light in this compact- sized product.
- Plug type terminals are included for installation.
- Works on 12 V AC / DC.

Part number **Color**
D45-29-307 Red

Replacement lens	
Part number	Color
D45-29-387	Red

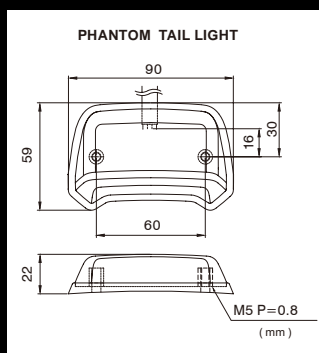

STAND



TRANSPORT



TOOL



CONTROL



EXHAUST



ELECTRICAL



DRIVE



BODY



ACCESSORIES



DRC
MOTO LED **LICENSE PLATE LIGHT**

- Chip LED lights for licence plate.
- Very compact design, best for installing under the rear fender.
- Long operating life. Reduced electrical consumption.
- High impact, water and shock resistant.
- Works on 12 V AC / DC.
- Dimensions : L 50 mm x W 41 mm x H 3.5 mm.

Part number
D45-39-410

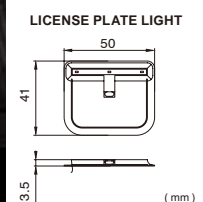

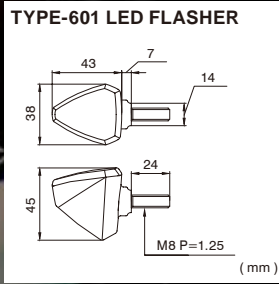

DRC MOTO LED 601 LED FLASHER

- Triangular style flasher.
- Terminals and nuts are included for installation.
- Comes in pairs. Works on 12 V AC / DC.

Part number
D45-60-107
D45-60-108

Color
Orange
Smoke

Replacement lens	
Part number	Color
D45-60-187	Orange
D45-60-188	Smoke



DRC MOTO LED 586 LED FLASHER

- Installs on the fender with screws for secure installation.
- Rubber mount base fits even curved surfaces.
- Terminals and bolts are included for installation.
- Comes in pairs. Works on 12 V AC / DC.

Part number **Color**
D45-58-617 Orange
D45-58-618 Smoke

Replacement lens	
Part number	Color
D45-58-687	Orange
D45-58-688	Smoke

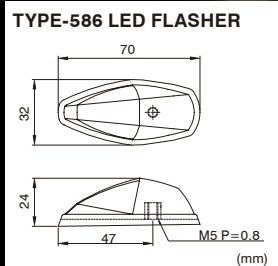

DRC MOTO LED FRONT FLASHER HOLDERS

- Flasher mounting hardware bolts to your top clamp.
- Screw hole is 8 mm in diameter.
- Available in 3 different types.



Type-9901

Front fork tightening bolts : 1 pc, front side
Part number
D45-59-901

Type-9902

Front fork tightening bolts : 2 pcs front side
Bike: XR, CRM, RMX, KLX D-Tracker, 250SB etc
Part number
D45-59-902



Type-9912

Front fork tightening bolts : 2 pcs side
Bike : DRZ400, Tricker
Part number
D45-59-912

DRC MOTO LED FLASHER HOLDER PLATE

- Flasher mount adapter for Yamaha and Kawasaki OEM flasher mounting bracket.
- Use OE brackets with the plates to mount DRC LED flashers.
- Flasher attachment hole diameter : 8 mm
- Available in titanium and blue anodized colors.

Part number **Color**
D45-59-950 Y / K Titanium 2 set
D45-59-952 Y / K Blue 2 set
D45-59-953 Y / K Black 2 set

Bike	Year
YAMAHA	
YZF-R25	15-17
YZF-R6	06-14
YZF-R1	02-14
MT-07	14-16
MT-09	14-16
MT-01	05-09
FZ6/FAZER	04-10
FZ8/FAZER	11-16
FZ1/FAZER	08-14
XJ6N/F/S	09-16
TDM900	02-10
V-MAX #	09-17
WR250R/X	07-17
KAWASAKI	
KSR110	13
KLX125/D-TRACKER125	10-16
KLX150	09-13
KLX250/D-TRACKER X	08-16
NINJA250/R	08-

Only rear flasher use.



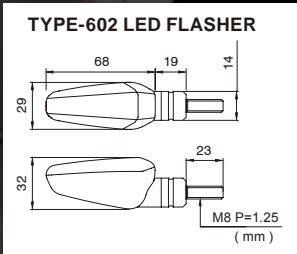

DRC MOTO LED 602 LED FLASHER

- Flexible flasher stays to prevent breakage upon impact.
- Lens colors available: orange, smoke and clear.
- Terminals and nuts are included for installation.
- Comes in pairs. Works on 12 V AC / DC.

Part number	Color
D45-60-207	Orange
D45-60-208	Smoke
D45-60-209	Clear

Replacement lens	
Part number	Color
D45-60-287	Orange
D45-60-288	Smoke
D45-60-289	Clear

MOTO LED flashers may not work properly without optional parts.

- STAND
- TRANSPORT
- TOOL
- CONTROL
- EXHAUST
- ELECTRICAL
- DRIVE
- BODY
- ACCESSORIES



DRC MOTO LED INDICATOR WIRING KIT

This kit is required when flasher operates like hazard indicators after the IC relay installation. Place these harnesses in-between the wires from the pilot lamp and the wires from the chassis.
 * Some models (*3) require this kit for proper operation.
 *3 ----- XR230, KSR110, KLX250, D-TRACKER-'07 etc.
Part number [D45-91-051](#)

DRC MOTO LED RESISTOR WIRE

When standard bulb flasher is replaced by LED flasher, electric consumption becomes low and stock flasher relay does not work correctly. This Resistor wire helps stabilize the electric power to the LED flasher from stock flasher relay.
 : Electric power consumption level is the same as with stock flasher.
 : Easy installation.
 : One resistor per flasher.
 * Some models (*2) require 2 resistors.
 : This harness will produce heat when used. Please install in areas where heat is not a problem.
 *2 ----- XR230, DR250R, DRZ400S/SM etc.
Part number [D45-90-710](#)

DRC MOTO LED IC RELAY for DC



Stock flasher relay is designed to work with standard bulb flashers. When the stock flasher is changed to LED flashers, the stock flasher relay does not work properly due to the difference in power consumption between the stock flasher bulb and the LED flasher. This IC Relay enables LED flashers to work in any configuration.
 * Some models require the use of the stock IC relay along with this IC relay. (*1)
 : Reduced electrical power usage.
 : Some technical skills required for installation.
 : One IC relay required for each bike.
 : Flasher pilot light can not be used with position light when installed on XR250.
 : If the flasher operates like hazard indicators after installation, indicator lamp wiring kit is required.
 : Works on 12V DC.
 Can not be used with WR250F/450F
 *1----- RMX250S, DRZ400S/SM etc.
Part number [D45-69-830](#)
 Installation of the LED flashers requires special knowledge and technique. Please contact your local dealer if you have any question upon installation.

Important note for using LED flasher

LED flashers have very low consumption and the stock flasher relay may not work properly. The most frequent problem, is that the LED may flash at a quick rate using stock flasher relays. Please refer to the chart below to choose our IC relay or Resistor wire for your installation.

	Electric consumption	Difficulty of installation	Parts cost	AC or DC
IC Relay	Low	Skills required	Cheap	DC
Resistor wire kit	Same as stock	Easy	Reasonable	DC/AC

* DRC IC Relay can not be used with motorcycles (XR50/100M, XLR250, WR250F/WR450F, XR650 etc) due to the AC power design. Please use Resistor wire kit for AC power motorcycle.

EASY INSTALLATION, ALL IN ONE ELECTRIC KIT!!



DRC MOTO LED EZ ELECTRIC WIRE KIT

- Easy to install electrical parts (excluding headlight, tail light and flashers) for competition bikes.
- Easy installation. No experience necessary.
- Power source for this kit is completely self-contained (uses 8 AA batteries).
- No need to " chop " into your wiring harness.
- Moto LED's tail lights and flashers are recommended.

Part number **D45-70-052**

- Replacement Parts -

- A. D45-70-161** Main Harness
- B. D45-70-163** Flasher/Horn Switch
- C. D45-70-165** Main Switch
- D. D45-70-167** IC Horn
- E. D45-70-169** Battery Box
- F. D45-70-183** Oil Pressure Switch 1pk (M10-1.25)

DRC MOTO LED EZ ELECTRIC WIRE KIT with ANATO / 601 Flasher

- Complete electrical parts (excluding headlight) for competition bikes.
- Comes with ANATO ED Rear Fender and 2 pairs of 601 Flashers.
- Easy installation. No experience necessary.
- Power source for this kit is completely self-contained (Uses 8 AA batteries).
- No need to " chop " into your wiring harness.

Part number **D45-70-053**

- G. D45-69-830** IC Relay for DC
- H. D45-40-101** Motoled Anato ED Rear Fender Kit
- I. D45-60-107** Motoled 601 LED Flasher

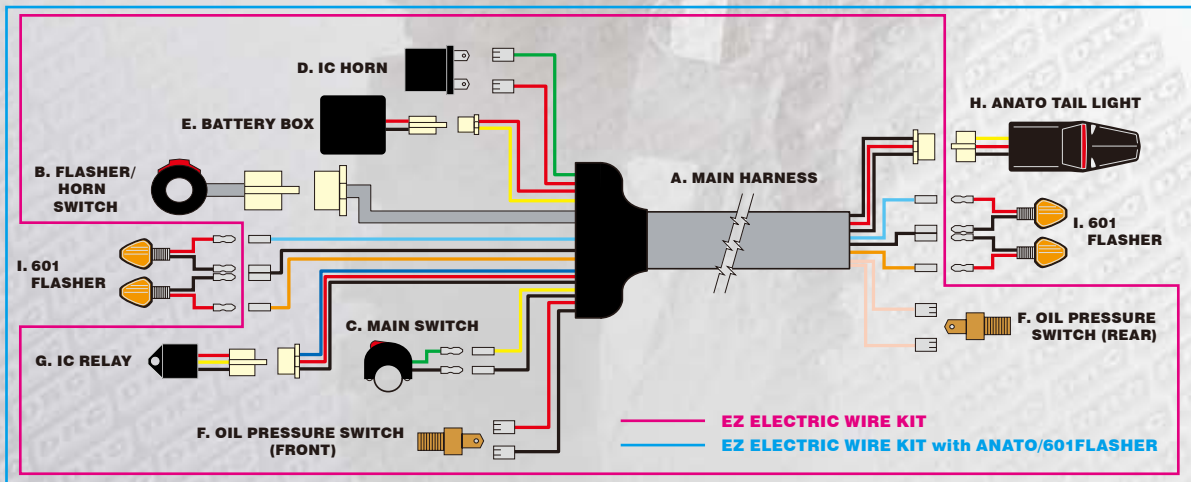

DRC MOTO LED OIL PRESSURE SWITCH

- Brake oil pressure switch for stop light.
- Made of light weight aluminum with compact design.
- Available in " bolt " or " banjo " type, depending on your machine.
- Terminals are included for installation.

BANJO TYPE

- Part number
D45-71-491 (M10-1.25)
D45-71-492 (M10-1.00)

BOLT TYPE

- Part number
D45-71-481 (M10-1.25)
D45-71-482 (M10-1.00)

STAND



TRANSPORT



TOOL



CONTROL



EXHAUST



ELECTRICAL



DRIVE



BODY



ACCESSORIES



EZ BATTERY CHARGING KIT

No need to remove the battery for charging!

easy to use !!

DRC EZ BATTERY CHARGING KIT

- Convenient when you store your bike for a long time.
- Terminal unit can be used for various kinds of battery chargers.
- No need to remove the battery when you connect the harness to the terminal unit.
- Easy operation. Just turn the battery charger on.
- Additional battery charging harness available. Part number: D45-01-002

Part number	Set
D45-01-001	Battery charging harness Terminal Unit

Battery charging harness only
D45-01-002



Terminal Unit



Battery charging harness

1



Install the battery charging harness to your bike.

2



Connect the battery charging connector and the terminal unit connector.

3



Connect battery charging clips to the terminal unit and start easy battery charging.



DURA LIGHT

Bike	Year	Size	Part #	Tooth
CR125R	04-07	520	D331-549**L	13
CR250R	88-07	520	D331-539**L	13
CR500R	88-01	520	D331-539**L	13
CRF150R	07-18	420	D331-307**L	15
CRF250R	04-17	520	D331-549**L	13
CRF250X	04-17	520	D331-549**L	13
CRF450R	02-18	520	D331-539**L	13
CRF450RX	17-18	520	D331-539**L	13
CRF450X	05-17	520	D331-539**L	13
TRX450	04-05	520	D331-539**L	13
TTR50	06-17	420	D331-304**L	13,14
TTR90	00-07	420	D331-304**L	13,14
TTR110	08-17	420	D331-304**L	13,14
MX90	74-75	428	D331-404**L	13,14
MX/YZ125	74-76	428	D331-404**L	13,14
YZ60	81-84	420	D331-304**L	13,14
YZ60	81-01	428	D331-404**L	13,14
YZ65	02-18	428	D331-412**L	14
YZ125	05-18	520	D331-548**L	13
YZ125X	17-18	520	D331-548**L	13
YZ250	99-18	520	D331-530**L	13
YZ250X	16-18	520	D331-530**L	13
YZ250F	01-18	520	D331-548**L	13
YZ250FX	15-18	520	D331-548**L	13
YZ400F	98-99	520	D331-530**L	13
YZ426F	00-02	520	D331-530**L	13
YZ450F	03-18	520	D331-530**L	13
YZ450FX	16-18	520	D331-530**L	13
WR250F	01-18	520	D331-548**L	13
WR250R/X	07-17	520	D331-548**L	13
WR250Z	99-02	520	D331-530**L	13
WR400F	98-99	520	D331-530**L	13
WR426F	00-02	520	D331-530**L	13
WR450F	03-18	520	D331-530**L	13
AT11AT125	70	428	D331-404**L	13,14
CT1/CT175	70	428	D331-404**L	13,14
DT1/DT250	68-78	520	D331-530**L	13
DT125	74-81	428	D331-404**L	13,14
DT125R	88-98	428	D331-412**L	14
DT200R	88-90	428	D331-412**L	14
DT230LANZA	97-98	428	D331-412**L	14
DT400	75- 520	D331-530**L	13	
DT50LW(17W)	82-96	420	D331-304**L	13,14
DT90	74-76	428	D331-404**L	13,14
HT1/HT90	70	428	D331-404**L	13,14
PW80	83-06	420	D331-304**L	13,14
RT1/RT360/DT360	69-74	520	D331-530**L	13
TDR125	89- 428	D331-412**L	14	
TDR250	91 520	D331-530**L	13	
TT500	76 520	D331-530**L	13	
TY125	76-89	428	D331-404**L	13,14
TY175	77-80	428	D331-404**L	13,14
XT500	76-81	520	D331-530**L	13
TA125	73-74	428	D331-404**L	13,14
KX60	83-00	420	D331-304**L	13,14
KX65	00-18	420	D331-304**L	13,14
KX80/85/100	79-18	420	D331-304**L	13,14
KX250	99-08	520	D331-530**L	13
KX250F	06-18	520	D331-547**L	13
KX450F	06-18	520	D331-530**L	13
KLX450R	08-09	520	D331-530**L	13
NINJA650/R	09-16	520	D331-530**L	13
RM80	82-01	428	D331-404**L	13,14
RM85	02-17	428	D331-404**L	13,14
RM125	75 428	D331-404**L	13,14	
RM250	13-15	520	D331-524**L	13
RMZ450	13-14	520	D331-541**L	13
RMZ450Z	10-17	520	D331-541**L	13
RA125	84 428	D331-404**L	13,14	
TM125	73-75	428	D331-404**L	13,14
TS90	70 428	D331-404**L	13,14	
TS125	71-81	428	D331-404**L	13,14
LT80	87-88	428	D331-404**L	13,14
RV90	76-77	428	D331-404**L	13,14
RV125	73-74	428	D331-404**L	13,14
85SX	03-17	428	D331-411**L	14
125SX	98-18	520	D331-537**L	13,14
125EXC	96-16	520	D331-537**L	13,14
125XC-W	17-18	520	D331-537**L	13,14
150SX	09-18	520	D331-537**L	13,14
150XC	10-14	520	D331-537**L	13,14
150XC-W	17-18	520	D331-537**L	13,14
200EXC	97-16	520	D331-537**L	13,14
200XC-W	06-16	520	D331-537**L	13,14
250SX	94-18	520	D331-537**L	13,14
250EXC/TPI	07-18	520	D331-537**L	13,14
250XC	06-18	520	D331-537**L	13,14
250XC-W	06-18	520	D331-537**L	13,14
250SX-F	06-18	520	D331-537**L	13,14
250XC-F	06-18	520	D331-537**L	13,14
250XC-F	07-18	520	D331-537**L	13,14
250XC-F	03-18	520	D331-537**L	13,14
400XC-F	08-18	520	D331-537**L	13,14
450XC-W	07-16	520	D331-537**L	13,14
500EXC/F	12-18	520	D331-537**L	13,14
500XC-W	12-16	520	D331-537**L	13,14
530XC-W	08-11	520	D331-537**L	13,14
530XC-W	09-10	520	D331-537**L	13,14
FREERIDE250F	18 520	D331-537**L	13,14	
FREERIDE250R	14-17	520	D331-537**L	13,14
FREERIDE350	12-17	520	D331-537**L	13,14
TC85	14-17	428	D331-411**L	14
TC125	14-18	520	D331-537**L	13,14
TC250	14-18	520	D331-537**L	13,14
FC250	14-18	520	D331-537**L	13,14
FC350	14-18	520	D331-537**L	13,14
FC450	14-18	520	D331-537**L	13,14
FE450	14-18	520	D331-537**L	13,14
TE125	14-16	520	D331-537**L	13,14
TE150	17-18	520	D331-537**L	13,14
TE250/i	14-18	520	D331-537**L	13,14
TE300/i	14-18	520	D331-537**L	13,14
FE250	14-18	520	D331-537**L	13,14
FE350	14-18	520	D331-537**L	13,14
FE450	14-18	520	D331-537**L	13,14
TE125	17-18	520	D331-537**L	13,14
TX125	17-18	520	D331-537**L	13,14
TX300	17-18	520	D331-537**L	13,14
FX350	17-18	520	D331-537**L	13,14
FX450	17-18	520	D331-537**L	13,14
701 ENDBURO	16-18	520	D331-538**L	14,15,16
701SUPER MOTO	16-18	520	D331-538**L	14,15,16
125EX	03-14	520	D331-535**L	12,13,14,15
200/250/350/400/450	97-13	520	D331-536**L	13

DRC

DURA FRONT SPROCKET

- Front sprocket available from DRC, made of durable SCM 420 steel.
- Great looking black zinc finish for corrosion resistance.
- Front sprockets available for most dirt bikes.
- Lighter front sprocket design available for recent racing models.

** Enter tooth number to complete part number when ordering.

DURA STD OTHER

Bike	Year	Size	Part #	Tooth
65SX	98-18	420	D331-306**	12,13,14
85SX	03-17	428	D331-411**	13,14
125SX	98-18	520	D331-537**	12,13,14,15
125EXC	96-16	520	D331-537**	12,13,14,15
125XC-W	17-18	520	D331-537**	12,13,14,15
150SX	09-18	520	D331-537**	12,13,14,15
150XC	10-14	520	D331-537**	12,13,14,15
150XC-W	17-18	520	D331-537**	12,13,14,15
200EXC	97-16	520	D331-537**	12,13,14,15
200XC-W	06-16	520	D331-537**	12,13,14,15
250SX	94-18	520	D331-537**	12,13,14,15
250EXC/TPI	07-18	520	D331-537**	12,13,14,15
250XC	06-18	520	D331-537**	12,13,14,15
250XC-W	06-18	520	D331-537**	12,13,14,15
250SX-F	06-18	520	D331-537**	12,13,14,15
250XC-F	07-18	520	D331-537**	12,13,14,15
300EXC/TPI	06-16	520	D331-537**	12,13,14,15
300XC	06-18	520	D331-537**	12,13,14,15
300XC-W	06-18	520	D331-537**	12,13,14,15
350SX-F	11-18	520	D331-537**	12,13,14,15
350EXC-F	12-18	520	D331-537**	12,13,14,15
350XC-F	11-18	520	D331-537**	12,13,14,15
350XC-F-W	12-17	520	D331-537**	12,13,14,15
450SX-F	07-18	520	D331-537**	12,13,14,15
450XC/F	03-18	520	D331-537**	12,13,14,15
450XC-F	08-18	520	D331-537**	12,13,14,15
450XC-W	07-16	520	D331-537**	12,13,14,15
500EXC/F	12-18	520	D331-537**	12,13,14,15
500XC-W	12-16	520	D331-537**	12,13,14,15
530XC-W	08-11	520	D331-537**	12,13,14,15
530XC-W	09-10	520	D331-537**	12,13,14,15
FREERIDE250F	18 520	D331-537**	13,14,15	
FREERIDE250R	14-17	520	D331-537**	13,14,15
FREERIDE350	12-17	520	D331-537**	13,14,15
690ENDBURO/R	08-17	520	D331-538**	14,15,16
690DUKE	08-16	520	D331-538**	14,15,16
690SMC/R	08-16	520	D331-538**	14,15,16
CR125/WR125	98-08	520	D331-553**	13
TE250/350/400/510/610	90-08	520	D331-551**	12,13,14,15,16
WR250	00-08	520	D331-551**	12,13,14,15,16
WR360	00-08	520	D331-551**	12,13,14,15,16
TC65	17-18	420	D331-306**	12,13,14
TC85	14-17	428	D331-411**	13,14
TC125	14-18	520	D331-537**	12,13,14,15
TC250	14-18	520	D331-537**	12,13,14,15
FC250	14-18	520	D331-537**	12,13,14,15
FC350	14-18	520	D331-537**	12,13,14,15
FC450	14-18	520	D331-537**	12,13,14,15
TE125	14-16	520	D331-537**	12,13,14,15
TE150	17-18	520	D331-537**	12,13,14,15
TE250/i	14-18	520	D331-537**	12,13,14,15
TE300/i	14-18	520	D331-537**	12,13,14,15
FE250	14-18	520	D331-537**	12,13,14,15
FE350	14-18	520	D331-537**	12,13,14,15
FE450	14-18	520	D331-537**	12,13,14,15
FE501	14-18	520	D331-537**	12,13,14,15
TX125	17-18	520	D331-537**	12,13,14,15
TX300	17-18	520	D331-537**	12,13,14,15
FX350	17-18	520	D331-537**	12,13,14,15
FX450	17-18	520	D331-537**	12,13,14,15
701 ENDBURO	16-18	520	D331-538**	14,15,16
701SUPER MOTO	16-18	520	D331-538**	14,15,16
125EX	03-14	520	D331-535**	12,13,14,15
200/250/350/400/450	97-13	520	D331-536**	13

DURA STD SUZUKI

Bike	Year	Size	Part #	Tooth
DRZ70	08-17	428	D331-401**	13,14
DRZ125	03-16	428	D331-413**	14,15,16
JR50	80 420	D331-301**	12,13,14,15	
JR80	82-04	428	D331-401**	13,14
RM80	77-81	428	D331-401**	13,14
RM85	82-01	428	D331-404**	13,14,15
RM125	02-17	428	D331-404**	13,14,15
RM125 #	75-79	520	D331-544**	12,13
RM250	76-79	428	D331-414**	13,14
RM250	80-08	520	D331-544**	12,13
RM250	75-81	520	D331-552**	13,14,15
RM250	82-08	520	D331-523**	12,13,14,15
RMZ250	04-06	520	D331-520**	13
RMZ250	07-12	520	D331-544**	12,13
RMZ250	13-15	520	D331-524**	13,14
RMZ250	05-12	520	D331-540**	13,14
RMZ450	13-14	520	D331-541**	1



DURA STD Type

** Enter tooth number to complete part number when ordering.

DURA STD YAMAHA

Bike	Year	Size	Part #	Tooth
TTR90	06-17	420	D331-304-***	12,13,14,15
TTR90	00-07	420	D331-304-***	12,13,14,15
TTR110	08-17	420	D331-304-***	12,13,14,15
TTR225	99-04	428	D331-406-***	13,14,15,16
TTR230	05-17	520	D331-503-***	13
MX90	74-75	428	D331-404-***	13,14,15
MX/YZ125	74-76	428	D331-404-***	13,14,15
YZ50	80	420	D331-301-***	12,13,14,15
YZ60	81-84	420	D331-304-***	12,13,14,15
	74-77	420	D331-301-***	12,13,14,15
YZ80	78-80	428	D331-401-***	13,14
	81-01	428	D331-404-***	13,14,15
YZ85	02-18	428	D331-412-***	13,14,15,16,17
	77-86	520	D331-501-***	12,13
YZ125	87-04	520	D331-501-***	12,13,14,15
	05-18	520	D331-548-***	12,13,14
YZ125X	17-18	520	D331-548-***	12,13,14
YZ175	76	520	D331-501-***	12,13
	77-98	520	D331-513-***	13,14,15,16
YZ250	99-18	520	D331-530-***	12,13,14
YZ250X	16-18	520	D331-530-***	12,13,14
YZ250F	01-18	520	D331-548-***	12,13,14
YZ250FX	15-18	520	D331-548-***	12,13,14
YZ400F	98-99	520	D331-530-***	12,13,14
YZ426F	00-02	520	D331-530-***	12,13,14
YZ450F	03-18	520	D331-530-***	12,13,14
YZ450FX	16-18	520	D331-530-***	12,13,14
WR125	98-02	520	D331-535-***	12,13,14,15
WR200	50	520	D331-535-***	12,13,14,15
WR250F	01-18	520	D331-548-***	12,13,14
WR250R/X	07-17	520	D331-548-***	12,13,14
WR250Z	89-98	520	D331-513-***	13,14,15,16
	99-02	520	D331-530-***	12,13,14
WR400F	98-99	520	D331-530-***	12,13,14
WR426F	00-02	520	D331-530-***	12,13,14
WR450F	03-18	520	D331-530-***	12,13,14
AG200	85	428	D331-406-***	14,15,16
AT1/AT1125	70	428	D331-404-***	13,14,15
BW400	85-88	520	D331-501-***	13,13
BW350	87-88	520	D331-501-***	13,13
CT1/CT175	70	428	D331-404-***	13,14,15
DT1/DT250	68-78	520	D331-530-***	12,13,14
DT125	74-81	428	D331-404-***	13,14,15
	85-87	428	D331-405-***	13,14,15,16
DT125R	88-98	428	D331-412-***	13,14,15,16,17
DT125R #	88-98	520	D331-535-***	12,13,14,15
DT200R	88-90	428	D331-412-***	13,14,15,16,17
DT200R #	88-90	520	D331-535-***	12,13,14,15
DT200WR	91-94	520	D331-535-***	12,13,14,15
DT230LANZA #	97-98	428	D331-412-***	13,14,15,16,17
DT230LANZA	97-98	428	D331-412-***	13,14,15,16,17
DT400	75-	520	D331-530-***	12,13,14
DT50LW(17W)	82-96	420	D331-304-***	12,13,14,15
DT90	74-76	428	D331-404-***	13,14,15
FT50	71	420	D331-301-***	12,13,14,15
GT50/80	420	D331-301-***	12,13,14,15	
H1/HT90	70	428	D331-404-***	13,14,15
IT175	77-83	520	D331-501-***	12,13
IT200	84-86	520	D331-501-***	12,13
JT60	71	420	D331-301-***	12,13,14,15
PW80	83-06	420	D331-304-***	12,13,14,15
RT1/RT360/DT360	69-74	520	D331-530-***	12,13,14
SEROW225	85-04	428	D331-406-***	14,15,16
SEROW250	05-17	428	D331-415-***	13,14,15
TDR125	89-	428	D331-412-***	13,14,15,16,17
TDR250	91	520	D331-530-***	12,13,14
TDR50/80	88-	428	D331-406-***	13,14,15,16
TT250	86-87	520	D331-515-***	14,15
TT250R	93-97	520	D331-550-***	13,14
TT250RAID	94-96	428	D331-417-***	17,18
TT250RAID #	94-96	520	D331-550-***	13,14
TT350	86-92	520	D331-515-***	14,15
TT500	76	520	D331-530-***	12,13,14
TT600	83-92	520	D331-515-***	14,15
TW125	99-05	428	D331-410-***	14,15
TW200	87-01	428	D331-410-***	14,15
TW225	02-07	428	D331-410-***	14,15
TY125	76-89	428	D331-404-***	13,14,15
TY175	77-80	428	D331-404-***	13,14,15
TY250S/R	84-90	520	D331-512-***	11,12
TY250Z	94	520	D331-535-***	12,13,14,15
TY350R	85	520	D331-512-***	11,12
TY50/80	75	420	D331-301-***	12,13,14,15
TRICKER	05-17	428	D331-415-***	13,14,15
XT125R/X	08-11	428	D331-405-***	13,14,15,16
XT250T	83-84	520	D331-552-***	13,14,15
XT250X	06-17	428	D331-415-***	13,14,15
XT400	82	520	D331-515-***	14,15
XT500	76-81	520	D331-530-***	12,13,14
XT600TENERE	83-86	520	D331-515-***	14,15
XTZ125	03-12	428	D331-406-***	14,15,16
XTZ660TENERE	08-15	520	D331-534-***	14,15
XTZ750 SUPERTENERE	90	520	D331-528-***	16
YFS200 BLASTER	88-06	520	D331-503-***	13
BRONCO	96	428	D331-406-***	14,15,16
FS1	70	420	D331-301-***	12,13,14,15
FZ400R	84-87	520	D331-515-***	14,15
MT03	06-12	520	D331-534-***	14,15
RZ125	82-86	428	D331-406-***	13,14,15,16
TA125	73-74	428	D331-404-***	13,14,15
TZR125	87-99	428	D331-406-***	13,14,15,16
XJR400	93	520	D331-515-***	14,15
YSR50/80	87-92	420	D331-301-***	12,13,14,15

520 Converted

DURA STD Kawasaki

Bike	Year	Size	Part #	Tooth	
KX60	83-00	420	D331-304-***	12,13,14,15	
KX65	00-18	420	D331-304-***	12,13,14,15	
KX80/85/100	79-18	420	D331-304-***	12,13,14,15	
	80-93	520	D331-501-***	12,13	
KX125	94-08	520	D331-509-***	12,13,14,15	
	74-86	520	D331-514-***	13,14	
KX250	87-98	520	D331-513-***	13,14,15,16	
	99-08	520	D331-530-***	12,13,14	
	04-05	520	D331-520-***	13	
KX250F	06-18	520	D331-547-***	12,13,14	
KX420	80-82	520	D331-514-***	13,14	
KX450F	06-18	520	D331-530-***	12,13,14	
KX500	83-86	520	D331-514-***	13,14	
	87-04	520	D331-513-***	13,14,15,16	
KLX450R	08-09	520	D331-530-***	12,13,14	
	125TR	71-73	428	D331-406-***	14
	175TR	71-73	428	D331-406-***	14
KX250R (F11) #	73-76	520	D331-517-***	15	
250TR	82	520	D331-533-***	14,15	
350TR(F5) #	71	520	D331-517-***	15	
AE50/80	81	420	D331-302-***	12,13,14,15	
D-TRACKER/X	01-16	520	D331-532-***	13,14,15	
D-TRACKER125	10-16	428	D331-416-***	13,14	
KD125	75-79	428	D331-513-***	13,14,15,16	
KD175	76-79	428	D331-406-***	13,14,15,16	
KDX125SR	90-99	428	D331-405-***	13,14,15,16	
KDX175	79-82	520	D331-501-***	12,13	
KDX175	83	520	D331-501-***	12,13	
KDX200	84-88	520	D331-513-***	13,14,15,16	
KDX200R	89-93	520	D331-513-***	13,14,15,16	
KDX200SR	89-93	520	D331-513-***	13,14,15,16	
KDX220R	94-05	520	D331-513-***	13,14,15,16	
KDX220SR	94-99	520	D331-513-***	13,14,15,16	
KDX250	82-85	520	D331-514-***	13,14	
KDX250R	91-94	520	D331-513-***	13,14,15,16	
KDX250SR	91-94	520	D331-513-***	13,14,15,16	
KDX400	79	520	D331-514-***	13,14	
KDX420	80-81	520	D331-514-***	13,14	
KDX450	82	520	D331-514-***	13,14	
KL250	79-83	520	D331-513-***	13,14,15,16	
KL250	93-95	520	D331-533-***	14,15	
KL400	91-99	520	D331-533-***	14,15	
KL500	01-07	520	D331-533-***	14,15	
KLR250	84-05	520	D331-533-***	14,15	
KL600	84-86	520	D331-533-***	14,15	
KL650R	89-17	520	D331-533-***	14,15	
KL700	80-84	520	D331-514-***	13,14	
KL750	82-84	520	D331-514-***	13,14	
KLX110	02-17	420	D331-302-***	12,13,14,15	
KLX125	10-16	428	D331-416-***	13,14	
KLX250	01-16	520	D331-532-***	13,14,15	
KLX250R	93-00	520	D331-513-***	13,14,15,16	
KLX250SR/ES	93-00	520	D331-513-***	13,14,15,16	
KLX300R	96-07	520	D331-513-***	13,14,15,16	
KMX125	86-89	428	D331-405-***	13,14,15,16	
KMX200	87-91	428	D331-405-***	13,14,15,16	
SUPERSHERPA	97-09	520	D331-513-***	13,14,15,16	
KXT250	84-86	520	D331-514-***	13,14	
A1 #	69	520	D331-517-***	15	
250SS #	72	520	D331-517-***	15	
AR50	81	420	D331-302-***	12,13,14,15	
AR80	81	420	D331-302-***	12,13,14,15	
BJ250	85	520	D331-533-***	14,15	
CS250	85	520	D331-533-***	14,15	
EN500	96-00	520	D331-533-***	14,15	
EX500	520	D331-533-***	14,15		
GPX400R	520	D331-533-***	14,15		
GPZ400R	520	D331-533-***	14,15		
GPZ550	520	D331-533-***	14,15		
KH250 #	75-82	520	D331-517-***	15	
KR-1	88-	520	D331-533-***	14,15	
KV75	75	420	D331-301-***	12,13,14,15	
NINJA250R	08-17	520	D331-532-***	13,14,15	
NINJA250SL	15-16	520	D331-532-***	13,14,15	
NINJA650R	09-16	520	D331-530-***	12,13,14	
Z250	13-17	520	D331-532-***	13,14,15	
Z250SL	16-17	520	D331-532-***	13,14,15	
ZXR6R	03-06	520	D331-529-***	14,15	
ZXR400	520	D331-533-***	14,15		

520 Converted

DURA STD HONDA

CR50/60	83-86	420	D331-303-***	13,14,15
	80-85	420	D331-303-***	13,14,15
CR80R	86-02	420	D331-308-***	13,14,15
CR85R	03-07	420	D331-308-***	13,14,15
CR125M	74-78	428	D331-408-***	13,14,15,16,17
	79-85	520	D331-507-***	13,14
	86	520	D331-546-***	13
CR125R	87-03	520	D331-545-***	12,13,14
	04-07	520	D331-549-***	12,13,14
CR250M	73-77	520	D331-504-***	13,14
	79-85	520	D331-511-***	14
CR250R	86-87	520	D331-522-***	14
	88-07	520	D331-539-***	13,14
CR450/480/500R	81-85	520	D331-511-***	14
CR500R	86-87	520	D331-522-***	14
	88-01	520	D331-539-***	13,14
CRF110F	13-16	420	D331-303-***	13,14,15
CRF125F	14-18	428	D331-402-***	13,14
CRF150F	03-17	520	D331-508-***	12,13,14
CRF230F	03-17	520	D331-508-***</	

STAND



TRANSPORT



TOOL



CONTROL



EXHAUST



ELECTRICAL



DRIVE



BODY



ACCESSORIES



SUPER DURABLE
LIGHT WEIGHT
LONG LIFE

DURA
SPROCKET
デュラ スプロケット

DRC
DURA SPROCKET

- Made of durable heat treated steel that is stronger and longer lasting than aluminum sprockets.
- The best balanced, durable and light weight design. 30% lighter than standard steel sprockets available on the market.
- Precision laser cut for the lightest steel sprocket design.

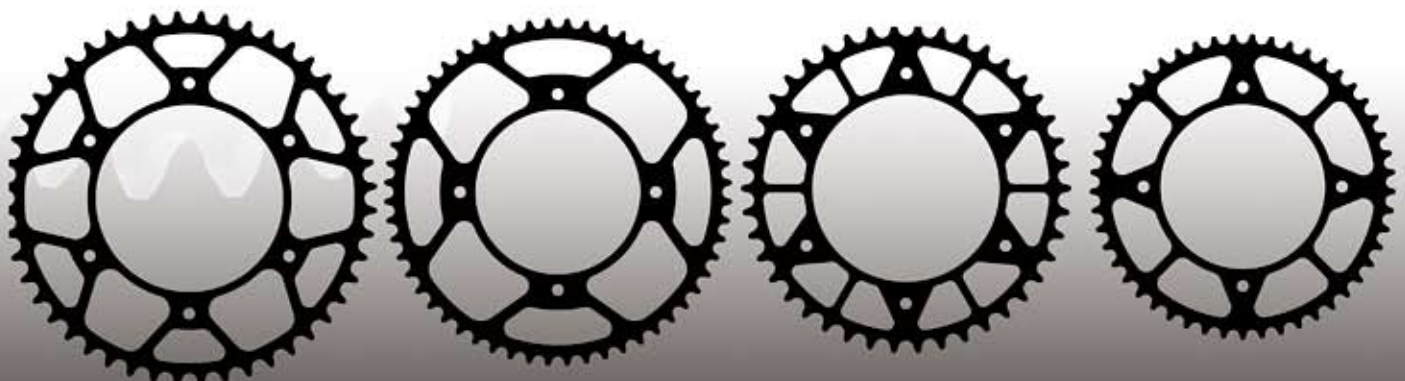

DURA SPROCKET APPLICATION



** Enter tooth number to complete part number when ordering.

	Bike	Year	Size	Part #	Tooth			
HONDA	CR80R/85R	85-07	420	D34-01-0**	46,47,48,49,50,51,55,56,57			
	CRF150R	07-18	420	D34-01-0**	46,47,48,49,50,51,55,56,57			
	CRF100F/XR100R	91-12	420	D34-05-0**	49,50,51			
	CRF125F	14-18						
	CR125R/250R	87-07	520	D34-02-0**	39,40,41,42,43,44,45,46,47,48,49,50,51,52,53			
	CRF150F/230F	03-17						
	CRF250R	04-17						
	CRF450R	02-18						
	CRF450RX	17-18						
	CRF250X/450X	04-17						
	XR250R(ME06)	90-95				520	D34-03-0**	39,40,42,44,45,46,48
	XR250R(ME08) XR400R	96-05				520	D34-02-0**	39,40,41,42,43,44,45,46,47,48,49,50,51,52,53
	XR600R/XR650L	91-17				520	D34-03-0**	39,40,42,44,45,46,48
	XR650R	00-07				520	D34-02-0**	39,40,41,42,43,44,45,46,47,48,49,50,51,52,53
	CRM50/80	88-97	420	D34-01-0**	46,47,48,49,50,51,55,56,57			
	SL230	97-04	520	D34-02-0**	39,40,41,42,43,44,45,46,47,48,49,50,51,52,53			
	XR230	05-12						
	XR250/BAJA/MOTARD (MD30)	95-07	520	D34-02-0**	39,40,41,42,43,44,45,46,47,48,49,50,51,52,53			
	CRF250L/M	12-17	520	D34-03-0**	39,40,42,44,45,46,48			
	CRF250RALLY	17	520	D34-03-0**	39,40,42,44,45,46,48			
	CRM250R	89-96	520	D34-03-0**	39,40,42,44,45,46,48			
	CRM250AR	97-98	520	D34-02-0**	39,40,41,42,43,44,45,46,47,48,49,50,51,52,53			
YZ80/85	93-18	428	D34-31-0**	46,47,48,49,50,51,52,53				
YZ125/250	85-98	520	D34-51-0**	44,45,46,47,48,49,50,51				
YZ250F	99-18	520	D34-52-0**	42,43,44,45,46,47,48,49,50,51,52				
YZ400-450F	01-18							
YZ125X	99-18							
YZ250X	17-18							
YZ250FX	16-18							
YZ450FX	15-18							
WR250F	16-18							
WR400F-450F	01-18							
WR250	99-18							
TDR50/80	89-01				520	D34-51-0**	44,45,46,47,48,49,50,51	
TTR125	88-	428	D34-53-0**	49,54				
XTZ125	02-17	428	D34-53-0**	49,54				
DT125R	03-17	428	D34-53-0**	49,54				
DT125R/200R DT230LANZA	-87	428	D34-53-0**	49,54				
DT125R/200R DT230LANZA (428-520 Converted)	88-	428	D34-54-0**	53,55,57				
DT200WR	#1 88-	520	D34-51-0**	44,45,46,47,48,49,50,51				
TT250R	#1 91-94	520	D34-51-0**	44,45,46,47,48,49,50,51				
TT250R RAID	#1 93-97	428	D34-54-0**	53,55,57				
TT250R RAID (428-520 Converted)	#1 94-96	520	D34-51-0**	44,45,46,47,48,49,50,51				
WR250R/X	#1 07-17	520	D34-52-0**	42,43,44,45,46,47,48,49,50,51,52				
KAWASAKI	KX65	01-18	420	D34-20-0**	46,47,48			
	KX80/85/100	90-18	420	D34-22-0**	49,50,51,52			
	KX125/250	90-08	520	D34-24-0**	39,40,41,42,43,44,45,46,47,48,49,50,51,52,53			
	KX250F	04-18						
	KX450F	06-18						
	KLX450R	08-15						
	KLX125/D-TRACKER125	10-16	428	D34-25-0**	44,47,49			
	KLX150S	09-13						
	KDX125SR	90-99	428	D34-26-0**	50,52,54			
	KDX125SR (428-520 Converted)	90-99	520	D34-24-0**	39,40,41,42,43,44,45,46,47,48,49,50,51,52,53			
KDX200-250R/SR	89-							
KLX250/300R/SR/ES	93-16							
D-TRACKER	98-16							
SUZUKI	RM80/85	89-17	428	D34-31-0**	46,47,48,49,50,51,52,53			
	RM125/250	89-08	520	D34-32-0**	40,41,42,43,44,45,46,47,48,49,50,51,52			
	RM-Z250	04-06	520	D34-24-0**	39,40,41,42,43,44,45,46,47,48,49,50,51,52,53			
	RM-Z450	07-18	520	D34-32-0**	40,41,42,43,44,45,46,47,48,49,50,51,52			
	RMX450Z	05-18	520	D34-32-0**	40,41,42,43,44,45,46,47,48,49,50,51,52			
	TS125R (428-520 Converted)	10-17	520	D34-32-0**	40,41,42,43,44,45,46,47,48,49,50,51,52			
	TS200R	90-96	520	D34-32-0**	40,41,42,43,44,45,46,47,48,49,50,51,52			
	SX125R, DJEBEL125, DF125, DR125 (428-520 Converted)	89-	520	D34-36-0**	45			
	SX200R, DJEBEL200, DF200, DR200SE	-						
	RMX250S/R	89-98	520	D34-32-0**	40,41,42,43,44,45,46,47,48,49,50,51,52			
	DR250S/DJEBEL250	90-94	520	D34-33-0**	41,42,43,44,45,46,47,48,49,50,51,52			
	DR250R/DJEBEL250XC	95-08	520	D34-32-0**	40,41,42,43,44,45,46,47,48,49,50,51,52			
	DRZ400R	00-05	520	D34-32-0**	40,41,42,43,44,45,46,47,48,49,50,51,52			
	DRZ400S(JAPAN)	00-03	520	D34-32-0**	40,41,42,43,44,45,46,47,48,49,50,51,52			
	DRZ400S(US)	04-09	520	D34-33-0**	41,42,43,44,45,46,47,48,49,50,51,52			
	DRZ400SM(JAPAN)	00-17	520	D34-32-0**	40,41,42,43,44,45,46,47,48,49,50,51,52			
	DRZ400SM(US)	05-09	520	D34-33-0**	41,42,43,44,45,46,47,48,49,50,51,52			
DRZ400SM(US)	05-17	520	D34-32-0**	40,41,42,43,44,45,46,47,48,49,50,51,52				
K T M	85SX	03-18	428	D34-77-0**	46,47,48,49,50			
	125-690 SX/SXF/EXC/EXC-F/EXC-R/XC/XCW/SMR	91-18	520	D34-75-0**	38,39,40,41,42,43,44,45,46,47,48,49,50,51,52			
HUSABERG	350-650 FC/FE/FS	00-08	520	D34-75-0**	38,39,40,41,42,43,44,45,46,47,48,49,50,51,52			
HUSQVARNA	WC/CR/TE/TC/TXC/SM/SMR 125-610	90-08	520	D34-33-0**	41,42,43,44,45,46,47,48,49,50,51,52			
	TC85	14-18	428	D34-77-0**	46,47,48,49,50			
	TC/TE/FC/FE/TX/FX 125-501	14-18	520	D34-75-0**	38,39,40,41,42,43,44,45,46,47,48,49,50,51,52			
GAS GAS	125-515 cc (EC/FSR MC SM)	97-08	520	D34-33-0**	41,42,43,44,45,46,47,48,49,50,51,52			

#1 DRC Tapered bolts and nuts set are required for fitting
 #2 Singapore and Japan models use.

STAND



TRANSPORT



TOOL



CONTROL



EXHAUST



ELECTRICAL



DRIVE



BODY



ACCESSORIES

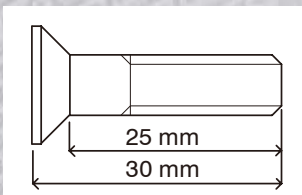

DRC SPROCKET BOLT / NUT SET

- Sprocket mounting hardware.
- Kit includes 6, 8 mm tapered bolts, 6 washers and 6 locking nuts.
- Can be used for most dirt bikes.

Part number **D58-32-282** Bolt size M8 x 25 mm

DRC CHAIN ROLLER

- More durable than stock
- Available in 3 diameter sizes.
- Colors available: black, blue and red.

S size (32 mm)

Part number	Color
D47-41-341	Black
D47-41-342	Blue
D47-41-343	Red

L size (42 mm)

Part number	Color
D47-41-441	Black
D47-41-442	Blue
D47-41-443	Red

M size (36 mm)

Part number	Color
D47-41-641	Black
D47-41-642	Blue
D47-41-643	Red

Upper	Lower
CR125R/250R 04- CRF250R/X,CRF450R/X 04- KX250F/450F 07- KLX450R 08-	CR125R/250R 05- CRF250R 05-,CRF250X 06- CRF450R/X 05- KX250F/450F 07- KLX450R 08-

S size

M size

L size



STAND



TRANSPORT



TOOL



CONTROL



EXHAUST



ELECTRICAL



DRIVE



BODY



ACCESSORIES



DRC RIM LOCK

- Die-cast aluminum body with molded rubber flap to prevent abrasion of inner tube.
- Recommended for use on all off road bikes or any use that requires low tire pressures.
- Bolt is made of SUS304 stainless steel to prevent corrosion.
- Available in 5 different sizes.

Part number	Size
D43-21-014	1.40 inch
D43-21-016	1.60 inch
D43-21-018	1.85 inch
D43-21-021	2.15 inch
D43-21-025	2.50 inch



DRC RIM HOLE PLUG

- Plug cap for rim lock holes on the rim.
- Prevents mud and dust from entering the tire through the rim lock hole.
- Comes in pairs.

Part number
D58-03-301



DRC AIR VALVE CAP WITH VALVE WRENCH

- The aluminum part can be used as a valve core remover / wrench.
- Made of A6061 aluminum.
- Available in 6 beautiful anodized colors.
- Comes in pairs.

Part number	Color	Part number	Color
D58-05-102	Blue	D58-05-105	Titanium
D58-05-103	Gold	D58-05-106	Red
D58-05-104	Black		



DRC AIR VALVE CAPS PLASTIC 4 PCS

- Plastic air valve cap.
- Available in 4 factory colors.
- Comes in 2 pairs and 2 colors.

Part number	Color
D58-03-211	Blue & Green
D58-03-212	Red & Yellow



DRC AIR VALVE CAPS

- Aluminum air valve cap.
- Add some "bling" to your bike.
- Available in 6 beautiful anodized colors.
- Comes in pairs.

Part number	Color	Part number	Color
D58-03-102	Blue	D58-03-105	Titanium
D58-03-103	Gold	D58-03-106	Red
D58-03-104	Black	D58-03-107	Orange



DRC AIR VALVE MUD GUARDS

- Keeps dirt and water out of your tire.
- Available in black, blue, red and orange.
- Comes in pairs.

Part number	Color	Part number	Color
D58-06-001	Black	D58-06-003	Red
D58-06-002	Blue	D58-06-007	Orange



DRC RIM LOCK SPACERS

- Form fit provides a secure, tighter fit over stock set-up.
- Made of aluminum and available in 6 beautiful anodized colors.
- Comes in pairs.

Part number	Color	Part number	Color
D58-01-102	Blue	D58-01-105	Titanium
D58-01-103	Gold	D58-01-106	Red
D58-01-104	Black	D58-01-107	Orange



DRC RIM LOCK NUTS

- Threaded at the top only. Takes less time to remove or tighten.
- Made of aluminum and available in 6 beautiful anodized colors.
- Comes in pairs.

Part number	Color	Part number	Color
D58-02-102	Blue	D58-02-105	Titanium
D58-02-103	Gold	D58-02-106	Red
D58-02-104	Black	D58-02-107	Orange



SMJ SUPAR MOTO
IKKI MORITA



Bike	Year	Part #
HONDA		
CR125/250	02-07	D48-02-932
CRF150R	07-18	D48-02-932
CRF250R	04-17	D48-02-932
CRF450R	02-18	D48-02-932
CRF450RX	17-18	D48-02-932
CRF250X	04-17	D48-02-932
CRF250L/M	12-17	D48-02-932
CRF250RALLY	17	D48-02-932
XR250R	95-04	D48-02-924
SUPER XR250/BAJA	95-02	D48-02-924
XR250/MOTARD	03-07	D48-02-924
YAMAHA		
YZ85	02-18	D48-02-906
YZ125/250	99-18	D48-02-906
YZ250F	01-18	D48-02-906
YZ400F-450F	99-18	D48-02-906
YZ125X	17-18	D48-02-906
YZ250X	16-18	D48-02-906
YZ250FX	15-18	D48-02-906
YZ450FX	16-18	D48-02-906
WR250F	01-18	D48-02-906
WR400F-450F	99-18	D48-02-906
WR250R/X	07-17	D48-02-937
KAWASAKI		
KX250F/450F	09-18	D48-02-931
KLX250/300/D-TRACKER	-16	D48-02-922
SUZUKI		
RM125/250	91-02	D48-02-921
RM-Z250	10-18	D48-02-920
	08-09	D48-02-905
RM-Z450	10	D48-02-920
	12-18	D48-02-920
RMX450Z	10-17	D48-02-920
RMX250R	89-99	D48-02-921
RMX250S	93-99	D48-02-921
DR-Z400E/R/S/SM	00-17	D48-02-921
KTM		
125SX/250-450SX-F	98-15	D48-02-910
	16-18	D48-02-982
	98-16	D48-02-910
250SX	17-18	D48-02-982
	17-18	D48-02-910
125-530 EXC/EXC-F	98-16	D48-02-910
	17-18	D48-02-982
150-300XC/250XC-F	06-16	D48-02-910
	17-18	D48-02-982
350-450XC-F	08-15	D48-02-910
	16-18	D48-02-982
125-530XC-W/XCF-W	06-16	D48-02-910
	17-18	D48-02-982
690ENDURO/R	08-17	D48-02-910
690SMC/R	08-17	D48-02-910
690SUPER MOTO/R	07-09	D48-02-910
950ADVENTURE/S	03-06	D48-02-910
950SUPER ENDURO	ALL	D48-02-910
950SUPER MOTO/R	05-08	D48-02-910
990ADVENTURE	ALL	D48-02-910
990SUPER MOTO/R/T	09-13	D48-02-910
1050ADVENTURE	15-16	D48-02-910
1090ADVENTURE/R	17	D48-02-910
1190ADVENTURE/R	13-16	D48-02-910
1290SUPER ADVENTUR/R/S/T	15-17	D48-02-910
HUSQVARNA		
WR125/TE250/SM250	07-09	D48-02-981
TC125/FC 250-450	14-15	D48-02-910
	16-18	D48-02-982
TC250	14-16	D48-02-910
	17-18	D48-02-982
TE/FE125-501	14-16	D48-02-910
	17-18	D48-02-982
TX/FX125-450	17-18	D48-02-982
701ENDURO	16-18	D48-02-910
701SUPER MOTO	16-18	D48-02-910
FS450	15	D48-02-910
	16-18	D48-02-982



DRC
MOTARD FOOT PEG

- Equipped with replaceable peg slider for super moto riding.
- Shorter length, higher peg position prevents peg body wear by avoiding hitting asphalt.
- 50 mm step width provides better grip and control.
- Made of chromium molybdenum steel for extreme durability.
- Black powder coating finish.
- Replacement peg slider available.

EQUIPPED PEG SLIDER



DRC
REPLACEMENT PEG SLIDER

Comes in pairs.
4 screws for attachment are included.
Part number
D48-02-999



DRC
WIDE FOOT PEG SPRING 2PCS

YZ/WR250F/450F'06-, YZ125/250'06-
Part number
D48-02-006



STAND



TRANSPORT



TOOL



CONTROL



EXHAUST



ELECTRICAL



DRIVE



BODY



ACCESSORIES



DRC
WIDE FOOT PEG

- Durable steel wide foot pegs.
- Made of chromium molybdenum steel for extreme durability.
- 50 mm step width provides better grip and control.
- Mid, High (5 mm higher than medium peg position) and Low (5 mm lower than medium peg position) are available for rider's body type or use. (Excluding some models.)
- Black powder coating finish.

* Foot peg height may differ from stock peg height on some models.



HEIGHT POSITION HIGH



High gravity point allows for easy lean on the bike. Good for shorter riders.

HEIGHT POSITION LOW

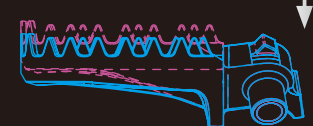

Low gravity point provides better traction during standing ride. Good for taller riders.

DRC
ULTRA WIDE FOOTPEG

- Wider foot pegs than our DRC foot pegs for pro use.
- 57 mm width foot pegs provides better foot peg traction and control.
- Made of chromium molybdenum steel for extreme durability.
- Black powder coating finish.



CRF1000L Stock

35 mm

CRF1000L Ultra Wide

57mm

STAND



TRANSPORT



TOOL



CONTROL



EXHAUST



ELECTRICAL



DRIVE



BODY



ACCESSORIES



WIDE FOOT PEG / ULTRA WIDE FOOT PEG Application



Bike	Year	Wide Foot Peg				Ultra-Wide Foot Peg
		Low (-5)	Mid	High (+5)		
HONDA	CRF150R	07-18	D48-02-532	D48-02-632	D48-02-832	
HONDA	CR125/250	02-07	D48-02-532	D48-02-632	D48-02-832	
HONDA	CRF250R	04-17	D48-02-532	D48-02-632	D48-02-832	
HONDA	CRF450R	02-18	D48-02-532	D48-02-632	D48-02-832	
HONDA	CRF450R X	17-18	D48-02-532	D48-02-632	D48-02-832	
HONDA	CRF250X	04-17	D48-02-532	D48-02-632	D48-02-832	
HONDA	CRF450X	05-17	D48-02-532	D48-02-632	D48-02-832	
HONDA	XR/CRF50/70	00-17	D48-02-408	D48-02-508	D48-02-832	
HONDA	CRF110F	13-16	D48-02-533	D48-02-633	D48-02-833	
HONDA	CRF125F	14-18	D48-02-533	D48-02-633	D48-02-833	
HONDA	CRF230F	03-17	D48-02-503	D48-02-603	D48-02-803	
HONDA	CRM50/80	ALL	D48-02-542	D48-02-642	D48-02-842	
HONDA	CRM250R/AR	91-98	D48-02-542	D48-02-642	D48-02-842	
HONDA	TLM200	88-93	D48-02-534	D48-02-634	D48-02-834	
HONDA	TLM220	88-93	D48-02-534	D48-02-634	D48-02-834	
HONDA	CRF250L/M	12-17	D48-02-532	D48-02-632	D48-02-832	
HONDA	CRF250RALLY	17	D48-02-532	D48-02-632	D48-02-832	
HONDA	CRF1000L	16-17	D48-02-534	D48-02-634	D48-02-834	
HONDA	SL230	97-01	D48-02-534	D48-02-634	D48-02-834	
HONDA	TLR250	86	D48-02-534	D48-02-634	D48-02-834	
HONDA	XL250 DEGREE	91-95	D48-02-534	D48-02-634	D48-02-834	
HONDA	XR250R	87-94	D48-02-541	D48-02-641	D48-02-841	
HONDA	XR230	05-13	D48-02-541	D48-02-641	D48-02-841	
HONDA	XR250R(ME06)	86-95	D48-02-541	D48-02-641	D48-02-841	
HONDA	XR250R(ME08)	86-95	D48-02-541	D48-02-641	D48-02-841	
HONDA	SUPER XR250/BAJA	95-02	D48-02-524	D48-02-624	D48-02-824	
HONDA	XR250/MOTARD	03-07	D48-02-524	D48-02-624	D48-02-824	
HONDA	XR400R	96-04	D48-02-534	D48-02-634	D48-02-834	
HONDA	XR600R	92-00	D48-02-534	D48-02-634	D48-02-834	
HONDA	XR650L	92-16	D48-02-534	D48-02-634	D48-02-834	
HONDA	XR650R	00-07	D48-02-534	D48-02-634	D48-02-834	
YAMAHA	YZ85	02-18	D48-02-406	D48-02-506	D48-02-606	D48-02-806
YAMAHA	YZ125/250	99-18	D48-02-406	D48-02-506	D48-02-606	D48-02-806
YAMAHA	YZ250F	01-16	D48-02-406	D48-02-506	D48-02-606	D48-02-806
YAMAHA	YZ450F	03-15	D48-02-406	D48-02-506	D48-02-606	D48-02-806
YAMAHA	YZ125X	17-18	D48-02-406	D48-02-506	D48-02-606	D48-02-806
YAMAHA	YZ250X	16-18	D48-02-406	D48-02-506	D48-02-606	D48-02-806
YAMAHA	YZ250FX	15-18	D48-02-406	D48-02-506	D48-02-606	D48-02-806
YAMAHA	YZ450FX	16-18	D48-02-406	D48-02-506	D48-02-606	D48-02-806
YAMAHA	WR250F	07-18	D48-02-406	D48-02-506	D48-02-606	D48-02-806
YAMAHA	WR400F-450F	99-15	D48-02-406	D48-02-506	D48-02-606	D48-02-806
YAMAHA	DT200WR	16-18	D48-02-406	D48-02-506	D48-02-606	D48-02-806
YAMAHA	DT230LANZA	ALL	D48-02-535	D48-02-635	D48-02-835	
YAMAHA	SEROW225	97-98	D48-02-535	D48-02-635	D48-02-835	
YAMAHA	SEROW250/TRICKER	95-04	D48-02-535	D48-02-635	D48-02-835	
YAMAHA	TT250R/RAID	04-17	D48-02-535	D48-02-635	D48-02-835	
YAMAHA	WR250R / X	93-97	D48-02-535	D48-02-635	D48-02-835	
YAMAHA	XTZ125	07-17	D48-02-437	D48-02-537	D48-02-637	D48-02-837
YAMAHA	XTZ125	13-17	D48-02-535	D48-02-635	D48-02-835	
KAWASAKI	KX65	00-18	D48-02-523	D48-02-623	D48-02-823	
KAWASAKI	KX80/85/100	98-18	D48-02-523 #1	D48-02-623	D48-02-823	
KAWASAKI	KX125-250	91-96	D48-02-526	D48-02-626	D48-02-826	
KAWASAKI	KX250F/450F	09-18	D48-02-531	D48-02-631	D48-02-831	
KAWASAKI	KLX110	02-17	D48-02-451	D48-02-551	D48-02-651	D48-02-851
KAWASAKI	KDX125SR	90-99	D48-02-561	D48-02-661	D48-02-861	
KAWASAKI	KDX200R/SR	89-93	D48-02-561	D48-02-661	D48-02-861	
KAWASAKI	KDX220R/SR	ALL	D48-02-526	D48-02-626	D48-02-826	
KAWASAKI	KDX250R/SR	ALL	D48-02-526	D48-02-626	D48-02-826	
KAWASAKI	KLX125-D-TRACKER125	10-16	D48-02-507	D48-02-607	D48-02-807	
KAWASAKI	KLX150S	09-13	D48-02-507	D48-02-607	D48-02-807	
KAWASAKI	KLX250/300/D-TRACKER	-16	D48-02-522	D48-02-622	D48-02-822	
KAWASAKI	SUPER SHERPA	97-10	D48-02-561	D48-02-661	D48-02-861	

Bike	Year	Wide Foot Peg				Ultra-Wide Foot Peg
		Low (-5)	Mid	High (+5)		
SUZUKI	RM85	02-17	D48-02-561	D48-02-661	D48-02-861	
SUZUKI	RM125/250	91-02	D48-02-521	D48-02-621	D48-02-821	
SUZUKI	RM-Z250	07-09	D48-02-504	D48-02-604	D48-02-804	
SUZUKI	RM-Z450	10-18	D48-02-420	D48-02-520	D48-02-620	D48-02-820
SUZUKI	RMX450Z	08-09	D48-02-505	D48-02-605	D48-02-805	
SUZUKI	DR250/70	10-17	D48-02-420	D48-02-520	D48-02-620	D48-02-820
SUZUKI	TS125R	08-13	D48-02-451	D48-02-551	D48-02-651	D48-02-851
SUZUKI	TS200R	89-97	D48-02-535	D48-02-635	D48-02-835	
SUZUKI	RMX250R	89-96	D48-02-521	D48-02-621	D48-02-821	
SUZUKI	RMX250S	89-99	D48-02-521	D48-02-621	D48-02-821	
SUZUKI	DJEBEL250/250XC	93-99	D48-02-521	D48-02-621	D48-02-821	
SUZUKI	DR250/350S/R	ALL	D48-02-507	D48-02-607	D48-02-807	
SUZUKI	DR-Z400E/R/S/SM	00-17	D48-02-521	D48-02-621	D48-02-821	
KTM	65SX	09-18	D48-02-410	D48-02-510	D48-02-610	D48-02-810
KTM	85SX	03-17	D48-02-410	D48-02-510	D48-02-610	D48-02-810
KTM	125SX/250-450SX-F	18	D48-02-482	D48-02-582	D48-02-682	D48-02-882
KTM	250SX	98-15	D48-02-410	D48-02-510	D48-02-610	D48-02-810
KTM	125-530 EXC/EXC-F	16-18	D48-02-482	D48-02-582	D48-02-682	D48-02-882
KTM	250-500 EXC/EXC-F	98-16	D48-02-410	D48-02-510	D48-02-610	D48-02-810
KTM	150-300XC/250XC-F	06-16	D48-02-410	D48-02-510	D48-02-610	D48-02-810
KTM	350-450XC-F	17-18	D48-02-482	D48-02-582	D48-02-682	D48-02-882
KTM	200-530XC-W/XCF-W	08-15	D48-02-410	D48-02-510	D48-02-610	D48-02-810
KTM	125-300XC-W	16-18	D48-02-482	D48-02-582	D48-02-682	D48-02-882
KTM	FREERIDE250F	06-16	D48-02-410	D48-02-510	D48-02-610	D48-02-810
KTM	FREERIDE250R	18	D48-02-410	D48-02-510	D48-02-610	D48-02-810
KTM	FREERIDE350	14-17	D48-02-410	D48-02-510	D48-02-610	D48-02-810
KTM	690ENDURO/R	12-17	D48-02-410	D48-02-510	D48-02-610	D48-02-810
KTM	690SMC/R	08-17	D48-02-410	D48-02-510	D48-02-610	D48-02-810
KTM	690SUPER MOTO/R	08-17	D48-02-410	D48-02-510	D48-02-610	D48-02-810
KTM	950ADVENTURE/S	07-09	D48-02-410	D48-02-510	D48-02-610	D48-02-810
KTM	950SUPER ENDURO/R	03-06	D48-02-410	D48-02-510	D48-02-610	D48-02-810
KTM	990ADVENTURE/R/S	ALL	D48-02-410	D48-02-510	D48-02-610	D48-02-810
KTM	990ADVENTURE/R/T	05-08	D48-02-410	D48-02-510	D48-02-610	D48-02-810
KTM	1050ADVENTURE/R	ALL	D48-02-410	D48-02-510	D48-02-610	D48-02-810
KTM	1090ADVENTURE/R	15-16	D48-02-410	D48-02-510	D48-02-610	D48-02-810
KTM	1190ADVENTURE/R	17	D48-02-410	D48-02-510	D48-02-610	D48-02-810
KTM	1290SUPER ADVENTUR/R/S/T	13-16	D48-02-410	D48-02-510	D48-02-610	D48-02-810
KTM	1290SUPER ADVENTUR/R/S/T	15-17	D48-02-410	D48-02-510	D48-02-610	D48-02-810
HUSQVARNA	WR125,TE250,SM250	07-09	D48-02-481	D48-02-581	D48-02-681	D48-02-881
HUSQVARNA	TC85	14-17	D48-02-410	D48-02-510	D48-02-610	D48-02-810
HUSQVARNA	TC125/FC 250-450	18	D48-02-482	D48-02-582	D48-02-682	D48-02-882
HUSQVARNA	TC250	14-15	D48-02-410	D48-02-510	D48-02-610	D48-02-810
HUSQVARNA	TE/FE125-501	16-18	D48-02-482	D48-02-582	D48-02-682	D48-02-882
HUSQVARNA	TX125	14-16	D48-02-410	D48-02-510	D48-02-610	D48-02-810
HUSQVARNA	TX/FX300-450	17-18	D48-02-582	D48-02-682	D48-02-782	D48-02-882
HUSQVARNA	701ENDURO	17-18	D48-02-482	D48-02-582	D48-02-682	D48-02-882
HUSQVARNA	701SUPER MOTO	16-18	D48-02-410	D48-02-510	D48-02-610	D48-02-810
HUSQVARNA	FS450	15	D48-02-410	D48-02-510	D48-02-610	D48-02-810
HUSQVARNA	FS450	16-18	D48-02-582	D48-02-682	D48-02-782	D48-02-882

#1 Stock -10 mm
#2 Stock +5 mm
#3 Stock -5 mm

Wide Foot Peg Spring 2 pcs
(YZ/WR250F/450F'06-,YZ125/250'06-)
D48-02-006

Bike	Year	Pin/Spring
HONDA	CR125/250	02-07 D48-01-102
HONDA	CRF150R	07-18 D48-01-101
HONDA	CRF250R	04-17 D48-01-102
HONDA	CRF450R	02-18 D48-01-102
HONDA	CRF450R X	17-18 D48-01-102
HONDA	CRF250X	04-17 D48-01-102
HONDA	CRF450X	05-17 D48-01-102
HONDA	CRM50/80	ALL D48-01-109
HONDA	CRF110F	13-16 D48-01-103
HONDA	CRF125F	14-18 D48-01-103
HONDA	CRF230F	03-17 D48-01-103
HONDA	CRM250R/AR	91-98 D48-01-105
HONDA	CRF250L/M	12-17 D48-01-101
HONDA	CRF250RALLY	17 D48-01-101
HONDA	CRF1000L	16-17 D48-01-104
HONDA	SL230	97-01 D48-01-104
HONDA	TLM200	88-93 D48-01-105
HONDA	TLM220	88-93 D48-01-105
HONDA	TLR250	86 D48-01-105
HONDA	XL250 DEGREE	91-95 D48-01-105
HONDA	XR250R	87-94 D48-01-108
HONDA	XR230	05-13 D48-01-104
HONDA	XR250R(ME06)	86-95 D48-01-108
HONDA	XR250R(ME08)	86-95 D48-01-108
HONDA	SUPER XR250/BAJA	95-02 D48-01-106
HONDA	XR250/MOTARD	03-07 D48-01-106
HONDA	XR400R	96-04 D48-01-106
HONDA	XR600R	92-00 D48-01-106
HONDA	XR650L	92-16 D48-01-106
HONDA	XR650R	00-07 D48-01-107
YAMAHA	YZ85	02-18 D48-01-110
YAMAHA	YZ125/250	99-18 D48-01-110
YAMAHA	YZ250F	01-16 D48-01-110
YAMAHA	YZ450F	03-15 D48-01-110
YAMAHA	YZ125X	17-18 D48-01-110
YAMAHA	YZ250X	16-18 D48-01-110
YAMAHA	YZ250FX	15-18 D48-01-110
YAMAHA	YZ450FX	16-18 D48-01-110
YAMAHA	WR250F	01-18 D48-01-110
YAMAHA	WR400F-450F	99-18 D48-01-112
YAMAHA	DT200WR	ALL D48-01-112
YAMAHA	DT230LANZA	97-98 D48-01-112
YAMAHA	SEROW225	95-04 D48-01-113
YAMAHA	SEROW250/TRICKER	04-17 D48-01-112
YAMAHA	TT250R/RAID	93-97 D48-01-112
YAMAHA	WR250R/X	07-17 D48-01-111
YAMAHA	XTZ125	13-17 D48-01-113
KAWASAKI	KX65	00-18 D48-01-122
KAWASAKI	KX80/85/100	98-18 D48-01-122
KAWASAKI	KX125-250	91-96 D48-01-116
KAWASAKI	KX250F/450F	09-18 D48-01-114
KAWASAKI	KDX125SR	90-99 D48-01-115
KAWASAKI	KDX200R/SR	89-93 D48-01-115
KAWASAKI	KDX220R/SR	ALL D48-01-116
KAWASAKI	KDX250R/SR	ALL D48-0

DRC ALUMINUM BOLT

- Made of 7009 aluminum.
- Light weight.
- Select from flange-head or taper-head for each bolt size.
- Suitable for mounting plastics and more.
- Colors available: Titanium, Gold, Red and Blue.
- Available in M6 size.
- Sold in set of 4 and 20.
- Tightening torque M6 Bolts.....6N /m



M6 Flange Bolt

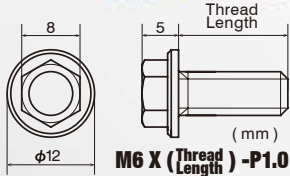

M6 Taper Bolt

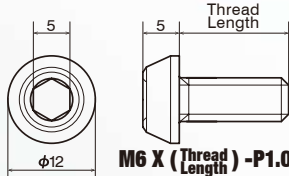

DRC ALUMINUM NUT

- Made of 7009 aluminum.
- Light weight.
- Suitable for mounting plastics and more.
- Colors available: Titanium, Gold, Red and Blue.
- Available in M6 size.
- Sold in set of 4 and 20.

M6 Flange Nut

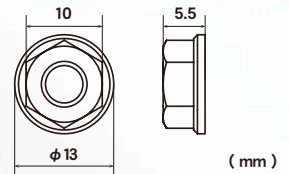

M6 Aluminum Flange Bolt			
Color	Size	4 pack	20 pack
Blue	M6X12-P1.0	D58-51-112	D58-51-612
	M6X16-P1.0	D58-51-116	D58-51-616
	M6X20-P1.0	D58-51-120	D58-51-620
	M6X25-P1.0	D58-51-125	D58-51-625
	M6X30-P1.0	D58-51-130	D58-51-630
	M6X35-P1.0	D58-51-135	D58-51-635
Red	M6X12-P1.0	D58-51-212	D58-51-712
	M6X16-P1.0	D58-51-216	D58-51-716
	M6X20-P1.0	D58-51-220	D58-51-720
	M6X25-P1.0	D58-51-225	D58-51-725
	M6X30-P1.0	D58-51-230	D58-51-730
	M6X35-P1.0	D58-51-235	D58-51-735
Gold	M6X12-P1.0	D58-51-312	D58-51-812
	M6X16-P1.0	D58-51-316	D58-51-816
	M6X20-P1.0	D58-51-320	D58-51-820
	M6X25-P1.0	D58-51-325	D58-51-825
	M6X30-P1.0	D58-51-330	D58-51-830
	M6X35-P1.0	D58-51-335	D58-51-835
Titanium	M6X12-P1.0	D58-51-412	D58-51-912
	M6X16-P1.0	D58-51-416	D58-51-916
	M6X20-P1.0	D58-51-420	D58-51-920
	M6X25-P1.0	D58-51-425	D58-51-925
	M6X30-P1.0	D58-51-430	D58-51-930
	M6X35-P1.0	D58-51-435	D58-51-935

M6 Aluminum Taper Bolt			
Color	Size	4 pack	20 pack
Blue	M6X12-P1.0	D58-52-112	D58-52-612
	M6X16-P1.0	D58-52-116	D58-52-616
	M6X20-P1.0	D58-52-120	D58-52-620
	M6X25-P1.0	D58-52-125	D58-52-625
	M6X30-P1.0	D58-52-130	D58-52-630
	M6X35-P1.0	D58-52-135	D58-52-635
Red	M6X12-P1.0	D58-52-212	D58-52-712
	M6X16-P1.0	D58-52-216	D58-52-716
	M6X20-P1.0	D58-52-220	D58-52-720
	M6X25-P1.0	D58-52-225	D58-52-725
	M6X30-P1.0	D58-52-230	D58-52-730
	M6X35-P1.0	D58-52-235	D58-52-735
Gold	M6X12-P1.0	D58-52-312	D58-52-812
	M6X16-P1.0	D58-52-316	D58-52-816
	M6X20-P1.0	D58-52-320	D58-52-820
	M6X25-P1.0	D58-52-325	D58-52-825
	M6X30-P1.0	D58-52-330	D58-52-830
	M6X35-P1.0	D58-52-335	D58-52-835
Titanium	M6X12-P1.0	D58-52-412	D58-52-912
	M6X16-P1.0	D58-52-416	D58-52-916
	M6X20-P1.0	D58-52-420	D58-52-920
	M6X25-P1.0	D58-52-425	D58-52-925
	M6X30-P1.0	D58-52-430	D58-52-930
	M6X35-P1.0	D58-52-435	D58-52-935

M6 Aluminum Flange Nut			
Color	size	4 pack	20 pack
Blue	M6-P1.0	D58-53-101	D58-53-601
Red	M6-P1.0	D58-53-201	D58-53-701
Gold	M6-P1.0	D58-53-301	D58-53-801
Titanium	M6-P1.0	D58-53-401	D58-53-901

DRC ALUMINUM SPACER

- Made of forged 6061 Aluminum, light weight.
- Available ϕ 18 mm M6 and ϕ 20 mm M6 washer sizes.
- Suitable for mounting plastics and more.
- Available in 4 different designs and 5 different anodized colors.
- ϕ 18 mm M6 spacers are sold in sets of 4 and 20.
- ϕ 20 mm M6 spacers are sold in sets of 10.



Type 01 (M6 18 mm)

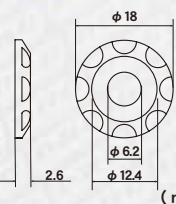

Type 02 (M6 18 mm)

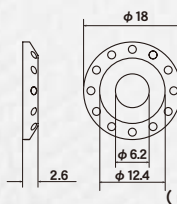

Type 11 (M6 18 mm)

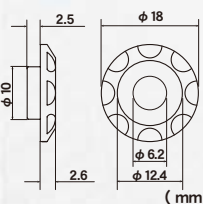

Type 12 (M6 18 mm)

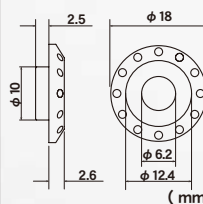

Type 31 (M6 20 mm)

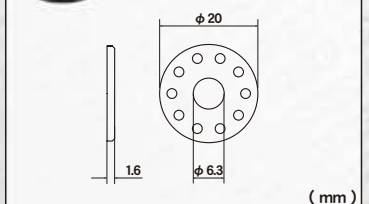

ϕ 18 M6 Aluminum Spacer			
Color	Size	4 Pack	20 Pack
Blue	Type 01	D58-57-111	D58-57-114
Red		D58-57-121	D58-57-124
Gold		D58-57-131	D58-57-134
Titanium	Type 02	D58-57-141	D58-57-144
Black		D58-57-151	D58-57-154
Blue		D58-57-211	D58-57-214
Red	Type 11	D58-57-221	D58-57-224
Gold		D58-57-231	D58-57-234
Titanium		D58-57-241	D58-57-244
Black	Type 12	D58-57-251	D58-57-254
Blue		D58-57-411	D58-57-414
Red	Type 31	D58-57-421	D58-57-424
Gold		D58-57-431	D58-57-434
Titanium		D58-57-441	D58-57-444
Black	Type 12	D58-57-451	D58-57-454

ϕ 20 M6 Aluminum Spacer			
Color	Size	4 Pack	20 Pack
Blue	Type 11	D58-57-311	D58-57-314
Red		D58-57-321	D58-57-324
Gold		D58-57-331	D58-57-334
Titanium	Type 12	D58-57-341	D58-57-344
Black		D58-57-351	D58-57-354
Blue		D58-57-411	D58-57-414
Red	Type 31	D58-57-421	D58-57-424
Gold		D58-57-431	D58-57-434
Titanium		D58-57-441	D58-57-444
Black	Type 12	D58-57-451	D58-57-454

ϕ 20 M6 Aluminum Spacer		
Color	size	10 pack
Blue	Type 31	D58-58-114
Red		D58-58-124
Gold		D58-58-134
Titanium	Type 31	D58-58-144
Black		D58-58-154



Steel and Stainless M6 Bolts / Nuts



Steel	M6 Steel Flange Bolt		
	Size	5 pack	25 pack
	M6X15-P1.0	D58-31-415	D58-31-815
	M6X20-P1.0	D58-31-420	D58-31-820
	M6X25-P1.0	D58-31-425	D58-31-825
	M6X30-P1.0	D58-31-430	D58-31-830
	M6X35-P1.0	D58-31-435	D58-31-835
	M6X40-P1.0	D58-31-440	D58-31-840
	M6X45-P1.0	D58-31-445	D58-31-845

Stain Less	M6 Stainless Flange Bolt		
	Size	5 pack	15 pack
	M6X10-P1.0	D58-35-110	D58-35-210
	M6X15-P1.0	D58-35-115	D58-35-215
	M6X20-P1.0	D58-35-120	D58-35-220
	M6X25-P1.0	D58-35-125	D58-35-225
	M6X30-P1.0	D58-35-130	D58-35-230
	M6X35-P1.0	D58-35-135	D58-35-235

Stain Less	M6 Stainless Cap Bolt		
	Size	5 pack	15 pack
	M6X10-P1.0	D58-35-510	D58-35-610
	M6X15-P1.0	D58-35-515	D58-35-615
	M6X20-P1.0	D58-35-520	D58-35-620
	M6X25-P1.0	D58-35-525	D58-35-625
	M6X30-P1.0	D58-35-530	D58-35-630
	M6X35-P1.0	D58-35-535	D58-35-635

Stain Less	M6 Stainless Taper Bolt	
	Size	4 pack
	M6X10-P1.0	D58-36-010
	M6X15-P1.0	D58-36-015
	M6X25-P1.0	D58-36-025
	M6X30-P1.0	D58-36-030



DRC M6 FLANGE BOLT

M6 X (Thread Length) - P1.0

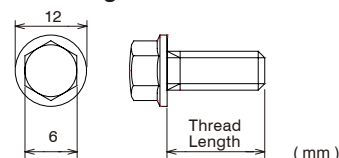

DRC M6 CAP BOLT

M6 X (Thread Length) = P1.0

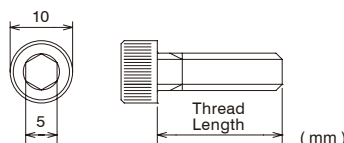

DRC M6 TAPER BOLT

M6 X (Thread Length) = P1.0

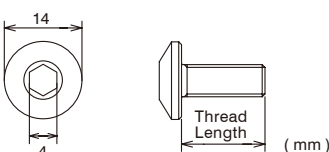

DRC M6 FLANGE NUT

M6 X - P1.0

M6 nut steel

D58-31-501 5 pack
D58-31-901 25 pack

M6 nut stainless

D58-35-801 5 pack
D58-35-901 15 pack



DRC M6 FLANGE LOCK NUT

M6 X - P1.0

D58-31-502 5 pack
D58-31-902 25 pack



DRC Steel M6 Bolt / Nut BOX SET

15 mm / 20 mm / 25 mm / 30 mm / 35 mm / 40 mm / 45 mm
(Each x 15 pcs / Nut x 15 pcs)

Part number
D58-31-098

DRC Stainless M6 Bolt / Nut BOX SET

10 mm / 15 mm / 20 mm / 25 mm / 30 mm / 35 mm
(Each x 15 pcs / Nut x 15 pcs)

Stainless Flange Part number D58-35-001
Stainless Cap Part number D58-35-401



Make your bike look stylish with anodized aluminum washers and bolts.

** Please check Tightening torque with your service manual.
Routine screw and bolt torque checking required.
Please do not use aluminum bolts and nuts in areas of high temperature.





DRC
STAINLESS BRAKE PIN SET

- Features an 8 mm hex head, allowing quick and easy brake pad changes. (Excluding **D58-33-241**)
- Made of SUS304 stainless steel that resists corrosion, heat and galling.
- Comes in a set for each specific configuration.
- Replacement pins are available.

Bike	Year	Set	Front	Rear	
HONDA	CR125R	90-01 D58-33-201	D58-33-072	D58-33-074	
		02-07 D58-33-202	D58-33-072	D58-33-093	
	CR250R	90-01 D58-33-201	D58-33-072	D58-33-074	
		02-07 D58-33-202	D58-33-072	D58-33-093	
	CRF250R	04-17 D58-33-202	D58-33-072	D58-33-093	
	CRF450R	02-18 D58-33-202	D58-33-072	D58-33-093	
	CRF450RX	17-18 D58-33-202	D58-33-072	D58-33-093	
	CRF250X	04-17 D58-33-202	D58-33-072	D58-33-093	
	CRF450X	05-17 D58-33-202	D58-33-072	D58-33-093	
	CRM250R/AR	91-98 D58-33-201	D58-33-072	D58-33-074	
	XR230	05-12 D58-33-201	D58-33-072	D58-33-074	
	XR250/MOTARD	03-07 D58-33-201	D58-33-072	D58-33-074	
	SUPER XR/BAJA	95-02 D58-33-201	D58-33-072	D58-33-074	
	XLR250/BAJA	89-94 D58-33-201	D58-33-072	D58-33-074	
	XR400MOTARD	05-07 D58-33-201	D58-33-072	D58-33-074	
YAMAHA	XR400R	95-04 D58-33-201	D58-33-072	D58-33-074	
	XR600R	89-99 D58-33-201	D58-33-072	D58-33-074	
	XR650R	00-07 D58-33-201	D58-33-072	D58-33-074	
	YZ125	98-18 D58-33-201	D58-33-072	D58-33-074	
	YZ250	98-18 D58-33-201	D58-33-072	D58-33-074	
	YZ250F	01-18 D58-33-201	D58-33-072	D58-33-074	
	YZ400F	98 D58-33-201	D58-33-072	D58-33-074	
	YZ426F	00-02 D58-33-201	D58-33-072	D58-33-074	
	YZ450F	03-18 D58-33-201	D58-33-072	D58-33-074	
	YZ125X	17-18 D58-33-201	D58-33-072	D58-33-074	
	YZ250X	16-18 D58-33-201	D58-33-072	D58-33-074	
	YZ250FX	15-18 D58-33-201	D58-33-072	D58-33-074	
	YZ450FX	16-18 D58-33-201	D58-33-072	D58-33-074	
	WR250F	01-18 D58-33-201	D58-33-072	D58-33-074	
	WR450F	03-18 D58-33-201	D58-33-072	D58-33-074	
KAWASAKI	WR250R	07-17 D58-33-232	D58-33-091	D58-33-074	
	WR250X	07-17 D58-33-231	D58-33-074	D58-33-074	
	KX125	95-96 D58-33-201	D58-33-072	D58-33-074	
		97-08 D58-33-221	D58-33-082	D58-33-074	
	KX250	95-96 D58-33-201	D58-33-072	D58-33-074	
		97-08 D58-33-221	D58-33-082	D58-33-074	
	KX250F	04-18 D58-33-221	D58-33-082	D58-33-074	
	KX450F	06-18 D58-33-221	D58-33-082	D58-33-074	
	KLX450R	06-15 D58-33-221	D58-33-082	D58-33-074	
	KLX250/D-TACKER	98-07 D58-33-201	D58-33-072	D58-33-074	
		99-04 D58-33-201	D58-33-072	D58-33-074	
	SUZUKI	RM125	05-08 D58-33-202	D58-33-072	D58-33-093
		RM250	99-04 D58-33-201	D58-33-072	D58-33-074
			05-08 D58-33-202	D58-33-072	D58-33-093
			04-06 D58-33-221	D58-33-082	D58-33-074
RMZ250		07 D58-33-201	D58-33-072	D58-33-074	
		08-18 D58-33-202	D58-33-072	D58-33-093	
RMZ450		05-07 D58-33-201	D58-33-072	D58-33-074	
		08-18 D58-33-202	D58-33-072	D58-33-093	
RMX450Z		10-17 D58-33-202	D58-33-072	D58-33-093	
RMX250S/R		96-98 D58-33-201	D58-33-072	D58-33-074	
DRZ400S/R		00-05 D58-33-201	D58-33-072	D58-33-074	
DRZ400SM		04-17 D58-33-202	D58-33-072	D58-33-093	
KTM		125-530 SX/SX-F/EXC/EXC-F/XC/XC-W	00-18 D58-33-241	D58-33-096	D58-33-097
		CR/WR125	07-12 D58-33-241	D58-33-096	D58-33-097
		TC250	04-13 D58-33-241	D58-33-096	D58-33-097
	TC450	04-10 D58-33-241	D58-33-096	D58-33-097	
	TC510	05-10 D58-33-241	D58-33-096	D58-33-097	
	TE250	06-13 D58-33-241	D58-33-096	D58-33-097	
	TE450	06-10 D58-33-241	D58-33-096	D58-33-097	
	TE510	06-10 D58-33-241	D58-33-096	D58-33-097	
	TXC250/450/510	08-10 D58-33-241	D58-33-096	D58-33-097	
	TC125/250	14-17 D58-33-241	D58-33-096	D58-33-097	
	TC125/250 <i>bremsbo type only</i>	18 D58-33-241	D58-33-096	D58-33-097	
	TE125-300	14-17 D58-33-241	D58-33-096	D58-33-097	
	FC250-450	14-17 D58-33-241	D58-33-096	D58-33-097	
	FC250-450 <i>bremsbo type only</i>	18 D58-33-241	D58-33-096	D58-33-097	
	FE250-501	14-17 D58-33-241	D58-33-096	D58-33-097	
TX125/300	17 D58-33-241	D58-33-096	D58-33-097		
FX350/450	17 D58-33-241	D58-33-096	D58-33-097		

Please refer to fitting application below for each configuration.

CONTENTS LIST

Set Part number	Front	Rear
D58-33-202	37 mm A-TYPE	39 mm C-TYPE
	1 pc	1 pc
	D58-33-072	D58-33-093
D58-33-221	37 mm B-TYPE	52 mm A-TYPE
	1 pc	1 pc
	D58-33-082	D58-33-074
D58-33-201	37 mm A-TYPE	52 mm A-TYPE
	1pcs	1 pc
	D58-33-072	D58-33-074
D58-33-231	-	52 mm A-TYPE
	-	2 pcs
	-	D58-33-074
D58-33-232	31 mm C-TYPE	52 mm A-TYPE
	1 pc	1 pc
	D58-33-091	D58-33-074
D58-33-241	56 mm Front	61 mm Rear
	1 pc	1 pc
	D58-33-096	D58-33-097

D58-33-072

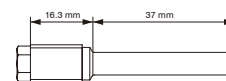

D58-33-074

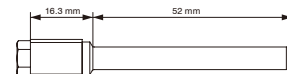

D58-33-082

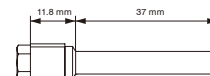

D58-33-091

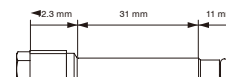

D58-33-093

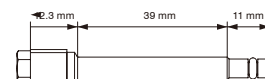

D58-33-096

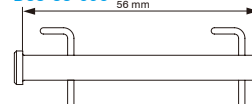

D58-33-097

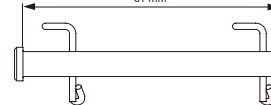

*Clip pin included

Replacement

DRC
KTM BRAKE PIN CLIP SET

Part number **D58-33-095**
Front pin : 2 pcs Rear pin : 2 pcs



DRC
BRAKE SAVER

- Prevents brake pedal from catching on berms, branches and rocks.
- Available colors: Black, Blue and Red.

Part number
D58-19-100 Black
D58-19-101 Blue
D58-19-103 Red

DRC
SAFETY WIRE PLATE

- Provides safety wire hooking point on your engine case.
- Place in between engine cover and its bolt near by oil filler or drain bolts.
- Made of stainless steel.
- Comes with 3 plates.

Part number
D58-20-111



STAND



TRANSPORT



TOOL



CONTROL



EXHAUST



ELECTRICAL



DRIVE



BODY



ACCESSORIES



High heat resistance and durable silicon rubber

Durable mesh fiber

DRC RADIATOR HOSE

- Durable silicone radiator hose for dirt bikes.
- Available for MX, ED racers and street dirt bikes.
- Smooth inner surface allows for increased coolant flow.
- Printed white DRC logo.
- Available in red, blue and orange colors.

Bike	Year	Red	Blue	Hose qty		
HONDA	CR125R	05-07	D47-01-183	-	5	
	CR250R	05-07	D47-01-193	-	5	
	CRF150R	07-18	D47-01-013	-	4	
	CRF250R	04-09	D47-01-043	-	4	
		10-13	D47-01-053	-	4	
		14-15	D47-01-063	-	5	
		16-17	D47-01-033	-	5	
		09-12	D47-01-083	-	7	
	CRF450R	13-14	D47-01-093	-	6	
		15-16	D47-01-103	-	6	
		17-18	D47-01-023	-	4	
		CRF250X	04-17	D47-01-043	-	4
		CRF450X	05-17	D47-01-163	-	4
	CRM250R	94-96	D47-01-113	-	4	
	CRM250AR	97-00	D47-01-123	-	4	
CRF250L/M	12-17	D47-01-143	-	2		
CRF250RALLY	17	D47-01-143	-	2		
YAMAHA	YZ85	02-18	-	D47-01-602	2	
	YZ125	05-18	-	D47-01-782	4	
	YZ250	05-18	-	D47-01-792	4	
	YZ250F	07-09	-	D47-01-642	4	
		10-13	-	D47-01-652	3	
		14-18	-	D47-01-662	4	
	YZ450F	06-09	-	D47-01-682	4	
		10-13	-	D47-01-692	4	
		14-17	-	D47-01-702	4	
	18	-	D47-01-732	4		
	YZ125X	17-18	-	D47-01-782	4	
	YZ250X	16-18	-	D47-01-792	4	
	YZ250FX	15-18	-	D47-01-752	4	
	YZ450FX	16-18	-	D47-01-712	4	
	WR250F	07-14	-	D47-01-742	5	
WR450F	15-18	-	D47-01-752	4		
	07-09	-	D47-01-682	4		
	12-15	-	D47-01-762	4		
WR250R/X	16-18	-	D47-01-712	4		
	07-17	D47-01-723	D47-01-722	3		
	01-18	-	D47-01-202	3		
KX65	01-13	-	D47-01-212	3		
	14-18	D47-01-223	D47-01-222	3		
	14-18	D47-01-223	D47-01-222	3		
KX100	05-08	-	D47-01-392	4		
	07-08	-	D47-01-232	5		
	09-16	-	D47-01-242	5		
KX250F	17-18	-	D47-01-252	4		
	06-08	-	D47-01-272	6		
	09-15	-	D47-01-282	6		
KX450F	16-18	-	D47-01-292	6		
	08-15	-	D47-01-272	6		
	93-07	D47-01-313	D47-01-312	5		
KLX250/D-TRACKER	08-16	D47-01-323	D47-01-322	4		
	02-17	D47-01-403	-	2		
	01-08	D47-01-593	D47-01-592	3		
RM250	07-09	D47-01-443	-	5		
	10	D47-01-453	-	3		
	11-12	D47-01-463	-	5		
RMZ250	13-18	D47-01-473	-	6		
	08-14	D47-01-483	-	5		
	15-17	D47-01-493	-	5		
RMZ450	18	-	D47-01-502	5		
	10-17	D47-01-483	-	5		
	00-17	D47-01-523	D47-01-522	3		
RMX450Z	10-17	D47-01-483	-	5		
DRZ400S/SM	00-17	D47-01-523	D47-01-522	3		

Bike	Year	Orange	Hose qty	
KTM	65SX	02-08	D47-01-807	3
	85SX	09-15	D47-01-827	2
		16-18	D47-01-828	2
		04-12	D47-01-817	2
	125SX	13-17	D47-01-818	2
		07-10	D47-01-987	3
		11-15	D47-01-988	3
	150SX	16-18	D47-01-989	3
		09-10	D47-01-987	3
		11-15	D47-01-988	3
	250SX	16-18	D47-01-989	3
		07-10	D47-01-997	3
		11-16	D47-01-998	3
	250XC	17-18	D47-01-999	3
		11-16	D47-01-998	3
17-18		D47-01-999	3	
300XC	11-16	D47-01-998	3	
	17-18	D47-01-999	3	
	08-10	D47-01-837	3	
250SX-F	11-12	D47-01-847	3	
	13-15	D47-01-957	2	
	16-18	D47-01-958	3	
350SX-F	11-15	D47-01-957	2	
	16-18	D47-01-958	3	
	11-12	D47-01-877	3	
450SX-F	13-15	D47-01-878	3	
	16-18	D47-01-879	3	
	08-09	D47-01-867	3	
450SMR	08-09	D47-01-867	3	
250EXC-F	08-11	D47-01-897	2	

Bike	Year	Red	Blue	Hose qty	
HUSQVARNA	WR250/300	06-10	D47-02-193	-	4
	TE,SMR250	10-11	D47-02-053	-	3
	TC250,TCX250	10-11	D47-02-063	-	4
	SM/TE610	06-09	D47-02-073	-	3
	SMS/TE630	10-11	D47-02-213	-	6
	TC85	14-17	-	D47-01-812	2
	TC125	14-15	-	D47-01-982	3
		16-18	-	D47-01-983	3
		14-16	-	D47-01-992	3
	TC250	17-18	-	D47-01-993	3
		14-15	-	D47-01-952	2
		16-18	-	D47-01-953	3
	TC300	14-15	-	D47-01-952	2
		16-18	-	D47-01-953	3
		14-15	-	D47-01-872	3
FC250/350	16-18	-	D47-01-873	3	
	16-18	-	D47-01-872	3	
	07-10	D47-02-233	-	4	
GASGAS	EC200/250/300	07-10	D47-02-233	-	4
	EC200/250/300	11	D47-02-243	-	5
APRILIA	RXV 450/550	06-11	D47-02-633	-	4
	SXV 450/550	06-11	D47-02-633	-	4
TM	MX,EN,SMR/M 250F	05-11	-	D47-02-462	4
	450F/530F				

JMX
TEAM SRM

DRC UNI-FLOW HOSE

- Gas cap hose with one way valve.
- Prevents fuel from flowing out of gas tank.
- Swivel valve design allows smooth removal of gas cap without twisting the gas cap hose.
- Valve is made of A7009-T6 aluminum.
- Available 4 hose colors.

Part number	Color	Part number	Color
D58-08-201	Black	D58-08-203	Blue
D58-08-202	Red	D58-08-206	Orange

DRC RADIATOR CAP

- High pressure radiator cap for racing use.
- High pressure of 1.6 kgf / cm² increases coolant's boiling point.
- Prevents the boiling and vaporization of the coolant during hard riding.
- Protects your engine from overheating.

Part number
D47-31-016

- STAND
- TRANSPORT
- TOOL
- CONTROL
- EXHAUST
- ELECTRICAL
- DRIVE
- BODY
- ACCESSORIES



DRC
161 OFF ROAD MIRROR

- Pivot function provides sensitive mirror adjustment.
- Can be folded during hard riding.
- Large viewable mirror body.

Part number	Size
D58-16-110	Right Type
D58-16-120	Left Type
D58-16-140	YAMAHA (Right Type)



STAND



TRANSPORT



TOOL



CONTROL



EXHAUST



ELECTRICAL



DRIVE



BODY



ACCESSORIES



DRC
MIRROR HOLDER

- Universal Mirror holder, best for after market perch or on motorcycles without mirror holes.
- Holder body is Made of A7009 aluminum.
- Stainless steel screws will not rust.
- Available in black and silver colors.

Part number	Color
D41-06-101	Black
D41-06-106	Silver



DRC
KILL SWITCH

- Universal engine kill switch.
- Terminals are included for installation.

Part number
D45-00-100



DRC
MIRROR HOLE PLUG

- Aluminum screw cap to seal your mirror hole.
- Protect your mirror hole thread from water, dust and mud.
- Made of 7009 aluminum, bolt size = M10 - 1.25
- Available in 4 different anodized colors.

Part number	Color	Part number	Color
D41-06-502	Blue	D41-06-508	Titanium
D41-06-503	Red	D41-06-509	Gold



DRC
GASKET WASHER

- Aluminum gasket washer can be used for drain bolts or gaskets on your bike.
- 6 different washer sizes available.
- Available 5 pcs pack for personal use, 50 pcs pack for shop use.

GASKET WASHER

Parts No	Description	Quantity
D59-52-530	M6	5 pcs
D59-52-540	M8	5 pcs
D59-52-550	M10	5 pcs
D59-52-560	M12	5 pcs
D59-52-565	M12 (KTM)	5 pcs
D59-52-570	M14	5 pcs
D59-52-830	M6	50 pcs
D59-52-840	M8	50 pcs
D59-52-850	M10	50 pcs
D59-52-860	M12	50 pcs
D59-52-865	M12 (KTM)	50 pcs
D59-52-870	M14	50 pcs



DRC
SKID PLATE FOAM

- Prevents mud from accumulating and adding weight to your machine.
- Installs between your skid plate and engine.

Part number	Size
D58-17-012	300 mm x 150 mm x 40 mm



DRC
CARGO ANCHOR KNOB

- Provides additional hooking point for your cargo net.
- Easy to mount, just replace with your seat or sub frame bolts.
- Hook body is made of light weight aluminum with anodized finish, bolt is made of stainless steel for less corrosion.
- 2 length of hooks and bolts sizes are available.
- Comes in pairs.

CARGO ANCHOR KNOB

Bolt	A	Parts No
M6	32 mm	D59-51-062
M6	47 mm	D59-51-065
M8	33.5 mm	D59-51-081
M8	48.5 mm	D59-51-085

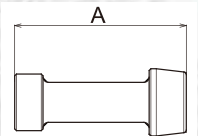

DRC
FOOT PEG HOLDER KLX125/150

- Durable foot peg holder for KLX125/150S.
- Made of 7009 aluminum for extreme strength.
- 25% lighter and 4 times stronger than OE foot peg holder.
- Comes with foot peg pins. Works best with DRC wide foot pegs

Part number
D48-03-211



DRC
FRONT FORK SPRING for KLX125/150

- Hard front fork spring for KLX125/150S.
- Increase spring ratio by 30% more than OE spring.
- Provides more stability for hard off-road riding.
- *Rear suspension adjustment is required. *Can not be used for D-Tracker 125.

Part number
D35-01-113



DRC
ACCESSORIES



DIRTFREAK

DRC

DRC
TRACK TAPE



- Track tape for MX and Ed track use.
- Available DF yellow/black, DRC red.
- Width : 75 mm
- Length : 200 m per roll

Part number	Description
DF29-7021	DIRTFREAK
DF29-7071	DRC



DRC
PROTECTION CLEAR DECAL

- Clear decals to protect your bikes from scratching, rocks and debris during your ride.
- Thickness : 0.15 mm 3 sheets per package.

Part number	Size
D50-10-010	30 cm (12 inch) x 45 cm (18 inch)



DRC
CARBON LOOK DECAL

- Carbon look decal Sheets. 0.15 mm thick sheet is easy to install even on curved Surfaces.
- Good to use on front outer tube, swing arm, air Box and more. Comes in 2 sheets.

Part number	Size
D50-02-001	30 cm (12 inch) x 45 cm (18 inch)



DRC
BOOTS BAG

Part number	Color
D28-01-020	Black



DRC
EZ MECHANIC BAG

- Compact mechanic bag for race paddock and pit.
- 6 pockets inside of the bag for wrench socket or small tools.

Size W : 35 cm (14 inch) x H : 20 cm (8 inch)

Part number
D27-01-011



*Tools are not included.

DRC
TOOL WRAP

- Easy to carry your tools and other supplies.
- Wrap roll tight and save room when you stow it in your bag.
- Includes small pockets for carrying small things like chain links or fuses.

Part number	Size
D28-05-001	300 mm x 150 mm



DRC
STICKER

Part number	Size
D50-01-102	6 cm (2.3")
D50-01-104	10 cm (4")
D50-01-106	13.5 cm (5.3")



DRC
CAP

Part number	Color
D20-21-111	Black
D20-21-116	Black/White

Size Free (hook and loop fastener type)

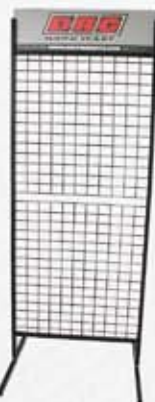

ZETA/DRC
DISPLAY RACK

Size 70 cm x 190 cm (2.3' x 6.2')

Part number
D39-11-111

STAND



TRANSPORT



TOOL



CONTROL



EXHAUST



ELECTRICAL



DRIVE



BODY



ACCESSORIES





DELTA
BARREL 4 SILENCER

- Improved emission efficiency and exhaust pressure. DELTA BARREL 4 silencer provides high power in the entire power band.
- Special inner silencer body and multi-stage expanding mid pipe design provides power at the high end, and rich torque at bottom and middle bands.

Mid pipe is made of stainless steel. Silencer body is light weight aluminum. Exhaust center of gravity is positioned for motorcycle control performance. The best silencer for street or trail.

Designed for street, enduro, super motard use.

Sound output : **94 db**

FIM approved end-cap design

Use with stock or DELTA head pipe.

Gasket not included. Use stock gasket.

DELTA
BARREL 4-S SILENCER



- JMCA (JAPAN MOTORCYCLE ACCESSORIES ASSOCIATION) approved low noise and emission gas silencer, and provides high power and torque.
- Light weight construction, but quiet and provides more horsepower and torque.

Mid pipe is made of stainless steel. Silencer body is light weight aluminum. Exhaust center of gravity is positioned for motorcycle control performance. The best silencer for street or trail.

Designed for street, enduro, super motard use.

Sound output : **92 db**

Use with stock or DELTA head pipe.

Gasket not included. Use stock gasket.

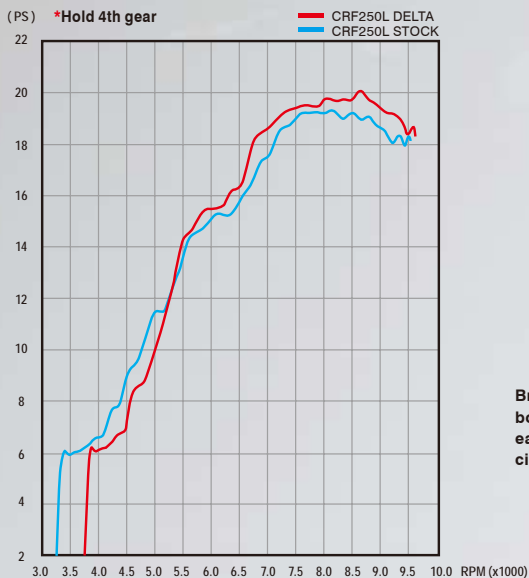

Provides more power and torque than stock pipes
Dyno graph for CRF250L as shown above.

FIM approved aluminum die-cast end cap.

Brushed aluminum finish, light weight silencer body. Uses the best inside restrictor specific for each model. This provide a smooth exhaust gas circulation and increases horse power.

Silencer body and mid pipe are clamped in place by springs.

Multi-stage expanding mid pipe design provides more torque at the middle and bottom ranges.





DELTA TORQ HEAD PIPE

- DELTA head pipe for more power and torque when using DELTA silencers.
- Developed for characteristics specific to each bike for more performance.
- Provides better power, acceleration and engine traction than stock head pipe.
- Upgrades performance characteristics for each model.
- Made of SUS304 stainless.

* See below fitting application for part no.



DELTA CARBON TAIL PIECE

- Carbon tail piece for DELTA silencers .
- Made of high quality durable and light weight carbon.
- Perfect fit with DELTA silencer.

Part number
DL99-9813



DELTA SILENCER HEAT PROTECTOR

- Carbon heat protector for DELTA silencers for WR250R/X , Tricker , Serow250 , XT250X , and CRF250L/M.
- Helps to prevent burning yourself during your ride.
- Attached with adjustable stainless steel bands.

Part number
DL32-5031

EXHAUST



COVER DECAL



MUD PARTS



INNER WEAR



BARREL4 (BARREL4-S) & TORQ HEAD PIPE

DR-Z400SM

D-Tracker X

WR250X

CRF250L

XR230

XR50 Motard

BARREL4 MINI FULL EXHAUST

BIKE	Year	BARREL4	BARREL4-S (JMCA)	TORQ HEAD PIPE
HONDA				
XR50MOTARD #1	05-07	DL30-4102	DL30-5102	-
XR230	05-07	-	-	DL30-2106
XLR250R/BAJA	89-94	DL30-6106	DL30-7106	-
XR250/MOTARD/BAJA	95-07	DL30-6109	-	-
CRF250L/M	12-16	DL30-6101	DL30-7101	-
	17	DL30-6111	DL30-7111	DL30-2110
CRF250RALLY	12-16	DL30-6112	DL30-7112	DL30-2111
	17	DL30-6112	DL30-7112	DL30-2111
YAMAHA				
SEROW225/W/WE	89-04	DL30-6201	-	-
TRICKER	04-07	DL30-6205	DL30-7202	DL30-2202
	08-17		DL30-7206	
SEROW250	05-07		DL30-7202	
	08-17		DL30-7207	
XT250X	06-07	DL30-7202	DL30-2204	
	08-17	DL30-7207		
WR250R/X #3	07-17	DL30-6204	DL30-7204	DL30-2204
KAWASAKI				
KLX125	10-16	DL30-6410	DL30-7411	DL30-2410
D-TRACKER125	10-16		DL30-7412	
KLX250/D-TRACKER	01-07	DL30-6402	DL30-7402	DL30-2402
KLX250	08-16	DL30-6404	DL30-7405	
D-TRACKER X	08-16	DL30-6404	DL30-7406	
SUZUKI				
250SB	02-06	DL30-6402	-	DL30-2402
DRZ400S	00-08	-	-	DL30-2301 #2
DRZ400SM	05-17	DL30-6303	DL30-7303	

#1 Full exhaust system.

#2 Can be used with stock heat guard.

#3 For Japan use only. It is not compatible with international O2 sensor.

LOW NOISE INNER

- Low noise inner for DELTA Barrel 4 silencer.
- Reduced sound without reduced horsepower.
- Easy to install and remove stock restrictor for replacement.
- Can not be used for Barrel S-4 and Barrel 4 Mini

Part number
DL99-9819

TAIL PIECE

- FIM approved end cap.
- Can not be used for Barrel 4 Mini silencer.

Part number
DL99-9811

RESTRICTOR

Part number Size
DL99-9817 22 mm





MOTION
MX GRIPPER SEAT COVER

- Universal seat cover for thin mx type seats.
- Seamless design for better control in hard riding.
- Used by Taka Higashino.

Part number **Color**
MO47-0301 Black

EXHAUST



COVER
DECAL



MUD
PARTS



INNER
WEAR



FMX
DAISUKE SUZUKI
MX GRIPPER SEAT COVER



MOTION
ALL GRIPPER SEAT COVER

- All gripper design provides excellent seat grip control.
- Simple solid color, fits almost all models.
- Provides excellent no-slip grip.

Part number **Color**
MO47-0101 Black

Detail

Larger seat cover with easy installation material designed to fit most dirt bike models.

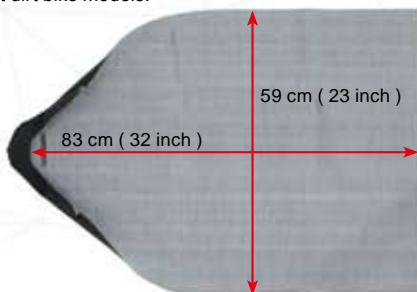

Non-slip, 100% gripper material. Unique shape, and superior sewing, makes installation easy.





MX2

1234567890
1234567890

Full size MX racer For 1 - 2 digit number
Black / White H 16.5 cm (6.5 inch)



ED2

1234567890
1234567890

Head light number plate
Mini MX racer etc. For 1 - 2 digit number
Black / White H 14 cm (5.5 inch)



MN2

1234567890
1234567890

CRF50F / TTR50E etc.
Black / White H 10 cm (4 inch)



MX3

1234567890

Full size MX racer
For 1 - 3 digit number
Black H 16.5 cm (6.5 inch)



ED3

1234567890

Head light number plate
Mini MX racer etc. For 1 - 3 digit number
Black H 14 cm (5.5 inch)



EXHAUST



COVER
DECAL



MUD
PARTS



INNER
WEAR



MOTION

STANDARD NUMBERS

- Standard numbers for number plates.
- Smaller size for recent dirt bikes.
- Available in 3 sizes. Fits MX and pit bike.
- Narrow design for 3 digit numbers. (MX3)
- Cut from 0.1 mm (4 mil) adhesive backed vinyl.
- 3 numbers per pack

Number	MX2 (3 pk)		MX3 (3 pk)	ED2 (3 pk)		ED3 (3 pk)	MN2 (3 pk)	
	Black	White	Black	Black	White	Black	Black	White
0	MO11-0200	MO11-0210	MO11-0300	MO11-2200	MO11-2210	MO11-2300	MO11-3200	MO11-3210
1	MO11-0201	MO11-0211	MO11-0301	MO11-2201	MO11-2211	MO11-2301	MO11-3201	MO11-3211
2	MO11-0202	MO11-0212	MO11-0302	MO11-2202	MO11-2212	MO11-2302	MO11-3202	MO11-3212
3	MO11-0203	MO11-0213	MO11-0303	MO11-2203	MO11-2213	MO11-2303	MO11-3203	MO11-3213
4	MO11-0204	MO11-0214	MO11-0304	MO11-2204	MO11-2214	MO11-2304	MO11-3204	MO11-3214
5	MO11-0205	MO11-0215	MO11-0305	MO11-2205	MO11-2215	MO11-2305	MO11-3205	MO11-3215
6	MO11-0206	MO11-0216	MO11-0306	MO11-2206	MO11-2216	MO11-2306	MO11-3206	MO11-3216
7	MO11-0207	MO11-0217	MO11-0307	MO11-2207	MO11-2217	MO11-2307	MO11-3207	MO11-3217
8	MO11-0208	MO11-0218	MO11-0308	MO11-2208	MO11-2218	MO11-2308	MO11-3208	MO11-3218
9	MO11-0209	MO11-0219	MO11-0309	MO11-2209	MO11-2219	MO11-2309	MO11-3209	MO11-3219

MOTION

FRONT FORK DECAL

- Back printed on high gloss vinyl.
- Uses high quality adhesive.
- Will withstand aggressive riding and pressure washing.
- Sold in pairs.



Clear KYB
Black/White
MO52-0118



Carbon KYB
Red
MO52-0316



Clear Showa
Red/Black
MO52-0112



Carbon Showa
Red/White
MO52-0311

MOTION

FRONT FENDER SIDE DECAL



ZETA Racing
Black
MO33-0701



ZETA Racing
White
MO33-0702



MUD OFF FENDER MAT

- Fender mat set includes mats for front and rear fenders.
- Fender mat keeps your bike lighter in muddy race.
- Easy to install with adhesive back.
- Provides better control by minimizing mud accumulation.
- No need to change suspension ratio because of minimal weight gain.
- Fender mat is very light weight and does not affect motorcycle weight.
- Used by Team HRC, Team SUZUKI, and the Kawasaki Racing Team to get the best race performance result in muddy conditions.

Part number **Mat size**
MD58-0005 Front : 220 mm x 980 mm, Rear : 280 mm x 800 mm



Easy to install, fits on all dirt bikes.

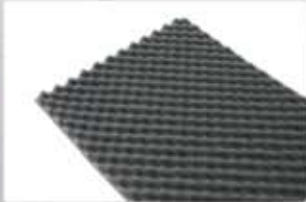

Low water absorption, high elasticity, more than 90 % resilience and a specially finished surface.



Installed FENDER MAT



Not Installed

After a 30 minute ride in muddy conditions, bikes have 23 kgs weight difference in production tests.

EXHAUST



COVER DECAL



MUD PARTS



INNER WEAR



MUD OFF RADIATOR FOAM

- Prevents mud from sticking on the radiator louvers and keeps the radiator cool in a muddy race.
- Provides maximum cooling, and keeps mud and rocks out during a muddy race.
- Easy to install with enclosed zip ties.
- Comes in pairs with zip ties.

Part number **Color**
MD58-1300 Dark Gray



MUD OFF FREE MAT

- Universal mat to prevent sticking mud.
- Easy to install anywhere with the adhesive back.
- Usable on the frame, front fork, swing arm, radiator shroud, upper side of fenders, hand guards, inside of side panel, helmet and more.
- Available in natural white and dark gray.

Part number **Color** **Mat size**
MD58-1001 Natural White 30 cm x 50 cm
MD58-1002 Dark Gray 30 cm x 50 cm

MUD OFF FOOTREST MAT

- Wrap special foam around foot rest movement area to prevent mud getting into this area.
- Keep your step in the right place during muddy race.
- Easy to install, just stick it on your step.
- comes in a pair.

Part number **Color**
MD58-1200 Dark Gray



MUD OFF BACK GROUND

- Special foamed back ground for front number plate at muddy race.
- For the best effect, use with MUDOFF URETHANE NUMBERS.
- Comes in one back ground per pack.
- Back ground size : 30 cm x 33 cm

Part number **Color** **Part number** **Color**
MD50-0001 Red **MD50-0004** Yellow
MD50-0002 Black **MD50-0005** White
MD50-0003 Blue **MD50-0006** Green



MUD OFF URETHANE NUMBERS

- Special urethane foam numbers prevent mud sticking and keep your number viewable during a muddy race.
- Standard and slanted numbers are available.
- For the best effect, use with MUDOFF BACK GROUND.
- One number per pack.

STANDARD



STANDARD part number

S size : H 14 cm L size : H 18 cm

Number	Color (size)			
	Black (L)	White (L)	Black (S)	White (S)
#0	MD50-0500	MD50-0600	MD50-0700	MD50-0800
#1	MD50-0501	MD50-0601	MD50-0701	MD50-0801
#2	MD50-0502	MD50-0602	MD50-0702	MD50-0802
#3	MD50-0503	MD50-0603	MD50-0703	MD50-0803
#4	MD50-0504	MD50-0604	MD50-0704	MD50-0804
#5	MD50-0505	MD50-0605	MD50-0705	MD50-0805
#6	MD50-0506	MD50-0606	MD50-0706	MD50-0806
#7	MD50-0507	MD50-0607	MD50-0707	MD50-0807
#8	MD50-0508	MD50-0608	MD50-0708	MD50-0808
#9	MD50-0509	MD50-0609	MD50-0709	MD50-0809

SLANT



SLANT part number

S size : H 14 cm L size : H 18 cm

Number	Color (size)			
	Black (L)	White (L)	Black (S)	White (S)
#0	MD50-0100	MD50-0200	MD50-0300	MD50-0400
#1	MD50-0101	MD50-0201	MD50-0301	MD50-0401
#2	MD50-0102	MD50-0202	MD50-0302	MD50-0402
#3	MD50-0103	MD50-0203	MD50-0303	MD50-0403
#4	MD50-0104	MD50-0204	MD50-0304	MD50-0404
#5	MD50-0105	MD50-0205	MD50-0305	MD50-0405
#6	MD50-0106	MD50-0206	MD50-0306	MD50-0406
#7	MD50-0107	MD50-0207	MD50-0307	MD50-0407
#8	MD50-0108	MD50-0208	MD50-0308	MD50-0408
#9	MD50-0109	MD50-0209	MD50-0309	MD50-0409



Comes with a sub visor and 6 tear offs.

MUD OFF
RACING SUB VISOR



- Extension sub visor for your helmet.
- Prevents dirt from sticking on your goggles during muddy race or while riding.
- Made of high quality, light weight, clean, low strain, high impact durable, heat resistant, noncombustible plastic.
- Comes with 6 pcs tear offs for the visor.
- Tear off film provides a clear view at once.
- May be used on most helmets for off road riding.

Part number
MD15-0001



MUD OFF
HELMET MUDDY COVER



- Prevents mud from sticking on the helmet to keep it light weight.
- Universal fit, can be used for most of off road helmets.
- Comes with visor and chin guard covers.
- Available in blue, red and silver colors.

Part number **Color**
MD15-0101 Red
MD15-0102 Blue
MD15-0103 Silver

EXHAUST



COVER DECAL



MUD PARTS



INNER WEAR



MUD OFF
BOOTS COVER



- Boot cover for off road boots.
- Keep the mud out of boots.
- Prevents mud and dirt from entering boot buckle area and inside of the boot.
- Easy to install and remove.
- Available in adult and kids sizes.
- Comes in pairs.

Part number **Description**
MD22-0101 Kids size (M)
MD22-0102 Adult size (L)



MUD OFF
MUDDY GLOVE



- MUDOFF racing muddy glove is designed for use in a muddy race.
- Knit construction to prevent slippage of your hands from the handlebar grips.
- Wrist belt twisted on the wrist area prevents the glove from coming off during your muddy race.
- Increased handgrip by soaking a little water on the palm. It also can prevent grip slipping when you're running in heavy rain or muddy conditions.
- Tips of index finger and middle finger are made of rubber to increase lever control.

Part number **Size**
MD03-0001 Free Size

MUD OFF
TIRE ROLL COVER



- Tire cover helps prevent messing up your truck or van.
- Keep your van clean after the muddy ride.
- Keeps tire clean after washing.
- Used also as a tire cover in the garage.
- Available in 3 different sizes for all dirt bikes.

Part number **Description**
MD58-1010 S (10 - 14 inch)
MD58-1020 M (F 19, R 16 inch)
MD58-1030 L (F 21, R 18-19 inch)



S size M size L size

MUD OFF
MECHANIC COLLOID FOAM



- 100% biodegradation soap for Mechanics.
- Liquid soap magically transforms into foam every time you pump.
- Used for hand washing after wrenching, and also on dirty parts.
- One push provides only 1 ml soap.

Part number **Description**
MD51-0050 Mechanic colloid Foam bottle 400 ml
MD51-0051 Mechanic colloid Form refill 400 ml



Pump 400ml

MUD OFF
WEAR SHAMPOO



- Detergent for MX wear and gear.
- Pine oil cleaning component cleans all mud and dirt.
- No fluorine, No bleach, No petrochemicals in this detergent.
- Biodegradable.
- Easy to dissolve liquid detergent.

Part number **Description**
MD51-0040 Wear shampoo Bottle 400 ml
MD51-0041 Wear shampoo Form refill 400 ml



Bottle 400 ml

MUD OFF
CLEAN DOWN



- Mud cleaner for dirt bikes, cleans all mud on motorcycles.
- Superfine particle colloids in cleaner helps to remove greasy mud and dirt.
- Very high detergency, but it is safe against metal surfaces, plastic and rubber material.
- Made of 100% Brazilian pine sap for biodegradation.
- Available in spray type.

Part number **Description**
MD51-0031 Clean Down Spray 400 ml
MD51-0032 Clean Down Form refill 400 ml



Spray 400 ml



Mesh Panel



Elbow pad



DFG
NEO FIT SHIRT **COOL MAX***
Vented

- Excellent sweat absorption and quick dry material keeps your body cool by evaporating sweat. Provides comfort during your ride.
- Larger mesh panel used under shoulders and back for efficient ventilation.
- For all season use, even in a hard riding in cold weather conditions.

Part number	Size	Color	Material
DG1202-0103	S	Gray	Polyester
DG1202-0104	M		
DG1202-0105	L		
DG1202-0106	XL		

DFG
NEO FIT SHIRT **COOL MAX***
Vented-Longsleeve

- Long sleeve shirt using COOL MAX designed for all season.
- Four line fibers provide cooling effect by quick absorption and quick dry.
- Tight fit, shaped shirt used for MX wear and inner jacket.
- Easy to wear with neck brace.
- Mesh material for breathable under arms.
- Breathable to under shoulders in mesh material.
- Light foam sleeve is detachable.
- Compatible with inner pad for sealed layer arm cover.

STANDARD FIT

Part number	Size	Color	Material
DG1202-0133	S	Black	Polyester
DG1202-0134	M		
DG1202-0135	L		
DG1202-0136	XL		

LOOSE FIT

Part number	Size	Color	Material
DG1202-0123	SB	Black	Polyester
DG1202-0124	MB		
DG1202-0125	LB		
DG1202-0126	XLB		



Elbow pad

DFG
NEO FIT SHIRT **THERMOLITE***
Thermal

- Long sleeve inner shirt made of THERMOLITE for warmth, moisture absorption and quick drying in cold weather condition.
- Keeps your body warm by removing moisture during your ride.
- Breathable raised fabric on the back keeps your body warm and dry.
- Lightweight padded elbows, the best under shirt to use in cold weather riding.

Part number	Size	Color	Material
DG1202-0013	S	Black	Polyester
DG1202-0014	M		
DG1202-0015	L		
DG1202-0016	XL		



Mesh Panel

COOL MAX Pad

COOL MAX*

DFG
NEO FIT PANTS **Vented**

- Constructed of superior moisture-absorbing, quick-drying material for comfort during your hard ride.
- Mesh panel on thigh and back side of knee for maximum ventilation.
- For all season use.

Part number	Size	Color	Material
DG1201-0113	S	Black	Nylon
DG1201-0114	M		
DG1201-0115	L		
DG1201-0116	XL		



COOL MAX Pad

COOL MAX*

DFG
NEO FIT PANTS **THERMOLITE***
Thermal

- Constructed of thermal, quick drying material for winter riding.
- Material keeps dry to prevent cooling by body perspiration.
- Thick wind-proof material and raised lining fabric keeps your body warm on winter rides.

Part number	Size	Color	Material
DG1201-1113	S	Black	Polyester
DG1201-1114	M		
DG1201-1115	L		
DG1201-1116	XL		

MATERIAL



The performance of INVISTA's COOLMAX® fabric is inherent in the structure itself. The specially engineered fibers allow fabric designers to create high-performance fabrics that are soft, breathable, and moisture wicking.



INVISTA's THERMOLITE® fabric and insulation provides warmth and comfort without weight, even when wet. Because it is comfortable and lightweight, THERMOLITE® fabric and insulation allows freedom of movement making it the perfect layer. Its hollow-core fibers trap in air for greater insulation for light, yet heavy-duty performance.

JACKET

	M	L	XL	XXL
Height	165-175	170-180	175-185	180-190
Chest	87-92	92-97	97-102	100-108
Waist	73-78	78-83	83-88	86-94

NEO FIT SHIRT (cm)

	S	M	L	XL	SB	MB	LB	XLB
Height	155-165	165-175	170-180	175-185	155-165	165-175	170-180	175-185
Chest	82-87	87-92	92-97	97-102	88-93	93-98	98-103	103-108
Waist	68-73	73-78	78-83	83-88	74-79	79-84	84-89	89-94

NEO FIT PANTS (inch)

	S	M	L	XL
Waist	-30	30-32	32-34	34-

SIZE CHART



DFG SHIELD LAYER ELBOW

- Arm sleeve with elbow pad. Stays in place without constriction.
- Light weight and compact design to fit under jersey.
- Made of quick-drying and elasticized material for comfort.
- Available 2 sizes, S/M and L/XL size.
- Comes in pairs.

Part number	Size	Material
DG0801-1201	S / M 23-28cm (9-11 inch)	Nylon/Polyester
DG0801-1202	L / XL 28cm- (10.5 inch)	

DFG AXIS KNEE SHIN GUARD

- Hard shell type.
- 3 straps hold tightly on your legs.
- Inner soft shell protects knee and shin.
- Vented holes for breathability and comfort.
- 2 piece AXIS SHIN GUARD helps body action.
- Passed EN1621-1

Part number	Size	Material
DG0803-3101	Adult	Polypropylene
DG0803-3105	Youth / Women	

DFG AXIS ELBOW GUARD

- Hard shell type.
- Comfort fit design.
- Inner soft shell guards your arm.
- Slits helps remove heat.
- Breathable vented holes.
- Cross type strap attaches tightly on your arm.
- Passed EN1621-1

Part number	Size	Material
DG0803-1101	Adult	Polypropylene
DG0803-1105	Youth / Women	



Mesh Panel



Elbow protector

DFG SHIELD LAYER ARM COVER

- Arm sleeve type elbow guard with CE elbow protector.
- Detachable elbow foam pad passed EN1621-1
- 3 straps hold tightly on your legs.
- Three-dimensional shape sleeve improves comfort fitness.
- Mesh keeps arms breathable.
- Soft foam helps rider's body action.
- Silicon grip and adjustable system prevents slippage.
- Modest design fits any style.
- Less pressure on your body protects from fatigue.
- Protects rider from UV with UPF50+ in long hot weather ride.
- Stretchability and quick dry lasts long in comfortable conditions.
- Works well in hard riding situation.

Part number	Size	Material
DG0801-4201	S / M	Nylon
DG0801-4203	L / XL	



Polyyou® material

DFG RIDE TECH BOOTS INSOLE

- Developed to use with off road riding boots.
- Made of high elasticity polyurethane insole absorbs shock and vibration during your ride.
- Ergonomic sole design supports your foot, provide better foot control.
- Used Polyyou® material for antibacterial and deodorize insole.
- Surface mesh cloth provides better breathability and fast dry.
- Comes in pairs.
- Free size 25.5cm – 30.0cm / 7 inch – 12 inch

Part number	Material
DG0901-0101	Polyurethane/Polyester

POLIYOU®

Polyyou® is antibacterial, deodorize, better breathability and fast dry material.

MATERIAL

SWEAT CAP

	S / M	L / XL
Part A	15 cm	16 cm
Part B	48 cm	52 cm
Stretched width	-58 cm	-62 cm

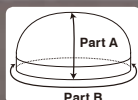

SHIELD LAYER ELBOW/SHIELD LAYER ARM COVER

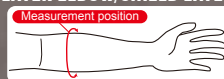

SIZE CHART

EXHAUST



COVER DECAL



MUD PARTS



INNER WEAR





White/White



Compactable for storage.



Black/Black

DFG

PROOF JACKET



- Suitable for circuit riding or race in such as rain or cold weather.
 - Using Waterproof / breathable fabric.
 - Able to wear with inner protector.
 - Use a light thin ripstop fabric excellent in tear strength.
 - Ventilation on the back, reduce steaming in the jacket.
- ※ Not completely waterproof.

Part number	Size	Color	Material
DG2362-0204	M	White/ White	Nylon
DG2362-0205	L		
DG2362-0206	XL		
DG2362-0207	XXL		

Part number	Size	Color	Material
DG2362-0304	M	Black/ Black	Nylon
DG2362-0305	L		
DG2362-0306	XL		
DG2362-0307	XXL		

 Microfiber fabric for
sweat absorption

Mesh construction

DFG

SWEAT CAP

Vented



- Sweat cap especially designed for MX and motorsport riding.
- Wear the sweat cap under your helmet to prevent sweat from getting inside your goggles and/or eyes.
- High water absorption microfiber fabric is placed inside the head band to absorb sweat during your ride.
- Cap body is made of high breathable mesh for comfort.
- Best to use for hard riding in summer and winter seasons.

Part number	Size	Color	Material
DG1205-0023	S / M	Black	Polyester
DG1205-0024	L / XL		



Red

Blue

Yellow

White



Tabi



Silicon print

Short type



Long type



DFG

RACING TABI SOCKS

COOLMAX*



DFG

AIR FLOW SOCKS

COOLMAX*



- Knee high type socks for MX and dirt bike riding.
- Coolmax fabric keeps your feet comfortable during your ride.
- Cushion construction design for absorbing shocks
- The best socks to use with DFG Neo Fit Pants.
- One size (25 cm - 29 cm)

Part number	Color	Part number	Color	Material
DG1101-1092	Blue	DG1101-1095	Yellow	Polyester
DG1101-1093	Red	DG1101-1096	White	

SHORT TYPE

Part number	Size	Material
DG1102-1041	S / M 25.0-27.0cm (7.0-9.0US)	Polyester
DG1102-1042	L / XL 27.5-29.5cm (9.5-11.5US)	

LONG TYPE

Part number	Size	Material
DG1102-2041	S / M 25.0-27.0cm (7.0-9.0US)	Polyester
DG1102-2042	L / XL 27.5-29.5cm (9.5-11.5US)	



Ballistic Nylon



Installation image.

DFG

BOOTS GAITER



- Prevents water or mud from entering boots on rainy days.
- Easy wrapping install.
- Protects straps buckles by preventing mud from entering.
- Reflector behind the cover to ensure visibility.
- Keep your boots long and clean.
- Free size

Part number	Color	Material
DG2252-020	Black/Black	Polyester (PVC coating)



Ballistic Nylon



Installation image.

DFG

MUDPASS GAITER



- Prevents mud and water entering in between the boots and MX pants.
- Uses waterproof, stretch fabric (chloroprene).
- Wrap type provides quick and smooth removal.
- Hook and loop fastener provides free tightening adjustment.
- Ballistic nylon with high strength and durability.
- Free size

Part number	Color	Material	Size
DG2251-010	Black/Black	Chloroprene	L : 60cm H : 18cm

EXHAUST



COVER
DECAL



MUD
PARTS



INNER
WEAR



DFG

HELMET BAG



- Convenient for carrying helmet.
- Prevents scratches on the helmet when loading on a van or carrying.
- Big enough size for off-road helmet with visor.
- Sponge foam outside of the bag absorbs shock protection.
- Soft fabric inside of the bag protects the helmet.
- Slit type pocket to insert replacement lenses etc. inside the bag.
- Outer pocket is convenient for storing accessories such as goggles.
- Shoulder strap included.

Part number	Color	Material	Size
DG2802-0001	Black	Polyester	W : 40cm H:38cm D:27cm



Compactible for storage.

DFG

LAUNDRY BAG



- The best laundry bag for MX gear etc.
- Mesh on the side for breathability.
- Outer pocket is convenient for storing accessories such as gloves.
- Foldable design for easy storage.

Part number	Color	Material	Size
DG2801-010	Black	Nylon	W : 34cm H : 57cm D : 34cm
			Folding
			W : 18cm H : 5cm

DFG

STICKERS



DG5031-1100 size M (10cm)



DG5031-1000 size S (6cm)

FLIGHT TOP BRIDGE

for
RACING/
STREET



1199S PANIGALE

ZETA FLIGHT TOP BRIDGE

- Maximum light weight design with great rigidity balance.
- Made of durable CNC machined aluminum with black anodized finish.
- Comes with titanium front fork clamp bolts.

	Bike	Year	Part #
HONDA	CBR250RR	17	ZS41-0210
YAMAHA	YZF-R25/R3	15-17	ZS41-3210
	YZF-R1/M	15-17	ZS41-3810
KAWASAKI	NINJA 250/R	08-17	ZS41-1210
	NINJA ZX-10R	16-17	ZS41-1810
	NINJA H2/R	15-17	ZS41-1850
SUZUKI	GSX-R600/750	06-17	ZS41-2610
	GSX-R1000	09-17	ZS41-2810
BMW	S1000RR	15-17	ZS41-5810
	1198/S/R,1098/S/R,848/EVO	07-13	ZS41-6810
DUCATI	1199S/R,1299S/R,959,899 PANIGALE	12-17	ZS41-6820
APRILIA	RSV4 R/FACTORY APRC	09-14	ZS41-7810

Spec

Material : 6061-T6 Aluminium
Clamp Bolt : Ti-6AL-4V

ZETA
HIGH PERFORMANCE PRODUCTS
STREET

CONTROL

LEVER

BODY

ELECTRICAL



CBR250RR



[Design]

Rounded edge design for less stress concentration and rigidity.



[Rigidity Balance]

Top bridge body is flexible when the bike is deeply banked for smooth front fork movement.



[Factory Look]

Recent light weight design used on Moto GP and WSBK race bikes.



[Light weight design]

Super light weight design, but still provides great rigidity balance. RSV4 stock top bridge weight = 534 g, ZETA top bridge = 494 g. ZETA is 40 g lighter than stock RSV4 top bridge.



[Ti-6AL-4V bolt]

Clamp bolt is made of titanium for light weight and stable tightening torque.

Aim for fastest lap!

FLIGHT HANDLE

ZETA
HIGH PERFORMANCE PRODUCTS
STREET

2017 Moto America Champion
Yoshimura Suzuki Factory
Racing Team **TONI ELIAS**

Used by
TRICK STAR Racing



CONTROL



LEVER



BODY



ELECTRICAL



for
RACING

ZETA FLIGHT HANDLE

- ZETA Clip on handle for racing use.
- All bolts and pins are made of Ti-6AL-4V titanium.
- Clamp body is made of 7009-T6 aluminum with precision CNC light weight finish for light weight and durability.
- Handlebar is made of 6061-T6 aluminum to ease impact and protect clamp body in event of a crash.
- Available in standard and short offset handle with many clamps and handlebar angles.

Type	Part #	Clamp			Handlebar	
		Diameter (mm)	Offset (mm)	Angle	Length (mm)	Replacement
STD	ZS03-0133	50	39	6°	270	ZS03-8002
	ZS03-0135	50	39	9°	270	ZS03-8002
	ZS03-0167	53	40.5	6°	270	ZS03-8002
Short	ZS03-0233	50	29	6°	205 *	ZS03-8003
	ZS03-0237	50	29	12°	205 *	ZS03-8003
	ZS03-0257	52	30	12°	205 *	ZS03-8003
	ZS03-0333	50	29	6°	222 *	ZS03-8004
	ZS03-0337	50	29	12°	222 *	ZS03-8004
	ZS03-0357	52	30	12°	222 *	ZS03-8004

Effective length

Spec

Material(clamp) : A7009-T6
 Material(bar) : A6061-T6
 Surface finish : Color anodized finish
 Handlebar out side diameter : 22.2 mm
 Handlebar inside diameter : 16 mm
 Clamp thickness : 36 mm

FUNCTION



HIGH QUALITY

Made of machined A7009-T6 aluminum for light weight.
 All bolts and pins are made of Ti-6AL-4V titanium.

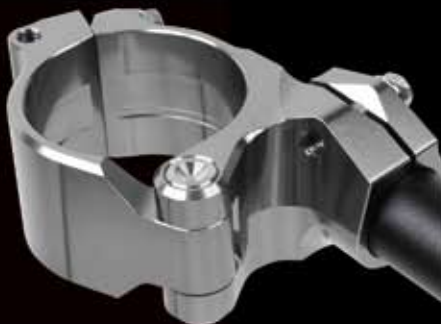

CLAMP

Clamp attaching design for quick handle installation and removal.
 Gap on the inner side of clamp provides better contact pressure.



HANDLEBAR

Throttle side has polished finish for smooth throttle control.
 Clutch side has shot peening finish for secure grip holding.



Handlebar adjustable system

Provides comfort or sport riding handlebar positions.

for
STREET

ZETA

PILOT HANDLE

- Provide many handlebar positions on your bike, great to use for sport riding and touring.
- Clamp and handlebar are made of A6061-T6 aluminum for durability.
- Clamp body is CNC machined, available red or titanium anodized colors.
- Handlebar bracket available in 2 different heights, 25 mm and 45 mm.
- Provides 2 different handlebar angles, 5 degree or 10 degree by changing handlebar bracket position on clamp body.
- Optional offset plate available if you need more space between OE clamp and handle bracket.
- Replacement handles available.

Size	Part #			
	Ti-color		Red	
Fork clamp	High (45 mm)	Middle (25 mm)	High (45 mm)	Middle (25 mm)
φ37	ZS03-1371	ZS03-1372	ZS03-1375	ZS03-1376
φ41	ZS03-1411	ZS03-1412	ZS03-1415	ZS03-1416
φ43	ZS03-1431	ZS03-1432	ZS03-1435	ZS03-1436
φ50	ZS03-1501	ZS03-1502	ZS03-1505	ZS03-1506
φ53	ZS03-1531	ZS03-1532	ZS03-1535	ZS03-1536

Spec

Material : A6061-T06
 Surface finish : Color anodized finish
 Handlebar out side diameter : φ 22.2
 Handlebar inside diameter : φ 16
 Handlebar length : 270 mm
 Clamp thickness : 34 mm
 (30 mm for φ37 clamp)



CLAMP

Gap on the inner side of clamp provides better contact pressure and prevents clamp from moving on to front forks and handlebars.



HIGH QUALITY

Fully machined from A6061-T6 aluminum, to achieve a light weight and durable product.

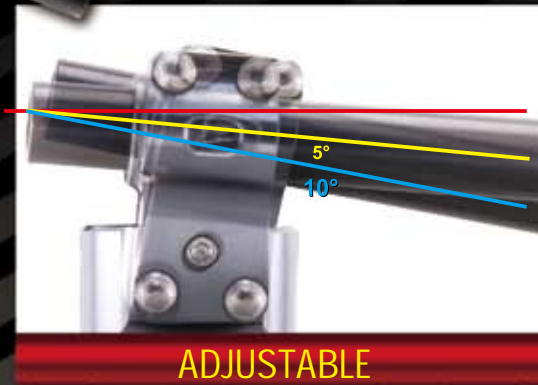

ADJUSTABLE

Provides 2 different handlebar angles, 10 degree angle for sport riding, 5 degree angle for comfortable riding position.

Replacement



REPLACEMENT BARS

ZS03-8002 * Required drilling hole for control switch.

Optional



OFFSET PLATE KIT (5 mm)

Use this plate kit when you need more space between OE clamp and handle bracket.

ZS03-1911 Ti-color
 ZS03-1915 Red

* Comes with attachment bolts.



High (45 mm)

Middle (25 mm)

HANDLEBAR BRACKET KIT

High (45 mm)

Middle (25 mm)

ZS03-1941 Ti-color
 ZS03-1945 Red

ZS03-1942 Ti-color
 ZS03-1946 Red



Bike	Year	Gold	Ti-color
HONDA			
CBR250R	11-17	ZS48-1104	ZS48-1108
CBR250RR	17	ZS48-1104	ZS48-1108
CB250F	14-17	ZS48-1104	ZS48-1108
CBR300R	15-17	ZS48-1104	ZS48-1108
CB300F	15-17	ZS48-1104	ZS48-1108
400X	13-17	ZS48-1104	ZS48-1108
CB400F	13-16	ZS48-1104	ZS48-1108
CB400SF	92-16	ZS48-1104	ZS48-1108
CBR400R	13-17	ZS48-1104	ZS48-1108
CB500X	13-17	ZS48-1104	ZS48-1108
CB500F	13-17	ZS48-1104	ZS48-1108
CBR500R	13-17	ZS48-1104	ZS48-1108
CBR600RR	03-17	ZS48-1104	ZS48-1108
CB650F	14-17	ZS48-1104	ZS48-1108
CBR650F	14-18	ZS48-1104	ZS48-1108
NC700X	12-17	ZS48-1104	ZS48-1108
NC750S/X	14-17	ZS48-1104	ZS48-1108
VFR800	98-09	ZS48-1104	ZS48-1108
VFR800F	14-17	ZS48-1104	ZS48-1108
CB1000R	11-17	ZS48-1104	ZS48-1108
CBR1000RR	04-17	ZS48-1104	ZS48-1108
CB1100	10-17	ZS48-1104	ZS48-1108
CBR1100XX	97-03	ZS48-1104	ZS48-1108
VFR1200F	10-14	ZS48-1104	ZS48-1108
CB1300SF	03-17	ZS48-1104	ZS48-1108
YAMAHA			
MT-25	16-17	ZS48-1404	ZS48-1408
MT-03	16-17	ZS48-1404	ZS48-1408
YZF-R25	15-17	ZS48-1404	ZS48-1408
YZF-R3	15-17	ZS48-1404	ZS48-1408
FZ6	04-08	ZS48-1414	ZS48-1418
FZ6R	07-17	ZS48-1414	ZS48-1418
YZF-R6	06-16	ZS48-1404	ZS48-1408
FZ07	15-17	ZS48-1414	ZS48-1418
MT07	14-17	ZS48-1414	ZS48-1418
FZ8	11-15	ZS48-1404	ZS48-1408
FZ09	14-17	ZS48-1414	ZS48-1418
MT09	14-17	ZS48-1414	ZS48-1418
XSR900	16-17	ZS48-1414	ZS48-1418
FZ1	01-15	ZS48-1414	ZS48-1418
FZ1 FAZER (North America)			
FZ1 FAZER (Japan)	08-15	ZS48-1414	ZS48-1418
FZ10	17	ZS48-1414	ZS48-1418
YZF-R1	98-14	ZS48-1404	ZS48-1408
XJR1200	94-96	ZS48-1414	ZS48-1418
FJR1300	03-15	ZS48-1404	ZS48-1408
XJR1300	98-15	ZS48-1414	ZS48-1418
V-MAX	09-17	ZS48-1404	ZS48-1408

Bike	Year	Gold	Ti-color
KAWASAKI			
NINJA 250	13-17	ZS48-1204	ZS48-1208
NINJA 300	13-17	ZS48-1204	ZS48-1208
NINJA 250R	08-12	ZS48-1204	ZS48-1208
Z250	13-17	ZS48-1204	ZS48-1208
Z300	15-16	ZS48-1204	ZS48-1208
ER-4N	11-13	ZS48-1204	ZS48-1208
NINJA 400R	11-13	ZS48-1204	ZS48-1208
NINJA 400	14-17	ZS48-1204	ZS48-1208
ER-6f	07-10	ZS48-1204	ZS48-1208
ER-6n	06-14	ZS48-1204	ZS48-1208
ZX-6R	00-17	ZS48-1204	ZS48-1208
ZX-6RR	03-05	ZS48-1204	ZS48-1208
NINJA 650	12-16	ZS48-1204	ZS48-1208
NINJA 650R	09-11	ZS48-1204	ZS48-1208
VERSYS650	10-17	ZS48-1204	ZS48-1208
Z750	04-05	ZS48-1204	ZS48-1208
Z750S	05	ZS48-1204	ZS48-1208
ZX-7R	00-02	ZS48-1204	ZS48-1208
ZX-7RR	96-97	ZS48-1204	ZS48-1208
Z800	13-16	ZS48-1204	ZS48-1208
ZX-9R	99-03	ZS48-1204	ZS48-1208
NINJA 1000	11-16	ZS48-1204	ZS48-1208
VERSYS1000	12-17	ZS48-1204	ZS48-1208
Z1000	03-17	ZS48-1204	ZS48-1208
ZX-10R	11-15	ZS48-1204	ZS48-1208
ZRX1100	97-00	ZS48-1204	ZS48-1208
ZRX1100II	97-00	ZS48-1204	ZS48-1208
ZRX1200DAEG	09-16	ZS48-1204	ZS48-1208
ZRX1200R	01-08	ZS48-1204	ZS48-1208
ZRX1200S	01-04	ZS48-1204	ZS48-1208
ZX-12R	00-06	ZS48-1204	ZS48-1208
ZZR1200	02-05	ZS48-1204	ZS48-1208
ZX-14R	12-17	ZS48-1204	ZS48-1208
ZZR1400	06-11	ZS48-1204	ZS48-1208
SUZUKI			
GSR250/S, GW250, INAZUMA250	12-17	ZS48-1014	ZS48-1018
GSX250R	17	ZS48-1014	ZS48-1018
GLADIUS400	09-14	ZS48-1014	ZS48-1018
GSR400	06-14	ZS48-1014	ZS48-1018
GSX-R600	01-03	ZS48-1014	ZS48-1018
V-STROM650/XT	04-17	ZS48-1014	ZS48-1018
GSX-R750	00-03	ZS48-1014	ZS48-1018
GSX-R1000	01-04	ZS48-1014	ZS48-1018

ZETA BAR END PLUGS

- Made of high strength aluminum and stainless steel.
- Functions as a weight to prevent unpleasant vibration.
- Design to fit specific models, easy to install.
- Available in gold and titanium colors.



Universal L

Universal S

ZETA BAR END PLUGS Universal

- Universal bar end plug for sport bike.
- Available universal S and L models.
- L model comes with stainless steel bar weight to prevent unpleasant vibration.
- Available in gold and titanium colors.
- * handlebar inner diameter 13.5 mm - 19 mm

Size	Gold	Ti-color
Universal S	ZS48-1004	ZS48-1008
Universal L	ZS48-1014	ZS48-1018



ZE56-10504

ZE56-10514

ZETA F-FORK TOP CAP INITIAL ADJUSTER

- Top cap initial adjuster for Ninja 250 / 300 and YZF-R25 / R3
- Allows you to adjust spring pre load.
- Pre load adjustable range is -5 mm to +10 mm, provides pre load setting for racing use and soften for light weight riders.
- Integrated air bleeder, bleeds high pressure air without any tools from the front fork after hard and high speed riding.
- * Ninja 250 / 300 required to change handlebar to clip on handlebar for installation.

Bike	Year	Gold
YAMAHA	YZF-R25	ZE56-10514
	YZF-R25 ABS	ZE56-10514
	YZF-R3	ZE56-10514
KAWASAKI	NINJA250R	ZE56-10504
	NINJA250	ZE56-10504
	NINJA250 ABS	ZE56-10504
	NINJA300	ZE56-10504
	NINJA300 ABS	ZE56-10504

ZETA FORK TOP CAP NINJA 250 / 300

- CNC machined aluminum front fork cap for Ninja 250 / 300.
- Use this fork cover cap when you change to aftermarket clip on handles.
- Black anodized finish with laser printed logo.
- Comes in pairs.

ZS59-8011 Black



High Type 1

Medium Type 2

Medium Type 1

Low Type 2

Low Type 1

Medium Type 1

CB400SF

Height Type 1

CB500X

ZETA
GT HANDLEBAR

- Handlebar sizes which are designed for a relaxed and comfortable ride.
- Laser printed handlebar positioning gauge for accurate bar position setting.
- Made of durable aluminum with shot peened anodized finish.
- Matte titanium anodized surface finish.
- Handlebar diameter : 22.2 mm / Bar end inner diameter : 13.5 mm

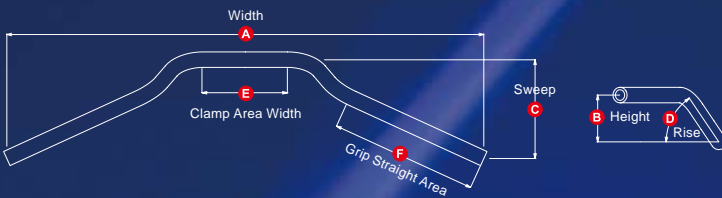

Model	Part#	Handlebar dimensions					
		A	B	C	D	E	F
Low type-1	ZS07-1008	670	52	116	60°	115	200
Low type-2	ZS07-1018	680	63	135	67°	120	205
Medium type-1	ZS07-1108	685	67	142	56°	120	205
Medium type-2	ZS07-1118	685	71	152	62°	120	205
Height type-1	ZS07-1208	740	98	150	63°	120	200

Laser printed logos and handlebar positioning gauge for accurate handlebar position setting.



Ninja 400R [ZS86-1208](#)

ZETA
HANDLEBAR STABILIZER

- Made of CNC machined aluminum with anodized finish.
- Durable yet light weight design.
- Available in titanium color.
- Comes with special stainless bolts.

Bike	Year	Part #	Bike	Year	Part #
HONDA			KAWASAKI		
GROM_MSX125	13-18	ZS33-1108	Z250	13-17	ZS33-1218
CB250F	14-17	ZS33-1108	ER-4N	11-13	ZS33-1208
CB300F	15-17	ZS33-1108	NINJA 400R	11-13	ZS33-1208
VTR/VTR-F	09-17	ZS33-1108	NINJA 400	14-17	ZS33-1208
400X	13-17	ZS33-1108	ER-6F	09-10	ZS33-1208
CB400F	13-16	ZS33-1108	ER-6N	09-11	ZS33-1208
CB400SF	92-16	ZS33-1108	NINJA 650	12-16	ZS33-1208
CB500X	13-17	ZS33-1108	NINJA 650R	09-11	ZS33-1208
CB500F	13-17	ZS33-1108	Z800	13-16	ZS33-1218
CB650F	14-18	ZS33-1108			
NC700S/X	12-17	ZS33-1108			
NC750S/X	14-17	ZS33-1108			
CB1100	10-16	ZS33-1118			
CB1300SF	03-17	ZS33-1118			

ZETA
BAR CLAMP

- Made of CNC machined aluminum with anodized finish.
- Exclusive look on your handlebar clamp.
- Available in gold and titanium colors.

Part #	Color
ZS40-1104	Gold
ZS40-1108	Ti-color

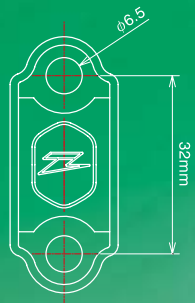

CONTROL



LEVER



BODY



ELECTRICAL





CBR250R



Ninja 250



ZETA

BAR RISE KIT NINJA 250 and CBR250R

- Bar rise spacer provides higher bar position.
- Made of CNC machined aircraft grade aluminum and titanium anodized finish.

Part #	Bike	Year	Spacer thickness
ZS53-1108	CBR250R	11-	10 mm
ZS53-1208	Ninja 250	08-	8 mm



CBR250R



Ninja 250

CONTROL



LEVER



BODY



ELECTRICAL



ZE53-0219

ZE53-0130

ZETA

BAR RISE KIT 20 mm OFF SET

- Handlebar rise and offset kit.
- Provides 26 mm higher, 20 mm back and forth positions from stock handlebar position.
- Provide comfort riding position for sport bike with 20 mm backward position.

Part number **ZE53-0526**

Bar rise kit offset dimension

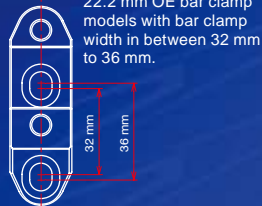
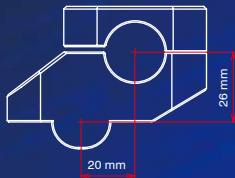

- Can be used with 22.2 mm OE bar clamp models with bar clamp width in between 32 mm to 36 mm.

ZETA

BAR RISE KIT UNIVERSAL

- Universal bar riser kit for over sized (28.6 mm, 1 1/8") bar mount and standard sized (22.2 mm, 7/8").
- Provides 19 mm and 30 mm higher bar position than stock bar position.
- For use on bar handle sports bikes.
- Comes with bar clamp bolts. - Made of A7009-T6 aluminum.

Size	Part #	Height	Size	Part #	Height
7/8 in (22.2 mm)	ZE53-0119	19 mm	1 1/8 in (28.6 mm)	ZE53-0219	19 mm
	ZE53-0130	30 mm		ZE53-0230	30 mm

Bar rise kit dimension

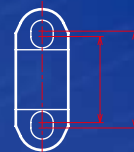
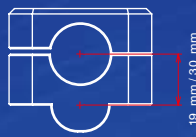

Standard bar
32 mm - 36 mm



CB500X



CB500X

FLIGHT PERCH BLACK



ACCURATE RATIO
Provides 2 different lever ratios, light pulling and accurate clutch control, by changing position of Ratio Device.

LIGHT RATIO

Clutch Switch (ZS60-5882)

TITANIUM BOLT
Titanium M6 bolt and pivot pin

**2017 Moto America Champion
Yoshimura Suzuki Factory
Racing Team
TONI ELIAS**

for **RACING**

RATIO DEVICE

**ZETA
FLIGHT PERCH RD 4 Finger [Black]**

- Racing Flight clutch perch comes with ratio device.
- Provides 2 different lever ratios, light pulling and accurate clutch control, by changing position of Ratio Device (**PATENT PENDING**).
- Comes with quick cable adjuster for quick and easy clutch play adjustment, even during the ride.
- Lever bearing for less friction. Fully CNC machined, super light weight design.
- Conforms to FIM and MFJ regulations.
- Available perch comes with clutch switch for street use and without switch for racing use.
- M6 bolts and pivot pins are made of titanium.

ZS60-5881	4 Finger	W/O Switch
ZS60-5882	4 Finger	With Switch

4 Finger

**ZETA
FLIGHT PERCH 3 Finger & 4 Finger [Ti - Color]**

- Clutch perch set for cable type clutch developed with 2017 Moto America winning clutch perch.
- Flight perch comes with 3 fingers short lever arm.
- Used by Moto America Factory Yoshimura Suzuki Racing Team, Japanese Yoshimura Suzuki Kawasaki Team Green.
- Conforms to FIM and MFJ regulations.

ZS60-5886	3 Finger
ZS60-5883	4 Finger

4 Finger

3 Finger

FLIGHT PERCH BLACK / Ti-Color

FLIGHT LEVER



Vent Holes
Lever body is designed to decrease wind pressure, and in case of a fall, the breaking point is pre-calculated to avoid worst case "DNF".



Folding lever
Lever swings upward in the event of crash and prevents lever breakage.



Quick Cable Adjuster
Large size 1/6 rotating wire adjuster. Easy to adjust clutch play even during the ride.



Quick Clamp System
Hinge style clamp for easy and quick maintenance. Hinge pin is made of titanium alloy.

Lever End Ball 19 mm lever end ball complies to MFJ and FIM regulations.

Lever Adjuster Bolt
Simple and light weight design for non step adjustment .

FLIGHT LEVER Replacement FLIGHT PERCH Replacement

Clutch Lever Arm		Brake Lever Arm		Adjust Knob		Lever Assy		Lever Arm		Perch Assy		Adjuster		Bolt set		Switch Set (Black)	
L4SH	Ti-Color	R4SH	Ti-Color	Red	ZS60-9113	4 Finger	Black	4F Ti-Color	Black	Color	Part number	Color	Part number	Stainless	ZS60-5938		
L4SH	Black	R4SH	Black	Brown	ZS60-9119	4 Finger	Ti-Color	ZS60-5990	Black	Black	ZS60-5918	Red	ZS60-5925	Ti-6AL-4V	ZS60-5939		
L4SP	Ti-Color	R3SH	Black		ZS60-3994	4 Finger	Black	3 F Ti-Color	Ti-Color	Black	ZS60-5919	Red	ZS60-5925				
L3SP	Black	R3SH	Black		ZS60-3994	3 Finger	Ti-Color	ZS60-5906	Ti-Color	Blue	ZS60-5919	Blue	ZE43-9394				
L3SP	Ti-Color	R3SH	Ti-Color		ZS60-3995												



ZETA
FLIGHT LEVER Brake/Clutch
3 Finger & 4 Finger

- Used by YOSHIMURA Racing team, US YOSHIMURA SUZUKI FACTORY RACING TEAM, WESTBY YAMALUBE YAMAHA and Kawasaki Team Green.
- Holes on lever body is designed to decrease wind pressure up to over 300 km / h.
- The braking point is pre-calculated in case of a fall.
- Fully CNC machined from A7009 / A6061 aluminum, super light weight design.
- Conforms to FIM and MFJ regulations.
- Available 3 finger and 4 finger lever arm lengths.
- Available in black and titanium anodized colors.

Used by
Kawasaki Team GREEN



CONTROL



LEVER



BODY



ELECTRICAL



Bike	Year	Clutch lever					
		4 Fi Black	Lever Type	3 Fi Ti-Color	Lever Type		
H CBR600RR	03-17	-	-	ZS60-5010	L4SP	ZS60-5015	L3SP
CBR954	02-03	-	-	ZS60-5010	L4SP	ZS60-5015	L3SP
CBR1000RR/SP/SP2	08-17	-	-	ZS60-5010	L4SP	ZS60-5015	L3SP
CBR1000S	14-17	-	-	ZS60-5010	L4SP	ZS60-5015	L3SP
Y XJ6N	09-15	-	-	ZS60-5210	L4SP	ZS60-5215	L3SP
YZF-R6	99-17	-	-	ZS60-5210	L4SP	ZS60-5215	L3SP
YZF-R1M/S	00-17	-	-	ZS60-5210	L4SP	ZS60-5215	L3SP
MT-07/FZ-07	14-17	-	-	ZS60-5210	L4SP	ZS60-5215	L3SP
MT-09/FZ-09	14-17	-	-	ZS60-5210	L4SP	ZS60-5215	L3SP
FZ-1/FAZER	06-15	-	-	ZS60-5210	L4SP	ZS60-5215	L3SP
H2/H2R	15-17	ZS60-5851	L4SH	-	-	-	-
ZX-6R	00-17	-	-	ZS60-5110	L4SP	ZS60-5115	L3SP
ZX-10R/RR	04-17	-	-	ZS60-5110	L4SP	ZS60-5115	L3SP
ZX-12R	00-06	-	-	ZS60-5110	L4SP	ZS60-5115	L3SP
ZX-9R	00-03	-	-	ZS60-5110	L4SP	ZS60-5115	L3SP
Z750	07-10	-	-	ZS60-5110	L4SP	ZS60-5115	L3SP
Z1000	03-16	-	-	ZS60-5110	L4SP	ZS60-5115	L3SP
NINJA1000	11-18	-	-	ZS60-5110	L4SP	ZS60-5115	L3SP
VERSYS1000	12-14	-	-	ZS60-5110	L4SP	ZS60-5115	L3SP
S GSX-R750/600	06-17	-	-	ZS60-5210	L4SP	ZS60-5215	L3SP
GSX-R1000	05-06	-	-	ZS60-5210	L4SP	ZS60-5215	L3SP
GSX-R1000/R	09-17	-	-	ZS60-5210	L4SP	ZS60-5215	L3SP
GSX-S1000/F	15-17	-	-	ZS60-5210	L4SP	ZS60-5215	L3SP
B M W S1000RR	10-14	-	-	ZS60-5810	L4SP	ZS60-5815	L3SP
S1000RR	15-17	-	-	ZS60-5830	L4SP	ZS60-5835	L3SP
S1000R	14-17	-	-	ZS60-5830	L4SP	ZS60-5835	L3SP
HP4	13-14	-	-	ZS60-5810	L4SP	ZS60-5815	L3SP
D U C A T I 1299 PANIGALE/S	15-17	ZS60-5851	L4SH	-	-	-	-
1199 PANIGALE/S/TRICOLOLE	12-14	ZS60-5851	L4SH	-	-	-	-
1199 PANIGALE R	13-17	ZS60-5851	L4SH	-	-	-	-
959 PANIGALE	16-17	ZS60-5851	L4SH	-	-	-	-
899 PANIGALE	14-15	ZS60-5851	L4SH	-	-	-	-
1198/1098/S/R	08-11	ZS60-5851	L4SH	-	-	-	-
999/S/R	03-07	ZS60-5851	L4SH	-	-	-	-
848/749/S/R/EVO/EVO CORSE SE	03-13	ZS60-5851	L4SH	-	-	-	-
O T T O M A R B R E M B O R A D I A L M A S T E R 19 x 20 for Ratio	-	-	-	ZS60-5710	L4SH	-	-
B R E M B O R A D I A L M A S T E R 19 x 18 16 x 18 for Ratio	-	-	-	ZS60-5720	L4SH	-	-

Bike	Year	Brake lever					
		4Fi Black	Lever Type	4 Fi Ti-Color	Lever Type	3 Fi Ti-Color	Lever Type
H CBR600RR	07-17	-	-	ZS60-3010	R4SH	ZS60-3015	R3SH
CBR1000RR/SP/SP2	04-17	-	-	ZS60-3010	R4SH	ZS60-3015	R3SH
CBR1000S	14-17	-	-	ZS60-3010	R4SH	ZS60-3015	R3SH
Y YZF-R6	17	-	-	ZS60-3620	R4SH	ZS60-3625	R3SH
YZF-R1M/S	05-16	-	-	ZS60-3610	R4SH	ZS60-3615	R3SH
YZF-R1	15-17	-	-	ZS60-3620	R4SH	ZS60-3625	R3SH
V-MAX	04-14	-	-	ZS60-3610	R4SH	ZS60-3615	R3SH
MT-01	09-17	-	-	ZS60-3610	R4SH	ZS60-3615	R3SH
MT-01	05-09	-	-	ZS60-3610	R4SH	ZS60-3615	R3SH
K H2/H2R	15-17	ZS60-3811	R4SH	-	-	-	-
ZX-6R	07-17	-	-	ZS60-3210	R4SH	ZS60-3215	R3SH
ZX-10R	06-15	-	-	ZS60-3210	R4SH	ZS60-3215	R3SH
ZX-10R/RR	16-17	ZS60-3811	R4SH	-	-	-	-
ZX-14R HiGrade /SE	06-17	-	-	ZS60-3210	R4SH	ZS60-3215	R3SH
Z1000	07-17	-	-	ZS60-3210	R4SH	ZS60-3215	R3SH
NINJA1000	11-18	-	-	ZS60-3210	R4SH	ZS60-3215	R3SH
1400GTR /CONCOURS 14	08-17	-	-	ZS60-3210	R4SH	ZS60-3215	R3SH
S GSX-R750/600	04-17	-	-	ZS60-3410	R4SH	ZS60-3415	R3SH
GSX-R1000/R	05-17	-	-	ZS60-3410	R4SH	ZS60-3415	R3SH
GSX-S1000/F	15-17	-	-	ZS60-3410	R4SH	ZS60-3415	R3SH
B-KING	07-09	-	-	ZS60-3410	R4SH	ZS60-3415	R3SH
B M W S1000RR	10-17	-	-	ZS60-3410	R4SH	ZS60-3415	R3SH
S1000R	14-17	-	-	ZS60-3410	R4SH	ZS60-3415	R3SH
HP4	13-14	-	-	ZS60-3410	R4SH	ZS60-3415	R3SH
D U C A T I 1299 PANIGALE/S	15-17	ZS60-3811	R4SH	-	-	-	-
1199 PANIGALE/S/TRICOLOLE	12-14	ZS60-3811	R4SH	-	-	-	-
1199 PANIGALE R	13-17	ZS60-3811	R4SH	-	-	-	-
959 PANIGALE	16-17	ZS60-3811	R4SH	-	-	-	-
899 PANIGALE	14-15	ZS60-3811	R4SH	-	-	-	-
1198/1098/S/R	08-11	ZS60-3811	R4SH	-	-	-	-
999/S/R	03-07	ZS60-3811	R4SH	-	-	-	-
848/749/S/R/EVO/EVO CORSE SE	03-13	ZS60-3811	R4SH	-	-	-	-
O T T O M A R B R E M B O R A D I A L M A S T E R 19 x 20 for Ratio	-	-	-	ZS60-3710	R4SH	ZS60-3715	R3SH
B R E M B O R A D I A L M A S T E R 19 x 18 16 x 18 for Ratio	-	-	-	ZS60-3720	R4SH	ZS60-3725	R3SH



ZETA
FLIGHT LEVER Remote Adjuster

- Provides fine adjustment to the brake lever from the left side handlebar.
- Able to tighten slack in your brakes with your free hand without letting off the throttle.
- CNC machined handlebar support included.

Part Number **ZS60-3989**
Replacement wire **ZS60-3998**

Used by
AMA SUPER BIKE
YOSHIMURA RACING TEAM

Pilot LEVER

ZETA PILOT LEVER

- High quality CNC machined levers for sport bikes.
- Folding lever system to prevent lever breakage.
- Short lever arm for sport riding.
- Available in black and titanium anodized colors.

for
STREET

Ninja H2



CONTROL



LEVER



BODY



ELECTRICAL



LEVER TYPE

L3WA/R3WA

L3WB/R3WB

FUNCTION



FOLDING UP / DOWNWARD

Lever swings upward or downward in the event of crash to prevent lever breakage.



FOLDING FORWARD

Lever swings forward in the event of crash to prevent lever breakage.



CNC MACHINED LEVER

Precision CNC machined finish to reduce weight and for better lever control.



ADJUST KNOB

Provides more sensitive lever adjusting positions than OEM levers. (20 lever positions)

Pilot lever Clutch

BIKE	Year	Ti-color	Black	Lever Type
CB1300SF/SB/ST	98-17	ZS61-2020	ZS61-2025	L3WA
CB1000SF	92-97	ZS61-2020	ZS61-2025	L3WA
CB1100/EX	10-17	ZS61-2020	ZS61-2025	L3WA
CBR1100XX	97-06	ZS61-2020	ZS61-2025	L3WA
CBR1000RR	04-07	ZS61-2020	ZS61-2025	L3WA
CBR1000RR/SP/SP2	08-17	ZS61-2010	ZS61-2015	L3WA
CBR1000S	14-17	ZS61-2010	ZS61-2015	L3WA
CBR954RR	02-03	ZS61-2010	ZS61-2015	L3WA
CBR600RR	03-17	ZS61-2010	ZS61-2015	L3WA
CB1000R	11-17	ZS61-2020	ZS61-2025	L3WA
X-4	97-03	ZS61-2020	ZS61-2025	L3WA
VFR1200X	14-17	ZS61-2020	ZS61-2025	L3WA
VFR1200F	10-17	ZS61-2020	ZS61-2025	L3WA
VFR800	03-08	ZS61-2020	ZS61-2025	L3WA
VFR800F/X	14-17	ZS61-2020	ZS61-2025	L3WA
VTR1000F	98-05	ZS61-2020	ZS61-2025	L3WA
V-MAX	09-17	ZS61-2610	ZS61-2615	L3WA
MT-10/FZ-10	17	-	ZS61-2625	L3WA
MT-01	05-09	ZS61-2610	ZS61-2615	L3WA
MT-09 TRACER	15-17	ZS61-2410	ZS61-2415	L3WA
MT-09/FZ-09	14-17	ZS61-2410	ZS61-2415	L3WA
MT-07/FZ-07	14-17	ZS61-2410	ZS61-2415	L3WA
XSR900	16-17	ZS61-2410	ZS61-2415	L3WA
XSR700	16	ZS61-2410	ZS61-2415	L3WA
YZF-R1M/S	00-17	ZS61-2410	ZS61-2415	L3WA
YZF-R6	99-17	ZS61-2410	ZS61-2415	L3WA
Z1/N/S	06-16	ZS61-2410	ZS61-2415	L3WA
FZ8/N/S/FAZER	11-15	ZS61-2410	ZS61-2415	L3WA
FZ6/R/FAZER	04-17	ZS61-2410	ZS61-2415	L3WA
FJR1300A	01-17	ZS61-2610	ZS61-2615	L3WA
XJR1300C	94-16	ZS61-2610	ZS61-2615	L3WA
XJR1200/1300	94-15	ZS61-2610	ZS61-2615	L3WA
XJ6	09-16	ZS61-2410	ZS61-2415	L3WA
XT1200Z TENERE	10-17	ZS61-2610	ZS61-2615	L3WA
H2/HZR	15-17	ZS61-2810	ZS61-2815	L3WB
1400GT/CONCOURS 14	08-17	ZS61-2220	ZS61-2225	L3WB
ZX-12R	00-07	ZS61-2210	ZS61-2215	L3WA
ZX-10R/RR	04-17	ZS61-2210	ZS61-2215	L3WA
ZX-9R	00-03	ZS61-2210	ZS61-2215	L3WA
ZX-7R	00-02	ZS61-2610	ZS61-2615	L3WA
ZX-6R/ABS	02-17	ZS61-2210	ZS61-2215	L3WA
ZX-14R/HiGrade/SE	02-17	ZS61-2220	ZS61-2225	L3WB
ZZR1200	02-03	ZS61-2610	ZS61-2615	L3WA
ZX-11	97-01	ZS61-2610	ZS61-2615	L3WA
ZRX1100/1200DAEG	97-16	ZS61-2610	ZS61-2615	L3WA
NINJA1000	11-18	ZS61-2210	ZS61-2215	L3WA
Z1000	04-16	ZS61-2210	ZS61-2215	L3WA
Z800	13-16	ZS61-2210	ZS61-2215	L3WA
Z750	07-10	ZS61-2210	ZS61-2215	L3WA
ZEPHER1100/RS	92-06	ZS61-2610	ZS61-2615	L3WA
GPZ900R	91-03	ZS61-2610	ZS61-2615	L3WA
VERSYS1000	12-14	ZS61-2210	ZS61-2215	L3WA
GSX1400	01-08	ZS61-2420	ZS61-2425	L3WA
GSX1300R HAYABUSA	99-17	ZS61-2420	ZS61-2425	L3WA
BANDIT1200/1250/S/F	01-16	ZS61-2420	ZS61-2425	L3WA
GSX-S1000/F	15-17	ZS61-2410	ZS61-2415	L3WA
GSX-R1000	05-06	ZS61-2410	ZS61-2415	L3WA
GSX-R1000	07-08	ZS61-2420	ZS61-2425	L3WA
GSX-R1000R	09-17	ZS61-2410	ZS61-2415	L3WA
GSX-R750	06-17	ZS61-2410	ZS61-2415	L3WA
GSX-R600	06-17	ZS61-2410	ZS61-2415	L3WA
GS1200SS	01-02	ZS61-2420	ZS61-2425	L3WA
V-STORM 1000/XT	07-17	ZS61-2420	ZS61-2425	L3WA
SV1000S	03-07	ZS61-2420	ZS61-2425	L3WA
TL1000R	98-03	ZS61-2420	ZS61-2425	L3WA
1299 PANIGALE/S	15-17	ZS61-2810	ZS61-2815	L3WB
1199 PANIGALE/S/ TRICOLORE	12-14	ZS61-2810	ZS61-2815	L3WB
1199 PANIGALE R	13-17	ZS61-2810	ZS61-2815	L3WB
959 PANIGALE	16-17	ZS61-2810	ZS61-2815	L3WB
899 PANIGALE	14-15	ZS61-2810	ZS61-2815	L3WB
1198/1098/S/R	08-11	ZS61-2810	ZS61-2815	L3WB
999/S/R	03-07	ZS61-2810	ZS61-2815	L3WB
848/749/S/R/EVO/EVO CORSE SE	03-13	ZS61-2810	ZS61-2815	L3WB
STREETFIGHTER/S	10-13	ZS61-2810	ZS61-2815	L3WB
STREETFIGHTER 848	12-15	ZS61-2810	ZS61-2815	L3WB
HYPERMOTARD1100S/EVO	08-12	ZS61-2810	ZS61-2815	L3WB
MONSTER1200/S/R	14-17	ZS61-2810	ZS61-2815	L3WB
MONSTER1100S/EVO	08-13	ZS61-2810	ZS61-2815	L3WB
MONSTER S4R/S	06-08	ZS61-2810	ZS61-2815	L3WB
MULTISTRADA1200/S/ SPIKES PEAK/ENDURO X DIAVEL/S	10-17	ZS61-2810	ZS61-2815	L3WB
X DIAVEL/S	17	ZS61-2810	ZS61-2815	L3WB
DIAVEL STRADA	11-17	ZS61-2810	ZS61-2815	L3WB
DIAVEL CARBON	13	ZS61-2810	ZS61-2815	L3WB
DIAVEL DARK	12-17	ZS61-2810	ZS61-2815	L3WB
BONNEVILLE	11-15	ZS61-2830	ZS61-2835	L3WB
BONNEVILLE SE	09-12	ZS61-2830	ZS61-2835	L3WB
BONNEVILLE T100	01-15	ZS61-2830	ZS61-2835	L3WB
DAYTONA 675	06-15	ZS61-2830	ZS61-2835	L3WB
DAYTONA 675 R	11-15	ZS61-2830	ZS61-2835	L3WB
DAYTONA 675 SE	11	ZS61-2830	ZS61-2835	L3WB
DAYTONA595&955	97-00	ZS61-2830	ZS61-2835	L3WB
DAYTONA600&650	04-05	ZS61-2830	ZS61-2835	L3WB
DAYTONA955	01-05	ZS61-2830	ZS61-2835	L3WB
SCRAMBLER	06-16	ZS61-2830	ZS61-2835	L3WB
SP3ED FOUR	03-05	ZS61-2830	ZS61-2835	L3WB
SPEED TRIPLE/R	98-15	ZS61-2830	ZS61-2835	L3WB
SPEED TRIPLE (T509)	97	ZS61-2830	ZS61-2835	L3WB
SPRINT GT	11-12	ZS61-2830	ZS61-2835	L3WB
SPRINT GT S	00-04	ZS61-2830	ZS61-2835	L3WB
SPRINT ST	99-12	ZS61-2830	ZS61-2835	L3WB
SPRINT ST 1050	07	ZS61-2830	ZS61-2835	L3WB
STREET TRIPLE	11-12	ZS61-2830	ZS61-2835	L3WB
STREET TRIPLE 85	13-16	ZS61-2830	ZS61-2835	L3WB
STREET TRIPLE S	17	ZS61-2830	ZS61-2835	L3WB
STREET TRIPLE675	08-10	ZS61-2830	ZS61-2835	L3WB
STREET TRIPLE675R	09-16	ZS61-2830	ZS61-2835	L3WB
THRUXTON	04-16	ZS61-2830	ZS61-2835	L3WB
TIGER 1050	07-12	ZS61-2830	ZS61-2835	L3WB
TIGER 1050 SE	11-12	ZS61-2830	ZS61-2835	L3WB
TIGER 800	11-14	ZS61-2830	ZS61-2835	L3WB
TIGER 800 XC	11-14	ZS61-2830	ZS61-2835	L3WB
TT600	00-03	ZS61-2830	ZS61-2835	L3WB
NISSIN RADIAL CAST		ZS61-2220	ZS61-2225	L3WB

Pilot lever Brake

BIKE	Year	Ti-color	Black	Lever Type
CB1300SF	98-00	ZS61-1020	ZS61-1025	R3WA
CB1300SF/SB/ST	03-17	ZS61-1430	ZS61-1435	R3WA
CB400SF/SB ABS	08-13	ZS61-1020	ZS61-1025	R3WA
CB400SF/ABS	14-16	ZS61-1430	ZS61-1435	R3WA
CB400SF/SB	97-16	ZS61-1430	ZS61-1435	R3WA
CBR1100XX	97-06	ZS61-1020	ZS61-1025	R3WA
CBR1000S	14-17	ZS61-1010	ZS61-1015	R3WB
CBR1000RR/SP/SP2	04-17	ZS61-1010	ZS61-1015	R3WB
CBR900RR	98-99	ZS61-1430	ZS61-1435	R3WA
CBR600RR	07-17	ZS61-1010	ZS61-1015	R3WB
CBR600F4/F4I	99-06	ZS61-1430	ZS61-1435	R3WB
CB1000R	11-17	ZS61-1010	ZS61-1015	R3WB
X-4	97-03	ZS61-1430	ZS61-1435	R3WA
X-11	99-00	ZS61-1020	ZS61-1025	R3WA
CB1100/EX	10-17	ZS61-1430	ZS61-1435	R3WA
CB1000SF	92-97	ZS61-1430	ZS61-1435	R3WA
CB750	07-08	ZS61-1430	ZS61-1435	R3WA
VTR1000F	98-05	ZS61-1430	ZS61-1435	R3WA
VFR800	03-08	ZS61-1430	ZS61-1435	R3WA
VFR800F/X	14-17	ZS61-1430	ZS61-1435	R3WA
VFR1200X	14-17	ZS61-1430	ZS61-1435	R3WA
RFR400	94-96	ZS61-1430	ZS61-1435	R3WA
NSR250R	87-96	ZS61-1430	ZS61-1435	R3WA
HORNET900	02-07	ZS61-1430	ZS61-1435	R3WA
HORNET600	98-02	ZS61-1430	ZS61-1435	R3WA
HORNET250	96-07	ZS61-1430	ZS61-1435	R3WA
CB400SS	02-08	ZS61-1430	ZS61-1435	R3WA
VTR	98-17	ZS61-1430	ZS61-1435	R3WA
DN-01	08	ZS61-1430	ZS61-1435	R3WA
NC700S/X	12-17	ZS61-1430	ZS61-1435	R3WA
NC750S/X	14-17	ZS61-1430	ZS61-1435	R3WA
X-ADV	17	ZS61-1430	ZS61-1435	R3WA
CRF1000L	16-17	ZS61-1430	ZS61-1435	R3WA
V-MAX	09-17	ZS61-1610	ZS61-1615	R3WB
MT-10/FZ-10	17	ZS61-1620	ZS61-1625	R3WB
MT-01	05-09	ZS61-1610	ZS61-1615	R3WB
MT-09 TRACER	15-17	ZS61-1620	ZS61-1625	R3WA
MT-09/FZ-09	14-17	ZS61-1620	ZS61-1625	R3WA
MT-07/FZ-07	14-17	ZS61-1620	ZS61-1625	R3WA
XSR900	16-17	ZS61-1620	ZS61-1625	R3WA
XSR700	16	ZS61-1620	ZS61-1625	R3WA
YZF-R1	04-14	ZS61-1610	ZS61-1615	R3WB
YZF-R1M/S	15-17	ZS61-1630	ZS61-1635	R3WB
YZF-R6	05-16	ZS61-1630	ZS61-1635	R3WB
FZ1/N/S	06-16	ZS61-1620	ZS61-1625	R3WA
FZ8/N/S/FAZER	11-15	ZS61-1620	ZS61-1625	R3WA
FZ6/FAZER	04-17	ZS61-1620	ZS61-1625	R3WA
FJR1300	01-02	ZS61-1440	ZS61-1445	R3WA
FJR1300A	03-17	ZS61-1620	ZS61-1625	R3WA
XJR1300C	15-16	ZS61-1620	ZS61-1625	R3WA
XJR1200/1300	94-15	ZS61-1440	ZS61-1445	R3WA
XJR400R/R II	93-07	ZS61-1440	ZS61-1445	R3WA
ZR250R/RS/SP/ SPR	90-95	ZS61-1440	ZS61-1445	R3WA
XJ6	09-16	ZS61-1620	ZS61-1625	R3WA
XT1200Z TENERE	10-17	ZS61-1620	ZS61-1625	R3WA
XT600Z TENERE	08-15	ZS61-1620	ZS61-1625	R3WA
TRX850	95-99	ZS61-1440	ZS61-1445	R3WA
TDM850	97-01	ZS61-1440	ZS61-1445	R3WA
TDM900	02-03	ZS61-1440	ZS61-1445	R3WA
TDM900	04-09	ZS61-1620	ZS61-1625	R3WA
H2/HZR	15-17	ZS61-1810	ZS61-1815	R3WB
1400GT/ CONCOURS 14	08-17	ZS61-1010	ZS61-1015	R3WB
ZX-12R	00-07	ZS61-1440	ZS61-1445	R3WA
ZX-10R	06-15	ZS61-1010	ZS61-1015	R3WB
ZX-10R/RR	16-17	ZS61-1810	ZS61-1815	R3WB
ZX-6R	07-17	ZS61-1010	ZS61-1015	R3WB
ZX-6R/ABS	02-04	ZS61-1440	ZS61-1445	R3WA
ZX-14R HiGrade/SE	16-17	ZS61-1810	ZS61-1815	R3WB
ZX-14R	06-17	ZS61-1010	ZS61-1015	R3WB
ZZR1200	02-05	ZS61-1440	ZS61-1445	R3WA
ZX-11	97-01	ZS61-1440	ZS61-1445	R3WA
ZRX1100/1200/DAEG	97-16	ZS61-1440	ZS61-1445	R3WA
NINJA1000	11-18	ZS61-1010	ZS61-1015	R3WB
NINJA650R	09-16	ZS61-1020	ZS61-1025	R3WA
NINJA400R/R	11-17	ZS61-1020	ZS61-1025	R3WA
Z750	04-05	ZS61-1440	ZS61-1445	R3WA
Z750S	04-07	ZS61-1440	ZS61-1445	R3WA
Z1000	03-06	ZS61-1440	ZS61-1445	R3WA
Z1000	07-18	ZS61-1010	ZS61-1015	R3WB
ZEPHER750/1100/RS	92-06	ZS61-1440	ZS61-1445	R3WA
GPZ900R	91-03	ZS61-1440	ZS61-1445	R3WA
ZZR250/400	90-07	ZS61-1440	ZS61-1445	R3WA
ZRX400/II	94-08	ZS61-1440	ZS61-1445	R3WA
ZEPHERX	89-06	ZS61-1440	ZS61-1445	R3WA
ZR75	99-05	ZS61-1440	ZS61-1445	R3WA



ZS62-1018

ZS62-1030

■ Pivot



Pivot design with return spring allows the lever to fold outward to prevent bending or breaking.

■ Adjustable



Adjustable reach system provides the perfect lever position for all riders.

■ CNC Machined lever arm



Machined ZETA logo provides better lever grip.

■ Lever Type

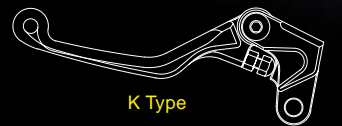

K Type

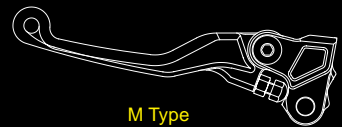

M Type

PIVOT LEVER SET
CNC MACHINED CP

ZETA PIVOT LEVER SET STREET

- Pivot lever set for sport bike.
- CNC Machined aluminum folding levers.
- The pivot design allows the lever to fold outward to prevent bending or breaking in the event of a crash.
- Made of CNC machined aircraft grade aluminum.
- Available titanium and black anodized colors.

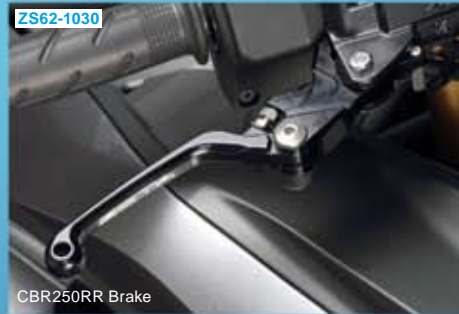

CBR250RR Brake



CBR250RR Clutch

Bike	Year	Pivot Lever CP		Lever Type		
		Black	Ti-color	4 Finger	Clutch Brake	
H O N D A	GROM	13-18	ZS62-1020	ZS62-1028	K	K
	CBR250RR	17	ZS62-1030	-	K	K
	CB250F/300F	14-17	-	-	K	K
	CBR250R/300R	11-17	ZS62-1020	ZS62-1028	K	K
	NSR250R	89-96	-	-	-	-
	VTR/VTR-F	98-17	ZS62-1010	ZS62-1018	K	M
	400X	13-17	-	-	-	-
	CB400F	13-16	ZS62-1020	ZS62-1028	K	K
	CB500X/F	13-17	-	-	-	-
	CBR400R	13-17	-	-	-	-
Y	NC700S/X	12-17	ZS62-1010	ZS62-1018	K	M
	NC750S/X	14-17	-	-	-	-
	MT-25	16-17	-	-	-	-
	MT-03	16-17	-	-	-	-
K	YZF-R25	15-17	ZS62-1610	ZS62-1618	K	M
	YZF-R3	15-17	-	-	-	-
	NINJA250SL	15-16	-	-	-	-
K	NINJA250/300/R	08-17	ZS62-1210	ZS62-1218	K	K
	Z250/300	15-17	-	-	-	-



ZE41-4145

ZE42-4127

ZETA PIVOT LEVER CP

- Pivot lever for sport bike.
- CNC Machined aluminum folding levers.
- The pivot design allows the lever to fold outward to prevent bending or breaking in the event of a crash.
- Hard anodized finish, made of CNC machined aircraft grade aluminum.
- Exclusively designed for each bike, 3 and 4 finger lever lengths available.

Pivot Lever Street Clutch (CP)					
Bike	Year	4 Finger	3 Finger	Type	
H O N D A	GROM	13-18	-	-	
	CB250F/300F	14-17	-	-	
	CBR250R/300R	11-17	-	-	
	VTR/VTR-F	98-17	-	-	
	NSR250R	89-96	-	-	
	400X	13-17	ZE42-4115	-	K
	CB400F	13-16	-	-	
	CB500X/F	13-17	-	-	
	CBR400R	13-17	-	-	
	CBR500R	13-17	-	-	
Y	NC700S/X	12-17	-	-	
	NC750S/X	14-17	-	-	
	NINJA 250SL	15-16	-	-	
	NINJA 250/300/R	08-17	ZE42-4127	ZE42-3127	K
K	Z250/300	13-17	-	-	

Pivot Lever Street Brake (CP)					
Bike	Year	4 Finger	3 Finger	Type	
H O N D A	GROM	13-18	-	-	
	CB250F/300F	14-17	ZE41-4145	ZE41-3145	K
	CBR125R/250R/300R	11-17	-	-	
	HORNET250	96-07	-	-	
	NSR250R	87-96	ZE41-4298	-	M
	VTR/VTR-F	98-17	-	-	
	400X	13-17	-	-	
	CB400F	13-16	ZE41-4145	ZE41-3145	K
	CB500X/F	13-17	-	-	
	CB400FOUR	97-98	ZE41-4298	-	M
	CB400SS	02-08	-	-	
	CBR400R	13-17	ZE41-4145	ZE41-3145	K
	CBR500R	13-17	-	-	
	CBR400RR	88-94	-	-	
	RVF400	94-96	-	-	
	NC700S/X	12-17	ZE41-4298	-	M
	NC750S/X	14-17	-	-	
X-ADV	17	-	-		
Y	TZR250/R/RS/SPR	90-95	ZE41-4299	-	M
	XJR400R/R/II	01-07	-	-	
K A W A S A K I	NINJA 250SL	15-16	-	-	
	NINJA250/300/R	08-17	ZE41-4145	ZE41-3145	K
	Z250/300	13-17	-	-	
	ZZR250	90-07	-	-	
	ZZR400	90-06	-	-	
	ZRX400/II	94-08	ZE41-4299	-	M
	ZEPHYR/X	89-06	-	-	
	BALOUS/II	91-07	-	-	
	S U Z U K I	RGV250 GANMA	88-95	-	-
		GOOSE250/350	92-00	-	-
BANDIT250/400/V		89-00	ZE41-4299	-	M
SV400/S		99-05	-	-	
INAZUMA400		97-01	-	-	
K T M	DUKE125/200/250/390	11-16	ZE41-4286	ZE41-3286	M
	RC125/200/250/390	15-16	-	-	

Replacement parts



Ti-color

- Clutch Lever Arm K-Type**
ZE42-3100 3 Finger
ZE42-4100 4 Finger
- Brake Lever Arm K-Type**
ZE41-3100 3 Finger
ZE41-4100 4 Finger
- Clutch Lever Arm M-Type**
ZE42-3200 3 Finger
ZE42-4200 4 Finger
- Brake Lever Arm M-Type**
ZE41-3200 3 Finger
ZE41-4200 4 Finger

Brack

- Clutch Lever Arm K-Type**
ZE42-3100 3 Finger
ZE42-4100 4 Finger
- Brake Lever Arm K-Type**
ZE41-3100 3 Finger
ZE41-4100 4 Finger
- Brake Lever Arm M-Type**
ZE41-4200 4 Finger



Mount Kit
ZE41-0190 Brake
ZE42-0190 Clutch

for RACING

ZS72-1162

ZS72-1142

ZETA PLASTIC LEVER GUARD

- Lever guard redesigned for race.
- Resin lever guard has high strength and excellent flexibility.
- Steel bar ends and inner brackets provide the effect of balancer weights and contribute to vibration countermeasures.
- Installation workability has also improved.
- It is a truly race part which does not have the adjustment mechanism with the setting of only the right side.

Part #	Inner diameter
ZS72-1142	14 mm (14 - 15.5 mm)
ZS72-1162	16 mm (16 - 17.5 mm)

Replacement Arm
Part number **ZS72-1190**

CONTROL



LEVER



BODY



ELECTRICAL



for RACING /STREET

Gold

Ti-color

Black

ZETA LEVER GUARD

- Lever guard prevents accidental brake lever incidents at the race, track day or street riding.
- Made of A7009-T6 aluminum for durable construction, with length adjustable function to fit most bikes.
- Can also be used for clutch lever side by changing the part direction.
- Available Gold and Titanium colors.
- Sold by unit quantity (One side only)
- Can be used for handlebar with inner diameter from 13.5 mm to 19 mm.

Part #	Color
ZS72-1000	Black
ZS72-1004	Gold
ZS72-1008	Ti-color

Replacement Arm
Part number **ZS72-1094**

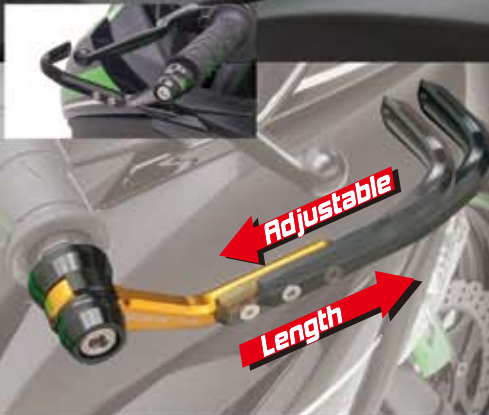

ZETA SCREEN BOLT KIT

- High strength aluminum alloy and anodized finish.
- Easily weight reduction and dress-up effects simply by replacing it from the stock.
- Two colors options, black and red, easy to match to any models.

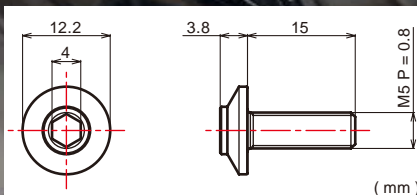

Color	Part #	pcs
Black	ZS88-1040	4
	ZS88-1060	6

Color	Part #	pcs
Red	ZS88-1042	4
	ZS88-1062	6



ZETA
STEERING STEM NUT & BOLT

- CNC Machined steering stem nut and bolt.
- Made of A7009-T6 aluminum, light weight design.
- Available in Gold and Titanium color anodized colors.

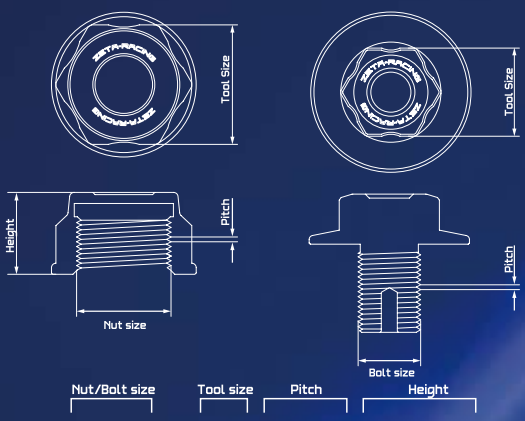

M24 x 30-P1.0 H18.2

Bike	Year	Size	Gold	Ti-Color
HONDA				
GROM,MSX125	13-18	M24x30-P1.0 H18.2	ZS58-1104	ZS58-1108
VTR	99-17	M24x30-P1.0 H18.2	ZS58-1104	ZS58-1108
CBR250R	11-17	M24x30-P1.0 H18.2	ZS58-1104	ZS58-1108
CBR250RR	17	M24x30-P1.0 H18.2	ZS58-1104	ZS58-1108
CB250F	14-17	M24x30-P1.0 H18.2	ZS58-1104	ZS58-1108
CBR300R	15-17	M24x30-P1.0 H18.2	ZS58-1104	ZS58-1108
CB300F	15-17	M24x30-P1.0 H18.2	ZS58-1104	ZS58-1108
400X	13-17	M24x30-P1.0 H18.2	ZS58-1104	ZS58-1108
CB400F	13-16	M24x30-P1.0 H18.2	ZS58-1104	ZS58-1108
CBR400R	13-17	M24x30-P1.0 H18.2	ZS58-1104	ZS58-1108
CB400SF	92-16	M24x30-P1.0 H18.2	ZS58-1104	ZS58-1108
CB500F	13-17	M24x30-P1.0 H18.2	ZS58-1104	ZS58-1108
CB500X	13-17	M24x30-P1.0 H18.2	ZS58-1104	ZS58-1108
CBR500R	13-17	M24x30-P1.0 H18.2	ZS58-1104	ZS58-1108
CBR600RR	03-17	M24x30-P1.0 H18.2	ZS58-1104	ZS58-1108
CB650F	14-18	M24x30-P1.0 H18.2	ZS58-1104	ZS58-1108
CBR650F	14-18	M24x30-P1.0 H18.2	ZS58-1104	ZS58-1108
NC700S/X	12-17	M24x30-P1.0 H18.2	ZS58-1104	ZS58-1108
NC750S/X	14-17	M24x30-P1.0 H18.2	ZS58-1104	ZS58-1108
VFR800	98-09	M24x30-P1.0 H18.2	ZS58-1104	ZS58-1108
VFR800F/X	14-17	M24x30-P1.0 H18.2	ZS58-1104	ZS58-1108
CB1000R	11-17	M24x30-P1.0 H18.2	ZS58-1104	ZS58-1108
CBR1000RR	04-07	M24x30-P1.0 H18.2	ZS58-1104	ZS58-1108
CB1100	10-17	M24x30-P1.0 H18.2	ZS58-1104	ZS58-1108
VFR1200F	10-14	M24x30-P1.0 H18.2	ZS58-1104	ZS58-1108
VFR1200X	14-15	M24x30-P1.0 H18.2	ZS58-1104	ZS58-1108
CB1300SF	03-17	M24x30-P1.0 H18.2	ZS58-1104	ZS58-1108
YAMAHA				
FZ6/R	04-17	M22x27-P1.0 H18.5	ZS58-1404	ZS58-1408
YZF-R6	99-17	M28x36-P1.0 H17	ZS58-1304	ZS58-1308
FZ8	11-14	M28x36-P1.0 H17	ZS58-1304	ZS58-1308
FZ-09/FJ-09	14-17	M22x27-P1.0 H18.5	ZS58-1404	ZS58-1408
MT-09/TRACER	14-17	M22x27-P1.0 H18.5	ZS58-1404	ZS58-1408
XSR900	16-17	M22x27-P1.0 H18.5	ZS58-1404	ZS58-1408
YZF-R1/M/S	98-17	M28x36-P1.0 H17	ZS58-1304	ZS58-1308
FZ1(NORTH AMERICA)	01-05	M22x27-P1.0 H18.5	ZS58-1404	ZS58-1408
FZ1 FAZER(JAPAN)	06-15	M28x36-P1.0 H17	ZS58-1304	ZS58-1308
V-MAX	99-07	M22x27-P1.0 H18.5	ZS58-1404	ZS58-1408
XJR1300	98-15	M22x27-P1.0 H18.5	ZS58-1404	ZS58-1408
KAWASAKI				
NINJA250/R	08-17	M16x22-P1.5 L=22	ZS58-1204	ZS58-1208
Z250	13-17	M16x22-P1.5 L=22	ZS58-1204	ZS58-1208
NINJA300	13-17	M16x22-P1.5 L=22	ZS58-1204	ZS58-1208
ER-4N	11-13	M26x30-P1.0 L=18	ZS58-1214	ZS58-1218
NINJA400/R	11-17	M26x30-P1.0 L=18	ZS58-1214	ZS58-1218
ZX-6R	05-12	M28x36-P1.0 H17	ZS58-1304	ZS58-1308
ER-6F	13-17	M26x30-P1.0 L=18	ZS58-1214	ZS58-1218
ER-6N	07-10	M26x30-P1.0 L=18	ZS58-1214	ZS58-1218
NINJA650/R	06-14	M26x30-P1.0 L=18	ZS58-1214	ZS58-1218
VERSYS650	06-18	M26x30-P1.0 L=18	ZS58-1214	ZS58-1218
NINJA1000	07-17	M26x30-P1.0 L=18	ZS58-1214	ZS58-1218
Z650	11-18	M26x30-P1.0 L=18	ZS58-1214	ZS58-1218
Z750/S	17	M26x30-P1.0 L=18	ZS58-1214	ZS58-1218
Z800	04-10	M26x30-P1.0 L=18	ZS58-1214	ZS58-1218
Z900	13-16	M26x30-P1.0 L=18	ZS58-1214	ZS58-1218
Z1000	17	M26x30-P1.0 L=18	ZS58-1214	ZS58-1218
ZX1000	04-16	M26x30-P1.0 L=18	ZS58-1214	ZS58-1218
ZX-10R	08-10	M26x30-P1.0 L=18	ZS58-1214	ZS58-1218
VERSYS1000	11-15	M28x36-P1.0 H17	ZS58-1304	ZS58-1308
VERSYS1000	12-17	M26x30-P1.0 L=18	ZS58-1214	ZS58-1218
SUZUKI				
GSR250,GW250, INAZUMA250	12-17	M22x27-P1.0 H18.5	ZS58-1404	ZS58-1408
GSR250S	14-15	M22x27-P1.0 H18.5	ZS58-1404	ZS58-1408
GSX250R	17	M22x27-P1.0 H18.5	ZS58-1404	ZS58-1408
V-STROM250	17	M22x27-P1.0 H18.5	ZS58-1404	ZS58-1408
GSX-R600	06-17	M28x36-P1.0 H17	ZS58-1304	ZS58-1308
GSR750	13-16	M22x27-P1.0 H18.5	ZS58-1404	ZS58-1408
GSX-R750	06-17	M28x36-P1.0 H17	ZS58-1304	ZS58-1308
GSX-S750	17	M22x27-P1.0 H18.5	ZS58-1404	ZS58-1408
GSX-R1000	06-17	M28x36-P1.0 H17	ZS58-1304	ZS58-1308



ZETA
REAR BRAKE CLEVIS

- Made of CNC machined aluminum with anodized finish.
- Durable yet lightweight design provides the sensitive rear brake feel.
- Available in gold and titanium colors.
- Stainless steel pin is resistant to rust.

Bike	Year	Gold	Ti-color	
HONDA	CB250F	14-17		
	CB300F	15-17		
	CBR250R	11-17		
	CBR300R	15-17		
	400X	13-17	ZS89-5044	ZS89-5048
	CB400F	13-15		
	CB400SF	08-16		
YAMAHA	CBR400R	13-17		
	CB500X/F	13-17		
	CBR500R	13-17		
KAWASAKI	MT-25/03	16-17	ZS89-5034	ZS89-5038
	YZF-R25/R3	15-17		
	NINJA 250/R	08-17		
	Z250	13-17		
	NINJA 300	13-17	ZS89-5034	ZS89-5038
KAWASAKI	ER-4N	11-13		
	NINJA 400R	11-13		
	ER-6N	09-11		
	NINJA 650R	09-11		

CONTROL



BODY



ELECTRICAL



Master Cylinder Cover Clutch					
Bike	Year	Gold	Ti-color		
VFR800	98-09	ZS86-0124	ZS86-0128	DUZUO	
VFR800F	14-15	ZS86-0124	ZS86-0128		
CB1000	94-95	ZS86-0124	ZS86-0128		
CB1000R	11-17	ZS86-0424	ZS86-0428		
CBR1000F	87-96	ZS86-0124	ZS86-0128		
CBR1000RR	04-07	ZS86-0424	ZS86-0428		
RV1000R	00-06	ZS86-0424	ZS86-0428		
CB1100	10-15	ZS86-0124	ZS86-0128		
CBR1100XX	97-03	ZS86-0124	ZS86-0128		
ST1100	97-03	ZS86-0124	ZS86-0128		
CB1300SF	98-17	ZS86-0124	ZS86-0128		
ST1300	03-13	ZS86-0124	ZS86-0128		
X-4	97-03	ZS86-0124	ZS86-0128		
XJR1200	94-96	ZS86-0144	ZS86-0148		YAMAHA
FJR1300	03-15	ZS86-0144	ZS86-0148		
XJR1300	98-15	ZS86-0144	ZS86-0148		
XJR1300C	15	ZS86-0144	ZS86-0148		
ZX-9R	94-97	ZS86-0144	ZS86-0148		
GPZ1100	95-07	ZS86-0144	ZS86-0148		
ZEPHYR1100	92-05	ZS86-0144	ZS86-0148		
ZEPHYR1100RS	96-02	ZS86-0144	ZS86-0148		
ZR1100	92-95	ZS86-0144	ZS86-0148		
ZRX1100	99-00	ZS86-0144	ZS86-0148		
ZX-11	92-01	ZS86-0144	ZS86-0148		
ZRX1200DAEG	09-16	ZS86-0144	ZS86-0148		
ZRX1200R	01-05	ZS86-0144	ZS86-0148		
ZRX1200S	01-04	ZS86-0144	ZS86-0148		
ZZR1200	02-05	ZS86-0144	ZS86-0148		
GS650F	08-09	ZS86-0154	ZS86-0158	KAWASAKI	
GSX-R1000	07-08	ZS86-0424	ZS86-0428		
SV1000	03-05	ZS86-0154	ZS86-0158		
SV1000S	03-07	ZS86-0424	ZS86-0428		
TL1000R	98-03	ZS86-0424	ZS86-0428		
V-STROM1000/XT	02-17	ZS86-0154	ZS86-0158		
GSX-R1100	91-92	ZS86-0154	ZS86-0158		
GSX-R1100W	93-98	ZS86-0154	ZS86-0158		
BANDIT1200	97-05	ZS86-0154	ZS86-0158		
BANDIT1250/S	07-15	ZS86-0154	ZS86-0158		
GSX1250F	11	ZS86-0154	ZS86-0158		
GSX1300R	99-17	ZS86-0154	ZS86-0158		
HAYABUSA	99-17	ZS86-0154	ZS86-0158		



FZ09/MT09/Tracer ZS86-0168

Ninja 250 ZS86-0424

ZETA MASTER CYLINDER COVER

- Made of CNC machined aluminum with anodized finish.
- Makes your cylinder cover look exclusive.
- Available in gold and titanium colors.
- Available for front and rear brake cylinder cover and clutch cylinder cover.



ZS86-0138



ZS86-0124



ZS86-0158



ZS86-0418



ZS86-0424

Master Cylinder Cover Front				
Bike	Year	Gold	Ti-color	
GROM	13-18	ZS86-0114	ZS86-0118	YAMAHA
MSX125	13-15	ZS86-0114	ZS86-0118	
PCX150	13-15	ZS86-0114	ZS86-0118	
HORNET 250	96-06	ZS86-0114	ZS86-0118	
VTR/VTR-F	98-15	ZS86-0114	ZS86-0118	
CB250F	14-17	ZS86-0114	ZS86-0118	
CB300F	15-17	ZS86-0114	ZS86-0118	
CBR250R	11-17	ZS86-0114	ZS86-0118	
CBR250RR	17	ZS86-0114	ZS86-0118	
CBR300R	15-17	ZS86-0114	ZS86-0118	
400X	13-17	ZS86-0114	ZS86-0118	
CB400F	89-90	ZS86-0124	ZS86-0128	
CB400SF	13-16	ZS86-0114	ZS86-0118	
CBR400R	92-16	ZS86-0124	ZS86-0128	
CB500X	13-17	ZS86-0114	ZS86-0118	
CB500F	13-17	ZS86-0114	ZS86-0118	
CBR500R	13-17	ZS86-0114	ZS86-0118	
CB600F	04-06	ZS86-0124	ZS86-0128	
CBR600F	91-06	ZS86-0124	ZS86-0128	
CBR600RR	03-06	ZS86-0124	ZS86-0128	
07-17	ZS86-0414	ZS86-0418		
CB650F	14-18	ZS86-0124	ZS86-0128	
CBR650F	14-18	ZS86-0124	ZS86-0128	
NC700X/S	12-17	ZS86-0124	ZS86-0128	
NT700	10-11	ZS86-0124	ZS86-0128	
CB750	04-08	ZS86-0124	ZS86-0128	
NC750X/S	14-17	ZS86-0124	ZS86-0128	
VFR800	98-09	ZS86-0124	ZS86-0128	
VFR800F	14-15	ZS86-0114	ZS86-0118	
CB900F	02-07	ZS86-0114	ZS86-0118	
CBR900RR	95-03	ZS86-0114	ZS86-0118	
CB1000	94-95	ZS86-0114	ZS86-0118	
CB1000R	11-17	ZS86-0114	ZS86-0118	
CBR1000F	93-96	ZS86-0114	ZS86-0118	
04-07	ZS86-0114	ZS86-0118		
CBR1000RR	08-17	ZS86-0424	ZS86-0428	
RVT1000R	00-06	ZS86-0414	ZS86-0418	
CB1100	10-15	ZS86-0114	ZS86-0118	
CBR1100XX	97-03	ZS86-0114	ZS86-0118	
ST1100	95-03	ZS86-0114	ZS86-0118	
VFR1200X	14	ZS86-0414	ZS86-0418	
CB1300SF	98-17	ZS86-0114	ZS86-0118	
ST1300	03-13	ZS86-0114	ZS86-0118	
X-4	97-03	ZS86-0114	ZS86-0118	
GSR250	12-17	ZS86-0114	ZS86-0118	
GSR250S	14-15	ZS86-0154	ZS86-0158	
GW250	12-17	ZS86-0154	ZS86-0158	
INAZUMA250	12-15	ZS86-0154	ZS86-0158	
GSX250R	17	ZS86-0154	ZS86-0158	
V-STROM250	17	ZS86-0154	ZS86-0158	
BANDIT400	91-93	ZS86-0154	ZS86-0158	
GLADIUS400	10-13	ZS86-0154	ZS86-0158	
GSR400	06-13	ZS86-0154	ZS86-0158	
GSX-R600	97-17	ZS86-0414	ZS86-0418	
GSX-R600W	92-93	ZS86-0414	ZS86-0418	
GS650F	08-09	ZS86-0154	ZS86-0158	
SV650S	99-09	ZS86-0154	ZS86-0158	
V-STROM650/XT	04-17	ZS86-0154	ZS86-0158	
GLADIUS650	09	ZS86-0154	ZS86-0158	
GSR750	13-15	ZS86-0154	ZS86-0158	
GSX-R750	93-17	ZS86-0414	ZS86-0418	
GSX750F	89-06	ZS86-0154	ZS86-0158	
GSX-S750	17	ZS86-0154	ZS86-0158	
GSX-R1000	01-17	ZS86-0414	ZS86-0418	
SV1000	03-05	ZS86-0154	ZS86-0158	
SV1000S	03-07	ZS86-0414	ZS86-0418	
TL1000R	98-03	ZS86-0414	ZS86-0418	
TL1000S	97-01	ZS86-0414	ZS86-0418	
V-Strom1000/XT	02-17	ZS86-0154	ZS86-0158	
GSX-R1100	91-92	ZS86-0154	ZS86-0158	
GSX-R1100W	93-98	ZS86-0154	ZS86-0158	
BANDIT1200	97-05	ZS86-0154	ZS86-0158	
BANDIT1250/S	07-15	ZS86-0154	ZS86-0158	
GSX1250F	11	ZS86-0154	ZS86-0158	
GSX1300R	99-17	ZS86-0154	ZS86-0158	
HAYABUSA	99-17	ZS86-0154	ZS86-0158	

Master Cylinder Cover Front				
Bike	Year	Gold	Ti-color	
FZ6/R	04-17	ZS86-0164	ZS86-0168	YAMAHA
R6S	06-09	ZS86-0414	ZS86-0418	
YZF-R6	99-17	ZS86-0414	ZS86-0418	
FZ-07	15-17	ZS86-0164	ZS86-0168	
MT-07	14-17	ZS86-0164	ZS86-0168	
NSR900	16-17	ZS86-0164	ZS86-0168	
FZ-09	14-17	ZS86-0164	ZS86-0168	
MT-09/TRACER	14-17	ZS86-0164	ZS86-0168	
FZ1	01-05	ZS86-0144	ZS86-0148	
FZ1 FAZER	06-15	ZS86-0164	ZS86-0168	
YZF-R1	08-15	ZS86-0164	ZS86-0168	
XJR1200	94-96	ZS86-0144	ZS86-0148	
XTZ1200ZE	10-17	ZS86-0164	ZS86-0168	
FJR1300	03	ZS86-0144	ZS86-0148	
XJR1300	04-15	ZS86-0164	ZS86-0168	
XJR1300C	15	ZS86-0164	ZS86-0168	
Z125 PRO	16-17	ZS86-0114	ZS86-0118	
NINJA 250R	92-07	ZS86-0144	ZS86-0148	
NINJA 250R/S	08-17	ZS86-0114	ZS86-0118	
NINJA 250SL	15-16	ZS86-0114	ZS86-0118	
Z250	13-17	ZS86-0114	ZS86-0118	
Z250SL	16-17	ZS86-0114	ZS86-0118	
VERSYS-X 250	17	ZS86-0114	ZS86-0118	
VERSYS-X 300	17	ZS86-0114	ZS86-0118	
Z300	16	ZS86-0114	ZS86-0118	
NINJA 300	13-17	ZS86-0114	ZS86-0118	
ER-4N	11-13	ZS86-0134	ZS86-0138	
NINJA 400R	11-17	ZS86-0134	ZS86-0138	
ZRX	94-08	ZS86-0144	ZS86-0148	
ZRX-II	95-06	ZS86-0144	ZS86-0148	
ZZR400	93-06	ZS86-0144	ZS86-0148	
NINJA 500	94-09	ZS86-0144	ZS86-0148	
ZEPHYR ZR550	92-08	ZS86-0144	ZS86-0148	
NINJA 600R	92-97	ZS86-0144	ZS86-0148	
ZX-6	92-01	ZS86-0144	ZS86-0148	
ZX-6R	95-97	ZS86-0144	ZS86-0148	
ZX-6RR	98-17	ZS86-0414	ZS86-0418	
ZR600	03-05	ZS86-0144	ZS86-0148	
ZZR600	05-08	ZS86-0414	ZS86-0418	
ER-6F	09-10	ZS86-0144	ZS86-0148	
ER-6N	09-14	ZS86-0134	ZS86-0138	
NINJA 650R	09-17	ZS86-0134	ZS86-0138	
NINJA 650R	06-08	ZS86-0144	ZS86-0148	
VERSYS650	07-08	ZS86-0144	ZS86-0148	
09-17	ZS86-0134	ZS86-0138		
Z650	17	ZS86-0134	ZS86-0138	
Z750	04-05	ZS86-0144	ZS86-0148	
Z750S	06-10	ZS86-0144	ZS86-0148	
ZR-7	00	ZS86-0144	ZS86-0148	
ZR750	92-93	ZS86-0144	ZS86-0148	
ZR-7S	01-05	ZS86-0144	ZS86-0148	
ZX-7RR	91-03	ZS86-0414	ZS86-0418	
ZX-7R	96-97	ZS86-0144	ZS86-0148	
ZX-9R	98-03	ZS86-0414	ZS86-0418	
NINJA 1000	11-16	ZS86-0414	ZS86-0418	
12-14	ZS86-0144	ZS86-0148		
VERSYS1000	15-17	ZS86-0134	ZS86-0138	
03-06	ZS86-0144	ZS86-0148		
Z1000	07-09	ZS86-0414	ZS86-0418	
ZX-10R	04-15	ZS86-0144	ZS86-0148	
GPZ1100	95-07	ZS86-0144	ZS86-0148	
ZEPHYR1100	92-05	ZS86-0144	ZS86-0148	
ZEPHYR1100RS	96-02	ZS86-0144	ZS86-0148	
ZR1100	92-95	ZS86-0144	ZS86-0148	
ZRX1100	99-00	ZS86-0144	ZS86-0148	
ZX-11	92-01	ZS86-0144	ZS86-0148	
ZRX1200DAEG	09-16	ZS86-0144	ZS86-0148	
ZRX1200R	01-05	ZS86-0144	ZS86-0148	
ZRX1200S	01-04	ZS86-0144	ZS86-0148	
ZX-12R	00-05	ZS86-0144	ZS86-0148	
ZZR1200	02-05	ZS86-0144	ZS86-0148	
ZX-14	06-11	ZS86-0414	ZS86-0418	
ZX-14R	12-17	ZS86-0414	ZS86-0418	
ZZR1400	06-11	ZS86-0414	ZS86-0418	

Master Cylinder Cover Rear				
Bike	Year	Gold	Ti-color	
HORNET250	96-06	ZS86-0414	ZS86-0418	YAMAHA
VTR/VTR-F	98-15	ZS86-0414	ZS86-0418	
400X	13-17	ZS86-0114	ZS86-0118	
CB400F	89-90	ZS86-0114	ZS86-0118	
CB400SF	13-16	ZS86-0114	ZS86-0118	
CBR400R	92-16	ZS86-0114	ZS86-0118	
CB500X	13-17	ZS86-0114	ZS86-0118	
CB500F	13-17	ZS86-0114	ZS86-0118	
CBR500R	13-17	ZS86-0114	ZS86-0118	
CB600F	04-06	ZS86-0114	ZS86-0118	
CBR600F	91-06	ZS86-0114	ZS86-0118	
CBR600RR	03-17	ZS86-0114	ZS86-0118	
CB650F	14-18	ZS86-0114	ZS86-0118	
CBR650F	14-18	ZS86-0114	ZS86-0118	
NC700X/S	12-17	ZS86-0114	ZS86-0118	
NT700	10-11	ZS86-0114	ZS86-0118	
CB750	04-08	ZS86-0114	ZS86-0118	
NC750X/S	14-17	ZS86-0114	ZS86-0118	
VFR800	98-09	ZS86-0114	ZS86-0118	
VFR800F	14-15	ZS86-0114	ZS86-0118	
CB900F	02-07	ZS86-0114	ZS86-0118	
CBR				

CONTROL



LEVER



BODY



ELECTRICAL



ZETA ENGINE PLUG

- Made of CNC machined aluminum with anodized finish.
- Ideal for dressing up your engine.
- Available in gold and titanium colors.
- # Please use stock o-ring.



ZETA OIL FILLER CAP

- Made of CNC machined aluminum with anodized finish.
- 19 mm hex wrench head.
- Equipped with wiring hole to prevent losing the part.
- Available in gold and titanium colors.
- # Please use stock o-ring.

Bike	Year	Engine Plugs		Qty
		Gold	Ti-color	
GROM	13-18	-	ZS89-1108	2
MSX125	13-15	-	ZS89-1108	2
VTR/VTR-F	09-15	-	ZS89-1118	1
CB250F	14-17	-	ZS89-1108	2
CB300F	15-17	-	ZS89-1108	2
CBR250R	11-17	-	ZS89-1108	2
CBR250RR	17	-	ZS89-1108	2
CBR300R	15-17	-	ZS89-1108	2
CB400SF REVO	08-16	-	ZS89-1108	2
CB400F/CBR400R/400X	13-17	ZS89-1114	ZS89-1118	1
CB500F/CBR500R/CB500X	13-17	ZS89-1114	ZS89-1118	1
CBR600RR	03-17	ZS89-1114	ZS89-1118	1
CB650F	14-18	ZS89-1114	ZS89-1118	1
CBR650F	14-18	ZS89-1114	ZS89-1118	1
NC700X/S	12-17	-	ZS89-1108	2
NC750X/S	14-17	-	ZS89-1108	2
CBR1000RR	04-16	ZS89-1114	ZS89-1118	1
CBR1000S	14-16	ZS89-1114	ZS89-1118	1
CB1300SF	98-17	-	ZS89-1108	2
MT-25/03	16-17	ZS89-1404	ZS89-1408	1
YZF-R25/R3	15-17	ZS89-1404	ZS89-1408	1
FZ-07	15-16	ZS89-1414	ZS89-1418	1
MT-07	14-17	ZS89-1414	ZS89-1418	1
FZ-09	14-17	ZS89-1414	ZS89-1418	1
MT-09/TRACER	14-17	ZS89-1414	ZS89-1418	1
XSR900	16-17	ZS89-1414	ZS89-1418	1
NINJA 250	13-17	ZS89-1214	ZS89-1218	1
Z250	13-17	ZS89-1214	ZS89-1218	1
VERSYS-X 250	17	ZS89-1214	ZS89-1218	1
VERSYS-X 300	17	ZS89-1214	ZS89-1218	1
NINJA 300	13-17	ZS89-1214	ZS89-1218	1
ER-4N	11-13	ZS89-1204	ZS89-1208	2
NINJA 400	14-17	ZS89-1204	ZS89-1208	2
ER-6F	12-13	ZS89-1204	ZS89-1208	2
ER-6N	08-14	ZS89-1204	ZS89-1208	2
NINJA 650	12-16	ZS89-1204	ZS89-1208	2
VERSYS	11-14	ZS89-1204	ZS89-1208	2
VERSYS650	15-17	ZS89-1204	ZS89-1208	2
GSXR250	12-17	ZS89-1304	ZS89-1308	1
GSXR250S	14-15	ZS89-1304	ZS89-1308	1
GSX250R	17	ZS89-1304	ZS89-1308	1
GW250	12-17	ZS89-1304	ZS89-1308	1
INAZUMA 250	12-15	ZS89-1304	ZS89-1308	1
V-STORM250	17	ZS89-1304	ZS89-1308	1

Bike	Year	Oil Filler Cap	
		Gold	Ti-color
CB250F	14-17	ZS89-2104	ZS89-2108
CB300F	15-17	ZS89-2104	ZS89-2108
CBR250R	11-17	ZS89-2104	ZS89-2108
CBR250RR	17	ZS89-2104	ZS89-2108
CBR300R	15-17	ZS89-2104	ZS89-2108
400X	13-17	ZS89-2104	ZS89-2108
CB400F	13-16	ZS89-2104	ZS89-2108
CB400SF	99-16	ZS89-2104	ZS89-2108
CBR400R	13-17	ZS89-2104	ZS89-2108
CB500X	13-17	ZS89-2104	ZS89-2108
CB500F	13-17	ZS89-2104	ZS89-2108
CBR500R	13-17	ZS89-2104	ZS89-2108
CBR600RR	03-17	ZS89-2104	ZS89-2108
CBR929RR	03-17	ZS89-2104	ZS89-2108
CBR964RR	02-03	ZS89-2104	ZS89-2108
CB1100	10-15	ZS89-2104	ZS89-2108
CBR1000RR	04-17	ZS89-2104	ZS89-2108
CBR1000S	14-16	ZS89-2104	ZS89-2108
VTR1000F	98-05	ZS89-2104	ZS89-2108
VFR1200F	10-12	ZS89-2104	ZS89-2108
VFR1200X	14-15	ZS89-2104	ZS89-2108
X-4	97-03	ZS89-2104	ZS89-2108
NINJA 250	13-17	ZS89-2204	ZS89-2208
NINJA 250R	08-12	ZS89-2204	ZS89-2208
NINJA 250SL	15-16	ZS89-2104	ZS89-2108
Z250	13-17	ZS89-2204	ZS89-2208
Z250SL	16-17	ZS89-2104	ZS89-2108
ZZR250	90-07	ZS89-2204	ZS89-2208
VERSYS-X 250	17	ZS89-2204	ZS89-2208
VERSYS-X 300	17	ZS89-2204	ZS89-2208
NINJA 300	13-17	ZS89-2204	ZS89-2208
ER-4n	11-13	ZS89-2104	ZS89-2108
EX-4	94-95	ZS89-2204	ZS89-2208
FX400R	86-90	ZS89-2204	ZS89-2208
GPZ400R/S	83-88	ZS89-2204	ZS89-2208
NINJA 400	14-17	ZS89-2104	ZS89-2108
NINJA 400R	11-13	ZS89-2104	ZS89-2108
ZEPHYR400 KAI	96-07	ZS89-2204	ZS89-2208
ZXR400/R	89-99	ZS89-2204	ZS89-2208
ZZR400	90-06	ZS89-2204	ZS89-2208
ER-6F	06-10	ZS89-2104	ZS89-2108
ER-6N	06-14	ZS89-2104	ZS89-2108
NINJA 600R	09-11	ZS89-2104	ZS89-2108
NINJA 650	12-18	ZS89-2104	ZS89-2108
VERSYS650	07-14	ZS89-2104	ZS89-2108
ZX-6R	00-17	ZS89-2204	ZS89-2208
ZX-6RR	03-05	ZS89-2204	ZS89-2208
Z650	17	ZS89-2104	ZS89-2108
Z750/S	04-10	ZS89-2204	ZS89-2208
ZR-7	99-01	ZS89-2204	ZS89-2208
ZXR750	89-95	ZS89-2104	ZS89-2108
ZXR750R	91-94	ZS89-2104	ZS89-2108
Z800	13-16	ZS89-2104	ZS89-2108
GPZ900R	91-03	ZS89-2204	ZS89-2208
ZX-9R	98-03	ZS89-2204	ZS89-2208
GPZ1100	95-99	ZS89-2204	ZS89-2208
NINJA 1000	10-17	ZS89-2104	ZS89-2108
VERSYS1000	12-17	ZS89-2104	ZS89-2108
Z1000	10-17	ZS89-2104	ZS89-2108
Z1000	03-09	ZS89-2204	ZS89-2208
ZX-10R	04-17	ZS89-2204	ZS89-2208
ZRX1100/II	97-00	ZS89-2204	ZS89-2208
ZZ-R1100	99-01	ZS89-2204	ZS89-2208
ZRX1200R/S/DAEG	01-16	ZS89-2204	ZS89-2208
ZX-12R	00-06	ZS89-2204	ZS89-2208
ZZR1200	02-05	ZS89-2204	ZS89-2208
ZX-14R	12-17	ZS89-2204	ZS89-2208
ZZR1400	06-11	ZS89-2204	ZS89-2208
1400GTR	08-16	ZS89-2204	ZS89-2208

Bike	Year	Oil Filler Cap	
		Gold	Ti-color
FZR250/R	87-94	ZS89-2404	ZS89-2408
FZX250 ZEAL	91-92	ZS89-2404	ZS89-2408
MT-25	16-17	ZS89-2404	ZS89-2408
MT-03	16-17	ZS89-2404	ZS89-2408
YZF-R25	15-17	ZS89-2404	ZS89-2408
YZF-R3	15-17	ZS89-2404	ZS89-2408
FZ400	97	ZS89-2404	ZS89-2408
XJR400	93-96	ZS89-2404	ZS89-2408
FZ6/FAZER	04-06	ZS89-2404	ZS89-2408
FZS600/S FAZER	00-03	ZS89-2404	ZS89-2408
FZXR750	90	ZS89-2404	ZS89-2408
FZ6R	09-17	ZS89-2404	ZS89-2408
YZF-R6	99-17	ZS89-2404	ZS89-2408
MT-07	14-17	ZS89-2404	ZS89-2408
FZ-07	15-17	ZS89-2404	ZS89-2408
FZ8	11-13	ZS89-2404	ZS89-2408
TDM850	98-01	ZS89-2404	ZS89-2408
XJ900 DIVERSION	00-02	ZS89-2404	ZS89-2408
FZ-1	06-15	ZS89-2404	ZS89-2408
FZ-1FAZER	06-15	ZS89-2404	ZS89-2408
FZS1000FAZER	01-05	ZS89-2404	ZS89-2408
YZF-R1	98-14	ZS89-2404	ZS89-2408
XJR1200	94-96	ZS89-2404	ZS89-2408
XTZ1200Z/ZE	10-17	ZS89-2404	ZS89-2408
FJR1300/A/AS	01-16	ZS89-2404	ZS89-2408
XVS1300A	99-09	ZS89-2404	ZS89-2408
GSXR250	12-17	ZS89-2304	ZS89-2308
GSXR250S	14-15	ZS89-2304	ZS89-2308
GW250	12-17	ZS89-2304	ZS89-2308
INAZUMA 250	12-15	ZS89-2304	ZS89-2308
GSX250R	17	ZS89-2304	ZS89-2308
V-STORM250	17	ZS89-2304	ZS89-2308
GSR400	06-12	ZS89-2304	ZS89-2308
GLADIUS 400	09-13	ZS89-2304	ZS89-2308
IMPULUS 400	94-07	ZS89-2304	ZS89-2308
INAZUMA 400	97-02	ZS89-2304	ZS89-2308
GSX-R600	97-17	ZS89-2304	ZS89-2308
V-STORM650	04-17	ZS89-2304	ZS89-2308
GSF750	96-00	ZS89-2304	ZS89-2308
GSR750	13-15	ZS89-2304	ZS89-2308
GSX-R750	89-17	ZS89-2304	ZS89-2308
GSX-S750	17	ZS89-2304	ZS89-2308
GSX-R1000	01-17	ZS89-2304	ZS89-2308
GSX-S1000/F	15-17	ZS89-2304	ZS89-2308
SV1000/S	03-07	ZS89-2304	ZS89-2308
V-STROM1000	04-17	ZS89-2304	ZS89-2308
GSX-R1100/W	86-98	ZS89-2304	ZS89-2308
BANDIT1200/S	01-06	ZS89-2304	ZS89-2308
BANDIT1250/S/IF	06-15	ZS89-2304	ZS89-2308
GS1200SS	01-02	ZS89-2304	ZS89-2308
GSF1200	01-06	ZS89-2304	ZS89-2308
GSF1250	08-09	ZS89-2304	ZS89-2308
GSX1300R	08-17	ZS89-2304	ZS89-2308
HAYABUSA	08	ZS89-2304	ZS89-2308
B-KING	08	ZS89-2304	ZS89-2308
GSX1400	01-08	ZS89-2304	ZS89-2308

CONTROL



LEVER



BODY



ELECTRICAL



ZS80-9110

ZS80-9100

ZETA DRIVE COVER

- Made of CNC machined aluminum with anodized finish.
- Easy maintenance.
- Available in titanium color.
- Made of A7009-T6 aluminum.

Drive Cover			
	Bike	Year	Ti-color
HONDA	CBR250R	11-17	
	CBR300R	15-17	
	CB250F	14-17	ZS80-9100
	CB300F	15-17	
	CB400SF REVO	08-16	ZS80-9110
KAWASAKI	Ninja 250	13-17	
	Z250	13-17	ZS80-9200
	Ninja 300	13-17	

Ninja 250 ZS80-9200



YZF-R25

ZS56-2208



Ninja 250

ZS56-2408

ZS56-2108

ZETA STEP BRACKET KIT

- Adjust the stock rear set back for a better riding position and more ground clearance.
- 3 different position adjustments to fit your riding position.
- Made of CNC titanium anodized aluminum, comes with stainless gear change rod and nuts.

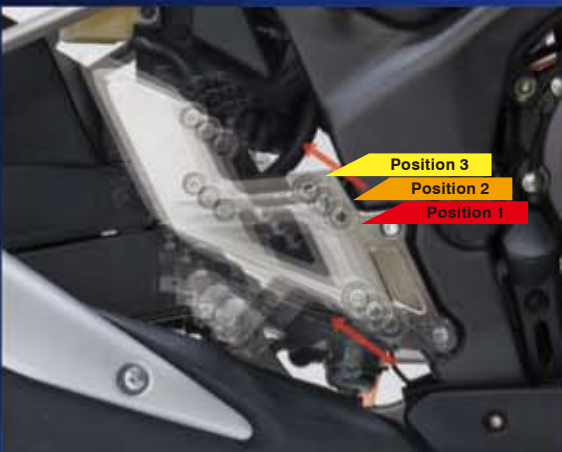

Step Bracket Kit		Offset (mm)							
Bike	Year	Part #	Position 1		Position 2		Position 3		
			Back	Up	Back	Up	Back	Up	
HONDA	CBR250R	11-13	ZS56-2108	33	10	43	20	53	30
	MT-25	16-17		28	3	38	10	-	-
	MT-03	16-17		28	3	38	10	-	-
YAMAHA	YZF-R25	15-17	ZS56-2408	28	3	38	10	-	-
	YZF-R3	15-17		28	3	38	10	-	-
KAWASAKI	Ninja250R	08-12		21	5	26	18	31	32
	Ninja250	13-17	ZS56-2208	21	5	26	18	31	32
	Ninja300	13-17		21	5	26	18	31	32
	Z250	13-17		21	5	26	18	31	32

ZETA MAGNETIC DRAIN BOLT

- Magnetic drain bolt for Sport bikes.
- Designed to pick up excess bits of metal in your engine oil.
- Made of A7009-T6 aluminum. Light weight design.
- Press fit magnet on the drain plugs.
- Includes safety wire holes to prevent misplaced part.
- Available in blue, red anodized colors.

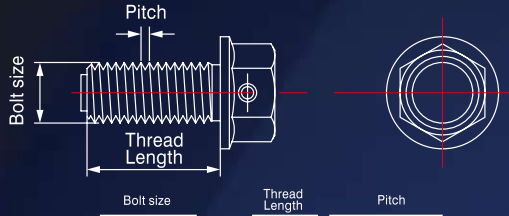

M12 X 14-P1.5

Magnetic Drain Bolt					
Bike	Year	Size	Blue	Red	
CBR125R	13-14	M12X15-P1.5	ZE58-1522	ZE58-1523	
GROM_MSX125	13-18	M12X15-P1.5	ZE58-1522	ZE58-1523	
VTR/F	98-17	M12X15-P1.5	ZE58-1522	ZE58-1523	
CBR250R	11-17	M12X15-P1.5	ZE58-1522	ZE58-1523	
CBR250RR	90-99	M14X14-P1.5	ZE58-1622	ZE58-1623	
	17	M12X15-P1.5	ZE58-1522	ZE58-1523	
CB250F	14-17	M12X15-P1.5	ZE58-1522	ZE58-1523	
CB300F	15-17	M12X15-P1.5	ZE58-1522	ZE58-1523	
CBR300R	15-17	M12X15-P1.5	ZE58-1522	ZE58-1523	
400X	13-17	M12X15-P1.5	ZE58-1522	ZE58-1523	
CB400F	13-16	M12X15-P1.5	ZE58-1522	ZE58-1523	
CB400SF	92-16	M12X15-P1.5	ZE58-1522	ZE58-1523	
CBR400R	13-17	M12X15-P1.5	ZE58-1522	ZE58-1523	
CBR400RR	90-99	M12X15-P1.5	ZE58-1522	ZE58-1523	
RVF400	94-01	M12X15-P1.5	ZE58-1522	ZE58-1523	
VFR400R	89-93	M12X15-P1.5	ZE58-1522	ZE58-1523	
CB500F	13-17	M12X15-P1.5	ZE58-1522	ZE58-1523	
CB500X	13-17	M12X15-P1.5	ZE58-1522	ZE58-1523	
CBR500R	13-17	M12X15-P1.5	ZE58-1522	ZE58-1523	
CBR600F	91-06	M12X15-P1.5	ZE58-1522	ZE58-1523	
CBR600SE	98	M12X15-P1.5	ZE58-1522	ZE58-1523	
CBR600SJR	96	M12X15-P1.5	ZE58-1522	ZE58-1523	
CBR600RR	03-17	M12X15-P1.5	ZE58-1522	ZE58-1523	
CB650F	14-18	M12X15-P1.5	ZE58-1522	ZE58-1523	
CBR650F	14-18	M12X15-P1.5	ZE58-1522	ZE58-1523	
NC700S/X	12-17	M12X15-P1.5	ZE58-1522	ZE58-1523	
NC750S/X	14-17	M12X15-P1.5	ZE58-1522	ZE58-1523	
RVF750/R	94-97	M12X15-P1.5	ZE58-1522	ZE58-1523	
VFR750F	90-97	M12X15-P1.5	ZE58-1522	ZE58-1523	
VFR800	98-09	M12X15-P1.5	ZE58-1522	ZE58-1523	
VFR800FX	14-17	M12X15-P1.5	ZE58-1522	ZE58-1523	
CBR900RR	92-03	M12X15-P1.5	ZE58-1522	ZE58-1523	
CBR954RR	02-03	M12X15-P1.5	ZE58-1522	ZE58-1523	
CB1000	95	M14X14-P1.5	ZE58-1622	ZE58-1623	
CB1000SF	92-97	M14X14-P1.5	ZE58-1622	ZE58-1623	
CB1000R	11-17	M12X15-P1.5	ZE58-1522	ZE58-1523	
CBR1000RR	08-17	M12X15-P1.5	ZE58-1522	ZE58-1523	
RVT1000R	00-06	M12X15-P1.5	ZE58-1522	ZE58-1523	
VTR1000F	97-07	M12X15-P1.5	ZE58-1522	ZE58-1523	
VTR1000SP-1/2	00-03	M12X15-P1.5	ZE58-1522	ZE58-1523	
CB1100	10-15	M14X14-P1.5	ZE58-1622	ZE58-1623	
CBR1100XX	97-03	M14X14-P1.5	ZE58-1622	ZE58-1623	
ST1100	91-03	M12X15-P1.5	ZE58-1522	ZE58-1523	
X-11	99-01	M14X14-P1.5	ZE58-1622	ZE58-1623	
VFR1200F	10-14	M14X14-P1.5	ZE58-1622	ZE58-1623	
VFR1200X	14-15	M14X14-P1.5	ZE58-1622	ZE58-1623	
CB1300SF	98-17	M14X14-P1.5	ZE58-1622	ZE58-1623	

ZETA SWING ARM SPOOL

- CNC machined aluminum swing arm spool.
- Can be used with most street racing stands available on the market.
- Available in M6, M8 and M10 bolt sizes to fit most Japanese street bikes.
- Available in titanium and gold colors.
- Comes in pairs.

Magnetic Drain Bolt		Year	Size	Blue	Red
FZR250R		87-94	M14X14-P1.5	ZE58-1622	ZE58-1623
MT-25/03		16-17	M12X15-P1.5	ZE58-1522	ZE58-1523
YZF-R25/R3		15-17	M12X15-P1.5	ZE58-1522	ZE58-1523
ZEAL		91-99	M14X14-P1.5	ZE58-1622	ZE58-1623
FZ400		97	M14X14-P1.5	ZE58-1622	ZE58-1623
FZR400RR		90-94	M14X14-P1.5	ZE58-1622	ZE58-1623
SRX400		85-99	M14X14-P1.5	ZE58-1622	ZE58-1623
XJR400R/S		93-08	M14X14-P1.5	ZE58-1622	ZE58-1623
FZ6/R		04-17	M14X14-P1.5	ZE58-1622	ZE58-1623
SRX600		85-94	M14X14-P1.5	ZE58-1622	ZE58-1623
YZF-R6		99-17	M14X14-P1.5	ZE58-1622	ZE58-1623
XJ6F/S		09-13	M14X14-P1.5	ZE58-1622	ZE58-1623
FZ-07		15-17	M14X14-P1.5	ZE58-1622	ZE58-1623
MT-07		14-17	M14X14-P1.5	ZE58-1622	ZE58-1623
FZ8		11-14	M14X14-P1.5	ZE58-1622	ZE58-1623
TDM850		92-01	M14X14-P1.5	ZE58-1622	ZE58-1623
TRX850		95-01	M14X14-P1.5	ZE58-1622	ZE58-1623
FZ-09/FJ-09		14-17	M14X14-P1.5	ZE58-1622	ZE58-1623
MT-09/TRACER		14-17	M14X14-P1.5	ZE58-1622	ZE58-1623
XSR900		16-17	M14X14-P1.5	ZE58-1622	ZE58-1623
FZ1-N (JAPAN)		08-12	M14X14-P1.5	ZE58-1622	ZE58-1623
FZ1 FAZER		08-15	M14X14-P1.5	ZE58-1622	ZE58-1623
FZ1(NORTH AMERICA)		01-15	M14X14-P1.5	ZE58-1622	ZE58-1623
YZF1000R THUNDERACE		96-01	M14X14-P1.5	ZE58-1622	ZE58-1623
YZF-R1		98-14	M14X14-P1.5	ZE58-1622	ZE58-1623
XJR1200		94-96	M14X14-P1.5	ZE58-1622	ZE58-1623
FJR1300		01-15	M14X14-P1.5	ZE58-1622	ZE58-1623
XJR1300		98-15	M14X14-P1.5	ZE58-1622	ZE58-1623
		90-07	M14X14-P1.5	ZE58-1622	ZE58-1623
V-MAX		09-17	M14X14-P1.5	ZE58-1622	ZE58-1623
BALIOUS/II		91-07	M12X15-P1.5	ZE58-1522	ZE58-1523
NINJA250		13-17	M12X15-P1.5	ZE58-1522	ZE58-1523
NINJA250R		88-12	M12X15-P1.5	ZE58-1522	ZE58-1523
NINJA250SL		16-16	M10X15-P1.5	ZE58-1322	ZE58-1323
VERSYS-X250		17	M12X15-P1.5	ZE58-1522	ZE58-1523
VERSYS-X300		17	M12X15-P1.5	ZE58-1522	ZE58-1523
Z250		13-17	M12X15-P1.5	ZE58-1522	ZE58-1523
Z250SL		16-17	M10X15-P1.5	ZE58-1322	ZE58-1323
Z300		15-16	M12X15-P1.5	ZE58-1522	ZE58-1523
ZXR250		89-99	M12X15-P1.5	ZE58-1522	ZE58-1523
ZZR250		90-07	M12X15-P1.5	ZE58-1522	ZE58-1523
NINJA300		13-17	M12X15-P1.5	ZE58-1522	ZE58-1523
ER-4N		11-13	M12X15-P1.5	ZE58-1522	ZE58-1523
NINJA400		14-17	M12X15-P1.5	ZE58-1522	ZE58-1523
NINJA400R		11-13	M12X15-P1.5	ZE58-1522	ZE58-1523
W400		06-08	M12X15-P1.5	ZE58-1522	ZE58-1523
ZEPHYR400/KAI		89-08	M12X15-P1.5	ZE58-1522	ZE58-1523
ZRX400		94-08	M12X15-P1.5	ZE58-1522	ZE58-1523
ZXR400		89-01	M12X15-P1.5	ZE58-1522	ZE58-1523
ZZR400		90-07	M12X15-P1.5	ZE58-1522	ZE58-1523
NINJA 500		94-09	M12X15-P1.5	ZE58-1522	ZE58-1523
ZR500		90-95	M12X15-P1.5	ZE58-1522	ZE58-1523
NINJA 600R		88-97	M12X15-P1.5	ZE58-1522	ZE58-1523
ZX-6R/RR		91-16	M12X15-P1.5	ZE58-1522	ZE58-1523
ZRR600		02-08	M12X15-P1.5	ZE58-1522	ZE58-1523
ER-6F		09-10	M12X15-P1.5	ZE58-1522	ZE58-1523
ER-6N		09-14	M12X15-P1.5	ZE58-1522	ZE58-1523
NINJA 650R		09-18	M12X15-P1.5	ZE58-1522	ZE58-1523
VERSYS 650		10-17	M12X15-P1.5	ZE58-1522	ZE58-1523
W650		99-08	M12X15-P1.5	ZE58-1522	ZE58-1523
Z650		17	M12X15-P1.5	ZE58-1522	ZE58-1523
NINJA 750R		87-90	M12X15-P1.5	ZE58-1522	ZE58-1523
ZR-7/S		00-05	M12X15-P1.5	ZE58-1522	ZE58-1523
ZX-7R/RR		89-03	M12X15-P1.5	ZE58-1522	ZE58-1523
Z750/S		04-10	M12X15-P1.5	ZE58-1522	ZE58-1523
ZEPHYR750/RS		91-06	M12X15-P1.5	ZE58-1522	ZE58-1523
ZR750		91-93	M12X15-P1.5	ZE58-1522	ZE58-1523
ZRX750		89-95	M12X15-P1.5	ZE58-1522	ZE58-1523
Z800		13-16	M12X15-P1.5	ZE58-1522	ZE58-1523
ZX-9R		94-03	M12X15-P1.5	ZE58-1522	ZE58-1523
NINJA 1000		11-18	M12X15-P1.5	ZE58-1522	ZE58-1523
VERSYS1000		12-17	M12X15-P1.5	ZE58-1522	ZE58-1523
Z1000		03-18	M12X15-P1.5	ZE58-1522	ZE58-1523
ZX-10		88-90	M12X15-P1.5	ZE58-1522	ZE58-1523
ZX-10R		04-17	M12X15-P1.5	ZE58-1522	ZE58-1523
GPZ1100		95-99	M12X15-P1.5	ZE58-1522	ZE58-1523
ZEPHYR1100/RS		92-06	M12X15-P1.5	ZE58-1522	ZE58-1523
ZR1100		92-95	M12X15-P1.5	ZE58-1522	ZE58-1523
ZRX1100		97-00	M12X15-P1.5	ZE58-1522	ZE58-1523
ZX-11		90-01	M12X15-P1.5	ZE58-1522	ZE58-1523
ZZR1100		90-01	M12X15-P1.5	ZE58-1522	ZE58-1523
ZX-12R		00-06	M12X15-P1.5	ZE58-1522	ZE58-1523
ZRX1200DAEG		09-16	M12X15-P1.5	ZE58-1522	ZE58-1523
ZRX1200R/S		01-08	M12X15-P1.5	ZE58-1522	ZE58-1523
ZRX1200		02-05	M12X15-P1.5	ZE58-1522	ZE58-1523
ZX-14		06-11	M12X15-P1.5	ZE58-1522	ZE58-1523
ZX-14R		12-17	M12X15-P1.5	ZE58-1522	ZE58-1523
BANDIT250/V		90-00	M14X10-P1.25	ZE58-1612	ZE58-1613
GSZ250/S,GW250, INAZUMA250		11-17	M14X10-P1.25	ZE58-1612	ZE58-1613
GSX250R		17	M14X10-P1.25	ZE58-1612	ZE58-1613
GSX250S		91-99	M14X10-P1.25	ZE58-1612	ZE58-1613
V-STROM250		17	M14X10-P1.25	ZE58-1612	ZE58-1613
GSR400		06-14	M14X10-P1.25	ZE58-1612	ZE58-1613
GSX400S		92-99	M14X10-P1.25	ZE58-1612	ZE58-1613
GSX400		94-00	M14X10-P1.25	ZE58-1612	ZE58-1613
INAZUMA400		97-02	M14X10-P1.25	ZE58-1612	ZE58-1613
GSX-R400R		90-95	M14X10-P1.25	ZE58-1612	ZE58-1613
GSX400R/RV		93-00	M14X10-P1.25	ZE58-1612	ZE58-1613
GSX-R600		01-17	M14X10-P1.25	ZE58-1612	ZE58-1613
KATANA(GSF600F)		98-06	M14X10-P1.25	ZE58-1612	ZE58-1613
SV650		16-17	M12X10-P1.25	ZE58-1412	ZE58-1413
V-STROM650/XT		04-17	M12X10-P1.25	ZE58-1412	ZE58-1413
GSRT750		13-15	M14X10-P1.25	ZE58-1612	ZE58-1613
GSX750S		82-86	M14X10-P1.25	ZE58-1612	ZE58-1613
GSF750		96-00	M14X10-P1.25	ZE58-1612	ZE58-1613
GSX-R750		00-17	M14X10-P1.25	ZE58-1612	ZE58-1613
GSX-S750		17	M14X10-P1.25	ZE58-1612	ZE58-1613
KATANA(GSF750F)		98-06	M14X10-P1.25	ZE58-1612	ZE58-1613
V-STROM1000/XT		02-17	M14X10-P1.25	ZE58-1612	ZE58-1613
SV1000S		03-07	M14X10-P1.25	ZE58-1612	ZE58-1613
TL1000R/S		97-03	M14X10-P1.25	ZE58-1612	ZE58-1613
GSX-R1000		01-17	M14X10-P1.25	ZE58-1612	ZE58-1613
GSX1100S		94-00	M14X10-P1.25	ZE58-1612	ZE58-1613
GSX-R1100		89-92	M14X10-P1.25	ZE58-1612	ZE58-1613
GSX-S1000		16-17	M14X10-P1.25	ZE58-1612	ZE58-1613
GSX-S1000F		16-17	M14X10-P1.25	ZE58-1612	ZE58-1613
BANDIT1200/S		01-06	M14X10-P1.25	ZE58-1612	ZE58-1613
GSF1200/S		95-99	M14X10-P1.25	ZE58-1612	ZE58-1613
INAZUMA1200		98-99	M14X10-P1.25	ZE58-1612	ZE58-1613
BANDIT1250/S ABS		07-15	M14X10-P1.25	ZE58-1612	ZE58-1613
BANDIT1250					

ZS93-3404 YZF-R25



ZS93-3404

ZS93-3108

ZETA CHAIN ADJUSTER CAP

- ZETA Chain adjuster for sport bikes.
- Made of CNC machined aluminum with titanium and gold anodized finish.
- ZETA laser printed logo.
- Comes in pairs.

Chain Adjuster Caps			
Bike	Year	Gold	Ti-color
HONDA			
CB250F	14-17		
CBR250R	11-17	ZS93-3104	ZS93-3108
CB300F	14-17		
CBR300R	14-17		
YAMAHA			
YZF-R25	15-17		
YZF-R3	15-17	ZS93-3404	ZS93-3408
MT-25	16-17		
MT-03	16-17		
KAWASAKI			
NINJA250/R	08-17		
NINJA250SL	15-16		
NINJA300	13-17	ZS93-3104	ZS93-3108
Z250	13-17		
Z250SL	15-17		
Z300	15-16		

ZS93-2404 YZF-R1 (L)



ZS93-2408

ZS93-2304

ZETA REAR AXLE BLOCK

- ZETA Axle block for sport bikes.
- Made of CNC machined aluminum with titanium and gold anodized finish.
- Scales on both sides of axle block for easy chain adjustment.
- ZETA laser printed logo.
- Comes in pairs.

Rear Axle Block			
Bike	Year	Gold	Ti-color
HONDA			
CBR600RR	09-17	ZS93-2104	ZS93-2108
CBR1000RR	08-16		
YAMAHA			
FZ8	11-13		
FZ1	06-15	ZS93-2404	ZS93-2408
YZF-R1/M	04-17		
KAWASAKI			
ZX-6R	09-17	ZS93-2204	ZS93-2208
ZX-10R	11-17		
SUZUKI			
GSX-R600	00-09		
	11-17		
GSX-R750	00-09	ZS93-2314	ZS93-2318
	11-17		
GSX-R1000	01-17		
GSX1300R HAYABUSA	08-17		

ZS93-2404 YZF-R1 (R)



CONTROL



LEVER



BODY



ELECTRICAL





DRC
RADIATOR HOSE

- Durable silicone radiator hose for street bikes.
- Smooth inner surface allows for increased coolant flow.
- Printed white DRC logo.
- Available in red, blue and orange colors.

Bike	Year	Red	Hose qty
HONDA			
CB250F	14-17	D47-05-113	2
CBR250R	11-17	D47-05-113	2
VTR	09-17	D47-05-143	4
400X	13-17	D47-05-253	4
CB400F	13-16	D47-05-253	4
CB400SF	08-16	D47-05-223	4
CBR400R	13-17	D47-05-253	4
CB500X	13-17	D47-05-253	4
CB500F	13-17	D47-05-253	4
CBR500R	13-17	D47-05-253	4
CTX700/N	13-17	D47-05-323	3
NC700X/S	12-17	D47-05-323	3
NC750X/S	14-17	D47-05-323	3
CBR1000RR	12-16	D47-05-423	10
YAMAHA			
FZ07	15-17	D47-08-473	5
MT07	14-17	D47-08-473	5
FZ09	14-16	D47-08-493	5
MT09/TRACER	14-16	D47-08-493	5

Bike	Year	Blue	Hose qty
YAMAHA			
FZ-1/FAZER	11-15	D47-08-462	6
YZF-R1	10-14	D47-08-422	7

Bike	Year	Red	Hose qty
KAWASAKI			
Z250	13-17	D47-06-143	5
NINJA 250	13-17	D47-06-143	5
NINJA 300	13-17	D47-06-143	5
ER-4N	11-13	D47-06-223	2
NINJA 400R	11-13	D47-06-223	2
ER-6F	09-11	D47-06-223	2
ER-6N	09-11	D47-06-223	2
NINJA 1000	11-16	D47-06-323	6
ZRX1200DAEG	09-16	D47-06-423	4
ZX-14R	12-17	D47-06-453	5
SUZUKI			
GSR250, GW250, INAZUMA250	12-17	D47-07-123	6
GLADIUS400	09-15	D47-07-223	4
GSX-R1000	12-16	D47-07-413	3
GSX1300R HAYABUSA	08-17	D47-07-553	3

Bike	Year	Orange	Hose qty
KTM			
125DUKE	11-16	D47-09-129	4
200DUKE	11-16	D47-09-129	4

High heat resistance and durable silicon rubber

Durable mesh fiber



DRC
MIRROR HOLE PLUG

- Aluminum screw cap to seal your mirror hole.
- Protect your mirror hole thread from water, dust and mud.
- Made of 7009 aluminum, bolt size = M10 - 1.25
- Available in 4 different anodized colors.

Part number	Color	Part number	Color
D41-06-502	Blue	D41-06-508	Titanium
D41-06-503	Red	D41-06-509	Gold



DRC
RADIATOR CAP

- High pressure radiator cap for racing use.
- High pressure of 1.6 kgf / cm² increases coolant's boiling point.
- Prevents the boiling and vaporization of the coolant during hard riding.
- Protects your engine from overheating.

Part number
D47-31-016



D45-10-110



NINJA 250



D45-10-310



YZF-R25



D45-10-350



MT-09

DRC
FENDER ELIMINATOR KIT

- Fender eliminator kit makes rear fender compact and cool looking.
- Designed to mount OE flasher and license plate light.
- Made of durable steel with black paint finish.
- Comes with license plate holding bolts, washers and nuts.

	Bike	Year	Part #
YAMAHA	YZF-R25/R3	15-17	D45-10-310
	MT-09/FZ-09	14-16	D45-10-350
KAWASAKI	NINJA 250/300/Z250	13-17	D45-10-110



Flex-1



Flex-3

DRC
MOTO LED FLEX TAIL LIGHT

Flex-1 D45-29-310

- Flex fit shell and body with 16 high quality chip LEDs.
- Even fits curved surfaces.
- Tail light and stop light in this compact-sized product.
- High impact, water and shock resistant.
- Includes aluminum bolts and nuts.
- Plug type terminals are included for installation.
- Works on 12 V AC / DC.
- Dimensions : L 109 mm x W 19 mm x H 9 mm.

Flex-3 D45-29-316

- Universal LED tail light.
- 12 pcs oval LEDs.
- Tail light and stop light in this compact-sized product.
- Reduced electric power consumption
- Works on 12 V AC / DC.
- Dimensions : L 109 mm x W 19 mm x H 19 mm

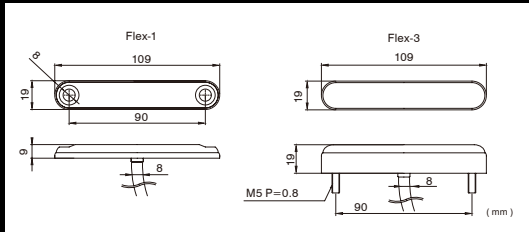

DRC
MOTO LED PHANTOM TAIL LIGHT

- High intensity LED light for the rear fender.
- Tail light base is made of flex rubber. Enables a great fit on all shapes of rear fenders with M 5 bolts.
- 8 high-intensity LEDs are used.
- Tail light and stop light in this compact-sized product.
- Plug type terminals are included for installation.
- Works on 12 V AC / DC.

Part number **Color**
D45-29-307 Red

Replacement lens	
Part number	Color
D45-29-387	Red

YOSHIMURA SUZUKI MOTUL RACING

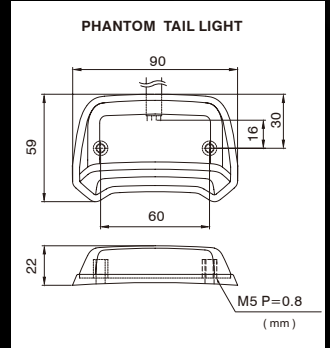

Orange

Smoke

Clear

DRC
MOTO LED 602 LED FLASHER

- Flexible flasher stays to prevent breakage upon impact.
- Lens colors available: orange, smoke and clear.
- Terminals and nuts are included for installation.
- Comes in pairs. Works on 12 V AC / DC.

Part number	Color	Replacement lens	
		Part number	Color
D45-60-207	Orange	D45-60-287	Orange
D45-60-208	Smoke	D45-60-288	Smoke
D45-60-209	Clear	D45-60-289	Clear



Orange

Smoke

DRC
MOTO LED 586 LED FLASHER

- Installs on the fender with screws for secure installation.
- Rubber mount base fits even curved surfaces.
- Terminals and bolts are included for installation.
- Comes in pairs. Works on 12 V AC / DC.

Part number	Color	Replacement lens	
		Part number	Color
D45-58-617	Orange	D45-58-687	Orange
D45-58-618	Smoke	D45-58-688	Smoke



Orange

Smoke

DRC
MOTO LED 601 LED FLASHER

- Triangular style flasher.
- Terminals and nuts are included for installation.
- Comes in pairs. Works on 12 V AC / DC.

Part number	Color	Replacement lens	
		Part number	Color
D45-60-107	Orange	D45-60-187	Orange
D45-60-108	Smoke	D45-60-188	Smoke

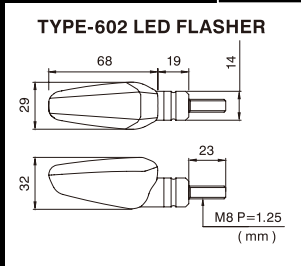

TYPE-602 LED FLASHER

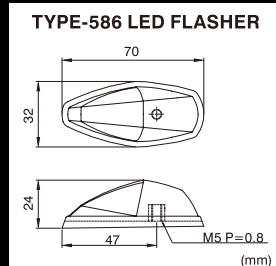

TYPE-586 LED FLASHER

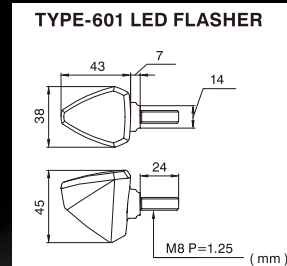

TYPE-601 LED FLASHER

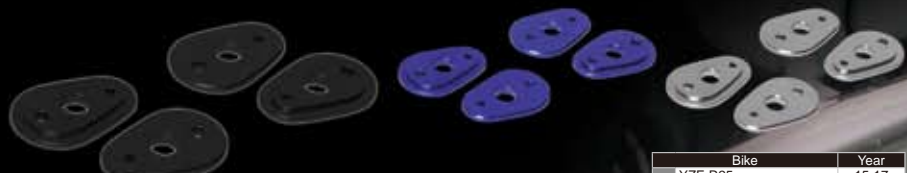

DRC
MOTO LED FLASHER HOLDER PLATE

- Flasher mount adapter for Yamaha and Kawasaki OEM flasher mounting bracket.
- Use OE brackets with the plates to mount DRC LED flashers.
- Flasher attachment hole diameter : 8 mm
- Available in titanium, blue and black anodized colors.
- 2 set.

Part number	Color
D45-59-950	Titanium
D45-59-952	Blue
D45-59-953	Black

MOTO LED flashers may not work properly without optional parts. P103

Bike	Year
YZF-R25	15-17
YZF-R6	06-14
YZF-R1	02-14
MT-07/09	14-16
MT-01	05-09
FZ6/FAZER	04-10
FZ8/FAZER	11-16
FZ1/FAZER	08-14
XJ6N/F/S	09-16
TDM900	02-10
V-MAX (Rear)	09-17
WR250R/X	07-17
KSR110	13
KLX125/D-TRACKER125	10-16
KLX150	09-13
KLX250/D-TRACKER X	08-16
NINJA250/R	08-



- High quality light weight titanium bolts, nuts, washers and pivot pins available from ZETA.
- Brake disc bolt kit and sprocket kit available for specific models.
- Made of hot forged Ti-6AL-4V for a durable and extremely light weight-product.
- High precision CNC machined bolt and nut head, head size is one size-smaller than industrial standard for reduced weight.

Hot forging, CNC machining, thread rolling

ZETA titanium product is designed to be light weight with no decoration. Titanium products are not only machined but also hot forged to provide more tensile strength than material strength. Bolt and nut are designed with a smaller CNC machined head for a lighter design.

Titanium type and strength difference between other material.

Pure Titanium	Lower price than other titanium alloy, great corrosion resistance, but less strength.
Alfa alloy	Great creep resistance and welding work, but bad workability.
Beta alloy	Most durable titanium alloy, easy workability, but high production cost.
Alfa beta alloy	Great durability, ductility, toughness and workability. Zeta Titanium product is made of this material, Ti-6AL-4V.

Ti-6AL-4V

ZETA titanium products are made of Ti-6AL-4V. This chemical notation means this titanium includes 6% aluminum (AL) and 4% vanadium (V). This material is light weight and durable. It is used in aircraft and space industries, nuclear industry, industrial turbine, race car and motorcycle etc.

Titanium Name	Alloy name	Tensile strength
Pure titanium	JIS Grade 1	275-412N / mm ²
Pure titanium	JIS Grade 2	343-510N / mm ²
Pure titanium	JIS Grade 3	481-618N / mm ²
Alfa alloy	Ti-5AL-2.5Sn	850N / mm ²
Alfa-beta alloy	Ti-6AL-4V	900N / mm²
Beta alloy	Ti-15Mo-5Zr-3Al	1470N / mm ²

Other alloy	Alloy name	Tensile strength
Duralumin	2017-T4	425N / mm ²
Super duralumin	2024-T361	495N / mm ²
Extra super duralumin	7075-T6	481-618N / mm ²
Steel	SS400	400N / mm ²
Carbon steel	S45C	570N / mm ²
Chromium molybdenum steel	SCM435	930N / mm ²

RACING FLANGE BOLT
M10 P=1.25 L 20 mm - 75 mm
* Includes safety wire holes.

RACING FLANGE BOLT
M6 P=1.0 L 85 mm - 100 mm

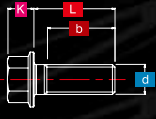

RACING FLANGE BOLT
M6 P=1.0 L 10 mm - 80 mm



ZETA

RACING FLANGE BOLT

- One size smaller bolt head design for light weight. Motorcycle use.
- Comes with wire holes for bolts larger than M7 sizes.
- Sold in single pieces.

RACING FLANGE BOLT

Part #	d	S	Dc	K	b	L
ZT03-0610	M6 P=1.0	8	11	5.3	8	10
ZT03-0616	M6 P=1.0	8	11	5.3	14	16
ZT03-0620	M6 P=1.0	8	11	5.3	18	20
ZT03-0625	M6 P=1.0	8	11	5.3	18	25
ZT03-0630	M6 P=1.0	8	11	5.3	18	30
ZT03-0635	M6 P=1.0	8	11	5.3	18	35
ZT03-0640	M6 P=1.0	8	11	5.3	18	40
ZT03-0645	M6 P=1.0	8	11	5.3	18	45
ZT03-0650	M6 P=1.0	8	11	5.3	18	50
ZT03-0655	M6 P=1.0	8	11	5.3	18	55
ZT03-0660	M6 P=1.0	8	11	5.3	18	60
ZT03-0665	M6 P=1.0	8	11	5.3	18	65
ZT03-0670	M6 P=1.0	8	11	5.3	18	70
ZT03-0675	M6 P=1.0	8	11	5.3	18	75
ZT03-0680	M6 P=1.0	8	11	5.3	18	80
ZT03-0685	M6 P=1.0	8	11	5.3	18	85
ZT03-0690	M6 P=1.0	8	11	5.3	18	90
ZT03-0695	M6 P=1.0	8	11	5.3	18	95
ZT03-06A0	M6 P=1.0	8	11	5.3	18	100
ZT03-0816	M8 P=1.25	10	14	6.8	14	16
ZT03-0820	M8 P=1.25	10	14	6.8	18	20
ZT03-0825	M8 P=1.25	10	14	6.8	22	25
ZT03-0830	M8 P=1.25	10	14	6.8	22	30
ZT03-0835	M8 P=1.25	10	14	6.8	22	35
ZT03-0840	M8 P=1.25	10	14	6.8	22	40
ZT03-0845	M8 P=1.25	10	14	6.8	22	45
ZT03-0850	M8 P=1.25	10	14	6.8	22	50
ZT03-0855	M8 P=1.25	10	14	6.8	22	55
ZT03-0860	M8 P=1.25	10	14	6.8	22	60
ZT03-1025	M10 P=1.25	12	17	8.2	23	25
ZT03-1030	M10 P=1.25	12	17	8.2	26	30
ZT03-1035	M10 P=1.25	12	17	8.2	26	35
ZT03-1040	M10 P=1.25	12	17	8.2	26	40
ZT04-0720	M7 P=1.0	10	14	6.8	18	20
ZT04-0816	M8 P=1.25	10	14	6.8	14	16
ZT04-0820	M8 P=1.25	10	14	6.8	18	20
ZT04-0825	M8 P=1.25	10	14	6.8	22	25
ZT04-0830	M8 P=1.25	10	14	6.8	22	30
ZT04-0835	M8 P=1.25	10	14	6.8	22	35
ZT04-0840	M8 P=1.25	10	14	6.8	22	40
ZT04-0845	M8 P=1.25	10	14	6.8	22	45
ZT04-0850	M8 P=1.25	10	14	6.8	22	50
ZT04-0855	M8 P=1.25	10	14	6.8	22	55
ZT04-1020	M10 P=1.25	12	17	8.2	18	20
ZT04-1025	M10 P=1.25	12	17	8.2	23	25
ZT04-1030	M10 P=1.25	12	17	8.2	26	30
ZT04-1035	M10 P=1.25	12	17	8.2	26	35
ZT04-1040	M10 P=1.25	12	17	8.2	26	40
ZT04-1045	M10 P=1.25	12	17	8.2	26	45
ZT04-1050	M10 P=1.25	12	17	8.2	26	50
ZT04-1055	M10 P=1.25	12	17	8.2	26	55
ZT04-1060	M10 P=1.25	12	17	8.2	26	60
ZT04-1065	M10 P=1.25	12	17	8.2	26	65
ZT04-1070	M10 P=1.25	12	17	8.2	26	70
ZT04-1075	M10 P=1.25	12	17	8.2	26	75
ZT04-1120	M10 P=1.5	12	17	8.2	18	20
ZT04-1125	M10 P=1.5	12	17	8.2	23	25
ZT04-1130	M10 P=1.5	12	17	8.2	26	30
ZT04-1135	M10 P=1.5	12	17	8.2	26	35

* Includes safety wire holes.

CAP BOLT
M8 P=1.25 L 16 mm - 55 mm



CAP BOLT STRAIGHT

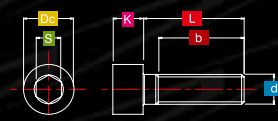

CAP BOLT LOW HEAD

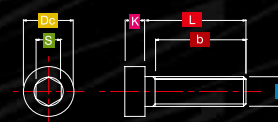

CAP BOLT STRAIGHT
M6 P=1.0 L 10 mm - 45 mm



CAP BOLT EXTRA LOW HEAD

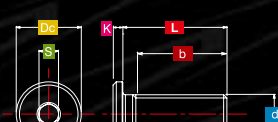

CAP BOLT LOW HEAD
M8 P=1.25 L 20 mm - 40 mm



CAP BOLT TAPER

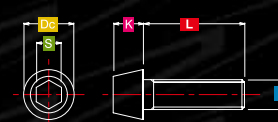

CAP BOLT TAPER
M5 P=0.8 L 12 mm - 30 mm



CAP BOLT EXTRA LOW HEAD
M6 L 12 mm - 20 mm



ZETA

CAP BOLT

- Cap bolt available in straight and tapered types.
- Bolt head is forged, CNC finish.
- Sold in single pieces.

CAP BOLT

Part #	d	S	Dc	K	b	L
STRAIGHT						
ZT07-0610	M6 P=1.0	5	10	6	8	10
ZT07-0616	M6 P=1.0	5	10	6	14	16
ZT07-0620	M6 P=1.0	5	10	6	18	20
ZT07-0625	M6 P=1.0	5	10	6	23	25
ZT07-0630	M6 P=1.0	5	10	6	24	30
ZT07-0635	M6 P=1.0	5	10	6	24	35
ZT07-0640	M6 P=1.0	5	10	6	24	40
ZT07-0645	M6 P=1.0	5	10	6	24	45
ZT07-0816	M8 P=1.25	6	13	8	14	16
ZT07-0820	M8 P=1.25	6	13	8	18	20
ZT07-0825	M8 P=1.25	6	13	8	23	25
ZT07-0830	M8 P=1.25	6	13	8	28	30
ZT07-0835	M8 P=1.25	6	13	8	28	35
ZT07-0840	M8 P=1.25	6	13	8	28	40
ZT07-0845	M8 P=1.25	6	13	8	28	45
ZT07-0850	M8 P=1.25	6	13	8	28	50
ZT07-0855	M8 P=1.25	6	13	8	28	55
ZT07-1020	M10 P=1.25	8	16	10	18	20
ZT07-1025	M10 P=1.25	8	16	10	23	25
ZT07-1030	M10 P=1.25	8	16	10	28	30
ZT07-1035	M10 P=1.25	8	16	10	32	35
ZT07-1040	M10 P=1.25	8	16	10	32	40
ZT07-1045	M10 P=1.25	8	16	10	32	45
ZT07-1120	M10 P=1.5	8	16	10	18	20
ZT07-1125	M10 P=1.5	8	16	10	23	25
ZT07-1130	M10 P=1.5	8	16	10	28	30
LOW HEAD						
ZT07-2512	M5 P=0.8	4	8.5	3.5	10	12
ZT07-2516	M5 P=0.8	4	8.5	3.5	14	16
ZT07-2520	M5 P=0.8	4	8.5	3.5	16	20
ZT07-2525	M5 P=0.8	4	8.5	3.5	16	25
ZT07-2530	M5 P=0.8	4	8.5	3.5	16	30
ZT07-2535	M5 P=0.8	4	8.5	3.5	16	35
ZT07-2612	M6 P=1.0	5	10	4	10	12
ZT07-2616	M6 P=1.0	5	10	4	14	16
ZT07-2620	M6 P=1.0	5	10	4	18	20
ZT07-2625	M6 P=1.0	5	10	4	18	25
ZT07-2630	M6 P=1.0	5	10	4	18	30
ZT07-2635	M6 P=1.0	5	10	4	18	35
ZT07-2820	M8 P=1.25	6	13	5	18	20
ZT07-2825	M8 P=1.25	6	13	5	22	25
ZT07-2830	M8 P=1.25	6	13	5	22	30
ZT07-2835	M8 P=1.25	6	13	5	22	35
ZT07-2840	M8 P=1.25	6	13	5	22	40
EXTRA LOW HEAD						
ZT07-3612	M6 P=1.0	3	10	1.5	10	12
ZT07-3616	M6 P=1.0	3	10	1.5	14	16
ZT07-3620	M6 P=1.0	3	10	1.5	18	20
ZT07-3816	M8 P=1.25	4	13	1.5	14	16
ZT07-3820	M8 P=1.25	4	13	1.5	18	20



ZETA

FLAT HEAD BOLT

- Countersunk bolt. 1 pc.

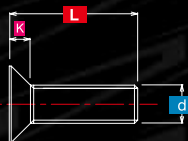

Part #	d	S	Dc	K	L
ZT09-6121	M6 P=1.0	4	12	3.3	12
ZT09-6161	M6 P=1.0	4	12	3.3	16
ZT09-6201	M6 P=1.0	4	12	3.3	20



KTM 250SX LEFT



YZ250FX RIGHT



ZETA
CHAIN ADJUSTER BOLT

- By using titanium bolts the unsprung weight is reduced, and compared to stock bolts, strength is increased and visual appeal is enhanced.
- Nut is designed one size smaller, for reduced weight and compactness. And because titanium bolts to form a non-conductive coating on the surface, it will not rust.
- M8 is used by the four main Japanese manufacturers of off-road, and also some on-road manufacturers (Axle block bolt adjustment type vehicle).
- M10 is mainly used on KTM off-road models, and Husqvarna.

Chain Adjust Bolts & Nuts Set						
Part #	d	S	K	L	Description	qty
ZT38-5500	M8 P=1.25	10	5.5	50	Chain Adjuster bolt	1
ZT38-5501	M8 P=1.25	10	5.5	50	Chain Adjuster bolt & Nut	2
ZT38-7500	M10 P=1.25	10	5.5	50	Chain Adjuster bolt	1
ZT38-7501	M10 P=1.25	10	5.5	50	Chain Adjuster bolt & Nut	2



KX450F LEFT



YZF R1 RIGHT

ZT38-7501 Approximate band Onroad			
Bike	Year	Part #	
KTM			
690 DUKE	08-16		
990 SUPER DUKE	06-13		
990 SUPERMOTO	08-12		
1050 ADVENTURE	15-16	ZT38-7501	
1190 ADVENTURE	13-16		
1190 RC8/R	08-12		
1290 SUPER ADVENTURE	15-16		

ZT38-7501 Approximate band Offroad			
Bike	Year	Part #	
KTM			
85SX	06-15		
105-450SX/SX-F	06-18		
250-530/EXC-F/R	07-18	ZT38-7501	
125-690SXS/C,SMC/R,ENDURO/R	06-17		
990 ADVENTURE	06-12		
HUSQVARNA			
TC/FC/TX/FX/TE/FE 125-701	14-17	ZT38-7501	

ZT38-5501 Approximate band Onroad			
Bike	Year	Part #	
H			
CBR250RR	17		
CB650F	17	ZT38-5501	
CBR650F	17		
CBR600RR	09-16		
CBR1000RR	08-17		
X-ADV	17		
Y			
MT-09/TRACER	14-17		
XSR900	16-17		
FZ1	06-15	ZT38-5501	
FZ10	17		
MT-10	17		
YZF-R6	17		
YZF-R1/M	04-17		
K			
NINJA400	14-17		
VERSYS650	07-17	ZT38-5501	
VERSYS1000	12-17		
ZX-6R	09-17		
ZX-10R	11-17		
S			
GSX-R600	00-17		
GSX-R750	00-17	ZT38-5501	
GSX-R1000	01-17		
GSX1300R HAYABUSA	08-17		
GSX-S1000	17		
V-STROM1000	02-17		

ZT38-5501 Approximate band Offroad			
Bike	Year	Part #	
H			
CR125R/250R	87-07		
CRF150R	07-18		
CRF250R	04-18		
CRF450R	02-18		
CRF450RX	17-18	ZT38-5501	
CRF250X/450X	04-17		
CRF250L/M/RALLY	12-17		
CRF1000L AFRICA TWIN	16-17		
XR650R	00-07		
Y			
YZ125/250	90-18		
YZ250F	01-18		
YZ400/426/450F	98-18		
YZ125X/250X	16-18	ZT38-5501	
YZ250FX/450FX	15-18		
WR250F	01-18		
WR400/426/450F	98-18		
WR250R/X	07-17		
K			
KX85	01-18		
KX100	16-18		
KX125/250	88-08		
KX250F	04-18	ZT38-5501	
KX450F	06-18		
KLX450R	08-15		
KLX250/D-TRACKER X	08-16		
S			
RM125/250	89-08		
RMZ250	04-18		
RMZ450	05-18	ZT38-5501	
RMX450Z	10-14		
DRZ400SM	05-17		



ZETA
WASHER

- Made of CNC machined Ti-6AL-4V
- Excellent accuracy, unlike common press machine punched washers.
- Reduce weight by replacing with titanium washers, as well as increasing strength, improved visual appeal.
- Lineup for the high frequency of use M6, M8 and M10.

WASHER				
Part #	Size	Inner diameter	Outer diameter	Thickness
ZT20-1061	M6	6.4	12	1.6
ZT20-1081	M8	8.4	16	1.6
ZT20-1101	M10	10.4	20	2.1

ZETA
EXHAUST NUT

- Titanium exhaust nut does not rust like OEM steel exhaust nuts.
- Flange design, can be tightend with 6 mm wrench or hex wrench.

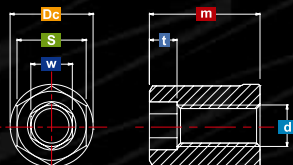

Part #	d	S	Dc	w	m	t	qty
ZT23-1061	M6 P=1.0	10	12	6	16	4	1
ZT36-1068	M6 P=1.0	10	12	6	16	4	8
ZT23-1081	M8 P=1.25	12	14	8	18	4.5	1
ZT36-1088	M8 P=1.25	12	14	8	18	4.5	8

ZETA
FLANGE NUT COMPACT

- Titanium compact head size nut.
- Attained one size smaller head design because of its durable and light weight Ti-6AL-4V material.
- Great to use in high tightening torque and high temperature situations.
- Sold in single pieces.

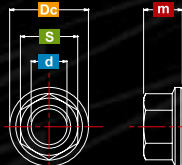

Part #	d	S	Dc	m
ZT21-2051	M5 P=0.8	7	9.5	4.7
ZT21-2061	M6 P=1.0	8	11	5.4
ZT21-2081	M8 P=1.25	10	14	6.8
ZT21-2101	M10 P=1.25	12	17	8.2

ZETA
FLANGE LOCK NUT

- ZETA original locking function. No use locking plate or locking nylon used.
- Original locking function holds secure, but has less damage to the bolt than U lock nut.
- Sold in single pieces.

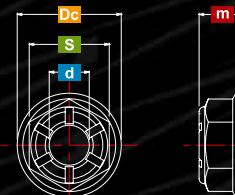

Part #	d	S	Dc	m
ZT21-1051	M5 P=0.8	8	11	4.9
ZT21-1061	M6 P=1.0	10	13	5.7
ZT21-1081	M8 P=1.25	12	16	7.6
ZT21-1101	M10 P=1.25	14	19	9.6
ZT21-1121	M12 P=1.25	17	23	11.6



ZETA BANJO BOLT

- Titanium brake banjo bolts available for many sizes to fit most brake hoses.
- Light weight design, comes with wiring holes.
- 1.0 thread size banjo bolts for Brembo master cylinders and brake calipers.
- Sold in single pieces.

Part #	d	S	Dc	K	L	Brake System	Type
ZT15-1000	M10 P=1.0	12	15	7	20.5	brembo	Z-WHEEL, EARL'S
ZT15-1010	M10 P=1.0	12	15	7	18.5	brembo	GOODRIDGE
ZT15-1020	M10 P=1.25	12	15	7	22.0	NISSIN, TOKICO	UNIVERSAL

ZETA AIR FREE BANJO BOLT

- Easy air bleeding with air bleeder at the tip of banjo bolt.
- Especially excellent for calipers and master cylinders without bleeders.
- Two kinds of screw pitch, 1.0 and 1.25, 1.0 fits on Brembo.

Part #	d	S	Dc	K	L	Brake System	Type
ZT15-1200	M10 P=1.0	12	15	23	20.5	brembo	Z-WHEEL, EARL'S
ZT15-1210	M10 P=1.0	12	15	23	18.5	brembo	GOODRIDGE
ZT15-1220	M10 P=1.25	12	15	23	22.0	NISSIN, TOKICO	UNIVERSAL

ZETA CALIPER BRIDGE BOLT

- Titanium caliper bridge bolt kit.
- Make your caliper weight lighter.
- Highly corrosion resistant, won't rust like steel OE bolts.
- For Brembo 2 piece brake caliper use.
- Comes with 4 bolts.

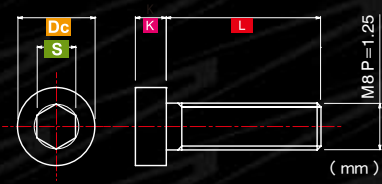

Part #	d	S	Dc	K	L	qty
ZT07-2835	M8 P=1.25	6	13	5	35	1
ZT37-3064	M8 P=1.25	6	13	5	35	4
ZT07-2840	M8 P=1.25	6	13	5	40	1
ZT37-3084	M8 P=1.25	6	13	5	40	4

ZETA CALIPER MOUNT BOLT

- Light weight titanium caliper mount bolt kit for sport bikes.
- Bolt size is designed compact, to reduce weight.
- Can be used on Brembo brake calipers.
- Wiring holes on the bolt to meet racing regulations.
- Comes with 2 bolts for rear brake calipers. 4 bolts for front radial brake calipers.

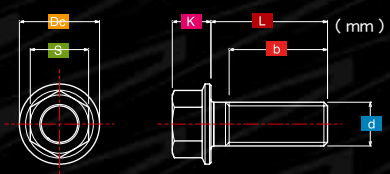

Part #	d	S	Dc	K	b	L	qty	Type
ZT33-1072	M7 P=1.0	10	14	6.8	18	20	2	brembo Rear Caliper, Racing
ZT33-1082	M8 P=1.25	10	14	6.8	18	20	2	brembo Rear Caliper, Street
ZT33-1504	M10 P=1.25	12	17	8.2	26	50	4	Radial Mount Caliper
ZT33-1554	M10 P=1.25	12	17	8.2	26	55	4	Radial Mount Caliper
ZT33-1604	M10 P=1.25	12	17	8.2	26	60	4	Radial Mount Caliper
ZT33-1654	M10 P=1.25	12	17	8.2	26	65	4	Radial Mount Caliper
ZT33-1704	M10 P=1.25	12	17	8.2	26	70	4	Radial Mount Caliper
ZT33-1754	M10 P=1.25	12	17	8.2	26	75	4	Radial Mount Caliper

ZETA BRAKE ADAPTER

- Titanium straight fitting brake hose adapter.
- Available 1.25 and 1.0 (Brembo) thread sizes.
- Sold in single pieces.

Part #	Size
ZT15-2000	M10 P=1.0
ZT15-2010	M10 P=1.25



ZETA

MASTER CYLINDER BOLT KIT



Part #	Type	Part #	qty	Description
ZT32-1110	Brembo Master Cylinder Flange Bolt Kit	ZT99-9001	1	Flange Bolt M6x19
		ZT03-0620	2	Flange Bolt M6x20
		ZT15-3110	1	Pivot Pin
		ZT15-4100	1	Washer M6
		ZT08-0620	1	Bleeder Screw M10 P=1.0
ZT32-1120	Brembo Master Cylinder Taper Cap Bolt Kit	ZT08-0625	3	Taper Cap Bolt M6x20
		ZT15-3110	1	Pivot Pin
		ZT15-4100	1	Washer M6
		ZT15-4100	1	Bleeder Screw M10 P=1.0

- The Kit includes clamp bolt, pivot pin, bleeder screw etc. for Brembo master cylinder and RCS master cylinder.
- Compatible with flange and taper cap type.

Part #	Type	Part #	qty	Description
ZT32-1210	RCS Master Cylinder Flange Bolt Kit	ZT03-0625	3	Flange Bolt M6x25
		ZT21-2061	1	Flange Nut Compact M6
		ZT15-3120	1	Pivot Pin
		ZT15-4100	1	Bleeder Screw M10 P=1.0
		ZT08-0625	3	Taper Cap Bolt M6x25
ZT32-1220	RCS Master Cylinder Taper Cap Bolt Kit	ZT21-2061	1	Flange Nut Compact M6
		ZT15-3120	1	Pivot Pin
		ZT15-4100	1	Bleeder Screw M10 P=1.0

ZETA

PIVOT PIN



- Titanium Pivot pin for Brembo master cylinder.
- Stock pivot pin is made of steel, which easily rusts, wears and can freeze.
- This titanium pivot pin does not rust and provides smooth lever movement.
- Gold anodized finish for an exclusive look.

Part #	Type	Set
ZT15-3110	Brembo Racing	Washer & Snap Pin
ZT15-3110	Brembo Street	Washer & Snap Pin
ZT15-3120	Brembo RCS	-
ZT15-3130	NISSIN	-

ZETA

BLEEDER SCREW



- 8 mm and 10 mm wrench size bleeder screw for Brembo master cylinder.
- Easy operation and lighter than stock 11 mm wrench size bleeder.

Part #	Size	Type
ZT15-4100	M10 P=1.0	Brembo
ZT15-4080	M8 P=1.25	NISSIN, Brembo

ZETA

MASTER CYLINDER CLAMP BOLT SET



- Titanium bolt set for Brembo master cylinder clamp.
- Compatible with flange type and tapered cap type. Comes with 2 bolts.

Part #	Type
ZT82-1202	Brembo M6x20 Flange Bolt set
ZT82-1252	RCS M6x25 Flange Bolt Set
ZT88-1202	Brembo M6x20 Taper Bolt set
ZT88-1252	RCS M6x25 Taper Bolt Set



CRF250L
FRONT



NINJA ZX-10R
FRONT



WR250R
REAR

CRF250L
REAR



NINJA ZX-10R
REAR



ZETA
AXLE SHAFT

**SIGNIFICANT LIGHT WEIGHT
TITANIUM AXLE SHAFT**

LIGHT WEIGHT

The specific gravity of Ti-6AL-4V is about 4.4. This is about 56 % with respect to the specific gravity of 7.8 of stock axle shaft using iron (SS400) and carbon steel (S45C), or chromium molybdenum steel shaft (SCM440). This means that if you manufacture the axle shaft with the same mass, 64 titanium will be able to produce about 44 % reduction in weight. The reduced weight of the axle shaft also reduces the unsprung weight and corner approaches will improve the handling and stability. In addition, the reduction of unsprung weight will not only improve the movement of the suspension, but also improve brake performance.

ULTRA STRENGTH

Strength of Ti-6AL-4V is comparable to chromium molybdenum steel (SCM435) 900 - 930 Mpa. With the higher strength axle shaft, you will be able to feel more road surface information more directly. You will be able to sense the bumpy road that could not be felt until now.

BENDING

The Young's modulus of Ti-6AL-4V is about half of iron and chromium molybdenum steel at 106 Gpa. The Young's modulus represents the rigidity and elasticity, the higher the number, the higher the rigidity. Generally, one thinks "high-strength = high rigidity," also 64 titanium has been taken for granted as high rigidity, but actually it is only half the rigidity of iron. Therefore it is easily deformed, but there is elastic deformation where a material tries to return to its original state, and plastic deformation where deformation is permanent. 64 titanium has a wide range of elastic deformation. In other words this is "BENDING". It is this bending that produces the suspension effect, and high strength that softly transmits road surface information.

Not only Light. Not only strong. Not only flexible. If it is made of aluminum or magnesium it will be lighter than 64 titanium but it will lack strength. If it is made of chromium-molybdenum steel and nickel-chromium steel it will be stronger than 64 titanium, but it will be heavy. There are also materials having Young's modulus lower than 64 titanium, but it will not mean that there is "BENDING." 64 titanium is superior to a balance of these materials. Therefore it may be said that it is the best material for the axle shaft.

Also we must not forget the appearance of titanium. It is more difficult to rust than stock shaft and chromium-molybdenum steel shaft that has a protective surface treatment. However, it does not escape corrosion where the surface is compromised for some reason. Ti-6AL-4V forms a passive film surface to prevent semi-permanent rust to form.

Material	Material symbol and heat treatment	Tensile strength (T/Mpa)	Young's modulus (E/Gpa)	Specific gravity
Roller steel for general structure	SS400(Annealing)	450	206	7.87
Carbon steel for mechanical structure	S45C(Normalizing)	570 or more	205	7.83
Chromium-molybdenum steel	SCM440(Tempering quenching)	980 or more	206	7.86
Austenitic stainless steel	SUS304(Solution treatment)	520 or more	197	7.93
Pure aluminum	A1085 P(Annealing)	55	69	2.70
Duralumin (aluminum alloy)	A2017 P(Natural aging)	355	69	2.79
Ultra duralumin (aluminum alloy)	A2024 P(Natural aging)	430	74	2.78
Extra Ultra duralumin (aluminum alloy)	A7075 P(quench-and-temper)	573	72	2.81
Pure titanium (JIS grade1)	TF270	275-412	106	4.51
Pure titanium (JIS grade 2)	TF340	343-510	106	4.51
Pure titanium (JIS grade 3)	TF480	481-618	106	4.51
Titanium (α alloy)	Ti-5AL-2.5Sn	850	118	4.48
Titanium (α-β alloy)	Ti-6AL-4V	900	106	4.43
Titanium (β alloy)	Ti-15Mo-5Zr-3AL	1470	75-95	4.80

AXLE SHAFT OFFROAD

Please check your race regulation before racing with titanium axle shaft.

Bike	Year	Front			Rear			
		Part #	Compared with genuine #1	Tool size #2	Part #	Compared with genuine #1	Tool size #2	
HONDA	CR125R	04-07	ZT60-1164	-115 g	-	ZT60-1264 #1	-157 g	-
	CR250R	04-07	ZT60-1164	-115 g	-	ZT60-1264 #1	-157 g	-
	CRF150R/II	07-18	ZT60-1161	-122 g	Socket 14 mm	ZT60-1261 #6	-290 g	-
	CRF250R	04-17	ZT60-1164	-115 g	-	ZT60-1264 #1	-157 g	-
	CRF450R	02-18	ZT60-1164	-115 g	-	ZT60-1264 #1	-157 g	-
	CRF450RX	17-18	ZT60-1164	-115 g	-	ZT60-1264 #1	-157 g	-
	CRF250X	04-17	-	-	-	ZT60-1264 #1	-157 g	-
	CRF450X	05-17	-	-	-	ZT60-1264 #1	-157 g	-
	CRF250L/M	12-16	ZT60-1173 #6	-198 g	Hexagon 14 mm	ZT60-1273 #6	-325 g	Socket 17 mm
	CRF250L/M, RALLY	17	ZT60-1174	-165 g	-	ZT60-1273 #6	-325 g	Socket 17 mm
	YZ125/250	99-07	ZT60-4164 #8	-120 g	-	ZT60-4264	-178 g	-
		08-18	ZT60-4163 #8	-110 g	-	ZT60-4264	-178 g	-
YAMAHA	YZ250F	01-06	ZT60-4164 #8	-120 g	-	ZT60-4264	-178 g	-
		07-08	ZT60-4163 #8	-110 g	-	ZT60-4264	-178 g	-
		09-13	ZT60-4163 #8	-110 g	-	ZT60-4265	-162 g	-
		14-18	ZT60-4165 #7	-142 g	Hexagon 22 mm	ZT60-4265	-162 g	-
	YZ400 /426/450F	99-07	ZT60-4164 #8	-120 g	-	ZT60-4264	-178 g	-
		08	ZT60-4163 #8	-110 g	-	ZT60-4264	-178 g	-
	YZ450F	09-13	ZT60-4163 #8	-110 g	-	ZT60-4265	-162 g	-
		14-18	ZT60-4165 #7	-142 g	Hexagon 22 mm	ZT60-4265	-162 g	-
	YZ125X	17-18	ZT60-4163 #8	-110 g	-	ZT60-4264	-178 g	-
	YZ250X	16-18	ZT60-4163 #8	-110 g	-	ZT60-4264	-178 g	-
	YZ250FX	15-18	ZT60-4165 #7	-142 g	Hexagon 22 mm	ZT60-4264	-178 g	-
	YZ450FX	16-18	ZT60-4165 #7	-142 g	Hexagon 22 mm	ZT60-4264	-178 g	-
KAWASAKI	WR250F	01-18	ZT60-4164 #8	-120 g	-	ZT60-4264	-178 g	-
	WR400 /426/450F	99-18	ZT60-4164 #8	-120 g	-	ZT60-4264	-178 g	-
	WR250R/X	07-17	ZT60-4173	-112 g	Hexagon 17 mm	ZT60-4273	-198 g	-
	KX125	04-08	ZT60-2164	-101 g	-	ZT60-2264 #2	-153 g	-
	KX250	04-08	ZT60-2164	-101 g	-	ZT60-2264 #2	-153 g	-
	KX250F	04-18	ZT60-2164	-101 g	-	ZT60-2264 #2	-153 g	-
	KX450F	06-18	ZT60-2164	-101 g	-	ZT60-2264 #2	-153 g	-
	KLX450R	08-15	ZT60-2164	-101 g	-	ZT60-2264 #2	-153 g	-
	KDX220R/SR	94-05	ZT60-2172	-132 g	Hexagon 14 mm	ZT60-2272 #3-1	-214 g	-
	KLX250R/SR	93-97	ZT60-2172	-132 g	Hexagon 14 mm	ZT60-2272 #3-1	-214 g	-
	KLX250 /D-TRACKER	98-06	ZT60-2172	-132 g	Hexagon 14 mm	ZT60-2272 #3-1	-214 g	-
	KLX250 /D-TRACKERX	07	ZT60-2173	-152 g	Hexagon 17 mm	ZT60-2272	-214 g	-
KLX250	08-16	ZT60-2173	-152 g	Hexagon 17 mm	ZT60-2273	-198 g	-	
KLX300R	96-07	ZT60-2172	-132 g	Hexagon 14 mm	ZT60-2272 #3-1	-214 g	-	
KLX650R	93-96	ZT60-2172	-132 g	Hexagon 14 mm	ZT60-2272 #3-1	-214 g	-	

Bike	Year	Front			Rear		
		Part #	Compared with genuine #1	Part #	Compared with genuine #1	Part #	
SUZUKI	RMZ250	04-06	ZT60-2164	-101 g	ZT60-2264	-153 g	
	RMZ450	07-18	ZT60-3164	-116 g	ZT60-3264	-169 g	
	RMX450Z	05-18	ZT60-3164	-116 g	ZT60-3264	-169 g	
	DRZ400/E	10-17	ZT60-3164	-116 g	ZT60-3264	-169 g	
	DRZ400S	00-17	ZT60-3173	-120 g	ZT60-2272 #3-2	-154 g	
	DRZ400SM	00-17	ZT60-3173	-120 g	ZT60-2272 #3-2	-154 g	
		05-17	ZT60-3173	-120 g	ZT60-3273	-168 g	
	KTM	125/150/250SX	03-12	ZT60-5163 #4	-130 g	ZT60-5263 #5	-188 g
			13-14	ZT60-5163 #4	-130 g	ZT60-5264 #5	-186 g
			15-18	ZT60-5164 #4	-104 g	ZT60-5264 #5	-186 g
		250/350/450SX-F	05-12	ZT60-5163 #4	-130 g	ZT60-5263 #5	-188 g
			13-14	ZT60-5163 #4	-130 g	ZT60-5264 #5	-186 g
		15-18	ZT60-5164 #4	-104 g	ZT60-5264 #5	-186 g	
125-530EXC/R		03-15	ZT60-5163 #4	-130 g	ZT60-5263 #5	-188 g	
		16-18	ZT60-5164 #4	-104 g	ZT60-5263 #5	-188 g	
250-500EXC-F		07-15	ZT60-5163 #4	-130 g	ZT60-5263 #5	-188 g	
		16-18	ZT60-5164 #4	-104 g	ZT60-5263 #5	-188 g	
450SMR		07-12	ZT60-5163 #4	-130 g	ZT60-5263 #5	-188 g	
HUSQVARNA		690 ENDURO/R	13	ZT60-5163 #4	-130 g	ZT60-5264 #5	-186 g
		14-16	-	-	-	-	
	TC125/250	09-15	ZT60-5163 #4	-130 g	ZT60-5263 #5	-188 g	
	FC250/450	16-18	ZT60-5164 #4	-104 g	ZT60-5264 #5	-186 g	
	FC350	15-18	ZT60-5164 #4	-104 g	ZT60-5264 #5	-186 g	
	TE125/250/300	16-18	ZT60-5164 #4	-104 g	ZT60-5264 #5	-186 g	
	TE150	16-18	ZT60-5164 #4	-104 g	ZT60-5264 #5	-186 g	
	FE250/350/450/501	16-18	ZT60-5164 #4	-104 g	ZT60-5264 #5	-186 g	
	TX125	17-18	ZT60-5164 #4	-104 g	ZT60-5263 #5	-188 g	
	TX300	17-18	ZT60-5164 #4	-104 g	ZT60-5264 #5	-186 g	
	FX350/450	17-18	ZT60-5164 #4	-104 g	ZT60-5264 #5	-186 g	

AXLE SHAFT STREET

Bike	Year	Front		Rear	
		Part #	Compared with genuine #1	Part #	Compared with genuine #1
YAMAHA	YZF-R6	17	ZT61-4101	-	-
	YZF-R1/M	15-17	ZT61-4101	ZT61-4201	-
	MT-10	17	ZT61-4101	ZT61-4201	-
		14-16	ZT61-4102	ZT61-4202	-
	MT-09	17	ZT61-4102	-	-
	MT-09 TRACER XSR900	15-17	ZT61-4102	ZT61-4202	-
KAWASAKI	NINJA ZX-6R	16-17	ZT61-2102	ZT61-2201	-
		13-17	-	ZT61-2201	-
		08-10	ZT61-2102	-	-
	NINJA ZX-10R	11-15	ZT61-2102	ZT61-2201	-
		16-17	ZT61-2101	ZT61-2201	-
		06-17	ZT61-2102	ZT61-2202	-
SUZUKI	NINJA H2/R	15-17	ZT61-2101	-	-
	GSX1300R	08-17	ZT61-3101	ZT61-3201	-
	S1000RR	10-17	ZT61-6101	ZT61-6201	-
BMW	S1000R	14-17	ZT61-6101	ZT61-6201	-
	HP4	13-14	ZT61-6101	ZT61-6201	-
		15-17	ZT61-7101	-	-
DUCATI	PANIGALE R	15-17	ZT61-7101	-	-
	1299 PANIGALE/S	15-17	ZT61-7101	-	-
	1199 PANIGALE R	13-14	ZT61-7101	-	-
	1199 PANIGALE/S	12-14	ZT61-7101	-	-
	959 PANIGALE	16-17	ZT61-7101	-	-
	899 PANIGALE	14-15	ZT61-7101	-	-
	SUPER SPORT/S	17	ZT61-7102	-	-
	MULTISTRADA1200/S	10-17	ZT61-7102	-	-
	MULTISTRADA950	17	ZT61-7102	-	-
	MONSTER1200/S/R	14-17	ZT61-7102	-	-
	MONSTER821	14-17	ZT61-7102	-	-
	MONSTER797	17	ZT61-7102	-	-

Street rear axle shaft comes with titanium nut and safety clip.



ZETA CYLINDER HEAD BOLT

- Side bolt for cylinder head to optimally dress up the engine.
- Oil line bolt for Kawasaki, engine plug for Suzuki oil cooling engine and Katana offered.
- Please use new O-ring and gasket for installation.

Part #	Size	Type
ZT15-5330	M14 P=1.5	KAWASAKI Oil Line Bolt
ZT15-5530	M14x12 P=1.25	SUZUKI Engine Plug



KAWASAKI Oil Line Bolt

SUZUKI Engine Plug

(mm)



ZETA

OFF ROAD TITANIUM BOLT KIT



-Kit package includes the required number to suit each motorcycle

OFF ROAD TITANIUM BOLT KIT

Part Application

Part #	Type	Size	qty
ZT83-2302	Flange Bolt Set #	M8X30	2
ZT83-2304	Flange Bolt Set #	M8X30	4
ZT83-2352	Flange Bolt Set #	M8X35	2
ZT83-2354	Flange Bolt Set #	M8X35	4
ZT83-2402	Flange Bolt Set #	M8X40	2
ZT83-2404	Flange Bolt Set #	M8X40	4
ZT83-2454	Flange Bolt Set #	M8X45	4
ZT83-2504	Flange Bolt Set #	M8X50	4
ZT84-2302	Flange Bolt Set #	M10x30	2
ZT84-2352	Flange Bolt Set #	M10x35	2
ZT84-2402	Flange Bolt Set #	M10x40	2
ZT87-1304	Cap Bolt Set	M8X30	4

No wiring hole

Front-Axle Pinch Bolt



Caliper Mount Bolt Kit



Handbar Clamp



Upper Stem Fork Clamp



Under Stem Fork Clamp



OFF ROAD TITANIUM BOLT KIT Application

Bike	Year	Handle Bar Clamp Bolt	Upper Stem Fork Clamp	Under Stem Fork Clamp	Front Axle Pinch Bolt	Caliper Mount Bolt Kit
HONDA						
CR85R/R II	03-07	ZT83-2304	ZT83-2352	ZT83-2404	-	ZT83-2302
CR125R	02-07	ZT83-2354	ZT83-2454	ZT83-2404	ZT83-2402	ZT83-2352
CR250R	02-07	ZT83-2354	ZT83-2454	ZT83-2404	ZT83-2402	ZT83-2352
CRF150R/ II	07-18	ZT83-2304	ZT83-2352	ZT83-2404	-	ZT83-2302
CRF250R	04-17	ZT83-2354	ZT83-2454	ZT83-2404	ZT83-2402	ZT83-2352
CRF450R	02-16	ZT83-2354	ZT83-2454	ZT83-2404	ZT83-2402	ZT83-2352
CRF450RX	17-18	ZT83-2354	ZT83-2454	ZT83-2404	ZT83-2402	ZT83-2352
CRF250X	04-17	ZT83-2354	ZT83-2454	ZT83-2404	ZT83-2402	ZT83-2352
CRF450X	05-17	ZT83-2354	ZT83-2454	ZT83-2404	ZT83-2402	ZT83-2352
CRF250L/M/RALLY	12-17	ZT83-2354	ZT83-2454	ZT83-2404	ZT83-2402	ZT83-2352
CRM250R/AR	94-98	ZT83-2354	ZT83-2454	ZT83-2404	ZT83-2402	ZT83-2352
XR230/MOTARD	05-13	ZT83-2354	ZT83-2454	ZT83-2354	-	ZT83-2402
XR250/MOTARD	03-07	ZT83-2354	ZT83-2504	ZT83-2404	ZT83-2402	ZT83-2402
KAWASAKI						
KX85/ II	01-13	ZT83-2304	ZT83-2352	ZT83-2404	-	ZT83-2402
KX125R	14-18	ZT83-2354	ZT83-2352	ZT83-2404	-	ZT83-2402
KX100	16-18	ZT83-2354	ZT83-2352	ZT83-2404	-	ZT83-2402
KX125	03-05	ZT83-2304	ZT83-2354	ZT83-2404	ZT83-2404	ZT83-2402
	06-08	ZT83-2354	ZT83-2404	ZT83-2404	ZT83-2404	ZT83-2402
	03-04	ZT83-2304	ZT83-2354	ZT83-2404	ZT83-2404	ZT83-2402
KX250	05	ZT83-2304	ZT83-2404	ZT83-2404	ZT83-2402	ZT83-2402
	06-08	ZT83-2354	ZT83-2404	ZT83-2404	ZT83-2404	ZT83-2402
KX250F	04-05	ZT83-2304	ZT83-2354	ZT83-2404	ZT83-2404	ZT83-2402
	06-18	ZT83-2354	ZT83-2404	ZT83-2454	ZT83-2404	ZT83-2402
KX450F	06-14	ZT83-2354	ZT83-2404	ZT83-2404	ZT83-2404	ZT83-2402
	15-18	ZT83-2354	ZT83-2404	ZT83-2454	ZT83-2404	ZT83-2402
D-TRACKER125	10-15	ZT83-2304	ZT83-2352	ZT83-2354	-	ZT84-2402
KLX125	10-16	ZT83-2304	ZT83-2352	ZT84-2352	-	ZT84-2402
KLX250/D-TRACKER	98-07	ZT83-2304	ZT83-2404	ZT84-2402	-	ZT83-2402
KLX250/D-TRACKER X	08-16	ZT83-2304	ZT83-2404	ZT84-2402	ZT83-2404	ZT83-2402
SUZUKI						
RM85/L	02-04	ZT83-2354	ZT83-2404	ZT83-2404	-	-
	05-12	ZT83-2354	ZT83-2404	ZT83-2404	-	ZT83-2302
RM125	01	ZT83-2404	ZT83-2404	ZT83-2404	ZT83-2404	ZT83-2402
	02-08	ZT83-2354	ZT83-2404	ZT83-2404	ZT83-2404	ZT83-2402
RM250	01-08	ZT83-2354	ZT83-2404	ZT83-2404	ZT83-2404	ZT83-2402
	04-06	ZT83-2304	ZT83-2354	ZT83-2404	ZT83-2404	ZT83-2402
RMZ250	07-15	ZT83-2354	ZT83-2404	ZT83-2404	ZT83-2404	ZT83-2402
	16-18	ZT83-2354	ZT83-2454	ZT83-2404	ZT83-2404	ZT83-2402
RMZ450	05-18	ZT83-2354	ZT83-2404	ZT83-2404	ZT83-2404	ZT83-2402
DRZ400S	00-17	ZT83-2354	ZT83-2504	ZT83-2454	ZT83-2354	ZT83-2402
DRZ400SM	05-06	ZT83-2354	ZT83-2404	ZT83-2404	ZT83-2404	ZT83-2402
	07-17	ZT83-2404	ZT83-2404	ZT83-2404	ZT83-2404	ZT83-2402

Bike	Year	Handle Bar Clamp Bolt	Upper Stem Fork Clamp	Under Stem Fork Clamp	Front Axle Pinch Bolt	Caliper Mount Bolt Kit
YAMAHA						
YZ85/LW	02-14	ZT83-2304	ZT83-2352	ZT83-2404	-	ZT83-2352
	15-18	ZT83-2304	ZT83-2402	ZT83-2404	-	ZT83-2352
	95-06	ZT83-2354	ZT83-2404	ZT83-2404	ZT83-2404	ZT83-2352
YZ125	07	ZT83-2404	ZT83-2404	ZT83-2404	ZT83-2404	ZT83-2352
	08-14	ZT83-2404	ZT83-2404	ZT83-2404	ZT83-2404	ZT83-2352
	15-18	ZT83-2404	ZT83-2404	ZT83-2354	ZT83-2354	ZT83-2352
	95-06	ZT83-2354	ZT83-2404	ZT83-2404	ZT83-2404	ZT83-2352
YZ250	07	ZT83-2404	ZT83-2404	ZT83-2404	ZT83-2404	ZT83-2352
	08-14	ZT83-2404	ZT83-2404	ZT83-2404	ZT83-2404	ZT83-2352
	15-18	ZT83-2404	ZT83-2404	ZT83-2354	ZT83-2354	ZT83-2352
YZ250F	01-05	ZT83-2404	ZT83-2404	ZT83-2404	ZT83-2404	ZT83-2352
	06	ZT83-2354	ZT83-2354	ZT83-2404	ZT83-2404	ZT83-2352
	07-18	ZT83-2354	ZT83-2354	ZT83-2354	ZT83-2354	ZT83-2352
YZ400F	98-99	ZT83-2354	ZT83-2404	ZT83-2404	ZT83-2404	ZT83-2352
YZ426F	00-02	ZT83-2354	ZT83-2404	ZT83-2404	ZT83-2404	ZT83-2352
	03-05	ZT83-2354	ZT83-2404	ZT83-2404	ZT83-2404	ZT83-2352
YZ450F	06	ZT83-2354	ZT83-2354	ZT83-2404	ZT83-2404	ZT83-2352
	07	ZT83-2354	ZT83-2354	ZT83-2354	ZT83-2404	ZT83-2352
	08-18	ZT83-2354	ZT83-2354	ZT83-2354	ZT83-2354	ZT83-2352
YZ125X	17-18	ZT83-2404	ZT83-2404	ZT83-2354	ZT83-2354	ZT83-2352
YZ250X	16-18	ZT83-2404	ZT83-2404	ZT83-2354	ZT83-2354	ZT83-2352
YZ250FX	15-18	ZT83-2354	ZT83-2354	ZT83-2354	ZT83-2354	ZT83-2352
YZ450FX	16-18	ZT83-2354	ZT83-2354	ZT83-2354	ZT83-2354	ZT83-2352
WR250F	01-06	ZT83-2354	ZT83-2404	ZT83-2404	ZT83-2404	ZT83-2352
	07-14	ZT83-2354	ZT83-2354	ZT83-2404	ZT83-2404	ZT83-2352
	15-18	ZT83-2354	ZT83-2354	ZT83-2354	ZT83-2404	ZT83-2352
WR400F	98-00	ZT83-2354	ZT83-2404	ZT83-2404	ZT83-2404	ZT83-2352
WR426F	01-02	ZT83-2354	ZT83-2404	ZT83-2404	ZT83-2404	ZT83-2352
	03-06	ZT83-2354	ZT83-2404	ZT83-2404	ZT83-2404	ZT83-2352
WR450F	07-15	ZT83-2354	ZT83-2354	ZT83-2404	ZT83-2404	ZT83-2352
	16-18	ZT83-2354	ZT83-2354	ZT83-2354	ZT83-2404	ZT83-2352
SEROW250	05-17	ZT87-1304	ZT83-2404	ZT83-2354	-	ZT84-2302
WR250R/X	07-17	ZT83-2354	ZT83-2404	ZT83-2404	ZT83-2404	ZT83-2352



Bike	Year	Part #
CR80R/R II	96-02	ZT34-2504N
CR85R/R II	03-07	ZT34-2504N
CR125R/250R	92-07	ZT34-2506N
CRF150R/ II	07-18	ZT34-2504N
CRF250R	04-17	ZT34-2506N
CRF450R	02-18	ZT34-2506N
CRF450RX	17-18	ZT34-2506N
CRF250X	04-17	ZT34-2506N
CRF450X	05-17	ZT34-2506N
CRF50F	04-14	ZT34-2504N
CRF70F/80F/100F	04-12	ZT34-2504N
CRF125F	14-15	ZT34-2504N
CRF150F/230F	03-11	ZT34-2506N
CRM50/80	94-98	ZT34-2504N
CRM250AR	97-98	ZT34-2506N
TLM220R	90-93	ZT34-2504N
XR50R	00-03	ZT34-2504N
XR70R	97-03	ZT34-2504N
XR80R	85-03	ZT34-2504N
XR100R	90-03	ZT34-2504N
XR250R	96-04	ZT34-2506N
XR400R	96-06	ZT34-2506N
XR650R	00-07	ZT34-2506N
SL230	97-04	ZT34-2506N
XR230	05-13	ZT34-2506N
XR250	95-07	ZT34-2506N
XR250 BAJA	95-04	ZT34-2506N
XR230 MOTARD	08-13	ZT34-2506N
XR250 MOTARD	03-07	ZT34-2506N
YZ80/LW	93-01	ZT34-2504N
YZ85/LW	02-18	ZT34-2504N
YZ125/250	90-18	ZT34-2506N
YZ250F	01-18	ZT34-2506N
YZ400F	98-99	ZT34-2506N
YZ426F	00-02	ZT34-2506N
YZ450F	03-18	ZT34-2506N
YZ125X	17-18	ZT34-2506N
YZ250X	16-18	ZT34-2506N
YZ250FX	15-18	ZT34-2506N
YZ450FX	16-18	ZT34-2506N
WR250F	01-18	ZT34-2506N
WR400F	98-00	ZT34-2506N
WR426F	01-02	ZT34-2506N
WR450F	03-18	ZT34-2506N
WR250R/X	07-17	ZT34-2706N

Bike	Year	Part #
KX125/250	89-08	ZT34-2506N
KX250F	04-18	ZT34-2506N
KX450F	06-18	ZT34-2506N
KLX450R	08-15	ZT34-2506N
KDX125SR	90-99	ZT34-2506N
KDX200SR	90-93	ZT34-2506N
KDX220SR	94-99	ZT34-2506N
KDX250SR	91-94	ZT34-2506N
KDX220R	94-05	ZT34-2506N
KDX250R	91-95	ZT34-2506N
KLX250/D-TRACKER	98-07	ZT34-2506N
KLX250/D-TRACKER X	08-16	ZT34-2506N
KLX250ES	94-97	ZT34-2506N
KLX250SR	93-97	ZT34-2506N
KLX300R	96-07	ZT34-2506N
KLX650R	93-96	ZT34-2506N
RM80	94-01	ZT34-2504N
RM85/L	02-12	ZT34-2504N
RM125/250	90-08	ZT34-2506N
RMZ250	07-18	ZT34-2506N
RMZ450	05-18	ZT34-2506N
RMX450Z	10-14	ZT34-2506N
RMX250R	96-98	ZT34-2506N
RMX250S	96-98	ZT34-2506N
RH250	84-88	ZT34-2506N
DRZ125/L	03-09	ZT34-2504N
DRZ400	00-04	ZT34-2506N
DRZ400E/E	00-17	ZT34-2506N
DRZ400SM	05-17	ZT34-2506N
DR250S	90-94	ZT34-2506N
DR350S	90-93	ZT34-2506N
DR650SE	96-00	ZT34-2506N
DR800S	91-96	ZT34-2506N
85SX	03-18	ZT34-2504N
125SX	01-18	ZT34-2506N
150SX	09-18	ZT34-2506N
250SX	01-18	ZT34-2506N
250SX-F	05-18	ZT34-2506N
350SX-F	11-18	ZT34-2506N
450SX-F	07-18	ZT34-2506N
450SX-R	03-06	ZT34-2506N
125XC	03-14	ZT34-2506N
200XC	00-16	ZT34-2506N
250/300XC	00-17	ZT34-2506N
250XC-R	01-06	ZT34-2506N
250XC-F	07-18	ZT34-2506N
350XC-F	12-18	ZT34-2506N
400XC-R	00-05	ZT34-2506N
450XC-R	03-08	ZT34-2506N
525XC-R	03-07	ZT34-2506N
400XC	09-11	ZT34-2506N
450XC/F	09-18	ZT34-2506N
500XC/F	12-18	ZT34-2506N
530XC	09-11	ZT34-2506N
150XC	12-18	ZT34-2506N
300XC-W	12-18	ZT34-2506N
FREERIDE 250R	14-17	ZT34-2504N
FREERIDE 350	12-17	ZT34-2504N
450SMR	05-14	ZT34-2506N
690ENDURO/R,SMC/R	08-14	ZT34-2506N



ZETA SPROCKET BOLT & NUT SET

- Titanium sprocket bolt and nut set, lighter than OEM sprocket bolts and nuts.
- Rust and stain resistant due to passive film on titanium material.
- Sprocket bolt set and bolt & nut set available.

Part #	qty	Bolt Type	Description
ZT11-0825	1	COUNTER SUNK	Sprocket Bolt
ZT34-2504N	4	COUNTER SUNK	Sprocket Bolt & Nut
ZT34-2506N	6	COUNTER SUNK	Sprocket Bolt & Nut
ZT11-1828	1	PAN HEAD	Sprocket Bolt
ZT34-2706N	6	PAN HEAD	Sprocket Bolt & Nut

COUNTER SUNK Dimensions
ZT11-0825

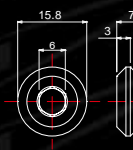

PAN HEAD Dimensions
ZT11-1828

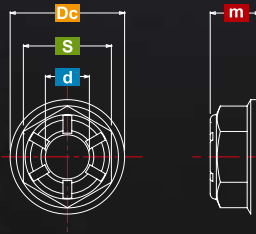
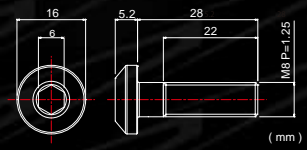

Part #	d	S	Dc	m	qty
ZT35-0806	M8 P=1.25	12	16	7.6	6
ZT35-1005	M10 P=1.25	14	19	9.6	5
ZT35-1006	M10 P=1.25	14	19	9.6	6
ZT35-1205	M12 P=1.25	17	23	11.6	5



ZETA SPROCKET NUT SET

- Titanium sprocket flange lock nut set.
- One size smaller size nut head for reduced weight.
- Lighter than OEM sprocket nuts,
- Nut sizes available : M8, M10 and M12, comes in 5 pc or 6 pc sets.



ZETA WHEEL NUT SET for NINJA H2 / R

- 64 Lightweight, high-strength wheel nut made of titanium.
- 17 g for stock 31 g, and 70 g lighter than a bike. Reduction in unsprung weight improves turnability, acceleration, deceleration, braking performance and fuel economy.
- It includes Titanium washer

Part #	Size	Kit
ZT39-1315	M12 P=1.25	5 pcs

Flange Bolt

Countersunk

Thin Head

Pan Head

Flat Head

ZETA

BRAKE DISC BOLT



- Titanium brake disc bolts kit.
- Different bolt head design from OE bolts for better workability.
- Available as a kit for specific models.
- Available for sport bikes and off road bikes applications.

Flange Bolt

Countersunk

Thin Head

Pan Head

Flat Head

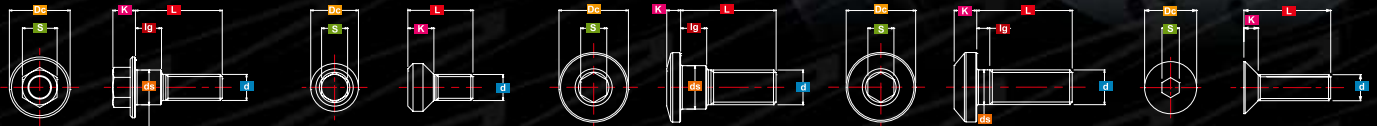

Type	Part #	d	S	Dc	K	ds	lg	L	qty
Thin Head 8 mm-M6x15	ZT10-3141	M6 P=1.0	5	14	3	8	23	15	1
	ZT31-3144	M6 P=1.0	5	14	3	8	23	15	4
	ZT31-3146	M6 P=1.0	5	14	3	8	23	15	6
Thin Head 9 mm-M6x14	ZT10-3421	M6 P=1.0	5	13	2.8	9	2.5	14	1
	ZT31-3424	M6 P=1.0	5	13	2.8	9	2.5	14	4
	ZT31-3426	M6 P=1.0	5	13	2.8	9	2.5	14	6
Thin Head 10 mm-M8x14.5	ZT10-3721	M8 P=1.25	6	14.8	3.2	10	2.5	14.5	1
	ZT31-3724	M8 P=1.25	6	14.8	3.2	10	2.5	14.5	4
	ZT31-3726	M8 P=1.25	6	14.8	3.2	10	2.5	14.5	6
Thin Head 10 mm-M8x20	ZT10-3741	M8 P=1.25	6	16	3.2	10	4.5	20	1
	ZT31-3743	M8 P=1.25	6	16	3.2	10	4.5	20	3
	ZT31-3744	M8 P=1.25	6	16	3.2	10	4.5	20	4
	ZT31-3745	M8 P=1.25	6	16	3.2	10	4.5	20	5
	ZT31-3746	M8 P=1.25	6	16	3.2	10	4.5	20	6
	ZT10-3761	M8 P=1.25	6	16	3.2	10	6	22	1
	ZT31-3763	M8 P=1.25	6	16	3.2	10	6	22	3
Thin Head 10 mm-M8x22	ZT31-3764	M8 P=1.25	6	16	3.2	10	6	22	4
	ZT31-3765	M8 P=1.25	6	16	3.2	10	6	22	5
	ZT31-3766	M8 P=1.25	6	16	3.2	10	6	22	6
Thin Head 10 mm-M8x28	ZT10-3781	M8 P=1.25	6	16	3.2	10	9	28	1
	ZT31-3785	M8 P=1.25	6	16	3.2	10	9	28	5
Pan Head 8 mm-M8x16	ZT10-1621	M8 P=1.25	6	16	5.2	-	2	16	1
	ZT31-1626	M8 P=1.25	6	16	5.2	-	2	16	6
	ZT10-1651	M8 P=1.25	6	16	5.2	-	3	22	1
	ZT31-1655	M8 P=1.25	6	16	5.2	-	3	22	5
Pan Head 8 mm-M8x22	ZT31-1656	M8 P=1.25	6	16	5.2	-	3	22	6
	ZT10-0521	M6 P=1.0	8	14	5.3	-	2.5	12.5	1
Flange Bolt 6 mm-M6x12.5	ZT31-0526	M6 P=1.0	8	14	5.3	-	2.5	12.5	6
	ZT10-0231	M6 P=1.0	8	10.5	5.3	-	2	13	1
Flange Bolt 6 mm-M6x13	ZT31-0234	M6 P=1.0	8	10.5	5.3	-	2	13	4
	ZT31-0236	M6 P=1.0	8	10.5	5.3	-	2	13	6
	ZT10-0261	M6 P=1.0	8	10.5	5.3	-	2	16	1
Flange Bolt 6 mm-M6x16	ZT31-0263	M6 P=1.0	8	10.5	5.3	-	2	16	3
	ZT31-0264	M6 P=1.0	8	10.5	5.3	-	2	16	4
	ZT31-0265	M6 P=1.0	8	10.5	5.3	-	2	16	5
	ZT31-0266	M6 P=1.0	8	10.5	5.3	-	2	16	6
Flange Bolt 6 mm-M6x16	ZT03-0616	M6 P=1.0	8	11	5.3	-	2	16	1
	ZT31-5706	M6 P=1.0	8	11	5.3	-	2	16	6

Type	Part #	d	S	Dc	K	ds	lg	L	qty
Flange Bolt 6 mm-M6x17	ZT10-0551	M6 P=1.0	8	13	5.2	-	3	17	1
	ZT31-0554	M6 P=1.0	8	13	5.2	-	3	17	4
	ZT31-0555	M6 P=1.0	8	13	5.2	-	3	17	5
Flange Bolt 6 mm-M6x20	ZT31-0556	M6 P=1.0	8	13	5.2	-	3	17	6
	ZT03-0620	M6 P=1.0	8	11	5.3	-	2	20	1
	ZT31-5614	M6 P=1.0	8	11	5.3	-	2	20	4
Flange Bolt & Nut 6 mm-M6x20	ZT31-5616	M6 P=1.0	8	11	5.3	-	2	20	6
	ZT31-5614N #	M6 P=1.0	8	11	5.3	-	2	20	4
	ZT31-5616N #	M6 P=1.0	8	11	5.3	-	2	20	6
Flange Bolt 8 mm-M8x20	ZT03-0820	M8 P=1.25	10	14	6.8	-	2.5	20	1
	ZT31-4824	M8 P=1.25	10	14	6.8	-	2.5	20	4
	ZT31-4826	M8 P=1.25	10	14	6.8	-	2.5	20	6
Flange Bolt 8 mm-M6x20	ZT10-0781	M6 P=1.0	8	14	5.2	8	6	20	1
	ZT31-0785	M6 P=1.0	8	14	5.2	8	6	20	5
	ZT31-0786	M6 P=1.0	8	14	5.2	8	6	20	6
Flange Bolt 8 mm-M8x20	ZT10-0801	M8 P=1.25	10	13.7	6.5	-	3	20	1
	ZT31-3825	M8 P=1.25	10	13.7	6.5	-	3	20	5
	ZT31-3826	M8 P=1.25	10	13.7	6.5	-	3	20	6
Flange Bolt 10 mm-M8x22	ZT10-0822	M8 P=1.25	10	15.8	5.8	10	6	22	1
	ZT31-0814	M8 P=1.25	10	15.8	5.8	10	6	22	4
	ZT31-0815	M8 P=1.25	10	15.8	5.8	10	6	22	5
Flange Bolt 10 mm-M8x28	ZT31-0816	M8 P=1.25	10	15.8	5.8	10	6	22	6
	ZT10-0828	M8 P=1.25	10	15.8	5.8	10	9	28	1
	ZT31-0835	M8 P=1.25	10	15.8	5.8	10	9	28	5
Counter Sunk M6x14	ZT10-2631	M6 P=1.0	6	11	5	-	-	14	1
	ZT31-2634	M6 P=1.0	6	11	5	-	-	14	4
	ZT31-2636	M6 P=1.0	6	11	5	-	-	14	6
Counter Sunk M6x18	ZT10-2651	M6 P=1.0	6	11	6	-	-	18	1
	ZT31-2653	M6 P=1.0	6	11	6	-	-	18	3
	ZT31-2654	M6 P=1.0	6	11	6	-	-	18	4
Flat Head M6x12	ZT31-2656	M6 P=1.0	6	11	6	-	-	18	6
	ZT09-6121	M6 P=1.0	4	12	3.3	-	-	12	1
	ZT31-6124	M6 P=1.0	4	12	3.3	-	-	12	4
Flat Head M6x16	ZT09-6161	M6 P=1.0	4	12	3.3	-	-	16	1
	ZT31-6163	M6 P=1.0	4	12	3.3	-	-	16	3
	ZT31-6166	M6 P=1.0	4	12	3.3	-	-	16	6
Flat Head M6x20	ZT09-6201	M6 P=1.0	4	12	3.3	-	-	20	1
	ZT31-6203	M6 P=1.0	4	12	3.3	-	-	20	3

With nut

STREET DISC BOLT SET



Bike	Year	Front			Rear		
		Size	qty	Part #	Size	qty	Part #
HONDA							
CB1300SF / BOLD'OL	05-13	Flange Bolt 6 mm-M6x17	6	ZT31-0556	Thin Head 10 mm-M8x22	6	ZT31-3766
	14-17	Flange Bolt 6 mm-M6x17	5	ZT31-0555	Thin Head 10 mm-M8x22	6	ZT31-3766
X-4	97-03	Flange Bolt 6 mm-M6x17	6	ZT31-0556	Thin Head 10 mm-M8x22	6	ZT31-3766
VFR1200F	10-17	Flange Bolt 6 mm-M6x17	6	ZT31-0556	Thin Head 10 mm-M8x22	5	ZT31-3745
CB1100	10-17	Flange Bolt 6 mm-M6x17	5	ZT31-0555	Thin Head 10 mm-M8x22	5	ZT31-3765
CBR1100XX	97-06	Flange Bolt 6 mm-M6x17	6	ZT31-0556	Thin Head 10 mm-M8x22	6	ZT31-3766
CBR1000RR	04-16	Flange Bolt 6 mm-M6x17	6	ZT31-0556	Thin Head 10 mm-M8x22	4	ZT31-3764
	17	Flange Bolt 6 mm-M6x17	5	ZT31-0555	Thin Head 10 mm-M8x22	4	ZT31-3764
CRF1000L AFRICA TWIN	17	Flange Bolt 6 mm-M6x17	6	ZT31-0556	Thin Head 10 mm-M8x22	4	ZT31-3764
VTR1000F	97-06	Flange Bolt 6 mm-M6x17	6	ZT31-0556	Thin Head 10 mm-M8x22	4	ZT31-3764
CBR954RR	02-03	Flange Bolt 6 mm-M6x17	6	ZT31-0556	Thin Head 10 mm-M8x22	4	ZT31-3764
CBR929RR	00-01	Flange Bolt 6 mm-M6x17	6	ZT31-0556	Thin Head 10 mm-M8x22	4	ZT31-3764
CB900F HORNET	02-07	Flange Bolt 6 mm-M6x17	6	ZT31-0556	Thin Head 10 mm-M8x22	4	ZT31-3764
NC750S/X	14-17	Thin Head 10 mm-M8x22	5	ZT31-3765	Thin Head 10 mm-M8x22	5	ZT31-3765
NC700S/X	12-17	Thin Head 10 mm-M8x22	5	ZT31-3765	Thin Head 10 mm-M8x22	5	ZT31-3765
CBR600RR	03-17	Flange Bolt 6 mm-M6x17	6	ZT31-0556	Thin Head 10 mm-M8x22	4	ZT31-3764
CBR250RR	17	Flange Bolt 8 mm-M8x20	6	ZT31-4826	Thin Head 10 mm-M8x22	4	ZT31-3764
YAMAHA							
XJR1300	98-02	Pan Head 8 mm-M8x22	6	ZT31-1656	Pan Head 8 mm-M8x22	6	ZT31-1656
	03-15	Flange Bolt 8 mm-M8x20	6	ZT31-0786	Pan Head 8 mm-M8x22	6	ZT31-1656
XJR1200	96-97	Pan Head 8 mm-M8x22	6	ZT31-1656	Pan Head 8 mm-M8x22	6	ZT31-1656
FZ1-S FAZER	08-14	Flange Bolt 8 mm-M6x20	5	ZT31-0785	Thin Head 10 mm-M8x20	5	ZT31-3745
FZ1-N	08-12	Flange Bolt 8 mm-M6x20	5	ZT31-0785	Thin Head 10 mm-M8x20	5	ZT31-3745
MT-10	17	Flange Bolt 8 mm-M6x20	5	ZT31-0785	Thin Head 10 mm-M8x20	5	ZT31-3745
YZF-R1	04-14	Flange Bolt 8 mm-M6x20	5	ZT31-0785	Thin Head 10 mm-M8x20	5	ZT31-3745
YZF-R1/M	15-17	Flange Bolt 8 mm-M6x20	5	ZT31-0785	Thin Head 10 mm-M8x20	5	ZT31-3745
TDM900	02-12	Flange Bolt 8 mm-M6x20	6	ZT31-0786	Pan Head 8 mm-M8x22	6	ZT31-1656
MT-09	15-17	Flange Bolt 8 mm-M6x20	5	ZT31-0785	Thin Head 10 mm-M8x20	5	ZT31-3745
FZ8/FAZER8	11-17	Flange Bolt 8 mm-M6x20	5	ZT31-0785	Pan Head 8 mm-M8x22	5	ZT31-1655
MT-07	15-17	Flange Bolt 8 mm-M6x20	5	ZT31-0785	Thin Head 10 mm-M8x20	5	ZT31-3745
YZF-R6	03-04	Flange Bolt 8 mm-M6x20	6	ZT31-0786	Thin Head 10 mm-M8x20	5	ZT31-3745
	06-17	Flange Bolt 8 mm-M6x20	5	ZT31-0785	Thin Head 10 mm-M8x20	5	ZT31-3745
XJ6 DIVERSION F	09-16	Flange Bolt 8 mm-M6x20	6	ZT31-0786	Pan Head 8 mm-M8x22	5	ZT31-1655
XJ6	09-16	Flange Bolt 8 mm-M6x20	6	ZT31-0786	Pan Head 8 mm-M8x22	5	ZT31-1655
YZF-R25/R3	15-17	Pan Head 8 mm-M8x22	5	ZT31-1655	Pan Head 8 mm-M8x22	3	ZT31-1653
KAWASAKI							
1400GTR	08-16	Thin Head 10 mm-M8x22	5	ZT31-3765	Thin Head 10 mm-M8x22	4	ZT31-3764
ZZR1400	06-17	Thin Head 10 mm-M8x22	5	ZT31-3765	Thin Head 10 mm-M8x22	4	ZT31-3764
		Flange Bolt 10 mm-M8x22	5	ZT31-0815			
ZZR1200	02-05	Thin Head 10 mm-M8x22	5	ZT31-3765	Thin Head 10 mm-M8x22	5	ZT31-3765
ZX-12R	00-06	Thin Head 10 mm-M8x22	5	ZT31-3765	Thin Head 10 mm-M8x22	4	ZT31-3764
ZRX1200 DAEG	09-16	Thin Head 10 mm-M8x22	5	ZT31-3765	Thin Head 10 mm-M8x22	4	ZT31-3764
ZRX1200	01-07	Thin Head 10 mm-M8x22	5	ZT31-3765	Thin Head 10 mm-M8x22	5	ZT31-3765
ZRX1100	96-00	Thin Head 10 mm-M8x22	5	ZT31-3765	Thin Head 10 mm-M8x22	5	ZT31-3765
ZZR1100D	93-00	Thin Head 10 mm-M8x22	5	ZT31-3765	Thin Head 10 mm-M8x22	4	ZT31-3764
ZEPHYR1100	92-06	Thin Head 10 mm-M8x22	5	ZT31-3765	Thin Head 10 mm-M8x22	6	ZT31-3766
ZX-10R	04-17	Thin Head 10 mm-M8x22	5	ZT31-3765	Thin Head 10 mm-M8x22	4	ZT31-3764
		Thin Head 10 mm-M8x22	5	ZT31-3765			
NINJA1000	11-17	Flange Bolt 10 mm-M8x22	5	ZT31-0815	Thin Head 10 mm-M8x22	4	ZT31-3764
		Thin Head 10 mm-M8x22	5	ZT31-3765			
Z1000	03-17	Flange Bolt 10 mm-M8x22	5	ZT31-0815	Thin Head 10 mm-M8x22	4	ZT31-3764
VERSYS1000	15-17	Thin Head 10 mm-M8x22	5	ZT31-3765	Thin Head 10 mm-M8x22	4	ZT31-3764
GPZ900R	93-99	Thin Head 10 mm-M8x22	5	ZT31-3765	Thin Head 10 mm-M8x22	6	ZT31-3766
NINJA250	13-17	Thin Head 10 mm-M8x22	5	ZT31-3765	Thin Head 10 mm-M8x22	3	ZT31-3763
SUZUKI							
GSX1400	01-06	Thin Head 10 mm-M8x28	5	ZT31-3785	Thin Head 10 mm-M8x28	5	ZT31-3785
		Flange Bolt 10 mm-M8x28	5	ZT31-0835			
		Thin Head 10 mm-M8x28	5	ZT31-3785			
GSX1300R HAYABUSA	99-07	Flange Bolt 10 mm-M8x28	5	ZT31-0835	Thin Head 10 mm-M8x28	5	ZT31-3785
		Thin Head 10 mm-M8x22	5	ZT31-3765			
		Flange Bolt 10 mm-M8x22	5	ZT31-0815	Thin Head 10 mm-M8x22	6	ZT31-3766
GSX1300 B-KING	08	Thin Head 10 mm-M8x22	5	ZT31-3765	Thin Head 10 mm-M8x22	6	ZT31-3766
		Thin Head 10 mm-M8x22	5	ZT31-3765			
BANDIT1250/F/S	07-16	Flange Bolt 10 mm-M8x22	5	ZT31-0815	Thin Head 10 mm-M8x22	5	ZT31-3765
V-STROM1000/XT ABS	17	Thin Head 10 mm-M8x22	5	ZT31-3765	Thin Head 10 mm-M8x22	4	ZT31-3764
GSX-S1000F/ABS	15-17	Flange Bolt 8 mm-M6x20	6	ZT31-0786	Thin Head 10 mm-M8x22	5	ZT31-3765
GSX-S1000/ABS	15-17	Flange Bolt 8 mm-M6x20	6	ZT31-0786	Thin Head 10 mm-M8x22	5	ZT31-3765
		Thin Head 10 mm-M8x28	5	ZT31-3785	Thin Head 10 mm-M8x28	5	ZT31-3785
GSX-R1000	05-08	Thin Head 10 mm-M8x22	5	ZT31-3765	Thin Head 10 mm-M8x22	5	ZT31-3765
		Flange Bolt 8 mm-M6x20	6	ZT31-0786	Thin Head 10 mm-M8x22	5	ZT31-3765
GSX-R750	06-07	Thin Head 10 mm-M8x22	5	ZT31-3765	Thin Head 10 mm-M8x22	5	ZT31-3765
		Flange Bolt 8 mm-M6x20	6	ZT31-0786	Thin Head 10 mm-M8x22	5	ZT31-3765
GSX-R600	06-07	Thin Head 10 mm-M8x22	5	ZT31-3765	Thin Head 10 mm-M8x22	5	ZT31-3765
		Flange Bolt 8 mm-M6x20	6	ZT31-0786	Thin Head 10 mm-M8x22	5	ZT31-3765
GSX250R	17	Flange Bolt 8 mm-M6x20	6	ZT31-0786	Thin Head 10 mm-M8x22	5	ZT31-3765

Bike	Year	Front		
		Size	qty	Part #
DUKATI				
DIAVEL/DARK/CARBON	11-17	Flange Bolt 8 mm-M8X20	5	ZT31-3825
1299 PANIGALE/S/R	15-17	Flange Bolt 8 mm-M8X20	5	ZT31-3825
1199 PANIGALE/S/R	12-15	Flange Bolt 8 mm-M8X20	5	ZT31-3825
959 PANIGALE	16-17	Flange Bolt 8 mm-M8X20	5	ZT31-3825
899 PANIGALE	14-15	Flange Bolt 8 mm-M8X20	5	ZT31-3825
SS 1000/DS	03-06	Flange Bolt 8 mm-M8X20	6	ZT31-3826
MONSTER 1200/S/R	14-17	Flange Bolt 8 mm-M8X20	5	ZT31-3825
MONSTER 821/DARK	15-17	Flange Bolt 8 mm-M8X20	5	ZT31-3825
MULTISTRADA 1200/S/PIKES	10-17	Flange Bolt 8 mm-M8X20	5	ZT31-3825
HYPERMOTARD/SP	13-15	Flange Bolt 8 mm-M8X20	5	ZT31-3825
HYPERMOTARD 939/SP	16-17	Flange Bolt 8 mm-M8X20	5	ZT31-3825
STREETFIGHTER 848/S	10-15	Flange Bolt 8 mm-M8X20	5	ZT31-3825
PAUL SMART 1000	06	Flange Bolt 8 mm-M8X20	6	ZT31-3826
GT 1000/TOURING	07-10	Flange Bolt 8 mm-M8X20	6	ZT31-3826
SPORT 1000/S	06-09	Flange Bolt 8 mm-M8X20	6	ZT31-3826
MV AGUSTA				
F4/R/RR	12-16	Flange Bolt 8 mm-M8X20	5	ZT31-3825
F3 800/RC	15-16	Flange Bolt 8 mm-M8X20	5	ZT31-3825
F3 675	15-16	Flange Bolt 8 mm-M8X20	5	ZT31-3825
BRUTALE 1090 RR	13-16	Flange Bolt 8 mm-M8X20	5	ZT31-3825
DRAGSTAR 800/RR	15-16	Flange Bolt 8 mm-M8X20	5	ZT31-3825
BRUTALE 800/RR	13-16	Flange Bolt 8 mm-M8X20	5	ZT31-3825
BRUTALE 675	12-14	Flange Bolt 8 mm-M8X20	5	ZT31-3825
TURISMO VELOCE 800	15-16	Flange Bolt 8 mm-M8X20	5	ZT31-3825
RIVALE 800	13-16	Flange Bolt 8 mm-M8X20	5	ZT31-3825
STRADALE 800	15-16	Flange Bolt 8 mm-M8X20	5	ZT31-3825



Front DISC BOLT
Flange Bolt 10 mm - M8 x 22 **ZT31-0815**



Front DISC BOLT
Thin Head 10 mm - M8 x 22 **ZT31-3765**

Front disc, quantity for one side



OFF ROAD DISC BOLT SET



Rear DISC BOLT (KX450F)
Thin Head 10 mm - M8 x 14.5 **ZT31-3724**



Front DISC BOLT (YZ250FX)
Counter Sunk M6 x 14 **ZT31-2636**

- #1 Front disc, quantity for one side
- #2 Lock nut included. Nut not included.
ZT31-5616 (6 qty), **ZT31-5614** (4 qty)
- #3 Disk bolt set only.
Need **ZT21-1061** (lock nut) for mounting

* [-] No drum brake, or no special with configuration.
* The following compatibility table is for sales part number of common models, if model is not shown on the table, please check OEM size prior to purchasing.
* Apply locktight when installing disc bolts.

Bike	Year	Front			Rear		
		Size	qty	Part #	Size	qty	Part #
CR80R/85R/RII	96-07	Flange Bolt 6 mm-M6x17	4	ZT31-0554	Flange Bolt 6 mm-M6x17	4	ZT31-0554
	95-01	Flange Bolt 6 mm-M6x20 & Nut	6	ZT31-5616N #2	Thin Head 10 mm-M8x22	4	ZT31-3764
CR125R/250R	02-07	Flange Bolt 6 mm-M6x20 & Nut	6	ZT31-5616N #2	Flange Bolt 6 mm-M6x20 & Nut	4	ZT31-5614N #2
	07-18	Flange Bolt 6 mm-M6x17	4	ZT31-0554	Flange Bolt 6 mm-M6x17	4	ZT31-0554
CRF250R	04-17	Flange Bolt 6 mm-M6x20 & Nut	6	ZT31-5616N #2	Flange Bolt 6 mm-M6x20 & Nut	4	ZT31-5614N #2
CRF450R	02-18	Flange Bolt 6 mm-M6x20 & Nut	6	ZT31-5616N #2	Flange Bolt 6 mm-M6x20 & Nut	4	ZT31-5614N #2
CRF450RX	17-18	Flange Bolt 6 mm-M6x20 & Nut	6	ZT31-5616N #2	Flange Bolt 6 mm-M6x20 & Nut	4	ZT31-5614N #2
CRF250X	04-17	Flange Bolt 6 mm-M6x20 & Nut	6	ZT31-5616N #2	Flange Bolt 6 mm-M6x20 & Nut	4	ZT31-5614N #2
CRF450X	05-17	Flange Bolt 6 mm-M6x20 & Nut	6	ZT31-5616N #2	Flange Bolt 6 mm-M6x20 & Nut	4	ZT31-5614N #2
CRF125F	14-18	Flange Bolt 6 mm-M6x17	4	ZT31-0554	-	-	-
CRF150F/230F	03-11	Flange Bolt 6 mm-M6x17	4	ZT31-0554	-	-	-
CRM50/80	94-98	Flange Bolt 6 mm-M6x17	4	ZT31-0554	Thin Head 10 mm-M8x22	4	ZT31-3764
CRM250R/AR	89-98	Flange Bolt 6 mm-M6x17	4	ZT31-0554	Thin Head 10 mm-M8x22	4	ZT31-3764
CRF250L/IM/R ALLY	12-17	Flange Bolt 6 mm-M6x17	6	ZT31-0556	Thin Head 10 mm-M8x22	4	ZT31-3764
CRF1000L AFRICA TWIN	16-17	Flange Bolt 6 mm-M6x17	6 #1	ZT31-0556	Thin Head 10 mm-M8x22	4	ZT31-3764
SL230	97-04	Flange Bolt 6 mm-M6x17	4	ZT31-0554	Thin Head 10 mm-M8x22	4	ZT31-3764
XR50/100 MOTARD	05-08	Thin Head 10 mm-M8x22	3	ZT31-3763	Thin Head 10 mm-M8x22	3	ZT31-3763
XR230/MOTARD	05-13	Flange Bolt 6 mm-M6x17	4	ZT31-0554	Thin Head 10 mm-M8x22	4	ZT31-3764
XR250R/BAJA	88-94	Flange Bolt 6 mm-M6x17	4	ZT31-0554	Thin Head 10 mm-M8x22	4	ZT31-3764
XR250/BAJA	95-07	Flange Bolt 6 mm-M6x17	4	ZT31-0554	Thin Head 10 mm-M8x22	4	ZT31-3764
XR250 MOTARD	03-07	Flange Bolt 6 mm-M6x17	4	ZT31-0554	Thin Head 10 mm-M8x22	4	ZT31-3764
XR250R	90-04	Flange Bolt 6 mm-M6x17	4	ZT31-0554	Thin Head 10 mm-M8x22	4	ZT31-3764
XR400 MOTARD	05-08	Flange Bolt 6 mm-M6x17	4	ZT31-0554	Thin Head 10 mm-M8x22	4	ZT31-3764
XR400R	96-06	Flange Bolt 6 mm-M6x17	4	ZT31-0554	Thin Head 10 mm-M8x22	4	ZT31-3764
XR600R	91-00	Flange Bolt 6 mm-M6x17	4	ZT31-0554	Thin Head 10 mm-M8x22	4	ZT31-3764
XR650R	00-07	Flange Bolt 6 mm-M6x17	4	ZT31-0554	Flange Bolt 6 mm-M6x17	4	ZT31-0554
KR650L	93-15	Thin Head 10 mm-M8x22	4	ZT31-3764	Thin Head 10 mm-M8x22	4	ZT31-3764
KRV750 AFRICA TWIN	93-00	Thin Head 10 mm-M8x22	4 #1	ZT31-3764	Thin Head 10 mm-M8x22	4	ZT31-3764
YZ280/85/LW	93-18	Counter Sunk M6x18	3	ZT31-2653	Counter Sunk M6x18	4	ZT31-2654
	90-97	Counter Sunk M6x18	6	ZT31-2656	Counter Sunk M6x18	6	ZT31-2656
YZ125/250	98-07	Counter Sunk M6x18	6	ZT31-2656	Flange Bolt 6 mm-M6x12.5	6	ZT31-0526
	08-18	Counter Sunk M6x14	6	ZT31-2636	Flange Bolt 6 mm-M6x12.5	6	ZT31-0526
	01-07	Counter Sunk M6x18	6	ZT31-2656	Flange Bolt 6 mm-M6x12.5	6	ZT31-0526
YZ250F	08-18	Counter Sunk M6x14	6	ZT31-2636	Flange Bolt 6 mm-M6x12.5	6	ZT31-0526
YZ2400/426/450F	98-07	Counter Sunk M6x18	6	ZT31-2656	Flange Bolt 6 mm-M6x12.5	6	ZT31-0526
	08-17	Counter Sunk M6x14	6	ZT31-2636	Flange Bolt 6 mm-M6x12.5	6	ZT31-0526
YZ450F	18	Counter Sunk M6x14	6	ZT31-2636	Counter Sunk M6x14	6	ZT31-2636
YZ125X	17-18	Counter Sunk M6x14	6	ZT31-2636	Flange Bolt 6 mm-M6x12.5	6	ZT31-0526
YZ250X	16-18	Counter Sunk M6x14	6	ZT31-2636	Flange Bolt 6 mm-M6x12.5	6	ZT31-0526
YZ250FX	15-18	Counter Sunk M6x14	6	ZT31-2636	Flange Bolt 6 mm-M6x12.5	6	ZT31-0526
YZ450FX	16-18	Counter Sunk M6x14	6	ZT31-2636	Flange Bolt 6 mm-M6x12.5	6	ZT31-0526
WR250F	01-07	Counter Sunk M6x18	6	ZT31-2656	Flange Bolt 6 mm-M6x12.5	6	ZT31-0526
	08-18	Counter Sunk M6x14	6	ZT31-2636	Flange Bolt 6 mm-M6x12.5	6	ZT31-0526
WR400/426/450F	98-07	Counter Sunk M6x18	6	ZT31-2656	Flange Bolt 6 mm-M6x12.5	6	ZT31-0526
WR450F	08-18	Counter Sunk M6x14	6	ZT31-2636	Flange Bolt 6 mm-M6x12.5	6	ZT31-0526
DT200WR	91-94	Thin Head 8 mm-M6x15	6	ZT31-3146	Thin Head 8 mm-M6x15	6	ZT31-3146
DT230L/ANZA	97-00	Thin Head 8 mm-M6x15	6	ZT31-3146	Thin Head 8 mm-M6x15	6	ZT31-3146
SEROW/250W/WE	93-01	Flange Bolt 6 mm-M6x17	6	ZT31-0556	Thin Head 10 mm-M8x22	3	ZT31-3743
SEROW250	05-17	Flange Bolt 6 mm-M6x17	6	ZT31-0556	Thin Head 10 mm-M8x22	3	ZT31-3743
TTR125LW/LWE	00-06	Thin Head 8 mm-M6x15	4	ZT31-3144	-	-	-
TTR225/230	99-11	Flange Bolt 6 mm-M6x17	6	ZT31-0556	-	-	-
TT250R/RAID	93-97	Thin Head 8 mm-M6x15	6	ZT31-3146	Thin Head 8 mm-M6x15	6	ZT31-3146
TRICKER	04-17	Flange Bolt 6 mm-M6x17	6	ZT31-0556	Thin Head 10 mm-M8x20	3	ZT31-3743
WR250R	07-17	Flange Bolt 6 mm-M6x15	6	ZT31-5706	Flange Bolt 6 mm-M6x15	6	ZT31-5706
WR250X	07-17	PanHead Bolt M8x16	6	ZT31-1626	Flange Bolt 6 mm-M6x15	6	ZT31-5706
XT250X	06-17	Flange Bolt 6 mm-M6x17	6	ZT31-0556	Thin Head 10 mm-M8x20	3	ZT31-3743
XT600E	90-95	Flange Bolt 6 mm-M6x15	6	ZT31-5706	Flange Bolt 6 mm-M6x17	6	ZT31-0556
KX65	00-18	Thin Head 9 mm-M6x14	4	ZT31-3424	Thin Head 9 mm-M6x14	4	ZT31-3424
KX80/II	87-00	Flat Head Bolt M6x12	4	ZT31-6124	Flat Head Bolt M6x12	4	ZT31-6124
KX85/II	01-18	Thin Head 9 mm-M6x14	6	ZT31-3426	Thin Head 9 mm-M6x14	4	ZT31-3424
KX100	16-18	Thin Head 9 mm-M6x14	6	ZT31-3426	Thin Head 9 mm-M6x14	4	ZT31-3424
KX125/250	89-02	Counter Sunk M6x14	4	ZT31-2634	Counter Sunk M6x14	6	ZT31-2636
	03-08	Thin Head 9 mm-M6x14	4	ZT31-3424	Thin Head 10 mm-M8x14.5	4	ZT31-3724
KX250F	04-18	Thin Head 9 mm-M6x14	4	ZT31-3424	Thin Head 10 mm-M8x14.5	4	ZT31-3724
KX450F	06-18	Thin Head 9 mm-M6x14	4	ZT31-3424	Thin Head 10 mm-M8x14.5	4	ZT31-3724
KLX450R	08-15	Thin Head 9 mm-M6x14	4	ZT31-3424	Thin Head 10 mm-M8x14.5	4	ZT31-3724
D-TRACKER125	10-15	Thin Head 10 mm-M8x14.5	6	ZT31-3726	Thin Head 10 mm-M8x14.5	6	ZT31-3726
KLX125	10-16	Thin Head 10 mm-M8x14.5	6	ZT31-3726	Thin Head 10 mm-M8x14.5	6	ZT31-3726
D-TRACKER/X	98-16	Thin Head 10 mm-M8x14.5	4	ZT31-3724	Thin Head 10 mm-M8x14.5	6	ZT31-3726
KDX125SR	90-99	Thin Head 10 mm-M8x14.5	4	ZT31-3724	Thin Head 10 mm-M8x14.5	6	ZT31-3726
KDX200SR	90-93	Thin Head 10 mm-M8x14.5	4	ZT31-3724	Thin Head 10 mm-M8x14.5	6	ZT31-3726
KDX220SR	94-99	Thin Head 10 mm-M8x14.5	4	ZT31-3724	Thin Head 10 mm-M8x14.5	6	ZT31-3726
KDX220R	94-05	Thin Head 10 mm-M8x14.5	4	ZT31-3724	Thin Head 10 mm-M8x14.5	6	ZT31-3726
KDX250R/SR	91	Thin Head 10 mm-M8x14.5	4	ZT31-3724	Thin Head 10 mm-M8x14.5	6	ZT31-3726
	92-95	Counter Sunk M6x14	4	ZT31-2634	Thin Head 10 mm-M8x14.5	6	ZT31-3726
KLX250	98-16	Thin Head 10 mm-M8x14.5	4	ZT31-3724	Thin Head 10 mm-M8x14.5	6	ZT31-3726
KLX250ES	94-97	Thin Head 10 mm-M8x14.5	4	ZT31-3724	Thin Head 10 mm-M8x14.5	6	ZT31-3726
KLX250SR	93-97	Thin Head 10 mm-M8x14.5	4	ZT31-3724	Thin Head 10 mm-M8x14.5	6	ZT31-3726
KLX250R/300R	93-07	Counter Sunk M6x14	4	ZT31-2634	Thin Head 10 mm-M8x14.5	6	ZT31-3726
SUPER SHERPA	97-08	Thin Head 10 mm-M8x14.5	6	ZT31-3726	-	-	-
KLX650	93-96	Thin Head 10 mm-M8x14.5	4	ZT31-3724	Thin Head 10 mm-M8x14.5	6	ZT31-3726
KLX650R	93-96	Counter Sunk M6x14	4	ZT31-2634	Thin Head 10 mm-M8x14.5	6	ZT31-3726
RM80/85/L	94-12	Flat Head Bolt M6x20	3	ZT31-6203 #3	Flat Head Bolt M6x12	4	ZT31-6124
	88-95	Flat Head Bolt M6x16	6	ZT31-6166	Flat Head Bolt M6x16	6	ZT31-6166
RM125/250	96-05	Counter Sunk M6x18	6	ZT31-2656	Counter Sunk M6x18	6	ZT31-2656
	06-08	Counter Sunk M6x18	6	ZT31-2656	Flange Bolt 6 mm-M6x13	6	ZT31-0236
RMZ250	07-18	Thin Head 9 mm-M6x14	4	ZT31-3424	Thin Head 10 mm-M8x14.5	4	ZT31-3724
RMZ450	05-18	Thin Head 9 mm-M6x14	4	ZT31-3424	Thin Head 10 mm-M8x14.5	4	ZT31-3724
RMX450Z	10-17	Thin Head 9 mm-M6x14	4	ZT31-3424	Thin Head 10 mm-M8x14.5	4	ZT31-3724
DRZ125L	03-09	Flat Head Bolt M6x20	3	ZT31-6203 #3	-	-	-
RMX250R/S	89-95	Flat Head Bolt M6x16	6	ZT31-6166	Flat Head Bolt M6x16	6	ZT31-6166
	96-98	Counter Sunk M6x18	6	ZT31-2656	Counter Sunk M6x18	6	ZT31-2656
SX125R/200R	85-91	Thin Head 10 mm-M8x20	4	ZT31-3744	-	-	-
TS125R/200R	89-97	Thin Head 10 mm-M8x20	4	ZT31-3744	-	-	-
DJEBEL125/200	93-06	Thin Head 10 mm-M8x20	4	ZT31-3744	-	-	-
DR250R/RX	95-05	Flat Head Bolt M6x16	6	ZT31-6166	Thin Head 10 mm-M8x20	4	ZT31-3744
DR250S/350S	90-94	Thin Head 10 mm-M8x20	4	ZT31-3744	-	-	-
DR650SE	96-00	Thin Head 10 mm-M8x20	6	ZT31-3746	Thin Head 10 mm-M8x20	6	ZT31-3746
DR800S	91-96	Thin Head 10 mm-M8x20	6	ZT31-3746	Thin Head 10 mm-M8x20	6	ZT31-3746
DRZ400/E/S	00-17	Counter Sunk M6x18	6	ZT31-2656	Counter Sunk M6x18	6	ZT31-2656
DRZ400SM	05-17	Counter Sunk M6x18	6	ZT31-2656	Counter Sunk M6x18	6	ZT31-2656
50SX	07-13	Flange Bolt 6 mm-M6x13	4	ZT31-0234	Flange Bolt 6 mm-M6x16	5	ZT31-0265
	14-18	Flange Bolt 6 mm-M6x13	4	ZT31-0234	Flange Bolt 6 mm-M6x16	4	ZT31-0264
65SX	02-05	Flat Head Bolt M6x16	3	Z			



2018

Z ZETA

HIGH PERFORMANCE PRODUCTS

DRC

HARDWARE

STREET CATALOG



FLIGHT TOP BRIDGE

for
RACING/
STREET



1199S PANIGALE

ZETA FLIGHT TOP BRIDGE

- Maximum light weight design with great rigidity balance.
- Made of durable CNC machined aluminum with black anodized finish.
- Comes with titanium front fork clamp bolts.

	Bike	Year	Part #
HONDA	CBR250RR	17	ZS41-0210
YAMAHA	YZF-R25/R3	15-17	ZS41-3210
	YZF-R1/M	15-17	ZS41-3810
KAWASAKI	NINJA 250/R	08-17	ZS41-1210
	NINJA ZX-10R	16-17	ZS41-1810
	NINJA H2/R	15-17	ZS41-1850
SUZUKI	GSX-R600/750	06-17	ZS41-2610
	GSX-R1000	09-17	ZS41-2810
BMW	S1000RR	15-17	ZS41-5810
	1198/S/R,1098/S/R,848/EVO	07-13	ZS41-6810
DUCATI	1199S/R,1299S/R,959,899 PANIGALE	12-17	ZS41-6820
APRILIA	RSV4 R/FACTORY APRC	09-14	ZS41-7810

Spec
Material : 6061-T6 Aluminium
Clamp Bolt : Ti-6AL-4V

ZETA HIGH PERFORMANCE PRODUCTS STREET

CONTROL



LEVER



BODY



ELECTRICAL



CBR250RR



[Design]

Rounded edge design for less stress concentration and rigidity.



[Rigidity Balance]

Top bridge body is flexible when the bike is deeply banked for smooth front fork movement.



[Factory Look]

Recent light weight design used on Moto GP and WSBK race bikes.



[Light weight design]

Super light weight design, but still provides great rigidity balance. RSV4 stock top bridge weight = 534 g, ZETA top bridge = 494 g. ZETA is 40 g lighter than stock RSV4 top bridge.



[Ti-6AL-4V bolt]

Clamp bolt is made of titanium for light weight and stable tightening torque.

Aim for fastest lap!

FLIGHT HANDLE

ZETA
HIGH PERFORMANCE PRODUCTS
STREET

2017 Moto America Champion
Yoshimura Suzuki Factory
Racing Team **TONI ELIAS**

Used by
TRICK STAR Racing



CONTROL



LEVER



BODY



ELECTRICAL



for
RACING

ZETA FLIGHT HANDLE

- ZETA Clip on handle for racing use.
- All bolts and pins are made of Ti-6AL-4V titanium.
- Clamp body is made of 7009-T6 aluminum with precision CNC light weight finish for light weight and durability.
- Handlebar is made of 6061-T6 aluminum to ease impact and protect clamp body in event of a crash.
- Available in standard and short offset handle with many clamps and handlebar angles.

Type	Part #	Clamp			Handlebar	
		Diameter (mm)	Offset (mm)	Angle	Length (mm)	Replacement
STD	ZS03-0133	50	39	6°	270	ZS03-8002
	ZS03-0135	50	39	9°	270	ZS03-8002
	ZS03-0167	53	40,5	6°	270	ZS03-8002
	ZS03-0233	50	29	6°	205*	ZS03-8003
Short	ZS03-0237	50	29	12°	205*	ZS03-8003
	ZS03-0257	52	30	12°	205*	ZS03-8003
	ZS03-0333	50	29	6°	222*	ZS03-8004
	ZS03-0337	50	29	12°	222*	ZS03-8004
	ZS03-0357	52	30	12°	222*	ZS03-8004

Effective length

Spec

Material(clamp) : A7009-T6
 Material(bar) : A6061-T6
 Surface finish : Color anodized finish
 Handlebar out side diameter : 22.2 mm
 Handlebar inside diameter : 16 mm
 Clamp thickness : 36 mm

FUNCTION



HIGH QUALITY

Made of machined A7009-T6 aluminum for light weight.
 All bolts and pins are made of Ti-6AL-4V titanium.

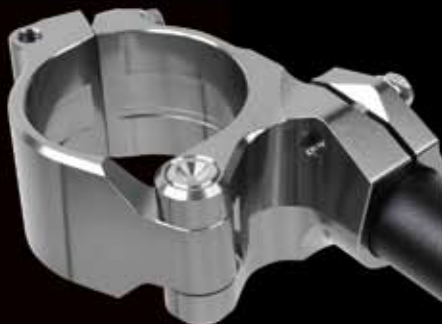

CLAMP

Clamp attaching design for quick handle installation and removal.
 Gap on the inner side of clamp provides better contact pressure.



HANDLEBAR

Throttle side has polished finish for smooth throttle control.
 Clutch side has shot peening finish for secure grip holding.



Handlebar adjustable system

Provides comfort or sport riding handlebar positions.

for
STREET

ZETA

PILOT HANDLE

- Provide many handlebar positions on your bike, great to use for sport riding and touring.
- Clamp and handlebar are made of A6061-T6 aluminum for durability.
- Clamp body is CNC machined, available red or titanium anodized colors.
- Handlebar bracket available in 2 different heights, 25 mm and 45 mm.
- Provides 2 different handlebar angles, 5 degree or 10 degree by changing handlebar bracket position on clamp body.
- Optional offset plate available if you need more space between OE clamp and handle bracket.
- Replacement handles available.

Size	Part #			
	Ti-color		Red	
Fork clamp	High (45 mm)	Middle (25 mm)	High (45 mm)	Middle (25 mm)
φ37	ZS03-1371	ZS03-1372	ZS03-1375	ZS03-1376
φ41	ZS03-1411	ZS03-1412	ZS03-1415	ZS03-1416
φ43	ZS03-1431	ZS03-1432	ZS03-1435	ZS03-1436
φ50	ZS03-1501	ZS03-1502	ZS03-1505	ZS03-1506
φ53	ZS03-1531	ZS03-1532	ZS03-1535	ZS03-1536

Spec

Material : A6061-T06
 Surface finish : Color anodized finish
 Handlebar out side diameter : φ 22.2
 Handlebar inside diameter : φ 16
 Handlebar length : 270 mm
 Clamp thickness : 34 mm
 (30 mm for φ37 clamp)



CLAMP

Gap on the inner side of clamp provides better contact pressure and prevents clamp from moving on to front forks and handlebars.



HIGH QUALITY

Fully machined from A6061-T6 aluminum, to achieve a light weight and durable product.

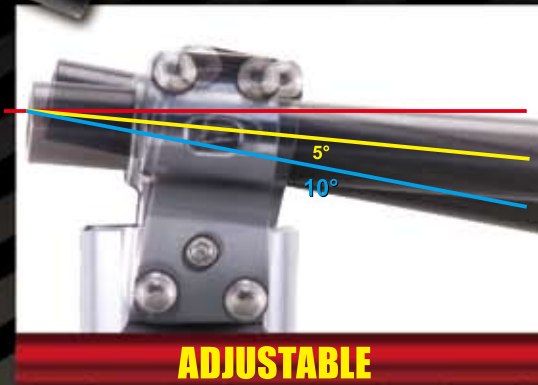

ADJUSTABLE

Provides 2 different handlebar angles, 10 degree angle for sport riding, 5 degree angle for comfortable riding position.

Replacement



REPLACEMENT BARS

ZS03-8002 * Required drilling hole for control switch.

Optional



OFFSET PLATE KIT (5 mm)

Use this plate kit when you need more space between OE clamp and handle bracket.

ZS03-1911 Ti-color
 ZS03-1915 Red

* Comes with attachment bolts.



HANDLEBAR BRACKET KIT

High (45 mm) Middle (25 mm)
 ZS03-1941 Ti-color ZS03-1942 Ti-color
 ZS03-1945 Red ZS03-1946 Red

CONTROL



LEVER



BODY



ELECTRICAL





Bike	Year	Gold	Ti-color
HONDA			
CBR250R	11-17	ZS48-1104	ZS48-1108
CBR250RR	17	ZS48-1104	ZS48-1108
CB250F	14-17	ZS48-1104	ZS48-1108
CBR300R	15-17	ZS48-1104	ZS48-1108
CB300F	15-17	ZS48-1104	ZS48-1108
400X	13-17	ZS48-1104	ZS48-1108
CB400F	13-16	ZS48-1104	ZS48-1108
CB400SF	92-16	ZS48-1104	ZS48-1108
CBR400R	13-17	ZS48-1104	ZS48-1108
CB500X	13-17	ZS48-1104	ZS48-1108
CB500F	13-17	ZS48-1104	ZS48-1108
CBR500R	13-17	ZS48-1104	ZS48-1108
CBR600RR	03-17	ZS48-1104	ZS48-1108
CB650F	14-17	ZS48-1104	ZS48-1108
CBR650F	14-18	ZS48-1104	ZS48-1108
NC700X	12-17	ZS48-1104	ZS48-1108
NC750S/X	14-17	ZS48-1104	ZS48-1108
VFR800	98-09	ZS48-1104	ZS48-1108
VFR800F	14-17	ZS48-1104	ZS48-1108
CB1000R	11-17	ZS48-1104	ZS48-1108
CBR1000RR	04-17	ZS48-1104	ZS48-1108
CB1100	10-17	ZS48-1104	ZS48-1108
CBR1100XX	97-03	ZS48-1104	ZS48-1108
VFR1200F	10-14	ZS48-1104	ZS48-1108
CB1300SF	03-17	ZS48-1104	ZS48-1108
YAMAHA			
MT-25	16-17	ZS48-1404	ZS48-1408
MT-03	16-17	ZS48-1404	ZS48-1408
YZF-R25	15-17	ZS48-1404	ZS48-1408
YZF-R3	15-17	ZS48-1404	ZS48-1408
FZ6	04-08	ZS48-1414	ZS48-1418
FZ6R	07-17	ZS48-1414	ZS48-1418
YZF-R6	06-16	ZS48-1404	ZS48-1408
FZ07	15-17	ZS48-1414	ZS48-1418
MT07	14-17	ZS48-1414	ZS48-1418
FZ8	11-15	ZS48-1404	ZS48-1408
FZ09	14-17	ZS48-1414	ZS48-1418
MT09	14-17	ZS48-1414	ZS48-1418
XSR900	16-17	ZS48-1414	ZS48-1418
FZ1 (North America)	01-15	ZS48-1414	ZS48-1418
FZ1 FAZER (Japan)	08-15	ZS48-1414	ZS48-1418
FZ10	17	ZS48-1414	ZS48-1418
YZF-R1	98-14	ZS48-1404	ZS48-1408
XJR1200	94-96	ZS48-1414	ZS48-1418
FJR1300	03-15	ZS48-1404	ZS48-1408
XJR1300	98-15	ZS48-1414	ZS48-1418
V-MAX	09-17	ZS48-1404	ZS48-1408

Bike	Year	Gold	Ti-color
KAWASAKI			
NINJA 250	13-17	ZS48-1204	ZS48-1208
NINJA 300	13-17	ZS48-1204	ZS48-1208
NINJA 250R	08-12	ZS48-1204	ZS48-1208
Z250	13-17	ZS48-1204	ZS48-1208
Z300	15-16	ZS48-1204	ZS48-1208
ER-4N	11-13	ZS48-1204	ZS48-1208
NINJA 400R	11-13	ZS48-1204	ZS48-1208
NINJA 400	14-17	ZS48-1204	ZS48-1208
ER-6f	07-10	ZS48-1204	ZS48-1208
ER-6n	06-14	ZS48-1204	ZS48-1208
ZX-6R	00-17	ZS48-1204	ZS48-1208
ZX-6RR	03-05	ZS48-1204	ZS48-1208
NINJA 650	12-16	ZS48-1204	ZS48-1208
NINJA 650R	09-11	ZS48-1204	ZS48-1208
VERSYS650	10-17	ZS48-1204	ZS48-1208
Z750	04-05	ZS48-1204	ZS48-1208
Z750S	05	ZS48-1204	ZS48-1208
ZX-7R	00-02	ZS48-1204	ZS48-1208
ZX-7RR	96-97	ZS48-1204	ZS48-1208
Z800	13-16	ZS48-1204	ZS48-1208
ZX-9R	99-03	ZS48-1204	ZS48-1208
NINJA 1000	11-16	ZS48-1204	ZS48-1208
VERSYS1000	12-17	ZS48-1204	ZS48-1208
Z1000	03-17	ZS48-1204	ZS48-1208
ZX-10R	11-15	ZS48-1204	ZS48-1208
ZRX1100	97-00	ZS48-1204	ZS48-1208
ZRX1100II	97-00	ZS48-1204	ZS48-1208
ZRX1200DAEG	09-16	ZS48-1204	ZS48-1208
ZRX1200R	01-08	ZS48-1204	ZS48-1208
ZRX1200S	01-04	ZS48-1204	ZS48-1208
ZX-12R	00-06	ZS48-1204	ZS48-1208
ZZR1200	02-05	ZS48-1204	ZS48-1208
ZX-14R	12-17	ZS48-1204	ZS48-1208
ZZR1400	06-11	ZS48-1204	ZS48-1208
SUZUKI			
GSR250/S, GW250, INAZUMA250	12-17	ZS48-1014	ZS48-1018
GSX250R	17	ZS48-1014	ZS48-1018
GLADIUS400	09-14	ZS48-1014	ZS48-1018
GSR400	06-14	ZS48-1014	ZS48-1018
GSX-R600	01-03	ZS48-1014	ZS48-1018
V-STROM650/XT	04-17	ZS48-1014	ZS48-1018
GSX-R750	00-03	ZS48-1014	ZS48-1018
GSX-R1000	01-04	ZS48-1014	ZS48-1018

ZETA BAR END PLUGS

- Made of high strength aluminum and stainless steel.
- Functions as a weight to prevent unpleasant vibration.
- Design to fit specific models, easy to install.
- Available in gold and titanium colors.



Universal L

Universal S

ZETA BAR END PLUGS Universal

- Universal bar end plug for sport bike.
- Available universal S and L models.
- L model comes with stainless steel bar weight to prevent unpleasant vibration.
- Available in gold and titanium colors.
- * handlebar inner diameter 13.5 mm - 19 mm

Size	Gold	Ti-color
Universal S	ZS48-1004	ZS48-1008
Universal L	ZS48-1014	ZS48-1018



ZETA F-FORK TOP CAP INITIAL ADJUSTER

- Top cap initial adjuster for Ninja 250 / 300 and YZF-R25 / R3
- Allows you to adjust spring pre load.
- Pre load adjustable range is -5 mm to +10 mm, provides pre load setting for racing use and soften for light weight riders.
- Integrated air bleeder, bleeds high pressure air without any tools from the front fork after hard and high speed riding.
- * Ninja 250 / 300 required to change handlebar to clip on handlebar for installation.

Bike	Year	Gold
YAMAHA	YZF-R25	ZE56-10514
	YZF-R25 ABS	ZE56-10514
	YZF-R3	ZE56-10514
KAWASAKI	NINJA250R	ZE56-10504
	NINJA250	ZE56-10504
	NINJA250 ABS	ZE56-10504
	NINJA300	ZE56-10504
	NINJA300 ABS	ZE56-10504

ZETA FORK TOP CAP NINJA 250 / 300

- CNC machined aluminum front fork cap for Ninja 250 / 300.
- Use this fork cover cap when you change to aftermarket clip on handles.
- Black anodized finish with laser printed logo.
- Comes in pairs.

ZS59-8011 Black



High Type 1

Medium Type 2

Medium Type 1

Low Type 2

Low Type 1

Medium Type 1

CB400SF

Height Type 1

CB500X

ZETA
GT HANDLEBAR



- Handlebar sizes which are designed for a relaxed and comfortable ride.
- Laser printed handlebar positioning gauge for accurate bar position setting.
- Made of durable aluminum with shot peened anodized finish.
- Matte titanium anodized surface finish.
- Handlebar diameter : 22.2 mm / Bar end inner diameter : 13.5 mm

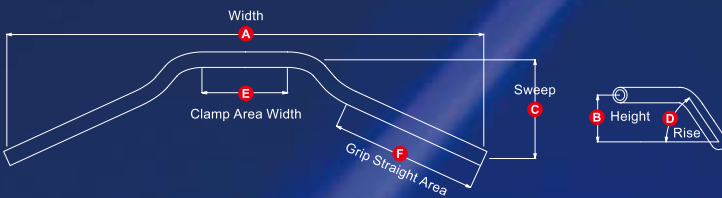

Model	Part#	Handlebar dimensions					
		A	B	C	D	E	F
Low type-1	ZS07-1008	670	52	116	60°	115	200
Low type-2	ZS07-1018	680	63	135	67°	120	205
Medium type-1	ZS07-1108	685	67	142	56°	120	205
Medium type-2	ZS07-1118	685	71	152	62°	120	205
Height type-1	ZS07-1208	740	98	150	63°	120	200

Laser printed logos and handlebar positioning gauge for accurate handlebar position setting.



Ninja 400R [ZS86-1208](#)

ZETA
HANDLEBAR STABILIZER

- Made of CNC machined aluminum with anodized finish.
- Durable yet light weight design.
- Available in titanium color.
- Comes with special stainless bolts.

Bike	Year	Part #	Bike	Year	Part #
HONDA			KAWASAKI		
GROM,MSX125	13-18	ZS33-1108	Z250	13-17	ZS33-1218
CB250F	14-17	ZS33-1108	ER-4N	11-13	ZS33-1208
CB300F	15-17	ZS33-1108	NINJA 400R	11-13	ZS33-1208
VTR/VTR-F	09-17	ZS33-1108	NINJA 400	14-17	ZS33-1208
400X	13-17	ZS33-1108	ER-6F	09-10	ZS33-1208
CB400F	13-16	ZS33-1108	ER-6N	09-11	ZS33-1208
CB400SF	92-16	ZS33-1108	NINJA 650	12-16	ZS33-1208
CB500X	13-17	ZS33-1108	NINJA 650R	09-11	ZS33-1208
CB500F	13-17	ZS33-1108	Z800	13-16	ZS33-1218
CB650F	14-18	ZS33-1108			
NC700S/X	12-17	ZS33-1108			
NC750S/X	14-17	ZS33-1108			
CB1100	10-16	ZS33-1118			
CB1300SF	03-17	ZS33-1118			

ZETA
BAR CLAMP

- Made of CNC machined aluminum with anodized finish.
- Exclusive look on your handlebar clamp.
- Available in gold and titanium colors.

Part #	Color
ZS40-1104	Gold
ZS40-1108	Ti-color

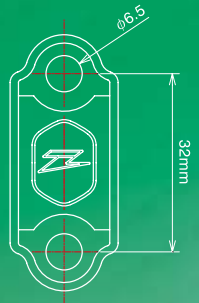



CBR250R



Ninja 250



ZETA

BAR RISE KIT NINJA 250 and CBR250R

- Bar rise spacer provides higher bar position.
- Made of CNC machined aircraft grade aluminum and titanium anodized finish.

Part #	Bike	Year	Spacer thickness
ZS53-1108	CBR250R	11-	10 mm
ZS53-1208	Ninja 250	08-	8 mm



CBR250R



Ninja 250

CONTROL



LEVER



BODY



ELECTRICAL



ZE53-0219

ZE53-0130

ZETA

BAR RISE KIT 20 mm OFF SET

- Handlebar rise and offset kit.
- Provides 26 mm higher, 20 mm back and forth positions from stock handlebar position.
- Provide comfort riding position for sport bike with 20 mm backward position.

Part number **ZE53-0526**

Bar rise kit offset dimension

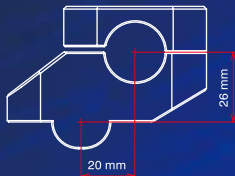

- Can be used with 22.2 mm OE bar clamp models with bar clamp width in between 32 mm to 36 mm.

ZETA

BAR RISE KIT UNIVERSAL

- Universal bar riser kit for over sized (28.6 mm, 1 1/8") bar mount and standard sized (22.2 mm, 7/8").
- Provides 19 mm and 30 mm higher bar position than stock bar position.
- For use on bar handle sports bikes.
- Comes with bar clamp bolts. - Made of A7009-T6 aluminum.

Size	Part #	Height	Size	Part #	Height
7/8 in (22.2 mm)	ZE53-0119	19 mm	1 1/8 in (28.6 mm)	ZE53-0219	19 mm
	ZE53-0130	30 mm		ZE53-0230	30 mm

Bar rise kit dimension

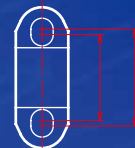
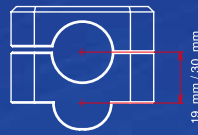

Standard bar
32 mm - 36 mm



CB500X



CB500X



ZETA
FLIGHT LEVER Brake/Clutch
3 Finger & 4 Finger

- Used by YOSHIMURA Racing team, US YOSHIMURA SUZUKI FACTORY RACING TEAM, WESTBY YAMALUBE YAMAHA and Kawasaki Team Green.
- Holes on lever body is designed to decrease wind pressure up to over 300 km / h.
- The braking point is pre-calculated in case of a fall.
- Fully CNC machined from A7009 / A6061 aluminum, super light weight design.
- Conforms to FIM and MFJ regulations.
- Available 3 finger and 4 finger lever arm lenth.
- Available in black and titanium anodized colors.

Used by
Kawasaki Team GREEN

**4 Finger
Black**

**3 Finger
Ti Color**

CONTROL



LEVER



BODY



ELECTRICAL



	Bike	Year	Clutch lever					
			4 Fi Black	Lever Type	3 Fi Ti-Color	Lever Type		
H	CBR600RR	03-17	-	-	ZS60-5010	L4SP	ZS60-5015	L3SP
	CBR954	02-03	-	-	ZS60-5010	L4SP	ZS60-5015	L3SP
	CBR1000RR/SP/SP2	08-17	-	-	ZS60-5010	L4SP	ZS60-5015	L3SP
	CBR1000S	14-17	-	-	ZS60-5010	L4SP	ZS60-5015	L3SP
Y	XJ6N	09-15	-	-	ZS60-5210	L4SP	ZS60-5215	L3SP
	YZF-R6	99-17	-	-	ZS60-5210	L4SP	ZS60-5215	L3SP
	YZF-R1M/S	00-17	-	-	ZS60-5210	L4SP	ZS60-5215	L3SP
	MT-07/FZ-07	14-17	-	-	ZS60-5210	L4SP	ZS60-5215	L3SP
	MT-09/FZ-09	14-17	-	-	ZS60-5210	L4SP	ZS60-5215	L3SP
K	FZ-1/FAZER	06-15	-	-	ZS60-5210	L4SP	ZS60-5215	L3SP
	H2/H2R	15-17	ZS60-5851	L4SH	-	-	-	
	ZX-6R	00-17	-	-	ZS60-5110	L4SP	ZS60-5115	L3SP
	ZX-10R/RR	04-17	-	-	ZS60-5110	L4SP	ZS60-5115	L3SP
	ZX-12R	00-06	-	-	ZS60-5110	L4SP	ZS60-5115	L3SP
	ZX-9R	00-03	-	-	ZS60-5110	L4SP	ZS60-5115	L3SP
	Z750	07-10	-	-	ZS60-5110	L4SP	ZS60-5115	L3SP
	Z1000	03-16	-	-	ZS60-5110	L4SP	ZS60-5115	L3SP
	NINJA1000	11-16	-	-	ZS60-5110	L4SP	ZS60-5115	L3SP
	VERSYS1000	12-14	-	-	ZS60-5110	L4SP	ZS60-5115	L3SP
S	GSX-R750/600	06-17	-	-	ZS60-5210	L4SP	ZS60-5215	L3SP
	GSX-R1000	05-06	-	-	ZS60-5210	L4SP	ZS60-5215	L3SP
	GSX-R1000/R	09-17	-	-	ZS60-5210	L4SP	ZS60-5215	L3SP
	GSX-S1000/F	15-17	-	-	ZS60-5210	L4SP	ZS60-5215	L3SP
BMW	S1000RR	10-14	-	-	ZS60-5810	L4SP	ZS60-5815	L3SP
	S1000RR	15-17	-	-	ZS60-5830	L4SP	ZS60-5835	L3SP
	S1000R	14-17	-	-	ZS60-5830	L4SP	ZS60-5835	L3SP
	HP4	13-14	-	-	ZS60-5810	L4SP	ZS60-5815	L3SP
DUCATI	1299 PANIGALE/S	15-17	ZS60-5851	L4SH	-	-	-	
	1199 PANIGALE/S/TRICOLELE	12-14	ZS60-5851	L4SH	-	-	-	
	1199 PANIGALE R	13-17	ZS60-5851	L4SH	-	-	-	
	959 PANIGALE	16-17	ZS60-5851	L4SH	-	-	-	
	899 PANIGALE	14-15	ZS60-5851	L4SH	-	-	-	
	1198/1098/S/R	08-11	ZS60-5851	L4SH	-	-	-	
	999/S/R	03-07	ZS60-5851	L4SH	-	-	-	
	848/749/S/R/EVO/EVO CORSE SE	03-13	ZS60-5851	L4SH	-	-	-	
OTTOMER	BREMBO RADIAL MASTER 19 x 20 for Ratio	-	-	-	ZS60-5710	L4SH	-	
	BREMBO RADIAL MASTER 19 x 18 16 x 18 for Ratio	-	-	-	ZS60-5720	L4SH	-	

	Bike	Year	Brake lever					
			4Fi Black	Lever Type	4 Fi Ti-Color	Lever Type	3 Fi Ti-Color	Lever Type
H	CBR600RR	07-17	-	-	ZS60-3010	R4SH	ZS60-3015	R3SH
	CBR1000RR/SP/SP2	04-17	-	-	ZS60-3010	R4SH	ZS60-3015	R3SH
	CBR1000S	14-17	-	-	ZS60-3010	R4SH	ZS60-3015	R3SH
	YZF-R6	17	-	-	ZS60-3620	R4SH	ZS60-3625	R3SH
Y	YZF-R1M/S	05-16	-	-	ZS60-3610	R4SH	ZS60-3615	R3SH
	YZF-R1	15-17	-	-	ZS60-3620	R4SH	ZS60-3625	R3SH
	V-MAX	04-14	-	-	ZS60-3610	R4SH	ZS60-3615	R3SH
	MT-01	09-17	-	-	ZS60-3610	R4SH	ZS60-3615	R3SH
	MT-01	05-09	-	-	ZS60-3610	R4SH	ZS60-3615	R3SH
K	H2/H2R	15-17	ZS60-3811	R4SH	-	-	-	
	ZX-6R	07-17	-	-	ZS60-3210	R4SH	ZS60-3215	R3SH
	ZX-10R	06-15	-	-	ZS60-3210	R4SH	ZS60-3215	R3SH
	ZX-10R/RR	16-17	ZS60-3811	R4SH	-	-	-	
	ZX-14R HiGrade /SE	06-17	-	-	ZS60-3210	R4SH	ZS60-3215	R3SH
	Z1000	07-17	-	-	ZS60-3210	R4SH	ZS60-3215	R3SH
	NINJA1000	11-18	-	-	ZS60-3210	R4SH	ZS60-3215	R3SH
	1400GTR /CONCOURS 14	08-17	-	-	ZS60-3210	R4SH	ZS60-3215	R3SH
	GSX-R750/600	04-17	-	-	ZS60-3410	R4SH	ZS60-3415	R3SH
	GSX-S1000/R	05-17	-	-	ZS60-3410	R4SH	ZS60-3415	R3SH
S	GSX-S1000/F	15-17	-	-	ZS60-3410	R4SH	ZS60-3415	R3SH
	B-KING	07-09	-	-	ZS60-3410	R4SH	ZS60-3415	R3SH
	S1000RR	10-17	-	-	ZS60-3410	R4SH	ZS60-3415	R3SH
	S1000R	14-17	-	-	ZS60-3410	R4SH	ZS60-3415	R3SH
BMW	HP4	13-14	-	-	ZS60-3410	R4SH	ZS60-3415	R3SH
	1299 PANIGALE/S	15-17	ZS60-3811	R4SH	-	-	-	
DUCATI	1199 PANIGALE/S/TRICOLELE	12-14	ZS60-3811	R4SH	-	-	-	
	1199 PANIGALE R	13-17	ZS60-3811	R4SH	-	-	-	
	959 PANIGALE	16-17	ZS60-3811	R4SH	-	-	-	
	899 PANIGALE	14-15	ZS60-3811	R4SH	-	-	-	
	1198/1098/S/R	08-11	ZS60-3811	R4SH	-	-	-	
	999/S/R	03-07	ZS60-3811	R4SH	-	-	-	
	848/749/S/R/EVO/EVO CORSE SE	03-13	ZS60-3811	R4SH	-	-	-	
	BREMBO RADIAL MASTER 19 x 20 for Ratio	-	-	-	ZS60-3710	R4SH	ZS60-3715	R3SH
OTTOMER	BREMBO RADIAL MASTER 19 x 18 16 x 18 for Ratio	-	-	-	ZS60-3720	R4SH	ZS60-3725	R3SH

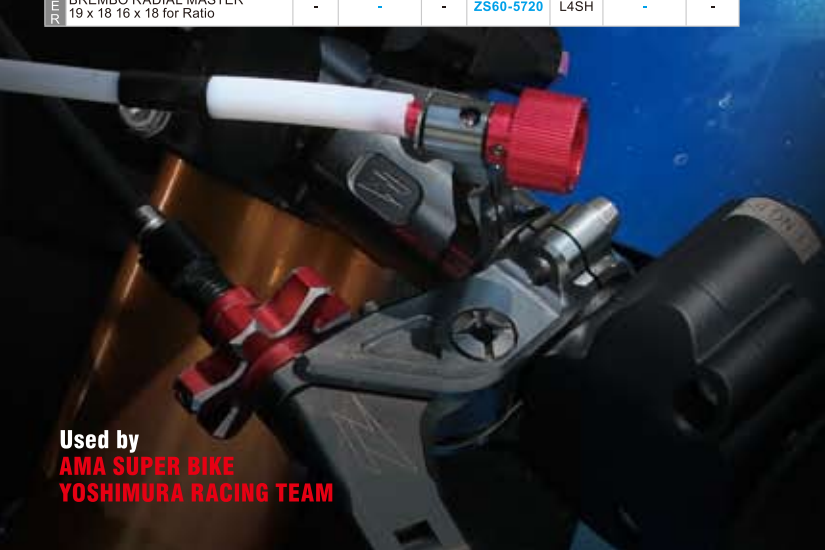

ZETA
FLIGHT LEVER Remote Adjuster

- Provides fine adjustment to the brake lever from the left side handlebar.
- Able to tighten slack in your brakes with your free hand without letting off the throttle.
- CNC machined handlebar support included.

Used by
**AMA SUPER BIKE
YOSHIMURA RACING TEAM**

Part Number **ZS60-3989**
Replacement wire **ZS60-3998**

Pilot LEVER

ZETA

PILOT LEVER

- High quality CNC machined levers for sport bikes.
- Folding lever system to prevent lever breakage.
- Short lever arm for sport riding.
- Available in black and titanium anodized colors.

for
STREET

Ninja H2



CONTROL



LEVER



BODY



ELECTRICAL



LEVER TYPE

L3WA/R3WA

L3WB/R3WB

FUNCTION



FOLDING UP / DOWNWARD

Lever swings upward or downward in the event of crash to prevent lever breakage.



FOLDING FORWARD

Lever swings forward in the event of crash to prevent lever breakage.



CNC MACHINED LEVER

Precision CNC machined finish to reduce weight and for better lever control.



ADJUST KNOB

Provides more sensitive lever adjusting positions than OEM levers. (20 lever positions)

Pilot lever Clutch

BIKE	Year	Ti-color	Black	Lever Type
CB1300SF/SB/ST	98-17	ZS61-2020	ZS61-2025	L3WA
CB1000SF	92-97	ZS61-2020	ZS61-2025	L3WA
CB1100/EX	10-17	ZS61-2020	ZS61-2025	L3WA
CBR1100XX	97-06	ZS61-2020	ZS61-2025	L3WA
CBR1000RR	04-07	ZS61-2020	ZS61-2025	L3WA
CBR1000RR/SP/SP2	08-17	ZS61-2010	ZS61-2015	L3WA
CBR1000S	14-17	ZS61-2010	ZS61-2015	L3WA
CBR954RR	02-03	ZS61-2010	ZS61-2015	L3WA
CBR600RR	03-17	ZS61-2010	ZS61-2015	L3WA
CB1000R	11-17	ZS61-2020	ZS61-2025	L3WA
X-4	97-03	ZS61-2020	ZS61-2025	L3WA
VFR1200X	14-17	ZS61-2020	ZS61-2025	L3WA
VFR1200F	10-17	ZS61-2020	ZS61-2025	L3WA
VFR800	03-08	ZS61-2020	ZS61-2025	L3WA
VFR800FX	14-17	ZS61-2020	ZS61-2025	L3WA
VTR1000F	98-05	ZS61-2020	ZS61-2025	L3WA
V-MAX	09-17	ZS61-2610	ZS61-2615	L3WA
MT-10/FZ-10	17	-	ZS61-2625	L3WA
MT-01	05-09	ZS61-2610	ZS61-2615	L3WA
MT-09 TRACER	15-17	ZS61-2410	ZS61-2415	L3WA
MT-09/FZ-09	14-17	ZS61-2410	ZS61-2415	L3WA
MT-07/FZ-07	14-17	ZS61-2410	ZS61-2415	L3WA
XSR900	16-17	ZS61-2410	ZS61-2415	L3WA
XSR700	16	ZS61-2410	ZS61-2415	L3WA
YZF-R1M/S	00-17	ZS61-2410	ZS61-2415	L3WA
YZF-R6	96-17	ZS61-2410	ZS61-2415	L3WA
FZ1/N/S	06-16	ZS61-2410	ZS61-2415	L3WA
FZ8/N/S/FAZER	11-15	ZS61-2410	ZS61-2415	L3WA
FZ6/R/FAZER	04-17	ZS61-2410	ZS61-2415	L3WA
FJR1300A	01-17	ZS61-2610	ZS61-2615	L3WA
XJR1300C	94-16	ZS61-2610	ZS61-2615	L3WA
XJR1200/1300	94-15	ZS61-2610	ZS61-2615	L3WA
XJ6	09-16	ZS61-2410	ZS61-2415	L3WA
XT1200Z TENERE	10-17	ZS61-2610	ZS61-2615	L3WA
H2/H2R	15-17	ZS61-2810	ZS61-2815	L3WB
1400GTR /CONCOURS 14	08-17	ZS61-2220	ZS61-2225	L3WB
ZX-12R	00-07	ZS61-2210	ZS61-2215	L3WA
ZX-10R/RR	04-17	ZS61-2210	ZS61-2215	L3WA
ZX-9R	00-03	ZS61-2210	ZS61-2215	L3WA
ZX-7R	00-02	ZS61-2610	ZS61-2615	L3WA
ZX-6R/ABS	02-17	ZS61-2210	ZS61-2215	L3WA
ZX-14R HiGrade/SE	00-17	ZS61-2220	ZS61-2225	L3WB
ZXR11	02-03	ZS61-2610	ZS61-2615	L3WA
ZXR1200	97-01	ZS61-2610	ZS61-2615	L3WA
ZRX1100/1200DAEG	97-16	ZS61-2610	ZS61-2615	L3WA
NINJA1000	11-16	ZS61-2210	ZS61-2215	L3WA
Z1000	04-16	ZS61-2210	ZS61-2215	L3WA
Z800	13-16	ZS61-2210	ZS61-2215	L3WA
Z750	07-10	ZS61-2210	ZS61-2215	L3WA
ZEPHER1100/RS	92-06	ZS61-2610	ZS61-2615	L3WA
GPZ900R	91-03	ZS61-2610	ZS61-2615	L3WA
VERSYS1000	12-14	ZS61-2210	ZS61-2215	L3WA
GSX1400	01-08	ZS61-2420	ZS61-2425	L3WA
GSX1300R HAYABUSA	99-17	ZS61-2420	ZS61-2425	L3WA
BANDIT1200/1250/S/F	01-16	ZS61-2420	ZS61-2425	L3WA
GSX-S1000/F	15-17	ZS61-2410	ZS61-2415	L3WA
GSX-R1000	05-06	ZS61-2410	ZS61-2415	L3WA
GSX-R1000	07-08	ZS61-2420	ZS61-2425	L3WA
GSX-R1000/R	09-17	ZS61-2410	ZS61-2415	L3WA
GSX-R750	06-17	ZS61-2410	ZS61-2415	L3WA
GSX-R600	06-17	ZS61-2410	ZS61-2415	L3WA
GS1200SS	01-02	ZS61-2420	ZS61-2425	L3WA
V-STORM 1000/XT	07-17	ZS61-2420	ZS61-2425	L3WA
SV1000S	03-07	ZS61-2420	ZS61-2425	L3WA
TL1000R	98-03	ZS61-2420	ZS61-2425	L3WA
1299 PANIGALE/S	15-17	ZS61-2810	ZS61-2815	L3WB
1199 PANIGALE/S/ TRICOLORE	12-14	ZS61-2810	ZS61-2815	L3WB
1199 PANIGALE R	13-17	ZS61-2810	ZS61-2815	L3WB
959 PANIGALE	16-17	ZS61-2810	ZS61-2815	L3WB
899 PANIGALE	14-15	ZS61-2810	ZS61-2815	L3WB
1198/1098/S/R	08-11	ZS61-2810	ZS61-2815	L3WB
999/S/R	03-07	ZS61-2810	ZS61-2815	L3WB
848/749/S/R/EVO/EVO CORSE SE	03-13	ZS61-2810	ZS61-2815	L3WB
STREETFIGHTER/S	10-13	ZS61-2810	ZS61-2815	L3WB
STREETFIGHTER 848	12-15	ZS61-2810	ZS61-2815	L3WB
HYPERMOTARD1100/S/EVO	08-12	ZS61-2810	ZS61-2815	L3WB
MONSTER1200/S/R	14-17	ZS61-2810	ZS61-2815	L3WB
MONSTER1100S/EVO	08-13	ZS61-2810	ZS61-2815	L3WB
MONSTER S4R/S	06-08	ZS61-2810	ZS61-2815	L3WB
MULTISTRADA1200/S/ PIKES PEAK/ENDURO X DIAVEL/S	10-17	ZS61-2810	ZS61-2815	L3WB
X DIAVEL/S	17	ZS61-2810	ZS61-2815	L3WB
DIAVEL STRADA	13	ZS61-2810	ZS61-2815	L3WB
DIAVEL CARBON	12-17	ZS61-2810	ZS61-2815	L3WB
DIAVEL DARK	13	ZS61-2810	ZS61-2815	L3WB
DIAVEL DARK	13	ZS61-2810	ZS61-2815	L3WB
BONNEVILLE	11-15	ZS61-2830	ZS61-2835	L3WB
BONNEVILLE SE	09-12	ZS61-2830	ZS61-2835	L3WB
BONNEVILLE T100	01-15	ZS61-2830	ZS61-2835	L3WB
DAYTONA 675	06-15	ZS61-2830	ZS61-2835	L3WB
DAYTONA 675 R	11-15	ZS61-2830	ZS61-2835	L3WB
DAYTONA 675 SE	11	ZS61-2830	ZS61-2835	L3WB
DAYTONA595&955	97-00	ZS61-2830	ZS61-2835	L3WB
DAYTONA600&650	04-05	ZS61-2830	ZS61-2835	L3WB
DAYTONA955	01-05	ZS61-2830	ZS61-2835	L3WB
SCRAMBLER	06-16	ZS61-2830	ZS61-2835	L3WB
SPEED FOUR	03-05	ZS61-2830	ZS61-2835	L3WB
SPEED TRIPLE/R	98-15	ZS61-2830	ZS61-2835	L3WB
SPEED TRIPLE (T509)	97	ZS61-2830	ZS61-2835	L3WB
SPRINT GT	11-12	ZS61-2830	ZS61-2835	L3WB
SPRINT RS	00-04	ZS61-2830	ZS61-2835	L3WB
SPRINT ST	99-12	ZS61-2830	ZS61-2835	L3WB
SPRINT ST 1050	07	ZS61-2830	ZS61-2835	L3WB
STREET TRIPLE	11-12	ZS61-2830	ZS61-2835	L3WB
STREET TRIPLE 85	13-16	ZS61-2830	ZS61-2835	L3WB
STREET TRIPLE S	17	ZS61-2830	ZS61-2835	L3WB
STREET TRIPLE675	08-10	ZS61-2830	ZS61-2835	L3WB
STREET TRIPLE675R	09-16	ZS61-2830	ZS61-2835	L3WB
THRUXTON	04-16	ZS61-2830	ZS61-2835	L3WB
TIGER 1050	07-12	ZS61-2830	ZS61-2835	L3WB
TIGER 1050 SE	11-12	ZS61-2830	ZS61-2835	L3WB
TIGER 800	11-14	ZS61-2830	ZS61-2835	L3WB
TIGER 800 XC	11-14	ZS61-2830	ZS61-2835	L3WB
TT600	00-03	ZS61-2830	ZS61-2835	L3WB
NISSAN RADIAL CAST		ZS61-2220	ZS61-2225	L3WB

Pilot lever Brake

BIKE	Year	Ti-color	Black	Lever Type
CB1300SF	98-00	ZS61-1020	ZS61-1025	R3WA
CB1300SF/SB/ST	03-17	ZS61-1430	ZS61-1435	R3WA
CB400SF/SB ABS	08-13	ZS61-1020	ZS61-1025	R3WA
CB400SF/SB	14-16	ZS61-1430	ZS61-1435	R3WA
CB400SF/RS	97-16	ZS61-1430	ZS61-1435	R3WA
CBR1100XX	97-06	ZS61-1020	ZS61-1025	R3WA
CBR1000S	14-17	ZS61-1010	ZS61-1015	R3WB
CBR1000RR/SP/SP2	04-17	ZS61-1010	ZS61-1015	R3WB
CBR900RR	98-99	ZS61-1430	ZS61-1435	R3WA
CBR600RR	07-17	ZS61-1010	ZS61-1015	R3WB
CBR600F4/F4i	99-06	ZS61-1430	ZS61-1435	R3WA
CB1000R	11-17	ZS61-1010	ZS61-1015	R3WB
X-4	97-03	ZS61-1430	ZS61-1435	R3WA
X-11	99-00	ZS61-1020	ZS61-1025	R3WA
CB1100/EX	10-17	ZS61-1430	ZS61-1435	R3WA
CB1000SF	92-97	ZS61-1430	ZS61-1435	R3WA
CB750	07-08	ZS61-1430	ZS61-1435	R3WA
VTR1000F	98-05	ZS61-1430	ZS61-1435	R3WA
VFR800	03-08	ZS61-1430	ZS61-1435	R3WA
VFR800FX	14-17	ZS61-1430	ZS61-1435	R3WA
VFR1200X	14-17	ZS61-1430	ZS61-1435	R3WA
RVR400	94-96	ZS61-1430	ZS61-1435	R3WA
NSR250R	87-96	ZS61-1430	ZS61-1435	R3WA
HORNET900	02-07	ZS61-1430	ZS61-1435	R3WA
HORNET600	98-02	ZS61-1430	ZS61-1435	R3WA
HORNET250	96-07	ZS61-1430	ZS61-1435	R3WA
CB400SS	02-08	ZS61-1430	ZS61-1435	R3WA
VTR	98-17	ZS61-1430	ZS61-1435	R3WA
DN-01	08	ZS61-1430	ZS61-1435	R3WA
NC700S/X	12-17	ZS61-1430	ZS61-1435	R3WA
NC750X	14-17	ZS61-1430	ZS61-1435	R3WA
X-ADV	17	ZS61-1430	ZS61-1435	R3WA
CRF1000L	16-17	ZS61-1430	ZS61-1435	R3WA
V-MAX	09-17	ZS61-1610	ZS61-1615	R3WB
MT-10/FZ-10	17	ZS61-1620	ZS61-1625	R3WB
MT-01	05-09	ZS61-1610	ZS61-1615	R3WB
MT-09 TRACER	15-17	ZS61-1620	ZS61-1625	R3WB
MT-09/FZ-09	14-17	ZS61-1620	ZS61-1625	R3WB
MT-07/FZ-07	14-17	ZS61-1620	ZS61-1625	R3WB
XSR900	16-17	ZS61-1620	ZS61-1625	R3WB
XSR700	16	ZS61-1620	ZS61-1625	R3WB
HORNET600	04-14	ZS61-1610	ZS61-1615	R3WB
YZF-R1	15-17	ZS61-1630	ZS61-1635	R3WB
YZF-R1M/S	05-16	ZS61-1610	ZS61-1615	R3WB
YZF-R6	17	ZS61-1630	ZS61-1635	R3WB
FZ1/N/S	06-16	ZS61-1620	ZS61-1625	R3WA
FZ8/N/S/FAZER	11-15	ZS61-1620	ZS61-1625	R3WA
FZ6/R/FAZER	04-17	ZS61-1620	ZS61-1625	R3WA
FJR1300	01-02	ZS61-1440	ZS61-1445	R3WA
FJR1300A	03-17	ZS61-1620	ZS61-1625	R3WA
XJR1300C	15-16	ZS61-1620	ZS61-1625	R3WA
XJR1200/1300	94-15	ZS61-1440	ZS61-1445	R3WA
XJR400R/R II	93-07	ZS61-1440	ZS61-1445	R3WA
TZR250R/RS/SP/ SPR	90-95	ZS61-1440	ZS61-1445	R3WA
XJ6	09-16	ZS61-1620	ZS61-1625	R3WA
XT1200Z TENERE	10-17	ZS61-1620	ZS61-1625	R3WA
XT660Z TENERE	08-15	ZS61-1620	ZS61-1625	R3WA
TRX850	95-99	ZS61-1440	ZS61-1445	R3WA
TDM850	97-01	ZS61-1440	ZS61-1445	R3WA
TDM900	02-03	ZS61-1440	ZS61-1445	R3WA
TDM900	04-09	ZS61-1620	ZS61-1625	R3WA
H2/H2R	15-17	ZS61-1810	ZS61-1815	R3WB
1400GTR / CONCOURS 14	08-17	ZS61-1010	ZS61-1015	R3WB
ZX-12R	00-07	ZS61-1440	ZS61-1445	R3WA
ZX-10R	06-15	ZS61-1010	ZS61-1015	R3WB
ZX-10R/RR	16-17	ZS61-1810	ZS61-1815	R3WB
ZX-6R	07-17	ZS61-1010	ZS61-1015	R3WB
ZX-6R/ABS	02-04	ZS61-1440	ZS61-1445	R3WA
ZX-14R HiGrade/SE	16-17	ZS61-1810	ZS61-1815	R3WB
ZX-14R	06-17	ZS61-1010	ZS61-1015	R3WB
ZXR1200	02-05	ZS61-1440	ZS61-1445	R3WA
ZX-11	97-01	ZS61-1440	ZS61-1445	R3WA
ZXR1100/1200/DAEG	97-16	ZS61-1440	ZS61-1445	R3WA
NINJA1000	11-18	ZS61-1010	ZS61-1015	R3WB
NINJA650R	09-16	ZS61-1020	ZS61-1025	R3WA
NINJA400R	11-17	ZS61-1020	ZS61-1025	R3WA
Z750	04-05	ZS61-1440	ZS61-1445	R3WA
Z750S	04-07	ZS61-1440	ZS61-1445	R3WA
Z1000	03-06	ZS61-1440	ZS61-1445	R3WA
Z1000	07-18	ZS61-1010	ZS61-1015	R3WB</



ZS62-1018

ZS62-1030

■ Pivot

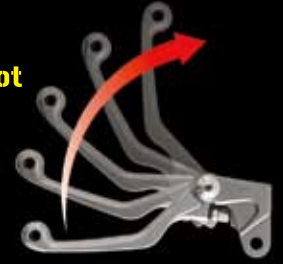

Pivot design with return spring allows the lever to fold outward to prevent bending or breaking.

■ Adjustable



Adjustable reach system provides the perfect lever position for all riders.

PIVOT LEVER SET
CNC MACHINED CP

ZETA PIVOT LEVER SET STREET

- Pivot lever set for sport bike.
- CNC Machined aluminum folding levers.
- The pivot design allows the lever to fold outward to prevent bending or breaking in the event of a crash.
- Made of CNC machined aircraft grade aluminum.
- Available titanium and black anodized colors.



CBR250RR Brake



CBR250RR Clutch

■ CNC Machined lever arm



Machined ZETA logo provides better lever grip.

■ Lever Type

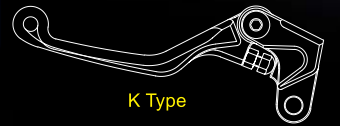

K Type

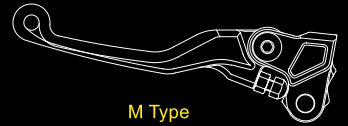

M Type

Bike	Year	Pivot Lever CP		Lever Type 4 Finger		
		Black	Ti-color	Clutch	Brake	
H O R D A	GROM	13-18	ZS62-1020	ZS62-1028	K	K
	CBR250RR	17	ZS62-1030	-	K	K
	CB250F/300F	14-17	-	-	K	K
	CBR250R/300R	11-17	ZS62-1020	ZS62-1028	K	K
	NSR250R	89-96	-	-	-	-
	VTR/VTR-F	98-17	ZS62-1010	ZS62-1018	K	M
	400X	13-17	-	-	-	-
	CB400F	13-16	ZS62-1020	ZS62-1028	K	K
	CB500X/F	13-17	-	-	-	-
	CBR400R	13-17	-	-	-	-
Y	NC700S/X	12-17	ZS62-1010	ZS62-1018	K	M
	NC750S/X	14-17	-	-	-	-
	MT-25	16-17	-	-	-	-
	MT-03	16-17	-	-	-	-
K	YZF-R25	15-17	ZS62-1610	ZS62-1618	K	M
	YZF-R3	15-17	-	-	-	-
	NINJA250SL	15-16	-	-	-	-
K	NINJA250/300R	08-17	ZS62-1210	ZS62-1218	K	K
	Z250/300	15-17	-	-	-	-



ZE41-4145

ZE42-4127

3 Finger

4 Finger

ZETA PIVOT LEVER CP

- Pivot lever for sport bike.
- CNC Machined aluminum folding levers.
- The pivot design allows the lever to fold outward to prevent bending or breaking in the event of a crash.
- Hard anodized finish, made of CNC machined aircraft grade aluminum.
- Exclusively designed for each bike, 3 and 4 finger lever lengths available.

Pivot Lever Street Clutch (CP)					
Bike	Year	4 Finger	3 Finger	Type	
H O R D A	GROM	13-18	-	-	
	CB250F/300F	14-17	-	-	
	CBR250R/300R	11-17	-	-	
	VTR/VTR-F	98-17	-	-	
	NSR250R	89-96	-	-	
	400X	13-17	ZE42-4115	-	K
	CB400F	13-16	-	-	
	CB500X/F	13-17	-	-	
	CBR400R	13-17	-	-	
	CBR500R	13-17	-	-	
Y	NC700S/X	12-17	-	-	
	NC750S/X	14-17	-	-	
	NINJA 250SL	15-16	-	-	
	NINJA 250/300R	08-17	ZE42-4127	ZE42-3127	K
K	Z250/300	13-17	-	-	

Pivot Lever Street Brake (CP)					
Bike	Year	4 Finger	3 Finger	Type	
H O R D A	GROM	13-18	-	-	
	CB250F/300F	14-17	ZE41-4145	ZE41-3145	K
	CBR125R/250R/300R	11-17	-	-	
	HORNET250	96-07	-	-	
	NSR250R	87-96	ZE41-4298	-	M
	VTR/VTR-F	98-17	-	-	
	400X	13-17	-	-	
	CB400F	13-16	ZE41-4145	ZE41-3145	K
	CB500X/F	13-17	-	-	
	CB400FOUR	97-98	ZE41-4298	-	M
Y	CB400SS	02-08	-	-	
	CBR400R	13-17	ZE41-4145	ZE41-3145	K
	CBR500R	13-17	-	-	
	CBR400RR	88-94	-	-	
	RVF400	94-96	-	-	
	NC700S/X	12-17	ZE41-4298	-	M
	NC750S/X	14-17	-	-	
	X-ADV	17	-	-	
	TZR250/R/RS/SPR	90-95	ZE41-4299	-	M
	XJR400R/R/II	01-07	-	-	
K A W A S 	NINJA 250SL	15-16	-	-	
	NINJA250/300R	08-17	ZE41-4145	ZE41-3145	K
	Z250/300	13-17	-	-	
	ZZR250	90-07	-	-	
	ZZR400	90-06	ZE41-4299	-	M
	ZRX400/II	94-08	-	-	
	ZEPHYR/X	89-06	-	-	
	BALIUS/II	91-07	-	-	
	RGV250 GANMA	88-95	-	-	
	GOOSE250/350	92-00	ZE41-4299	-	M
S U Z U K I	BANDIT250/400/V	89-00	-	-	
	SV400/S	95-05	-	-	
	INA ZUMA400	97-01	-	-	
	DUKE125/200/250/390	11-16	ZE41-4286	ZE41-3286	M
K T M	RC125/200/250/390	15-16	-	-	

Replacement parts



Ti-color

- Clutch Lever Arm K-Type**
ZE42-3100 3 Finger
ZE42-4100 4 Finger
- Brake Lever Arm K-Type**
ZE41-3100 3 Finger
ZE41-4100 4 Finger
- Clutch Lever Arm M-Type**
ZE42-3200 3 Finger
ZE42-4200 4 Finger
- Brake Lever Arm M-Type**
ZE41-3200 3 Finger
ZE41-4200 4 Finger

Brack

- Clutch Lever Arm K-Type**
ZE42-3100 3 Finger
ZE42-4100 4 Finger
- Brake Lever Arm K-Type**
ZE41-3100 3 Finger
ZE41-4100 4 Finger
- Brake Lever Arm M-Type**
ZE41-4200 4 Finger



Mount Kit
ZE41-0190 Brake
ZE42-0190 Clutch

for RACING

RIGHT

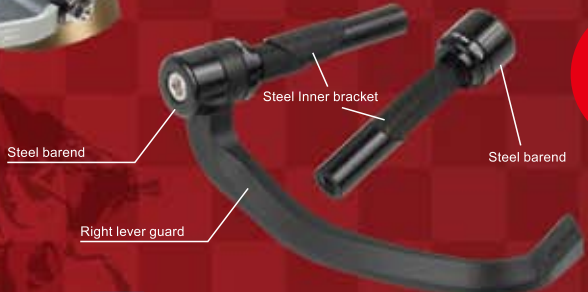

LEFT



ZETA FLIGHT LEVER GUARD

- Lever guard redesigned for race.
- Resin lever guard has high strength and excellent flexibility.
- Steel bar ends and inner brackets provide the effect of balancer weights and contribute to vibration countermeasures.
- Installation workability has also improved.
- It is a truly race part which does not have the adjustment mechanism with the setting of only the right side.

Part #	Inner diameter
ZS72-1142	14 mm (14 - 15.5 mm)
ZS72-1162	16 mm (16 - 17.5 mm)

Replacement Arm
Part number [ZS72-1190](#)

CONTROL



LEVER



BODY



ELECTRICAL



for RACING /STREET



ZETA LEVER GUARD

- Lever guard prevents accidental brake lever incidents at the race, track day or street riding.
- Made of A7009-T6 aluminum for durable construction, with length adjustable function to fit most bikes.
- Can also be used for clutch lever side by changing the part direction.
- Available Gold and Titanium colors.
- Sold by unit quantity (One side only)
- Can be used for handlebar with inner diameter from 13.5 mm to 19 mm.

Part #	Color
ZS72-1000	Black
ZS72-1004	Gold
ZS72-1008	Ti-color

Replacement Arm
Part number [ZS72-1094](#)



Adjustable

Length

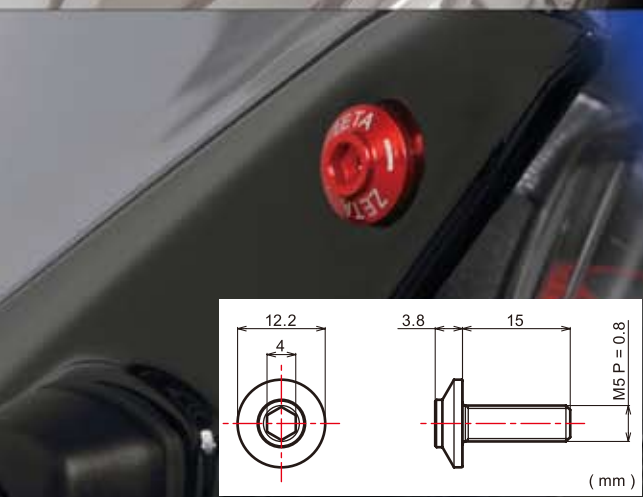

ZETA SCREEN BOLT KIT

- High strength aluminum alloy and anodized finish.
- Easily weight reduction and dress-up effects simply by replacing it from the stock.
- Two colors options, black and red, easy to match to any models.

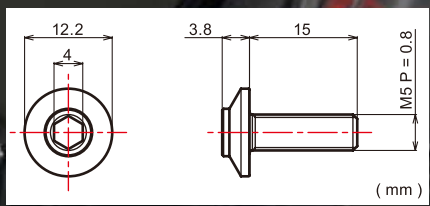

Color	Part #	pcs
Black	ZS88-1040	4
	ZS88-1060	6

Color	Part #	pcs
Red	ZS88-1042	4
	ZS88-1062	6





ZETA
STEERING STEM NUT & BOLT

- CNC Machined steering stem nut and bolt.
- Made of A7009-T6 aluminum, light weight design.
- Available in Gold and Titanium color anodized colors.

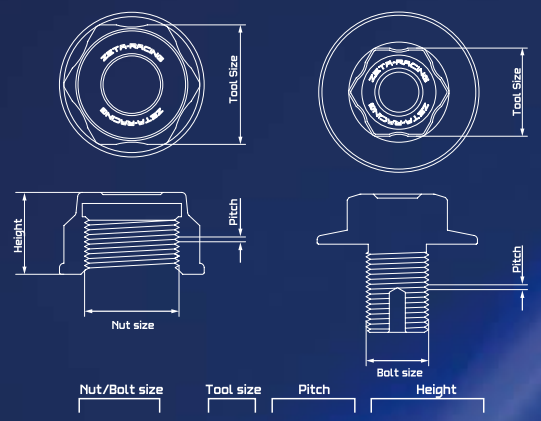

M24 x 30-P1.0 H18.2

Bike	Year	Size	Gold	Ti-Color
HONDA				
GROM,MSX125	13-18	M24x30-P1.0 H18.2	ZS58-1104	ZS58-1108
VTR	99-17	M24x30-P1.0 H18.2	ZS58-1104	ZS58-1108
CBR250R	11-17	M24x30-P1.0 H18.2	ZS58-1104	ZS58-1108
CBR250RR	17	M24x30-P1.0 H18.2	ZS58-1104	ZS58-1108
CB250F	14-17	M24x30-P1.0 H18.2	ZS58-1104	ZS58-1108
CBR300R	15-17	M24x30-P1.0 H18.2	ZS58-1104	ZS58-1108
CB300F	15-17	M24x30-P1.0 H18.2	ZS58-1104	ZS58-1108
400X	13-17	M24x30-P1.0 H18.2	ZS58-1104	ZS58-1108
CB400F	13-16	M24x30-P1.0 H18.2	ZS58-1104	ZS58-1108
CBR400R	13-17	M24x30-P1.0 H18.2	ZS58-1104	ZS58-1108
CB400SF	92-16	M24x30-P1.0 H18.2	ZS58-1104	ZS58-1108
CB500F	13-17	M24x30-P1.0 H18.2	ZS58-1104	ZS58-1108
CB500X	13-17	M24x30-P1.0 H18.2	ZS58-1104	ZS58-1108
CBR500R	13-17	M24x30-P1.0 H18.2	ZS58-1104	ZS58-1108
CBR600RR	03-17	M24x30-P1.0 H18.2	ZS58-1104	ZS58-1108
CB650F	14-18	M24x30-P1.0 H18.2	ZS58-1104	ZS58-1108
CBR650F	14-18	M24x30-P1.0 H18.2	ZS58-1104	ZS58-1108
NC700S/X	12-17	M24x30-P1.0 H18.2	ZS58-1104	ZS58-1108
NC750S/X	14-17	M24x30-P1.0 H18.2	ZS58-1104	ZS58-1108
VFR800	98-09	M24x30-P1.0 H18.2	ZS58-1104	ZS58-1108
VFR800F/X	14-17	M24x30-P1.0 H18.2	ZS58-1104	ZS58-1108
CB1000R	11-17	M24x30-P1.0 H18.2	ZS58-1104	ZS58-1108
CBR1000RR	04-07	M24x30-P1.0 H18.2	ZS58-1104	ZS58-1108
CB1100	10-17	M24x30-P1.0 H18.2	ZS58-1104	ZS58-1108
VFR1200F	10-14	M24x30-P1.0 H18.2	ZS58-1104	ZS58-1108
VFR1200X	14-15	M24x30-P1.0 H18.2	ZS58-1104	ZS58-1108
CB1300SF	03-17	M24x30-P1.0 H18.2	ZS58-1104	ZS58-1108
YAMAHA				
FZ6/R	04-17	M22x27-P1.0 H18.5	ZS58-1404	ZS58-1408
YZF-R6	99-17	M28x36-P1.0 H17	ZS58-1304	ZS58-1308
FZ8	11-14	M28x36-P1.0 H17	ZS58-1304	ZS58-1308
FZ-09/FJ-09	14-17	M22x27-P1.0 H18.5	ZS58-1404	ZS58-1408
MT-09/TRACER	14-17	M22x27-P1.0 H18.5	ZS58-1404	ZS58-1408
XSR900	16-17	M22x27-P1.0 H18.5	ZS58-1404	ZS58-1408
YZF-R1/M/S	98-17	M28x36-P1.0 H17	ZS58-1304	ZS58-1308
FZ1(NORTH AMERICA)	01-05	M22x27-P1.0 H18.5	ZS58-1404	ZS58-1408
FZ1 FAZER(JAPAN)	06-15	M28x36-P1.0 H17	ZS58-1304	ZS58-1308
V-MAX	99-07	M22x27-P1.0 H18.5	ZS58-1404	ZS58-1408
XJR1300	98-15	M22x27-P1.0 H18.5	ZS58-1404	ZS58-1408
KAWASAKI				
NINJA250/R	08-17	M16x22-P1.5 L=22	ZS58-1204	ZS58-1208
Z250	13-17	M16x22-P1.5 L=22	ZS58-1204	ZS58-1208
NINJA300	13-17	M16x22-P1.5 L=22	ZS58-1204	ZS58-1208
ER-4N	11-13	M26x30-P1.0 L=18	ZS58-1214	ZS58-1218
NINJA400/R	11-17	M26x30-P1.0 L=18	ZS58-1214	ZS58-1218
ZX-6R	05-12	M28x36-P1.0 H17	ZS58-1304	ZS58-1308
ER-6F	13-17	M26x30-P1.0 L=18	ZS58-1214	ZS58-1218
ER-6N	07-10	M26x30-P1.0 L=18	ZS58-1214	ZS58-1218
06-14	M26x30-P1.0 L=18	ZS58-1214	ZS58-1218	
NINJA650/R	06-18	M26x30-P1.0 L=18	ZS58-1214	ZS58-1218
VERSYS650	07-17	M26x30-P1.0 L=18	ZS58-1214	ZS58-1218
NINJA1000	11-18	M26x30-P1.0 L=18	ZS58-1214	ZS58-1218
Z650	17	M26x30-P1.0 L=18	ZS58-1214	ZS58-1218
Z750/S	04-10	M26x30-P1.0 L=18	ZS58-1214	ZS58-1218
Z800	13-16	M26x30-P1.0 L=18	ZS58-1214	ZS58-1218
Z900	17	M26x30-P1.0 L=18	ZS58-1214	ZS58-1218
Z1000	04-16	M26x30-P1.0 L=18	ZS58-1214	ZS58-1218
ZX-10R	08-10	M26x30-P1.0 L=18	ZS58-1214	ZS58-1218
11-15	M28x36-P1.0 H17	ZS58-1304	ZS58-1308	
VERSYS1000	12-17	M26x30-P1.0 L=18	ZS58-1214	ZS58-1218
SUZUKI				
GSR250, GW250, INAZUMA250	12-17	M22x27-P1.0 H18.5	ZS58-1404	ZS58-1408
GSR250S	14-15	M22x27-P1.0 H18.5	ZS58-1404	ZS58-1408
GSX250R	17	M22x27-P1.0 H18.5	ZS58-1404	ZS58-1408
V-STROM250	17	M22x27-P1.0 H18.5	ZS58-1404	ZS58-1408
GSX-R600	06-17	M28x36-P1.0 H17	ZS58-1304	ZS58-1308
GSR750	13-16	M22x27-P1.0 H18.5	ZS58-1404	ZS58-1408
GSX-R750	06-17	M28x36-P1.0 H17	ZS58-1304	ZS58-1308
GSX-S750	17	M22x27-P1.0 H18.5	ZS58-1404	ZS58-1408
GSX-R1000	06-17	M28x36-P1.0 H17	ZS58-1304	ZS58-1308



ZETA
REAR BRAKE CLEVIS

- Made of CNC machined aluminum with anodized finish.
- Durable yet lightweight design provides the sensitive rear brake feel.
- Available in gold and titanium colors.
- Stainless steel pin is resistant to rust.

Bike	Year	Gold	Ti-color	
HONDA	CB250F	14-17		
	CB300F	15-17		
	CBR250R	11-17		
	CBR300R	15-17		
	400X	13-17	ZS89-5044	ZS89-5048
	CB400F	13-15		
	CB400SF	08-16		
YAMAHA	CBR400R	13-17		
	CB500X/F	13-17		
	CBR500R	13-17		
KAWASAKI	MT-25/03	16-17	ZS89-5034	ZS89-5038
	YZF-R25/R3	15-17		
	NINJA 250/R	08-17		
	Z250	13-17		
	NINJA 300	13-17	ZS89-5034	ZS89-5038
KAWASAKI	ER-4N	11-13		
	NINJA 400R	11-13		
	ER-6N	09-11		
	NINJA 650R	09-11		



Master Cylinder Cover Clutch				
Bike	Year	Gold	Ti-color	
VFR800	98-09	ZS86-0124	ZS86-0128	YAMAHA
VFR800F	14-15	ZS86-0124	ZS86-0128	
CB1000	94-95	ZS86-0124	ZS86-0128	
CB1000R	11-17	ZS86-0424	ZS86-0428	
CBR1000F	87-96	ZS86-0124	ZS86-0128	
CBR1000RR	04-07	ZS86-0424	ZS86-0428	
RV11000R	00-06	ZS86-0424	ZS86-0428	
CB1100	10-15	ZS86-0124	ZS86-0128	
CBR1100XX	97-03	ZS86-0124	ZS86-0128	
ST1100	91-03	ZS86-0124	ZS86-0128	
CB1300SF	98-17	ZS86-0124	ZS86-0128	
ST1300	03-13	ZS86-0124	ZS86-0128	
X-4	97-03	ZS86-0124	ZS86-0128	
XJR1200	94-96	ZS86-0144	ZS86-0148	
FJR1300	03-15	ZS86-0144	ZS86-0148	
XJR1300	98-15	ZS86-0144	ZS86-0148	
XJR1300C	15	ZS86-0144	ZS86-0148	
ZX-9R	94-97	ZS86-0144	ZS86-0148	
GPZ1100	95-07	ZS86-0144	ZS86-0148	
ZEPHYR1100	92-05	ZS86-0144	ZS86-0148	
ZEPHYR1100RS	96-02	ZS86-0144	ZS86-0148	
ZR1100	92-95	ZS86-0144	ZS86-0148	
ZRX1100	99-00	ZS86-0144	ZS86-0148	
ZX-11	92-01	ZS86-0144	ZS86-0148	
ZRX1200DAEG	09-16	ZS86-0144	ZS86-0148	
ZRX1200R	01-05	ZS86-0144	ZS86-0148	
ZRX1200S	01-04	ZS86-0144	ZS86-0148	
ZZR1200	02-05	ZS86-0144	ZS86-0148	
GS650F	08-09	ZS86-0154	ZS86-0158	
GSX-R1000	07-08	ZS86-0424	ZS86-0428	
SV1000	03-05	ZS86-0154	ZS86-0158	
SV1000S	03-07	ZS86-0424	ZS86-0428	
TL1000R	98-03	ZS86-0424	ZS86-0428	
V-STROM 1000/XT	02-17	ZS86-0154	ZS86-0158	
GSX-R1100	91-92	ZS86-0154	ZS86-0158	
GSX-R1100W	93-98	ZS86-0154	ZS86-0158	
BANDIT1200	97-05	ZS86-0154	ZS86-0158	
BANDIT1250/S	07-15	ZS86-0154	ZS86-0158	
GSX1250F	11	ZS86-0154	ZS86-0158	
GSX1300R	99-17	ZS86-0154	ZS86-0158	
HAYABUSA				



FZ09/MT09/Tracer ZS86-0168

Ninja 250 ZS86-0424

ZETA MASTER CYLINDER COVER

- Made of CNC machined aluminum with anodized finish.
- Makes your cylinder cover look exclusive.
- Available in gold and titanium colors.
- Available for front and rear brake cylinder cover and clutch cylinder cover.



ZS86-0138



ZS86-0124



ZS86-0158



ZS86-0418



ZS86-0424

Master Cylinder Cover Front				
Bike	Year	Gold	Ti-color	
GROM	13-18	ZS86-0114	ZS86-0118	YAMAHA
MX125	13-15	ZS86-0114	ZS86-0118	
PSX150	13-15	ZS86-0114	ZS86-0118	
HORNET 250	96-06	ZS86-0114	ZS86-0118	
VTR/VTR-F	98-15	ZS86-0114	ZS86-0118	
CB250F	14-17	ZS86-0114	ZS86-0118	
CB300F	15-17	ZS86-0114	ZS86-0118	
CBR250R	11-17	ZS86-0114	ZS86-0118	
CBR250RR	17	ZS86-0114	ZS86-0118	
CBR300R	15-17	ZS86-0114	ZS86-0118	
400X	13-17	ZS86-0114	ZS86-0118	
CB400F	89-90	ZS86-0124	ZS86-0128	
CB400SF	13-16	ZS86-0114	ZS86-0118	
CB400R	92-16	ZS86-0124	ZS86-0128	
CB500X	13-17	ZS86-0114	ZS86-0118	
CB500F	13-17	ZS86-0114	ZS86-0118	
CBR500R	13-17	ZS86-0114	ZS86-0118	
CB600F	04-06	ZS86-0124	ZS86-0128	
CBR600F	91-06	ZS86-0124	ZS86-0128	
CBR600RR	03-06	ZS86-0124	ZS86-0128	
07-17	ZS86-0124	ZS86-0128		
CB650F	14-18	ZS86-0124	ZS86-0128	
CBR650F	14-18	ZS86-0124	ZS86-0128	
NC700X/S	12-17	ZS86-0124	ZS86-0128	
NT700V	10-11	ZS86-0124	ZS86-0128	
CB750	04-08	ZS86-0124	ZS86-0128	
NC750X/S	14-17	ZS86-0124	ZS86-0128	
VFR800	98-09	ZS86-0124	ZS86-0128	
VFR800F	14-15	ZS86-0124	ZS86-0128	
CB900F	02-07	ZS86-0124	ZS86-0128	
CB1000	94-95	ZS86-0124	ZS86-0128	
CB1000R	11-17	ZS86-0414	ZS86-0418	
CBR1000F	87-96	ZS86-0124	ZS86-0128	
CBR1000S	14-16	ZS86-0414	ZS86-0418	
CBR1000RR	06-17	ZS86-0414	ZS86-0418	
CB1100	10-15	ZS86-0124	ZS86-0128	
CBR1100XX	97-03	ZS86-0124	ZS86-0128	
ST1100	91-03	ZS86-0124	ZS86-0128	
VFR1200X	14	ZS86-0124	ZS86-0128	
CB1300SF	96-17	ZS86-0124	ZS86-0128	
ST1300	03-13	ZS86-0124	ZS86-0128	
X-4	97-03	ZS86-0124	ZS86-0128	
GSR250	12-17	ZS86-0154	ZS86-0158	
GSR250S	14-15	ZS86-0154	ZS86-0158	
GW250	12-17	ZS86-0154	ZS86-0158	
INAZUMA250	12-15	ZS86-0154	ZS86-0158	
GSX250R	17	ZS86-0154	ZS86-0158	
V-STROM250	17	ZS86-0154	ZS86-0158	
BANDIT400	91-93	ZS86-0154	ZS86-0158	
GLADIUS400	10-13	ZS86-0154	ZS86-0158	
GSR400	06-13	ZS86-0154	ZS86-0158	
GSX-R600	97-17	ZS86-0414	ZS86-0418	
GSX-R600W	92-93	ZS86-0414	ZS86-0418	
GS650F	08-09	ZS86-0154	ZS86-0158	
SV650	99-09	ZS86-0154	ZS86-0158	
SV650S	99-09	ZS86-0154	ZS86-0158	
V-STROM 650/XT	04-17	ZS86-0154	ZS86-0158	
GLADIUS650	09	ZS86-0154	ZS86-0158	
GSR750	13-15	ZS86-0154	ZS86-0158	
GSX-R750	93-17	ZS86-0414	ZS86-0418	
GSX750F	89-06	ZS86-0154	ZS86-0158	
GSX-S750	17	ZS86-0154	ZS86-0158	
GSX-R1000	01-17	ZS86-0414	ZS86-0418	
SV1000	03-05	ZS86-0154	ZS86-0158	
SV1000S	03-07	ZS86-0414	ZS86-0418	
TL1000R	98-03	ZS86-0414	ZS86-0418	
TL1000S	97-01	ZS86-0414	ZS86-0418	
V-Strom 1000/XT	02-17	ZS86-0154	ZS86-0158	
GSX-R1100	91-92	ZS86-0154	ZS86-0158	
GSX-R1100W	93-98	ZS86-0154	ZS86-0158	
BANDIT1200	97-05	ZS86-0154	ZS86-0158	
BANDIT1250/S	07-15	ZS86-0154	ZS86-0158	
GSX1250F	11	ZS86-0154	ZS86-0158	
GSX1300R	99-17	ZS86-0154	ZS86-0158	
HAYABUSA				

Master Cylinder Cover Front				
Bike	Year	Gold	Ti-color	
FZ6/R	04-17	ZS86-0164	ZS86-0168	YAMAHA
R6S	06-09	ZS86-0414	ZS86-0418	
YZF-R6	99-17	ZS86-0414	ZS86-0418	
FZ-07	15-17	ZS86-0164	ZS86-0168	
MT-07	14-17	ZS86-0164	ZS86-0168	
XSR900	16-17	ZS86-0164	ZS86-0168	
FZ100	14-17	ZS86-0164	ZS86-0168	
MT-09/TRACER	14-17	ZS86-0164	ZS86-0168	
FZ1	06-15	ZS86-0164	ZS86-0168	
FZ1 FAZER	08-15	ZS86-0164	ZS86-0168	
YZF-R1	98-17	ZS86-0414	ZS86-0418	
XJR1200	94-96	ZS86-0144	ZS86-0148	
XT1200Z/E	10-17	ZS86-0164	ZS86-0168	
FJR1300	03	ZS86-0144	ZS86-0148	
XJR1300	98-15	ZS86-0144	ZS86-0148	
XJR1300C	15	ZS86-0164	ZS86-0168	
Z125 PRO	16-17	ZS86-0114	ZS86-0118	
NINJA 250R	92-07	ZS86-0144	ZS86-0148	
NINJA 250/R	08-17	ZS86-0114	ZS86-0118	
NINJA 250SL	15-16	ZS86-0114	ZS86-0118	
Z250	13-17	ZS86-0114	ZS86-0118	
Z250SL	16-17	ZS86-0114	ZS86-0118	
VERSYS-X 250	17	ZS86-0114	ZS86-0118	
VERSYS-X 300	17	ZS86-0114	ZS86-0118	
Z300	16	ZS86-0114	ZS86-0118	
NINJA 300	13-17	ZS86-0114	ZS86-0118	
ER-4N	11-13	ZS86-0134	ZS86-0138	
NINJA 400/R	11-17	ZS86-0134	ZS86-0138	
ZRX	94-08	ZS86-0144	ZS86-0148	
ZRX-II	95-06	ZS86-0144	ZS86-0148	
ZZR400	93-06	ZS86-0144	ZS86-0148	
NINJA 500	94-09	ZS86-0144	ZS86-0148	
ZEPHYR ZR550	92-08	ZS86-0144	ZS86-0148	
NINJA 600R	92-97	ZS86-0144	ZS86-0148	
ZX-6	92-01	ZS86-0144	ZS86-0148	
ZX-6R	95-97	ZS86-0144	ZS86-0148	
ZX-6RR	98-17	ZS86-0414	ZS86-0418	
ZZR600	02-04	ZS86-0144	ZS86-0148	
ER-6F	05-08	ZS86-0144	ZS86-0148	
ER-6N	09-10	ZS86-0144	ZS86-0148	
ER-6N	09-14	ZS86-0134	ZS86-0138	
NINJA 650/R	09-17	ZS86-0134	ZS86-0138	
NINJA 650R	06-08	ZS86-0144	ZS86-0148	
VERSYS650	07-08	ZS86-0144	ZS86-0148	
09-17	ZS86-0134	ZS86-0138		
Z650	17	ZS86-0134	ZS86-0138	
Z750	04-05	ZS86-0144	ZS86-0148	
Z750S	06-10	ZS86-0144	ZS86-0148	
ZR-7	05-07	ZS86-0144	ZS86-0148	
ZR-7	00	ZS86-0144	ZS86-0148	
ZR750	92-93	ZS86-0144	ZS86-0148	
ZR-7S	01-05	ZS86-0144	ZS86-0148	
ZX-7R	91-03	ZS86-0414	ZS86-0418	
ZX-7RR	96-97	ZS86-0414	ZS86-0418	
ZX-7R	94-97	ZS86-0144	ZS86-0148	
ZX-9R	98-03	ZS86-0414	ZS86-0418	
NINJA 1000	11-16	ZS86-0414	ZS86-0418	
ZX-10R	12-14	ZS86-0144	ZS86-0148	
VERSYS1000	15-17	ZS86-0134	ZS86-0138	
03-06	ZS86-0144	ZS86-0148		
Z1000	07-09	ZS86-0414	ZS86-0418	
ZX-10R	04-15	ZS86-0414	ZS86-0418	
GPZ1100	95-07	ZS86-0144	ZS86-0148	
ZEPHYR1100	92-05	ZS86-0144	ZS86-0148	
ZEPHYR1100RS	96-02	ZS86-0144	ZS86-0148	
ZR1100	92-95	ZS86-0144	ZS86-0148	
ZRX1100	99-00	ZS86-0144	ZS86-0148	
ZX-11	92-01	ZS86-0144	ZS86-0148	
ZRX1200DAEG	09-16	ZS86-0144	ZS86-0148	
ZRX1200R	01-05	ZS86-0144	ZS86-0148	
ZRX1200S	01-04	ZS86-0144	ZS86-0148	
ZX-12R	00-05	ZS86-0144	ZS86-0148	
ZZR1200	02-05	ZS86-0144	ZS86-0148	
ZX-14	06-11	ZS86-0414	ZS86-0418	
ZX-14R	12-17	ZS86-0414	ZS86-0418	
ZZR1400	06-11	ZS86-0414	ZS86-0418	

Master Cylinder Cover Rear				
Bike	Year	Gold	Ti-color	
HORNET250	96-06	ZS86-0414	ZS86-0418	YAMAHA
VTR/VTR-F	98-15	ZS86-0414	ZS86-0418	
400X	13-17	ZS86-0114	ZS86-0118	
CB400F	89-90	ZS86-0114	ZS86-0118	
CB400SF	13-16	ZS86-0114	ZS86-0118	
CBR400R	92-16	ZS86-0414	ZS86-0418	
CB500X	13-17	ZS86-0114	ZS86-0118	
CB500F	13-17	ZS86-0114	ZS86-0118	
CBR500R	13-17	ZS86-0114	ZS86-0118	
CB600F	04-06	ZS86-0144	ZS86-0148	
CBR600F	91-06	ZS86-0414	ZS86-0418	
CBR600RR	03-17	ZS86-0114	ZS86-0118	
CB650F	14-18	ZS86-0114	ZS86-0118	
CBR650F	14-18	ZS86-0114	ZS86-0118	
NC700X/S	12-17	ZS86-0114	ZS86-0118	
NT700V	10-11	ZS86-0414	ZS86-0418	
CB750	04-08	ZS86-0414	ZS86-0418	
NC750X/S	14-17	ZS86-0114	ZS86-0118	
VFR800	98-09	ZS86-0414	ZS86-0418	
VFR800F	14-15	ZS86-0114	ZS86-0118	
CB900F	02-07	ZS86-0414	ZS86-0418	
CBR900RR				

CONTROL



LEVER



BODY



ELECTRICAL



ZETA ENGINE PLUG

- Made of CNC machined aluminum with anodized finish.
- Ideal for dressing up your engine.
- Available in gold and titanium colors.
- # Please use stock o-ring.



ZETA OIL FILLER CAP

- Made of CNC machined aluminum with anodized finish.
- 19 mm hex wrench head.
- Equipped with wiring hole to prevent losing the part.
- Available in gold and titanium colors.
- # Please use stock o-ring.

Engine Plugs		Year	Gold	Ti-color	Qty
H O N D A	GROM	13-18	-	ZS89-1108	2
	MSX125	13-15	-	ZS89-1108	2
	VTR/VTR-F	09-15	-	ZS89-1118	1
	CB250F	14-17	-	ZS89-1108	2
	CB300F	15-17	-	ZS89-1108	2
	CBR250R	11-17	-	ZS89-1108	2
	CBR250RR	17	-	ZS89-1108	2
	CBR300R	15-17	-	ZS89-1108	2
	CB400SF REVO	08-16	-	ZS89-1108	2
	CB400F/CBR400R/400X	13-17	ZS89-1114	ZS89-1118	1
	CB500F/CBR500R/CB500X	13-17	ZS89-1114	ZS89-1118	1
	CBR600RR	03-17	ZS89-1114	ZS89-1118	1
	CB650F	14-18	ZS89-1114	ZS89-1118	1
	CBR650F	14-18	ZS89-1114	ZS89-1118	1
	NC700X/S	12-17	-	ZS89-1108	2
NC750X/S	14-17	-	ZS89-1108	2	
CBR1000RR	04-16	ZS89-1114	ZS89-1118	1	
CBR1000S	14-16	ZS89-1114	ZS89-1118	1	
CB1300SF	98-17	-	ZS89-1108	2	
Y A M A H A	MT-25/03	16-17	ZS89-1404	ZS89-1408	1
	YZF-R25/R3	15-17	ZS89-1404	ZS89-1408	1
	FZ-07	15-16	ZS89-1414	ZS89-1418	1
	MT-07	14-17	ZS89-1414	ZS89-1418	1
	FZ-09	14-17	ZS89-1414	ZS89-1418	1
K A W A S A K I	MT-09/TRACER	14-17	ZS89-1414	ZS89-1418	1
	XSR900	16-17	ZS89-1414	ZS89-1418	1
	NINJA 250	13-17	ZS89-1214	ZS89-1218	1
	Z250	13-17	ZS89-1214	ZS89-1218	1
	VERSYS-X 250	17	ZS89-1214	ZS89-1218	1
	VERSYS-X 300	17	ZS89-1214	ZS89-1218	1
	NINJA 300	13-17	ZS89-1214	ZS89-1218	1
	ER-4N	11-13	ZS89-1204	ZS89-1208	2
	NINJA 400	14-17	ZS89-1204	ZS89-1208	2
	ER-6F	12-13	ZS89-1204	ZS89-1208	2
	ER-6N	09-14	ZS89-1204	ZS89-1208	2
	NINJA 650	12-16	ZS89-1204	ZS89-1208	2
	VERSYS	11-14	ZS89-1204	ZS89-1208	2
	VERSYS650	15-17	ZS89-1204	ZS89-1208	2
	S U Z U K I	GSXR250	12-17	ZS89-1304	ZS89-1308
GSXR250S		14-15	ZS89-1304	ZS89-1308	1
GSX250R		17	ZS89-1304	ZS89-1308	1
GW250		12-17	ZS89-1304	ZS89-1308	1
INAZUMA 250		12-15	ZS89-1304	ZS89-1308	1
V-STORM250	17	ZS89-1304	ZS89-1308	1	

Oil Filler Cap		Year	Gold	Ti-color
H O N D A	CB250F	14-17	ZS89-2104	ZS89-2108
	CB300F	15-17	ZS89-2104	ZS89-2108
	CBR250R	11-17	ZS89-2104	ZS89-2108
	CBR250RR	17	ZS89-2104	ZS89-2108
	CBR300R	15-17	ZS89-2104	ZS89-2108
	400X	13-17	ZS89-2104	ZS89-2108
	CB400F	13-16	ZS89-2104	ZS89-2108
	CBR400R	13-17	ZS89-2104	ZS89-2108
	CB400SF	99-16	ZS89-2104	ZS89-2108
	CB500F	13-17	ZS89-2104	ZS89-2108
	CB500X	13-17	ZS89-2104	ZS89-2108
	CBR500R	13-17	ZS89-2104	ZS89-2108
	CBR500RR	03-17	ZS89-2104	ZS89-2108
	CBR929RR	02-03	ZS89-2104	ZS89-2108
	CBR954RR	02-03	ZS89-2104	ZS89-2108
H O N D A	CB1100	10-15	ZS89-2104	ZS89-2108
	CBR1000RR	04-17	ZS89-2104	ZS89-2108
	CBR1000S	14-16	ZS89-2104	ZS89-2108
	VTR1000F	98-05	ZS89-2104	ZS89-2108
	VFR1200F	10-12	ZS89-2104	ZS89-2108
	VFR1200X	14-15	ZS89-2104	ZS89-2108
	X-4	97-03	ZS89-2104	ZS89-2108
	NINJA 250	13-17	ZS89-2204	ZS89-2208
	NINJA 250R	08-12	ZS89-2204	ZS89-2208
	NINJA 250SL	15-16	ZS89-2104	ZS89-2108
	Z250	13-17	ZS89-2204	ZS89-2208
	Z250SL	16-17	ZS89-2104	ZS89-2108
	ZZR250	90-07	ZS89-2204	ZS89-2208
	VERSYS-X 250	17	ZS89-2204	ZS89-2208
	VERSYS-X 300	17	ZS89-2204	ZS89-2208
K A W A S A K I	NINJA 300	13-17	ZS89-2204	ZS89-2208
	ER-4n	11-13	ZS89-2104	ZS89-2108
	EX-4	94-95	ZS89-2204	ZS89-2208
	FX400R	86-90	ZS89-2204	ZS89-2208
	GPZ400R/S	83-88	ZS89-2204	ZS89-2208
	NINJA 400	14-17	ZS89-2104	ZS89-2108
	NINJA 400R	11-13	ZS89-2104	ZS89-2108
	ZEPHYR400 KAI	96-07	ZS89-2204	ZS89-2208
	ZXR400/R	89-99	ZS89-2204	ZS89-2208
	ZZR400	90-06	ZS89-2204	ZS89-2208
	ER-6F	06-10	ZS89-2104	ZS89-2108
	ER-6N	06-14	ZS89-2104	ZS89-2108
	NINJA 600R	09-11	ZS89-2104	ZS89-2108
	NINJA 650	12-18	ZS89-2104	ZS89-2108
	VERSYS650	07-14	ZS89-2104	ZS89-2108
S U Z U K I	ZX-6R	00-17	ZS89-2204	ZS89-2208
	ZX-6RR	03-05	ZS89-2204	ZS89-2208
	Z650	17	ZS89-2104	ZS89-2108
	Z750/S	04-10	ZS89-2204	ZS89-2208
	ZR-7	99-01	ZS89-2204	ZS89-2208
	ZXR750	89-95	ZS89-2104	ZS89-2108
	ZXR750R	91-94	ZS89-2104	ZS89-2108
	Z800	13-16	ZS89-2104	ZS89-2108
	GPZ900R	91-03	ZS89-2204	ZS89-2208
	ZX-9R	98-03	ZS89-2204	ZS89-2208
	GPZ1100	95-99	ZS89-2204	ZS89-2208
	NINJA 1000	10-17	ZS89-2104	ZS89-2108
	VERSYS1000	12-17	ZS89-2104	ZS89-2108
	Z1000	10-17	ZS89-2104	ZS89-2108
	Z1000	03-09	ZS89-2204	ZS89-2208
ZX-10R	04-17	ZS89-2204	ZS89-2208	
ZRX1100/II	97-00	ZS89-2204	ZS89-2208	
ZZR-R1100	99-01	ZS89-2204	ZS89-2208	
S U Z U K I	ZRX1200R/S/DAEG	01-16	ZS89-2204	ZS89-2208
	ZX-12R	00-06	ZS89-2204	ZS89-2208
	ZZR1200	02-05	ZS89-2204	ZS89-2208
	ZX-14R	12-17	ZS89-2204	ZS89-2208
	ZZR1400	06-11	ZS89-2204	ZS89-2208
	1400GTR	08-16	ZS89-2204	ZS89-2208

Oil Filler Cap		Year	Gold	Ti-color
Y A M A H A	FZR250/R	87-94	ZS89-2404	ZS89-2408
	FZX250 ZEAL	91-92	ZS89-2404	ZS89-2408
	MT-25	16-17	ZS89-2404	ZS89-2408
	MT-03	16-17	ZS89-2404	ZS89-2408
	YZF-R25	15-17	ZS89-2404	ZS89-2408
	YZF-R3	15-17	ZS89-2404	ZS89-2408
	FZ400	97	ZS89-2404	ZS89-2408
	XJR400	93-96	ZS89-2404	ZS89-2408
	FZ6/FAZER	04-06	ZS89-2404	ZS89-2408
	FZS600/S FAZER	00-03	ZS89-2404	ZS89-2408
	FZX750	90	ZS89-2404	ZS89-2408
	FZF7R	09-17	ZS89-2404	ZS89-2408
	YZF-R6	99-17	ZS89-2404	ZS89-2408
	MT-07	14-17	ZS89-2404	ZS89-2408
	FZ-07	15-17	ZS89-2404	ZS89-2408
S U Z U K I	FZ8	11-13	ZS89-2404	ZS89-2408
	TDM850	98-01	ZS89-2404	ZS89-2408
	XJ900 DIVERSION	00-02	ZS89-2404	ZS89-2408
	FZ-1	06-15	ZS89-2404	ZS89-2408
	FZ-1FAZER	06-15	ZS89-2404	ZS89-2408
	FZS1000FAZER	01-05	ZS89-2404	ZS89-2408
	YZF-R1	98-14	ZS89-2404	ZS89-2408
	XJR1200	94-96	ZS89-2404	ZS89-2408
	XTZ1200Z/ZE	10-17	ZS89-2404	ZS89-2408
	FJR1300A/IAS	01-16	ZS89-2404	ZS89-2408
	XVS1300A	99-09	ZS89-2404	ZS89-2408
	GSXR250	12-17	ZS89-2304	ZS89-2308
	GSXR250S	14-15	ZS89-2304	ZS89-2308
	GW250	12-17	ZS89-2304	ZS89-2308
	INAZUMA 250	12-15	ZS89-2304	ZS89-2308
GSX250R	17	ZS89-2304	ZS89-2308	
V-STORM250	17	ZS89-2304	ZS89-2308	
GSR400	06-12	ZS89-2304	ZS89-2308	
GLADIUS 400	09-13	ZS89-2304	ZS89-2308	
IMPULUS 400	94-07	ZS89-2304	ZS89-2308	
INAZUMA 400	97-02	ZS89-2304	ZS89-2308	
GSX-R600	97-17	ZS89-2304	ZS89-2308	
V-STORM650	04-17	ZS89-2304	ZS89-2308	
GSF750	96-00	ZS89-2304	ZS89-2308	
GSR750	13-15	ZS89-2304	ZS89-2308	
GSX-R750	89-17	ZS89-2304	ZS89-2308	
GSX-S750	17	ZS89-2304	ZS89-2308	
GSX-R1000	01-17	ZS89-2304	ZS89-2308	
GSX-S1000/F	15-17	ZS89-2304	ZS89-2308	
SV1000/S	03-07	ZS89-2304	ZS89-2308	
V-STROM1000	04-17	ZS89-2304	ZS89-2308	
GSX-R1100W	86-98	ZS89-2304	ZS89-2308	
BANDIT1200/S	01-06	ZS89-2304	ZS89-2308	
BANDIT1250/S/IF	06-15	ZS89-2304	ZS89-2308	
GS1200SS	01-02	ZS89-2304	ZS89-2308	
GSF1200	01-06	ZS89-2304	ZS89-2308	
GSF1250	08-09	ZS89-2304	ZS89-2308	
GSX1300R HAYABUSA	08-17	ZS89-2304	ZS89-2308	
B-KING	08	ZS89-2304	ZS89-2308	
GSX1400	01-08	ZS89-2304	ZS89-2308	



ZS80-9110

ZS80-9100

ZETA DRIVE COVER

- Made of CNC machined aluminum with anodized finish.
- Easy maintenance.
- Available in titanium color.
- Made of A7009-T6 aluminum.

Drive Cover			
	Bike	Year	Ti-color
HONDA	CBR250R	11-17	
	CBR300R	15-17	
	CB250F	14-17	ZS80-9100
	CB300F	15-17	
	CB400SF REVO	08-16	ZS80-9110
	Ninja 250	13-17	
KAWASAKI	Z250	13-17	ZS80-9200
	Ninja 300	13-17	

Ninja 250 ZS80-9200

CONTROL



LEVER



BODY



ELECTRICAL



YZF-R25

ZS56-2208



Ninja 250

ZS56-2408

ZS56-2108

ZETA STEP BRACKET KIT

- Adjust the stock rear set back for a better riding position and more ground clearance.
- 3 different position adjustments to fit your riding position.
- Made of CNC titanium anodized aluminum, comes with stainless gear change rod and nuts.

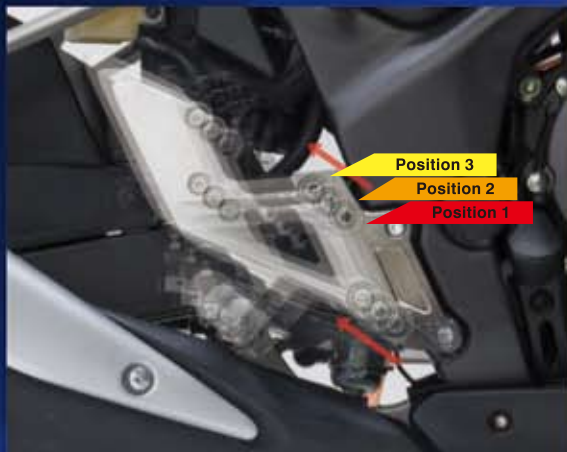

Position 3

Position 2

Position 1

Step Bracket Kit				Offset (mm)					
Bike	Year	Part #	Position 1		Position 2		Position 3		
			Back	Up	Back	Up	Back	Up	
HONDA	CBR250R	11-13	ZS56-2108	33	10	43	20	53	30
	MT-25	16-17		28	3	38	10	-	-
	MT-03	16-17		28	3	38	10	-	-
YAMAHA	YZF-R25	15-17	ZS56-2408	28	3	38	10	-	-
	YZF-R3	15-17		28	3	38	10	-	-
	Ninja250R	08-12		21	5	26	18	31	32
KAWASAKI	Ninja250	13-17	ZS56-2208	21	5	26	18	31	32
	Ninja300	13-17		21	5	26	18	31	32
	Z250	13-17		21	5	26	18	31	32

ZETA MAGNETIC DRAIN BOLT

- Magnetic drain bolt for Sport bikes.
- Designed to pick up excess bits of metal in your engine oil.
- Made of A7009-T6 aluminum. Light weight design.
- Press fit magnet on the drain plugs.
- Includes safety wire holes to prevent misplaced part.
- Available in blue, red anodized colors.

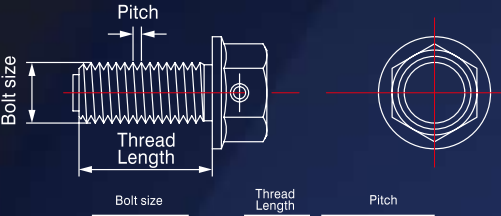

M12 X 14-P1.5

Magnetic Drain Bolt				
Bike	Year	Size	Blue	Red
CBR125R	13-14	M12X15-P1.5	ZE58-1522	ZE58-1523
GROM_MSX125	13-18	M12X15-P1.5	ZE58-1522	ZE58-1523
VTR/F	98-17	M12X15-P1.5	ZE58-1522	ZE58-1523
CBR250R	11-17	M12X15-P1.5	ZE58-1522	ZE58-1523
CBR250RR	90-99	M14X14-P1.5	ZE58-1622	ZE58-1623
	17	M12X15-P1.5	ZE58-1522	ZE58-1523
CB250F	14-17	M12X15-P1.5	ZE58-1522	ZE58-1523
CB300F	15-17	M12X15-P1.5	ZE58-1522	ZE58-1523
CBR300R	15-17	M12X15-P1.5	ZE58-1522	ZE58-1523
400X	13-17	M12X15-P1.5	ZE58-1522	ZE58-1523
CB400F	13-16	M12X15-P1.5	ZE58-1522	ZE58-1523
CB400SF	92-16	M12X15-P1.5	ZE58-1522	ZE58-1523
CBR400R	13-17	M12X15-P1.5	ZE58-1522	ZE58-1523
CBR400RR	90-99	M12X15-P1.5	ZE58-1522	ZE58-1523
RVF400	94-01	M12X15-P1.5	ZE58-1522	ZE58-1523
VFR400R	89-93	M12X15-P1.5	ZE58-1522	ZE58-1523
CB500F	13-17	M12X15-P1.5	ZE58-1522	ZE58-1523
CB500X	13-17	M12X15-P1.5	ZE58-1522	ZE58-1523
CBR500R	13-17	M12X15-P1.5	ZE58-1522	ZE58-1523
CBR600F	91-06	M12X15-P1.5	ZE58-1522	ZE58-1523
CBR600SE	98	M12X15-P1.5	ZE58-1522	ZE58-1523
CBR600SJR	96	M12X15-P1.5	ZE58-1522	ZE58-1523
CBR600RR	03-17	M12X15-P1.5	ZE58-1522	ZE58-1523
CB650F	14-18	M12X15-P1.5	ZE58-1522	ZE58-1523
CBR650F	14-18	M12X15-P1.5	ZE58-1522	ZE58-1523
NC700S/X	12-17	M12X15-P1.5	ZE58-1522	ZE58-1523
NC750S/X	14-17	M12X15-P1.5	ZE58-1522	ZE58-1523
RVF750R	94-97	M12X15-P1.5	ZE58-1522	ZE58-1523
VFR750F	90-97	M12X15-P1.5	ZE58-1522	ZE58-1523
VFR800	98-09	M12X15-P1.5	ZE58-1522	ZE58-1523
VFR800FIX	14-17	M12X15-P1.5	ZE58-1522	ZE58-1523
CBR900RR	92-03	M12X15-P1.5	ZE58-1522	ZE58-1523
CBR954RR	02-03	M12X15-P1.5	ZE58-1522	ZE58-1523
CB1000	95	M14X14-P1.5	ZE58-1622	ZE58-1623
CB1000SF	92-97	M14X14-P1.5	ZE58-1622	ZE58-1623
CB1000R	11-17	M12X15-P1.5	ZE58-1522	ZE58-1523
CBR1000RR	08-17	M12X15-P1.5	ZE58-1522	ZE58-1523
RVT1000R	00-06	M12X15-P1.5	ZE58-1522	ZE58-1523
VTR1000F	97-07	M12X15-P1.5	ZE58-1522	ZE58-1523
VTR1000SP-1/2	00-03	M12X15-P1.5	ZE58-1522	ZE58-1523
CB1100	10-15	M14X14-P1.5	ZE58-1622	ZE58-1623
CBR1100XX	97-03	M14X14-P1.5	ZE58-1622	ZE58-1623
ST1100	91-03	M12X15-P1.5	ZE58-1522	ZE58-1523
X-11	99-01	M14X14-P1.5	ZE58-1622	ZE58-1623
VFR1200F	10-14	M14X14-P1.5	ZE58-1622	ZE58-1623
VFR1200X	14-15	M14X14-P1.5	ZE58-1622	ZE58-1623
CB1300SF	98-17	M14X14-P1.5	ZE58-1622	ZE58-1623

ZETA SWING ARM SPOOL

- CNC machined aluminum swing arm spool.
- Can be used with most street racing stands available on the market.
- Available in M6, M8 and M10 bolt sizes to fit most Japanese street bikes.
- Available in titanium and gold colors.
- Comes in pairs.

Magnetic Drain Bolt		Year	Size	Blue	Red
FZR250R	Bike	87-94	M14X14-P1.5	ZE58-1622	ZE58-1623
MT-25/03		16-17	M12X15-P1.5	ZE58-1522	ZE58-1523
YZF-R25/R3		15-17	M12X15-P1.5	ZE58-1522	ZE58-1523
ZEAL		91-99	M14X14-P1.5	ZE58-1622	ZE58-1623
FZ400		97	M14X14-P1.5	ZE58-1622	ZE58-1623
FZR400RR		90-94	M14X14-P1.5	ZE58-1622	ZE58-1623
SRX400		85-99	M14X14-P1.5	ZE58-1622	ZE58-1623
XJR400R/S		93-08	M14X14-P1.5	ZE58-1622	ZE58-1623
FZ6/R		04-17	M14X14-P1.5	ZE58-1622	ZE58-1623
SRX600		85-94	M14X14-P1.5	ZE58-1622	ZE58-1623
YZF-R6		99-17	M14X14-P1.5	ZE58-1622	ZE58-1623
XJ6F/S		09-13	M14X14-P1.5	ZE58-1622	ZE58-1623
FZ-07		15-17	M14X14-P1.5	ZE58-1622	ZE58-1623
MT-07		14-17	M14X14-P1.5	ZE58-1622	ZE58-1623
FZ8		11-14	M14X14-P1.5	ZE58-1622	ZE58-1623
TDM850		92-01	M14X14-P1.5	ZE58-1622	ZE58-1623
TRX850		95-01	M14X14-P1.5	ZE58-1622	ZE58-1623
FZ-09/FJ-09		14-17	M14X14-P1.5	ZE58-1622	ZE58-1623
MT-09/TRACER		14-17	M14X14-P1.5	ZE58-1622	ZE58-1623
XSR900		16-17	M14X14-P1.5	ZE58-1622	ZE58-1623
FZ1-N (JAPAN)		08-12	M14X14-P1.5	ZE58-1622	ZE58-1623
FZ1 FAZER		08-15	M14X14-P1.5	ZE58-1622	ZE58-1623
FZ1(NORTH AMERICA)		01-15	M14X14-P1.5	ZE58-1622	ZE58-1623
YZF1000R THUNDERACE		96-01	M14X14-P1.5	ZE58-1622	ZE58-1623
YZF-R1		98-14	M14X14-P1.5	ZE58-1622	ZE58-1623
XJR1200		94-96	M14X14-P1.5	ZE58-1622	ZE58-1623
FJR1300		01-15	M14X14-P1.5	ZE58-1622	ZE58-1623
XJR1300		98-15	M14X14-P1.5	ZE58-1622	ZE58-1623
V-MAX		90-07	M14X14-P1.5	ZE58-1622	ZE58-1623
		09-17	M14X14-P1.5	ZE58-1622	ZE58-1623
BALUIS/II		91-07	M12X15-P1.5	ZE58-1522	ZE58-1523
NINJA250		13-17	M12X15-P1.5	ZE58-1522	ZE58-1523
NINJA250R		88-12	M12X15-P1.5	ZE58-1522	ZE58-1523
NINJA250SL		15-16	M10X15-P1.5	ZE58-1322	ZE58-1323
VERSYS-X250		17	M12X15-P1.5	ZE58-1522	ZE58-1523
VERSYS-X300		17	M12X15-P1.5	ZE58-1522	ZE58-1523
Z250		13-17	M12X15-P1.5	ZE58-1522	ZE58-1523
Z250SL		16-17	M10X15-P1.5	ZE58-1322	ZE58-1323
Z300		15-16	M12X15-P1.5	ZE58-1522	ZE58-1523
ZXR250		89-99	M12X15-P1.5	ZE58-1522	ZE58-1523
ZZR250		90-07	M12X15-P1.5	ZE58-1522	ZE58-1523
NINJA300		13-17	M12X15-P1.5	ZE58-1522	ZE58-1523
ER-4N		11-13	M12X15-P1.5	ZE58-1522	ZE58-1523
NINJA400		14-17	M12X15-P1.5	ZE58-1522	ZE58-1523
NINJA400R		11-13	M12X15-P1.5	ZE58-1522	ZE58-1523
W400		06-08	M12X15-P1.5	ZE58-1522	ZE58-1523
ZEPHYR400/KAI		89-08	M12X15-P1.5	ZE58-1522	ZE58-1523
ZRX400		94-08	M12X15-P1.5	ZE58-1522	ZE58-1523
ZXR400		89-01	M12X15-P1.5	ZE58-1522	ZE58-1523
ZZR400		90-07	M12X15-P1.5	ZE58-1522	ZE58-1523
NINJA 500		94-09	M12X15-P1.5	ZE58-1522	ZE58-1523
ZR500		90-93	M12X15-P1.5	ZE58-1522	ZE58-1523
NINJA 600R		88-97	M12X15-P1.5	ZE58-1522	ZE58-1523
ZX-6R/RR		91-16	M12X15-P1.5	ZE58-1522	ZE58-1523
ZRR600		02-08	M12X15-P1.5	ZE58-1522	ZE58-1523
ER-6F		09-10	M12X15-P1.5	ZE58-1522	ZE58-1523
ER-6N		09-14	M12X15-P1.5	ZE58-1522	ZE58-1523
NINJA 650R		09-18	M12X15-P1.5	ZE58-1522	ZE58-1523
VERSYS 650		10-17	M12X15-P1.5	ZE58-1522	ZE58-1523
W650		99-08	M12X15-P1.5	ZE58-1522	ZE58-1523
2650		17	M12X15-P1.5	ZE58-1522	ZE58-1523
NINJA 750R		87-90	M12X15-P1.5	ZE58-1522	ZE58-1523
ZR-7S		00-05	M12X15-P1.5	ZE58-1522	ZE58-1523
ZX-7R/RR		89-03	M12X15-P1.5	ZE58-1522	ZE58-1523
Z750S		04-10	M12X15-P1.5	ZE58-1522	ZE58-1523
ZEPHYR750/RS		91-06	M12X15-P1.5	ZE58-1522	ZE58-1523
ZR750		91-93	M12X15-P1.5	ZE58-1522	ZE58-1523
ZXR750		83-95	M12X15-P1.5	ZE58-1522	ZE58-1523
Z800		13-16	M12X15-P1.5	ZE58-1522	ZE58-1523
ZX-9R		94-03	M12X15-P1.5	ZE58-1522	ZE58-1523
NINJA 1000		11-18	M12X15-P1.5	ZE58-1522	ZE58-1523
VERSYS1000		12-17	M12X15-P1.5	ZE58-1522	ZE58-1523
Z1000		03-18	M12X15-P1.5	ZE58-1522	ZE58-1523
ZX-10		88-90	M12X15-P1.5	ZE58-1522	ZE58-1523
ZX-10R		04-17	M12X15-P1.5	ZE58-1522	ZE58-1523
GPZ1100		95-99	M12X15-P1.5	ZE58-1522	ZE58-1523
ZEPHYR1100/RS		92-06	M12X15-P1.5	ZE58-1522	ZE58-1523
ZR1100		92-95	M12X15-P1.5	ZE58-1522	ZE58-1523
ZRX1100		97-00	M12X15-P1.5	ZE58-1522	ZE58-1523
ZX-11		90-01	M12X15-P1.5	ZE58-1522	ZE58-1523
ZZR1100		90-01	M12X15-P1.5	ZE58-1522	ZE58-1523
ZX-12R		00-06	M12X15-P1.5	ZE58-1522	ZE58-1523
ZRX1200DAEG		09-16	M12X15-P1.5	ZE58-1522	ZE58-1523
ZRX1200R/S		01-08	M12X15-P1.5	ZE58-1522	ZE58-1523
ZXR1200		02-05	M12X15-P1.5	ZE58-1522	ZE58-1523
ZX-14		06-11	M12X15-P1.5	ZE58-1522	ZE58-1523
ZX-14R		12-17	M12X15-P1.5	ZE58-1522	ZE58-1523
BANDIT250/V		90-00	M14X10-P1.25	ZE58-1612	ZE58-1613
GSR250S/GW250, INAZUMA250		11-17	M14X10-P1.25	ZE58-1612	ZE58-1613
GSX250R		17	M14X10-P1.25	ZE58-1612	ZE58-1613
GSX250S		91-99	M14X10-P1.25	ZE58-1612	ZE58-1613
V-STROM250		17	M14X10-P1.25	ZE58-1612	ZE58-1613
GSR400		06-14	M14X10-P1.25	ZE58-1612	ZE58-1613
GSX400S		92-99	M14X10-P1.25	ZE58-1612	ZE58-1613
GSX400		94-00	M14X10-P1.25	ZE58-1612	ZE58-1613
INAZUMA400		97-02	M14X10-P1.25	ZE58-1612	ZE58-1613
GSX-R400R		90-95	M14X10-P1.25	ZE58-1612	ZE58-1613
FR400R/RV		93-00	M14X10-P1.25	ZE58-1612	ZE58-1613
GSX-R600		01-17	M14X10-P1.25	ZE58-1612	ZE58-1613
KATANA(GSF600F)		98-06	M14X10-P1.25	ZE58-1612	ZE58-1613
SV650		16-17	M12X10-P1.25	ZE58-1412	ZE58-1413
V-STROM650/XT		04-17	M12X10-P1.25	ZE58-1412	ZE58-1413
GSR750		13-15	M14X10-P1.25	ZE58-1612	ZE58-1613
GSX750S		82-86	M14X10-P1.25	ZE58-1612	ZE58-1613
GSF750		96-00	M14X10-P1.25	ZE58-1612	ZE58-1613
GSX-R750		00-17	M14X10-P1.25	ZE58-1612	ZE58-1613
GSX-S750		17	M14X10-P1.25	ZE58-1612	ZE58-1613
KATANA(GSF750F)		98-06	M14X10-P1.25	ZE58-1612	ZE58-1613
V-STROM1000/XT		02-17	M14X10-P1.25	ZE58-1612	ZE58-1613
SV1000S		03-07	M14X10-P1.25	ZE58-1612	ZE58-1613
TL1000R/S		97-03	M14X10-P1.25	ZE58-1612	ZE58-1613
GSX-R1000		01-17	M14X10-P1.25	ZE58-1612	ZE58-1613
GSX1100S		94-00	M14X10-P1.25	ZE58-1612	ZE58-1613
GSX-R1100		89-92	M14X10-P1.25	ZE58-1612	ZE58-1613
GSX-S1000		16-17	M14X10-P1.25	ZE58-1612	ZE58-1613
GSX-S1000F		16-17	M14X10-P1.25	ZE58-1612	ZE58-1613
BANDIT1200/S		01-06	M14X10-P1.25	ZE58-1612	ZE58-1613
GSF1200/S		95-99	M14X10-P1.25	ZE58-1612	ZE58-1613
INAZUMA1200		98-99	M14X10-P1.25	ZE58-1612	ZE58-1613
BANDIT1250/S ABS		07-15	M14X10-P1.25	ZE58-1612	ZE58-1613
BANDIT1250F		1			

ZS93-3404 YZF-R25



ZS93-3404

ZS93-3108

ZETA

CHAIN ADJUSTER CAP

- ZETA Chain adjuster for sport bikes.
- Made of CNC machined aluminum with titanium and gold anodized finish.
- ZETA laser printed logo.
- Comes in pairs.

Chain Adjuster Caps			
Bike	Year	Gold	Ti-color
HONDA			
CB250F	14-17		
CBR250R	11-17	ZS93-3104	ZS93-3108
CB300F	14-17		
CBR300R	14-17		
YAMAHA			
YZF-R25	15-17		
YZF-R3	15-17	ZS93-3404	ZS93-3408
MT-25	16-17		
MT-03	16-17		
KAWASAKI			
NINJA250/R	08-17		
NINJA250SL	15-16		
NINJA300	13-17	ZS93-3104	ZS93-3108
Z250	13-17		
Z250SL	15-17		
Z300	15-16		

ZS93-2404 YZF-R1 (L)



ZS93-2408

ZS93-2304

ZETA

REAR AXLE BLOCK

- ZETA Axle block for sport bikes.
- Made of CNC machined aluminum with titanium and gold anodized finish.
- Scales on both sides of axle block for easy chain adjustment.
- ZETA laser printed logo.
- Comes in pairs.

Rear Axle Block			
Bike	Year	Gold	Ti-color
HONDA			
CBR600RR	09-17	ZS93-2104	ZS93-2108
CBR1000RR	08-16		
YAMAHA			
FZ8	11-13		
FZ1	06-15	ZS93-2404	ZS93-2408
YZF-R1/M	04-17		
KAWASAKI			
ZX-6R	09-17	ZS93-2204	ZS93-2208
ZX-10R	11-17		
SUZUKI			
GSX-R600	00-09		
	11-17		
GSX-R750	00-09	ZS93-2314	ZS93-2318
	11-17		
GSX-R1000/R	01-17		
GSX1300R HAYABUSA	08-17		

ZS93-2404 YZF-R1 (R)





DRC
RADIATOR HOSE

- Durable silicone radiator hose for street bikes.
- Smooth inner surface allows for increased coolant flow.
- Printed white DRC logo.
- Available in red, blue and orange colors.

Bike	Year	Red	Hose qty
HONDA			
CB250F	14-17	D47-05-113	2
CBR250R	11-17	D47-05-113	2
VTR	09-17	D47-05-143	4
400X	13-17	D47-05-253	4
CB400F	13-16	D47-05-253	4
CB400SF	08-16	D47-05-223	4
CBR400R	13-17	D47-05-253	4
CB500X	13-17	D47-05-253	4
CB500F	13-17	D47-05-253	4
CBR500R	13-17	D47-05-253	4
CTX700/N	13-17	D47-05-323	3
NC700X/S	12-17	D47-05-323	3
NC750X/S	14-17	D47-05-323	3
CBR1000RR	12-16	D47-05-423	10
YAMAHA			
FZ07	15-17	D47-08-473	5
MT07	14-17	D47-08-473	5
FZ09	14-16	D47-08-493	5
MT09/TRACER	14-16	D47-08-493	5

Bike	Year	Blue	Hose qty
YAMAHA			
FZ-1/FAZER	11-15	D47-08-462	6
YZF-R1	10-14	D47-08-422	7

Bike	Year	Red	Hose qty
KAWASAKI			
Z250	13-17	D47-06-143	5
NINJA 250	13-17	D47-06-143	5
NINJA 300	13-17	D47-06-143	5
ER-4N	11-13	D47-06-223	2
NINJA 400R	11-13	D47-06-223	2
ER-6F	09-11	D47-06-223	2
ER-6N	09-11	D47-06-223	2
NINJA 1000	11-16	D47-06-323	6
ZRX1200DAEG	09-16	D47-06-423	4
ZX-14R	12-17	D47-06-453	5
SUZUKI			
GSR250, GW250, INAZUMA250	12-17	D47-07-123	6
GLADIUS400	09-15	D47-07-223	4
GSX-R1000	12-16	D47-07-413	3
GSX1300R HAYABUSA	08-17	D47-07-553	3

Bike	Year	Orange	Hose qty
KTM			
125DUKE	11-16	D47-09-129	4
200DUKE	11-16	D47-09-129	4

High heat resistance and durable silicon rubber

Durable mesh fiber



DRC
MIRROR HOLE PLUG

- Aluminum screw cap to seal your mirror hole.
- Protect your mirror hole thread from water, dust and mud.
- Made of 7009 aluminum, bolt size = M10 - 1.25
- Available in 4 different anodized colors.

Part number	Color	Part number	Color
D41-06-502	Blue	D41-06-508	Titanium
D41-06-503	Red	D41-06-509	Gold

DRC
RADIATOR CAP

- High pressure radiator cap for racing use.
- High pressure of 1.6 kgf / cm² increases coolant's boiling point.
- Prevents the boiling and vaporization of the coolant during hard riding.
- Protects your engine from overheating.

Part number
D47-31-016



D45-10-110



NINJA 250



D45-10-310



YZF-R25



D45-10-350



MT-09

DRC
FENDER ELIMINATOR KIT

- Fender eliminator kit makes rear fender compact and cool looking.
- Designed to mount OE flasher and license plate light.
- Made of durable steel with black paint finish.
- Comes with license plate holding bolts, washers and nuts.

	Bike	Year	Part #
YAMAHA	YZF-R25/R3	15-17	D45-10-310
	MT-09/FZ-09	14-16	D45-10-350
KAWASAKI	NINJA 250/300/Z250	13-17	D45-10-110



Flex-1



Flex-3

DRC
MOTO LED **FLEX TAIL LIGHT**

Flex-1 [D45-29-310](#)

- Flex fit shell and body with 16 high quality chip LEDs.
- Even fits curved surfaces.
- Tail light and stop light in this compact-sized product.
- High impact, water and shock resistant.
- Includes aluminum bolts and nuts.
- Plug type terminals are included for installation.
- Works on 12 V AC / DC.
- Dimensions : L 109 mm x W 19 mm x H 9 mm.

Flex-3 [D45-29-316](#)

- Universal LED tail light.
- 12 pcs oval LEDs.
- Tail light and stop light in this compact-sized product.
- Reduced electric power consumption
- Works on 12 V AC / DC.
- Dimensions : L 109 mm x W 19 mm x H 19 mm

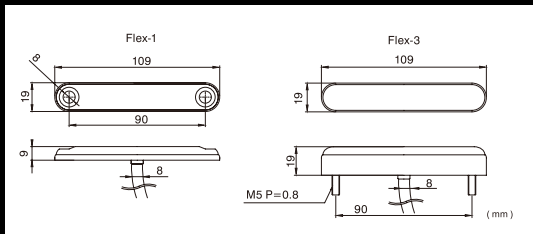

DRC
MOTO LED **PHANTOM TAIL LIGHT**

- High intensity LED light for the rear fender.
- Tail light base is made of flex rubber. Enables a great fit on all shapes of rear fenders with M 5 bolts.
- 8 high-intensity LEDs are used.
- Tail light and stop light in this compact- sized product.
- Plug type terminals are included for installation.
- Works on 12 V AC / DC.

Part number [D45-29-307](#) Color Red

Replacement lens	
Part number D45-29-387	Color Red

YOSHIMURA SUZUKI MOTUL RACING

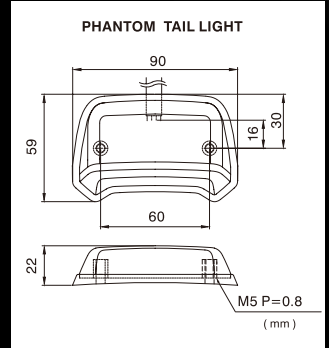

Orange

Smoke

Clear

DRC
MOTO LED **602 LED FLASHER**

- Flexible flasher stays to prevent breakage upon impact.
- Lens colors available: orange, smoke and clear.
- Terminals and nuts are included for installation.
- Comes in pairs. Works on 12 V AC / DC.

Part number	Color	Replacement lens	
		Part number	Color
D45-60-207	Orange	D45-60-287	Orange
D45-60-208	Smoke	D45-60-288	Smoke
D45-60-209	Clear	D45-60-289	Clear



Orange

Smoke

DRC
MOTO LED **586 LED FLASHER**

- Installs on the fender with screws for secure installation.
- Rubber mount base fits even curved surfaces.
- Terminals and bolts are included for installation.
- Comes in pairs. Works on 12 V AC / DC.

Part number	Color	Replacement lens	
		Part number	Color
D45-58-617	Orange	D45-58-687	Orange
D45-58-618	Smoke	D45-58-688	Smoke



Orange

Smoke

DRC
MOTO LED **601 LED FLASHER**

- Triangular style flasher.
- Terminals and nuts are included for installation.
- Comes in pairs. Works on 12 V AC / DC.

Part number	Color	Replacement lens	
		Part number	Color
D45-60-107	Orange	D45-60-187	Orange
D45-60-108	Smoke	D45-60-188	Smoke

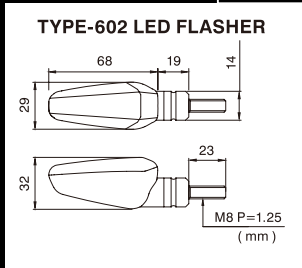

TYPE-602 LED FLASHER

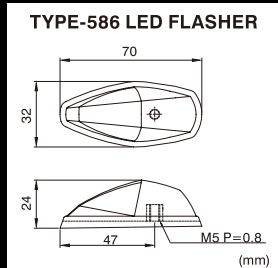

TYPE-586 LED FLASHER

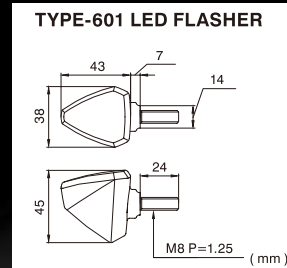

TYPE-601 LED FLASHER

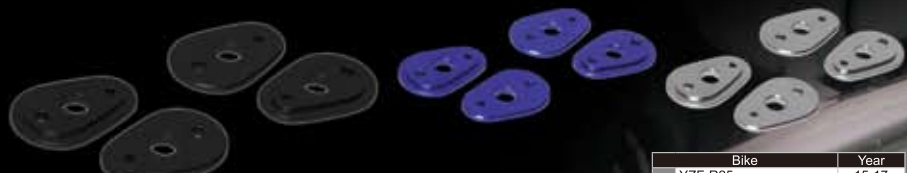

DRC
MOTO LED **FLASHER HOLDER PLATE**

- Flasher mount adapter for Yamaha and Kawasaki OEM flasher mounting bracket.
- Use OE brackets with the plates to mount DRC LED flashers.
- Flasher attachment hole diameter : 8 mm
- Available in titanium, blue and black anodized colors.
- 2 set.

Part number [D45-59-950](#) Color Titanium
[D45-59-952](#) Color Blue
[D45-59-953](#) Color Black

MOTO LED flashers may not work properly without optional parts. P103

Bike	Year
YZF-R25	15-17
YZF-R6	06-14
YZF-R1	02-14
MT-07/09	14-16
MT-01	05-09
FZ6/FAZER	04-10
FZ8/FAZER	11-16
FZ1/FAZER	08-14
XJ6N/F/S	09-16
TDM900	02-10
V-MAX (Rear)	09-17
WR250R/X	07-17
KSR110	13
KLX125/D-TRACKER125	10-16
KLX150	09-13
KLX250/D-TRACKER X	08-16
NINJA250/R	08-





- High quality light weight titanium bolts, nuts, washers and pivot pins available from ZETA.
- Brake disc bolt kit and sprocket kit available for specific models.
- Made of hot forged Ti-6AL-4V for a durable and extremely light weight-product.
- High precision CNC machined bolt and nut head, head size is one size-smaller than industrial standard for reduced weight.

Hot forging, CNC machining, thread rolling

ZETA titanium product is designed to be light weight with no decoration. Titanium products are not only machined but also hot forged to provide more tensile strength than material strength. Bolt and nut are designed with a smaller CNC machined head for a lighter design.

Ti-6AL-4V

ZETA titanium products are made of Ti-6AL-4V. This chemical notation means this titanium includes 6% aluminum (AL) and 4% vanadium (V). This material is light weight and durable. It is used in aircraft and space industries, nuclear industry, industrial turbine, race car and motorcycle etc.

Titanium type and strength difference between other material.

Pure Titanium	Lower price than other titanium alloy, great corrosion resistance, but less strength.
Alfa alloy	Great creep resistance and welding work, but bad workability.
Beta alloy	Most durable titanium alloy, easy workability, but high production cost.
Alfa beta alloy	Great durability, ductility, toughness and workability. Zeta Titanium product is made of this material, Ti-6AL-4V.

Titanium Name	Alloy name	Tensile strength
Pure titanium	JIS Grade 1	275-412N / mm ²
Pure titanium	JIS Grade 2	343-510N / mm ²
Pure titanium	JIS Grade 3	481-618N / mm ²
Alfa alloy	Ti-5AL-2.5Sn	850N / mm ²
Alfa-beta alloy	Ti-6AL-4V	900N / mm²
Beta alloy	Ti-15Mo-5Zr-3Al	1470N / mm ²

Other alloy	Alloy name	Tensile strength
Duralumin	2017-T4	425N / mm ²
Super duralumin	2024-T361	495N / mm ²
Extra super duralumin	7075-T6	481-618N / mm ²
Steel	SS400	400N / mm ²
Carbon steel	S45C	570N / mm ²
Chromium molybdenum steel	SCM435	930N / mm ²

RACING FLANGE BOLT
M10 P=1.25 L 20 mm - 75 mm
* Includes safety wire holes.

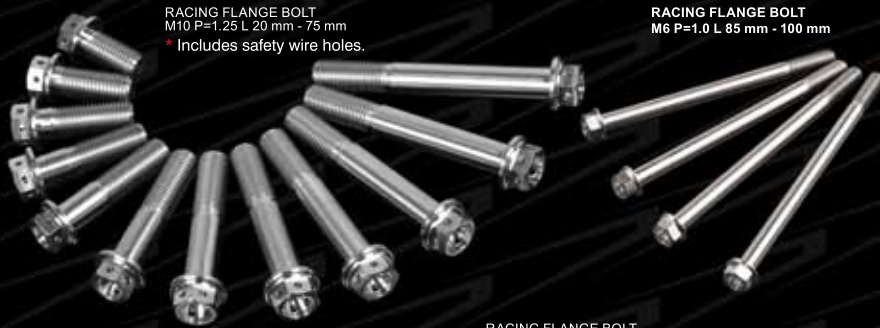

RACING FLANGE BOLT
M6 P=1.0 L 85 mm - 100 mm

RACING FLANGE BOLT
M6 P=1.0 L 10 mm - 80 mm

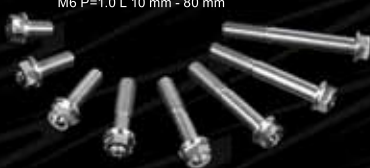
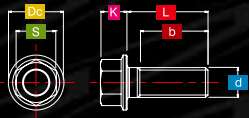

ZETA

RACING FLANGE BOLT

- One size smaller bolt head design for light weight. Motorcycle use.
- Comes with wire holes for bolts larger than M7 sizes.
- Sold in single pieces.

RACING FLANGE BOLT

Part #	d	S	Dc	K	b	L
ZT03-0610	M6 P=1.0	8	11	5.3	8	10
ZT03-0616	M6 P=1.0	8	11	5.3	14	16
ZT03-0620	M6 P=1.0	8	11	5.3	18	20
ZT03-0625	M6 P=1.0	8	11	5.3	18	25
ZT03-0630	M6 P=1.0	8	11	5.3	18	30
ZT03-0635	M6 P=1.0	8	11	5.3	18	35
ZT03-0640	M6 P=1.0	8	11	5.3	18	40
ZT03-0645	M6 P=1.0	8	11	5.3	18	45
ZT03-0650	M6 P=1.0	8	11	5.3	18	50
ZT03-0655	M6 P=1.0	8	11	5.3	18	55
ZT03-0660	M6 P=1.0	8	11	5.3	18	60
ZT03-0665	M6 P=1.0	8	11	5.3	18	65
ZT03-0670	M6 P=1.0	8	11	5.3	18	70
ZT03-0675	M6 P=1.0	8	11	5.3	18	75
ZT03-0680	M6 P=1.0	8	11	5.3	18	80
ZT03-0685	M6 P=1.0	8	11	5.3	18	85
ZT03-0690	M6 P=1.0	8	11	5.3	18	90
ZT03-0695	M6 P=1.0	8	11	5.3	18	95
ZT03-06A0	M6 P=1.0	8	11	5.3	18	100
ZT03-0816	M8 P=1.25	10	14	6.8	14	16
ZT03-0820	M8 P=1.25	10	14	6.8	18	20
ZT03-0825	M8 P=1.25	10	14	6.8	22	25
ZT03-0830	M8 P=1.25	10	14	6.8	22	30
ZT03-0835	M8 P=1.25	10	14	6.8	22	35
ZT03-0840	M8 P=1.25	10	14	6.8	22	40
ZT03-0845	M8 P=1.25	10	14	6.8	22	45
ZT03-0850	M8 P=1.25	10	14	6.8	22	50
ZT03-0855	M8 P=1.25	10	14	6.8	22	55
ZT03-0860	M8 P=1.25	10	14	6.8	22	60
ZT03-1025	M10 P=1.25	12	17	8.2	23	25
ZT03-1030	M10 P=1.25	12	17	8.2	26	30
ZT03-1035	M10 P=1.25	12	17	8.2	26	35
ZT03-1040	M10 P=1.25	12	17	8.2	26	40
ZT04-0720	M7 P=1.0	10	14	6.8	18	20
ZT04-0816	M8 P=1.25	10	14	6.8	14	16
ZT04-0820	M8 P=1.25	10	14	6.8	18	20
ZT04-0825	M8 P=1.25	10	14	6.8	22	25
ZT04-0830	M8 P=1.25	10	14	6.8	22	30
ZT04-0835	M8 P=1.25	10	14	6.8	22	35
ZT04-0840	M8 P=1.25	10	14	6.8	22	40
ZT04-0845	M8 P=1.25	10	14	6.8	22	45
ZT04-0850	M8 P=1.25	10	14	6.8	22	50
ZT04-0855	M8 P=1.25	10	14	6.8	22	55
ZT04-1020	M10 P=1.25	12	17	8.2	18	20
ZT04-1025	M10 P=1.25	12	17	8.2	23	25
ZT04-1030	M10 P=1.25	12	17	8.2	26	30
ZT04-1035	M10 P=1.25	12	17	8.2	26	35
ZT04-1040	M10 P=1.25	12	17	8.2	26	40
ZT04-1045	M10 P=1.25	12	17	8.2	26	45
ZT04-1050	M10 P=1.25	12	17	8.2	26	50
ZT04-1055	M10 P=1.25	12	17	8.2	26	55
ZT04-1060	M10 P=1.25	12	17	8.2	26	60
ZT04-1065	M10 P=1.25	12	17	8.2	26	65
ZT04-1070	M10 P=1.25	12	17	8.2	26	70
ZT04-1075	M10 P=1.25	12	17	8.2	26	75
ZT04-1120	M10 P=1.5	12	17	8.2	18	20
ZT04-1125	M10 P=1.5	12	17	8.2	23	25
ZT04-1130	M10 P=1.5	12	17	8.2	26	30
ZT04-1135	M10 P=1.5	12	17	8.2	26	35

* Includes safety wire holes.



CAP BOLT
M8 P=1.25 L 16 mm - 55 mm

CAP BOLT STRAIGHT

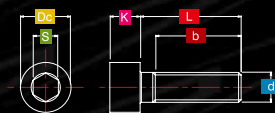

CAP BOLT STRAIGHT
M6 P=1.0 L 10 mm - 45 mm

CAP BOLT LOW HEAD

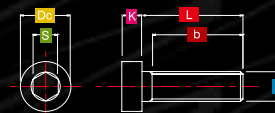

CAP BOLT LOW HEAD
M8 P=1.25 L 20 mm - 40 mm

CAP BOLT EXTRA LOW HEAD

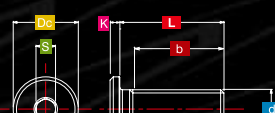

CAP BOLT TAPER
M5 P=0.8 L 12 mm - 30 mm

CAP BOLT TAPER

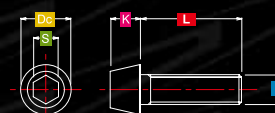

CAP BOLT EXTRA LOW HEAD
M6 L 12 mm - 20 mm

CAP BOLT

Part #	d	S	Dc	K	b	L
STRAIGHT						
ZT07-0610	M6 P=1.0	5	10	6	8	10
ZT07-0616	M6 P=1.0	5	10	6	14	16
ZT07-0620	M6 P=1.0	5	10	6	18	20
ZT07-0625	M6 P=1.0	5	10	6	23	25
ZT07-0630	M6 P=1.0	5	10	6	24	30
ZT07-0635	M6 P=1.0	5	10	6	24	35
ZT07-0640	M6 P=1.0	5	10	6	24	40
ZT07-0645	M6 P=1.0	5	10	6	24	45
ZT07-0816	M8 P=1.25	6	13	8	14	16
ZT07-0820	M8 P=1.25	6	13	8	18	20
ZT07-0825	M8 P=1.25	6	13	8	23	25
ZT07-0830	M8 P=1.25	6	13	8	28	30
ZT07-0835	M8 P=1.25	6	13	8	28	35
ZT07-0840	M8 P=1.25	6	13	8	28	40
ZT07-0845	M8 P=1.25	6	13	8	28	45
ZT07-0850	M8 P=1.25	6	13	8	28	50
ZT07-0855	M8 P=1.25	6	13	8	28	55
ZT07-1020	M10 P=1.25	8	16	10	18	20
ZT07-1025	M10 P=1.25	8	16	10	23	25
ZT07-1030	M10 P=1.25	8	16	10	28	30
ZT07-1035	M10 P=1.25	8	16	10	32	35
ZT07-1040	M10 P=1.25	8	16	10	32	40
ZT07-1045	M10 P=1.25	8	16	10	32	45
ZT07-1120	M10 P=1.5	8	16	10	18	20
ZT07-1125	M10 P=1.5	8	16	10	23	25
ZT07-1130	M10 P=1.5	8	16	10	28	30
LOW HEAD						
ZT07-2512	M5 P=0.8	4	8.5	3.5	10	12
ZT07-2516	M5 P=0.8	4	8.5	3.5	14	16
ZT07-2520	M5 P=0.8	4	8.5	3.5	16	20
ZT07-2525	M5 P=0.8	4	8.5	3.5	16	25
ZT07-2530	M5 P=0.8	4	8.5	3.5	16	30
ZT07-2535	M5 P=0.8	4	8.5	3.5	16	35
ZT07-2612	M6 P=1.0	5	10	4	10	12
ZT07-2616	M6 P=1.0	5	10	4	14	16
ZT07-2620	M6 P=1.0	5	10	4	18	20
ZT07-2625	M6 P=1.0	5	10	4	18	25
ZT07-2630	M6 P=1.0	5	10	4	18	30
ZT07-2635	M6 P=1.0	5	10	4	18	35
ZT07-2820	M8 P=1.25	6	13	5	18	20
ZT07-2825	M8 P=1.25	6	13	5	22	25
ZT07-2830	M8 P=1.25	6	13	5	22	30
ZT07-2835	M8 P=1.25	6	13	5	22	35
ZT07-2840	M8 P=1.25	6	13	5	22	40
EXTRA LOW HEAD						
ZT07-3612	M6 P=1.0	3	10	1.5	10	12
ZT07-3616	M6 P=1.0	3	10	1.5	14	16
ZT07-3620	M6 P=1.0	3	10	1.5	18	20
ZT07-3816	M8 P=1.25	4	13	1.5	14	16
ZT07-3820	M8 P=1.25	4	13	1.5	18	20

ZETA

CAP BOLT

- Cap bolt available in straight and tapered types.
- Bolt head is forged, CNC finish.
- Sold in single pieces.

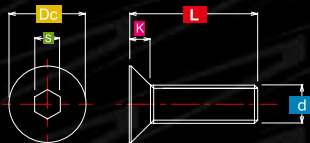

ZETA

FLAT HEAD BOLT

- Countersunk bolt. 1 pc.

Part #	d	S	Dc	K	L
ZT09-6121	M6 P=1.0	4	12	3.3	12
ZT09-6161	M6 P=1.0	4	12	3.3	16
ZT09-6201	M6 P=1.0	4	12	3.3	20

Part #	d	S	Dc	K	b	L
TAPER						
ZT08-0512	M5 P=0.8	4	8.5	5	10	12
ZT08-0516	M5 P=0.8	4	8.5	5	14	16
ZT08-0520	M5 P=0.8	4	8.5	5	18	20
ZT08-0525	M5 P=0.8	4	8.5	5	22	25
ZT08-0530	M5 P=0.8	4	8.5	5	22	30
ZT08-0535	M5 P=0.8	4	8.5	5	22	35
ZT08-0612	M6 P=1.0	5	10	6	10	12
ZT08-0616	M6 P=1.0	5	10	6	14	16
ZT08-0620	M6 P=1.0	5	10	6	18	20
ZT08-0625	M6 P=1.0	5	10	6	23	25
ZT08-0630	M6 P=1.0	5	10	6	24	30
ZT08-0635	M6 P=1.0	5	10	6	24	35
ZT08-0820	M8 P=1.25	6	13	8	18	20
ZT08-0825	M8 P=1.25	6	13	8	23	25
ZT08-0830	M8 P=1.25	6	13	8	28	30
ZT08-0835	M8 P=1.25	6	13	8	28	35
ZT08-0840	M8 P=1.25	6	13	8	28	40



KTM 250SX LEFT



YZ250FX RIGHT



ZETA
CHAIN ADJUSTER BOLT

- By using titanium bolts the unsprung weight is reduced, and compared to stock bolts, strength is increased and visual appeal is enhanced.
- Nut is designed one size smaller, for reduced weight and compactness. And because titanium bolts to form a non-conductive coating on the surface, it will not rust.
- M8 is used by the four main Japanese manufacturers of off-road, and also some on-road manufacturers (Axle block bolt adjustment type vehicle).
- M10 is mainly used on KTM off-road models, and Husqvarna.

Chain Adjust Bolts & Nuts Set						
Part #	d	S	K	L	Description	qty
ZT38-5500	M8 P=1.25	10	5.5	50	Chain Adjuster bolt	1
ZT38-5501	M8 P=1.25	10	5.5	50	Chain Adjuster bolt & Nut	2
ZT38-7500	M10 P=1.25	10	5.5	50	Chain Adjuster bolt	1
ZT38-7501	M10 P=1.25	10	5.5	50	Chain Adjuster bolt & Nut	2



KX450F LEFT



YZF R1 RIGHT

ZT38-7501 Approximate band Onroad			
Bike	Year	Part #	
KTM			
690 DUKE	08-16		
990 SUPER DUKE	06-13		
990 SUPERMOTO	08-12		
1050 ADVENTURE	15-16	ZT38-7501	
1190 ADVENTURE	13-16		
1190 RC8/R	08-12		
1290 SUPER ADVENTURE	15-16		

ZT38-7501 Approximate band Offroad			
Bike	Year	Part #	
KTM			
85SX	06-15		
105-450SX/SX-F	06-18		
250-530/EXC-F/R	07-18		ZT38-7501
125-690XS/C,SMC/	06-17		
R.ENDURO/R	06-12		
HUSQVARNA			
990 ADVENTURE	06-12		ZT38-7501
TC/FC/TX/FX/TE/FE			
125-701	14-17		ZT38-7501

ZT38-5501 Approximate band Onroad			
Bike	Year	Part #	
H			
CBR250RR	17		
CB650F	17		
CBR600F	17	ZT38-5501	
CBR600RR	09-16		
CBR1000RR	08-17		
X-ADV	17		
Y			
MT-09/TRACER	14-17		
XSR900	16-17		
FZ1	06-15		
FZ10	17	ZT38-5501	
MT-10	17		
YZF-R6	17		
YZF-R1/M	04-17		
K			
NINJA400	14-17		
VERSYS650	07-17		
VERSYS1000	12-17	ZT38-5501	
ZX-6R	09-17		
ZX-10R	11-17		
S			
GSX-R600	00-17		
GSX-R750	00-17		
GSX-R1000	01-17		
GSX1300R HAYABUSA	08-17	ZT38-5501	
GSX-S1000	17		
V-STROM1000	02-17		

ZT38-5501 Approximate band Offroad			
Bike	Year	Part #	
H			
CR125R/250R	87-07		
CRF150R	07-18		
CRF250R	04-18		
CRF450R	02-18		
CRF450RX	17-18	ZT38-5501	
CRF250X/450X	04-17		
CRF250L/M/RALLY	12-17		
CRF1000L AFRICA TWIN	16-17		
XR650R	00-07		
Y			
YZ125/250	90-18		
YZ250F	01-18		
YZ400/426/450F	98-18		
YZ125X/250X	16-18		
YZ250FX/450FX	15-18	ZT38-5501	
WR250F	01-18		
WR400/426/450F	98-18		
WR250R/X	07-17		
K			
KX85	01-18		
KX100	16-18		
KX125/250	88-08		
KX250F	04-18	ZT38-5501	
KX450F	06-18		
KLX450R	08-15		
KLX250/D-TRACKER X	08-16		
S			
RM125/250	89-08		
RMZ250	04-18		
RMZ450	05-18	ZT38-5501	
RMX450Z	10-14		
DRZ400SM	05-17		



ZETA
WASHER

- Made of CNC machined Ti-6AL-4V
- Excellent accuracy, unlike common press machine punched washers.
- Reduce weight by replacing with titanium washers, as well as increasing strength, improved visual appeal.
- Lineup for the high frequency of use M6 , M8 and M10.

WASHER				
Part #	Size	Inner diameter	Outer diameter	Thickness
ZT20-1061	M6	6.4	12	1.6
ZT20-1081	M8	8.4	16	1.6
ZT20-1101	M10	10.4	20	2.1



ZETA
EXHAUST NUT

- Titanium exhaust nut does not rust like OEM steel exhaust nuts.
- Flange design, can be tightend with 6 mm wrench or hex wrench.

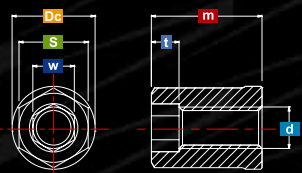

Part #	d	S	Dc	w	m	t	qty
ZT23-1061	M6 P=1.0	10	12	6	16	4	1
ZT36-1068	M6 P=1.0	10	12	6	16	4	8
ZT23-1081	M8 P=1.25	12	14	8	18	4.5	1
ZT36-1088	M8 P=1.25	12	14	8	18	4.5	8



ZETA
FLANGE NUT COMPACT

- Titanium compact head size nut.
- Attained one size smaller head design because of its durable and light weight Ti-6AL-4V material.
- Great to use in high tightening torque and high temperature situations.
- Sold in single pieces.

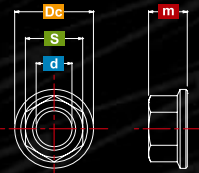

Part #	d	S	Dc	m
ZT21-2051	M5 P=0.8	7	9.5	4.7
ZT21-2061	M6 P=1.0	8	11	5.4
ZT21-2081	M8 P=1.25	10	14	6.8
ZT21-2101	M10 P=1.25	12	17	8.2



ZETA
FLANGE LOCK NUT

- ZETA original locking function. No use locking plate or locking nylon used.
- Original locking function holds secure, but has less damage to the bolt than U lock nut.
- Sold in single pieces.

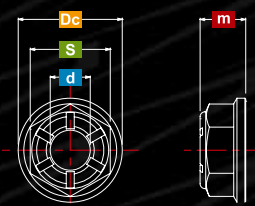

Part #	d	S	Dc	m
ZT21-1051	M5 P=0.8	8	11	4.9
ZT21-1061	M6 P=1.0	10	13	5.7
ZT21-1081	M8 P=1.25	12	16	7.6
ZT21-1101	M10 P=1.25	14	19	9.6
ZT21-1121	M12 P=1.25	17	23	11.6



ZETA BANJO BOLT

- Titanium brake banjo bolts available for many sizes to fit most brake hoses.
- Light weight design, comes with wiring holes.
- 1.0 thread size banjo bolts for Brembo master cylinders and brake calipers.
- Sold in single pieces.

Part #	d	S	Dc	K	L	Brake System	Type
ZT15-1000	M10 P=1.0	12	15	7	20.5	brembo	Z-WHEEL, EARL'S
ZT15-1010	M10 P=1.0	12	15	7	18.5	brembo	GOODRIDGE
ZT15-1020	M10 P=1.25	12	15	7	22.0	NISSIN,TOKICO	UNIVERSAL

ZETA AIR FREE BANJO BOLT

- Easy air bleeding with air bleeder at the tip of banjo bolt.
- Especially excellent for calipers and master cylinders without bleeders.
- Two kinds of screw pitch, 1.0 and 1.25, 1.0 fits on Brembo.

Part #	d	S	Dc	K	L	Brake System	Type
ZT15-1200	M10 P=1.0	12	15	23	20.5	brembo	Z-WHEEL, EARL'S
ZT15-1210	M10 P=1.0	12	15	23	18.5	brembo	GOODRIDGE
ZT15-1220	M10 P=1.25	12	15	23	22.0	NISSIN,TOKICO	UNIVERSAL

ZETA CALIPER BRIDGE BOLT

- Titanium caliper bridge bolt kit.
- Make your caliper weight lighter.
- Highly corrosion resistant, won't rust like steel OE bolts.
- For Brembo 2 piece brake caliper use.
- Comes with 4 bolts.

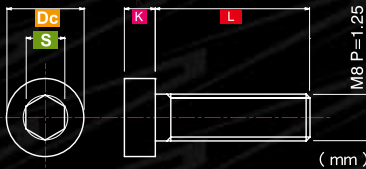

Part #	d	S	Dc	K	L	qty
ZT07-2835	M8 P=1.25	6	13	5	35	1
ZT37-3064	M8 P=1.25	6	13	5	35	4
ZT07-2840	M8 P=1.25	6	13	5	40	1
ZT37-3084	M8 P=1.25	6	13	5	40	4

ZETA CALIPER MOUNT BOLT

- Light weight titanium caliper mount bolt kit for sport bikes.
- Bolt size is designed compact, to reduce weight.
- Can be used on Brembo brake calipers.
- Wiring holes on the bolt to meet racing regulations.
- Comes with 2 bolts for rear brake calipers. 4 bolts for front radial brake calipers.

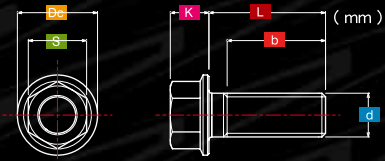

Part #	d	S	Dc	K	b	L	qty	Type
ZT33-1072	M7 P=1.0	10	14	6.8	18	20	2	brembo Rear Caliper, Racing
ZT33-1082	M8 P=1.25	10	14	6.8	18	20	2	brembo Rear Caliper, Street
ZT33-1504	M10 P=1.25	12	17	8.2	26	50	4	Radial Mount Caliper
ZT33-1554	M10 P=1.25	12	17	8.2	26	55	4	Radial Mount Caliper
ZT33-1604	M10 P=1.25	12	17	8.2	26	60	4	Radial Mount Caliper
ZT33-1654	M10 P=1.25	12	17	8.2	26	65	4	Radial Mount Caliper
ZT33-1704	M10 P=1.25	12	17	8.2	26	70	4	Radial Mount Caliper
ZT33-1754	M10 P=1.25	12	17	8.2	26	75	4	Radial Mount Caliper

ZETA BRAKE ADAPTER

- Titanium straight fitting brake hose adapter.
- Available 1.25 and 1.0 (Brembo) thread sizes.
- Sold in single pieces.

Part #	Size
ZT15-2000	M10 P=1.0
ZT15-2010	M10 P=1.25





ZETA

MASTER CYLINDER BOLT KIT



- The Kit includes clamp bolt, pivot pin, bleeder screw etc. for Brembo master cylinder and RCS master cylinder.
- Compatible with flange and taper cap type.

Part #	Type	Part #	qty	Description
ZT32-1110	Brembo Master Cylinder Flange Bolt Kit	ZT99-9001	1	Flange Bolt M6x19
		ZT03-0620	2	Flange Bolt M6x20
		ZT15-3110	1	Pivot Pin
		ZT15-4100	1	Washer M6
		ZT08-0620	1	Bleeder Screw M10 P=1.0
ZT32-1120	Brembo Master Cylinder Taper Cap Bolt Kit	ZT15-3110	1	Taper Cap Bolt M6x20
		ZT15-3110	1	Pivot Pin
		ZT15-3120	1	Washer M6
		ZT15-4100	1	Bleeder Screw M10 P=1.0

Part #	Type	Part #	qty	Description
ZT32-1210	RCS Master Cylinder Flange Bolt Kit	ZT03-0625	3	Flange Bolt M6x25
		ZT21-2061	1	Flange Nut Compact M6
		ZT15-3120	1	Pivot Pin
		ZT15-4100	1	Bleeder Screw M10 P=1.0
		ZT08-0625	3	Taper Cap Bolt M6x25
ZT32-1220	RCS Master Cylinder Taper Cap Bolt Kit	ZT21-2061	1	Flange Nut Compact M6
		ZT15-3120	1	Pivot Pin
		ZT15-4100	1	Bleeder Screw M10 P=1.0

ZETA

PIVOT PIN



- Titanium Pivot pin for Brembo master cylinder.
- Stock pivot pin is made of steel, which easily rusts, wears and can freeze.
- This titanium pivot pin does not rust and provides smooth lever movement.
- Gold anodized finish for an exclusive look.

Part #	Type	Set
ZT15-3110	Brembo Racing	Washer & Snap Pin
ZT15-3110	Brembo Street	Washer & Snap Pin
ZT15-3120	Brembo RCS	-
ZT15-3130	NISSIN	-

ZETA

BLEEDER SCREW



- 8 mm and 10 mm wrench size bleeder screw for Brembo master cylinder.
- Easy operation and lighter than stock 11 mm wrench size bleeder.

Part #	Size	Type
ZT15-4100	M10 P=1.0	Brembo
ZT15-4080	M8 P=1.25	NISSIN, Brembo

ZETA

MASTER CYLINDER CLAMP BOLT SET



- Titanium bolt set for Brembo master cylinder clamp.
- Compatible with flange type and tapered cap type. Comes with 2 bolts.

Part #	Type
ZT82-1202	Brembo M6x20 Flange Bolt set
ZT82-1252	RCS M6x25 Flange Bolt Set
ZT88-1202	Brembo M6x20 Taper Bolt set
ZT88-1252	RCS M6x25 Taper Bolt Set



CRF250L
FRONT



NINJA ZX-10R
FRONT



WR250R
REAR

CRF250L
REAR



NINJA ZX-10R
REAR



ZETA
AXLE SHAFT

**SIGNIFICANT LIGHT WEIGHT
TITANIUM AXLE SHAFT**

LIGHT WEIGHT

The specific gravity of Ti-6AL-4V is about 4.4. This is about 56% with respect to the specific gravity of 7.8 of stock axle shaft using iron (SS400) and carbon steel (S45C), or chromium molybdenum steel shaft (SCM440). This means that if you manufacture the axle shaft with the same mass, 64 titanium will be able to produce about 44% reduction in weight. The reduced weight of the axle shaft also reduces the unsprung weight and corner approaches will improve the handling and stability. In addition, the reduction of unsprung weight will not only improve the movement of the suspension, but also improve brake performance.

Not only Light. Not only strong. Not only flexible. If it is made of aluminum or magnesium it will be lighter than 64 titanium but it will lack strength. If it is made of chromium-molybdenum steel and nickel-chromium steel it will be stronger than 64 titanium, but it will be heavy. There are also materials having Young's modulus lower than 64 titanium, but it will not mean that there is "BENDING." 64 titanium is superior to a balance of these materials. Therefore it may be said that it is the best material for the axle shaft.

Also we must not forget the appearance of titanium. It is more difficult to rust than stock shaft and chromium-molybdenum steel shaft that has a protective surface treatment. However, it does not escape corrosion where the surface is compromised for some reason. Ti-6AL-4V forms a passive film surface to prevent semi-permanent rust to form.

ULTRA STRENGTH

Strength of Ti-6AL-4V is comparable to chromium molybdenum steel (SCM435) 900 - 930 Mpa. With the higher strength axle shaft, you will be able to feel more road surface information more directly. You will be able to sense the bumpy road that could not be felt until now.

BENDING

The Young's modulus of Ti-6AL-4V is about half of iron and chromium molybdenum steel at 106 Gpa. The Young's modulus represents the rigidity and elasticity, the higher the number, the higher the rigidity. Generally, one thinks "high-strength = high rigidity," also 64 titanium has been taken for granted as high rigidity, but actually it is only half the rigidity of iron. Therefore it is easily deformed, but there is elastic deformation where a material tries to return to its original state, and plastic deformation where deformation is permanent. 64 titanium has a wide range of elastic deformation. In other words this is "BENDING". It is this bending that produces the suspension effect, and high strength that softly transmits road surface information.

Material	Material symbol and heat treatment	Tensile strength (T/Mpa)	Young's modulus (E/Gpa)	Specific gravity
Roller steel for general structure	SS400(Annealing)	450	206	7.87
Carbon steel for mechanical structure	S45C(Normalizing)	570 or more	205	7.83
Chromium-molybdenum steel	SCM440(Tempering quenching)	980 or more	206	7.86
Austenitic stainless steel	SUS304(Solution treatment)	520 or more	197	7.93
Pure aluminum	A1085 P(Annealing)	55	69	2.70
Duralumin (aluminum alloy)	A2017 P(Natural aging)	355	69	2.79
Ultra duralumin (aluminum alloy)	A2024 P(Natural aging)	430	74	2.78
Extra Ultra duralumin (aluminum alloy)	A7075 P(quench-and-temper)	573	72	2.81
Pure titanium (JIS grade1)	TF270	275-412	106	4.51
Pure titanium (JIS grade 2)	TF340	343-510	106	4.51
Pure titanium (JIS grade 3)	TF480	481-618	106	4.51
Titanium (α alloy)	Ti-5AL-2.5Sn	850	118	4.48
Titanium (α-β alloy)	Ti-6AL-4V	900	106	4.43
Titanium (β alloy)	Ti-15Mo-5Zr-3Al	1470	75-95	4.80

AXLE SHAFT OFFROAD

Please check your race regulation before racing with titanium axle shaft.

Bike	Year	Front			Rear			
		Part #	Compared with genuine #1	Tool size #2	Part #	Compared with genuine #1	Tool size #2	
HONDA	CR125R	04-07	ZT60-1164	-115 g	-	ZT60-1264 #1	-157 g	-
	CR250R	04-07	ZT60-1164	-115 g	-	ZT60-1264 #1	-157 g	-
	CRF150R/II	07-18	ZT60-1161	-122 g	Socket 14 mm	ZT60-1261 #6	-290 g	-
	CRF250R	04-17	ZT60-1164	-115 g	-	ZT60-1264 #1	-157 g	-
	CRF450R	02-18	ZT60-1164	-115 g	-	ZT60-1264 #1	-157 g	-
	CRF450RX	17-18	ZT60-1164	-115 g	-	ZT60-1264 #1	-157 g	-
	CRF250X	04-17	-	-	-	ZT60-1264 #1	-157 g	-
	CRF450X	05-17	-	-	-	ZT60-1264 #1	-157 g	-
	CRF250L/M	12-16	ZT60-1173 #6	-198 g	Hexagon 14 mm	ZT60-1273 #6	-325 g	Socket 17 mm
	CRF250L/M, RALLY	17	ZT60-1174	-165 g	-	ZT60-1273 #6	-325 g	Socket 17 mm
YAMAHA	YZ125/250	99-07	ZT60-4164 #8	-120 g	-	ZT60-4264	-178 g	-
		08-18	ZT60-4163 #8	-110 g	-	ZT60-4264	-178 g	-
	YZ250F	01-06	ZT60-4164 #8	-120 g	-	ZT60-4264	-178 g	-
		07-08	ZT60-4163 #8	-110 g	-	ZT60-4264	-178 g	-
		09-13	ZT60-4163 #8	-110 g	-	ZT60-4265	-162 g	-
		14-18	ZT60-4165 #7	-142 g	Hexagon 22 mm	ZT60-4265	-162 g	-
	YZ400 /426/450F	99-07	ZT60-4164 #8	-120 g	-	ZT60-4264	-178 g	-
		08	ZT60-4163 #8	-110 g	-	ZT60-4264	-178 g	-
	YZ450F	09-13	ZT60-4163 #8	-110 g	-	ZT60-4265	-162 g	-
		14-18	ZT60-4165 #7	-142 g	Hexagon 22 mm	ZT60-4265	-162 g	-
YZ125X	17-18	ZT60-4163 #8	-110 g	-	ZT60-4264	-178 g	-	
KAWASAKI	YZ250X	16-18	ZT60-4163 #8	-110 g	-	ZT60-4264	-178 g	-
	YZ250FX	15-18	ZT60-4165 #7	-142 g	Hexagon 22 mm	ZT60-4264	-178 g	-
	YZ450FX	16-18	ZT60-4165 #7	-142 g	Hexagon 22 mm	ZT60-4264	-178 g	-
	WR250F	01-18	ZT60-4164 #8	-120 g	-	ZT60-4264	-178 g	-
	WR400 /426/450F	99-18	ZT60-4164 #8	-120 g	-	ZT60-4264	-178 g	-
	WR250R/X	07-17	ZT60-4173	-112 g	Hexagon 17 mm	ZT60-4273	-198 g	-
	KX125	04-08	ZT60-2164	-101 g	-	ZT60-2264 #2	-153 g	-
	KX250	04-08	ZT60-2164	-101 g	-	ZT60-2264 #2	-153 g	-
	KX250F	04-18	ZT60-2164	-101 g	-	ZT60-2264 #2	-153 g	-
	KX450F	06-18	ZT60-2164	-101 g	-	ZT60-2264 #2	-153 g	-
SUZUKI	KLX450R	08-15	ZT60-2164	-101 g	-	ZT60-2264 #2	-153 g	-
	KDX220R/SR	94-05	ZT60-2172	-132 g	Hexagon 14 mm	ZT60-2272 #3-1	-214 g	-
	KLX250R/SR	93-97	ZT60-2172	-132 g	Hexagon 14 mm	ZT60-2272 #3-1	-214 g	-
	KLX250 /D-TRACKER	98-06	ZT60-2172	-132 g	Hexagon 14 mm	ZT60-2272 #3-1	-214 g	-
		07	ZT60-2173	-152 g	Hexagon 17 mm	ZT60-2272	-214 g	-
	KLX250 /D-TRACKERX	08-16	ZT60-2173	-152 g	Hexagon 17 mm	ZT60-2272	-198 g	-
	KLX300R	96-07	ZT60-2172	-132 g	Hexagon 14 mm	ZT60-2272 #3-1	-214 g	-
	KLX650R	93-96	ZT60-2172	-132 g	Hexagon 14 mm	ZT60-2272 #3-1	-214 g	-

Bike	Year	Front			Rear			
		Part #	Compared with genuine #1	Part #	Compared with genuine #1	Part #	Compared with genuine #1	
SUZUKI	RMZ250	04-06	ZT60-2164	-101 g	-	ZT60-2264	-153 g	
		07-18	ZT60-3164	-116 g	-	ZT60-3264	-169 g	
	RMZ450	05-18	ZT60-3164	-116 g	-	ZT60-3264	-169 g	
	RMX450Z	10-17	ZT60-3164	-116 g	-	ZT60-3264	-169 g	
	DRZ400/E	00-17	ZT60-3173	-120 g	-	ZT60-2272 #3-2	-154 g	
	DRZ400S	00-17	ZT60-3173	-120 g	-	ZT60-2272 #3-2	-154 g	
	DRZ400SM	05-17	ZT60-3173	-120 g	-	ZT60-3273	-168 g	
	KTM	125/150/250SX	03-12	ZT60-5163 #4	-130 g	-	ZT60-5263 #5	-188 g
			13-14	ZT60-5163 #4	-130 g	-	ZT60-5264 #5	-186 g
			15-18	ZT60-5164 #4	-104 g	-	ZT60-5264 #5	-186 g
		05-12	ZT60-5163 #4	-130 g	-	ZT60-5263 #5	-188 g	
250/350/450SX-F		13-14	ZT60-5163 #4	-130 g	-	ZT60-5264 #5	-186 g	
		15-18	ZT60-5164 #4	-104 g	-	ZT60-5264 #5	-186 g	
125-530EXC/R		03-15	ZT60-5163 #4	-130 g	-	ZT60-5263 #5	-188 g	
		16-18	ZT60-5164 #4	-104 g	-	ZT60-5263 #5	-188 g	
250-500EXC-F		07-15	ZT60-5163 #4	-130 g	-	ZT60-5263 #5	-188 g	
		16-18	ZT60-5164 #4	-104 g	-	ZT60-5263 #5	-188 g	
HUSQVARN	450SMR	07-12	ZT60-5163 #4	-130 g	-	ZT60-5263 #5	-188 g	
		13	ZT60-5163 #4	-130 g	-	ZT60-5264 #5	-186 g	
		14-16	-	-	-	ZT60-5264 #5	-186 g	
	690 ENDURO/R	09-15	ZT60-5163 #4	-130 g	-	-	-	
	TC125/250	16-18	ZT60-5164 #4	-104 g	-	ZT60-5264 #5	-186 g	
	FC250/450	15-18	ZT60-5164 #4	-104 g	-	ZT60-5264 #5	-186 g	
	FC350	16-18	ZT60-5164 #4	-104 g	-	ZT60-5264 #5	-186 g	
	TE125/250/300	16-18	ZT60-5164 #4	-104 g	-	ZT60-5264 #5	-188 g	
	TE150	17-18	ZT60-5164 #4	-104 g	-	ZT60-5264 #5	-188 g	
	FE250/350/450/501	16-18	ZT60-5164 #4	-104 g	-	ZT60-5264 #5	-188 g	
SUZUKI	TX125	17-18	ZT60-5164 #4	-104 g	-	ZT60-5263 #5	-188 g	
	TX300	17-18	ZT60-5164 #4	-104 g	-	ZT60-5264 #5	-186 g	
	FX350/450	17-18	ZT60-5164 #4	-104 g	-	ZT60-5264 #5	-186 g	
		17-18	ZT60-5164 #4	-104 g	-	ZT60-5264 #5	-186 g	

AXLE SHAFT STREET

Bike	Year	Front		Rear	
		Part #	Compared with genuine #1	Part #	Compared with genuine #1
YAMAHA	YZF-R6	17	ZT61-4101	-	-
	YZF-R1/M	15-17	ZT61-4101	ZT61-4201	-
	MT-10	17	ZT61-4101	ZT61-4201	-
		14-16	ZT61-4102	ZT61-4202	-
	MT-09	17	ZT61-4102	-	-
	MT-09 TRACER XSR900	15-17	ZT61-4102	ZT61-4202	-
KAWASAKI	NINJA ZX-6R	05-12	ZT61-2102	ZT61-2202	-
		13-17	-	ZT61-2201	-
		08-10	ZT61-2102	-	-
	NINJA ZX-10R	11-15	ZT61-2102	ZT61-2201	-
		16-17	ZT61-2101	ZT61-2201	-
		06-17	ZT61-2102	ZT61-2202	-
SUZUKI	NINJA H2/R	15-17	ZT61-2101	-	-
	GSX1300R	08-17	ZT61-3101	ZT61-3201	-
	S1000RR	10-17	ZT61-6101	ZT61-6201	-
BMW	S1000R	14-17	ZT61-6101	ZT61-6201	-
	HP4	13-14	ZT61-6101	ZT61-6201	-
	PANIGALE R	15-17	ZT61-7101	-	-
	1299 PANIGALE/S	15-17	ZT61-7101	-	-
	1199 PANIGALE R	13-14	ZT61-7101	-	-
	1199 PANIGALE/S	12-14	ZT61-7101	-	-
	959 PANIGALE	16-17	ZT61-7101	-	-
	899 PANIGALE	14-15	ZT61-7101	-	-
	SUPER SPORT/S	17	ZT61-7102	-	-
	MULTISTRADA1200/S	10-17	ZT61-7102	-	-
DUCATI	MULTISTRADA950	17	ZT61-7102	-	-
	MONSTER1200/S/R	14-17	ZT61-7102	-	-
	MONSTER821	14-17	ZT61-7102	-	-
	MONSTER797	17	ZT61-7102	-	-
		17	ZT61-7102	-	-

Street rear axle shaft comes with titanium nut and safety clip.



ZETA CYLINDER HEAD BOLT

- Side bolt for cylinder head to optimally dress up the engine.
- Oil line bolt for Kawasaki, engine plug for Suzuki oil cooling engine and Katana offered.
- Please use new O-ring and gasket for installation.

Part #	Size	Type
ZT15-5330	M14 P=1.5	KAWASAKI Oil Line Bolt
ZT15-5530	M14x12 P=1.25	SUZUKI Engine Plug



ZETA

OFF ROAD TITANIUM BOLT KIT



-Kit package includes the required number to suit each motorcycle

OFF ROAD TITANIUM BOLT KIT

Part Application

Part #	Type	Size	qty
ZT83-2302	Flange Bolt Set #	M8X30	2
ZT83-2304	Flange Bolt Set #	M8X30	4
ZT83-2352	Flange Bolt Set #	M8X35	2
ZT83-2354	Flange Bolt Set #	M8X35	4
ZT83-2402	Flange Bolt Set #	M8X40	2
ZT83-2404	Flange Bolt Set #	M8X40	4
ZT83-2454	Flange Bolt Set #	M8X45	4
ZT83-2504	Flange Bolt Set #	M8X50	4
ZT84-2302	Flange Bolt Set #	M10x30	2
ZT84-2352	Flange Bolt Set #	M10x35	2
ZT84-2402	Flange Bolt Set #	M10x40	2
ZT87-1304	Cap Bolt Set	M8X30	4

No wiring hole

Front-Axle Pinch Bolt



Caliper Mount Bolt Kit



Handbar Clamp



Upper Stem Fork Clamp



Under Stem Fork Clamp



OFF ROAD TITANIUM BOLT KIT Application

Bike	Year	Handle Bar Clamp Bolt	Upper Stem Fork Clamp	Under Stem Fork Clamp	Front Axle Pinch Bolt	Caliper Mount Bolt Kit
HONDA						
CR85R/R II	03-07	ZT83-2304	ZT83-2352	ZT83-2404	-	ZT83-2302
CR125R	02-07	ZT83-2354	ZT83-2454	ZT83-2404	ZT83-2402	ZT83-2352
CR250R	02-07	ZT83-2354	ZT83-2454	ZT83-2454	ZT83-2404	ZT83-2402
CRF150R/ II	07-18	ZT83-2304	ZT83-2352	ZT83-2404	-	ZT83-2302
CRF250R	04-17	ZT83-2354	ZT83-2454	ZT83-2454	ZT83-2404	ZT83-2402
CRF450R	02-16	ZT83-2354	ZT83-2454	ZT83-2454	ZT83-2404	ZT83-2402
CRF450RX	17-18	ZT83-2354	ZT83-2454	ZT83-2404	ZT83-2404	ZT83-2402
CRF250X	04-17	ZT83-2354	ZT83-2454	ZT83-2454	ZT83-2404	ZT83-2402
CRF450X	05-17	ZT83-2354	ZT83-2454	ZT83-2454	ZT83-2404	ZT83-2402
CRF250L/M/RALLY	12-17	ZT83-2354	ZT83-2454	ZT83-2454	ZT83-2404	ZT83-2302
CRM250R/AR	94-98	ZT83-2354	ZT83-2454	ZT83-2404	ZT83-2404	ZT83-2402
XR230/MOTARD	05-13	ZT83-2354	ZT83-2454	ZT83-2354	-	ZT83-2402
XR250/MOTARD	03-07	ZT83-2354	ZT83-2504	ZT83-2404	ZT83-2402	ZT83-2402
KAWASAKI						
KX85/ II	01-13	ZT83-2304	ZT83-2352	ZT83-2404	-	ZT83-2402
	14-18	ZT83-2354	ZT83-2352	ZT83-2404	-	ZT83-2402
KX100	16-18	ZT83-2354	ZT83-2352	ZT83-2404	-	ZT83-2402
KX125	03-05	ZT83-2304	ZT83-2354	ZT83-2404	ZT83-2404	ZT83-2402
	06-08	ZT83-2354	ZT83-2404	ZT83-2404	ZT83-2404	ZT83-2402
	03-04	ZT83-2304	ZT83-2354	ZT83-2404	ZT83-2404	ZT83-2402
KX250	05	ZT83-2304	ZT83-2404	ZT83-2404	ZT83-2404	ZT83-2402
	06-08	ZT83-2354	ZT83-2404	ZT83-2404	ZT83-2404	ZT83-2402
KX250F	04-05	ZT83-2304	ZT83-2354	ZT83-2404	ZT83-2404	ZT83-2402
	06-18	ZT83-2354	ZT83-2404	ZT83-2454	ZT83-2404	ZT83-2402
KX450F	06-14	ZT83-2354	ZT83-2404	ZT83-2404	ZT83-2404	ZT83-2402
	15-18	ZT83-2354	ZT83-2404	ZT83-2454	ZT83-2404	ZT83-2402
D-TRACKER125	10-15	ZT83-2304	ZT83-2352	ZT83-2354	-	ZT84-2402
KLX125	10-16	ZT83-2304	ZT83-2352	ZT84-2352	-	ZT84-2402
KLX250/D-TRACKER	98-07	ZT83-2304	ZT83-2404	ZT84-2402	-	ZT83-2402
KLX250/D-TRACKER X	08-16	ZT83-2304	ZT83-2404	ZT84-2402	ZT83-2404	ZT83-2402
SUZUKI						
RM85/L	02-04	ZT83-2354	ZT83-2404	ZT83-2404	-	-
	05-12	ZT83-2354	ZT83-2404	ZT83-2404	-	ZT83-2302
RM125	01	ZT83-2404	ZT83-2404	ZT83-2404	ZT83-2404	ZT83-2402
	02-08	ZT83-2354	ZT83-2404	ZT83-2404	ZT83-2404	ZT83-2402
RM250	01-08	ZT83-2354	ZT83-2404	ZT83-2404	ZT83-2404	ZT83-2402
	04-06	ZT83-2304	ZT83-2354	ZT83-2404	ZT83-2404	ZT83-2402
RMZ250	07-15	ZT83-2354	ZT83-2404	ZT83-2404	ZT83-2404	ZT83-2402
	16-18	ZT83-2354	ZT83-2454	ZT83-2454	ZT83-2404	ZT83-2402
RMZ450	05-18	ZT83-2354	ZT83-2404	ZT83-2404	ZT83-2404	ZT83-2402
DRZ400S	00-17	ZT83-2354	ZT83-2504	ZT83-2454	ZT83-2354	ZT83-2402
DRZ400SM	05-06	ZT83-2354	ZT83-2404	ZT83-2404	ZT83-2404	ZT83-2402
	07-17	ZT83-2404	ZT83-2404	ZT83-2404	ZT83-2404	ZT83-2402

Bike	Year	Handle Bar Clamp Bolt	Upper Stem Fork Clamp	Under Stem Fork Clamp	Front Axle Pinch Bolt	Caliper Mount Bolt Kit
YAMAHA						
YZ85/LW	02-14	ZT83-2304	ZT83-2352	ZT83-2404	-	ZT83-2352
	15-18	ZT83-2304	ZT83-2402	ZT83-2404	-	ZT83-2352
	95-06	ZT83-2354	ZT83-2404	ZT83-2404	ZT83-2404	ZT83-2352
YZ125	07	ZT83-2404	ZT83-2404	ZT83-2404	ZT83-2404	ZT83-2352
	08-14	ZT83-2404	ZT83-2404	ZT83-2404	ZT83-2404	ZT83-2352
	15-18	ZT83-2404	ZT83-2404	ZT83-2354	ZT83-2354	ZT83-2352
	95-06	ZT83-2354	ZT83-2404	ZT83-2404	ZT83-2404	ZT83-2352
YZ250	07	ZT83-2404	ZT83-2404	ZT83-2404	ZT83-2404	ZT83-2352
	08-14	ZT83-2404	ZT83-2404	ZT83-2404	ZT83-2354	ZT83-2352
	15-18	ZT83-2404	ZT83-2404	ZT83-2354	ZT83-2354	ZT83-2352
	01-05	ZT83-2404	ZT83-2404	ZT83-2404	ZT83-2404	ZT83-2352
YZ250F	06	ZT83-2354	ZT83-2354	ZT83-2404	ZT83-2404	ZT83-2352
	07-18	ZT83-2354	ZT83-2354	ZT83-2354	ZT83-2354	ZT83-2352
YZ400F	98-99	ZT83-2354	ZT83-2404	ZT83-2404	ZT83-2404	ZT83-2352
YZ426F	00-02	ZT83-2354	ZT83-2404	ZT83-2404	ZT83-2404	ZT83-2352
	03-05	ZT83-2354	ZT83-2404	ZT83-2404	ZT83-2404	ZT83-2352
YZ450F	06	ZT83-2354	ZT83-2354	ZT83-2404	ZT83-2404	ZT83-2352
	07	ZT83-2354	ZT83-2354	ZT83-2354	ZT83-2404	ZT83-2352
	08-18	ZT83-2354	ZT83-2354	ZT83-2354	ZT83-2354	ZT83-2352
YZ125X	17-18	ZT83-2404	ZT83-2404	ZT83-2354	ZT83-2354	ZT83-2352
YZ250X	16-18	ZT83-2404	ZT83-2404	ZT83-2354	ZT83-2354	ZT83-2352
YZ250FX	15-18	ZT83-2354	ZT83-2354	ZT83-2354	ZT83-2354	ZT83-2352
YZ450FX	16-18	ZT83-2354	ZT83-2354	ZT83-2354	ZT83-2354	ZT83-2352
	01-06	ZT83-2354	ZT83-2404	ZT83-2404	ZT83-2404	ZT83-2352
WR250F	07-14	ZT83-2354	ZT83-2354	ZT83-2404	ZT83-2404	ZT83-2352
	15-18	ZT83-2354	ZT83-2354	ZT83-2354	ZT83-2404	ZT83-2352
WR400F	98-00	ZT83-2354	ZT83-2404	ZT83-2404	ZT83-2404	ZT83-2352
WR426F	01-02	ZT83-2354	ZT83-2404	ZT83-2404	ZT83-2404	ZT83-2352
	03-06	ZT83-2354	ZT83-2404	ZT83-2404	ZT83-2404	ZT83-2352
WR450F	07-15	ZT83-2354	ZT83-2354	ZT83-2404	ZT83-2404	ZT83-2352
	16-18	ZT83-2354	ZT83-2354	ZT83-2354	ZT83-2404	ZT83-2352
SEROW250	05-17	ZT87-1304	ZT83-2404	ZT83-2354	-	ZT84-2302
WR250R/X	07-17	ZT83-2354	ZT83-2404	ZT83-2404	ZT83-2404	ZT83-2352

TITANIUM





Bike	Year	Part #
CR80R/R II	96-02	ZT34-2504N
CR85R/R II	03-07	ZT34-2504N
CR125R/250R	92-07	ZT34-2506N
CRF150R/ II	07-18	ZT34-2504N
CRF250R	04-17	ZT34-2506N
CRF450R	02-18	ZT34-2506N
CRF450RX	17-18	ZT34-2506N
CRF250X	04-17	ZT34-2506N
CRF450X	05-17	ZT34-2506N
CRF50F	04-14	ZT34-2504N
CRF70F/80F/100F	04-12	ZT34-2504N
CRF125F	14-15	ZT34-2504N
CRF150F/230F	03-11	ZT34-2506N
CRM50/80	94-98	ZT34-2504N
CRM250AR	97-98	ZT34-2506N
TLM220R	90-93	ZT34-2504N
XR50R	00-03	ZT34-2504N
XR70R	97-03	ZT34-2504N
XR80R	85-03	ZT34-2504N
XR100R	90-03	ZT34-2504N
XR250R	96-04	ZT34-2506N
XR400R	96-06	ZT34-2506N
XR650R	00-07	ZT34-2506N
SL230	97-04	ZT34-2506N
XR230	05-13	ZT34-2506N
XR250	95-07	ZT34-2506N
XR250 BAJA	95-04	ZT34-2506N
XR230 MOTARD	08-13	ZT34-2506N
XR250 MOTARD	03-07	ZT34-2506N
YZ80/LW	93-01	ZT34-2504N
YZ85/LW	02-18	ZT34-2504N
YZ125/250	90-18	ZT34-2506N
YZ250F	01-18	ZT34-2506N
YZ400F	98-99	ZT34-2506N
YZ426F	00-02	ZT34-2506N
YZ450F	03-18	ZT34-2506N
YZ125X	17-18	ZT34-2506N
YZ250X	16-18	ZT34-2506N
YZ250FX	15-18	ZT34-2506N
YZ450FX	16-18	ZT34-2506N
WR250F	01-18	ZT34-2506N
WR400F	98-00	ZT34-2506N
WR426F	01-02	ZT34-2506N
WR450F	03-18	ZT34-2506N
WR250R/X	07-17	ZT34-2706N

Bike	Year	Part #
KX125/250	89-08	ZT34-2506N
KX250F	04-18	ZT34-2506N
KX450F	06-18	ZT34-2506N
KLX450R	08-15	ZT34-2506N
KDX125SR	90-99	ZT34-2506N
KDX200SR	90-93	ZT34-2506N
KDX220SR	94-99	ZT34-2506N
KDX250SR	91-94	ZT34-2506N
KDX220R	94-05	ZT34-2506N
KDX250R	91-95	ZT34-2506N
KLX250/D-TRACKER	98-07	ZT34-2506N
KLX250/D-TRACKER X	08-16	ZT34-2506N
KLX250ES	94-97	ZT34-2506N
KLX250SR	93-97	ZT34-2506N
KLX300R	96-07	ZT34-2506N
KLX650R	93-96	ZT34-2506N
RM80	94-01	ZT34-2504N
RM85/L	02-12	ZT34-2504N
RM125/250	90-08	ZT34-2506N
RMZ250	07-18	ZT34-2506N
RMZ450	05-18	ZT34-2506N
RMX450Z	10-14	ZT34-2506N
RMX250R	96-98	ZT34-2506N
RMX250S	96-98	ZT34-2506N
RH250	84-88	ZT34-2506N
DR125/L	03-09	ZT34-2504N
DR2400	00-04	ZT34-2506N
DRZ400E/E	00-17	ZT34-2506N
DRZ400SM	05-17	ZT34-2506N
DR250S	90-94	ZT34-2506N
DR350S	90-93	ZT34-2506N
DR650SE	96-00	ZT34-2506N
DR800S	91-96	ZT34-2506N
85SX	03-18	ZT34-2504N
125SX	01-18	ZT34-2506N
150SX	09-18	ZT34-2506N
250SX	01-18	ZT34-2506N
250SX-F	05-18	ZT34-2506N
350SX-F	11-18	ZT34-2506N
450SX-F	07-18	ZT34-2506N
450SX-R	03-06	ZT34-2506N
125XC	03-14	ZT34-2506N
200XC	00-16	ZT34-2506N
250/300EXC	00-17	ZT34-2506N
250XC-R	01-06	ZT34-2506N
250XC-F	07-18	ZT34-2506N
350XC-F	12-18	ZT34-2506N
400XC-R	00-05	ZT34-2506N
450XC-R	03-08	ZT34-2506N
525XC-R	03-07	ZT34-2506N
400XC	09-11	ZT34-2506N
450XC/F	09-18	ZT34-2506N
500XC/F	12-18	ZT34-2506N
530XC	09-11	ZT34-2506N
150XC	12-18	ZT34-2506N
300XC-W	12-18	ZT34-2506N
FREERIDE 250R	14-17	ZT34-2504N
FREERIDE 350	12-17	ZT34-2504N
450SMR	05-14	ZT34-2506N
690ENDURO/R,SMC/R	08-14	ZT34-2506N



ZETA SPROCKET BOLT & NUT SET

- Titanium sprocket bolt and nut set, lighter than OEM sprocket bolts and nuts.
- Rust and stain resistant due to passive film on titanium material.
- Sprocket bolt set and bolt & nut set available.

Part #	qty	Bolt Type	Description
ZT11-0825	1	COUNTER SUNK	Sprocket Bolt
ZT34-2504N	4	COUNTER SUNK	Sprocket Bolt & Nut
ZT34-2506N	6	COUNTER SUNK	Sprocket Bolt & Nut
ZT11-1828	1	PAN HEAD	Sprocket Bolt
ZT34-2706N	6	PAN HEAD	Sprocket Bolt & Nut

COUNTER SUNK Dimensions ZT11-0825

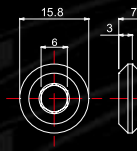

PAN HEAD Dimensions ZT11-1828

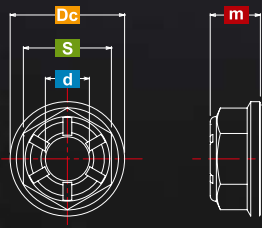
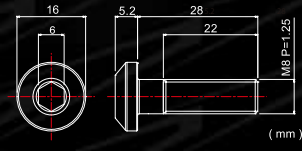

Part #	d	S	Dc	m	qty
ZT35-0806	M8 P=1.25	12	16	7.6	6
ZT35-1005	M10 P=1.25	14	19	9.6	5
ZT35-1006	M10 P=1.25	14	19	9.6	6
ZT35-1205	M12 P=1.25	17	23	11.6	5



ZETA SPROCKET NUT SET

- Titanium sprocket flange lock nut set.
- One size smaller size nut head for reduced weight.
- Lighter than OEM sprocket nuts,
- Nut sizes available : M8, M10 and M12, comes in 5 pc or 6 pc sets.



ZETA WHEEL NUT SET for NINJA H2 / R

- 64 Lightweight, high-strength wheel nut made of titanium.
- 17 g for stock 31 g, and 70 g lighter than a bike. Reduction in unsprung weight improves turnability, acceleration, deceleration, braking performance and fuel economy.
- It includes Titanium washer

Part #	Size	Kit
ZT39-1315	M12 P=1.25	5 pcs

Flange Bolt

Countersunk

Thin Head

Pan Head

Flat Head

ZETA

BRAKE DISC BOLT

- Titanium brake disc bolts kit.
- Different bolt head design from OE bolts for better workability.
- Available as a kit for specific models.
- Available for sport bikes and off road bikes applications.

Flange Bolt

Countersunk

Thin Head

Pan Head

Flat Head

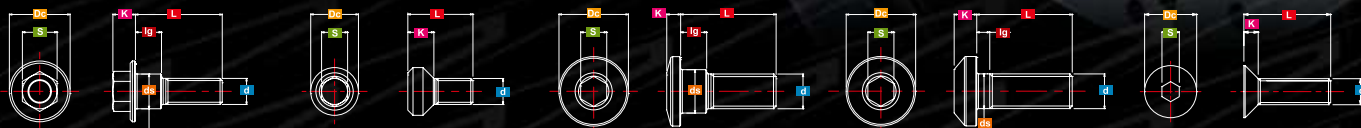

Type	Part #	d	S	Dc	K	ds	lg	L	qty
Thin Head 8 mm-M6×15	ZT10-3141	M6 P=1.0	5	14	3	8	23	15	1
	ZT31-3144	M6 P=1.0	5	14	3	8	23	15	4
	ZT31-3146	M6 P=1.0	5	14	3	8	23	15	6
Thin Head 9 mm-M6×14	ZT10-3421	M6 P=1.0	5	13	2.8	9	2.5	14	1
	ZT31-3424	M6 P=1.0	5	13	2.8	9	2.5	14	4
	ZT31-3426	M6 P=1.0	5	13	2.8	9	2.5	14	6
Thin Head 10 mm-M8×14.5	ZT10-3721	M8 P=1.25	6	14.8	3.2	10	2.5	14.5	1
	ZT31-3724	M8 P=1.25	6	14.8	3.2	10	2.5	14.5	4
	ZT31-3726	M8 P=1.25	6	14.8	3.2	10	2.5	14.5	6
Thin Head 10 mm-M8×20	ZT10-3741	M8 P=1.25	6	16	3.2	10	4.5	20	1
	ZT31-3743	M8 P=1.25	6	16	3.2	10	4.5	20	3
	ZT31-3744	M8 P=1.25	6	16	3.2	10	4.5	20	4
Thin Head 10 mm-M8×22	ZT31-3745	M8 P=1.25	6	16	3.2	10	4.5	20	5
	ZT31-3746	M8 P=1.25	6	16	3.2	10	4.5	20	6
	ZT10-3761	M8 P=1.25	6	16	3.2	10	6	22	1
Thin Head 10 mm-M8×28	ZT31-3763	M8 P=1.25	6	16	3.2	10	6	22	3
	ZT31-3764	M8 P=1.25	6	16	3.2	10	6	22	4
	ZT31-3765	M8 P=1.25	6	16	3.2	10	6	22	5
Pan Head 8 mm-M8×16	ZT31-3766	M8 P=1.25	6	16	3.2	10	6	22	6
	ZT10-3781	M8 P=1.25	6	16	3.2	10	9	28	1
	ZT31-3785	M8 P=1.25	6	16	3.2	10	9	28	5
Pan Head 8 mm-M8×22	ZT10-1621	M8 P=1.25	6	16	5.2	-	2	16	1
	ZT31-1626	M8 P=1.25	6	16	5.2	-	2	16	6
	ZT10-1651	M8 P=1.25	6	16	5.2	-	3	22	1
Flange Bolt 6 mm-M6×12.5	ZT31-1655	M8 P=1.25	6	16	5.2	-	3	22	5
	ZT31-1656	M8 P=1.25	6	16	5.2	-	3	22	6
	ZT10-0521	M6 P=1.0	8	14	5.3	-	2.5	12.5	1
Flange Bolt 6 mm-M6×13	ZT31-0526	M6 P=1.0	8	14	5.3	-	2.5	12.5	6
	ZT10-0231	M6 P=1.0	8	10.5	5.3	-	2	13	1
	ZT31-0234	M6 P=1.0	8	10.5	5.3	-	2	13	4
Flange Bolt 6 mm-M6×16	ZT31-0236	M6 P=1.0	8	10.5	5.3	-	2	13	6
	ZT10-0261	M6 P=1.0	8	10.5	5.3	-	2	16	1
	ZT31-0263	M6 P=1.0	8	10.5	5.3	-	2	16	3
Flange Bolt 6 mm-M6×16	ZT31-0264	M6 P=1.0	8	10.5	5.3	-	2	16	4
	ZT31-0265	M6 P=1.0	8	10.5	5.3	-	2	16	5
	ZT31-0266	M6 P=1.0	8	10.5	5.3	-	2	16	6
Flange Bolt 6 mm-M6×16	ZT03-0616	M6 P=1.0	8	11	5.3	-	2	16	1
	ZT31-5706	M6 P=1.0	8	11	5.3	-	2	16	6

Type	Part #	d	S	Dc	K	ds	lg	L	qty
Flange Bolt 6 mm-M6×17	ZT10-0551	M6 P=1.0	8	13	5.2	-	3	17	1
	ZT31-0554	M6 P=1.0	8	13	5.2	-	3	17	4
	ZT31-0555	M6 P=1.0	8	13	5.2	-	3	17	5
Flange Bolt 6 mm-M6×20	ZT31-0556	M6 P=1.0	8	13	5.2	-	3	17	6
	ZT03-0620	M6 P=1.0	8	11	5.3	-	2	20	1
	ZT31-5614	M6 P=1.0	8	11	5.3	-	2	20	4
Flange Bolt & Nut 6 mm-M6×20	ZT31-5616	M6 P=1.0	8	11	5.3	-	2	20	6
	ZT31-5614N #	M6 P=1.0	8	11	5.3	-	2	20	4
	ZT31-5616N #	M6 P=1.0	8	11	5.3	-	2	20	6
Flange Bolt 8 mm-M8×20	ZT03-0820	M8 P=1.25	10	14	6.8	-	2.5	20	1
	ZT31-4824	M8 P=1.25	10	14	6.8	-	2.5	20	4
	ZT31-4826	M8 P=1.25	10	14	6.8	-	2.5	20	6
Flange Bolt 8 mm-M6×20	ZT10-0781	M6 P=1.0	8	14	5.2	8	6	20	1
	ZT31-0785	M6 P=1.0	8	14	5.2	8	6	20	5
	ZT31-0786	M6 P=1.0	8	14	5.2	8	6	20	6
Flange Bolt 8 mm-M8×20	ZT10-0801	M8 P=1.25	10	13.7	6.5	-	3	20	1
	ZT31-3825	M8 P=1.25	10	13.7	6.5	-	3	20	5
	ZT31-3826	M8 P=1.25	10	13.7	6.5	-	3	20	6
Flange Bolt 10 mm-M8×22	ZT10-0822	M8 P=1.25	10	15.8	5.8	10	6	22	1
	ZT31-0814	M8 P=1.25	10	15.8	5.8	10	6	22	4
	ZT31-0815	M8 P=1.25	10	15.8	5.8	10	6	22	5
Flange Bolt 10 mm-M8×28	ZT31-0816	M8 P=1.25	10	15.8	5.8	10	6	22	6
	ZT10-0828	M8 P=1.25	10	15.8	5.8	10	9	28	1
	ZT31-0835	M8 P=1.25	10	15.8	5.8	10	9	28	5
Counter Sunk M6×14	ZT10-2631	M6 P=1.0	6	11	5	-	-	14	1
	ZT31-2634	M6 P=1.0	6	11	5	-	-	14	4
	ZT31-2636	M6 P=1.0	6	11	5	-	-	14	6
Counter Sunk M6×18	ZT10-2651	M6 P=1.0	6	11	6	-	-	18	1
	ZT31-2653	M6 P=1.0	6	11	6	-	-	18	3
	ZT31-2654	M6 P=1.0	6	11	6	-	-	18	4
Flat Head M6×12	ZT31-2656	M6 P=1.0	6	11	6	-	-	18	6
	ZT09-6121	M6 P=1.0	4	12	3.3	-	-	12	1
	ZT31-6124	M6 P=1.0	4	12	3.3	-	-	12	4
Flat Head M6×16	ZT09-6161	M6 P=1.0	4	12	3.3	-	-	16	1
	ZT31-6163	M6 P=1.0	4	12	3.3	-	-	16	3
	ZT31-6166	M6 P=1.0	4	12	3.3	-	-	16	6
Flat Head M6×20	ZT09-6201	M6 P=1.0	4	12	3.3	-	-	20	1
	ZT31-6203	M6 P=1.0	4	12	3.3	-	-	20	3

With nut

STREET DISC BOLT SET

TITANIUM



Bike	Year	Front			Rear		
		Size	qty	Part #	Size	qty	Part #
HONDA							
CB1300SF / BOLD'OL	05-13	Flange Bolt 6 mm-M6x17	6	ZT31-0556	Thin Head 10 mm-M8x22	6	ZT31-3766
	14-17	Flange Bolt 6 mm-M6x17	5	ZT31-0555	Thin Head 10 mm-M8x22	6	ZT31-3766
X-4	97-03	Flange Bolt 6 mm-M6x17	6	ZT31-0556	Thin Head 10 mm-M8x22	6	ZT31-3766
VFR1200F	10-17	Flange Bolt 6 mm-M6x17	6	ZT31-0556	Thin Head 10 mm-M8x22	5	ZT31-3745
CB1100	10-17	Flange Bolt 6 mm-M6x17	5	ZT31-0555	Thin Head 10 mm-M8x22	5	ZT31-3765
CBR1100XX	97-06	Flange Bolt 6 mm-M6x17	6	ZT31-0556	Thin Head 10 mm-M8x22	6	ZT31-3766
CBR1000RR	04-16	Flange Bolt 6 mm-M6x17	6	ZT31-0556	Thin Head 10 mm-M8x22	4	ZT31-3764
	17	Flange Bolt 6 mm-M6x17	5	ZT31-0555	Thin Head 10 mm-M8x22	4	ZT31-3764
CRF1000L AFRICA TWIN	17	Flange Bolt 6 mm-M6x17	6	ZT31-0556	Thin Head 10 mm-M8x22	4	ZT31-3764
VTR1000F	97-06	Flange Bolt 6 mm-M6x17	6	ZT31-0556	Thin Head 10 mm-M8x22	4	ZT31-3764
CBR954RR	02-03	Flange Bolt 6 mm-M6x17	6	ZT31-0556	Thin Head 10 mm-M8x22	4	ZT31-3764
CBR929RR	00-01	Flange Bolt 6 mm-M6x17	6	ZT31-0556	Thin Head 10 mm-M8x22	4	ZT31-3764
CB900F HORNET	02-07	Flange Bolt 6 mm-M6x17	6	ZT31-0556	Thin Head 10 mm-M8x22	4	ZT31-3764
NC750S/X	14-17	Thin Head 10 mm-M8x22	5	ZT31-3765	Thin Head 10 mm-M8x22	5	ZT31-3765
NC700S/X	12-17	Thin Head 10 mm-M8x22	5	ZT31-3765	Thin Head 10 mm-M8x22	5	ZT31-3765
CBR600RR	03-17	Flange Bolt 6 mm-M6x17	6	ZT31-0556	Thin Head 10 mm-M8x22	4	ZT31-3764
CBR250RR	17	Flange Bolt 8 mm-M8x20	6	ZT31-4826	Thin Head 10 mm-M8x22	4	ZT31-3764
YAMAHA							
XJR1300	98-02	Pan Head 8 mm-M8x22	6	ZT31-1656	Pan Head 8 mm-M8x22	6	ZT31-1656
	03-15	Flange Bolt 8 mm-M6x20	6	ZT31-0786	Pan Head 8 mm-M8x22	6	ZT31-1656
XJR1200	96-97	Pan Head 8 mm-M8x22	6	ZT31-1656	Pan Head 8 mm-M8x22	6	ZT31-1656
FZ1-S FAZER	08-14	Flange Bolt 8 mm-M6x20	5	ZT31-0785	Thin Head 10 mm-M8x20	5	ZT31-3745
FZ1-N	08-12	Flange Bolt 8 mm-M6x20	5	ZT31-0785	Thin Head 10 mm-M8x20	5	ZT31-3745
MT-10	17	Flange Bolt 8 mm-M6x20	5	ZT31-0785	Thin Head 10 mm-M8x20	5	ZT31-3745
YZF-R1	04-14	Flange Bolt 8 mm-M6x20	5	ZT31-0785	Thin Head 10 mm-M8x20	5	ZT31-3745
YZF-R1/M	15-17	Flange Bolt 8 mm-M6x20	5	ZT31-0785	Thin Head 10 mm-M8x20	5	ZT31-3745
TDM900	02-12	Flange Bolt 8 mm-M6x20	6	ZT31-0786	Pan Head 8 mm-M8x22	6	ZT31-1656
MT-09	15-17	Flange Bolt 8 mm-M6x20	5	ZT31-0785	Thin Head 10 mm-M8x20	5	ZT31-3745
FZ8/FAZER8	11-17	Flange Bolt 8 mm-M6x20	5	ZT31-0785	Pan Head 8 mm-M8x22	5	ZT31-1655
MT-07	15-17	Flange Bolt 8 mm-M6x20	5	ZT31-0785	Thin Head 10 mm-M8x20	5	ZT31-3745
YZF-R6	03-04	Flange Bolt 8 mm-M6x20	6	ZT31-0786	Thin Head 10 mm-M8x20	5	ZT31-3745
	06-17	Flange Bolt 8 mm-M6x20	5	ZT31-0785	Thin Head 10 mm-M8x20	5	ZT31-3745
XJ6 DIVERSION F	09-16	Flange Bolt 8 mm-M6x20	6	ZT31-0786	Pan Head 8 mm-M8x22	5	ZT31-1655
XJ6	09-16	Flange Bolt 8 mm-M6x20	6	ZT31-0786	Pan Head 8 mm-M8x22	5	ZT31-1655
YZF-R25/R3	15-17	Pan Head 8 mm-M8x22	5	ZT31-1655	Pan Head 8 mm-M8x22	3	ZT31-1653
KAWASAKI							
1400GTR	08-16	Thin Head 10 mm-M8x22	5	ZT31-3765	Thin Head 10 mm-M8x22	4	ZT31-3764
ZZR1400	06-17	Thin Head 10 mm-M8x22	5	ZT31-3765	Thin Head 10 mm-M8x22	4	ZT31-3764
		Flange Bolt 10 mm-M8x22	5	ZT31-0815			
ZZR1200	02-05	Thin Head 10 mm-M8x22	5	ZT31-3765	Thin Head 10 mm-M8x22	5	ZT31-3765
ZX-12R	00-06	Thin Head 10 mm-M8x22	5	ZT31-3765	Thin Head 10 mm-M8x22	4	ZT31-3764
ZRX1200 DAEG	09-16	Thin Head 10 mm-M8x22	5	ZT31-3765	Thin Head 10 mm-M8x22	4	ZT31-3764
ZRX1200	01-07	Thin Head 10 mm-M8x22	5	ZT31-3765	Thin Head 10 mm-M8x22	5	ZT31-3765
ZRX1100	96-00	Thin Head 10 mm-M8x22	5	ZT31-3765	Thin Head 10 mm-M8x22	5	ZT31-3765
ZZR1100D	93-00	Thin Head 10 mm-M8x22	5	ZT31-3765	Thin Head 10 mm-M8x22	4	ZT31-3764
ZEPHYR1100	92-06	Thin Head 10 mm-M8x22	5	ZT31-3765	Thin Head 10 mm-M8x22	6	ZT31-3766
ZX-10R	04-17	Thin Head 10 mm-M8x22	5	ZT31-3765	Thin Head 10 mm-M8x22	4	ZT31-3764
		Thin Head 10 mm-M8x22	5	ZT31-3765			
NINJA1000	11-17	Flange Bolt 10 mm-M8x22	5	ZT31-0815	Thin Head 10 mm-M8x22	4	ZT31-3764
		Thin Head 10 mm-M8x22	5	ZT31-3765			
Z1000	03-17	Flange Bolt 10 mm-M8x22	5	ZT31-0815	Thin Head 10 mm-M8x22	4	ZT31-3764
VERSYS1000	15-17	Thin Head 10 mm-M8x22	5	ZT31-3765	Thin Head 10 mm-M8x22	4	ZT31-3764
GPZ900R	93-99	Thin Head 10 mm-M8x22	5	ZT31-3765	Thin Head 10 mm-M8x22	6	ZT31-3766
NINJA250	13-17	Thin Head 10 mm-M8x22	5	ZT31-3765	Thin Head 10 mm-M8x22	3	ZT31-3763
SUZUKI							
GSX1400	01-06	Thin Head 10 mm-M8x28	5	ZT31-3785	Thin Head 10 mm-M8x28	5	ZT31-3785
		Flange Bolt 10 mm-M8x28	5	ZT31-0835			
	99-07	Thin Head 10 mm-M8x28	5	ZT31-3785	Thin Head 10 mm-M8x28	5	ZT31-3785
GSX1300R HAYABUSA		Flange Bolt 10 mm-M8x28	5	ZT31-0835			
	08-17	Thin Head 10 mm-M8x22	5	ZT31-3765	Thin Head 10 mm-M8x22	6	ZT31-3766
		Flange Bolt 10 mm-M8x22	5	ZT31-0815			
GSX1300 B-KING	08	Thin Head 10 mm-M8x22	5	ZT31-3765	Thin Head 10 mm-M8x22	6	ZT31-3766
BANDIT1250I/F/S	07-16	Thin Head 10 mm-M8x22	5	ZT31-3765	Thin Head 10 mm-M8x22	5	ZT31-3765
		Flange Bolt 10 mm-M8x22	5	ZT31-0815			
V-STROM1000/XT ABS	17	Thin Head 10 mm-M8x22	5	ZT31-3765	Thin Head 10 mm-M8x22	4	ZT31-3764
GSX-S1000F/ABS	15-17	Flange Bolt 8 mm-M6x20	6	ZT31-0786	Thin Head 10 mm-M8x22	5	ZT31-3765
GSX-S1000/ABS	15-17	Flange Bolt 8 mm-M6x20	6	ZT31-0786	Thin Head 10 mm-M8x22	5	ZT31-3765
	01-04	Thin Head 10 mm-M8x28	5	ZT31-3785	Thin Head 10 mm-M8x28	5	ZT31-3785
GSX-R1000	05-08	Thin Head 10 mm-M8x22	5	ZT31-3765	Thin Head 10 mm-M8x22	5	ZT31-3765
	09-17	Flange Bolt 8 mm-M6x20	6	ZT31-0786	Thin Head 10 mm-M8x22	5	ZT31-3765
	06-07	Thin Head 10 mm-M8x22	5	ZT31-3765	Thin Head 10 mm-M8x22	5	ZT31-3765
GSX-R750	08-17	Flange Bolt 8 mm-M6x20	6	ZT31-0786	Thin Head 10 mm-M8x22	5	ZT31-3765
	06-07	Thin Head 10 mm-M8x22	5	ZT31-3765	Thin Head 10 mm-M8x22	5	ZT31-3765
GSX-R600	08-17	Flange Bolt 8 mm-M6x20	6	ZT31-0786	Thin Head 10 mm-M8x22	5	ZT31-3765
GSX250R	17	Flange Bolt 8 mm-M6x20	6	ZT31-0786	Thin Head 10 mm-M8x22	5	ZT31-3765

Bike	Year	Front		
		Size	qty	Part #
DUKATI				
DIABLO/DARK/CARBON	11-17	Flange Bolt 8 mm-M8X20	5	ZT31-3825
1299 PANIGALE/S/R	15-17	Flange Bolt 8 mm-M8X20	5	ZT31-3825
1199 PANIGALE/S/R	12-15	Flange Bolt 8 mm-M8X20	5	ZT31-3825
959 PANIGALE	16-17	Flange Bolt 8 mm-M8X20	5	ZT31-3825
899 PANIGALE	14-15	Flange Bolt 8 mm-M8X20	5	ZT31-3825
SS 1000/DS	03-06	Flange Bolt 8 mm-M8X20	6	ZT31-3826
MONSTER 1200/S/R	14-17	Flange Bolt 8 mm-M8X20	5	ZT31-3825
MONSTER 821/DARK	15-17	Flange Bolt 8 mm-M8X20	5	ZT31-3825
MULTISTRADA 1200/S/PIKES	10-17	Flange Bolt 8 mm-M8X20	5	ZT31-3825
HYPERMOTARD/SP	13-15	Flange Bolt 8 mm-M8X20	5	ZT31-3825
HYPERMOTARD 939/SP	16-17	Flange Bolt 8 mm-M8X20	5	ZT31-3825
STREETFIGHTER 848/S	10-15	Flange Bolt 8 mm-M8X20	5	ZT31-3825
PAUL SMART 1000	06	Flange Bolt 8 mm-M8X20	6	ZT31-3826
GT 1000/TOURING	07-10	Flange Bolt 8 mm-M8X20	6	ZT31-3826
SPORT 1000/S	06-09	Flange Bolt 8 mm-M8X20	6	ZT31-3826
MV/AGUSTA				
F4/R/RR	12-16	Flange Bolt 8 mm-M8X20	5	ZT31-3825
F3 800/RC	15-16	Flange Bolt 8 mm-M8X20	5	ZT31-3825
F3 675	15-16	Flange Bolt 8 mm-M8X20	5	ZT31-3825
BRUTALE 1090 RR	13-16	Flange Bolt 8 mm-M8X20	5	ZT31-3825
DRAGSTAR 800/RR	15-16	Flange Bolt 8 mm-M8X20	5	ZT31-3825
BRUTALE 800/RR	13-16	Flange Bolt 8 mm-M8X20	5	ZT31-3825
BRUTALE 675	12-14	Flange Bolt 8 mm-M8X20	5	ZT31-3825
TURISMO VELOCE 800	15-16	Flange Bolt 8 mm-M8X20	5	ZT31-3825
RIVALE 800	13-16	Flange Bolt 8 mm-M8X20	5	ZT31-3825
STRADALE 800	15-16	Flange Bolt 8 mm-M8X20	5	ZT31-3825



Front DISC BOLT
Flange Bolt 10 mm - M8 x 22 **ZT31-0815**

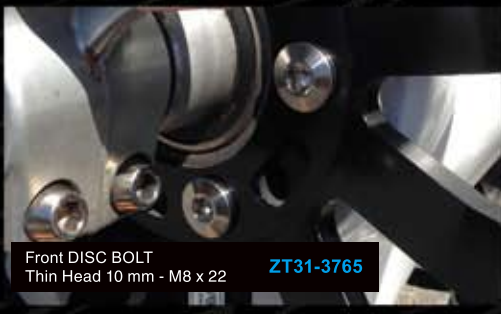

Front DISC BOLT
Thin Head 10 mm - M8 x 22 **ZT31-3765**

Front disc, quantity for one side